

# Proceedings: Seventeenth Annual Gulf of Mexico Information Transfer Meeting

December 1997

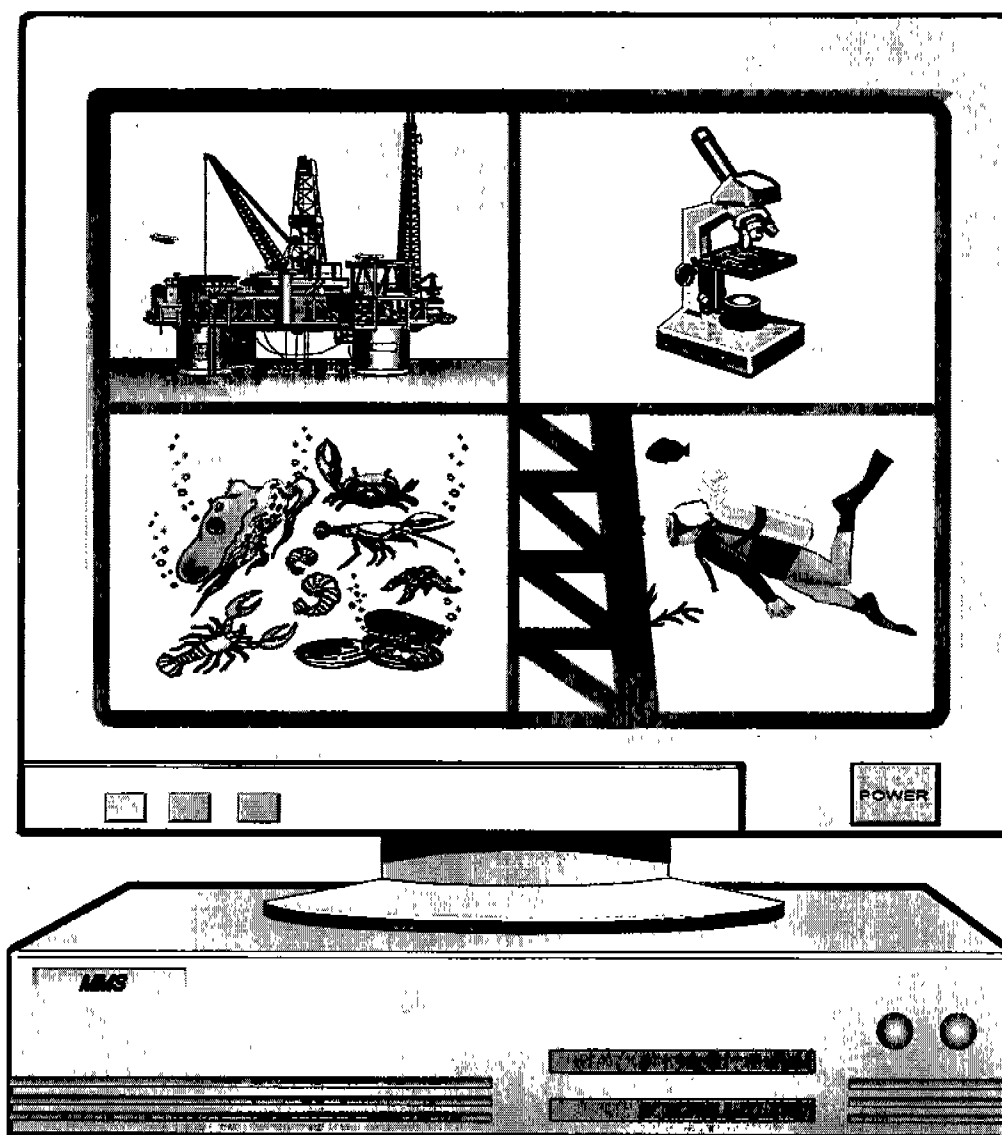

# **Proceedings: Seventeenth Annual Gulf of Mexico Information Transfer Meeting**

**December 1997**

Editors

**Melanie McKay**  
Copy Editor

**Judith Nides**  
Production Editor

Prepared under MMS Contract  
1435-0001-30665

by

University of New Orleans  
Office of Conferences Services  
New Orleans, Louisiana 70148

Published by

**U.S. Department of the Interior**  
Minerals Management Service  
Gulf of Mexico OCS Region

**New Orleans**  
**September 1999**



10

## **DISCLAIMER**

This report was prepared under contract between the Minerals Management Service (MMS) and the University of New Orleans, Office of Conference Services. This report has been technically reviewed by the MMS and approved for publication. Approval does not signify that contents necessarily reflect the views and policies of the Service, nor does mention of trade names or commercial products constitute endorsement or recommendation for use. It is, however, exempt from review and compliance with MMS editorial standards.

## **REPORT AVAILABILITY**

Extra copies of this report may be obtained from the Public Information Office (Mail Stop 5034) at the following address:

U.S. Department of the Interior  
Minerals Management Service  
Gulf of Mexico OCS Region  
Public Information Office (MS 5034)  
1201 Elmwood Park Boulevard  
New Orleans, Louisiana 70123-2394  
Telephone Numbers: (504) 736-2519  
1-800-200-GULF

## **CITATION**

This study should be cited as:

U.S. Department of the Interior, Minerals Management Service. 1999. Proceedings: seventeenth annual Gulf of Mexico information transfer meeting, December 1997. U.S. Dept. of the Interior, Minerals Management Service, Gulf of Mexico OCS Region, New Orleans, La. OCS Study MMS 99-0042. 710 pp.



## TABLE OF CONTENTS

	<u>Page</u>
LIST OF FIGURES .....	vii
LIST OF TABLES .....	xxi
ACKNOWLEDGMENTS .....	xxvii
INTRODUCTION .....	xxix
SESSION 1A: DEEPWATER OPERATIONS, PART I – Chair: Mr. G. Ed Richardson, Co-Chair: Mr. Jim Regg .....	1
SESSION 1B: NORTHEASTERN GULF OF MEXICO ENVIRONMENTAL STUDIES, PART I – Chair: Dr. Robert Rogers, Co-Chair: Mr. Robert Meyer .....	37
SESSION 1C: GEOGRAPHIC INFORMATION SYSTEM (GIS) APPLICATIONS – Chair: Dr. Norman Froomer, Co-Chair: Mr. Warren Barton .....	63
SESSION 1D: ATMOSPHERIC SCIENCES – Chair: Dr. William T. Hutzell, Co-Chair: Ms. Terry Scholten .....	93
SESSION 2A: DEEPWATER OPERATIONS, PART II – Chair: Mr. Jim Regg, Co-Chair: Mr. G. Ed Richardson .....	129
SESSION 2B: NORTHEASTERN GULF OF MEXICO ENVIRONMENTAL STUDIES PART II – Chair: Dr. Robert Rogers, Co-Chair: Mr. Gary Goeke .....	199
SESSION 2C: SOCIAL AND ECONOMIC STUDIES – Co-Chairs: Dr. Harry H. Luton and Dr. Joanna Endter-Wada .....	215
SESSION 1E: THE MMS SEA FLOOR MONITORING PROGRAM – Chair: Mr. Nick Wetzell, Co-Chair: Dr. Jack Irion .....	243
SESSION 1F: DE SOTO CANYON – Chair: Dr. Ann Scarborough Bull, Co-Chair: Dr. Tom McIlwain .....	275
SESSION 1G: U.S. - MEXICO NATURAL RESOURCES (WITH EMPHASIS ON LAGUNA MADRE) PART I – Co-Chairs: Mr. Howard Ness and Ms. Maria Pia Gallina .....	313

**TABLE OF CONTENTS**  
(continued)

	<u>Page</u>
SESSION 2E: PLATFORM ECOLOGY – Chair: Dr. Ann Scarborough Bull, Co-Chair: Dr. Pasquale Roscigno .....	359
SESSION 2F: ENVIRONMENTAL AND SOCIOECONOMIC INFORMATION IN DEEP WATERS OF THE GULF OF MEXICO – Co-Chairs: Dr. Robert M. Avent and Dr. William Schroeder .....	411
SESSION 2G: U.S. - MEXICO NATURAL RESOURCES (WITH EMPHASIS ON LAGUNA MADRE) PART II – Co-Chairs: Mr. Howard Ness and Ms. Maria Pia Gallina .....	425
SESSION 1H: HISTORY AND STATUS OF THE MANTEO PROJECT – Co-Chairs: Mr. Hammond Eve and Ms. Kim Crawford .....	475
SESSION 1J: U.S. – MEXICO OFFSHORE ENERGY ISSUES – Chair: Ms. Marvene O’Rourke, Co-Chair: Dr. Alexis Lugo-Fernández .....	539
SESSION 1K: GULF OF MEXICO COASTAL AND MARINE ENVIRONMENTAL MONITORING, PART I – Chair: Dr. Richard Defenbaugh, Co-Chair: Mr. Joe Perryman .....	593
SESSION 2H: COASTAL MARINE INSTITUTE, FATE & EFFECTS STUDY: A MINI SYMPOSIUM – Co-Chairs: Dr. Robert Carney and Dr. Pasquale Roscigno .....	631
SESSION 2K: GULF OF MEXICO COASTAL AND MARINE ENVIRONMENTAL MONITORING, PART II – Chair: Dr. Richard Defenbaugh, Co-Chair: Dr. Robert Avent .....	661
INDEX TO AUTHORS .....	697
ATTENDEES .....	701

## LIST OF FIGURES

<u>No.</u>	<u>Page</u>
1A.1. Percentage of leases by sale and water depth in CGOM .....	4
1A.2. Percentage of leases by sale and water depth in WGOM .....	5
1A.3. Number of DWOP's received by year .....	9
1A.4. Central Gulf of Mexico leases by water depth .....	16
1A.5. Western Gulf of Mexico Sales .....	17
1A.6. Deepwater development systems .....	21
1B.1. Map of the region showing bathymetry, various features, and key locations .....	42
1B.2. Map of the northeastern Gulf of Mexico showing the boundaries of the study area and ecosystem core regions. Major physical exchange paths and forcing mechanisms are indicated schematically .....	46
1B.3. Labeled satellite image showing Loop Current, possible LC eddy separation, large boundary filament over slope and outer shelf offshore of the Big Bend Area .....	47
1B.4. Locations of final monitoring sites .....	51
1B.5. Map of mooring positions (solid dots) and standard hydrographic (CTD) stations (open squares) for the De Soto Canyon experiment .....	55
1B.6. Mean 40-HLP current velocities and standard deviation ellipses for (a) 30 m depth level, and (b) the 200 (solid) and 300 (dashed) m depth levels, for the indicated period .....	56
1B.7. Surface geostrophic velocities calculated from the hydrographic casts relative to 1000 dbar for (a) the 19 - 28 March and (b) 8 - 17 July surveys .....	57
1C.1. Estuarine distribution and relative abundance of juvenile red drum in North Carolina during the high salinity period .....	73
1C.2. Example HS Modeling Process for Eastern Oyster in Pensacola Bay, Florida .....	74
1D.1. Graph for well test 34.9 miles from land .....	98

**LIST OF FIGURES  
(continued)**

<u>No.</u>	<u>Page</u>
1D.2. OCD Main Menu .....	102
1D.3. Input Menu screen .....	102
1D.4. Model Domain screen. The user needs to specify two latitudes and two longitudes that define the model domain, and the grid resolution for the model domain .....	103
1D.5. Map Display of the shoreline geometry, sources (with an “S” prefix), and receptors (with an “R” prefix) .....	103
1D.6. Output Options screen, where output options are logically grouped .....	104
1D.7. PEAK screen for the ANALYSIS postprocessor .....	105
1D.8. Exceedance Map screen, where all predicted concentration values exceeding a user-specified value are displayed. The sources, labeled as S1, S2, etc., are also displayed .....	105
1D.9. Time series for two SO <sub>2</sub> events observed at Breton Island .....	110
1D.10. Time series for two NO <sub>2</sub> events observed at Breton Island .....	111
1D.11. Backward trajectories estimated for two high SO <sub>2</sub> events observed at Breton Island in November 1994 (top) and February 1995 (bottom). Circle indicates approximately 75-mile radius from Breton .....	112
1D.12. Backward trajectories estimated for two high NO <sub>2</sub> events observed at Breton Island in May 1995 (top) and October 1996 (bottom). Circle indicates approximately 75-mile radius from Breton .....	113
1D.13. NOAA Daily Weather Map Series for two high SO <sub>2</sub> events observed at Breton Island in November 1994 (top) and February 1995 (bottom). Image time is 0700 EST .....	114
1D.14. NOAA Daily Weather Map Series for two high NO <sub>2</sub> events observed at Breton Island in May 1995 (top) and October 1996 (bottom). Image time is 0700 EST .....	115

**LIST OF FIGURES  
(continued)**

<u>No.</u>	<u>Page</u>
1D.15. Nested 108/36/12/4 Km MM5 Meteorological Modeling Domain used with the 6-11 September 1993 and 15-19 August 1993 GMAQS episodes to optimize the placement of meteorological sensors for the Breton Aerometric Monitoring Program . . . . .	121
1D.16. Surface MM5 wind predictions and observations (bold vectors) on the 36 Km grid on 18 August 1993 at 1900 EST . . . . .	122
1D.17. Surface MM5 wind predictions and observations (bold vectors) on the 12 Km grid on 18 August 1993 at 1900 EST . . . . .	123
2A.1. The seismic industry will continue to increase the amount of in-sea equipment for the acquisition of 3D seismic surveys . . . . .	131
2A.2. The multi-3D concept configuration . . . . .	132
2A.3. The marine vibrator . . . . .	132
2A.4. The vibrator has greater stability and repeatability than the airgun . . . . .	133
2A.5. Water and oil movement at three different times in the life of the reservoir . . . . .	133
2A.6. 3D time-lapse monitoring illustrated through the use of synthetic data . . . . .	134
2A.7. North Sea 3D seismic surveys . . . . .	134
2A.8. Vertical and seafloor cables provide true 3D seismic data . . . . .	136
2A.9. Data comparison indicating the improved resolution and greater continuity in events delivered by the seabed cable systems . . . . .	137
2A.10. An example of imaging beneath gas using S-wave energy . . . . .	139
2A.11. Refraction of one type of wave due to the roughness of the salt surface will create uneven illumination of reflectors beneath the salt . . . . .	140
2A.12. A 4 -component seismic seabed cable . . . . .	140
2A.13. An illustration of how a 4-component seismic operation might be laid out . . . . .	141



**LIST OF FIGURES**  
**(continued)**

<u>No.</u>	<u>Page</u>
2A.14. Current costs of seabed cable surveys . . . . .	141
2A.15. ADS Capabilities . . . . .	144
2A.16. Umbilical Termination Assembly (UTA) during installation . . . . .	145
2A.17. Subsea template . . . . .	146
2A.18. Integration testing . . . . .	147
2A.19. Hydra AT . . . . .	148
2A.20. Magellan 725 . . . . .	149
2A.21. Auger Triton . . . . .	150
2A.22. Scorpio 5000 . . . . .	151
2A.23. Deepwater development options: dry trees . . . . .	165
2A.24. Deepwater development options: subsea trees . . . . .	166
2A.25. Progression of deepwater developments . . . . .	167
2A.26. Deepwater developments distribution by development type (1982-2000) . . . . .	168
2A.27. Deepwater development regional distribution (1982-2000) . . . . .	169
2A.28. Key field development selection drivers . . . . .	170
2A.29. Why deepwater field development are attractive . . . . .	171
2A.30. Deepwater development selection . . . . .	172
2A.31. Semisubmersible FPS features . . . . .	173
2A.32. Semisubmersible FPS applications: production hub or local host facility . . . . .	174

**LIST OF FIGURES**  
**(continued)**

<u>No.</u>	<u>Page</u>
2A.33. Semisubmersible FPS applications: drilling and production hub or local host facility .....	175
2A.34. Innovative purpose built production semisubmersible .....	176
2A.35. Deepwater semisubmersible FPS issues. ....	177
2A.36. New semisubmersible FPS concepts. ....	178
2A.37. Monohull FPS features .....	179
2A.38. Monohull FPS applications .....	180
2A.39. Monohull FPS leading issues .....	181
2A.40. New monohull FPS leading issues .....	182
2A.41. New monohull FPS concepts .....	183
2A.42. The location of the Chevron Genesis Spar Project .....	185
2A.43. Profiles of the Spar Platform .....	186
2A.44. Illustrations of the SeaHorse, SeaStar and Morpeth SeaStar platforms .....	189
2A.45. The Morpeth SeaStar, below the surface view .....	190
2A.46. Morpeth Field Development .....	191
2A.47. Morpeth Hull – Tier 1 Segment .....	192
2A.48. Morpeth SeaStar, above and below the surface view .....	193
2A.49. Hook radius vs. lifting capacity and hook radius vs. hook height .....	194
2A.50. Morpeth / GI 115 field layout .....	195
2A.51. Morpeth Corridor Project Status Review –Nov. 1997 .....	196

**LIST OF FIGURES**  
**(continued)**

<u>No.</u>	<u>Page</u>
2B.1. Areas of 1996 Wetland Habitat Mapping Update .....	206
1E.1. Side-scan image of a historic steamship off Horn Island, Mississippi .....	250
1E.2. Images of pinnacles and the “smoking gun” anchor scar found at Main Pass 224 .....	255
1E.3. Seismic response of Sonnier Bank salt dome .....	257
1E.4. Three-dimensional view of Sonnier Bank. The central part of the dome was heavily eroded during periods of subaerial exposure. The area shown is three miles wide and three miles long .....	258
1E.5. Low energy seismic outline of Sonnier Bank. Note change in scale from previous illustrations .....	259
1E.6. Exposed rock beds at Sonnier Bank. These beds were deposited horizontally and subsequently displaced to a vertical position by the action of the rising salt dome. The beds range from less than one inch to several inches in thickness ....	260
1F.1. Location of study area in the northeastern Gulf of Mexico .....	287
1F.2. USGS Pinnacles project study area and sampling stations during Cruise FCSC-9701, August 1997 .....	288
1F.3. SEAMAP Spring Survey plankton sampling sites in the vicinity of the DeSotoCanyon (April and May 1986-1993) .....	293
1F.4. SEAMAP Fall Survey plankton sampling sites in the vicinity of the DeSoto Canyon (September 1986-1994) .....	294
1F.5. Temporal distribution of spawning (light) and settlement (dark) of gag, <i>Mycteroperca microlepis</i> , for three regions arranged from north to south along the West Florida Shelf in 1995. The top hydrated ova expressed as percentage hydrated .....	301
1F.6. Tracks of satellite-tracked surface drifters near the gag spawning grounds (stippled area) on the West Florida Shelf during the 1996 spawning and settlement period. Surface drifter data courtesy of Dr. Tony Sturges, Florida State University, Tallahassee, Florida .....	302

**LIST OF FIGURES**  
**(continued)**

<u>No.</u>	<u>Page</u>
1G.1. The Kemp's ridley sea turtle ( <i>Lepidochelys kempi</i> , Garman, 1880). . . . .	327
1G.2. Kemp's ridley sea turtle nesting beach. . . . .	328
1G.3. A Kemp's ridley sea turtle nest. . . . .	329
1G.4. Abundance of the Kemp's ridley turtles, Rancho Nuevo Beach, Tamaulipas, Mexico . . . . .	330
1G.5. Total nesting of Kemp's ridley turtles in Rancho Nuevo, Tepehuajes and B. del Tordo, Tamaulipas, Mexico. . . . .	331
1G.6. Beach erosion in a Kemp's ridley sea turtle nesting area. . . . .	332
1G.7. A corral for recovered Kemp's ridley sea turtle eggs. . . . .	333
1G.8. Nesting abundance of Kemp's ridley turtle in north and south beaches of Rancho Nuevo, Tamaulipas, Mexico. . . . .	334
1G.9. Trend of nesting of Kemp's ridley turtle population, Rancho Nuevo Beach in Tamaulipas. . . . .	335
1G.10. Trend of nesting abundance of Kemp's ridley turtle, Rancho Nuevo, Tepehuajes and El Tordo, Tamaulipas. . . . .	336
1G.11. Number of non-headstarted sea turtles located stranded on offshore beaches along the Texas coast during each week from 1 January – 15 November 1997. . . . .	344
1G.12. Number of Kemp's ridley sea turtle nests and adult Kemp's ridleys located stranded on offshore beaches along the Texas coast during each week from 1 January – 15 November 1997. . . . .	345
2E.1. Locations of Green Canyon 18, Grand Isle 94B and South Timbalier 54G superimposed on an AVHRR satellite image of the Louisiana coast. Note the positions of the Mississippi River plume in relation to the three platforms. Aerial photos of each platform are not to the same scale . . . . .	362

**LIST OF FIGURES**  
**(continued)**

<u>No.</u>	<u>Page</u>
2E.2. Influence of lunar phase on catch-per-unit-effort (CPUE) of all taxa combined from off-rig and surface light traps (upper two panels), and for selected taxa from surface light trap samples collected at GI94B during May 1996. Lunar icons indicate the moon phase corresponding to each sample . . . . .	368
2E.3. Length frequency distributions of selected taxa collected from surface light trans and surface off-rig light traps . . . . .	369
2E.4. Schematic view of stationary hydroacoustic transducer deployment to measure horizontal relative density of fishes associated with petroleum platforms . . . . .	375
2E.5. Schematic view of stationary hydroacoustic transducer deployment to measure <i>in situ</i> target strength and density of fishes throughout the water column on each side of the platform for the three study sites . . . . .	376
2E.6. Mean relative horizontal fish density to a distance of 82 m from petroleum platforms Green Canyon 18 (GC18), Grand Isle 94 (GI 94) and South Timbalier 54 (ST 54) . . . . .	380
2E.7. Mean fish density by depth at petroleum platforms Grand Isle 94 (GI 94) and South Timablier 54 (ST 54) . . . . .	381
2E.8. Mean fish density by depth at the petroleum platform Green Canyon 18 (GC 18) . . . . .	382
2E.9. Seasonal mean stomach contents by habitat for <i>Paranthias furcifer</i> . . . . .	390
2E.10. Mean daily stomach conent (percentage by weight) by habitat for <i>Paranthias furcifer</i> . . . . .	391
E.11. Seasonal mean weight of stomach contents in grams by habitat for <i>Paranthias furcifer</i> . . . . .	392
2E.12. Final sampling design . . . . .	396
2E.13. Habitat suitability indices for trawlable ages . . . . .	405
2E.14. Habitat suitability indices for adult reef fish . . . . .	406

**LIST OF FIGURES**  
**(continued)**

<u>No.</u>	<u>Page</u>
2E.15. Red snapper platform removal assessment . . . . .	407
2G.1. Se proponen diferentes escenarios posibles del riesgo resultante de la mezcla de aguas de diferente integridad ecológica . . . . .	459
1H.1. Atlantic Area leases (24 in Mid Atlantic and 1 in South Atlantic) . . . . .	479
1H.2. Sale 56 leases within the Manteo Unit . . . . .	480
1H.3. Sale 78 leases within the Manteo Unit . . . . .	481
1H.5. Manteo Unit lease owners, bonus bid amount, and original effective dates . . . . .	484
1H.4. Atlantic Area owners of leases outside the Manteo Unit . . . . .	485
1H.6. Bathymetry of Cape Hatteras region. From Emery and Uchupi (1972) . . . . .	498
1H.7. Mean monthly data from Diamond Shoals Light Tower. Data from National Data Buoy Center . . . . .	500
1H.8. Surface temperatures image in the western North Atlantic showing location of Manteo site. The Gulf Stream shows as dark while cooler waters are lighter greys and cold shelf water is dark again. from NOAA Northeast Coastwatch Center . . . . .	502
1H.9. Surface temperature on December 3, 1997 in Cape Hatteras region. Directions of inferred currents indicated. Warm waters are light and cold waters are dark. from NOAA Northeast Coastwatch Center . . . . .	503
1H.10. Location of the study area off Cape Hatteras, North Carolina . . . . .	526
1H.11. Location of sampling stations on the continental slope off Cape Hatteras. Overlay onto the station locations is the predicted dispersion and deposition patterns (stippled area) from the Offshore Operators' Committee model (Brandsma 1990). The stippled area represents deposition of 67 to 75% of the simulated discharge of 4,000 barrels of drilling muds and cuttings (approximately what the drilling of the exploratory well will generate). The remainder of the material did not settle to the bottom within the model boundaries . . . . .	527

**LIST OF FIGURES**  
**(continued)**

<u>No.</u>	<u>Page</u>
1H.12. Density of total megafauna with depth at 10 locations on the eastern U.S. continental margin. Data for these locations were collected for studies described in Hecker <i>et al.</i> (1983), Hecker (1990), and Blake <i>et al.</i> (1985, 1987). Data from the present survey are shaded (Cape Hatteras 1992) .....	532
1H.13. Density of (a) the wolf eelpout <i>Lycenchelys verrilli</i> and (b) the anemone <i>Actinauge verrilli</i> with depth at 10 locations on the eastern U.S. continental margin. Data for these locations were collected for studies described in Hecker <i>et al.</i> (1983), Hecker (1990), and Blake <i>et al.</i> (1985, 1987). Data from the present survey are shaded (Cape Hatteras 1992) .....	533
1H.14. Density of (a) the witch flounder <i>Glyptocephalus cynoglossus</i> and (b) the foraminiferan <i>Bathysiphon filiformis</i> with depth at 10 locations on the eastern U.S. continental margin. Data for these locations were collected for studies described in Hecker <i>et al.</i> (1983), Hecker (1990), and Blake <i>et al.</i> (1985, 1987). Data from the present survey are shaded (Cape Hatteras 1992) .....	534
1J.1. Estimated Mexican federal funding for Science & Technology, 1997 .....	555
1J.2. Research & Development as percentage of GNP .....	556
1J.3. Financing by sectors, different countries .....	557
1J.4. Energy Science & Technology, 1996 .....	558
1J.5. Gulf of Mexico (GOM) deepwater leasehold .....	563
1J.6. Gulf of Mexico OCS deepwater lease activity .....	564
1J.7. Deepwater development milestones .....	565
1J.8. Deepwater discoveries .....	567
1J.9. Deepwater developments .....	568
1J.10. Deepwater GOM production .....	569
1J.11. Shell deepwater activity .....	570

**LIST OF FIGURES**  
**(continued)**

<u>No.</u>	<u>Page</u>
1J.12. Auger summary .....	571
1J.13. Mars on location .....	573
1J.14. Mars summary .....	574
1J.15. Ram/Powell .....	575
1J.16. Ram/Powell summary .....	576
1J.17. Forces changing in the future .....	577
1J.18. Lease Sale 166 central planning area .....	581
1J.19. Western Gulf of Mexico Lease Sale 168 tracts receiving bids .....	582
1J.20. Leasing activity in the Gulf from 1992-1997 .....	583
1J.21. MEXUS Plan participating agencies .....	587
1J.22. MEXUS planning concept .....	588
1J.23. Mexican Joint Response Team .....	589
1J.24. United States Joint Response Team .....	590
1K.1. Example of Relational database management system (RDBMS - Microsoft Access 7.0) form integrating monitoring information synthesized from survey on Health of Living Aquatic Resources and Existing Tools for Measurement: Interim Report .....	601
1K.2. Balance of ecosystem health, integrity, and productivity (after Dokken <i>et al.</i> 1997) .....	602
1K.3. The two regions of the coast of the state of Campeche .....	611
1K.4. Accretionary growth of corals, measured by averaging data from four separate cores of <i>Montastraea faveolata</i> at the East and West Flower Garden Banks (data from Gittings <i>et al.</i> 1992b and USDOI/MMS 1996) .....	626



**LIST OF FIGURES**  
**(continued)**

<u>No.</u>	<u>Page</u>
2H.1. Empire Canal Site. Sampling stations A through G were selected for initial sampling. Sampling stations 1 through 7 were selected for secondary sampling stations based on bottom water salinity stratification. Asterisks indicate stations selected for current monitoring . . . . .	637
2H.2. Manilla Village small, semi-enclosed bay site. Sampling stations are indicated by numbers . . . . .	639
2H.3. Lake Washington small bay site. Sampling stations established using the COT method are indicated by letter. Sampling stations established using the SST method are indicated by number . . . . .	640
2H.4. Immunodetection of polyclonal anti-trout CYP2K1 in <i>Aiptasia pallida</i> , <i>Bunodosoma cavernata</i> , <i>Anthopleura elegantissima</i> (from: CA & AK), <i>Anthopleura xanthogrammica</i> and <i>Condylactis gigantea</i> . . . . .	653
2H.5. Western blot of <i>A. elegantissima</i> cytosol probed with anti-HSP-70 IgG: Induction by 3-methylcholanthrene . . . . .	654
2H.6. Western blot analysis of <i>A. elegantissima</i> microsomes probed with polyclonal anti-trout CYP 1A1: effect of Cd and 3MC exposure . . . . .	654
2H.7. HPLC profile of benzo[a]pyrene metabolites from <i>Bunodosoma cavernata</i> microsomal-dependent MFO <i>in vitro</i> . . . . .	655
2H.8. AH profile comparison of a condensate oil, South Louisiana crude oil, a composite weathered creosote, and wood smoke . . . . .	658
2K.1. Pompano Phase I drilling and production platform is located in MMS lease block Viosca Knoll 989 and is connected by subsea pipeline to a bottom drilling template, Pompano Phase II, located in MMS lease block Mississippi Canyon 28 . . . . .	676
2K.2. Location where core samples and video transects (inset) were obtained around the Pompano Phase II subsea template, 10-11 July 1997. Sediment hydrocarbon samples were obtained at all sites. Sediment samples for infauna analysis were obtained only at sites C3-16 and C3-20 . . . . .	679
2K.3. Total volumes of Petrofree-LE discharged in conjunction with drilling of the Pompano Phase II site . . . . .	680

**LIST OF FIGURES**  
**(continued)**

<u>No.</u>	<u>Page</u>
2K.4. Petrofree-LE concentrations measured in bottom sediments around the Pompano Phase II subsea template 10-11 July 1997. Panels on left show concentrations in absolute scale; panels on right in logarithmic scale . . . . .	681
2K.5. Macrofaunal densities observed at eight MMS stations sampled during summer 1985 are compared to macrofaunal densities around the Pompano Phase II subsea template. Inset shows locations and depths of the MMS stations relative to Pompano Phase II . . . . .	682
2K.6. Estimated densities of demersal fish based upon photographic transects. Data from eight MMS stations sampled during summer 1985 are compared to those from the Pompano Phase II subsea template sampled during summer 1997. Inset shows locations and depths of the MMS stations relative to Pompano Phase II . . . . .	683
2K.7. Regional map of Gulf of Mexico showing sampling site locations (triangles) and mega-site regions for geophysical survey (shaded) . . . . .	687
2K.8. Cartoon of the chemosynthetic community formation in a sediment diffusion habitat. Gas and oil migrate along fault planes that penetrate reservoirs—oil platform drawn to scale (lower), then diffuse through unconsolidated sediments approaching the seafloor (middle left). Formation of gas hydrate, layers of biota, and authigenic carbonate entrap hydrocarbons in uppermost sediment (middle right), facilitating microbial degradation of hydrocarbons and subsequent reduction of seawater sulfate to sulfides needed for tube worm symbiosis (upper right). ( <i>Painting by Bruce Moser.</i> ) . . . . .	689
2K.9. Cartoon of the chemosynthetic community formation in a brine pooling habitat. Salt diapir pressurizes a shallow reservoir of methane—also known as a shallow gas hazard (left). Subsequent release of gas excavates a surface crater and diatrema (middle). High concentrations of methane are available to seep mussels around edges of brine pool formed by dissolution of salt—submersible drawn to scale (right). ( <i>Painting by Bruce Moser.</i> ) . . . . .	691



## LIST OF TABLES

<u>No.</u>	<u>Page</u>
1C.1. GWIS Gulf-wide Data (Geographic) .....	68
1C.2. GWIS Florida Data (Geographic) .....	68
1C.3. GWIS Alabama Data (Geographic) .....	69
1C.4. GWIS Mississippi (Geographic) .....	69
1C.5. GWIS Louisiana (UTM) .....	70
1C.6. GWIS Texas .....	70
1D.1. Results from OCD Modeling Runs .....	97
1D.2. Breton Island Annual Mean and Standard Deviation SO <sub>2</sub> and NO <sub>2</sub> Concentrations (ppb) October 1994 Through April 1997 .....	108
1D.3. SO <sub>2</sub> and NO <sub>2</sub> Maximums At Breton Island (ppb) .....	108
1D.4. Distribution of High SO <sub>2</sub> (> 5 ppb) and NO <sub>2</sub> (>22 ppb) Concentrations at Breton Island .....	109
1D.5. Candidate air quality models for the Breton Study: Formulation and references .....	118
1F.1. Reef fishes documented from Pinnacles area on the outer continental shelf off Alabama-Mississippi in August 1997; asterisk (*) indicates species only observed with ROV's. Family classification and phylogenetic sequence of presentation follows Nelson (1994) .....	290
1F.2. Relative abundance of fishes at reefs of varying topographic profile, recorded by ROV survey on the Alabama-Mississippi continental shelf in August 1997. Values were calculated by taking the total number of individuals per species divided by the total number of fishes recorded for a single reef site in each category .....	291
1F.3. Comparison of DeSoto Canyon area and Gulfwide ichthyoplankton collections taken during nine, SEAMAP Spring Surveys in April and May 1986-1993 .....	295
1F.4. Comparison of DeSoto Canyon area and Gulfwide ichthyoplankton collections taken during ten, SEAMAP Fall Surveys in September 1986-1994 .....	296

**LIST OF TABLES**  
**(continued)**

<u>No.</u>	<u>Page</u>
1F.5. Dominant taxa taken in collections from the DeSoto Canyon area during nine, SEAMAP Spring Surveys in April and May 1986-1993. Number in parenthesis represents value for Gulfwide collections .....	296
1F.6. Dominant taxa taken in collections from the DeSoto Canyon area during ten, SEAMAP Fall Surveys in September 1986-1994. Number in parenthesis represents value for Gulfwide collections .....	297
1F.7. Percent occurrence and mean abundance of tuna larvae (number under 10 m <sup>2</sup> ) in collections from the DeSoto Canyon area and Gulfwide during SEAMAP Spring and Fall Surveys .....	298
1F.8. Percent occurrence and mean abundance of dolphin and billfish larvae (number under 10 m <sup>2</sup> ) in collections from the DeSoto Canyon area and Gulfwide during SEAMAP Spring and Fall Surveys .....	298
1F.9. Percent occurrence and mean abundance of snapper larvae (number under 10 m <sup>2</sup> ) in collections from the DeSoto Canyon area and Gulfwide during SEAMAP and Fall Surveys .....	298
1G.1. General information on cooperative fishing production companies established at Laguna Madre .....	350
1G.2. Generalidades de las sociedades cooperativas de producción pesquera establecidas en la Laguna Madre .....	355
2E.1. Relative abundance (CPUE) of ichthyoplankton families collected from GC18, GI94B and ST54G during May and June using surface (S), bottom (B) and off-rig (O) light traps. The catch-per-unit-effort (CPUE) indicates the mean number of fish per 10 min set. Horizontal lines separate the four ecological groups (top to bottom): pelagic, reef, midwater, demersal .....	365
2E.2. Randomized block analysis of variance of horizontal fish densities at Grand Isle 94, Green Canyon 18 and South Timbalier 54 petroleum platforms .....	378
2E.3. Randomized block analysis of variance of vertical fish densities at Grand Isle 94, Green Canyon 18 and South Timbalier 54 petroleum platforms .....	379

**LIST OF TABLES**  
**(continued)**

<u>No.</u>	<u>Page</u>
2E.4. Species composition of fishes from visual point surveys and estimated number of fish at South Timbalier 54, Grand Isle 94 and Green Canyon 18 petroleum platforms .....	383
2E.5. Estimated fish mortality .....	397
2E.6. Red snapper tag-recovery study .....	398
2E.7. Red snapper population and mortality estimates .....	398
2E.8. GIS coverages and Oracle tables held by LGL .....	402
2E.9. Fish species accounts from Phase I and model species from Phase II. ....	403
2F.1. Pre- and Post Royalty Relief Leasing Activity (1994-1997). Blocks Receiving Bids, CGOM .....	416
2G.1. Volume of Fish Production in Tamaulipas per Catch of the Main Species (S.D.A.F. and P. General Fishing Management 1996) .....	430
2G.2. Main Aquatic Species Produced in Tamaulipas (SEMARNAP 1996) .....	430
2G.3. Breeding production in seafood farming centers in Tamaulipas 1996 (S.D.A.F. and P. General Fishing Management 1996) .....	431
2G.4. Levels of heavy metals detected in sediments of the San Andrés lagoon .....	435
2G.5. Volumen de la Producción pesquera por capturar de las principales especies en Tamaulipas (S.D.A.F. y P. Dir. General de Pesca 1996). ....	443
2G.6. Principales Especies Acuícolas Producidas en Tamaulipas. (SEMARNAP 1996) ....	444
2G.7. Producción de Crías en los Centros Acuícolas de Tamaulipas, 1996 (S.D.A.F.y P. Dirección General de Pesca 1996) .....	444
2G.8. Niveles de metales pesados detectados en sedimentos de la laguna de San Andrés, Vazquez (1990) .....	449
1H.1. Expiration dates for the four leases outside the Manteo Unit .....	482

**LIST OF TABLES**  
**(continued)**

<u>No.</u>	<u>Page</u>
1H.2. Components of the North Carolina Coastal Management Program for Reviewing OCS Activities .....	488
1H.3. Summary of data collected on the continental slope off Cape Hatteras, North Carolina, in the vicinity of Manteo 467 on R/V Endeavor cruise EN-241, 26 August to 6 September 1992 .....	528
1H.4. Summary of sedimentary characteristic on the continental off Cape Hatteras, North Carolina, in the vicinity of Manteo 467. Estimated sediment accumulation for Station SA-10 was an outlier, possibly related to a recent sedslopeiment disturbance, and is presented separately (as values in parentheses) .....	530
1H.5. Summary of benthic community characteristics on the continental slope off Cape Hatteras, North Carolina, in the vicinity of Manteo 467. Infaunal parameters are for 16 box core stations .....	531
1J.1. Western Gulf of Mexico sales comparison of blocks receiving bids before and after royalty relief .....	584
1K.1. Survey response, recommended indicators of "health of living aquatic resources." .....	599
1K.2. Responses to survey on Health of Living Aquatic Resources (LARS) and Existing Tools for Measurement .....	600
1K.3. Legal instruments consider for the coastal management in Mexico (Saavedra 1996; Zarate-Lomeli <i>et al.</i> , in press) .....	614
1K.4. The five categories of proposed regional monitoring programs .....	616
1K.5. Measurements of percent coral cover (all species combined; mean $\pm$ 95% confidence interval, if available) by various investigators working at the East and West Flower Garden Banks since 1972 .....	626
2H.1. Total target aromatic hydrocarbons from the produced water and sediments of stations located 300 meters from the point source discharge on COT and SST transects with their corresponding Fossil Fuel Pollution Index value .....	643
2H.2. Integrated Relationships of Biomarkers and Levels of Biological Organization .....	652

**LIST OF TABLES**  
**(continued)**

<u>No.</u>	<u>Page</u>
2K.1. Number of sightings (n) and mean group-size and water depth of species of cetaceans in the U.S. Gulf of Mexico sighted during spring 1996. The group-sizes and water depth distributions are typical of those found during the fall ship survey and, the summer and winter aerial survey. (False killer whales, rough-toothed dolphins, Fraser's dolphins and pygmy killer whales were sighted during aerial surveys or subsequent ship surveys.) . . . . .	673
2K.2. List of Principal Investigators and Scientific Review Board Members . . . . .	686





## ACKNOWLEDGMENTS

The Minerals Management Service wishes to express gratitude to the numerous individuals who assisted in putting this Information Transfer Meeting together. Historically, session topics cover issues that fall within the boundaries of the United States. There has been international participation of speakers in the past; however, this is the first meeting that dedicated entire sessions to international issues.

A special note of thanks must be given to Patricia Arteaga, University of New Orleans, Office of Conference Services. This meeting presented many challenges because of the sessions devoted to international issues. Patricia's bilingual talents, diligence, and professionalism were instrumental to the success of this meeting.

We are grateful to the chairs and co-chairs for the many hours spent in organizing and chairing the sessions and for spending time gathering presentation summaries. We also wish to thank all our speakers for their participation, and we wish to extend our sincere appreciation to our Mexican colleagues.

There were two special exhibits used for this meeting. A 3D exhibit featured 1998 as the Year of the Ocean, so declared by the United Nations. The Year of the Ocean provided an opportunity for governments, organizations, and individuals to raise public awareness of the role the ocean plays in our lives and to initiate changes needed to sustain the marine resources on which we depend. A.B. Wade, MMS Office of Communications, coordinated the development and availability of this inventive exhibit, which was popular among attendees. Her creative idea was a welcomed addition. The idea for the second exhibit was provided by Lee Tilton, Chief, Visuals Information Section, MMS Gulf of Mexico Region. A bilingual exhibit that highlighted cross-boundary issues presented during this meeting was developed. Additionally, a bilingual agenda was posted for attendees. This diplomatic endeavor was very much appreciated by our Mexican counterparts and Lee is to be commended for his ambassadorship.

The University of New Orleans, Office of Conference Services, was the contractor responsible for the meeting. The dedicated staff and subcontractors played an integral role in the execution of this meeting and the completion of this proceedings. Their tireless efforts are greatly appreciated.

The staff of the Hotel Inter-Continental were very personable and accommodating to our countless requests.



## INTRODUCTION

The primary purposes of the ITM are (1) to provide a forum for interchange on topics of current interest relative to environmental assessments in support of offshore oil and gas activities in the Gulf of Mexico OCS Region; (2) to present the accomplishments of the MMS Environmental Studies Program for the Gulf of Mexico and of other research programs or study projects; and (3) to foster an exchange of information of regional interest among scientists, staff members, and decision-makers from MMS, other Federal or State governmental agencies, regionally important industries, and academia and to encourage opportunities for these attendees to meet and nurture professional acquaintances and peer contacts.

The ITM agenda is planned and coordinated by the MMS staff of the Gulf of Mexico OCS Regional Office around the three themes mentioned above—issues of current interest to the Region or MMS oil and gas program; accomplishments of the agency; and regional information exchange. Presentations are by invitation through personal contacts between session chairpersons and speakers who have demonstrated knowledge or expertise on the subject.

The United States and Mexico have been working cooperatively on a wide range of issues. Increasing environmental and socioeconomic pressures will generate a need for closer and broader cooperation. Common interests promote friendly national and economic ties between our two countries, and help to preserve, and enhance our environment. This ITM incorporated sessions devoted to U.S./Mexico border issues. The U.S. Department of the Interior's U.S./Mexico Border Field Coordinating Committee is dedicated to managing a small representation of the many issues our countries work on in the spirit of cooperation.

The ITM is considered a meeting of regional importance and is one of the Region's primary outreach efforts. Attendance in recent years has been 300-400 persons, including scientists, managers, and laypersons from government, academia, industry, environmental groups, and the general public.

Support funding is provided through the MMS Environmental Studies Program. Logistical support for the ITM is provided by a contractor and subcontractors selected through the Federal procurement process. A proceedings volume is prepared for each ITM based on summaries of brief technical papers submitted by each speaker and on each session chair's added comments.



**SESSION 1A****DEEPWATER OPERATIONS, PART I**

Chair: Mr. G. Ed Richardson  
Co-Chair: Mr. Jim Regg  
Date: December 16, 1997

Presentation	Author/Affiliation
Deepwater Operations	Mr. G. Ed Richardson Minerals Management Service Gulf of Mexico OCS Region
Deepwater Operations Plans Update	Mr. James B. Regg Minerals Management Service Gulf of Mexico OCS Region
Environmental Information Needs for Deepwater Proposals	Mr. G. Ed Richardson Minerals Management Service Gulf of Mexico OCS Region
DeepStar: Results from Phase III and the Future Under Phase IV	Dr. Paul Hays Texaco
Deepwater Pipeline Installations	Dr. Robert C. Malahy Global Industries, Ltd. Houston, Texas
Deepwater Spill Response	Mr. Harry I. Rich Clean Gulf Associates



## DEEPWATER OPERATIONS

Mr. G. Ed Richardson  
Minerals Management Service  
Gulf of Mexico OCS Region

### INTRODUCTION: OVERVIEW AND FOCUS

#### Overview

Both the Central and Western Planning Areas of the Gulf of Mexico Region have experienced an unprecedented increase in leasing activities in the deepwater areas in recent years. Figures 1A.1 and 1A.2 depict the percentage of leases by sale from 1994 to 1997, differentiated by water depths, for the Central and Western Planning Areas of the Gulf of Mexico, respectively. The most significant increase in leasing activities occurred in water depths greater than 800 meters (2,625 feet) for the years 1996 and 1997. Despite this influx of interest in the deepwater areas, leasing activities on the shelf (water depths of less than 200 meters) have also continued. This demonstrates continued interests by operators to explore and develop shelf-related prospects.

Much of the interest in deepwater areas was fostered by the passage of the Outer Continental Shelf Deep Water Royalty Relief Act (DWRRA), Public Law 104-58. The act clarified and expanded the Secretary of the Interior's authority in 43 U.S.C. 1337(a)(3) to reduce royalty rates on existing leases in order to promote development, increase production, and encourage production of marginal resources on producing and non-producing leases. This expanded authority applies to oil and gas leases on the Federal Outer Continental Shelf (OCS) in water depths of at least 200 meters (656 feet) in the Gulf of Mexico west of 87 degrees, 30 minutes west longitude. The leases had to be in existence before 28 November 1995 to be considered for relief provisions. Authorized leases may qualify for a royalty suspension volume if the MMS determines that a field from which it would produce hydrocarbons needs royalty relief to be economic. The MMS published its implementing regulations to the DWRRA in 30 CFR Part 203.

#### Focus

The focus of the session is the sharing of information to improve our understanding of deepwater operations now and in the future. The session's papers will further focus on the MMS' perspective addressing the Deepwater Operations Plan and environmental information needs for deepwater National Environmental Policy Act (NEPA) documents. The next three papers will focus on the oil and gas industry's perspective. They will address Phase III and Phase IV of the DeepStar initiative, deepwater pipeline installations, and deepwater spill response capabilities.



# Percentage of Leases by Sale and Water Depth in CGOM

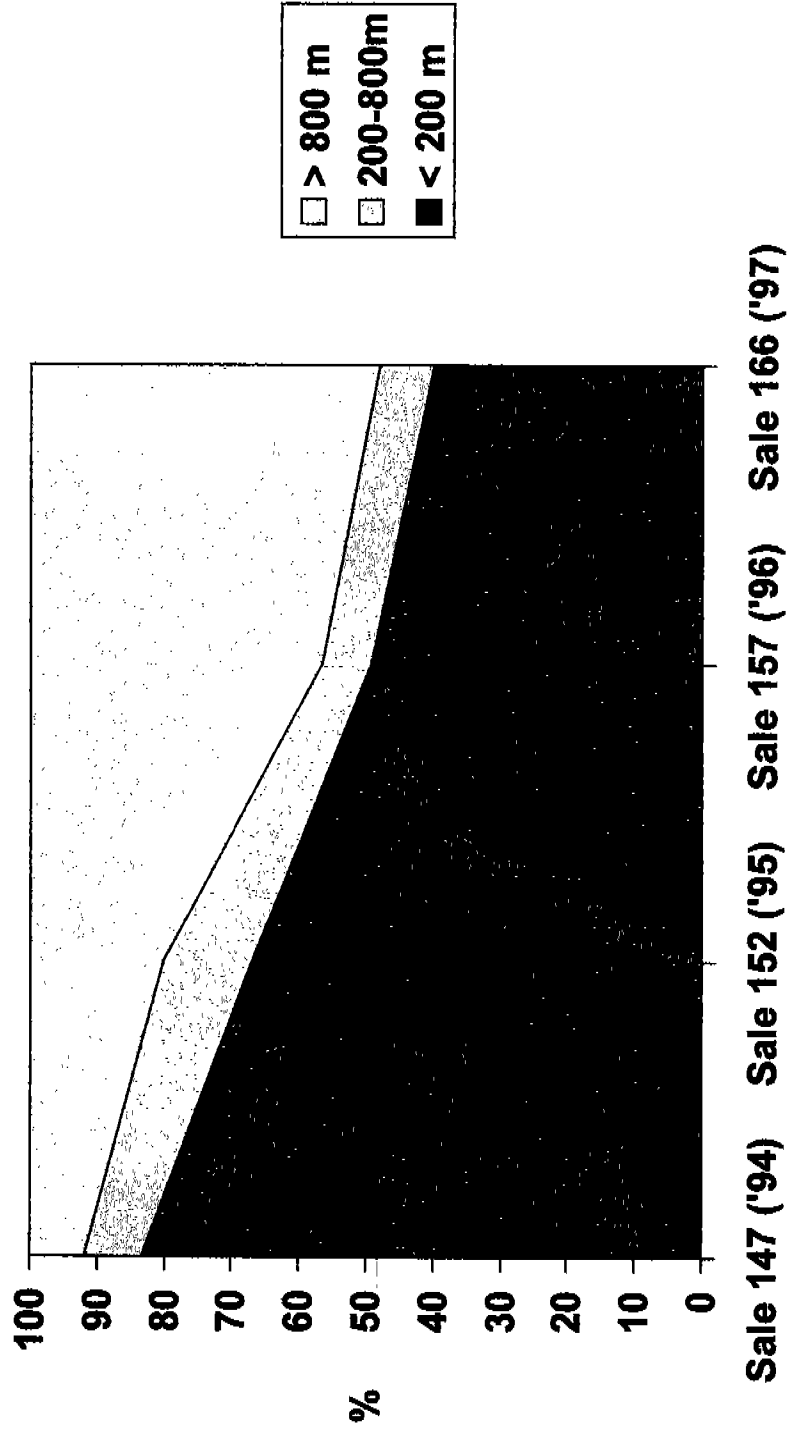

Figure 1A.1. Percentage of leases by sale and water depth in CGOM.

# Percentage of Leases by Sale and Water Depth in WGOM

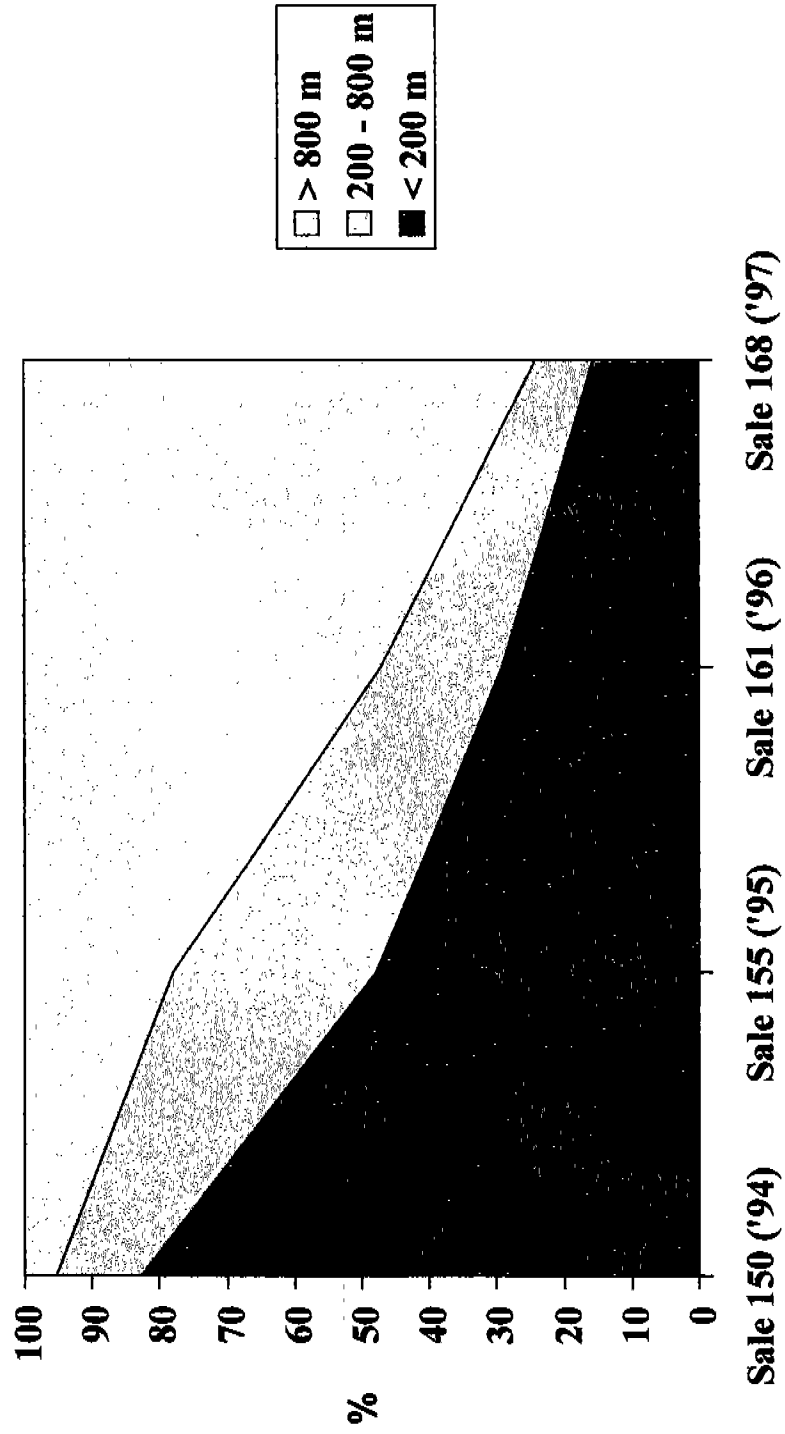

Figure 1A.2. Percentage of leases by sale and water depth in WGOM.

## DEEPWATER OPERATIONS PLANS UPDATE

Mr. James B. Regg  
Minerals Management Service  
Gulf of Mexico OCS Region

### INTRODUCTION

The U.S. Department of Interior's Minerals Management Service (MMS) is responsible for the leasing of Outer Continental Shelf (OCS) lands and the regulation and inspection of operations conducted on those leases. Recent lease sale results have demonstrated the transition of interest to deepwater areas in the Gulf of Mexico. With this deepwater emphasis, a number of issues have been raised that affect policies and regulatory decisions. Existing OCS operating regulations were developed to address the technology and operations conducted in shallower waters where surface production techniques standard to the offshore industry represent the typical development scenario. The existing regulations do not address the equipment and procedures used in deepwater and subsea development projects. In some instances, approvals have necessitated departures from established regulations, standards, and policies. The MMS has worked diligently to address concerns in a timely manner and to keep abreast of the technological evolutions and innovation that are driving the push into deep water. This paper will describe one of the initiatives within MMS to address deepwater activities.

At the 1996 MMS Gulf of Mexico (GOM) Region Information Transfer Meeting, an overview of the Deepwater Operations Plan (DWOP) was presented. The findings of an internal MMS Deepwater Workgroup were summarized at that meeting, with particular emphasis on the DWOP recommendations. This paper is intended to update the information presented and to discuss some experiences to date with the process. Several changes will also be outlined.

When browsing through all the literature directed at deepwater activities, it becomes obvious that there are no set criteria for defining deepwater. The MMS has selected 1,000 feet (305 m) as the deepwater marker for certain regulatory decisions and for statistical purposes. This paper will also use the 1,000-foot water depth marker for deepwater.

### DEEPWATER ACTIVITIES

There is little debate that the GOM has been going through a substantial revitalization within the past four to five years. Record numbers of leases have been issued by MMS and substantial deepwater acreage has been obtained by operators in the past two years. Deepwater drilling activity is at an all-time high and production from deepwater reservoirs is also increasing. The statistics gathered by MMS indicate that the number of rigs concurrently operating in water depths greater than 1,000 feet (305 m) has averaged nearly 30 during late 1997, up from just three in 1994. The continued growth of the deepwater GOM, especially the ultra-deep blocks, might be constrained by the availability of drilling vessels capable of operating in those water depths. Similarly, shortages of equipment and

manufacturing capacity may be limiting factors for development. Numerous trade journals have published articles about the successes of GOM deepwater projects, lists of projects under development or which are pending, and water depth records for deepwater drilling, mooring, and installations. The important point is that the GOM offshore has seen a much-needed revitalization with the excitement of deepwater drilling and production. It is in everyone's best interest that the successes continue.

## DEEPWATER OPERATIONS PLAN

A companion to the revitalization of GOM hydrocarbon exploration and development is the need for MMS to keep pace with the evolving technology and new techniques associated with deepwater operations. Efforts are underway within MMS to make sure that the technology and regulatory issues and concerns associated with deepwater exploration and development are well understood and addressed before they become barriers.

MMS reviews and updates its regulatory program to reflect advancements in offshore equipment and operating technologies. Operating experiences, industry recommended practices, feedback from our customers, and regulatory programs from other countries are reviewed to identify areas where the MMS regulatory program could be improved. There are situations where it is not in the best interest of MMS, industry, or the public to develop new regulations. The rapidly evolving technology associated with deepwater activities is such a case.

A Notice to Lessees and Operators (NTL) was issued in 1996 to address the growing complexities and issues evolving with deepwater development projects. Discussions with the industry consortium DeepStar and MMS's active involvement with the Regulatory Issues Committee provided an open forum between the regulators and operators to identify regulatory and operational issues that impact the industry. Through the DeepStar Regulatory Issues Committee, MMS, and industry participants were able to jointly evolve the DWOP concept.

A DWOP is required for all deepwater development projects [water depths greater than 1,000 feet (305 m)] and all projects utilizing subsea production technology. Projects that use conventional fixed-leg platforms are exempt from the DWOP requirements. The DWOP addresses technology, safety systems, inspection, testing and maintenance practices, alternative compliance, and other subject areas. The Plan is a proprietary document submitted to MMS in three parts: conceptual, preliminary, and final. Each Part is described further as follows:

- Conceptual Part. The conceptual part addresses the general design basis and philosophy used to develop the field. This part provides an early opportunity for MMS and the lessee to agree on a plan of development prior to major expenditures for engineering design. The conceptual part should be submitted for approval after the operator has identified the concept(s) for development and prior to commencing with engineering design. A conceptual part is required for all projects requiring a DWOP.

- Preliminary Part. The preliminary part provides an opportunity for approval of the system and associated operations plan prior to major commitments and expenditures for hardware. It should be submitted for approval after the lessee has substantially completed system design and prior to commencing procurement and fabrication. Recognizing that various facets of the development require different lead times for procurement and fabrication, the preliminary part may be submitted in several different parts to suit the project schedule. In any case, the preliminary part shall be approved prior to initiating production.
- Final Part. The final part updates information previously submitted in the preliminary or conceptual parts. This part shall be submitted for approval within 90 days following initial production.

The three-part DWOP is intended to coincide with the operator's knowledge regarding the project and will provide an early opportunity for the operator and MMS to agree on the proposed development strategy (design basis and philosophy) prior to major expenditures. The DWOP is also intended to reduce the overall risk of the deepwater development project. The DWOP approach has reduced the need for MMS to constantly revise regulations to keep pace with rapidly evolving deepwater technology.

With DeepStar assistance, a guideline for implementing the DWOP requirement was developed. The MMS published that guideline as an attachment to NTL 96-4N. The guideline was developed using a known and previously approved GOM subsea development project as a model; those projects using floating production systems were to be addressed on a case-by-case basis. The DWOP NTL (96-4N) became effective 19 August 1996.

#### DWOP EXPERIENCE

Figure 1A.3 and show the number of DWOP's received by year. Most plans have involved subsea developments to date; MMS expects that future deepwater development projects will utilize more floating production systems. Note that the DWOP's received during 1995, before NTL 96-4N became effective, were provided by DeepStar member companies on a voluntary basis.

Some of the significant issues addressed in DWOP's to date include:

- several new technologies, including the subsea horizontal (spool) production tree;
- techniques for minimizing produced fluid problems (paraffins, hydrates);
- production riser design as such relates to allowable levels of sustained annular pressure;
- testing and operability of safety valves (closing times, acceptance criteria, testing frequency);
- mooring systems;
- completion timing (i.e., shut-in subsea well for extended time period while waiting to complete installation of host facility);
- well intervention, including both workovers and loss of well control;
- hazards analyses.

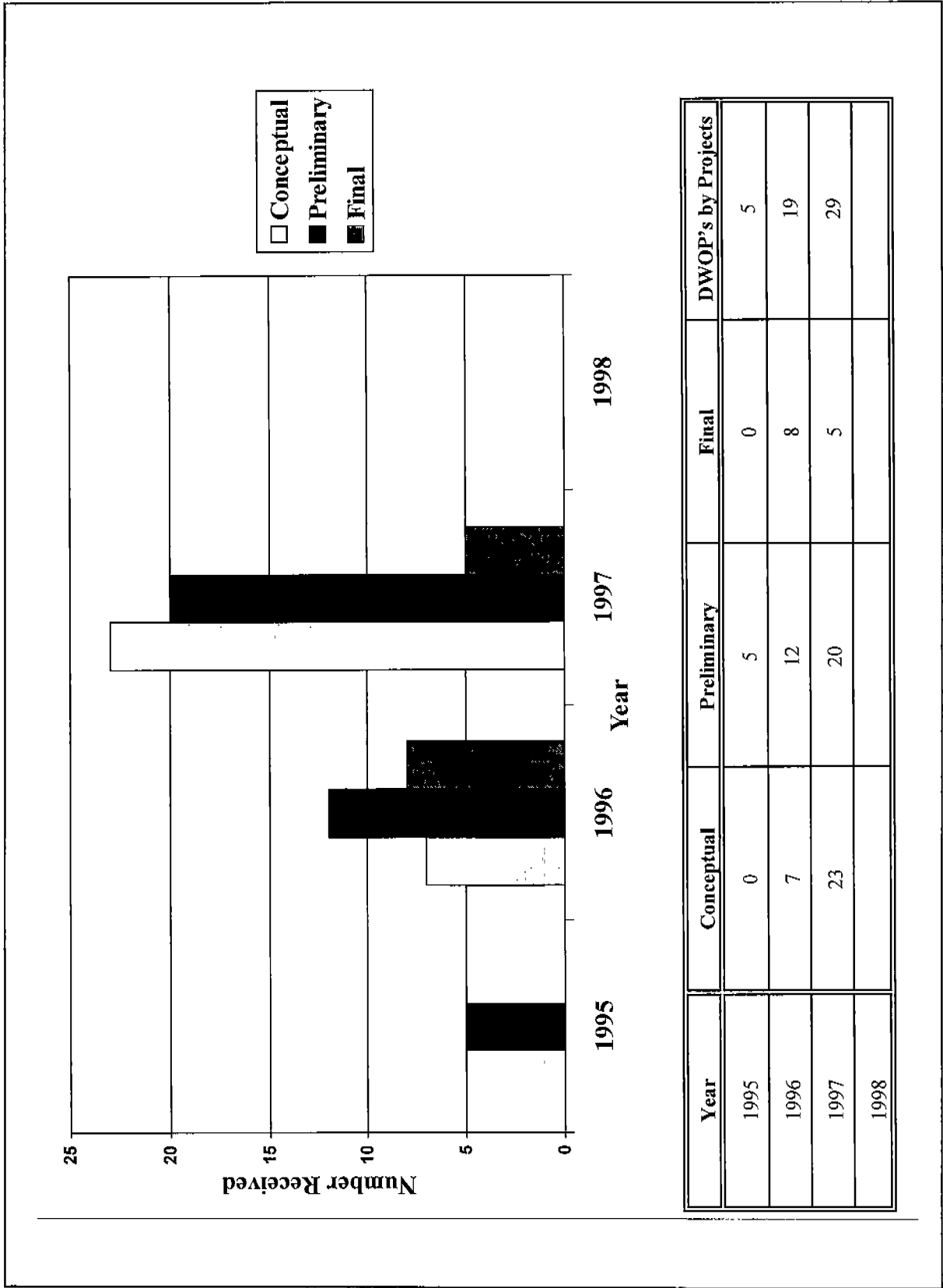

Figure 1A.3. Number of DWOP's received by year.

Several of these issues have been addressed in the DWOP as alternative means of complying with MMS regulations (30 CFR 250). More than 20 regulations have been identified where there is a likelihood for deviation from MMS regulations. Before MMS can approve alternative compliance measures (equipment, procedure, etc.) in a DWOP, the operator must provide sufficient justification that the alternative means provide an equal or greater level of safety or reliability, as appropriate, when compared to the existing requirements.

#### REVISED DWOP GUIDELINE: WHAT'S NEW?

A continuing dialogue with DeepStar and others has resulted in the revision of the first DWOP guideline to simplify the language, address the concerns raised during the first year of implementation, and to include specific information in the DWOP about floating production systems. An internal (MMS) review of the revised DWOP guideline has been completed. A revised NTL has also been prepared to replace the existing NTL 96-4N and should become effective during early 1998.

Roughly 40 % of the DWOP's received to date have been for the shallow water subsea development projects. Many of these DWOP's involve equipment and system operability that are similar to DWOP projects approved by MMS. As such, the new NTL and guideline incorporate the following change:

“A Conceptual Part is *required* for all development projects in water depths greater than 1,000 feet (305 m) and all projects utilizing subsea production technology. For those subsea projects in *less than* 1,000 feet of water that are similar to previously-approved projects, MMS may waive the requirement for a Preliminary Part.”

This streamlined approach for the shallow water subsea developments will allow MMS to emphasize the review of the more complex DWOP's.

The guideline has been substantially reworded and reorganized to be more user friendly. Some of the structure changes include minimizing duplicate wording/requirements, including a list of abbreviations and definitions, a description of the relationship to other submittals, and procedures on how to address (submit) revisions, updates, and amendments to the DWOP. Where practical, the specific detailed information needs included in the previous guideline have been replaced with more performance-oriented requirements.

#### CONCLUSION

The likely continued high level of interest in the GOM deepwater will mean a steady flow of DWOP's to the MMS for approval. Many of the planned developments will involve floating production system technology. A revised guideline developed in conjunction with DeepStar has put MMS in the position to effectively respond to the needs of industry from a technical and permitting standpoint. The guideline should also help operators with the preparation of a DWOP. The early dialogue established through the DWOP process is a key factor in understanding the concerns of both operators and MMS. When used as intended, the DWOP should help reduce some of the risks

associated with deepwater development projects by knowing well in advance MMS' position on technology and techniques not specifically addressed in the existing regulations.

The slide show that accompanied this presentation follows.

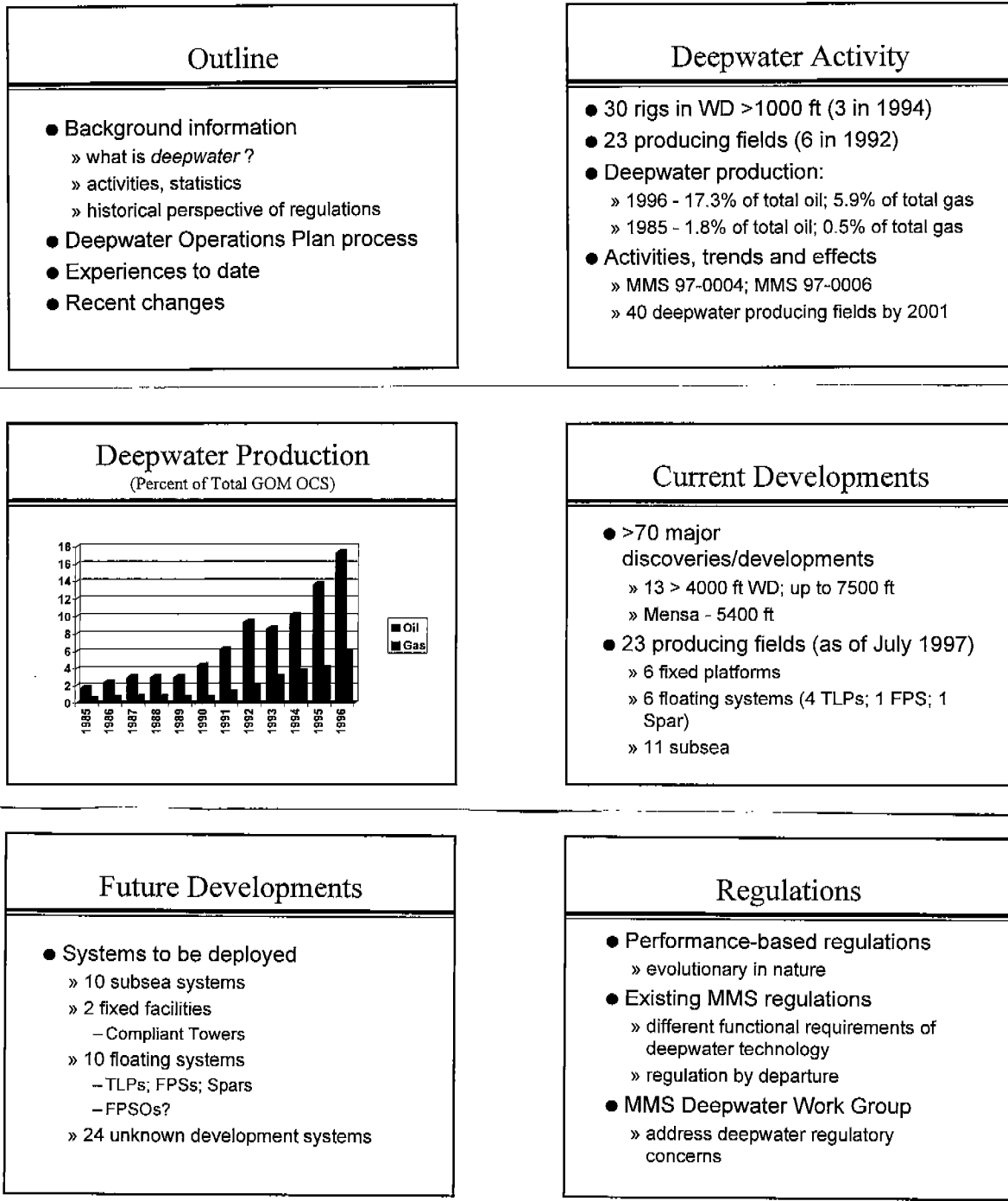



### Typical Departures

- Casing annulus monitoring
- Safety device location, operation, testing, leakage
  - » USV, SCSSV, SDV, FSV, PSHL, etc.
- ESD location, operation, testing
- Abandonment and site clearance
- Pipeline/Flowline working pressure
- Bottomhole pressure survey

### Deepwater Operations Plan

- MMS Work Group Report - April 1995
- Total systems approach to the review of a deepwater project
  - » safety and operating system perspective
  - » permitting perspective
- NTL effective August 19, 1996
  - » DeepStar, OOC involvement
  - » Guidelines

### DWOP Purpose and Benefits

- Total systems approach
- Early dialogue
- Proprietary document
- Alternative compliance and departures
- MMS approval of design prior to major expenditures
- Avoid unnecessary regulatory rewrites

### DWOP Approach

- NTL 96-4N
- 3 Parts: Conceptual, Preliminary, Final
- Guidelines addressing equipment, operations, testing, maintenance
- Used subsea analog for guidelines
- MMS review and approval

### Conceptual Part

- Innovative and unusual technology
- Overall description of project
  - » host facility; hazards; expected production conditions; development method
- Single vs. multi-phase projects
- Submit when decision made to develop
- 30 days to take action

### Preliminary Part

- Update Conceptual
- Alternative compliance/departures
  - » descriptive supporting information
  - » predictive process hazards analysis
- Schematics and descriptions
  - » surface equipment and operation
  - » subsea equipment and operation
- Maintenance

### Preliminary Part

- Submit after complete system design; prior to procurement and fabrication
- 90 days to take action
- Approval prior to initiate production

### Final Part

- Update previous submittals
- Revisions based on operating experience
- 60 days to take action
- Annual updates if development drilling continues beyond Final Part approval

### DWOPs Received

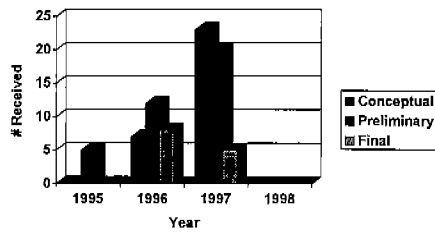

valid through 12/16/97

### Recent Projects - DWOPs

- Neptune - Oryx
  - » first production Spar; 1930 feet of water
- Mensa - Shell
  - » subsea; 5400 feet of water (record)
  - » 68 mile pipeline to host; 150 MMcfd
- Ram-Powell - Shell
  - » 4th GOM TLP; largest to date

### Other Significant DWOPs

- Diana - Exxon
- Marlin, King - Amoco
- Petronius - Texaco
- Genesis - Chevron
- Morpeth - British-Borneo
- Troika, Pompano - BP
- Tahoe, Popeye, Europa - Shell

### Issues Addressed in DWOPs

- Alternative technologies
  - » production tree, riser design
  - » structural variants, mooring design
  - » flow assurance techniques
- Safety valves
  - » testing, operability
- Completion timing
- Well intervention

### Revised DWOP Guideline

- Restructured Guideline
  - » Commonly asked questions
  - » Description; Purpose; Applicability; Definitions; Submittal/Approval; Revisions
- Subsea, Floating Production Systems, and Nonconventional Fixed Structures
- Conceptual Part required, but...
  - » waive Preliminary Part?

### DWOP Contents

- Wellbore
  - » Drilling and completion considerations
- Structural information
- Mooring system
- Stationkeeping systems
- Risers

### DWOP Contents (cont'd)

- Vessel-based offtake systems
- Pipelines
- Subsea production systems
- Surface production systems
- Operating procedures
- Hazards Analysis

### Deepwater Structure Concepts

- Panel discussion
- 5-10 minute presentations
- Open discussion of structure concepts, issues, concerns, needs
- Information sharing

---

Jim Regg is a Petroleum Engineer with the MMS Gulf of Mexico Region, located in New Orleans. He currently works in the Field Operations office, responsible for technical, safety, research and regulatory issues relating to drilling and production activities. He coordinates the Deepwater Operations Plan (DWOP) process for MMS. Jim has offshore experience in drilling and production operations in Alaska and the Gulf of Mexico, and also experience with the MMS offshore inspection program. He has had numerous papers published, conducted several workshops, and serves on several joint MMS-industry initiatives. Jim received a Petroleum Engineering degree from the Pennsylvania State University. He will be presenting an update of the DWOP process.

## ENVIRONMENTAL INFORMATION NEEDS FOR DEEPWATER PROPOSALS

Mr. G. Ed Richardson  
Minerals Management Service  
Gulf of Mexico OCS Region

### INTRODUCTION

The Gulf of Mexico OCS Region experienced a dramatic increase in deepwater leasing activities in 1996 and 1997. Much of this increase may be attributed to the Deepwater Royalty Relief Act and its implementing regulations. It provided substantial incentives to prospective bidders by allowing lessees to forgo a certain amount of royalty payments on their initial production. The rate of royalty relief is based on water depth. Figures 1A.4 and 1A.5 show the number of leases displayed by water depth for the last four sales in the Central and Western Planning Areas, respectively. The sales that transpired in 1994 and 1995 were conducted prior to royalty relief while the sales in 1996 and 1997 occurred with royalty relief provisions in effect. Note the marked increase in the number of leases for water depths of greater than 800 m (2,625 ft) in the 1996 and 1997 sales.

From 1994 to 1997, leasing activity on shallow water blocks [up to 200 m (656 ft) water depth] remained at a relative steady rate. These data indicate that the increase in deepwater leasing activities added to the overall leasehold positions in the Gulf of Mexico rather than substituting for shallow water leasing activities.

Deepwater operations may have some unique considerations when compared with conventional operations that transpire on the shelf in shallower waters. As a result, the MMS devised the Deepwater Operations Plan (DWOP) to address the engineering and operational aspects of proposed deepwater operations. The environmental information needed to evaluate each deepwater proposal has been requested on a case-by-case basis for each Exploration Plan, Development Operations Coordination Document, or pipeline application (lease-term or right-of-way) received by the MMS.

The MMS complies with the National Environmental Policy Act, as amended, by evaluating each proposal submitted by an operator against specific criteria to ensure proper environmental evaluation of the plan or application. The potential effects from a proposal are investigated and a Categorical Exclusion Review or an Environmental Assessment is prepared prior to the MMS' decision to approve, disapprove or modify the plan or application.

This paper focuses on the environmental information needs unique to deepwater operations. A regulatory framework is offered as background information. A discussion is provided on chemosynthetic community detection and protection. Environmental information needs are explained for "Host" and "New" facilities proposed in deepwater. Finally, a discussion of environmental information needs for the transportation of hydrocarbon production via pipelines or barging/tankering operations is included.

# Central Gulf of Mexico Sales

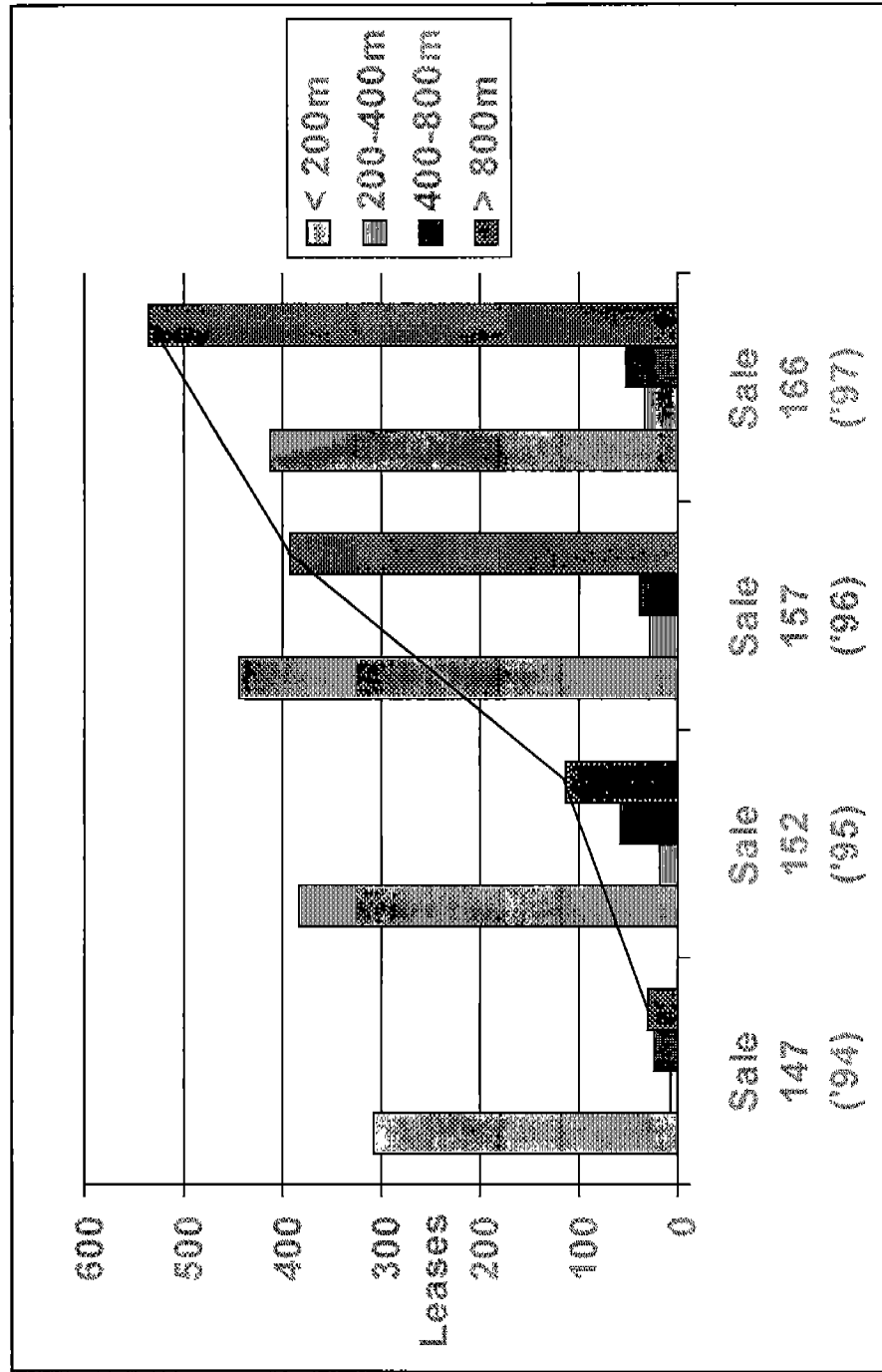

Figure 1A.4. Central Gulf of Mexico leases by water depth.

# Western Gulf of Mexico Sales

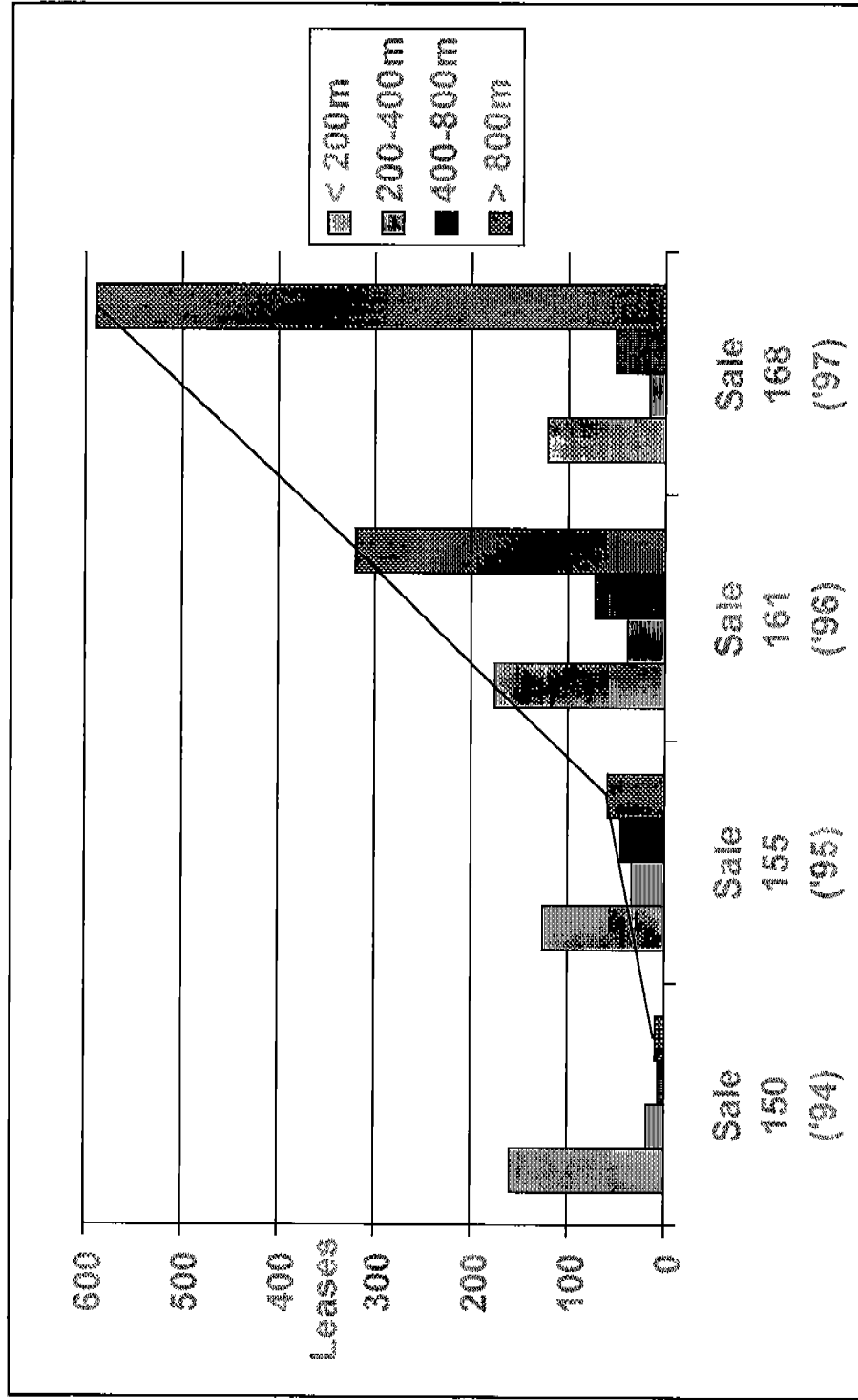

Figure 1A.5. Western Gulf of Mexico sales.

## REGULATORY FRAMEWORK

Certain pre-lease activities such as geological and geophysical exploration of the OCS are regulated by the MMS under 30 CFR Part 251. Awarding of the lease initiates the post-lease activities for MMS. The lease may contain both operational and environmental stipulations that become a part of the lease and require compliance by the lessee/operator. The MMS' Operating Regulations contained in 30 CFR 250 provide guidance to the operators for activities on the OCS. Specifically, 30 CFR 250 Subpart B, Exploration and Development and Production Plans, and Subpart J, Pipelines and Pipeline Rights-of-Way, are the focus for this paper.

To clarify these regulations, the MMS publishes Notices to Lessees and Operators (NTLs). These documents are specific to a topic and help the operator understand how to comply with the regulations. Examples of NTLs include: 83-03, OCS Shallow Hazard Requirements; 86-09, Environmental Report/Information Guidelines for Plans; 88-11, Implementation of Measures to Detect and Protect Deepwater Chemosynthetic Communities; 96-04N, Deepwater Operations Plans; and 96-06N, Conservation Information.

Letters to Lessees and Operators (LTLs) are similar to NTLs and clarify regulatory requirements. Examples of these LTLs include: 12 October 88, POE, POD/P and DOCD Requirements; 5 September 89, Modify and Clarify POE and DOCD Requirements; and 31 August 94, Forms for Air Quality When Submitting Plans.

## CHEMOSYNTHETIC COMMUNITIES

NTL 88-11 provides for the detection and protection of high-density chemosynthetic communities on the Federal OCS. These communities are defined in the NTL as "...assemblages of tubeworms, clams, mussels, bacterial mats, and associated organisms." Requirements for chemosynthetic community analyses apply to all bottom-disturbing activities in water depths of greater than 400 m (1,312 ft).

Prior to the approval of an Application for Permit to Drill (APD) or a pipeline application, the operator/applicant must delineate all seafloor areas which would be disturbed by the proposed operations. An analysis of geophysical information for these areas and any other pertinent information available will be furnished to the MMS which discusses the possibility of disturbing geological phenomena that could support chemosynthetic organisms. These geological phenomena may include areas such as hydrocarbon-charged sediments, seismic "wipe-out" zones, anomalous mounds or knolls, gas vents, or oil seeps.

If the MMS' review of the information submitted by the operator/applicant results in a determination that high-density chemosynthetic communities may be present and could potentially be harmed by the proposed activities, the operator will be required to take one of the following actions:

1. Modify the plan/application to relocate the proposed operations to avoid impacting possible chemosynthetic communities;

2. Modify the plan/application to provide additional information such as a photo-survey, a video survey or already available information to document whether high-density chemosynthetic communities exist in the areas of concern;
3. Adhere to certain conditions of plan or application approval. This may include the use of a remotely operated vehicle (ROV) during anchor setting and other activities. The ROV may be used to monitor impacts caused by the proposed work; or
4. Adhere to any other condition deemed necessary by the Regional Director.

### HOST FACILITIES

Host facilities may be either “planned” or existing platforms/structures that are usually located in shallower water to support deepwater activities or facilities. Characteristically, production, separation, and treatment operations transpire at the host facilities to process the hydrocarbons extracted at a deepwater site. An example is Shell’s subsea Mensa project. Natural gas extracted from the subsea completions in Mississippi Canyon Block 687 [water depth of 1,639 m (5,376 ft)] is transported approximately 163 km (63 miles) by pipeline to its host facility in West Delta Block 143 [water depth of 113 m (370 feet)] for processing. Umbilical lines from the host facilities control the wells and their production at the deepwater location. These umbilicals may also transport flow assurance chemicals to the deepwater wells and facilities.

Of concern to the MMS are the changes to conditions that result from a facility becoming a host. This may include the additional discharges and emissions at the host facilities and the operational and safety support systems for the deepwater project. The MMS conducts an initial environmental review or analysis under the implementing regulations of the National Environmental Policy Act, as amended, (NEPA) on the operator’s Development Operations Coordination Document (DOCD) or Development/Production Plan (DPP). Conclusions and any mitigative measures developed for the initial environmental evaluation were based on the conditions presented in the plan. If conditions change as a result of the facility’s becoming a host, the MMS must conduct an evaluation to determine if the conclusions reached from the initial NEPA review are still appropriate or if modification to the plan/application is needed. Examples of concerns for host facilities include spill response, flow assurance measures (such as storage, use, and toxicity of chemicals), storage and/or shipment of produced hydrocarbons, and additional support at facilities and onshore bases/terminals.

### NEW FACILITIES

As operations transpire in ever-deepening water depths, the structures used to discover, extract, and produce the hydrocarbons are also changing in their design and installation. Traditionally, fixed platforms were used on the “shelf.” Initial deepwater structures such as Cognac [water depth 312 m (1,023 feet)] and Bullwinkle [water depth 405 m (1,329 feet)] were modified fixed structure designs. Economic and engineering considerations lead operators to devise other structures for the deepwater environment. See Figure 1A.6 for a diagrammatic representation of the types of new structures



designed and in use in the Gulf of Mexico. Each design has “suggested” water depth ranges for its application.

The Departmental Manual which provides guidance on implementing the NEPA requires the MMS to prepare an Environmental Assessment (EA) for all proposals that involve “new or unusual technology” [516 DM 6, 10.4.C(10)]. Applicants must adequately describe any new or unusual technology that will be used in their new structures/facilities. Processing time for a plan or an application may be lessened with the inclusion of an appropriate discussion of these technologies in the submittal.

Applicants should thoroughly review the requirements in 30 CFR 250 Subpart B (Plans) and Subpart J (Pipelines) and the appropriate NLTs and LTLs for guidance in preparing their submittals. If questions arise, contact the Gulf of Mexico OCS Region to answer your specific questions.

## TRANSPORTATION OF HYDROCARBON PRODUCTION

Traditionally, pipelines have transported hydrocarbon production from the OCS to shore. An extensive pipeline infrastructure on the “shelf” already exists. Estimates suggest that there are approximately 26,000 miles of pipeline located on the Gulf’s seafloor. The MMS records also indicate that a small amount of liquid hydrocarbons is barged to shore. In the Gulf’s deepwater areas, few pipelines have been installed. As an alternative, operators may consider sea-going barges and/or tankers to transport liquid production to shore. Natural gas produced at a deepwater project has several options: pipeline to shore, re-injection into the producing formation to maintain reservoir pressure or “conversion” to a product that is transportable by vessels.

### Pipelines

New development and production in deepwater areas will result in additional pipelining activities. Both flowlines (lease-term pipelines) and pipeline rights-of-way are expected to increase. New pipelines to shore may be required because of the lack of infrastructure capacity, characteristics of the produced hydrocarbons, or process and marketing conditions. Proposed pipelines that result in a new corridor to shore will require MMS prepare an Environmental Assessment [516 DM 6, 10.4.C(15)]. For these applications, the MMS will require more environmental and operational information to prepare an Environmental Assessment than is required for a Categorical Exclusion Review. Early submission of the pipeline application and its supporting environmental information to the MMS is essential to meet scheduled construction and installation deadlines. An applicant should try to maximize the use of available information when submitting its application to the MMS. For example, an applicant may include portions of its Corps of Engineers pipeline permit with the MMS’ application. This may provide useful information to the MMS on nearshore effects that will be addressed in the NEPA document for the proposed action. The objective of the supportive information is to expedite the MMS’ environmental evaluation. Applicants are encouraged to have an early and open dialog with the MMS.

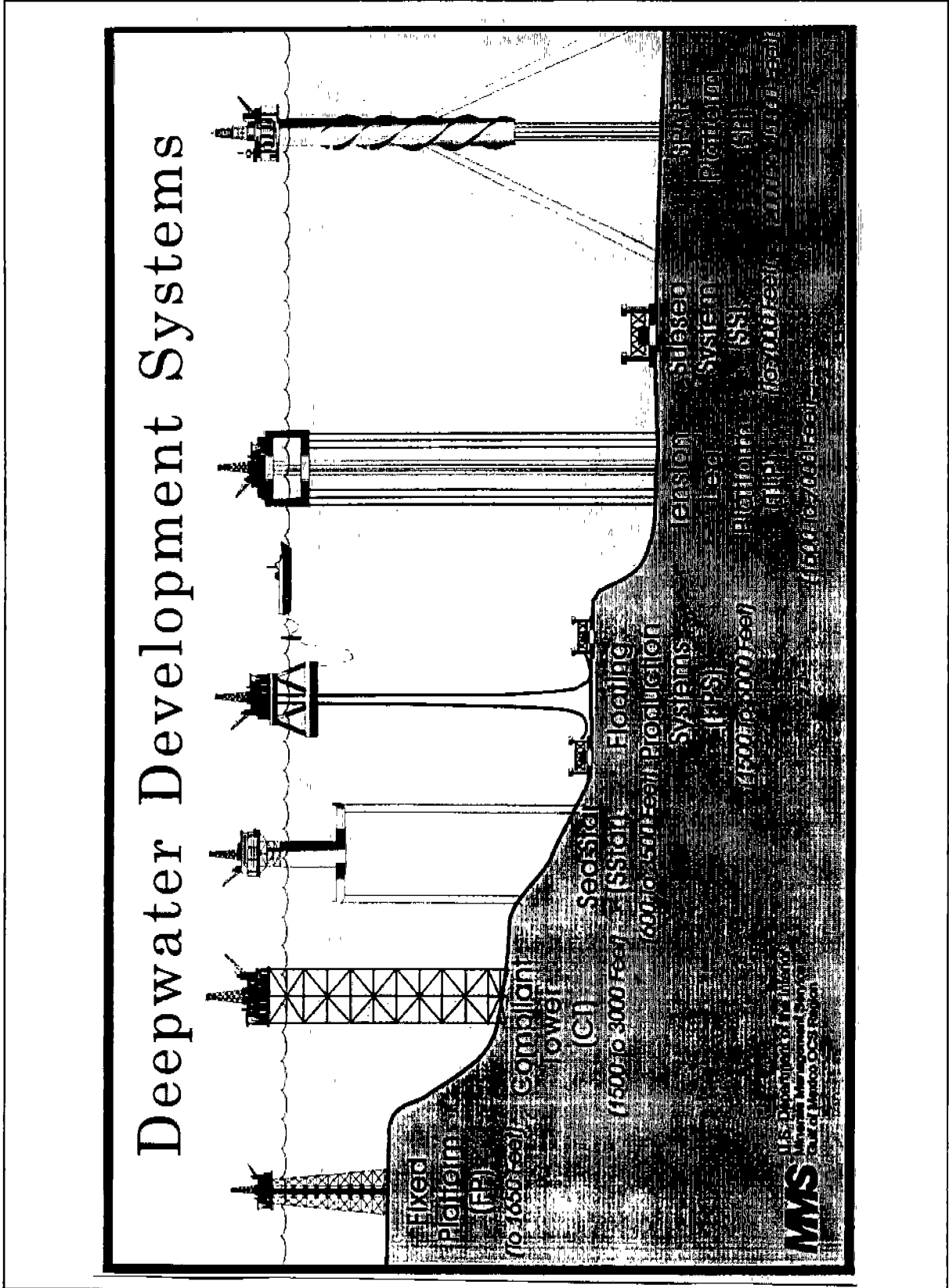

Figure 1A.6. Deepwater development systems.

There are some special considerations an applicant should recognize and for which appropriate information should be provided. If hydrogen sulfide (H<sub>2</sub>S) is entrained in the pipeline flow, the applicant should provide the known or expected concentration of H<sub>2</sub>S. Air quality modeling from a potential release may be required. An applicant must also describe any flow assurance measures that it expects to use. Descriptions of the chemicals and rate of use are needed by the MMS.

### Barging Operations

Currently, 53 platforms in the Gulf of Mexico barge their liquid hydrocarbon production to shore. This experience is limited to the shallow water regime since all of these activities transpire in water depths of less than 60 m (197 feet). Approximately 27 of these platforms pipe their liquid hydrocarbon production to another platform for storage and offloading to barges for shipment to shore. A few platforms barge their liquids to another platform for storage and the production is subsequently piped to shore. About 3% of the liquid hydrocarbon production in the MMS' Central Planning Area of the Gulf of Mexico is barged to shore. Most of these operations occur east of the Mississippi River. The Western Planning Area has about 7% of its hydrocarbon liquids transported by vessels.

There has also been some barging of liquids from extended well tests at deepwater sites to shore. More of these operations are expected. There are newly designed drillships being constructed with sizeable liquid storage capacities (100,000 to 500,000 bbls). Such a vessel could be used to store liquids from an extended well test that would evaluate reservoir characteristics before major capital expenditures for development are considered. The liquids from the test might be barged to shore before the drillship moves to a new location.

### Tankering Operations

Currently, tankering operations in the Gulf of Mexico are limited to "lightering" activities. "Lightering" operations involve the offloading of hydrocarbon liquids from very large crude carriers (VLCC) to smaller tankers for transportation to shore. Much of the "lightering" activities occur in four large U.S. Coast Guard designated transshipment areas within the Gulf. All of these areas are located at least 155 km (60 miles) from the shoreline. The U.S. Coast Guard prepared an Environmental Assessment before designating the areas for transshipment operations.

A DOCD or DPP that proposed tankering operations in the Gulf would most likely require the MMS to prepare an Environmental Assessment to evaluate the potential environmental effects from these activities. If a Finding of Significant Impact was determined from the results of the Environmental Assessment, the MMS must prepare an Environmental Impact Statement. To expedite any NEPA analysis of tankering operations, the MMS would use other environmental documents to "tier" (40 CFR 1502.20) and/or "incorporate by reference" (40 CFR 1502.21) information already available in the public domain.

For any DOCD or DPP that proposed tankering operations, the MMS would need both operational and environmental data to prepare the NEPA document that evaluated the potential effects from the proposed activities. Examples of the type of operational information needed include:

1. size and capacity of tanks and vessels
2. storage and offloading capacities
3. routes and frequencies of transshipments
4. offloading procedures and durations
5. limitations for offloading
6. inspection and maintenance schedules, and
7. shore base and terminal information.

Examples of the type of environmental information needed include:

1. source, frequency, and volume of spills,
2. environmental effects from spills
3. spill response capabilities
4. safety and system “shut downs”
5. emissions and discharges
6. effects at the shore and within the coastal zone, and
7. socioeconomic information.

## SUMMARY

A brief explanation of the MMS’ regulatory framework for deepwater activities is offered. The focus is on Exploration Plans, Development and Production Plans, and Pipelines. A discussion of chemosynthetic community detection and protection is explained. The “host” facility concept is addressed and the need for MMS’ review of these facilities as they support deepwater projects is provided. New facilities are discussed with environmental information needs of the MMS. Finally, a discussion of the transportation of hydrocarbon production from deepwater facilities by pipelines or by barging or tankering operations is offered.

---

Mr. G. Ed Richardson is a Senior Environmental Scientist with the Environmental Assessment Section of the Office of Leasing and Environment in the Minerals Management Service’s Gulf of Mexico OCS Region in New Orleans, LA. His career spans over 26 years of environmental and regulatory experience in state and federal government agencies and in the oil and gas industry. He received his Masters of Science degree from Clemson University in microbiology, environmental health, and biochemistry.

## DEEPSTAR: RESULTS FROM PHASE III AND THE FUTURE UNDER PHASE IV

Dr. Paul Hays  
Texaco

### INTRODUCTION

DeepStar Phase III consists of 20 oil companies and about 40 vendor companies contributing to a deep water technology development effort. The two most recent companies to join are Oryx and Statoil. Presently, 19 of the oil companies have signed letters of intent to participate in the two-year Phase IV program beginning January 1998. The base program involves \$9 million in research with about half of the program funding focused on pipeline flow assurance issues. We have another \$2 million contributed by new participants which will be held in reserve until our base program is initiated. Then technical committees will provide recommendations to a Senior Advisory committee which will decide on program direction and balance when it authorizes the expenditure of the remaining funds.

Most of you are probably aware of the DeepStar program, which is now moving into its seventh year as an ongoing joint industry effort. Formed in leaner times (1992), DeepStar represented Texaco's effort to pursue development of extended reach subsea tie-backs from the deep water Gulf back to existing shelf infrastructure. A quick view of water depth contours indicated that a large section of the deep water Gulf extending out to 1,829 m (6,000 ft) could be readily produced with very few shallow water regional processing centers, if the components of the extended reach technology were feasible. Our mission continues to be: "An industry-wide cooperative effort focused on identification and development of economically viable, low-risk methods to produce hydrocarbons from deepwater tracts in the Gulf of Mexico." DeepStar emphasizes deep water more than Gulf of Mexico. A significant component of the research is generic and has world-wide application.

Since DeepStar began in 1992, very few extended reach tie-backs have been initiated. This provides testimony to the difficulty of achieving extended reach subsea tie-backs. Shell's Mensa is the case in point. Although hydrates are a concern, the field is essentially a dry gas field. Whereas for the more general case of heavy, viscous, paraffinic crudes typically encountered in the Gulf, the near-term development solutions still appear to give primacy to surface-based completions. As evidence, consider the compliant towers, spars, and TLP's that have been initiated or completed since 1992. Subsea systems have been installed, e.g. BP's Pompano. It's just that these are not the long offset [104-155 km (40 - 60 mile)] tie-backs originally envisioned as the classic DeepStar design basis.

We quickly learned that we had to study more than extended reach tie-backs if we wanted our DeepStar technology development efforts to contribute meaningfully to future prospects. We began looking at produced fluids (flow assurance), subsea equipment (including pipelines, flowlines, and umbilicals), we considered vessels, mooring and riser systems, as well as drilling and completion issues. Later (Phase IIA) we added a reservoir engineering committee and focused our studies of

public domain information on those characteristics that are common to deep water Gulf of Mexico reservoirs.

## ACHIEVEMENTS AND LESSONS LEARNED

An early vision of DeepStar was to progress to deployment of the components of deep water subsea systems. The program's progression has definitely been in the direction of more testing. The evolution has been gradual, though the progression has been steady. We cite as evidence the flow assurance portion of DeepStar Phase IV, which consists of four field tests and offshore deployment of an electrically heated pipe system.

We have come this far in steps. Early in Phase II we focused on metal tube umbilicals which are being qualified for dynamic service in Phase III. In Phase III, the subsea committee has tried to fill a gap in their work on deep water pipeline repair by giving attention to contents containment during the repair operation. This effort builds on previous phases which examined both bottom-based and surface-based repair techniques.

In Phase III, a qualification test is being completed that seeks to provide reliable and consistent subsea distribution of chemicals to reduce long offset umbilical costs.

A two-year test of a polyester mooring line is scheduled to be completed in August 1998. The system deployed in 914 m (3,000 ft) near Shell's Auger TLP has been instrumented for data retrieval. In Phase IV, a postmortem will be carried out to help us learn how well we can predict the behavior of this potential economic alternative to conventional chain and wire rope mooring systems.

We unsuccessfully tested vertically-loaded drag embedment anchors in Phase IIA of DeepStar. Then in August 1996, as part of Phase III, we successfully deployed the anchors in shallow water. It is hoped that anchor manufacturers' participation in the tests will lead to continued improvements in these economic alternatives to drilled and grouted piles for taut leg mooring systems.

In concert with the National Institute of Standards and Technology, DeepStar successfully tested a composite drilling riser. A 20-ft pup joint was loaded well beyond design conditions without failure. This \$4.8 million project will be in its final year in 1998 and is very likely to deliver products such as 6,000 ft composite risers and 10,000 ft composite risers that deployed on future drilling vessels. A field test carried out in early 1997 successfully demonstrated the technique of removing hydrate blockages in flowlines by lowering pressure on one side of the line. This was a prime example of what an ongoing cooperative effort can bring to bear on a problem. A test loop has been developed in Phase III to demonstrate the feasibility of deploying coiled tubing to remove blockages in flowlines for distances extending up to 13 km (5miles) around either side of an entry point designed into a system. A successful demonstration of this technique using laboratory scale apparatus has been achieved. Several participants are actively considering use of this technology for remediation of pipelines that are currently plugged.

Tests with coatings to prevent wax deposition have not proved to be as successful as hoped. Only by pursuing the path to its logical conclusion with a comprehensive testing program would we have ever known this with confidence.

A matrix of chemical compatibility has been successfully developed. Many chemicals used to treat production are incompatible. If mixed, they may gel or crystallize, resulting in plugged umbilicals or injection ports. Working with the vendors, we have developed a compatibility matrix of generic chemical families and concentrations. The matrix will provide future guidance regarding viable chemical mixtures for “dosing” a well’s production.

## HIGHLIGHTS OF PHASE IV

### Regulatory Committee

A DeepStar committee has been charged with looking at regulatory issues since 1992. We will continue to target continuing discussion between the two regulatory authorities with whom we are most involved, the MMS and the Coast Guard. As issues related to floating production systems come up, we need to work together to sort out overlaps in regulatory domains and strive to resolve the conflicts.

As the oil industry moves further away from the shoreline, the economic viability of a field developed with pipelines running back to shore becomes a more pressing issue. The industry has successfully deployed a Floating Production Storage and Offloading (FPSO) system off the coast of California when the operator wasn’t permitted to run a pipeline to shore. The relative safety of this California application, along with numerous other world-wide applications of FPSO’s must be examined more closely with respect to the issue of deploying FPSO systems in the Gulf of Mexico. In Phase IV, we will continue to work with the MMS to capture data from world-wide usage of FPS’s and FPSO’s into a database. We would like the MMS to become more familiar with the usage and merit of these systems as evidenced by the world-wide deployment track record.

DeepStar will continue to provide a forum for open industry discussion on these issues. For example, we cite the April 1997 DeepStar/MMS workshop on FPSO’s, the minutes of which are being offered as an MMS report.

### Flow Assurance Program

The core of the Phase IV Flow Assurance (FA) program is a series of four field tests. The objective of the program is to retrieve sufficient multiphase flow and solids deposition data to validate and improve current FA predictive tools. In addition, available management and remediation technologies will be qualified in the field, not necessarily offshore or even deepwater fields, but the key will be the field scale and location of the tests.

Instrumentation will be a key aspect of the program. We will use both novel and established instrumentation systems, including fiber optics and solids deposition monitors. As noted previously,

the extensive and unique data recorded from this program will be used to validate and improve current FA predictive software.

We plan to field qualify available management and remediation technologies. These will include the latest chemical developments for wax and hydrate inhibition, and possibly other novel approaches. We will field qualify optimum depressuring techniques for hydrate remediation and test the suitability of aggressive and multi-diameter pigs.

In addition to chemical and mechanical strategies, we plan to field qualify an electrically heated pipe system. If this system proves to be a practical solution, it would be able to keep the pipeline out of wax and hydrate formation conditions, and it may also be an excellent remediation tool. This final section of the program will be conducted under the guidance of our subsea committee.

#### Vessel, Mooring, and Riser Committee

This approximately \$1 million program addresses diverse issues related to our need to improve the reliability of deepwater floating structures. Shallow-water fixed platforms have a large, well understood experience base for which analytical tools are well proven. In contrast, floating structures have a small experience base and intrinsic difficulties related to model testing in deepwater where reliability of the design is a central issue of contention.

In Phase IV, we will address deepwater mooring and riser analytic capabilities. In particular, we will focus on mooring and riser systems for applications beyond 1,829 m (6,000 ft) water depth. As mentioned previously, we will likely remove the taut leg polyester mooring test and conduct a post-mortem in the fourth quarter of 1998. The last component is a small effort contributed to the industry by DeepStar to expedite the completion of two industry standards documents. One of them on "Reliability Based Mooring Design Code," may end up being either an ISO or an API document. The other document is API RP 2FPX on "Planning, Designing and Constructing Floating Production Systems." This effort has been languishing, and with DeepStar seed money this effort will see a draft recommended practice (RP) in a much nearer term. However, DeepStar will never become an adjunct to the API or ISO standards committees. Most of what we do will always be near term, proprietary technology development. Only occasionally will we lapse into philanthropy.

#### Drilling and Completion and Reservoir Engineering Committees

These efforts are presently much smaller than the other committees with funding for Phase IV likely to be on the order of \$500,000 and \$200,000 respectively. One issue where these committees do have commonality is on CTR's focused on "Multi-Lateral Completions." Both committees are looking at various aspects of this issue, and a coordinated effort is likely to evolve and bear fruit.

Due to the significant portion of project development budgets spent on drilling, it seems that this is an area ripe for expansion in DeepStar Phase IV. Perhaps what is needed is a new DeepStar participant that is willing to charge new life into this project.



## DEEPSTAR'S FUTURE

When a program has been around for as long as DeepStar, there are many reasons for its success.

Surely, it has met an industry need to develop commonly required technology by using the combined financial and intellectual resources of the 20 ongoing participants. Further, as the industry continues with its strong deepwater focus, coupled with the industry wide shortage of experienced personnel, it is not hard to foresee that the need and benefits of joint efforts will continue. In spite of the evident success, we have to pause and ask ourselves if we are really doing enough to ensure our own industry's growth and vitality.

Patterned after the DeepStar model, many other jointly funded consortiums have been initiated and made to grow in this very active climate. DeepStar should not cover everything, and specialty focused JIP's will continue to evolve afresh in a very dynamic environment. DeepStar has been very successful both in terms of longevity and accomplishments. Though we have not yet done enough, and our task of helping provide a unifying framework for the industry's technology development effort is far from complete. We are still far from what we could achieve in service to our industry.

Here is the dilemma: as more and more operators see the deepwater opportunity, we as an industry expose ourselves to risk if we don't bring along more than just the major oil and gas companies. Although the cost for a new participant in DeepStar is now roughly \$1 million (because participation fees are cumulative), we may be approaching a maximum number of those who will ever join if we don't make changes to the program. Even though all the operators who purchase deepwater leases can surely afford to pay the fees to purchase DeepStar's technology, they are not set up to participate actively. This is a problem that needs resolution, as we would like the industry as a whole to approach deepwater development from a sensible, safety conscious perspective. How can we modify DeepStar to ensure that those smaller participants can gain access to and benefit from our technology in spite of their more limited technology development budgets and staffing policies?

Perhaps we can encourage greater participation with a third tier. Now oil and gas companies essentially fund the program. Vendors contribute technology to the program and become aware of the oil industry's needs for a lesser \$5,000 fee per phase. Perhaps the third tier would consist of the smaller companies that are starting to pick up deepwater activity, yet don't have extensive staff available to follow the whole program in detail. For some lesser fee, they could be allowed into the program as passive participants (non-voting). Perhaps company size may be one of the requirements for achieving the reduced fee, so we don't get every company trying to pay minimum, reneging voting rights and thus negating the size of the program funding. These are issues we must grapple with over the next couple of years.

If DeepStar continues to live on and grow, at some point it may be spun off as a self-sustaining entity. Its vitality as an industry-led consortium can be kept alive by structural changes, such as the requirement that first tier participants not only pay a fee, but further, have an obligation to contribute manpower. Texaco has guaranteed the program over the last six years. But such a commitment must come from a higher level than the senior technical committee within DeepStar. Participants'

corporate technology leaders (presidents and vice-presidents) need to step forward, recognize the benefits they have gained thus far, and express a willingness to share a greater load in ensuring our industry's future prosperity.

---

Paul Hays received his Ph.D. from the University of Illinois at Urbana, Illinois in May 1980. After a brief stint with General Dynamics in Fort Worth focusing on unsteady aerodynamics (flutter), he joined the oil industry in 1981. Paul's whole career focus has been on deep water, although in the beginning, deep water offshore Norway was 305 m (1,000 ft). Gradually the water depth focus increased and the region of interest has come to center on the Gulf of Mexico.

In 1992 the DeepStar project began a program to develop technology to enable extended reach tie-back field development in GOM water depths ranging between 914 and 1,829 m (3,000 to 6,000 ft). Paul began work with DeepStar focusing on pipelines. As the program expanded in Phase II, he took on additional responsibility for production risers. In Phase IIA, he assumed additional responsibility for the drilling and completions committee. Paul assumed responsibility for leading the DeepStar program at the kick-off of Phase III in February 1996.

## **DEEPWATER PIPELINE INSTALLATIONS**

Dr. Robert C. Malahy  
Global Industries, Ltd.  
Houston, Texas

**Disclaimer:** The Session Chair derived the following paper from slides presented by the author at the 1997 Information Transfer Meeting. No manuscript was provided by the author.

### **WHAT IS NEW IN DEEPWATER**

Operators face a new and changing work environment. Risk and cost are proportional to the water depth of a project. There is a shortage of experienced personnel and of pipelaying equipment. There is new emphasis on reliability, planning and training for deepwater operations.

### **WHAT IS REQUIRED IN DEEPWATER**

Dynamically positioned vessels may be used in many deepwater pipeline installations. Pipelaying equipment must face significant challenges, including high-tension capacities on the barges to hold the pipeline and near-vertical departure angles for the pipeline. The industry is faced with the development of new pipelaying techniques to overcome these and many other problems of the deepwater environment.

## DYNAMIC POSITIONING

Dynamic positioning utilizes multiple thrusters within a vessel for station-keeping operations. No anchors are involved. The thrusters are controlled by computers that may be interconnected to a satellite global positioning system. The thrusters will have high-power output to facilitate station keeping under adverse weather and current conditions.

## DEEPWATER PIPELAYING

The catenary pipe span dramatically increases with water depth. High vertical tension is required for these applications. Tension values may approach approximately 1,000+ kips. Low horizontal tension is expected (~10 percent  $T_{top}$ ). Huge stingers may be required to mitigate stress on a pipeline as it exits the lay barge. Departure angle for a pipeline in deepwater may approach 90 degrees. Anchored pipelaying barges may require large winches. Wire line for the anchors may be 7.6 to 12.7 cm (3 to 5 inches) in diameter. Winches may have more than 3,658 m (12,000 ft) of line capacity to ensure adequate anchor line scope for station keeping operations.

## DEEPWATER PIPELAY METHODS

Various pipelaying methods are proposed for deepwater and “transitional” water depths. These methods include:

- Horizontal “Stove Pipe” S-Lay
- Vertical J-Lay
- Reel Methods
  - Horizontal
  - Vertical
- Bottom Tow

### Horizontal “Stove Pipe” S-Lay

For deepwater applications, this method is a modification of the conventional pipe assembly system used in shallow waters. Its advantages include horizontal assembly and multiple work stations. This technology is useful for both shallow or deepwater areas. A limitation to this system is the requirement for a large, complex stinger.

### Vertical J-Lay

The J-lay system has a near vertical departure angle for the assembled pipe. This eliminates the need for a stinger system to support the exiting pipeline. The J-lay method may have high tension requirements. It’s primary limitation is the availability of a single work station because of the near vertical orientation.

## Reel Methods

Advantages to this method of pipelaying include:

- Welding and inspection at onshore facilities,
- Faster lay rates compared to “conventional” assembly lay barges, and
- Less weather sensitive.

Limitations to this method are the size of pipelines that may be reeled, the fact that pipe coated in concrete cannot be laid by this method, and the high cost of mobilization.

Vertical Reel: The vertical reel method has certain advantages, including the fact that the pipe is held in a near vertical manner. No stinger is required with this method. Only ramp levelwinds are required. Vertical reels are limited by their smaller capacity and minimal work space on the reel barge.

Horizontal Reel: The horizontal reel method has advantages over the vertical reel method in that it has an increased capacity and increased available workspace. In addition, conventional pipelaying techniques apply. This method’s disadvantages include the requirement for a stinger system, levelwind tensioners, and specialized pipe straighten equipment.

## Bottom Tow

A few bottom tows have taken place in the Gulf of Mexico Region. The advantages to this method include:

- On shore assembly and inspection,
- Capability to bundle multiple lines into a single segment, and
- Use small, cheaper vessels to tow pipeline.

Higher costs of and increased risks are limiting factors for the bottom-tow method.

## DEEPWATER TERMINATIONS

Three types of deepwater terminations are discussed. They include:

- Steel catenary riser(s),
- Stab and hinge over initiation, and
- Pipeline end manifold with jumper(s).

### Steel Catenary Riser

This system may be used with either fixed or floating production structures. It can serve as a first- or second-end termination. The system is fatigue sensitive and subject to structure motion, vortex vibration, and controlled geometry. Special welding techniques may be required.

### Stab and Hinge Over Initiation

This method may be used for first-end initiation. The system may be installed vertically or may use pull-in cables to “land” components. There are three major components to the system: (1) the collet connector, (2) the male stab (carrot), and (3) the female stab guide.

### Pipeline End Manifold

The pipeline end manifold is used as the second end termination point. Its complexity varies from a simple skid to a complete manifold system. There are four major components to the system: (1) the collet connector, (2) the valve(s), (3) the mud may, and (4) the lay down yoke.

## DEEPWATER PIPELAY VESSELS

The following is a brief description of several deepwater pipelaying vessels. They are “classed” by their lay methodology. Vessels are identified by their company affiliation followed by their name.

- Allseas: *Lorelay*
  - Horizontal “Stove Pipe” S-Lay
  - 360 kips Tension
  - 184 ft Stinger
- Allseas: *Solitaire*
  - Horizontal “Stove Pipe” S-Lay
  - 1,150 kips Tension
  - 360 ft Stinger
- Coflexip - Stena: *Apache*
  - Dynamically Positioned Reel Ship
  - Vertical Reel
  - Up to 14-inch Pipe
  - 280 kips Tension
- Global Industries: *Chickasaw*
  - Horizontal Reel
  - Up to 12-inch Pipe
  - 180 kips Tension
  - 140 ft Stinger
- Global Industries: *Hercules*
  - Horizontal “Stove Pipe” S-Lay
  - Up to 42-inch Pipe
  - Horizontal Reel
  - Up to 18-inch Pipe
  - 1,200 kips Tension
  - 310 ft Stinger
- J. Ray McDermott: *DB 50*
  - Dynamically Positioned Derrick Ship
  - Vertical J-Lay
  - Up to 20-inch Pipe
  - 2,000 kips Tension
- Saipem: *S 7000*
  - Dynamically Positioned Derrick Semisubmersible
  - Vertical J-Lay
  - Up to 36-inch Pipe
  - 2,000 kips Tension

Operators will be faced with some significant challenges as production activities move into the ever-deepening waters of the Gulf of Mexico. Pipeline laying technology will continue to evolve to meet these challenges.

---

Dr. Robert (Bob) C. Malahy is the Deepwater Technology Advisor and “in-house” consultant on deepwater for Global Industries, Ltd., in Houston, Texas. Global Industries is an offshore construction company with operations in the Gulf of Mexico and around the world. Dr. Malahy received his Ph.D in mechanical engineering from Rice University in Houston, Texas. He has worked in the area of offshore pipeline installations for 25 years.

## **DEEPWATER SPILL RESPONSE**

Mr. Harry I. Rich  
Clean Gulf Associates

### **INTRODUCTION**

Oil exploration and production in the deep waters of the Gulf of Mexico present many new logistical and technical challenges. One of the challenges is preparedness to respond in case the extensive preventive measures fail to control and contain the produced well fluids.

This presentation looks at the issues involved in responding to a deepwater oil spill and how that response will be different from a response in more conventional operations.

### **SOURCE CONTROL**

One of the issues of concern will be the availability of rigs if the drilling of a relief well becomes necessary. In today’s deepwater drilling market, few rigs are available that are not presently committed. Consideration should be given to forming cooperative arrangements among operators, whereby rig equipment could be shared in times of an emergency. This would require provisions for the loan of deployed rigs with a plan for suspension of operations.

Other considerations will be the determination of technical expertise required for source control in the deepwater, and the recognition that logistical differences exist that could result in long response times if not properly managed.

### **SURVEILLANCE**

The ability to predict the location of oil as it moves from the seafloor to the surface will be important and is being researched. Due to the variables involved, it will be necessary to utilize all systems

available for the surveillance and tracking once the oil reaches the surface. The industry has substantial tools available for this purpose. The ability to measure and forecast winds and currents is well established. Also available are conventional aircraft, both fixed wing and rotor, as well as remote sensing aircraft and satellite imagery.

#### MECHANICAL CLEAN-UP CAPABILITIES

Substantial oil spill response resources are available to the industry for use in the deepwater Gulf of Mexico. This presentation will focus on the major components to include storage capacity and recovery capacity. Recovery capacity is expressed in barrels of oil per day of EDRC (estimated de-rated recovery capacity). The capabilities of the Marine Spill Response Corporation (MSRC) and Clean Gulf Associates (CGA) were looked at in detail; however, all capacities available to the industry was determined. It should be mentioned that due to a recent partner arrangement between MSRC and CGA, where MSRC maintains and operates CGA equipment, one call now gets equipment from both organizations. The total capabilities from both organizations, along with additional equipment provided by contractors is 406,000 barrels of storage and 247,700 barrels of EDRC.

#### DISPERSANTS

The pre-approval authority granted to the Federal on Scene Coordinator (FOSC) will facilitate the use of dispersants in response to a deepwater oil spill. Certain restrictions apply, such as a ten-meter depth limitation, but these restrictions will not have an adverse impact in the prompt and effective use of this response tool. The successful use of dispersants will be dependent on oil weathering and emulsion formation. Significant stockpiles exist and are readily available for use. Currently, the combined stockpiles of CGA, Louisiana Offshore Oil Port (LOOP), Airborne Support, Inc. (ASI), Clean Caribbean Corp. (CCC), Exxon, and Nalco are 186,000 gallons.

Application and application monitoring equipment for dispersants are also readily available. ASI has one dedicated DC-4 and two dedicated DC-3 aircraft. Other equipment is available from commercial sources. Military C-130 aircraft are also available through the United States Coast Guard (USCG) if commercial assets are not sufficient. Spotter aircraft and monitoring equipment can be obtained through ASI. The USCG also has significant equipment and operators for dispersant application monitoring.

#### *IN SITU* BURNING

As with dispersants, the FOSC also has pre-approval authority for *in situ* burning. This tool will require sufficient fire boom to concentrate oil into a sufficiently thick layer to burn. The successful use of *in situ* burning will be dependent on oil weathering and emulsion formation. Fire boom packages are available from MSRC, Texas General Land Office (TxGLO), CCC, and other contractors and individual companies.

## BEHAVIOR OF DEEPWATER RELEASES

The release of oil from a deepwater blowout is a complicated physical and chemical phenomenon, which requires additional research to more fully understand. Dependent on the properties of the oil released and conditions in the environment, the oil could reach “neutral buoyancy” and cease to rise. The oil could be transported long distances under the influence of subsurface currents. It could also form stable emulsions, which would hinder the effectiveness of conventional cleanup methods.

Additional research is needed in the areas of deepwater blowout behavior that would study phase separation, underwater transport and emulsification. This would also include deepwater blowout modeling, 3-D current modeling and 3-D trajectory models.

Additional surveillance needs must be investigated and made readily available to the industry. Acoustic doppler current profilers are currently installed on some large offshore equipment, such as deepwater rigs and marine construction equipment. This equipment could be used to predict the movement of oil from the seafloor along with sidescan sonar. Other possible surveillance equipment would be the Rossby drifters, which is a drifting buoy equipped with microprocessor-controlled flotation. The buoy is preset to drift at a certain depth and to temporarily surface at a preset interval to report its position via satellite.

## MAJOR DIFFERENCES

Deepwater spill response will differ from conventional response in a number of ways. The underwater migration of oil must be considered and the proper research and planning applied to effectively predict results. The equipment availability and logistical challenges must be properly planned. In addition, due to the higher production capabilities of deepwater wells, spills of larger size are possible. Spill response capabilities in equipment, manpower, and training must be maintained for the larger size spills.

## ACTION TAKEN

All of the issues identified here have been recognized and are being addressed by various groups. The Minerals Management Service (MMS) has the funding to begin deepwater blowout behavior studies and blowout modeling studies. A number of other possible studies are also being considered by the MMS. The Technical/Operations Committee of CGA is currently working on an identification of needs review. The Environmental Sciences Sub-committee on OOC is currently making an assessment of additional research required. An OOC Deepwater Task Force has recently convened to review and formulate directions between regulatory agencies and industry. This group plans to help coordinate the efforts of all other interested parties and address funding needs. The Regulatory Committee of DeepStar is considering funding for some of the areas of concern.

---



Harry I. Rich, a native of New Iberia, Louisiana, graduated with a B.S. degree in mechanical engineering from the University of Southwestern Louisiana in 1969. He joined Texaco that same year and since then has held various positions in petroleum and facility engineering. He is Assistant Regional Manager in Texaco's New Orleans Offshore Region. Harry is currently the Incident Commander for Texaco's corporate Gulf Region Oil Spill Response Team and serves on the Executive Committee of Clean Gulf Associates. He is a registered professional engineer in petroleum engineering.

## SESSION 1B

### NORTHEASTERN GULF OF MEXICO ENVIRONMENTAL STUDIES, PART I

Chair: Dr. Robert Rogers

Co-Chair: Mr. Robert Meyer

Date: December 16, 1997

Presentation	Author/Affiliation
Northeastern Gulf of Mexico Environmental Studies: Overview and Focus	Dr. Robert Rogers Minerals Management Service Gulf of Mexico OCS Region
Northeastern Gulf of Mexico Data Search and Synthesis	Dr. Sneed B. Collard University of West Florida
Northeastern Gulf of Mexico Coastal and Marine Ecosystems Program: Ecosystem Monitoring, Mississippi/Alabama Shelf	Dr. David A. Gettleston Mr. David B. Snyder Continental Shelf Associates, Inc. Jupiter, Florida
De Soto Canyon Physical Oceanography	Dr. Peter Hamilton Science Applications International Corporation Raleigh, North Carolina
Operational Remote Sensing of the Northeast Gulf of Mexico	Dr. Richard P. Stumpf Ms. Heather Henkel U.S. Geological Survey St. Petersburg Florida



## **NORTHEASTERN GULF OF MEXICO ENVIRONMENTAL STUDIES: OVERVIEW AND FOCUS**

Dr. Robert Rogers  
Minerals Management Service  
Gulf of Mexico OCS Region

The Minerals Management Service (MMS) has a lengthy history of sponsoring environmental studies in the Eastern Gulf of Mexico extending back to the initiation of studies in 1974 under the Bureau of Land Management (BLM) Studies Program. The first major study contract awarded was for the Mississippi-Alabama-Florida (MAFLA) Baseline Study. The three-year field effort was a multi-disciplinary description of the environment of the eastern Gulf OCS carried out by the State University System of Florida Institute of Oceanography. The study was designed to provide a baseline of environmental conditions in the study area for assessing later changes due to potential impacts of development activities.

Since that time, approximately 40 studies have been carried out in the eastern Gulf of Mexico at a funding level of approximately \$41 million. Through the years, a number of other MMS-sponsored studies have emphasized such subjects as zooplankton diversity and ichthyoplankton distributions, as well as sea grass locations. Coastal resources have been mapped and profiles prepared for a number of important ecological habitats.

One of the more recent studies has been a survey of six offshore exploratory drill sites in a variety of environments and water depths using a small research submersible. The survey was designed to document variability between sites and changes over time. Study results are available in the report, "Habitat Impacts of Offshore Drilling: Eastern Gulf of Mexico" (OCS Study, MMS 93-0021).

With a renewed interest in gas exploration and development in the eastern Gulf has come the need for a comprehensive plan for carrying out environmental studies in this area. This integrated approach was implemented in 1995. Generally, the approach involved gathering information, both published and unpublished; and presenting it in as useful a format for management decisions as possible. It was envisioned that further field efforts would be formulated from data gaps identified from this information base.

The first study implemented under this integrated approach involved a search of existing environmental and socioeconomic information.. This project was administered by the Biological Resources Division (BRD) of the U.S. Geological Survey and was completed in 1996 as the Northeastern Gulf of Mexico Data Search and Synthesis (OCS Study, MMS 96-0014 through 96-0020).

Results are presented in a multi-volume literature and synthesis report broken into major disciplines (physical oceanography, meteorology, geology, chemistry, biology and socioeconomics). A

conceptual model and identification of data gaps were also presented as an integral part of the synthesis report.

Another study that was administered through the BRD and has recently been completed is the "Characterization and Trends in Recreational and Commercial Fishing from the Florida Panhandle" (OCS Study, MMS 97-0020). The Florida Panhandle supports diverse fish and invertebrate assemblages that form the basis for multi-species commercial and recreational fisheries. The study describes these fisheries and will be used to supplement our information base from which management decisions may be made that affect these fisheries. In 1997, a study entitled, "Ecosystem Monitoring of the Mississippi/Alabama Shelf" was begun to monitor environmental conditions at three distinct types of topographic features present along the Mississippi-Alabama OCS. As this study progresses, seasonal information will be gathered regarding populations and diversity of biological organisms related to turbidity, zonation, and other physical environmental parameters. Environmental information regarding live bottom communities of this multi-year effort will be applicable to offshore habitats of the Florida OCS.

To address physical oceanographic concerns, a workshop was held in Florida in 1994 to discuss studies needs offshore the Florida Panhandle. A number of studies have resulted from this workshop. Another workshop is planned for next summer to discuss future field efforts and how the existing physical oceanographic elements fit into this study design.

Two physical oceanographic studies presently going on are the DeSoto Canyon eddy intrusion and a study of the satellite imagery of the north central gulf of Mexico. The DeSoto Canyon Intrusion study involves a new circulation study with moorings, hydrographic surveys, and remote sensing. Observations began in March 1997 with the deployment of moorings on the slope between the Mississippi Delta and the DeSoto canyon. Measurements will continue until April 1999.

The study of satellite imagery involves the compilation of selected satellite images of relevant processes for preparing a physical oceanography atlas of the area. Data sets will be distributed through an Internet web-site and the archived data will be distributed through CD-ROM.

In 1996, concurrently with the offshore data search and synthesis, a coastal program was initiated to characterize the coastal environment. The overall study purpose was to collect, organize and analyze available coastal information from various disciplines into a data base useful in management decisions. The study is being carried out by the National Wetlands Research Center of BRD in close coordination with state agencies and other federal agencies. Coastal information includes sea grass mapping, wetland habitats, and man's activities (coastal boat launches, waste water treatment sites, marinas, etc.).

As an integral part of this coastal characterization, the development of an offshore live bottom community profile was initiated. This profile will be a compilation of existing information on this important habitat of the northeastern Gulf OCS in order to develop a clearer picture of this important resource. Within the study area, the live bottom communities described are hard bottom communities developed on rock outcrops.

Another MMS-sponsored study that has recently been initiated is the "Assessment of Changes to Coastal Habitats Related to OCS-related Pipelines, Pipelines Canals, Navigation Canals and Mitigation Activities." Most of this study will concentrate on areas of active development such as Louisiana and Texas, but will also include Mississippi and Alabama.

This study is being carried out through an interservice agreement with the National Wetlands Research Center. Acquisition of information will involve a great deal of cooperation with states affected by these coastal development activities and other federal agencies involved in regulations and permits.

The purpose of this Information Transfer Meeting (ITM) session was to provide researchers involved with a number of these MMS-sponsored environmental studies in the northeastern Gulf of Mexico an opportunity to describe their projects and present some of their more significant findings. Most of these projects have been progressing for a number of years with a few recently having been completed.

---

Dr. Robert Rogers is an oceanographer on the Environmental Studies Staff of the MMS Gulf of Mexico Regional Office. He has been active for the last few years in the design and coordination of MMS studies related to the northeastern Gulf of Mexico. Dr. Rogers received his B.S. and M.S. degrees from Louisiana State University and Ph.D. from Texas A&M University.

## **NORTHEASTERN GULF OF MEXICO DATA SEARCH AND SYNTHESIS**

Dr. Sneed B. Collard  
University of West Florida

### INTRODUCTION

Marine environments are described in terms of real, though sometimes rather vaguely defined ecological units which, in order of increasing size, complexity and inclusiveness, are recognized as communities, ecosystems or "ecoregions." As shown in Figure 1B.1, the continental shelf of the northeastern Gulf of Mexico (NEGOM) is an ecoregion extending from Perdido Bay to the Big Bend, and from the shoreline to the shelf break (~ 29° N; 82°40' W to 87°30' W).

As the title suggests, the work involved two primary tasks. The first was to determine what was known, what was not known, and what needed to be learned about the ecology and oceanography of the NEGOM. The second was to construct a conceptual ecological (trophodynamic) model of the region based on a synthesis of existing information. The problem was approached by: (1) gathering and summarizing information by discipline (data search); (2) assessing the depth and quality of

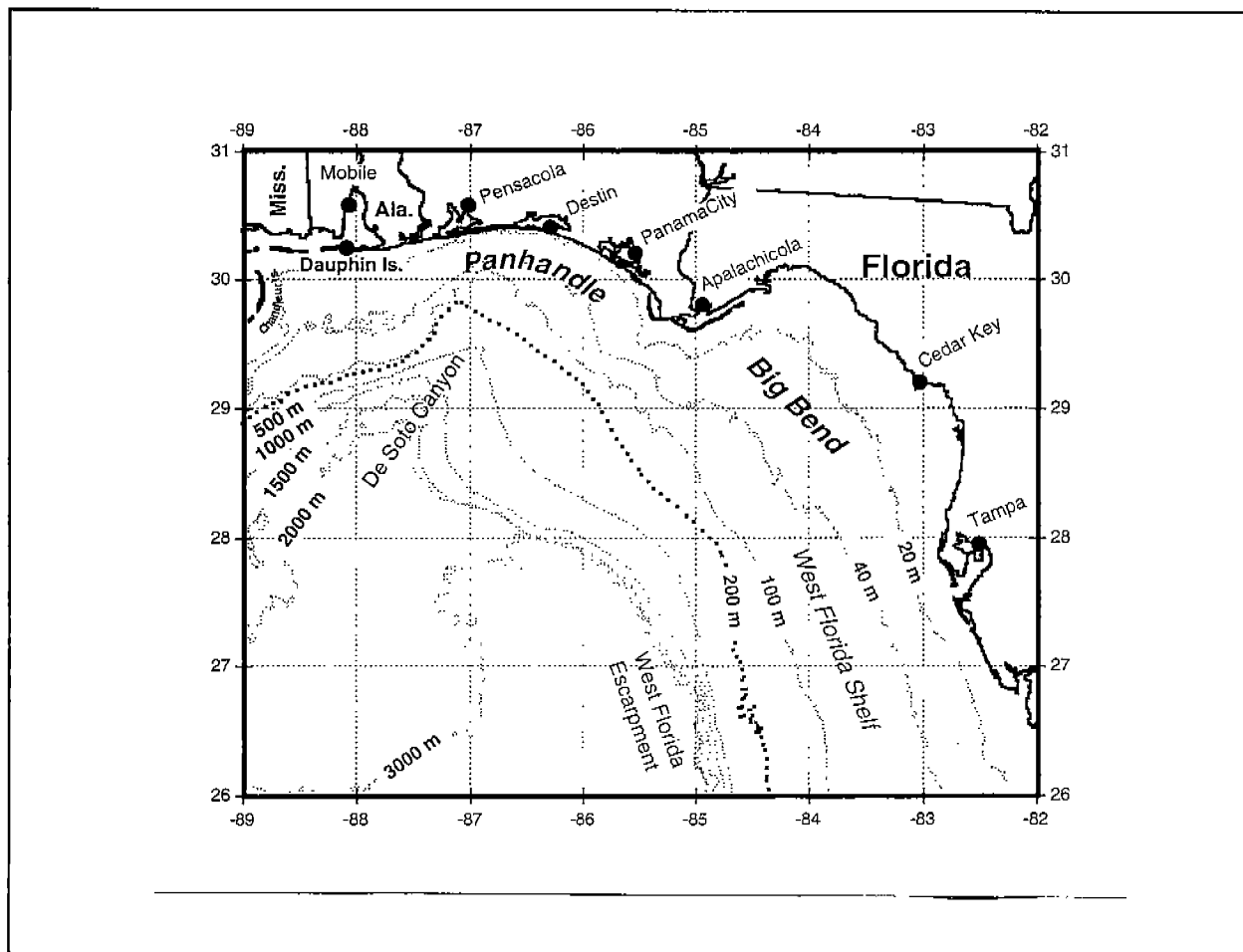

Figure 1B.1. Map of the region showing bathymetry, various features, and key locations.

information; (3) identifying non-trivial data gaps; and (4) synthesizing information across disciplines in conceptual ecological models of the region, its subregions, and its major ecosystems (synthesis). Biological aspects of the work (from Chapters 5 and 7, in SAIC 1997) are emphasized below.

#### DATA SEARCH

In addition to an intensive Dialog®-based electronic search of the literature described in SAIC (1997), additional biology-related citations and abstracts were obtained using Biosis®, ASFA, Water Resources Abstracts, First Search®, Waterlit® and Aqualine® databases. On-site literature searches were conducted at eight EPA and nine NOAA laboratories, five universities, six research institutions and numerous agencies. A significant amount of useful unpublished information (including works in progress), was obtained during interviews with investigators from, among other organizations, USFWS, NMFS, USGS, USACE, Florida Marine Research Institute, Florida Institute of Oceanography, Center for Marine Conservation, Northwest Florida Water Management District, Florida Natural Area Inventory, Nature Conservancy, Panhandle Regional Environmental Center, Florida Department of Community Affairs, Florida Game and Freshwater Fish Commission, Florida

Department of Transportation and the Coastal Plains Institute. In all, 1,693 relevant biological documents were obtained during this phase of the project. Information obtained from the literature, unpublished works, and the author's field collection records was incorporated into a brief biological characterization of the NEGOM.

#### SYNOPSIS OF INFORMATION AND REGIONAL DATA GAPS

From shore to the continental shelf-slope boundary, geological, sedimentological, chemical, hydrological, physical oceanographic and biological features of the Florida Panhandle (~ Perdido Key to Cape San Blas), and the Big Bend (~ Ochlockonee Bay to Cedar Key), are sufficiently different to be considered putative "core subregions" of the NEGOM. A transition zone with fuzzy boundaries (~ Cape San Blas to Ochlockonee Bay), lies between western and eastern subregions.

The major physiographic feature of the NEGOM is DeSoto Canyon, which dominates the eastern Gulf of Mexico basin. The major coastal feature of the region is Cape San Blas, which lies northeast of the canyon. The shelf is relatively narrow near the head of DeSoto Canyon, and progressively broadens to the east and southeast. The Panhandle, from Perdido Bay to eastern Apalachicola Bay-St. George Sound, is a moderate-to-low energy, sandy coast, characterized by an almost continuous chain of barrier islands and embayments. There are no barrier islands east of Ochlockonee Bay, which marks the western boundary of the low energy, brackish water Big Bend region.

Basin circulation in the NEGOM is dominated by the Loop Current (LC), which transports warm, salty, oligotrophic water and tropical organisms into the eastern Gulf of Mexico. The behavior of the LC and its eddies is complex, and the extent and biological consequences of coupling between shelf and basin watermasses and currents are not clear. Periodic incursions of LC-derived water transport subtropical-tropical species into shelf and nearshore environments where, given suitable substrates and warm-water conditions, they form minor components of Panhandle species assemblages. The role of shelf currents in the fate and transport of nutrients, meroplankton (*e.g.*, larval fishes, developmental stages of benthic invertebrates), pelagic organisms (phytoplankton, zooplankton, fishes), and toxic substances (*e.g.*, hydrocarbons, trace metals), is poorly known.

Net transport of sediments and larval organisms in nearshore/longshore currents is to the southeast from the eastern side of Cape San Blas, and northwest from the western side of the Cape. Circulation in Panhandle estuaries is highly variable, and depends upon river flow, tides, basin geometry, bathymetry, winds and other factors. Regional estuaries are shallow, drowned river valleys, and may be well-mixed or highly stratified and hypoxic during summer months. Sediments, nutrients and pollutants are largely, but not wholly retained within these embayments.

Inner and middle shelf sediments west of Cape San Blas are predominantly sandy, with patches of shell rubble and algal nodules. Fines accumulate in pockets between sand ridges. East of St. Vincent Island (Apalachicola Bay), nearshore sediments are described as sandy, with transitional carbonate-quartz substrata on the inner shelf, and carbonaceous sediments on the middle shelf. Limestone outcroppings in the Big Bend, and rock pinnacles near the steeply terraced head of DeSoto Canyon provide hard substrate habitats. Species assemblages characteristic of unconsolidated, oxygenated



sands dominate benthic shelf communities inshore of DeSoto Canyon. Sediments in water deeper than 100 m are largely comprised of compact clays, and the fauna of these substrates is depauperate.

As discussed elsewhere (SAIC 1997), nutrients are contributed to shelf waters via large fresh and brackish water discharges from the Mississippi River and Mobile Bay, respectively. In contrast, nutrient enrichment of shelf waters from western Panhandle estuaries is relatively low. Numerous small rivers enter the Big Bend “open estuary,” but their nutrient contribution to shelf waters is apparently minor. Deep, nutrient rich water is upwelled into the euphotic zone along northern portions of the West Florida Shelf, south of Cape San Blas, and along eastern portions of DeSoto Canyon.

Primary productivity in the NEGOM increases from offshore to coastal waters as a function of nutrient availability. Shelf phytoplankton production is highest in upwelling areas and in coastal frontal zones, and may impact production rates downstream from these areas. However, neither the fate and transport of energy nor the relationship between water column primary production and benthic secondary production on the shelf have been adequately investigated. Estuarine primary production is high or very high, and many of the region’s estuaries have reached or exceeded their assimilative capacity for nutrients. Salt marsh, seagrass and benthic algal production varies considerably between different panhandle estuaries, but a majority have experienced decreases in marsh and seagrass habitats during the past two to three decades. Losses of these two community types have resulted in decreases in fish and invertebrate diversity, and are symptomatic of degraded environmental quality.

In general, the diversity of shelf and coastal fish communities is high and remarkably uniform throughout the region. The NEGOM shelf is reported to be inhabited by twice as many species and eight times as many unique (endemic) species as the northwestern Gulf shelf. Differences in the composition of fish assemblages on the shelf are related to depth and substrate type, and exhibit variation corresponding to developmental and reproduction-related movements from one habitat to another (*e.g.*, open ocean to estuary). Estuaries in the NEGOM support similar fish faunas, with the same or very nearly the same ten numerically dominant species.

Although knowledge of benthic invertebrate communities on the NEGOM continental shelf is limited, epifaunal and infaunal species assemblages vary, as do the fishes, with depth and substrate type. In decreasing order of their numerical abundance and species diversity, polychaetes, decapod and amphipod crustaceans dominate shelf habitats. One-fourth to one-third of the polychaetes collected on the shelf were allied with either West Indian or Carolinian faunal provinces, some 25-30% were Gulf of Mexico endemics, and a somewhat smaller number of species were cosmopolitan. Outer shelf invertebrate collections suggest that tropical species become more common with increasing depth. The composition of estuarine benthic communities is regulated by a large suite of environmental variables. Among the most important of these are substrate type and quality, depth of the redox layer, salinity and water quality, including dissolved oxygen levels.

The water quality of regional estuaries is reported to be “generally good.” However, decreased diversity within benthic invertebrate and fish communities as a result of the progressive

disappearance of salt marsh and seagrass habitats suggests that some decrease in the overall environmental quality of most Panhandle embayments and coastal waters has occurred over the past 20-30 years. Hypoxia, anoxia, thermal and osmotic stress, pollutants and toxic algal blooms contribute to, or cause episodic mass mortality events in the region's estuaries and coastal waters. Using biotic richness and diversity as indicators, the environmental "quality" of NEGOM embayments apparently increases from west to east.

#### SHELF-SPECIFIC DATA GAPS

The frequency, duration, scale and physical-chemical characteristics of upwelled water in northern portions of the West Florida Escarpment (the "Green River" seen in satellite images of the northern Gulf), at the head of DeSoto Canyon, and in the region south of Cape San Blas, warrant investigation and documentation. Short-term, episodic upwelling in these, and possibly other areas associated with the NEGOM shelf-slope boundary, may bring nutrient-rich water to the surface, and periodically increase local and downstream primary productivity. If upwelling is a frequent occurrence in some or all of the areas mentioned, nutrient enrichment in the euphotic zone may influence patterns of water column production over relatively large areas of the NEGOM and may, via trophic coupling (*e.g.*, developmental migrations, fecal pellet "fallout"), turbulent mixing, and downwelling at frontal boundaries, significantly impact secondary production in benthic communities of the shelf (Figure 1B.2).

As discussed in SAIC (1997), physical oceanographic processes in NEGOM shelf waters are complex. Knowledge of the origin, fate and transport of nutrients, toxic substances and pelagic organisms (primary producers, holozooplankton and meroplanktonic invertebrates and fishes) depends to a large extent on knowledge of episodic and "on average" interactions between coastal,

shelf and Loop Current (or LC-derived) watermasses. The sources, pathways and sinks of energy flow within and between ecosystems and their major biological components is a fundamental ecological question. While some understanding of salt marsh, estuarine and nearshore trophodynamics in the NEGOM has been acquired, very little is known about ecological processes on the continental shelf. Lacking more detailed information on physical oceanographic processes, biological processes can neither be described nor understood (Figure 1B.3)

Significant amounts of particulate and dissolved organic material (POM, DOM), other nutrients, suspended sediments and fresh water discharged from the Mississippi River and, to a lesser extent, from Mobile Bay, enter NEGOM shelf waters. Water column and benthic communities of the outer shelf west of DeSoto Canyon may be influenced by Mississippi River water, while inner shelf community structure may be influenced by eastward flowing water from Mobile, and perhaps Perdido Bay. The physical-chemical and consequent biological significance of these two major freshwater discharges into western portions of the NEGOM have not been adequately assessed.

The distribution of sand substrata on western portions of the middle shelf may not be uniform (Chapter 3 in SAIC 1997). Echinoderms and other taxa characteristic of fine, clastic, carbonate, and

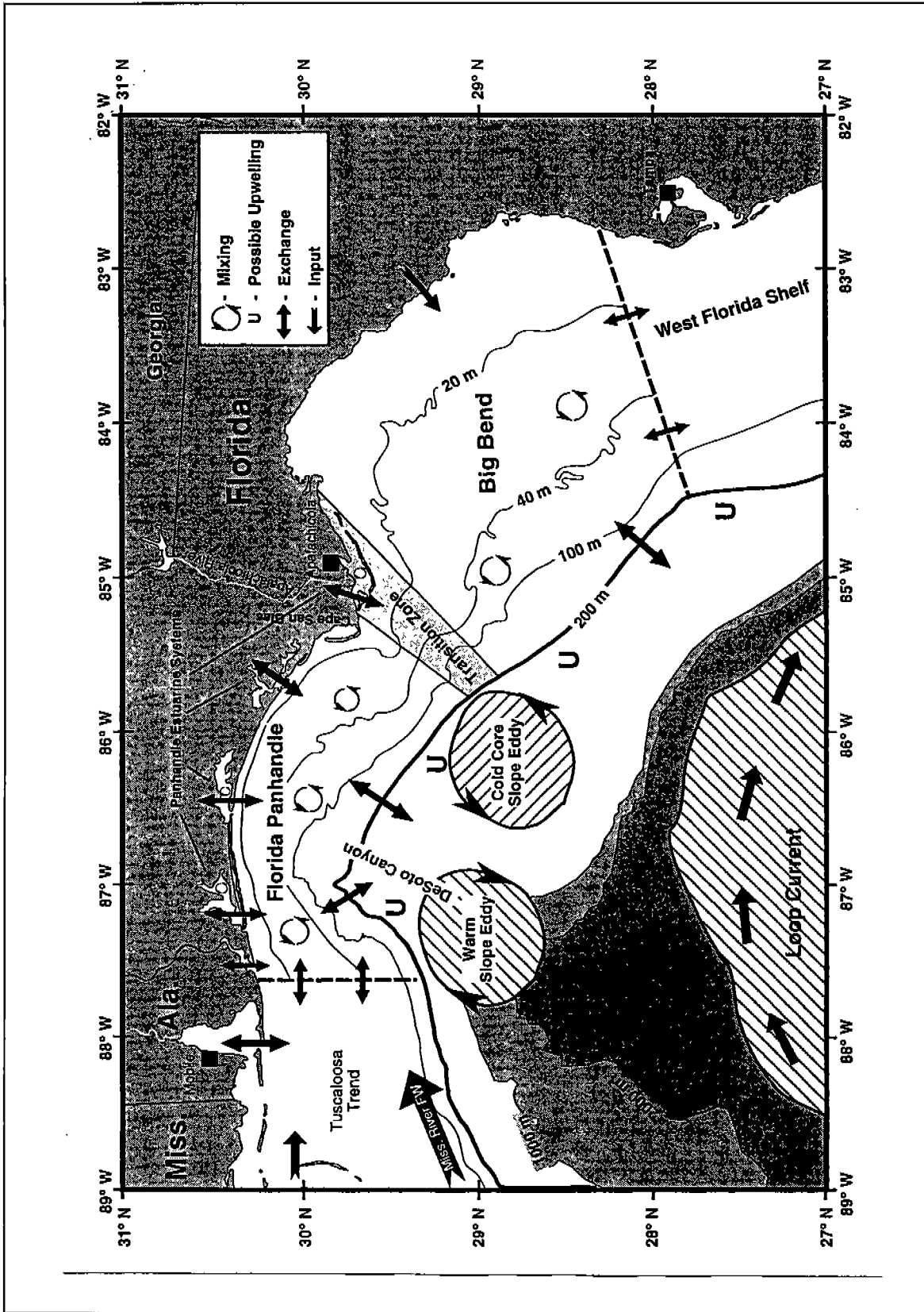

Figure 1B.2. Map of the northeastern Gulf of Mexico showing the boundaries of the study area and ecosystem core regions. Major physical exchange paths and forcing mechanisms are indicated schematically.

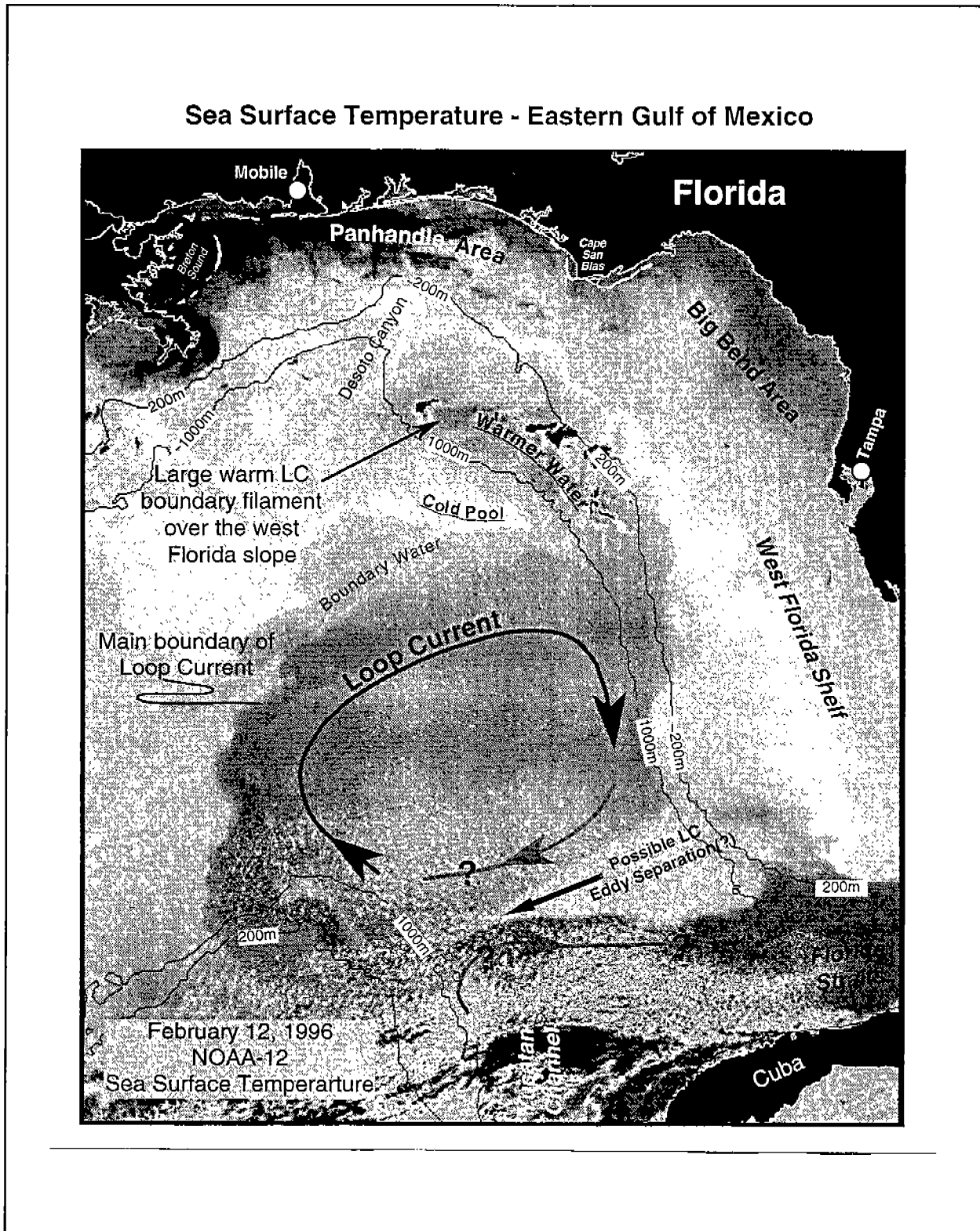

Figure 1B.3. Labeled satellite image showing Loop Current, possible LC eddy separation, large boundary filament over slope and outer shelf offshore of the Big Bend Area.

hard substrates have been reported, and the distribution and areal extent of these non-sandy patches requires further documentation.

Biological communities of the Big Bend continental shelf and their trophodynamic interactions with coastal, West Florida Shelf, Loop Current, and upwelled basin water are poorly understood. This region of the NEGOM seems to be physicochemically and geologically unique, and this may be reflected in the structure of its benthic biological communities. Because the biological importance of shelf communities of the Big Bend has not been adequately assessed, a multidisciplinary investigation of this area is warranted.

The quasi-seasonal occurrence of tropical pleuston (*e.g.*, *Physalia*, *Velella*, *Porpita*), macroplankton (*e.g.*, salps, pteropods) and reef fishes (*e.g.*, *Chaetodon* spp., *Pomacanthus* spp.) in Panhandle coastal waters suggests that intrusions of subtropical-tropical water may reach nearshore environments. While the occurrence of surface-associated organisms such as *Sargassum* spp., and some of the chondrophores, jellyfishes and ctenophores stranded on beaches or transported into estuaries can be explained by wind drift, subsurface species are likely to have been advected inshore by currents. Tropical invertebrates and fishes are commonly encountered on and near artificial "reefs" which are commonly deployed on sandy (*i.e.*, soft) bottoms unsuitable for colonization by "live-bottom" epifaunal animals. The presence of tropical benthic adults on hard-substrates suggests that: (a) planktonic stages of subtropical-tropical species are not uncommon in shelf waters; (b) the predominance of soft substrates in the western portion of the NEGOM may limit the distribution of adults of these species in benthic shelf communities; and (c) benthic species assemblages characterized from trawl catches may not reflect the species composition and diversity of *potential* benthic communities, which are controlled by substrate type rather than by recruitment constraints. This speculation has significance when, as is often the case, epibenthic species diversity is used as a surrogate indicator of environmental quality. The distribution of hard substrates and associated benthic organisms deserves further investigation.

The distribution of sargassum and its inquilines in the eastern Gulf of Mexico has received scant attention. Remote sensing of the distribution of "Gulf weed" (primarily *Sargassum natans* and *S. fluitans*) may reveal valuable information about sea states and, more importantly, the distribution and longevity of frontal zones and boundaries. Sargassum as an important habitat (*e.g.*, for larval fishes; hatchling and post-hatchling sea turtles) has not been investigated in the eastern Gulf of Mexico.

Artificial reefs of various sizes and materials are being deployed with increasing frequency on the inner shelf. Some of these reefs are unstable during heavy storm conditions because of their small size and/or placement. While much has been written about the presumed benefits of artificial substrates (increased productivity, etc.), relatively little work has been done on assessing the possible negative impact of these materials on natural communities. For example, it would be of value to know whether the translocation and/or destruction of artificial reefs during the three hurricanes of 1995 negatively impacted "natural" live bottom communities in the vicinity of their original location. The long-term impact of artificial reefs on the abundance and sustainable yields of recreationally and commercially important fish species remains uncertain, although a relatively large literature on the subject is available.

## REFERENCES

Science Applications International Corporation. 1997. Outer continental shelf environmental studies program: Northeastern Gulf of Mexico coastal and marine data search and synthesis; Synthesis Report. U.S. Dept. Of the Interior, U.S. Geological Survey, Biological Resources Division, USGS/BRD/CR — 1997-00004. 304 pp.

---

Dr. Sneed Collard is a professor of biology at the University of West Florida and Director of Marine Biological Research at Armstrong Laboratory, Tyndall Air Force Base. His research area is biological oceanography with a current emphasis on marine biosensors. Dr. Collard received his B.A. and M.A. degrees in zoology and his Ph.D. degree in biology from the University of California, Santa Barbara.

**NORTHEASTERN GULF OF MEXICO COASTAL AND MARINE ECOSYSTEMS  
PROGRAM: ECOSYSTEM MONITORING, MISSISSIPPI/ALABAMA SHELF**

Dr. David A. Gettleson  
Mr. David B. Snyder  
Continental Shelf Associates, Inc.  
Jupiter, Florida

## INTRODUCTION

Continental Shelf Associates, Inc. (CSA) was awarded a contract by the U.S. Geological Survey, Biological Resources Division to conduct an ecological study of an area offshore Mississippi/Alabama. The project team consists of CSA, the Geochemical & Environmental Research Group of Texas A&M University, University of Texas, Applied Marine Sciences, Inc., and independent consultants.

## GEOGRAPHIC AREA OF STUDY

The geographic area of study is the Mississippi-Alabama pinnacle trend area in approximately 50 to 150 m water depths (Figure 1B.4). Several studies have been conducted in the area, which was first described by Ludwick and Walton (1957). There have been four Minerals Management Service-funded studies (Woodward-Clyde Consultants 1979; Texas A&M University 1990; Continental Shelf Associates, Inc. 1992; Shinn *et al.* 1993) and an oil and gas lease block clearance survey (Continental Shelf Associates, Inc. 1985) conducted in the area.

## STUDY OBJECTIVE

The objective of this study is to describe and monitor biological communities and environmental conditions at hard-bottom features located within the geographic area of study. A number of oil and gas lease blocks are encompassed by the study area with at least one oil and gas production platform present. Information gained from this study will be used to review existing lease stipulations to determine their adequacy in protecting the biological communities present on the hard-bottom features. This study also meets several objectives of the National Research Council (1992) regarding the assessment of environmental impacts from oil and gas operations. These objectives include (1) identifying representative species; (2) describing seasonal patterns; (3) acquiring basic ecological information for key or representative species; and (4) obtaining information on factors that determine sensitivity of biota to outer continental shelf activities and their recovery potential.

## STUDY COMPONENTS

The 4-year study is divided into four phases of one year duration each with annual reports planned at the end of each phase. The phases are as follows:

- Phase 1 - Reconnaissance, Baseline, and Monitoring;
- Phase 2 - Monitoring;
- Phase 3 - Monitoring; and
- Phase 4 - Data Interpretation and Information Synthesis.

Five of the 11 cruises planned for the study have been completed. These encompassed reconnaissance (1 cruise), baseline (1 cruise), monitoring (2 cruises), and mooring servicing (1 cruise). During the reconnaissance portion of Phase 1, five "megsites" (Figure 1B.4) (approximately 25 to 35 km<sup>2</sup> areas) were selected for detailed study. These sites were selected as being representative of the hard-bottom features previously identified in the area (Texas A&M University 1990; Continental Shelf Associates, Inc. 1992). The megasites were surveyed in November 1996 using swath bathymetry, high resolution side-scan sonar (11 and 72 kHz), and a subbottom profiler (2 to 8 kHz). Nine areas of approximately 0.2 to 1.5 km<sup>2</sup> size were selected during the cruise and surveyed in more detail. Previously collected video and still photographic data from these nine sites were reviewed and additional visual data collected using a remotely operated vehicle to aid in the selection of nine study sites. The study sites were selected to provide representative hard-bottom features of high, medium, and low relief in the eastern, central, and western portions of the study area (Figure 1B.4).

The focus of the baseline and monitoring portions of the study is to understand the geological and oceanographic processes as factors in controlling/influencing the hard-bottom communities at the nine study sites. Data were gathered during the reconnaissance survey on substrate characteristics; hard-bottom orientation, size, and morphology; and depth of surrounding soft sediments. Two of four baseline and monitoring cruises have been completed (April and October 1997). The remaining two monitoring cruises will be conducted over a 2-year period (April 1998 and April 1999). Data on microtopography are being obtained from the collection and analysis of rock samples and video and photographic data during these cruises. Grab samples collected during the monitoring cruises

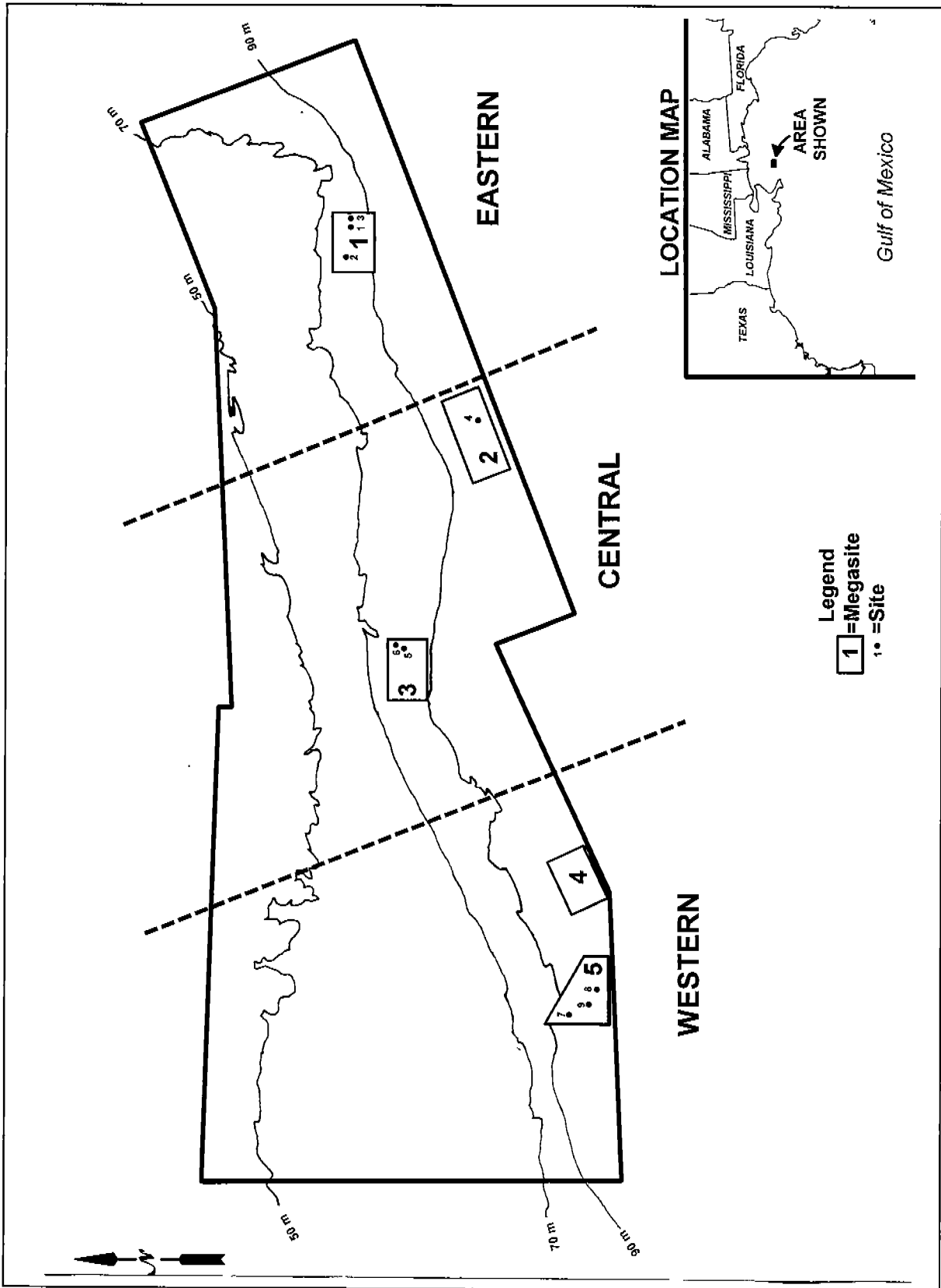

Figure 1B.4. Locations of final monitoring sites.



are being analyzed for grain size (four cruises) and concentrations of hydrocarbons and metals (first cruise only). Six instrument arrays comprised of current meters; sediment traps; and temperature, salinity, dissolved oxygen, and turbidity (optical backscattering) sensors were deployed during the first cruise in the vicinity of the hard-bottom features. The arrays are being recovered and redeployed at 3-month intervals and recovered on the fourth monitoring cruise. Sediment trap contents are being analyzed for grain size, total inorganic and organic carbon, and metals. During each of the four cruises, water column profiles are being made for conductivity, temperature, dissolved oxygen, transmissivity, and optical backscatter, and samples are being collected for analysis of particle sizes, dissolved oxygen, and salinity.

Biological data includes quantitative still photographs from fixed quadrants and random stations and quantitative video from random transects during the four cruises. Voucher specimens are also being collected to aid in taxonomic identifications of biota observed in the visual data. Fish assemblages associated with the study sites are being described from the available visual data collected during the monitoring surveys. There are two additional biological "companion" studies. The first involves a more in-depth analysis of the biological, geological, and physical data on a micro-habitat basis. The second involves the deployment of settling plates on fixed arrays to study epibiota recruitment, growth, and community development. Settling plate arrays include enclosed and non-enclosed plates plus controls to study predation/disturbance effects. Plates were placed near bottom and above any identified nepheloid layer. Eight arrays were placed at one site, and one array is being recovered each quarter. One array was also placed at each of three additional sites to be recovered after 1 year. An additional array will be deployed at each of the three sites after 1 year and recovered after a 1-year deployment.

The data interpretation and synthesis efforts will involve understanding the relationship of the measured geological and physical factors to the hard-bottom communities through statistical analyses. A series of questions determined by the study objective with clearly stated null hypotheses will also be identified and statistically tested.

#### REFERENCES

- Continental Shelf Associates, Inc. 1985. Live-bottom survey of drillsite locations in Destin Dome Area Block 617. Report to Chevron U.S.A., Inc. 40 pp. + app.
- Continental Shelf Associates, Inc. 1992. Mississippi-Alabama Shelf Pinnacle Trend Habitat Mapping Study. OCS Study MMS 92-0026. U.S. Department of the Interior, Minerals Mgmt. Service, Gulf of Mexico OCS Regional Office, New Orleans, La. 75 pp. + app.
- Ludwick, J.C. and W.R. Walton. 1957. Shelf-edge, calcareous prominences in the northeastern Gulf of Mexico. *Amer. Assoc. Petrol. Geol. Bull.* 41(9):2,054-2,101.
- National Research Council. 1992. Assessment of the U.S. Outer Continental Shelf Environmental Studies Program. Volume II: Ecology. National Academy Press, Washington, DC. 152 pp.

Shinn, E.A., B.H. Lidz, and C.D. Reich. 1993. Habitat impacts of offshore drilling: Eastern Gulf of Mexico. OCS Study MMS 93-0021. U.S. Department of the Interior, Minerals Mgmt. Service, New Orleans, La. 73 pp.

Texas A&M University. 1990. Mississippi-Alabama Continental Shelf Ecosystem Study Data Summary and Synthesis. OCS Study MMS 91-0063. U.S. Department of the Interior, Minerals Mgmt. Service, Gulf of Mexico OCS Regional Office, New Orleans, La.

Woodward-Clyde Consultants. 1979. Eastern Gulf of Mexico marine habitat mapping study. Report to U.S. Department of the Interior, Bureau of Land Management, OCS Office, New Orleans, La. Contract No. AA551-CT8-22.

---

Dr. David A. Gettleson is President and Scientific Director of Continental Shelf Associates, Inc. (CSA), located in Jupiter, Florida. He has 19 years of scientific management experience with major research programs for federal, state, and industrial clients. He has been involved in the preparation of numerous environmental assessment documents covering a wide range of human activities in the marine environment, including oil and gas operations, dredging and dredged material disposal, beach restoration, artificial reef siting, power plant effluents, sewage outfalls, and waste incineration. Dr. Gettleson received a B.A. degree in biology from Rollins College in 1971 and earned his Ph.D. degree in biological oceanography from Texas A&M University in 1976.

Mr. David B. Snyder is a Senior Staff Scientist with CSA. He has 14 years of experience with aquatic environmental assessment and research programs for federal, state, and industrial clients. He has participated as research or chief scientist on over 50 scientific cruises conducted in domestic and international waters. Mr. Snyder has managed several fishery-related projects, including bycatch studies, life history studies, and ichthyofaunal assessments in a variety of marine and freshwater habitats. Mr. Snyder received a B.S. degree in zoology from the University of Florida in 1978 and an M.S. degree in ichthyology/marine biology from Florida Atlantic University in 1984.

## DE SOTO CANYON PHYSICAL OCEANOGRAPHY

Dr. Peter Hamilton  
Science Applications International Corporation  
Raleigh, North Carolina

### INTRODUCTION

The physical oceanography of the northeastern Gulf of Mexico continental slope is being investigated with a new circulation study involving moorings, hydrographic surveys and remote sensing. The experiment began in March 1997 with the deployment of 13 moorings on the slope between the Mississippi Delta and the De Soto canyon. Measurements will continue until April 1999. Major objectives are to investigate the effect of the Loop Current eddies and Loop Current derived intrusions on the slope and outer shelf circulation, exchange processes between the slope and shelf, and the characteristics of the eddy field over the slope. The moored array has high resolution in the along—and across—slope directions as well as in the upper 100 m of the water column through the use of acoustic Doppler current profiler (ADCP) instruments. This is the first time that such extensive current measurements have been made on the northern Gulf of Mexico slope. The experiment has been designed to resolve important eddy scales that have previously only been observed in high resolution hydrography (Berger *et al.* 1996). This data will also be very useful to numerical model studies of the Gulf in that it will provide verification and process information on the smaller scale eddy fields and shelf-slope exchange that the models need to be able to reproduce.

The first two, four-month, deployments have been successfully completed, along with three hydrographic surveys. This paper will discuss the preliminary interpretations of the first deployment (March to July 1997) and the first two hydrographic surveys. Figure 1B.5 shows the positions of the moorings and CTD station positions of the surveys. All moorings except D9 were equipped with a 300 KHz ADCP at 80 or 90 m which produced velocity data at 2 m intervals to within 8 or 10 m of the sea surface. The moorings on the 500 and 1300 m isobaths also had instrumentation at deeper levels. The D9 instrumentation is a 150 KHz ADCP at 200 m which profiles in 8 m bins to within 30 m of the surface.

### RESULTS

The characteristics of the subtidal current fluctuations from the first deployment show some similarities with the shelf break measurements made by LATEX A on the Louisiana and Texas shelves. Flows can be quite sustained over several weeks with variances in the across isobath direction being nearly as large as in the along isobath direction. Higher frequency fluctuations are more prevalent at the shelf break and near the canyon (D1 and D9). Flows are also highly variable in space, often going in opposite directions at adjacent moorings. The mean current vectors and standard deviation ellipses for the 40-HLP records at selected depths are given in Figure 1B.5. The upper 100 m of the water column is well illustrated by the 30 m depth statistics which show generally eastward mean flows following the general trend of the isobaths. The fluctuation ellipses

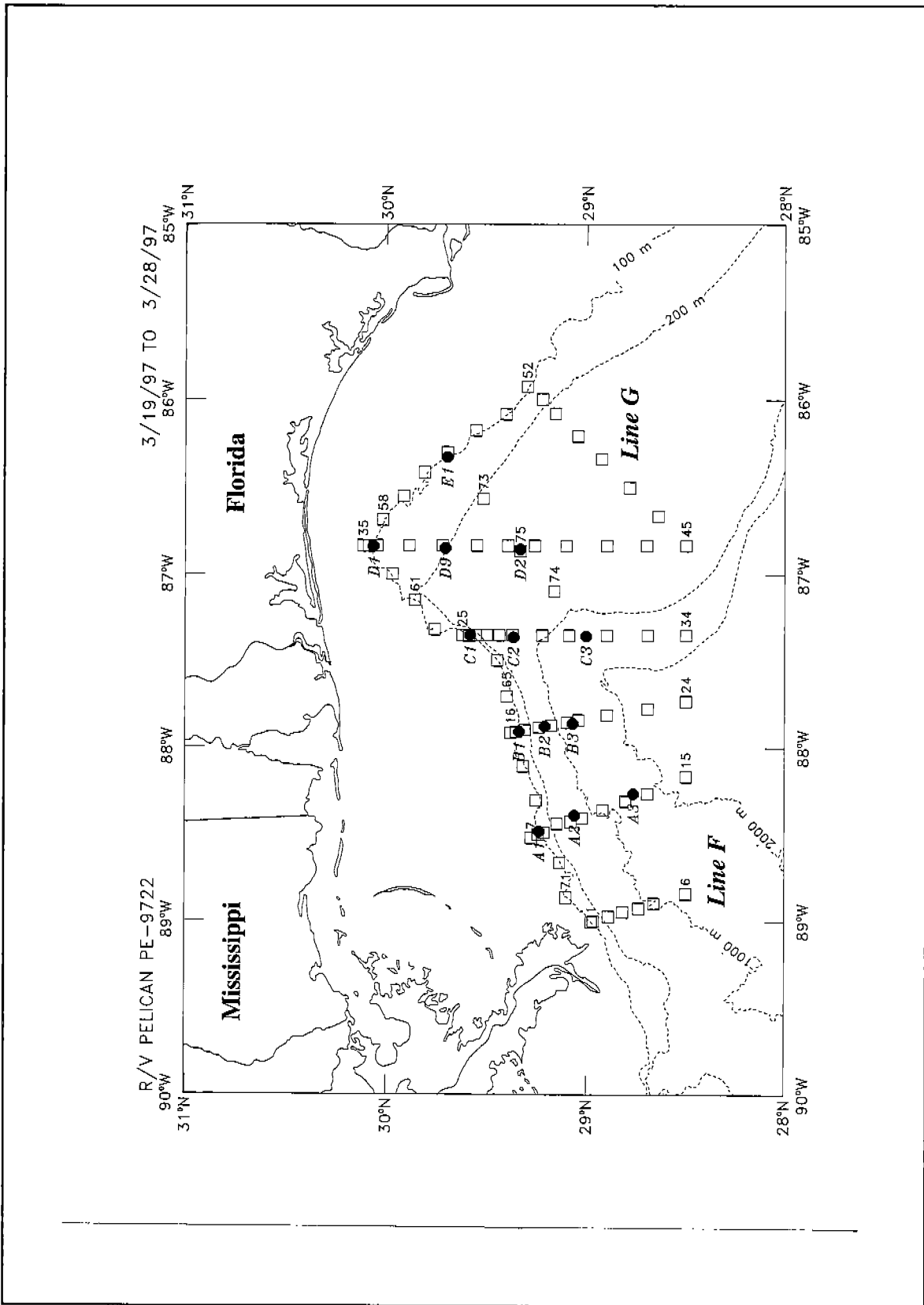

Figure 1B.5. Map of mooring positions (solid dots) and standard hydrographic (CTD) stations (open squares) for the De Soto Canyon experiment.

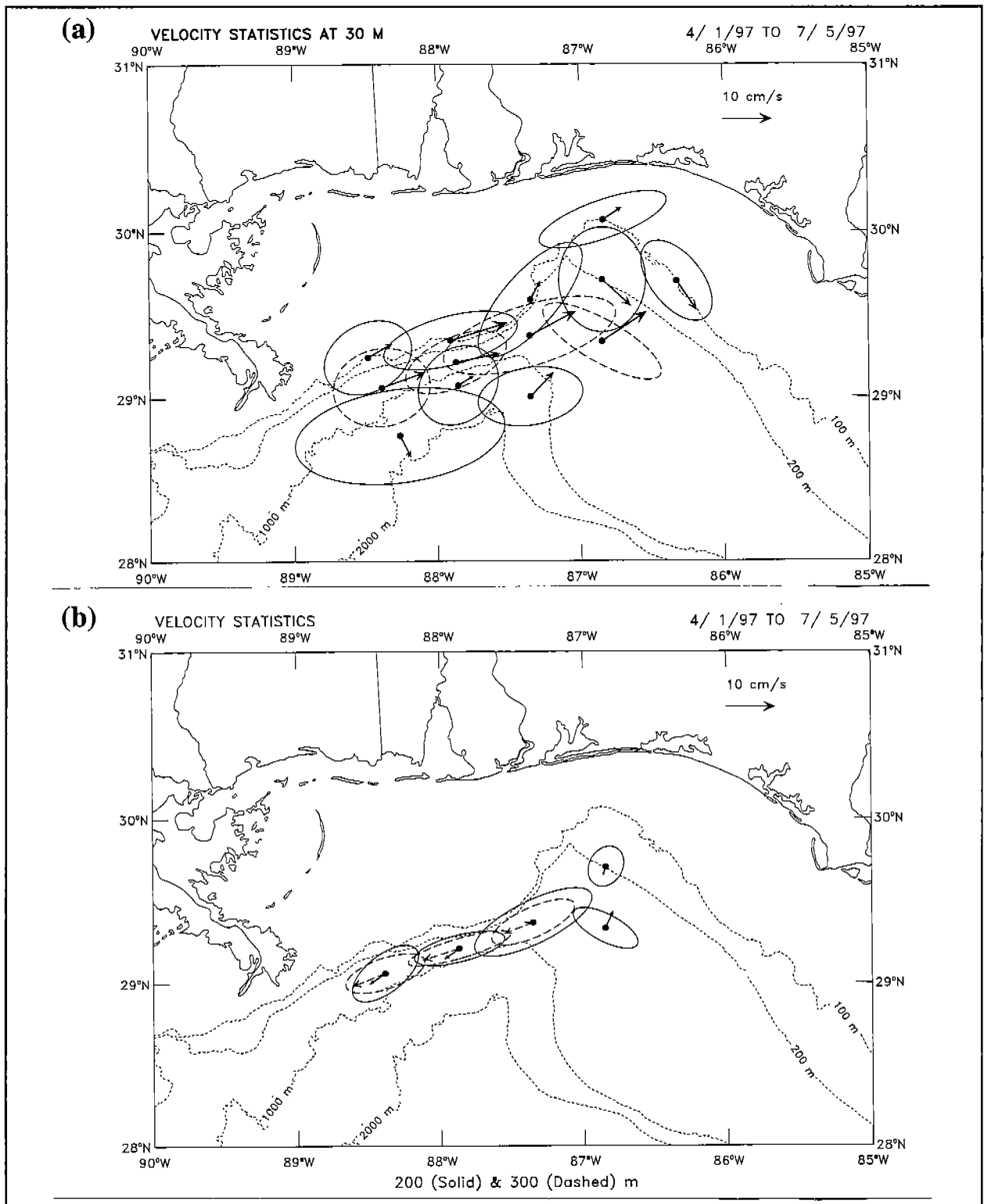

Figure 1B.6. Mean 40-HLP current velocities and standard deviation ellipses for (a) 30 m depth level, and (b) the 200 (solid) and 300 (dashed) m depth levels, for the indicated period.

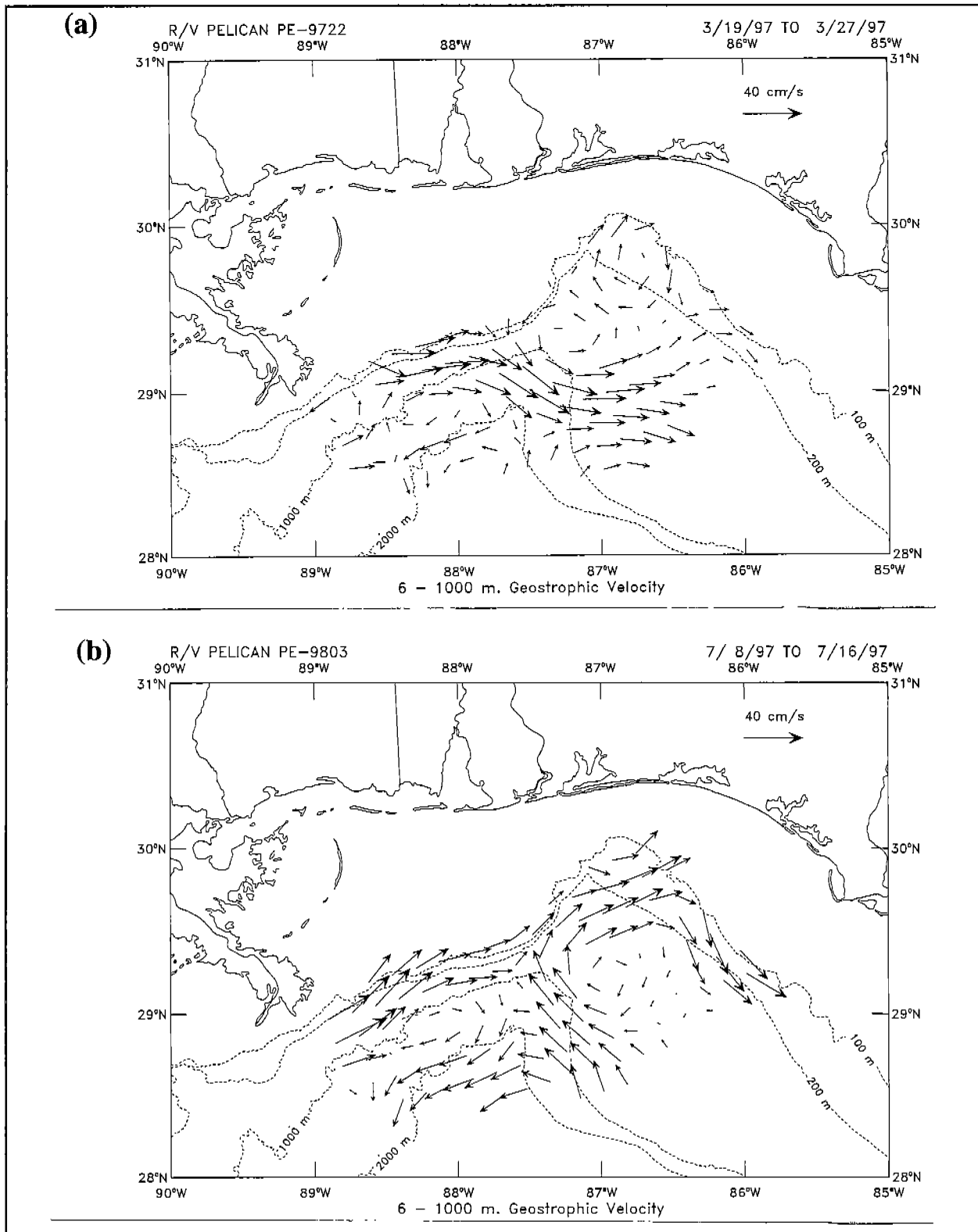

Figure 1B.7. Surface geostrophic velocities calculated from the hydrographic casts relative to 1000 dbar for (a) the 19 - 28 March and (b) 8 - 17 July surveys.

where the flows in the southwestern part of the grid are westward. However, this deep cyclonic also tend to align along the isobaths but show considerable cross isobath magnitudes even where the slope is steep (e.g. transect B). Exceptions to these trends occur in the canyon (transect D) where D2 has a large mean that is almost perpendicular to the west Florida slope, and at D9 where the standard deviation ellipse is nearly circular. The mean flows at D2, D9 and E1 (Figure 1B.6a) imply a convergence and a southeasterly flow along the upper west Florida slope between D2 and E1. The geostrophic surface current maps from the March and July hydrographic surveys also imply converging flows on the upper slope, though the patterns reflect the differing slope eddy fields at these two times (Figure 1B.7). Flows below about 200 m are often in the opposite direction and this is evident in the 200 and 300 m mean statistics shown in Figure 1B.6b. A vigorous cold eddy was stationed at the base of the slope, south of Mobile Bay, during most of the deployment producing cyclonic circulation in deeper waters over the slope. Some evidence of this is seen in Figure 1B.7 circulation does not penetrate to the surface all the time and is not observable in the upper layer temperature signals. Upper layer eddy circulation's are anticyclonic (Figure 1B.7) for some of the deployment and seem to be distinct from the deeper eddy flows. There was no major Loop Current eddy activity in this region during this time and the Loop Current was generally south of 26 °N. The upper layer eddy flows have important consequences for the transport of water from the shelf. Low salinity water of Mississippi origin is often present along the shelf break in the west. The March hydrographic survey showed patches of the plume being advected westward and offshore by the surface layer slope eddies. Time series of salinity at the 20 m level on shelf break moorings B1, C1 and E1 show that patches of brackish surface water, being transported to different positions along the shelf break. The July survey showed particularly low salinities (< 25) present at the head of the De Soto canyon (D1), and on the outer west Florida shelf (E1). It is not certain if this water is from the Mississippi, transported eastward by the type of upper slope currents shown in Figure 1B.6b, or derives from rivers discharging onto the inner Alabama or northwest Florida shelves. The time series of bottom temperature at D1 also show a strong cooling event at the beginning of July that affects the De Soto canyon. This appears to be an upwelling event enhanced by the topography of the canyon. Strong upwelling is presumably important to the shelf's productivity at the head of the canyon.

Preliminary investigations of these data indicate a complex system, particularly in the region of the canyon. The circulation is dominated by cyclonic and anticyclonic eddies of differing scales and depth structures. These influence shelf-slope exchange and the fate of fresh water discharged onto the northeast Gulf shelf by the Mississippi and other large rivers. Strong upwelling events are observed at the head of the canyon though the flow patterns and forcings that cause them have not yet been deciphered

#### REFERENCES

- Berger, T.J., P. Hamilton, J.J. Singer, R.R. Leben, G.H. Born, and C.A. Fox, 1996. Louisiana/Texas Shelf Physical Oceanography Program: Eddy Circulation Study, Final Synthesis Report. Volume I: Technical Report. OCS Study MMS 96-0051. U.S. Department of the Interior, Minerals Mgmt. Service, Gulf of Mexico OCS Region, New Orleans, LA. 324 pp.
-

Dr. Peter Hamilton is a Senior Oceanographer with Science Applications International Corporation. He has served as a Principal Investigator on many MMS programs. He received his Ph.D from the University of Liverpool (U.K.) in 1973.

## OPERATIONAL REMOTE SENSING OF THE NORTHEAST GULF OF MEXICO

Dr. Richard P. Stumpf  
Ms. Heather Henkel  
U.S. Geological Survey  
St. Petersburg Florida

### INTRODUCTION

This study processes satellite imagery for the MMS Northeast Gulf of Mexico (NEGOM) program in order to provide near real-time imagery and an archive of standard imagery for general analysis. The project includes imagery from the Advanced Very High Resolution Radiometer (AVHRR) for sea surface temperature (SST) and coastal water turbidity, and integrates the SST images with altimetry data for the Gulf of Mexico that is being developed by the Colorado Center for Astro-dynamical Research. These and future products provide information on frontal boundaries and major circulation features such as the Loop Current. The data sets are distributed through an Internet web site and the archived data (from fall 1996 to the present) will be distributed through CD-ROM. Images are available through the web at [http://coastal.er.usgs.gov/east\\_gulf](http://coastal.er.usgs.gov/east_gulf).

### METHODS

The AVHRR provides the best available information on circulation through imagery sea surface temperature. During the fall through spring, AVHRR thermal imagery reveals the location of the Loop Current, and various frontal features in the northeastern Gulf of Mexico. Water reflectance imagery from the AVHRR provides information on resuspension events in shallow water (< 10 m) and the position of river and estuary plumes during high discharge, in particular the Mississippi and Mobile plumes, but also plumes from the other bays along the Florida Panhandle.

AVHRR is on two operational NOAA polar-orbiting environmental satellites, NOAA-12 and NOAA-14. Each satellite makes two overpasses each day, NOAA-14 at about 0200 and 1400 EST and NOAA-12 at 0800 and 2000 EST. Thermal imagery is available from all passes. Reflectance imagery can be obtained from NOAA-14 afternoon pass. The AVHRR has a 1-km field of view at nadir, and overpasses occur nearly every day.

The USGS receives the unprocessed AVHRR data from the Joint use Remote Sensing Facility at the University of South Florida (co-located at the Florida Department of Environmental Protection).



Backup sources include NOAA Coastal Services Center and the NOAA CoastWatch program. Twice each day, the imagery is processed to SST using standard NOAA algorithms, and to water reflectance using standard algorithms developed at USGS. The results are mapped to a standard Mercator projection covering a region from 80°W to 90°W and 22°N to 32°N. Owing to a slight clock error on the satellites, positioning can be off by 2-10 km, so automated techniques for registration are implemented, provided cloud cover is limited. A cloud flag, coastline, and latitude/longitude ticks, are applied to the images. Two sets of images are created, the current image as a 2-km resolution GIF file for display, and a full-resolution geoTIFF format file for an online archive on the web site. The geoTIFF format is suitable for analysis by any data processing or image processing package.

The AVHRR has orbits 100 minutes apart separated by about 25 degrees of longitude, with a swath on the ground of about 2500 km. As a result of daily shifts in the orbit position, images from two consecutive orbits may be required in order to cover the entire study area. We use compositing techniques to merge consecutive orbits in order to assure that the final scene has complete coverage.

Altimetry data sets are obtained from Robert Leben of the Colorado Center for Astrodynamical Research (CCAR). The altimetry data has been processed to sea surface heights relative to the geoid and are updated nearly every day with new data. The sea surface heights are then contoured and superimposed on the SST image for the day.

For distribution on CDROM, which will take place in winter 1998, all images will be properly registered and prepared in geoTIFF format.

## DATA QUALITY

While the data set provides information on the temperature of the Gulf and the location of various circulation features, there are some limitations in the data quality. Clouds, of course, can obscure the results. The SST algorithms correct for water vapor in the atmosphere, but they are not effective at dealing with clouds, and high clouds tend to produce excessive distortion in the imagery, while not always being detected by the cloud-flagging algorithms. During winter 1997-98, rainfall over the region is expected to be higher than normal, owing to the El Niño, suggesting that cloud cover will probably be more common. While rare, dropouts sometimes occur, owing to failures at the primary receiving station at USF. If critical (cloud-free) time periods are involved, imagery will be acquired from secondary sites for the archive. SST is not effective during the summer in this area. The water temperature is quite uniform at about 31-32 °C, so circulation features cannot easily be resolved. Occasionally during the summer, the edge of the Loop Current can be found from circulation-driven upwelling.

## FUTURE PLANS

We have begun examination of data from the SeaWiFS ocean color sensor. This data set may be effective at monitoring deep-water circulation features during the summer. Processing and development of SeaWiFS products (as well as other derived remote sensing products) will be performed cooperatively with Frank Muller-Karger at USF, an MMS-funded researcher. It is critical

to understand that SeaWiFS data sets are the property of Orbital Sciences, and can only be released to authorized users. Users can obtain authorization as a research user from NASA, through the SeaWiFS web page:

*<http://seawifs.gfsc.nasa.gov/SEAWIFS/ANNOUNCEMENTS/ANNOUNCEMENTS.html>*.

NASA-authorized research users are allowed access to data 14 days after collection. For real-time access, NASA has some temporary real-time licenses. Also, access to realtime imagery can be purchased from Orbital Sciences. After 1 January, Orbital Sciences is expected to restrict access to SeaWiFS data. At that time *any SeaWiFS imagery released through our web site will be restricted in access to authorized users.*

The web site will also link to other appropriate MMS sites, as a means of providing one source for data for this region.

---

Richard P. Stumpf is a research scientist with the U.S. Geological Survey conducting research on coastal applications of remotely sensed data. He was previously with NOAA and has a Ph.D. from the University of Delaware.

Heather Henkel is a programmer working at the USGS, with B.S. degree from the University of Wisconsin.



## SESSION 1C

### GEOGRAPHIC INFORMATION SYSTEM (GIS) APPLICATIONS

Chair: Dr. Norman Froomer

Co-Chair: Mr. Warren Barton

Date: December 16, 1997

Presentation	Author/Affiliation
Introduction: Overview and Focus	Dr. Norman Froomer Minerals Management Service Gulf of Mexico OCS Region
Gulf-Wide Information System (GWSI) Program Status	Ms. Lynda Wayne Center for Coastal, Energy, and Environmental Resources (CCEER) Louisiana State University
Coastal GIS Products and Applications: Coastal Ocean Resource Assessments (CORA) and Habitat Suitability Modeling (HSM)	Dr. M.E. Monaco Ms. T.A. Gill Mr. T. Battista Mr. J.C. Christensen Ms. H.L. Johnson NOAA's Office of Ocean Resources, Conservation and Assessment Strategic Environmental Assessments (SEA) Division, Silver Spring
Current Status of the Florida Marine Spill Analysis System (FMSAS) Version 3	Mr. Henry Norris Mr. Chris Johnson Dr. Peter Rubec Florida Department of Environmental Protection Florida Marine Research Institute St. Petersburg, Florida

Selected Applications of GIS Analysis for  
Natural Resource Management at the  
National Wetlands Research Center

Dr. James B. Johnston  
Mr. John Barras  
Mr. William R. Jones  
Mr. Steve Hartley  
Mr. Pierre Bourgeois  
National Wetlands Research Center  
Lafayette, Louisiana

Developing Biological Resource Data For the  
Gulf-Wide Information System in Texas

Mr. David Bezanson  
Mr. Steven G. Buschang  
Mr. Walter S. Harris  
Texas General Land Office

## INTRODUCTION: OVERVIEW AND FOCUS

Dr. Norman Froomer  
Minerals Management Service  
Gulf of Mexico OCS Region

The Gulf-Wide Information System (GWIS) project is supported by the Minerals Management Service through cooperative and interagency agreements with the National Oceanic and Atmospheric Administration (NOAA), Louisiana State University (LSU) and each of the five Gulf of Mexico coastal states (Texas, Louisiana, Mississippi, Alabama, and Florida). The objective of GWIS is to develop a geographic database to support oil spill contingency planning and other coastal and marine environmental assessments and analyses in the Gulf of Mexico. The GWIS database provides a consistent view of biological, human use, and administrative data across the entire U.S. Gulf of Mexico.

The GWIS project is currently in the final months of its data development phase. Data deliverables from GWIS partners have either been received or will be received during the spring and early summer of 1998. Quality control/quality assurance will be performed on GWIS data deliverables beginning in spring 1998. Data management and project coordination for GWIS has been performed by the Center for Coastal Energy and Environmental Resources (CCEER) at LSU.

The GWIS database has been developed through partnerships and cooperative efforts with other federal agencies and the Gulf coastal states. The GWIS data structure has been developed to create a consistent Gulf wide database from data developed by a number of different organizations. In the process, a data standard for environmental assessment data has emerged. The development of a standard has numerous benefits for data exchange, data updates, and developing software products to map and analyze the data. The Strategic Environmental Assessment Division of NOAA, for example, is developing an estuarine and coastal fisheries database for GWIS based on NOAA's Estuarine and Marine Living Resources (ELMR) database. Because GWIS is compatible with these NOAA products, updates to NOAA databases will become immediately available in GWIS. Furthermore, projects by NOAA to develop GIS products to analyze and map fisheries data can be used with GWIS fisheries and other biological data.

NOAA's Coastal Ocean Resource Assessment (CORA) desktop GIS application supports sophisticated and powerful spatial and logical queries on coastal and marine fisheries and other biological databases. NOAA is also developing Habitat Suitability Modeling (HSM) tools using GIS technology to visualize mathematical expressions representing habitat quality for marine species.

Another example of benefits from the collaborative work being done in GWIS is the Marine Spill Assessment System (MSAS), an ArcView spatial decision support system developed by the state of Florida for oil spill planning and response applications. While Florida developed MSAS independently of GWIS, MSAS works with the GWIS data base. GWIS is a large, complex database that needs a relatively easy-to-use graphical interface for users to be able to access needed

information. MMS is using MSAS functionality as a basis for a generic environmental assessment GIS for the agency.

While MMS does not have a direct agreement with the U.S. Geological Survey Biological Resources Division (BRD) through GWIS, the BRD has developed much of the habitat data for GWIS through agreements with states participating in the GWIS project. Several projects are underway at BRD to develop habitat data in support of future environmental assessment GIS work. In addition, biological data are being developed for the GIS project at the Texas General Land Office.

---

Dr. Norman Froomer is Geographer with the Office of Leasing and Environment in the Minerals Management Service's Gulf of Mexico Regional Office. Before MMS, Dr. Froomer was on the Geography faculty at the University of New Orleans. For the past several years he has worked in the areas of GIS data base and application development.

## **GULF-WIDE INFORMATION SYSTEM (GWSI) PROGRAM STATUS**

Ms. Lynda Wayne  
Center for Coastal, Energy, and Environmental Resources (CCEER)  
Louisiana State University

### SUMMARY

The GWIS program is an initiative to coordinate GIS data development in the Gulf of Mexico region in an effort to facilitate oil spill contingency planning and other forms of environmental analyses. Early program development focused on the identification and specification of needed data and information layers. This information is documented in the *GWIS Data Specification Manual* and *GWIS Data Dictionary*. During 1997, primary activities included:

- Database Design
- Data Development
- Data Management and Review

### DATABASE DESIGN

Refinement of the data specification continued with emphasis on the need to reduce redundancy within the data structure. Primary revisions were made to the socio-economic and *Environmental Sensitivity Index* (ESI) data formats. A data 'summit' was held with primary participants to explore alternative data formats and to reach consensus. The results of this summit were summarized in a brief report and incorporated into an October 1997 revision of the *GWIS Data Dictionary*.

Subsequent revisions were made to the data dictionary and the most recent version posted in December 1997.

## DATA DEVELOPMENT

Data development to date is summarized in Tables 1C.1 – 1C.6. All data has been received by LSU-CCEER and will be submitted to the QA/QC program once completed. Data distribution of these data sets is currently the responsibility of the data provider as listed.

## DATA MANAGEMENT AND COORDINATION

Data is continually submitted to LSU via the Internet. Several communication networks have been established for the collection of data and the exchange of information. Primary methods of communication include:

Data transfer via FTP site: [flotant.csi.lsu.edu](ftp://flotant.csi.lsu.edu) (by password protected permission only)

Discussion and exchange of general information by listserver: subscribe by contacting [webmaster@flotant.csi.lsu.edu](mailto:webmaster@flotant.csi.lsu.edu)

General information about the GWIS project and participants via WWW: <http://flotant.csi.lsu.edu>

## SUMMARY

Data collection and coordination will continue in 1998. Additional data specifications are expected in the coming year. In addition, recent developments in data access and management tools such as the AVMSAS program developed by ESRI for the FMRI and the NOAA sponsored CORA program will greatly serve the oil spill contingency planning and greater environmental assessment community. Interested parties are encouraged to visit the GWIS website listed above to monitor program activity and access information.

---

Lynda Wayne is a research scientist with the LSU Center for Coastal, Energy, and Environmental Resources (CCEER). She serves as project manager for the GWIS program and has participated in related GIS data management efforts including the National Spatial Data Infrastructure (NSDI) initiative, the EPA Gulf of Mexico Data and Information Transfer (DIT) Committee, the Louisiana Coastal GIS Network (LCGISN), and the Louisiana GIS Council. Ms. Wayne is also active in research related to coastal landscape ecology. She received her BLA in landscape architecture from Virginia Tech and her MLA in landscape architecture from Louisiana State University.



Table 1C.1. GWIS Gulf-wide Data (Geographic).

---

*Provided by LSU CCEER and MMS*

---

Shoreline (1:2,000,000)	MMS Lease Blocks
Roads (1:2,000,000)	MMS Protraction Areas
State Boundaries	National Parks
County Boundaries	Place Names
Fairways	Urban Areas
Federal Waters	Reef/Permit Areas
Flower Gardens	Waterways

---

Table 1C.2. GWIS Florida Data (Geographic).

---

*Provided by the Florida Marine Research Institute (FMRI)*

---

Full Study Area	Panhandle Area
ESI Shoreline	Census
Place Names	Quad Index
Roads	Zip Code / Demographics
Bathymetry	

---

Table 1C.3. GWIS Alabama Data (Geographic)..

---

*Provided by the Geological Survey of Alabama (GSA)*

---

Airports	Survey Area
Bathymetry	Water Intakes
Birds	Recreation
Nests	Cultural Points
Reptiles	Data Tables:
Terrestrial Mammals	BIORES
Invertebrates	BREED
Habitats	SEASON
ESI Shorelines	SOURCES
Pipelines	SPECIES
Platforms	INFERRED

---

Table 1C.4. GWIS Mississippi (Geographic).

---

*Provided by the Mississippi Office of Geology*

---

Airports	Pipelines (state)
Topography	Survey Areas
Birds	Place Names
Nests	Quad Index
Reptiles	Casinos
Terrestrial Mammals	Cultural Points
Invertebrates	Recreation
ESI Shorelines	Railroads
Habitat	Reef
Lease (state)	Refineries

---

Table 1C.5. GWIS Louisiana (UTM).

*Provided by LSU*

Quad Index	Satellite Imagery
Parish Boundaries	Population
Roads	Wetlands (point)
Hydrography	Historic (points)
Shoreline	High Tide Line

*ESI Pilot Study in progress for 26 quad area*

Table 1C.6. GWIS Texas.

*Provided by the Texas General Land Office (TGLO)*

Middle Coast (Geographic)

Shoreline	Quad Index
Habitat	Place Names
Survey Area	Roads
Marine Mammals	Social / Economic
Reptiles	Data Tables:
Invertebrates	ACTIVITY
Fish	BIORES
Birds	BREED
Management Areas	SOURCES
	SPECIES
	SOC_DATA

Northern Coast (UTM)

ESI Shoreline	Invertebrates
Habitat	Fish
Marine Mammals	Birds
Reptiles	Recreation

## COASTAL GIS PRODUCTS AND APPLICATIONS: COASTAL OCEAN RESOURCE ASSESSMENTS (CORA) AND HABITAT SUITABILITY MODELING (HSM)

Dr. M.E. Monaco  
 Ms. T.A. Gill  
 Mr. T. Battista  
 Mr. J.C. Christensen  
 Ms. H.L. Johnson

NOAA's Office of Ocean Resources, Conservation and Assessment  
 Strategic Environmental Assessments (SEA) Division, Silver Spring

Over the last decade the SEA Division of NOAA has worked to develop a variety of map and table products on coastal resources of the United States, focusing on both biological resources and habitat (Monaco and Christensen 1997). The Division's Biogeographic Characterization Branch (BCB) of NOAA and the Environmental Systems Research Institute (ESRI) are currently developing two tools to analyze and display coastal biological and environmental data sets in ESRI's ArcView GIS, one of the world's premier desktop geographic information systems (GIS). CORA and HSM will be useful in modeling, identifying, analyzing, and displaying important habitat areas and distributions of coastal species, with an initial emphasis on fish and invertebrate species and coastal habitats.

### COASTAL OCEAN RESOURCE ASSESSMENT (CORA)

CORA is a desktop GIS application being developed for conducting and displaying spatial assessments of coastal biological and environmental data sets. CORA is a custom extension of ArcView and is scheduled for completion in September 1998. The CORA prototype addresses the coastal resource data sets of North Carolina, including:

- NOAA's Estuarine Living Marine Resources (ELMR) data base on fish and invertebrate distributions, relative abundance, and life history attributes in estuaries;
- North Carolina's Division of Marine Fisheries, Fishery-Independent Monitoring data;
- NOAA's Environmental Sensitivity Index (ESI) data base, which contains distribution information on three major resource types: biological, shoreline, and human use;
- SEAMAP Bottom type (e.g., hard bottom) data for the coastal ocean.

When complete, CORA will be used for general coastal resource assessment and analysis; fisheries distribution analysis; identification of essential fish habitat (EFH); and evaluation of habitat modifications. Example CORA analyses include:

- Determining which species/life stages use North Carolina (NC) estuaries during summer;
- Generating a map and table for juvenile red drum distribution and relative abundance in NC estuaries;
- Describing the life history characteristics of Atlantic croaker;
- Determining which fish species use hard bottom habitat in the coastal ocean;

- Determining which species utilize the 5 -15 ppt salinity range;
- Mapping the number of ELMR species that use each estuarine salinity zone.

### CORA FUNCTIONALITY

CORA is designed to lead the user through a series of windows to define and customize resource assessments and products. CORA prompts the user to select analysis areas either from a list of existing geographic area files or by drawing an area on a map. CORA also prompts the user for selections on time period, resources, and desired output products. Other CORA features include:

- Customizing assessments or comparisons of resources in one or two analysis areas;
- Generating a variety of species distribution maps and tables that vary by month and life stage and that can show relative abundance, range, number-of-species, or presence;
- Customizing searches of ELMR species and life stages, based on life history attributes;
- Auditing trail files that record selections made for each analysis;
- Expanding or adding to existing CORA data sets (e.g., more species);
- Linking to data stored in an external relational database (e.g., personal Oracle).

### CORA PRODUCTS

Although there are variations on each, CORA output includes maps, tables, audit trails, and layouts (combinations of maps, tables, etc). The output varies based on the data sets and selections made by the user. For example, an ELMR species distribution map could show highest relative abundance or presence during a time period, or range (Figure 1C.1).

### CORA SOFTWARE AND HARDWARE

CORA will operate on Windows NT 4.0, a 150 MHz processor with 32-64 MB RAM and 500+ MB of disk storage. CORA requires ArcView 3.0a, the CORA ArcView extension (available from NOAA), Oracle or personal Oracle, and the applicable ODBC (open database connectivity) drivers.

### HABITAT SUITABILITY MODELING (HSM)

The HSM tool uses GIS technology to visualize mathematical expressions that represent a unitless index of habitat quality as a function of environmental and biological variables that define "habitat" for a particular species and life stage (Figure 1C.2).

Field sampling is an essential component to understanding species habitat associations and distributions. However, fisheries monitoring programs are unable to sample for all species and life stages, across all habitats in space and time. Therefore, it is difficult for resource managers to know when, where, and for which species and life stages certain habitat types and areas are important. HS modeling is an important tool used by biologists to integrate information on species habitat associations with the geographic distributions of those habitat/environment types (Rubec, Monaco

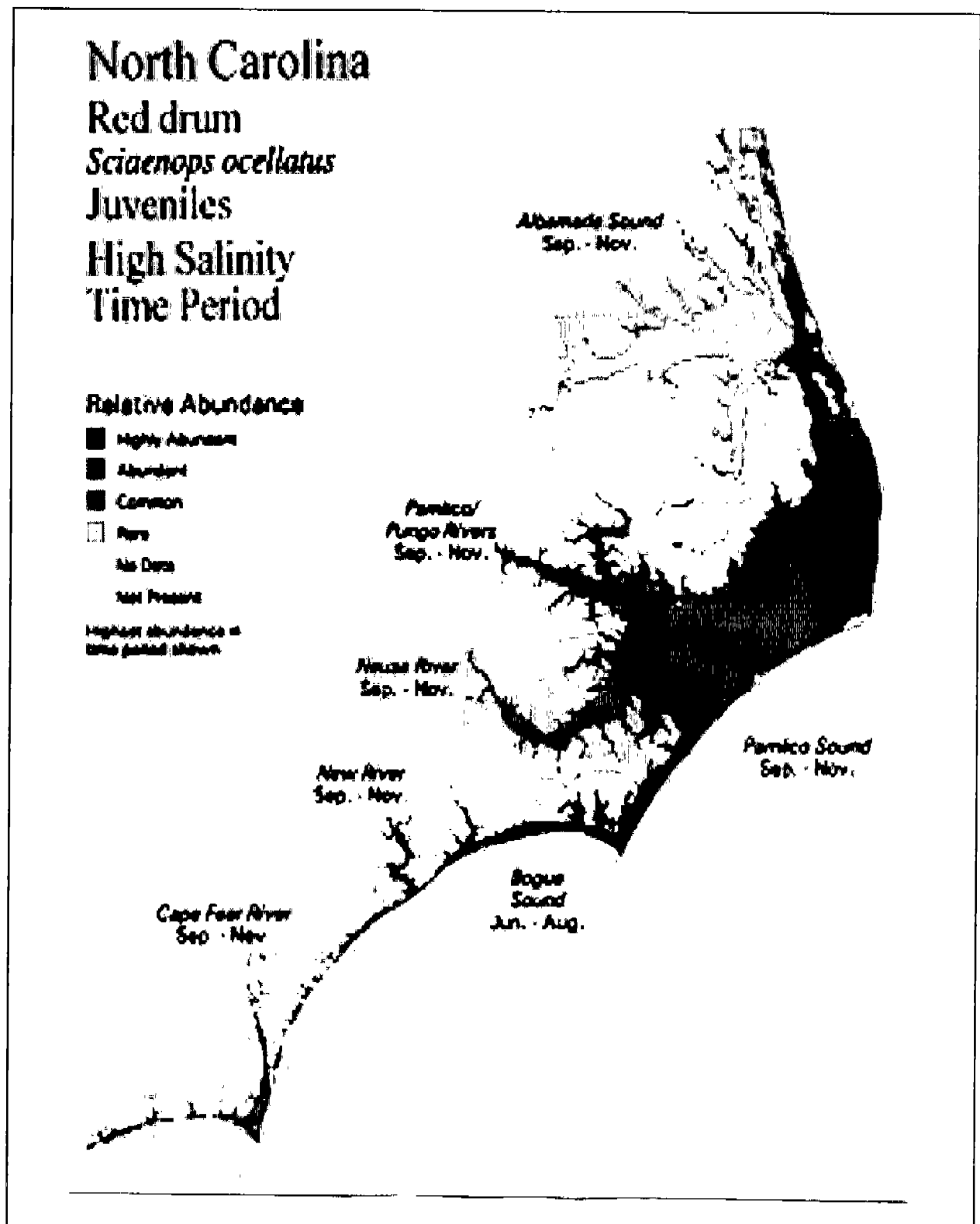

Figure 1C.1. Estuarine distribution and relative abundance of juvenile red drum in North Carolina during the high salinity period.

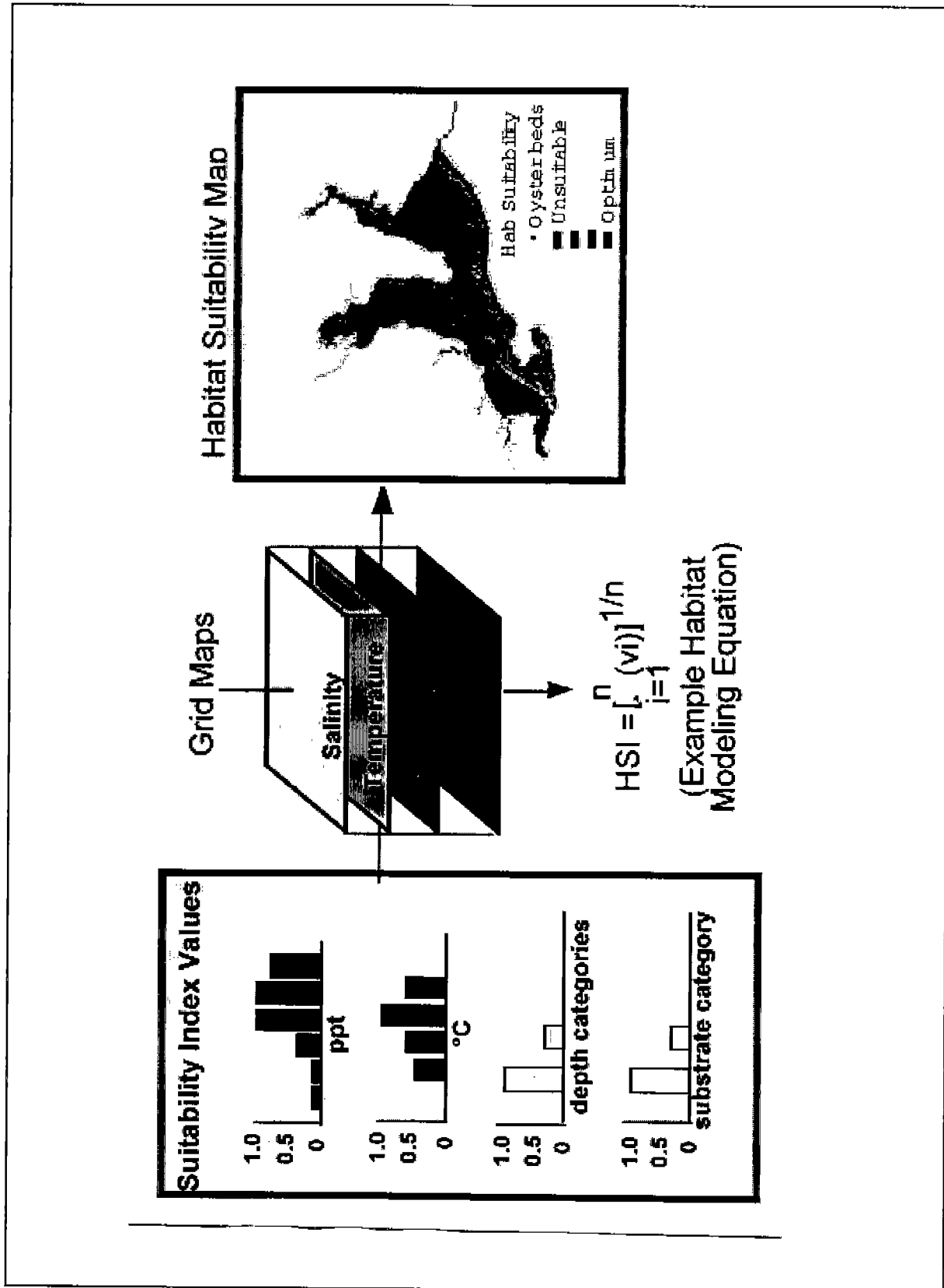

Figure 1C.2. Example HS Modeling Process for Eastern Oyster in Pensacola Bay, Florida.

and McMichael Jr. 1998 (*in press*). This modeling approach provides an estimate of habitat acreage and locations for a variety of species, life stages, and time periods in the coastal United States.

HSM will be a desktop GIS tool for developing, fine-tuning, and displaying modeled maps and data tables of species' habitat associations. HSM will provide biologists and resource managers a GIS tool for developing and evolving habitat models, based on a variety of habitat modeling techniques, algorithms, data sets, and species habitat associations. The prototype is scheduled for completion in the summer of 1998.

The HSM tool is designed to lead the user through a series of windows to define and customize the HSM input, model and products. HSM allows the user to specify a variety of modeling scenarios, by selecting and changing the classifications, data layers, and modeling algorithms, and regenerating the map results with relatively little effort. The user must have a working knowledge of habitat suitability modeling methods, the biology of the species, and GIS technology. The user must also provide the necessary geographic habitat data sets in a gridded format, a table of the species/life stage habitat associations, and the required software and hardware.

The HSM prototype is being built in ArcView and uses ArcView's Spatial Analyst extension (a gridding function). NOAA's current habitat suitability modeling studies have been conducted in ArcInfo, which requires a high level of expertise (Christensen *et al.* 1997 and Brown *et al.* 1997). Although the HSM prototype will require a working knowledge of GIS and biology, it makes HS GIS modeling more accessible and easier to use.

The prototype HSM tool addresses oyster habitat in Pensacola Bay Florida. The environmental data sets used in the prototype include shoreline (for Pensacola Bay); bathymetry; seasonal estuarine salinity; water temperature; submerged vegetation; emergent vegetation; sediment type; species HSM Values; and species life history tables.

#### CURRENT HSM GIS EFFORTS BY NOAA AND PARTNERS

- Pensacola Bay, FL: Assess potential impacts of altered freshwater inflow (NOAA/SEA and Environmental Protection Agency (EPA); Christensen *et al.* 1997)
- Casco/Sheepscot Bays, ME: Identify important fishery habitats (NOAA SEA and U.S. Fish and Wildlife Service; Brown *et al.* 1997)
- Apalachicola Bay, FL: Support development of Environmental Impact Statement (NOAA/SEA, U.S. Army Corps of Engineers and Florida State University)
- Charlotte Harbor & Tampa Bay, FL: Assess transferability of models across similar biogeographic areas (NOAA/SEA, Florida Marine Research Institute and University of Miami; Rubec, Monaco and McMichael Jr. 1998 (*in press*))
- Terrebonne/Timbalier Bays, LA: Help identify oyster lease sites after freshwater diversion (NOAA/SEA and EPA)



## HSM SOFTWARE AND HARDWARE

HSM will operate on Windows NT 4.0 using a 150 MHz processor with 32-64 MB RAM and 500+ MB of disk storage. HSM will require ArcView 3.0a, the ArcView Spatial Analyst extension, and the custom HSM functionality (available from NOAA).

## FUTURE APPLICATIONS

CORA and HSM are desktop analysis, assessment, and display tools that can assist scientists and managers with information gathering and decision making on coastal resources. Once the prototypes for CORA and HSM are completed, they will be expanded for use in other coastal states and institutions.

CORA will be used to combine and display a variety of related coastal data sets for simple and complex assessments. HSM will be used to generate habitat suitability maps for additional species and life stages in different areas. HSM has already proven to be a useful tool in the identification of essential fish habitat (NOAA's SEA Division and SEFSC 1997), and the evaluation of habitat modifications (e.g., modification to freshwater inflow) (U.S. DOC/NOAA and the Gulf of Mexico Program 1996; and Christensen *et al.* 1996).

## REFERENCES

- Brown, S.K., Buja, K.R., Jury, S.H., Monaco, M.E. and A. Banner. 1997. Habitat suitability index models in Casco and Sheepscot Bays, Maine. Silver Spring, MD: National Oceanic and Atmospheric Administration, and Falmouth, ME: U.S. Fish and Wildlife Service. 86 pp.
- Christensen, J.D., Battista, T.A., Monaco, M.E. and C.J. Klein. 1997. Habitat suitability index modeling and GIS Technology to Support Habitat Management: Pensacola Bay, Florida Case Study. Silver Spring, MD: National Oceanic and Atmospheric Administration. 91 pp.
- Christensen, J.D., Monaco, M.E. and T.A. Lowery. 1997. An index to assess the sensitivity of Gulf of Mexico species to changes in estuarine salinity regimes. *Gulf Research Reports* Vol. 9, No. 4, 219-229, 1997.
- Monaco, M.E. and J.D. Christensen. 1997. Published in "Changing Oceans and Changing Fisheries: Environmental Data for Fisheries Research and Management" (G.W. Boehlert and J.D. Schemacher, ed.) NMFS Technical Memorandum NOAA-TM-NMFS-SWFSC-239, April 1997, Pacific Grove, CA pp. 133-139.
- NOAA's Strategic Environmental Assessments (SEA) Division and Southeast Fisheries Science Center (SEFSC). 1997. Work plan for products and services for the identification of essential fish habitat in the Gulf of Mexico. Silver Spring, MD: National Oceanic and Atmospheric Administration. 15 pp.

Rubec, P.J., Monaco, M.E. and R.H. McMichael Jr. 1998 (*in press*). Methods Being Developed in Florida to Determine Essential Fish Habitat. Fisheries.

U.S. Dept. of Commerce NOAA and the Gulf of Mexico Program. 1996. Meeting the Gulf of Mexico Program's Shellfish Challenge Plan Part I: Results of Strategic Assessment. Silver Spring, MD: National Oceanic and Atmospheric Administration. 73 pp.

---

Dr. Mark Monaco, the first author, has been with NOAA for 14 years and is chief of SEA's Biogeographic Characterization Branch. His areas of research interest include fisheries, estuarine ecology and biogeography. Dr. Monaco received his B.S. and M.S. in fisheries and environmental biology from The Ohio State University, and his Ph.D. in marine, estuarine, and environmental sciences from the University of Maryland. Information on the other authors is too lengthy, but is available through NOAA's SEA Division.

## CURRENT STATUS OF THE FLORIDA MARINE SPILL ANALYSIS SYSTEM (FMSAS) VERSION 3

Mr. Henry Norris  
Mr. Chris Johnson  
Dr. Peter Rubec

Florida Department of Environmental Protection  
Florida Marine Research Institute  
St. Petersburg, Florida

### ABSTRACT

The FMSAS is a spatial decision support system that is designed for oil spill response. The third version incorporates several new enhancements developed as a result of user feedback and from our own experience. Most of the enhancements have focused on making the system easier to use yet at the same time making it capable of handling more complicated situations. Other efforts have centered on improving the adaptability of the system so that it can be modified to satisfy user needs beyond spill response.

### INTRODUCTION

FMSAS development started in early 1992. During the next five years it evolved to take advantage of new technologies and to support increasing user needs. The original FMSAS, based on an earlier system developed by Environmental Systems Research, Inc. (ESRI) for Abu Dhabi (Sorensen, 1995), started out as an Arc/Info application running on UNIX workstations located at the Florida Marine Research Institute (FMRI). This original version, though powerful, suffered from several shortcomings, the greatest of which were that it was not portable, that it covered only a small portion of the state, and that an Arc/Info expert was needed to operate it. Version 2 of the FMSAS, co-developed by ESRI and FMRI, was an ArcView 2.1a application that remedied these main problems. However, it soon became apparent that this version too had shortcomings. First, ArcView 2.1a was not a true Geographic Information System (GIS) (Friel *et al.* 1996). Next, the then-current laptop PCs were not powerful enough. The third and current version of the FMSAS, also co-developed by ESRI and FMRI, is a much more user-friendly and powerful system that runs in ArcView 3.0. This latest system takes full advantage of ArcView 3.0's powerful suite of GIS tools and is installed on Pentium laptop PCs.

A priority for the new FMSAS was adaptability beyond the needs of the spill response community. Other agencies and individuals, when shown the FMSAS, deemed its core analytical and map-making capabilities potentially useful. The FMSAS started being viewed as a "springboard" system that could be used to develop numerous other environmental analysis applications.

## ENHANCEMENTS TO FMSAS

The second version of the FMSAS operating in ArcView 2.1a was deployed on laptop PCs to all six BER regional offices from early 1996 through October 1997. During this time, BER staff provided feedback to FMRI about problems they encountered and what new software tools they would like to see added. This feedback, combined with our own experiences and comments solicited from other spill response experts, became ESRI's marching orders when development of FMSAS version 3 began. Version 3 was delivered to FMRI in August 1997 and deployed to the BER field stations in November 1997.

The BER feedback identified two types of deficiencies: system and software usability and hardware. The following list identifies the main problems and their solutions, although, many more enhancements were made.

### SYSTEM AND SOFTWARE USABILITY

1. **Problem:** The graphical user interface (GUI) was complicated. It was largely menu driven. The menu items were hard to understand and to find.

**Solution:** This problem was corrected by using ESRI's new dialog designer extension which provides Visual Basic-like tools for GUI development. The tool allowed the creation of easy-to-use dialogue boxes and buttons. The software tools were logically grouped and menus were simplified using plain English.

2. **Problem:** The original Resources at Risk (RAR) tool was designed to identify which natural and human resources were present in an area affected by an oil spill. Although useful, it had limitations. First, it suffered from not having traditional GIS "clipping" functions, which meant that the user could only get approximate area calculations instead of true area calculations. Second, it did not differentiate among impacted resources that fell within a managed area and those that did not. This is important in Florida where damage assessments vary according to such distinctions. Third, the user was limited to a fixed number of databases; new databases could not be added to the RAR list. Fourth, the RAR output could not be loaded into industry standard spreadsheets such as Excel and Quattro Pro.

**Solution:** The first two problems were addressed when the FMSAS was migrated from ArcView 2.1a to ArcView 3.0. The new ArcView was designed to perform true "clips." The third was corrected by writing additional code to allow both the importing of new GIS databases and also direct user input. The fourth was addressed by having the RAR report delivered as a comma-separated ASCII file, which is importable by most spreadsheets.

3. **Problem:** In version 2 the data and their graphic representation had taken a “back seat” to software migration. The cartographic display was poor, legend names were cryptic, and some important databases were still in a developmental stage.

**Solution:** First, the QA/QC process for the databases were accelerated; second the legend files were rebuilt to work better in the “screen” environment; and third all the legend names were changed to be more intuitive.

4. **Problem:** Version 2 was unable to analyze MMS’s new Gulf-Wide Information Systems (G-WIS) Environmental Sensitivity Index (ESI) data structure (CCEER, 1996). The FMSAS had been hard-wired to analyze only the existing ESI data (RPI 1995). This deficiency meant that the additional data found in G-WIS ESI could not be accessed and analyzed.

**Solution:** A tool was developed by ESRI to handle both traditional and G-WIS ESI. The user simply specifies which ESI database to analyze.

5. **Problem:** There was no simple way to find locations by name. The user had to know where the place actually was and then move there. If the user was not familiar with the location, the system did not provide an easy way to find it. Furthermore, marine spills are often positionally described as being a specified distance and bearing from a named place or feature such as an aid to navigation. The system was not capable of handling positions defined by distance and bearing.

**Solution:** A simple dialog box was designed that allows the user to enter the name of a place, such as a town, or a latitude/longitude coordinate and with a press of a button have that place centered right on the screen. This same dialog box also allows the user to enter a true bearing and distance from a location and then go there automatically. Additional entries let users define how much of the area around the selected place they wish to have also displayed on the screen.

6. **Problem:** Limitations existed with the tools that managed the progression of a spill. They were confusing to use and did not easily keep track of several spills going on at the same time such as occurred during the 1993 Tampa Bay spill (Friel *et al.* 1993). Furthermore, there was no way to “buffer” or increase the perimeter of a spill boundary by a specified distance. This is extremely important for planning where a frequent requirement in “what if” scenarios is the ability to show a spill boundary surrounded by increasingly larger concentric spill boundaries.

**Solution:** This limitation has been handled well in the new Spill Event Manager. Spills are easily added, either entered directly on-screen, from existing GIS files, or from latitude/longitude coordinates. Multiple spill boundaries are kept linked to their spill source and maintained separately from other boundaries and sources in an easily understood and well organized display. FMSAS Version 3 takes advantage of

ArcView 3.0's buffering ability to allow both boundaries and spill source points to be buffered.

7. Problem: The system could not track the deployment of booms.

Solution: The Spill Event Manager allows the user to add the locations of booms and keep track of them over time. The characteristics of the boom, such as type, length and can be entered into a database.

8. Problem: Linking media objects such as digital photos, movies, and audio files to map features was very cumbersome. Users wanted this ability but were frustrated by the work involved.

Solution: ESRI programmers enhanced the "hot link" tool interface so that a "wizard"-like dialog box walks the user through the linking process. The user can now link an unlimited number of files to any map feature or graphical feature. These files are all organized in a menu and can be accessed with the push of a button.

9. Problem: The system was unable to import NOAA HAZMAT's Oil Spill Simulation Model (OSSM) output (Galt *et al.* 1996). The earlier FMSAS could not load these files which are of great importance for spill response planning because they communicate possible short-term spill movement. They also provide responders with textual and graphical information regarding the reliability of the information.

Solution: A tool was added that imports the OSSM trajectory information for display and analysis.

10. Problem: Overly complicated and poor map making capabilities. Hard-copy maps are in great demand during spills for example, during the Tampa Bay spill several hundred maps were printed by FMRI. The early version of the FMSAS had a menu-driven map making tool that was unintuitive and hard to use.

Solution: A simple button was added to the main view that would allow the user to make various sized maps of what was displayed on the screen without having to go into a separate "map composer" module. A legend, scalebar, inset map and north arrow are all automatically added. All the user has to do is enter a title and hit the print button. The existing menu based mapping tool still exists should the user decide to make a more customized map; however, it too has been significantly redesigned for ease of use.

11. Problem: Metadata were not easily accessible. The user could not quickly find the information describing the data layers.

**Solution:** A button was added to the GUI that allows the user to access any metadata file. All the user has to do is highlight the data layer in the data menu to the left of the map and then push the metadata button. The appropriate metadata text file is immediately displayed.

**12. Problem:** There was no way to efficiently handle large files of scanned imagery such as USGS quads, NOAA nautical charts or digital orthophoto quads. These files had been identified by users as being extremely useful as base maps.

**Solution:** ArcView 3.0 was upgraded to handle ARC/INFO image catalogs. FMSAS Version 3 takes advantage of this upgrade and now allows users to access multiple scanned images as a single data layer. In addition, the image catalog will only draw the images required by the visual extent of your “view”, which greatly speeds up drawing time.

**13. Problem:** No User Guide. The user was dependent on the ArcView manual and any notes taken during their training. Also the on-line help only explained the core ArcView tools but not the FMSAS specific tools. This resulted in FMRI assuming a time-consuming telephone “help desk” role.

**Solution:** A user manual was written for the FMSAS specifically targeted to users who had minimal exposure to computers and GIS. Plain English was used throughout and computer and GIS jargon were kept to an absolute minimum. Every single tool has been explained in an easily understood manner with numerous screen shots to help the user understand. The manual is also stored on FMRI’s Internet home page as an Adobe Acrobat PDF file, so a manual can be easily replaced if it is lost.

## HARDWARE

**Problem:** Hardware limitations centered on speed and storage capabilities. When the first ArcView FMSAS was delivered, the fastest chip available for laptop PCs was the 486, the most RAM available was 32 megabytes, and storage was less than one gigabyte, meaning that additional data had to be accessed from an external CD-ROM. The FMSAS would run under these constraints; however, performance was diminished quite considerably.

**Solution:** Industry standards have progressed so that current motherboards can be configured with more RAM and larger hard drives, Pentium chips are the new standard and internal CD-ROM’s are now efficient in size, speed and cost. The new laptop PCs are equipped with Pentium II chips, have 128 megabytes of RAM and over 2 gigabytes of storage.

## CONCLUSION

This paper highlights several operational enhancements to the FMSAS, with a particular emphasis on hardware and software. These advances have been implemented in strong partnership with several agencies and organizations. Input, solicited from various experts within the U.S. Coast Guard, Minerals Management Service (and associated G-WIS participants), National Oceanic and Atmospheric Administration, and Florida Department of Environmental Protection has influenced FMSAS development for maximum utility and impact. FMSAS development has benefited from a truly unique web of mutually-beneficial relationships that leverage the strengths and resources of each partner. Continual strengthening of this web, while maintaining a bias towards action will ensure future protection of coastal resources using advanced information management technologies.

## REFERENCES

- Center for Coastal, Energy, and Environmental Resources (CCEER). 1996. Gulf-Wide Information System (G-WIS) Database Specifications Manual. Louisiana State Univ. p. 72.
- Friel, C., H. Norris, and P.J. Rubec. 1997. Development and application of the Florida Marine Spill Analysis System. Proceedings: 16th Annual Information Transfer Meeting, December 1996. U.S. Department of the Interior, Minerals Mgmt. Service, Gulf of Mexico OCS Region, La. OCS Study MMS 97-0038. pp. 271-276.
- Friel, C. T. Leary, H. Norris, R. Warford, B. Sargent. 1993. GIS Tackles Oil Spill in Tampa Bay. GIS World 6(11):30-33.
- Galt, J. A., D. L. Payton, H. Norris and C. Friel. 1996. Digital Distribution Standard for NOAA Trajectory Analysis Information. NOAA HAZMAT Report 96-4:1-43.
- Research Planning, Inc. 1995. Environmental Sensitivity Index Guidelines. NOAA Technical Memorandum NOS ORCA 92. Seattle: Hazardous Materials Response and Assessment Division, National Oceanic and Atmospheric Administration. pp. 78.
- Sorensen, Mark. 1995. Arc/Info Marine Spill GIS. Spill Science & Technology Bulletin. Vol. 2, March 1995, pp. 81-85.



## SELECTED APPLICATIONS OF GIS ANALYSIS FOR NATURAL RESOURCE MANAGEMENT AT THE NATIONAL WETLANDS RESEARCH CENTER

Dr. James B. Johnston  
Mr. John Barras  
Mr. William R. Jones  
Mr. Steve Hartley  
Mr. Pierre Bourgeois  
National Wetlands Research Center  
Lafayette, Louisiana

### BACKGROUND

The U.S. Geological Survey's (USGS) Biological Resources Division mission is to provide leadership in gathering, analyzing, and disseminating biological information as support for sound management of the nation's natural resources. Since becoming operational in October 1996 through the transfer of programs from various bureaus within the Department of the Interior, the BRD, in cooperation with other federal, state, and local partners, has begun research, inventory and monitoring, information sharing, and technology transfer. Through these activities, the BRD is fostering an understanding of biological systems and their benefits to society, and providing the essential scientific support and technical assistance required for management and policy decisions. The role of BRD's National Wetlands Research Center (NWRC) in Lafayette, Louisiana, with project offices in Baton Rouge, LA and Gulf Breeze, FL, is to provide leadership in research and development related to the Nation's natural resources for the Southeast. The research focuses on wetlands ecology, animal ecology, and the development and application of spatial analysis techniques for natural resource related studies.

Current geographic information system (GIS) technologies in use at NWRC are designed to provide natural resource managers with the on-line data and computerized techniques necessary to make informed decisions. Major GIS activities at NWRC include: compilation and analysis of digital databases for monitoring of natural resources; integration and transfer of databases with existing digital databases from various sources into a comprehensive GIS; and development of multifunctional decision support systems for natural resource managers using these data. NWRC is also an active participant in the National Information Infrastructure (NII), in particular the National Spatial Data Infrastructure (NSDI) and the National Biological Information Infrastructure (NBII), which will facilitate the dissemination of research results and other knowledge and information gained from these efforts. This summary provides an overview of three major spatial analysis projects at NWRC.

### COASTAL WETLANDS PLANNING, PROTECTION, AND RESTORATION ACT

The Coastal Wetlands Planning, Protection, and Restoration Act (CWPPRA) passed by Congress created an interagency task force of State and Federal agencies responsible for the design and

implementation of coastal conservation and restoration projects in Louisiana. The nine categories of projects are: freshwater introduction and diversions, sediment diversions, marsh management, hydrologic restoration, beneficial use of dredged material, shoreline protection, barrier island restoration, vegetative planting, and sediment and nutrient trapping. All projects are monitored to evaluate their success. The monitoring efforts of the NWRC for CWPPRA projects include obtaining high resolution (1:12,000 to 1:24,000) color infrared aerial photography for each project and performing site-specific habitat mapping for selected projects where it is deemed necessary to the monitoring effort by the Technical Advisory Group. Projects may be monitored for up to twenty years. Aerial photography is acquired for pre-project conditions and then is acquired three more times over the monitoring period of 20 years. The basic goal of habitat monitoring is to provide a consistency of products so that wetland habitat changes can be accurately assessed throughout the project life. To ensure this consistency, detailed standard operating procedures were developed for each stage of the monitoring process including aerial photograph acquisition, photointerpretation, digital conversion, and GIS analysis.

The digital conversion phase includes the scanning of high resolution, color infrared aerial photography. The aerial photography is scanned, georectified with field collected GPS, mosaiced, and plotted to provide an accurate and current base map for each restoration site. The photointerpreted mylars are digitized and converted to ARC/INFO file format. These ARC/INFO habitat data layers are stored with the Universal Transverse Mercator (UTM) projection.

Each year of habitat data will be incorporated into the GIS on a project-by-project basis. Individual project maps consisting of the digital base maps overlaid with the habitat data will be created for each year of data collected. These maps and associated digital data sets can be easily distributed to users. Area summary statistics for each habitat type are generated for each project using ARC/INFO. As additional time periods of data are accumulated, multirate wetland trend data (both digital and hardcopies) indicating loss and/or gain of wetlands and changes in wetland habitat composition over time, will be used as a tool for assessing management effectiveness, measured by net revegetation, for each project. Approximately 80 projects will be monitored for coastal Louisiana.

#### ENVIRONMENTAL MONITORING AND ASSESSMENT PROGRAMS— ESTUARIES ACTIVITIES

NWRC has been involved in Geographic Information Systems (GIS) since 1980 to assist in monitoring the nature and extent of change in estuaries throughout the country. A GIS is currently providing spatial analysis support for mapping the Gulf of Mexico estuaries and their contaminants. The NWRC, in conjunction with the U.S. Environmental Protection Agency (USEPA), through an Interagency Agreement (IAG) in 1993, is establishing methods to track the changes and status in environmental resources of the Atlantic, Gulf of Mexico, and Pacific coasts of the United States over the long term. Through these activities EPA and the NWRC believe the effectiveness of pollution control strategies can be confirmed. In order to accomplish this monitoring, the USEPA established Environmental Monitoring and Assessment Program (EMAP). Through this IAG, NWRC and EMAP formed a partnership to advance GIS research and development activities which include:

- Providing a tool for cooperation and participation in national and international GIS research activities related to the management and monitoring of global estuarine and wetland resources.
- Collecting and analyzing data using GIS to determine the distribution, abundance, status, condition, and trends of ecological resources in coastal ecosystems.
- Conducting GIS and other studies to improve the capability for predicting and understanding the effects of natural and anthropogenic stresses on coastal ecosystems and biological diversity.
- Providing scientific and technical assistance, including the use of GIS, in support of legislative, regulatory, and resource management decisions.
- Disseminating information and GIS technologies to resource managers, scientists, and the public.

### LOUISIANA GAP ANALYSIS

Typically, federal and state efforts to maintain biodiversity have relied on protecting species once they become threatened or endangered. While it is important to protect these valuable species, a better approach is to view entire regions for native animal and plant species distributions in conjunction with current management practices of conservation lands. Gap Analysis will provide this regional assessment of animals and plants performed at the state level. This provides land managers with information past their jurisdictional boundaries, which many times is not available, to facilitate better management decisions regarding land-use and protection of species. Gap Analysis relies on a cooperative effort among Federal and State agencies, non-profit organizations, universities, and private businesses, including agricultural and forestry interests. The Louisiana GAP project is using Landsat 5 TM imagery and color infrared photography along with other auxiliary data sets (SPOT, Breeding Bird data, Field Survey (GPS) data) to classify 23 major vegetation groups and land-use categories for the state.

Ongoing applications of the Louisiana GAP data to agricultural and forestry entities include: (1) correlating vegetation/land use with hydric soils to delineate potential forested wetland restoration sites; (2) mapping and quantifying agricultural lands to model non-point source runoffs into streams and rivers; (3) correlating neotropical birds usage to forest types; and (4) assessing and monitoring forest change as it relates to urban expansion. This presentation will discuss the Louisiana GAP project, agricultural and forestry applications, and GAP data transfer and training to users. The GAP Analysis is also ongoing in the other four Gulf states (TX, MS, AL, and FL).

### CONCLUSION

In closing, the National Wetlands Research Center's mission in spatial analysis is to research and develop new spatial analysis applications, techniques, and methodologies related to natural resource

management. These applications, techniques, and methodologies are then transferred to natural resource managers as computerized decision-making tools. To accomplish this mission, NWRC relies on the input and application responses from resource managers to define its research tasks and obtain domain expert knowledge and related information. NWRC also maintains a strong training program for users through workshops and formal courses.

Lastly, NWRC has developed numerous databases for its partners. These include [www.nwrc.gov/sdms](http://www.nwrc.gov/sdms) (NWRC's homepage and spatial data server), [www.lacoast.gov](http://www.lacoast.gov) (CWPPRA's homepage) and [www.btneq.org](http://www.btneq.org) (Barataria-Terrebonne National Estuary Program's homepage).

---

Dr. James B. Johnston serves as the Chief of Spatial (Habitat) Analysis at NWRC in Lafayette, Louisiana. John Barras serves as the Field Supervisor of the NWRC's Coastal Restoration Office in Baton Rouge, Louisiana. William Jones and Steve Hartley are GIS Project Leaders at NWRC and Pierre Bourgeois is the Field Supervisor for NWRC's Environmental Analysis Project Office in Gulf Breeze, Florida.

## DEVELOPING BIOLOGICAL RESOURCE DATA FOR THE GULF-WIDE INFORMATION SYSTEM IN TEXAS

Mr. David Bezanson  
Mr. Steven G. Buschang  
Mr. Walter S. Harris  
Texas General Land Office

### ABSTRACT

The Texas General Land Office gathered information about location and distribution of flora and fauna of the middle Texas Gulf Coast from multiple sources, including the Texas Parks and Wildlife Department estuarine fauna dataset as well as from a series of workshops hosted by the Texas General Land Office. This information was developed for the U.S. Minerals Management Service and compiled in a standard format as part of the Gulf-Wide Information System (GWIS). The area of coverage extended from Sargent Beach to the northern Laguna Madre. The resulting dataset of species distribution, abundance and seasonality, will be archived at a World Wide Web site to be maintained for the GWIS project.

### INTRODUCTION

In November 1996, the U.S. Minerals Management Service (MMS) contracted with the Texas General Land Office (GLO) to produce a set of spatial data layers describing fauna and flora of part of the Texas Gulf Coast. The data were created in ARC/INFO v. 7.0 and related software and designed for use in coastal management and especially in oil spill contingency planning. The project was part of an effort to compile consistent resource data throughout the entire Gulf of Mexico region and combine the data into a geographic information system (GIS) structure, the Gulf-Wide Information System (GWIS).

The project was undertaken in direct response to the identification of the need for unified, Gulf-wide biological data for spill response planning. Prior to this project, data gaps existed within the states and there were no consistent multistate data standards. GWIS designed the format to incorporate data from Texas, Louisiana, Mississippi and Florida. All of these states have to date provided deliverables, either partial or complete, to the GWIS clearinghouse at Louisiana State University.

Information was collected through a series of workshops held on the Texas coast in which biological data, floral and faunal, was gathered. Representatives from academic institutions, state and federal agencies, and local interests provided information and review of existing data. Other information was assimilated from estuarine fauna data collected by the Texas Parks and Wildlife Department (TPWD) and from existing literature.

The design of biological data layers incorporated in the GWIS was based on guidelines developed for environmental sensitivity index (ESI) mapping by the National Oceanic and Atmospheric

Association (NOAA) in cooperation with Research Planning, Inc. ESI maps have been produced in dozens of countries to support oil spill planning and usually include species and habitats which are potentially vulnerable to oil contamination or damage from cleanup activities. Biological data layers were created at a map scale of approximately 1:24,000, without bias or anticipation of outcome. Each data layer may be viewed as a “standalone” product or as part of the GWIS data structure.

The completed GWIS data layers delineated specific areas of high use or concentrations of habitat-dependent aquatic and marine animals. The following summary explains the methods used to create the final digital data layers.

### PROJECT AREA AND METHODS

The project area was limited by availability of resources and was designed to complement a previous biological-resource mapping effort of the upper Texas coast using ESI mapping standards (NOAA/NOS ORCA Technical Memorandum, “Environmental Sensitivity Index Guidelines,” October 1995). Data collection covered the Texas coast from Sargent Beach near Freeport (the south border of the previously mapped area) to the north end of the Laguna Madre, taking in the Matagorda, San Antonio, Copano-Aransas, and Corpus Christi bay systems.

The biological data collected for the GWIS project were created using ARC/INFO entities called regions, which comprise one or more polygonal areas with a single unique identifier. This identifier links the region attribute table to separate data tables containing lists of species occurring within each region, seasonal occurrence of species in the project area, and classification and legal status of species. The identifier is linked to multiple life stage profiles for certain species; if a species was known or believed to breed within a region, the identifier was linked to the life stage/seasonality profile that includes breeding information for the species.

An additional data field contains numbers or concentration of a species in the region. As data regarding concentration were limited and variable, only a few species (mostly waterfowl and nesting birds) were given numeric values in the concentration field. Some other occurrences of species were given a subjective value (e.g. high, medium or low) based on anecdotal information and judgments by observers.

Most information about species occurrence and distribution was collected in a series of meetings held in locations on the Texas coast with local field biologists, land managers, and others. TPWD and U.S. Fish and Wildlife Service (USFWS) personnel gave information about lands and species managed by those agencies. Representatives of the Texas A&M University-Corpus Christi, University of Texas Marine Science Institute, the Conrad Blucher Institute, U.S. Geological Survey, Texas Department of Health, Lower Colorado River Authority, Corpus Christi Bay National Estuary Program, and nonprofit organizations including the Coastal Conservation Association, Nature Conservancy of Texas, Texas State Marine Education Center, and Audubon Society also attended, as well as private citizens such as commercial guides, a commercial oysterman, and birding groups. Participants described species flora and fauna and their habitat and distribution.

Information gathered at the meetings was supplemented by existing databases of colonial waterbird and waterfowl surveys and other published sources. Mapping of fish and some invertebrates was based on bag seine, trawl, and gillnet sampling of estuarine fauna conducted by the TPWD's Coastal Fisheries Division between 1989 and 1994. ARC/INFO was used to access the TPWD survey database and locate records of fish and invertebrates in the coastal bays. Concentration areas, spawning areas, and migration routes were inferred or delineated by commercial guides and recreational fishermen.

Before the project began, TPWD and GLO response personnel identified species of mammals, birds, reptiles, fishes, and macroinvertebrates likely to be affected by oil contamination.

Only one mammalian species was considered in the project, the Atlantic bottlenose dolphin (*Tursiops truncatus*), with areas of observed concentrations in bays mapped. Other mammals will probably be treated in other project phases.

0

Bird feeding and nesting areas are often considered priority protection areas in spill response because of their susceptibility to disturbance from cleanup activities. The project scope included roughly eighty species of wading birds, shorebirds, waterfowl, gulls and terns, and raptors. In the meetings, areas of significant bird use were identified. (Some occurrences were described generically as occurrences of "wading birds," "shorebirds," "waterfowl" or other categories, in areas where a number of similar species may be present.) Several endangered, threatened, and rare bird species were discussed, including the whooping crane (*Grus americana*), piping plover (*Charadrius melodus*), reddish egret (*Egretta rufescens*), peregrine falcon (*Falco peregrinus*), brown pelican (*Pelecanus occidentalis*), wood stork (*Mycteria americana*), and snowy plover (*Charadrius alexandrinus*). Special attention was paid to areas utilized by wintering whooping cranes and other critically endangered species. Park and refuge personnel (such as at the Aransas-Matagorda wildlife refuge complex) provided information reflecting species distribution on managed conservation lands. Amateur birdwatchers provided additional information about sightings.

Several species of reptiles were mapped, including Texas diamondback terrapin (*Malaclemys terrapin littoralis*), a species of concern in Texas, American alligator (*Alligator mississippiensis*) and Gulf saltmarsh snake (*Nerodia clarkii*), all of which utilize emergent coastal marshes, as well as four species of sea turtles, all federally endangered. Several other reptiles or amphibians will likely be treated in future biological mapping of the lower Texas coast.

Representative estuarine, riverine and offshore fish species were mapped. Information gathered in the meetings focused primarily on sport fish and important forage fish. The TPWD estuarine fauna database was used extensively to map fish within the bays and estuaries. Existing literature provided information about species seasonality, spawning and distribution. Commercial and recreational fishing guides also supplied areas of concern for sport fish.

Mapping of macroinvertebrates focused on species which are sampled by TPWD. Some of these—brown, white and pink shrimp (*Penaeus aztecus*, *P. setiferus*, *P. duorarum*), blue crab (*Callinectes sapidus*), stone crab (*Menippe sp.*) and bay squid (*Lolliguncula brevis*)—are of

commercial importance. Others, such as the lesser blue crab (*C. similis*), hermit crabs, grass shrimp (*Palenometes pugio*), rangia (*Rangia cuneata*), quahog (*Mercenaria campechensis*), bay scallop (*Argopecten irradians*), razor clam (*Ensis minor*), and invasive edible brown mussel (*Perna perna*) were mapped where information was given.

A goal of the project was to map the distribution of oyster (*Crassostrea virginica*) reefs, with greater precision than descriptions of the distribution of mobile species, as oysters create micro-habitat which is immobile and in some cases vulnerable to oil. Reefs in some parts of the area have been mapped by the TPWD from aerial photography of various dates and levels of accuracy. Some large surface reefs show up on NOAA maps.

Several habitats or plant assemblages were mapped based on information from the meetings, National Wetland Inventory data created by the USFWS, the Texas Natural Heritage Program database, and other sources. These included areas of aquatic vegetation, marsh types, algal flats, black mangrove, and a few grasslands and rice fields. The GLO hopes to map plant assemblages in greater detail on future spill response maps.

## RESULTS

More than 2,000 separate records of animals and plants were collected, including occurrences of more than 200 species. The resulting datasets may be considered an initial survey of macrofauna and habitats that should be considered during oil spill planning and response activities on the central Texas coast. Further refinement of the data layers is expected as future cartographic and data products evolve to support spill response.

The absence of records for a species or region does not necessarily mean that the species is not present. Comprehensiveness of the estuarine fauna dataset is limited by the methods of capture used, accessibility of areas to sampling, and inconsistencies in sampling procedures within the region. Most surveyed species are widely distributed throughout all or part of the project area; in most cases, these species were only recorded in regions in which relatively high numbers of animals were reported or captured by TPWD. Information gathered in the meetings was entirely anecdotal and general; little negative information was given (for example, the absence of a species).

The limitations of anecdotal information are obvious and include the difficulty of human access to coastal areas, the interest and effort devoted to a species (information about red drum or whooping cranes, for example, is more extensive than for non-commercial or unmanaged species) and other factors.

Surprisingly, specific spatial locations of oysters were not available for parts of the area, and oyster distribution was based on a variety of sources. Within the Matagorda and adjacent bays, the most specific information on oysters came from a commercial oysterman who sketched the general locations of harvestable reefs on base maps.



The finished biological datasets will be modified for use in ARC/INFO and ArcView applications to query species data and produce ESI maps. The GLO and NOAA are cooperating to distribute ESI data for the upper Texas coast in a CD-ROM and hardcopy atlas, incorporating species distribution, concentration, and seasonality; the GLO intends to distribute similar products containing the GWIS datasets in the future.

The data will be available at a World Wide Web site (location of the archive has not been determined) which will be linked to a central Web page for the GWIS project, currently located at <http://flotant.csi.lsu.edu/gwis>.

#### ACKNOWLEDGMENTS

The Texas General Land Office wishes to thank the U.S. Minerals Management Service, Louisiana State University, and the other participants in the GWIS project. We also extend our appreciation to the representatives of Texas Parks and Wildlife Department and many other entities who gave generous amounts of time to providing the information that made the mapping effort a success.

---

David Bezanson has been a GIS analyst with the Texas General Land Office for more than five years, supporting the Texas oil spill response and coastal management programs. Bezanson is currently completing an M.A. in geography at the University of Texas-Austin.

Steven G. Buschang is a contract biologist with the Texas General Land Office specializing in GIS biological mapping, marine invertebrate zoology, and wetlands biology. Buschang, a Texas Academy of Sciences member, holds a B.S. in marine biology from Southwest Texas State University. He is currently involved in a habitat prioritization mapping project and species distribution mapping for the Texas coast.

## SESSION 1D

### ATMOSPHERIC SCIENCES

Chair: Dr. William T. Hutzell

Co-Chair: Ms. Terry Scholten

Date: December 16, 1997

Presentation	Author/Affiliation
Atmospheric Sciences Session: Overview and Focus	Dr. William T. Hutzell Minerals Management Service Gulf of Mexico OCS Region
New Technique for Estimating SO <sub>2</sub> Impacts From Well Testing: Permitting the Unknown	Mr. David Scalfano Northlake Engineers Inc.
Introduction to the Graphical User Interface (GUI) for the Offshore and Coastal Dispersion (OCD) Model	Mr. Joseph C. Chang Ms. Kathy J. Hahn Earth Tech, Inc. Concord, Massachusetts
Atmospheric Transport of Sulphur Dioxide and Nitrogen Dioxide Over Breton Island	Dr. S. A. Hsu Louisiana State University
Modeling and Analysis in Support of the Design of the Breton Aerometric Monitoring Program (BAMP)	Dr. T. W. Tesche Mr. Dennis E. McNally Alpine Geophysics, LLC Covington, Kentucky



## **ATMOSPHERIC SCIENCES SESSION: OVERVIEW AND FOCUS**

Dr. William T. Hutzell  
Minerals Management Service  
Gulf of Mexico OCS Region

The Environmental Studies Program changed the title of this session from Air Quality to Atmospheric Sciences because the program has a broader objective than evaluating atmospheric composition or ambient concentrations. Its objective is to understand better how offshore energy production and the atmosphere interact to affect air quality. The work inferred by this objective is improving knowledge and science in two areas: (1) processes that transform offshore pollution into ambient concentrations; and (2) measurements that estimate ambient concentrations from offshore air pollution. The first area studies the meteorology and sources of air pollution in the Gulf of Mexico. The second area covers estimated concentrations and also deals with the techniques used. Considering the work mentioned, the phrase, Atmospheric Sciences, seems more appropriate than Air Quality because it describes the expertise and professional disciplines required to reach this objective.

The papers in this section cover the two areas just mentioned. The first two discuss new techniques for estimating changes in ambient concentrations from offshore energy production. Each speaker shows a tool or an aid that makes obtaining an estimate easier and less time consuming. The last two presentations discuss the atmospheric processes controlling ambient concentrations over the Breton National Wilderness Area. The first presentation by Dr. S.A. Hsu interprets these processes based on observations. Next, Dr. T. Tesche describes understanding and predicting the same processes based on computer studies.

## NEW TECHNIQUE FOR ESTIMATING SO<sub>2</sub> IMPACTS FROM WELL TESTING: PERMITTING THE UNKNOWN

Mr. David Scalfano  
Northlake Engineers Inc.

### INTRODUCTION

The oil and gas exploration and production industry is very active in the Gulf of Mexico. Drilling is approaching an all time high. Many new reservoirs, especially in the central Gulf of Mexico, have widely varying concentrations of hydrogen sulfide (H<sub>2</sub>S) in the formation gas.

Exploratory wells, those in new areas or different geological zones, normally require a flow test after reaching the target zone. This test will determine if the hydrocarbon bearing sands will flow at commercial rates. The safest and most practical method for testing a well is through a controlled drill stem test in which the well is allowed to flow to the surface. At the surface, the gas and liquid rates are measured. Then the gas and small volumes of liquids are burned through a designated flare stack. Larger volumes of liquids are usually captured in an offshore barge. The flaring of formation gas and liquids that contain H<sub>2</sub>S creates sulfur dioxide, a criteria air pollutant.

All new Outer Continental Shelf (OCS) wells have to be permitted through the Mineral Management Service (MMS). The permit process requires the permittee to estimate the air emissions from the drilling and testing of a new well. Most wells are permitted 2 months to 2 years before the actual drilling of the well. For this reason there can be a great deal of uncertainty in the actual air emissions from the testing of a sour well (one that contains significant H<sub>2</sub>S). The actual concentration of H<sub>2</sub>S can vary widely from one formation to the next and the flowrate of any new well is difficult to predict. Consequently, the rate of SO<sub>2</sub> emissions will vary substantially.

According to 30 CFR (Code of Federal Regulations) 250.45, the allowable significance level that any exempted (exempted from controls) source can have on the nearest onshore area for SO<sub>2</sub> is 25 micrograms per cubic meter for the 3 -hour averaging time, 5 micrograms per cubic meter for the 24-hour averaging time and 1 microgram per cubic meter annual averaging time. Since most well tests are only from 1 to 7 days in duration, the controlling limitations are the 3-hour and 24 -hour averaged levels.

This report will discuss some SO<sub>2</sub> dispersion modeling runs (Marks 1996,1997) with the Offshore Coastal Dispersion Model (OCD-Dicristofaro and Hannah 1989) and present one method in permitting sour flare test to afford the permittee maximum flexibility during the drilling and testing operations.

## ESTABLISHING PERMIT LIMITS

One major operator in the Gulf of Mexico has performed air dispersion modeling at four different locations to measure impact of sour well tests. The locations ranged from 6.5 miles from shore to 34.9 miles from shore. Table 1D.1 charts the results of the modeling runs:

Table 1D.1. Results from OCD Modeling Runs.

Distance From land (miles)	24 hr. avg. allowable (#/hr)	Rate/Distance	3 hr. avg. allowable (#/hr)	Rate/Distance
34.9	693.5	19.9	905.5	25.9
17.0	238.0	14.0	308.0	18.1
15.7	299.8	19.1	309.1	19.7
6.5	-	-	138.2	21.3

The ratio of rate over distance from shore gives an indication of a multiplier that could be established to calculate allowable emission rates from different distances. These ratios range from 14.0 to 19.9 in the 24-hour average and 18.1 to 25.9 in the 3-hour average.

## DEVELOPING A FLEXIBLE PERMIT

Concerning the uncertainties of a sour well test and the need to permit these wells before a drill takes place, how can a permittee design flexibility into the process? This author's recommendation is to develop a simple line graph of the 3-hour averaged and 24-hour averaged emission rate. This emission rate is calculated by using a predetermined multiplier (such as 20 times distance from shore) or from modeling results. From this allowable emission rate corresponding gas flowrates (MMCFD –million cubic feet per day) versus H<sub>2</sub>S concentration (ppm-parts per million) are calculated for a range of expected H<sub>2</sub>S concentrations. These rates are graphed with the H<sub>2</sub>S concentrations on the X- axis and the gas flow rate on the Y-axis as shown below in Figure 1D.1. This line represents a maximum allowable emission rate for either the 24-hour averaging or 3-hour averaging times.

In this case the mass emission rates were 693.5 #/hr. for the 24-hr. averaging period and 905.5 #/hr. for the 3-hr. averaging period. A formula defining the line can be calculated by multiplying the mass emission rate by 134.625 to derive the coefficient shown in Table 1D.1. The typical formula is derived as follows:

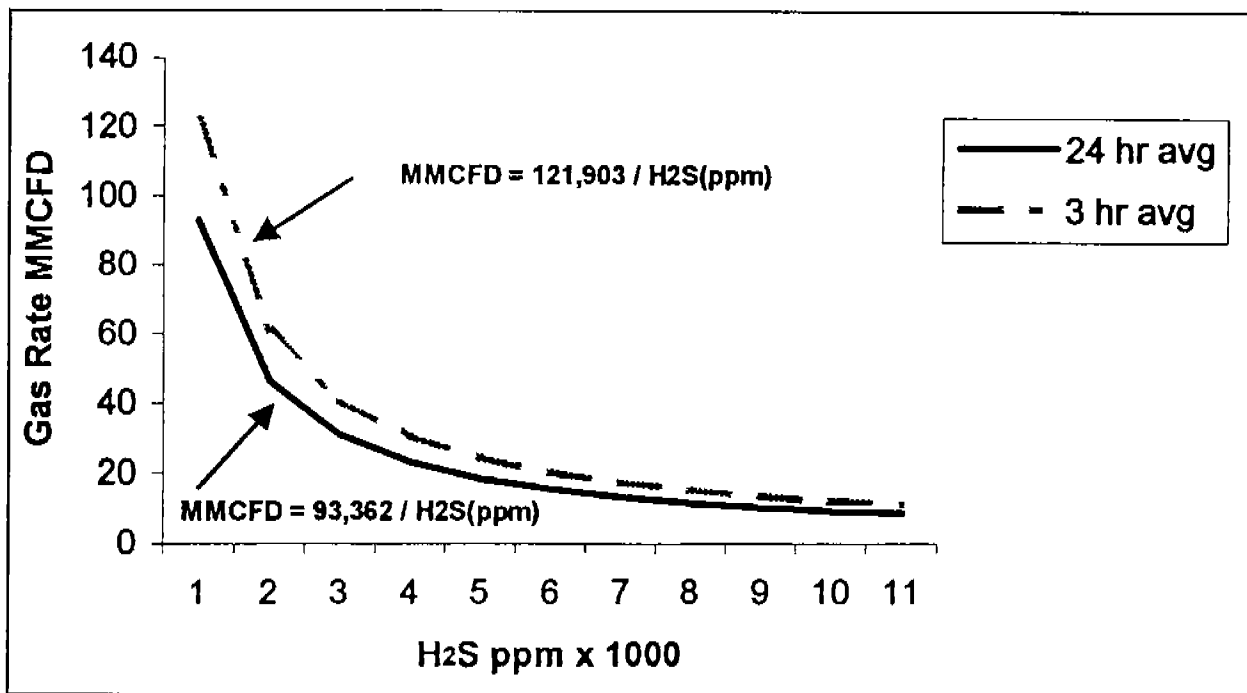

Figure 1D.1. Graph for well test 34.9 miles from land.

- Gas Rate (MMCFD) = SOx rate(lb/hr)x(359 ft<sup>3</sup>/lb mole x 24 hr/day / 64 lb/lb-mole)/H2S ppm
- Gas Rate (MMCFD) = SOx rate (lb/hr) x (134.625)/H2S ppm  
Gas Rate (MMCFD) = 693.5 x (134.625)/H2S ppm
- Gas Rate (MMCFD) = 693.5 x (134.625)/H2S ppm
- Gas Rate (MMCFD) = 93,362/H2S ppm

This formula can be used to calculate allowable flowrate once H2S is known. This graph can be submitted with the permit application and become a permit condition.

After the drilling is complete and it is time for a well test, the person in charge can refer quickly to this graph and depending on the H2S concentration, determine what the maximum allowable flow rate should be. This gives the on site person in charge the ability to adjust according to field conditions and stay in compliance with permitted levels. This avoids the case where a certain limit is set on H2S concentration or flowrate.

## RECOMMENDATIONS

This author recommends that any other data from air dispersion models involving SO<sub>2</sub> emissions in the Gulf of Mexico be combined with this data. An industry committee, including MMS representatives, could review the data and develop multipliers that operators could use to permit future well test and other operations. If enough modeling has been done on NO<sub>x</sub> emissions the same methodology could be applied, and multipliers developed. These tools should help operators and the government during the permit process and once operations commence.

## REFERENCES

Marks, S. 1996. KBN Engineering and Applied Science, Inc. *Modeling run for MP 97 Block dated 6 June 1996.*

Marks, S. 1996. KBN Engineering and Applied Science, Inc. *Modeling run for MP 299 Block dated 5 July 1996.*

Marks, S. 1996. KBN Engineering and Applied Science, Inc. *Modeling run for VK 252 Block dated 21 June 1996.*

Marks, S. 1997. KBN Engineering and Applied Science, Inc. *Modeling run for MO 864 Block dated 6 February 1997.*

Dicristofaro, D. C. and S. R. Hannah. 1989. OCD :The Offshore Coastal Dispersion Model, 2 vols. Earthtech Report # A085-1, Prepared for MMS, U.S. Dept. of Interior, 381 Elden St. Herndon, VA. 22070-4817.

Code of Federal Regulations, Parts 200-699 Revised 1 July 1997. Published by the Office of the Federal Regulations, National Archives and Records Administration, U.S. Government Printing Office, Washington, D.C. 1997.

---

David Scalfano has been owner and principal engineer for Northlake Engineers and Surveyors, Inc. in Mandeville, Louisiana, for the past six months. Previously Mr. Scalfano has worked 16 years for Chevron USA in the Gulf of Mexico operations serving as environmental engineer responsible for air emissions for 6 years and construction engineer for 10 years. During that time he was active in industry advocacy efforts and served on subcommittees for Offshore Operators Committee and the Louisiana Mid-Continent Oil and Gas Association. Mr. Scalfano is a Registered Professional Environmental and Civil Engineer in Louisiana. He received his B.S. in civil engineering from Louisiana Tech University and performed graduate studies in environmental engineering at the University of New Orleans.



## INTRODUCTION TO THE GRAPHICAL USER INTERFACE (GUI) FOR THE OFFSHORE AND COASTAL DISPERSION (OCD) MODEL

Mr. Joseph C. Chang  
Ms. Kathy J. Hahn  
Earth Tech, Inc.  
Concord, Massachusetts

### ABSTRACT

An introduction to the new Graphical User Interface (GUI) for the Offshore and Coastal Dispersion (OCD) model is given. The GUI greatly increases the user-friendliness of the model and reduces potential user errors. The user can now prepare, execute, analyze, and visualize an OCD application in a menu-driven environment.

### INTRODUCTION

The Offshore and Coastal Dispersion (OCD) model (Hanna *et al.* 1985; DiCristofaro and Hanna 1989) was first developed in the 1980s to simulate the effects of offshore emissions from point, area, or line sources on the air quality of coastal regions.

To reduce difficulties and errors in applying OCD, the Minerals Management Service (MMS) funded a project in 1996 to develop a GUI program for OCD. The produced program seeks to provide comprehensive support for the user in applying the OCD model. The user can set up the model control file (either create a new one or edit an existing one), execute the OCD model, and post-process the results through a series of menu-driven "screens." On-line help system is available when questions arise. The user can visualize model inputs and results through map displays. The GUI also performs error-checking on the data specified by the user. Any invalid input will be flagged by the GUI. Default values, if applicable, for some input parameters are provided.

The reader is referred to Chang and Hahn (1997) for a detailed description of the OCD GUI program. Some of the GUI highlights are given below.

### STRUCTURE OF GUI

The GUI program includes a total of six top-level "menus," including *File*, *Input*, *Run*, *Utilities*, *Setup*, and *Help* (see Figure 1D.2). The *File* menu defines the paths and names of the model input, output, and log files, and allows the user to save files under different names. The *Input* menu is responsible for the specifications of model inputs. The *Run* menu executes OCD. The user accesses various pre- and post-processors of OCD via the *Utilities* menu. The *Setup* menu allows the user to change the settings of the Windows environment. The *Help* menu includes on-line help, which is also available through the *Help* button on individual screens.

If the user loads an existing OCD control file through the *File* menu, the main menu screen immediately updates to display a brief summary of the current control file, as shown in Figure 1D.2.

The OCD control file consists of 17 data groups (Chang and Hahn, 1997), where some input parameters from different data groups can be considered the same category. To follow a more logical approach that is appropriate to a menu-driven environment, the GUI program places all related input parameters under similar “submenus.” Besides the *Sequential* submenu, there are a total of nine submenus, including *Run Information*, *Model Domain*, *Sources*, *Dispersion*, *Receptors*, *Meteorology*, *Chemical Transformation*, *Output Options*, and *Display Map*, under the *Input* main menu (see Figure 1D.3). The user can access any submenu separately, or the *Sequential* menu will guide the user through all nine submenus in sequence to create a complete OCD control file.

The *Model Domain* submenu defines the geographical region of interest and the corresponding shoreline geometry within that region in order for OCD to properly simulate the transition between overwater and overland plume dispersion. The user has to specify two latitudes and two longitudes that define the model domain of interest, plus the grid resolution for the domain (see Figure 1D.4). Then, by clicking the “Run MAKEGEO...” button, a digitized shoreline geometry (see Figure 1D.5 for an example) will be automatically created, through the *Display Map* submenu. The task of generating digitized shoreline data which normally would take at least half a day to complete by hand, now requires only a few seconds by the GUI program. The MAKEGEO preprocessor, originally developed by the MMS, includes databases of coastal information for the Pacific coast, Gulf of Mexico coast, Atlantic coast, and Alaska coast.

*Sources*, *Dispersion*, *Receptors*, *Meteorology*, and *Chemical Transformation* submenus specify remaining modeling information for the current OCD run. The OCD model has many output options and can generate much useful information. However, the disadvantage is that a myriad of output options are often confusing to the user. The *Output* submenu logically groups these output options to increase clarity (see Figure 1D.6).

After an OCD run has been completed, the user can invoke the ANALYSIS postprocessor to perform the following tasks to analyze the results.

- Tabulate for each receptor the top N X-hour (block) average concentrations, together with the day and hour of occurrence (the *TOPVAL* module).
- Tabulate for each receptor the cumulative frequencies of X-hour (block) average concentrations (the *CUMFRQ* module).
- Tabulate for each receptor all X-hour (block) average concentrations, together with the corresponding meteorological conditions, where a specified threshold value was exceeded (the *PEAK* module).

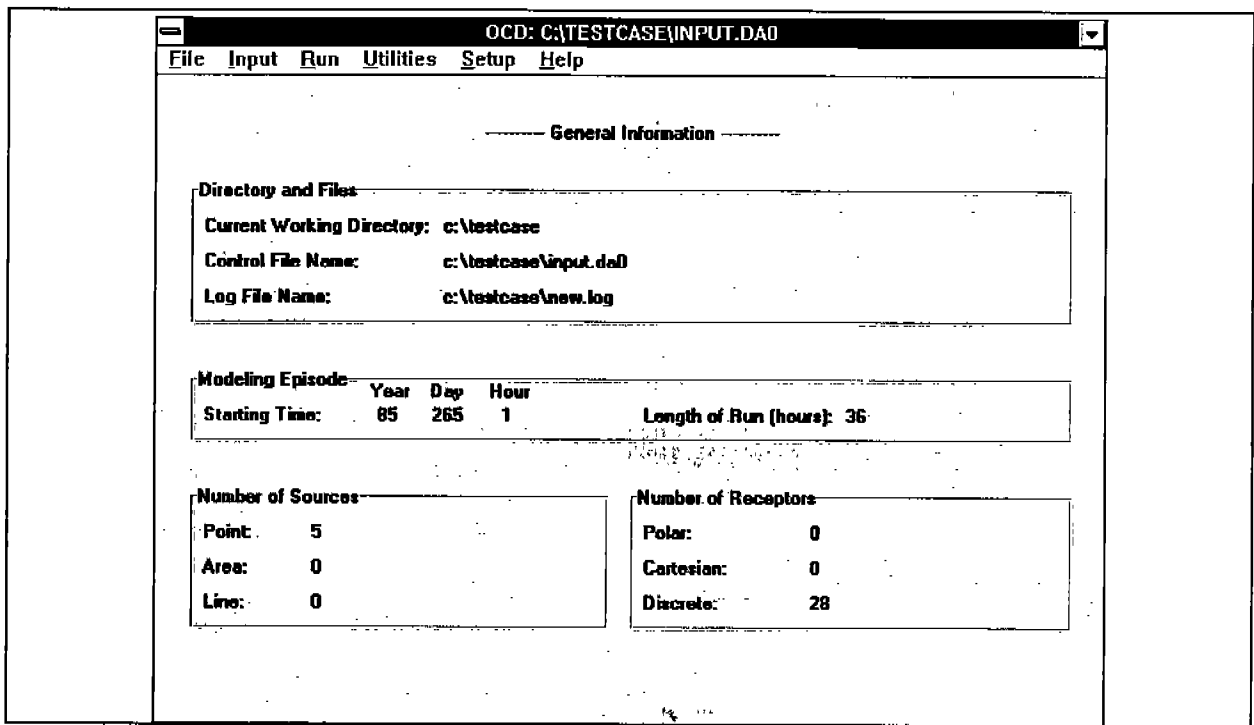

Figure 1D.2. OCD Main Menu.

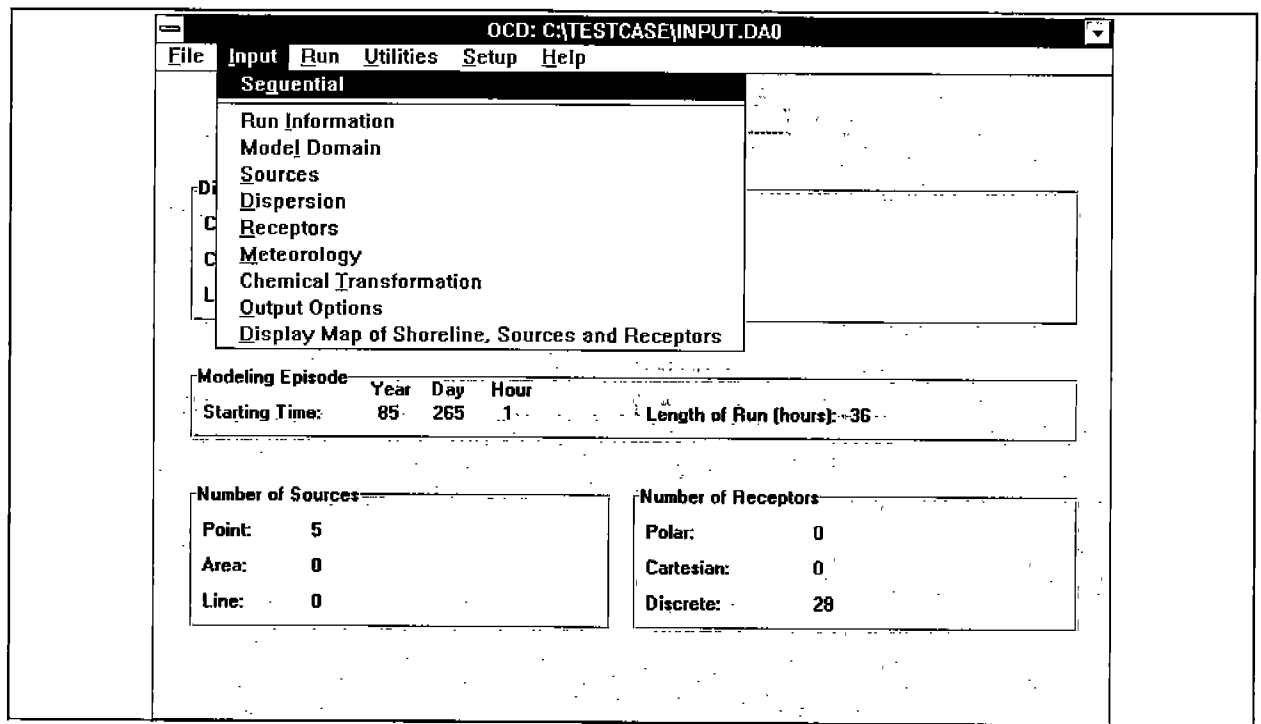

Figure 1D.3. Input Menu screen.

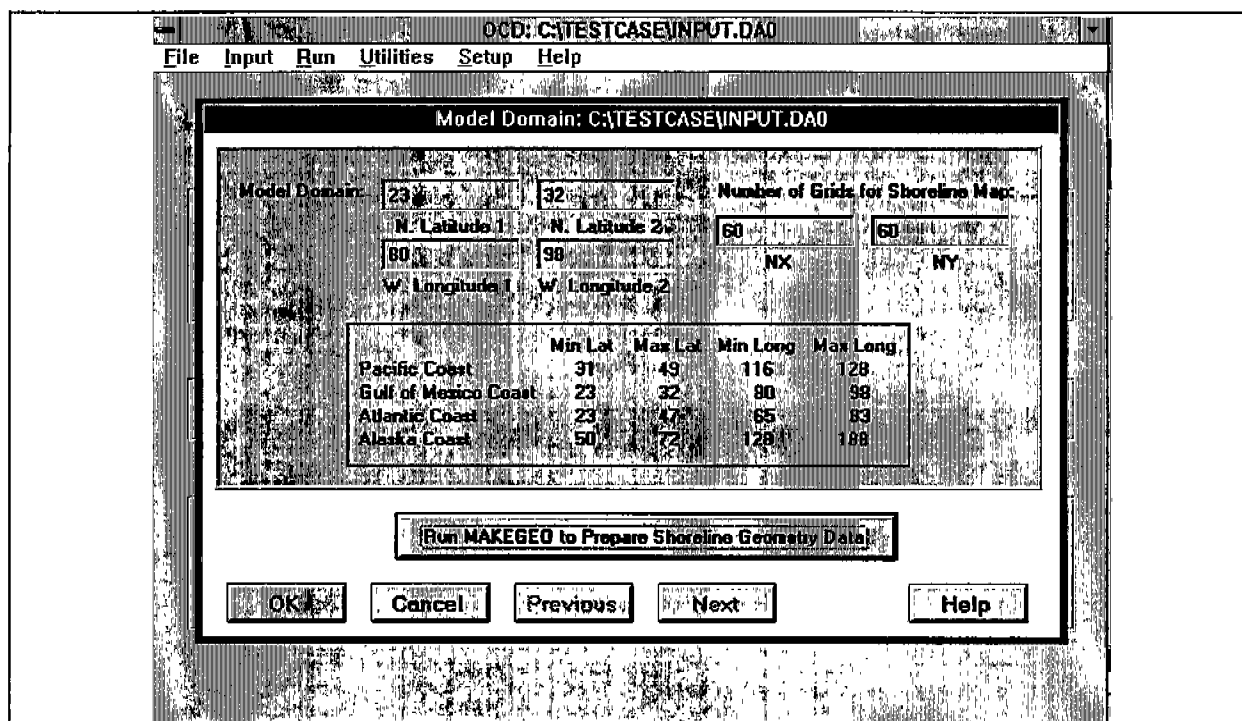

Figure 1D.4. Model Domain screen. The user needs to specify two latitudes and two longitudes that define the model domain, and the grid resolution for the model domain.

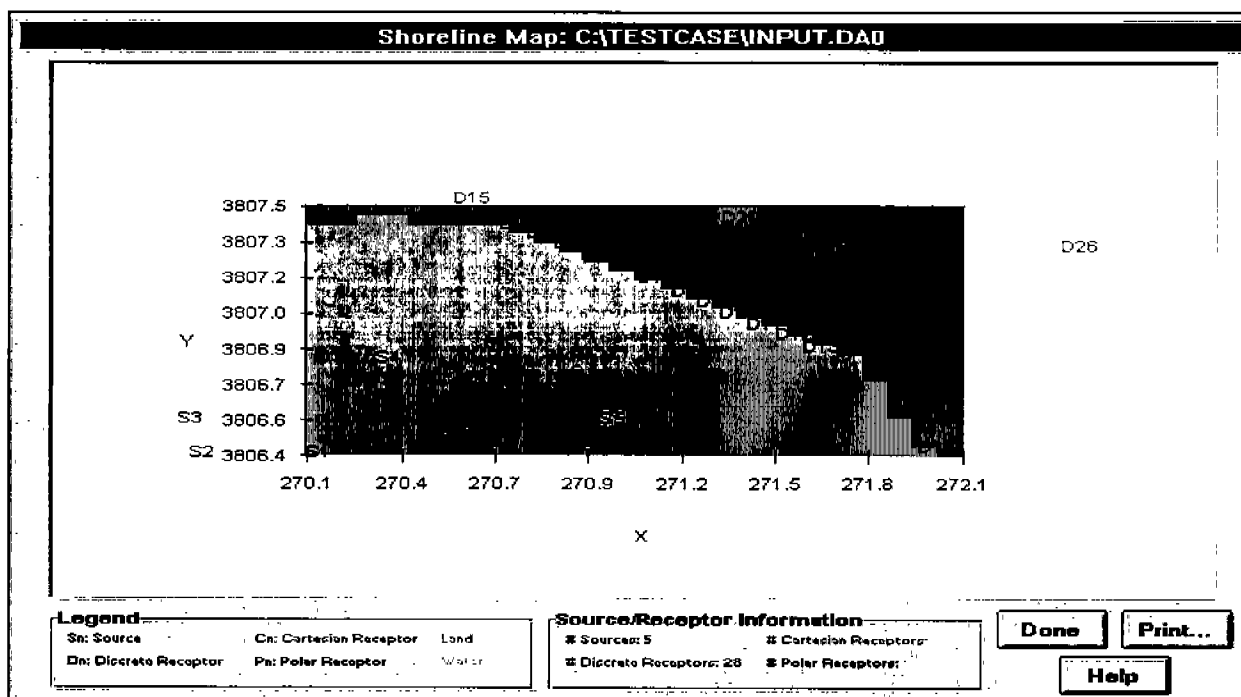

Figure 1D.5. Map Display of the shoreline geometry, sources (with an "S" prefix), and receptors (with an "R" prefix).

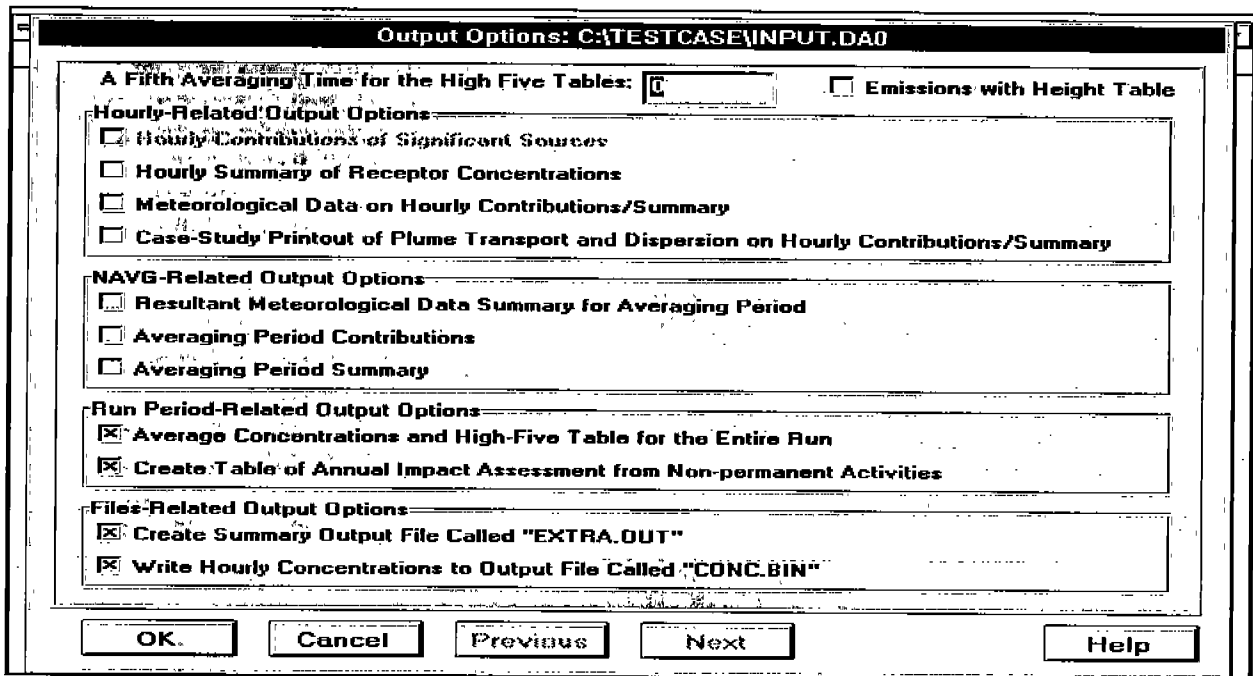

Figure 1D.6. Output Options screen, where output options are logically grouped.

- Extract the X-hour (block) average concentrations from the binary concentration file, and then write out the data in fixed-width ASCII format so that concentration isopleths can be further generated by independent plotting software (the *EXTRCT* module).
- Calculate X-hour running average concentrations, and then write out the average concentrations to a new binary file similar to the input binary concentration file (the *AVERGE* module).
- Read up to 12 binary concentration files, all synchronized in time, and add hourly concentrations from each file (the *SEQADD* module).

Figure 1D.7 shows the menu screen for the *PEAK* module, with all applicable user inputs displayed. Other post-processing modules can be similarly accessed.

After the *ANALYSIS* postprocessor has been run, the user can graphically display the results to gain a quick summary, or to determine whether the results appear reasonable. Figure 1D.8 shows a map of all predicted average concentrations exceeding a threshold of  $80 \mu\text{g}/\text{m}^3$  for a 3-hour period.

In addition to the *MAKEGEO* and *ANALYSIS* programs mentioned above, the user can also access other utility programs (Chang and Hahn 1997) via the GUI. Furthermore, the GUI has a “test-run” feature that verifies model inputs without running the *OCD* model.

The GUI program was developed using Microsoft’s Visual Basic language, and runs under the Windows 3.1, 95, and NT environments.

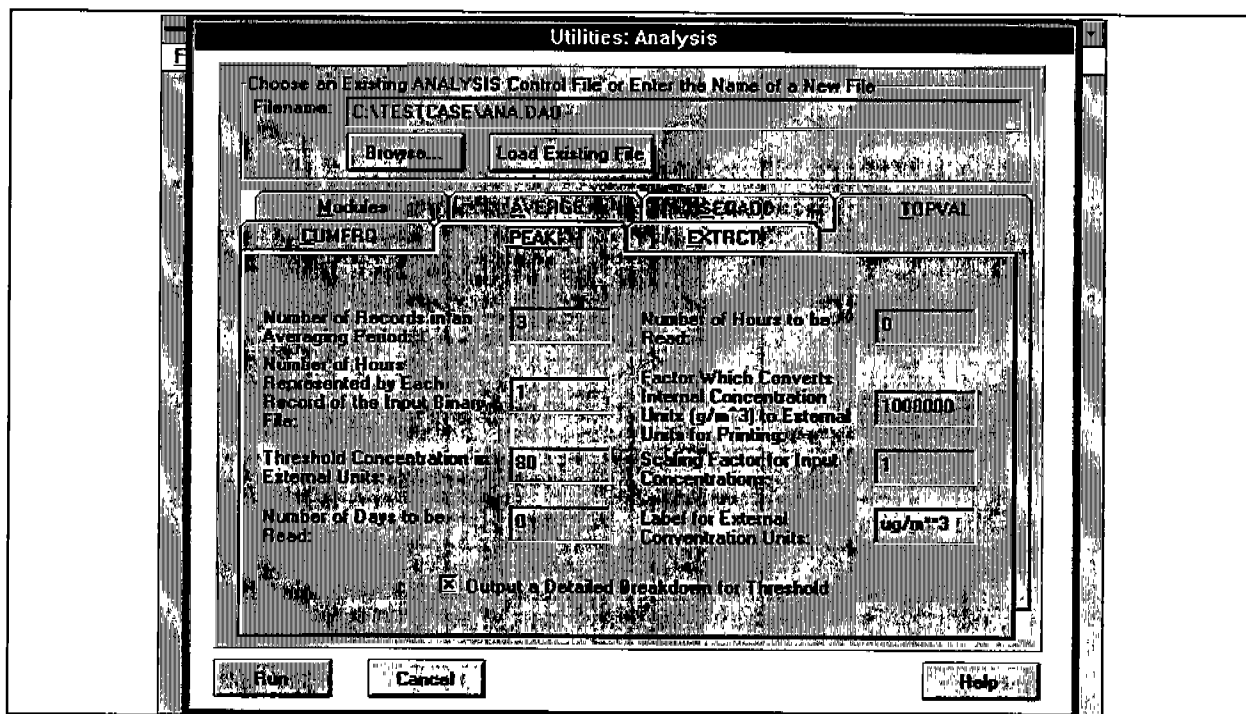

Figure 1D.7. PEAK screen for the ANALYSIS postprocessor.

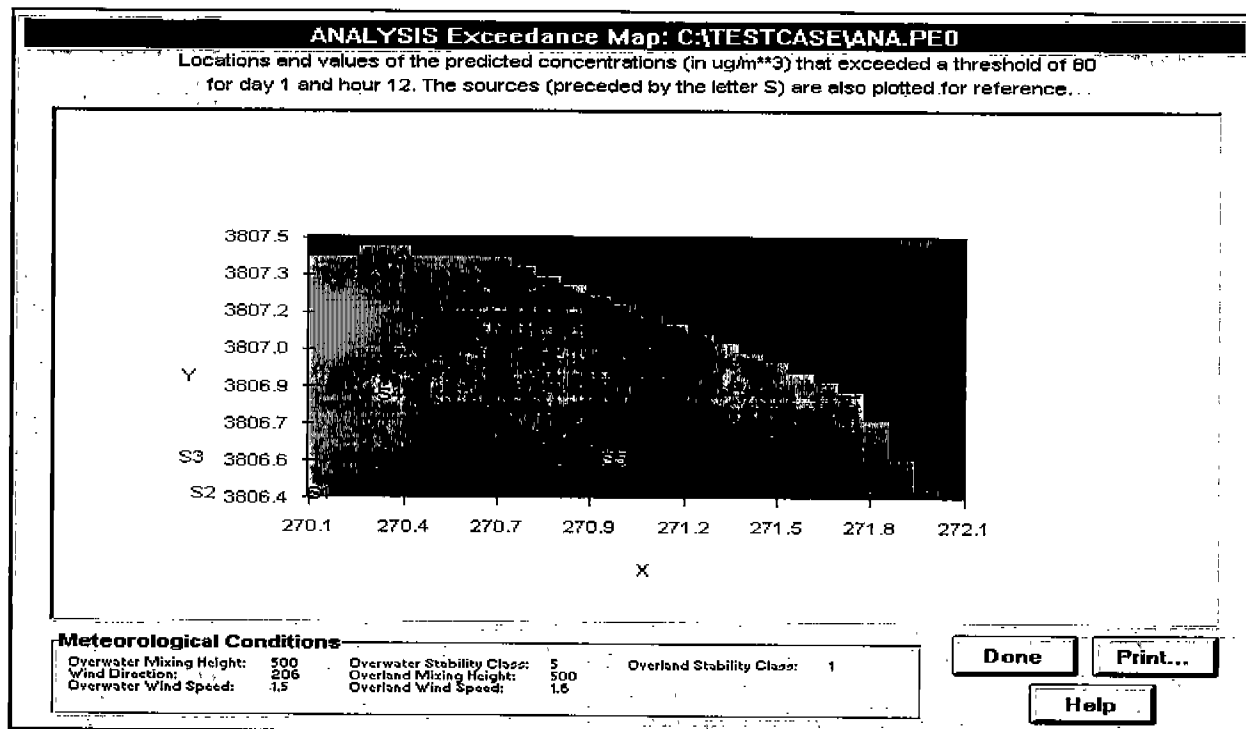

Figure 1D.8. Exceedance Map screen, where all predicted concentration values exceeding a user-specified value are displayed. The sources, labeled as S1, S2, etc., are also displayed.

## SUMMARY

The new Graphical User Interface (GUI) program for the Offshore and Coastal Dispersion (OCD) model was introduced. The GUI provides a user-friendly environment for the OCD model, where the user can easily and efficiently set up a model run, execute the program, and analyze the results.

## REFERENCES

- Chang, J.C., and K.J. Hahn, 1997: *User's Guide for Offshore and Coastal Dispersion (OCD) Model Version 5*. Earth Tech Report No. 21129, prepared for Minerals Management Service, Gulf of Mexico OCS Region, 1201 Elmwood Park Blvd., New Orleans, LA 70123-2394.
- DiCristofaro, D.C., and S.R. Hanna, 1989: *OCD: The Offshore and Coastal Dispersion Model*. Two volumes. Earth Tech Report No. A085-1, prepared for Minerals Management Service, U.S. Department of the Interior, 381 Elden Street, Herndon, VA 22070-4817, under contract no. 14-12-0001-30396.
- Hanna, S.R., L.L. Schulman, R.J. Paine, J.E. Pleim, and M. Baer, 1985: Development and evaluation of the Offshore and Coastal Dispersion Model. *J. Air Poll. Control Assoc.*, **35**, 1039-1047.

---

Mr. Joseph Chang is manager of the Model Development and Analysis Section of Earth Tech. Mr. Chang's main areas of interest include passive plume dispersion, heavy-gas dispersion, and model uncertainty. Mr. Chang, a certified consulting meteorologist, is co-developer for the Hybrid Plume Dispersion Model (HPDM), the Offshore and Coastal Dispersion (OCD) model, and the UF<sub>6</sub> version of the HGSYSTEM dense gas dispersion model. Mr. Chang is one of the authors for a 1996 AIChE workbook, entitled *Guidelines for Use of Vapor Cloud Dispersion Models*. Mr. Chang received his M.S. in meteorology from the Massachusetts Institute of Technology.

Ms. Kathy Hahn, a senior scientist at Earth Tech, has more than eleven years of experience in the design and development of application software for microcomputers. Ms. Hahn is involved with radiological dose assessment models and air quality models for the nuclear industry, and various Windows-based data management software. Ms. Hahn received her B.S. in mathematics from Pennsylvania State University.

## ATMOSPHERIC TRANSPORT OF SULPHUR DIOXIDE AND NITROGEN DIOXIDE OVER BRETON ISLAND

Dr. S. A. Hsu  
Louisiana State University

### INTRODUCTION

Measurements of ambient air quality levels for sulphur dioxide (SO<sub>2</sub>) and nitrogen dioxide (NO<sub>2</sub>), along with surface meteorological conditions over the Breton Island, Louisiana area have been collected intermittently since the summer of 1993, and are currently ongoing. This presentation will briefly discuss several findings from analyzed data prior to May 1997, and will illustrate the synoptic-scale meteorological patterns associated with selected high concentration episodes.

### METHODS AND RESULTS

The monitoring station at Breton Island has been deployed within the third floor of the main building at the Kerr-McGee facility since October 1994. Following the direct impact of Hurricane Danny in July 1997, the monitoring equipment was re-located to a ground-level container within 30 yards adjacent to the main building. The storm caused significant damage to the location, and approximately 6 weeks of data was lost. This event, combined with repeated equipment failures associated with on-site power fluctuations, will act to reduce the data return rate for 1997.

Tables 1D.2 through 1D.4 describe some initial results indicated by the data collected from October 1994 through April 1997. To summarize:

- Annual average concentrations of both SO<sub>2</sub> and NO<sub>2</sub>, based on data collected, were less than 5 ppb;
- Maximums for SO<sub>2</sub> were higher than in previous short-term studies, while those for NO<sub>2</sub> were lower;
- High SO<sub>2</sub> concentrations are most frequently associated with northerly winds; high NO<sub>2</sub> concentrations are more varied but primarily related to south-southwesterly winds; and
- Annual atmospheric stability over Breton Island is projected to range from slightly unstable to free convective.

The strong relationship between wind direction and high pollutant concentrations listed in Table 1D.4 is further illustrated in Figures 1D.9 through 1D.14. Several high concentration events were randomly selected based mainly on data quality preceding and following the observed peaks. Backward trajectories for two SO<sub>2</sub> and two NO<sub>2</sub> events are plotted in Figures 1D.11 and 1D.12 by starting at Breton Island and moving backward in time and space. Values of plus and minus two standard



Table 1D.2. Breton Island Annual Mean and Standard Deviation SO<sub>2</sub> and NO<sub>2</sub> Concentrations (ppb) October 1994 Through April 1997.

Year	SO <sub>2</sub>			NO <sub>2</sub>		
	# Samples	Mean	Deviation	# Samples	Mean	Deviation
1994	1955	1.2	1.9	1874	3.0	2.7
1995	5969	1.1	1.9	6066	4.2	4.3
1996	3732	1.0	1.6	3439	3.8	5.1
1997	1992	1.4	2.1	2022	4.1	4.6

Table 1D.3. SO<sub>2</sub> and NO<sub>2</sub> Maximums At Breton Island (ppb).

	1 Hour Maximum	Wind Speed m/s	Wind Direction	3-Hour Maximum	Wind Speed m/s	Wind Direction	24-Hour Maximum	Period Average
September 1993								
SO <sub>2</sub>	22.2	3.8	45	11.9	1.1	106	6.3	2.8
NO <sub>2</sub>	NA	NA	NA	NA	NA	NA	NA	NA
July - August 1994								
SO <sub>2</sub>	25.0	1.7	143	13.3	6.2	52	2.8	0.8
NO <sub>2</sub>	59.0	3.4	317	31.0	3.4	51	12.0	3.8
October 1994 - April 1997								
SO <sub>2</sub>	36.0	4.1	135	24.0	5.2	146	7.9	1.1*
NO <sub>2</sub>	35.0	6.4	277	28.3	5.8	202	17.8	4.6*

\* Based on composite years assembled from most complete months during the measurement period.

Table 1D.4. Distribution of High SO<sub>2</sub> (> 5 ppb) and NO<sub>2</sub> (>22 ppb) Concentrations at Breton Island.

Wind Direction	SO <sub>2</sub> (509 samples)	NO <sub>2</sub> (69 samples)
0 - 45	344	2
46 - 90	64	2
91 - 135	13	11
136 - 180	7	6
181 - 225	8	35
226 - 270	4	10
271 - 315	18	3
316 - 360	51	0

deviations are included to show the extremes. From Figures 1D.9 through 1D.12, it can be seen that the winds in these examples are steady with small deviations for at least 5–10 hours prior to the maximum concentrations observed. Two synoptic patterns appear to dominate in these cases; either pre-frontal when south-southwesterly winds are intensified, or under northerly-northeasterly winds produced by a large high pressure center over the northern U.S., often following a front (see Figures 1D.13 and 1D.14). It is interesting that northwesterly winds can produce high NO<sub>2</sub> at Breton Island (as in the October 1996 example), but this peak is less than those seen under southerly winds. Note that high concentration events occur throughout the year under varying synoptic conditions; however, these trajectories appear to be most prevalent.

#### SUMMARY

Although operational and environmental difficulties have contributed to a low data return rate, a long-term air quality and meteorological record continues to be collected at Breton Island. Annual mean concentrations of both SO<sub>2</sub> and NO<sub>2</sub> during the period of October 1994 through April 1997 are less than 5 ppb; however, higher concentration events frequently occur. High SO<sub>2</sub> concentrations are predominantly seen with northerly winds while high NO<sub>2</sub> most often occurs with south-southwesterly winds. These wind trajectories are typically produced by the passage of a frontal system and subsequent building of high pressure behind the front.

---

Dr. S. A. Hsu received his Ph.D. in meteorology from the University of Texas at Austin. He has been a professor at Louisiana State University since 1969. His research interests are coastal and marine meteorology, air-sea interaction, and pollution transport physics. Dr. Hsu has published extensively, including a book entitled *Coastal Meteorology*.

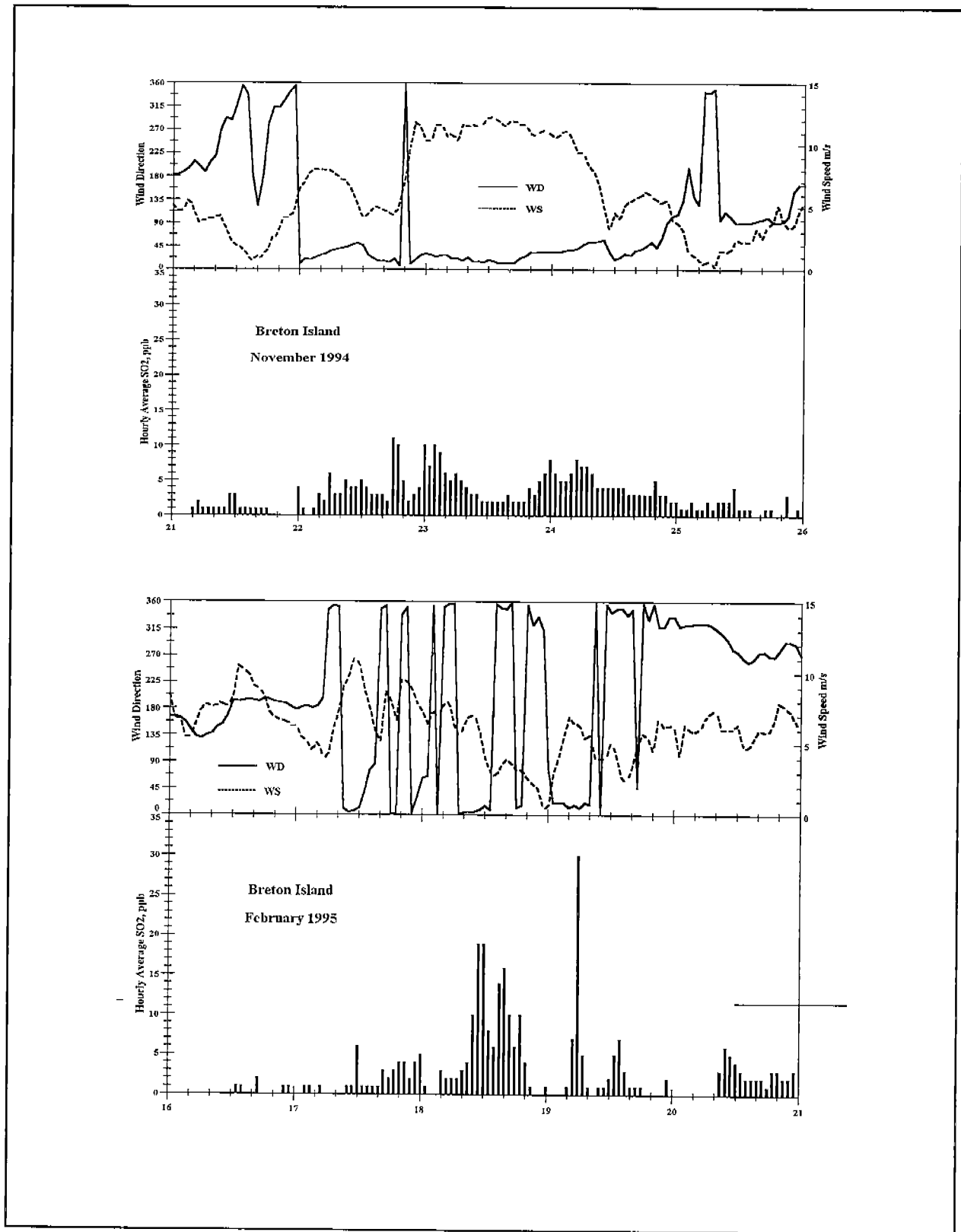

Figure 1D.9. Time series for two SO<sub>2</sub> events observed at Breton Island.

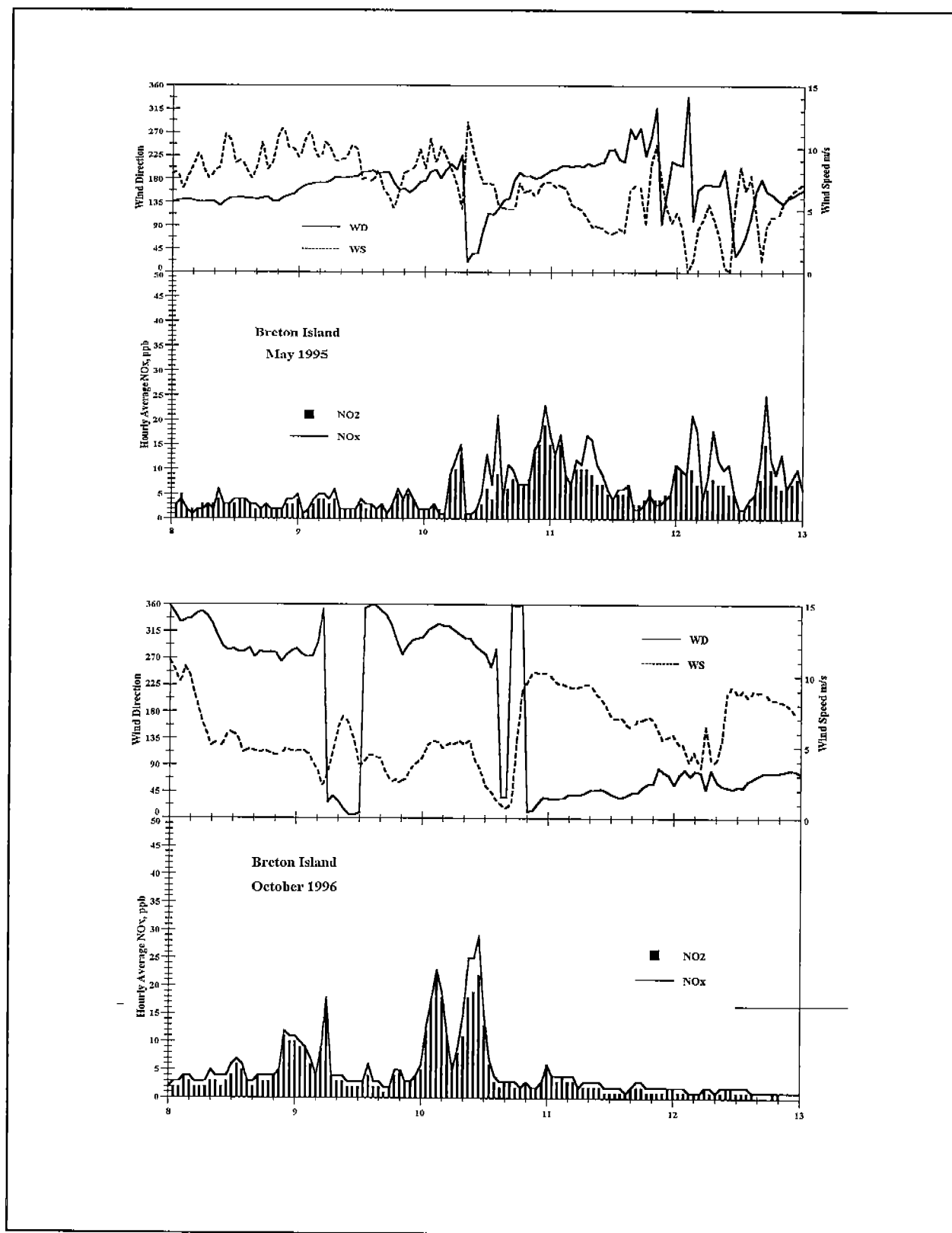

Figure 1D.10. Time series for two NO<sub>2</sub> events observed at Breton Island.

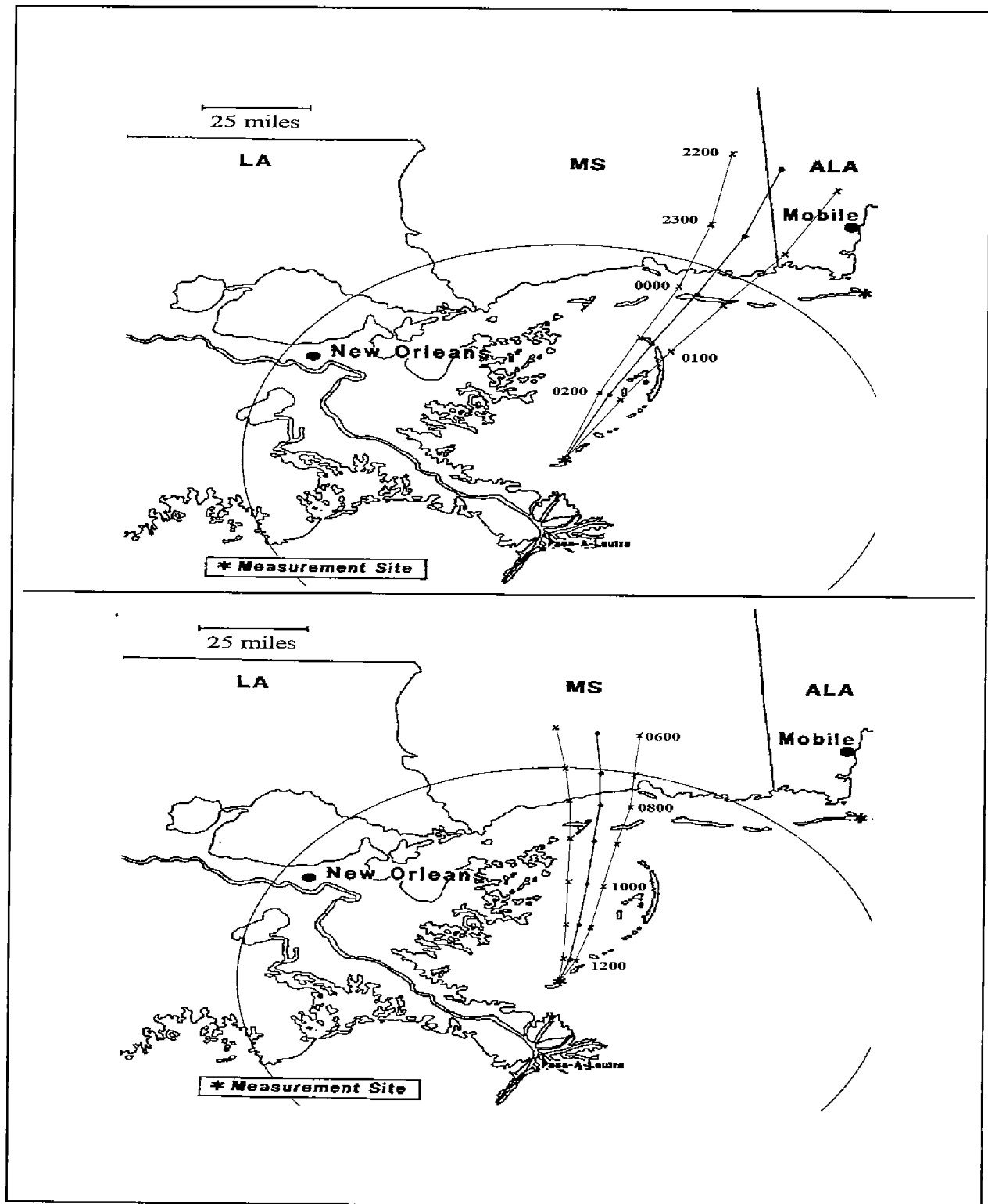

Figure 1D.11. Backward trajectories estimated for two high  $\text{SO}_2$  events observed at Breton Island in November 1994 (top) and February 1995 (bottom). Circle indicates approximately 75-mile radius from Breton.

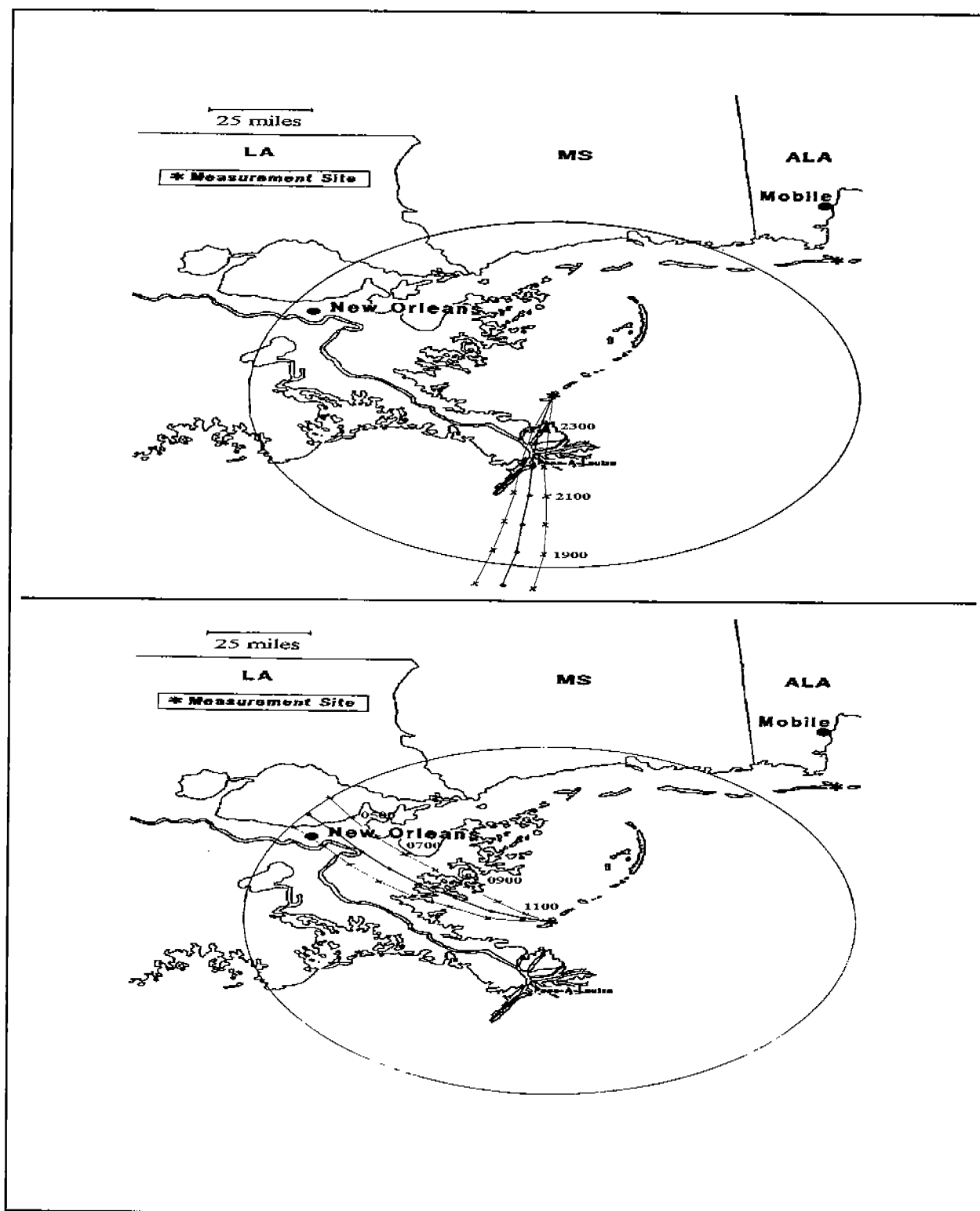

Figure 1D.12. Backward trajectories estimated for two high NO<sub>2</sub> events observed at Breton Island in May 1995 (top) and October 1996 (bottom). Circle indicates approximately 75-mile radius from Breton.

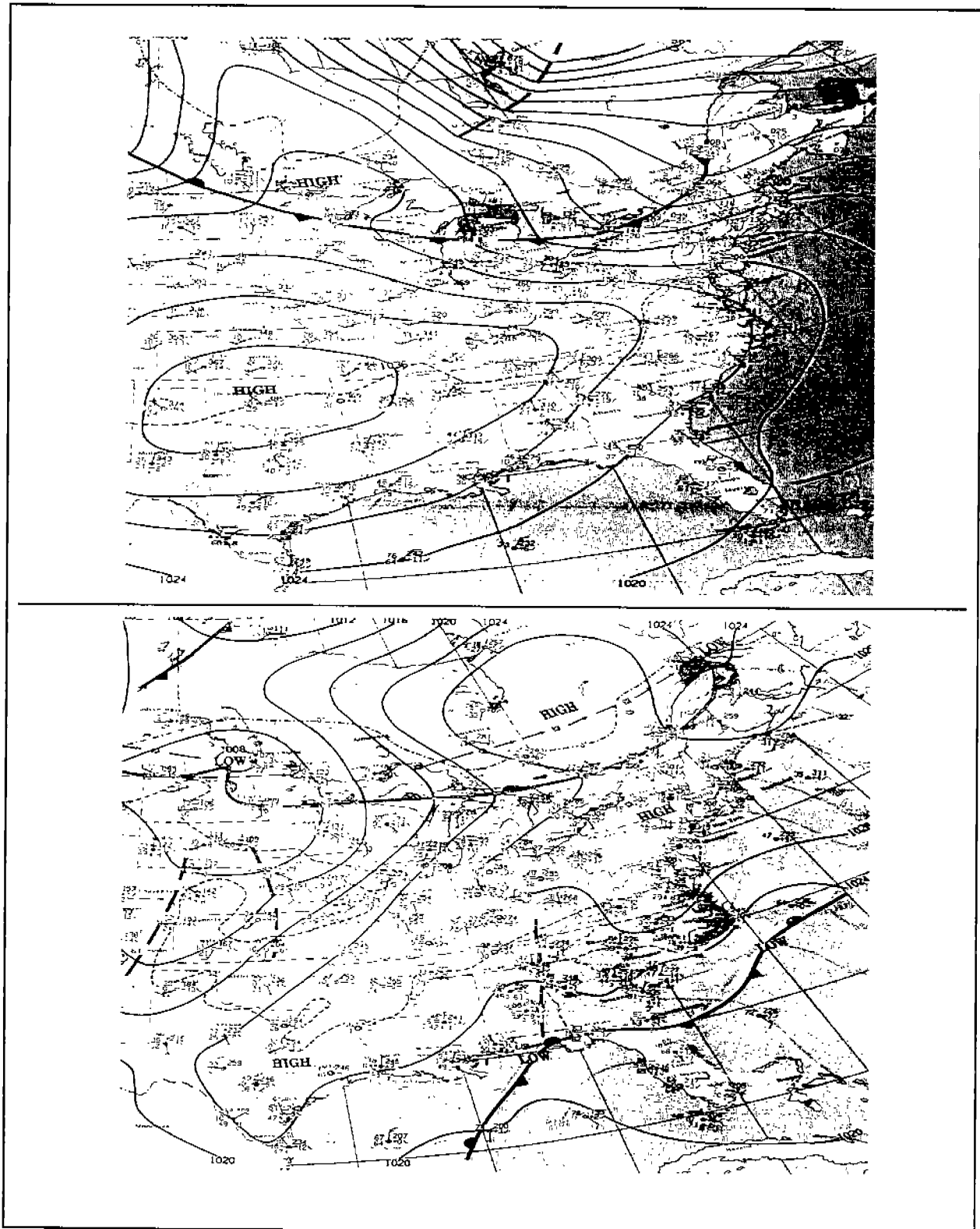

Figure 1D.13. NOAA Daily Weather Map Series for two high  $\text{SO}_2$  events observed at Breton Island in November 1994 (top) and February 1995 (bottom). Image time is 0700 EST.

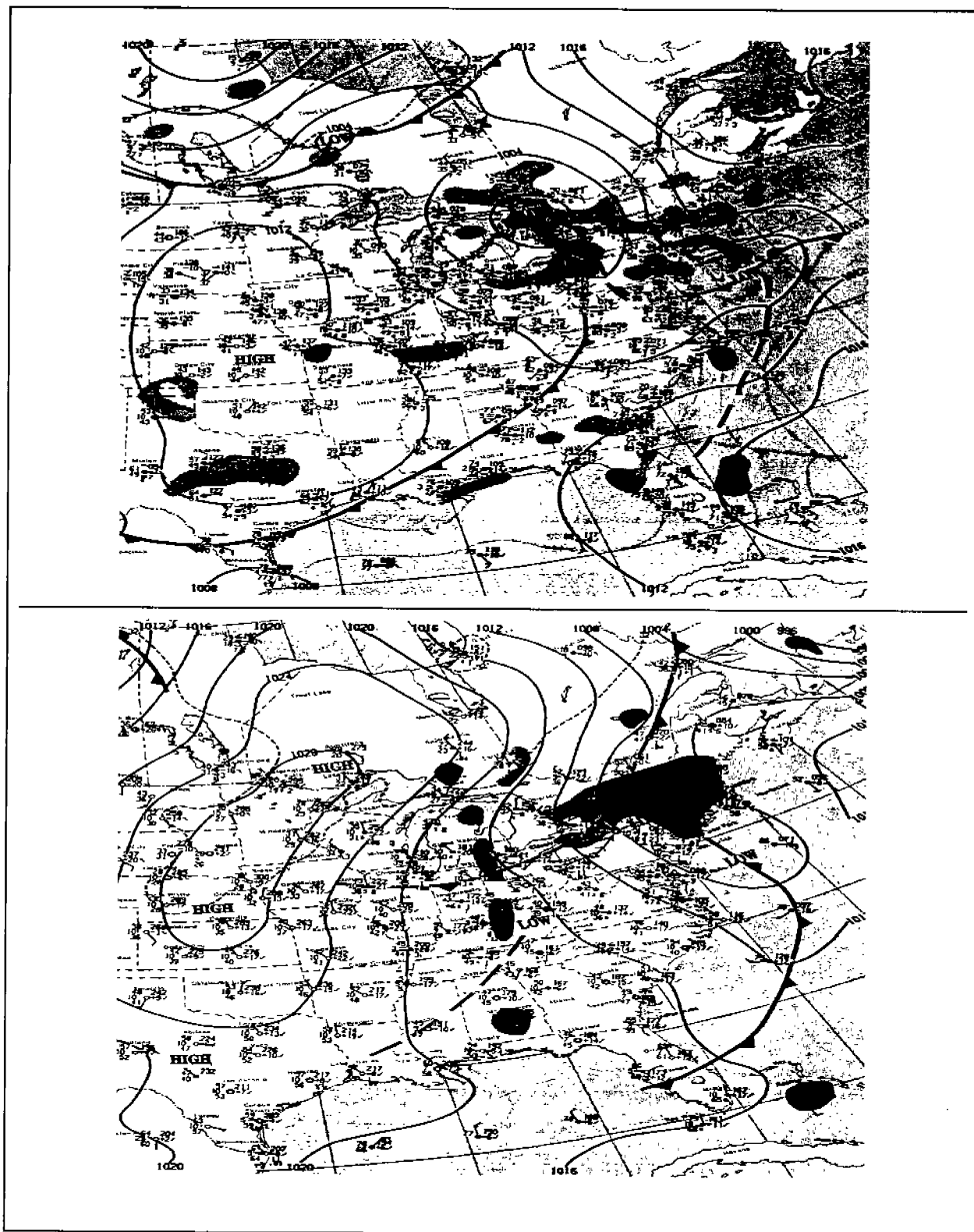

Figure 1D.14. NOAA Daily Weather Map Series for two high  $\text{NO}_2$  events observed at Breton Island in May 1995 (top) and October 1996 (bottom). Image time is 0700 EST.



## MODELING AND ANALYSIS IN SUPPORT OF THE DESIGN OF THE BRETON AEROMETRIC MONITORING PROGRAM (BAMP)

Dr. T. W. Tesche  
Mr. Dennis E. McNally  
Alpine Geophysics, LLC  
Covington, Kentucky

### INTRODUCTION

In response to meteorological data collection requirements issued by the Minerals Management Service (MMS), the Offshore Operators Committee (OOC) recently initiated the Breton Aerometric Monitoring Program (BAMP), a joint industry-agency cooperative study aimed at collecting emissions and aerometric data in the Federal Class I Breton National Wilderness Area (BNWA), located in the Central Gulf of Mexico. The BNWA has the potential to be impacted by anthropogenic emissions from offshore and onshore activities of both stationary, area, mobile, and naturally-occurring (i.e., bio-geogenic) sources. Recent offshore oil and gas exploration and development in the region has raised concerns by the Federal Lands Manager (the Fish and Wildlife Service) that the Class I increments for sulfur dioxide (3-hr, 24-hr, and annual average) and nitrogen dioxide (annual average) may have been consumed. Accordingly, the BAMP was conceived as a means whereby current, focused emissions, air quality and meteorological data could be collected in support of subsequent air quality dispersion modeling activities aimed at elucidating potential PSD impacts in the Breton region.

The firm of Walk Haydel Environmental (joined by Dames and Moore, Alpine Geophysics LLC, Louisiana State University, Northlake Engineers and Surveyors, Inc., and Nash Roberts, Inc.) was contracted by the OOC to develop the plan for the Breton Aerometric Monitoring Program. BAMP consists of two Phases. In Phase I, three main tasks are currently underway: (a) identification of appropriate dispersion models and their data requirements; (b) development of a plan for identifying major emissions sources in the study area and for identifying changes that have occurred in the inventory since the PSD baseline was established; and (c) design of an aerometric monitoring network to produce the data needed for dispersion model evaluation and application. Once Phase I is completed (estimated early 1998) Phase II will begin. Major elements will include: (a) collection of pertinent emissions data and, in parallel, (b) implementation of the field monitoring program. The Phase II monitoring program will continue for one year.

With contract negotiations completed in late autumn 1997, work on Phase I began on all four tasks in parallel. This paper discusses results achieved to date on the modeling activities performed in support of the BAMP program design. The recent draft report by Lee *et al.*, (1997) summarizes accomplishments on the emissions inventorying tasks. Work on the design of the field program network and operation is currently underway and will be reported in the Phase I final report in early 1998. We turn now to a discussion of the initial modeling activities as they relate to the design of the BAMP.

## STUDY APPROACH AND CURRENT RESULTS

The goal of the modeling analyses under Phase I (i.e., Task 1) was to assist in the development of an aerometric monitoring program plan that satisfies the input and verification requirements of the range of air quality dispersion models likely to be employed by the MMS, the OOC and other. Key elements included identifying: (a) existing aerometric data resources, (b) key meteorological and air quality processes affecting model selection and usage, (c) the range of appropriate, available meteorological and air quality models, (d) specific data requirements for validating and operating the recommended models, and (e) the specific data collection requirements, as embodied in the BAMP field program. Below, we summarize the results of recently-completed analyses and the status of ongoing modeling-related efforts in support of the field program design.

### Conceptual Model Development

One of the first (and ongoing) efforts of the modeling analysis is to develop a concise description of the dominant meteorological and air quality atmospheric processes which must be accounted for in the modeling techniques to be selected, verified, and applied to the Breton region. Currently, a detailed written *conceptual model* is being developed of the key meteorological and air quality processes leading to high 3-hr, 24-hr, and annual average concentrations of SO<sub>2</sub> and annual NO<sub>2</sub> concentrations in the BNWA. When completed, the conceptual model will identify the characteristics and occurrence frequency of adverse meteorological regimes, the physico-chemical processes influencing the formation, transport, transformation, and removal of SO<sub>2</sub>, and NO<sub>2</sub>, and the typical temporal and spatial scales pertinent to the aggregation of emissions sources and important onshore and offshore receptor areas. The conceptual model will serve as the basis for judging the suitability of candidate meteorological and air quality models for the Breton region, and defining the *additional* monitoring requirements for the BAMP.

### Assessment of Available Models

In parallel with the conceptual model development, a detailed assessment of potential modeling methods and their associated data requirements is being performed. Our approach and some current results are given below.

- **Identify Classes of Models:** Initial work has been performed to identify the most appropriate suite of meteorological and air quality dispersion models to be applied in the Breton region to assess 3-hr, 24-hr, and annual SO<sub>2</sub> and annual NO<sub>2</sub> increments. A detailed review was initiated of the full range of Gaussian (plume, puff and segment), Lagrangian (box and particle), Eulerian (grid-based inert and photochemical), and hybrid (plume-in-grid, telescoping grid, nested grid) dispersion models potentially fulfilling both the pertinent regulatory requirements (i.e., pollutants, averaging times, source types and configurations) and the demands to be placed on the candidate air quality models by the Breton Conceptual Model of key atmospheric processes. Table 1D.5 identifies a "short-list" of candidate models currently being investigated in greater detail. To date, the focus has been almost exclusively on deterministic models although the merits of including statistical and receptor-oriented

Table 1D.5. Candidate air quality models for the Breton Study: Formulation and references.

Model	Overall Description	Model Formulation References
<b>Gaussian Formulation</b>		
OCD	Straight line Gaussian model developed to determine the impact of offshore emissions from point sources on the air quality of coastal regions. Incorporates overwater plume transport and dispersion as well as boundary layer changes as the plume crosses the shoreline. Features include down-wash, plume penetration of elevated inversions, use of turbulent intensities for dispersion, continuous shoreline fumigation, and treatment of the TIBL.	Hanna <i>et al.</i> 1984, 1985; DiCristofaro and Hanna 1989; Chang and Hahn 1996;
AERMOD	Newly-developed straight line Gaussian model for estimating ground-level impacts of point, area, and line sources. Incorporates source culpability (i.e., attribution) analyses, and standard plume rise and dispersion estimates together with flexible, user-specified emissions source distributions and receptor grids.	EPA 1997
SDM	Multi-point Gaussian dispersion model that can be used to determine ground-level concentrations from tall stationary point sources near a shoreline environment.	
<b>Lagrangian Formulation</b>		
MESOPUFF II	Short-term regional-scale (> 10-50 km) puff model designed to calculate concentrations of up to five pollutant species (SO <sub>2</sub> , SO <sub>4</sub> , NO <sub>x</sub> , HNO <sub>3</sub> , NO <sub>3</sub> ). Transport, puff growth, chemical transformation, and wet and dry deposition are accounted for in the model.	Scire <i>et al.</i> 1994
CALPUFF	Non-steady-state Gaussian puff model that includes: (a) capability of treating time-varying point and area sources, (b) modeling domains from tens of meters to hundreds of kilometers, (c) averaging times from 1-hr to 1-yr, (d) inert and linearly-reactive pollutants, (e) linear removal processes, and (f) applicability to rough or complex terrain settings.	Scire <i>et al.</i> 1995
AVACTA II	Short-term Gaussian puff and/or segment model for transport and calm conditions. Accepts 3-D meteorology and emissions inputs and user-specified plume-rise formulas, dispersion parameters. Computes SO <sub>2</sub> and SO <sub>4</sub> concentrations and wet/dry deposition.	Zannetti 1990
INPUFF	Gaussian integrated puff model for the accidental release of a substance over several minutes or of modeling continuous stack plumes.	
<b>Eulerian Formulation</b>		
CAMx	A new regional photochemical model containing many advanced features such as grid nesting, sub-grid-scale Plume-in-Grid (PiG), alternative numerical advection solvers, and alternative chemical mechanisms. Includes detailed ozone source apportionment technology (OSAT) algorithms.	ENVIRON 1997; Yocke 1996

observational models (where the latter category might be useful in corroborating the predictions of the former) will be explored.

A number of reviews of existing regulatory air quality dispersion models have been reported in the recent literature (e.g., Tesche 1985; Roth *et al.* 1988; Zannetti 1990; Seigneur 1994) and many new models have been developed and tested over the last 5 to 7 years. Examples of Gaussian and Lagrangian models include ISC, SDM, AERMOD, OCD-5, MESOPUFF-II, and CALPUFF. Newer grid-based models (Yocke 1996) include CAM-x, SAQM, and CALGRID. Examples of aerosol or particle models include 3AM, UAM-Aero, PDM and PIC. Since subsequent modeling will be in support of state and federal regulatory decision-making, we have specifically excluded proprietary models from consideration due to their restrictions on open, public access.

A survey of pertinent meteorological models (interpolative, diagnostic, and prognostic) was also undertaken since all of the air quality models require some form of meteorological description and input parameters, e.g., wind speed, wind direction, temperature structure, humidity, radiation, cloud, precipitation and moisture. This analysis built upon recent meteorological modeling reviews (e.g., Pielke; 1989; Zanetti 1990; Seaman 1995, 1997; McNally and Tesche 1996).

- **Assess Model Algorithms:** Once the most attractive dispersion models were identified, we examined the models' technical formulations, computational algorithms, numerical implementation, and operational features. These model attributes will subsequently be compared with the modeling requirements established in the Breton Conceptual Model to ascertain areas of needed model algorithm improvement, and data sets that must be included in the design of the BAMP.
- **Assess Model Evaluation Exercises:** For each model, we examined whether and to what extent the model had been successfully tested in previous studies, particularly in coastal, complex meteorology environments. Second, since thorough model verification studies are quite expensive, we sought to identify those gaps in a particular model's prior testing that might be filled through focused data collection in the BAMP. Thus, pertinent model evaluation and application studies have been reviewed for each of the candidate models. Particular emphasis was placed on judging whether the evaluations were thorough and sufficiently rigorous to reveal flaws in the models or data sets should they exist. Guidance on the model evaluation process and the needs for rigorous performance testing are described extensively in the literature (Tesche *et al.* 1990; Roth and Tesche 1991; Tesche 1993; Roth *et al.* 1997; Russell and Dennis 1997; Arnold *et al.* 1998). Among the key findings of this review is that: (a) collection of data sets for thorough performance testing of dispersion models is expensive and is seldom pursued thoroughly enough to provide for rigorous, scientific testing of models; (b) there are very little current data available in the Breton study area that can be used to rigorously test air quality or meteorological models; and (c) the best prospects for model testing relate to the use of existing specialized tracer dispersion experiments performed in other coastal regions in the U.S., particularly along the West Coast.

### Enhancement of the BAMP Network Design Through Advanced Modeling

A novel and very cost-effective method has recently been used in the BAMP project to aid in field program design. This method, involving the use of a sophisticated mesoscale meteorological model, enables one to objectively optimize the design of meteorological monitoring networks by identifying those key locations where collection of meteorological data would *provide the greatest utility and information content* with respect to subsequent meteorological and air quality modeling studies. A brief summary of the approach and results for the BAMP are presented here.

Researchers at Penn State University recently completed a research study (Seaman and Stauffer 1997; Tesche and McNally 1997) that developed, evaluated and successfully demonstrated an innovative technique (Stauffer *et al.* 1998) for optimizing the siting of meteorological monitors. Using the NCAR/PSU MM5 prognostic meteorological model, the Field Correlation Technique (FCT) was developed which determines objectively the degree of spatial and temporal coherence in the fields of meteorological variables (i.e. wind, temperature, moisture) at local to regional scales. Underpinning the method is the fact that the stronger the spatial and temporal coherence in a variable field, the fewer measurement sites are necessary to describe adequately the dominant characteristics of that field. Conversely, where the MM5/FCT method reveals *lower coherence*, an increased need for monitoring is indicated in those areas of the grid region. In actual application to the design of the 1997 SCOS field study in California, the objective guidance developed through MM5/FCT provided critical information about the coherence of the wind and mass fields in the Southern California coastal region (Seaman and Stauffer 1997) and led to the optimization of new aloft monitoring sites and the re-deployment of three existing microwave profiles for the SCOS field study that was conducted last summer.

For the Breton study, we adapted the MM5-FDDA prognostic meteorological model to the BNWA region for two historical air pollution episodes: 6-11 September 1993 and 15-19 August 1993. Both of these episodes occurred during the 1993 Gulf of Mexico Air Quality Study (GMAQS). The MM5 was set up and applied on a nested 108/36/12/4 km grid shown in Figure 1D.15. A detailed model performance evaluation revealed that the MM5 model performed reliably for these two base cases, consistent with previous performance evaluations of this and other state-of-science models. Examples of the MM5 surface wind fields are shown in Figures 1D.16 and 1D.17 at 1900 EST on one day during the August 1993 episode.

After having demonstrated satisfactory MM5 performance for the two historical GMAQS episodes, we then used the FCT technique to develop model-derived estimates of the utility of the existing array of meteorological sensors, as well as to identify other locations where supplemental monitoring would be most beneficial to subsequent model verification and application studies. Results of this application are still being analyzed, but preliminary findings confirm that the boundary layer wind and thermal structure over the Gulf are highly variable in space and time and that adequate characterization of the meteorological fields through *in situ* instrumentation will be both costly and operationally challenging.

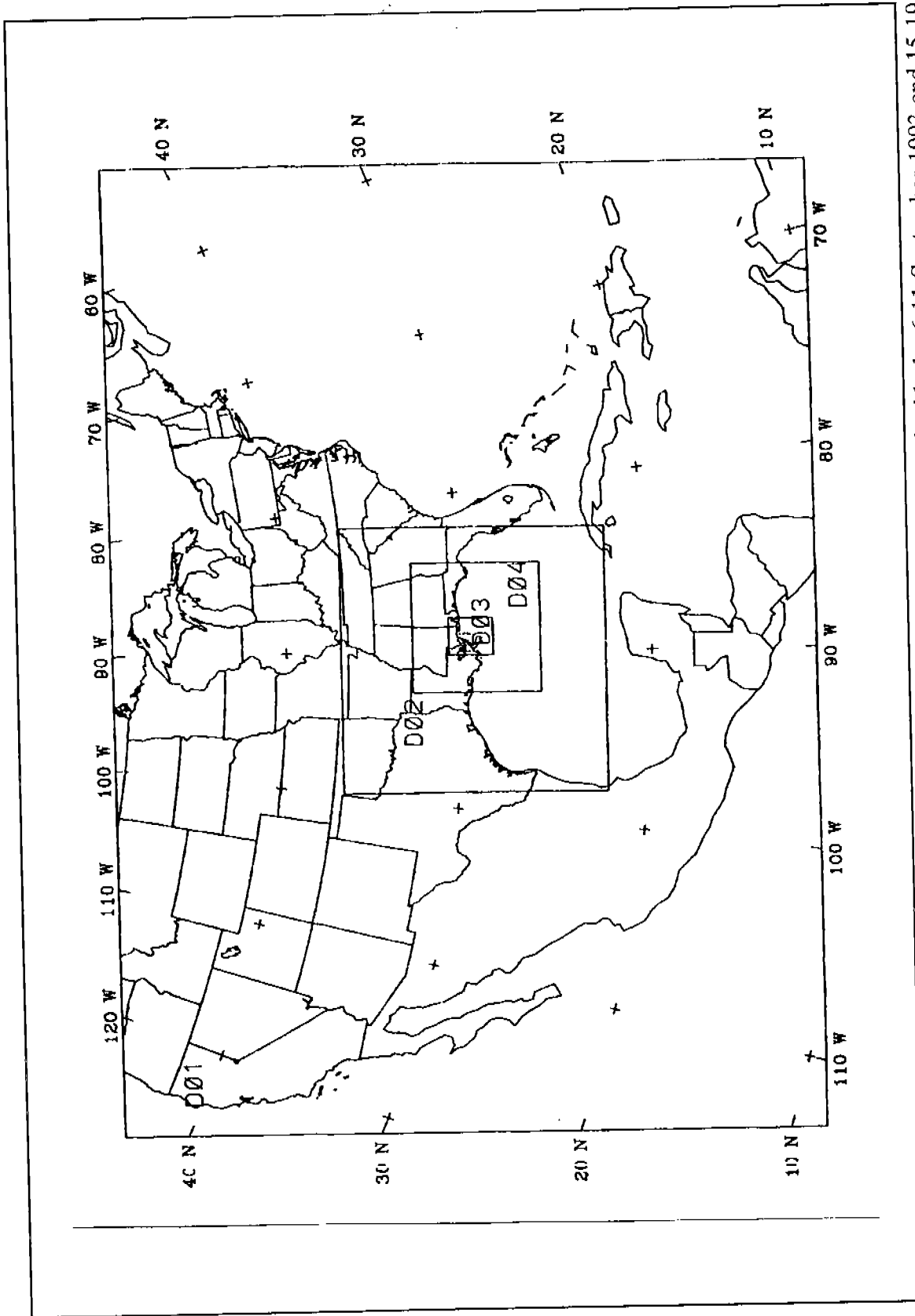

Figure 1D.15. Nested 108/36/12/4 Km MM5 Meteorological Modeling Domain used with the 6-11 September 1993 and 15-19 August 1993 GMAQS episodes to optimize the placement of meteorological sensors for the Breton Aerometric Monitoring Program.

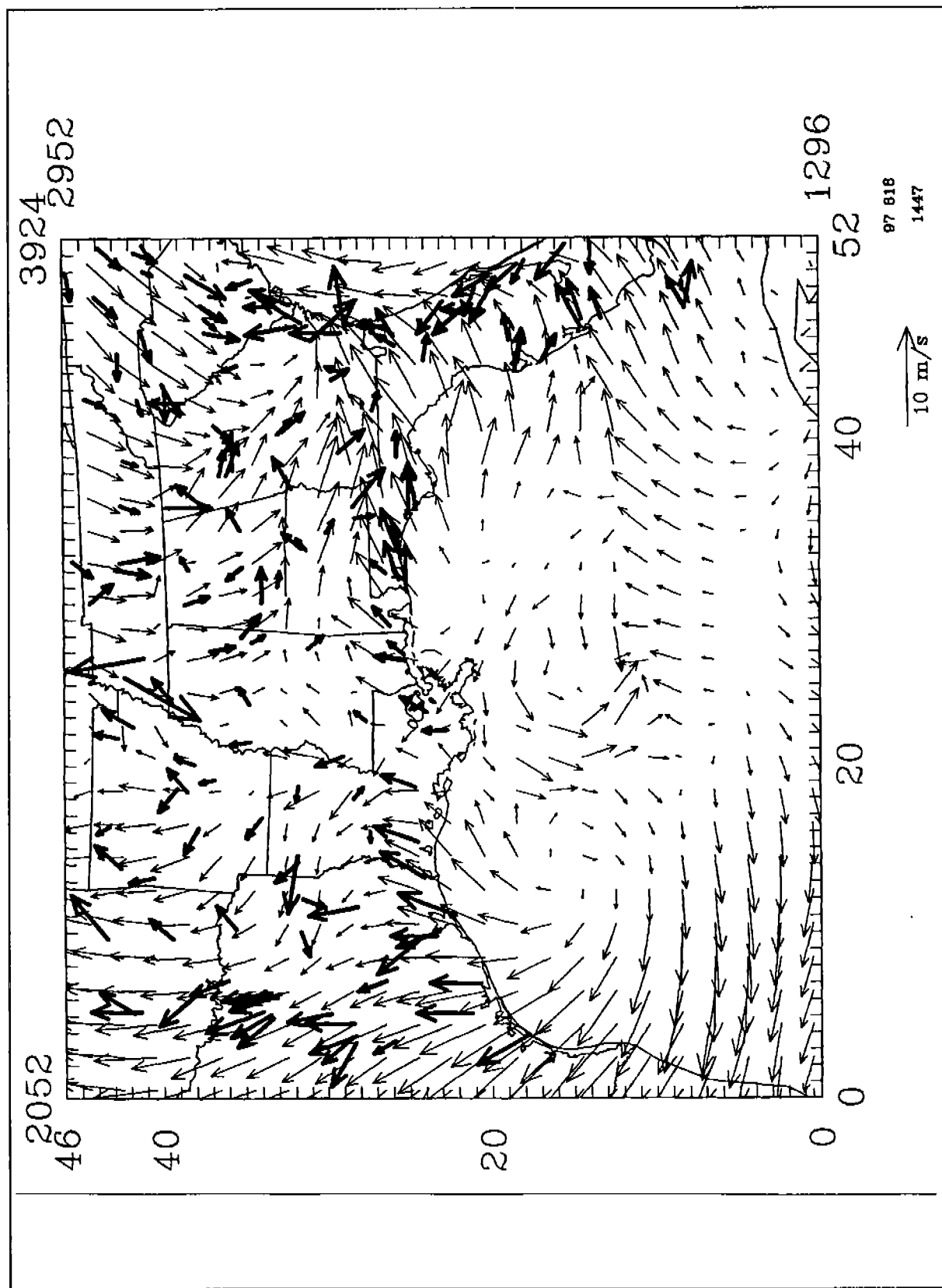

Figure 1D.16. Surface MM5 wind predictions and observations (bold vectors) on the 36 Km grid on 18 August 1993 at 1900 EST.

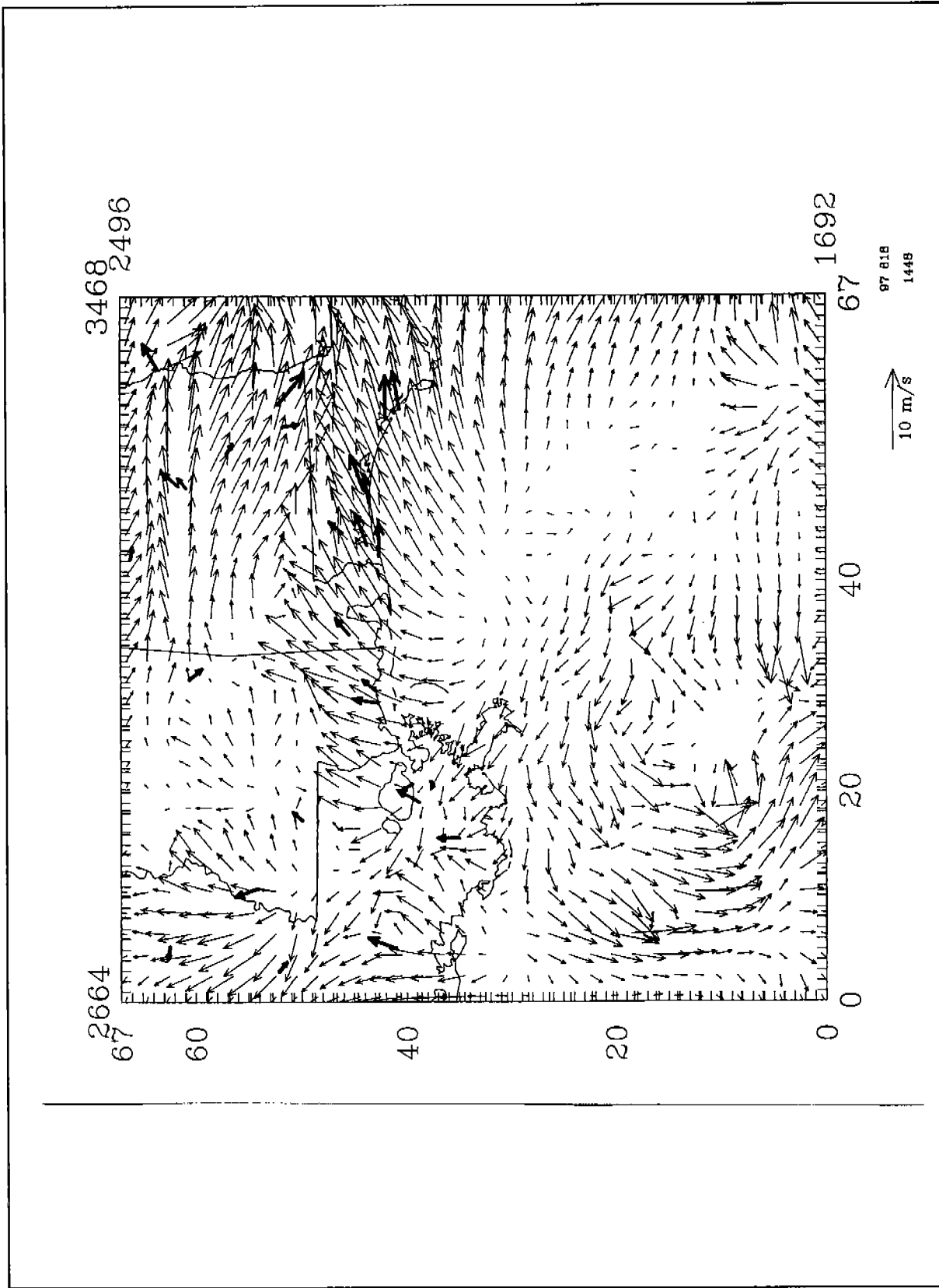

Figure 1D.17. Surface MM5 wind predictions and observations (bold vectors) on the 12 Km grid on 18 August 1193 at 1900 EST.



An added benefit of the MM5 application to the GMAQS data sets is the finding that the model produces reasonable mesoscale wind, temperature, and moisture fields in the BAMP study region. This is an important finding from the air quality modeling perspective since regardless of whether simple or complex air quality models are chosen, they will require a model for supplying meteorological inputs. In our recent applications, the MM5 has demonstrated a strong capability for providing these fields and provides a benchmark for the accuracy and skill to be expected of any meteorological modeling method subsequently selected for use by the OOC and the MMS in the BNWA region.

## SUMMARY

The principal objectives of the ongoing modeling analyses are to identify in priority order the meteorological and air quality data measurements needed to support the set-up, evaluation, and operation of the recommended models, and develop monitoring recommendations based on existing dispersion model needs. As Phase I is completed, the study team will synthesize the findings from: (a) the Breton Conceptual Model; (b) the inventory of existing aerometric data collection activities; and (c) the model input data requirements to develop a prioritized list of aerometric parameters which need to be collected in the BAMP. These data requirements will be identified along with recommendations of frequency and location of sampling, method of sampling, and the intended purpose(s) of the data to be collected. Attention will also be given to the need for special atmospheric studies (e.g., surface and aloft multiple tracer diffusion experiments; smoke releases with time-lapse photography; airborne remote sensing) where these studies might significantly enhance the model evaluation and application efforts.

## REFERENCES

- Arnold, J.G., R.L. Dennis, and G.S. Tonnesen. 1998. Advanced techniques for evaluating Eulerian Air Quality Models. *In* Proceedings of the 10<sup>th</sup> Joint Conference on the Applications of Air Pollution Meteorology, 11-16 January 1998, Phoenix, AZ.
- Chang, J.C., and K.J. Hahn. 1996. Development of the Graphical User Interface (GUI) and Other Enhancements for the Offshore Coastal Dispersion (OCD) Model. Prepared by EARTH TECH, Concord, MA.
- DiCristofaro, D.C., and S.R. Hanna. 1989. OCD: The Offshore and Coastal Dispersion Model. EARTH TECH report No. A085-1, prepared for the Minerals Mgmt. Service, Herndon, VA.
- ENVIRON. 1997. User's Guide to the Comprehensive Air Quality Model with Extensions (CAMx), Version 1.10. ENVIRON International Corporation, Novato, CA.
- EPA. 1997. User's Guide for the AMS/EPA Regulatory Model - AERMOD. Prepared by the U.S. EPA, Office of Air Quality Planning and Standards, Research Triangle Park, NC.

- Hanna, S.R. *et al.* 1984. User's Guide to the Offshore and Coastal Dispersion (OCD) Model. Environmental Research and Technology, Concord, Mass., Contract No. 14-08-0001-21138.
- Hanna, S.R. *et al.* 1985. Development and evaluation of the Offshore Coastal Dispersion Model. J. Air Pollution Control Assoc., Vol. 35, pp. 1039-1047.
- Hsu, S.A. and B.W. Blanchard. 1997. Long-term measurements of SO<sub>2</sub> and NO<sub>2</sub> concentrations and related meteorological conditions in the northeastern Gulf of Mexico Region. Interim Report, prepared for the Minerals Mgmt. Service, prepared by the Coastal Studies Institute, Louisiana State University, Baton Rouge, LA. Contracts MMS-14-35-0001-30775 and MMS-14-35-0001-30660 Task 19925.
- Lee, E. *et al.* 1997. Breton Aerometric Monitoring Program, Task 2: Emissions Inventory. Prepared for the Offshore Oil Operators Committee by Walk Hayel, Environmental, New Orleans, LA., Project No. 7466.20.
- McNally, D. E., and T. W. Tesche. 1996. Evaluation of the MM5 Model for the July 1988 and July 1995 Episodes and Comparison with the OTAG Meteorological Model, RAMS. 89th Annual Meeting of the Air and Waste Management Association, Nashville, TN.
- Pielke, R.A. 1989. Status of subregional and mesoscale models: volume 2: mesoscale meteorological models in the United States. Prepared for EPRI, prepared by Aster, Inc., Fort Collins, CO.
- Roth, P.M. *et al.* 1988. Guidelines for air quality models. Prepared for the California Air Resources Board, Sacramento, CA. by Envair, San Rafael, CA.
- Roth, P.M. and T.W. Tesche. 1991. A conceptual framework for evaluating the performance of grid-based air quality simulation models. NATO International Conference on Air Pollution and its Effects. Athens, Greece.
- Roth, P.M., T.W. Tesche, and S.D. Reynolds. 1997. A critical review of regulatory air quality modeling for tropospheric ozone. NARSTO Critical Review Paper. 1998 NARSTO Ozone Assessment, to be submitted to Atmospheric Environment.
- Russell, A.G., and R.L. Dennis. 1997. Critical review of photochemical models and modeling. NARSTO Critical Review Paper. 1998 NARSTO Ozone Assessment, to be submitted to Atmospheric Environment.
- Seaman, N.L. 1995. Status of meteorological pre-processors for air quality modeling. International Conf. On Particulate Matter, Air and Waste Mgt. Assn., Pittsburgh, PA.
- Scire, J. S. *et al.* 1984. User's Guide to the MESOPUFF II Model and Related Processor Programs. EPA 600/8-84-013. US EPA, Research Triangle Park, NC.

- Scire, J.S. *et al.* 1995. A User's Guide for the CALPUFF Dispersion Model. Prepared by EARTH TECH, Concord, MA, for the U.S. Forest Service, Cadillac, MI.
- Seaman, N. L.. 1997. Meteorological modeling for air quality assessments. NARSTO Critical Review Paper. 1998 NARSTO Ozone Assessment, to be submitted to Atmospheric Environment.
- Seaman N.L. and D.R. Stauffer. 1997. Use of the MM5 Model as an aid in designing the 1997 Southern California ozone study: part II, numerical modeling studies in support of the SoCAB field study design. Prepared for the California Air Resources Board by Pennsylvania State University, University Park, PA.
- Seigneur, C. 1994. The status of mesoscale air quality models. Planning and Managing Regional Air Quality: Modeling and Measurement Studies, Lewis Publishers, Boca Raton, FL.
- Stauffer, D.R. *et al.* 1998. A statistical technique using MM5 numerical simulations in support of a field program design for the 1997 Southern California Ozone Study. *In* Proceedings of the 10<sup>th</sup> Joint Conference on the Applications of Air Pollution Meteorology, 11-16 January. 1998, Phoenix, AZ.
- Tesche, T.W. 1985. Photochemical dispersion modeling: a review of model concepts and recent applications studies. *Environment International*, Vol. 9, pp. 465-489.
- Tesche, T.W. 1993. Evaluation procedures for regional emissions, meteorological, and air quality simulation models. 86<sup>th</sup> Annual Meeting of the Air and Waste Mgt Assoc. Denver, CO.
- Tesche, T.W., and D.E. McNally. 1997. Use of the MM5 Model as an aid in designing the 1997 Southern California ozone study: part I, final evaluation of the MM5 Model for the 3-6 August 1990 SARMAP Episode over the Central California Region. Prepared for the California Air Resources Board by Alpine Geophysics, LLC, Covington, KY.
- Tesche, T.W., *et al.* 1990. Improvement of procedures for evaluating photochemical models. Prepared for the California Air Resources Board by Alpine Geophysics, Placerville, CA.
- Yocke, M.A. 1996. Hybrid grid models for regional air quality assessment. 16<sup>th</sup> Information Transfer Meeting, Minerals Mgmt. Service, New Orleans, LA.
- Zanetti, P. 1990. Air Pollution Modeling, Van Nostrand Reinhold, New York.

---

Dr. T. W. Tesche is the principal scientist at Alpine Geophysics, LLC. He has nearly 25 years of experience in developing and applying emissions, meteorological, and advanced air quality models worldwide. He was a major participant in the design and/or evaluation of a number of inert species,

photochemical and secondary aerosol models , including the Urban Airshed Model (UAM), Reactive Plume Model (RPM), Annual-average Airshed Aerosol Model (3-AM), the TRAJ photochemical trajectory model, and the Regional Transport Model (RTM-II). Most recently, he has been involved in the evaluation and application of advanced nested meteorological and photochemical dispersion models to the problems of urban- and regional-scale photochemical oxidant pollution in the eastern U.S. Dr. Tesche received his B.S. in mechanical engineering from the University of New Mexico, M.S. degrees in civil and mechanical engineering from the University of California (Davis/Berkeley), and a Ph.D. in environmental engineering from UC-Davis. He is a Certified Consulting Meteorologist with the American Meteorological Society.



## SESSION 2A

### DEEPWATER OPERATIONS, PART II

Chair: Mr. Jim Regg  
 Co-Chair: Mr. G. Ed Richardson

Date: December 16, 1997

Presentation	Author/Affiliation
Deepwater High Resolution Seismic Survey Methods	Mr. Jack Caldwell Geco-Prakla
Deepwater Equipment Capabilities	Mr. Richard Frisbie Oceaneering International, Inc.
Marine Safety Regulatory Update	CDR Guy A. Tetreau Chief, Eighth District Marine Safety Compliance Branch
New Deepwater Structure Concepts: Panel Discussion—Introduction	Mr. Jim Regg Minerals Management Service Gulf of Mexico OCS Region
New Deepwater Structure Concepts: Panel Discussion—Introduction to Moses Mini-TLP	Mr. Lawnie Sturdevant MODEC (U.S.A.) Inc.
New Deepwater Structure Concepts: Panel Discussion—Deepwater Development Options	Mr. Richard D'Souza Aker Maritime
New Deepwater Structure Concepts: Panel Discussion—Chevron's Genesis Spar Project	Mr. W. Scott Young Chevron
New Deepwater Structure Concepts: Panel Discussion—Morpeth Field Development	Mr. G. Ross Frazer British-Borneo Exploration, Inc.



## ADVANCES IN DEEPWATER, HIGH RESOLUTION SEISMIC SURVEY METHODS

Dr. Jack Caldwell  
Geco-Prakla, Houston

### INTRODUCTION

This paper provides a brief overview of some of the continued improvements and recent advances being made in the acquisition and use of deepwater 3D seismic data. Topics to be covered include (1) the fact that more and more in-sea equipment is being towed behind purpose-built and purpose-modified seismic vessels, (2) the development of techniques and equipment which allows for the simultaneous acquisition of multiple purpose 3D surveys using a single vessel, (3) the rebirth of the marine vibrator, (4) the potential to better manage oil and gas reservoirs through the use of repeat 3D seismic surveys (popularly known as 4D seismic), and (5) the high interest in using mode-converted shear wave data in the marine setting, and the increasing variety of marine seismic acquisition geometries. Emphasis is placed on topics (4) and (5), since they have potentially huge economic effects with regard to optimizing production from oil and gas fields.

### MORE IN-SEA EQUIPMENT

Improvements in vessel technology as well as in towing systems, recording systems, safety systems, etc., ensure that the seismic industry will continue to increase the amount of in-sea equipment for the acquisition of 3D seismic surveys (Figure 2A.1). Spreads of up to 1200 meters and more and streamer lengths of up to 12 km will be seen in 1998, deliverable by some contractors with a single vessel, and deliverable by other contractors with up to three vessels. The acquisition footprint associated with a single traverse of a seismic vessel will increase in area over the next couple of years, and the deep water tracts provide the open water areas where operations of this type are most cost-effective.

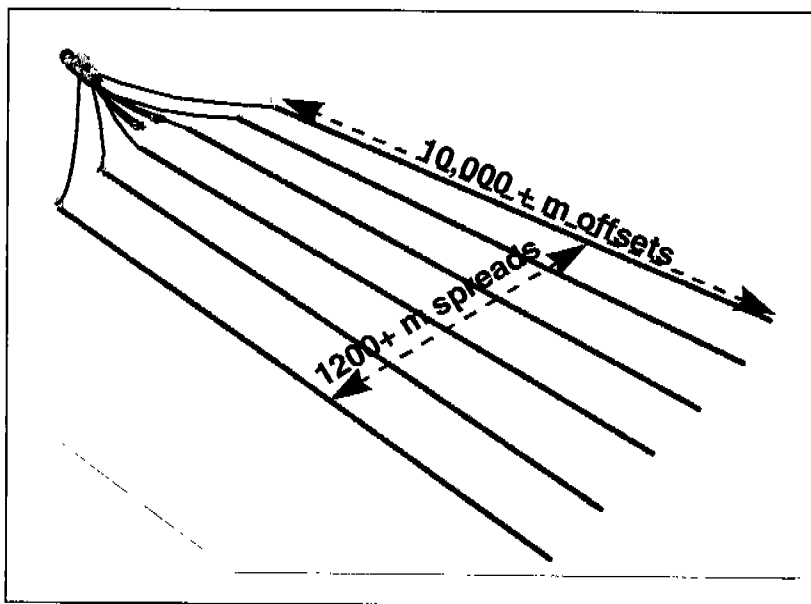

Figure 2A.1. The seismic industry will continue to increase the amount of in-sea equipment for the acquisition of 3D seismic surveys.



## MULTIPLE PURPOSE 3D

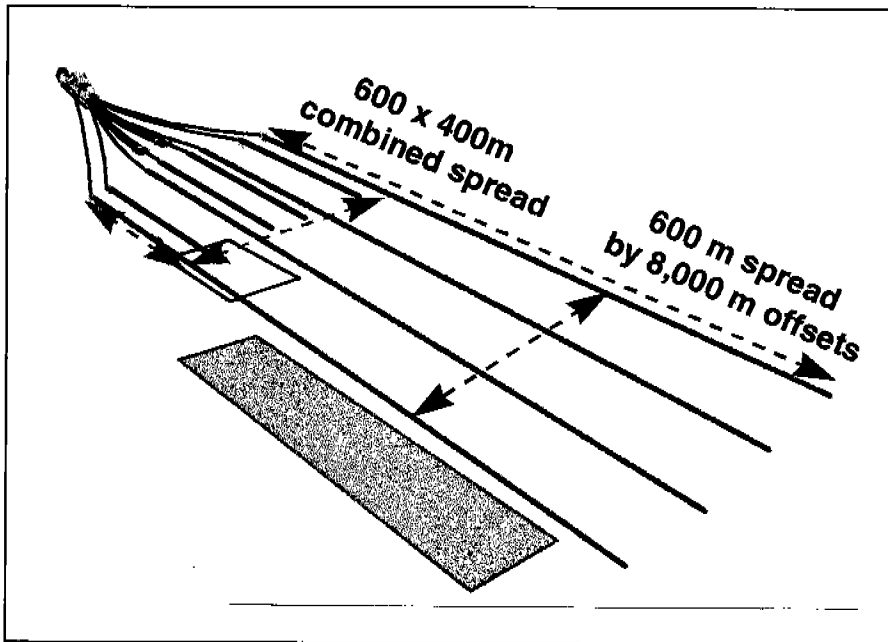

Figure 2A.2. The multi-3D concept configuration..

In addition to putting more, longer, wider configurations together, the industry can also configure the equipment to accomplish two objectives at once, as the multi-3D concept has already demonstrated in the Gulf of Mexico (Figure 2A.2). In this technique, a high resolution site survey is acquired simultaneously with a conventional, long offset, deep imaging, exploration/development 3D seismic survey. The rectangular blocks drawn in Figure 2A.2 indicate the different subsurface

image areas generated by the two different spread geometries, one composed of smaller bins yielding higher resolution data, and one composed of larger bins yielding conventional 3D resolution. Operationally, this technique requires some special expertise, as well as the novel use of some fairly standard equipment. Note the dual source, and unequal streamer separations and streamer lengths employed.

## MARINE VIBRATOR

The marine vibrator (illustrated in Figure 2A.3) idea is not new, having been experimented with sporadically for the last 15 - 20 years. It appears that the vibrator is ready as a viable technology and also that the industry may be ready to support it commercially in some specific applications. The primary attractiveness for the marine vibrator is in its potential to provide higher resolution data than airguns currently deliver. This can be accomplished because the vibrator output signal is very stable and

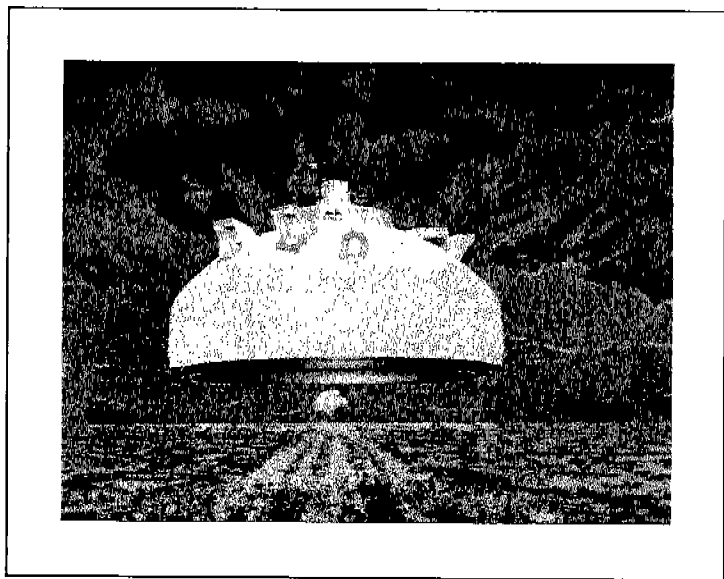

Figure 2A.3. The marine vibrator.

repeatable (Figure 2A.4) and because it has a wide, programmable bandwidth—the signal can be tailored to the particular target of interest. If you look closely at Figure 2A.4, you can see a variability in the details of the peaks and troughs of the 5 traces associated with five firings of a single airgun. In comparison, note the much greater similarity among the 5 traces associated with five sweeps of a vibrator. This illustrates the improved stability and repeatability of the vibrator over the airgun.

While airgun arrays today have greater productivity than vibrators, an array of vibrators may be a more environmentally friendly source than an array of airguns, due to the lower peak output power levels of the vibrator.

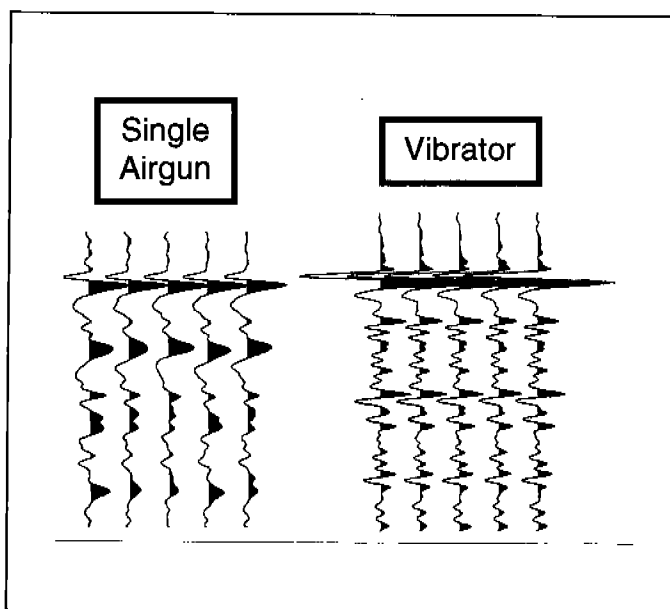

Figure 2A.4. The vibrator has greater stability and repeatability than the airgun.

#### SEISMIC TIME-LAPSE MONITORING (STLM) OR 4D SEISMIC

The idea of water pushing out oil or water flowing in behind oil (oil is medium gray, water is black), is shown in cartoon fashion in Figure 2A.5, which portrays three different times in the life of the reservoir. If we could accurately picture the movement of fluids in a reservoir, then we could use that information to drill additional wells to drain the bypassed areas, or otherwise better manage our reservoirs. It has been shown in a few published studies that seismic holds much promise for monitoring the movement of fluids when used in conjunction with all other data available (well log, geologic, core, production, etc.). The basic concept of 3D seismic time-lapse monitoring is illustrated

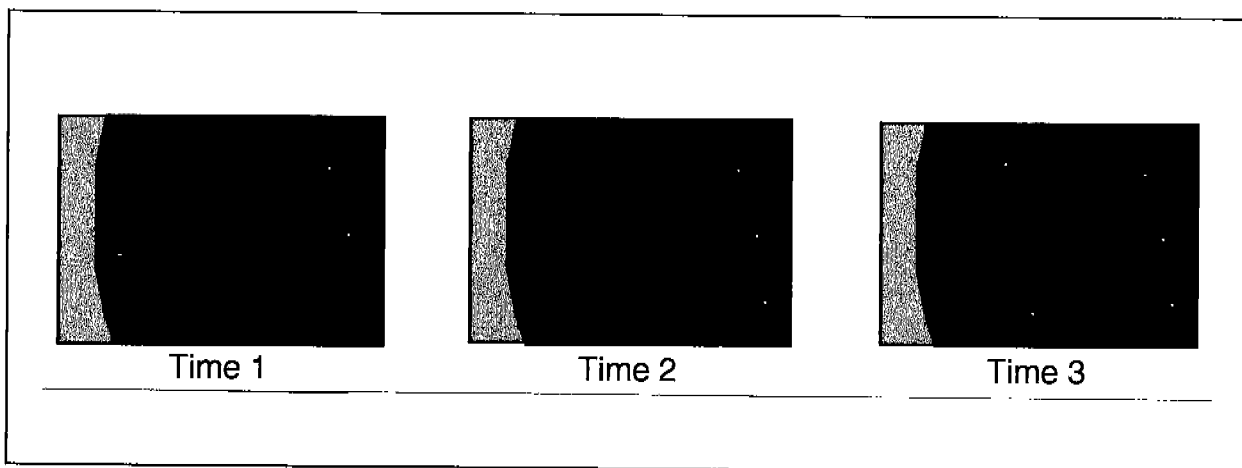

Figure 2A.5. Water and oil movement at three different times in the life of the reservoir.

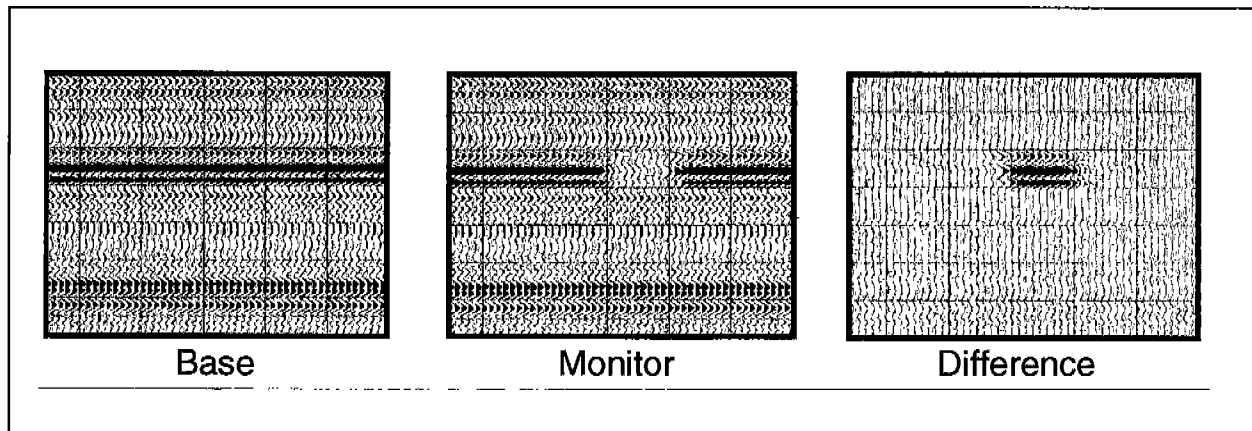

Figure 2A.6. 3D time-lapse monitoring illustrated through the use of synthetic data.

through the use of synthetic data in Figure 2A.6 in a perfect world, the difference between seismic data acquired before a field starts production (the Base survey), and seismic data acquired after a field has undergone some production (the Monitor survey) will be zero everywhere except where the production of oil and/or gas from a reservoir causes a change in the seismic response (this “differencing” between data sets yields the “difference” data set). In reality, it has been determined, for at least some situations, that some attribute(s) of the seismic data will change as a result of the movement of the fluids, and that by mapping the change(s) in that (those) seismic attributes, we will be able to infer the movement of the fluids. In Figure 2A.6 the change is in the amplitude of the seismic event in the middle of the section.

Figure 2A.7 shows a real world, North Sea, field example where seismic attributes were used to map the fluid distribution in a reservoir under production. 3D seismic surveys were shot in 1985 and 1995, although the survey shot in 1985 was not shot with time-lapse monitoring in mind. Both data sets were reprocessed so as to maximize the consistency in the two data sets.

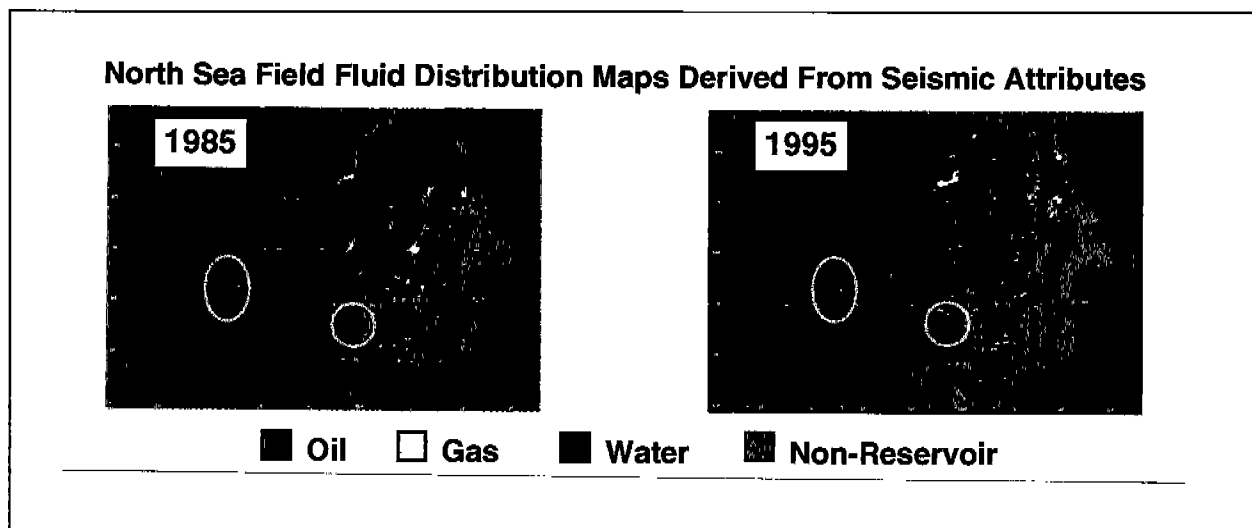

Figure 2A.7. North Sea 3D seismic surveys.

Fourteen (14) seismic attributes were used to achieve the fluid characterization illustrated here. Although in numerous places differences exist in the depicted fluids, the circled areas show where perhaps the largest changes in the reservoir have occurred in the intervening time between the two surveys, indicating places where water has replaced oil. Subsequent drilling has confirmed the correctness of this picture.

The repeatability of one seismic survey to the next is probably the major question the industry has with respect to STLM. The following list of statements sum up the situation:

- Monitor Surveys Must Look Forward and Backward
- Newer Surveys Must Take Advantage of Advancements
- Newer Surveys Will Be Bastardized to Compare to Older Surveys
- TLM Objectives May Be Quantitative and/or Qualitative
- Acquisition and Processing Will Mfect Repeatability

The fourth statement requires a bit of explanation: if the information to be derived from a STLM project is quantitative, then more-than-likely, the repeatability will have to be greater than if the objectives are qualitative. So acceptable repeatability will be related to the desired objectives of the STLM. The major factors which may affect repeatability, outside of the reservoir changes themselves which we wish to see, include the seismic source, the elements of the seismic acquisition system, the processing system, the weather, and the structures and facilities associated with the producing oil field:

- Is the source itself repeatable? Is its coupling repeatable? Does the source occupy exactly the same positions in a later survey as it did in an earlier survey (location)? Do we assign to the source the proper location (positioning)?
- Is the receiver itself repeatable? Is its coupling repeatable? Does the receiver occupy exactly the same positions in a later survey as it did in an earlier survey (location)? Do we assign to the receiver the proper location (positioning)?
- Was the same recording system used in all surveys to be compared? Are the system responses the same from survey to survey? Were the acquisition parameters (filter settings, etc.) set in the system the same way for all surveys?
- Were weather conditions the same for all surveys, and were they done at the same time of year? Was wind/precipitation noise the same for all surveys? Was the sea state the same, or were wave action/currents much worse for one survey than for another? Was the ground wet, frozen, ploughed, snow-covered, etc., for all surveys?
- Are there facilities present now that were not there for earlier surveys and are the same facilities running the same way as they were for earlier surveys?

To do quantitative STLM, we have to be able to address many of these questions. As we move from quantitative STLM to qualitative STLM, the importance of repeatability diminishes, but certainly does not completely go away.

Partly to address some of the repeatability issues, and partly to acquire higher quality and/or more complete seismic data, the industry is beginning to use cables either temporarily or permanently placed on the seafloor, or trenched down into it, and vertical arrays of cables containing many sensors. The reasons for burying cables are (1) to improve repeatability from survey to survey by ensuring that the receivers are in exactly the same position for each survey, (2) to ensure higher quality data because the sensors are in a quieter environment on the seafloor than they are when being towed near the sea surface, (3) to reduce sensitivity to weather, and (4) to reduce overall cost when doing numerous repeat surveys (see Figure 2A.14).

Figure 2A.8 depicts an array of vertical cables, and the trenching of a cable into the seafloor. Cables laid temporarily on the seafloor, as well as vertical cables, provide true 3D seismic, equivalent to land 3D, in which full and complete azimuth and offset distribution can be achieved, unlike marine towed streamer 3D in which the azimuth distributions are quite limited due to the swath style of shooting (the sources are essentially in line with the streamer receivers).

#### MARINE 4-COMPONENT SEISMOLOGY

Another application which makes use of either sensor-filled cables or individual sensor packages placed in direct contact with the seafloor is that of 4-component seismic. The four components are a hydrophone, a vertical geophone, and two horizontal geophones oriented perpendicular to each other, and all four are included at each receiver station location.

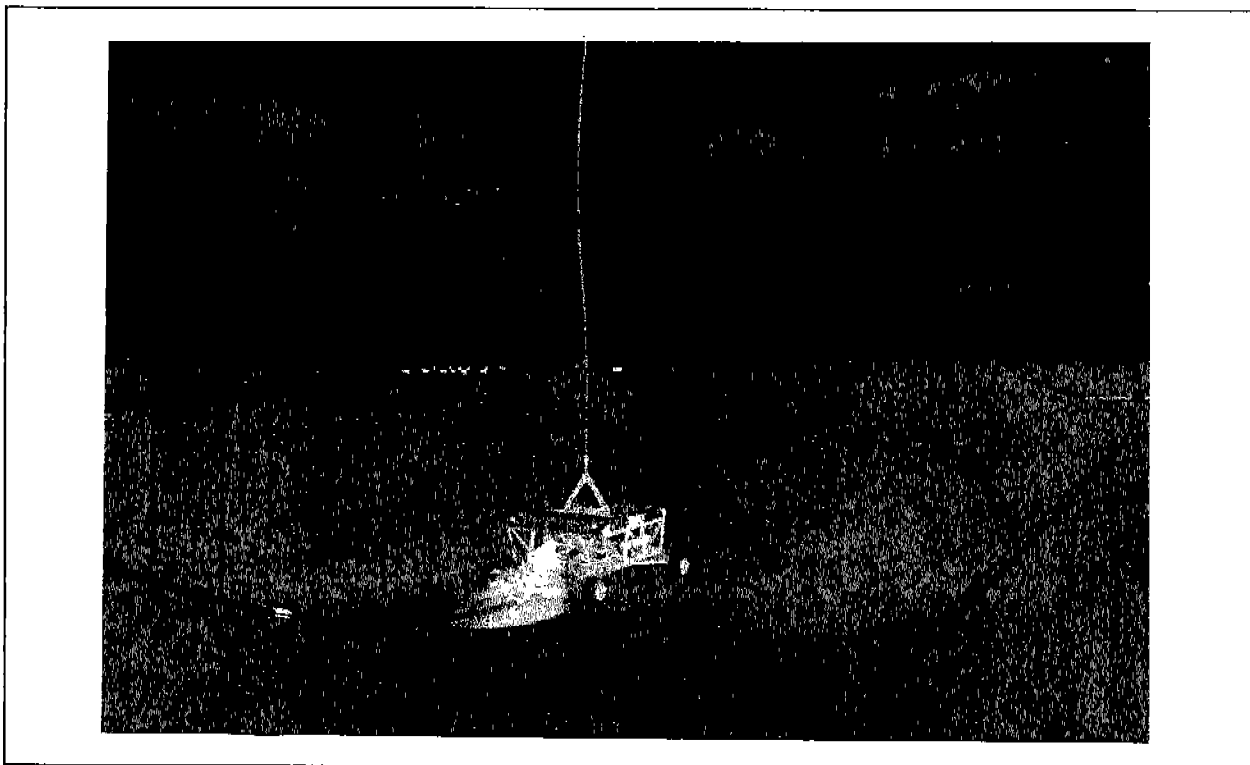

Figure 2A.8. Vertical and seafloor cables provide true 3D seismic data.

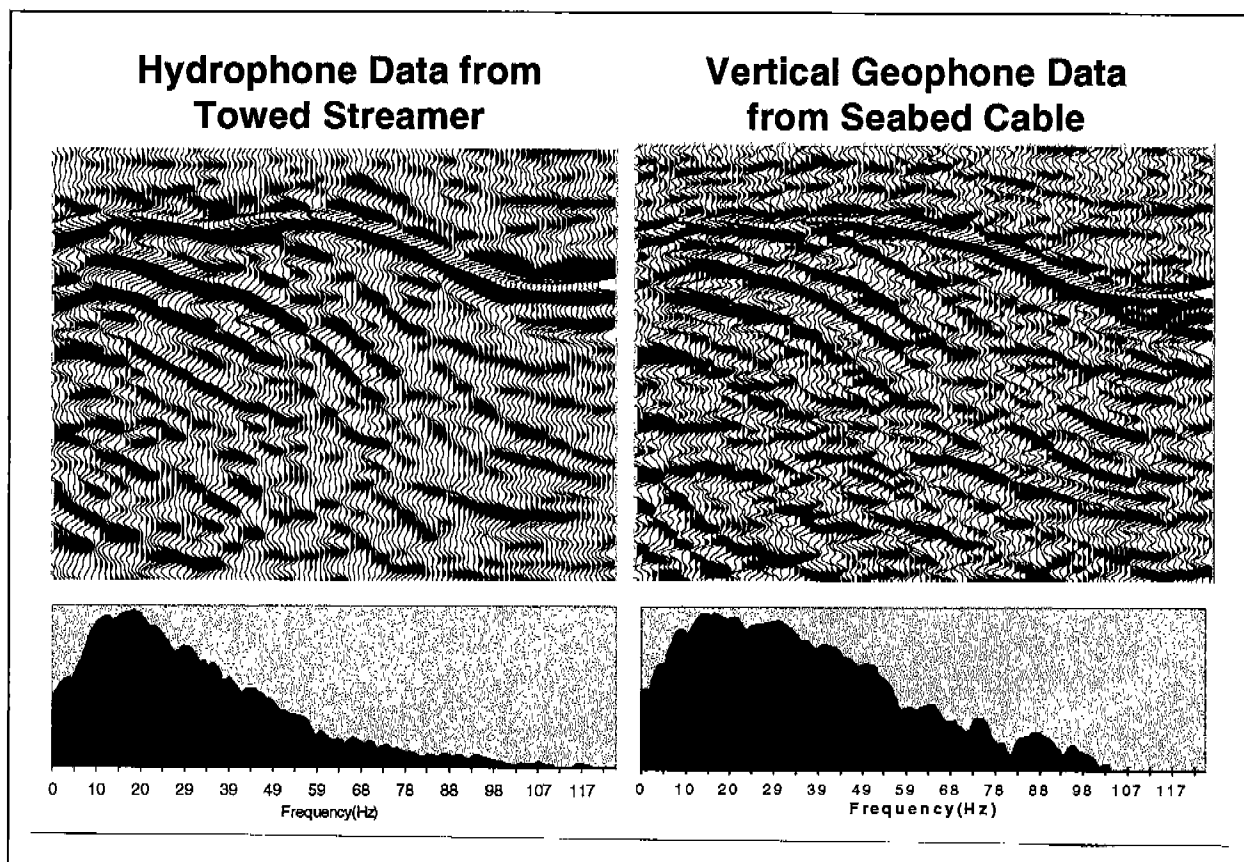

Figure 2A.9. Data comparison indicating the improved resolution and greater continuity in events delivered by the seabed cable systems.

Although they have been in use for only the last 18 months so their track record is brief, the second generation seabed cables (the first generation of seabed cables being those commonly known as ocean bottom cables - OBC) routinely deliver higher quality data than conventional towed streamer data (see Figure 2A.9) for several reasons: higher  $f_o$ , less smear, broader bandwidth, the absence of towing and weather-related noise, and the ability to combine the vertical geophone output with the hydrophone output (combining these outputs results in the removal of much downgoing multiple energy). Figure 2A.9 is a data comparison which indicates the improved resolution and greater continuity in events delivered by the seabed cable systems.

Notwithstanding the fact that these cables deliver better data than towed streamers, the reason for going to the hardship and expense of deploying such seabed systems is to record a type of wave not recordable by streamers: the shear (S-) wave. Conventional towed streamer marine systems only record compressional (P-) waves. When a P-wave passes through a rock, its behavior is affected by both the matrix of the rock (the solid part) and the pore spaces of the rock (that portion filled with liquids and/or gases). To a first approximation, when an S-wave passes through a rock, its behavior is affected by only the matrix of the rock. Two other important properties of S-waves are that they

travel at roughly half the speed of P-waves, and they can not exist in fluids (hence the necessity of placing the recording sensors on the seafloor).

The recording of both of these wave types makes it possible to infer much more information about the rocks in the sub surface and the fluids they contain, and it is the hope of acquiring this additional information which has caused the industry's recent strong and active interest in recording both P-waves and S-waves. There are several applications of this technology which apply equally well in both the onshore and offshore environment:

- Improved lithology (mineralogy) prediction
- Improved pore fluid prediction
- Better S/N in areas of low P-wave impedance contrast or high P-wave attenuation
- Calibration for AVO (amplitude versus offset) studies
- Azimuthal anisotropy (the variation of seismic properties with horizontal direction)
- Another parameter for seismic reservoir monitoring (4D seismic).

The other applications listed below are primarily relevant to the offshore situation:

- Imaging within and beneath gas-invaded zones, shale diapirs, mud volcanoes
- Imaging base of salt, volcanics
- Illuminating P-wave shadow zones beneath salt bodies, particularly those with tops and/or bases which show significant topography
- Capability of deep water multiple removal
- Potential for cost savings when compared to the cost of offshore wells.

Figure 2A.10 is an example of imaging beneath gas using S-wave energy. It was this example presented in 1994 (Berg *et al.* 1994), that kick-started the interest in marine multicomponent seismology leading to the multicomponent campaign of about a dozen tests in the North Sea during the Fall of 1996. This figure shows the P-wave data (the PP section, depicting P-wave downgoing energy and P-wave upgoing energy) being obliterated in the area of the gas chimney, whereas the PS section (P-wave downgoing energy and S-wave upgoing energy) provides a relatively clear picture beneath the gas. This particular application of 4C seismic has been successful in more than a dozen cases since 1996. The other application (with about the same number of successes) is that of diagnosing the lithology and/or the fluids filling the pore spaces of a reservoir rock. Both of these applications are very important in field development work and reservoir management, so the interest in marine 4C seismology is quite high.

An application not seriously tested in the extensive North Sea activity in 1996 and 1997 is that of imaging beneath salt bodies. The interest in subsalt is very high in the Gulf of Mexico, but the use of seismic imaging to obtain a clear picture of the structure and stratigraphy beneath salt has shown poor results to date. It is thought that 4C seismic might provide a breakthrough, and a survey to test that application was completed in January, 1998. The processing results, not available yet, are eagerly awaited.

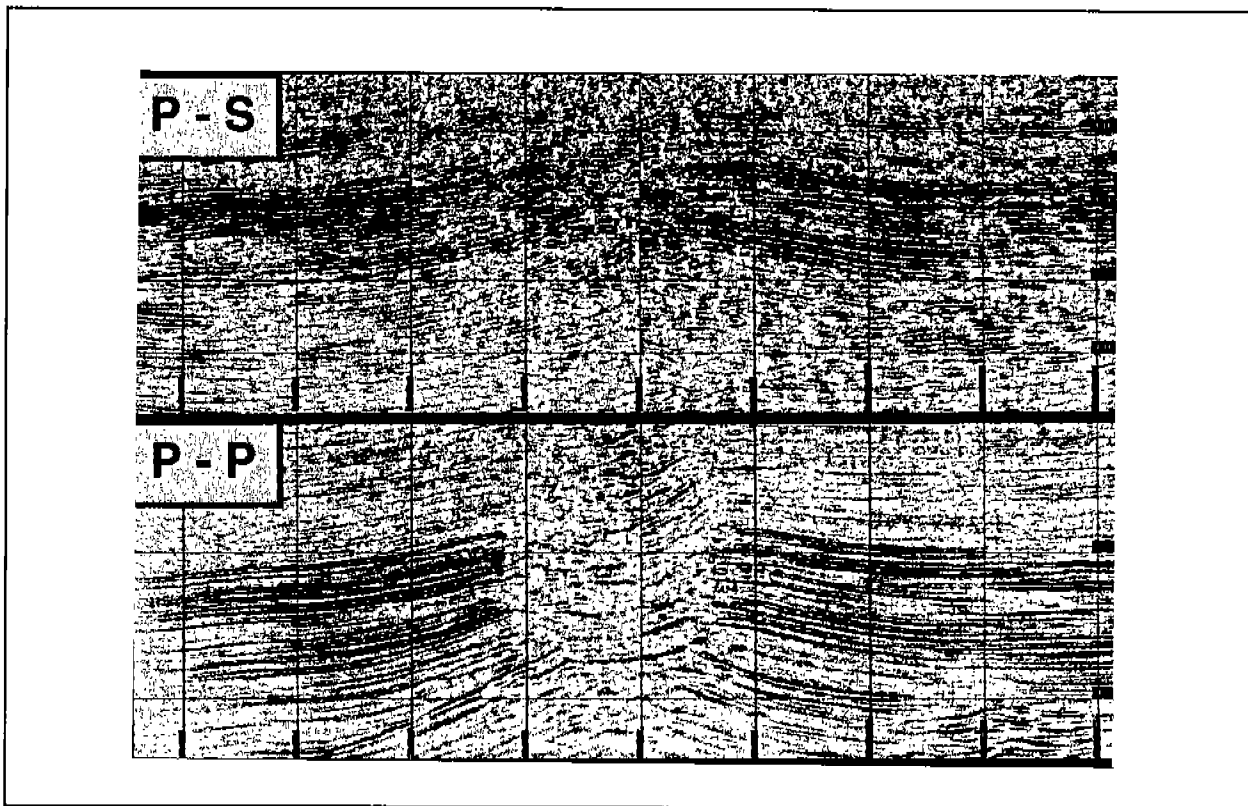

Figure 2A.10. An example of imaging beneath gas using S-wave energy.

Because salt has much higher P-wave and S-wave velocities than the sediments above and below it, each type of wave is strongly refracted at the salt boundaries, and significant mode-conversion occurs (Ogilvie and Purnell 1996). It is believed that large amounts of S-wave energy are obscuring the P-wave events beneath the salt. If the S-wave energy is recorded, it can be removed, or it can be used to obtain an image from beneath the salt body. Additionally, as Figure 2A.11 illustrates, the refraction of one type of wave due to the roughness of the salt surface will create uneven illumination of reflectors beneath the salt. This uneven illumination results in zones where a particular wave type will be focused, or defocused. The shadow zones so created to one type of wave are likely to be bright zones to the other type of energy. The use of both types of energy will thus yield a more complete picture of the geometry of the reflectors beneath salt.

Figure 2A.12 shows a picture of a 4-component seismic seabed cable, and Figure 2A.13 illustrates how a 4-component seismic operation might be laid out. A side-scan sonar survey is run prior to placing the cable on the seafloor to ensure that there is nothing on the seafloor which can damage the acquisition system, and that there is nothing on the seafloor which the acquisition system can damage. Depending on the length of the cable, and the conditions on the seafloor, the cable is either dragged into or draped in position. For 2D work, the source vessel shoots along the line of a single seabed cable. For 3D work, two or more receiver cables are laid out parallel to each other, and the source vessel shoots several lines overlying the area covered by the seabed cables. These source lines may be shot parallel to the seabed cables or perpendicular to them, and the orientation chosen



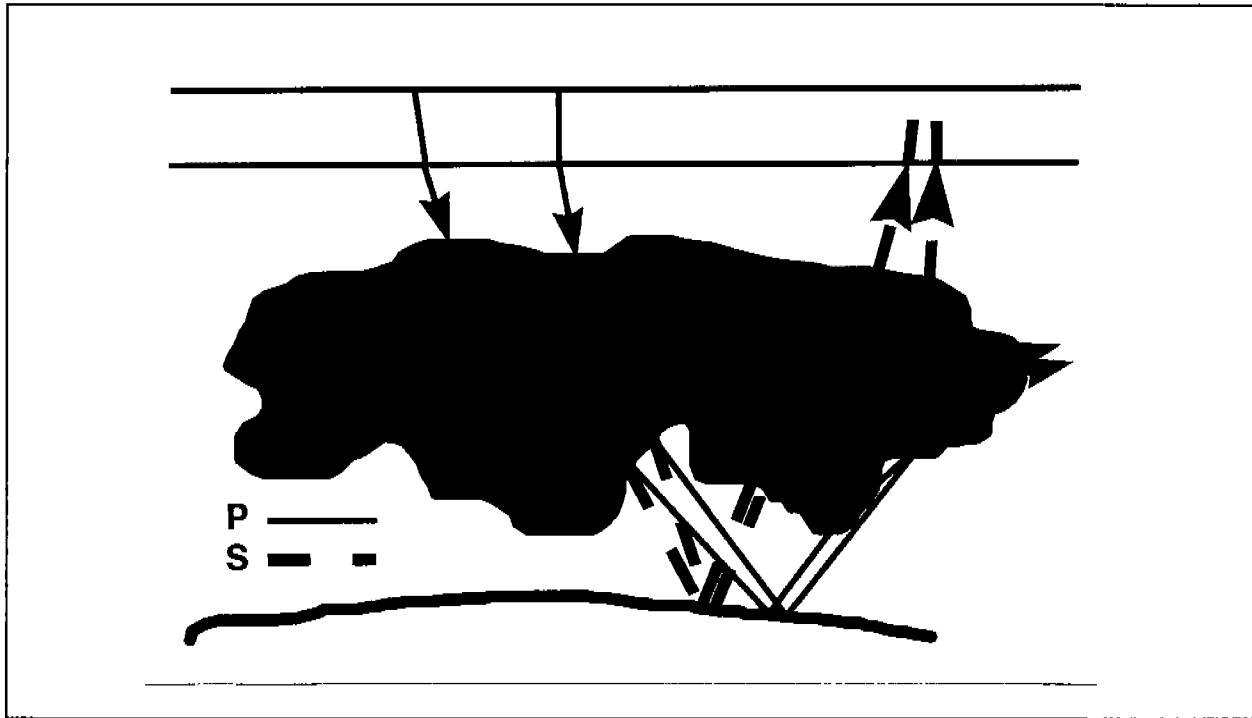

Figure 2A.11. Refraction of one type of wave due to the roughness of the salt surface will create uneven illumination of reflectors beneath the salt.

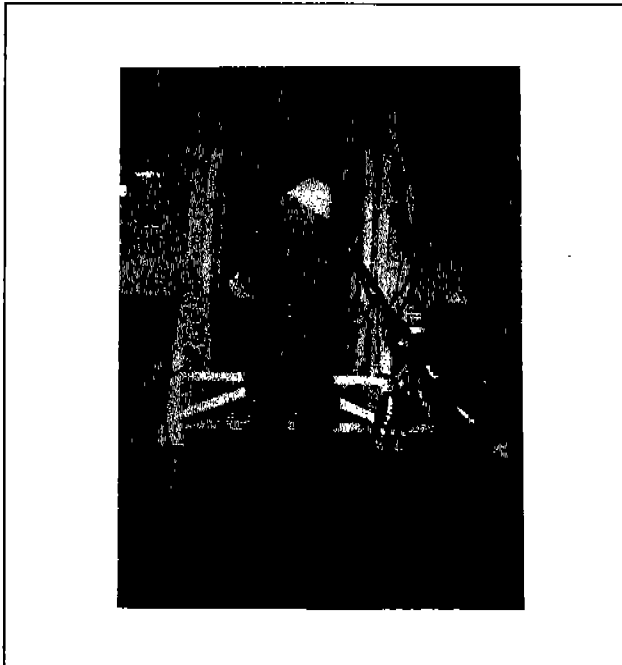

Figure 2A.12. A 4-component seismic seabed cable.

depends on the specific requirements and economics of the particular survey. One thing to keep in mind about these seabed cable surveys is that if a cable is dragged on the seafloor, particularly in deeper water areas, then the permitting process will probably take a longer lead time than commonly required for towed streamer surveys.

Finally, the issue of cost of seabed cable surveys should be mentioned. Figure 2A.14 summarizes the present situation in a generic way. Retrievable 4C surveys ("A") cost more than their towed streamer counterparts ("B" & "F" endpoints), but the cost differential will diminish as the technology matures. For seismic-time-lapse-monitoring, permanent instaflation approaches will be more expensive, in a cumulative sense, for a small number of repeat surveys, but as the number of repeats reaches a certain level (which will depend on

ffie specific situation, but which seems to be around 10-15), then the total cost will be less than that of a series of conventional surveys.

**CONCLUSION**

This paper has provided a brief overview of some of the continued improvements and recent advances being made in the acquisition and use of deepwater 3D seismic data. A constant stream of new developments has been ongoing for some time, and it does not look to abate for some time to come. Conventional towed streamer 3D surveys will

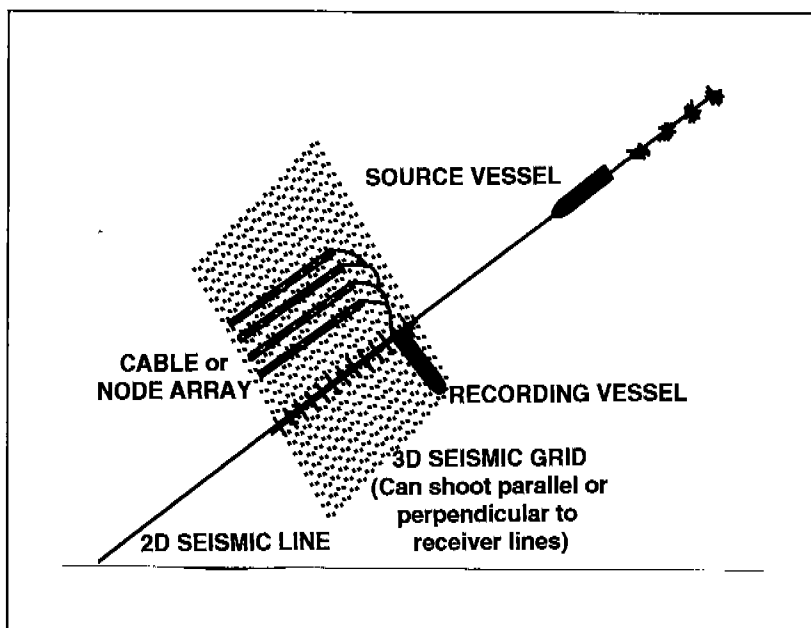

Figure 2A.13. An illustration of how a 4-component seismic operation might be laid out.

continue to be done more efficiently and to deliver higher data quality. The marine vibrator may soon be a source in demand for high resolution surveys and when the environmental conditions dictate it. Time-lapse seismic monitoring, and 4-component seismic will become important technologies delivered by the seismic contractors for improved reservoir characterization and management.

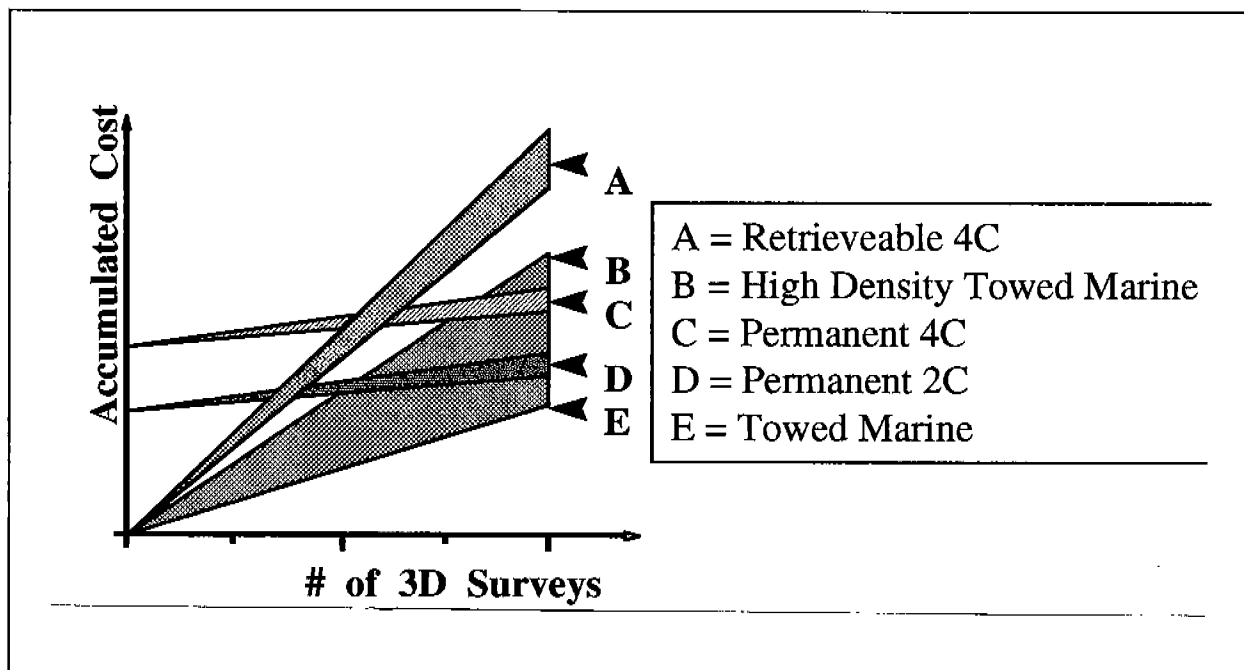

Figure 2A.14. Current costs of seabed cable surveys.

## REFERENCES

- Berg, E., B. Svenning and L. Martin. 1994. SUMIC: a new strategic tool for exploration and reservoir mapping. Annual EAEG meeting, Vienna.
- Ogilvie, J. and G.W. Purnell. 1996. Effects of salt-related mode conversions on subsalt prospecting. *Geophysics* 61.
- 

Dr. Jack Caldwell is Manager of Reservoir Characterization and Monitoring for Geco-Prakla, a Schlumberger company. He has a B.S. degree in math and a Ph.D. in geophysics. Dr. Caldwell has 20 years of experience—10 years with Texaco and Marathon, and another 10 years with Schlumberger. He is currently responsible for reservoir characterization and monitoring activities using seismic techniques for the North and South American Region.

**DEEPWATER EQUIPMENT CAPABILITIES**

Mr. Richard Frisbie  
Oceaneering International, Inc.

(Bullet Summary Prepared by Jim Regg, Session Chair)

## SUMMARY

- The presentation summarized the capabilities and technology development for supporting deepwater projects, including submersibles, remotely operated vehicles (ROVs), manipulators, etc. The availability of such equipment and their advantages were also discussed.
- Much of the technology and capability development for submersibles, ROVs, manipulators, surveying tools used by that equipment has evolved from work by the Navy.
- Oceaneering believes that as activities continue to move into deeper water, designers and equipment manufacturers should strive to make the seafloor equipment as simple as possible. Because tools are easily retrieved, manufacturers should develop tools for installation and maintenance/repair.
- There are many subsea connections associated with deepwater projects, including pipeline connections to the production tree or manifold; umbilical to the tree, distribution center, or termination unit; and others.
- The presentation described both manned and remotely operated systems.

- Remotely operated vehicles are required for tasks as simple as video surveillance to those as complex as actuating valves, manipulating functions on the subsea equipment, and replacing seal assemblies.
- Subsea equipment designs must account for the size and capabilities of ROVs and other such equipment. For example, a subsea development involving multiple wells installed on a seafloor template will need to address the ROV interfaces (capabilities, space needs, etc.) used in accessing the various parts of the tree and control modules. Several template-based subsea developments were shown and discussed, including Exxon's Zinc, and BP's Pompano projects. Shell's Mensa Subsea Project was also described.
- The importance of system integration testing was discussed, with the Mensa Project (5,300 feet of water) serving as the backdrop. Accessibility is important; equally important is the reliability and demonstrated capabilities of equipment. System Integration Testing allows the company to verify the capabilities of ROVs, and related tools, and to verify the interfaces between tools and the subsea production equipment at the surface prior to installing on the seafloor.
- ROVs are becoming very specialized to support drilling, construction/installation, production and maintenance operations, and pipeline surveying in deepwater. Several examples of Oceaneering ROVs were provided, including the Challenger (construction support), Scorpio (pipeline survey), Hydra (drilling support), Spirit (visual survey and support), Magellan (remote intervention), and the Auger Triton. The Auger Triton is designed for supporting the tension leg platform with a variety of work packages and manipulators. Power ratings, excursion capabilities, and water depth ratings were described for the ROVs.
- The method of deployment for ROVs was also described.
- Oceaneering is building ROVs at a rate of two per month to support the deepwater operations in the GOM and other areas of the world.
- Figures 2A.15 – 2A.22 highlight various aspects of deepwater technology developments.

---

Dick Frisbie is the Senior Vice President for Deepwater Technology with Oceaneering International, Inc. He has over 20 years experience in the underwater industry with involvement in the development of commercially available remotely-operated vehicles (ROV's) beginning in 1974. Mr. Frisbie developed Oceaneering's worldwide deepwater ROV capability since that time. In 1987, he formed Oceaneering Product Systems to expand Oceaneering into Floating Production Systems. In 1988, he formed Oceaneering Space Systems to transfer the robotic and remote work capabilities from subsea to space. Mr. Frisbie returned to Oceaneering's deepwater business in 1993.

**ADS CAPABILITIES**

**ADVANTAGES**

- One Atmospheric**
- 2000 FSW**
- No Decompression**
- Manipulators**
- Cost Saving**
- Weight / Space Savings**
- Full 3D Awareness**

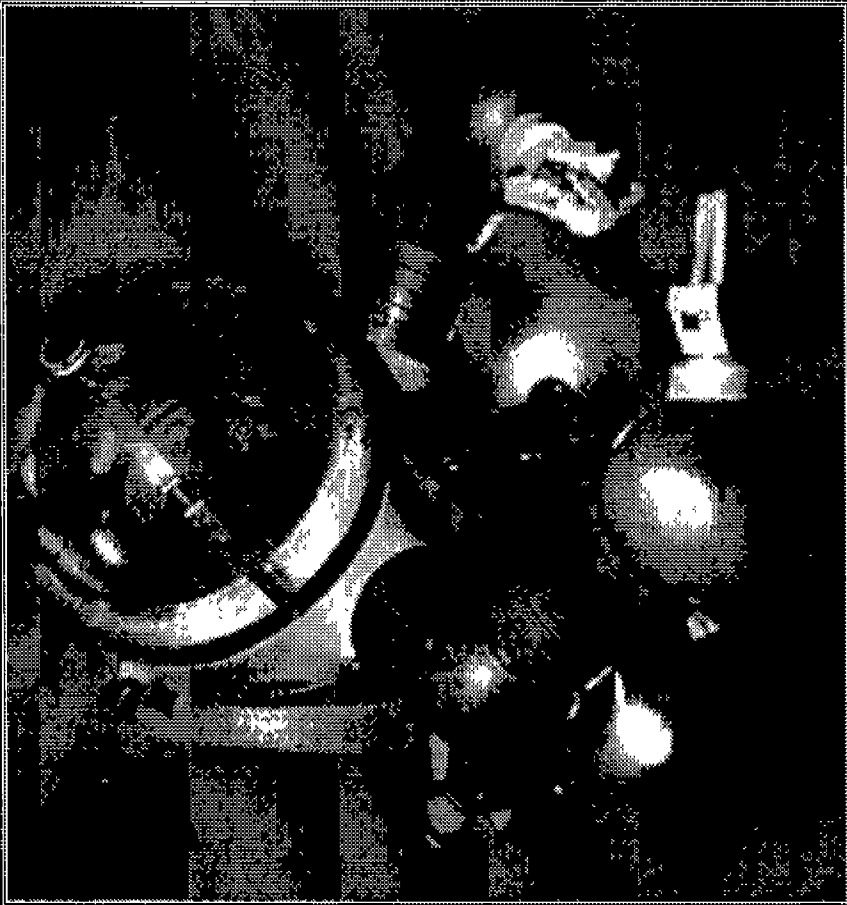

**100% SAFETY RECORD**

**OCEA**

Figure 2A.15. ADS Capabilities.

UMBILICAL TERMINATION  
ASSEMBLY (UTA) DURING INSTALLATION

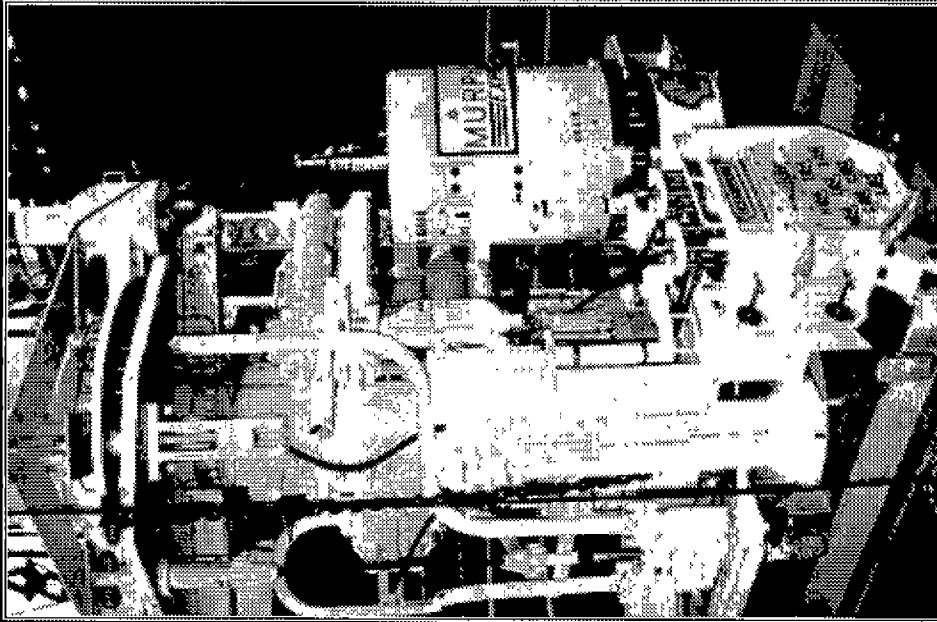

Figure 2A.16. Umbilical Termination Assembly (UTA) during installation.

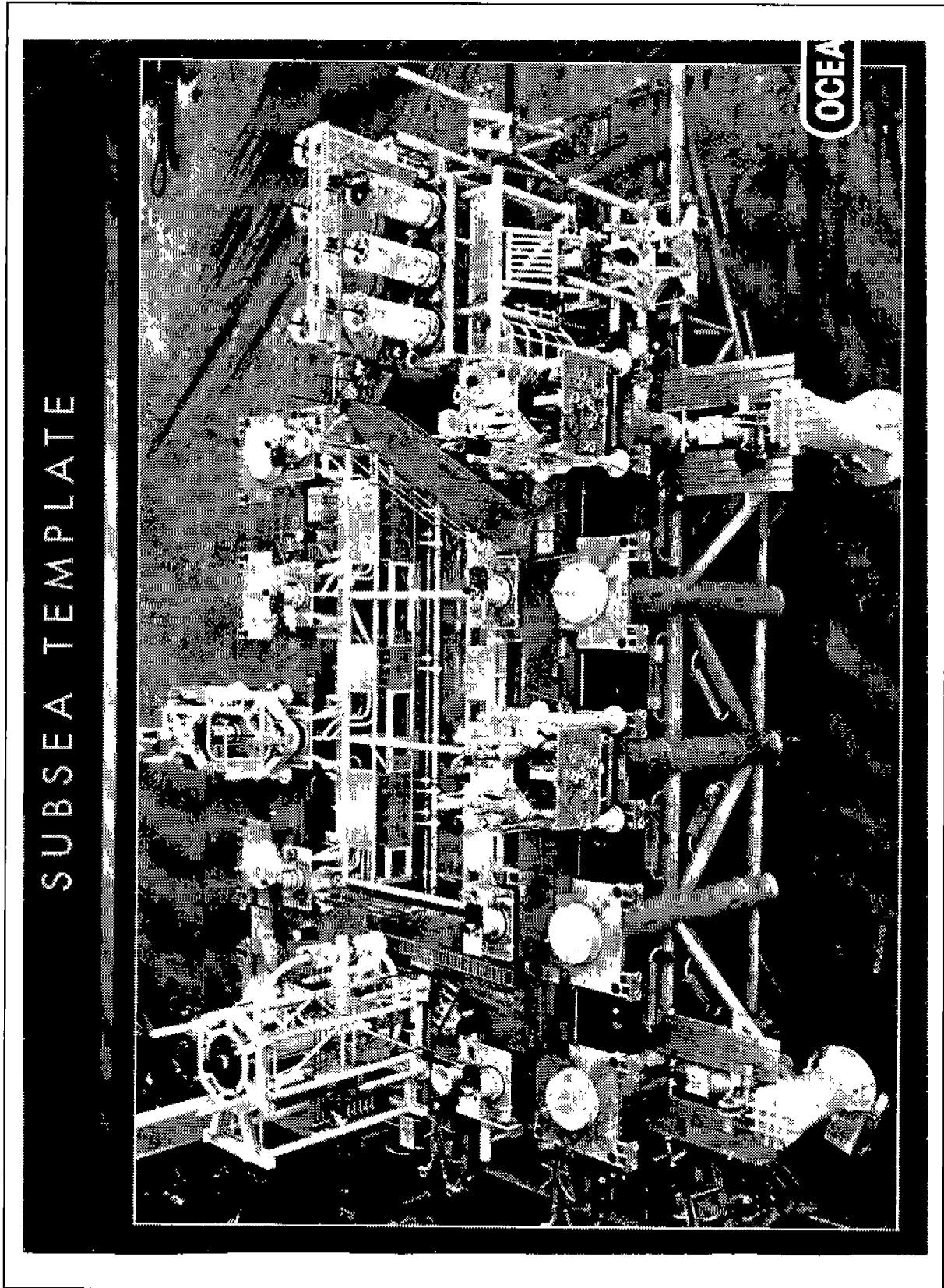

Figure 2A.17. Subsea template.

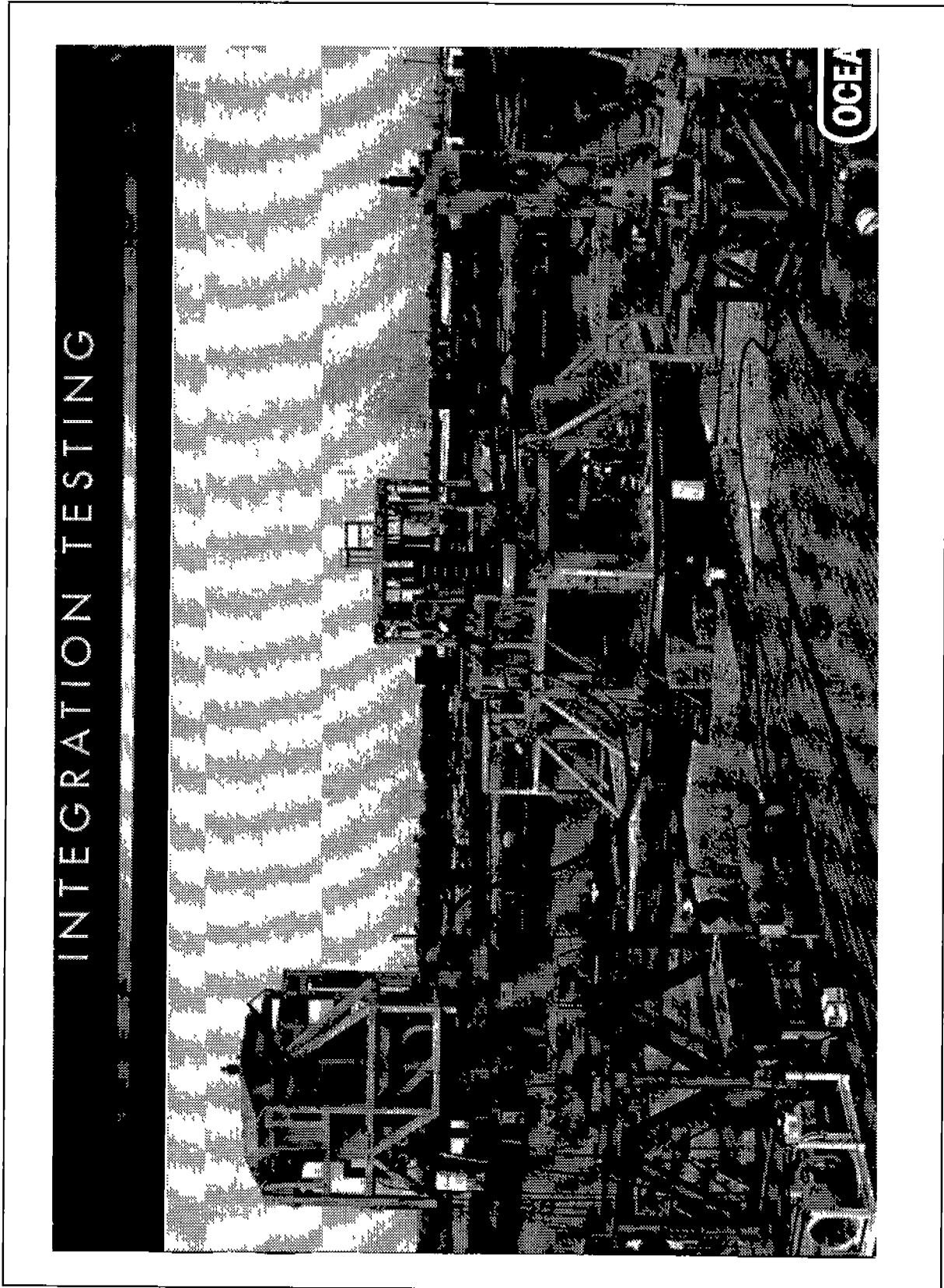
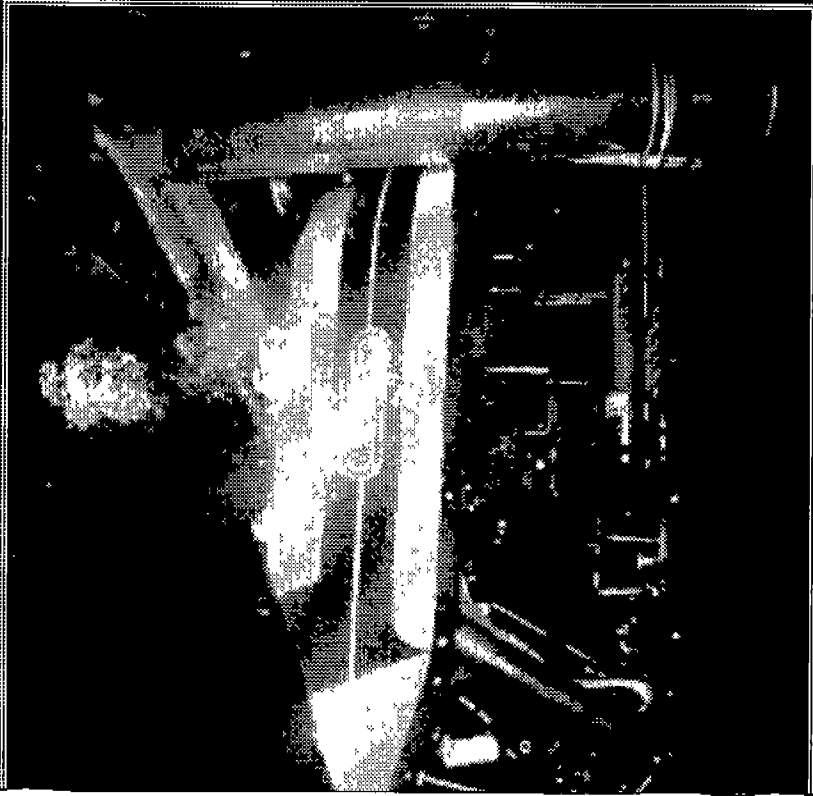

Figure 2A.18. Integration testing.



**HYDRA AT**



- Drilling Support ROV
- 2000m Rating
- Cage Deployed Dual Manipulators
- Optical Fibber Umbilical
- 75 HP / 100 HP
- Multiple Tooling Package
- Extensive Deepwater Record

**OCEANEER**

Figure 2A.19. Hydra AT.

# MAGELLAN 725

## REMOTE INTERVENTION

Maximum Depth  
Rating 7,000 meters  
(22,400 FSW)

25hp Hydraulic Power  
Pack for Vehicle  
Propulsion

Twin Manipulator  
Package  
(5 & 7 Function)

Interface and Carriage of Client Determined Equipment  
Packages

State of Art Camera, Sonar and Subsea Navigation Systems

Total Lift Capacity 180kgs (400lbs)

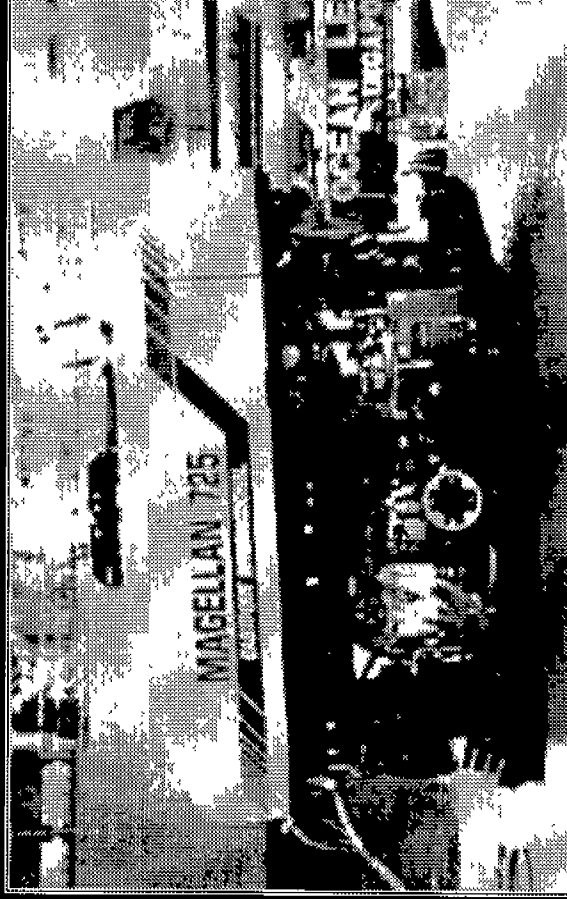

Figure 2A.20. Magellan 725.

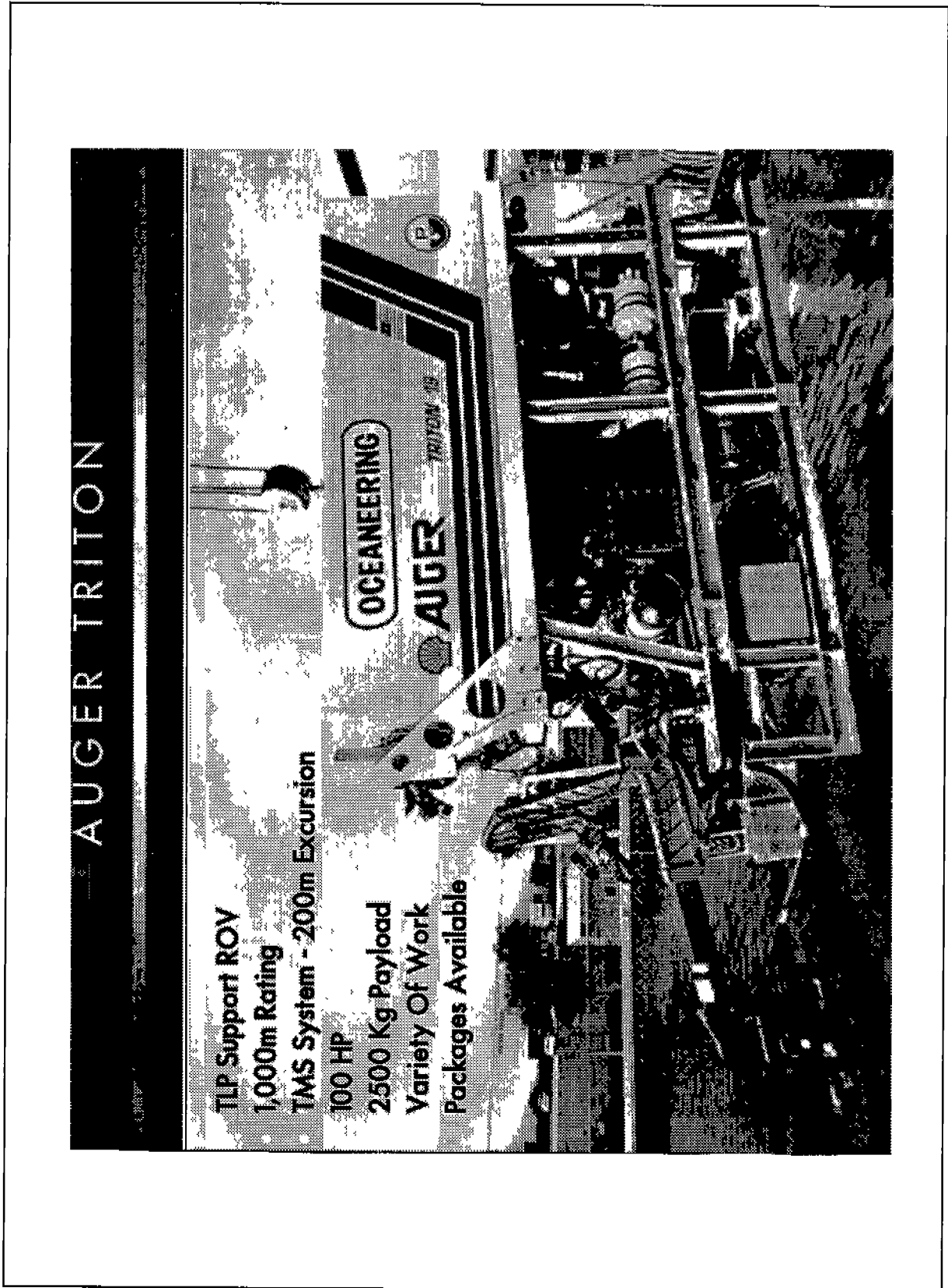

Figure 2A.21. Auger Triton.

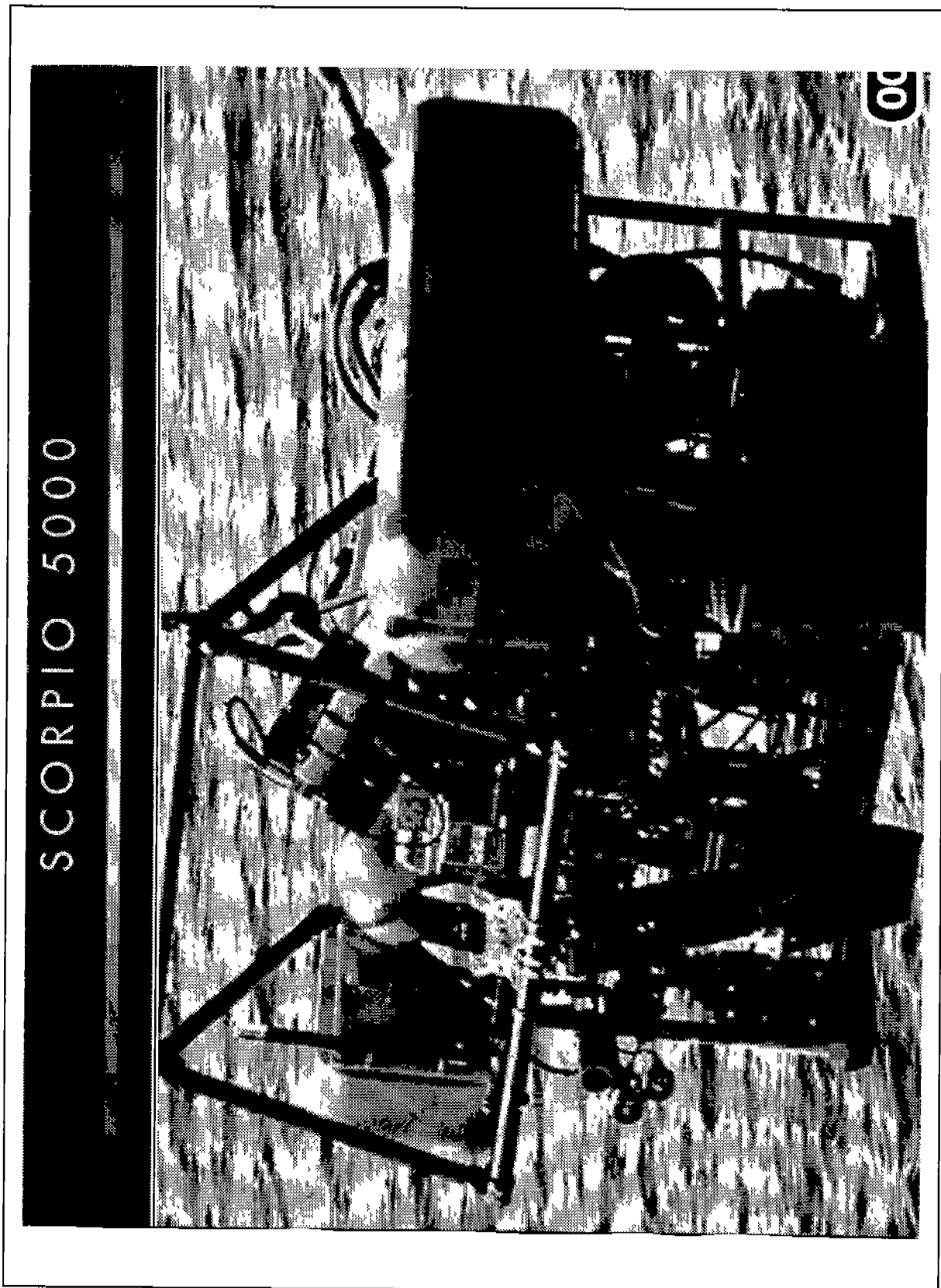

Figure 2A.22. Scorpio 5000.

## MARINE SAFETY REGULATORY UPDATE

CDR Guy A. Tetreau  
Chief, Eighth District Marine Safety Compliance Branch

The Eighth District's (D8) Marine Safety Division, in addition to enforcing marine safety laws and regulations, has a responsibility to facilitate the marine industry. We take very seriously our responsibility to know our industry and ensure that regulatory project personnel properly balance the needs of industry with the needs for safety of life and property.

### UPDATE ON USCG/MMS MOU

We expect to have this update published in the *Federal Register* in January 1998.

The Coast Guard is considering giving MMS responsibility for yearly inspection of platform self-inspection oversight, although we will do the initial inspection. The Coast Guard wants to retain much of the inspection responsibility for floating units; still to be determined is the question of response roles, specifically as it relates to shutting down a pipeline or operation in response to a spill.

### AB-MOU ENDORSEMENTS FOR MMDs

On 24 February 1997, Commandant (G-MOC) issued a policy letter directing our Regional Examination Centers to cease the practice of issuing merchant mariners documents (MMDs) with an AB-MOU or Lifeboatman-MOU restriction. The letter pointed out that there is no legal authority for issuing these restricted MMDs.

Working with the International Association of Drilling Contractors (IADC), we determined that there was a significant demand for mariners with these credentials; we pointed out that failure to continue issuing these restricted MMDs without a change to the manning of mobile offshore drilling units (MODUs) would have a very detrimental effect upon the industry. Their concerns focus on two things:

1. That the training/qualification aspect of the MMD process was desirable and
2. Not having AB's on board could cause problems overseas, especially considering Standards of Training, Certification, and Watchkeeping for seafarers (STCW).

Based upon our recommendation, COMDT authorized the continued issuance of these MMDs pending a study by D8 and IADC regarding the best long-term solution to this problem.

We will meet with IADC during January 1998 to resolve this issue. Possible solutions include removing the requirement for AB's on MODUs and determining whether there is a need for a Lifeboatman-MOU endorsement and if so, seeking legislative authority to issue such.

## TANKERMAN REGULATORY PROJECT

Published as a Final Rule in the *Federal Register* of May 8, 1997, this rule:

would apply to offshore supply vessels (OSVs) as self-propelled tankships. As such, it would have required the person in charge (PIC) of any OSV transferring cargo to have a license and an MMD with a tankerman endorsement.

Major problems with rulemaking:

It could not be applied to OSVs as self-propelled tankships because 46 *USC* specifically exempts OSVs from the definition of a tank vessel for the purposes of any law.

Current Status:

As of this date, it has been determined that this rulemaking does not apply to OSVs as self-propelled tank ships. The pollution prevention regulations, do, however, apply to the transfer of fuel from OSVs and as such, the PIC must be licensed or have an MMD with a tankerman endorsement.

D8 ACTIONS TO STANDARDIZE DECISIONS REGARDING  
UNIQUE RIGS AND PORTABLE QUARTERS

Between the dates of 8-10 December 1997, we got representatives of our Gulf coast Marine Safety Officers (MSOs) together to:

1. Formulate a consistent D8 policy regarding portable quarters.
2. To document and standardize decisions that have been made regarding equipment, operations and manning on non-standard rigs (Spars and TLPs).
3. To review and comment on the latest draft of 33 *CFR* Subchapter N-Outer Continental Shelf Activities.

The meeting went extremely well, and several decisions were agreed upon including:

1. A D8 policy for portable quarters and inspection of floating OCS facilities will be prepared within the next 6 weeks
2. Line-throwing appliances and signal flares are not required.
3. Self-activating smoke signals and fire axes are required.
4. Railing heights can be per the MODU rules (1 meter) or the platform rules (41”).
5. Facility must meet the operational requirements of 46 *CFR* 109.

You can expect to see increased standardization among D8 units. If you have problems of inconsistency, please let us know at D8.

## IMPLEMENTATION OF SUBCHAPTER L AS IT APPLIES TO EXISTING VESSELS

Subchapter L (Offshore Supply Vessels) was published as a final rule on 19 September 1997. This rulemaking was one of the first projects developed with significant assistance/involvement of industry. It brought liftboats (which were recently uninspected and which never had a specific set of regulations applied to them) in as offshore supply vessels. This regulatory package implemented as regulation many requirements that the Coast Guard had previously implemented as policy.

To alleviate concerns voiced by industry during the development of this regulatory package, the Coast Guard stated that these regulations would not be applied to existing vessels. The regulatory applicability includes:

1. ...applies to each OSV...contracted for, or the keel of which was laid, on or after March 15, 1996.

To prevent an unscrupulous builder from laying up hundreds of keels before 15 March 1996 and continuing to build grandfathered OSVs for the next ten years, the Coast Guard added a provision that "...each OSV must complete construction and have a Certificate of Inspection by March 16, 1998."

Because the offshore industry is experiencing a period of growth, most OSV's that were previously laid up are being reactivated. Therefore, we have received requests to bring old vessels under inspection under the existing regulations. HQ has decided that a change in vessel service (from oceanographic research vessel status to OSV) constitutes a major modification under the definition in Title 46 CFR, which defines any change of vessel type as a major modification. We in D8 have disagreed with COMDT on this interpretation and issued enclosure (3) which allowed existing vessels previously certificated as OSV's to return to OSV service under existing regulations until the final rule was published. Eventually, HQ put out an even less restrictive policy that was even less restrictive and allowed previously certificated OSV's to return to OSV service under existing regulations for the life of the vessel. That policy reiterated the philosophy that a change of vessel service equates to a change of vessel type, which constitutes a major modification. HQ also said that any vessel not previously certificated or certificated as anything but an OSV would have to be inspected under the new Subchapter L. Within a short while existing liftboats which had never been inspected were asking to come in under the existing inspection regiment. Because we read the applicability section to Subchapter L as less restrictive than the HQ policy, we have allowed existing liftboats to become certificated under existing inspection protocols up till the cutoff date of 16 March 1998.

## COAST GUARD CHALLENGES FROM INCREASED ACTIVITY IN THE GULF

### Problem #1

Difficulties reaching regional examination centers (REC) to make appointments or to get questions answered regarding licensing or documentation issues.

Discussion: The manpower shortage to meet industries' increasing need for licensed and documented personnel is compounded by several factors.

1. The government is in a non-growth mode, and new employees are extremely difficult, if not impossible, to hire.
2. A new body of international regulations (STCW) recently have become applicable. These new regulations require new licenses and document endorsements, which increases workload. Additionally, the regulations to implement this new and very complex international treaty have not been written. Substantial investment in training will be required for implementation.
3. To reduce processing time and workload through better automation, the Coast Guard recently began to use a new generation of hardware and software to perform licensing and documentation transactions. The new system is fraught with problems that have increased workload and delays. To date, the problems have not been resolved.

Actions Being Taken by the Coast Guard:

- A. MSO New Orleans services more customers than any REC in the country. Additionally, they have been the most seriously affected by the Gulf upsurge. To improve customer service and unit morale, the REC was moved from the central business district, (where there was no parking or waiting rooms for customers) to a location in East New Orleans with larger and newer spaces and plenty of free parking (9820 Lake Forest Blvd off Read Blvd exit).
- B. A study of the manpower needs of the four REC's in D8 has been completed. This study identified five billet moves that will improve customer service at all D8 REC's with a special emphasis on the Gulf Region units. We are seeking approval for these moves by the summer of 1998.
- C. We have made use of innovative partnerships with industry that streamline the process and allow private enterprise to perform several of the prerequisite functions pursuant to issuance of licenses and documents.

#### Problem #2

Inadequate number of Marine Inspectors to satisfy the demands brought about by a significant increase in new constructions and annual vessel inspections.

To quantify this problem, we conducted a comprehensive audit of workload looking 2 years into the future. From this audit, we forwarded a letter to HQ seeking the reprogramming of up to 35 marine inspector billets that are being freed up due to the dismantling of our marine inspector training program at four units around the country. We anticipate some relief from this request, but it may not occur by summer 1998. Following our national releveling study, we looked within the 13 MSOs in



D8 to see if personnel transfers could be used to help with the imbalance of workload. Although this study is not complete, it is likely that we will take action to move some billets into our busier ports. Neither of these initiatives will likely yield any significant relief by summer 1998.

Other actions we have taken to alleviate this problem include:

- A. Developing and implementing an alternative inspection procedure known as the Streamlined Inspection Process. This program allows vessel owners with a commitment to quality to inspect their own vessels. This program is carried out under the watchful eye of the Coast Guard through company and vessel audits. This D8 program has been in effect for approximately 3 years with exceptional results for both the vessel owner and the Coast Guard. A Supplemental Notice of Proposed Rulemaking (SNPR) to make this a national program was issued on 8 April 1997. An Interim Final Rule is expected out in the near future.
- B. We have looked for jobs that we can stop doing. Approximately 2 years ago, we unilaterally implemented a manpower resource saving initiative by implementing a law that was several years old. That 1990 law was never adopted by the Coast Guard due to an inability to define "in bulk." Essentially, this law stated that unmanned barges that did not carry hazardous material or oil in bulk did not require inspection. We defined in bulk as 10,000 gallons and stated that we would not inspect barges that did not carry these materials. Although the program met heavy resistance from industry, it has been accepted and is now national policy with the exception that the national program leaves the option of inspection to the vessel owner. We also encouraged HQ to implement a policy that did not require the Coast Guard to witness the inspection of every inflatable liferaft being serviced. This policy is now in place nationally.
- C. We have, on a case by case basis, allowed the use of company hired third party inspectors to act on behalf of the Coast Guard.

#### CONFINED SPACE ENTRY

During Spring 1997, we had a meeting with IADC and various industry representatives to discuss the Coast Guard's Confined Space Entry (CSE) policy. Essentially, they believed the Coast Guard's policy of requiring Marine Chemists was too restrictive.

While most of the CG does require Marine Chemist certification of spaces prior to entry by CG personnel, D8 already had a policy that allowed the use of Offshore Competent Persons (OCP) when the only hazards were oxygen and flammables (i.e. no toxics). Two particular problems were pointed out during this meeting: First, the policy was too restrictive in that it required the OCP to be a shoreside professional as opposed to rig based and second, it required a Marine Chemist any time a mat tank or spud can had to be examined because of H<sub>2</sub>S. As a result of this meeting, we modified our procedure to allow the OCP to come from anywhere (if competent) and we stopped the practice

of entering mat tanks and spud cans (we accepted ABS certification of these spaces). These changes had the potential to provide substantial relief to industry.

We also started to look at this problem and to take seriously our responsibility to develop regulations and training and qualification standards for competent persons. When Subchapter N is printed in February 1998, it will address confined space entry on the OCS.

During a meeting at D8 on 11 December 1998 which was headed by a HQ Industrial Hygienist, this topic was discussed at length. This meeting followed Commandant (G-MSO) D8 test of a new CSE policy (ltr 16000.6 dtd 22 Sep 97). Although this policy received a very cold response from field units, changes were developed during the meeting that should lead to the development of a policy that better responds to the concerns of industry while guaranteeing the safety of CG inspectors involved in this dangerous activity.

---

A 1978 graduate of the University of New Hampshire with a degree in biochemistry, CDR Tetreau has spent 19 years in the Coast Guard's Marine Safety and Environmental Protection program. During two initial tours in the busy port of New York, CDR Tetreau established a specialty in vessel examination and casualty investigation. As a Master Instructor at the Coast Guard's largest training center, he trained students in both of these disciplines. He currently serves as Chief of the Coast Guard's largest district compliance office where he provides oversight of all U.S. and foreign vessel inspection programs and offshore activities across 26 states and the Gulf of Mexico. Included among his responsibilities are oversight of programs for the inspections of commercial fishing vessels and uninspected towing vessels, Port State Control examinations of foreign vessels, inspection of vessels and facilities involved in the exploration and productions of oil and minerals in the Gulf of Mexico and oversight of all U.S. Vessel examination programs including the new Streamlined Inspection Process and the ABS managed Alternative Compliance Program.

## **NEW DEEPWATER STRUCTURE CONCEPTS: PANEL DISCUSSION—INTRODUCTION**

Mr. Jim Regg  
Minerals Management Service  
Gulf of Mexico OCS Region

The following list of questions was used to help focus the discussion of new deepwater structure concepts by the industry/MMS panel:

- I. What is driving the development of new structure concepts?
- II. What are the issues and concerns facing operators as they consider these new structure concepts, and how are they accommodated or being addressed?
- III. What approaches are used where there are no industry-accepted standards?
- IV. What role do you see in the development and evolution of mooring system technology with these new structure concepts? Can you list some of the particular areas that need to be further developed? What about the use of synthetics? Will dynamic positioning become a major player for floating systems and at what depth will such be considered?
- V. What role will subsea development play with the new structure concepts?
- VI. Is storage an option that is being considered for Gulf of Mexico (GOM) and the new structure concepts? Is it reasonable to expect the use of Floating Production, Storage, and Offloading systems FPSOs in the GOM? Why or why not?
- VII. Are there specific research/development needs with respect to new structure concepts before they are used for deepwater projects? What are the needs and concerns?

## NEW DEEPWATER STRUCTURE CONCEPTS: PANEL DISCUSSION—INTRODUCTION TO MOSES MINI-TLP

Mr. Lawnie Sturdevant  
MODEC (U.S.A.) Inc.

### DESCRIPTION

The MOSES (Minimum Offshore Surface Equipment Structure) mini-tension leg platform (TLP) is an advance in TLP technology that retains the primary advantages of a TLP (i.e. surface wellheads) but at an affordable price for small to medium size deepwater fields. MOSES opens a new arena for TLPs that can be made small, with significantly reduced capital and operating costs, and that can be delivered in a relatively short time.

The hull, which provides most of MOSES's buoyancy, is essentially a large base that has an octahedral shape in plan view. Tendon support trussed beams run radially through each quadrant of the hull and extend beyond the hull's perimeter. Tendon loads are reacted, through the support beams, by the hull's base structure. Four small diameter columns extend from the hull to support the deck. Since the columns emanate from the same hull structure, there are no prying, squeezing and racking loads transmitted to the deck. The mooring system and hull design is thus de-coupled from that of the deck; consequently, design and fabrication of the deck is greatly simplified and tendon loads can be optimized.

Geometry of the hull structure has been simplified, which allows the hull to be built using standard structural shapes: wide flanges, flat plate and angles. The use of complicated and expensive castings and/or extrusions for structural nodes is therefore eliminated.

By simplifying the hull's design, standard shipyard block construction techniques can be used. Such techniques will further reduce cost, improve quality and shorten fabrication schedules while providing contract flexibility.

As with our other product lines, Floating Productions Systems (FPSs), Floating Storage and Offloading (FSOs) and Floating Production, Storage, and Offloading (FPSOs), MODEC offers a full range of contract execution including alliance principles (integrated project team, gain sharing, etc.). MODEC can also provide leasing and other financial assistance.

### AVAILABLE CONFIGURATIONS

MOSES Mini-TLPs can be configured to meet your requirements, including:

- Dry trees at deck level
- Near surface trees located approximately 40 to 60 feet below mean sea level

- Subsea completions
- With or without workover capabilities
- With or without drilling capabilities
- Other configurations can be developed in conjunction with client requirements.

#### PRIMARY ADVANTAGES OVER OTHER FLOATING SYSTEMS

- Reduced capital and operating costs
- Reduced schedule
- Shipyard construction
- Uses existing technology
- Achieves de-coupling in design of lower hull, tendons and deck
- The hull, with its large diameter base and four small diameter surface piercing columns, provides superior hydrodynamic performance: highly stable in operating, storm and survival conditions.
- Can be installed by the same SSDV used to drill the wells or by a derrick barge; thus, giving greater flexibility and more competitive installation cost.

#### MAIN FEATURES

Tendon system uses standard 13-3/8" well casing and specially developed threaded connectors for high performance, long fatigue life and reliability at low cost.

Well and riser systems use conventional 9-5/8" casing tiebacks, supported by economical, passive short stroke tensioners.

Deck design is similar to a conventional jacket deck, which results in significantly reduced cost for the same functionality.

#### MOSES' STATUS

The MOSES Mini-TLP is ready for field application. A significant amount of design, including global and detailed structural analysis, has been performed by MODEC and associated third parties. A prototype, central column mini-TLP was deployed in 1992 - 1993 in 61 m water depth offshore Japan by JOIA (Japan Ocean Industry Association). MODEC successfully model tested both central column and four column MOSES models at Marin in 1995.

The slide show that accompanied this presentation follows.

## INTRODUCTION TO MOSES MINI-TLP

Presented by: Lawnic Sturdevant  
Manager, Sales & Marketing  
MODEC (U.S.A.), Inc.

MODEC (U.S.A.) INC. December 16, 1997 p:\m\sturdevant\_intl.ppt

## MODEC, INC.

- History
  - General Contractor Specialized in Marine Equipment
  - Founded in 1968
  - Focus on Offshore Industry
  - Subsidiary of Mitsui Engineering & Shipbuilding Co., Ltd. (MES)

MODEC (U.S.A.) INC. December 16, 1997 p:\m\sturdevant\_intl.ppt

## MODEC Experience

- 29 Years as a General Contractor for Offshore Construction, Drilling and Production Vessels
  - 1st Wave : Construction Vessels
  - 2nd Wave : Drilling Rigs
  - 3rd Wave : FPSO/FSO/EWT
  - 4th Wave : MOSES Mini-TLP

MODEC (U.S.A.) INC. December 16, 1997 p:\m\sturdevant\_intl.ppt

## MODEC, INC.

- Major Projects

Equipment Type	Number of Units Supplied
<b>Construction Equipment:</b>	
- Derrick/Lay Barges	20
- Tow/Launch Barges	15
<b>Drilling Equipment:</b>	
- Jack-up Drilling Rigs	17
<b>FPSOs, Marine Terminals &amp; Others:</b>	
- FPSO General Contractor	6
- FPSO/FSO Engr & PM	3
- EWT/EPS	2
- SPM/Marine Terminals	10

MODEC (U.S.A.), INC. December 16, 1997 p:\m\sturdevant\_intl.ppt

## MOSES Development Goals

- Low Cost Design
- Surface Well Completions
- Standard TLP Tie-back Equipment
- Development Drilling &/or Workover Capability
- Shipyard Construction using Standard Structural Shapes
- Efficient "Real Estate": i.e. use as:
  - Wellhead Platform
  - Full Drilling & Processing Platform
  - etc.

MODEC (U.S.A.) INC. December 16, 1997 p:\m\sturdevant\_intl.ppt

## Market Drivers

- Increasing Deepwater Activity
- Current High Development Cost
- Increasing Number of "Marginal" Discoveries
- Emphasis on Low Cost (CAPEX + OPEX) Solutions
- Desire for Surface Access on Oil Wells (i.e. Wax/Hydrates/Frequent Recompletions for Stacked Pays)
- Lack of Rig Availability (for drilling & for conversion to FPS)
- High Utilization at Major Fab Yards
- Shorter Cycle Time
- Use of Existing Technology

MODEC (U.S.A.), INC. December 16, 1997 p:\m\sturdevant\_intl.ppt

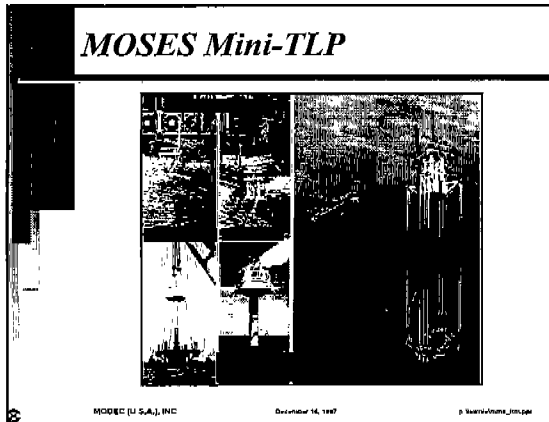

### MOSES Mini-TLP

■ **History Summary**

- 1991 : MOSES Development Commenced by Dr. Pieter Wybro
- 1992-93 : JOIA Field Trials of 1/3 Scale Mini-TLP
- 1994 : Initial Patents Awarded
- 1994 : Joint Development/Marketing Agreement with MODEC
- 1995 : Model Test
- 1996 : ABS Review
- 1996 : Extension Patents Awarded
- 1997 : Extension Patents Awarded

MODEC (U.S.A.) INC.      December 16, 1997      p 2/14/moses\_min.jpg

### MOSES Market Positioning

■ **Targeted Market**

- Geographical : primarily deepwater GOM
- Water depths : greater than 1,500 ft
- Well counts : 12 or less
- Well fluids : primarily oil
- Reservoir size : 50 to 150 MMbbls recoverable
- Displacement : 18,000 tons max. (i.e. smaller than Jolliet)
- Operator focus: emphasis on major operators in the GOM for now

MODEC (U.S.A.), INC.      December 16, 1997      p 3/14/moses\_min.jpg

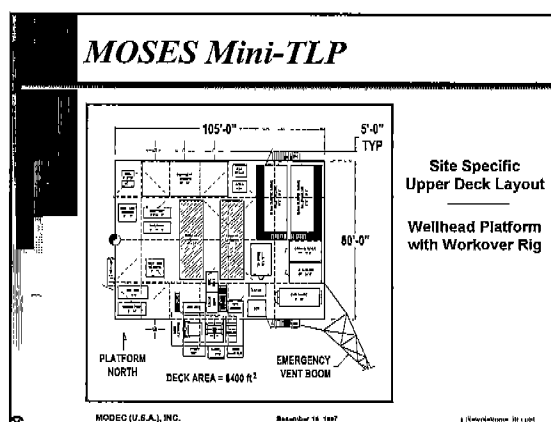
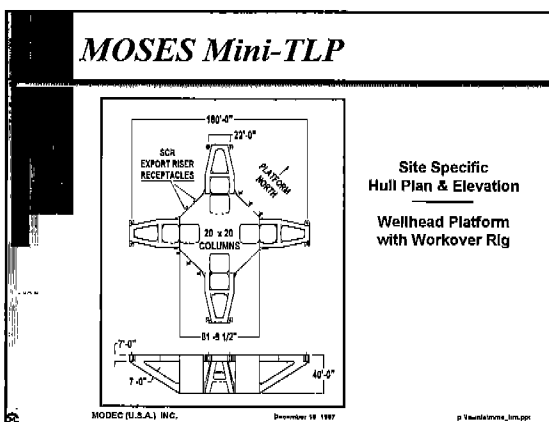
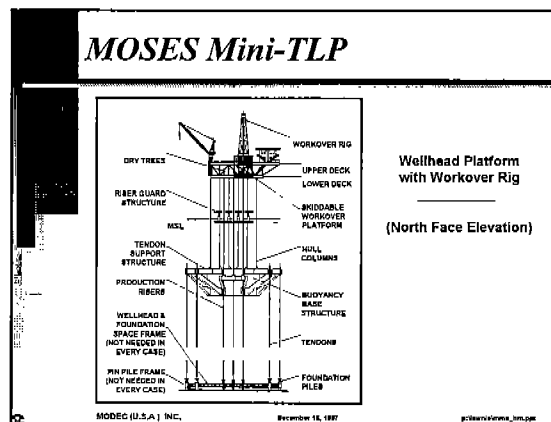

### MOSES Mini-TLP

**Site Specific Lower Deck Layout Wellhead Platform with Workover Rig**

ITEM	DESCRIPTION	DIMENSION
1	RECEIVER BAY	12'-0\"/>
2	WELL HEADLIFTING BAY	12'-0\"/>
3	WORKOVER BAY	12'-0\"/>
4	CONCRETE MIXING BAY	12'-0\"/>
5	PRODUCTION FACILITY BAY	12'-0\"/>
6	WATER AND FUEL BAY	12'-0\"/>
7	COMMUNICATIONS BAY	12'-0\"/>
8	STORAGE FOR SUPPLIES BAY	12'-0\"/>
9	SUBSTITUTE BAY	12'-0\"/>
10	GAS LIFT WORKOVER BAY	12'-0\"/>

MODEC (U.S.A.) INC.      December 16 1997      p:\sean\sean\_mtlp.dwg

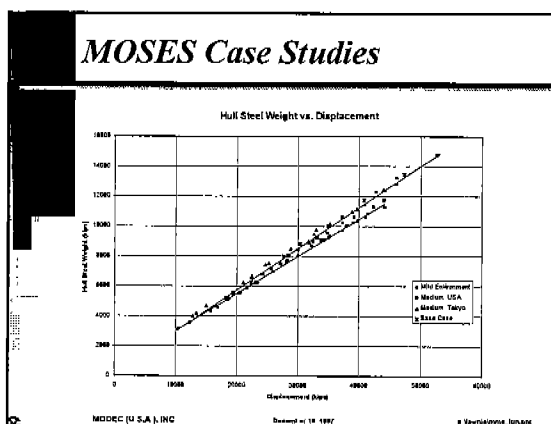
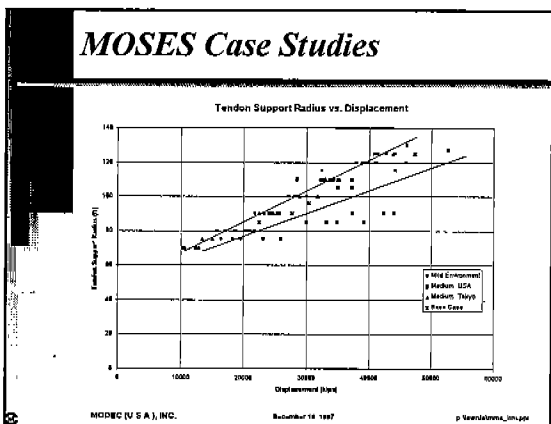
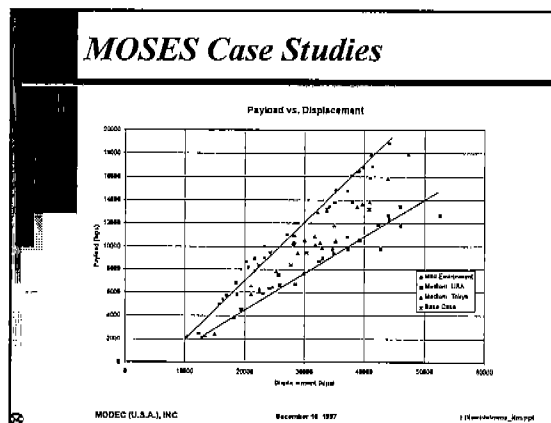

### MOSES Mini-TLP

- Rig Integration Work with Sundowner**
  - Scope: Integrate Development Drilling Rig on MOSES
  - M.O.U. Signed in Dec. '96
  - Based on Successful 800 Series M.A.S.E. (minimum area, self erecting) Rig
  - 1,000,000 lb Net Hook Load Capacity
  - Top Drive with Split Block
  - 2,000 hp Drawworks
  - Objectives:
    - Broaden MOSES's operational capability in response to Operators' desires
    - Minimize Drilling Rig Weight and Area Requirements
    - Optimize Structural Interface
    - Streamline Operational Procedures

MODEC (U.S.A.) INC.      December 16 1997      p:\sean\sean\_mtlp.dwg

### MOSES Drilling Mode

**Weight Comparison of Rig Types**

Weight values are given in kips

Drilling Weight Applied Loads	API Rig 5,000	Standard M.A.S.E. 2,900	Integrated M.A.S.E. (MOSES) 900
Hook	550	550	450
Splitblock	950	850	930
Mud (1200 bbl)	750	700	700
Drill Water	175	175	175*
Fuel	150	150	150
Portable Water	175	175	175
Bulk Mud & Cement	700	600	600
Misc	100	100	50
<b>TOTAL</b>	<b>11,500</b>	<b>5,990</b>	<b>4,150</b>

\* Can use salt water to mix mud if EDTI Products (i.e. Bingham type fluids) are used

Note the capabilities of the above rigs are identical. Each rig has:

- 1 million lb hook load
- split block top drive
- 2,000 hp drawworks
- 2 x 1,600 hp mud pumps

MODEC (U.S.A.) INC.      December 16 1997      p:\sean\sean\_mtlp.dwg



Mr. Lawnie Sturdevant has more than 23 years' experience in the oil and gas industry, including 17 years offshore. He initially began his career as a design engineer and has held positions in project and construction management before moving into sales and marketing 15 years ago. Mr. Sturdevant is currently Manager of Sales & Marketing with MODEC (USA), Inc. He holds a B.S.M.E from the University of Oklahoma and a M.B.A. from the University of Houston.

**NEW DEEPWATER STRUCTURE CONCEPTS: PANEL  
DISCUSSION—DEEPWATER DEVELOPMENT OPTIONS**

Mr. Richard D'Souza  
Aker Maritime

This portion of the discussion consisted, in part, of Figures 2A.23 – 2A.41 that appear on the following pages.

---

Richard D'Souza has a Master of Science degree in Naval Architecture from the University of Michigan and a Master of Science degree in Civil Engineering from Tulane University. He has 24 years' experience in the engineering design and construction of a variety of mobile offshore drilling units, arctic caisson units, and floating production systems. He has authored numerous technical papers on deepwater floating production units and mooring systems. He is currently a Vice President at Aker Engineering, Incorporated, a division of Aker Maritime Incorporated, dedicated to providing innovative, cost-effective solutions for offshore oil and gas extraction and production.

# Deepwater Development Options [Dry Trees]

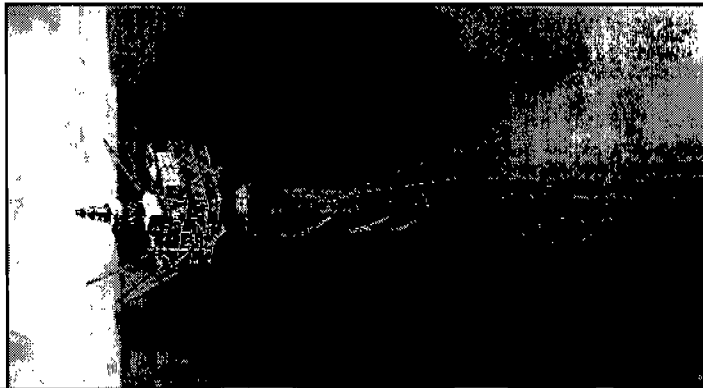

Spar

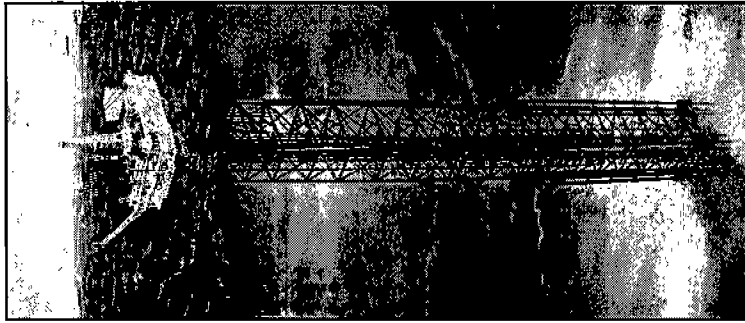

Compliant Tower

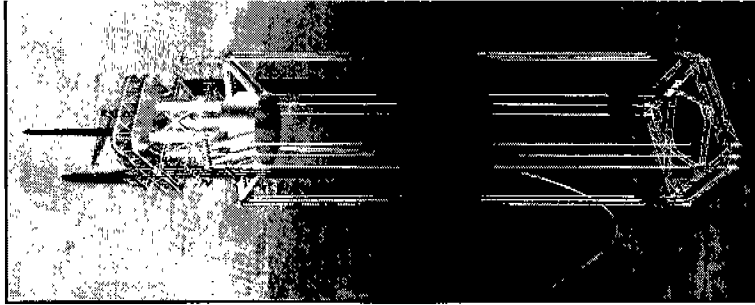

Tension Leg Platform

Figure 2A.23. Deepwater development options: dry trees.

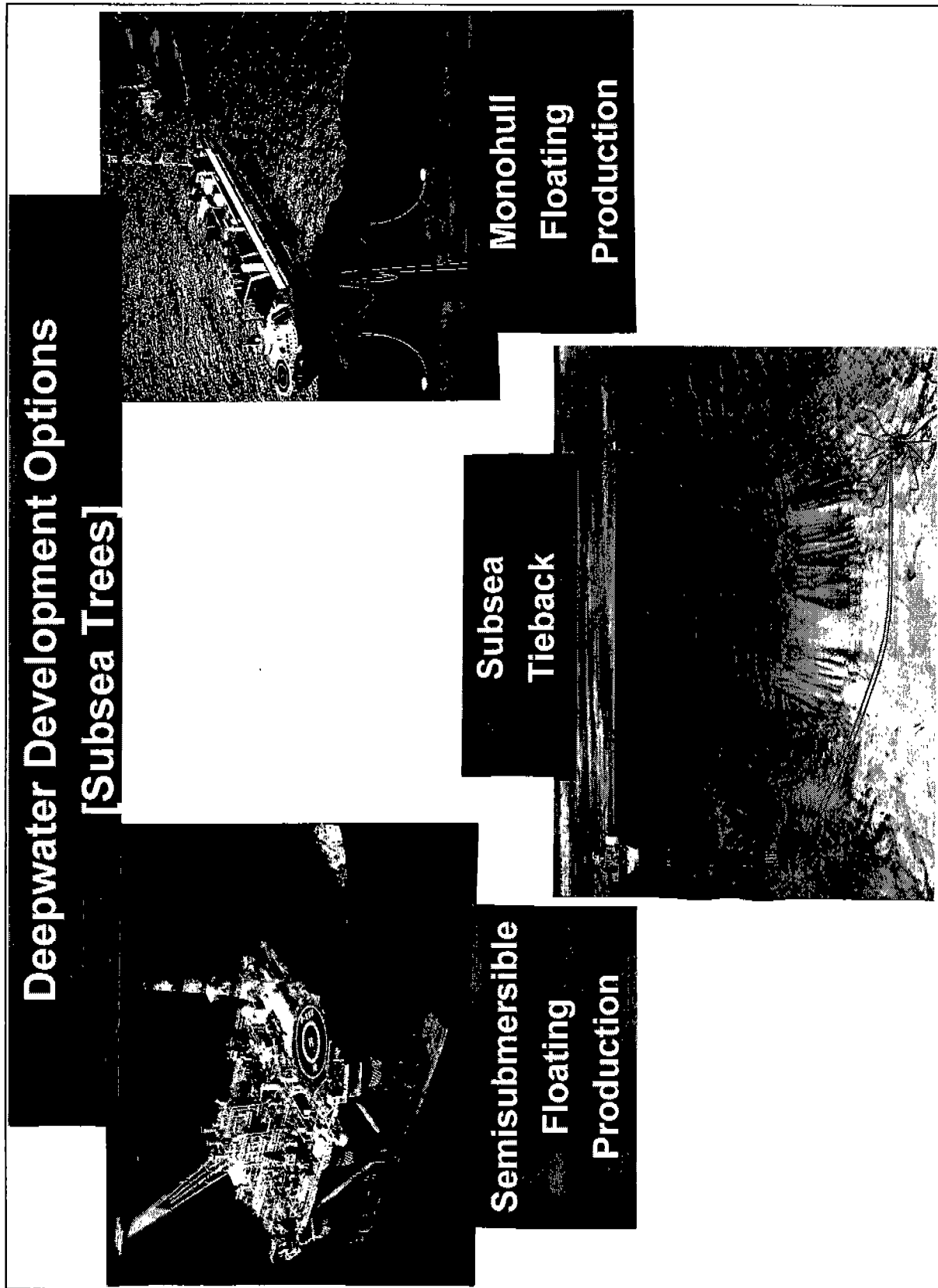
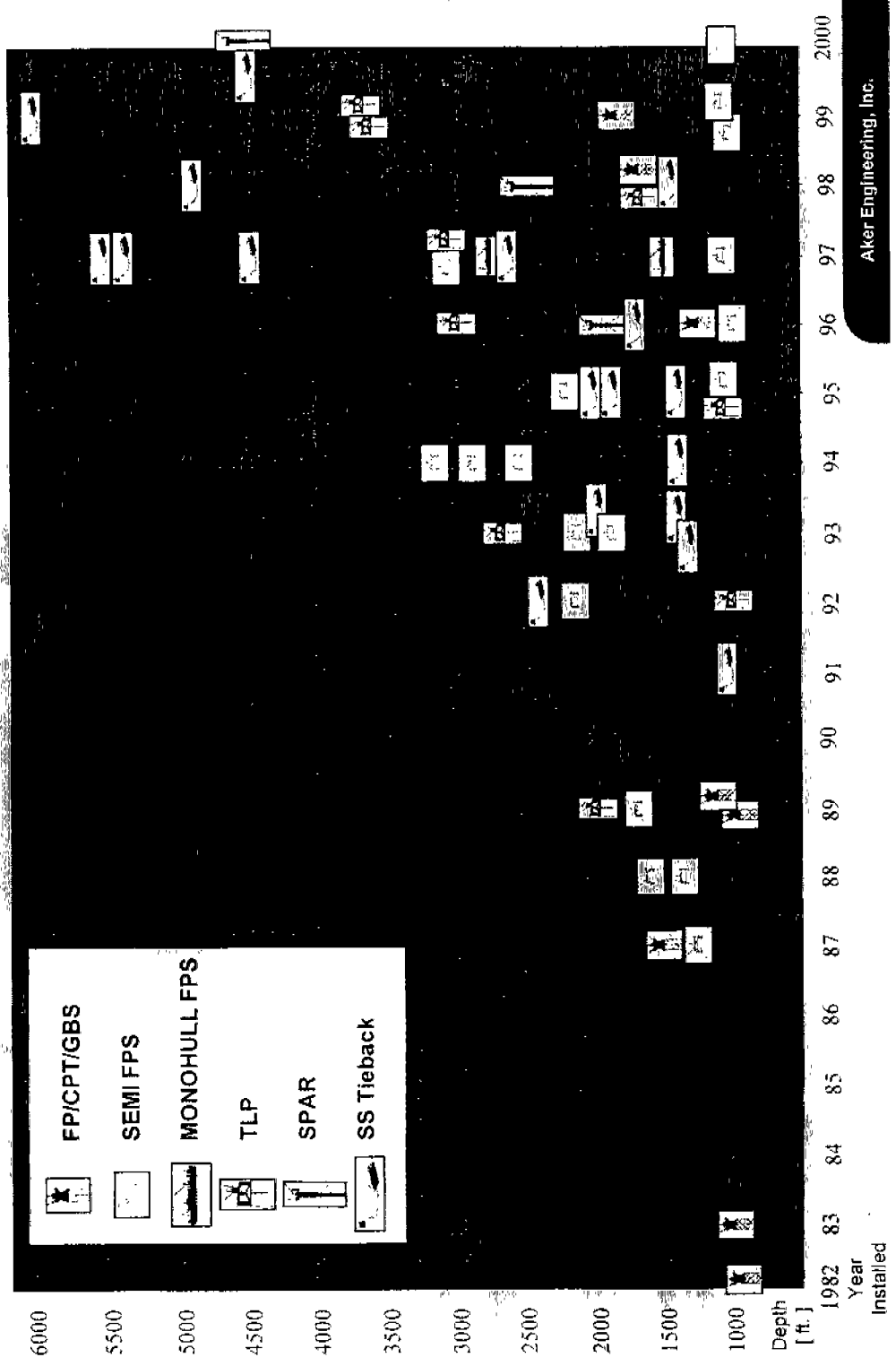

Figure 2A.24. Deepwater development options: subsea trees.



# Progression of Deepwater Developments



Aker Engineering, Inc.

Figure 2A.25. Progression of deepwater developments.

# Deepwater Developments Distribution by Development Type [1982-2000]

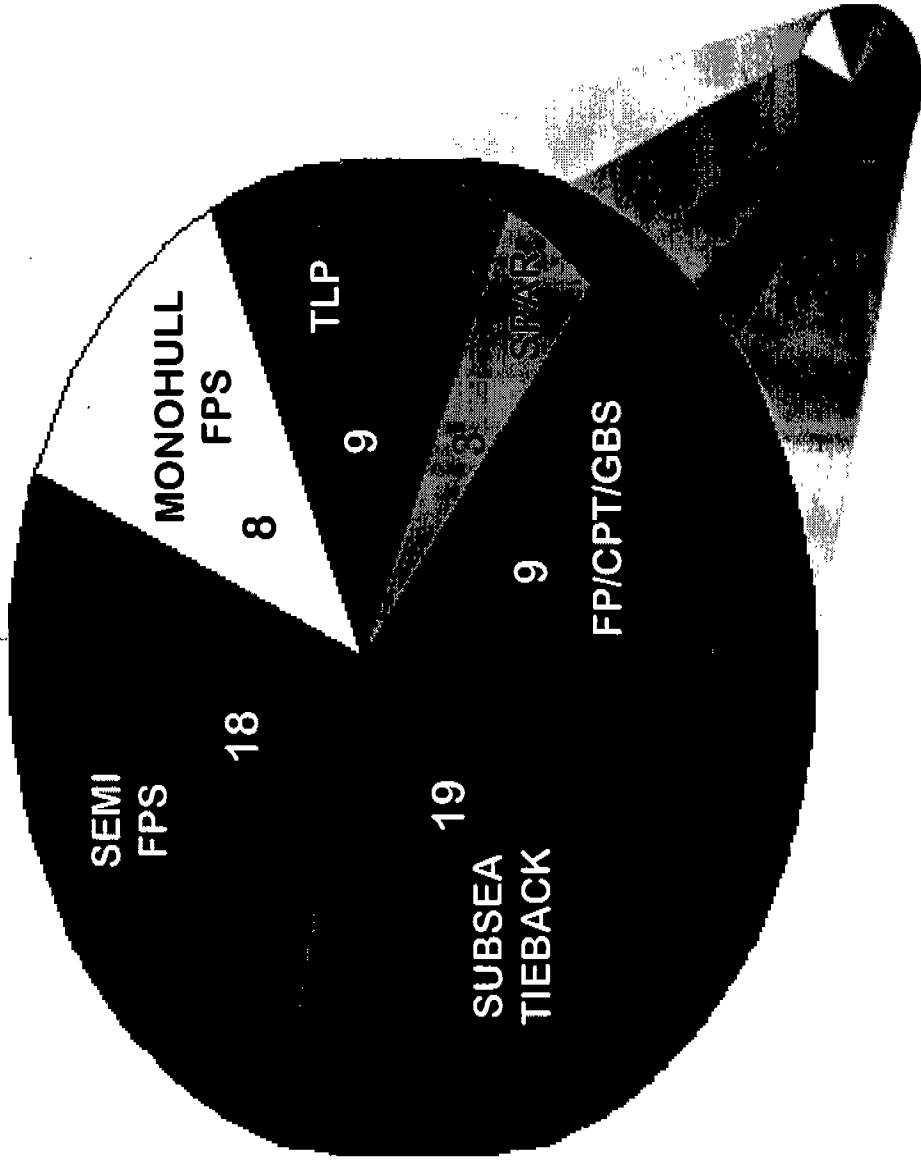

Figure 2A.26. Deepwater developments distribution by development type (1982-2000).

# Deepwater Development Regional Distribution [1982-2000]

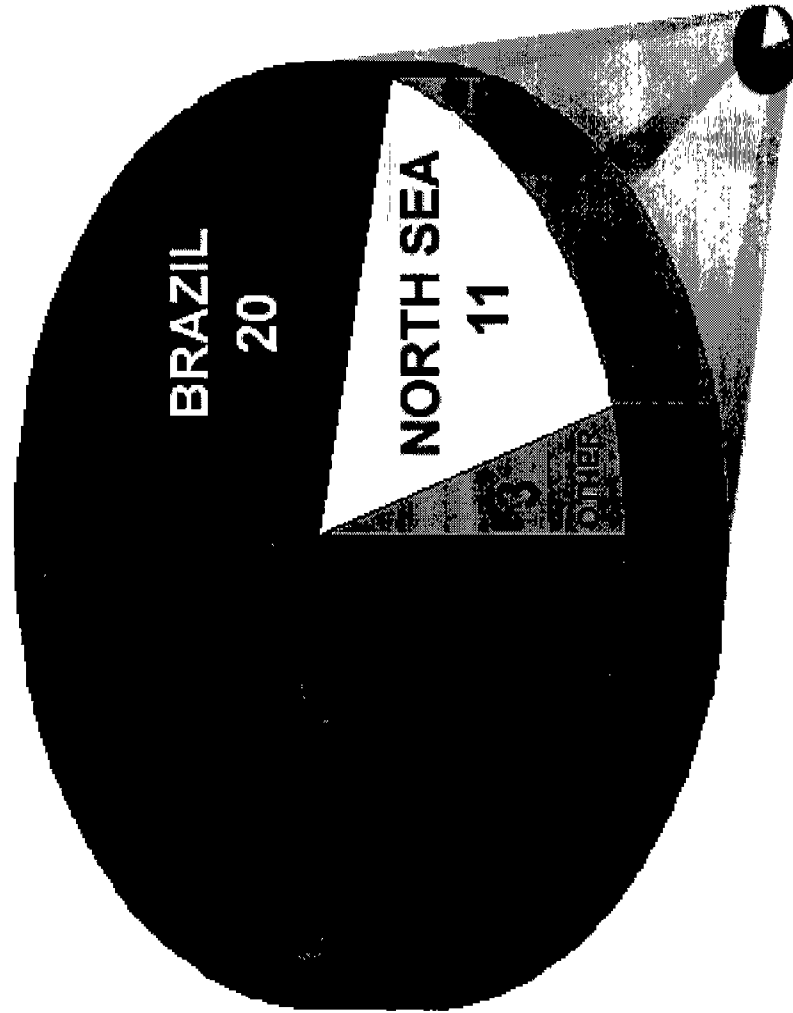

Figure 2A.27. Deepwater development regional distribution (1982-2000).

## **KEY FIELD DEVELOPMENT SELECTION DRIVERS**

- **Water Depth, Metocean Conditions**
- **Proximity of Infrastructure**
- **Reservoir Fluid Properties**
- **Recoverable Reserves**
- **Number of Drill Centers, Well Count, Production Rate**
- **Type and Frequency of Well Intervention**
- **Risk Weighted Field Development Life Cycle Economic**

Figure 2A.28. Key field development selection drivers.

## **WHY DEEPWATER FIELD DEVELOPMENT ECONOMICS ATTRACTIVE**

- **Discovery Rates (3D Seismic)**
- **Large Reservoirs (>500 mm BOE)**
- **High Well Productivity (Horizontals, Multi-laterals, Geophysics)**
- **Extending Subsea Tiebacks (Flow Assurance, Subsea Boosting, Metering Separation)**
- **Reduced Cycle Time (Overlap Engineering and Reservoir Appraisal, Improved Processes)**

Figure 2A.29. Why deepwater field development are attractive.



## **DEEPWATER FIELD DEVELOPMENT SELECTION**

- **One Size Does Not fit All: No Single Production Concept Fits Every Need**
- **Technology is Developing Rapidly**
- **Life Cycle Economics Basis for Selection**
- **Cycle Time Versus Reservoir Development Optimization**
- **Risk Based Assessment to Handle Uncertainty**

Figure 2A.30. Deepwater development selection.

## **Semisubmersible FPS Features**

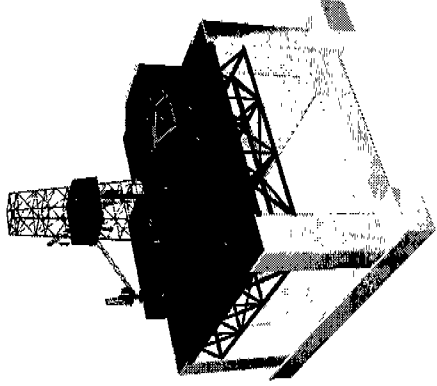

- **Proven Production Platform (Worldwide)**
- **Proven Subsea and Flex Riser Technology (3000 ft)**
- **Drilling and Workover Capability (to 6,000 ft)**
- **Platform Relatively Insensitive to Water Depth and Well Count**
- **Cost-Effective Fit-for-Purpose Newbuild Hull Designs**
- **Ease of Platform Installation, Hook-up, Relocation**

Figure 2A.31. Semisubmersible FPS features.

## Semisubmersible FPS Applications

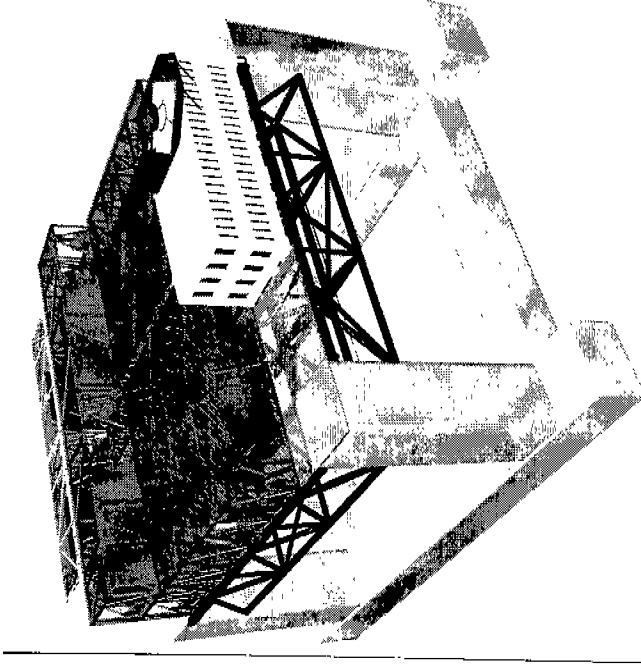

Production Hub  
or Local Host Facility

### Performance History

- **27 in Operation Worldwide**
- **7 in Planning (Brazil, N. Sea)**
- **Water Depths 300 to 3000 ft.**
- **Topside Payloads up to 30,000 s. tons**

Figure 2A.32. Semisubmersible FPS applications: production hub or local host facility.

# Semisubmersible FPS Applications

Drilling and Production Hub  
or  
Local Host Facility

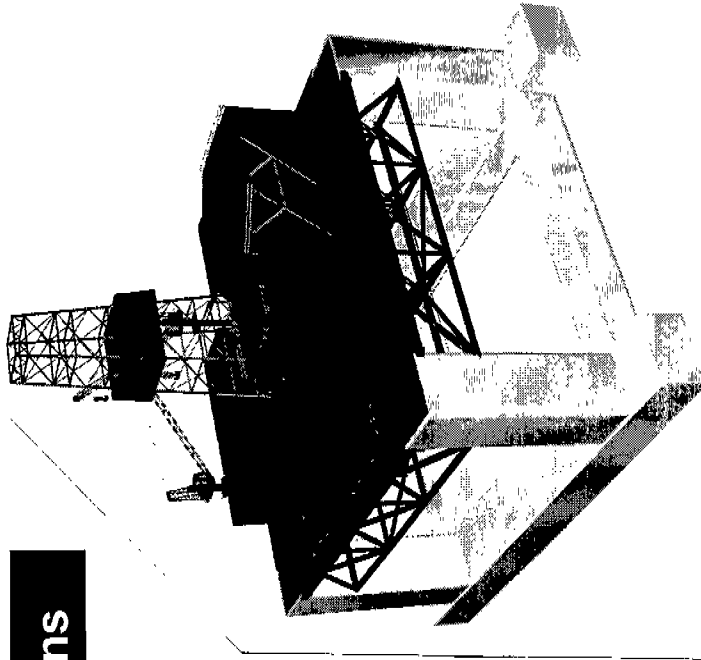

## Performance History

<u>Project</u>	<u>Location</u>	<u>Topsides (s.tons)</u>	<u>W. Depth (ft.)</u>	<u>Status</u>
Placid GC29	GoM	6000	1600	Decommissioned
GB 388	GoM	6000	2200	Operating
Njord	N. Sea	22000	1000	Operating
Lihua	S. China Sea	6000	1000	Operating
Balmoral	N. Sea		500	Operating
Visund	N. Sea	25000	1000	In Construction
Snorre Nord	N. Sea	N/A	1000	In Planning

Note: Semisub Modu's have drilled in 6000 ft. in GoM

Figure 2A.33. Semisubmersible FPS applications: drilling and production hub or local host facility.

## **Innovative Purpose Built Production Semisubmersible**

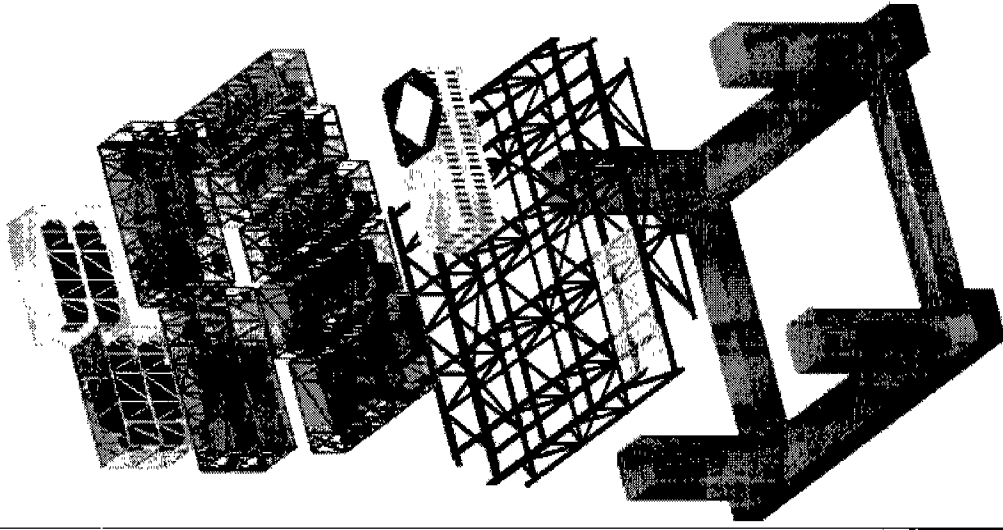

- **Innovative Splash Zone Truss with Flat Top Deck**
- **Split Topside and Hull Fabrication**
- **Fabrication Friendly Hull**
- **Multiple Options for Topside to Hull Integration**
- **Hull Form Optimized for Low Vertical Motions**
- **Low Maintenance Marine Systems**

Figure 2A.34. Innovative purpose built production semisubmersible.

## **Deepwater Semisubmersible FPS Issues**

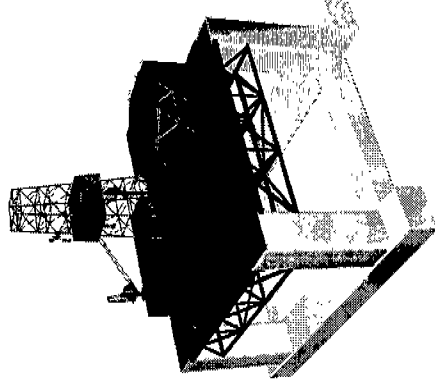

- **Reduce Drilling System Payload**
- **Increase Drilling, Well-Intervention Efficiency**
- **Reliable, Cost-Efficient Station-Keeping (Synthetics, Suction Anchors)**
- **Low Cost Production, Export Riser Systems (SCR's Hybrid)**

Figure 2A.35. Deepwater semisubmersible FPS issues..

# New Semisubmersible FPS Concepts

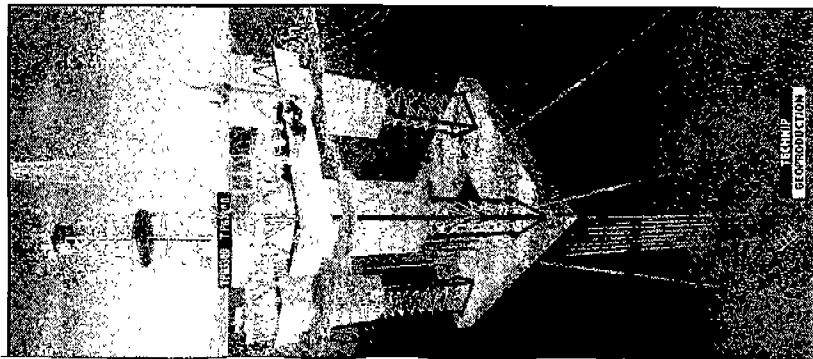

**TPG 3300**

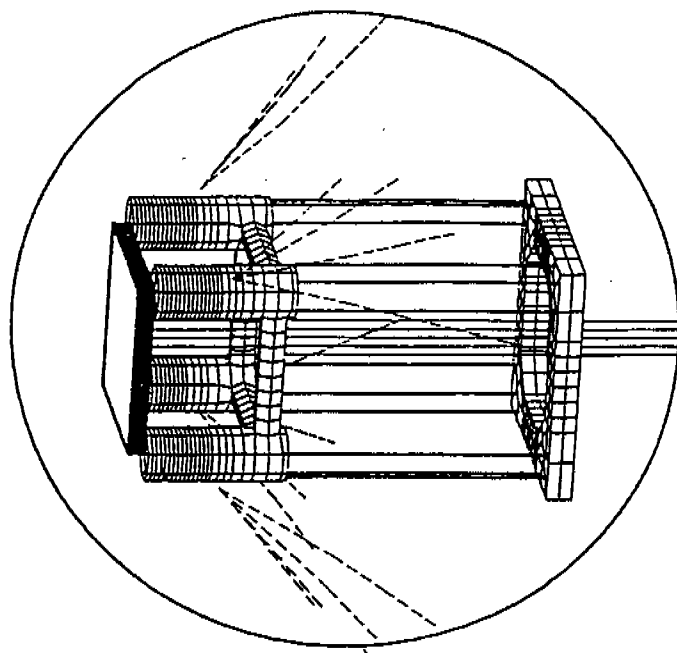

**Minimum Motion Platform**

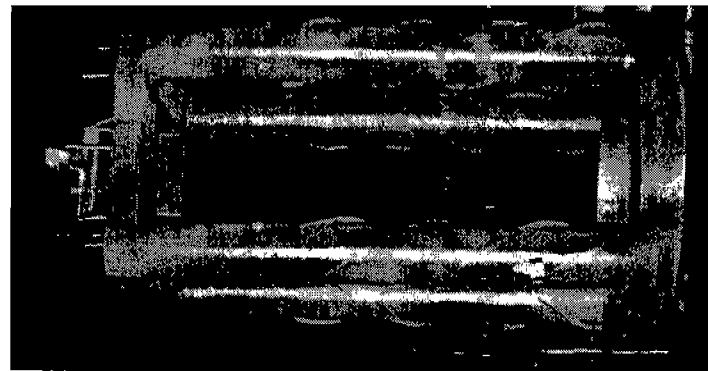

**Deep Concrete Floater**

Figure 2A.36. New semisubmersible FPS concepts.

## Monohull FPS Features

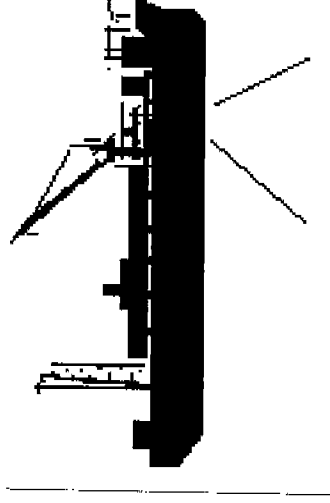

- **FPSO Eliminates Oil Pipeline**
- **Proven Subsea and Flex Riser Technology**
- **Feasibility for Future Expansion, Reuse**
- **Historically Short Development Schedules**
- **Minimizes Offshore Installation**
- **Hull Competitively Built Worldwide, Easy Transport to Site**

Figure 2A.37. Monohull FPS features.



## Monohull FPS Applications

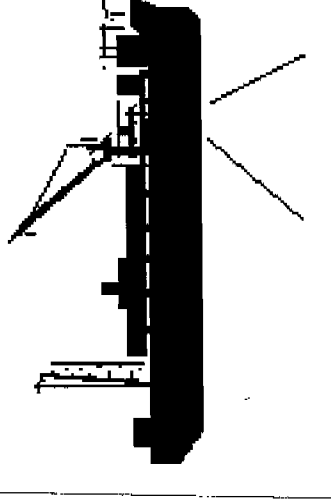

- **Most Widely Used Production Platform**
- **Production Hub or Local Host, Small or Large Oil/Gas Developments**
- **Mild to Moderate or Harsh Environment Applications**
- **Water Depths to 10,000 ft.**
- **Production Capacity >200,000 BOPD + Gas**
- **20+ Production, Injection, Export Risers**

Figure 2A.38. Monohull FPS applications.

## Monohull FPS Leading Issues

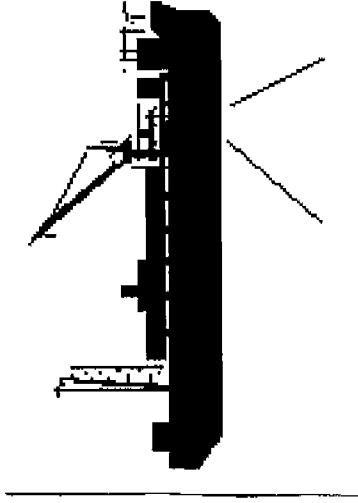

- **Design for Long-Term Siting**
- **Need for Industry Standards**
- **High Bearing Capacity Turrets for Ultra-Deepwater**
- **Advance Steel and Hybrid Riser Technology**
- **Integrate Production and Marine Systems**
- **20+ Production, Injection, Export Risers**

Figure 2A.39. Monohull FPS leading issues.

# New Monohull FPS Concepts

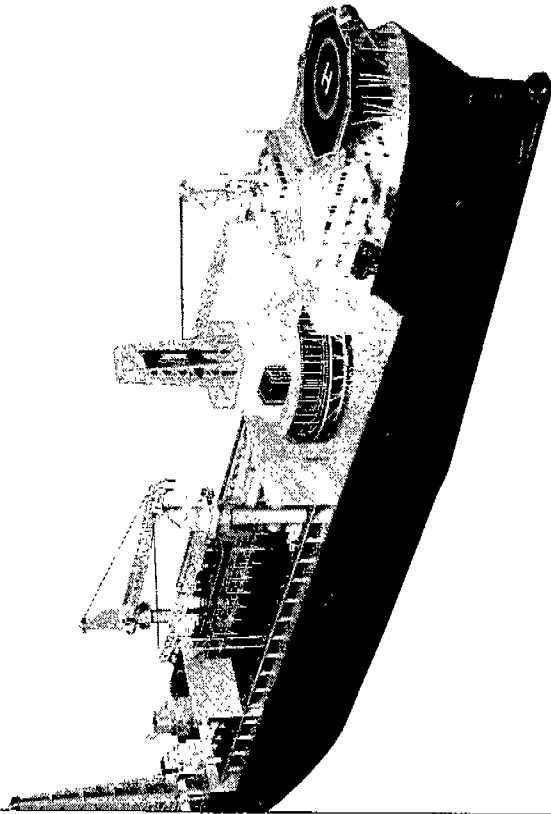

**FPSO with Drilling**

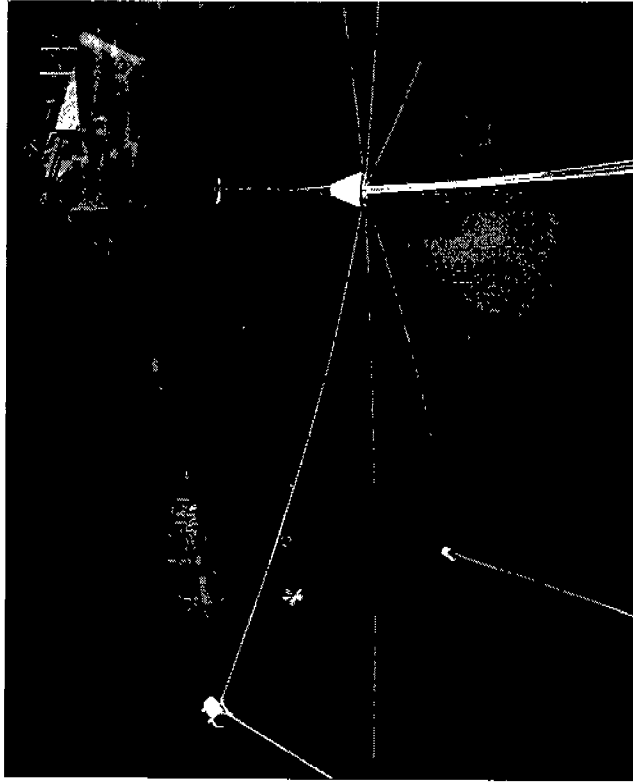

**Submerged Turret Production**

Figure 2A.40. New monohull FPS leading issues.

# New Monohull FPS Concepts

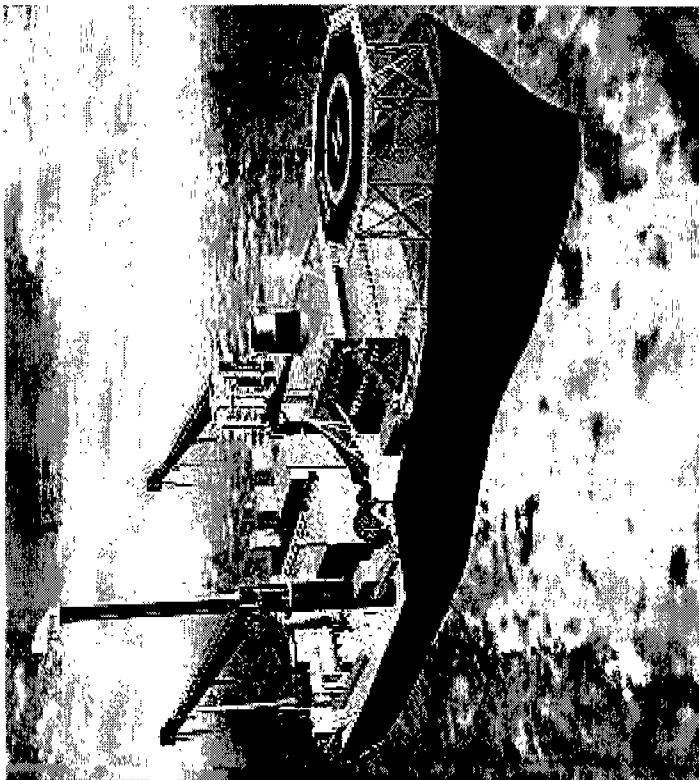

Ramform

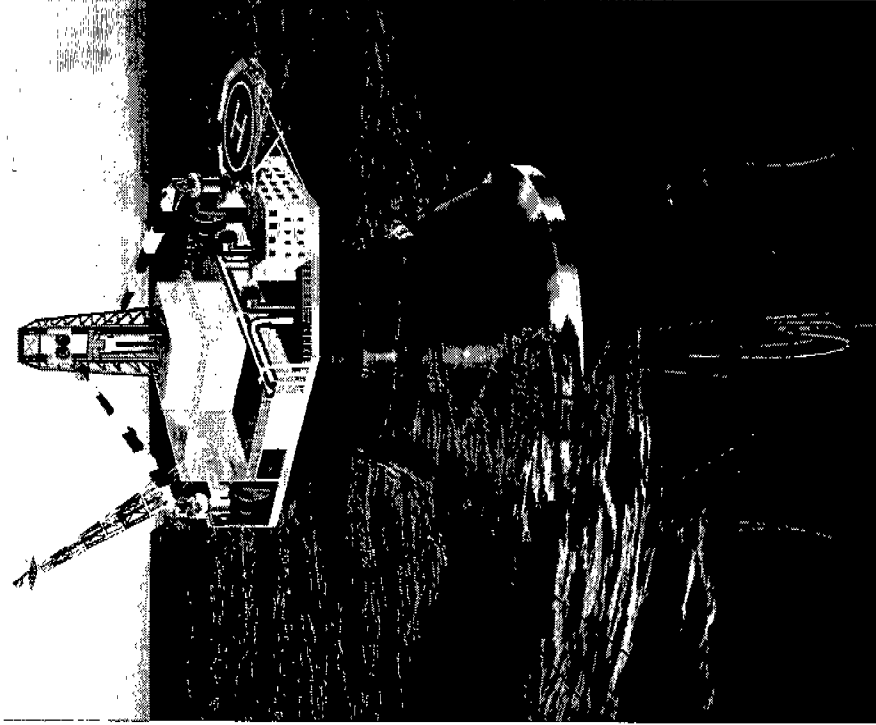

Buoyform

Figure 2A.41. New monohull FPS concepts.

**NEW DEEPWATER STRUCTURE CONCEPTS: PANEL  
DISCUSSION—CHEVRON'S GENESIS SPAR PROJECT**

Mr. W. Scott Young  
Chevron

(Bullet Summary Prepared by Jim Regg, Session Chair)

SUMMARY

- The Genesis Project is located in Green Canyon, Block 205, approximately 150 miles southwest of New Orleans (Figure 2A.42).
- Water depth at the location is approximately 2,600 feet.
- Chevron will use a Spar production system to develop Genesis.

The Spar is a deep-draft floating caisson with a centerwell through the entire length of the hull (void compartment). There are four major systems: hull, mooring system, topsides, and risers. The Spar relies on a traditional mooring system (i.e., anchor spread mooring) to maintain its position. About 90% of the structure is underwater. Because of its deep-draft hull, the Spar compares favorably with other floating concepts in terms of motion characteristics. As with the tension-leg platform, the spar offers direct access to the wellbore through a surface production tree and production riser. This access is an advantage to those floating systems that rely on subsea technology (Figure 2A.43).

- The Genesis Spar will be the second in the Gulf of Mexico; Oryx installed the first at Viosca Knoll Block 826 (known as Neptune); the Neptune Spar is a production-only system (no drilling from the Neptune Spar); production from the Neptune Spar was initiated in March 1997.
- The Genesis Spar will be larger than the Neptune Spar, supporting full production processing, secondary recovery operations, drilling and completion activities.
- The general Spar dimensions are 705 feet in length, 122 feet in diameter (compared to the Neptune Spar dimensions of 705 by 72 feet).
- The Genesis Spar will be moored to the seabed using a 14-line, lateral catenary system consisting of wire rope and chain.
- Construction of the hull is occurring in Finland.

*Genesis .... The field lies in 2600' of water  
150 miles south of New Orleans*

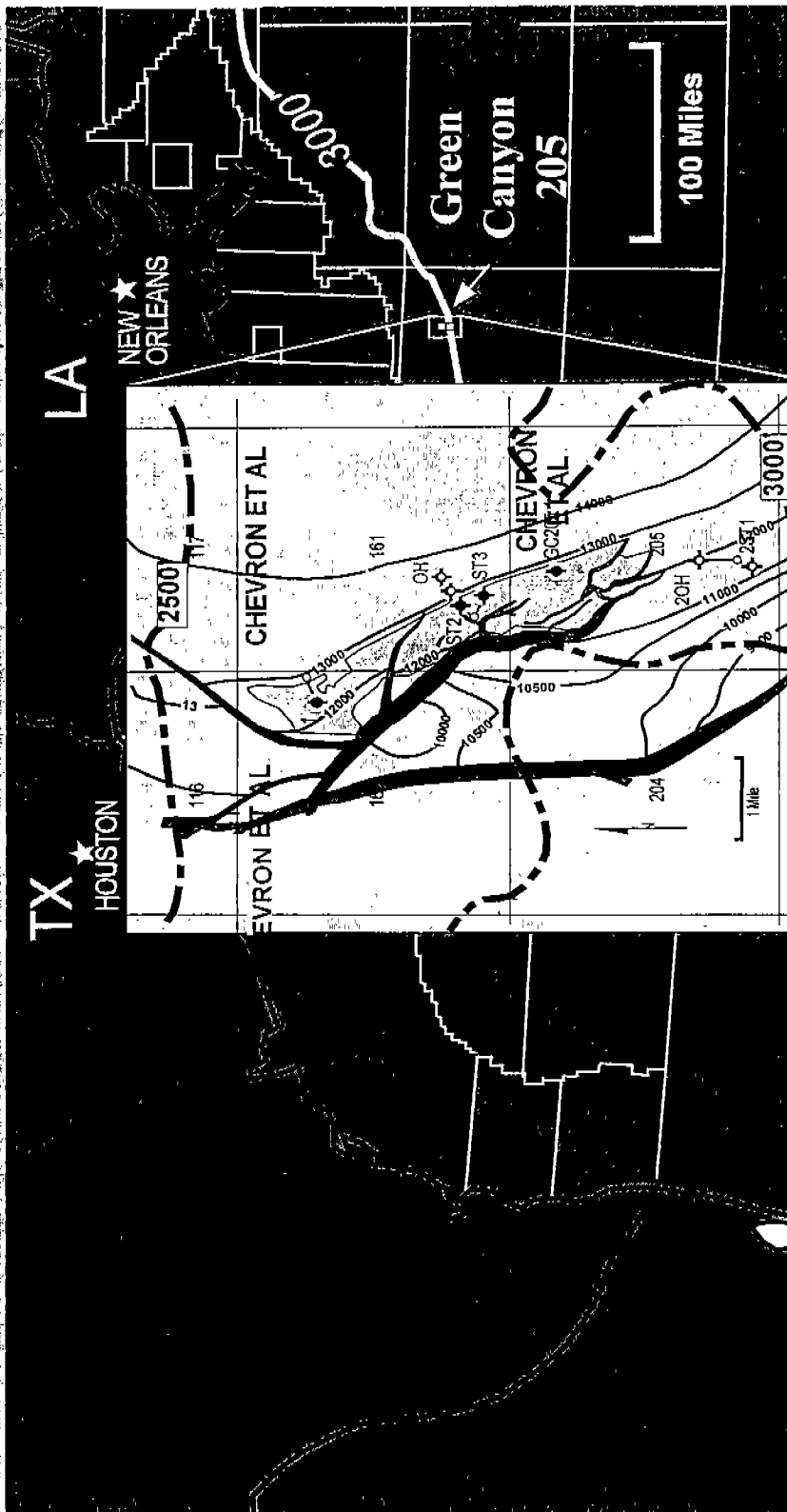

Figure 2A.42. The location of the Chevron Genesis Spar Project.

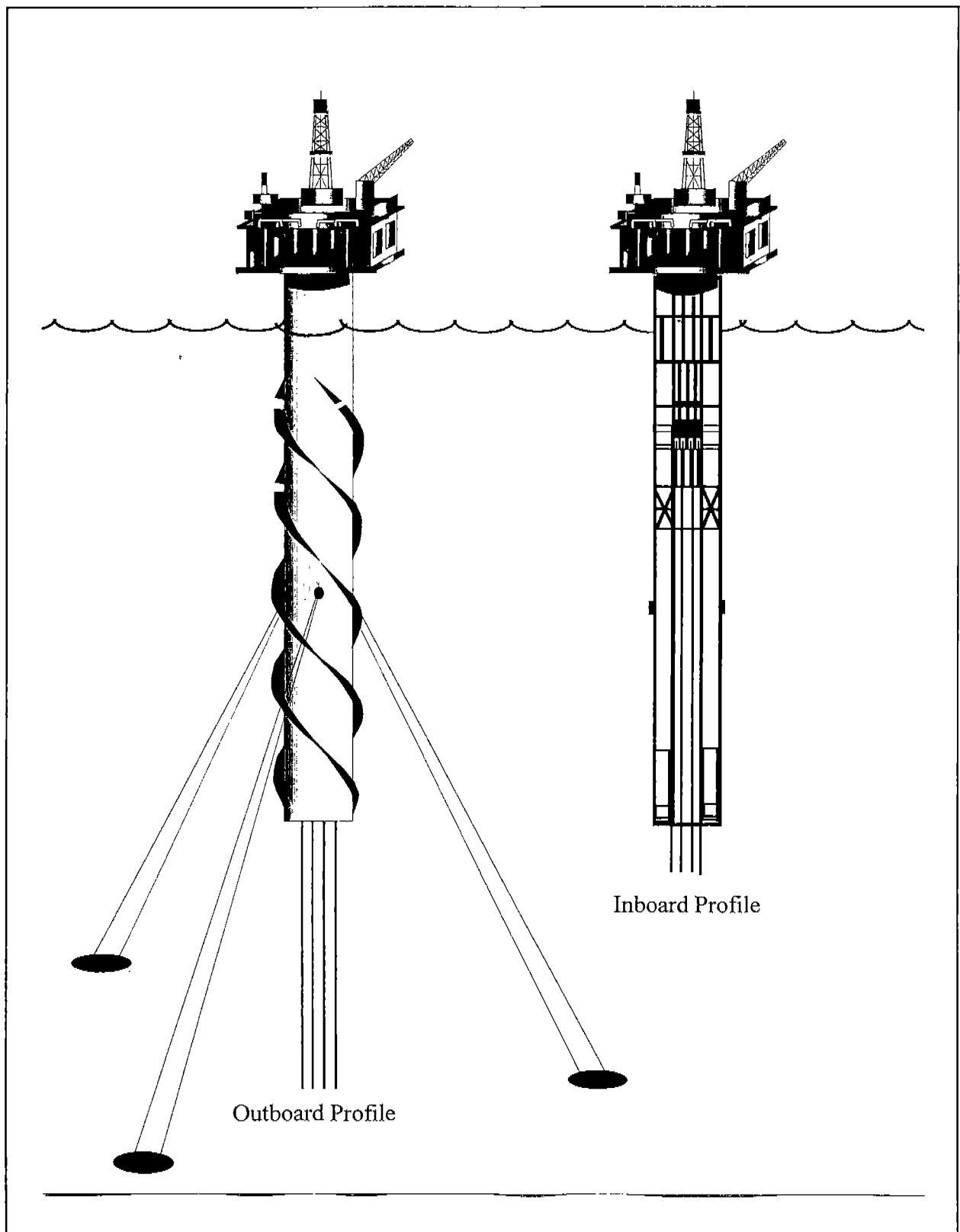

Figure 2A.43. Profiles of the Spar Platform.

- Key dates: Genesis Spar on location 5/98; first oil 12/98.
- Production design capacities are 55,000 barrels of oil per day (BOPD), 72 million cubic feet of gas per day (MMCFGPD), 30,000 barrels of water per day (BWPD).
- Secondary recovery (water flood and gas injection): 25,000 BWPD, 35 MMCFGPD (gas injection), future plans for 5 MMCFGPD gas lift.
- A number of operators are considering the use of Spars for developing hydrocarbon discoveries in the GOM, including some alternative designs such as the Truss Spar developed by Spars International.

---

W. Scott Young of Chevron is the Genesis Project Team Leader.

## **NEW DEEPWATER STRUCTURE CONCEPTS: PANEL DISCUSSION— MORPETH FIELD DEVELOPMENT**

Mr. G. Ross Frazer  
British-Borneo Exploration, Inc.

Figures 2A.44 – 2A.51 highlight various aspects of Morpeth Field development.

### EVOLUTION

- British-Borneo Exploration, Inc. (BBEI) historical use of SeaHorse genre platforms.
- BBEI desire to develop reserves in deepwater that could not support the conventional approaches (i.e., Floating Production System (FPS), Spar, large tension leg platform (TLP)).
- Atlantia's DOE grant to develop a concept to do just this (recent Tibbet's Award by the Clinton Administration for Entrepreneurship)
- Similar to the evolution of the business on the shelf; i.e., independents trying different field development approaches to increase the country's reserve base

### MORPETH SEASTAR

- BBEI will be using this vessel to develop its Morpeth Field (Ewing Bank) and recently acquired Allegheny Field (Green Canyon).



- The American Bureau of Shipping (ABS) and USCG have endorsed the concept as viable.
- The ABS is currently acting as the Certified Verification Agent (CVA ) and classing the vessel as *Floating Offshore Installation* (TLP).
- BBEI Project Team kept small (15 people); project management intent to use the abilities of selected vendors (i.e., Atlantia & McDermott).

#### CUTAWAY OF SEASTAR

- Considered at highest level, the SeaStar design is basically a passive, truncated spar buoy held in place with conventional tension-leg mooring system.
- BBEI's safety objectives incorporate:
  - No active ballast during normal operations
  - No machinery in the hull
  - No crude oil storage in the hull
  - Two tendons per corner for 100% redundancy
  - Complete HAZID, HAZOP, and, once installed, HAZAN exercise
- No new technology; rather combinations of proven technologies.

#### GULF ISLAND FABRICATION

- Constructability integral to design.
- Design flexible enough for Gulf of Mexico (GOM) jacket fabricators to construct.

#### J. RAY MC DERMOTT

- Pilings in early to allow setup time; tension piling (6 mos. for Morpeth).
- Tendons w/Vetco connector and Oil States couplings similar to Auger, Mars.
- Hull lifted from material barge & "floated" over tendons; ballasted down; tendons locked off when hull at proper level.
- Deck installed as standard four-pile GOM deck.
- Export lines (SCR's), flowlines & umbilicals installed.

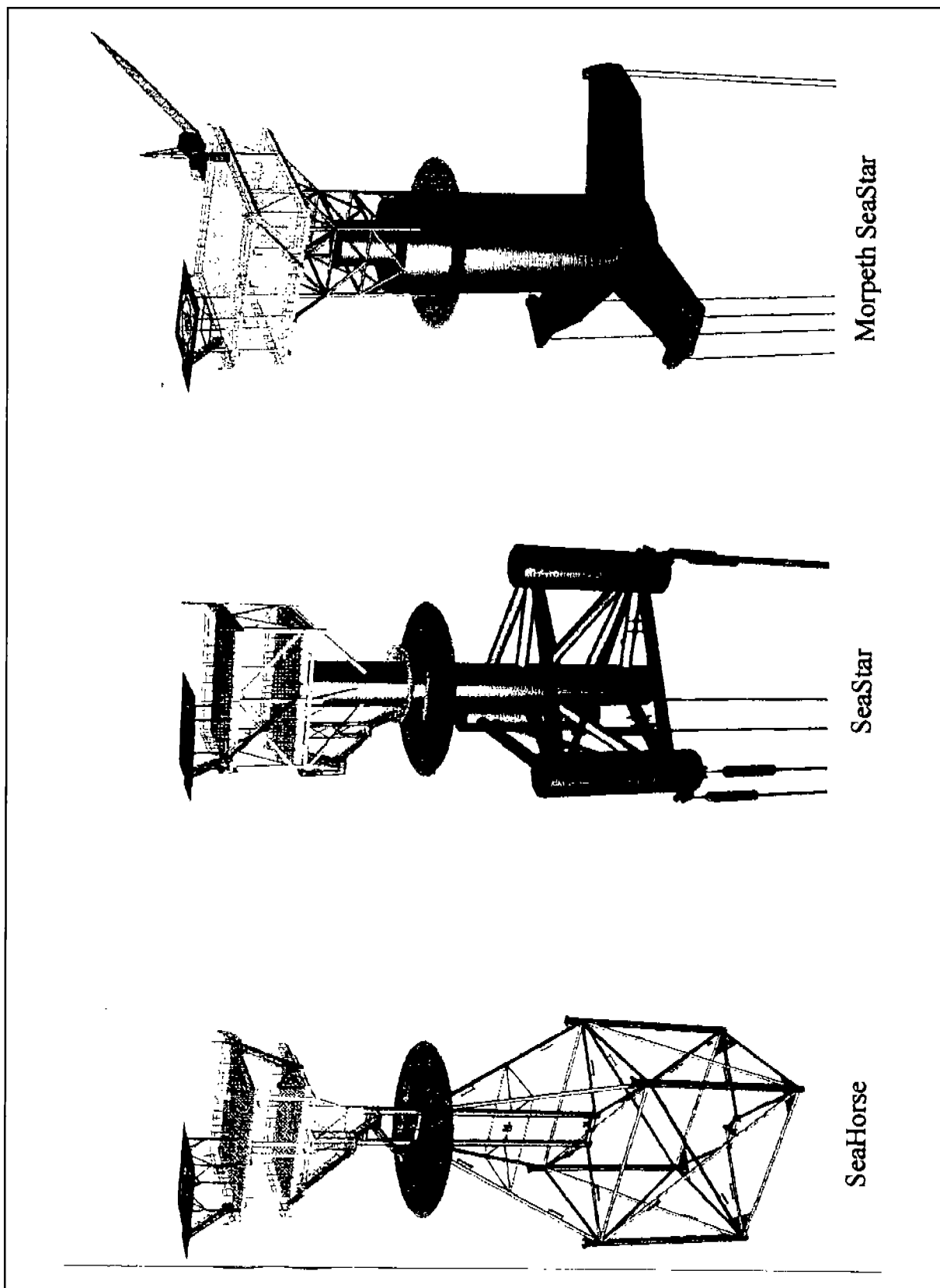

Figure 2A.44. Illustrations of the SeaHorse, SeaStar and Morpeth SeaStar platforms

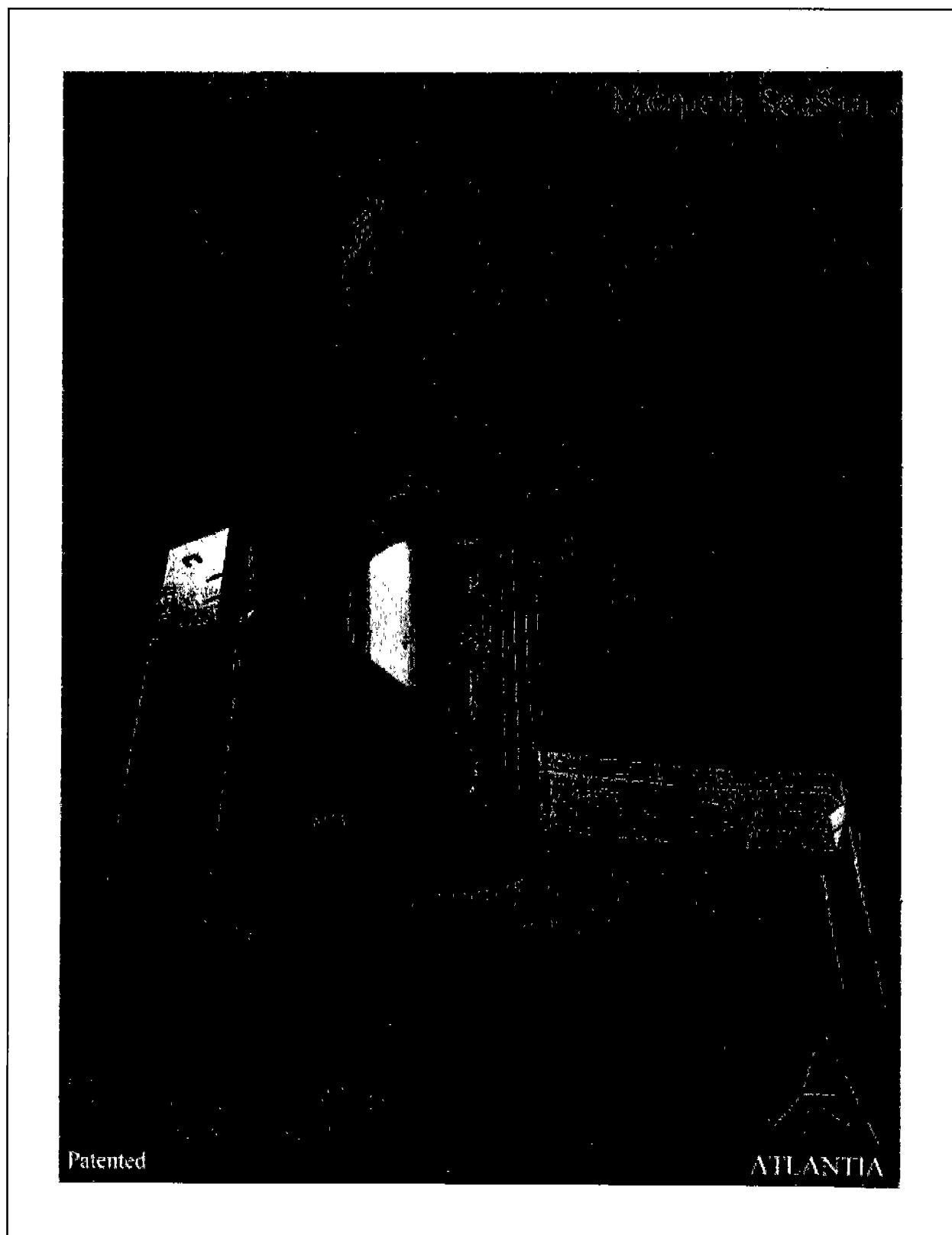

Figure 2A.45. The Morpeth SeaStar, below the surface view.

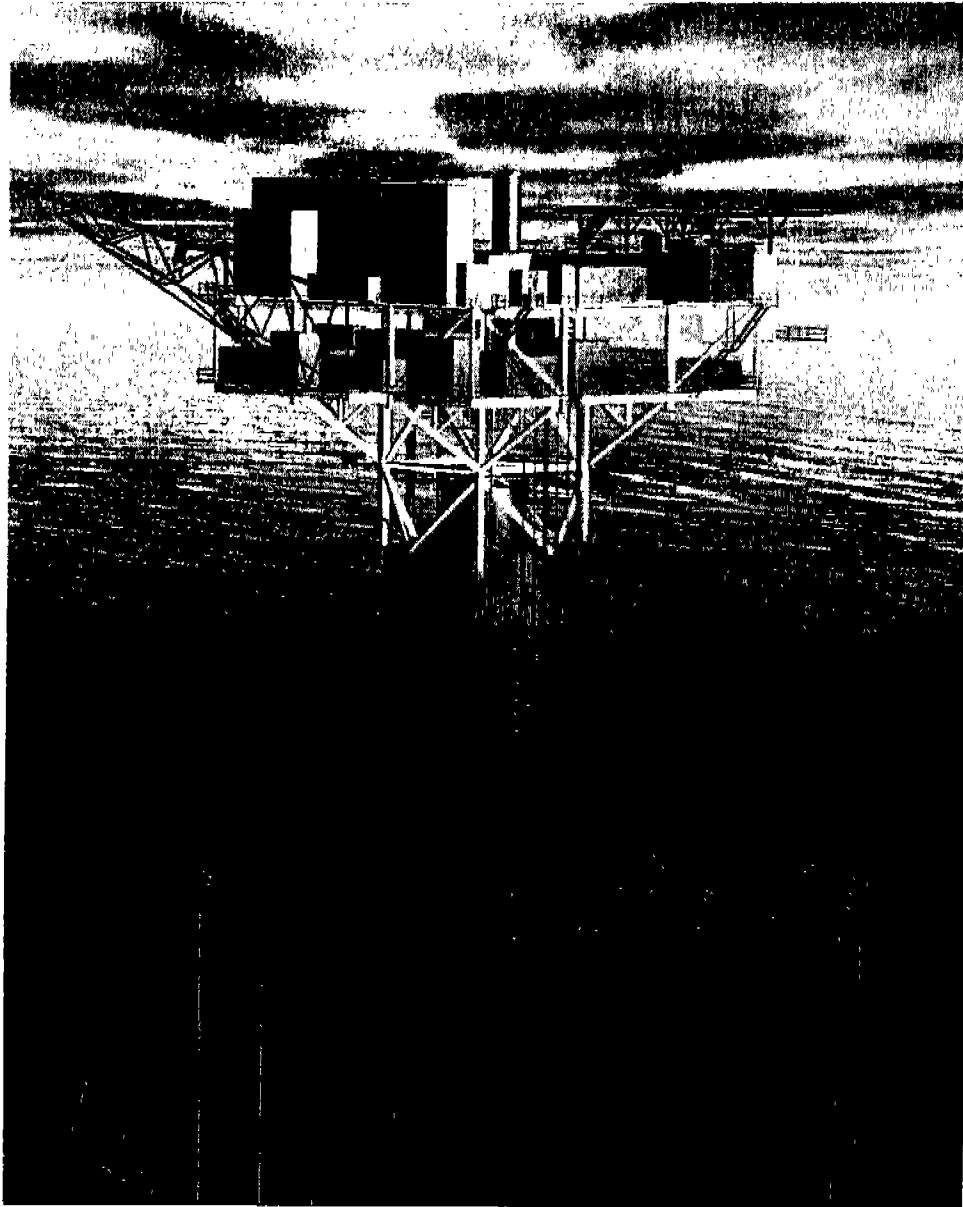

Figure 2A.46. Morpeth Field Development.

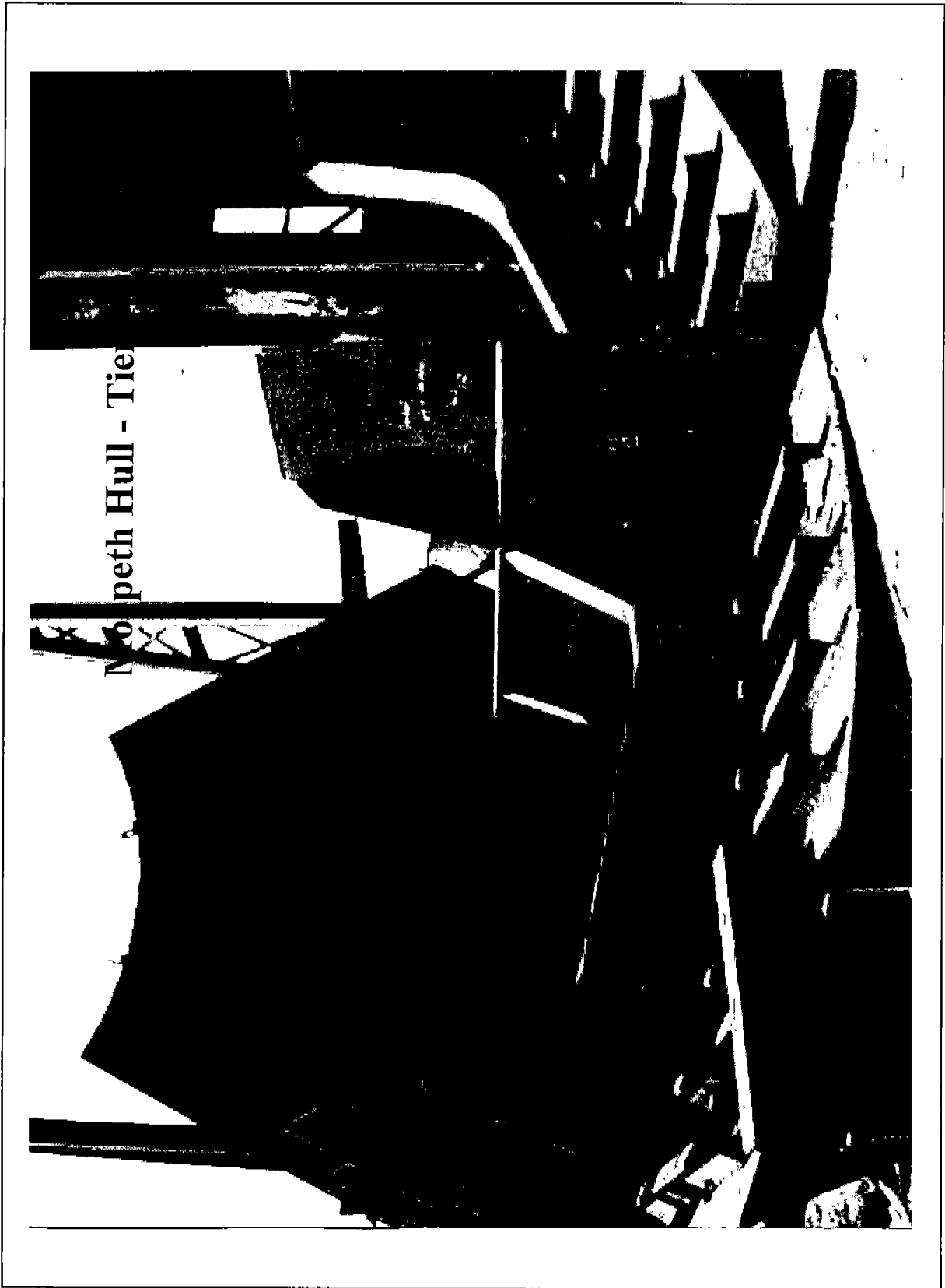

Figure 2A.47. Morpeth Hull – Tier 1 Segment.

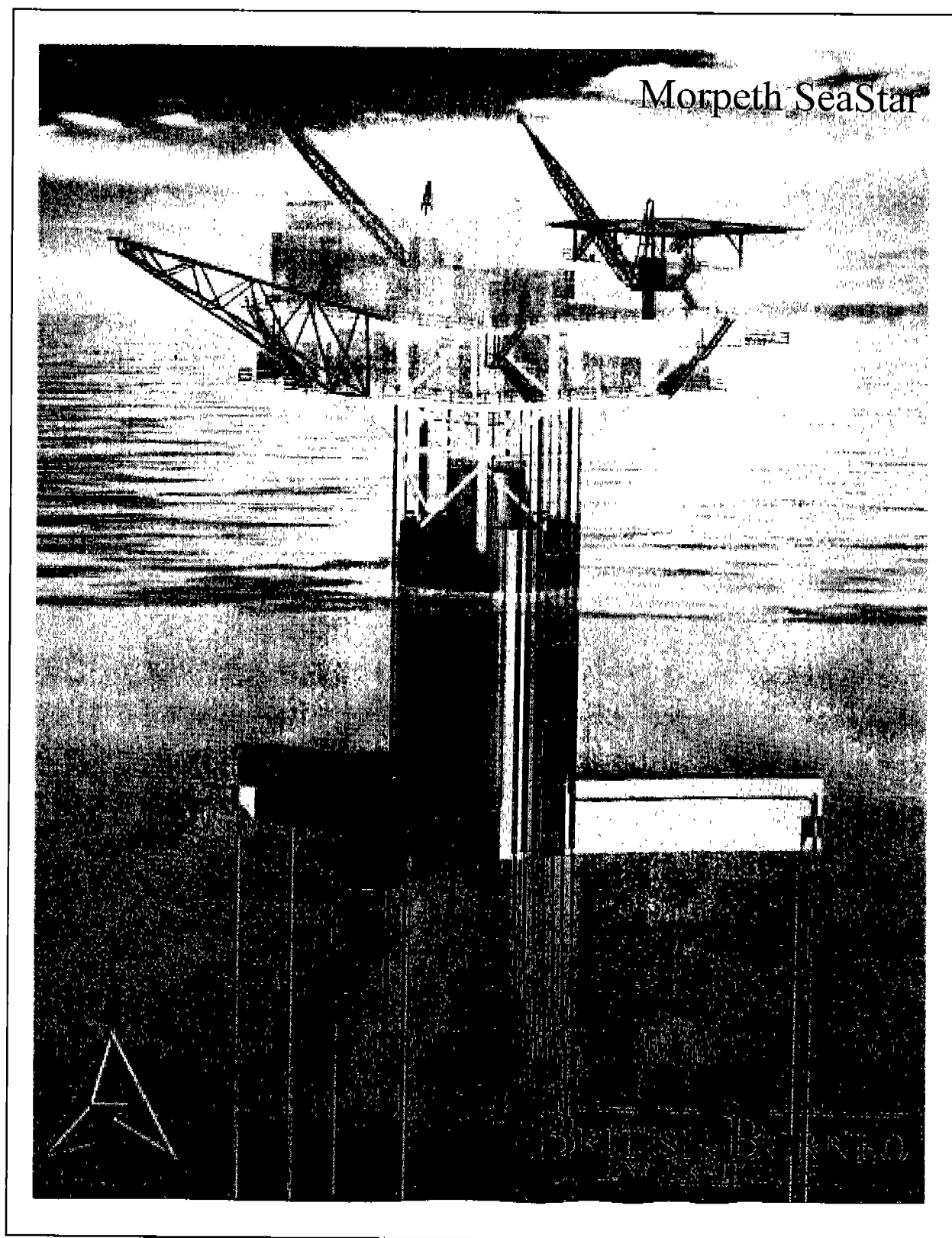

Figure 2A.48. Morpeth SeaStar, above and below the surface view.

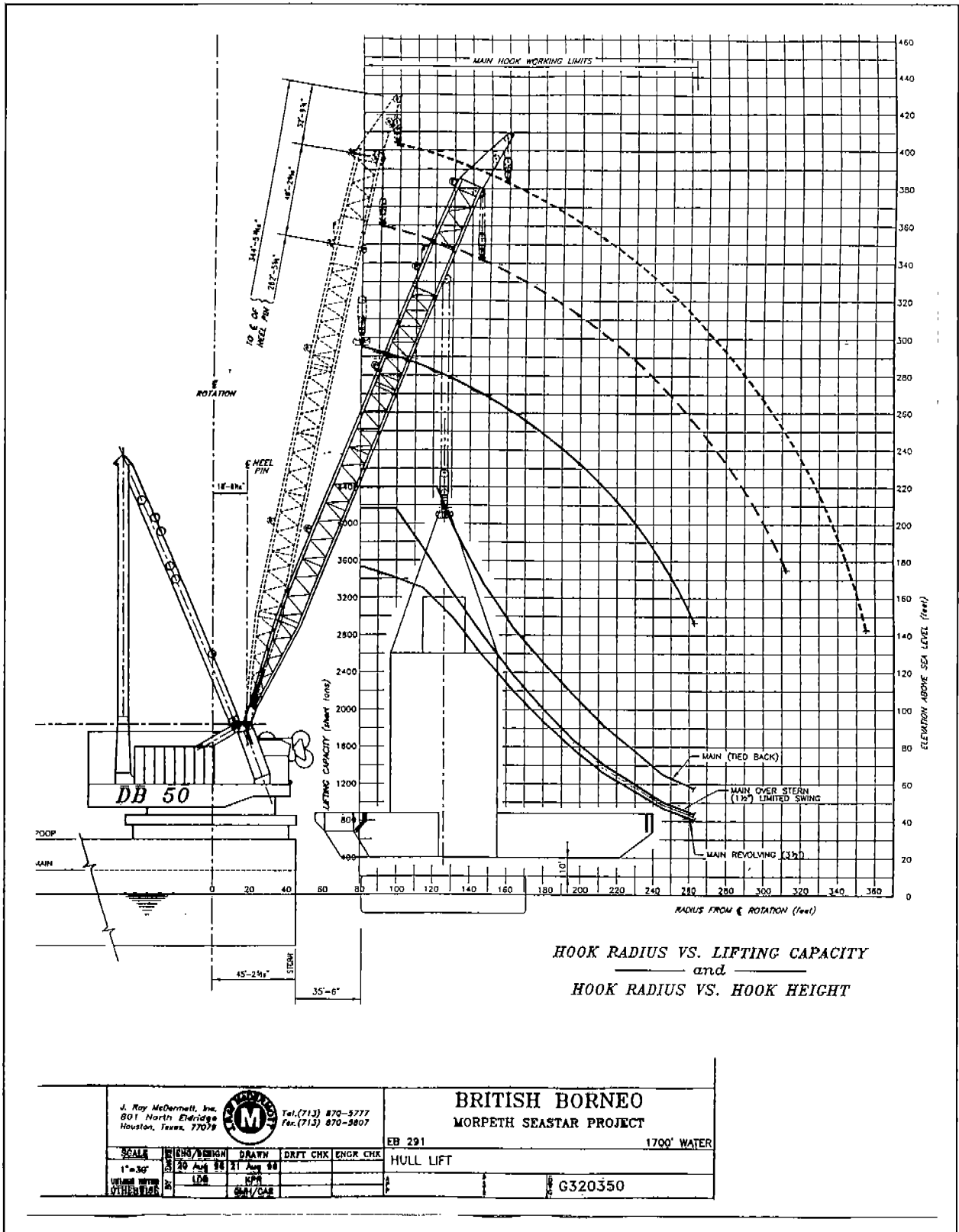

Figure 2A.49. Hook radius vs. lifting capacity and hook radius vs. hook height.

# Morpeth Field Development

## MORPETH / GI 115 FIELD LAYOUT

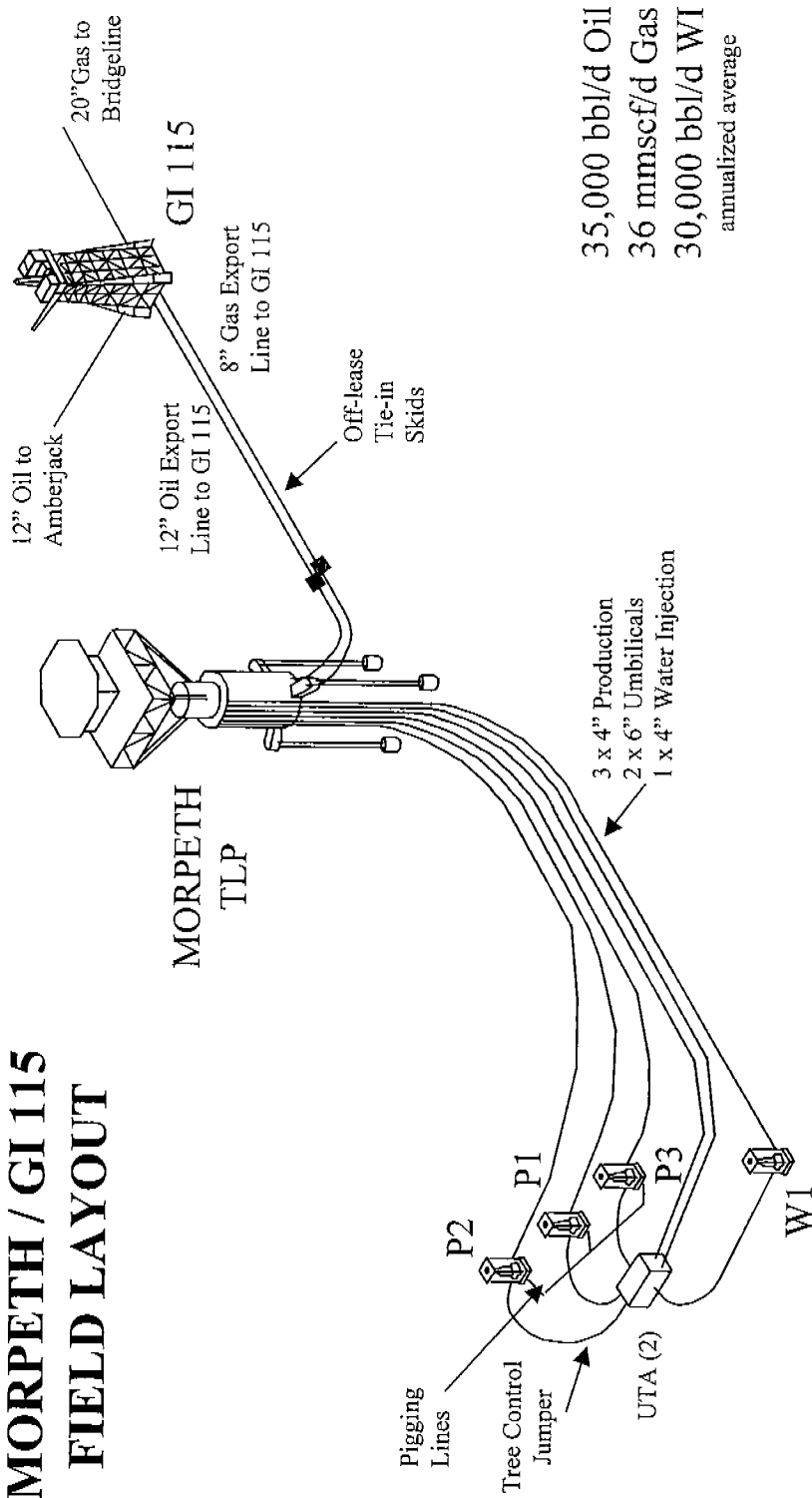

Figure 2A.50. Morpeth / GI 115 field layout.



**BRITISH - BORNEO**  
EXPLORATION, INC.

**MORPETH CORRIDOR PROJECT**  
**STATUS REVIEW - NOV. 1997**

**Morpeth Fact Sheet**

Location.....	Ewing Bank, Block 921
Water Depth.....	1700 ft
Processing.....	Pipeline spec. oil and gas
Annualized Average Throughput -Oil.....	35000 BOPD
Annualized Average Throughput -Gas.....	38 MMSCFD
Annualized Average Throughput-Water Injection.....	28000BWPD
Number of Production Wells (subsea).....	3 + 1 spare
Number of Water Injection Wells.....	1
Production Risers.....	4 in. flexible insulated
Control Umbilicals.....	2
Well/Riser Maintenance.....	Chemical injection, coiled tubing for riser cleanout
Export - Oil.....	12" Oil SCR and Pipeline to GI 115
Export - Gas.....	8" Gas SCR and Pipeline to GI 115
SeaStar TLP	
Payload (Deck/Facilities/Risers).....	8000 kips
Hull Weight.....	5000 kips
Displacement.....	22000 kips
Tendons.....	6 x 26 inch
Foundation.....	Independent piles for each tendon
Hull Dimensions	
Column Diameter.....	58 ft.
Draft.....	91 ft.
Pontoon Radius.....	115 ft.
Pontoon Height.....	25 ft.
Main Column Height.....	112 ft.
Design Life.....	20 years
Topsides	
Dry Equipment Weight.....	3000 kips
Deck Dimensions (two decks).....	110 x 110 ft
Quarters.....	18 man
Helideck.....	Bell 412

Figure 2A.51. Morpeth Corridor Project Status Review -Nov. 1997.

## FIELD LAYOUT SLIDE/MORPETH FACT SHEET

- 35,000 BOPD.
- 38,000 MCFPD.
- 28,000 BWPD (injection).
- Pipeline quality crude oil and natural gas exported via SCR's (lines only up & over GI 115).
- Project cost \$217MM (50/50 cost; within 3% of original budget of \$210MM); Seastar installed cost is \$92MM.
- Fabrication of hull is 39% complete; deck is 67% complete (end of November).

## MISCELLANEOUS DATA

- Payloads (kips – does not include in-place ballast):
 

Risers	633
Deck, structural	2265
Deck, equipment	2733
Deck, outfit	310
Deck, variable	1079
 Total	 7020
- First oil planned 3Q of 1998 or within two years of appraisal well results

---

Ross Frazer graduated from Texas A&M University in 1977 with a degree in nuclear engineering. He joined Houston Oil & Minerals Corporation at that time. After the company's purchase by Tenneco, Ross worked for a small drilling fund approximately one year before forming an operating company with two other engineers. In this capacity, Ross supplied operations and engineering expertise for clients on land and offshore in the Gulf Coast, East and South Texas and Central Louisiana. These clients included several startups in the Gulf of Mexico such as Seagull Energy, Total/Minatome and Brooklyn Union Exploration Co. Ross joined British-Borneo in July of 1993 as Operations Manager with responsibility for all phases of offshore operations from drilling through pipeline projects. In 1996, when the Morpeth Deepwater Field became reality, Ross was placed on the project team as Engineering Manager responsible for all aspects of engineering and construction relating to field facilities. Now that construction on the project is at a mature stage, Ross is making the transition to a new job as Manager of Regulatory Affairs, Verification and Partner Liaison for British-Borneo. He is a registered engineer in Texas and Louisiana.



## SESSION 2B

### NORTHEASTERN GULF OF MEXICO ENVIRONMENTAL STUDIES PART II

Chair: Dr. Robert Rogers

Co-Chair: Mr. Gary Goeke

Date: December 16, 1997

Presentation	Author/Affiliation
Northeastern Gulf of Mexico Coastal and Marine Ecosystem Program: Coastal Characterization: An Overview and Update	Dr. James B. Johnston Mr. Lawrence R. Handley Mr. William R. Jones Mr. Steve Robb U.S. Geological Survey National Wetlands Research Center
Northeast Gulf of Mexico Seagrass Mapping	Mr. Arturo Calix U.S. Geological Survey National Wetlands Research Center
Northeast Gulf of Mexico Habitat Mapping	Mr. Lawrence R. Handley U.S. Geological Survey National Wetlands Research Center
Ecology of Live-Bottom Habitats of the Northeastern Gulf of Mexico: A Community Profile	Mr. M. John Thompson Continental Shelf Associates, Inc. Jupiter, Florida
Assessment of Changes Related to OCS-Related Pipelines, Navigation Canals, and Mitigation	Samuel Holder, Jr. Minerals Management Service Gulf of Mexico OCS Region



**NORTHEASTERN GULF OF MEXICO COASTAL AND MARINE  
ECOSYSTEM PROGRAM—COASTAL CHARACTERIZATION:  
AN OVERVIEW AND UPDATE**

Dr. James B. Johnston  
Mr. Lawrence R. Handley  
Mr. William R. Jones  
Mr. Steve Robb  
U.S. Geological Survey  
National Wetlands Research Center

**INTRODUCTION**

The U.S. Geological Survey's Biological Resources Division (BRD) mission is to provide leadership in gathering, analyzing, and disseminating biological information as support for sound management of the nation's natural resources. Since becoming operational in October of 1996 through the transfer of programs from various bureaus within the Department of the Interior, the BRD, in cooperation with other federal, state, and local partners, has begun research, inventory and monitoring, information sharing, and technology transfer. Through these activities, the BRD is fostering an understanding of biological systems and their benefits to society, and providing the essential scientific support and technical assistance required for management and policy decisions. The role of BRD's National Wetlands Research Center (NWRC) in Lafayette, Louisiana, with project offices in Baton Rouge, Louisiana, and Gulf Breeze, Florida, is to provide leadership in research and development related to the nation's natural resources for the Southeast. The research focuses on wetlands ecology, animal ecology, and the development and application of spatial analysis techniques for natural resource-related studies.

Current geographic information system (GIS) technologies in use at NWRC are designed to provide natural resource managers with the on-line data and computerized techniques necessary to make informed decisions. Major GIS activities at NWRC include: compilation and analysis of digital databases for monitoring of natural resources; integration and transfer of databases with existing digital databases from various sources into a comprehensive GIS; and development of multifunctional decision support systems for natural resource managers using these data. NWRC is also an active participant in the National Information Infrastructure (NII), in particular the National Spatial Data Infrastructure (NSDI) and the National Biological Information Infrastructure (NBII), which will facilitate the dissemination of research results and other knowledge and information gained from these efforts. This summary and the three summaries that follow provide an overview and update of a four-year study entitled "Northeastern Gulf of Mexico Coastal and Marine Ecosystem Program: Coastal Characterization."

## OVERVIEW

The offshore oil and gas industry is developing oil and gas resources in the eastern Gulf of Mexico, a frontier area. The coastal area adjacent to the proposed development contains natural resources and socioeconomic infrastructures that may be affected by the proposed activities. During the mid 1970s to 1980s, available environmental and socioeconomic information pertaining to the Gulf of Mexico coastal habitats was synthesized for the Minerals Management Service in a series of "Coastal Ecosystem Characterizations." The data bases for these characterizations are now 10 to 20 years old and are in need of being updated. For the proposed offshore oil and gas development to proceed in a timely manner, federal, state, and local agency and private decision-makers need current information on coastal natural resources and processes and socioeconomic infrastructure upon which to base their decisions.

The Minerals Management Service (MMS), in response to the need for an integrated overview of coastal ecosystems, entered into a cooperative agreement with the, U.S. Geological Survey's National Wetlands Research Center (formally a part of the U.S. Fish and Wildlife Service) to prepare a series of "Coastal Ecosystem Characterizations" in areas of the Gulf of Mexico that might be affected by offshore oil and gas development. These characterizations compiled existing information and data by utilizing a holistic approach to identify functional relationships among natural processes and components of coastal ecosystems. The characterization approach is designed primarily to integrate environmental and socioeconomic data in a form useful for planning, impact assessment, and analysis, and to identify research needs. It is a tool that enables decision-makers to address problems including planning for urban and industrial developments, determining corridors for pipelines, siting of onshore and offshore facilities for OCS oil and gas activities and determining priorities for future research.

This Northeastern Gulf of Mexico (study) Coastal Characterization update includes the coastal areas of southeast Louisiana, Mississippi, Alabama, and the Florida Panhandle and focuses on updating the data related to the previous characterizations of area. The existing characterizations (2), the Mississippi Delta Plain Region (southeastern Louisiana and Mississippi) and the Northeastern Gulf of Mexico Coast (Alabama and the Florida Panhandle) are based on data that is now over 15 years old.

## UPDATE

This update centers on the status of data collected for biological resources, socioeconomic features, and the data management aspects of efforts. Other papers in this session address wetlands, seagrasses, and live bottoms. Data searches in Mississippi, Alabama, and Florida are completed. The greatest number of datasets were in Florida. Over fifty were identified that have applicability to the Outer Continental Shelf oil and gas program. The Florida Game and Fresh Water Fish Commission and Florida Department of Environmental Protection were the leading contributors of data. For Mississippi, the Mississippi Automated Resource Information Service and Mississippi Department of Marine Resources supplied majority of data sets (20) with South Alabama Regional Planning Commission and the U.S. Fish and Wildlife Service for Alabama (12 datasets). NWRC is also completing Thematic Mapper (TM) satellite image backdrop for study area. For coastal erosion rates,

there were no digital data so the updated (1989-1995) wetland maps and the 1979 and 1956 maps will be used to produce shoreline erosion data. Shellfish data was supplied by the National Oceanic and Atmospheric Administration Shellfish Program. By mid-1998, data set will be in a data dictionary housed on NWRC's Spatial Data and Metadata Server (<http://www.nwrc.gov/sdms>). The data will either be on the server or hot linked to the agency who has data. Lastly, the wetlands and seagrass data will also be on the server, as well as live bottom report. The project is scheduled for completion in December 1998.

---

Dr. James B. Johnston serves as the Chief of Spatial (Habitat) Analysis at NWRC in Lafayette, Louisiana. Larry Handley serves as a Supervisory Geographer at NWRC. William Jones and Steve Robb are GIS Project Leaders at NWRC's Lafayette, Louisiana and Gulf Breeze, Florida offices, respectively.

## **NORTHEAST GULF OF MEXICO SEAGRASS MAPPING**

Mr. Arturo Calix  
U.S. Geological Survey  
National Wetlands Research Center

The mapping laboratory at the National Wetlands Research Center was originally tasked with mapping the distribution of seagrass habitat in the northern Gulf of Mexico as a result of a joint agreement with the Environmental Protection Agency (EPA). As part of the Environmental Monitoring and Assessment Program (EMAP), the mapping effort became an important baseline information component for a comprehensive estuarine resource assessment.

The original study targeted coastal areas along the Gulf of Mexico from Brownsville, Texas to Anclote Key, Florida. Following the initial aerial photographic data acquisition mission from Chandeleur Islands, Louisiana and points eastward along the gulf, EPA budget cuts and changes in project goals restricted the coverage to areas between Louisiana and Anclote Key, Florida. As a result, the available funding was not enough to include coastal Texas and Louisiana. Interests in seagrass maps and data the project would generate led to the Minerals Management Service and Florida Department of Environmental Protection continuing to fund the mapping and digitizing. In addition, the project could not have been accomplished without the active participation of staff from a host of federal, state, and public entities, including the U.S. Fish and Wildlife Service, National Park Service, Dauphin Island Sea Lab, the National Marine Fisheries Service, and the Gulf Coast Research Lab.

Seagrass habitat communities are considered to be of significant ecological, environmental, and socioeconomical value. Urban development and natural impacts along the coast have produced



changes in these habitats, underscoring the importance of comprehensive assessments and research. The seagrasses are distributed throughout a range of areas under a variety of ecological conditions. The habitats can be described as either continuous or patchy beds of varying species and densities. They are typically found in protected or low-wave energy of relatively shallow waters, behind barrier islands, or estuaries with low turbidity. Seagrass beds are nursery habitat for a host of fish, microorganisms, and invertebrates. Seagrass is also an important food source for waterfowl. The Chandeleur Islands, located along a major migratory corridor for wintering duck populations, are characterized as having some of the most dense and productive seagrass beds remaining along the Gulf Coast. Seagrasses function as a water quality indicator since they show responses to pollutants, algal blooms, and other hydrologic events. Additionally, seagrasses reduce the erosion of valuable sediment by helping to stabilize substrates subject to tidal and/or wave energy. The most commonly found species of seagrasses present in the northern Gulf of Mexico are *Halodule wrightii* (shoalgrass), *Thalassia testudinum* (turtlegrass), *Ruppia maritima* (widgeongrass), *Cymodocea filiformis* (manatee grass), and various macroalgae. The extent and distribution of seagrass habitats are critical for monitoring such a vital natural resource. Producing maps for different periods helps to understand trends and changes in estuarine ecosystems.

The Chandeleur Islands chain is one example of a study area for which habitat changes and trends can be documented using historical and contemporary photographic data. The seagrasses have changed as a result of storm and hurricane impacts to the barrier islands over time. Storm surges cut across the islands at spots of lower elevation, dredging and transporting sediments through the overwashes and burying the grasses behind them. Similarly, development or navigational activities can have impacts to adjacent seagrass habitat. Changes in species distribution or other dynamics of seagrass beds become evident through spatial analysis of mapped data. Spatial analyses of seagrass maps of various time periods enhances our knowledge and provides insight on trends and potential ways to mitigate loss of resources. Understanding the geomorphologic processes and impacts of natural and man-induced activities on important resources is critical to effective management and protection.

The seagrass habitat database will eventually consist of approximately 140 quads mapped at a scale of 1:24,000 covering the coastal habitats from Chandeleur Islands, Louisiana to Anclote Key, Florida. The mapping protocol consists of data acquisition, stereoscopic photointerpretation, cartographic transfer, and digitization in accordance with nationally accepted mapping standards and conventions. Other important aspects of the protocol include the development of a classification system, quality control, and peer review. To date, final maps have been completed for Chandeleur Islands to St. Joseph Bay, Florida (Cape San Blas). Photointerpretation, map drafting, and groundtruthing are currently in progress for Apalachicola Bay through Anclote Keys, Florida. Digital data—ArcInfo (TM) format—is available for Chandeleur Islands through St. Andrew Bay, Florida.

The process begins with the acquisition of large scale aerial photography from which the seagrass habitats can be determined. Natural color emulsion, 1:24,000 scale, flown by NASA-Stennis in 1992 (June and November) is the primary data source. The photography is checked for quality, indexed, cut and prepped, and compiled by area (or estuary) into photo-packs. In most cases, only quads for areas where seagrass is detectable on the aerial photography have been mapped. The

photointerpretation phase consists of development of a classification system and the delineation of the habitats as they are viewed through a stereoscope. The information delineated on the photos is cartographically transferred to basemaps using a Zoom Transfer Scope. Work is checked throughout the process as part of quality control measures and cartographic integrity in accordance with nationally accepted map standards and conventions. The completed quads are tablet digitized. The digital data is maintained by quad (1:24k) and available from NWRC in ArcInfo (TM) format.

The classification system was designed to indicate the presence of either continuous or patchy seagrass. In addition, the shoreline is delineated distinguishing land from either water or seagrass. Land can be defined as any upland, irregularly flooded habitat, or the extent of vegetated (non-seagrass) cover. There are two classes of open water: RIV (riverine, fresh water) and EST (estuarine or marine open water), and five classes of seagrass habitats. In the seagrass category, there are four classes of patchy habitat based on percent ground cover (grass patch versus bare ground), ranging from very sparse to dense: PSG1 (up to 10% - very sparse), PSG2 (15-40% - sparse), PSG3 (45-70% - moderate), and PSG4 (75-95% - dense); and one class of continuous seagrass habitat, CSG (95 to 100% cover). No seagrass density distinction was made in the continuous class. Macroalgae (ALG) was delineated only in those cases where field verification of seagrass habitat resulted in the identification of algae.

Groundtruthing was performed throughout the mapping process. It included the participation of field staff from National Park Service—Gulf Islands National Seashore, U.S. Fish and Wildlife Service, Dauphin Island Sea Lab consortium, Florida Department of Environmental Protection, and other state and federal field offices. Draft maps have been sent out to project sponsors and to staff of many public agencies, academia, and private individuals for review. Digitization of all maps is expected to be completed by early summer of 1998.

---

Art Calix received a B.A. geography 1990 from the University of New Orleans, with an emphasis on cartography and remote sensing as well as Latin American studies. He has been on staff with the Spatial Analysis Branch since 1991 conducting mapping applications toward wetlands research. He has gained extensive knowledge in the classification of landcover vegetation, primarily wetlands and deepwater ecosystems through photointerpretation, field surveying, other remote sensing activities, and geographic information systems technology. Some of the projects he has been involved with include hurricane impact studies, marsh management, wildlife habitat structure, and seagrass mapping. He has conducted field work from Texas to Florida in environments ranging from desert to marine. Art also conducts training workshops in GPS technology, wetlands classification, and photointerpretation.

## NORTHEAST GULF OF MEXICO HABITAT MAPPING

Mr. Lawrence R. Handley  
U.S. Geological Survey  
National Wetlands Research Center

As part of the Northeast Gulf of Mexico Ecological Characterization Update the National Wetlands Research Center (NWRC) was tasked with providing updated wetland and upland habitat maps at 1:24,000 scale for northeastern Gulf of Mexico to aid in the assessment of environmental impacts of permitting, construction of projects, and potential oil spills. The National Wetlands Research Center and the National Wetlands Inventory (NWI) had previously mapped coastal Mississippi for 1956 and 1978, coastal Alabama for 1956, 1978, and coastal Florida for 1956 and 1978 as parts of three ecological characterization projects of the early 1980's. Coastal Alabama was mapped again using 1988 aerial photography as part of a project funded by the U.S. Fish and Wildlife Service, the Alabama Department of Economic and Community Affairs, and the EPA's Gulf of Mexico Program.

The Ecological Characterization Update targeted coastal areas along the northern Gulf of Mexico from the Chandeleur Islands of Louisiana to Cape San Blas, Florida (Figure 2B.1). Color infrared aerial photography was acquired by NASA Ames Research Center at a scale of 1:65,000 for the area in February 1996. The NWRC has duplicated over 1,000 copies of these frames of photography, and has scanned the 189 frames of aerial photography for coastal Mississippi and 100 frames of the photography for coastal Alabama at 300 dots per inch and produced CD-ROMS for the Mississippi Department of Marine Resources and the U.S. Fish and Wildlife Service.

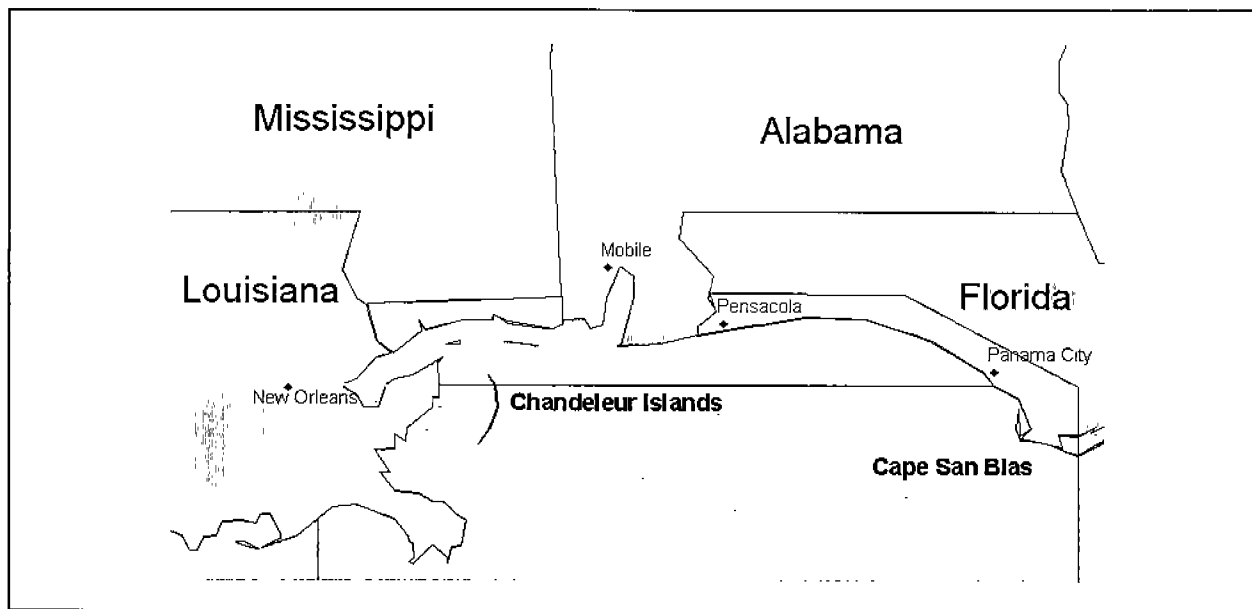

Figure 2B.1. Areas of 1996 Wetland Habitat Mapping Update.

The original intent of the project was to map wetlands and uplands. However, the Minerals Management Service program was limited by the amount of funding available and the cost of mapping. As a result, the 30 quads of coastal Alabama are not being mapped in this project and only wetlands are being mapped for the whole project area.

The wetland habitat database will eventually consist of 84 quads mapped at a scale of 1:24,000 covering the coastal habitats from Chandeleur Islands, Louisiana to Cape San Blas, Florida. The mapping protocol consists of data acquisition, stereoscopic photointerpretation, cartographic transfer, and digitization in accordance with nationally accepted mapping standards and conventions. Other important aspects of the project include the classification system, quality control, and peer review. To date, photointerpretation by NWRC and NWI has been completed for Chandeleur Islands, coastal Mississippi, and Eglin Air Force Base, Florida. Pre-photointerpretation groundtruthing has been conducted for coastal Mississippi and Florida. Map drafting is currently in progress by NWI for coastal Mississippi and the Eglin Air Force Base area of the panhandle of Florida.

The mapping process follows standard operating procedures developed by the NWRC and the NWI. The photography is checked for quality, indexed, cut and prepped, and compiled by area (or estuary) into photo-packs. The photointerpretation phase consists of applying the classification system and the delineation of the habitats as they are viewed through a stereoscope. The information delineated on the photos is cartographically transferred to basemaps using a Zoom Transfer Scope. The base maps for the project are standard USGS 1:24,000 scale quadrangles. Work is checked throughout the process as part of quality control measures and cartographic integrity in accordance with nationally accepted map standards and conventions. The completed quads are tablet digitized. The digital data is maintained by quad (1:24,000) and available from NWRC in ArcInfo (TM) format.

The NWI classification system, *Classification of Wetlands and Deepwater Habitats of the United States*, Cowardin, *et al.* is being used to delineate the wetlands on the aerial photography. Review of the draft maps will be performed with the assistance of the NWRC, NWI and staff from National Park Service-Gulf Islands National Seashore, U.S. Fish and Wildlife Service, Florida Department of Environmental Protection, and other state and federal field offices. Draft maps will be distributed to staff of many public agencies, academia, and private individuals for peer review. Digitization of all maps is expected to be completed by the fall of 1998.

## ECOLOGY OF LIVE-BOTTOM HABITATS OF THE NORTHEASTERN GULF OF MEXICO: A COMMUNITY PROFILE

Mr. M. John Thompson  
Continental Shelf Associates, Inc.  
Jupiter, Florida

### INTRODUCTION

In 1995, M. John Thompson of Continental Shelf Associates, Inc. (CSA) and Dr. William Schroeder of the Dauphin Island Sea Lab Marine Environmental Sciences Consortium were awarded a contract to develop a community profile for live-bottom habitats in the northeastern Gulf of Mexico. The objective of this contract was to summarize the available data on the ecology of offshore (>12 nmi from shore) live-bottom habitats located between Cape San Blas in the Florida Panhandle and the Mississippi River Delta of Louisiana. In this area, live-bottom communities are seen only in association with rock or hard-bottom outcrops. The completed community profile will serve as a reference for both researchers and resource management interest in the northeastern Gulf of Mexico.

### HARD-BOTTOM FEATURES IN THE NORTHEASTERN GULF OF MEXICO

The De Soto Canyon separates the Florida carbonate platform from the mud and clay sediment regimes seen off Mississippi and Alabama. To the east of the De Soto Canyon live-bottom communities are associated with rock outcrops and areas of extensive, but very low-relief hard-bottom that are periodically covered by sand. There are depressions or "solution features" seen in these hard-bottom areas that are the result of aerial weathering of this limestone platform during periods of lower sea level.

To the west of the De Soto Canyon, the outer edges of the continental shelf, and on the upper slope there are a number of trends of reef-like and pinnacle hard-bottom areas. These features appear to be related to similar high relief features seen around the southeastern U.S. They have been studied since the 1930's and are felt to be directly related to the fluctuations in, and rapid rise of, sea levels at the end of the last glacial period (18,000 and 10,000 YBP). They were apparently formed by reef organisms cemented together by calcareous algae. At one time they were active or growing reefs, but these reefs were "drowned" by the rapid rise in sea level as the ice sheets melted (Ludwick and Walton 1957; Ballard and Uchupi 1970; Thompson and Gilliland 1979). The organisms living on these hard substrates today represent new colonization rather than a continuation of original reef community.

Inshore, or slightly behind the shelf break at the head of the De Soto Canyon, areas of rock outcrop composed of a granulated sandstone are seen. These outcrops lie in bands or trends that roughly parallel existing bathymetric contours. Morphology, sedimentary structures, and sediment texture suggest these features are composed of sediments transported to the near shelf edge by riverine

processes during a period of lower sea level (Benson *et al.* in press). Cementing may have occurred during periods of sea level stillstands or short-term reversals in sea level rise.

Less well defined hard-bottom outcrop occurs on areas of the inner Mississippi/Alabama continental shelf where sandstones and mudstones protrude through the surficial sediments. These areas are rare and poorly developed on the Mississippi/Alabama shelf due to the high rates of sedimentation seen there.

#### ECOLOGICAL RELATIONSHIPS OF LIVE-BOTTOM COMMUNITIES

Essentially the type, structure, and distribution of live-bottom organisms seen on hard-bottom outcrops in the northeastern Gulf of Mexico are controlled by three physical factors:

- The location of the community relative to the mouth of the Mississippi;
- The size, relief, and texture or rugosity of the hard-bottom outcrop; and
- Depth and/or light availability.

Colonial invertebrates, such as the scleractinians and gorgonians, that create live-bottom habitats in the northeastern Gulf of Mexico grow slowly and require relatively stable environmental conditions. They are very sensitive to temperature, water quality, and sedimentation. Gittings *et al.* (1992) reported live-bottom community development was poorest in those areas closest to the mouth of the Mississippi River and progressively improved to the east. They suggested that the Mississippi River's plume may chronically influence water quality to a distance of 70 km east of the Delta. They term this the so-called "Mississippi Threshold" (Gittings *et al.* 1992).

The vertical relief of individual hard-bottom features is the single most significant factor influencing live-bottom community development. All of the major live-bottom studies conducted in the northeastern Gulf have demonstrated higher frequencies of occurrence and higher numbers of species with increasing vertical relief. While Gittings *et al.* (1992) pointed out that topographic features do not have to be aerially extensive or exceptionally tall to have well developed live-bottom communities, the highest numbers of species and richest communities were found on those features with the greatest surface area. Community development was more extensive on low-relief features that were part of a series or complex of such features than on isolated low-relief features of the same size. Variability in community development appeared greatest on low-relief features.

Live-bottom habitats are dominated by suspension feeders and sedimentation rates definitively influence community structures. The reduced biotic coverage reported by Continental Shelf Associates, Inc. (1992) around the base of pinnacle structures, along with the increased coverage seen on elevated horizontal surfaces, indicates the role sediment re-suspension and habitat orientation play in the development of these communities in the northeastern Gulf.

Water depth does not appear to play a major role in defining the live-bottom community. Only the coralline algae appear to be depth-limited and have not been reported to occur at depths greater than

78 m. It appears light transmission rather than depth restricts these species. Coralline algae are seen at greater depths farther from the mouth of the Mississippi.

De Soto Canyon is the definitive zoogeographical feature on the Mississippi, Alabama, and northwest Florida continental shelf. The live-bottom communities described by both Shipp and Hopkins (1978) and Barry A. Vittor & Associates, Inc. (1996) near the head of the Canyon are more complex than those described farther to the west, but they represent essentially the same faunal assemblage. To the east of De Soto Canyon both the sediments present and the type of hard-bottom exposed are different. The live-bottom faunal assemblage seen here is more closely related to that seen on the southwest Florida shelf, than to that seen off Mississippi and Alabama.

Nearshore live-bottom communities in the northern Gulf are subjected to relatively high seasonal temperature variations. These communities tend to resemble the warm temperate "Carolina Province" communities described from the eastern seaboard (Briggs 1974; Schroeder *et al.* 1989a,b). Offshore live-bottom communities in the northern Gulf of Mexico have a clear tropical affinity, but are much less diverse than their counterparts living in the southern Gulf of Mexico and Caribbean.

#### REFERENCES

- Ballard, R.D. and E. Uchupi. 1970. Morphology and quaternary history of the continental shelf of the Gulf coast of the United States. *Bul. Mar. Sci.* 20(3):547-559.
- Barry A. Vittor & Associates, Inc. 1996. Biological monitoring of the Destin Dome Block 57 #1 Well Site. Volume XVII *In* Destin Dome 56 Unit Development and Production Plan. Chevron U.S.A., Inc.
- Benson, D.J., W.W. Schroeder, and A.W. Shultz. *In press*. Sandstone hardbottoms along the western rim of De Soto Canyon, Northeastern Gulf of Mexico. *Gulf Coast Assoc. Geo. Soc. Trans.*
- Briggs, J. C. 1974. *Marine zoogeography*. New York: McGraw-Hill. 475 pp.
- Continental Shelf Associates, Inc. 1992. Mississippi-Alabama Shelf pinnacle trend habitat mapping study. OCS Study MMS 92-0026. U.S. Department of the Interior, Minerals Mgmt. Service, Gulf of Mexico OCS Region, New Orleans, LA. 75 pp. + app.
- Gittings, S.R., T.J. Bright, W.W. Schroeder, W.W. Sager, J.S. Laswell, and R. Rezak. 1992. Invertebrate assemblages and ecological controls on topographic features in the northeast Gulf of Mexico. *Bull. Mar. Sci.* 50(3):435-455.
- Ludwick, J.C. and W.R. Walton. 1957. Shelf-edge calcareous prominences in the northeastern Gulf of Mexico. *AAPG Bull.* 41:2,054-2,101.

- Schroeder, W.W., M.R. Dardeau, J.J. Dindo, P. Fleisher, K.L. Heck, Jr., and A.W. Shultz. 1989a. Geophysical and biological aspects of hardbottom environments on the L'MaFla shelf, northern Gulf of Mexico, pp. 17-21. *In* Proceedings Oceans '88 Conference.
- Schroeder, W.W., A.W. Shultz, and J.J. Dindo. 1989b. Inner-shelf hardbottom areas northeastern Gulf of Mexico. *Trans. Gulf Coast Assoc. Geol. Soc.* 38:535-541.
- Shipp, R.L. and T.L. Hopkins. 1978. Physical and biological observations of the northern rim of the De Soto Canyon made from a research submersible. *N.E. Gulf Sci.* 2(2):113-121.
- Thompson, M.J. and L.E. Gilliland. 1979. Topographic mapping of shelf edge prominences off southeastern Florida. *Southeast. Geol.* 21(2):155-164.

---

M. John Thompson is a senior staff scientist with Continental Shelf Associates, Inc. (CSA) located in Jupiter, Florida. He has over 25 years experience conducting marine ecological studies, much of it from the northeastern Gulf of Mexico. Mr. Thompson received his B.S. degree in biology from the University of Tampa in 1969 and his M.S. degree in marine biology from Florida Atlantic University in 1974. Prior to joining CSA in 1980, he was employed by Harbor Branch Oceanographic Institution where he worked in the areas of coral reef and seagrass community mapping and remote sensing.

## **ASSESSMENT OF CHANGES RELATED TO OCS-RELATED PIPELINES, NAVIGATION CANALS, AND MITIGATION**

Mr. Samuel Holder, Jr.  
Minerals Management Service  
Gulf of Mexico OCS Region

Oil and gas production in federal waters of the Gulf of Mexico is known to have generated more than 220 landfalls for pipelines. These pipelines carry materials to and from production platforms. Over the last 10 years, 2 to 25 pipeline landfalls have been installed per year for a yearly average of about 6. The large majority of these pipelines support the central planning area of the Gulf Region and come ashore in Louisiana. The most significant impacts generated by the installation of pipelines result from canals, ponds and spoilbanks that remain after construction is completed .

Navigation canals are also a subject of the study. The past proliferation and continued maintenance and use of navigation channels that provide transportation routes for traffic supporting the OCS Program have also caused similar impacts around the coast.



Adverse impacts of pipelines and canals vary broadly among coastal regions. These variations primarily depend upon the soils, hydrodynamics, topography, use and construction methods. Variations in the permit requirements of regional and state agencies have also caused some regional variation of impacts. The extent and nature of these impacts have long been studied and energetically debated among the academic, regulatory, environmental and commercial communities. Offshore oil and gas production programs of the states and federal government have received considerable criticism for impacts to wetlands around the Gulf.

The Minerals Management Service and the Biological Research Division (BRD) of the U.S. Geological Survey have initiated a study to compare the variability and extent of canal impacts among geologically distinct regions of the western and central planning areas of the Gulf of Mexico. The study will also compare results and longevity of techniques used to mitigate adverse impacts to document regional effectiveness. This analysis will provide insights into improving the effectiveness of workable mitigation techniques and into the development of new techniques that can be used in regions where existing mitigation techniques have not been adequately successful.

The study will be restricted to the coastal zones of Texas, Louisiana, Mississippi and Alabama. These regions will be divided into the geologically distinct regions or coastal subareas that exist there. Initially, these regions are thought to be the lower Texas coast south of the Bolivar Peninsula, Cheniere Plain, Mississippi Deltaic Plain, and the Mississippi-Alabama Coast.

OCS-related pipelines, pipeline canals, and navigation canals found inshore for the mid-1950s, late 1970s, and early 1990's will be identified and loaded into a geographic information system (GIS). Using the GIS and the BRD-digitized habitat maps, the length, area and type of OCS-related canals and spoil banks will be documented and mapped showing changes during each of these periods.

From this collection of data, researchers will identify primary and secondary impacts of pipeline and navigation canals and their progressions upon various coastal habitats. Distinctions will be made for each coastal subarea or distinct geo/physiographic area around the Gulf.

The study will also identify mitigation techniques used to reduce adverse impacts to wetlands by pipelines, canals, dredging, and dredged-material placement. The effectiveness of those techniques will also be evaluated to identify the reasons for effectiveness and failure in various geo/physiographical areas around the Gulf.

The findings of the study will not be limited to the opinions of the MMS and BRD. The views of state and Corps of Engineers permit analysts, other agency personnel, private land owners, academic and industry personnel involved with canal permitting and mitigation will be taken into consideration. Any new techniques for possible mitigation that are identified for a habitat type or distinct geo/physiographic area around the Gulf will be discussed. Modification of older mitigative techniques or their applications may also be explored.

---

Samuel W. Holder, Jr., received a B.S. degree in biology from Southeastern Louisiana University and a M.S. in biology from the University of New Orleans. Since 1991 he has been a natural resource specialist for the Minerals Management Service for which he documents and describes OCS-related impacts on coastal habitats of the northern Gulf of Mexico. Prior to that, he assisted the administration of the Jefferson Parish Coastal Management Program, assisted permit applications and public notices, and monitored industrial discharges for Jefferson Parish, Louisiana.



## SESSION 2C

### SOCIAL AND ECONOMIC STUDIES

Co-Chairs: Dr. Harry H. Luton  
Dr. Joanna Endter-Wada

Date: December 16, 1997

Presentation	Author/Affiliation
Introduction: Study Directions in the Gulf of Mexico since 1992	Dr. Harry Luton Minerals Management Service Gulf of Mexico OCS Region
A Socioeconomic and Environmental Issues Analysis of Oil and Gas Activity in the Outer Continental Shelf of the Western Gulf of Mexico	Dr. William R. Kelly University of Texas at Austin
Issues and Attitudes Toward OCS Development in Florida	Dr. Dallas A. Blanchard The University of West Florida
Baseline and Projection of OCS Effects for the Florida Panhandle	Dr. Eric S. Schubert Research and Planning Consultants Dr. C. Hobson Bryan University of Alabama - Tuscaloosa Dr. Raymond Burby University of New Orleans Dr. F. Larry Leistritz North Dakota State University Dr. Steve H. Murdock Texas A&M University
Sustainable Development in Oil and Gas Country: a Case Study of Abbeville, Louisiana	Dr. Deborah Tootle Dr. Charles Tolbert Dr. Edward Shihadeh Department of Sociology and Rural Sociology and The Louisiana Population Data Center Louisiana State University

Recent Effects of OCS Activities on Port  
Fourchon

Mr. Ted M. Falgout  
Port Director, Greater Lafourche Port  
Commission

Assessing the Impact of Growth in the Deep  
Water Oil Industry on the Economy of and  
Public Service Provision in Lafourche Parish  
Louisiana

Dr. Walter Keithly  
Coastal Fisheries Institute  
Louisiana State University  
Dr. David W. Hughes  
Mr. Matthew Fannin  
Dr. Jiemin Guo  
Department of Agricultural Economics  
and Agribusiness  
Louisiana State University

Migration and Commuting in Louisiana's  
Coastal Areas

Dr. Joachim Singelmann  
Departments of Sociology and Rural  
Sociology  
Louisiana State University

## **INTRODUCTION: STUDY DIRECTIONS IN THE GULF OF MEXICO SINCE 1992**

Dr. Harry Luton  
Minerals Management Service  
Gulf of Mexico OCS Region

A decade ago, when I was starting my job as the Social Science Coordinator at our Headquarters office, this region exhibited a real reticence to conduct social and economic research. The reasons were understandable. First, MMS has an applied research program. The first questions states and concerned individuals raised about the OCS program focused on biology, endangered species, oil spills, muds and cuttings, and the like. People were not asking questions about the program's social and economic effects. The MMS directed its limited research dollars toward issues that matter to people, and answering these non-social questions proved to be quite expensive.

Second, the MMS studies program was successful at doing what it was doing. Part of the inertia related to personnel. The MMS was staffed to procure fish studies, not fishermen studies. There were enough people working for MMS to conduct biological research and to apply its results. There were a lot fewer social scientists.

A third reason had to do with a certain reticence about conducting socioeconomic studies. Again, some of this reticence came from staffing, specifically, from academic rivalries. To a biologist, sociology looks like a "soft" science. The subject matter of social science and many of the issues it raises can look messy to managers. Yet, even this reticence had merit. The question managers most often asked comes from MMS's legal mandate (to regulate activities in the OCS but not activities on land). What good is socioeconomic information if the agency can't do anything about it?

The studies program in the GOMR has been changing because questions raised by the states, our science committee, and others have changed. The studies that follow are some of the first fruits of change in MMS's thinking about the relevance of social and economic research.

## **A SOCIOECONOMIC AND ENVIRONMENTAL ISSUES ANALYSIS OF OIL AND GAS ACTIVITY IN THE OUTER CONTINENTAL SHELF OF THE WESTERN GULF OF MEXICO**

Dr. William R. Kelly  
University of Texas at Austin

### **STUDY GOALS**

Minerals Management Service (MMS) seeks better to understand the issues related to oil and gas activity in the OCS of the Western Gulf of Mexico (WGOM) by assessing the concerns, fears, hopes, expectations and values of the public regarding oil and gas activity in potentially impacted areas, with a specific focus on the socioeconomic and environmental issues associated with oil and gas activity in the WGOM.

More specific goals include. (1) to better understand the nature, extent and evolution of these issues/concerns, (2) to better understand the relation between these issues/concerns and particular stakeholder groups, and (3) facilitate communication between MMS and stakeholder groups.

### **METHODS**

This research included a literature review and a survey of stakeholders.

#### **Literature Review**

The researchers conducted extensive searches of over fifteen electronic data bases and of state, federal and university resources. This review identified approximately 100 books, articles and reports as directly relevant to this research. The review and evaluation of these sources indicated that the questions posed by this MMS Statement of Work have not be systematically and rigorously addressed to date. The available materials either lacked sufficient substantive focus or had a different geographic focus. For this reason, the research findings rely primarily on the stakeholder survey.

#### **Stakeholder Survey**

The research design was qualitative, based on face-to-face personal interviews. Researchers used an open-ended discussion guide, which permitted flexibility for elaboration and perspective. Respondents represent a mix in terms of geographic location and sector of the economy, thus providing a variety of perspectives.

**Primary Sampling Units:** The primary sampling units were counties proximate to the Texas Gulf Coast. Demographics and economic profiles were used to select primary sampling units. Selection criteria included historic and current reliance on oil and gas industry; type of involvement in oil and gas industry; economic diversity; size; urbanity/rurality; and, location on the Gulf Coast.

Counties included: Aransas (primarily rural); Galveston (Galveston); Harris (Houston); Jefferson (Beaumont/Port Arthur); and, Nueces (Corpus Christi).

Respondents: The sample of respondents include community leaders in three sectors, business (Chambers of Commerce), government (state, county and local) and environmental organizations (Sierra Club, Audubon Society, etc.)

Sampling Strategies: Initially, researchers interviewed state senators and experienced local newspaper editors. They also identified potential respondents from the Texas Coastal Management Program (TCMP) database of over 4,000 names and affiliations. Researchers then developed a snowball sample that combined names from the TCMP database with referrals from state senators, local media and respondents.

Sampling Frame: Interviews were relatively evenly distributed across the five counties and the three categories of respondents (business, government and environmental organizations). A total of 39 personal, face-to-face interviews were conducted by Dr. Nancy Bell, a University of Texas post-doctoral fellow specializing in qualitative data collection. Interviews were conducted between March and June, 1997 and averaged one hour in length (range of 25 minutes to over 2 hours). As is standard of snowball sampling, the cutoff criterion was convergence/repetition of information. Approximately 60 hours of recorded interviews were transcribed and analyzed by topic, by respondent type and by geographic location.

### KEY SEARCH QUESTIONS

Questions that guided the research included:

1. the degree of dependence on the oil and gas industry;
2. perceived benefits received from communities involvement in or proximity to oil and gas activities;
3. local concerns about the presence of oil and gas industry along the Texas Gulf Coast;
4. local perception of the industry, including the quality of communication between industry officials and the local community; and,
5. the appropriate role for the federal government (MMS) to play with regard to local oil and gas issues.

### KEY RESEARCH FINDINGS

1. **Reliance on Industry:** The post-1980s economic strategy appears to be one of cautious reliance on oil and gas and recognition that long-term vitality requires adding to the economic mix (e.g., tourism and high technology). Economic diversification does not mean



lack of dependence since most areas are still heavily dependent on the industry, especially port cities.

2. **Perceived Benefits from the OCS Industry:** These include employment directly in the industry and indirectly in support services and in businesses supported by industry (e.g., retail, real estate, etc.); direct and indirect tax revenue from property taxes, sales taxes, and ad valorem taxes; and, tax revenues from support services.

Local schools are viewed as an important recipient of these tax monies. Also, the community involvement of OCS-related industries was noted, particularly charitable giving and volunteer time. The benefits of community involvement vary by location. Some view it as “good PR” and note declines in recent years. Comments on this benefit were absent in interviews from Nueces County. Other benefits included a positive effect on real estate values and tourism/recreation. Overall, perceived benefits appear to outweigh perceived risks.

3. **Concerns about the Industry:** By far, the primary concerns were environmental. These included transport spills from tankers, pipelines and rail, the effects of refining and petrochemical production, and concerns about air, water, and soil pollution. Some noted that the situation has improved. Environmental racism is an emerging issue and beach pollution also is noted. These were issues at Galveston, Port Aransas, Corpus Christi where issues of tar and trash on the beach were raised. The situation has improved but requires further improvement (e.g., more cooperative relationships, “voluntary compliance”). “Grandfathering” and other circumvention of environmental regulations is viewed as a significant problem.
4. **Other Concerns about the Industry:** Automation, downsizing and use of contract labor are perceived to have reduced employment with consequences for poverty, real estate and crime. Uncertainty and vulnerability due to reliance on industry (volatile industry and globalization) are issues which further underscore the need to diversify. Health and safety concerns due to proximity to plants were raised.
5. **Location Specific Concerns and Conflicts:** Two location-specific issues were identified, tax challenges in Jefferson County and water supply problems in Nueces County.

#### KEY RESEARCH FINDINGS INVOLVING THE RELATIONSHIP BETWEEN INDUSTRY AND COMMUNITY

Perceptions about the relationship between the OCS industry and the community vary. Government and business leaders in industry-dependent areas tend to believe that relations and communications are good. They often note their good working relationships and the cooperative relationships that exist. They view the industry as a good community partner. Trust is high.

Perhaps the biggest finding is that OCS issues are not big issues. There were few stakeholder groups that exhibited a single focus or pervasive involvement in these issues. Stakeholder issues cross-cut those interests and constituencies.

## ISSUES AND ATTITUDES TOWARD OCS DEVELOPMENT IN FLORIDA

Dr. Dallas A. Blanchard  
The University of West Florida

The University of West Florida team is behind schedule. The team has concentrated on the literature review, the digesting of those materials, the planning for Focus Groups and Key Informant interviews, and the conduct of the initial Focus Groups and Key Informant interviews.

### REVIEW OF LITERATURE

Sources used for the literature review have included the “standard” materials such as MMS Reports and works cited therein. Additional sources sought have included a Library of Congress subject search and a NEXIS newspaper search. The NEXIS search is renewed periodically to determine more recent articles. The bibliography now totals more than 200 single-spaced pages.

Outcomes planned from this review are:

6. An annotated bibliography with stress on socioeconomic/cultural factors,
7. An exhaustive list of potential concerns and interests, and
8. The development of hypotheses of interests and concerns based on socioeconomic/cultural profiles and historical factors.

### SOCIOECONOMIC PROFILE OF EASTERN GULF COAST REGION COUNTIES (*In Process*)

The study’s goals in establishing the socioeconomic profile of Eastern Region counties are to:

1. Establish “natural” socioeconomic/cultural common areas (following the example of Howard Odum’s research),
2. Develop hypotheses specific to the Eastern Gulf Coast Region which delineate areal interests and concerns and types of areal organizations concerned/interested. The team expects delineation of “natural” areas to be refined as the research proceeds. For example, the team now perceives there to be six major ecological/cultural regions: Gulf Shores, AL, to Mexico Beach/Carabelle, FL (white sands/tourism interest dominate), Mexico Beach/Carabelle to Cedar Key (commercial fishing/oystering), Cedar Key to Weeki Wachee (off-coast

tourism/fishing), Weeki Wachi to Naples (industrial/commercial & recreational fishing/tourism), Naples to the Keys, and the Keys (commercial and recreational fishing/tourism).

The team has found that there are significant distinctions in interests and concerns within these areas and expect more as the research progresses,

### CULTURAL RESEARCH PROCEDURES

The team has begun developing the procedures for determining environmental concerns and how those relate to basic cultural worldviews. The stress in this phase is on cultural meanings and the sources from which they arise.

For example, the team found distinct differences within Region I. While we have found a few groups and persons taking positions both for and against off-shore activities based on rational analysis of the larger issues, positions not based on personal concerns but based on perceived national and international needs and interests, more frequently we found that most groups and individuals take positions based on intensely personal and limited self-interests.

Distinctions we have found within Regions I and II include:

1. Attitudes depend on the degree and type(s) of social organizations.

For example, Destin, Gulf Shores, and Pensacola Beach have a number of condos with permanent residents and resident associations. Panama City Beach has few, mostly motels and appeals primarily to short-term residents. Thus, as one moves from Gulf Shores to Panama City, opposition to off-shore drilling and activities decreases dramatically.

Apalachicola has virtually no tourism and a primary interest in near-shore oystering and fishing. Thus, persons and organizations there perceive off-shore activities as non-threatening and of little concern.

2. Attitudes vary by the type of tourism, if any, now being serviced and types desired for the future.

Gulf Shores, Perdido Key, Pensacola Beach, and Destin seek longer term visitors, such as "snow birds," and have more intense concerns about drilling. Panama City beach has primarily short-term visitors (spring breakers, e.g.) and much less concern.

3. Attitudes vary by the proportion of permanent residents.

Permanent residents have more intense concerns about drilling, are more involved in social organizations.

4. Attitudes vary by the political context.

Alabama vs. Florida: In Baldwin County Alabama those concerned about drilling perceive county and state political structures as weakly supportive of their concerns and interests. Florida, to date, appears to have more unified political support at county and state levels for limiting drilling within 100 miles of the shore.

5. Attitudes vary by type(s) of accommodations available to tourists.

Single family rentals and condos vs. motels. The former have not only a larger proportion of permanent residents, they also have a larger proportion of long-term tourists, such as “snow birds” spending the major portion of their home area winter in Florida.

6. Attitudes vary by historical experiences with off-shore activities.

The Gulf Shores area has witnessed considerable State of Alabama leasing and drilling, both off-shore close to land and inside Mobile Bay. These experiences added to their desire to appeal to upper class tourists and new residents issue in an intense opposition to any off-shore activity. They have even introduced zoning regulations to prevent any off-shore support services from locating in their community.

#### FOCUS GROUP MEETINGS

Focus Group meetings are being held in key communities of a representative sample of interests and concerns. Procedures employed are:

- a. Interview Key Informants by phone
- b. Interview additional informants (from Key Informant calls)
- c. Develop list of interest groups and organizations
- d. Determine representative sample of perspectives for Focus Group inclusion

The chronology employed has been to begin at Western bounds, then move east and south--to maintain areal commonalities and highlight distinctions between and within them.

Focus groups have been conducted in areas I and II:

- a. Gulf Shores, AL
- b. Pensacola-Santa Rosa County
- c. Ft. Walton Beach-Destin
- d. Panama City
- e. Apalachicola

Based on experiences in these focus groups, in the future two focus groups will, when practicable, be conducted at each site, separating proponents and opponents of off-shore activities. We have

found it a “time killer” having both groups present when either or both stances have strong representatives, for it is virtually impossible for the facilitator to maintain control of the discussion and hold the participants to our objectives rather than their own agendas.

At present we expect to conduct future focus groups as follows:

- a. Tallahassee (concentrating on statewide organizations and interest groups)
- b. St. Marks
- c. Cedar Key
- d. St. Petersburg
- e. Tampa
- f. Sarasota
- g. Fort Myers
- h. Naples
- i. Key West

This progression and the specific sites are subject to revision as we gather additional information.

### **BASELINE AND PROJECTION OF OCS EFFECTS FOR THE FLORIDA PANHANDLE**

Dr. Eric S. Schubert  
Research and Planning Consultants

Dr. Raymond Burby  
University of New Orleans

Dr. C. Hobson Bryan  
University of Alabama - Tuscaloosa

Dr. F. Larry Leistritz  
North Dakota State University

Dr. Steve H. Murdock  
Texas A&M University

The MMS, in its most recent Five-Year Plan (1997-2002), stated its intention to lease an area for development in the western edge of the Eastern Planning Area of the Gulf of Mexico in the year 2001. Because the experience of Texas and Louisiana has indicated substantial social and economic impacts onshore from Outer Continental Shelf (OCS) activity, the MMS wanted to investigate the potential impacts on affected communities in the Eastern Gulf of Mexico.

The purpose of this study is to develop a projection of the effects of this potential offshore activity on the Florida Panhandle. The MMS asked the RPC team to develop a baseline socioeconomic description for Panama City, Pensacola, and Ft. Walton Beach and to develop projection models to investigate the possible socioeconomic consequences of various onshore support scenarios on these communities. The project includes studies on four local industries that could be impacted by the

operations of a support base in the Florida Panhandle: fishing, military, ports, and tourism. The project also analyzes possible user-conflicts or benefits that these industries might encounter with the operations of the support base located in the Florida Panhandle.

The RPC team defined the study area in the Florida Panhandle as the five counties of Escambia, Santa Rosa, Okaloosa, Walton, and Bay. Escambia and Santa Rosa comprise the Pensacola metropolitan area, Bay County comprises the Panama City metropolitan area, and Okaloosa and Walton Counties comprise the Fort Walton Beach metropolitan area.

As part of our investigation, we identified and reviewed the literature relevant to the locales and issues addressed in the study. The literature reviews focused on the four special industries and the socioeconomic impacts from offshore oil and gas development. The RPC team gathered historical and projected economic baselines from two sources: Bureau of Economic and Business Research at the University of Florida at Gainesville and the U.S. Bureau of Economic Analysis. Using field trips and phone calls, the RPC team collected primary data in the form of selected stakeholder interviews with representatives of the four industries, local, county and state government officials and local community and business leaders. In speaking with stakeholders, we focused on the issue of a support base rather than oil and gas exploration in general.

The RPC team is constructing an economic-demographic model to project the impacts of OCS activity in the Florida Panhandle. The MMS hopes to distribute this model to stakeholders and government planners in the Florida Panhandle to provide estimates of impacts supported by our research.

The Florida Panhandle will continue to experience the substantial demographic and economic growth that it now faces. The five county area contained 643,000 people in 1990 and is projected to have nearly 876,000 residents by 2010. In an average year in the 1990s, 7,400 people migrated to the Florida Panhandle. This migration has started to cause strains in the infrastructure, particularly in the Ft. Walton Beach metropolitan area. These infrastructure bottlenecks could get worse, as projected average annual migration will exceed 6,000 people through the year 2010.

The military has had a substantial presence in the Florida Panhandle since World War II. The four main military installations in the study area are the Pensacola Naval Air Station, Eglin Air Force Base (Fort Walton Beach), Tyndall Air Force Base, and the Coastal Systems Station (both in Panama City). The three air bases use the Northern Gulf of Mexico as a weapons testing and training range. The Coastal Systems Station uses St. Andrew's Bay and the nearby waters of the Gulf of Mexico for testing and training in antisubmarine and underwater warfare. The military employs over 30,000 people in the Florida Panhandle economy, accounting for 8.6 percent of all non-farm employment in 1995, compared with only 1.5 percent in the United States as a whole. These bases were largely untouched by the downsizing of the military in the 1990s and are expected to remain an important part of the Florida Panhandle economy for the foreseeable future.

Tourism in the Florida Panhandle began in the mid-1930s and grew rapidly after the Second World War, becoming what is now a key industry. Traditionally a place in the "Old South" to go for swimming and fishing, the Florida Panhandle is often called the "Southern Riviera."

"Sugar-white" beaches, fishing, other water-based activities, and natural habitats are key parts of the tourist experience in the Florida Panhandle, a type of tourism known as ecotourism. In the mid-1990s, the area annually attracted 10 million visitors who generated \$1.5 billion of business. Heavily visited by automobile traffic, the Florida Panhandle represents one of the few high quality beach areas available to many visitors in the southeastern U. S., with high proportions coming from Alabama, Arkansas, Louisiana, Mississippi, and Texas.

The study area has two major deepwater ports that would make the best locations for an onshore support base in the Florida Panhandle - the Port of Pensacola and the Port of Panama City. While the Port of Pensacola has a history extending back into the nineteenth century, the present-day location of the Port of Panama City opened only after World War II. The ports of Pensacola (ranked 78th) and Panama City (ranked 62nd) in 1995 were among the top 100 U.S. ports in the dollar value of goods exported. They ranked 120th and 100th, respectively, in the value of imports. The Port of Panama City served as an onshore support base for exploratory drilling in the Gulf of Mexico in the early 1980s and in 1990 and has an adjacent industrial park that houses industries associated with offshore oil and gas industry.

The commercial fishing industry employs around 700 people in the Florida Panhandle. In 1995, fishermen in the area landed 8.9 million pounds of fish and 2.4 million pounds of shellfish.

The projected levels of OCS development and production from the proposed leases in 2001 are small compared to the projected production levels from leases in the Western and Central Gulf of Mexico scheduled for auction in 1997-2002. Because the specialized needs of offshore exploration and production are likely to occur from states with established services such as Texas, Louisiana, and Alabama, expansion of offshore facilities and services into the Florida Panhandle likely would come in the form of an onshore support base that would service offshore platforms during the operation and maintenance portion of any offshore oil and gas development. This means that the potential impacts likely will be of a different form than often associated with oil and gas development and that direct socioeconomic impacts likely will be smaller than those that have occurred in the Western and Central Gulf of Mexico.

Though a small onshore base in the Florida Panhandle would cause few direct user-conflicts with the tourist industry, stakeholder views of the impacts of OCS development on tourism will result as much from perceived reality as from the evolution of actual events. Because tourism in the area is largely based on the aesthetics of the environment, environmental issues likely will dominate any debate on the benefits and costs of OCS development. The major threats likely to be perceived from OCS-related activity are environmental. Stakeholders in tourism and related industries in the Florida Panhandle fear that such development could depreciate the aesthetic or use quality of beaches, of coastal waters, and of fish and other wildlife.

The two ports would benefit from housing an onshore support base. The Coastal Systems Station expressed a concern that a high level of supply boat traffic from the Port of Panama City might interfere with its operations. The air bases would have potential conflicts with supply boats and helicopters crossing their testing ranges, but stipulations in any oil leases in the Eastern Gulf of Mexico puts the onus of these conflicts on the oil industry. Though the commercial and recreational fishing industry have well-known benefits and conflicts with offshore rigs in the Gulf of Mexico, our research did not uncover any major user-conflicts with onshore bases that would be located in one of the two ports.

Operations and maintenance (O&M) activity from the developed wells in the Eastern Planning Area will generate tens of millions of dollars of sales of goods and services for an onshore base each year. If an onshore service base were located in the Florida Panhandle, however, many O&M supplies would have to be imported from outside the region, limiting the potential economic benefits to the Florida Panhandle.

Even though the level of OCS-related increases in employment would be small given the projected size of an onshore support base, because the Florida Panhandle is projected to be at or near full employment, those jobs not taken by commuters from outside the Florida Panhandle would require additional net immigration into the area. Our preliminary estimates suggest that the project might increase the population of the area by 0.10% to 0.25% of the baseline population in 2010, or much less than one year's projected immigration under baseline conditions. Infrastructure impacts on local communities from OCS development also will be small in comparison to such impacts from projected economic growth in the baseline.

Few economic incentives are present to drive OCS support industries into the Florida Panhandle at the projected levels of OCS development in the Eastern Gulf of Mexico because support bases are most efficient when close to offshore wells. Concerns among stakeholders in the area's tourism industry about the risks of offshore oil and gas production have lent support to the Governor of Florida's public position that the federal government should not sell new oil and gas leases in Florida federal waters within one hundred miles of the Florida coast. If made law, this restriction would limit future appeal and opportunities for onshore OCS-related industry in the Florida Panhandle.

---

Dr. Eric S. Schubert has been an economist with Research and Planning Consultants since 1993. He has bachelors, masters, and doctoral degrees in economics from the University of Illinois at Urbana-Champaign. While at RPC, Dr. Schubert has developed regional input/output models for impact assessment and forecasting on projects in Alabama and Florida and has regularly worked on projects involving regional economics in Florida.

Dr. Hobson Bryan presently serves as Professor of Sociology, Department of Geography Regional and Urban Planning Program at the University of Alabama - Tuscaloosa. His teaching, research and consulting have included social impact assessment and policy analysis, with projects involving the



social consequences of alternative resource. He has authored over 80 publications in the fields of natural resource management, social assessment and social impact analysis.

Dr. Ray Burby presently is the DeBlois Chair in Urban and Public Affairs and Professor of Urban and Regional Planning, University of New Orleans. Dr. Burby's professional experience includes five years as the co-editor of *Journal of the American Planning Association*. Dr. Burby is the author of 12 books and over 100 chapters, articles and monographs in the planning, management and environmental management fields.

Dr. F. Larry Leistritz is a Professor of Agricultural Economics at North Dakota State University. Dr. Leistritz has over 25 years experience in socioeconomic impact assessment research and practice. His research and assessment experience has focused on socioeconomic impacts of resource and industrial development in rural areas. He has made presentations at conferences around the world and has authored 11 books and more than 100 journal articles and book chapters dealing with impact assessment.

Dr. Steve Murdock is Professor and Head, Department of Rural Sociology, Texas A&M University, as well as Chief Demographer, Texas State Data Center, State of Texas. Dr. Murdock is the author of 9 books on the determinants and consequences of demographic and social change and of over 100 technical articles and book chapters on the demographic and social impacts and implications of resource development and environmental. He has extensive experience in the conduct of socioeconomic assessments of the Gulf Coast Region and has served on the OCS Scientific Advisory Committee for the Environmental Studies Program of the Minerals Management Service.

## **SUSTAINABLE DEVELOPMENT IN OIL AND GAS COUNTRY: A CASE STUDY OF ABBEVILLE, LOUISIANA**

Dr. Deborah Tootle  
Dr. Charles Tolbert  
Dr. Edward Shihadeh  
Department of Sociology and Rural Sociology  
and  
The Louisiana Population Data Center  
Louisiana State University

### INTRODUCTION

The Abbeville study, begun in 1997, was inspired by previous work on the impact of the expansion and decline of oil and gas activity in Louisiana coastal communities. In the course of their research, Charles Tolbert and Edward Shihadeh at Louisiana State University identified a community that was heavily involved in offshore oil and gas activity but did not show the typical patterns of income

volatility associated with oil and gas development. Rather, the local economy appeared to be sustainable throughout the cyclical activity of offshore oil and gas activity. This community is the city of Abbeville, a city of 12,500 in coastal (and rural) Vermilion Parish. Abbeville is situated on the Vermilion River and is 20 miles from the Gulf of Mexico. The Vermilion transects the Intracoastal Waterway at Intracoastal City (which has an Abbeville post office address) and empties into the Vermilion Bay along the Gulf Of Mexico.

Unable to explain their findings with existing macro- or micro-level data sources, we decided to conduct a multi-method case study of Abbeville. Case studies are particularly useful methodologies for understanding community level events. Our methodology centered around the use of field research for gathering detailed information in a specific location. Field research is a long-standing and highly significant, but often overlooked, tradition in the social sciences. However it is one of the most effective means of collecting data that reflect social relationships and processes at the community level (Orum, Feagin and Sjoberg 1991).

One of the major advantages of using a field study methodology is that it involves the collection of data from various sources and covers numerous time periods, allowing for comprehensive analysis. The findings of this study will be useful to other coastal communities because it will provide insights into the social structures and social processes that contribute to sustainable, as opposed to volatile, economic development. We are in the process of expanding the study somewhat because of the recent closing of the Fruit of the Loom plant in Abbeville. Fruit of the Loom has been a major employer in the community and we want to see what effects its closure has. It may be possible that the oil and gas industry may offset some of the loss. Therefore, we are presenting some preliminary findings.

#### FOUNDATIONS OF ECONOMIC SUSTAINABILITY

The most obvious explanation for Abbeville's apparent sustainability is simply that Abbeville and the surrounding area was not dependent on oil and gas and therefore not seriously affected by the expansion and contraction of oil and gas activity. However, data from various sources showed this was not the case. We compared data from the 1980 and 1990 decennial censuses on employment in mining for Vermilion, St. Mary and Iberia Parishes. In 1980, 15.1 % of the workers in Vermilion Parish were employed in mining compared to 10.2 % in St. Mary and 14.2 % in Iberia. By 1990, 12.6 % of the work force in Vermilion Parish were employed in the mining industries, compared to 8 % in St. Mary and 10 % in Iberia Parishes. Although these data only reflect those workers employed in mining industries per se, and do not include workers in oil and gas-related fabrication and services, they do show that Vermilion Parish was seriously involved in oil and gas activity during the past decade.

Vermilion Parish and Abbeville became involved in the early stages of oil and gas activity in Louisiana. As early as the 1950s, the newspaper in Abbeville was reporting on the importance of the oil and gas industry in the Parish. The week of 15 October 1950 was declared Abbeville Oil Progress Week by the presiding mayor of Abbeville. And because of major oil operations in the area, the local community already perceived a need for deep water channel from the point where the Intracoastal

Canal intersected with Vermilion River. In 1950, the first contract for a pipeline from the Gulf coast into the Gulf was awarded; this pipeline extended from Vermilion-Cameron coast to Pure Oil Co. gas wells (Abbeville Meridional 1950).

A plausible explanation for the sustainability of Abbeville's economy is related to industrial diversity. Set in non-metropolitan Vermilion Parish, Abbeville is essentially a rural economy, which depends largely on resource-based and manufacturing industries. In recent years, rural economies have become less dependent on agriculture and tend to specialize in low-wage manufacturing and service sector jobs. They also tend to be dominated by a single industry (such as mining, or textiles manufacturing). Specialization tends to leave them vulnerable to business cycles and foreign competition. However, diversified rural economies are more stable and produce more consistent economic growth, and they can weather sharp economic downturns.

Another possible explanation for Abbeville's resilience relies on social resources. Social capital is a system of reciprocal expectations and obligations generated within systems of dense social relationships. Many researchers (Putnam 1993) feel that social capital can bolster the economic performance of a community and therefore cushion the effects of sharp economic downturns. The research literature indicates that the relationship between social characteristics and sustainable communities is complex. First, sustainable development involves changing perceptions and making local decisions about social resources and economic activity (Shaffer 1995). The ability to diversify a local economy depends on local labor force; social resources embodied in demographic attributes and human capital influence types of economic activity in which a community may participate (Flora, *et al.* 1992). In some cases, social relationships can counter the destabilizing effects associated with economic development and restructuring (Lobao and Schulman 1991). Economic and political actions that are embedded within dense networks of social relationships are more efficient than those that are not (Granovetter 1985) and communities where there is a high level of participation in voluntary organizations tend to be economically successful (Putnam 1993). Social capital enables local actors to mobilize economic resources when needed (Beaulieu and Ryan 1984). Because social capital can bolster the performance of a local economy (Putnam 1993), it may help to cushion the effects of sharp economic downturns, such as those associated with oil economy in the 1980s. Abbeville is part of Acadian Louisiana, where dense social relationships (i.e., extensive kinship networks) are the norm.

There has also been a great deal of work (in urban communities) showing that geographic dispersion of social characteristics plays an important role in generating economic opportunities. Communities where negative social characteristics are concentrated in particular areas are more vulnerable to social and economic disruption. Neighborhoods in Abbeville appear to be relatively integrated, both socially and economically.

## METHODOLOGY

Our methodological approach consists of a multilevel, multimethod study that includes document and historical study, and use of qualitative and quantitative techniques. We have not yet completed the quantitative portion of our study, in which we are using small-scale demographic techniques to

examine the geographic dispersion of social characteristics. We are therefore only presenting the methodology and findings from the more qualitative portion of our study. Our qualitative data collection technique consists of an approach referred to as “guided conversations” (Lofland and Lofland) in which we met with respondents in person and asked them to discuss specific topics relating to the study, such as how families in Abbeville responded to economic downturns. Each respondent was asked to address the same basic set of topics, but we also remained flexible and would address new issues as they emerged.

In community studies, investigators often use nonprobability sampling designs. A nonprobability sample is legitimate, and often preferable to probability sampling in small studies, especially where the probability of selecting an element from the universe is unknown, such as when the universe consists of respondents who are knowledgeable about a particular issue. In many community studies, investigators use snowball sampling, a process in which the investigators begin with an initial list of key informants and subsequently ask each informant to name another person (or persons) that is knowledgeable about the issue in question. A problem with using the snowballing technique is that it can compromise the internal validity of a study if snowballing does not lead to a diverse enough group of respondents. To avoid this problem, we relied primarily on another type of nonprobability strategy, the purposive sample, and incorporated elements of systematic selection into it where possible.

We are interested in talking with people who were knowledgeable about local economic development, and oil and gas activity, as well as civic and community responses. Therefore, we wanted to talk with oil and gas stakeholders, the local business community, and local community and civic leaders. We constructed a frame for a nonprobability sample from existing lists of stakeholders; we used phone, city and parish directories and membership lists. Oil and gas stakeholders, and members of the business community were pulled from Yellow Page listings and the membership lists of the Greater Abbeville-Vermillion Parish Chamber of Commerce. We included owners, operators and managers of businesses with direct and indirect linkages to the oil and gas industry. Civic leaders are pulled from city and parish government lists (i.e., Abbeville City Council, and Vermillion Parish Police Jury). We compiled a list of community leaders from those mentioned frequently in the newspaper for the last year. Within each category of respondents we used some form of systematic selection. Because most of the stakeholders are also members of the community, our four sets of respondents are not mutually exclusive. We did ask respondents about other people to whom we should talk. This minimal amount of snowballing was useful in identifying knowledgeable community members who acted informally not so much as community leaders, but rather as “community historians.” These respondents were useful in providing a basic understanding of the local social and economic setting.

At this time, we have completed our document study and the guided conversations with the oil and gas stakeholders, and most of the civic officials. We are in the process of talking to community leaders and other members of the business community (such as those in agriculture services).

At this point we have talked to 40 respondents and expect to complete about 50 guided conversations in all. Our respondents are primarily male (we have talked with 7 women) and mostly white (there

are 2 Black males in our sample), but they reflect the demographic characteristics of the oil and gas stakeholders and civic leaders in the community. Our respondents range in age from 40 to 85 years and all have lived in the community at least since the early 1980s. Nearly half (17) have a college degree or better; they do not reflect a cross-section of the community. They constitute an occupationally diverse group including oil field workers, a restaurant owner, attorneys and a hair dresser.

## PRELIMINARY FINDINGS

### Historical Background

The geography of Abbeville and surrounding Vermilion Parish affected settlement patterns, social relationships and economic development. Geographically, Vermilion Parish is very diverse. The northern part of the Parish is what is referred to as a “coastal prairie”; it is flat, agricultural land. The southern portion of the Parish consists largely of wetlands. Vermilion Parish is sparsely populated (48,000), and the vast majority of the population is in the northern part of the Parish. The parish consists of one city (Abbeville) and five villages and towns. Heading due south from Lafayette, one drives through village of Maurice to Abbeville. Erath and Delcambre are just east of Abbeville and the towns of Kaplan and Gueydan are west. Intracoastal City lies south of Abbeville and is considered to be an extension of Abbeville (Abbeville addresses, phone numbers), even though it is a half hour drive away. Intracoastal resembles an industrial park more than a residential area with most of those who work in Intracoastal City living in Abbeville.

The geography of coastal Louisiana had a profound effect on its settlement patterns and the relationships of residents to the land and natural resources. Vermilion Parish was settled as part of the Acadian movement from Nova Scotia. Historians divide settlements into east and west settlements. The eastern settlements, along Mississippi River and Lafourche Bayou, were preferable to immigrants and new settlers. Western settlements were considered to be part of the “wilderness,” and Vermilion Parish, consisting of coastal prairie and wetlands that did not provide many natural materials for building shelter or making fires was settled relatively late (Ancelet, Edwards and Pitre 1991; Brasseaux 1987). The western coastal parishes were settled primarily for farming and ranching. Abbeville was designated as a city in 1850 by an act of the state legislature and remains under a state charter today. Abbeville does not appear to have developed a plantation economy. Typically in plantation economies, large and small farms and agricultural enterprises co-existed. In the early years of Vermilion Parish however, the family farms were fairly homogeneous. Families would live on and farm property they received in Spanish land grants, and as families expanded, they would continue to farm in the same area so that the communities that developed were family based. Many families still own and farm the same land; it is not unusual for families to retain land that was originally accorded to them by the Spanish government. As a consequence, there are relatively few surnames and a dense complex of kinship groups exists in the area (Brasseaux 1987).

The *History of Vermilion Parish, Louisiana*, assembled by the Vermilion Historical Society, chronicles the ethnic diversity of the community. Nonetheless, most residents identify strongly with the French heritage of the area.

The French language continues to be used extensively. Even today some of the early morning and weekend radio and TV broadcasts (including those on Public Radio) are still broadcast in French. Many of the oldest generation do not speak English, and our some of our respondents talked about the divisions between the French speakers and the “Americans” that persisted until at least the 1960s. Until workers from oil and gas industry moved into the area in large numbers, residents of the community were geographically, socially and economically isolated.

During the middle of the 1900s, as oil and gas activity began to expand dramatically, Abbeville was clearly a farming community with a large contingent of tenant farmers. Abbeville was also a poor community. A survey from 1960 showed that 7.4% of the population in Abbeville had no visible means of support, and that 73% of white males worked irregularly (Abbeville Meridional 1960). Many of farmers were tenant farmers. Changes in local economic conditions began in earnest with the expansion of oil and gas activity.

#### Micro-Level Responses

In our guided conversations, we talked to respondents about both individual and family (micro) and community (macro) level responses to decline of oil and gas activity. In terms of micro level responses, our respondents most often reported that people in Abbeville “tightened their belts.” Although many skilled workers left the area, residents with family ties stayed here and gave up recreational activities and luxuries. Many people assumed second (in some cases, third, jobs). Many women entered the labor market and contributed to a family income. Other people took advantage of the diversity of natural resources and activities previously pursued recreationally to support themselves and their families.

In general, these strategies are very similar to those that anthropologists studying rural development have found that rural residents in the United States use in periods of economic downturns.

Other residents relied more on their extensive social relationships. Family ties and other social relationships, as forms of social capital, are important sources of social and economic resources, and information families and friends provided economic support in terms of housing and economic assistance. As one of our respondents told us “Everybody’s going to eat.” Families also provided jobs during the hard times associated with the decline in oil and gas activity. A local service station owner provides his wife, two of his children, his brother, his in-laws, and his god-child with employment, as they need it. These findings provide support for our supposition that social capital can soften the edges of economic hardship (Putnam 1993).

#### Macro-Level Responses

The local economy appears to be a relatively diverse economy, supporting agriculture, some industry and services. The vast majority of our respondents attributed Abbeville’s survival during the downturn of oil and gas activity to agriculture. As one respondent said “our economy is not built on the oil patch.” In 1963, Vermilion Parish was the top rice producing parish in the state; it remains so today. It was fifth in beef cattle production in 1963, it is first today. It has long been a leading

producer of seafood, and in the 1980s, crawfish farming also became a major industry. The Parish has a long history of sugar cane production and today harvests some of the largest crops in the state.

During the downturn, the city and parish pursued other economic development strategies. The city actively recruited Fruit of the Loom (FOL) to locate in Abbeville. FOL opened in 1990, initially employed almost 1000 people, 80% of whom live in the parish. The parish also opened the Port of Vermilion in 1983.

Parish and city officials in Abbeville (as in most of Acadiana) also began an intensive promotion of tourism during the decline of oil and gas activity. Abbeville is a quaint and attractive city, known for its seafood restaurants and amenities.

However, we found these economic development activities to have little impact on local economic sustainability during the downturn. Because FOL did not open until 1990, its presence is not reflected in our data. The Port of Vermilion did not open until 1983, and did not develop to any great extent. Today, it is still sparsely occupied. And although tourism is often perceived to provide a boost for local rural economies, the promotion of tourism is not practiced systematically in the community. On the basis of the what our respondents told us about agriculture, and the available data on agricultural production in the Parish, we are inclined to believe that agriculture played an important role in Vermilion Parish and probably in Abbeville as well.

It became more apparent, especially as we began spending time in Intracoastal City, which has been described by our respondents as “a staging area,” or a “center for logistics and operations for the oil and gas industry,” that the provision of services that facilitate industries (rather than consumers) is critical to the sustainability of the Abbeville economy. Intracoastal City, unlike other major sites of oil and gas activity, is not involved in fabrication as much as it is involved in oil related services. As one of our respondents in a major service company related, the exploration and drilling may have stopped during the downturn, but production continued, and everything that is needed on production rigs must be transported by either boat or helicopter. This includes personnel, equipment, drilling fluids, water. In 1983, 207 industries were located in Intracoastal City and 24,000 people moved through monthly (Abbeville-Meridional VOILA, April 1983).

The Abbeville area also supports other significant service industries. Abbeville is a primary center for agricultural production, storage and services. Intracoastal City is a supply and distribution center for the shrimp industry.

The importance of the service sector in Abbeville is strengthened by data from the U.S. Department of Agriculture that shows that Vermilion Parish specializes in services. St. Mary and Iberia parishes, in contrast, specialize in mining. Usually, services in rural areas consist primarily of consumer services. But we realized that the service base in this area is dependent to a large extent on what are called producer services. There has been a great deal of work on producer services in urban areas, where they contribute positively to the economy, but not on producer services in rural areas. Producer services are those that are linked to the underlying industrial specialization within a region,

such as agriculture and oil (Glasmeier and Howland 1995). We believe that the producer service base is a major factor contributing to the sustainability of Abbeville's economy.

It is clear from this study that both micro- and macro-level responses to the economic downturns precipitated by declining oil and gas activity were instrumental in maintaining economic sustainability. Abbeville's economic resiliency appears to be a consequence of industrial diversity overlaying a foundation of extensive social relationships. Social resources softened the economic hardship experienced by individuals and families. Industrial diversity, both between and within industries, helped the community weather the decline of a major source of economic support. Perhaps one of the most interesting findings is the possibility that a spatial division of labor in oil and gas activity is associated with geographically uneven economic development. Such a division of labor suggests that oil and gas activity will affect different coastal communities in different ways and at different points in time.

#### REFERENCES

- Abbeville Meridional. 1950, 1960, 1983.
- Ancelet, Barry Jean, Jay D. Edwards and Glen Pitre. 1991. *Cajun Country*. Jackson, MS: University Press of Mississippi.
- Beaulieu, Lionel J. and Vernon D. Ryan. 1984. Hierarchical influence structures in rural communities: a case study. *Rural Sociology* 49(1): 106-116.
- Brasseaux, Carl A. 1987. *The Founding of New Acadia: The Beginnings of Acadian Life in Louisiana, 1765-1803*. Baton Rouge, LA: Louisiana State University Press.
- Flora, Cornelia Butler, Jan L. Flora, Jacqueline D. Spears, and Louis E. Swanson. 1992. *Rural Communities: Legacy and Change*. Boulder, CO: Westview Press.
- Lobao, Linda M. and Michael D. Schulman. 1991. Farming patterns, rural restructuring, and poverty: a comparative regional analysis. *Rural Sociology* 56(4): 565-602
- Lofland, John and Lyn H. Lofland. 1975. *Analyzing Social Settings: A Guide to Qualitative Observation and Analysis*. Belmont, CA: Wadsworth Publishing Co.
- Glasmeier, Amy K. and Marie Howland. 1995. *From Combines to Computers: Rural Services and Development in the Age of Information and Technology*. Albany, NY: State University of New York Press.
- Granovetter, Mark. 1973. The strength of weak ties. *American Journal of Sociology* 78: 1360-80.



- Orum, Anthony M., Joe R. Feagin and Gideon Sjoberg. 1991. The nature of the case study. Pp. 1-27 in Joe R. Feagin, Anthony Orum and Gideon Sjoberg (eds.) *A Case for the Case Study*. Chapel Hill, NC: North Carolina Press.
- Putnam, Robert D. 1993. *Making Democracy work: Civic Traditions in Modern Italy*. Princeton, NJ: Princeton University Press.
- Shaffer, Ron. 1995. Achieving sustainable development in communities. *Journal of the Community Development Society*. 26(2): 145-153.
- Vermilion Historical Society. 1983. *History of Vermilion Parish*. Dallas, TX: TaylorPublishing.

## **RECENT EFFECTS OF OCS ACTIVITIES ON PORT FOURCHON**

Mr. Ted M. Falgout  
Port Director, Greater Lafourche Port Commission

Port Fourchon is Louisiana's only public Port Facility on the Gulf of Mexico. It is located in Lafourche Parish at the mouth of Bayou Lafourche. Traditionally, the Port has been used to support shelf oil and gas activities, as a support base for the Louisiana Offshore Oil Port (LOOP), for commercial fishing, for recreational fishing, and for limited amounts of foreign trade. Because of the Port's unique geographic location, and because of the Greater Lafourche Port Commission's ability to construct necessary infrastructure improvements, Port Fourchon has experienced steady growth over the past two decades.

Twenty years ago there were only two companies operating at Port Fourchon. Today there are more than 100, and the number is increasing daily. The overwhelming majority—probably over 95%—of this growth can be directly attributed to OCS oil and gas activity in the Gulf of Mexico. Until 1996, the Port was holding its own, so to speak. The Port Commission was able to stay ahead of industry's needs for port facilities. Then, seemingly out of nowhere, and certainly not out of the projections of MMS, came deepwater drilling.

The expansion of the industry into deepwater surprised everyone. We were equally surprised to discover that geographically, economically and environmentally, there is no better place than Port Fourchon to conduct the intermodal transfer necessary for the support of this activity. Because of the larger and deeper draft vessels required, there are very few options along the coast.

This fact became even clearer when Edison Chouest Offshore began constructing the new generation deepwater supply vessels designed to support deepwater activities. These are nearly 250 feet long and require a loaded draft of 20 feet instead of the standard 180 foot long, 16 foot draft shelf vessel that, for years, has been the workhorse of the Gulf.

This same company realized that larger and more efficient land based facilities would be needed to accommodate these new vessels. The company has constructed a state-of-the-art \$35 million dollar land based facility at Port Fourchon called C-Port and is starting another larger facility in January.

What does this mean? What impacts does the rapid expansion of deepwater activities have on this coastal port and our community? Port Fourchon has suddenly become the focal point for intermodal transfer of goods, services and personnel for the overwhelming majority of deepwater OCS activity. Every widget, gadget and person needed to develop this “New Frontier” must undergo an intermodal transfer from an onshore mode of transportation to an offshore mode and vice versa because virtually everything that goes out comes back for reuse, recycling or disposal. In addition, the Port moves over 6,000 people a week by air to offshore locations.

Oil and gas has consumed us. It is overwhelming. We cannot build fast enough. Companies are literally fighting for space at our Port.

Our E-Slip Development is a prime indicator of what is happening at this focal point of OCS activity. The E-Slip Development is sectioned into three phases. Each phase includes approximately 100 acres and a mile of waterfront. When we originally planned this development, we anticipated that this is all the property Port Fourchon would ever need for future growth. It took 10 years to lease out the first phase after completion. This was a little faster than we anticipated, but close to schedule. Construction on Phase II will be completed this spring and it is already 100% leased. We did not project the construction of Phase III until after 2005. However, we have just begun permitting on Phase III and it is already 100% spoken for. Construction, at best, is still two years away.

Tonnages handled at the Port have skyrocketed, increasing 275% in the last five years. Now we expect them to double again in four years.

A major downside to this boom of activity is its impact on landside infrastructure. Since much of this activity travels by truck, traffic in general—and especially heavy-load traffic—has increased significantly through our community as it heads to the Port.

The Port is served by a single two-lane highway which is substandard and extremely susceptible to flooding and storms. Highways that were built for my grandparents to visit each other on Sunday afternoons have been used for twenty years to carry the burden of OCS activity. Now they are being asked to accommodate overwhelming activity associated with deepwater.

An accident on the Leeville Bridge clearly portrays this impact. One truck jackknifed, shutting down the bridge for 3½ hours. This trapped 984 vehicles on the south side. Think of the consequences of such an accident with Grand Isle, Fourchon, 6,000 offshore workers, and thousands of oil and gas equipment trucks evacuating for a quickly approaching storm. The results could be catastrophic.

Realizing that infrastructure leading to the Port is our weakest link, we embarked on an effort to gain recognition for this little known problem. It is not just a local or state issue, it is one that has extreme national significance as well.

In January of 1997, the Port Commission and other stakeholders formed the LA 1 Coalition with the mission to construct highway improvements from Grand Isle to U.S. 90. Over \$300,000 was raised the first year to support this effort, and great strides have been made.

Just last week, Senator Mary Landrieu and Robert Hamilton toured the Port. Senator Landrieu sits on the Energy Committee and Robert Hamilton is the Assistant Secretary of Land and Minerals. Senator Landrieu is committed to introducing legislation that will allow coastal states to obtain a greater share of offshore mineral revenues. This could mean an additional hundred million a year for coastal infrastructure and environmental restoration in Louisiana.

Highways are certainly our most visible focal point impact and perhaps our greatest challenge, but this sudden influx of activity has caused many stress cracks in our community. We used to walk in stores and hear French spoken; now it is Spanish. From water shortage to housing shortage, from our schools to our law enforcement, every facet of our community is impacted.

In June of 1996, I wrote a letter to Mr. Oynes about the impacts of OCS activity on Port Fourchon and Lafourche Parish. He personally visited me and we discussed my views. He is committed to funding a study to document the OCS impacts upon the infrastructure of the Port and Lafourche.

**ASSESSING THE IMPACT OF GROWTH IN THE DEEP WATER OIL  
INDUSTRY ON THE ECONOMY OF AND PUBLIC SERVICE  
PROVISION IN LAFOURCHE PARISH LOUISIANA**

Dr. Walter Keithly  
Coastal Fisheries Institute  
Louisiana State University

Dr. David W. Hughes  
Mr. Matthew Fannin  
Dr. Jiemin Guo  
Department of Agricultural Economics and Agribusiness  
Louisiana State University

Recently, oil and gas production in the deep water Gulf of Mexico has unexpectedly increased at a rapid rate. Exploration and production growth rates in the region are among the highest levels in the world, as wells are being drilled in deeper and deeper waters in the outer continental shelf (OCS). Port Fourchon (in southern Lafourche Parish, Louisiana) is the key support facility for the expansion. While the local economy is benefitting, roads and other local public services are being increasingly strained.

The Louisiana Community Impact Model provides a framework for forecasting the economic, demographic, and fiscal consequences of a particular set of economic changes. Like similar models developed for other states, it is composed of labor market, input-output, fiscal impact, and public service impact modules. The model is being used to estimate the impact of growth in the Deep water off-shore oil industry and Port Fourchon on the economy and on the provision of public services in Lafourche Parish. Model results will be used to assess whether resulting gains in government revenue are exceeding increases in the cost of publicly provided services.

Because the port is a support station for OCS production, critical sectors include water transportation (supply ships and supply ship loading), air transportation (helicopters to oil rigs), and the motor freight transport sector (also critical to the public service impact). Especially important is the ongoing construction at the port that has been and is required to support the expansion of these sectors at the port. Also, it is important to estimate future levels of OCS activity and the resulting impact on these critical sectors of the Lafourche Parish economy.

Preliminary results from an input-output model of Lafourche Parish indicate the possible contribution to the local economy of growth in key sectors. Output multipliers show change in output across the entire economy for a one-dollar change in output for a given sector of the economy. Type I multipliers generated by input-output models show such effects when household spending effects are excluded. For Lafourche Parish, the output multiplier has been estimated at 1.2238 for construction, at 1.1976 for Motor Freight Transport and Warehousing, at 1.1743 for Air Transport, and at 1.3352 for Water Transportation. Given levels of ongoing activity at the port, these multipliers indicate that the impact of the OCS oil industry on Port Fourchon and on the Lafourche Parish economy will continue to be substantial.

The expansion of Port Fourchon on locally provided public services can also be expected to be substantial. In a separate part of the study, the growth in truck traffic from Port Fourchon for Louisiana Highway 1 was estimated. The highway is the only major transportation corridor to the port. Estimated growth in truck traffic was shown to have a substantial impact on the quality of service provided by the road. As a result, improvements in Louisiana Highway 1 are probably warranted.

Ongoing work for the project included continued improvement in the parish input-output model. The labor market component, fiscal impact component, and public service impact component of the Community Impact Model are currently being constructed. Further, projected levels of activity in the OCS and resulting future expansion of economic activity in Lafourche Parish are also being assessed. When completed, the model will be used to draw inferences concerning local benefits and costs of the rapidly expanding offshore oil industry.

## MIGRATION AND COMMUTING IN LOUISIANA'S COASTAL AREAS

Dr. Joachim Singelmann  
Departments of Sociology and Rural Sociology  
Louisiana State University

The work schedule specific to offshore oil and gas drilling activities in the Gulf of Mexico (GOM)—one or more weeks at work in the GOM followed by one week or more at home—permits workers from quite distant places to commute to work rather than moving their families through permanent migration to coastal parishes. Research has shown that most families would prefer not to migrate if they have the same economic and social opportunities at their place of residence. Since the work schedule specific to offshore oil and gas drilling requires only about two round-trip commutes per month, it can be expected that many families with offshore workers substitute commuting for more permanent migration. If that were indeed the response of families with offshore workers, the rate of net immigration—which is traditionally used as an indicator of economic development of an area—would underestimate the development potential, for it would take no account of the substitution effect of commuting. It is the purpose of this presentation to shed some light on these expectations.

Our analysis of commuting in Louisiana shows a substantial increase: during the period 1960-90, the number of commuters increased from 60,000 to over 200,000. This increase is not merely a function of a growing labor force in coastal areas, but rather a reflection of a larger reliance of the coastal economy on commuters. While commuters in 1960 accounted for 16.1 percent of total employment in Louisiana's coastal areas, they made up almost one third of all workers in 1990.

The importance of commuting for meeting labor demand is even more important for the mining industry in coastal areas (which includes offshore oil and drilling activities). Our estimates from the 1980 and 1990 censuses show that commuters made up 47 percent of all mining workers in Louisiana's coastal areas, compared with 30 percent for all industries combined. In 1990, more than one half of all mining workers in coastal areas were commuters (32 percent for all industries combined).

Our analysis also examined the distance traveled by commuters. Do commuters come from adjacent parishes, or do they travel long distances? This question is important, for it has implication for possible consumption on the part of commuters. If commuters reside in adjacent parishes, they can be expected to purchase more goods at their place of work than if they come from more distant places. According to our estimates, commuters from adjacent parishes outnumber commuters from places farther away, which is to be expected. However, this gap has been steadily narrowing since 1960. While in that year 83 percent of all commuters to coastal areas resided in adjacent parishes and 17 percent in more distant places, this breakdown changed to 65 percent and 35 percent, respectively. These estimates illustrate that commuting not only has become more important in coastal areas for meeting the labor needs of those areas, but that the coastal areas increasingly draw commuters from places that are farther away from the coast. In several parishes, commuters from non-adjacent

parishes account for over 70 percent of all commuters; these parishes include LaFourche, St. Bernhard, and St. Mary.

To get a better estimate of the distance traveled by commuters, we computed the distance between all counties in the United States, using county mid-points as measurement center for all residents in a specific county. Given those county-to-county distance computations, we estimated the average distance for all commuters in Louisiana. As expected, the average distance for commuters to coastal areas is greater than the distance for commuters to non-coastal areas, and commuters with jobs in the mining industry, on average, travel greater distances than commuters with jobs in other industries. Specifically, the average distance traveled by commuters who have mining jobs in coastal areas was 71 miles (one way) in 1980, compared to 42 miles for non-mining commuters to coastal areas. Although the average commuting distance decreased slightly by 1990, the distance differential between mining and non-mining commuters in coastal areas remained the same.

We also examined the distribution of distance patterns for the various groups of commuters. Our estimates show that for both 1980 and 1990, about one half of all commuters with jobs in the mining industry in coastal areas travel 40 miles (one way) or more; about 20 percent of these commuters travel more than 80 miles (one way) between residence and work.

These findings raise questions about a number of implications:

- a. Consumption. Given the importance of commuters for meeting the labor needs in coastal areas, especially for the mining industry, research needs to be conducted into their consumption patterns. How much money do these commuters spend in coastal areas compared to residents of coastal areas? Is there a difference in spending patterns between commuters from adjacent parishes and those from more distant places?
- b. Taxation. As with consumption, the importance of commuting in coastal areas requires a detailed examination of this specific composition of the labor market regarding its implication for taxation.
- c. Infrastructure. The issues of consumption and taxation need to be analyzed in the context of the burden on infrastructure. To the extent that commuters require less infrastructure (e.g. schools, social services, hospitals and medical services), their lower contribution to the area's tax base may be less consequential for the fiscal health of coastal communities.
- d. OCS impact. The findings regarding the importance of commuters in coastal areas, especially with regard to the mining industry, indicate that migration is not a sufficient proxy to estimate the impact of OCS gas and oil activities. Instead, OCS activities affect communities far away from coastal areas through the process of labor commuting.
- e. Economic stability. To the extent that much of the labor needs of the oil and gas industry in coastal areas are increasingly met by commuters, this labor recruitment pattern might provide the necessary flexibility for coastal communities to avoid the cycle of boom and bust that

characterized many communities in the past. Should the labor demand in these communities decrease, much of that decrease might be reflected in less commuting, thereby softening the impact of any industry downturns on unemployment of the coastal population.

## SESSION 1E

### THE MMS SEA FLOOR MONITORING PROGRAM

Chair: Mr. Nick Wetzel

Co-Chair: Dr. Jack Irion

Date: December 17, 1997

Presentation	Author/Affiliation
Introduction: Purpose and Regulatory Requirements	Mr. Nicholas Wetzel Minerals Management Service Gulf of Mexico OCS Region
The What, Where, Why, and How of Monitoring the Sea Floor	Dr. Jack B. Irion Minerals Management Service Gulf of Mexico OCS Region
Monitoring Sea Floor Damage in the Pinnacle Trend Main Pass Area	Mr. Tom Yourk Minerals Management Service Gulf of Mexico OCS Region
Environmental Characterization of Sonnier Bank	Mr. Terry Dempre Dr. Ann Scarborough Bull Minerals Management Service Gulf of Mexico OCS Region
Archaeology and the Gulf of Mexico Region Sea Floor Monitoring Program	Dr. Richard J. Anuskiewicz Minerals Management Service Gulf of Mexico OCS Region
Refining the High Probability Shipwreck Model in the Gomr	Dr. Jack B. Irion Minerals Management Service Gulf of Mexico OCS Region
Role of the Gulf of Mexico OCS Region's Scientific Diving Team in Seafloor Monitoring	Mr. Les Dauterive Minerals Management Service Gulf of Mexico OCS Region





## INTRODUCTION: PURPOSE AND REGULATORY REQUIREMENTS

Mr. Nicholas Wetzel  
Minerals Management Service  
Gulf of Mexico OCS Region

The following is an overview of the purpose and need for a sea floor monitoring program.

The Minerals Management Service (MMS) develops and includes mitigative measures or reminders of lease stipulations in the environmental documents that are prepared to assess the effects of proposed activities in the Gulf of Mexico OCS Region. Examples of these activities include mineral exploration and extraction operations, decommissioning of offshore structures, disposal of naturally occurring radioactive materials (NORM), pipelining activities, and geological and geophysical activities. Areas of biological and archaeological concern require protection from the potential effects of the proposed activities. These areas may include:

- Topographic features (Flower Garden Banks National Marine Sanctuary)
- Chemosynthetic communities
- Pinnacles or other live bottom areas
- Endangered, threatened, and protected species and their habitat
- Refuges and wilderness areas
- National sea shores
- Prehistoric and historic archaeological resources
- Artificial reef designated areas and sites

Presently, the MMS imposes certain mitigation in the environmental documents we prepare, primarily Categorical Exclusion Reviews (CERs) and Environmental Assessments (EAs), to minimize or preclude impacts from proposed operations. These mitigation typically require avoidance or use of a Remotely Operated Vehicle (ROV). On rare occasions, diver testing is employed when there is the potential for direct impact to biological or archaeological features.

Other mitigation provides specific guidance for controlling emissions where air quality exemption levels are an issue, or when the development or modification of a Site-Specific or Regional Oil Spill Contingency Plans occurs.

The MMS, in order to ensure safety and environmental protection, has the authority under 30 CFR 250.33 (o) for Exploration Plans, and 30 CFR 250.34 (s) for Development Plans, to require operators to conduct various monitoring programs. More specific guidance to operators has been and can be provided through Notice to Lessees (NTLs), Letters to Lessees (LTLs), and Lease Sale Environmental Impact Statements (EISs). Presently, monitoring programs can be initiated through NTL 88-11 for chemosynthetic communities, NTL 92-02 for site clearance, the Live-Bottoms (Low Relief) stipulation, and the Live Bottom (Pinnacle Trend) stipulation.

More recently, the Government Performance and Results Act of 1993, as amended in 1997 requires federal agencies to report on their performance in terms of measuring "Outcomes" that result from their activities, rather than outputs. Or more specifically, how effective is MMS in ensuring environmentally sound OCS operations.

Although many environmental effects are difficult to measure, it is the responsibility of the MMS to ensure OCS operations are carried out in an environmentally sound manner.

The initial phase of the MMS Monitoring Program will focus on expanding compliance monitoring: first, by requiring operators to demonstrate compliance with avoidance requirements by providing As-built maps showing anchor locations with their construction reports; secondly, through field checking by MMS personnel to verify that protected features were avoided using high resolution side-scan sonar and/or MMS divers.

A pilot project was initiated in 1997 to test the effectiveness of these measures of evaluating the condition of the sea floor. Dr. Jack Irion will describe the methods and projects undertaken during this pilot project.

---

Nicholas Wetzel is Supervisor of Unit II, Environmental Operations Section of the Minerals Management Service's Gulf of Mexico OCS Regional Office. His graduate work (University of California, Fresno: MS 1978) addressed the paleoecology and carbonate petrology of a Devonian stromatoporoid reef at Mountain Springs Summit, Nevada. He has been involved with conducting post-lease environmental reviews for the MMS since 1996. Prior to his work with MMS, he spent 18 years with the U.S. Bureau of Mines where he performed hundreds of pre-feasibility studies of mineral properties, which included reserve/resource estimation, mine engineering and design, metallurgical engineering and design, cost estimation, and mineral economics. He served as advisor to the Senate subcommittee for Energy and Minerals during the California Desert Conservation Act hearings and has provided expert testimony in validity hearings and other mineral related litigation.

## **THE WHAT, WHERE, WHY, AND HOW OF MONITORING THE SEA FLOOR**

Dr. Jack B. Irion  
Minerals Management Service  
Gulf of Mexico OCS Region

The MMS' Pilot Seafloor Monitoring Project provides tangible evidence of whether or not we're doing a good job in extracting hydrocarbons from beneath the sea in a way that preserves the quality of the underwater world. The following are the goals behind the Project, the methods we used to accomplish these goals, and a brief summary of this year's investigations.

MMS is charged with the responsibility of developing mineral resources on the outer continental shelf in an environmentally sound manner. This includes protecting marine mammals from harm during platform removals, preserving air quality by limiting the amount of emissions from offshore platforms, and protecting our coastlines from oil spills. These are all areas that are continually monitored, not only by MMS, but also by the Environmental Protection Agency, National Marine Fishery Service, and the operators themselves.

What is harder to monitor, because it is out of view, is the condition of the sea floor itself. Few people may, in fact, realize that the floor of the Gulf of Mexico is not just a featureless plain of sand and mud but includes spectacular coral reefs like the Flower Gardens, rocky outcrops pushed to the surface by salt domes, and ancient reef systems that formed during the last Ice Age when the continental shelf was dry land. These features are home to diverse variety of life ranging from tiny bristle worms to whale sharks. Even in the deep ocean, the sea floor is home to many unique species, including the methane-synthesizing “ice worms” only recently discovered.

Oil and gas development has the potential to effect the sea floor habitat in a variety of ways, but the most dramatic form comes during the laying of pipelines and the construction and removal of platforms. The large anchors that are used by pipeline lay-barges and construction barges can weigh up to 5 tons, can be dropped dozens of times during a single project, and frequently can be dragged for hundreds of feet, furrowing the sea floor like a gigantic knife. Compared to the relatively limited impact of a pipeline trench, these anchor scars have the potential for causing considerable damage to fragile sea floor habitats and other protected features such as historic shipwrecks. For some time MMS has required operators to avoid these features with their anchors, but no means existed to demonstrate compliance. The Environmental Operations Section was tasked with developing a program to test industry compliance and to gauge the effectiveness of MMS mitigations in protecting sea floor features.

The use of a Remotely Operated Vehicle (ROV) carrying a video camera was initially discussed. However, while these are wonderful tools for documenting specific targets, those of us involved in shipwreck research argued that they were too limited in their view range to make them effective search tools if you didn't know the precise location where damage might have occurred. They also are expensive, often require a good sized operating platform with a lifting boom, and are of limited usefulness in areas with strong currents and turbid waters.

Operating under the current government philosophy of doing more with less, we opted instead for a highly portable side-scan sonar system that could be operated from virtually any vessel with a 12-volt power source. The device consists of the towfish, 200 meters of cable, and a special board that mounts in a standard PC. In this case, the PC is ruggedized and splash-proofed, but it's basically just a 486 running Windows.

The side-scan sonar bounces sound off objects and measures its rate of return to image objects much the same as a camera uses light. The higher the frequency of the sound source, the more times an object is “pinged” and the greater the resolution is of the image. After a considerable amount of research, MMS procured a Marine Sonics 600 kHz sonar. By comparison, the standard sonar in use

in the Gulf is only 100 kHz. This same equipment, incidentally, is now being installed in the Navy's Nuclear Research Sub, NR-1. MMS had it first.

We had a number of requirements in selecting the tool to be used on this initiative, but the principal one was the ability to obtain good quality, highly detailed images of sea floor features. This test image around a dock shows fallen pilings and even automobile tires. We also wanted to be able to use this equipment in a wide variety of depths yet still keep it light and easily manageable by two people. We limited ourselves to the phototropic zone of 300 feet, the depth of the pinnacle features on the edge of the shelf break that are an important biological resource. This allowed us to store the necessary 200 meters of cable on a small reel without requiring special davits or winches. This depth limit allows us to image nearly all the sea floor features that MMS seeks to protect by stipulation except chemosynthetic organisms, which only occur below 400 meters.

Another important criterion of the device was to be able to image small objects on the sea floor. We felt this would be a useful tool for verifying site clean-ups after structure removals. The 600 kHz side-scan clearly images things as small as crab traps and even bicycles.

The Pilot Project was intended from the beginning to examine actual oil and gas development projects where MMS had invoked an avoidance mitigation. Avoidance mitigations are used to protect biological and archaeological features on the sea floor. By directing industry to avoid these features, the impact of the project on the environment is "mitigated," that is to say, lessened or eliminated. Our task, then, was to examine several construction projects where industry had been directed to avoid effecting biological and archaeological features and see if they, in fact, had done so. We were determined to look at each of the major kinds of features that MMS protects by stipulation or regulation. This will include the Pinnacle Trend in Main Pass, Sonnier Bank in Vermilion 305, and a possible shipwreck in High Island 108.

The first features to be examined were the Pinnacle Trend in Main Pass and Viosca Knoll. The Pinnacle Trend is a region of low-relief rocky areas and major carbonate pinnacles at the outer edge of the Mississippi-Alabama Shelf between the Mississippi River and the De Soto Canyon. These hard-bottom features provide a large surface area for the growth of sessile invertebrates and attract large numbers of fish. Mr. Tom Yourk, the marine biologist on the team, presents our findings in the Pinnacle Trend during the next presentation.

Another important biological feature that enjoys MMS protection is the topographic highs formed by sedimentary rocks pushed above the surrounding sea floor by salt domes in the Central Gulf. These features form offshore banks such as the Flower Gardens and Stetson Bank, which are now designated as National Marine Sanctuaries, as well as 18 other banks. One of the most significant of these is Sonnier Bank, where the MMS Scientific Dive Team has spent two seasons gathering important data to characterize this resource. Mr. Terry Dempsey, staff geophysicist, will describe the results of the 1997 survey in this session.

Since we are based in New Orleans and firmly grounded in the philosophical concept of *lagniappe*, we also were happy to jump on an opportunity to join a joint NOAA/MMS sponsored expedition to the Flower Gardens National Marine Sanctuary.

Although this investigation was not part of our original proposal to management, it gave us an opportunity to test the equipment over an extremely rough and irregular bottom, in this case, to see if we could use the side-scan to detect damage to the coral. We found that it was very difficult to distinguish impacts to the coral. On the other hand, the side-scan is very useful for mapping the morphology of the Bank. NOAA biologists were particularly interested in being able to accurately map these sand flats, which could address questions about the formation and development of the Flower Gardens.

Another major concern of MMS is the protection of archaeological resources, particularly historic shipwrecks. Before any well is drilled or pipeline is laid, industry is required to conduct their own remote sensing survey of the lease block to locate potential archaeological resources. These are likely to be reported to us only as small areas of anomalous magnetic disturbances or unidentified side-scan sonar targets that may be indicative of a shipwreck. Since we usually don't know from these data whether it's a historic shipwreck or not, industry is asked to either dive on the site and identify it, or avoid it. Usually they opt to avoid the area. This year's test project looked at just such an area in High Island to see how well industry did in avoiding these features. Dr. Rik Anuskiewicz, MMS senior staff marine archaeologist, reports on these findings.

A number of other opportunities arose to use the side-scan equipment to expand our knowledge of historic resources in the Gulf of Mexico. Returning to Biloxi following the Pinnacle survey, we documented a historic steamship off Horn Island, Mississippi (Figure 1E.1). This wreck was unknown to the Mississippi state archaeologist although under the Historic Shipwreck Protection Act, it is state property. We were able to provide them with exact coordinates and detailed images of the wreck.

The side-scan also was extremely useful in documenting a previously unknown wreck in High Island Area, the *New York*, which sank in a storm in 1846. The discovery of this wreck, which our records had indicated was in the Vermilion area, allowed us to release 9 block from the 50-meter survey requirement, resulting in a savings to operators of nearly \$400,000.

An interesting feature of the wreck is its steam engine, a rare crosshead type. Ironically, this block had been surveyed by industry using a 100 kHz sonar and no evidence of the shipwreck was found.

Another potential use for MMS' side-scan sonar is to assist the Field Operations Section in verifying compliance with site clean-up and operational issues. During the 1997 season we investigated sub-sea connections in the Grand Isle area and structure removals in West Delta 33 and West Delta 42.

The FY97 pilot project accomplished even more than was originally planned. Side-scan images were collected in several pipeline construction areas within the biologically-stipulated Pinnacle Trend Area offshore of Mississippi and Alabama. Also side-scan data was collected on protected biological

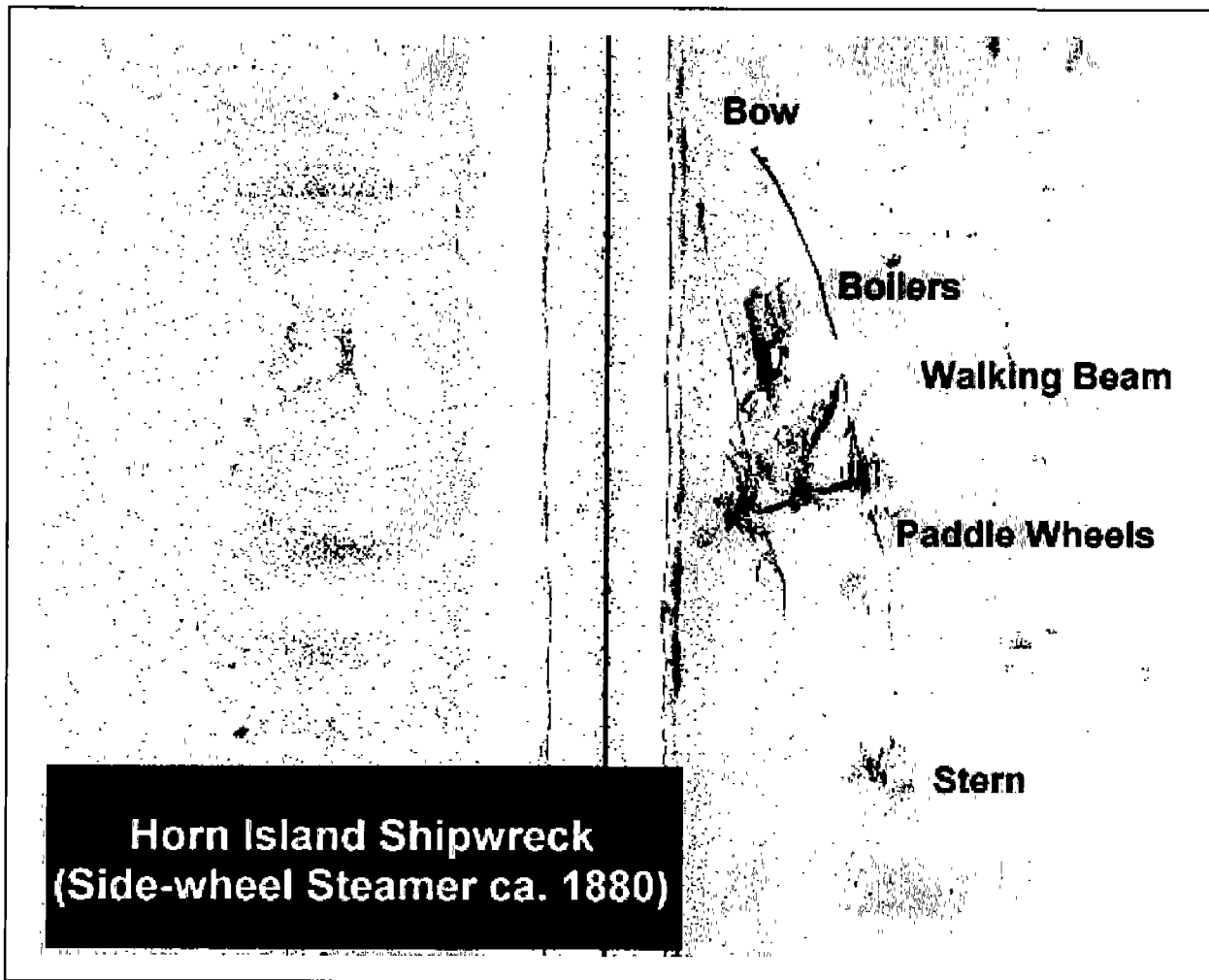

Figure 1E.1. Side-scan image of a historic steamship off Horn Island, Mississippi.

topographic features at Stetson and Sonnier banks, and at the Flower Gardens banks. Although the MMS pilot project observed some evidence of seafloor damage to protected biological features, in most cases it appeared that the oil and gas industry had complied with MMS recommended avoidance measures. Submerged archaeological features also were documented using the high resolution side-scan sonar system. A historic side-wheel steamer with an intact “walking beam” engine was documented off the coast of Mississippi. Another steamer, the *New York* (wrecked 1846), which was one of the first vessels to trade with the Republic of Texas, was investigated in an active lease block approximately 50 miles southeast of Galveston, Texas. This work was instrumental in establishing appropriate protective measures for these two significant historic sites with respect to oil and gas exploration and development.

In addition to fulfilling the needs of the MMS, the Seafloor Monitoring Pilot Project has provided an opportunity to form cooperative research partnerships with other agencies and institutions to achieve common research goals. Several monitoring projects were joint, cost sharing ventures with other state, federal, and private organizations, including NOAA, Texas A&M University, the New

Orleans Aquarium of the Americas, and the State of Florida, Bureau of Archaeological Research. Based on the success of the first year of the Seafloor Monitoring Project the MMS GOMR has been funded another year to continue their monitoring efforts. The FY98 monitoring studies and forthcoming recommendations by the MMS GOMR, will help to develop offshore mineral resources in an environmentally sound manner.

---

Dr. Jack B. Irion joined the Minerals Management Service, U.S. Department of the Interior, in August 1995, with the title of Marine Archaeologist. Prior to joining the MMS, Dr. Irion served as Vice President for Nautical Archaeological Services with the consulting firm of R. Christopher Goodwin & Associates, Inc., in New Orleans, Louisiana. For over 15 years, Dr. Irion provided archaeological consulting services to the Baltimore, Charleston, Mobile, New Orleans, Pittsburgh, Philadelphia, Savannah, Vicksburg, and Wilmington Districts of the Corps of Engineers, as well as to the Maryland Port Administration, and the State of Tennessee. Dr. Irion received his B.A. (1974) and M.A. (1977) in Archaeological Studies from The University of Texas at Austin. He was awarded his Ph.D. from the Institute of Latin American Studies of the University of Texas in 1991. During his career, Dr. Irion has specialized in conducting remote sensing surveys for shipwrecks, which succeeded in locating such historically significant vessels as the C.S.S. *Louisiana*, the sailing barque *Maxwell*, and the steamboats *Princess*, and *Kentucky*. In addition, he has directed numerous diving investigations on historic shipwrecks, including the steamship *Columbus* and the Civil War gunboats *Tawah* and *Key West*. Most recently, he has participated in MMS investigations of the Civil War vessel U.S.S. *Hatteras* and the steam packet *New York*.

## **MONITORING SEA FLOOR DAMAGE IN THE PINNACLE TREND MAIN PASS AREA**

Mr. Tom Yourk  
Minerals Management Service  
Gulf of Mexico OCS Region

### **INTRODUCTION**

The MMS is charged with leasing offshore tracts to industry for oil and gas exploration and development. This responsibility is accompanied by a mandate to minimize environmental impacts associated with these activities and to protect areas of significant environmental importance. Environmental protection is accomplished with the imposition of a variety of lease stipulations, mitigations, advisories, and reminders. These measures usually require site specific conditions, such as avoidance of specific features or other requirements.



## LIVE BOTTOM (PINNACLE TREND) STIPULATION

A region of topographic relief, known as the "pinnacle trend," is located in the northeastern portion of the Central Gulf of Mexico Planning Area and northwest portion of the Eastern Planning Area. This region is at the outer edge of the Mississippi-Alabama shelf between the Mississippi River and DeSoto Canyon. About 70 lease blocks are characterized as "pinnacle trend." The pinnacles are a series of topographic irregularities with variable biotal coverage, which provide structural habitat for a variety of pelagic fish. The pinnacles appear to be carbonate reefal structures in an intermediate stage between growth and fossilization. The "pinnacle trend," region contains a variety of features from low-relief rocky areas to major pinnacles, as well as ridges, scarps, and relict patch reefs. The heavily indurated pinnacles provide a surprising amount of surface area for the growth of sessile invertebrates and attract large numbers of fish. Additional hard-bottom features are located nearby on the continental shelf, outside the actual pinnacle trend.

The features of the pinnacle trend offer a combination of topographic relief, occasionally in excess of 20 m, and hard substrate for the attachment of sessile organisms and, therefore, have a greater potential to support significant live-bottom communities than surrounding areas on the Mississippi-Alabama Shelf. This potential to support live-bottom communities has made these features a focus of concern and discussion. The "pinnacle trend" is classified as a live bottom under the definition in the lease stipulation.

The Live Bottom (Pinnacle Trend) Stipulation is intended to protect the pinnacle trend and the associated hard-bottom communities from damage and, at the same time, permit the exploration and development of oil and gas resources.

The stipulation reads as follows:

Live Bottom (Pinnacle Trend) Stipulation (Central Planning Area)

(To be included only on leases in the following blocks: Main Pass Area, South and East Addition Blocks 190, 194, 198, 219-226, 244-266, 276-290; Viosca Knoll Area Blocks 473-476, 521, 522, 564, 565, 566, 609, 610, 654, 692-698, 734, 778.)

For the purpose of this stipulation, "live bottom areas" are defined as seagrass communities; or those areas which contain biological assemblages consisting of such sessile invertebrates as sea fans, sea whips, hydroids, anemones, ascidians, sponges, bryozoans, or corals living upon and attached to naturally occurring hard or rocky formations with rough, broken, or smooth topography; or areas whose lithotope favors the accumulation of turtles, fishes, and other fauna.

Prior to any drilling activities or the construction or placement of any structure for exploration or development on this lease, including, but not limited to, anchoring, well drilling, and pipeline and platform placement, the lessee will submit to the Regional Director (RD) a live bottom survey report containing a bathymetry map prepared utilizing remote sensing techniques. The bathymetry map shall be prepared for the purpose of determining

the presence or absence of live bottoms which could be impacted by the proposed activity. This map shall encompass such an area of the sea floor where surface disturbing activities, including anchoring, may occur.

If it is determined that the live bottoms might be adversely impacted by the proposed activity, the Regional Director (MMS) will require the lessee to undertake any measure deemed economically, environmentally, and technically feasible to protect the pinnacle area. These measures may include, but are not limited to, the following:

- the relocation of operations; and
- the monitoring to assess the impact of the activity on the live bottoms.

#### EFFECTIVENESS OF THE LEASE STIPULATION

The sessile and pelagic communities associated with the crest and flanks of the pinnacle and hard-bottom features could be adversely impacted by oil and gas activities if such activities take place on or near these communities. For many years, the stipulation has been made a part of leases on blocks with or near these biotic communities to mitigate to the greatest extent possible. This stipulation serves to protect these valuable and sensitive biological resources.

Activities which involve a possible physical perturbation (particularly anchor movement or placement) to localized pinnacle areas are expected to cause substantial damage to the pinnacle trend environment. These activities have the potential to destroy some of the biological communities and damage one or several individual pinnacles. The most potentially damaging of these are the impacts associated with mechanical damages that may result from anchors. However, the action typically is judged to be infrequent because of the limited operations in the vicinity of the pinnacles and the small size of many of the features. Minor impact is expected from large oil spills, blowouts, pipeline emplacement, muds and cuttings discharges, and structure removals. The frequency of impacts to the pinnacles is believed to be rare, and the severity is believed to be slight because of the widespread nature of the features.

The stipulation requires that a survey be done to encompass the potential area of proposed surface disturbance and that a bathymetry map depicting any pinnacles in the vicinity be made from this survey. By identifying the individual pinnacles present at the activity site, the lessee would be directed to avoid placement of the drilling rig and anchors on the sensitive areas. Thus, mechanical damage to the pinnacles is eliminated when measures required by the stipulation are imposed.

The question then remains: HOW EFFECTIVE IS THIS STIPULATION? To answer, it is necessary to have an effective monitoring program. Effective monitoring would consist of a means to identify physical damage to pinnacles, cover large sea floor areas and be maintained in a cost effective manner. To accomplish "effective monitoring" MMS has used the latest technology, called a Sea Scan PC. This side-scan sonar system consists of a 600 kHz tow fish operated with a customized portable PC, appropriate software, and GPS location system. The whole system is very portable and can be operated by two or three people.

In summary, a high resolution 600 kHz side-scan sonar was employed to image the sea floor along predetermined track lines. A Trimble NT200D Differential Global Positioning System (DGPS) provided positioning control with accuracy of +/-10 meters. The DGPS was linked to the Marine Sonic side-scan to link the acoustic imagery to real-time positioning data. Because of water depths of up to 300 feet in some project areas, the survey could be run no faster than one knot in order to fly the side-scan fish approximately 5 meters off the sea floor. In addition, a depressor vane and an additional 20 pounds of ballast were added to tow the fish in these depths. Most of the survey was conducted at 75-meters per channel for a total coverage of a 150-meter survey swath width. The instrument performed well, and acquired detailed acoustic images even in 300-foot depths. Details of this system are presented in another paper covering this subject. Suffice it to say that the system is state-of-the-art and provides a detailed level of resolution exceeding previous systems. Side-scan images can also be converted to standard graphic format and examined in any of the several graphic software programs available for PC use.

### SURVEY DATA

To test this system and assess its suitability in our monitoring effort, we conducted a sample survey in the Main Pass Area. The objective of this operation was to inspect the sea floor in the vicinity of a sample of MMS-stipulated projects and other features of interest for evidence of adverse impacts resulting from MMS-permitted actions. A secondary objective was to collect high-resolution images of sea floor features. Investigated sites in the Pinnacle Trend included three parallel pipelines in MP224 and MP249, an 8-inch gas pipeline in MP262 and MP281, and work barge anchors at a structure in MP 252. Other inspected features include a structure removal in MP160, an artificial reef in MP166 (erroneously reported to MMS as a potential historic shipwreck), and a historic steamship. The results of the survey were recorded on a series of slides that show the following:

- the sample area in Maine Pass;
- side-scan images of various types of pinnacles (typical, flat-top, and boulder);
- the “smoking gun” anchor scar in close proximity to pinnacles; and
- typical biological assemblages associated with pinnacles.

Figure 1E.2 shows the pinnacles and the “smoking gun” anchor scar found at Main Pass 224. We also have images showing anchor scars in close proximity to pipe lines. However, it's not known whether the pipe lines were constructed before or after the anchor scar.

### CONCLUSION

Clearly, the anchor scar observed close to the pinnacles represents the potential for damage. Since this example was found during our first and limited survey, it indicates a concern for stipulation violation and possible ongoing and future damaging activity in the pinnacle trend area. Future surveys will provide more and better information, but, for the moment, data suggest a definite need for additional survey and observation.

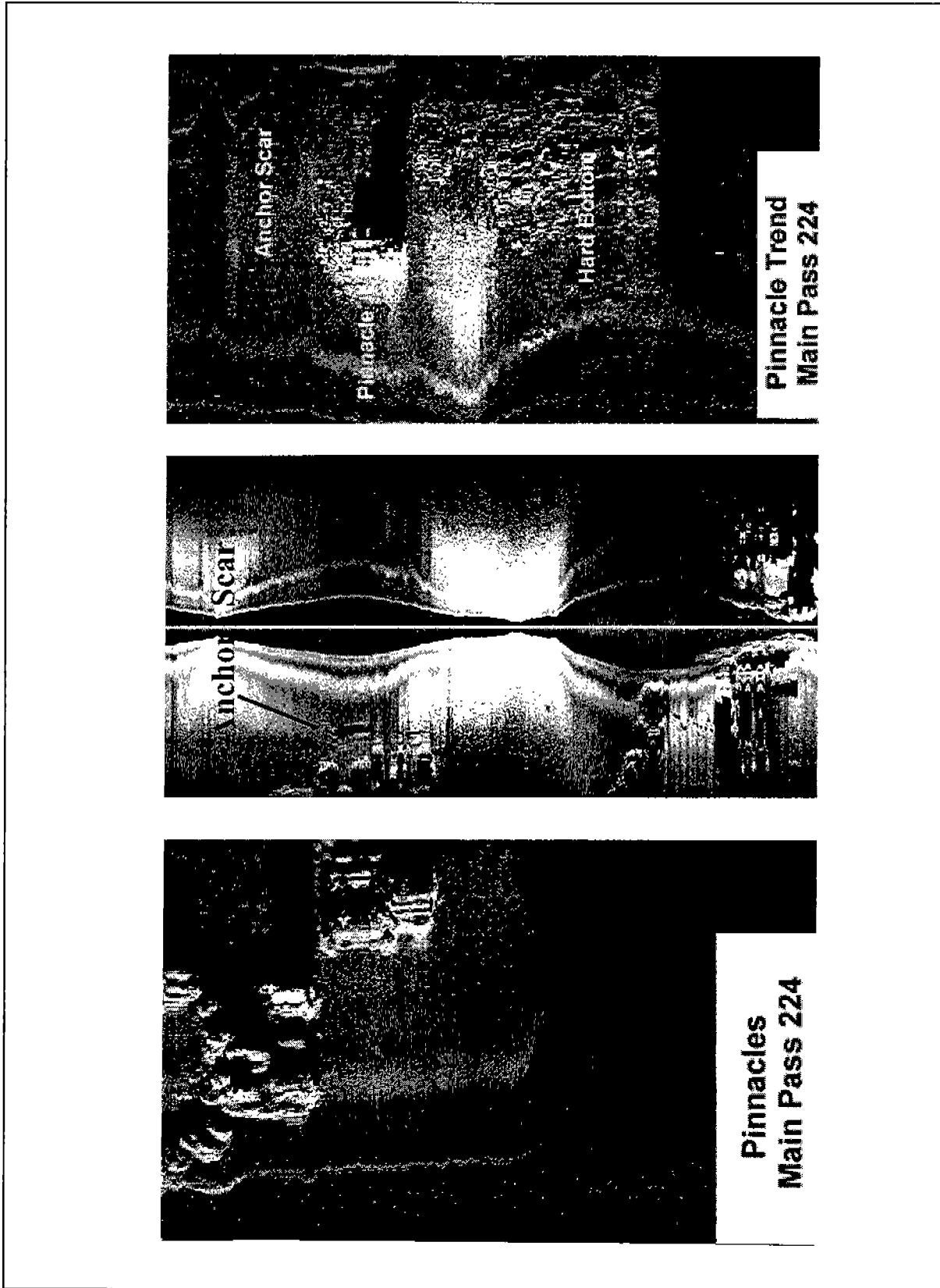

Figure IE.2. Images of pinnacles and the “smoking gun” anchor scar found at Main Pass 224.

The side-scan sonar imaging system will serve as a very useful tool in our efforts to ensure compliance with all the lease stipulations especially those pertaining to topographic features such as the pinnacle trend area.

---

Tom Yourk is currently an environmental scientist in the Minerals Management Service Leasing and Environmental Operations Section where he is involved with endangered species issues, database management, and offshore environmental monitoring using side scan sonar. Prior to this, he worked on environmental remediation for closed military bases under the Base Realignment and Closure Act with the U.S. Army and U.S. Air Force. He also worked with the U.S. Army Corps of Engineers in both the Planning Division and Regulatory Branch where he was involved with federal project environmental planning and 404 wetland permits respectively.

## ENVIRONMENTAL CHARACTERIZATION OF SONNIER BANK

Mr. Terry Dempre  
Dr. Ann Scarborough Bull  
Minerals Management Service  
Gulf of Mexico OCS Region

### INTRODUCTION

Sonnier Bank, located in Vermilion Area Block 305, resulted from reef development on outcropping rocks related to a piercement salt diapir. During the Jurassic period, thick salt deposits were formed by the evaporation of shallow seas across what is now the Gulf of Mexico. In subsequent times, large amounts of river transported sediments were deposited over this salt layer. The pressure of this overburden, along with the buoyancy of the relatively less dense salt, forced movement of salt bodies up towards the earth's surface and in some cases, through it. Such is the case at Sonnier Bank where a salt dome and related faulting have deformed and moved Pleistocene Age rock beds to an exposed position at the earth's surface (Figure 1E.3).

Climate changes during Pleistocene glacial periods led to a 300-foot or more drop in sea level resulting in the exposure of the rock beds at Sonnier Bank to erosion by wind and running water. The exposed central portion of the salt dome collapsed and the less resistant rock beds eroded away leaving the present situation of hard rock pinnacles rising from the 200-foot water depth of the sea floor to 75-foot below the water surface. These pinnacles originate from the upthrown sides of faults associated with the salt dome (Figure 1E.4). The pinnacles vary in size and depth and several are within depth limits accessible to dives (Figure 1E.5). In September 1997, Minerals Management Service led an expedition to investigate two of these structures. Minerals Management Service's Dive Team members made 14 dives to extensively photograph and video the geologic features. The

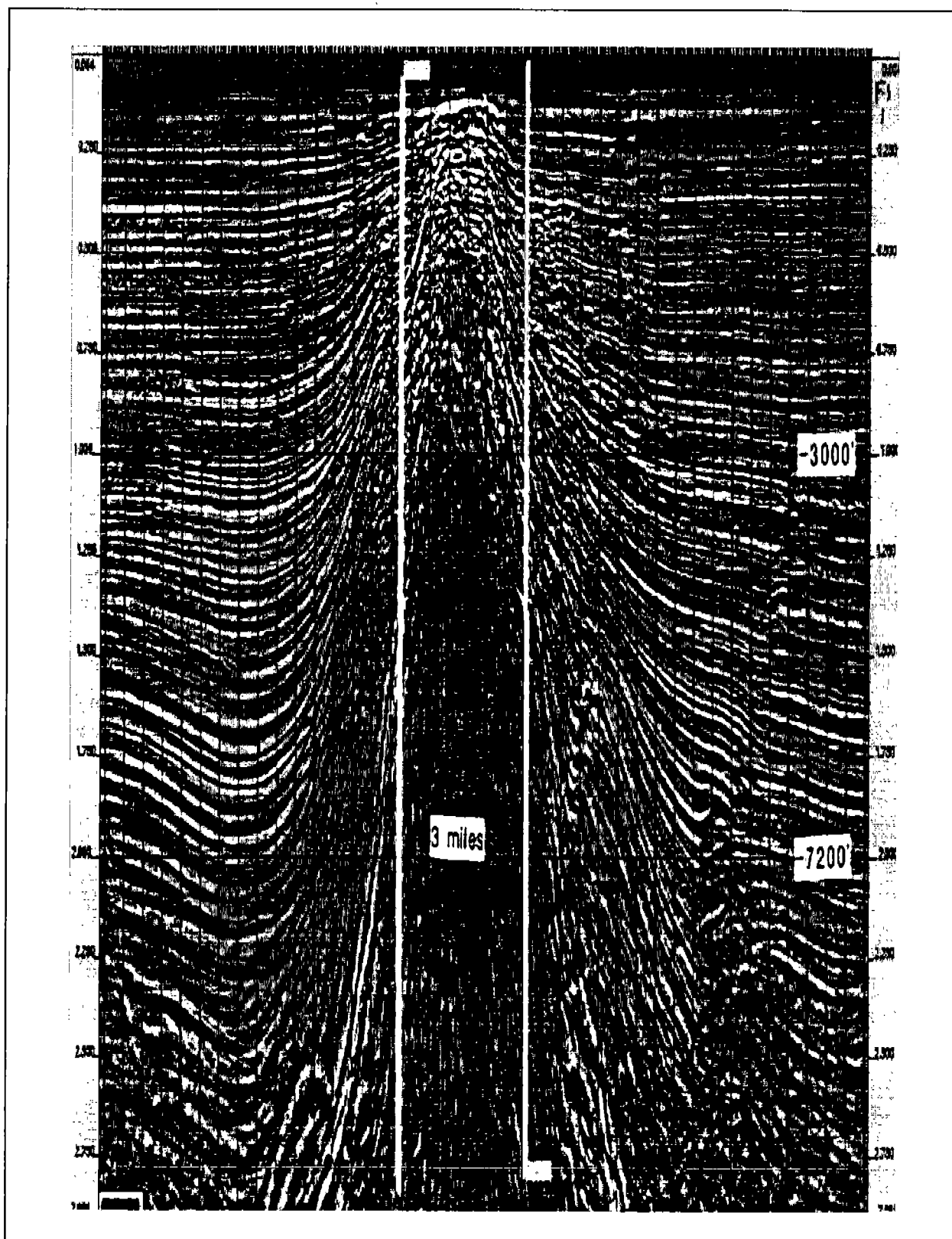

Figure 1E.3. Seismic response of Sonnier Bank salt dome.



Figure 1E.4. Three-dimensional view of Sonnier Bank. The central part of the dome was heavily eroded during periods of subaerial exposure. The area shown is three miles wide and three miles long.

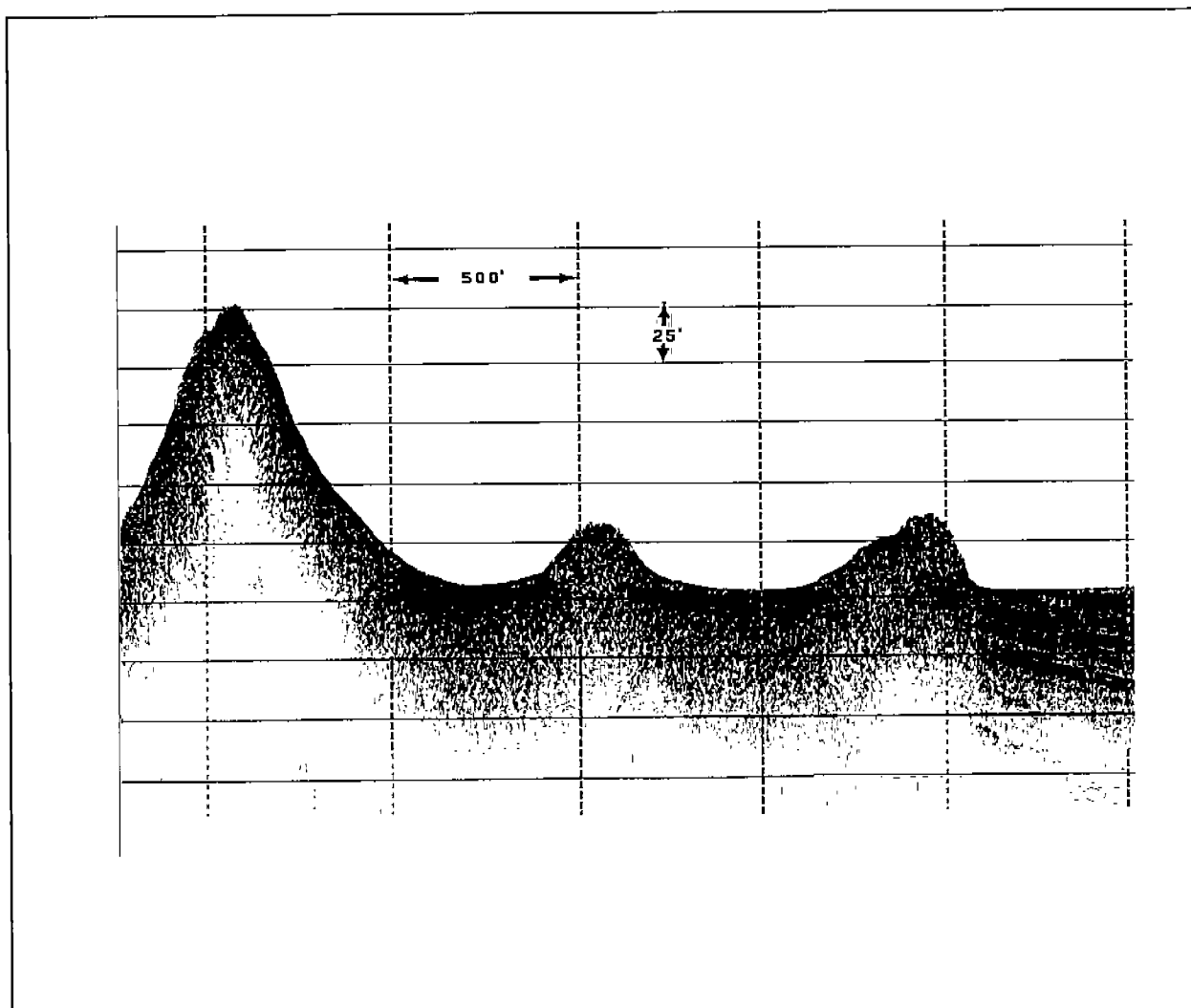

Figure 1E.5. Low energy seismic outline of Sonnier Bank. Note change in scale from previous illustrations.

outcropping beds exhibit dips of 45 degrees to 90 degrees and are composed of consolidated silts, clays, and sands. Thickness ranges from <1 inch to 1 foot (Figure 1E.6). Representative rock samples were collected and will be analyzed for mineral content and fossil age dating. A detailed side scan sonar survey was conducted over the area to aid interpretation of the complex structural relationships among the outcrops.

Salt domes are hydrocarbon production rich structures. The Vermilion Block 318 Field, on the south flank of the Sonnier dome, has several wells producing gas from Pleistocene age sands. Rock samples from Sonnier Bank will be correlated with the same age rock found in these wells.

The ongoing study of Sonnier Bank provides an opportunity to collect and analyze outcropping rocks on the floor of the Gulf of Mexico, thus contributing to a better understanding of salt movement and resulting effects on surrounding rock beds. These rocks also constitute the preserved sedimentary



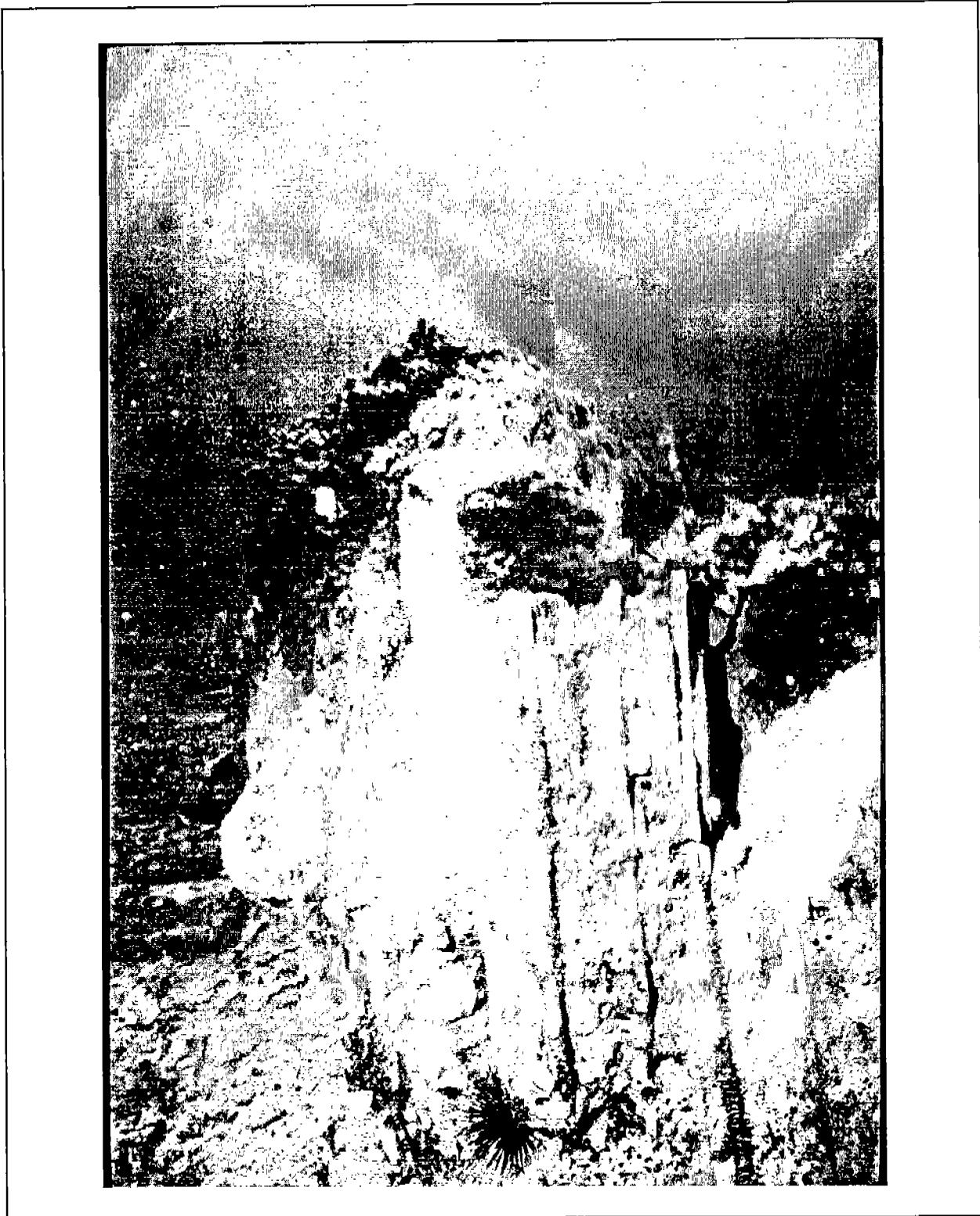

Figure 1E.6. Exposed rock beds at Sonnier Bank. These beds were deposited horizontally and subsequently displaced to a vertical position by the action of the rising salt dome. The beds range from less than one inch to several inches in thickness.

record of events resulting from changing sea levels. This information can be used to reconstruct the environment in which the sediments were deposited, helping in the prediction of the distribution of potential reservoir sands throughout the area. This is a vital step in the process of determining fair market value for lease tracts.

#### BRIEF DESCRIPTION OF THE LIVING RESOURCES AT SONNIER BANK

Sonnier Bank is a set of 8 pinnacles all within a single lease block, Vermilion 305, offshore in the Gulf of Mexico. We have identified a number of what we call topographic features (about 28) in the Gulf that rise up out of the surrounding mud/clay bottom. These features, of which Sonnier Bank is one, are all of greater biological importance, diversity, and interest than the surrounding seafloor areas. Banks in the Northern Gulf range from the Flower Garden Banks, which are now a National Marine Sanctuary, to features that are far less special for any number of reasons—low vertical relief, high sedimentation area, etc. MMS protects all of the identified features with stipulations that are attached to the lease at the time of the sale.

Sonnier Bank is an extraordinary place, but because of its out-in-the-middle-of-nowhere location, it is rarely visited. Prior to MMS's assessment of Sonnier Bank during 1996 and 97, the most recent scientific description, research also funded by MMS, is superficial and dates from 1974. The public interest in expanding Marine Sanctuaries, MMS's responsibility to adequately protect this place, and the fact that it was leased by Amoco in 1996, acted as a stimulus for MMS scientists, working through the MMS Dive Program, to go see it first hand. MMS put together a scientific effort to examine Sonnier Bank during 28 June–4 July 1996 and 29 September–3 October 1997. We evaluated and assessed the feature and all aspects of the biota to ensure that we afford Sonnier Bank the protection level that it warrants. We specifically mapped the features and observed the living biota. We could of course then speak with some direct knowledge when interacting with any interested parties, industries or environment groups.

The sponge fauna on Sonnier Bank was particularly well represented, with more varieties than divers could distinguish. Large barrel and vase type sponges dominated the landscape. Tube sponges and upright finger sponges were not found at Sonnier Bank. Numerous other species of ball, vase, and encrusting sponges were considered either common or abundant at Sonnier Bank. Brilliant-orange elephant ear sponges so abundant at the Flower Gardens Banks were also common at Sonnier. Black ball sponges, a preferred food of many angelfish and sea turtle species, were also conspicuous at Sonnier. The touch-me-not sponge was the dominant sponge, but because it grows very close to the substrate it is not as noticeable. Divers experienced great discomfort after the first encounters with this aptly named species that made installing the mooring buoy and mapping station quite difficult.

Cover on Sonnier Bank was variable but extremely high, probably 70%, and was dominated by fire coral, brown algae and in some places parchment tube worms. The species and abundance of algae indicate that waters over Sonnier Bank are clear and relatively sediment free during all seasons. Although coastal rivers and sediments do not seem to affect Sonnier Bank, the lack of hard corals indicates that temperatures do fall below 68 F during the winter time. With the exception of long-spined sea urchins and sea cucumbers, enchinoderms (starfish, etc.) did not appear to be an important

invertebrate group. The few species that were encountered likely play a significant role in affecting benthic community structure. Decapod crustaceans were probably not well represented, but the size of the specimens in relation to the Bank made them very conspicuous. Spiny and slipper lobster were likely at their maximum size by measurement. Slipper lobster probably weighed several pounds each.

Sonnier Bank has a surprisingly high density and diversity of fish. The community numbered over 100 species representing all trophic guilds. In all, 9 orders and 36 families of fish have been recorded at Sonnier Bank. Numerically dominant species included the planktivorous creole fish that is also common on bluewater offshore platforms in the Gulf. Reef fish such as the queen angelfish appeared to be unusually large. This trait is also common of angelfish at Stetson bank and may be due to the abundance of sponges on the banks, a preferred food item of angelfish, and a lesser degree of competition for that food. Reef fish species are food specialists and extremely faithful to location. The bright coloration and good condition found on all fish species at Sonnier Bank indicates a well-fed relatively unstressed population located in waters of very high quality and stable circumstances. The reef fish community was represented by nocturnal as well as diurnal species. The strong representation of reef fish species at Sonnier compares favorably with the Flower Garden Banks and Stetson Bank fish assemblages.

Several stingrays were evidently in residence during early summer at Sonnier Bank. All of the fish species including the stingrays were exceedingly tolerant of humans and were easily approached. These rays were full grown with tails measuring close to 10 feet in length. They may have been feeding on the large spiny lobster at the bank; however, divers did not observe scattered pieces of lobster carapace. Eighteen species of epipelagic fish were observed, including amberjack. These species occur most often in the upper depths of the water column surrounding the bank and do not necessarily exhibit a close affinity to reef structure. However they may descend on the reef in order to hunt for food. Early summer is the time for trigger fish spawning in the Gulf of Mexico. Triggerfish were visible at Sonnier Bank above the gravel-like sediments caught in pockets and around the edges of the bank. The triggerfish blew jets of water into these sediments which resulted in the formation of a conical depression into which they would lay and incubate their eggs. This was another indication of a healthy fish community.

---

Terry Dempre has worked as a geophysicist for the Resource Evaluation Section of the Minerals Management Service since 1981. His principal duties have been geologic and geophysical assessment of the Gulf of Mexico lease tracts for determination of fair market value. He has also been involved in mapping existing hydrocarbon fields as an aid to reserve estimates. His research interest focuses on Gulf of Mexico seafloor geology. His undergraduate years were spent at the University of New Orleans with graduate studies at Tulane University.

Ann Scarborough Bull has worked as a marine biologist for the Minerals Management Service since 1988. She performed her graduate research at the Marine Biological Laboratory, Woods Hole, and her post doctoral work at Johns Hopkins in Maryland. Her research interests focus on the role of offshore platforms in the fisheries of the Gulf of Mexico.

## ARCHAEOLOGY AND THE GULF OF MEXICO REGION SEA FLOOR MONITORING PROGRAM

Dr. Richard J. Anuskiewicz  
Minerals Management Service  
Gulf of Mexico OCS Region

### MONITORING ARCHAEOLOGICAL RESOURCES ON THE OCS THROUGH LEGISLATIVE MANDATES

The Federal Government has had a long legislative history of formulating laws and statutes to evaluate and protect, where appropriate, significant archaeological resources. As a part of this legislative history, monitoring became, and still is, the only method of checks and balances used to review and evaluate impacts to archaeological resources as a result of the Federal permitting process. Three major statutes and laws have contributed to Federal management of archaeological resources. They include the Antiquities Act of 1906, the Historic Site Act of 1935, and the National Historic Preservation Act of 1966, as amended (US DOI/NPS CRP 1990, Carnett 1991). The Antiquities Act initiated archaeological site protection by specifying protection of antiquities on lands owned or controlled by the Federal Government. The Historic Site Act declared a Federal policy to preserve historic and prehistoric resources. Perhaps the most appropriate piece of Federal legislation directly related to oil and gas development in the Gulf of Mexico is the National Historic Preservation Act. This legislation states that the Agency official with jurisdiction over a Federal undertaking has legal responsibility to identify and evaluate affected archaeological properties and assess an undertaking's effect upon them. In the MMS, each Regional Director is the Agency official doing the permitting to the oil and gas industry, and, therefore, has the legal responsibility of designating and protecting archaeological resources.

### RECOGNIZING POTENTIAL ARCHAEOLOGICAL RESOURCES ON THE SEA FLOOR

As Dr. Irion and Mr. Yourk pointed out in an earlier paper on the MMS Gulf of Mexico Region's (GOMR) monitoring program's new high-resolution side-scan sonar, technology can be used as an effective means to monitor impacts to the ocean floor. The MMS GOMR archaeological resource management program focuses on evaluating potential impacts to either prehistoric or historic resources on the seafloor. This is accomplished through reviewing geophysical reports for lease block and pipeline corridor surveys submitted to the MMS by the oil and gas industry. Submerged archaeological resources on the OCS fall into two basic categories: they are either prehistoric or historic features on or near the surface of the seafloor.

Potential prehistoric archaeological resources are more difficult to locate and identify than historic ones. Prehistoric resources are represented by former geologic land forms located on or buried just below the seafloor in shallow sediment. These features, such as natural levees, river and stream terraces, shell midden concentrations, and sinkholes, can be recorded and identified by surveying with shallow-penetrating seismic instrumentation. Potentially important prehistoric geologic features

can be identified by examining examples of subbottom profile data presented in archaeological and hazards survey reports submitted to the MMS by the oil and gas industry.

Historic archaeological resources, on the other hand, can be easier to identify because they usually are represented by a physical or tangible object on the seafloor such as the physical remains of a shipwreck. Shipwrecks lying on the sea floor can be accurately located, recorded, and mapped by using side-scan sonar imagery in consort with a magnetometer survey and Differential Global Positioning System navigation. The remains of shipwrecks buried in the shallow sediment are, of course, another potential problem. The MMS, however, takes a reasonable approach in managing these potential buried wreck sites on the OCS by specifically looking at the recommendations of the contract archaeologist and his analysis of avoidance of unidentified magnetic anomaly clusters recorded during lease block and pipeline surveys. From these recommendations, the MMS staff archaeologist reviews the report and determines the appropriate avoidance mitigations for plans and pipeline requesters as a condition of their construction permit.

#### POTENTIAL IMPACTS TO ARCHAEOLOGICAL RESOURCES ON THE OCS

There are three basic probable scenarios as to how archaeological resources can be physically impacted or disturbed on the OCS sea floor. They include commercial fishery trawling, private or commercial vessel anchoring, and seafloor construction activities associated with oil and gas exploration and development.

Anyone who has been on a Louisiana beach during shrimping season can attest to the systematic trawling pattern by hundreds of shrimp boats in their quest for shrimp offshore. One could venture to guess that just about every square foot of the Louisiana seafloor, out to the OCS Shelf Break, has had a shrimp trawl dragged across it. Trawling scars are relatively shallow and tend to smooth out the bottom and move sea floor debris around. This impact to the seafloor is real, on going, and continuing. Moving around of seafloor debris causes problems with resource evaluation (Irion and Bond 1988:88; Anuskiewicz and Irion 1995).

Another impact to the seafloor could come from commercial and private vessels anchoring overnight or waiting out a storm. We estimate that this type of impact probably has taken place at irregular intervals to some extent throughout the Gulf. The amount, shapes and depths of anchor scars from these vessels would vary depending upon vessel size, anchor weight, and water depth. What's important here is that we believe that these anchor scars do occur, but with a lot less frequency than those resulting from shrimping trawls and oil-and gas-related seafloor impacts.

The third and very plausible scenario of seafloor impact is caused by construction activities associated with oil and gas exploration and development. These potential seafloor impacts are the focus of the remainder of this presentation. The GOMR archaeological resource management program has always been concerned about oil and gas industry related impacts to potential archaeological resources on the seafloor. However, until now we did not have the budget, technology, and human resources support to develop a viable monitoring program (Irion and

Anuskiewicz 1997a). With all these support elements now available, we have completed our first successful year of seafloor monitoring.

Prior to going out and conducting archaeological monitoring we developed a strategy based on some basic questions. What type of damage would we expect to find as a result of oil and gas activities? What is the actual site or impact formation process (Anuskiewicz 1989:78)? In our research of these issues we learned that, generally, seafloor impacts by oil-and gas-related activities are caused by the placement of an exploratory jack-up rig, placement of a permanent production platforms, and cutting of a 1-meter trench in the seafloor to bury a pipeline. The jack-up rig placement causes the least amount damage to the ocean bottom because after the rig is floated in three legs are lowered in place. However, pipeline trenching and permanent platform placement cause the most seafloor impacts because of the use of anchor barges during the construction process.

With some idea of what to look for on the seafloor and management support of our program ideas, we looked towards the state of technology-transfer for our sea floor monitoring. During the development of a formal monitoring strategy for archaeological resources, GOMR staff archaeologists researched and field tested the available 600-kHz side-scan-sonar technology (Irion and Anuskiewicz 1997 b and c). In an earlier presentation, Dr. Irion discussed the imagery technology in detail and, frankly, we admit we were impressed at the image detail, resolution, instrument deployment, digital data gathering capabilities, and total cost.

To field test this new side-scan system's archaeological capability, we conducted a survey over a known 19<sup>th</sup>-century side-wheel steamboat wreck located off Horn Island, Mississippi. We feel this is an excellent example of the capabilities of this side-scan technology. From the 75-meter scale we clearly saw the outline of the iron hull, the bow and stern, paddle wheels, and steam engine components. The 25-meter scale view showed a lot more detail, including paddle wheel shafts and eccentrics, the walking beam, some engine parts, and the two boilers.

Applying this new side-scan technology to the archaeological resource management program was not too difficult. These potential resources either were or were not impacted. Our measurement tool was the high resolution side-scan imagery of the seafloor in areas where oil and gas activities occurred.

One of our archaeological monitoring projects involved side-scanning the remains of a 19<sup>th</sup>-century side-wheel steam vessel the *New York*, which sank during a hurricane in 1846. It is located in the High Island Area (Munson, Avery per. comm. 1997) about 82 kilometers offshore Texas. Historical records indicated the vessel broke up during the sinking. The remains of this vessel are protected by legislative mandates because these remains meet eligibility requirements for listing in the National Register of Historic Places. To provide reasonable protection from impacts that may be caused by oil and gas exploration and development, the MMS needed to determine the extent of the debris field associated with the shipwreck. This was accomplished by conducting a close-interval marine magnetometer and side-scan survey. Once this was completed, a reasonable set of avoidance mitigation criteria was developed so that oil and gas development in this block could continue and not impact this significant historic resource.

Our final example was an attempt to monitor lay barge anchor patterns associated with the construction of a pipeline. We knew that there were multiple anchoring positions needed to trench and physically construct a pipeline. However, what we didn't realize was the sheer number of anchor placements associated with this type of seafloor construction. Our test case example involved the installation of a 5,800-foot pipeline. We counted at least 124 anchoring positions used to construct a pipeline a little over one mile long. The lease block contract archaeologist recommended avoidance of three clusters of magnetic anomalies and an area of channel margins suggestive of prehistoric site potential. From the map submitted we can see that the lay barge anchor position did avoid the magnetic anomalies. However, the operators did not manage to avoid the channel margins recommended for avoidance.

### CONCLUSION

The first year of using a high resolution side-scan-sonar system, as a management tool for the archaeological resource management program was extremely successful. This system provides an easy-to-operate, cost-effective method to answer some basic questions when it comes to determining if an impact has occurred to the seafloor and to a potential archaeological resource. It's as easy as "yes" or "no" in most cases. Further, this instrument provides an accurate and effective means to evaluate historic resources on seafloor, as can be seen through the MMS evaluation of 1847 side-wheel steam ship. Year Two of this program will provide another field season and opportunity to gather more reliable information and better prepare the MMS archaeological resource program managers to make better resource management recommendations, and ultimately, better higher level management decisions.

### REFERENCES

- Anuskiewicz, Richard J., 1989. A study of maritime and nautical sites associated with St. Catherines Island, Georgia. Doctoral dissertation presented to the University of Tennessee, Knoxville.
- Anuskiewicz, Richard J. and Jack B. Irion, 1995. Trash or treasure? MMS Guidelines and Methodological Procedures for Identification of Submerged Magnetic Anomalies by the Commercial Diving Industry. *In*: Proceedings Fifteenth, Annual Gulf of Mexico Information Meeting. U.S. Department of the Interior, Minerals Mgmt. Service. New Orleans.
- Carnett, Carol, 1991. Legal background of archaeological resource protection. U.S. Department of the Interior, National Park Service, Cultural Resource, Archaeological Assistance. Washington, D.C.
- Irion, Jack B. and Clell L. Bond, 1998. Identification and evaluation of submerged anomalies, Mobile Harbor, Alabama. Report prepared for U.S. Army Corps of Engineers, Mobile District. Contract No. DACW01-83-C-0124, Report No. COESAM/PD-EC-84-004.

Irion, Jack B. and Richard J. Anuskiewicz, 1997a. Proposed development of environmental monitoring pilot project. Paper prepared for and presented to the Regional Director, Minerals Mgmt. Service, Gulf of Mexico Region. New Orleans.

Irion, Jack B and Richard J. Anuskiewicz, 1997b. Trip report for SeaFloor monitoring program, Pinnacle Trend, Main Pass Area. Report prepared for the Regional Supervisor, Leasing and Environment, Minerals Mgmt. Service, Gulf of Mexico Region. New Orleans.

Irion, Jack B. and Richard J. Anuskiewicz, 1997c. Trip report for SeaFloor monitoring program, High Island Area. Report prepared for the Regional Supervisor, Leasing and Environment, Minerals Mgmt. Service, Gulf of Mexico Region. New Orleans.

Munson, Avery, 1997. Personal Communication

U.S. Department of the Interior, National Park Service, Cultural Resource Programs, 1990. Federal historic preservation laws. Washington, D.C.

---

Rik Anuskiewicz was awarded his B.A. in 1972 and his M.A. in 1974 in Anthropology, with specialization in archaeology from California State University at Hayward. Rik was employed with the U.S. Army Corps of Engineer Districts of San Francisco, Savannah, and New England Division from 1974 to 1984, as a terrestrial and underwater archaeologist. In 1980 he began work on his doctorate. In 1984 he accepted his present position with Department of the Interior, Minerals Management Service, Gulf of Mexico Region as a marine archaeologist. Rik received his Ph.D. in 1989 in Anthropology, with specialization in marine remote-sensing and archaeology from the University of Tennessee at Knoxville. Rik's current research interest is focused on using remote-sensing instrumentation as a tool for middle-range theory building through the correlation of instrumental signatures to specific observable archaeological indices.

## **REFINING THE HIGH PROBABILITY SHIPWRECK MODEL IN THE GOMR**

Dr. Jack B. Irion  
Minerals Management Service  
Gulf of Mexico OCS Region

Part of the mission of the MMS is to ensure that significant archaeological sites are not adversely affected by oil and gas exploration and development. This responsibility often includes the protection of historic shipwrecks. Historical research conducted for MMS Studies 89-0023, 24, and 25 indicates that over 400 ships have sunk on the federal OCS dating from 1625 to 1947; thousands more have sunk closer to shore in state waters during the same period. Only a handful of these has been



scientifically excavated by archaeologists for the benefit of generations to come. In several cases, the MMS has partnered with state and federal agencies conducting this research. The work conducted by the MMS and other scientists in the Gulf of Mexico contributes to our understanding of how our nation developed by studying the technology that fostered the growth of the United States.

For several millennia, ships were the most sophisticated machines on earth. They have shaped history by expanding trade and waging war, spreading ideas (and sometimes plague), and discovering and colonizing new lands. At the same time, the crews of these ships lived in closed societies, with traditions, beliefs, vocabularies, and hierarchies that set them apart from those on shore. When one of these ships met with disaster at sea or sank as a result of war, its remains literally became a time capsule, preserving clues to the story of our past. When archaeologists scientifically excavate a shipwreck under water, they read these clues to form a picture of what it was like to live on a ship that sank hundreds of years ago. In that sense, shipwrecks are special archaeological sites because, unlike sites on land, everything on board was in use during a single moment in time. Because of this, the study of shipwreck sites has contributed to the understanding of broader issues of human history, and helps us to understand better who we are by telling us where we have been. The MMS has taken part in the study of some of the most historically significant shipwrecks in the Gulf.

#### A SEVENTEENTH CENTURY WRECK: LA SALLE'S *BELLE*

One of the most significant underwater archaeological finds in North America was made by a team from the Texas Historical Commission (THC) in 1992 in 12 feet of water in Matagorda Bay. After the team recovered a distinctive bronze cannon more than six feet long, weighing some 700 pounds and bearing the crest of Louis XIV, they hypothesized that the vessel was the French ship *Belle*. The *Belle* was the smallest of four ships sailed by French explorer René Robert Cavellier de La Salle in his ill-fated search for the mouth of the Mississippi River in 1684. The team also recovered pewter plates, lead shot, several complete pottery vessels, a stoneware pitcher, a sword hilt, a brass buckle, bells, straight pins, glass trade beads, and an iron pike with remnants of a wooden handle. The artifacts are well preserved, having been covered in the sand and mud of Matagorda Bay. Scientists from the MMS were invited to participate in this important project during the excavation and gained insight into how wrecks of a similar age might appear in federal waters. Analysis of the magnetic signature of this wreck will provide the MMS with valuable comparative data for the review and analysis of shallow hazard and archaeological survey reports.

Archaeological excavation of the wreck site began in 1996. Because conditions under the murky waters of Matagorda Bay were so poor, the THC undertook construction of a steel cofferdam around the site at a cost of over \$1 million. After the water was pumped out of the 148-foot by 118-foot enclosure, the wreck could be excavated as if on dry land.

Although an expensive procedure, the effort proved worthwhile and permitted the recovery of extraordinarily fragile objects such as coils of rope, items of clothing, and a wooden gun carriage. The remains of a French sailor were even found preserved in the bow section. Using the skull to reconstruct the face, scientists have re-created the appearance of one of La Salle's crew who lost his life on the Texas shore 313 years ago.

The vessel's mission included the establishment of a colony at the mouth of the Mississippi and trade with the Indians. The excavated hull contained ample evidence of the latter in the form of thousands of tiny glass beads and beautifully crafted hawk's bells. Other finds included crated muskets, two more bronze cannon for use in the intended fort, tools, and pewter dinnerware. One of the most historically valuable artifacts, however, is the hull of the ship itself. The *Belle* is the oldest French colonial shipwreck found in the New World, and represents a transition period in naval architecture. Study of the hull will provide information on the undocumented shift from ancient to modern methods of shipbuilding. Artifacts, including the hull, will be conserved at Texas A&M University.

#### AN EIGHTEENTH CENTURY SITE OFF LOUISIANA

An eighteenth century site was discovered off the Chandeleur Islands, east of the Mississippi River delta. The site was investigated by Texas A&M University published under MMS Report 89-0092. A ballast pile, pottery shards, a lead patch, a lead bilge pump tube, and six iron cannon were recorded during the investigation. No hull remains were found at the site and researchers concluded that the site represented the location of an accidental grounding and discard of unnecessary ballast and ordnance to lighten the ship. This hypothesis was supported by the fact that all six cannon were damaged in some way and, while useless as ordnance, could have functioned as ballast. Interestingly, three of the cannon were of Swedish manufacture and were cast between 1771 and 1784.

#### NINETEENTH CENTURY SHIPWRECKS

Over 70 vessels are believed to have wrecked on the OCS between the beginning of the nineteenth century and start of the Civil War in 1861. One of the most historically significant of these is the wreck of the *New York*, a side-wheel steamship engaged in trade between Galveston, New Orleans, and New York from 1839 to her loss in 1846. The wreck site was recently discovered by private citizens who are cooperating fully with the MMS to preserve the site's archaeological information and to ensure that it is not impacted by future oil and gas development. The MMS is taking an active role in encouraging divers to preserve and record the historical and archaeological data contained in wrecks on the federal OCS. In this way, the interests of the salvors, sport divers and the American people can be protected.

#### THE CIVIL WAR (1861-1865)

The Civil War in the Gulf is defined by the Northern strategy of the blockade of Southern ports and the daring attempts by Confederate vessels to run this blockade. A number of important Civil War vessels have been located in state waters, such as the Confederate ironclads CSS *Louisiana* in Plaquemines Parish, Louisiana, and the *Huntsville* and *Tuscaloosa* in the Mobile River. The remains of the Union ironclad *Tecumseh*, whose sinking by a Confederate mine prompted Farragut's famous order "Damn the torpedoes, full speed ahead!" are well known off Fort Morgan, Alabama. Only one U.S. warship, however, was sunk at sea in the Gulf. This important shipwreck, the USS *Hatteras*, has been the subject of repeated investigations by the MMS, the Texas Historical Commission, and Texas A&M University at Galveston.

The USS *Hatteras* was a side-wheel steamer acquired by the Navy in 1861 and armed with four 32-pounder cannon (a 20-pounder rifled cannon was added later). After distinguished service in the South Atlantic Blockading Squadron, the vessel was transferred to the Gulf Blockading Squadron on 26 January 1862. In less than a year, the *Hatteras* captured seven Confederate blockade runners off Vermilion Bay, Louisiana. Early in 1863, she was ordered to join the squadron under Rear Admiral David Farragut, who was attempting to retake the key Texas port of Galveston.

As the blockading squadron lay off the coast on the afternoon of 11 January 1863, a set of sails was sighted just over the horizon, and the *Hatteras* was ordered to give pursuit. She chased the intruder for four hours, closer and closer into shore, and farther and farther from her supporting fleet. Finally, as dusk was falling, the *Hatteras* came within hailing distance of the square-rigged, black-hulled vessel. Commander Homer C. Blake demanded to know the identity of the ship. "Her Britannic Majesty's Ship *Vixen*," came the reply. Blake ordered one of *Hatteras*' boats launched to inspect the "Britisher." Almost as soon as the boat was piped away, a new reply came from the mystery ship, "We are the CSS *Alabama*!" A broadside from the *Alabama*'s guns punctuated the reply. Within 13 minutes, the *Hatteras*, sinking rapidly, surrendered.

The *Hatteras* today rests in 58 feet of water about 20 miles off Galveston. Her 210-foot long iron hull is completely buried under about three feet of sand. Only the remains of her 500-horsepower walking beam steam engine and her two iron paddle wheels remain exposed above the sea floor. Since the site's discovery in the 1970s, MMS has engaged in periodic monitoring of the wreck to ensure that it is not damaged by surrounding oil and gas lease development. Although the wreck remains the property of the U.S. Navy, MMS has joined forces with the THC and Texas A&M at Galveston to preserve this important archaeological treasure for posterity. The wreck of the USS *Hatteras* is an integral part of the story of the Civil War on the Texas coast, the defense of which is regarded as one of the greatest military feats of the Confederacy. The ship's dramatic history, along with the fact that the remains of the vessel are virtually intact, make it one of the most important underwater archaeological sites in the United States.

## THE TWENTIETH CENTURY - SHIPWRECKS FROM WORLD WAR II

Federal law defines an historic site as being at least 50 years old. As a result, wrecks associated with World War II now meet that criterion. Nearly all the shipwrecks in the Gulf from that period relate to one cause—attack by the German submarines known as "U-boats." U-boat comes from the German word "Unterseeboot."

During the years 1942 and 1943, a fleet of over 20 German U-boats cruised the Gulf, seeking to disrupt the vital flow of oil carried by tankers from ports in Texas and Louisiana. They succeeded in sending 56 vessels to the bottom; 39 of these are now believed to be in state or federal waters off Texas, Louisiana, and Florida. After their initial, devastating success, U-boat attacks in the Gulf became rare by the end of 1943, after merchant vessels began cruising in armed convoys. The opening of the "Big Inch" pipeline from Texas to New Jersey also contributed to freeing the war effort from relying on ships to transport crude oil.

As a result of remote-sensing surveys required of the oil and gas industry by the MMS, several U-boat casualties have been located on the sea floor. These include the *Heredia*, a United Fruit Company freighter; the oil tanker *Sheherezade*; the *Gulfpenn*, which carried 90,000 barrels of fuel oil; and the *Robert E. Lee*, a passenger freighter sunk by the U-166. The U-166 was the only German U-boat sunk in the Gulf, ostensibly by an American torpedo plane 20 miles off the coast of Louisiana. Its exact whereabouts still remain a mystery that will, perhaps, one day be solved through the cooperative partnership of government and industry to protect and preserve our history beneath the sea.

As a result of industry surveys, over 80 shipwrecks have been identified in the Gulf of Mexico. Many of these are modern wrecks—supply boats, crewboats, shrimpers, etc. Most remain unidentified because industry generally elects to avoid a potential historic shipwreck rather than determine if it is, or is not, historic.

However, MMS' high probability model is based on the probable presence of an historic wreck in an individual block based on historic records. Because historic records are inherently inaccurate, if a wreck was found reported at a particular location, then not only that block, but also the eight blocks around it are designated as historic high probability block. This means that industry is required to survey the block using side-scan sonar, magnetometers, and sub-bottom profilers at a 50-meter lane spacing, as opposed to the normal 300-meter spacing required for hazard surveys. This translates into additional time and somewhere around an additional \$40,000 in survey cost for each block.

With the discovery and documentation of some of the historic wrecks that trigger the 50-meter designation, we are able to revise the list of historic blocks and provide some relief to industry in the form of reduced survey costs. This year alone, we have released lease blocks in Galveston, South Timbalier, and Vermilion areas because of the documented discoveries of the *Hatteras*, the *La Belle*, and the *New York*. This action has resulted in a savings to industry of nearly one half million dollars. As we continue to locate and identify shipwrecks in the Gulf, we will continue to release other blocks from the 50-meter survey requirement.

Unfortunately, as more and more areas are surveyed, we are also finding that our historic block designations are not quite as accurate as one would hope. There are many reasons for this: in the days before satellites when positioning was reckoned using astrolabes, sextants, and chronometers, an accuracy of five miles was considered outstanding. Under conditions of storms, hurricanes, or warfare, accurate reckoning of position at the point at which your ship was sinking beneath you was unlikely. Secondly, reporting of wreck positions depended upon survivors accurately reporting their tale. More often than not, wrecks are reported as occurring simply "between Galveston and New Orleans" or "about 50 miles southwest of Galveston." Even relatively recent wrecks from World War II are not accurately reported. Both the *Robert E. Lee*, a 1,632-ton passenger ship sunk 1 August 1942, by the U-166 and the *Gulf Penn*, an 8,862-ton freighter sunk in May of the same year, were found west of the high probability blocks in Mississippi Canyon thought to contain them. Side-scan has located three wrecks believed to be the *Heredia*, the *R. W. Gallagher*, the *Hamlet* in Ship Shoal Area, all far to the south of where their historically recorded positions placed them. More importantly, the 1846 wreck of the steamship *New York*, an historic site eligible for inclusion in the

National Register of Historic Places and one of the most important shipwreck sites in the Gulf, not only lay outside the high probability areas, but failed to be recognized by an oil company survey at 150-meter survey interval. It has become obvious, at least to the archaeologists at MMS, that the high probability area model is in sore need of revision now that it has been in effect for some 10 years. We are attacking this problem in two ways. First, we will be working with students at the University of New Orleans to conduct more in depth historical research, which we hope will provide us with better locational information. Secondly, we propose to investigate reported shipwrecks during the sea floor monitoring investigations using high resolution side-scan sonar and the MMS Scientific Dive Team. These investigations should help to positively identify more wrecks. Our underlying philosophy is that the more that is known about the location of historic shipwrecks on the sea floor, the less restrictive we have to be to industry in order to fulfill our obligation to safeguard our archaeological resources beneath the sea.

#### FURTHER READING

- Arnold, J. Barto, III and Robert S. Weddle. 1978. *The nautical archaeology of Padre Island*. Academic Press, New York.
- Garrison, Ervan G., C.P. Giammona, J. Jobling, A.R. Tripp, E.N. Weinstein, and G.A. Wolff. 1989. *An eighteenth-century ballast pile site, Chandeleur Islands, Louisiana*. OCS Study MMS 90-0092 prepared by Texas A&M Research Foundation, College Station, Texas.
- Hayes, Charles W. 1971. *Galveston, history of the island and the city*. Jenkins Garrett Press, Austin, Texas.
- Pearson, Chas. E. & Paul E. Hoffman. 1995. *The last voyage of El Nuevo Constante: The wreck and recovery of an eighteenth century shipwreck off the Louisiana coast*. LSU Press, Baton Rouge, Louisiana.
- Robinson, Charles M. 1995. *Shark of the Confederacy: the story of the CSS Alabama*. Naval Institute Press, Annapolis.
- Semmes, Raphael. 1962. *The Confederate raider, Alabama: selections from memoirs of service afloat during the War Between the States*. Fawcett, Greenwich, Conn.
- Weddle, Robert S. 1991. *The French thorn: rival explorers in the Spanish Sea, 1682-1762*. Texas A&M Press, College Station, Texas.
- Wiggins, Melanie. 1995. *Torpedoes in the Gulf*. Texas A&M University Press, College Station, Texas.
-

Dr. Jack B. Irion joined the Minerals Management Service, U.S. Department of the Interior, in August 1995, with the title of Marine Archaeologist. Prior to joining the MMS, Dr. Irion served as Vice President for Nautical Archaeological Services with the consulting firm of R. Christopher Goodwin & Associates, Inc., in New Orleans, Louisiana. For over 15 years, Dr. Irion provided archaeological consulting services to the Baltimore, Charleston, Mobile, New Orleans, Pittsburgh, Philadelphia, Savannah, Vicksburg, and Wilmington Districts of the Corps of Engineers, as well as to the Maryland Port Administration, and the State of Tennessee. Dr. Irion received his B.A. (1974) and M.A. (1977) in Archaeological Studies from The University of Texas at Austin. He was awarded his Ph.D. from the Institute of Latin American Studies of the University of Texas in 1991. During his career, Dr. Irion has specialized in conducting remote sensing surveys for shipwrecks, which succeeded in locating such historically significant vessels as the C.S.S. *Louisiana*, the sailing barque *Maxwell*, and the steamboats *Princess*, and *Kentucky*. In addition, he has directed numerous diving investigations on historic shipwrecks, including the steamship *Columbus* and the Civil War gunboats *Tawah* and *Key West*. Most recently, he has participated in MMS investigations of the Civil War vessel U.S.S. *Hatteras* and the steam packet *New York*.

## **ROLE OF THE GULF OF MEXICO OCS REGION'S SCIENTIFIC DIVING TEAM IN SEAFLOOR MONITORING**

Mr. Les Dauterive  
Minerals Management Service  
Gulf of Mexico OCS Region

Following its creation in 1982, the Minerals Management Service (MMS) made one of its highest priorities to establish public confidence in the offshore program by using good science in decision making. After the MMS was charged to permit offshore oil and gas development in an environmentally sound manner, it became necessary to know more about the environment it was protecting. Since that environment lies within the sea, the most efficient and cost-effective means of accomplishing that goal sometimes has been for MMS scientists to jump off a boat with a tank of compressed air on their backs and see for themselves. For over 20 years, the MMS Gulf of Mexico Region (GOMR) diver scientist have been doing just that, with the results that inter-agency conflicts have been resolved, significant biological features have been protected, safety issues have been reported and corrected, historic shipwrecks have been discovered, controversies have been averted, and seafloor impacts have been discovered.

The MMS GOMR dive team is comprised of a group of hard-working, dedicated diver scientist who strive to provide the Region with scientific information through underwater observation, photo and video documentation, and other forms of data-gathering supportive of the MMS mission. The scientific dive team consists of marine archaeologists, marine fisheries biologist, a coral reef ecologist, an environmental scientist, geographer, and geophysicist.

Categories of diving operations conducted by the dive team and supportive of the MMS mission involve the following:

- **Monitoring Environmental Studies Contracts:** The ability to get the Region's dive team as MMS contract technical representatives in the water allows for a direct monitoring of the contract study.
- **Assessment of Topographic Features and Live Bottom:** The ability of the Region's dive team to assess the condition of natural biological resources is used to determine the appropriate levels of protection afforded these resources.
- **Identification of Historic Shipwrecks:** The ability of the Region's dive team to identify shipwrecks by ground-truthing has released lease blocks from the 50-meter shipwreck survey requirements.
- **Geoscientific Research and Resource Evaluation:** The ability of the Region's dive team to provide documentation and samples of seafloor exposed rock formation has helped in determining the potential of lease sale tracts.
- **Rigs-to-Reefs Assessment:** The Region's dive team participation in state Rigs-to-Reefs assessment has facilitated the gathering of needed data on the success or non-success of retired platforms as reefs.
- **Operations and Environmental Resource Evaluation:** The ability of the Region's dive team to respond and report violations of underwater operations and environmental compliance requirements has provided verification of operator compliance or non-compliance with MMS regulations.

The role of the Region's scientific dive team in this year's pilot project on seafloor monitoring has been in ground-truthing the side-scan imagery and hands-on identification of an historic shipwreck, inspection of subsea well completions, well stubs, and site clearance locations; and identification and assessment of a protected biological significant feature.

Monitoring the seafloor in the future will rely on the Region's scientific dive team to continue and provide the means to ground-truth and monitor industry's performance and impacts to the seafloor and natural resources.

---

Mr. Les Dauterive, is a Senior Environmental Scientist with the Mineral Management Service Gulf of Mexico OCS Region. His responsibilities include managing the Region's diving operations and safety of the Region's Scientific Dive Team, and providing the Region's liaison and coordination with the industry and states on Rigs-to-Reefs development.

## SESSION 1F

### DE SOTO CANYON

Chair: Dr. Ann Scarborough Bull

Co-Chair: Dr. Tom McIlwain

Date: December 17, 1997

Presentation	Author/Affiliation
Past And Present University Marine Research in DeSoto Canyon	Dr. William W. Schroeder Marine Science Program University of Alabama Dauphin Island Sea Lab
Fisheries and Fishing Practices in the DeSoto Canyon Area	Dr. Thomas D. McIlwain National Marine Fisheries Service Miami, FL / Mississippi Laboratories
Community Structure and Trophic Relationships of Demersal Reef Fishes of the Mississippi-Alabama Outer Continental Shelf	Mr. Douglas C. Weaver Dr. Kenneth J. Sulak Dr. William F. Smith-Vaniz Florida Caribbean Science Center Gainesville, FL Dr. Steve W. Ross North Carolina National Estuarine Research Reserve Center for Marine Research Wilmington, NC
Early Life Stages of Fishes in the Vicinity of the DeSoto Canyon	Dr. Joanne Lyczkowski-Shultz National Marine Fisheries Service (NMFS) Pascagoula, MS
Factors Influencing the Timing and Magnitude of Settlement of Reeffish Recruiting to Seagrass Meadows along the West Florida Shelf	Dr. C.B. Grimes Dr. Gary Fitzhugh National Marine Fisheries Service Dr. C.C. Koenig Dr. F. C. Coleman Florida State University Tallahassee, FL



Fishery Habitat along the Outer West Florida Shelf and Importance to Conservation of Grouper/Snapper Stocks

Dr. G.R. Fitzhugh  
Dr. C.C. Koenig  
Mr. C. Gledhill  
Mr. M.A. Grace  
National Marine Fisheries Service  
Ms. K. Scanlon  
U.S. Geological Survey, Coastal and Marine Program  
Dr. C.B. Grimes  
National Marine Fisheries Service  
Dr. F.C. Coleman  
Florida State University

The Gulf-Loop Current and Its Spin-Off Eddies: Their Influence on Fisheries Production in the De Soto Canyon Region

Dr. John J. Govoni  
Dr. John T. Lamkin  
Dr. William J. Richards  
Dr. Joanne Lyczkowski-Shultz  
Mr. Thomas D. Leming  
National Oceanic and Atmospheric Administration

## PAST AND PRESENT UNIVERSITY MARINE RESEARCH IN DE SOTO CANYON

Dr. William W. Schroeder  
Marine Science Program  
University of Alabama  
Dauphin Island Sea Lab

The following bibliography served as the reference source for the material presented at this talk. Note that references from non-academic based research have been included in this bibliography.

Antoine, J.W. 1972. Structure of the Gulf of Mexico. pp. 1-34. *In* R. Rezak and V. J. Henry (eds.), Contributions of the geological and geophysical oceanography of the Gulf of Mexico, Vol. 3, Texas A&M University Oceanographic Studies, Houston, TX: Gulf Publishing Company.

Antoine, J.W., W. Bryant and B. Jones. 1967. Structural features of continental shelf, slope, and scarp, northeastern Gulf of Mexico. *AAPG Bull.* 51:257-262.

Antoine, J.W., *et al.* 1974. Continental margins of the Gulf of Mexico. pp. 683-693. *In* C.A. Burk, *et al.* (eds.), The geology of continental margins. New York, NY: Springer-Verlag.

Ballard, R.D. and E. Uchupi. 1970. Morphology and Quarternary history of the continental shelf of the Gulf coast of the United States. *Bull. Mar. Sci.* 20:547-559.

Barry A. Vittor & Associates, Inc. 1985. Tuscaloosa Trend Regional Data Search and Synthesis Study (Vol. I - Synthesis Report). Final report submitted to Minerals Mgmt. Service, New Orleans, LA. Contract No. 14-12-0001-30048. XXVI + 477 pp.

Barry A. Vittor & Associates, Inc. 1985. Tuscaloosa Trend Regional Data Search and Synthesis Study (Vol. II - Supplemental Reports). Final report submitted to Minerals Mgmt. Service, New Orleans, LA. Contract No. 14-12-0001-30048. XXV + 349 pp.

Benson, D.J., W.W. Schroeder and A.W. Shultz. 1997. Sandstone hardbottoms along the western rim of DeSoto Canyon, northeast Gulf of Mexico. *Gulf Coast Assoc. Geological Societies Transactions* XLVII:43-48.

Booker, J.T., Jr. 1974. Calanoid and cyclopids copepods of the Sameri cruises. M.S. Thesis, University of South Alabama.

Boschung, H.T. 1992. Catalogue of Freshwater and Marine Fishes of Alabama. *Bull. Alabama Mus. Nat. Hist.* No. 14. 266 pp.

Bouma, A.H. and R.G. Martin. 1978. Physiography of Gulf Mexico. pp. 3-20. *In* A. H. Bouma, G. T. Moore and J. M. Coleman (eds.), Framework, Facies and Oil-Trapping Characteristics of the Upper Continental Margin. American Association of Petroleum Geologists, Tulsa, OK.

- Bouma, A.H. and H.H. Roberts. 1990. Northern Gulf of Mexico continental slope. *Geo-Mar. Let.* 10:177-181.
- Bouma, A.H., G.T. Moore and J.M. Coleman (Editors). 1978. *Framework, Facies and Oil-Trapping Characteristics of the Upper Continental Margin*. American Association of Petroleum Geologists, Tulsa, OK.
- Brooks, J.M. (ed.). 1991. *Mississippi-Alabama Continental Shelf Ecosystem Study: Data Summary and Synthesis. Vol. II: Technical Narrative*. OCS Study MMS91-0063. U.S. Department of the Interior, Minerals Mgmt. Service, Gulf of Mexico OCS Regional Office, New Orleans, LA. 862 pp.
- Bryant, W.R. J. Lugo, C. Cordova and A. Salvador. 1991. Physiography and bathymetry. pp. 13-30. *In* A. Salvador (ed.), *The Gulf of Mexico Basin, The Geology of North America*. v. J., Geological Society of America.
- Caldwell, D.K. 1963. Tropical marine fishes of the Gulf of Mexico. *Quart. Jour. Florida Acad. Sci.* 26(2):188-191.
- Chew, F., K.L. Drennan and W.J. Demoran. 1962. Some results of drift bottle studies off the Mississippi delta. *Limnol. Oceanog.* 7:252-257.
- Clarke, A.J. (ed.). 1995. *Northeastern Gulf of Mexico physical oceanography workshop; Proceedings of Workshop, Tallahassee, Florida, April 5-7, 1994*. Prepared by Florida State University. OCS Study MMS94-0044. U.S. Department of the Interior, Minerals Mgmt. Service, Gulf of Mexico OCS Region, New Orleans, LA. 257 pp.
- Coleman, J.M., H.H. Roberts and W.R. Bryant. 1991. Late quaternary sedimentation. pp. 325-352. *In* A. Salvador (ed.), *The Gulf of Mexico Basin, The Geology of North America*. v. J., Geological Society of America.
- Continental Shelf Associates, Inc. 1985a. Live-bottom survey of drillsite locations in Destin Dome Area Block 617. Report to Chevron U.S.A., Inc. 40 pp + Appendices.
- Dames and Moore. 1979. *The Mississippi, Alabama, Florida, outer continental shelf baseline environmental survey, MAFLA 1977/1978*. v. 1-A, Program synthesis report. Bureau of Land Mgmt., Washington, D.C., BLM/YM/ES-79/01-Vol-1-A. 278 pp.
- Darnell, R.M. and J.A. Kleypas. 1987. *Eastern gulf shelf bio-atlas, a study of the distribution of demersal fishes and penaeid shrimp of soft bottoms of the continental shelf from the Mississippi River Delta to the Florida Keys*. OCS Study MMS 86-001. XV + 548 pp., 209 plates.

- Defenbaugh, R.E. 1976. A study of the benthic macroinvertebrates of the continental shelf of the northern Gulf of Mexico. Ph.D. Dissertation. Texas A&M University, College Station, TX. 476 pp.
- Dinnell, S.P. 1988. Circulation and sediment dispersal on the Louisiana-Mississippi-Alabama continental shelf. Ph.D. Dissertation. Louisiana State University. XII + 173 pp.
- Doyle, L.J. and T.N. Sparks. 1980. Sediments of the Mississippi, Alabama and Florida (MAFLA) continental shelf. *J. Sed. Pet.* 50(3):905-916.
- Drennan, K.L. 1963. Surface circulation in northeastern Gulf of Mexico. Gulf Coast Research Laboratory, Oceanography Section, Technical Report No. 1, Ocean Springs, MS. 110 pp.
- Drennan, K.L. 1968. Hydrographic studies in the northeast Gulf of Mexico. Gulf South Research Institute, Environmental Sciences & Engineering Laboratories, Report No. 68-0-1, ONR, Project No. 083-226, New Iberia, LA. 111 pp.
- El-Sayed, S.Z. *et al.* 1972. Chemistry, primary productivity, and benthic algae of the Gulf of Mexico, Serial Atlas of the Marine Environment, Folio 22. American Geographical Society, New York, NY 29 pp. + 6 plates.
- Florida A&M University. 1988. Meteorological database and synthesis for the Gulf of Mexico. OCS Study/MMS-88-0064. U.S. Department of the Interior, Minerals Mgmt. Service, Gulf of Mexico OCS Regional Office, New Orleans, LA. 486 pp.
- Gittings, S.R., T.J. Bright, W.W. Schroeder, W.W. Sager, J.S. Laswell and R. Rezak. 1992. Invertebrate assemblages and ecological controls on topographic features in the northeast Gulf of Mexico. *Bull. Mar. Sci.* 50(3):435-455.
- Harbison, R.N. 1968. Geology of DeSoto Canyon. *J. Geophysical Research* 73(16):5175-5185.
- Herring, H. James. 1993. A bathymetric and hydrographic climatological atlas for the Gulf of Mexico. Dynalysis of Princeton, Report No. 109, Princeton, NJ. 210 pp.
- Hopkins, T.S., S.A. Watts, J.B. McClintock and K.R. Marion. 1994. Contrasting size demographics, sub-lethal arm loss and arm regeneration in two populations of *Astropecten articulatus* (Say) in the northern Gulf of Mexico. pp. 311-316. *In* B. David, A. Guille, J. Féral and M. Roux (eds.), *Echinoderms through Time*. Rotterdam: Balkema.
- Hopkins, T.S., J.F. Valentine, J.B. McClintock, K.R. Marion and S.A. Watts. 1991. Community pattern of echinoderms associated with substrate and depth in the northern Gulf of Mexico. pp. 231-239. *In* T. Yanagisawa *et al.* (eds.), *Biology of Echinodermata*. Rotterdam: A. A. Balkema.

- Huh, O.K., W.J. Wiseman, Jr. and L.J. Rouse, Jr. 1978. Winter cycle of sea surface thermal patterns, northeastern Gulf of Mexico. *J. Geophys. Res.* 83:4523-4529.
- Huh, O.K., W.J. Wiseman, Jr. and L.J. Rouse, Jr. 1981. Intrusion of loop current waters onto the West Florida continental shelf. *J. Geophys. Res.* 86(C-5):4186-4192.
- Ichiye, T., H.-H. Kuo and M.R. Carnes. 1973. Assessment of Currents and Hydrography of the eastern Gulf of Mexico. Department of Oceanography, Texas A&M University Contribution No. 601. College Station, TX. 317 pp.
- Inoue, M. and S.E. Welsh. 1996. Numerical simulation of Gulf of Mexico circulation under present and glacial climatic conditions. OCS Study MMS 96-0067. U.S. Department of the Interior, Minerals Mgmt. Service, Gulf of Mexico OCS Region, New Orleans, LA. 146 pp.
- J.E. Chance and Associates, Inc. 1985. Photo-documentation survey of Blocks 56 (OCS-G-6406), 57 (OCS-G-6407), and 99 (OCS-G-6410) Destin Dome area, offshore Florida: Regulatory and Environment Division Project #85-8216, Lafayette, LA. 26 pp.
- Jordan, G.F. 1951. Continental slope off Apalachicola River, Florida. *AAPG Bull* 35:1978-1993.
- Jordan, G.F. 1952. Reef formation in the Gulf of Mexico off Apalachicola Bay, Florida. *Geol. Soc. America Bull.* 63:741-743.
- Kelly, F.J. 1991. Physical oceanography/water mass characterization. pp. 10-2 to 10-151. *In* J. M. Brooks (ed.), Mississippi-Alabama Continental Shelf Ecosystem Study: Data Summary and Synthesis. Vol. II: Technical Narrative. OCS Study MMS 91-0063. U.S. Department of the Interior, Minerals Mgmt. Service, Gulf of Mexico OCS Regional Office, New Orleans, LA. 862 pp.
- Laswell, J.S., W.W. Sager, W.W. Schroeder, R.Rezak, K.S. Davis and E.G. Garrison. 1990. Mississippi-Alabama marine ecosystem study: atlas of high-resolution geophysical data. OCS Study/MMS 90-0045. U.S. Department of the Interior, Minerals Mgmt. Service, Gulf of Mexico OCS Regional Office, New Orleans, LA. 42 pp.
- Leipper, D.F. 1954. Marine meteorology of the Gulf of Mexico, a brief review. pp. 89-98. *In* Gulf of Mexico, its origins, waters and marine life. *Bull Fish. Wild. Ser.* 55
- Leipper, D.F. 1970. A sequence of current patterns in the Gulf of Mexico. *J. Geophys. Res.* 75:637-657.
- Ludwick, J.C. 1964. Sediments in northeastern Gulf of Mexico. *In* T. L. Miller (ed.), *Papers in Marine Geology*. New York, NY: MacMillan Company. pp. 204-238.

- Ludwick, J.C. and W. R. Walton. 1957. Shelf edge, calcareous prominences in the northeastern Gulf of Mexico: American Association of Petroleum Geologists Bulletin 41:2054-2101.
- Marmer, H.A. 1954. Tides and sea level in the Gulf of Mexico. pp. 101-118. *In* Gulf of Mexico, its origins, waters and marine life. Bull Fish. Wild. Ser. 55
- Martin, R.G. 1978. Northern and eastern Gulf of Mexico continental margin: stratigraphic and structural framework. pp. 21-42. *In* A. H. Bouma, G. T. Moore and J. M. Coleman (eds.), Framework, Facies and Oil-Trapping Characteristics of the Upper Continental Margin. American Association of Petroleum Geologists, Tulsa, OK.
- Mazzullo, J. and C. Bates. 1985. Sources of Pleistocene and Holocene sand for the northwest Gulf of Mexico shelf and the Mississippi Fan. Trans. Gulf Coast Assoc. Geological Societies 35:457-465.
- McClintock, J.B., S.A. Watts, K.R. Marion and T.S. Hopkins. 1995. Gonadal cycle, gametogenesis and energy allocation in two sympatric mid shelf sea stars with contrasting modes of reproduction. Bull. Mar. Sci. 57(2):442-452.
- McClintock, J.B., T. Hopkins, K. Marion, S. Watts and G. Schinner. 1993. Population structure, growth and reproductive biology of the gorgonocephalid brittlestar *Asteropora annulata*. Bull. Mar. Sci. 52(3):925-936.
- McClintock, J.D. Vernon, S.A. Watts, K.R. Marion and T.S. Hopkins. 1994. Size frequency, recruitment and adult growth in the sea biscuit *Clypeaster ravenelii* in the northern Gulf of Mexico. pp. 777-781. *In* B. David, A. Guille, J. Féral and M. Roux (eds.), Echinoderms through Time. Rotterdam: Balkema.
- Mitchell, N.D., M.R. Dardeau and W.W. Schroeder. 1993. Colony morphology, age structure, and relative growth of two gorgonian corals, *Leptogorgia hebes* (Verrill) and *Leptogorgia virgulata* (Lamarck) from the northern Gulf of Mexico. Coral Reefs 12:65-70.
- Molinari, R.L. and D.A. Mayer. 1982. Current meter observations on the continental slope in the eastern Gulf of Mexico. J. Phys. Oceanogr. 12:1480-1492.
- Molinari, R.L., S. Baig, D.W. Behringer, G.A. Maul and R. Legeckis. 1977. Winter intrusions of the Loop Current. Science 198:505-507.
- Nester, R.D. 1978. The fishes of the northern rim of the DeSoto Canyon (northern Gulf of Mexico). M.S. Thesis, University of South Alabama, 89 pp.
- Parker, R.H. 1960. Ecology and distributional patterns of marine macroinvertebrates, northern Gulf of Mexico. F. P. Shepard, F. B. Phleger and T. H. van Andel (eds.). American Association of Petroleum Geologists, Tulsa, OK. pp. 203-337.

- Parker, S.J., A.W. Shultz and W.W. Schroeder. 1992. Sediment characteristics and seafloor topography of a palimpsest shelf, Mississippi-Alabama continental shelf. *In* C. H. Fletcher and J. F. Wehmiller (eds.), Quaternary Coasts of the United States: Marine and Lacustrine Systems: Society of Economic Paleontologists and Mineralogists Special Publication 48:243-251.
- Potts, D.T. and J.S. Ramsey. 1987. A preliminary guide to demersal fishes of the Gulf of Mexico continental slope (100 to 600 fathoms). Mississippi Alabama Sea Grant Publication 86-009. William Hosking (ed.). 95 pp.
- Rezak, R. and V.J. Henry (eds.). 1972. Contributions on the geological and geophysical oceanography of the Gulf of Mexico, Vol. 3. Texas A&M University, Oceanographic Studies, Gulf Publishing Company, Houston, TX. 303 pp.
- Rinkel, M.O. and J.I. Jones (eds.). 1973. Escarosa I, an oceanographic survey of the Florida territorial sea of Escambia and Santa Rosa Counties. State University System of Florida, Institute of Oceanography, St. Petersburg, FL. 366 pp.
- Sager, W.W. W.W. Schroeder, J.S. Laswell, K.S. Davis, R. Rezak and S.R. Gittings. 1992. Mississippi-Alabama outer continental shelf topographic features formed during the late Pleistocene-Holocene transgression. *Geo-Marine Letters* 12:41-48.
- Schroeder, W.W., A.W. Shultz and O.H. Pilkey. 1995. Late Quaternary oyster shells and sea-level history, inner continental shelf, northeast Gulf of Mexico. *J. Coast. Res.* 11(3):664-674.
- Schroeder, W.W., S.P. Dinnel, W.J. Wiseman, Jr. and W.J. Merrell. 1987. Circulation patterns inferred from the movement of detached buoys in the eastern Gulf of Mexico. *Cont. Shelf Res.* 7:883-894.
- Science Applications International Corporation. 1997. DeSoto Canyon Eddy Intrusion Study, Annual Report: Year 1. OCS Study/MMS 97-0028. U.S. Department of the Interior, Minerals Mgmt. Service, Gulf of Mexico OCS Region, New Orleans, LA. 11 pp.
- Shay, L.K. and R.L. Elsberry. 1987. Near-inertial ocean response to hurricane Frederic. *J. Phys. Oceanogr.* 17:1249-1269.
- Shipp, R.L. and T.S. Hopkins. 1978. Physical and biological observations of the northern rim of the DeSoto Canyon made from a research submersible: *Northeast Gulf Science* 2(2):113-121.
- Smith, G.B. 1976. Ecology and distribution of Gulf of Mexico reef fishes. *Fla. Mar. Res. Publ. No.* 19. 78 pp.
- State University System of Florida. 1972. A report on the hydro-biological zones of the eastern Gulf of Mexico (Abridged). Institute of Oceanography, St. Petersburg, FL. 144 pp.

- State University System of Florida. 1974. Marine environmental implications of offshore drilling in the eastern Gulf of Mexico, Robert E. Smith (ed.), Conference Proceedings. State University System of Florida No. 74-4, St. Petersburg, FL. 455 pp.
- State University System of Florida. 1975. Compilation and summation of historical and existing physical oceanographic data from the eastern Gulf of Mexico. Final Report for Department of the Interior, BLM Contract No. 08550-CT4-16. Institute of Oceanography, St. Petersburg, FL. 97 pp + 10 appendices.
- Thompson, L.E. 1995. Intra- and inter-site comparisons of the demersal ichthyofauna at three sites in the northeastern Gulf of Mexico. M.S. Thesis, The University of Alabama, Tuscaloosa. 195 pp.
- Vukovich, F.M., B.W. Crissman, M. Bushnell and W.J. King. 1979. Some aspects of the oceanography of the Gulf of Mexico using satellite and *in situ* data. *J. Geophys. Res.* 84:7749-7768.
- Walsh, J.J., D.A. Dieterle, M.B. Meyers and F.E. Miller-Karger. 1989. Nitrogen exchange at the continental margin: A numerical study of the Gulf of Mexico. *Prog. Oceanog.* 23:245-301.

---

Dr. Schroeder has been involved in oceanographic investigation for over 32 years and has conducted research along the Mississippi-Alabama coast and continental margins of the northern Gulf of Mexico for the past 25 years. He has authored and coauthored over 125 scientific publications dealing with estuarine, shelf and open ocean hydrography and circulation, shelf-estuarine interactions, hypoxia-anoxia events, coastal sediment processes, and geological and biological characterizations of continental margin habitats.



## FISHERIES AND FISHING PRACTICES IN THE DE SOTO CANYON AREA

Dr. Thomas D. McIlwain  
National Marine Fisheries Service  
Miami, FL / Mississippi Laboratories

### SUMMARY

Commercial fishers in the United States landed over 9.6 billion pounds of edible and industrial fishery products in 1996. Approximately 1.5 billion pounds of fishery products were harvested from the Gulf of Mexico by the commercial fishers. Recreational fishers took 42% of all fish caught and 29 % of all fishing trips in the Gulf of Mexico in 1996. Many of these resources are taken in the northeastern Gulf of Mexico in and around the DeSoto Canyon.

The rich fishery resources found in the Gulf of Mexico are a result of the many unique features of the Gulf, including its geology, oceanography, and nutrient sources, to mention a few. Because of these rich resources and the contribution that they make to the economy of the Gulf and the nation, we should all be concerned with potential impacts of man's activities in the Gulf that may impact these rich resources. This presentation discusses some of the fishery activities that currently take place in and around the DeSoto Canyon area of the Gulf and explains our concerns regarding oil and gas development in that area.

Fisheries in and around the DeSoto Canyon area in the northeastern Gulf of Mexico include bottom long lining for snapper, grouper and tilefish by the commercial fishers and hook-and-line recreational fisheries for these same species. There is a major commercial pelagic long-line fishery for tunas (blackfin and yellowfin) as well as for swordfish and sharks. These commercially important species also support a large and economically important recreational fishery. Additionally, bottom trawl and trap fisheries occur around the Canyon area. These include trawl fisheries for the royal red shrimp and butterfish and a trap fishery for Geryon crabs (deep-water crabs). The trawl and trap fisheries generally are found on the slope area surrounding the Canyon.

The DeSoto Canyon area appears to be a significant spawning area for many of the fishery resources mentioned above. The complex currents of the Canyon area critically affect the resultant offspring of the tunas and swordfish as they utilize the area as a nursery ground. Little is known of the early life histories of these species as well as of the many other species found in the area. Therefore, the area could be considered an essential fish habitat as outlined in the recently enacted Magnuson-Stevens Fishery Conservation and Management Act for many or all of the species mentioned above.

It is generally agreed that little knowledge exists about these rich resources found in and around DeSotoCanyon. This agreement has led to a list of issues that need to be addressed for the continuation of these fisheries and the orderly development of the resources of that area. Some of the major issues that have been developed, enumerated (Ann Scarborough Bull, personnel communication) and which need to be addressed via an integrated research program are as follows:

1. The physical presence of oil-related and gas-related structures and associated operations will likely conflict with or enhance fishing activity (both commercial and recreational) especially in, but not limited to, areas south and east of the Mississippi River delta.
2. As in many other world-wide locations, the physical presence of large structures in deepwater will likely act as Fish Attraction Devices (FADs) that will seriously impact management of highly migratory fish species.
3. As in many other world-wide locations, the physical presence of large structures in deepwater will likely act as FADs that will impacting populations of highly migratory fish species through changes in their feeding and spawning behavior.
4. Oil and gas development in deepwater will present old and new environmental hazards to fish resources, e.g., oil spills that occur on the seafloor.
5. Oil and gas development in deep water of the Gulf of Mexico will present unique site abandonment difficulties and raise questions concerning artificial reef planning as well as impact traditional fisheries in the area.

The fisheries currently found in the Canyon area are an important component of the fisheries found in the northeastern Gulf of Mexico. These fisheries will not be significantly impacted by planned oil and gas development activity if these issues are adequately addressed and resulting information is used in the planing process.

---

Dr. Tom McIlwain has worked the past three years for the National Marine Fisheries Service, Southeast Fisheries Science Center, Miami, FL / Mississippi Laboratories as a Fishery Administrator. He has primary responsibility for coordination of Southeast Fisheries Science Center (SEFSC) research activities with the Gulf of Mexico Fishery Management Council and other agencies. Dr. McIlwain is the former Director of the University of Southern Mississippi's Gulf Coast Research Laboratory where he spent over 30 years doing research on the fishery resources of the Gulf of Mexico. His other interests included marine Aquaculture, and is specifically interested in fish culture in the Gulf Exclusive Economic Zone. Dr. McIlwain received his B.S. in biology, and his M.S. and Ph.D. in zoology from the University of Southern Mississippi.

## COMMUNITY STRUCTURE AND TROPHIC RELATIONSHIPS OF DEMERSAL REEF FISHES OF THE MISSISSIPPI-ALABAMA OUTER CONTINENTAL SHELF

Mr. Douglas C. Weaver  
Dr. Kenneth J. Sulak  
Dr. William F. Smith-Vaniz  
Florida Caribbean Science Center  
Gainesville, FL

Dr. Steve W. Ross  
North Carolina National Estuarine Research Reserve Center for Marine Research  
Wilmington, NC

### INTRODUCTION

Prominent hard-bottom features, including "Pinnacles" described by Ludwick and Walton (1957), occur along the Mississippi-Alabama outer continental shelf in the northeastern Gulf of Mexico, northwest of the De Soto Canyon (Figure 1F.1). These calcareous structures vary in areal extent, height, form and habitat complexity, and some may reach 20m in vertical profile (Gittings *et al.* 1992). Somewhat comparable hard-bottom reef structures and their associated biological communities occur throughout the Gulf of Mexico and southeastern U.S. Atlantic outer continental shelf (Shipp and Hopkins 1978, Parker and Ross 1986, Dennis and Bright 1988).

The goals of this project are to determine faunal composition, relative abundance and diets of reef fishes inhabiting Pinnacles biotopes. Dominant fish species identified for dietary analysis include rough-tongue bass (*Pronotogrammus martinicensis*), red barbier (*Hemanthias vivanus*), yellowtail reeffish (*Chromis enchrysurus*), tattler (*Serranus phoebe*), reef butterflyfish (*Chaetodon sedentarius*), bank butterflyfish (*Chaetodon aya*), greenband wrasse (*Halichoeres bathyphilus*), short bigeye (*Pristigenys alta*) and bigeye (*Priacanthus arenatus*). This project will also analyze the role of these dominant resident reef fishes in the diet of apex predators, including greater and lesser amberjack (*Seriola dumerili* and *S. fasciata*), groupers (*Epinephelus* spp. and scamp, *Mycteroperca phenax*) and red snapper (*Lutjanus campechanus*).

### OBJECTIVES

1. Quantitatively define comparative species composition, abundance, dominance rank order, and species richness of demersal fishes for each of three target biotopes (low, medium and high profile features).
2. Delineate trophic function of each dominant fish species based on stomach content analysis.
3. Define a trophic scheme for the demersal fish component of the total fauna, within the framework of existing literature.

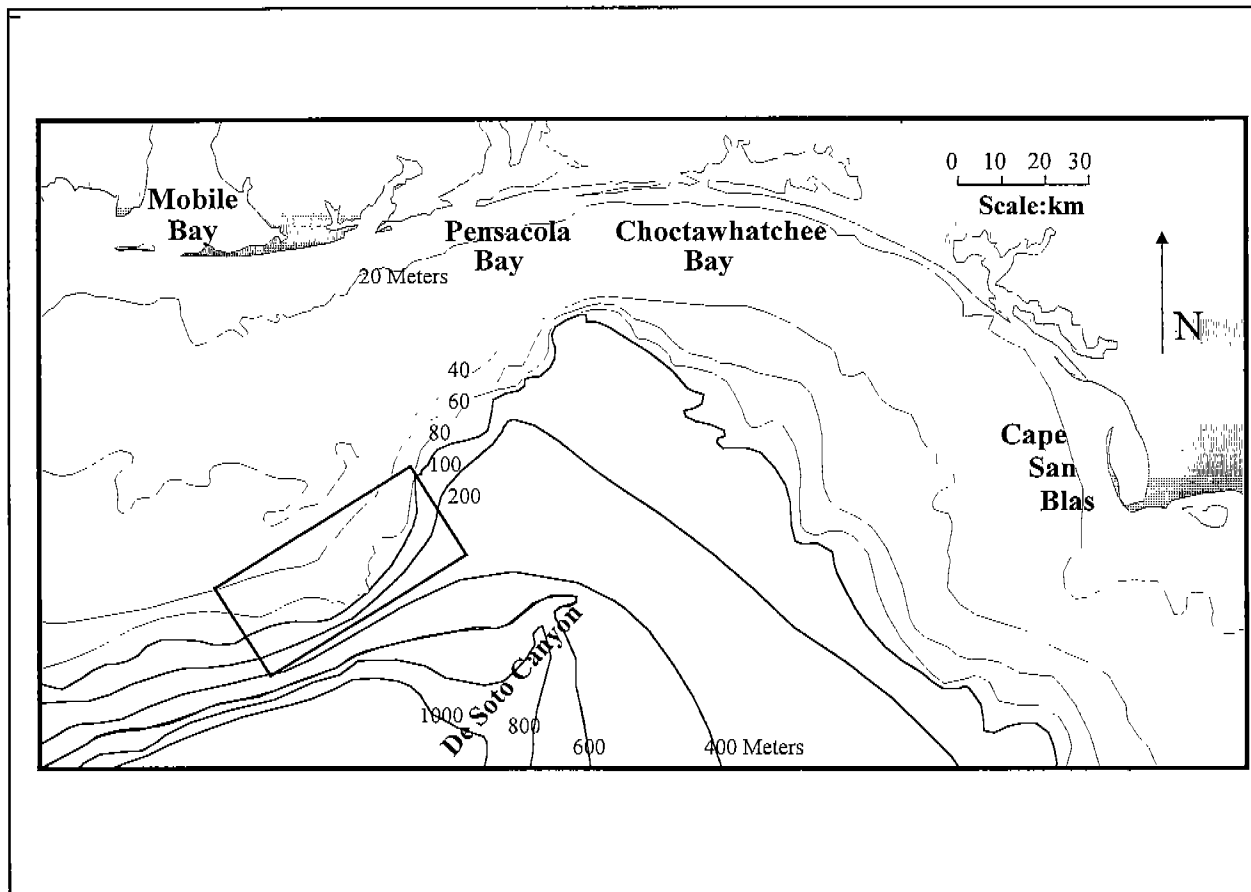

Figure 1F.1. Location of study area in the northeastern Gulf of Mexico.

## METHODS

Demersal fishes comprising the Pinnacles study area fauna were sampled and quantified during our initial research cruise USGS-AE-9701 (Figure 1F.2). Study reefs of low and medium profile (patch reefs) and high profile features (steep-sided pinnacles and flat-topped reefs) as described by Gittings *et al.* (1992) were investigated by remote operating vehicle (ROV), trapping, and hook and line sampling. Sampling stations spanned a depth range of 58 to 110m and were located in areas previously mapped bathymetrically.

Abundance and density of resident reef fishes at each study site were based on ROV videotape transects using a color video camera. The ROV videotapes were critically analyzed in the laboratory to identify and quantify species abundance and percent occurrence among reefs of varying profile.

Fishes collected by hook and line were preserved in 10% buffered formalin or frozen for subsequent laboratory analysis. Fishes were measured and stomachs dissected. Gut contents of each specimen were removed and prey items sorted and identified to the lowest possible taxonomic unit. Numerical abundance (N) was calculated as the number of prey items per taxon divided by the total number of

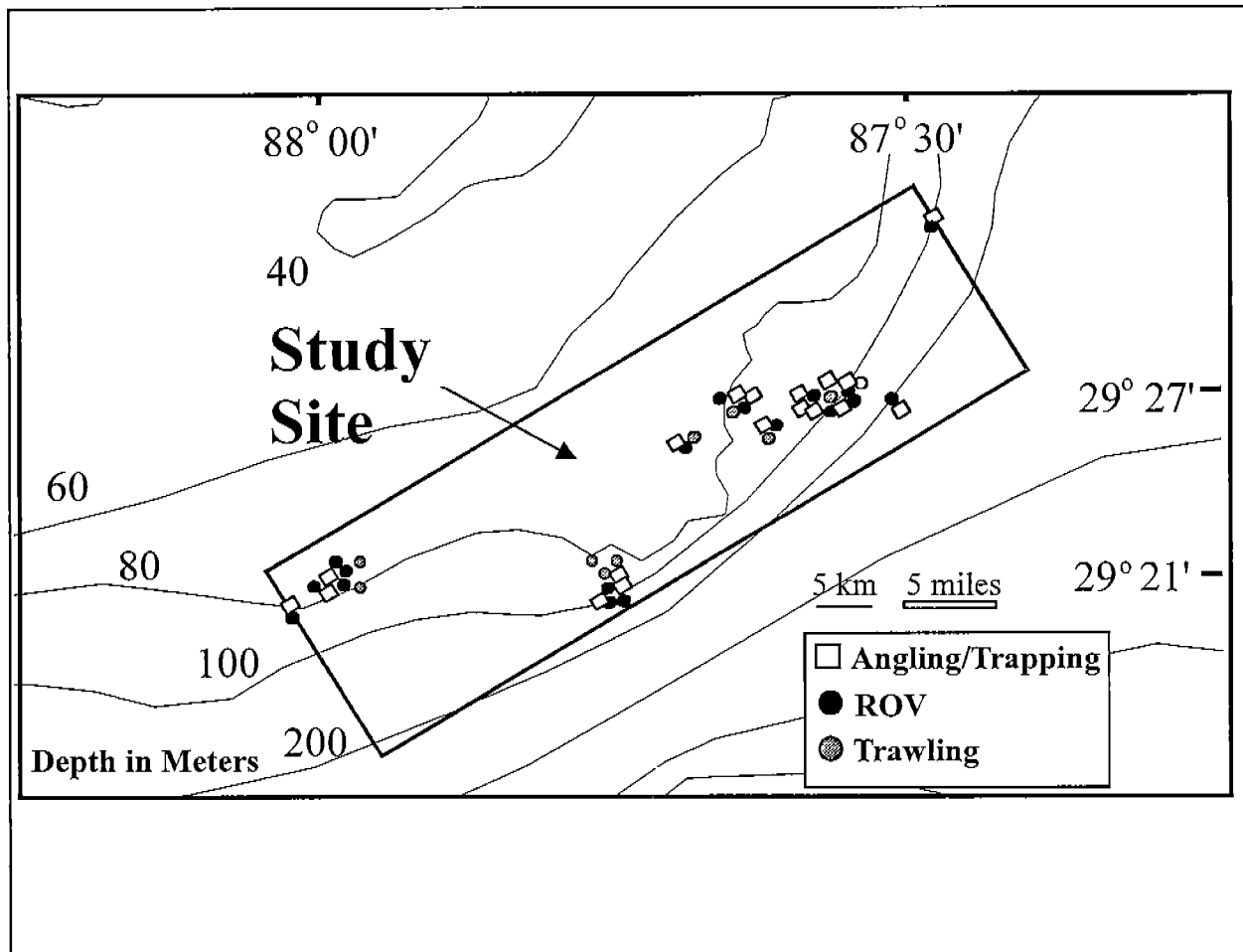

Figure 1F.2. USGS Pinnacles project study area and sampling stations during Cruise FCSC-9701, August 1997.

prey items for all specimens examined. For simplicity, only numerical abundance will be presented in this preliminary report.

## RESULTS

A total of 91 stations in five major study sites were sampled during cruise FCSC-9701. These resulted in time totals as follows:

- 94 hours of hook and line sampling (4-10 crew members per hour)
- 45 hours of ROV videotape at five sites, including diurnal/nocturnal comparisons at three sites
- 7.9 hours of trawling on soft-bottom habitats
- 84 hours of trap deployment

Combined sampling techniques documented ~150 species of demersal fishes, including 74 species of reef fishes (Table 1F.1), and over 1800 specimens for voucher materials and stomach content analysis. Numerically dominant reef-dwelling species were identified as *P. martinicensis*, *H. vivanus*, *P. alta*, *P. arenatus*, and *S. phoebe*. All were successfully sampled by hook and line, with >50% of individuals fully retaining their stomach contents. Preliminary results of stomach content analysis revealed distinct differences among these dominant reef-dwelling species. The diets of *P. martinicensis* (n=61) and *H. vivanus* (n=27) are dominated by pelagic plankton, including copepods, ostracods, gastropod and bivalve veligers, pelagic tunicates (salps and larvaceans) and pelagic polychaetes. However, these two species differed in the relative proportion of copepods consumed, comprising 60% of the diet in *P. martinicensis* and 88% in *H. vivanus*. The diets of the bigeye, *P. arenatus* (n=11) and short bigeye, *P. alta* (n=7) were dominated by large planktonic organisms and small nectonic (free-swimming) animals such as squids. *P. arenatus* fed on squids (41%), stomatopod zoeae (20%), shrimp zoeae (7%) and larval fishes (5%). The diet of *P. alta* was dominated by sergestid shrimp and other pelagic shrimps (56%), with the rest of the diet evenly comprised (~10% per taxa) of squids, shrimp zoeae, crab megalopae, and stomatopod zoeae.

Benthic foragers included the greenband wrasse, *H. bathyphilus* (n=8) and tattler, *S. phoebe* (n=39). The diet of *H. bathyphilus* was dominated (80%) by bivalves. Brittle stars and majid crabs each constituted 5% of the diet. Crab megalopae and squid (both prey taxa are pelagic) each made up 5% of the diet. *S. phoebe*, in contrast, fed primarily on galatheid, xanthid, and majid crabs (42%) and fishes (25%), including *H. vivanus*. Other benthic prey included brittle stars (5%). Pelagic prey groups constituted only 18% of the diet, and were comprised of crab megalopae (10%), squids (5%) and stomatopod zoeae (3%).

Gut contents of large piscivorous fishes commonly contained both *H. vivanus* and *P. martinicensis*. These streamer basses were found in stomach contents of red snapper, *L. campechanus*; greater amberjack and almaco jack, *S. dumerili* and *S. rivoliana*; leopard toadfish, *Opsanus pardus*; spotfin hogfish, *Bodianus pulchellus* and sand tilefish, *Malacanthus plumieri*. *Pronotogrammus martinicensis* and *H. vivanus* have also been reported from the stomach contents of deep-water groupers (Bullock and Smith 1991). Thus, our preliminary analyses reveal that small planktivores constitute the main food link between the lowest and highest trophic levels in the community.

Preliminary ROV transect analysis (Table 1F.2) indicates that the taxonomic composition of fish populations is correlated with reef height and water depth. The 6 resident reef species listed comprised over 90% of the individuals identified at each site. Planktivores dominated the medium and high profile reefs, while the benthic feeding species dominated low profile patches. Medium and high profile reefs harbor dense schools of *P. martinicensis* and *H. vivanus*, but these fishes are absent or rare on low profile reef structures.

## CONCLUSIONS

Preliminary results of this project reveal distinct differences in fish community structure with increasing reef profile. Planktivores become increasingly abundant and species diversity increases on large, high profile reef systems, while benthivores dominate small patch reef formations.

Table 1F.1. Reef fishes documented from Pinnacles area on the outer continental shelf off Alabama-Mississippi in August 1997; asterisk (\*) indicates species only observed with ROV's. Family classification and phylogenetic sequence of presentation follows Nelson (1994).

Family, Genus, Species, Author & Date	Common Name	Family, Genus, Species, Author & Date	Common Name
Muraenidae - morays		Carangidae - jacks	
<i>Gymnothorax kolpos</i> Böhlke & Böhlke, 1980	blacktail moray	<i>Caranx crysos</i> (Mitchill, 1815)	blue runner
<i>G. nigromarginatus</i> (Girard, 1858)	blackedge moray	<i>Selar crumenophthalmus</i> (Bloch, 1793)	bigeye scad
<i>G. saxicola</i> Jordan & Davis, 1891	honeycomb moray	<i>Seriola dumerili</i> (Risso, 1810)	greater amberjack
<i>Muraena retifera</i> Goode & Bean, 1882	reticulated moray	<i>S. fasciata</i> (Bloch, 1797)	lesser amberjack
Ophichthidae - snake eels		<i>S. rivoliana</i> Valenciennes, 1833	almaco jack
<i>Ophichthus gomesi</i> (Castelnau, 1855)	shrimp eel	<i>Trachurus lathami</i> Nichols, 1920	rough scad
<i>O. puncticeps</i> (Kaup, 1856)	palespotted eel	Lutjanidae - snappers	
Batrachoididae - toadfishes		<i>Lutjanus campechanus</i> (Poey, 1860)	red snapper
<i>Opsanus pardus</i> (Goode & Bean, 1880)	leopard toadfish	<i>Pristipomoides aquilonaris</i> (Goode & Bean, 1896)	wenchman
Antennariidae - frogfishes		<i>Rhomboplites aurorubens</i> (Cuvier, 1829)	vermillion snapper
<i>Antennarius radiosus</i> Garman, 1896	singlespot frogfish	Sparidae - porgies	
Ogcocephalidae - batfishes		<i>Calamus leucosteus</i> Jordan & Gilbert, 1885	whitebone porgy
<i>Ogcocephalus corniger</i> Bradbury, 1980	longnose batfish	<i>Calamus nodosus</i> Randall & Caldwell, 1966	knobbed porgy
<i>O. declivirostris</i> Bradbury, 1980	slantbrow batfish	<i>Pagrus pagrus</i> (Linnaeus, 1758)	red porgy
Corniger spinosus Agassiz, 1829		Sciaenidae - drums	
<i>Holocentrus adscensionis</i> (Osbeck, 1765)	spinycheek soldierfish	<i>*Pareques iwamotoi</i> Miller & Woods, 1988	blackbar drum
<i>Neoniphon marianus</i> (Cuvier, 1829)	squirrelfish	<i>Pareques umbrosus</i> (Jordan & Evermann, 1889)	cubbyu
Caproidae - boarfishes		Mullidae - goatfishes	
<i>*Antigonia capros</i> Lowe, 1843	deepbody boarfish	<i>Mullus auratus</i> Jordan & Gilbert, 1882	red goatfish
Fistulariidae - cornetfishes		<i>Upeneus parvus</i> Poey, 1853	dwarf goatfish
<i>*Fistularia petimba</i> Lacepède, 1803	red cornetfish	Chaetodontidae - butterflyfishes	
Aulostomidae - trumpetfishes		<i>*Chaetodon aya</i> Jordan, 1886	bank butterflyfish
<i>*Aulostomus maculatus</i> Valenciennes, 1845	trumpetfish	<i>*C. ocellatus</i> Bloch, 1787	spotfin butterflyfish
Scorpaenidae - scorpionfishes		<i>C. sedentarius</i> Poey, 1860	reef butterflyfish
<i>Pontinus rathbuni</i> Goode & Bean, 1896	highfin scorpionfishes	Pomacanthidae - angelfishes	
<i>Scorpaena agassizii</i> Goode & Bean, 1896	longfin scorpionfish	<i>Holacanthus bermudensis</i> Goode, 1876	blue angelfish
<i>S. dispar</i> Longley & Hildebrand, 1940	hunchback scorpionfish	<i>*H. tricolor</i> (Bloch, 1795)	rock beauty
Serranidae - sea basses		Labridae - wrasses	
<i>Centropristis ocyurus</i> (Jordan & Evermann, 1887)	bank seabass	<i>Bodianus pulchellus</i> (Poey, 1860)	spotfin hogfish
<i>C. philadelphica</i> (Linnaeus, 1758)	rock seabass	<i>Decodon puellaris</i> (Poey, 1860)	red hogfish
<i>Epinephelus flavolimbatus</i> Poey, 1865	yellowedge grouper	<i>Halichoeres bathyphilus</i> (Beebe & Tee-Van, 1932)	greenband wrasse
<i>E. niveatus</i> (Valenciennes, 1828)	snowy grouper	Pomacentridae - damselfishes	
<i>*Gonioplectrus hispanus</i> (Cuvier, 1828)	Spanish flag	<i>Chromis enchrysurus</i> Jordan & Gilbert, 1882	yellowtail reeffish
<i>Hemanthias leptus</i> (Ginsburg, 1952)	longtail bass	<i>*Stegastes variabilis</i> (Castelnau, 1855)	cocoa damselfish
<i>H. vivanus</i> (Jordan & Swain, 1885)	red barbier	Blenniidae - combtooth blennies	
<i>Liopropoma eukrines</i> (Starck & Courtenay, 1962)	wrasse bass	<i>*Parablennius marmoreus</i> (Poey, 1876)	seaweed blenny
<i>Mycteroperca phenax</i> Jordan & Swain, 1884	scamp	Gobiidae - gobies	
<i>Paranthias furcifer</i> (Valenciennes, 1828)	creole-fish	<i>*Coryphopterus</i> sp.	
<i>Pronotogrammus martinicensis</i> (Guichenot, 1868)	rougtongue bass	Trichiuridae - snake mackerels	
<i>Rypticus maculatus</i> Holbrook, 1855	whitespotted soapfish	<i>Trichiurus lepturus</i> Linnaeus, 1758	Atlantic cutlassfish
<i>Serranus phoebe</i> Poey, 1852	tattler	Balistidae - Triggerfishes	
Priacanthidae - bigeyes		<i>Balistes capricus</i> Gmelin, 1789	gray triggerfish
<i>Priacanthus arenatus</i> Cuvier, 1829	bigeye	Monacanthidae - filefishes	
<i>Pristigenys alta</i> (Gill, 1862)	short bigeye	<i>Monacanthus tuckeri</i> Bean, 1906	slender filefish
Apogonidae - cardinalfishes		Ostraciidae - boxfishes	
<i>Apogon pseudomaculatus</i> Longley, 1932	twospot cardinalfish	<i>*Lactophrys trigonus</i> (Linnaeus, 1758)	trunkfish
Malacanthidae - tilefishes		Tetraodontidae - puffers	
<i>Caulolatilus intermedius</i> Howell Rivero, 1936	anchor tilefish	<i>*Canthigaster rostrata</i> (Bloch, 1786)	sharpnose puffer
<i>C. chrysops</i> Poey, 1866	goldface tilefish	<i>*S. spengleri</i> (Bloch, 1785)	bandtail puffer
<i>Malacanthus plumieri</i> (Bloch, 1787)	sand tilefish	Diodontidae - porcupinefishes	
		<i>*C. schoepfi</i> (Walbaum, 1792)	striped burrfish
		<i>*Diodon holacanthus</i> Linnaeus, 1758	ballonfish

Table 1F.2. Relative abundance of fishes at reefs of varying topographic profile, recorded by ROV survey on the Alabama-Mississippi continental shelf in August 1997. Values were calculated by taking the total number of individuals per species divided by the total number of fishes recorded for a single reef site in each category.

Common Name	Scientific Name	Low Profile (<1m)	Medium Profile (1-5m)	High Profile (>5m)
Roughtongue Bass	<i>P. martinicensis</i>	0%	86%	45%
Red Barbier	<i>H. vivanus</i>	0%	—	36%
Yellowtail Reeffish	<i>C. enchrysur</i>	0%	—	10%
Short Bigeye	<i>P. alta</i>	13%	—	1%
wrasses	Labridae	40%	—	1%
Tattler	<i>S. phoebe</i>	40%	3%	3%
Other species		7%	16%	4%
<b>Total</b>		<b>100%</b>	<b>100%</b>	<b>100%</b>

Continued analysis and future research cruises will focus on identifying differences in community structure and trophic composition of fishes among different reef biotopes, including reef slope and reef crest of large, flat-topped mounds.

#### REFERENCES

- Bullock, L. B. and G. B. Smith. 1991. Seabasses (Pisces: Serranidae). Memoirs of the Hourglass Cruises 8(2). Florida Marine Research Institute, St. Petersburg, Florida. 243 pp.
- Dennis, G. D. and T. J. Bright. 1988. Reef fish assemblages on hard banks in the northwestern Gulf of Mexico. Bull. Mar. Sci. 43(2):280-307.
- Gittings, S. R., T. J. Bright, W. W. Schroeder, W. W. Saeger, J. S. Laswell and R. Rezak. 1992. Invertebrate assemblages and ecological controls on topographic features in the northeast Gulf of Mexico Bull. Mar. Sci. 50(3):435-455.
- Ludwick, J. C. and W. R. Walton. 1957. Shelf edge, calcareous prominences in the northeastern Gulf of Mexico. Amer. Assoc. Petrol. Geol. Bull. 41(9):2054-2101.
- Nelson, J. S. 1994. Fishes of the world (3rd ed.). John Wiley & Sons, Inc., New York. 300 pp.
- Parker, R. O. and S. W. Ross. 1986. Observing reef fishes from submersibles off North Carolina. N.E. Gulf Sci. 8(1):31-49.



Shipp, R. L. and T. S. Hopkins. 1978. Physical and biological observations of the northern rim of the DeSoto Canyon made from a research submersible. *N.E. Gulf Sci.* 2(2):113-121.

---

Mr. Douglas Weaver is a fish biologist at the USGS Florida Caribbean Science Center, Gainesville, FL. His areas of research interest are the feeding ecology and population dynamics of reef fishes of the Gulf of Mexico. He received his M.S. in zoology from the University of Florida, and is currently pursuing his Ph.D. in the Department of Fisheries and Aquatic Sciences at the University of Florida. Weaver is a staff intern in the Coastal and Marine Ecology Branch of the FCSC.

Dr. Kenneth J. Sulak is a research fish biologist and Chief Scientist in the Anadromous, Estuarine & Marine studies section at the USGS Florida Caribbean Science Center, Gainesville, FL. He has a Ph.D. and M.S. from the University of Miami, and a B.A. from Harvard University. Sulak is an expert in the taxonomy of deepwater fishes, and has over 20 years of experience in sea-going studies of the life history, community structure, ecology, and zoogeography and taxonomy of demersal marine fishes. He has participated in numerous oceanographic cruises from the Arctic to the tropics in the Atlantic and Indian oceans, including four submersible missions on ALVIN, JOHNSON-SEA-LINK, and NR-1. Sulak was formerly Director and Senior Fish Biologist at the Atlantic Reference Center, Huntsman Marine Science Center, Canada.

Dr. William F. Smith-Vaniz is a Research Marine Biologist in the Coastal and Marine Ecology Branch at the USGS Florida Caribbean Science Center, Gainesville, FL. He has a Ph.D. in marine sciences from the University of Miami and M.S. in fisheries from Auburn University. His primary interests include systematics, zoogeography and ecology of marine shorefishes worldwide. Before completing his graduate education, he was a technician in the Division of Fishes, National Museum of Natural History, and for many years was a research Curator in the Department of Ichthyology, Academy of Natural Sciences of Philadelphia.

Dr. Steve W. Ross is Research Director of the North Carolina National Estuarine Research Reserve, Wilmington, NC. He has a Ph.D. from the University of North Carolina. Ross is an expert in the taxonomy, life history, and ecology of hard-bottom reef fishes of the Carolinian Faunal Province and Gulf of Mexico. He has extensive experience with SCUBA, submersible and ROV census methods for quantification of demersal reef-dwelling and slope-dwelling fishes. Ross is a veteran of numerous coastal and oceanographic cruises, including missions on the NEKTON GAMMA and JOHNSON-SEA-LINK. He is currently co-authoring a monograph on the marine fish fauna of the Carolinas.

## EARLY LIFE STAGES OF FISHES IN THE VICINITY OF THE DESOTO CANYON

Dr. Joanne Lyczkowski-Shultz  
National Marine Fisheries Service (NMFS)  
Pascagoula, MS

### INTRODUCTION

This presentation summarizes observations on the kinds and abundance of fish larvae collected in the vicinity of the DeSoto Canyon (ie. the area lying north of 27.5° N latitude, and between 88.5° and 85.5° W longitude) during Southeast Area Monitoring and Assessment Program (SEAMAP) plankton surveys. SEAMAP provides platforms and equipment for collections from both piggybacked and dedicated plankton cruises. The NMFS and the states of Louisiana, Mississippi, Alabama, and Florida collect samples and data during these SEAMAP surveys. The goal of SEAMAP's plankton activities in the Gulf of Mexico is to collect data on the early life stages of fishes and invertebrates that will complement and enhance the fishery-independent data gathered during surveys of the adult life-stage. Plankton surveys are a very cost-effective way to gather abundance and distribution data

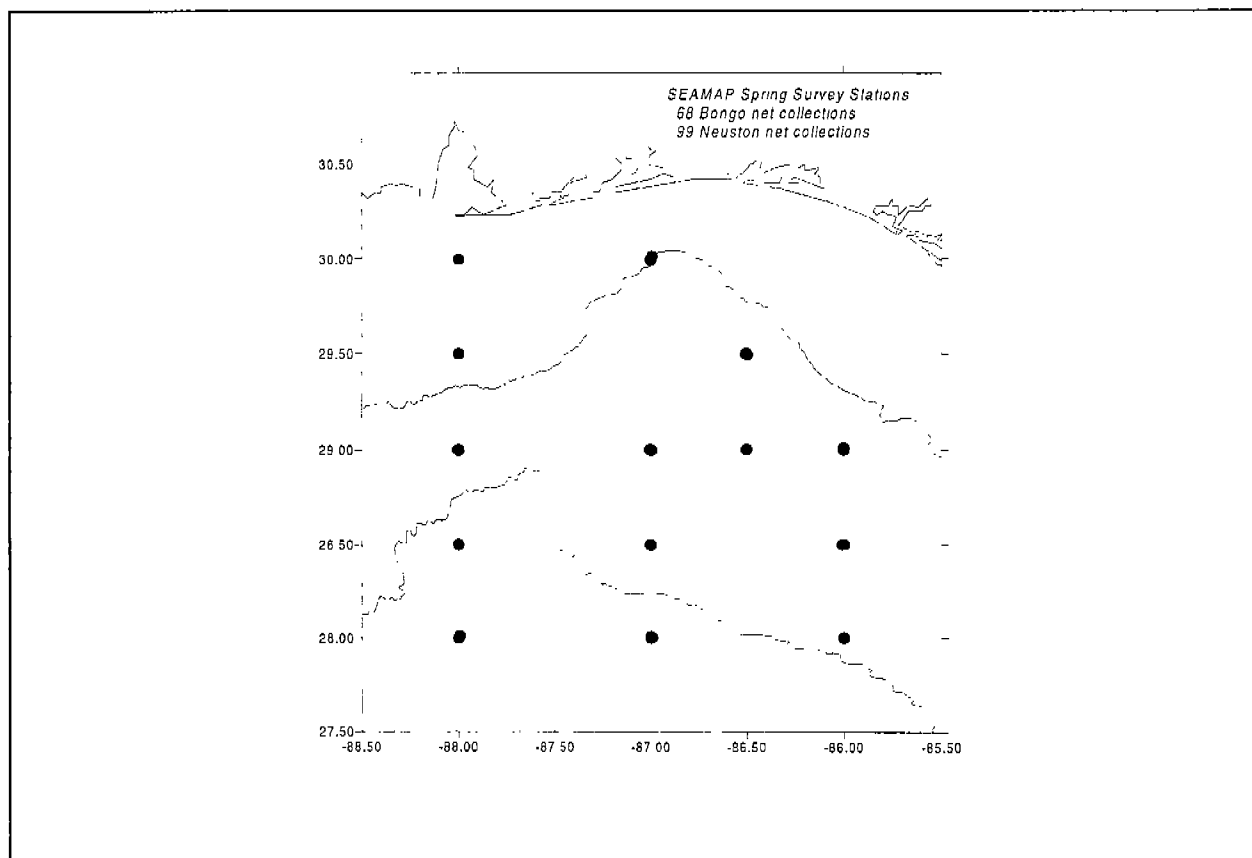

Figure 1F.3. SEAMAP Spring Survey plankton sampling sites in the vicinity of the DeSotoCanyon (April and May 1986-1993).

on a wide diversity of marine organisms. A single and relatively simple gear type, the plankton net, can be used to catch the young of reef fishes, bottomfishes, macroinvertebrates, and coastal migratory pelagic fishes. Plankton surveys have been used in the detection and appraisal of fishery resources; in the determination of spawning seasons and areas; in investigations of early survival and recruitment mechanisms; and in estimation of the abundance of a stock based on its spawning production.

## METHODS AND RESULTS

The SEAMAP plankton survey design consists of a 30 nm grid of fixed stations covering the entire U.S. Gulf of Mexico. (There have been a few successful U.S. and Mexico cooperative surveys in southern Gulf waters.) Standard SEAMAP gear, methods and protocols are used to collect samples during all SEAMAP surveys (see SEAMAP Operations Manual for Collection of Data, revision No. 3, September 1993). The principal gear used in this program are a bongo net (60 cm diameter and 0.335 mm mesh) and a neuston net (1 by 2 m mouth opening and 0.947 mm mesh).

The original intention was to sample both the open and continental shelf portions of the Gulf in their entirety at least once during each season. This proved to an impossible feat since survey data relevant

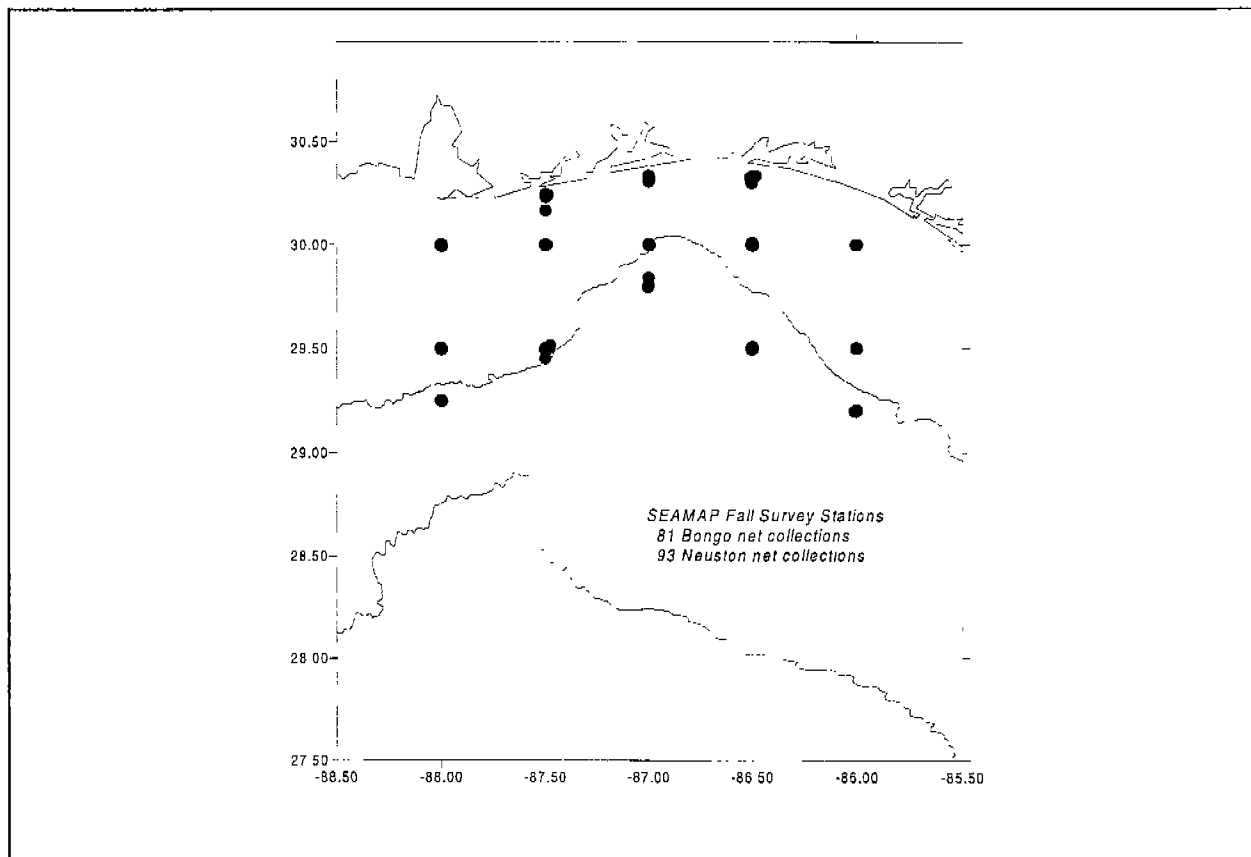

Figure 1F.4. SEAMAP Fall Survey plankton sampling sites in the vicinity of the DeSoto Canyon (September 1986-1994).

to fisheries-related issues must encompass an entire spawning area which for most species includes either the entire deep Gulf or continental shelf regions. Furthermore, once established, these surveys have to be conducted on an annual basis in order to build a historical database from which population trends can be assessed.

Information on fish larvae from the vicinity of the DeSoto Canyon is available from only two seasons and, due to historical survey limits, two different locales. Sixty-eight bongo net and 99 neuston net collections from 14 sites over the Canyon proper were taken during Spring Plankton surveys in April and May, 1986-1993 (Figure 1F.3). Eighty-one bongo net and 93 neuston net collections from 15 sites over the northernmost rim area of the Canyon and adjacent inner shelf were taken during Fall Plankton surveys in September, 1986-1994 (Figure 1F.4).

The diversity and overall abundance of fish larvae in the Canyon in April and May is comparable to Gulfwide values. Only 13% of all bongo and 15% of all neuston net samples taken during SEAMAP Spring surveys were collected in the vicinity of the Canyon. Yet these collections yielded 56 and 53% of all taxa caught Gulfwide (Table 1F.3). Mean abundance of larvae (all taxa combined) as measured by bongo and neuston nets exceeded Gulfwide abundances.

The percentage of total survey-collected taxa captured in the vicinity of the DeSoto Canyon was even greater in September than in spring months (Table 1F.4). This was not unexpected since most Canyon vicinity sampling sites during Fall surveys lie north of the Canyon proper. Mean abundance of larvae near the Canyon was somewhat less when compared to Gulfwide values. This was especially so for neuston collections.

Dominant taxa whose larvae occurred most frequently in collections in the vicinity of the Canyon were the same as the dominants found in the entire Gulfwide dataset (Tables 1F.5 and 1F.6). The only notable exceptions were goatfish (*Mullidae*) in spring neuston samples and round scad (*Decapturnus punctatus*) in fall neuston samples. Goatfish young were nearly twice as abundant in the Canyon area as Gulfwide. Young round scad occurred more than twice as frequently in

Table 1F.3. Comparison of DeSoto Canyon area and Gulfwide ichthyoplankton collections taken during nine, SEAMAP Spring Surveys in April and May 1986-1993.

	Bongo DeSoto	Gulfwide		Neuston DeSoto	Gulfwide
<b>Collections</b>	68	512		99	639
<b>%</b>	13%			15%	
<b>Taxa</b>	196	347		119	222
<b>%</b>	56%			53%	
<b>Mean Abundance</b>	1147 larve/10 m <sup>2</sup>	787 larve/10 m <sup>2</sup>		95 larve/10 m <sup>2</sup>	63 larve/10 m <sup>2</sup>

Table 1F.4. Comparison of DeSoto Canyon area and Gulfwide ichthyoplankton collections taken during ten, SEAMAP Fall Surveys in September 1986-1994.

	<b>Bongo DeSoto</b>	<b>Gulfwide</b>		<b>Neuston DeSoto</b>	<b>Gulfwide</b>
<b>Collections</b>	81	556		93	586
<b>%</b>	15%			16%	
<b>Taxa</b>	175	250		134	212
<b>%</b>	56%			63%	
<b>Mean Abundance</b>	1145 larve/10 m <sup>2</sup>	1207 larve/10 m <sup>2</sup>		120 larve/10 m <sup>2</sup>	220 larve/10 m <sup>2</sup>

Table 1F.5. Dominant taxa taken in collections from the DeSoto Canyon area during nine, SEAMAP Spring Surveys in April and May 1986-1993. Number in parenthesis represents value for Gulfwide collections.

	<b>Bongo</b>	
<b>Taxa</b>	<b>% Abundance</b>	<b>% Frequency of Occurrence</b>
Diaphus	17 (11)	88 (75)
Bregmaceros	7 (8)	88 (72)
Myctophidae	14 (12)	88 (81)
Hygophum	6 (6)	77 (71)
Myctophum	4 (4)	72 (62)
Cyclothone	2 (3)	69 (70)
<b>Taxa</b>	<b>% Abundance</b>	<b>% Frequency of Occurrence</b>
Exocoetidae	10 (16)	79 (80)
Mullidae	34 (19)	56 (44)
Mugil curema	2 (2)	27 (18)
Myctophum	15 (16)	27 (31)
Balistidae/Monacanthidae	3 (1)	26 (21)

collections from the Canyon as in Gulfwide collections. It is important to note that the fifth most frequently occurring category of larval fish taken in the fall was Unidentified Larvae (this category was seventh in the spring listing). This can be explained by the fact that larvae of only about 10% of the over 2,000 species of fishes occurring in the Gulf of Mexico and adjacent waters can be identified to the species level. The Canyon area vs. Gulfwide comparisons of the occurrence and mean abundance of larvae were made to gain insight into the relative importance of the DeSoto Canyon and surrounding area in the early life history of select Gulf fishes. Tuna larvae (genus *Thunnus*) occurred more frequently outside the Canyon area, but this difference was less evident in fall than in spring collections (Table 1F.7). Atlantic bluefin tuna larvae (*Thunnus thynnus*) occurred at a lower percentage of Canyon sites in spring than in the Gulf as a whole but were no less abundant there especially in bongo net collections. Dolphin (*Coryphaenidae*) and billfish (*Istiophoridae*) larvae occurred in both spring and fall collections in the Canyon area (Table 1F.8). Dolphin larvae occurred at about the same or greater frequency at Canyon sites in both spring and fall neuston and in fall bongo samples. Billfish larvae were found at proportionately fewer Canyon sites but their abundance was comparable to Gulfwide values. Snapper larvae (*Lutjanidae*), a group of fishes whose larvae are difficult to distinguish from one another, were abundant throughout the Gulf and the DeSoto Canyon area in September (Table 1F.9).

Table 1F.6. Dominant taxa taken in collections from the DeSoto Canyon area during ten, SEAMAP Fall Surveys in September 1986-1994. Number in parenthesis represents value for Gulfwide collections.

	<b>Bongo</b>	
<b>Taxa</b>	<b>% Abundance</b>	<b>% Frequency of Occurrence</b>
Gobiidae	7 (13)	94 (88)
Ophidiidae	4 (3)	85 (71)
Symphurus	5 (9)	85 (84)
Engraulidae	14 (12)	79 (76)
Unidentified Larvae	4 (4)	79 (76)
	<b>Neuston</b>	
<b>Taxa</b>	<b>% Abundance</b>	<b>% Frequency of Occurrence</b>
Exocoetidae	9 (4)	80 (76)
Engraulidae	39 (37)	69 (60)
Decapturus punctatus	6 (1)	54 (25)
Balistidae/Monacantidae	2 (1)	40 (34)
Gobiidae	1 (2)	40 (37)

Table 1F.7. Percent occurrence and mean abundance of tuna larvae (number under 10 m<sup>2</sup>) in collections from the DeSoto Canyon area and Gulfwide during SEAMAP Spring and Fall Surveys.

	Bongo DeSoto	Gulfwide		Neuston DeSoto	Gulfwide
Spring <i>Thunnus spp.</i>	19% 2.9	26% 4.3		13% 0.3	29% 1.8
Fall <i>Thunnus spp.</i>	14% 1.0	16% 2.1		11% 0.7	19% 1.2
Spring <i>Thunnus thynnus</i>	6% 2.2	10% 2.0		5% 0.2	9% 0.4

Table 1F.8. Percent occurrence and mean abundance of dolphin and billfish larvae (number under 10 m<sup>2</sup>) in collections from the DeSoto Canyon area and Gulfwide during SEAMAP Spring and Fall Surveys.

	Bongo DeSoto	Gulfwide		Neuston DeSoto	Gulfwide
Spring Coryphaenidae	9% 0.9	14% 1.2		43% 0.7	48% 0.9
Fall Coryphaenidae	2% 0.3	2% 0.1		27% 0.3	22% 0.4
Spring Istiophoridae	2% 0.1	4% 0.4		3% 0.1	8% 0.2
Fall Istiophoridae	1% 0.04	1% 0.1		4% 0.1	6% 0.1

Table 1F.9. Percent occurrence and mean abundance of snapper larvae (number under 10m<sup>2</sup>) in collections from the DeSoto Canyon area and Gulfwide during SEAMAP and Fall Surveys.

	Bongo DeSoto	Gulfwide		Neuston DeSoto	Gulfwide
Lutjanidae	57% 9.9	49% 8.5		26% 0.7	23% 1.0

## SUMMARY

It is apparent from this brief and preliminary data summary that the ichthyoplankton assemblage in the vicinity of the DeSoto Canyon reflects the high diversity of the fish fauna in the Gulf of Mexico. Despite the limited number of collections available it is clear that the Canyon region is likely an important spawning and/or nursery area for many species of fishes. The picture depicted in my presentation is, however, a static one. The true relevance of the Canyon to early life stages and ultimately to Gulf fish populations can only be evaluated with data from process oriented studies of the relationships between fish larvae and their water-column habitat. The worthy goal of such multidisciplinary investigations would be to elucidate the relationship between the physical and biological dynamics of the DeSoto Canyon and variations in growth and survival of fish larvae found there.

---

Dr. Lyczkowski-Shultz has been a NMFS Research Fishery Biologist since 1992. She is Plankton Team Leader at the Mississippi Laboratories, Pascagoula Facility; serves as the NMFS representative on the Southeast Area Monitoring and Assessment Program (SEAMAP) Subcommittee of the Gulf States Marine Fisheries Commission; and is an adjunct faculty member at the Universities of South Alabama and Southern Mississippi. Her research interests range from larval fish taxonomy to fisheries oceanography. Dr. Lyczkowski-Shultz received a B.A. in biology from SUNY at Buffalo, a M.A. in marine science from the College of William and Mary (Virginia Institute of Marine Science), and a Ph.D. in oceanography from the University of Maine.

**FACTORS INFLUENCING THE TIMING AND MAGNITUDE OF  
SETTLEMENT OF REEFFISH RECRUITING TO SEAGRASS  
MEADOWS ALONG THE WEST FLORIDA SHELF**

Dr. C.B. Grimes  
Dr. Gary Fitzhugh  
National Marine Fisheries Service

Dr. C.C. Koenig  
Dr. F. C. Coleman  
Florida State University  
Tallahassee, FL

A number of commercially and recreationally important reeffish species share the common life history characteristics of offshore spawning and transport of larvae inshore to settle in seagrass meadows throughout the Big Bend where they spend an obligatory nursery phase before recruiting to adult stocks offshore. Among these fishes are both winter and summer spawners, gag, *Mycteroperca microlepis*, and grey snapper, *Lutjanus griseus*, respectively, being good examples.



The NMFS Panama City Laboratory and the cooperative Florida State University Institute for Fishery Resource Ecology are engaged in studies designed to lead to forecasting recruitment to the fisheries by understanding how stock characteristics and environmental factors regulate settlement to seagrass habitats along the West Florida Shelf (WFS). Gag spawn in February and March in a defined area west of the Florida Middle Grounds, and larvae are transported inshore to settle in seagrass meadows 30-50 days later. Juveniles remain in the seagrass nursery areas until October or November when they recruit to adult stocks offshore.

Spawning and settlement dates hind-cast from microstructure of lapillae reveal distinct spatial and temporal patterns for young gag along the WFS. Both spawning and settlement are 10 to 14 days later in the northern (Panhandle) region than in southwest Florida; settlement is relatively consistent in southwest Florida; but highly variable in the northern region (Figure 1F.5).

We propose four mechanisms that may influence the timing and magnitude of settlement: (1) a latitudinal gradient in spawning along the WFS (i.e., spawning occurs earlier in the south than in the north); (2) limitation of settlement by seagrass habitat availability due to the annual cycle of seagrass die-back and regeneration; (3) changes in the main direction of larval transport due to the seasonal shift in the wind field from the winter to spring pattern; and (4) the temporal and spatial match/mismatch between the production cycles on the WFS and spawning and larval production.

Comparison of the temporal distribution of spawning derived from ovarian histology of spawning females to otolith-derived spawning dates of settled juveniles in the northern region shows that spawning occurred February to mid-April while surviving juveniles were spawned mid-March to mid-April. This result leads us to discount the importance of the spawning gradient mechanism (Figure 1F.5).

We are sampling presettlement juveniles in the northern region with channel nets to determine if the arrival dates of newly arriving settlers precedes otolith-derived settlement dates of settled juveniles. If true, this result would suggest that the larval supply preceded spring regeneration of seagrass habitat suitable for settlement, thus supporting the importance of the habitat limitation mechanism.

Trajectories of satellite-tracked surface drifters support a strong role for the transport mechanism. They reveal seasonally changing surface circulation of the WFS that would result in high settlement in the north and low settlement in the south during the later portion of the spawning season (Figure 1F.6).

The so called "Green River" is an interannually persistent area of high primary production on the WFS that coincides temporally and spatially with gag spawning west of the Florida Middle Grounds. It is likely that this production initiates a trophic cascade that supports feeding, growth, and survival of gag larvae during the pre-settlement phase of their life history. The temporal and spatial match/mismatch between the Green River and gag spawning and larval production may also influence the timing and magnitude of settlement.

---

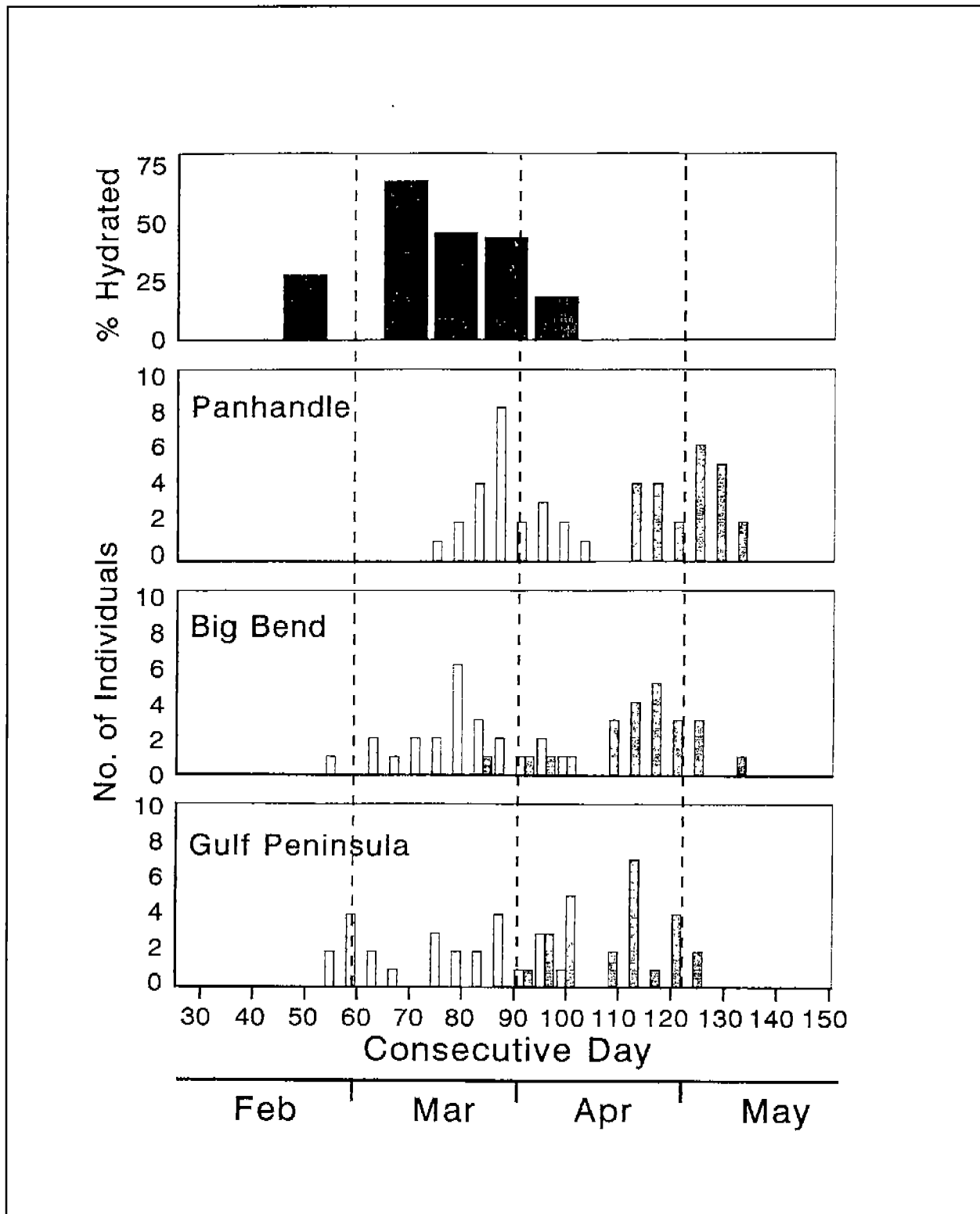

Figure 1F.5. Temporal distribution of spawning (light) and settlement (dark) of gag, *Mycteroperca microlepis*, for three regions arranged from north to south along the West Florida Shelf in 1995. The top hydrated ova expressed as percentage hydrated.

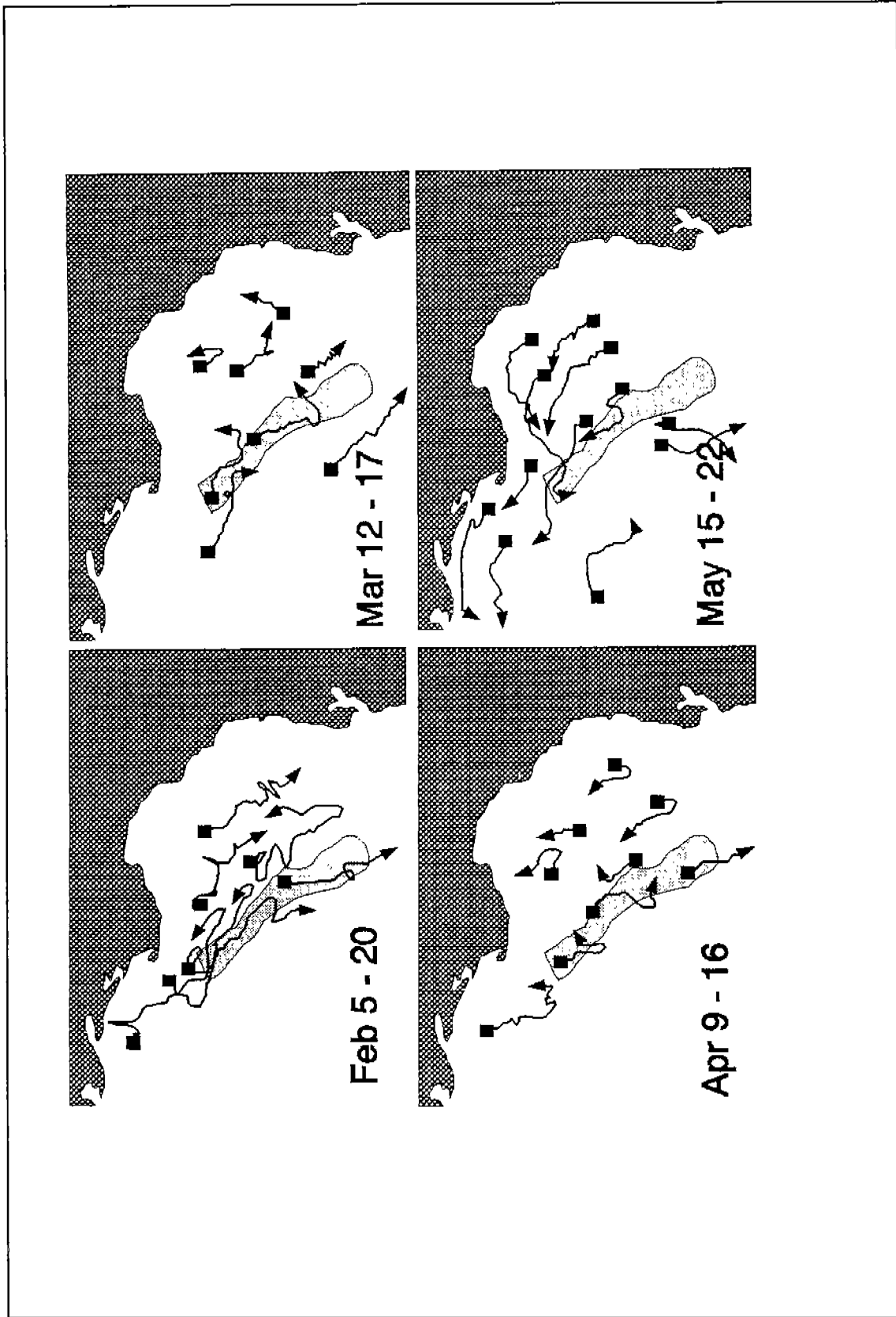

Figure 1F.6. Tracks of satellite-tracked surface drifters near the gag spawning grounds (stippled area) on the West Florida Shelf during the 1996 spawning and settlement period. Surface drifter data courtesy of Dr. Tony Sturges, Florida State University, Tallahassee, Florida.

Dr. Churchill Grimes has worked at the National Marine Fisheries Service, Panama City laboratory since 1984 and currently serves as Laboratory Director. His areas of research interest include early life history and recruitment dynamics of marine fishes. Dr. Grimes received his B.S. and M.S. in biology from East Carolina University and his Ph.D. in marine sciences from the University of North Carolina.

Dr. Gary Fitzhugh has worked at the Institute for Fisheries Resource Ecology of Florida State University for the past three years as a fisheries research biologist. His areas of research interest include recruitment biology, reproduction and life history of marine fishes. Dr. Fitzhugh received his B.S. in biology from Illinois State University, his M.S. in zoology from Louisiana State University and his Ph.D. in zoology from North Carolina State University.

Dr. Christopher Koenig has worked as a research faculty member in the Department of Biological Sciences at Florida State University for the past seventeen years. His areas of research interest include marine fisheries habitat assessment, recruitment processes and reproductive ecology of reef fishes. Dr. Koenig received his B.S. and M.S. in biology from Florida Atlantic University and his Ph.D. in biology from Florida State University.

Dr. Felicia Coleman has worked at Florida State University for the last seven years and serves as Coordinator for the Institute for Fishery Resource Ecology; a cooperative program between FSU and the National Marine Fisheries Service. Her areas of research interest includes reef fish reproduction and ecology and management of marine fishes. Dr. Coleman received her B.S. and M.S. in biology from the College of Charleston, South Carolina and her Ph.D. in biology from Florida State University.

## **FISHERY HABITAT ALONG THE OUTER WEST FLORIDA SHELF AND IMPORTANCE TO CONSERVATION OF GROUPER/SNAPPER STOCKS**

Dr. G.R. Fitzhugh

Dr. C.C. Koenig

Mr. C. Gledhill

Mr. M.A. Grace

National Marine Fisheries Service

Ms. K. Scanlon

U.S. Geological Survey, Coastal and Marine Program

Dr. C.B. Grimes

National Marine Fisheries Service

Dr. F.C. Coleman

Florida State University

There is an increasing awareness among the US regional fishery management councils of the need for conservation of marine fishery habitat. Such habitat forms the foundation of fishery production but may be negatively affected by various human activities, including fishing. This presentation offers an approach to the identification and conservation of important west Florida shelf-edge habitats and proposes the establishment of marine protected areas for their conservation.

Traditional stock assessment uses a single species approach to marine fishery management. When applied to multispecies fisheries such as the reef fish fishery, this approach has limited effectiveness because it ignores the complex interactions between species and the complex nature of the fishery. For example, when harvest restrictions are placed on one species, fishermen may heavily target alternate species, often to the decline of the alternate species. Additional complications may arise due to release mortality because of depth of capture, which often negates the beneficial effects of size limits. Marine harvest refugia provide a means of circumventing these problems and provide a measure of insurance against the uncertainty and risk involved in the fishery management process.

There are many potential benefits for marine reserves (Plan Development Team 1990) but there is overwhelming agreement among scientists that marine reserves can have a significant influence in fisheries management by preserving spawning habitat and assuring adequate recruitment via a "biomass bank" of adults. Marine protected areas have been in use in the United States since the 1930s but few reserves have been established for direct fishery benefits. In 1994 the South Atlantic Fishery management council established an experimental fishery reserve of valuable *Oculina* coral habitat off the east coast of Florida. The Gulf of Mexico Fishery Management Council is just initiating a review of alternatives for establishing marine fishery reserves in the Gulf of Mexico.

Our approach contains several components. First we are reviewing information on historical and current fishing patterns to identify the spawning aggregations and locations of associated habitat. Once we prioritize where to look, our survey incorporates side-scan sonar mapping to identify contiguous features, fishery acoustics for determination of relative abundance and video observations for abundance measures, identification of species and habitat type. Last, we are comparing results with an on-going study of circulation/transport patterns to understand the connection between spawning and nursery grounds, that will be critical for placement of reserves. For example, desirable reserve placement should be upstream of the best nursery habitat or be located such that larvae will be retained on the continental shelf.

Most of the snapper and groupers harvested in the Gulf of Mexico are captured from the west Florida shelf. These fishes are an important resource as they comprise a major target of marine fishing in Florida, an activity which generates in excess of a billion dollars to the state annually (Bell 1993). Several species that may benefit from habitat protection can be identified. Economically important shelf-edge species include groupers such as gag, scamp, and black grouper along with several species of snappers and porgies. On the shelf-slope, the deep water grouper complex includes speckled hind, yellowedge grouper, warsaw grouper, snowy grouper, and misty grouper. For some protogynous (sex-changing) species that aggregate, fishing mortality has caused a severe decline in the abundance of males warranting concerns about protection of spawning aggregations. For several species, declines in landings, mean sizes and size at maturity are indicators of overfished conditions. Speckled hind and warsaw grouper--both of which inhabit steep cliffs & rocky ledges on the continental slope--warrant particular concern and have been added this year to a list of candidate species for endangered/threatened status.

While there may be much promise for protecting habitat to conserve reef fish stocks, there is still a lack of documentation on specific hard-bottom and high-relief areas in the eastern GOM. In general, the west Florida shelf contains the greatest amount of reef habitat (38%--rock, coral, sponge) of the U.S. coast along the south Atlantic and GOM (Parker *et al.* 1983). Continental Shelf Associates (1992) refined this estimate to between 17-20% hard-bottom with about 3% making up high-relief (> 1m) features along the west Florida shelf. However, the CSA report pointed to several areas where data were lacking and estimated that only 9% of this entire shelf region had been surveyed in a manner allowing calculation of habitat area.

In reviewing historical and current fishing patterns, it becomes apparent that there are high relief shelf-edge regions that are generally unmapped and undocumented, but they may be well known to fishermen. Martin Moe (1963) conducted a survey of offshore fishing in Florida and reported habitat features and place names common at that time. Outer shelf areas were targeted principally by commercial fishermen although these areas were considered remote and lightly fished during the early 1960s. High-relief pinnacle and ridge areas were identified along the 70 m (40 fathom) contour west of the Big-Bend region and west of the Florida Everglades. These high relief features were not reported along the shelf edge from west central Florida. Topographic surveys also show the potential for extensive high-relief shelf-edge habitats west of the Big Bend region and west of the Everglades (Ludwig and Walton 1957, CSA 1992). Two more recent NMFS fishery surveys conducted using on-board observers, obtaining fishing locations, indicates that these areas are still targeted by hook-

and-line (bandit and electric reels) and longline gears (Denton and Davenport 1995, Alan Collins, unpublished data, NMFS Panama City lab). These commercial fisheries are known to target hard-bottom areas. Maps of catches from these surveys overlap with Moe's sites along the 70 m contour west of the Big Bend region and from ridges along the SW Florida shelf.

Because of these fishing patterns, we have begun an effort to survey select features along the west Florida shelf. This is preliminary work that is supported in part by a monitoring program conducted for the *Oculina* Research Reserve. In 1997 we conducted a side-scan, fishery acoustic and video survey of a 50 km<sup>2</sup> area along the outer shelf bounded north and south by latitudes 29° 06.0' N and 28° 03.0' N respectively, and east and west by longitudes 85° 18.0' W and 85° 36.0' W. The larger area formed a bight with a sharp drop along the shelf edge. This area was mainly devoid of hard-bottom features with the exception of an undocumented double ridge-line about 6 km in length along the southeastern edge of our study area. A preliminary onboard side-scan mosaic helped define our survey for further focus on fish abundance and distribution. The double ridge lines were up to 15 m relief at 60-70 m depth which corresponds to the depth reported for samples of actively spawning gag and scamp. By comparison, this area has very similar features to the pinnacle trends noted by Ludwig and Walton (1957) and are likely drowned reefs with origin during the Pleistocene. General habitat features were noted similar to other ridge surveys including limestone boulders, ledges with soft and hard corals--possibly *Oculina* sp., sponges and sessile invertebrates.

Fishery acoustic transects down the ridge lines provided a relative abundance measure (area backscatter). The highest returns in transects down the ridges occurred along western and seaward facing slopes. By looking for consistent acoustic patterns, we can address the degree to which fish may be responding to currents or habitat conditions. We also noted that largest targets (grouper-sized) were within two meters of the bottom during these daytime transects. Ground truthing becomes important in resolving these patterns as acoustic detectability of fishes becomes difficult close to the bottom. Preliminary video observations revealed scamp in courtship color and behavior.

During 1996 changes in the Magnuson Act, which directs marine fisheries management, have mandated more attention to fisheries habitat. For example essential fisheries habitat must be addressed in fishery management plans. Essential fish habitat primarily pertains to waters and substrates that are necessary for spawning, feeding and growth to maturity. Given the importance of outer shelf habitats for spawning of important reef fishes, it is clear that there is further need for identifying and mapping outer shelf areas along the eastern GOM. Also, there is a need for a more integrative view of resource use in the eastern GOM given increases in oil and gas exploration and development plans as well as continued increases in fishing effort. For example, there are two significant areas of high-relief habitat located in areas slated for oil and gas development (Pinnacle Trend area south of Mobile Bay and Destin Dome Unit 56 south of Pensacola) and currently there is not enough information to assess what amount of shelf-edge high-relief habitat remains or should remain undeveloped.

## REFERENCES

- Bell, F.W. 1993. Current and projected tourist demand for saltwater recreational fisheries in Florida. Florida Sea Grant College Program. 95p. SGR-111.
- Continental Shelf Associates, Inc. 1992. Compilation of existing data on the location and areal extent of reef fish habitat on the Mississippi/Alabama/Florida continental shelf - eastern Gulf of Mexico. Final Summary Report. Prepared for the National Oceanic and Atmospheric Administration, MARFIN project, Award No. NA17FF0380-1.
- Ludwick, J.C. and W.R. Walton. 1957. Shelf-edge, calcareous prominences in northeastern Gulf of Mexico. *Bulletin of the American Association of Petroleum Geologists* 41(9):2054-2101.
- Moe, M.A. 1963. A survey of offshore fishing in Florida. Professional Paper Series No. 4, Fla. State Board of Conservation, Marine Laboratory, St. Petersburg, Fla. 117 p.
- Plan Development Team. 1990. The potential of marine fishery reserves for reef fish management in the U.S. Southern Atlantic. NOAA Technical Memorandum NMFS-SEFC-261, 40p.
- Parker, R.O. Jr., D.R. Colby and T.D. Willis. 1983. Estimated amount of reef habitat on a portion of the U.S. South Atlantic and Gulf of Mexico continental shelf. *Bulletin of Marine Science* 33(4); 935-940.
- Scott-Denton, E. and G. Davenport. 1995. Characterization of the reef fish fishery of the eastern U.S. Gulf of Mexico. MARFIN Final Report, Grant No. 95MF1H07.

---

Dr. Gary Fitzhugh has worked at the Institute for Fisheries Resource Ecology of Florida State University for the past three years as a fisheries research biologist. His areas of research interest include recruitment biology, reproduction and life history of marine fishes. Dr. Fitzhugh received his B.S. in biology from Illinois State University, his M.S. in zoology from Louisiana State University and his Ph.D. in zoology from North Carolina State University.

Dr. Christopher Koenig has worked as a research faculty member in the Department of Biological Sciences at Florida State University for the past seventeen years. His areas of research interest include marine fisheries habitat assessment, recruitment processes and reproductive ecology of reef fishes. Dr. Koenig received his B.S. and M.S. in biology from Florida Atlantic University and his Ph.D. in biology from Florida State University.

Chris Gledhill has worked at the National Marine Fisheries Service Laboratory in Pascagoula, Miss. since 1985 as a fisheries biologist. His areas of research interest include fisheries acoustics and biology and ecology of reef fish. Mr. Gledhill received his B.S. in marine biology from University



of Massachusetts at N. Dartmouth, his M.S. in fisheries from University of Massachusetts at Amherst and is currently a doctoral candidate in marine science at University of South Alabama.

Mark Grace has worked at the National Marine Fisheries Service, Pascagoula Laboratory, since 1980 as a fishery biologist. His research interests include fishery survey and assessment and fisheries acoustics. Mr. Grace received his B.S. in zoology with emphasis in marine sciences from the University of Southern Mississippi.

Kathryn Scanlon has worked as a marine geologist with the U.S. Geological Survey, Coastal and Marine Program at the Woods Hole Field Center since 1979. Her areas of research interest include sea floor morphology and sedimentary processes, particularly as related to benthic habitats and mineral resources. Ms. Scanlon received her B.S. in geology at Cornell University and her M.S. in geology from the State University of New York at Albany.

Dr. Churchill Grimes has worked at the National Marine Fisheries Service, Panama City laboratory since 1984 and currently serves as Laboratory Director. His areas of research interest include early life history and recruitment dynamics of marine fishes. Dr. Grimes received his B.S. and M.S. in biology from East Carolina University and his Ph.D. in marine sciences from the University of North Carolina.

Dr. Felicia Coleman has worked at Florida State University for the last seven years and serves as Coordinator for the Institute for Fishery Resource Ecology; a cooperative program between FSU and the National Marine Fisheries Service. Her areas of research interest includes reef fish reproduction and ecology and management of marine fishes. Dr. Coleman received her B.S. and M.S. in biology from the College of Charleston, South Carolina and her Ph.D. in biology from Florida State University.

**THE GULF-LOOP CURRENT AND ITS SPIN-OFF EDDIES:  
THEIR INFLUENCE ON FISHERIES PRODUCTION IN  
THE DE SOTO CANYON REGION**

Dr. John J. Govoni  
Dr. John T. Lamkin  
Dr. William J. Richards  
Dr. Joanne Lyczkowski-Shultz  
Mr. Thomas D. Leming  
National Oceanic and Atmospheric Administration

It is axiomatic that primary production drives secondary production, which in turn drives fisheries production (Bakun, 1996), but the final linkage is not always clear. In the northern Gulf of Mexico, two physical features account for the nutrient influx that drives primary production: the discharge of the Mississippi River and the Gulf Loop Current and its spin-off eddies. Of these, upwelling along the edge of the Gulf Loop Current or within its cyclonic spin-off eddies, owing in part to the conservation of vorticity, delivers three times as much nitrogen to the euphotic zone as does the Mississippi River (Wiseman unpublished).

The Gulf Loop Current is zonally and meridionally dynamic. It makes frequent northward excursions (Maul 1977), at times impinging on the continental shelf of the northeastern Gulf and frequently shedding large (ca. 400 km) anticyclonic eddies that drift westward across the Gulf, often impinging on the Texas shelf before dissipating. Small counter-current, cyclonic eddies often accompany the northern reaches of the Gulf Loop Current or its large eddies (Wiseman, unpublished). The northern edge of the Gulf Loop Current and its eddies occasionally occupy the De Soto Canyon region.

The De Soto Canyon area of the Northeastern Gulf of Mexico is unique in its abundance of commercially important and diverse marine life. It may be an essential fisheries habitat for species ranging from yellowfin tuna and reef fish to deep water royal red shrimp and geryon crab. Also, it may serve as nursery habitat for tuna (bluefin as well as yellowfin), swordfish, groupers, Gulf butterfish and geryon crab and royal red shrimp (Herron *et al.*, 1989; Richards and Pothoff 1980a; Richards and Pothoff 1980b; Richards *et al.* 1989). Both pelagic and reef-associated species are economically important to the fisheries of the Gulf, and the ecosystem that produces these fisheries is virtually unstudied with respect to characteristics of fish spawning habitat and transport (Richards and McGowan 1989).

The hydrodynamics of De Soto Canyon are complex, yet can influence fish production in two possible ways: by providing elevated primary and secondary production that supports the survival and growth of fishes spawned within this region, and by effecting the transport of fish propagules into and out of local populations. The interaction of the Gulf Loop Current and its spin-off eddies often draws shelf water off the shelf where it is entrained into the body of the Current or its eddies (e.g., Tester *et al.* 1991). Plankton, including fish propagules embedded within this entrained water, will exit local populations to be expatriated or to immigrate to other areas. Eddy circulation can

result in the exchange of Loop Current water with the shelf near the De Soto Canyon as much as 40-50% of the time (Clarke 1995). The consequences of such phenomena for plankton (including ichthyoplankton) transport and distribution is presently unknown.

A nursery area implies that there exist concentrations of nutrients adequate to drive primary and consequent secondary production; i.e., prey for young fishes. Plant nutrients are often scarce in the surface layers of the open ocean where low primary productivity is the norm. The physical dynamics of frontal zones and spin-off eddies can provide the nutrients to the euphotic zone. The resulting impact on distributions of primary production, coupled with the strong vertical velocities often associated with frontal zones has important consequences for the distribution and abundance of organisms at higher trophic levels.

Frontal zones of the sort often present in the De Soto Canyon region are important to fisheries for several reasons. Large pelagic predators such as mackerel and tuna often aggregate in these areas because of the abundance of small forage fishes that are frequently found there (Bakun 1996). Recent work has shown that larval tuna and increased zooplankton abundance (Biggs *et al.* 1997) occur in areas of elevated concentrations of chlorophyll and a shallowing of the chlorophyll maximum layer. Localized frontal convergence can aggregate larval and juvenile fishes as well (Govoni 1989). Interactions of the Loop Current and spin-off eddies with the northern Gulf of Mexico continental shelf may produce a situation analogous to that of the southeastern U.S. continental shelf where the Gulf Stream is suspected as essential fisheries habitat (Lamkin 1997), but this has not been documented.

Given the largely unknown and complex hydrographic regime of De Soto Canyon, we believe that study of this area is clearly warranted. Work focusing on the spatial distribution of larval and juvenile fishes and the hydrography in the area of De Soto began in 1994 and has continued to 1997. The particular concern of this work was the circulation patterns within the canyon as well as at the edge of the Loop Current and its eddies. The temperature front caused by intrusions of warm water into the canyon appear to be areas of high biomass of both zooplankton and larval fish. Of particular interest is the abundance of the commercially important species of tuna and mackerel that are found along these fronts. Eulerian and Lagrangian data, collected concomitantly with plankton and micro-nekton data, would provide information on flow-fields, plankton, and fish abundance. These data could be used to calculate water volume and biomass transport.

With the initiation of the De Soto Canyon Eddy Intrusion Study by Minerals Management Service, the opportunity exists to answer some fundamental questions important to both MMS and NMFS. This information could play a key role in understanding the physical-biological interaction. When addressing the question of zooplankton stocks and fish production and transport, it is imperative that the physical regime be understood and thoroughly documented at the time of collection. By starting a biological effort concurrent with this program, we can take advantage of the information generated, and both programs will benefit from an exchange of information.

## REFERENCES

- Bakun, A. 1996. Patterns in the Ocean, ocean processes and marine population dynamics. Pub. Calif. Sea Grant College System, NOAA. 323 pp.
- Biggs, D.C., R.A. Zimmerman, R. Gasca, E. Suarez, I. Castellanos, and R.R. Leben. 1997. Note on plankton and cold-core rings in the Gulf of Mexico. *Fish. Bull.*, U.S. 95: 369-375.
- Clarke A.J. [ed.]. 1995. Northeastern Gulf of Mexico physical oceanography workshop; Proceedings of a workshop held in Tallahassee, Florida, April 5-7, 1994. U.S. Department of the Interior, Minerals Management Service, Gulf of Mexico OCS Region.
- Govoni, J.J. 1993. Flux of larval fishes across frontal boundaries: examples from the Mississippi River plume front and the western Gulf Stream front in winter. *Bull. Mar. Sci.* 53: 538-566.
- Herron, R.C., T.D. Leming, and J. Li. 1989. Satellite-detected fronts and butterflyfish aggregations in the northeastern Gulf of Mexico. *Con. Shelf Res.* 9: 569-588.
- Lamkin, J.T. 1997. The Loop Current and the abundance of Larval *Cubiceps pauciradiatus* (Pisces, Nomeidae) in the Gulf of Mexico: evidence for physical-biological interaction. *Fish. Bull.*, U.S. 95: 250-266.
- Leming, T.D. and D.R. Johnson. 1985. Application of circulation models to larval dispersement and recruitment. *MTS Journal* 19: 34-41.
- Maul, G.A. 1977. The annual cycle of the Loop Current, part I: observations during a one-year time series. *J. Mar. Res.* 35: 29-47.
- Richards, W.J. and M.F. McGowan. 1989. Biological productivity in the Gulf of Mexico: identifying the causes of variability in fisheries. Pages 287-325. *In* K. Sherman and L.M. Alexander, eds. Biomass and Geography of large marine ecosystems. AAAS Symposium Series 111. Westview Press, Boulder, Colorado.
- \_\_\_\_\_ and T. Potthoff. 1980a. Distribution and abundance of bluefin tuna larvae in the Gulf of Mexico in 1977 and 1978. *Int. Comm. Cons. Atl. Tunas, Coll. Vol. Sci. Pap.* 9(2):433-441.
- \_\_\_\_\_ and \_\_\_\_\_. 1980b. Larval distributions of scombrids (other than bluefin tuna) and swordfish in the Gulf of Mexico in the spring of 1977 and 1978. *Int. Comm. Cons. Atl. Tunas, Coll. Vol. Sci. Pap.* 9(3):680-694.
- \_\_\_\_\_, T. Leming, M.F. McGowan, J.T. Lamkin, and S. Kelley-Fraga. 1989. Distribution of fish larvae in relation to hydrographic features of the Loop Current boundary in the Gulf of Mexico. *Rapp. Reun. Cons. Int. Explor. Mer.*, 191: 169-176.

\_\_\_\_\_, F. McGowan, T. Leming, J.T. Lamkin and S. Kelley. 1993. Larval fish assemblages at the Loop Current boundary in the Gulf of Mexico. *Bull. Mar. Sci.* 53: 475-537.

Tester, P.A., R.P. Stumpf, F.M. Vukovich, P.K. Fowler, and J.T. Turner. 1991. An expatriate red tide bloom: Transport, distribution and persistence. *Limnol. Oceanogr.* 36: 1053-1061.

Wiseman, W.J., and W. Sturges. Physical oceanography of the Gulf of Mexico: its importance to biological oceanography.

---

John J. Govoni is an ecologist with the National Oceanic and Atmospheric Administration, National Marine Fisheries Service, Southeast Fisheries Science Center (SEFSC) at Beaufort, North Carolina. He received an A.B. from Saint Anselm College, a M.S. from the University of Massachusetts, Dartmouth, a Ph.D. from the College of William and Mary in 1980. His research interests are the organismal biology of larval fishes and the linkage of physical oceanography and fish distributions.

John T. Lamkin is a Commander in the U.S. NOAA Corps and Commanding Officer of NOAA SHIP TOWNSEND CROMWELL. He received B.S. and M.S. degrees from Texas A&M University, and a Ph.D. from the University of Miami. His research interest is in the taxonomy and spatial distribution of larval fishes.

William J. Richards, a Senior Scientist with the SEFSC in Miami, Florida, received a B.S. from Wesleyan University and the Ph.D. from Cornell University. His long research career has tracked the taxonomy, systematics, and ecology of fishes with an emphasis in early life histories.

Dr. Lyczkowski-Shultz, a NMFS Research Fishery Biologist since 1992, is Plankton Team Leader at the Mississippi Laboratories, Pascagoula Facility; NMFS representative on the Southeast Area Monitoring and Assessment Program (SEAMAP) Subcommittee of the Gulf States Marine Fisheries Commission; and an adjunct faculty member at the Universities of South Alabama and Southern Mississippi. Her research interests range from larval fish taxonomy to fisheries oceanography. She received a B.A. in biology from SUNY at Buffalo, a M.A. in marine science from the College of William and Mary (Virginia Institute of Marine Science), and a Ph.D. in oceanography from the University of Maine.

Thomas D. Leming is a research oceanographer with the SEFSC at Stennis Space Center, Bay St. Louis, Mississippi. He received a B.S. from the University of Washington, a M.S. from the University of Miami, and is a candidate for the Ph.D. at Louisiana State University. The research efforts are in physical and satellite oceanography applied to fisheries problems.



Socio-Economic Development and  
Conservation Perspectives of the Laguna  
Madre in Tamaulipas  
and  
Desarrollo Socio-Económico Y Perspectivas  
de Conservación en la Laguna Madre de  
Tamaulipas

Dr. M.A. Vásquez  
K. Logan  
F. Yépez  
Autonomous University of Tamaulipas

## **BINATIONAL COOPERATION FOR PROTECTED CONTIGUOUS NATURAL AREAS**

Ms. María Pia Gallina Tessaro  
Coordinating Unit of Protected Natural Areas  
of the National Institute of Ecology, Mexico

### **INTRODUCTION**

Efforts to address the border environmental concerns require a coordinated binational response. Ecosystems, hydrologic and atmospheric watersheds, the environment and natural resources in the border region cross political lines. Border environmental problems, independent of their place of origin, significantly affect the communities and ecosystems on both sides of the border.

Along the border, Mexico and the United States share ecosystems that do not recognize political boundaries. Therefore, the two governments can perform the tasks for the conservation, preservation, and maintenance of the biodiversity in their respective territories and can develop and coordinate these tasks in accordance with the regulations of each country. In this way, the two governments can take advantage of human as well as economic resources in the attainment of their common objective.

Border environmental cooperation between Mexico and the United States is an example of the effort made by the two governments to reach joint agreements in solving common problems, as established in Border Program XXI.

Working together, the Secretariat of Environment, Natural Resources and Fishing and the Department of the Interior have identified areas of common interest regarding specific aspects of border natural resources. The three areas of interest are:

1. biodiversity and protected areas;
2. conservation of forests and lands; and
3. marine and aquatic resources.

### **BACKGROUND**

Since the 1930s, both countries have exchanged proposals to establish bilateral instruments for conserving and protecting the ecosystems that integrate the protected areas of both countries.

In 1935, the Mexican and U.S. governments were interested in establishing an International Park on the border between Texas and the states of Chihuahua and Coahuila. Representatives of the two governments met that year to discuss the project and to name an international commission.

A year later, a permanent commission was appointed in the United States to meet with the representatives of the Mexican government and formulate the policies and plans to establish and



develop international parks, forest reserves and wildlife refuges along the border and beach patrols in the Sierra El Carmen in Mexico. The meetings were suspended due to the Second World War.

In 1944, negotiations resumed between both governments for the establishment of the International Park; nevertheless, only an alliance called "Of Good Neighbors" was established between the Big Bend National Park in Texas and the communities located along the border line.

Beginning in the 1970s, many training courses, wild flora and fauna studies, meetings and workshops were held to exchange knowledge and experience regarding the management of protected areas and the prevention and control of forest fires between both countries. Although many of these activities were informal, they were nonetheless significant to binational cooperation.

In 1992, the High Gulf Biosphere of California—Colorado River Delta in Baja California and Sonora and El Pinacate—Gran Desierto de Altar, in Sonora, which is adjacent to the Organ Pipe National Monument in Arizona, were declared Reserves. Protected flora and fauna areas in the Santa Elena Canyon in Chihuahua and Maderas del Carmen in Coahuila, which are adjacent to the Big Bend National Park in Texas, were established in 1994.

On 5 June 1997 at the Binational Meeting, and within the framework of the FRONTERA XXI Program, the Officials of SEMARNAP and the Department of the Interior signed the Letter of Intent by which they plan to increase the activities established for cooperation in the conservation of protected contiguous natural areas in the border area, selecting two pilot regions: Arizona, Sonora, Baja California and Texas, Chihuahua, Coahuila.

#### PROTECTED NATURAL AREAS ON THE NORTHERN BORDER

When the Northern Border Environmental Program (1994-2000) was drawn up in 1993 to sign the loan agreement with the World Bank (signed in 1994), to carry out environmental and conservation activities and projects on the border fringe, special emphasis was given to the protected natural areas of this region, and areas were identified which, because of their biodiversity, were susceptible to being declared as such.

The following protected areas were:

1. Reserva Nacional Forestal Sierra de los Ajos, Buenos Aires and La Purica, Sonora. Surface: 21,4494 hect. Decreed in 1936.
2. National Park Constitution of 1857, Baja California. Surface: 5,009 hect. Decreed in 1962.
3. Reserva de la Biosfera El Pinacate and Gran Desierto de Altar, Sonora. Surface: 714,556 hect. Decreed in 1993.
4. High Gulf of California Biosphere Reserve and California River Delta, Baja California, Sonora. Surface: 934,756 hect. Decreed in 1993.

Based on this agreement in 1994, the flora and fauna of the Maderas del Carmen and the Santa Elena Canyon were declared protected areas. Both are contiguous to Big Bend National Park. Studies were

initiated for another area in the region of Laguna Madre, Tamaulipas because of its importance as a wetland and the diversity of birds there.

One of the accomplishments of the Natural Resources Group of the FRONTERA XXI Program was the signing of the Letter of Intent by the officials of SEMARNAP and of the Department of the Interior on 5 May 1997. This agreement expanded the activities established for cooperation in protecting border areas of the United States and Mexico.

These activities occurred within the framework of pre-existing cooperation agreements between both countries, among which are the 1983 Agreement for the Protection and Improvement of the Environment in the Border Area; the 1988 Memorandum of Understanding on Cooperation in the Management and Protection of National Parks and other Protected Natural and Cultural Heritage Sites; the 1988 Tripartisan Agreement for the Conservation of Wetlands and their Migratory Birds between Canada, the United States and Mexico; the 1995 Memorandum of Understanding on Scientific and Technical Cooperation on Biological Information and Data; the 1996 Memorandum of Understanding that establishes the Trilateral Committee for the Conservation and Management of Wildlife and Ecosystems between the United States, Canada and Mexico and International Agreements such as the Convention on International Trade of Endangered Species of Wild Fauna and Flora (CITES), to which Mexico was added in 1991.

In the Letter of Intent, collaboration was proposed in areas such as:

- Formulation of harmonious and complementary policies related to the conservation of natural and cultural resources;
- Exchange of experiences between the personnel of both countries, evaluation techniques and resource management, training, and the generation of new conservation strategies;
- Arrangement of environmental education and training programs for resident communities on both sides of the border to stimulate their participation in conservation activities and sustainable use of the resources of protected natural areas;
- Broadening the base of scientific knowledge about the protected natural areas in their regional, ecological, cultural and socioeconomic context through cooperation on research projects and development of mutually accessible information systems current conditions and tendencies, by monitoring species, as well as future priorities for research on shared biological resources;
- Exploration to develop a mechanism for establishing a rapid communication network which enables timely and unified attention to environmental emergencies, particularly in cases of fires; and
- Cooperation on respective inspection and surveillance activities of each country to prevent and control illegal ecological behavior in the protected natural areas.

Within the framework of the referenced Letter of Intent, the two pilot regions will include, on one hand, the High Gulf Biosphere of California—Colorado River Delta and El Pinacate—Gran Desierto de Altar and the adjacent protected areas in the United States, Organ Pipe Cactus National Monument, Cabeza Prieta National Wildlife Refuge and Imperial National Wildlife Refuge, and on the other hand, the protected flora and fauna areas in the Santa Elena Canyon and Maderas del Carmen and the adjacent protected area in the United States, Big Bend National Park.

In the month of October, the first meeting was held between the representatives of DOI and UCANP in the El Pinacate-Gran Desierto de Altar Biosphere Reserve, Sonora, to identify specific binational cooperation activities that were formalized within the framework of the Letter of Intent. As a result, a work program was established in areas such as: evaluation of wildlife populations, environmental education and public involvement, habitat quality, legal application, training, habitat restoration and management, protection, threat management and ecological restoration, research and resource management, sustainable productive projects (ecotourism), among others, to be formalized in 1998.

The following meeting will be held in January 1998 for the Big Bend region, Santa Elena Canyon and Maderas del Carmen.

#### LAGUNA MADRE

In 1996 the National Commission for the Use and Knowledge of Biodiversity (CONABIO) and Pronatura, A.C. organized a workshop for identifying priority regions for conservation in Mexico. As a result of the workshop, 155 priority regions were identified, among which is the Laguna Madre region in Tamaulipas, 55 km south of the mouth of the Río Bravo. Laguna Madre is located within the 28 priority areas for migratory waterfowl in Mexico, which are the home of 83% of the population of hibernating ducks in our country. It is also the number one spot of hibernating waterfowl since it is the habitat for 15% of their population in Mexico.

The Laguna Madre region is located in the province of the northeastern coast of Tamaulipas, and has an expanse of approximately 9,055 km<sup>2</sup>. It is a part of the coastal wetlands, dominated by seagrass meadows along the coast of the Gulf of Mexico. It is rich in biodiversity and it is one of the two largest hypersaline lagoons in the world; it is highly productive because it sustains important commercial, recreational and fishing activities.

The edaphic variations and climatic differences in the area associated with the coastal systems have been the cause of diversity in vegetation, the main ones being the xerophilous mesquite woodlands (*Prosopis*) and the huizache (*Acacia*); the thornscrub with species such as the ebony (*Pithecellobium*); halophyte vegetation with succulents such as *Suaeda* and *Salicornia*, and *Spartina* and *Distichlis* halophyte pastures; and seagrass meadow vegetation.

The Laguna Madre shelters 323 species of land vertebrates of which at least 50 species are considered at risk of extinction. In the Laguna Madre region there are 219 species of birds, of which 144 species are residents; four (2.7%) are endemic to Mexico, another has a restricted distribution in Mexico and bordering areas but no specie restricted to the province.

One of the biological relevancies of Laguna Madre is that it serves as a natural corridor for migratory waterfowl, given the high percentage (59%) of this group, as indicated in the records of bird fauna in the area, and the amounts of resident species (38%). Such figures emphasize the importance of this area as a biological corridor and possible transition area.

The Laguna Madre of Tamaulipas shelters 26 species of anseriforms (68.42% of the species distributed in Mexico). Of these, the most abundant specie is the redheaded duck (*Aythya americana*) with an average hibernating population during the last 16 years in the area of 245,128 birds, which represents about 34% of the total population of the specie in North America.

The foregoing only mentions some of the relevant aspects of Laguna Madre, which has merited the special attention of the Mexican government. Additional areas soon may be declared as Protected Natural Area. An ecological order study is being conducted in the region that will orient activities according to soil type, so that productive activities will allow for development which is compatible with the conservation of resources in the region and the protection of priority areas.

---

Maria Pia Gallina Tessaro is a biologist who for the last four years has been working at the National Institute of Ecology, Mexico. She is currently part of both the Coordinating Unit of Protected Natural Areas and the Natural Resources Working Group of the Border XXI Program.

## **COOPERACION BINACIONAL PARA AREAS NATURALES PROTEGIDAS CONTIGUAS**

Ms. María Pia Gallina Tessaro  
Unidad Coordinadora de Areas Naturales Protegidas  
del Instituto Nacional de Ecología, México

### INTRODUCCION

Los esfuerzos por atender las preocupaciones ambientales fronterizas requieren de una respuesta binacional coordinada. Los ecosistemas, las cuencas hidrológicas y atmosféricas, el medio ambiente y los recursos naturales en la región fronteriza trascienden los límites políticos. Los problemas ambientales fronterizos, independientemente del lugar en donde se originen, impactan de manera significativa a las comunidades y a los ecosistemas en ambos lados de la frontera.

A lo largo de la frontera, México y Estados Unidos comparten ecosistemas que no reconocen las fronteras políticas; ello hace necesario que las tareas que llevan a cabo los gobiernos para la concervación, preservación y mantenimiento de la biodiversidad que se encuentra en sus respectivos territorios, puedan desarrollarse de una manera coordinada y armonizada, de acuerdo con la

normatividad de cada país, a fin de aprovechar los recursos tanto humanos, como económicos en el logro de ese objetivo común.

En el marco de la dinámica relación entre México y Estados Unidos, la cooperación ambiental fronteriza constituye un ejemplo de esfuerzo que realizan los dos gobiernos por alcanzar fórmulas conjuntas de entendimiento en la solución de problemas comunes, que se ha concretado en el Programa Frontera XXI.

Dentro de este programa, la Secretaría de Medio Ambiente, Recursos Naturales y Pesca y el Departamento del Interior han identificado áreas de interés común relacionadas con aspectos de recursos naturales específicos de la frontera, en los que ambos países desean continuar y/o ampliar las relaciones de trabajo. Los tres áreas de interés son: 1) bio-diversidad y áreas protegidas, 2) conservación de bosques y suelos y 3) recursos marinos y acuáticos.

En esta plática me enfocaré a los esfuerzos que se realizan en el rubro de áreas naturales protegidas.

#### ANTECEDENTES

Desde la década de los años treinta, han sido reiteradas las propuestas entre ambos países para establecer instrumentos bilaterales que conduzcan a la coordinación de actividades tendientes a conservar y proteger los ecosistemas que integran las áreas protegidas de uno y otro país.

En 1935, existió interés de parte de los gobiernos de México y Estados Unidos por establecer un Parque Internacional en la zona fronteriza entre Texas y los estados de Chihuahua y Coahuila. En ese año se llevaron a cabo las primeras reuniones entre representantes de los dos gobiernos para discutir el proyecto y nombrar una comisión internacional.

Al siguiente año se nombró una Comisión permanente en los Estados Unidos para reunirse con los representantes del gobierno mexicano y formular las políticas y planes para el establecimiento y desarrollo de parques, reservas forestales y refugios de fauna internacionales a lo largo de la frontera y se realizaron recorridos de campo en la Sierra El Carmen en México. Las reuniones se suspendieron por la Segunda Guerra Mundial.

En 1944, resurge nuevamente el interés y las negociaciones entre ambos gobiernos para el establecimiento del Parque Internacional, sin embargo sólo llegó a establecerse una alianza denominada "De Buenos Vecinos" entre el Big Bend National Park en Texas y las comunidades localizadas a lo largo de la línea fronteriza.

A partir de los años setenta se realizaron numerosos cursos de capacitación, estudio de flora silvestres, reuniones y talleres para intercambio de conocimiento y experiencias sobre manejo de áreas protegidas y prevención y control de incendios forestales entre ambos países, muchas de estas actividades de manera informal, pero no por ello menos significativa en la cooperación binacional.

Hasta 1992, se decretaron las reservas de Biosfera Alto Golfo de California - Delta del Río Colorado en Baja California y Sonora y El Pinacate - Gran Desierto de Altar, en Sonora, colindante esta última con el Organ Pipe National Monument en Arizona. En 1994, se establecieron las Areas de Protección de Flora y Fauna Cañón de Santa Elena en Chihuahua y Maderas del Carmen en Coahuila, colindantes con Big Bend National Park en Texas.

El 5 de junio de 1997, en la Reunión Binacional, y en el marco del Programa FRONTERA XXI, los Titulares de la SEMARNAP y el Departamento del Interior firmaron la Carta de Intención por la cual pretenden expandir las acciones establecidas para la cooperación de áreas naturales protegidas contiguas en la zona fronteriza, eligiendo dos regiones piloto: Arizona, Sonora, Baja California y Texas, Chihuahua, Coahuila.

### LAS AREAS NATURALES PROTEGIDAS EN LA FRONTERA NORTE

Cuando en 1993 se integró el Programa Ambiente Frontera Norte (1994-2000) para suscribir el acuerdo de préstamo con el Banco Mundial (firmado en 1994), para llevar a cabo acciones y proyectos ambientales y de conservación en la franja fronteriza, se le dió especial énfasis a las áreas naturales protegidas de esta región y se identificaron áreas que por su biodiversidad fueran susceptibles de ser declaradas como tales.

Existían las siguientes áreas protegidas:

4. Reserva Nacional Forestal Sierra de los Ajos, Buenos Aires y La Purica, Sonora. Sup: 21,4494 ha. Decretada en 1936.
5. Parque Nacional Constitución de 1857, Baja California. Sup: 5,009 ha. Decretada en 1962.
6. Reserva de la Biosfera El Pinacate y Gran Desierto de Altar, Sonora. Sup: 714,556 ha. Decretada en 1993.
7. Reserva de la Biosfera Alto Golfo de California y Delta del Río Colorado, Baja California, Sonora. Sup: 934,756 ha. Decretada en 1993.

Derivado de ello, se decretaron en 1994 las Areas de Protección de Flora y Fauna Maderas del Carmen y Cañón de Santa Elena, ambas áreas contiguas a Big Bend National Park y se iniciaron los estudios para otra área en la región de Laguna Madre, Tamaulipas, por su importancia como humedal y la diversidad de aves que en ella se presenta.

Uno de los logros del Grupo de Recursos Naturales del Programa FRONTERA XXI fue la firma de la Carta de Intención suscrita por los titulares de la SEMARNAP y del Departamento del Interior el 5 de mayo de 1997, para expandir las acciones establecidas para la cooperación en la protección de áreas naturales protegidas en la frontera de Estados Unidos y México.

Dichas acciones se llevarán a cabo dentro del marco de acuerdos de cooperación ya existentes entre ambos países, entre los que se encuentran el Convenio para la Protección y el Mejoramiento del Medio Ambiente en la Zona Fronteriza de 1983, el Memorándum de Entendimiento sobre Cooperación en el Manejo y Protección de Parques Nacionales y otros Sitios Naturales y de Herencia

Cultural Protegidos de 1988; el Acuerdo Tripartita para la Conservación de Humedales y sus Aves Migratorias entre Canadá, Estados Unidos y México de 1988; el Memorándum de Entendimiento sobre Cooperación Científica y Técnica en Información y Datos Biológicos de 1995; el Memorándum de Entendimiento que establece el Comité Trilateral para la Conservación y el Manejo de Vida Silvestre y Ecosistemas entre Estados Unidos, Canadá y México de 1996 y Convenios Internacionales como la Convención sobre el Comercio Internacional de Especies Amenazadas de Fauna y Flora Silvestres (CITES), al que México se adhirió en 1991.

En la carta de intención se propone la colaboración en áreas como:

- La armonización y complementariedad de políticas tendientes a la conservación de los recursos naturales y culturales;
- El intercambio de experiencias entre el personal de ambos países, técnicas de evaluación y manejo de recursos, capacitación y la generación de nuevas estrategias de conservación;
- La instrumentación de programas de educación y capacitación ambiental para las comunidades residentes en ambos lados de la frontera y estimular su participación en acciones de conservación y uso sustentable de los recursos de las áreas naturales protegidas;
- La ampliación de la base de conocimientos científicos de las áreas naturales protegidas, en su contexto regional ecológico, cultural y socioeconómico. mediante la cooperación en proyectos de investigación y el desarrollo de sistemas de información mutuamente accesibles que permitan identificar estados y tendencias actuales, a través del monitoreo de especies, así como futuras prioridades de investigación en recursos biológicos compartidos;
- La exploración del desarrollo de un mecanismo para establecer una red de comunicación expedita que permita la atención oportuna y conjunta de emergencias ambientales, particularment en los casos de incendios; y
- La cooperación en acciones de inspección y vigilancia, respectivas de cada país, para prevenir y controlar ilícitos en materia ecológica en las áreas naturales protegidas.

En el marco de la referida carta de intención se trabajarán en dos regiones piloto que incluyen, por un parte las Reservas de la Biosfera Alto Golfo de California - Delta del Río Colorado y el Pinacate-Gran Desierto de Altar y las áreas protegidas adyacentes en Estados Unidos, Organ Pipe Cactus National Monument, Cabeza Prieta National Wildlife Refuge e Imperial National Wildlife Refuge; y por la otra las Areas de Protección de Flora y Fauna Cañón de Santa Elena y Maderas del Carmen y el área protegida adyacente en Estados Unidos, Big Bend National Park.

En el mes de octubre se llevó a cabo la primera reunion entre los representantes del DOI y de la UCANP, en la Reserva de la Biosfera El Pinacate-Gran Desierto de Altar, Sonora, para identificar las acciones específicas de cooperación binacional que se intrumentarán enmarcadas bajo la carta de intención. De ello se estableció un programa de trabajo ambiental e involucramiento público,

calidad de hábitat, aplicación de la ley, entrenamiento, restauración ecológica, investigación y manejo de recursos, proyectos productivos sustentables (ecoturismo), entre otros, a instrumentarse en 1998.

La siguiente reunión se realizará en enero de 1998 para la región de Big Bend, Cañón de Santa Elena y Maderas del Carmen.

## LAGUNA MADRE

En 1996, Comisión Nacional para el Uso y Conocimiento de la Biodiversidad (CONABIO) y Pronatura, A.C. organizaron un taller para la identificación de regiones prioritarias para la conservación en México. Como resultado del taller, se identificaron 155 regiones prioritarias, entre las que se encuentran la región de Laguna Madre en Tamaulipas, a 55 km al sur de la desembocadura del Río Bravo. Laguna Madre se encuentra dentro de las 28 áreas prioritarias para las aves acuáticas migratorias en México, mismas que albergan el 83% de la población de patos invernantes al proveer de hábitat al 15% de la población de éstas en México.

La región de la Laguna Madre se encuentra ubicada en la provincia de la costa nororiental de Tamaulipas, con una extensión aproximada de 9,055 km<sup>2</sup>. Forma parte de los humedales costeros, dominados por praderas de pastos marinos a lo largo de la costa del Golfo de México. Es rica en biodiversidad y es una de las dos lagunas hipersalinas más grandes del mundo; es altamente productiva, por lo que es sustento de una importante actividad comercial, recreativa y pesquera.

Las variaciones edáficas y las diferencias climáticas que se presentan en la zona asociadas a los sistemas costeros, ha sido la causa de la diversidad de vegetación, siendo los principales: el matorral xerófilo con mezquite (*Prosopis*), huizache (*Acacia*); el bosque espinoso con especies como el ébano (*Pithecellobium*); vegetación halófila con suculentas como *Suaeda* y *Salicornia* y pastizales halófitos de *Spartina* y *Distichlis*; y vegetación de pastos marinos.

La Laguna Madre alberga 323 especies de vertebrados terrestres de las cuales por lo menos 50 especies están consideradas en riesgo de extinción.

En la región de la Laguna Madre se encuentran 219 especies de aves, de las cuales 144 especies son residentes; cuatro (2.7%) son endémicas en México, una más tiene una distribución restringida a México y áreas aledañas y ninguna especie restringida a la provincia.

Una de las relevancias biológicas que tienen la Laguna Madre es la de servir como un corredor natural para las aves acuáticas migratorias, dado el alto porcentaje (59%) de este grupo con respecto a los registros que se tienen de la avifauna del área, y a los valores de las especies residentes (38%), resaltando la importancia de esta zona como un corredor biológico y posible área de transición.

La Laguna Madre de Tamaulipas alberga a 26 especies de anseriformes (68.42% de las especies distribuidas en México). De éstas, la especie más abundante es el pato cabeza roja (*Aythya*



americana), con una población invernante promedio en los últimos 16 años en el área de 245,128 aves, que representa alrededor del 34% de la población total de la especie en Norte América.

Lo anterior, sólo para mencionar algunos de los aspectos relevantes de Laguna Madre, que ha merecido una atención particular del gobierno mexicano. Actualmente se tienen estudios que se encuentran en proceso de análisis para la definición de un área o áreas que en el corto plazo pudiera ser decretada como Area Natural Protegida. En la región se llevará a cabo un Estudio de Ordenamiento Ecológico que orientará las actividades, conforme a la vocación del suelo, para lograr que las actividades productivas permitan el desarrollo compatible con la conservación de los recursos de la región y la protección de áreas prioritarias.

## **OVERVIEW OF ENVIRONMENTAL AND SOCIO-ECONOMIC ASPECTS OF THE LAGUNA MADRE OF TEXAS**

Dr. Marc Woodin  
U.S. Geological Survey

The Laguna Madre of Texas is one of only three large, hypersaline lagoon ecosystems on the planet. One of the other two is the Laguna Madre of Tamaulipas; these two hypersaline lagoons are separated by only about 70 kilometers. A hypersaline environment is defined as a body of water having salinity between 40 and 80 ppt. (The salinity of standard sea water is 35ppt).

The Laguna Madre of Texas extends in a gently sweeping arc from Corpus Christi to Port Isabel, Texas, a distance of approximately 200 kilometers. The approximate mean width of the entire Laguna Madre is 5-8 kilometers, although the width of upper and lower basins differs. The upper laguna is only about 3 kilometers wide, while the maximum width of the lower Laguna Madre is about 13 kilometers. The upper and lower regions were created by a hurricane in 1919, when sand was deposited across the Laguna Madre for a length of about 30 kilometers. This deposit effectively bisected the laguna. While maximum depth of the Laguna Madre is three meters, mean depth is only about one meter. Much of the Laguna Madre is extensive shallows, while exposed sand flats (immersed intermittently) are also very extensive.

The Laguna Madre is separated from the Gulf of Mexico by Padre Island, with limited connection, historically, with the gulf. Additionally, there historically has been little freshwater inflow into the laguna. Limited freshwater inflow and the extensive shallow areas of the laguna lead to high evaporation rates in the semiarid, semitropical climate of southern Texas. As a consequence, the salinity levels in the Laguna Madre become elevated. Prior to 1948-49, the upper Laguna Madre frequently achieved salinity levels of 100 parts per thousand (ppt), while salinities in the lower laguna frequently reached 60 ppt.

A series of events has since acted to alter the hydrological regime of the Laguna Madre. The Gulf Intracoastal Waterway was constructed in 1948-49. This created a channel (about 3.5-4.5 meters deep) throughout the entire length of the laguna; channel width is 60 meters at the surface and about 40 meters at the bottom. An outlet to the Gulf of Mexico was dredged at Brazos Santiago, where the Brownsville Ship Channel exits. Another channel from Port Mansfield to the gulf was cut through Padre Island in 1962. The dredging of these passes has increased flow of gulf water into the Laguna Madre.

The hydrology of the Laguna Madre was further modified by agricultural drainage projects in the lower Rio Grande Valley. These projects were constructed to drain excess water into the lower Laguna Madre, via the Arroyo Colorado and the North Floodway, resulting in increased inflow of fresh water into the lower laguna in recent years. Impacting the upper laguna was the construction of the John F. Kennedy Causeway from the mainland to Padre Island at Corpus Christi. This structure blocked water exchange from Corpus Christi Bay into the upper laguna, except through the channel of the Gulf Intracoastal Waterway.

These changes to the hydrology of the Laguna Madre have acted in concert to moderate the salinity in the laguna. The frequency of hypersaline conditions in the Laguna Madre has declined, and prevailing salinity is now in the range of 30-40 ppt. (Quammen and Onuf 1993). Reduced salinities in the Laguna Madre have favored seagrass species less tolerant of the formerly prevalent hypersaline conditions. Consequently, beds of shoalgrass (*Halodule wrightii*), the species most tolerant of high salinity, declined in area in the lower laguna from 550 to 220 km<sup>2</sup> between 1965 and 1988 (Quammen and Onuf 1993). Area of bare bottom in the lower laguna increased from 50 to 190 km<sup>2</sup> from 1965 to 1988. Some of the loss of shoalgrass may also be attributed to dredging and the deposition of sediments in the open waters of the Laguna Madre (Onuf 1994). Continual resuspension of fine particulates in the dredge spoil increased turbidity, resulting in reduced light and loss of seagrass over time (Onuf 1994). More loss of shoalgrass in the upper Laguna Madre has been attributed to a prolonged bloom of brown tide (Onuf 1996). Reduced salinities, turbidity generated from dredge spoil, and the brown tide have all combined to cause decline in shoalgrass in the Laguna Madre. These trends are cause for concern for the population of redhead ducks that winters in the Laguna Madre. Approximately 80% of the redheads in North America have wintered for decades in the Laguna Madre of Texas and the Laguna Madre of Tamaulipas (Woodin 1996, Weller 1964). These birds are dependent on shoalgrass rhizomes for food on their winter range (Woodin 1996, Cornelius 1977). A stable or increasing redhead population closely linked to a declining shoalgrass resource could lead to an ecological "crunch" in the future.

#### REFERENCES

- Cornelius, S.E. 1977. Food and resource utilization by wintering redheads on lower Laguna Madre. *J. Wildl. Manage.* 41:374-385.
- Onuf, C.P. 1996. Seagrass responses to long-term light reduction by brown tide in upper Laguna Madre, Texas: distribution and biomass patterns. *Mar. Ecol. Prog. Ser.* 138:219-231.

Onuf, C.P. 1994. Seagrasses, dredging and light in Laguna Madre, Texas, U.S.A. *Estuarine, Coastal and Shelf Sci.* 39:75-91.

Quammen, M.L., and C.P. Onuf. 1993. Laguna Madre: seagrass changes continue decades after salinity reduction. *Estuaries* 16:302-310.

Weller, M.W. 1964. Distribution and migration of the redhead. *J. Wildl. Manage.* 28:64-103.

Woodin, M.C. 1996. Wintering ecology of redheads (*Aythya americana*) in the western Gulf of Mexico region. *Gibier Faune Sauvage (Game and Wildlife)* 13:653-665.

---

Dr. Marc Woodin has worked for approximately 10 years at the Texas Gulf Coast Field Station, which is now affiliated with the Environmental and Contaminants Research Center, U.S. Geological Survey. His research has focused on waterfowl wintering on the Laguna Madre of Texas. Dr. Woodin received his B. S. in zoology from the University of Illinois, his M.S. in wildlife biology from Colorado State University, and his Ph.D. in wildlife biology from the University of Minnesota.

**SHARED RESOURCES: MARINE TURTLE PROGRAMS' RANCHO  
NUEVO KEMP'S RIDLEY SEA TURTLE PROJECT**

Dr. Rene Marquez-M.<sup>1</sup>  
Mr. Patrick Burchfield<sup>2</sup>  
Mr. Manuel Sanchez-P.<sup>3</sup>  
Mr. Juan Diaz-F.<sup>3</sup>  
Mr. Jaime Peña-V.<sup>2</sup>  
Mr. Miguel A. Carrasco-A.<sup>1</sup>  
Ms. Alma S. Leo-P.<sup>4</sup>

<sup>1</sup>Instituto Nacional de la Pesca, CRIP-Manzanillo, México

<sup>2</sup>Gladys Porter Zoo, Brownsville, TX

<sup>3</sup>Instituto Nacional de la Pesca, México, D.F.

<sup>4</sup>CRIP-Tampico, Tamaulipas, México

INTRODUCTION

The Kemp's ridley sea turtle (*Lepidochelys kempi*, Garman, 1880) is an endemic species in the Gulf of México (Figure 1G.1). Its most important breeding ground in the state of Tamaulipas is limited to 120 km of sandy beach between Soto La Marina and Barra de Chavarría. The greatest concentration occurs in the middle 70 km, which include the "Natural Reserve of Rancho Nuevo" (Figure 1G.2). Annual nesting spans from March to July (Figure 1G.3), when the females arrive to

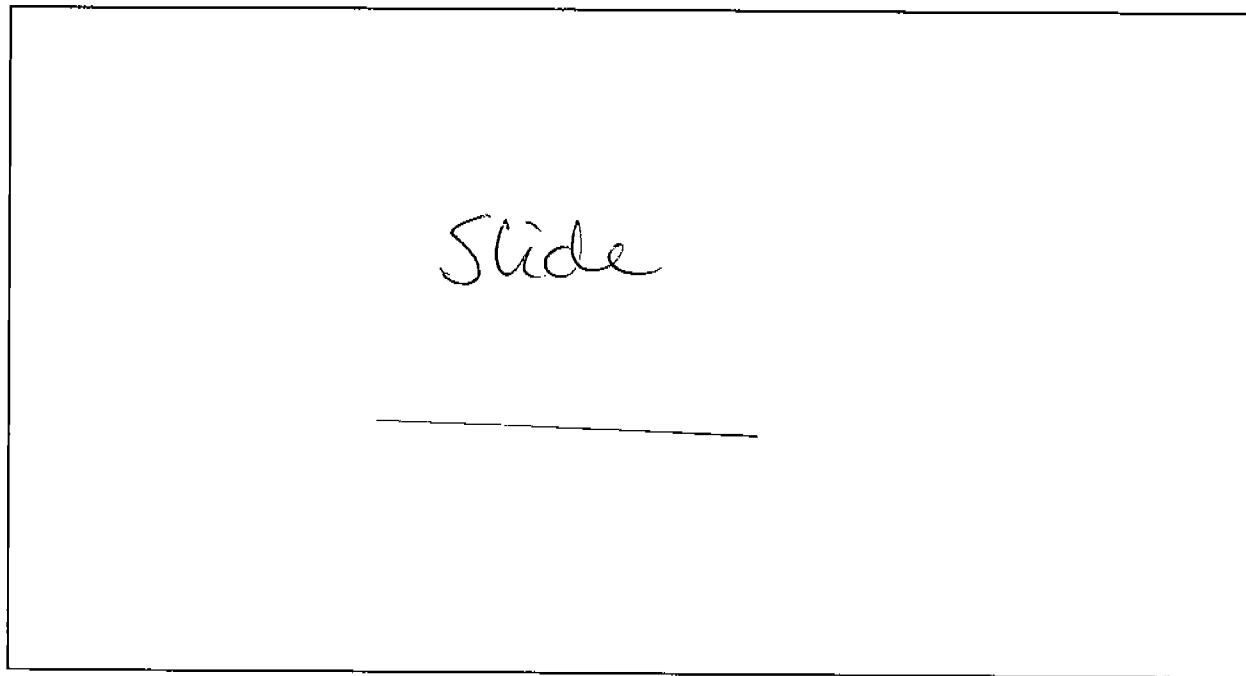

Figure 1G.1. The Kemp's ridley sea turtle (*Lepidochelys kempi*, Garman, 1880).

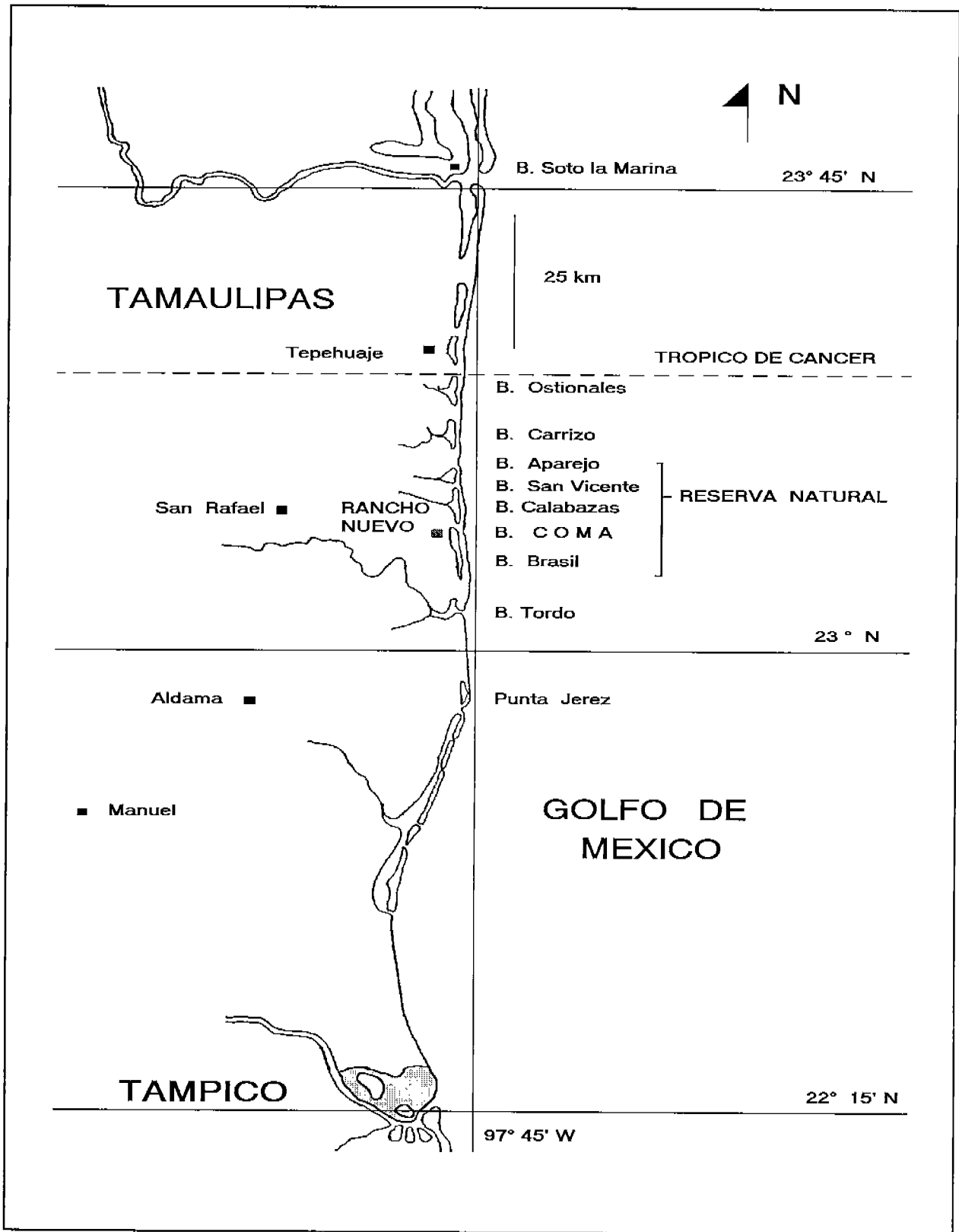

Figure 1G.2. Kemp's ridley sea turtle nesting beach.

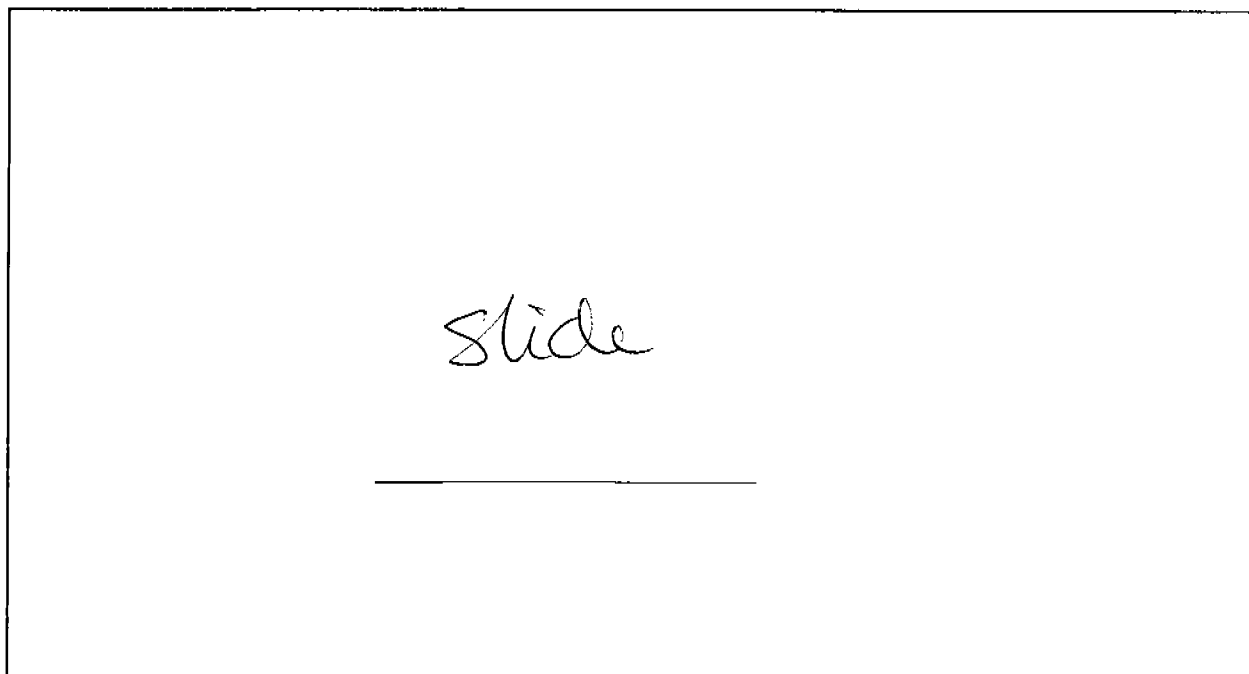

Figure 1G.3. A Kemp's ridley sea turtle nest.

lay hundreds of eggs and where between the end of April and September the hatchlings run in a frenzy towards the Gulf water and disappear for at least a decade until they reach the sexual maturity. After this period, the young females return to nest in the same place where they were born. Apparently, the species was abundant in the northwest Atlantic, particularly in the Gulf of México, but the total abundance of the nesting females was drastically depleted between the 1940s and 1970s, principally by commercial exploitation and incidental catch along the U.S. and Mexican coasts and by the extraction of their eggs along the breeding ground.

Beginning in 1966, an extensive protection of the breeding colony was implemented, among only by México and after 1978 through a U.S.-México collaboration program. with the National Marine Fisheries Service, the Fish and Wildlife Service and the National Fisheries Institute under the coordination of the Instituto Nacional de la Pesca. This joint program has promoted the implementation of a broad research and conservation structure between the two countries for sea turtles. As a result, the beach patrolling the coverage (in Tamaulipas State) has been increased from 30 to 120 km and from one to three turtle camps, plus extra camps in La Pesca, Altamira and Tampico as well as assistance to the camp of "Lechuguillas" in the state of Veracruz, which provides more possibilities for the survival to the most endangered sea turtle species.

On 18 June 1947 a historical arrival of around 40,000 nesting females occurred (Hildebrand 1963). The even was documented by Mr. Andrés Herrera with a 16mm camera. A drastic reduction of the population was observed in 1966. The U.S.-México Kemp's Ridley Sea Turtle Protection Joint Program was established, and several years later, the deterioration continued, and the lowest number of nests was observed in the beach of Rancho Nuevo during 1987 (748 nests). Nevertheless, the work continued, and as a result of the "Joint Program," the numbers of nests show a clear increase in 1997,

up to 1,514 (and even more if all the three camps (total of 2219 nests) are considered). According to that information, it is possible to calculate a significant increase in the “Rate of Recovery” from 1987 to 1997, for nesting females as  $R=1.0675$  only for Rancho Nuevo and  $R=1.1048$  for all the three camps. In both cases, the recovery is clear recover, but it is more rapid when the three camps are included in the calculation. It is possible that the recovery could have been accelerated as a result of the use of TED's (Turtle Excluder Devices). The use of this implement was instituted after 1 May 1990 in offshore and inshore U.S. waters. Unfortunately, the sea turtle strandings continue to be high in certain localities, such as Texas and Louisiana (387 Kemp's for all U.S. Atlantic coasts during 1994 and 383 in 1966, TEWG data). Obviously, not all strandings are originated by incidental captures in shrimp trawlers, but also not all dead turtles arrive at the seashores. Due to the high mortality of juveniles, subadults and adults by different causes, besides the incidental capture, the U.S.-México Collaborative Program should be reinforced and continued. By now this program could be considered one of the more successful binational efforts of collaboration. Results can be seen in Figures 1G.4 and 1G.5.

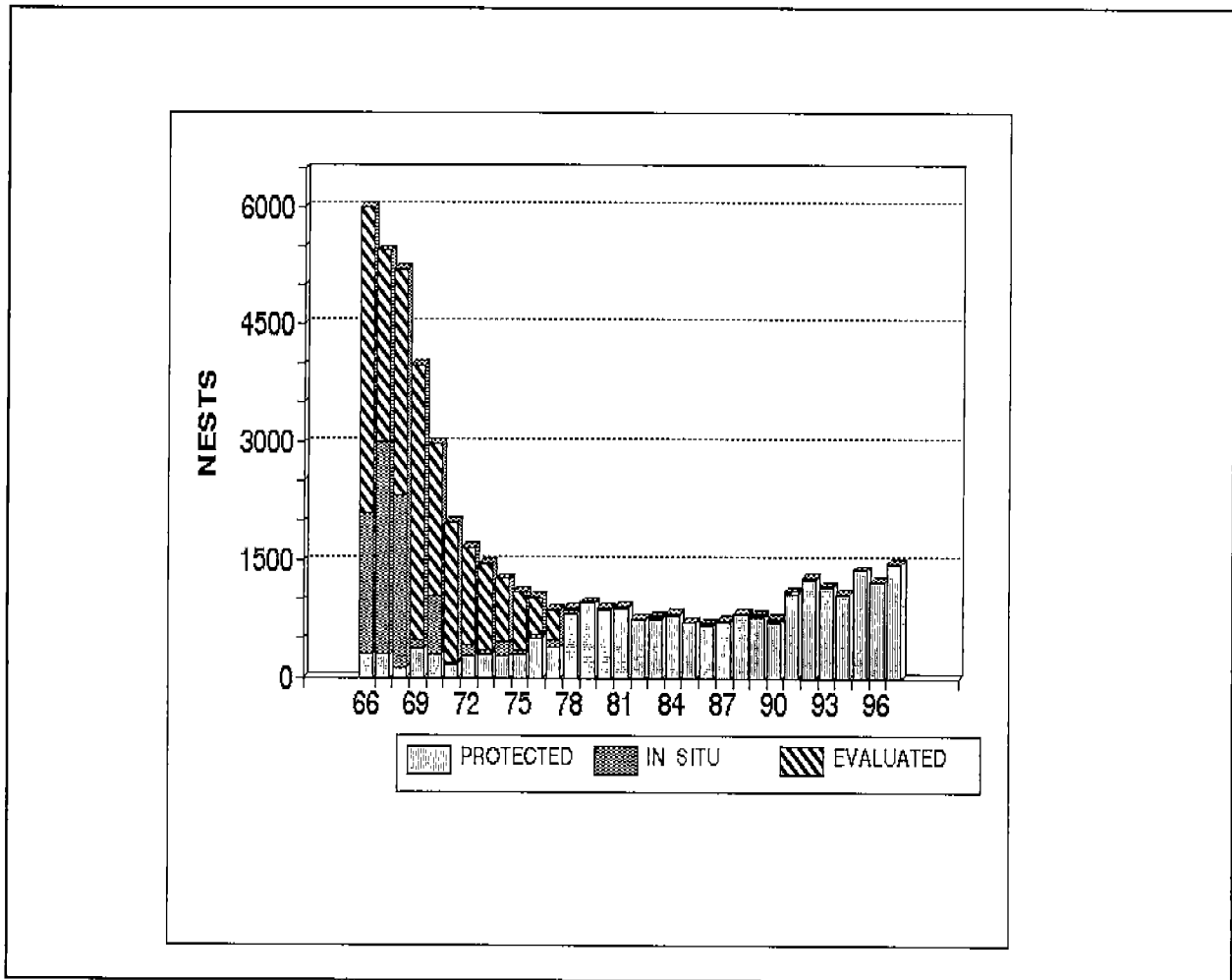

Figure 1G.4. Abundance of the Kemp's ridley turtles, Rancho Nuevo Beach, Tamaulipas, Mexico.

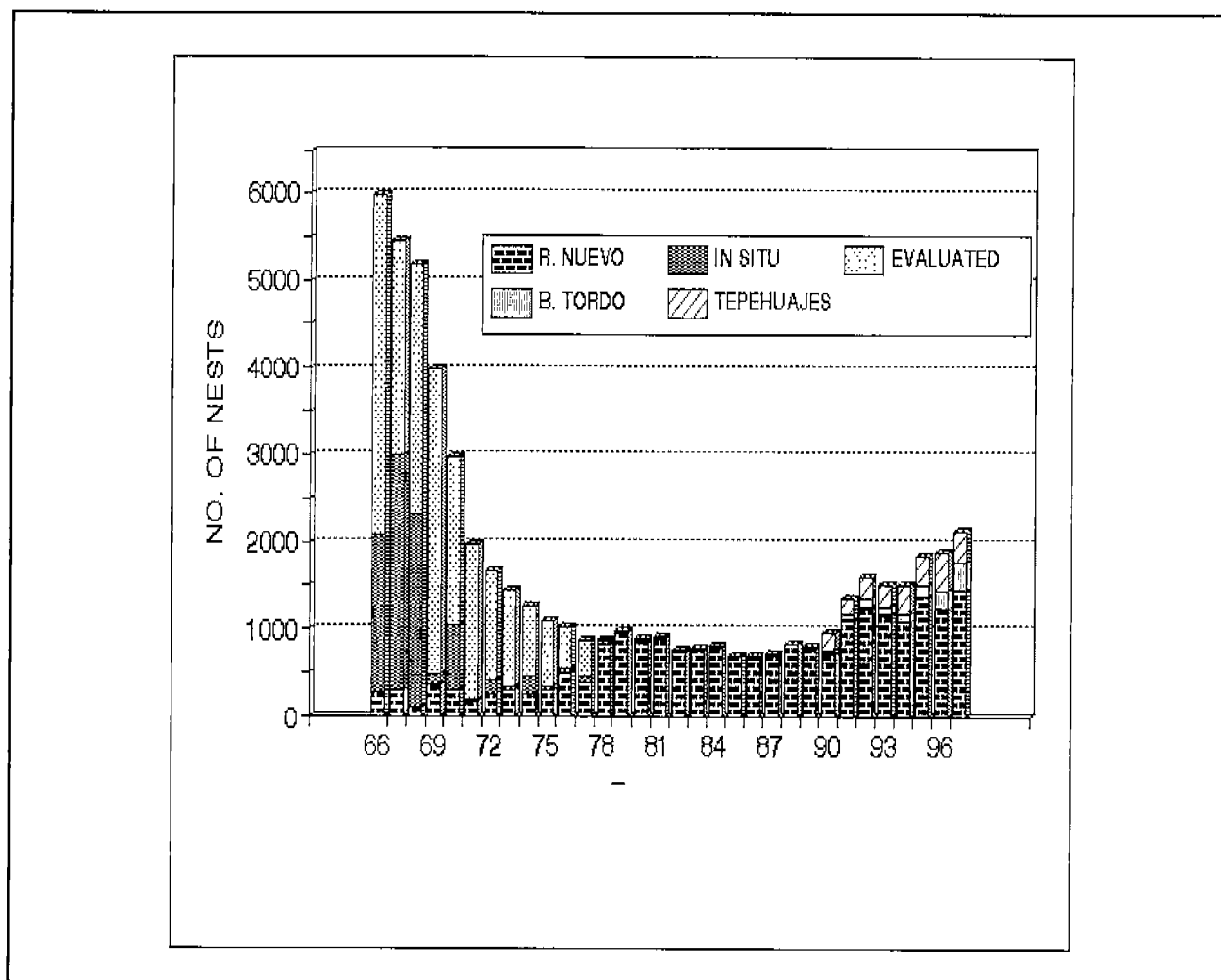

Figure 1G.5. Total nesting of Kemp's ridley turtles in Rancho Nuevo, Tepehuajes and B. del Tordo, Tamaulipas, Mexico.

Sea turtles are considered slow-growth and high-longevity reptiles; consequently, they are easy to deplete by overfishing. Nearly all the populations are considered threatened by extinction (Appendix I of CITES classification). In nature, the populations have big fluctuations, but a continual step up in the number of nests, recorded during several seasons, is not usual. In Mexico, two species have this behavior, the Kemp's ridley (*Lepidochelys kempî*), which reproduce in the central west coast of the Gulf of México, and the Olive ridley (*Lepidochelys olivacea*) which nest in several beaches of our Pacific coast. The most remarkable of these beaches is "La Escobilla" beach in the state of Oaxaca, where in 1987 57,000 nests were evaluated. In 1997, over 880,000 nests were evaluated, more than 15 times the last figure, though the breeding season will continue through February or March of the next year (Vasconcelos, personal communication).



## METHODS AND RESULTS

The protection of the Kemp's ridley sea turtle started in 1966, with a small group of biologists settled down in "Barra de Calabazas," several kilometers north-east from the small village of "Rancho Nuevo." The group was headed by biologist Humberto Chávez. The "Pesca" group patrolled the beach and recovered the nests from April to July. Beach erosion had resulted in many nests being fully exposed (Figure 1G.6). The eggs were deposited in a corral near the camp (Figure 1G.7). The hatchlings were released as soon as they were hatched, and all the observed turtles were tagged (Chávez *et al.* 1967). The next year, the work was headed by the author (Márquez y Contreras 1967). It has continued up to the present, except in 1968 when the camp was coordinated by Montoya and Vargas (1968) and between 1969 and 1970 by Casas-Andreu (1971) both of the INP. In 1971, we received a small grant of \$500 from Dr. Archie Carr (Caribbean Conservation Corporation) to start the annual operation, and by 1978, through an official agreement between the U.S. Fish and Wildlife Service and the Instituto Nacional de la Pesca (named MEXUS-Gulf), a joint collaboration began. This work has been improved year by year, but since 1978, the nesting continued decreasing slowly until the lowest points observed in 1985, 1986 and 1987. Apparently, those years were the bottom of the curve, because after 1987 the numbers have slowly but steadily expanded (Figures 1G.4 & 1G.5).

Based on this increase, it was suspected that the Kemp's ridley population not only was growing in Rancho Nuevo but also was expanding in the area. That supposition was confirmed by aerial surveys and reports of local people; then in 1989, besides the Rancho Nuevo Station, another camp was installed near Barra de Ostionales ("Campo Los Pericos"), 25.2 km north from the principal station. The result was the collection of a dozen of nests with 1,107 eggs and 816 hatchlings. In 1990,

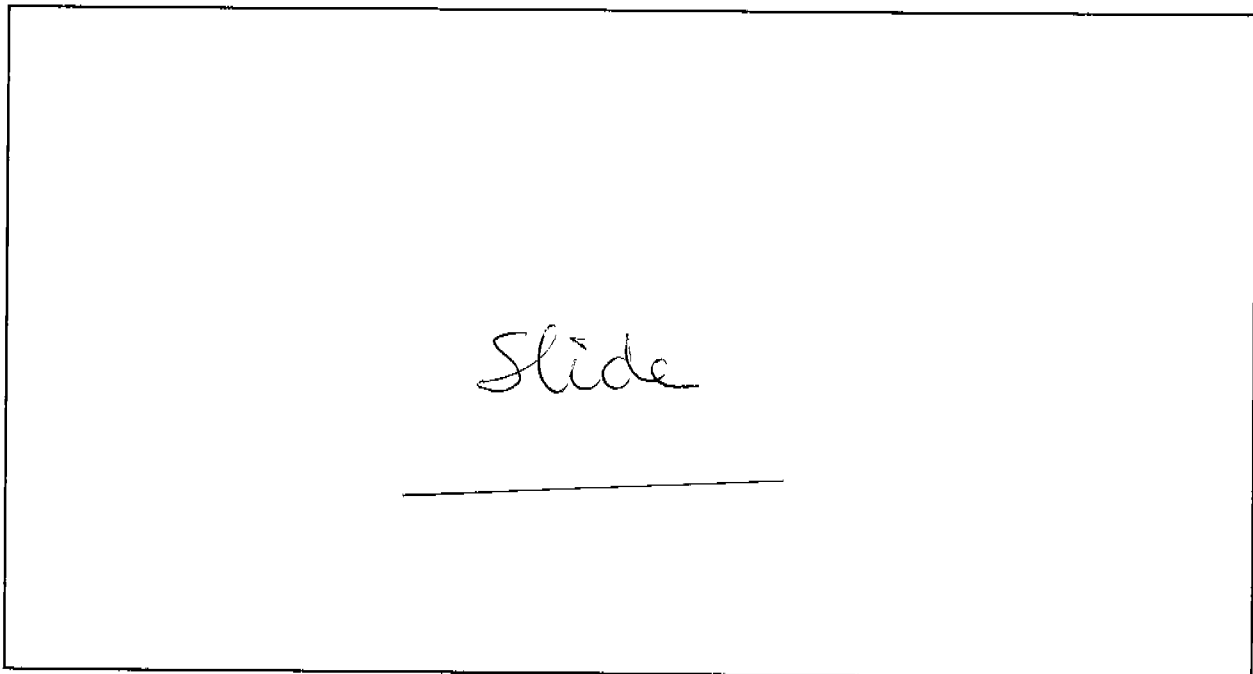

Figure 1G.6. Beach erosion in a Kemp's ridley sea turtle nesting area.

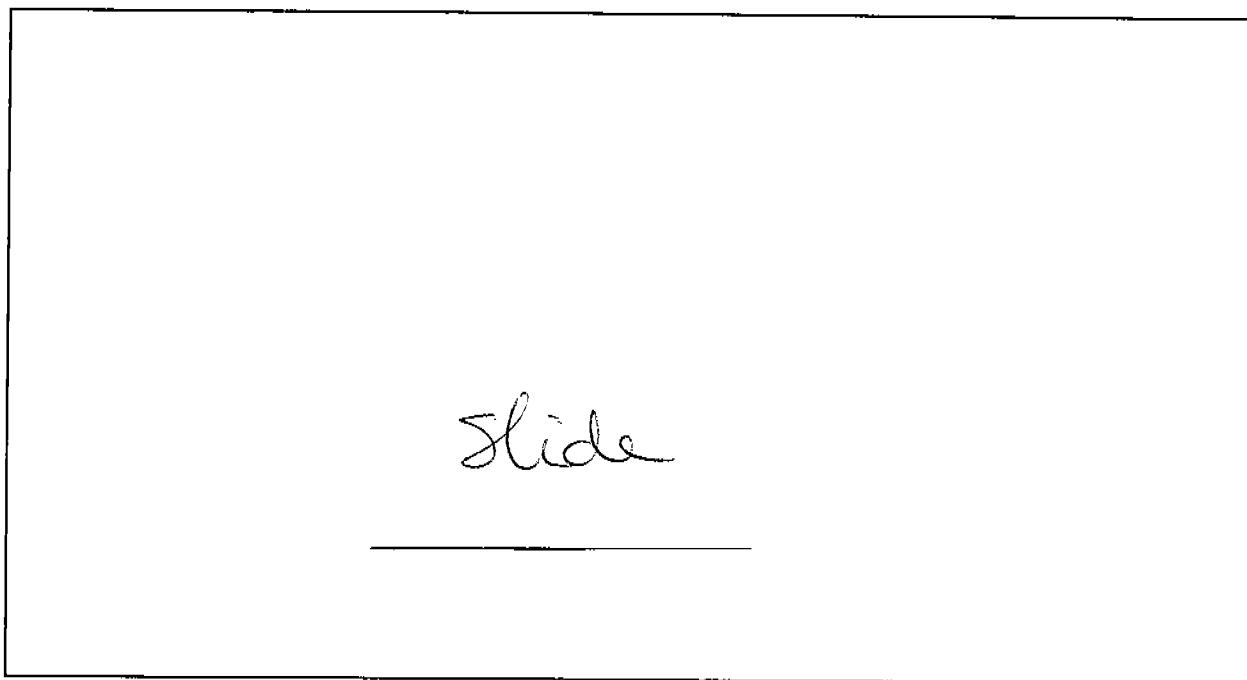

Figure 1G.7. A corral for recovered Kemp's ridley sea turtle eggs.

another extra camp was installed, and in from 1991 another. 13.4 km south, near Barra del Tordo, was officially established. Consequently, today's patrolled area is nearly 120 km. Although these camps have had very short lives, both of them show a positive trend in the number of nests (Figure 1G.8).

Outside the Rancho Nuevo area, the nesting occurs in only a few more places. Two important sites have been worked for the past several years: the Padre Island National Seashore (PAIS) beaches and Tecolutla in Veracruz state. Padre Island has been patrolled since the joint program started (1978) and recently has registered six and nine nests laid in 1966 and 1967 respectively (Shaver 1996). The Tecolutla area has been patrolled since the end of the 1970s by a fisheries inspector, who was protecting a couple of dozen nests each breeding season. Two years ago this program was recognized by the INP; in 1997 it was included in the joint program headed by the Ing. Rafael Bravo-G., who is a researcher in the CRIP-Veracruz (Fisheries Research Center). This inclusion resulted in the protection of 48 nests Lechuguillas beach.

#### Results in Tamaulipas

Figure 1G.4 shows the variations in the Kemp's ridley turtle nesting population, between the documented arrival of 18 June 1947 (with over 40,000 turtles, empirically evaluated by Carr (1963) and Hildebrand and the 23 May 1968 arrival when 2,000 nesting females were registered (Casas-A. 1971; Márquez *et al.* 1994) as well as those in the following years. Several low points for arrivals in Rancho Nuevo were observed between 1985 and 1987, with an estimated number of 742, 768 and 748 nests respectively; just after the next year (1988) the total number of nests increased, and this

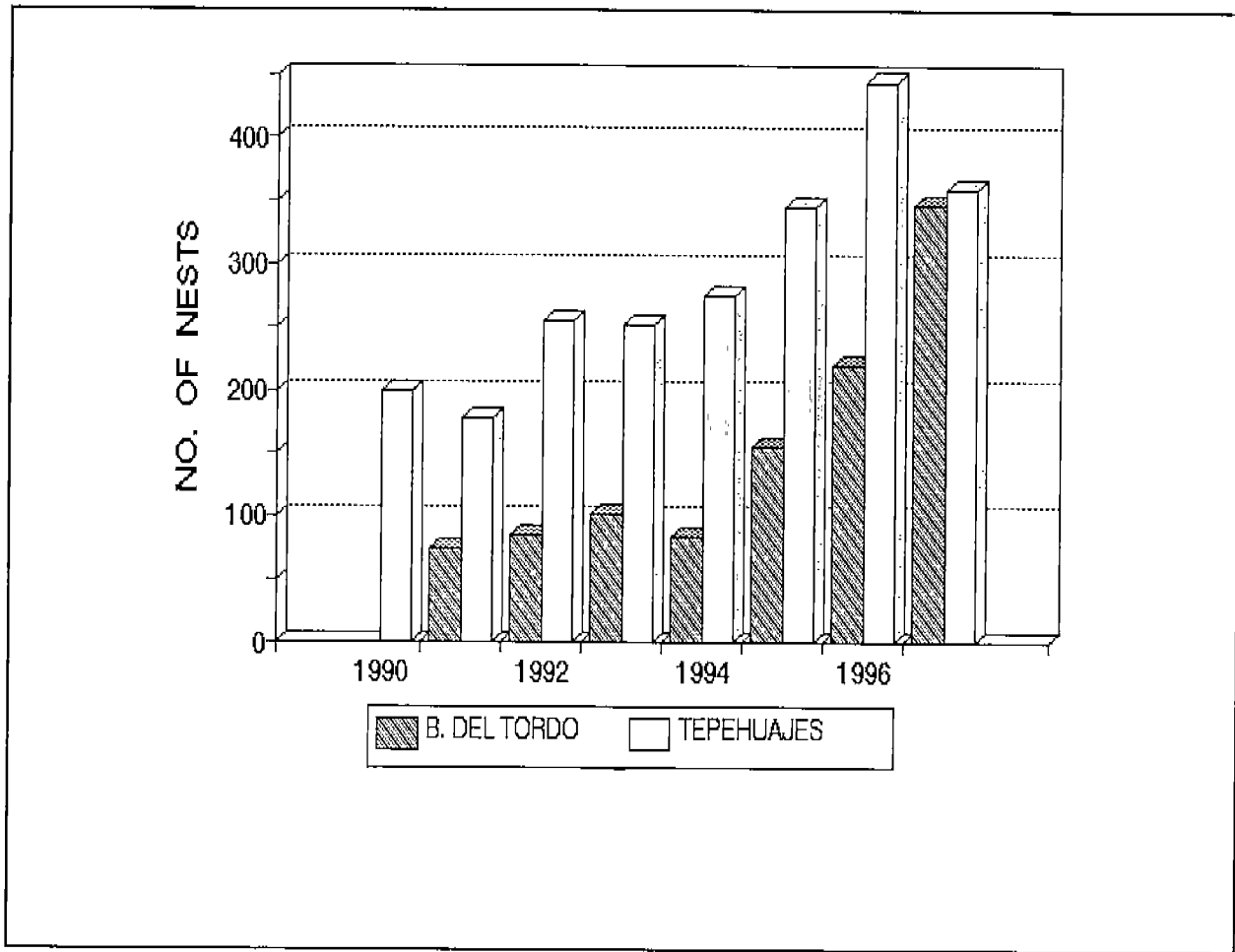

Figure 1G.8. Nesting abundance of Kemp's ridley turtle in north and south beaches of Rancho Nuevo, Tamaulipas, Mexico.

growth has continued each season up to the present, when the the 1997 total reached 1514 for Rancho Nuevo alone (Figure 1G.4) and 2219 if all three camps are included (Figure 1G.5).

The trend in the abundance of the Kemp's ridley nesting between 1978 and 1997 is shown by the total mortality ( $Z$ ) and the recovery rate ( $R$ ) in the Figures 1G.9 and 1G.10, represented by the linear regression of the natural logarithms of the annual number of nests, using the formula  $S = e^{-Zt}$ . The first figure (1G.9) represents only Rancho Nuevo data, and the next figure (1G.10) includes the two extra camps.

As Figure 1G.10 shows, the negative trend of the total mortality ( $Z$ ) for the total population assessed in the three camps has been decreasing steadily from  $Z=0.02697$  between 1978 and 1988 to  $Z=-0.1024$  between 1986 and 1997. For the same periods, the survival rates ( $S$ ) were increasing from  $S=0.9734$  to  $S=1.1078$ ; these evaluations were based on the nests from the Rancho Nuevo Natural Reserve and the north and south satellite camps. For the Rancho Nuevo fraction alone (Figure 1G.5), the population shows a slow but constant recovery ( $Z=0.02525$ ,  $S=0.9751$  between

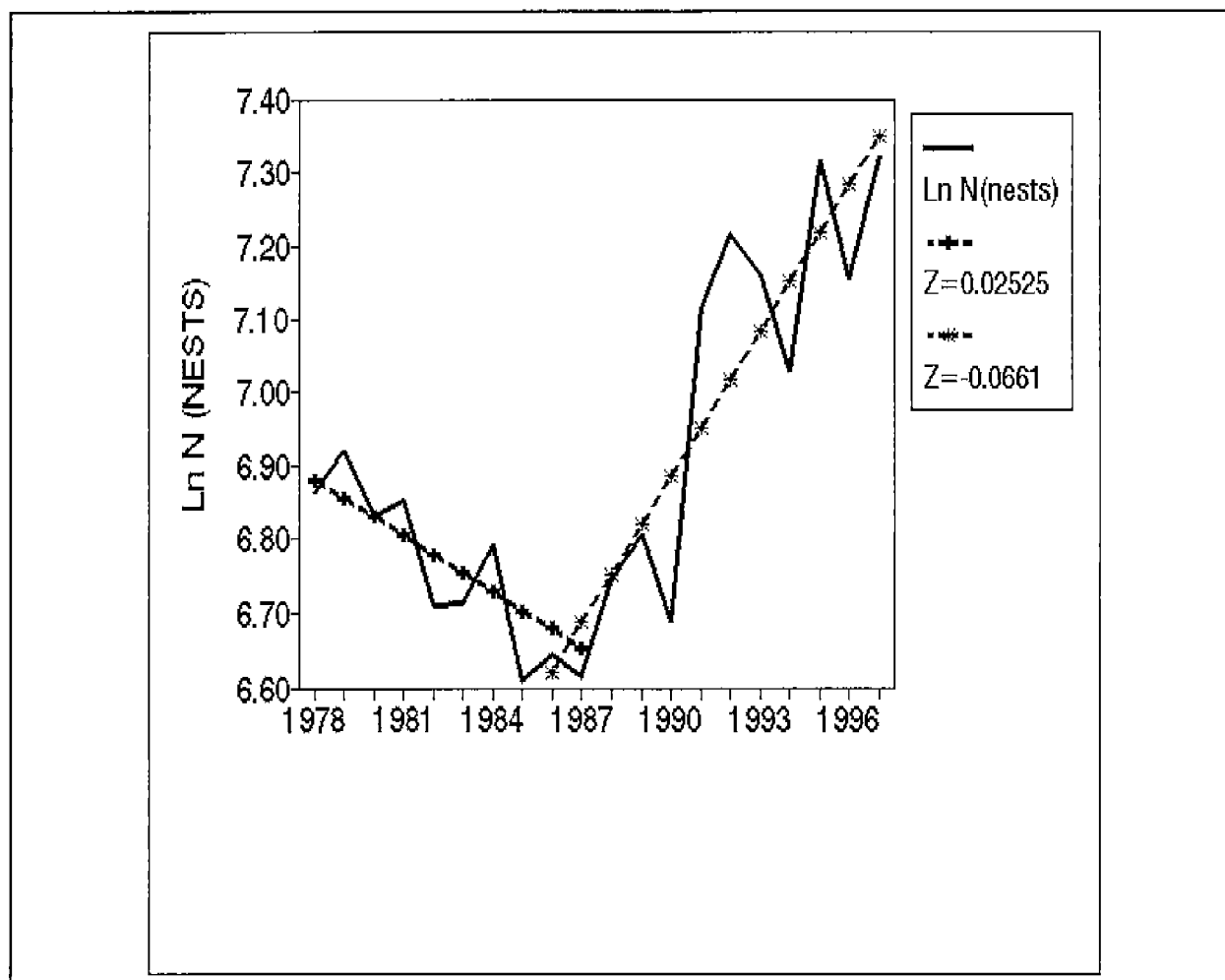

Figure 1G.9. Trend of nesting of Kemp's ridley turtle population, Rancho Nuevo Beach in Tamaulipas.

1978 and 1988 and  $Z=-0.0661$ ,  $S=1.0638$  between 1986-1997). In both cases, the trend can be observed in the number of nests (%) theoretically added to the reproductive effort. If we analyze the change in the number of nests for only this part of the beach, the result is that the net annual increment was 6.83% between 1987 and 1997. But if the comparison is made for all the three turtle camps, the annual increment for the same period has been of 10.78%.

This slow but steady recovery could be a natural response of the Kemp's ridley populations, but unfortunately the high numbers of stranded turtles occurred the last and 1994 years (Steiner 1994; Teas 1994, 1995) could be negatively overwhelming the incipient recovery of the population. Another important problem for the species survival is the incidental capture by shrimp trawlers in of the Gulf of México, principally along the Texas and Louisiana coasts.

Year by year the number of Kemp's ridley hatchlings released in Rancho Nuevo has increased, and we are expecting that the same will occur with the recruitment to the population in the future. The

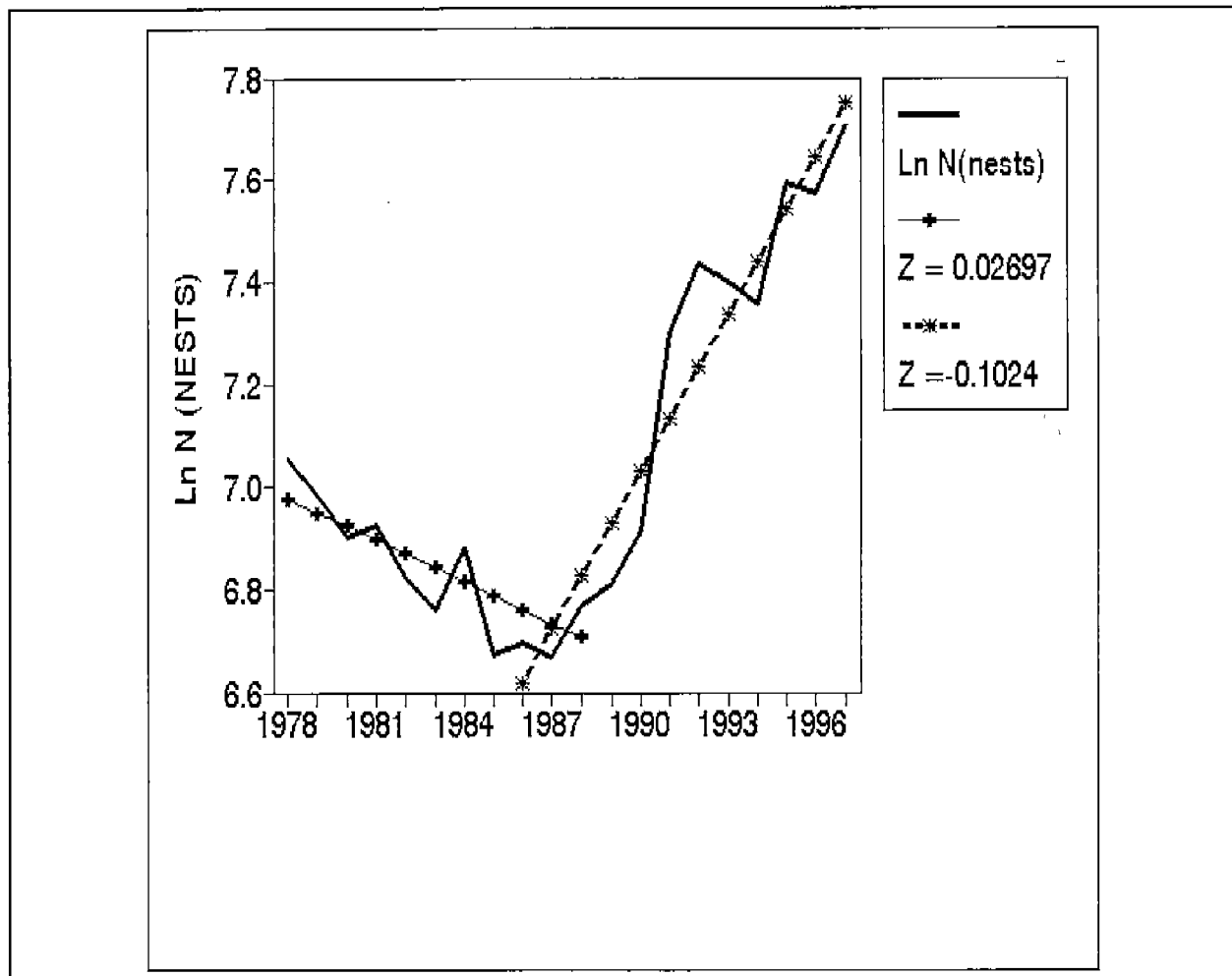

Figure 1G.10. Trend of nesting abundance of Kemp's ridley turtle, Rancho Nuevo, Tepehuajes and El Tordo, Tamaulipas.

increase in the Kemp's ridley nestings outside the common areas of reproduction, like Veracruz and Campeche in México and Texas, Florida, South Carolina and North Carolina in the United States, could be a good response to this, but if the high mortality continues, no effort will be enough to recover this endangered species.

#### ACKNOWLEDGMENTS

We would like to thank the Mexican and U.S. Fisheries authorities for their assistance. We also want to thank Rancho Nuevo, Mr. Antonio and Juan González of the students and teachers from the CET del Mar, Universidad del Noreste, Universidad de Tamaulipas, Direction of Fisheries from the Tamaulipas State, the Gladys Porter Zoo and HEART of Texas, and many others who have helped us enhance the population of Kemp's ridley sea turtle for 32 years.

## CONCLUSION

The breeding history of the Kemp's ridley sea turtle, one of the most endangered species today, was ignored until 1947, when the nesting beach was discovered. In 1966, the Mexican Fisheries Institute started protecting the beach and nesting and the study of the species, tagging adults, collecting nests and releasing hatchlings. The original population numbers are unknown, but it is clear that big arrivals occurred on the 1940s, like the one filmed and evaluated by Drs. Carr and Hildebrand in 1963 of about 40,000 nesting females in one day. Years later, the arrivals were of a couple of thousand females and now are between 200 and 300 turtles. The U.S.-Mexico program started in 1978, and as a result of past and present efforts (1966-1977), the population has started to show a slow increase.

## REFERENCES

- Carr, A. 1963. Panspecific reproductive convergence in *Lepidochelys kempii*. *Ergebn. Biol.*, 26:298-303.
- Casas-Andreu, G. 1971. National and Regional Reports: México. In: Marine Turtles. Proc. 2nd Working Meet. of Marine Turtle Specialists. IUCN Pub. New Series, Supp. Paper, 31:41-45.
- Chávez, H., M., Contreras G. and E. Hernández. 1967. Aspectos biológicos y protección de la tortuga lora *Lepidochelys kempii* (Garman), en la costa de Tamaulipas, México. *Inst. Nal. de Invest. Biol. Pesq.* 17:40pp.
- Hildebrand, H. H. 1963. Hallazgo del área de anidación de la tortuga lora *Lepidochelys kempii* (Garman), en la costa occidental del Golfo de México (Rept., Chel.). *Ciencia, Mex.* 12(4):105-112.
- Márquez-M., R. y M. Contreras. 1967. Marcado de tortuga lora (*Lepidochelys kempii*) en la Costa de Tamaulipas, 1967. INP/México. INIBP-Bol. Prog. Nal. de Marcado de Tortugas Marinas, 2(1):8pp.
- Márquez-M., R. 1994. Sinopsis de datos biológicos sobre la tortuga lora, *Lepidochelys kempii* (Garman, 2880) Instituto Nacional de la Pesca, México/FAO Sinopsis. SAST-Tortuga Lora 5.31(07)016.02, INP/S152:141pp.
- Montoya-C., A. y E. Vargas-M. 1968. Marcado de tortuga lora (*Lepidochelys kempii*) en la costa de Tamaulipas. INP/México. INIBP-Bol. Prog. Nal. de Marcado de Tortugas Marinas, 2(2):11pp.
- Steiner, T. 1994. Shrimpers implicated as strandings soar in the USA. *Marine Turtle Newsletter.* 67:2-5.
- Shaver, D. 1996. Tortugas marinas kempii iniciadas anidan en Texas. *Noticiero de Tortugas Marinas.* 74:6-7.

Teas, W. G. 1994. 1993 Annual report of the Sea Turtle and Salvage Network. Atlantic and Gulf coasts of the United States. January - December 1993. NOAA-NMFS-SFSC. Miami Lab. Cont. No. MIA-94/95-12: 46pp.

Teas, W. G., 1995. 1994 Semi-Annual report of the Sea Turtle and Salvage Network. Atlantic and Gulf coasts of the United States. January - December 1993. NOAA-NMFS-SFSC. Miami Lab. Cont. No. MIA-94/95, 23:12pp.

---

Dr. René Márquez-M. has been the National Coordinator of the Sea Turtle Research Program in the Instituto Nacional de la Pesca (INP) for many years of the past three decades. He is a member of the IUCN/SSC—Sea Turtles Group and the US-NMFS—Turtle Experts Working Group. His major interest is the recovery, evaluation and sustainable use of these species.

Patrick Burchfield is the Deputy Director of the Gladys Porter Zoo, and head of the U.S. group for the U.S.-Mexico Kemp's Ridley Joint Program. His major interest is the behavior of reptiles, particularly snakes.

Jaime Peña-V. is a research assistant at the Gladys Porter Zoo and field assistant for the program. Manuel Sánchez-P., Juan Díaz-F., Miguel Angel Carrasco-A. and Alma S. Leo-P. are all members of the INP National Sea Turtle Program.

## RECURSOS COMPARTIDOS: PROGRAMAS DE LA TORTUGA MARINA PROYECTO DE LA TORTUGA LORA EN RANCHO NUEVO

Dr. Rene Marquez-M.<sup>1</sup>  
Mr. Patrick Burchfield<sup>2</sup>  
Mr. Manuel Sanchez-P.<sup>3</sup>  
Mr. Juan Diaz-F.<sup>3</sup>  
Mr. Jaime Peña V.<sup>2</sup>  
Mr. Miguel A. Carrasco-A.<sup>1</sup>  
Ms. Alma S. Leo-P.<sup>4</sup>

<sup>1</sup>Instituto Nacional de la Pesca, CRIP-Manzanillo, México

<sup>2</sup>Gladys Porter Zoo, Brownsville, TX

<sup>3</sup>Instituto Nacional de la Pesca, México, D.F.

<sup>4</sup>CRIP-Tampico, Tamaulipas, México

Iniciamos con el Fish and Wildlife Service el programa; en la autoridad estamos trabajando en colaboración también con el National Marine Fisheries Service. Yo creo que es importante decir que a través de este programa se han logrado muchos amigos en ambos lados de nuestros países. Creo que es importante también hacer resaltar que la mayoría de tortugas marinas en el mundo están declinando en sus poblaciones. Sin embargo, las tortugas del género *Lepidochelys*, como es la tortuga lora del norte del Atlántico, y la tortuga golfina del Pacífico en México, han tenido un enorme incremento. Pudiera decirse en particular de la tortuga golfina del Pacífico que ha rebasado nuestras expectativas.

Hace alrededor de diez años, se publicó que estas poblaciones iban a desaparecer. Sin embargo, la población de 1987 de la tortuga golfina, que llegaba a la Playa de la Escobilla en Oaxaca alcanzaron una anidación de 57,000 nidos. Todo representa alrededor de unos 30-35,000 hembras anidando. En 1990 se estableció la veda total de tortugas marinas en nuestro país y ese mismo año la población se duplicó. Y de tal manera se ha ido incrementando tanto que el año pasado tuvimos 816,000 anidaciones que representa más de 300,000 hembras.

Este año, a pesar de los dos ciclones que golpearon la zona de Oaxaca el primer huracán acarrió demasiada palizada, palos, y madera a la playa y ocultó 30% de los nidos que existían allí. Se limpió la playa con muchos trabajos. De doscientas a trescientas gentes voluntarias limpiaron la playa antes de que ocurriera la siguiente arribazón. Ocurrió una arribazón de 150,000 tortugas en el mes de octubre y entonces volvió a pegar otro ciclón y volvió a cubrir la playa de madera. En estos momentos la gente sigue trabajando en la playa quitando madera por si viene otra arribazón. Entonces ha sido una labor, pudiera decirse "titánica", sobre todo por las condiciones tan difíciles en que se encuentran esas localidades de mucha necesidad, muchos daños, y a pesar de todo, la gente está preocupada y tratando de ayudar a las tortugas marinas. En estos momentos podemos decir que hay alrededor de 880,000 nidos, más nidos que el año pasado. Podría decirse que está llegando ya a un límite de capacidad esa playa.



Nosotros empezamos a trabajar en el Golfo de México en 1966. Aquí está localizada en la estación de investigación de tortugas marinas en Rancho Nuevo. Entre 1966 y 1977 trabajamos alrededor de unos 15 a 20 kilómetros a pie. A veces encontramos hueveros en vez de hacerles alguna sanción o algo, como muchas veces traían caballos, lo que hacíamos era obligarlos a que nos ayudaran a acarrear los nidos a los corrales. Eso era la manera entre 1966 y 1977 que se protegían alrededor de unos 300 nidos. En 1978, con la colaboración de los Estados Unidos en el programa, se duplicó inmediatamente el número de nidos protegidos y hasta la fecha se ha ido incrementando entre 10, 15 o hasta 20 por ciento el número de nidos protegidos, de tal manera que en la actualidad en este año logramos proteger 2,300 nidos en el área. El área también de protección se ha ampliado grandemente de los 15 a 20 kilómetros que trabajamos nosotros a pie. Se ha incrementado a 120 kilómetros. Hemos ampliado también el número de campamentos de conservación. Iniciamos en Rancho Nuevo en la parte central y en la actualidad tenemos dos campamentos más: uno al norte en un lugar que se conoce como Tepehuajes, y otro al sur en la Barra de Calabazas. Este aspecto de la playa de anidación es muy similar en algunas partes a la zona de Isla Padre, y es posible que a eso se deba también que aniden los especies en ambos lugares.

El corral está expuesto a mareas altas y a los ciclones en particular, pero afortunadamente esto ocurre casi al final de la temporada por lo que las pérdidas de anidaciones o de crías es mínima. Muchas veces hemos perdido desde 60 a 100 nidos por causas de inundaciones o de ciclones. Ponen entre 100 o alrededor de 115 huevos por nido. Cuando nosotros empezamos a trabajar en 1966, los números de huevos por nido eran alrededor de 110 a 115 huevos. En la actualidad, son entre 90 y 100 huevos.

Una de las actividades rutinarias consiste el trabajo, principalmente la localización de nidos en la playa, la recuperación de los nidos, el traslado de nidos a los corrales y esperar que ocurra el nacimiento y la liberación de las crías de manera inmediata. No conservamos las tortuguitas en ningún momento, ni en agua ni en corrales, de manera que tratamos de interrumpir al mínimo el ciclo natural de estos animales.

Una cosa muy importante y muy interesante es que también el número de tortugas en las arribazones ha ido aumentando poco a poco a partir de 1987. Nosotros tenemos en la actualidad este año una arribazón de 315 tortugas, y normalmente entre 1987, y el año pasado eran alrededor de 200 tortugas, las máximas arribazones. Eso indica también un incremento en la población.

Uno de los problemas naturales que pueden encontrar las tortugas es la erosión muy fácil en los terrenos por los ciclones o las mareas muy altas, y ponen los huevos a su deterioro. Por eso es que en esta zona, como es una especie dispuesta a extinción, nosotros transportamos los nidos a los corrales. También, un problema en la zona es que se dejan los nidos en la playa y son atacados por coyotes y otros depredadores. En este caso el nido que se trató de proteger contra la depredación de coyote fue un experimento que se hizo con una cantidad de diez nidos, y como ven, el coyote, de todos modos, no le importó la protección.

Durante los primeros años de actividades, tuvimos problemas con hueveros que todavía seguían yendo a la playa y se querían llevar nidos. Incluso tuvimos enfrentamientos con armas porque estaba

bastante difícil la situación. Pero en la actualidad, toda la gente que vive allí en la comunidad colabora, ayuda y ya cambió totalmente su mentalidad, y particularmente porque en treinta años ya son hijos de los que tuvimos problemas nosotros. Entonces ya es otra generación, otra mentalidad.

Otra circunstancia que es muy interesante es el cultivo de tortugas marinas. Hay mucha controversia en este sentido, sobre todo porque se considera que al introducir organismos cultivados al mercado internacional, se puede favorecer el incremento de contrabando de organismos de carácter éste, de origen natural o de origen silvestre. Esto es bastante discutible. Si se lleva un control perfecto de los organismos que están cultivando, no creo que haya ningún problema por cultivar las tortugas marinas. El Dr. Archie Carr hace unos veinte, veinticinco o treinta años, indicaba que el futuro de las tortugas marinas era en las granjas. Sin embargo, esa mentalidad ha cambiado y en la actualidad todo el mundo que trabaja con tortugas marinas está en contra del cultivo. Entonces eso también creo que habría que trabajar y cambiarlo porque las tortugas marinas son un recurso natural, un recurso natural que necesitan los países, particularmente en el trópico, y que deben aprender a conservarlos y a explotarlos. Es una lástima que en la Escobilla se echen a perder o pudrir 80,000,000 de nidos que son desovados en esta temporada. De esos ochenta millones de huevos, el setenta por 70% se echa a perder, por lo menos, y eso representa toneladas y toneladas de proteína que no se aprovecha, sobre todo teniendo la necesidad muy muy importante de alimentar a esas gentes que viven cerca o en esas playas.

Rancho Nuevo es la zona que se está trabajando en la actualidad. La reserva natural es de 15 kilómetros más o menos que la zona que trabajamos nosotros de 1966 a 1977 y se han incrementado dos campamentos, más uno donde dice Barra Ostionales y otro donde dice Barra del Tordo. Son dos campamentos muy importantes que han aportado alrededor de un 20% a 30% más de nidos protegidos. El año pasado y este año se agregaron otros campamentos ya más al sur casi llegando a Tampico, y de esa manera se ha incrementado también la conservación de nidos en la playa de tal manera que 800 nidos se protegieron en 1987. El año pasado en toda la zona de anidación, incluyendo el estado de Veracruz, logramos proteger dos 2,350 nidos.

La población se ha ido incrementando en los últimos años. Esta es una extrapolación de la arribazón de 1947, que fue alrededor de 40,000 nidos, y el año donde nosotros iniciamos a trabajar, 1966, hubo arribazones de 1,000-2,000 tortugas en un solo día.

Entonces, todavía la tendencia es más rápida. Aparentemente en Rancho Nuevo, si nos consideramos solamente Rancho Nuevo, se está incrementando en un 6% la población al año. Al incluir los otros dos campamentos de conservación, el incremento es alrededor de 11% anual, lo que representa alrededor de 200 nidos más que estamos obteniendo en los dos. Una circunstancia muy importante es el problema de la captura incidental. Ese es uno de los graves problemas que confronta una tortuga adulta hembra. Nos estamos quitando la posibilidad de anidación de ese animal y entonces estamos perdiendo parte del trabajo que estamos desarrollando con muchos esfuerzos. Entonces estamos también muy contentos, pudiera decirse, de la respuesta de la industria camaronera tanto nacional como la de los Estados Unidos en relación al uso del Excluidor de Tortuga Marina, y esto puede ser que también sea lo que está favoreciendo el incremento en la población.

## KEMP'S RIDLEY SEA TURTLE PROJECT AT PADRE ISLAND NATIONAL SEASHORE, TEXAS

Ms. Donna J. Shaver  
U.S. Geological Survey  
Padre Island National Seashore

### INTRODUCTION

Kemp's ridley (*Lepidochelys kempii*) is the most critically endangered sea turtle species in the world. Today there are probably fewer than 3,000 adults in the entire population and most nest in the vicinity of Rancho Nuevo, Tamaulipas, Mexico (Marquez-M. *et al.* 1996). International, multi-agency efforts to aid in the recovery of this species have been underway for the last two decades. One of these efforts was an experimental project to establish a secondary nesting colony of Kemp's ridley turtles at Padre Island National Seashore (PAIS), Texas (Shaver 1987, 1989), where nesting had been documented previously (Werler 1951; Carr 1967). National Park Service (NPS) and U.S. Geological Survey (USGS) staff at PAIS now attempt to detect sea turtle nestings on North Padre Island and maintain records of sea turtle nestings and strandings (turtles that wash ashore dead or alive) on the Texas coast. This paper discusses the effort to establish a secondary nesting colony of Kemp's ridley turtles at PAIS, nest detection program conducted on North Padre Island, Kemp's ridley nests found on the Texas coast, sea turtle strandings documented on the Texas coast, and implications of Kemp's ridley mortality in Texas on the effort to establish a secondary nesting colony.

### METHODS AND RESULTS

From 1978-1988, attempts were made to imprint Kemp's ridley turtles to PAIS so that they would return and establish a secondary nesting colony (Shaver 1989, 1990). Overall, 22,507 eggs were collected in Rancho Nuevo, packed in Padre Island sand, and shipped to PAIS for incubation. NPS staff at PAIS provided care to the incubating eggs and exposed the resulting hatchlings to the PAIS beach and surf. The National Marine Fisheries Service (NMFS) raised the hatchlings in captivity for 9-11 months, marked these headstarted turtles with up to four types of external and internal tags, and released them at a variety of locations (Fontaine *et al.* 1993; Caillouet *et al.* 1995).

An extensive program to detect nesting by sea turtles on North Padre Island provides protection to nesting turtles and their eggs as well as a means to evaluate results of the project to establish a secondary nesting colony. Critical components of the program are public education and beach patrols. Annual beach patrols began in 1986 and have improved and increased since that time (Shaver 1987, 1990, *in press a*). Staff and volunteers now patrol the entire Gulf of Mexico shoreline on North Padre Island (including 104 kilometers of PAIS and 24 kilometers north of PAIS), daily, from April through August.

The first published record of Kemp's ridley nesting on the Texas coast was based on an observation made in 1948 (Carr 1967). From 1948-1997, 32 Kemp's ridley clutches were confirmed on the Texas

coast (Werler 1951; Carr 1967; Shaver 1990, 1995, 1996a, *in press a*), with more verified Kemp's ridley nests at PAIS than at any other single location in the United States. During this period, nests documented in Texas were found only in the southern part of the state, on Mustang Island, North Padre Island (including PAIS), and South Padre Island/Boca Chica Beach. Observations from recent years suggest increased nesting, with 19 of the 32 nests being detected from 1995-1997. During 1997 alone, nine nests were found on the Texas coast. These represent: 1) the only confirmed Kemp's ridley nests found in the United States during 1997; 2) the most Kemp's ridley nests documented in Texas during a single year; and, 3) an increase in the number of Kemp's ridley nests detected in Texas for the third consecutive year.

Since 1979, PAIS staff have investigated the majority of confirmed sea turtle nesting emergences on the Texas coast. However, only a few of the nesting Kemp's ridley turtles were observed by PAIS staff and could be examined by them for the presence of tags used to mark the turtles released from the experimental project to establish a secondary nesting colony. The first two confirmed returnees from this experimental project were documented nesting at PAIS during 1996 (Shaver 1996a, 1996b, *in press a*). To date, no others nesting outside of captivity in Mexico or the United States have been conclusively linked to the experimental project.

Since 1979, virtually all sea turtle nests detected along the Texas coast have been protected from a variety of threats by removing the eggs from the beach and transferring them to the PAIS incubation facility. From 1980-1997, 1,988 Kemp's ridley hatchlings emerged from these protected clutches and were released on south Texas beaches. Most were released at PAIS and allowed to enter the surf without retrieval.

Texas waters are critically important to foraging, developing, nesting, and migrating Kemp's ridley turtles. The Sea Turtle Stranding and Salvage Network (STSSN) was established in 1980 to document strandings of sea turtles on United States beaches (Teas 1993). From 1 January 1980 through 15 November 1997, 4,649 non-headstarted sea turtles, of five species, were documented stranded on the Texas coast (Shaver 1996c, *in press b*). Since 1990, Kemp's ridley were found stranded on the Texas coast more frequently than any other species. In addition, more Kemp's ridleys (overall) and more adult Kemp's ridleys (60 cm straight-line carapace length or larger) were found stranded in Texas than in any other state in the United States.

From 1 January through 15 November 1997, 509 sea turtles were located stranded on the Texas coast. Among these stranded turtles were 174 Kemp's ridleys, including 25 adults. All 25 (eight females, five males, 12 unknown gender) were located dead. When 1997 is completed, it is likely that record numbers of sea turtles and adult Kemp's ridleys will have been found stranded on the Texas coast during 1997.

Correlations have been found between shrimp trawling in Gulf of Mexico waters off the Texas coast and strandings of sea turtles along Gulf of Mexico (offshore) beaches in Texas (Magnuson *et al.* 1990; Caillouet *et al.* 1996; Shaver 1996c, *in press b*). Despite mandatory use of turtle excluder devices (TEDs), incidental capture in shrimp trawls continues to be one of the most significant human-related sources of mortality for sea turtles on the Texas coast. During 1997, a 90% decrease

in offshore strandings occurred during the eight entire weeks of the Texas Closure (when Gulf waters off the Texas coast were closed to shrimping) as compared to the eight entire weeks preceding and following it (Figure 1G.11). Most Kemp's ridleys found stranded in Texas during 1997 were located dead, on offshore beaches, during times when Gulf of Mexico waters were open to shrimping.

Even though the Kemp's ridley nesting season extends from late-March through August (Marquez-M. *et al.* 1996), the nine confirmed Kemp's ridley nests found on the Texas coast during 1997 were located during a much shorter time period which corresponded with the Texas Closure (Figure 1G.12). Only one Kemp's ridley nest was found prior to the Closure, eight during the Closure, and none after shrimping resumed. In contrast, the 21 adult Kemp's ridleys that stranded on offshore beaches along the Texas coast during 1997 were located when Gulf waters were open to shrimping. The majority of these adults stranded in south Texas, where all of the nests were found. Five dead adult females were located stranded on south Texas offshore beaches from 10 April through 3 May, before any nestings were detected on the Texas coast. If these turtles had survived and nested on the Texas coast during 1997, the number of clutches laid in Texas this year may have doubled.

The Kemp's ridley population is apparently increasing, with increased nesting detected in Mexico (Marquez *et al.* 1996) and the United States during the last few years. However, the Kemp's ridley population is still far below former, delisting, and downlisting levels (U.S. Fish and Wildlife Service and NMFS 1992). The trend of increased Kemp's ridley nesting along the Texas coast and the success of efforts to establish a secondary nesting colony at PAIS could be threatened by continued

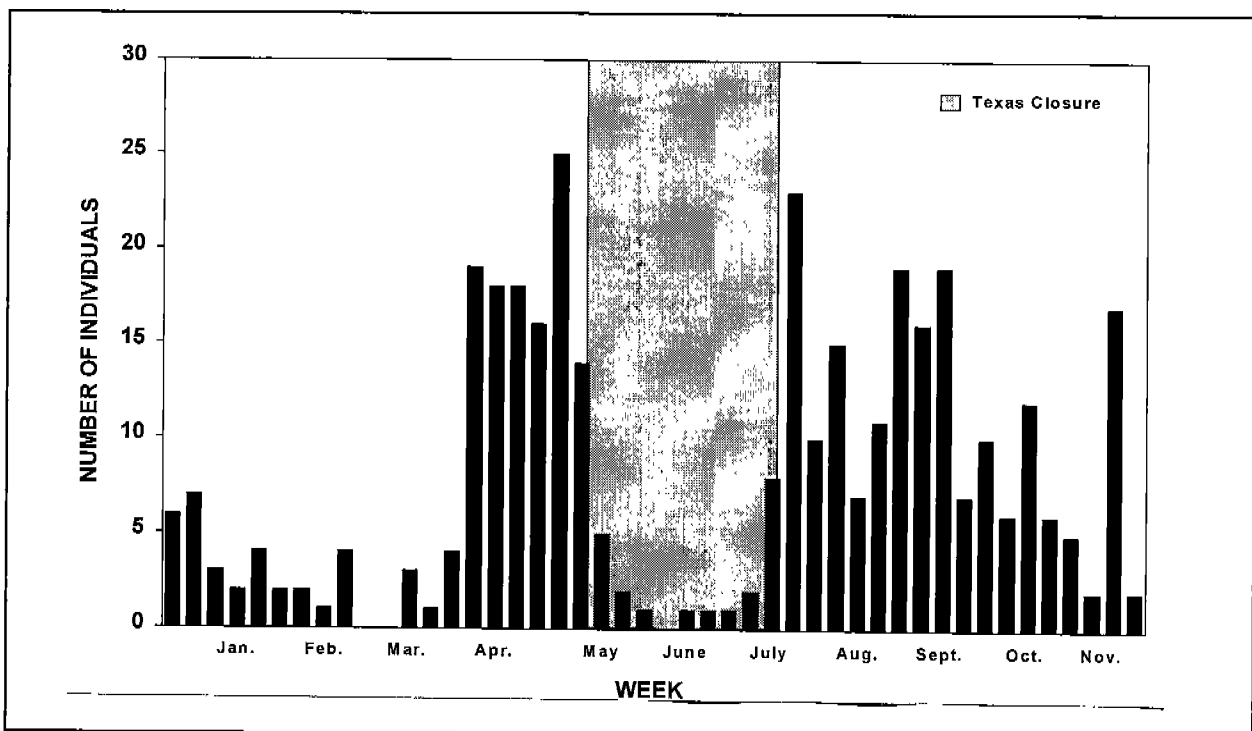

Figure 1G.11. Number of non-headstarted sea turtles located stranded on offshore beaches along the Texas coast during each week from 1 January – 15 November 1997.

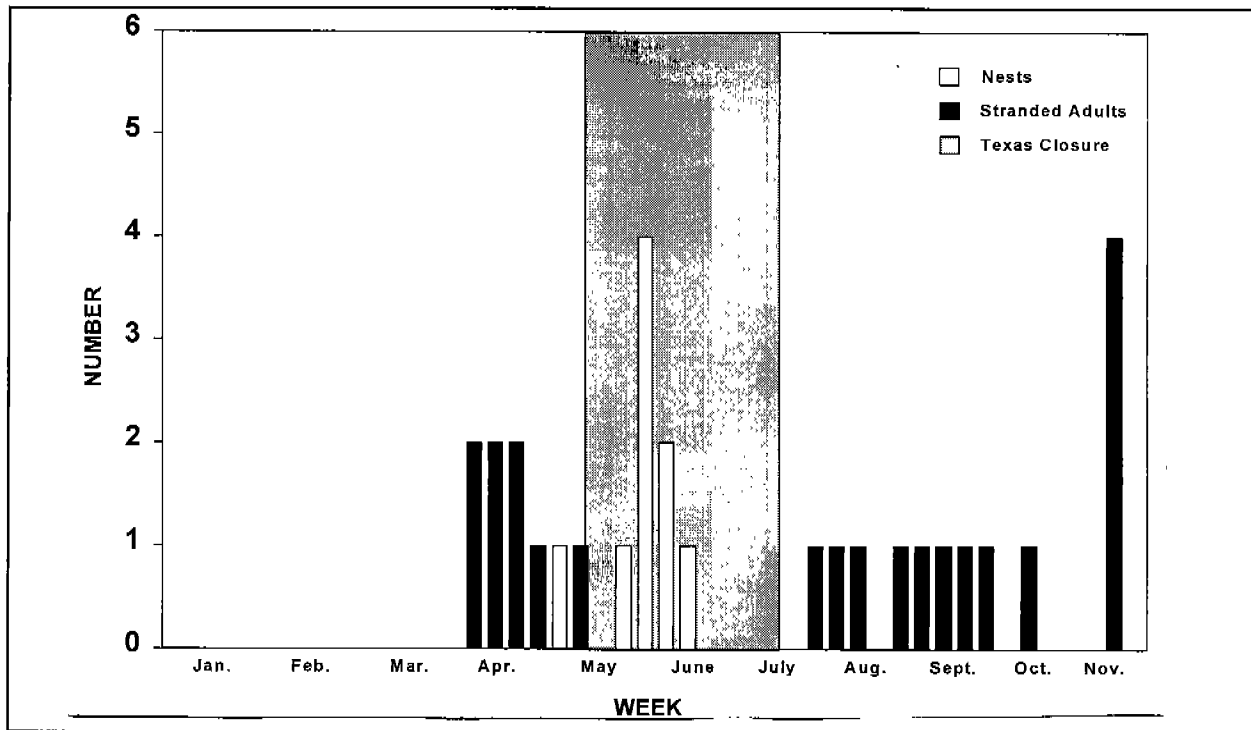

Figure 1G.12. Number of Kemp's ridley sea turtle nests and adult Kemp's ridleys located stranded on offshore beaches along the Texas coast during each week from 1 January – 15 November 1997.

mortality of breeding turtles offshore from south Texas nesting beaches. Even if a secondary nesting colony is established at PAIS, Kemp's ridleys must continue to be protected at the nesting beaches in the United States and Mexico and in the marine environment.

#### SUMMARY

From 1948-1997, 32 confirmed Kemp's ridley nests were located on the Texas coast. During that time, more Kemp's ridley nests were found at PAIS than at any other single area in the United States. The first two confirmed returnees from the experimental project to establish a secondary nesting colony of Kemp's ridley turtles nested at PAIS in 1996. Nineteen of the 32 Kemp's ridley nests found on the Texas coast were located from 1995-1997 and the number of detected nests increased during each of those three years. Strandings of sea turtles along the Texas coast were most numerous during 1994, 1996, and 1997 and continue to be correlated with shrimp trawling effort. More Kemp's ridleys (overall) and adult Kemp's ridleys are typically found stranded in Texas than in any other state in the United States. Efforts to establish a secondary nesting colony of Kemp's ridleys at PAIS could be threatened if mortality of breeding turtles offshore from south Texas nesting beaches continues.

## ACKNOWLEDGMENTS

Agencies in Mexico, including the Instituto Nacional de la Pesca, are thanked for their assistance with this program. Canon U.S.A., Inc., Gladys Porter Zoo, H.E.A.R.T, National Marine Fisheries Service, National Park Foundation, National Park Service, Texas Parks and Wildlife Department, U.S. Coast Guard, U.S. Fish and Wildlife Service, U.S. Geological Survey, and others in the United States are gratefully acknowledged for their contributions to various aspects of this work.

## REFERENCES

- Caillouet, C.W., Jr., C.T. Fontaine, S.A. Manzella-Tirpak, and D.J. Shaver. 1995. Survival of head-started Kemp's ridley sea turtles (*Lepidochelys kempii*) released into the Gulf of Mexico or adjacent bays. *Chelonian Conservation and Biology* 1(4):285-292.
- Caillouet, C.W., Jr., D.J. Shaver, W.G. Teas, J.B. Nance, D.B. Revera, and A.C. Cannon. 1996. Relationship between sea turtle stranding rates and shrimp fishing intensities in the northwestern Gulf of Mexico: 1986-1989 versus 1990-1993. *Fishery Bulletin* 94(2):237-249.
- Carr, A.F. 1967. So excellent a fishe: A natural history of sea turtles. American Mus. Nat. Hist., Natural History Press, Garden City, N.J. 248 pp.
- Fontaine, C.T., D.B. Revera, T.D. Williams, and C.W. Caillouet, Jr. 1993. Detection, verification, and decoding of tags and marks in head started Kemp's ridley sea turtles, *Lepidochelys kempii*. NOAA Tech. Memo. NMFS-SEFC-334. U.S. Dept. Commerce, National Marine Fisheries Service, Southeast Fish. Sci. Cent., Galveston, Tex. iii plus 40 pp.
- Magnuson, J.J., K.A. Bjorndal, W.D. DuPaul, G.L. Graham, D.W. Owens, C.H. Peterson, P.C.H. Pritchard, J.I. Richardson, G.E. Saul, and C.W. West. 1990. Decline of the sea turtles: Causes and prevention. Nat. Research Council, Natl. Acad. Sci. Press, Washington, D.C. 190 pp.
- Marquez-M., R., R.A. Byles, P. Burchfield, M. Sanchez-P., and J. Diaz-F. 1996. Good news! Rising numbers of Kemp's ridleys nest at Rancho Nuevo, Tamaulipas, Mexico. *Marine Turtle News*. 73:2-5.
- Shaver, D.J. 1987. Padre Island Kemp's ridley sea turtle project update. *Park Sci.* 7(4):8-9.
- Shaver, D.J. 1989. Results from eleven years of incubating Kemp's ridley sea turtle eggs at Padre Island National Seashore, p. 163-165. *In*: S.A. Eckert, K.L. Eckert, and T.H. Richardson (Compilers). Proceedings of the Ninth Annual Workshop on Sea Turtle Conservation and Biology. NOAA Tech. Memo. NMFS-SEFC-232. U.S. Dept. Commerce, National Marine Fisheries Service, Southeast Fish. Cent., Miami, Fla. 305 pp.
- Shaver, D.J. 1990. Kemp's ridley project at Padre Island enters a new phase. *Park Sci.* 10(1):12-13.

- Shaver, D.J. 1995. Kemp's ridley sea turtles nest in south Texas. *Marine Turtle News*. 70:10-11.
- Shaver, D.J. 1996a. Head-started Kemp's ridley turtles nest in Texas. *Marine Turtle News*. 74:5-7.
- Shaver, D.J. 1996b. A note about Kemp's ridleys nesting in Texas. *Marine Turtle News*. 75:25.
- Shaver, D.J. 1996c. Sea turtle strandings along the Texas coast during 1994, p. 45-49. *In*: University of New Orleans (Compiler). Proceedings: Fourteenth Annual Gulf of Mexico Information Transfer Meeting. OCS Study MMS 96-0024. U.S. Dept. of the Interior, Minerals Mgmt. Service, Gulf of Mexico OCS Region, New Orleans, La. 463 pp.
- Shaver, D.J. *In press a*. Kemp's ridley turtles from international project return to Texas to nest. Proceedings: Sixteenth Annual Gulf of Mexico Information Transfer Meeting.
- Shaver, D.J. *In press b*. Sea turtle strandings along the Texas coast, 1980-1994. NOAA Technical Reports (U.S. Fishery Bulletin).
- Teas, W.G. 1993. Species composition and size class distribution of marine turtle strandings on the Gulf of Mexico and southeast United States coasts, 1985-1991. NOAA Tech. Memo. NMFS-SEFSC-315, U.S. Dept. Commerce, National Marine Fisheries Service, Southeast Fish. Sci. Cent., Miami, Fla. 43 pp.
- U.S. Fish and Wildlife Service and National Marine Fisheries Service. 1992. Recovery Plan for the Kemp's Ridley Sea Turtle (*Lepidochelys kempii*). U.S. Dept. Commerce, National Marine Fisheries Service, St. Petersburg, Fla. 40 pp.
- Werler, J.E. 1951. Miscellaneous notes on the eggs and young of Texas and Mexican reptiles. *Zoologica* 36(1, 1-4):37-48.

---

Ms. Donna Shaver has worked at Padre Island National Seashore for the last 17 years and is currently employed there by the U.S. Geological Survey, Biological Resources Division, as a Research Biologist. Ms. Shaver oversees a variety of sea turtle research and conservation projects conducted at Padre Island National Seashore and is the Texas Coordinator for the Sea Turtle Stranding and Salvage Network. She received her B.S. in wildlife biology from Cornell University and her M.S. in biology from Texas A&I University and is currently enrolled in a Ph.D. program in zoology at Texas A&M University.



## SOCIO-ECONOMIC DEVELOPMENT AND CONSERVATION PERSPECTIVES OF THE LAGUNA MADRE IN TAMAULIPAS

Dr. M.A. Vásquez

K. Logan

F. Yépez

Autonomous University of Tamaulipas

The State of Tamaulipas is located northeast of the Mexican Republic and occupies seventh place in territorial extension, measuring 78,380 Km<sup>2</sup> with 420 Km of coastline. Due to its location, it is also in a transition area between the neotropic and the Neoarctic; in its coastal zone it has wetlands such as Laguna de San Andrés, Laguna de Morales, Laguna de Barrial, and Laguna Madre de Tamaulipas, which is an important area for the arrival of aquatic migratory and shore birds, such as the redheaded duck, the swallow duck, the snow goose, the Canadian goose, the widgeons, and the gray crane, among others. Due to this great richness, it is a very important economic source since close to 20,000 families survive from it during the shrimping and fishing season, making this lagoon system of great biologic and socioeconomic importance.

### LOCATION OF THE LAGUNA MADRE

Located to the northeast of the State of Tamaulipas between the 23° 25' and the 25° 55' parallels latitude north and the 97° 10' and the 97° 50' meridians longitude west, the lagoon system is bordered to the north by the Río Bravo delta, to the south by the mouth of the Río Soto la Marina, to the west on its northern side by the agricultural border and on its southern side by cattle lands, and to the east by the Gulf of Mexico with a uniform littoral barrier which has important mouths for the interchange of water, such as Las Calabazas, Los Bueyes, Santa María, Jesús María, and one of the important areas which serves as a harbor is the Mezquitil port. These mouths connect to the sea for short time periods since cyclones provoke the transportation of sediments, causing them to clog. In such a situation, in order to conserve this ecosystem, the Secretariat of Fishing maintains the three mouths in order to keep them stable, their average depth being 70 cm.

As a matter of record, we can mention that from its initial formation, the Lagoon has been filling with sediments from the sea and from continental erosion.

Rusnak (1960) estimates that the average sedimentation speed of the Laguna Madre is 12 cm. per hundred years based on the thickness of the olosenic sediments. Presently the sand deposits transported from the barrier by southeastern winds are predominant. Up to the present time, salinity has not been an important factor in sedimentation; however, there is a tendency toward progressive increase. It does not appear that the salinity will reach amounts such that would cause massive precipitation of all the dissolved salts. The desiccation of the Lagoon during recent years is mainly due to the change in hydrologic conditions caused by the decrease in the continental contributions, by irrigation projects and principally because of the complete isolation of the basin due to blockage at the mouths. It is also very unlikely that the Lagoon will regenerate itself by natural means unless

by a new advance of the sea or a sinking of the coast. Even if a cyclone opens the mouths, it is more likely that the water will tend to stagnate in the depression of the Lagoon than reestablish normal circulation.

#### SOCIOECONOMIC ASPECTS OF THE AREA OF INFLUENCE OF THE LAGUNA MADRE

The evolution of the history of man is based upon the use of natural resources for his survival; therefore, during the last 50 years important activities such as agriculture have taken place in the area of influence of the Laguna Madre. Today, over-exploitation has caused a decrease in its production and a loss of soil due to hydric and Aeolic erosion. These effects have brought about an economic decrease to the owners of the resources: cattle raising, under base conditions with regard to production of fodder; fishing, which has played an important role as a source of food; and hunting, by taking advantage of wildlife. During the 70s and 80s these activities were believed to be an inexhaustible source of economic resources; presently, during the 80s and 90s, these activities have decreased, which has caused immigration to the nearest developed cities, thereby creating the need for jobs, a need which seeks a palliative through the installation of factories on the border, which has its own risks and medium and long-term consequences.

The Laguna Madre is a refuge for nesting and reproduction of species of great economic importance such as the brown shrimp (*Penaeus aztecus*), which reproduces in the Gulf of Mexico, during two peak times. The largest occurs during the months of March and April, and the second, which is of lesser intensity, during the months of August and September. The spawning of the white shrimp (*Penaeus setiferus*) species occurs in oceanic waters, beginning in April and extending until November or the end of September, according to Linder and Anderson (1956); thus, we can also mention others, such as the pink shrimp (*Penaeus duorarum*), the striped mullet (*Mugil cephalus*), the white mullet (*Mugil curema*), the eastern oyster (*Crassostrea virginica*), the spotted sea trout (*Cynoscion nebulosus*), the drum (*Pogonias cromis*), the blue crab (*Callinectes sapidus*), and the red drum (*Sciaenops ocellata*).

Through lagoon fishing and the beginning of the development of other activities, the Laguna Madre focuses on characteristics that enable it to play a predominant role in the economic activity of the country. More than 5,000 fishermen depend on it, grouped into twenty cooperative fishing production companies, three corporate solidarity companies, and six licensing agents, whose members are scattered: Media Luna, Barracón del Tío Blas, Carbonera, Punta de Alambre, Carbajal and Punta de Piedra, in the San Fernando district; and in Enramadas in the Soto la Marina district. In addition to the cooperative fishermen, in the high season there is a floating population of 20,000 fishermen. There are twenty cooperative fishing production companies established at Laguna Madre, which consist of the human and fishing infrastructure shown in Table 1G.1.

#### SPECIES WITH COMMERCIAL AND/OR ETHNIC VALUE

Among the prominent edible species are the catán (*Lepisosteus osseus*) and the river mojarra (*Cichlasoma sp.*). Among the commercial food, the trout (*Cynoscion sp.*), the southern flounder

Table 1G.1. General information on cooperative fishing production companies established at Laguna Madre.

NAME	DISTRICT	PARTNERS	BOATS	MOTORS	OTHERS
CARBAJAL	SAN FERNANDO	298	462	N.D.	N.D.
CAUDILLOS	SAN FERNANDO	106	177	83	2555
FCO. J. MUJICA	SAN FERNANDO	38	69	30	270
T. GONZALEZ	SAN FERNANDO	45	42	2	172
ISLAS UNIDAS	SAN FERNANDO	91	393	N.D.	N.D.
LAGUNA MADRE	SAN FERNANDO	97	196	73	531
LA NADADORA	SAN FERNANDO	70	59	30	409
MATAMOROS	SAN FERNANDO	62	60	58	92
P. DE PIEDRA	SAN FERNANDO	106	93	65	574
SAN FERNANDO	SAN FERNANDO	55	16	16	1840
B. DE BOCA CIEGA	MATAMOROS	41	101	69	1638
B. DE CONCHILLAL	MATAMOROS	57	47	N.D.	N.D.
B. DE STA. MARIA	MATAMOROS	74	123	31	155
EL BARRANCON	MATAMOROS	100	411	85	N.D.
EL CHAMIZAL	MATAMOROS	44	157	62	762
LA NORTEÑA	MATAMOROS	56	28	9	1250
PESC. UNID. DE MAT.	MATAMOROS	76	74	51	7163
PLAN DE AYUTLA	MATAMOROS	57	65	31	160
RIN. DE LAS FLORES	MATAMOROS	68	99	69	1110
ENRAMADAS	MATAMOROS	66	42	15	4235

(*Paralichthys lethostigma*), the fat snook (*Centropomus paralellus*), the striped mullet (*Mugil cephalus*) and the snook (*Centropomus undecimalis*) are worth mentioning as important catches.

With respect to crustaceans, shrimp (*Penaeus sp.*) is one of the most common resources, then crayfish and crabs, octopus of the genus *Octopus*, one species of eastern oyster, one species of lobster and another of squid, all of which are used for food.

In the realm of socioeconomic detachment, a very interesting phenomenon has occurred: Laguna Madre is, and has been, a fishing production complex, which has provided a supply of fishing resources to the people who have taken advantage of this lagoon system without the slightest rational thought (in spite of the fact that regulations exist regarding some species); therefore, it is necessary to conduct studies propagating a mutual relationship, from which both parties would benefit.

## AGRICULTURE AND LIVESTOCK ACTIVITIES IN THE AREA OF INFLUENCE IN LAGUNA MADRE

The North of the State of Tamaulipas is characterized as being an extensive agricultural region in the production of basic grains, mainly sorghum, safflower and corn, along with cattle, which is widespread. These agricultural and livestock production systems are invariably accompanied by the deterioration of natural resources such as land and water. In support of this fact, recent studies indicate that erosion becomes more important due to the ineffective management practices and the fragility of the soil in composition and structure, where the plant coverage is insufficient to neutralize the impact of surface flow, intensifying the problem more and more. The main characteristic of the area of the district is, among others, the presence of dominant winds which come from the southeast and northwest at velocities greater than 19 Km/hr, occurring with greater intensity during the months of February and March.

The agricultural region of the area of influence of the lagoon has seasonally cultivated open lowland surface area of 750,000 hect., where the Distrito de Temporal Tecnificado No. 010 San Fernando, Tamaulipas is located, with an agricultural and livestock land surface of 486,400 hect. on which the CNA, during recent years, has performed tasks to conserve the land and water through the Mexican Institute of Water Technology.

The use of a large number of agrochemicals in various proportions during the last 20 years has had repercussions on the natural state of vitally important natural resources such as water and land. Some strategies devised for the purpose of conserving the characteristics of the lands surrounding this area include:

Alternatives to problems:

- Management practices which are adapted to the physiographic, social and economic characteristics of the agricultural and livestock areas.
- Reduction of Aeolic erosion through institutional and community participation.
- Control and reduction of sediments deposited in the lagoon system.
- Control of land slides and subsequent utilization in agricultural and livestock areas.
- Technical conservation support for the increase and diversification of agricultural and livestock production.
- Dissemination of the advantages which support conservation practices and land improvement.
- Regulation of the sale and application of chemical products used in agriculture.

- Regulation of the introduction of chemical products prohibited on the border of the United States.

## EDUCATION

Regarding education, Tamaulipas shows an advance according to the population census of 1990. Of the population between 6 and 14 years old, only 9.7% do not know how to read, and the rate of illiteracy of the population 15 years and older in the districts of Matamoros, Soto la Marina and San Fernando is 6.62%. In Matamoros the percentage of illiteracy (5.6%) is much less than in the state (6.85%), a situation which is explainable since Matamoros is one of the largest cities in the state, while in the districts of San Fernando and Soto la Marina the rate of illiteracy reaches (10.63% and 12.4%, respectively), because these districts have a large number of small communities which are very far away from the place where education can be obtained at any level.

Environmental education for conservation is an important point in order to counteract damage and promote conservation. For this reason, in 1995 UAT, DUMAC, NAWCC, USFWS and SEMARNAP initiated an environmental educational program whose purpose is to involve school-age (elementary) children and teachers in conservation programs, which is an important activity since the programs and courses developed have an educational promotion value for the teachers.

## NATURAL PROTECTED AREA

This lake area mainly reflects its importance in the great number and diversity of floristic and faunistic species. The latter are represented by 144 species of resident birds of which 2.7% are endemic to Mexico; likewise, it is an important natural corridor for birds which migrate from the north of the continent, linking in this area of influence two of the four migratory routes which converge in Mexico, such that Laguna Madre shelters 26 species of anseriforms equivalent to 68.42% of the species that arrive in Mexico, which make it the principal lacustrine area in the country by providing the habitat for 15% of the hibernating population in the country; the hibernating species of geese in this area are represented by three, which are the snow goose, the Canadian goose, and the white-headed goose. Another species is the red heron, which finds nourishment in the great intersea regions without emergent vegetation which are used as foraging areas for food. It is noteworthy that Laguna Madre of Tamaulipas and Texas are the only areas in the Gulf of Mexico which unite the ideal characteristics for the development of this specie and that give shelter to 40 to 50% of the world population of this specie which is considered by the NOM 059-ECOL 94 as endangered.

An important population of shorebirds converge in the intersea shore zones of the Lagoon, among which we shall mention *Charadrius melodus*, which is considered in danger of extinction by the United States and endangered according to the Official Mexican Standard. Two species of pelicans, the brown one and the white one, find their area of food and shelter within the zone, as well as species of great biological importance, such as falcons, parrots, eagles, etc. Regarding the land fauna in the area, there are 323 species of vertebrates such as the jaguar, ocelot, wildcat, jaguarondi, panther, lynx, wild boar, opossum, white-tailed deer, turtles, and snakes, among others.

From the phytogeographic point of view, within the xerophyte region the following types of plants are found: the xerophilous brush, the thornscrub, halophyte vegetation and seagrass meadow vegetation.

Because of its biological features and the fact that it is a source of socio-economic development, the Secretariat of the Environment, Natural Resources and Fishing, through the National System of Protected Natural Areas, has proposed that Laguna Madre of Tamaulipas be considered a Wild Flora [and] Fauna protected area, which would enable adequate management and administration of this lagoon complex.

## **DESARROLLO SOCIO-ECONÓMICO Y PERSPECTIVAS DE CONSERVACIÓN EN LA LAGUNA MADRE DE TAMAULIPAS**

Dr. M.A. Vásquez

K. Logan

F. Yépez

Autonomous University of Tamaulipas

El Estado de Tamaulipas se encuentra localizado al noroeste de la República Mexicana, ocupa el séptimo lugar en extensión territorial, con 78,380 Km<sup>2</sup> destacándose de costa con 420 Km, debido a su localización lo encontramos también en una zona de transición entre el neotrópico y el neoártico, en su zona costera destacan humedales tales como Laguna de San Andrés, Laguna de Morales, Laguna de Barrial y la Laguna Madre de Tamaulipas, la cual es un área importante para el arribo de las aves acuáticas migratorias y playeras, tales como pato cabeza roja, pato golondrino, el ganso nevado, el ganso canadiense, las cercetas y la grulla gris, entre otros. Debido a esta gran riqueza, es una fuente económica muy importante ya que de ella en época de captura del camarón y de escama sobreviven al rededor de 20,000 familias, este sistema lagunario es de una gran importancia biológica y socioeconómica.

### LOCALIZACIÓN DE LA LAGUNA MADRE

Se localiza al noroeste del Estado de Tamaulipas entre los paralelos 23° 25' y 25° 55' de latitud norte y los meridianos 97° 10' y 97° 50' de longitud oeste, dicho sistema lagunario limita al norte con delta del Río Bravo y al sur con la desembocadura del Río Soto la Marina. Limitado al oeste en su parte norte con la frontera agrícola y al sur con áreas ganaderas, este sistema al este limita con el Golfo de México por una barrera litoral uniforme en las cuales se encuentran algunas bocas importantes para el intercambio de agua, tales como las Calabazas, Los Bueyes, Santa María, Jesús María y una de las áreas importantes como puerto de abrigo es el puerto el Mezquital. Estas bocas tienen comunicación con el mar durante cortos periodos, debido a que los ciclones provocan el acarreo de sedimentos causados el azolvamiento de las mismas. En tal situación para la conservación de éste

ecosistema la Secretaría de Pesca da mantenimiento a tres bocas con el propósito de mantener su estabilidad, su profundidad promedio es de 70 cm.

Como antecedente podemos mencionar que desde su inicio de formación la Laguna se ha estado rellenando sedimentos provenientes del mar, y de la erosión continental.

Rusnak (1960), estima que la velocidad de sedimentación media de la Laguna Madre es de 12cm. por cada 100 años basándose en el espesor de los sedimentos olosénicos, actualmente predomina el depósito de arenas transportadas desde la barrera por los vientos del sureste, la salinidad no ha sido hasta ahora un factor importante en la sedimentación sin embargo existe una tendencia hacia un aumento progresivo. No se cree que la salinidad alcance valores tales que provoquen la precipitación masiva de todas las sales disueltas, la desecación de la Lagna en los últimos años se debe principalmente al cambio en las condiciones hidrológicas causadas por la disminución de las aportaciones continentales, por obras de irrigación y principalmente por el aislamiento completo de la cuenca debido al azolve de las bocas, tampoco se cree posible que la Laguna se regenere por medios naturales a no ser por un nuevo avance del mar o un hundimiento de la costa aún cuando un ciclón abriera las bocas es más probable que el agua tienda a estancarse en la depresión de la Laguna que restablecer una circulación normal.

#### ASPECTOS SOCIOECONÓMICOS DEL ÁREA DE INFLUENCIA DE LA LAGUNA MADRE

El devenir de la historia del hombre está basada en la utilización de los recursos naturales para su sobrevivencia, de éste modo en los últimos 50 años se han tenido actividades importantes en el área de influencia de Laguna Madre, actividades como la agricultura que hoy en día la sobrexplotación ha causado undecremento en su producción y la pérdida del suelo a través de la erosión hídrica y eólica efectos que han puesto de manifiesto la disminución económica de los tenedores del recurso, la ganadería en condiciones bajas de acuerdo a sus características en la producción de forraje, la pesca la cual ha jugado un papel importante como fuente de alimento junto con la caza a través del aprovechamiento de la vida silvestre. Estas actividades en los años 1970s y 1980s se creyeron una fuente inagotable de recursos económicos. En la actualidad para los años 1980s y 1990s, dichas actividades han disminuído lo que ha ocasionado la inmigración a los centros de desarrollo más cercanos, creándose con esto necesidades de empleos, mismas que han buscado un paleativo con la instalación de maquiladoras en la zona fonteriza, con sus riesgos y consecuencias a mediano y a largo plazo.

La Laguna madre es un refugio de anidación y reproducción de especies de gran importancia económica como lo son el camarón café (*Penaeus aztecus*), la cual lleva a cabo su reproducción en el Golfo de México, presentando dos picos de reproducción. El más grande comprende los meses de marzo y abril, y el segundo, el cual es de menor intensidad, comprende los meses de agosto y septiembre. El camarón blanco (*Penaeus setiferus*) el desove de esta especie se lleva a cabo en aguas oceánicas, iniciando en Abril y se extiende hasta Noviembre o fines de Septiembre, según Linder y Anderson (1956) y así podemos mencionar otras como, el camarón rosado (*Penaeus duorarum*), la lisa (*Mugil cephalus*), la lebrancha (*Mugil curema*), ostión (*Crassostrea virginica*), la trucha de

mar (*Cynoscion nebulosus*), el tambor (*Pogonias cromis*), la jaiba azul (*Callinectes sapidus*), la curvina (*Sciaenops ocellata*).

A través de la pesca lagunaria y gracias a lo incipiente de los desarrollos de otras actividades, la Laguna Madre, concentra características que le permiten jugar un papel preponderante en la actividad económica del país. De ella dependen más de 5,000 pescadores, agrupados en 20 sociedades cooperativas de producción pequeras, tres sociedades cooperativas de producción pequeras, tres sociedades de solidaridad social y seis permisionarios, todos ellos dispersos en las poblaciones; Media Luna, Barracón del Tío Blas, Carbonera, Punta de Alambre, Carbajal y Punta de Piedra, en el municipio de San Fernando; y en la población de Enramadas, en el municipio de Soto la Marina. Además de los pescadores cooperativos, en la época de mayor captura existe una población flotante de 20,000 pescadores. Son 20 la sociedades cooperativas de producción pesquera establecidas en la Laguna Madre, las cuales poseen la siguiente infraestructura humana y pequera:

Cuadro 1G.2. Generalidades de las sociedades cooperativas de producción pesquera establecidas en la Laguna Madre.

NOMBRE	MUNICIPIO	SOCIOS	EMBARC.	MOTORES	ARTES
CARBAJAL	SAN FERNANDO	298	462	N.D.	N.D.
CAUDILLOS	SAN FERNANDO	106	177	83	2555
FCO. J. MUJICA	SAN FERNANDO	38	69	30	270
T. GONZALEZ	SAN FERNANDO	45	42	2	172
ISLAS UNIDAS	SAN FERNANDO	91	393	N.D.	N.D.
LAGUNA MADRE	SAN FERNANDO	97	196	73	531
LA NADADORA	SAN FERNANDO	70	59	30	409
MATAMOROS	SAN FERNANDO	62	60	58	92
P. DE PIEDRA	SAN FERNANDO	106	93	65	574
SAN FERNANDO	SAN FERNANDO	55	16	16	1840
B. BOCA CIEGA	MATAMOROS	41	101	69	1638
B. DE CONCHILLAL	MATAMOROS	57	47	N.D.	N.D.
B. DE STA. MARIA	MATAMOROS	74	123	31	155
EL BARRANCON	MATAMOROS	100	411	85	N.D.
EL CHAMIZAL	MATAMOROS	44	157	62	762
LA NORTEÑA	MATAMOROS	56	28	9	1250
PESC. UNID. DE MAT	MATAMOROS	76	74	51	7163
PLAN DE AYUTLA	MATAMOROS	57	65	31	160
RIN. DE LAS FLORES	MATAMOROS	68	99	69	1110
ENRAMADAS	MATAMOROS	66	42	15	4235



## ESPECIES CON VALOR COMERCIAL Y/O ÉTNICO

Entre las especies comestibles destacan el catán (*lepisoteus osseus*) y la mojarra de río (*Cichlasima sp.*). Entre las comestibles comerciables cabe mencionar por su importancia de captura la trucha (*Cynoscion sp.*), el flander (*Paralichthys lethostigma*), el chucumite (*Centripomus paralellus*), la lisa (*Mugil cephalus*) y el robalo (*Centropomus undecimalis*).

En lo que respecta a los crustáceos, el camarón (*Penaeus sp.*) es uno de los recursos más comunes, las jaibas y los cangrejos, cuatro de pulpo del género *Octopus*, una especie de ostión y una de langosta otra de calamar, todos estos últimos utilizados de alimento.

En el aspecto de despegue socioeconómico se ha contemplado un fenómeno muy interesante: la Laguna Madre es, y ha sido, todo un complejo de producción pesquera, que ha permitido una fuente de abastacimientos de recursos pesqueros, y las poblaciones han aprovechado este sistema lagunario sin el menor condicionante de racionalidad (a pesar de que existe regulación sobre algunas especies); por tal motivo, aflora la necesidad de la ejecución de dichas investigaciones que propagen una relación de tipo mutualista, donde ambas partes se benefician.

## ACTIVIDADES AGROPECUARIAS EN EL ÁREA DE INFLUENCIA DE LA LAGUNA MADRE

El norte del estado de Tamaulipas se caracteriza por ser una región agrícola extensiva en la producción de granos básicos tales como el sorgo, cartamo y maíz, principalmente, lo anterior aunado a la ganadería que también se maneja en forma extensiva. Estos sistemas de producción agropecuario, están acompañados invariablemente por el deterioro de los recursos naturales como el suelo y el agua. En apoyo a ello existen recientes estudios que indican que la erosión se vuelve más importante debido a las malas prácticas de manejo y la fragilidad de sus suelos en composición y estructura, donde la cobertura vegetal es insuficiente para neutralizar el impacto de flujo superficial intensificándose cada vez más su problemática. La característica principal del área del distrito, es entre otras, los vientos dominantes que provienen del SE con dirección NW y velocidades mayores a los 19Km/hr, ocurriendo con mayor intensidad durante los meses de febrero y marzo.

La zona agrícola del área de influencia de la laguna, cuenta con una superficie abierta al cultivo de 750,000 has. bajo la modalidad de temporal y en ella se ubica el Distrito de Temporal Tecnificado No. 010 San Fernando, Tamaulipas con una superficie agropecuaria de 486,400 has. y en el cual la CNA realiza en los últimos años trabajos de Conservación de suelo y agua a través del Instituto Mexicano de Tecnología del Agua.

La utilización en los últimos 20 años una gran cantidad de agroquímicos con diversos propósitos, ha repercutido en el estado natural de recursos naturales de vital importancia como son el agua y el suelo. Dentro de las estrategias planteadas con el fin de conservar las características de los suelos circundantes a esta área se han incluido:

## ALTERNATIVAS A LA PROBLEMÁTICA

- Prácticas de manejo adecuadas a las características fisiográficas, sociales y económicas de las zonas agropecuarias.
- Reducción de la erosión eólica mediante la participación institucional y comunitaria.
- Control y reducción de sedimentos que se depositan en el sistema lagunario.
- Control de los escurrimientos superficiales y su posterior aprovechamiento en áreas agropecuarias.
- Aporte de tecnología conservacionista para el incremento y diversificación de la producción agropecuaria.
- Difusión de las ventajas que aportan las prácticas de conservación y mejoramiento de suelos.
- Regulación en la venta y aplicación de productos químicos utilizados en la agricultura.
- Regulación en la introducción de productos químicos no permitidos en la frontera de los Estados Unidos.

## EDUCACIÓN

En manera educativa, Tamaulipas muestra un avance, de acuerdo al censo poblacional de 1990, de la población entre 6 y 14 años, sólo el 9.7% no saben leer y la tasa de analfabetismo de la población de 15 años y más. Correspondiente a los municipios de Matamoros, Soto la Marina y San Fernando es el 6.62%. En Matamoros el porcentaje de analfabetismo (5.6%) es mucho menor que el del estado (6.85%), situación que se entiende ya que Matamoros es una de las ciudades más grandes del estado; mientras que en los municipios de San Fernando y Soto la Marina la tasa de analfabetismo sube (10.63% y 12.4% respectivamente), ya que estos municipios tienen un gran número de pequeñas comunidades muy alejadas de los lugares en donde se puede impartir la educación a cualquier nivel.

La educación ambiental para la conservación es un punto importante para contrarrestar su deterioro y promover su conservación, en este sentido la UAT, DUMAC, NAWCC, USFWS y SEMARNAP, iniciaron en 1995 un programa de educación ambiental el cual tiene como propósito, involucrar a los niños de edad escolar (básica) y maestros en los programas de conservación, lo importante de esta actividad es que los programas y cursos desarrollados cuentan con valor de promoción educativa para los maestros (Carrera Magisterial).

## ÁREA NATURAL PROTEGIDA

Esta área lacustre refleja su importancia principalmente en la gran cantidad y diversidad de especies florísticas y faunísticas. En estas últimas se encuentran representadas por 144 especies de aves residentes de las cuales el 2.7% son endémicas en México así mismo es un importante corredor natural para las aves migratorias provenientes del norte del continente, reuniendo en su área de influencia desde las cuatro rutas migratorias que convergen en México de esta forma la Laguna Madre alberga a 26 especies de anseriformes lo equivalente al 68.42% de las especies que arriban a México lo cual la convierte en la principal área lacustre del país, al proveer el hábitat para el 15% de la población invernante en el país; las especies invernantes de gansos en esta área están

representadas por tres de ellas que son, el ganso nevado, el ganso canadiense y el ganso frente blanca, otra de las especies es la garza roja, que se encuentra sustentado en las grandes zonas intermareales sin vegetación emergente utilizadas como áreas forrajeras para su alimentación, cabe señalar que la Laguna Madre de Tamaulipas y la de Texas son las únicas áreas en el Golfo de México que reúnen las características ideales para el desarrollo de ésta especie y que así mismo albergan del 40 al 50% de la población mundial de ésta especie considerada por la NOM 059-ECOL 94 como amenazada. Una población importante de aves playeras convergen en las zonas playeras intermareales de la Laguna entre las que podemos mencionar a *Charadrius melodus*, que está considerada en el peligro extinción para Estados Unidos y amenazada para la Norma Oficial Mexicana. Dos especies de pelícanos, el café y el blanco que encuentran su área de refugio y alimentación dentro de la zona, así también el área alberga especies de gran importancia biológica, como halcones, loros, águilas, etc. En cuanto a la fauna terrestre en el área existen 323 especies de vertebrados tales como jaguar, ocelote, tigrillo, jaguarundi, puma, lince, jabalí, zarigüeyas, venado cola blanca, tortugas, serpientes, entre otras.

Desde el punto de vista fitogeográfico dentro de la región xerófila con vegetación de tipo: matorral xerófilo, bosque espinoso y vegetación halófila y vegetación de pastos marinos.

Por sus características biológicas y la que representa como fuente de desarrollo socio-económico la Secretaría del Medio Ambiente Recursos Naturales y Pesca a través del Sistema Nacional de Áreas Naturales Protegidas han propuesto que la Laguna Madre de Tamaulipas sea considerada como una área de protección de FLORA FAUNA SILVESTRE lo cual permitiría lograr un adecuado manejo y administración de este complejo lagunario.

## SESSION 2E

## PLATFORM ECOLOGY

Chair: Dr. Ann Scarborough Bull  
 Co-Chair: Dr. Pasquale Roscigno  
 Date: December 17, 1997

Presentation	Author/Affiliation
Offshore Platforms as Fish Nursery Grounds	Mr. James G. Ditty Dr. Mark C. Benfield Dr. Richard F. Shaw Ms. Talat W. Farooqi Mr. Joseph S. Cope Coastal Fisheries Institute Louisiana State University
Variation in the Density and Species Composition of Fishes Associated with Three Petroleum Platforms in the Northern Gulf of Mexico	Dr. David R. Stanley Dr. Charles A. Wilson Coastal Fisheries Institute Louisiana State University
The Fish Community at a Petroleum Platform Six Months after an Explosive Event (Manuscript not submitted)	Mr. James Bolden Louisiana State University
Utilization of Fouling Community Elements by Reef Fishes at a Platform Artificial Reef in the Northwestern Gulf of Mexico	Mr. Carl R. Beaver Dr. Quenton R. Dokken Mr. Terry E. Riggs Center for Coastal Studies Texas A&M University, Corpus Christi
Fisheries Impacts of Underwater Explosives Used in Platform Salvage in the Gulf of Mexico 1993-1997	Mr. Gregg Gitschlag Galveston Laboratory Southeast Fisheries Center
Cumulative Ecological Significance of Oil and Gas Structures in the Gulf of Mexico: A Gulf of Mexico Fisheries Habitat Suitability Model—Phase II Model Description	Dr. Benny Gallaway Mr. John G. Cole LGL Ecological Research Associates, Inc.

1  
2  
3  
4

## OFFSHORE PLATFORMS AS FISH NURSERY GROUNDS

Mr. James G. Ditty  
Dr. Mark C. Benfield  
Dr. Richard F. Shaw  
Ms. Talat W. Farooqi  
Mr. Joseph S. Cope

Coastal Fisheries Institute, Louisiana State University

### ABSTRACTS

A study of ichthyoplankton sampling was conducted at three offshore petroleum platforms located along a transect from the outer to inner continental shelf off Louisiana. Larval and juvenile fishes were sampled during the reproductive season (April-September) using a combination of passively-fished plankton nets and a relatively new sampling gear—the light trap. Light traps were collected at 1-m, 20-m and on the surface at least 25-m downcurrent of the platform. Results from May and June revealed three different ichthyoplankton assemblages that corresponded to the prevailing hydrographic conditions around each platform. Reef fishes were most abundant at a mid-shelf platform. The influence of lunar phase on catch per unit effort was taxon specific. In some species, larger but fewer individuals were present away from the platform. This finding may indicate heavy, size-selective predation in the vicinity of the platform structure. Analyses of our complete dataset are ongoing.

### INTRODUCTION

The northern Gulf of Mexico is dominated by a soft (mud/silt/sand) bottom with relatively little natural hard-bottom reef. Offshore petroleum platforms constitute approximately 28% of the available hard bottom off Louisiana (Scarborough-Bull 1989) and this contribution increases substantially when their three-dimensional structure is considered.

Petroleum platforms attract a variety of marine fishes to their reef-like structure. These fish assemblages include schooling pelagics, reef-associates, demersal/benthic species, and—in deeper platforms—vertically migrating midwater species. While the fish aggregating properties of platforms are well accepted, there is presently no consensus on whether these platforms provide a functionally equivalent nursery habitat (i.e., predator refugia, food availability, growth rates) to natural hard-bottom reef communities.

The study we describe here was undertaken to (1) provide foundational information on the nursery ground/refugia role of oil and gas platforms for postlarval/juvenile fish; (2) begin across-shelf characterization of the early life-history stages of fish utilizing offshore petroleum platforms off central Louisiana; (3) respond to specific fisheries management requests for basic biological information on reef fish seasonality, vertical and across-shelf distributions, relative abundance and age/growth estimations; and (4) supplement and compare light trap sampling with conventional

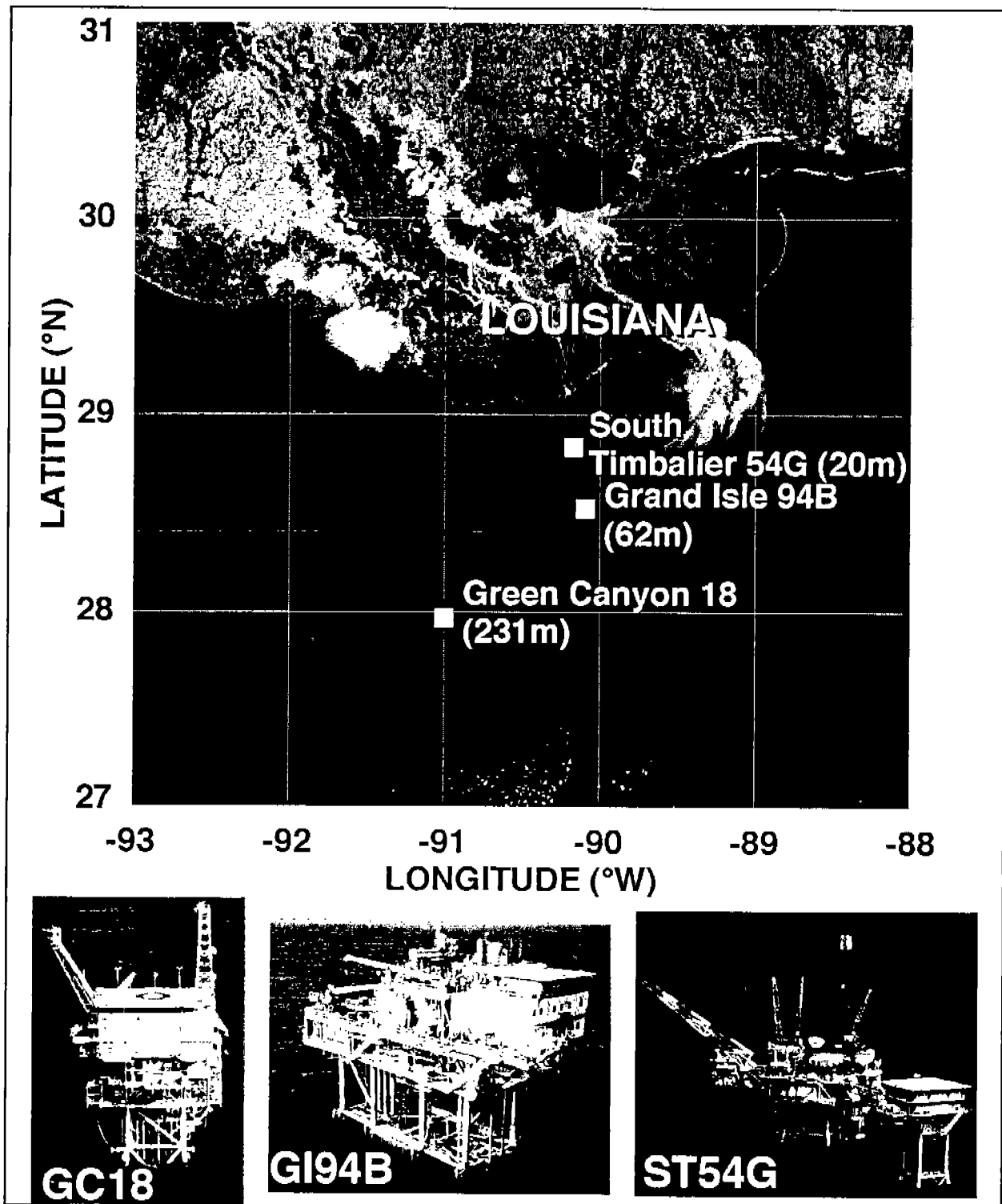

Figure 2E.1. Locations of Green Canyon 18, Grand Isle 94B and South Timbalier 54G superimposed on an AVHRR satellite image of the Louisiana coast. Note the positions of the Mississippi River plume in relation to the three platforms. Aerial photos of each platform are not to the same scale.

samplers (nets). Data analyses from our investigation are ongoing. This report will highlight results collected with light traps from an across the shelf during May-June.

## METHODS

### Study Sites

Our investigations took place at three platforms located west of the Mississippi River delta along a transect from the outer to inner continental shelf (Figure 2E.1). Green Canyon 18 (GC18) is an outer shelf platform (28.5222°N, -90.0920°W, 231m depth) platform operated by MOBIL. GC18 is exposed to clear, oligotrophic waters typical of open ocean hydrographic conditions and is characterized by the tropical/outer shelf faunal assemblage (Galloway and Lewbel 1982). It was sampled from July 1995-July 1996. Grand Isle 94B (GI94B) is a (27.9667°N, -91.0000°W, 62 m depth) mid-shelf platform operated by MOBIL. GI94B lies in more productive shelf water where the turbidity and salinity can fluctuate in response to periodic influence by the Mississippi River plume and is characterized by the brown shrimp faunal assemblage (Galloway and Lewbel 1982). GI94B was sampled from April 1996-September 1996. South Timbalier 54G (ST54G) is an Exxon platform located close to the coast (28.8333°N, -90.1667°W) in 20m of water. ST54G lies in turbid, highly productive coastal water characterized by the white shrimp faunal assemblage (Galloway and Lewbel 1982) and is consistently influenced by Mississippi discharge within the coastal boundary current. ST54G was sampled from April 1997-September 1997.

### Sampling Systems

Under ideal conditions, samples were collected from each platform on new and full moons, and each trip consisted of three successive nights of sampling that bracketed the target lunar phase. In addition to our regularly scheduled (new and full moon) samples, we conducted an extended sampling trip to GI94B to evaluate the influence of lunar phase on the abundance of fish in our light traps and nets.

On each night, larval and juvenile fishes were sampled using a combination of plankton nets and light traps. Plankton nets are a traditional gear for collecting ichthyoplankton and zooplankton, and we used passively-fished, 60-cm diameter, 335  $\mu$ m-mesh plankton nets equipped with a flow meter. In addition, we also used a 20-cm diameter, 64  $\mu$ m-mesh vertical net to provide an estimate of the zooplankton displacement volume or dry weight which might serve as an indicator of food availability for larval and juvenile fish. Light traps are a relatively new sampling gear which have been effectively employed in coral reef communities to collect reef fish. A bright light is used to attract fish into a transparent acrylic chamber which is designed to minimize subsequent escapement. We utilized a modified quatrefoil design equipped with a halogen lamp which has proved superior to other designs during comparative studies of light trap efficiencies conducted at a Gulf of Mexico oil platform.

Six replicate sets of samples were collected between sunset+1h and sunrise-1h. Each set consisted of six different samples: (1) a 15 min surface (1 m depth) plankton net cast; (2) a 20 min subsurface plankton net cast (collected at the depth of the first cross members which was approximately 20m);



(3) a vertical (20m - surface) net cast; (4) a 10 min surface light trap set; (5) a 10 min subsurface light trap set; and (6) a 10 min duration off-rig light trap set. Samples (1)-(5) were collected from beneath the platform while the off-rig light trap was allowed to drift at least 25 m away from the platform to provide a far-field sample of ichthyoplankton beyond the influence of the platform structure and immediate light field. All samples were preserved in buffered formalin and/or ethanol and then shipped to our laboratory where fish were removed and identified to the lowest possible taxonomic level.

Vertical profiles of salinity, temperature, and turbidity were collected beneath each platform at intervals each night using a Hydrolab Datasonde. Current speed and direction were logged near the platform using an Inter-Ocean S4 or Endeco current meter.

## RESULTS

### GC18

The ichthyoplankton assemblage at GC18 during May and June consisted of 19 families with an increase in both species richness and abundances from May to June (Table 2E.1). The assemblage was dominated by schooling pelagics from the families Carangidae and Scombridae. The carangids were primarily blue runner *Caranx crysos*, crevalle jack *C. hippos*, and horse-eye jack *C. latus*, all of which were also abundant near the surface as adults. The scombrids were predominantly the larvae of the bullet mackerel *Auxis rochei* or frigate mackerel *A. thazard*, and little tunny *Euthynnus alletteratus*.

Low numbers of reef-fish larvae representing 9 families were collected. These included Blenniidae: feather blenny *Hypsoblennius hertz*, redlip blenny *Ophioblennius atlanticus*; Gerreidae: *Eucinostomus* sp., Holocentridae: *Holocentrus* spp.; Gobiidae; Lutjanidae: schoolmaster or silk snapper *Lutjanus apodus/vivanus*, wenchman *Pristipomoides aquilonaris*; Pomacentridae: *Chromis* spp. and damselfish *Pomacentrus* sp.; Muraenidae; Priacanthidae: *Priacanthus* sp.; and Serranidae: yellowfin bass *Anthias nicholsi*, grouper *Epinephalus* spp. and *Myctoperca* spp., red barbier *Hemanthias vivanus*, *Pronotogrammus martinicensis*, and larvae of the *Serranus/Diplectrum/Centropristis* complex.

In spite of the high abundances of adult Bermuda chub *Kyphosus sectatrix* and great barracuda *Sphyræna barracuda* at this platform, none of their larvae or juveniles were captured. One unusual sample from this outer-shelf platform contained larvae of the clingfish *Gobiesox strumosus*, an estuarine species.

### GI94B

This mid-shelf platform produced the most diverse assemblage of fishes and at least 30 families were represented in our May and June light trap collections (Table 2E.1). In general, abundances and species richness declined from May to June although anchovies (Engraulidae) showed a marked increase in June.

Of the pelagic families, Carangidae were less abundant at GI94B than at GC18 while Scombridae increased in abundance and diversity. The latter family included bullet and/or frigate mackerel *Auxis*

Table 2E.1. Relative abundance (CPUE) of ichthyoplankton families collected from GC18, GI94B and ST54G during May and June using surface (S), bottom (B) and off-rig (O) light traps. The catch-per-unit-effort (CPUE) indicates the mean number of fish per 10 min set. Horizontal lines separate the four ecological groups (top to bottom): pelagic, reef, midwater, demersal.

Family	GC18						GI94B						ST54G					
	May			June			May			June			May			June		
	S	B	O	S	B	O	S	B	O	S	B	O	S	B	O	S	B	O
Atherinidae	—	—	—	—	—	—	—	—	—	—	—	—	—	—	—	0.67	—	—
Carangidae	0.20	—	0.10	1.35	0.15	3.25	0.40	—	0.05	0.2	0.28	0.83	0.25	—	0.07	0.72	—	—
Clupeidae	—	—	—	—	—	—	—	—	—	1.89	0.11	2.89	1.29	—	1.80	41.33	0.50	1.63
Coryphaenidae	—	—	—	—	—	—	—	—	0.05	—	—	—	—	—	—	—	—	51.97
Engraulidae	—	—	—	0.43	0.77	0.37	1.13	0.83	0.50	23.89	3.72	2.44	19.76	1.42	4.21	12.17	0.67	10.89
Exocoetidae	—	—	0.10	—	—	0.12	0.02	—	—	—	—	—	—	—	0.05	—	—	0.33
Mugilidae	—	—	—	—	—	—	0.05	—	0.15	—	0.06	—	0.03	—	0.13	—	—	—
Sciaenidae	—	—	—	—	—	—	—	—	—	—	—	—	0.78	0.37	0.84	0.06	—	0.28
Scombridae	0.60	—	0.30	3.07	0.15	0.37	4.42	—	1.31	2.44	0.11	12.06	0.25	—	1.63	0.28	—	4.60
Stromateidae	—	—	—	—	0.07	—	0.10	0.08	0.11	—	—	—	0.22	0.25	0.14	0.17	—	0.60
Blenniidae	—	—	—	—	0.36	—	61.27	1.75	14.94	0.35	—	14.11	0.38	0.08	0.21	3.28	0.17	4.50
Gerridae	—	—	—	0.14	—	1.00	0.02	—	—	—	—	0.06	—	—	—	—	—	0.07
Gobiidae	—	—	—	—	0.07	—	0.10	0.16	0.03	—	0.61	—	0.17	0.08	0.39	0.06	0.08	0.12
Holocentridae	—	—	0.10	0.50	—	0.87	—	—	0.03	—	—	—	—	—	—	—	—	—
Labridae	—	—	—	—	—	—	0.03	—	—	—	—	—	—	—	—	—	—	—
Lutjanidae	—	—	0.10	0.07	—	—	0.29	—	—	0.06	0.11	0.06	—	—	—	—	0.08	0.06
Muraenidae	—	—	—	—	—	0.12	—	—	—	—	—	—	—	—	—	—	—	—
Pomacentridae	—	—	0.10	—	—	0.12	1.82	—	1.31	0.11	0.11	0.44	—	—	—	—	—	0.47
Priacanthidae	—	—	—	0.07	—	—	—	—	—	—	—	—	—	—	—	—	—	0.07
Serranidae	0.20	—	0.10	0.07	—	—	0.28	—	—	—	—	—	—	—	—	0.06	—	—
Sparidae	—	—	—	—	—	—	0.05	—	—	—	—	—	—	—	—	—	—	—
Sphyraenidae	—	—	—	—	—	—	0.05	—	—	—	—	—	—	—	—	0.06	—	—
Tetraodontidae	—	—	—	—	—	—	0.03	—	—	—	—	—	0.03	—	—	0.22	—	1.39
Myctophidae	0.40	—	0.20	—	—	0.12	0.15	0.08	0.11	—	—	—	—	—	—	—	—	—
Paralepididae	—	—	—	—	—	—	—	—	—	—	0.17	—	—	—	—	—	—	—
Bothidae	—	—	0.10	—	—	—	0.02	0.08	0.27	—	—	—	0.03	—	0.13	0.17	—	0.52

(continued on next page)

Family	GC18						G194B						SI54G					
	May			June			May			June			May			June		
	S	B	O	S	B	O	S	B	O	S	B	O	S	B	O	S	B	O
Bregmacerotidae	—	0.20	—	—	—	—	0.11	0.42	0.05	0.12	0.33	—	0.06	0.18	0.20	—	—	—
Cynoglossidae	—	—	—	—	—	—	0.02	—	—	—	—	—	0.03	—	0.10	—	—	0.33
Microdesmidae	—	—	—	—	—	—	0.02	—	0.02	—	—	—	—	—	—	—	—	—
Mullidae	—	—	—	—	—	0.12	0.05	—	1.75	—	—	0.11	—	—	—	—	—	—
Nettastomidae	—	—	—	—	—	—	0.05	—	—	—	—	—	—	—	—	—	—	—
Ophichthidae	—	—	—	—	—	—	—	—	—	—	0.17	—	—	—	—	—	—	0.06
Ophidiidae	—	—	—	—	—	—	0.05	—	—	—	—	—	—	0.17	0.04	0.06	—	—
Opisthognathidae	—	—	—	—	—	—	2.22	—	0.11	—	—	—	—	—	—	—	—	—
Scorpaenidae	—	—	—	—	—	—	0.05	—	—	—	—	—	0.06	—	0.04	—	—	—
Soleidae	—	—	—	—	—	—	—	—	—	—	—	—	0.03	—	—	—	—	—
Synodontidae	—	—	—	0.27	—	—	42.27	0.42	3.95	6.22	3.56	7.28	6.68	11.83	0.23	0.83	—	0.50
Trichiuridae	—	—	—	—	—	—	0.05	—	—	—	0.28	—	0.03	0.43	—	—	—	—
Triglidae	—	—	—	—	—	—	—	—	—	—	—	—	0.03	—	0.07	—	—	—
Unidentified	—	0.40	—	—	0.07	—	0.65	0.33	0.08	—	—	—	—	—	0.07	—	—	—

spp., little tunny *E. alletteratus*, skipjack tuna *Katsuwonus pelamis*, king mackerel *Scomberomorus cavalla*, Spanish mackerel *S. maculatus*, and tuna *Thunnus* sp. Both Engraulidae: striped and/or longnose anchovy *Anchoa hepsetus/nasuta* and silver anchovy *Engraulis eurystole*; and Clupeidae: scaled sardine *Harengula jaguana* and Atlantic thread herring *Opisthonema oglinum*, were abundant in the pelagic assemblage.

Eleven reef-associated families were present, including Blenniidae (the most abundant family): feather blenny *Hypsoblennius hentz*, tessellated blenny *H. invemar*, seaweed blenny *Parablennius marmoratus*, and molly miller *Scartella cristata*; Gerreidae: *Eucinostomus* sp.; Gobiidae; Holocentridae: *Holocentrus* sp.; Labridae; Lutjanidae: red snapper *Lutjanus campechanus* and vermilion snapper *Rhomboplites aurorubens*; Pomacentridae (2nd most abundant reef-associated family): sergeant major *Abudefduf saxatilis*, night sergeant *A. taurus*, *Chromis* sp. and damselfish *Pomacentrus* sp.; Serranidae: yellowfin bass *A. nicholsi*, grouper *Epinephalus* spp., red barbier *Hemanthias vivanus*, longtail bass *H. leptus*, *Pronotogrammus martinicensis*, *Serranus/Diplectrum/Centropristis* complex and harlequin bass *Serranus tigrinus*; Sparidae: *Calamus* sp.; Sphyraenidae: northern sennet *Sphyraena borealis*; and Tetraodontidae: puffers *Sphaeroides* sp. Adult great barracuda *Sphyraena barracuda* were abundant at this platform, however, we did not collect any larvae or juveniles of this species, as was the case at GC18.

Demersal/benthic fishes were predominantly lizardfish (Synodontidae and Harpodontidae) including the inshore lizardfish *Synodus foetens*, offshore lizardfish *S. poeyi*, and snakefish *Trachinocephalus myops*.

#### ST54G

Coastal species dominated the fish assemblage collected from this inshore platform. Abundances were comparable during May and June with a modest increase in species richness during June (Table 2E.1).

Within the coastal pelagic assemblage, Clupeidae: scaled sardine *Harengula jaguana* and Atlantic thread herring *Opisthonema oglinum*; and Engraulidae: striped or longnose anchovy *Anchoa hepsetus/nasuta* and *Anchoviella/Engraulis* were most common. The scombrids: *Auxis* sp., little tunny *Euthynnus alletteratus*, king mackerel *Scomberomorus cavalla* and Spanish mackerel *S. maculatus* were also common.

Reef associates at this platform were essentially a subset of the assemblage found at GI94B. Blenniidae were most common and were the same species found at midshelf. Demersal taxa were abundant and this group included the soles (Soleidae) and searobins (Triglidae)—families which were not collected in light traps from GI94B or GC18. Lizardfishes were also very abundant at this platform consisting predominantly of the inshore lizardfish *Synodus foetens*.

#### Influence of Lunar Phase on Catch Per Unit Effort (CPUE)

Our regular sampling program was conducted on new and full moons which have been reported to be associated with important recruitment pulses of reef-fishes. When all taxa were combined, there

was no apparent lunar effect on the surface light trap catches and only a slight increase in CPUE for the off-rig light trap during the new moon (Figure 2E.2). Based on our current evaluation of samples collected on quarter moons at GI94B, lunar recruitment periodicity appears to vary among taxa. Although we could not obtain a complete sequence of samples spanning two consecutive full moon, our data suggest higher catches of some species such as the blennies *Hypsoblennius invemar* and *H. hentz/ionthas*, towards the full moon (Figure 2E.2). The inshore lizardfish *Synodus poeyi* shows pulses on the first and last quarters while the offshore lizardfish *S. poeyi* was similarly abundant on both quarters and the new moon (Figure 2E.2). Larvae of the bullet or frigate mackerels *Auxis* spp. were most abundant on the new moon during May, while catches of the little tunny *Euthynnus alletteratus* appear to increase towards the first quarter, suggesting that it may peak at the full moon (Figure 2E.2).

#### Size-Frequency Differences Among Surface and Off-Rig Samples

The length frequencies of fish larvae and juveniles collected by surface light trap samples directly beneath the platform were contrasted with lengths from surface off-rig samples that had drifted at least 25m downstream from the platforms prior to light trap activation. Results suggest that for some taxa such as the scombrids *Auxis* sp. and *Scomberomorus maculatus*, larger individuals were present

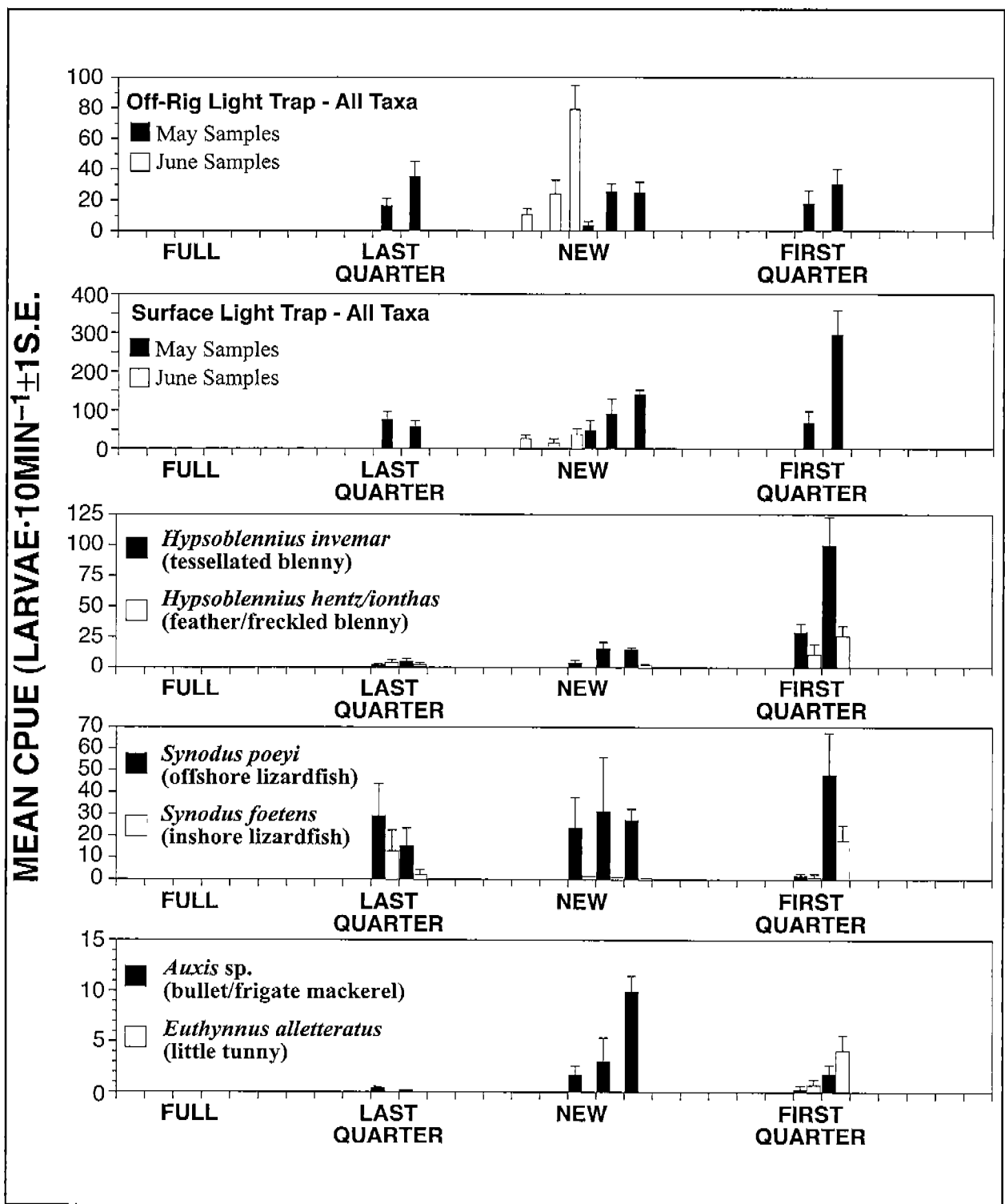

Figure 2E.2. Influence of lunar phase on catch-per-unit-effort (CPUE) of all taxa combined from off-rig and surface light traps (upper two panels), and for selected taxa from surface light trap samples collected at GI94B during May 1996. Lunar icons indicate the moon phase corresponding to each sample.

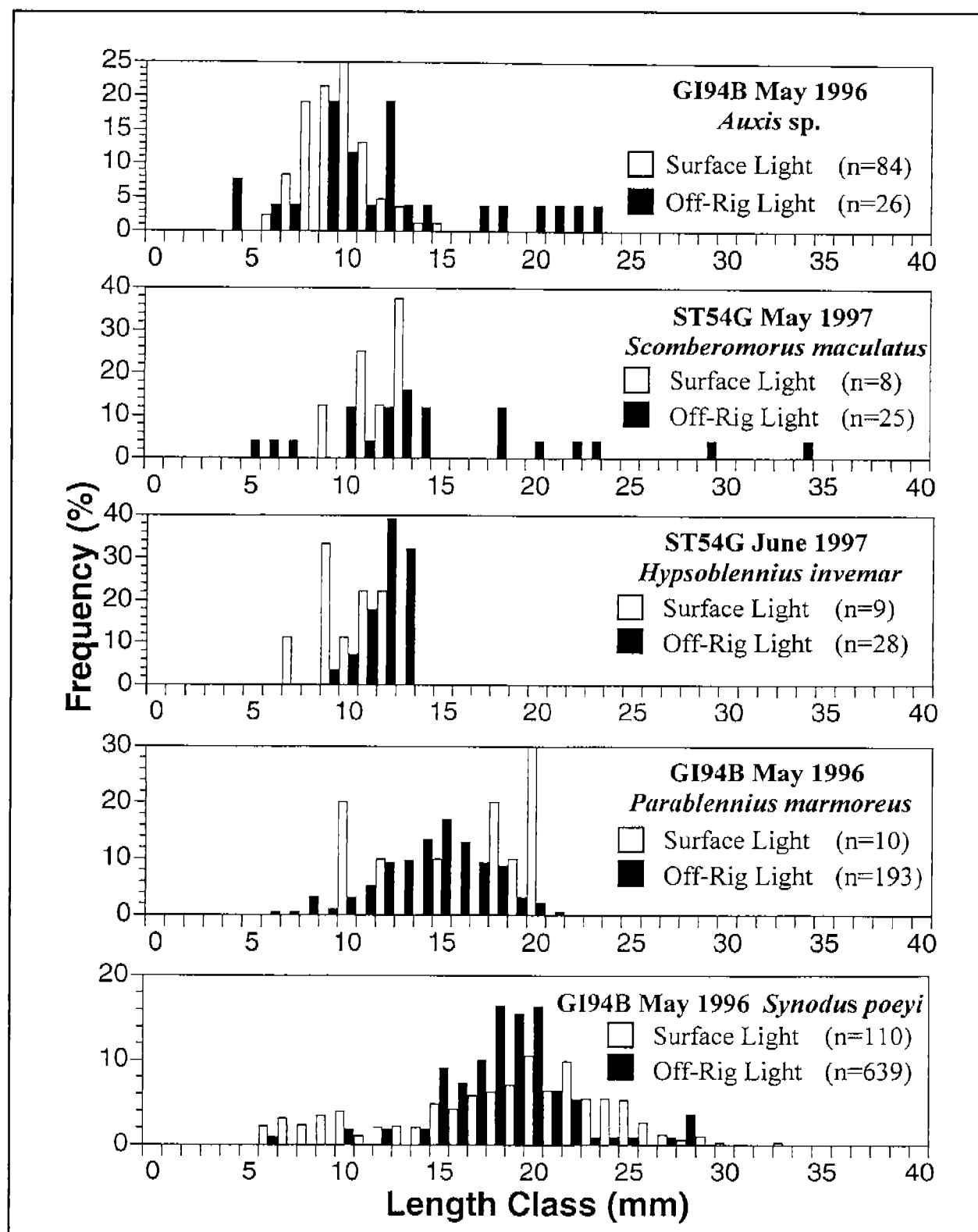

Figure 2E.3. Length frequency distributions of selected taxa collected from surface light traps and surface off-rig light traps.

in the off-rig samples than the beneath-rig surface light trap samples (Figure 2E.3). In contrast, other species, including two blennies (*Parablennius marmoratus* and *Hypsoblennius invemar*) and the offshore lizardfish *Synodus poeyi* showed similar size distributions beneath and downstream from the platforms (Figure 2E.3).

## DISCUSSION

The larvae of reef and non-reef associated fishes were clearly associated with petroleum platforms. The larval/juvenile fish assemblages collected by light traps at the three platforms were largely representative of the hydrographic regimes and geographic locations of each site. While reef-associated taxa were present at all sites, the relatively low abundances at GC18 were probably due to a combination of depth, distance from other natural/artificial reefs and oligotrophic water. The close proximity of ST54G to the coast and its almost constant exposure to the low salinities and high turbidities of the Mississippi River plume may have created conditions that were generally unfavorable for most reef-associated taxa. In contrast, the intermediate location and depth of GI94B, combined with the abundance of surrounding platforms and infrequent influence by the Mississippi River may have created conditions that were more favorable for reef-dwelling taxa.

Light traps are only effective for photopositive taxa. The species composition of the plankton net samples examined to date indicates a broader range of taxa, many of which were not present in light traps. Conversely, light traps contained some taxa which were not well represented in nets. In general, light traps captured larger individuals which would have actively avoided the passively-fished nets. These results suggest that both types of gear are important in obtaining an overview of the ichthyoplankton assemblage.

Our new/full moon sampling strategy appears sound and our data suggest that a shift to quarter moons would not provide a substantially different picture of the ichthyoplankton assemblages. Additional data from other months and gear (nets) is currently being evaluated to determine whether new or full moons provide a superior picture of species composition.

The abundant schools of blue runner *Caranx crysos*, little tunny *Euthynnus alletteratus*, bluefish *Pomatomix saltatrix* and other pelagic and demersal predators around platforms are an indication that predation pressure on new recruits is probably high. During our investigations we frequently observed predatory fish foraging beneath the platform and actively feeding in the artificial light plumes of the platforms. One interpretation of the size frequency distribution data is that for some species, larger individuals are subjected to intense predation pressure beneath the platform. The cover created by the fouling community on the platform casing may provide certain species with a refuge from these mobile predators.

The results presented in this report must be considered preliminary. Our field collections resulted in a large quantity of samples from the three platforms: GC18 (~500), GI94B (~850) and ST54G (~300). These data are being processed and analyzed. While this report reflects a relatively small subset of the entire data set, it does provide a unique insight (and to our knowledge, the first comprehensive investigation) into the complexity of the ichthyoplankton fauna of petroleum platforms.

## REFERENCES

Galloway, B.J. and G.S. Lewbel. 1982. The ecology of petroleum platforms in the northwestern Gulf of Mexico: a community profile. U.S. Fish and Wildl. Serv., FWS/OBS-82-27. XIV+92pp.

Scarborough-Bull, A. 1989. Some comparisons between communities beneath petroleum platforms off California and the Gulf of Mexico. *In* V.C. Reggio, Jr. (ed.), *Petroleum structures as artificial reefs: a compendium*, pp. 47-50. 4th Intl. Conf. Artificial Habitats Fish. Rigs-to-Reefs Spec. Sess., 4 Nov. 1987, Miami, FL., U.S. Dept. Interior, Minerals Mgmt. Serv., Gulf of Mex. OCS Regional Office.

---

James Ditty is a Research Associate IV in the Coastal Fisheries Institute at LSU and Ph.D. candidate in the Department of Oceanography and Coastal Sciences. He received his B.S. from Marshall University's Department of Zoology in 1977 and his M.S. from LSU's Forestry, Wildlife and Fisheries Department in 1981. He has been conducting ichthyoplankton research in the northern Gulf of Mexico for 19 years.

Dr. Mark Benfield is a Research Associate V in the Coastal Fisheries Institute and a guest investigator at the Woods Hole Oceanographic Institution. He received his B.Sc. in biology from the University of Toronto in 1980, his M.Sc. from the University of Natal (Durban) in biological sciences in 1985 and his Ph.D. in wildlife and fisheries sciences from Texas A&M University in 1991. He was a Postdoctoral Investigator in the Biology Department at the Woods Hole Oceanographic Institution from 1993-1996. He has conducted research on shrimp and zooplankton on the Indian Ocean coast, Gulf of Mexico and NW Atlantic Ocean.

Dr. Richard F. Shaw is the Director of the Coastal Fisheries Institute and a professor in the Department of Oceanography and Coastal Sciences at LSU. He received his B.A. in biology from Merrimack College in 1973 and his Ph.D. in oceanography from the University of Maine in 1981. He has been conducting ichthyoplankton research in the northern Gulf of Mexico for over 16 years and is the senior principal investigator on this MMS-funded project.

Talat Farooqi has a M.S. in marine biology and a M.Phil. in marine biology/ichthyology, both from the University of Karachi. She has been involved in Gulf ichthyoplankton/zooplankton identification for 13 years.

Joseph Cope received an M.S. in marine biology from the University of Delaware in 1991. He is presently an M.S. candidate at LSU's Department of Applied Statistics. Mr. Cope has been working on ichthyoplankton/zooplankton research in the Gulf of Mexico for 6 years and currently heads the field component of an MMS-funded investigation on the habitat value of man-made rock jetties for larval/juvenile fishes on the Louisiana coast.



**VARIATION IN THE DENSITY AND SPECIES COMPOSITION OF FISHES  
ASSOCIATED WITH THREE PETROLEUM PLATFORMS IN  
THE NORTHERN GULF OF MEXICO**

Dr. David R. Stanley  
Dr. Charles A. Wilson  
Coastal Fisheries Institute  
Louisiana State University

ABSTRACT

The 4,000 petroleum platforms in the northern Gulf of Mexico had a significant impact on the marine community in the region and constitute the world's largest artificial reef system. They vary in depth from a few meters to over 400 m and range geographically throughout the northern Gulf of Mexico.

Despite the number and ubiquitous placement of these structures little information existed on associated fisheries resources due to difficulties in sampling petroleum platforms with traditional fisheries methods. Hydroacoustics enabled researchers to accurately assess the fisheries resources associated with these structures. From 1994 to 1996 dual beam hydroacoustics were employed on quarterly research trips to measure the density and *in situ* target strengths of fishes associated with petroleum platforms in 20, 60 and 219 m of water. Species identification was provided by visual point counts using a remotely operated underwater vehicle. Density varied significantly with platform, distance from the platform, depth, platform side and time of the year. Platforms on the continental shelf had a near field area of influence of approximately 18 m while near field area of influence for the site on the continental slope was 10 m, but the relationship was not as well defined as other sites. Average estimated abundance and 95% confidence intervals over the study period was 26,347 (+/-3,636) at the 60 m site, 13,444 (+/- 4578) at the 20 m site and 11,224 (+/- 2618) at the 219 m site. Fishes were distributed throughout the water column at the sites on the continental shelf while at the 219 m site over 88% of the fishes were found in the upper 60 m.

INTRODUCTION

The largest artificial reef complex in the world, although unplanned, is composed of the 4,000 petroleum platforms on the outer continental shelf (OCS) of the northern Gulf of Mexico (GOM). Scientists have hypothesized that artificial reefs and platforms improve and/or diversify habitat, increase resources, modify the assemblages of organisms in the region or concentrate existing resources. Although little information is available, the placement of these defacto reefs has undoubtedly had an impact on the regional marine community. Only recently have assessment methods been developed to test these and other hypotheses concerning artificial reefs.

Since the first petroleum platform was placed off the Louisiana coast in 1948, these structures have been the preferred destination of commercial and recreational anglers. Past research has found that

platforms were the destination of 70% of all recreational angling trips in the Exclusive Economic Zone (more than 4.8 km from shore) (Reggio 1987) and 37% of all saltwater recreational angling trips off the Louisiana coast (Witzig 1986). The catch at these sites is estimated to constitute 30% of the recreational fisheries catch for the region (Avanti 1991). Results from a logbook program documented that 48 species were commonly caught and that catch rates of the target species, spotted seatrout (*Cynoscion nebulosus*) and red snapper (*Lutjanus campechanus*), averaged over two fish/angler hour (Stanley and Wilson 1991). High documented catch rates and the popularity with user groups in the region make platforms an important component in the regions fisheries. Despite the number of sites, the time the structures have been present and their importance to the regions' fisheries, little information exists on the assemblage of fishes associated with these petroleum platforms.

Research at petroleum platforms did not occur until the late 1970s. This research consisted of visual surveys conducted by SCUBA divers, remotely operated underwater vehicles (ROVs) and stationary cameras; most of these projects were short term, often only a "snapshot" of the fishes at each site (Sonnier *et al.* 1976; Gallaway *et al.* 1981; Continental Shelf Associates 1982; Gallaway and Lewbel 1982; Putt 1982). Results of this early research provided insights into the structures associated assemblages as abundance and species composition varied with platform, water depth and time of the year. However, results were difficult to compare due to problems with limited visibility, gear bias, diver avoidance and lack of standardized survey methodology. Although visual surveys are the method of choice for surveying natural and artificial reefs (Bortone and Kimmel 1991), the presence of SCUBA divers can bias the density and possibly the species composition of fishes at the site (Sale and Douglas 1981; Brock 1982; Bohnsack and Bannerot 1986; Stanley and Wilson 1995).

In response to the difficulty in assessing the fisheries resources associated with petroleum platforms and the biases inherent with visual only surveys, Gerlotto *et al.* (1989) demonstrated that towed hydroacoustics could be used to measure fish density near petroleum platforms off Cameroon. We later utilized complementary sampling methods of visual surveys and quantitative hydroacoustic surveys to document the assemblage of fishes associated with petroleum platforms in the northern Gulf of Mexico (Stanley and Wilson 1995; 1996; 1997; Wilson and Stanley 1991).

Despite the range of methodologies, investigators found that fish abundance and species composition change dramatically with proximity to platform, location, and time of year (Sonnier *et al.* 1976; Continental Shelf Associates 1982; Putt 1982; Gallaway and Lewbel 1982; Stanley and Wilson 1996; 1997). Gerlotto *et al.* (1989) found that fish densities were 5 to 50 times higher immediately adjacent to a platform than 50 m away. Stanley and Wilson (1996; 1997) reported the near field area of influence of a platform on the continental shelf (water depth 25 m) to be 16 m away from the platform. Fish densities within 16 m were 3 to 25 times higher than greater distances and that densities observed at distances greater than 30 m fish densities were comparable to background levels of the open waters of the northern GOM. Long-term studies reported that fish populations at petroleum platforms were highly variable over time. Putt (1982) observed fluctuations of a factor of two from month to month. While Stanley and Wilson (1996; 1997) reported that monthly and seasonal abundances change by up to a factor of five. Results from previous studies of the fishes associated with platforms have been informative but difficult to compare due to differences in site location and study timing.

In an effort to derive comparative data, the objectives of this research were to use dual beam hydroacoustics in conjunction with visual point count surveys to measure the density of fishes associated with three petroleum platforms off the Louisiana coast. The goals of the research were to determine the effect of water depth on fish density and species composition and ultimately measure the fisheries value of platforms of different depths in the same geographical region.

## METHODS

### Site Description

Research trips were conducted quarterly (August 1994 to March 1995) to petroleum platforms Grand Isle 94 (GI94) (located at 28°31.33 N and 90°05.52 W, water depth 60 m, installed 1975) and Green Canyon 18 (GC18) (located 27°56.48' N and 91°02.28' W, water depth 219 m, installed in 1988) operated by Mobil USA Inc. and quarterly (August 1995 and January 1996) to Exxon USA Inc.'s platform South Timbalier 54 G (ST54) (located 28°50.01'N and 90°22.40' W, water depth 22m, installed 1956).

Three arrays of stationary dual beam hydroacoustic equipment developed through our past research were used to determine the density of fishes associated with the study sites (Wilson and Stanley 1991; Stanley and Wilson 1995; 1996; 1997). Arrays 1 and 2 (Figure 2E.4) were designed to measure *in situ* target strength distribution and density of fishes immediately adjacent to each side of the platform. Array 1 consisted of four upward oriented transducers (120 kHz) suspended approximately 25 m below the surface (at ST 54 they were placed on the bottom), one on each side of the platform. The upward facing transducers provided acoustic coverage from the surface to a depth of 10-15 m (Figure 2E.4). Array 2 consisted of four downward oriented transducers (120 kHz) placed approximately 3 m below the surface, one on each side of the platform. The downward facing transducers provided acoustic coverage from a depth of 10 m to 1 - 5 m from the substrate depending on the site. The use of four transducers (both upward and downward orientations) enables the calculation of density throughout the water column and on all sides of the platform.

Array 3 was designed to estimate the near field density of fishes associated with the structure and consisted of four horizontally aligned dual beam transducers (120 kHz) deployed off each side of the platform at depth of 12 m (Figure 2E.5). This arrangement enables near field density estimates to a distance of approximately 80 m from the platform. The total number of fishes associated with the platform can then be calculated using density estimates from Arrays 1 and 2 and the near field distance estimates from Array 3.

Horizontal and vertical acoustic sampling was conducted over three consecutive 24-hour intervals for each month's sampling trip; two hours of hydroacoustic data were collected encompassing four periods (dawn, noon, dusk and midnight) over each 24-hour interval. Hydroacoustic data were collected sequentially from each of the transducers in five-minute intervals for each trip.

Acoustic data were collected using a Biosonics model ES2000 scientific echosounder/multiplexer-equalizer. The source levels ranged from 218.5 to 220.5 dB re  $\mu$ Pa at 1 m depending on the

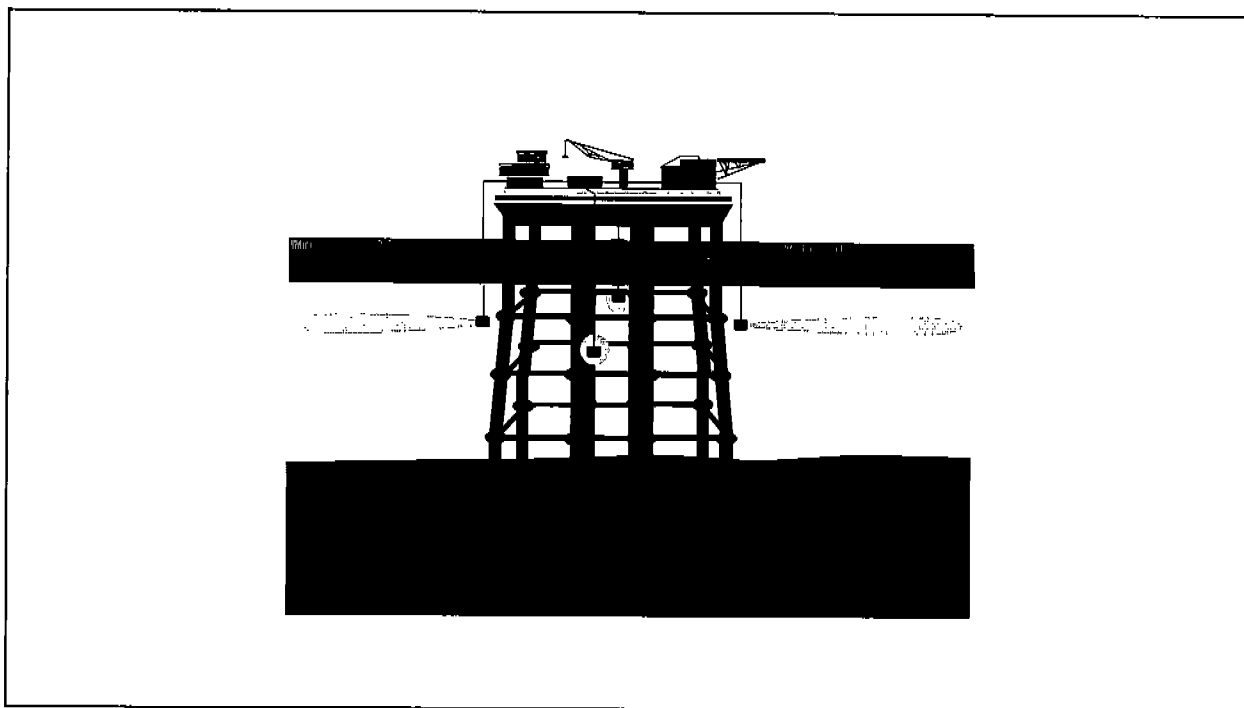

Figure 2E.4. Schematic view of stationary hydroacoustic transducer deployment to measure horizontal relative density of fishes associated with petroleum platforms.

transducer. The 20 log R system gains ranged from -156.4 to -146.8 dB re V  $\mu$ Pa and the 40 log R system gains ranged from -168.9 to -165.8 dB re V  $\mu$ Pa varying with transducer. Sampling rate ranged from 2 s<sup>-1</sup> to 10 s<sup>-1</sup> depending on array and sampling depth. Pulse width was 0.4 ms. Received signals were adjusted for spreading loss by applying a 40 log R time varied gain, digitized and recorded on digital audio tape (DAT). Reference voltages (approximately 5 V AC) were recorded on each DAT tape and used to calibrate the acoustic system prior to echo integration and target strength analyses. During data collection background noise levels were measured and did not exceed 40 mV. The voltage threshold used in later analyses was 100 mV corresponding to a minimum detectable target strength of -56 dB, or a fish of 2.5 cm total length, according to Love (1971).

Digitized hydroacoustic data were processed by a Biosonics model 281 dual-beam processor. Target strengths and an average backscattering cross section ( $\sigma$ ) for each depth strata were estimated using Biosonics TS software, and density estimates were calculated using Biosonics Crunch software with  $\sigma$  for each sample and depth strata. Fish densities were calculated for 5 to 20 m depth vertical intervals for Array 1 and 2 depending on site.

Visual point count surveys identifying individual fish to species were performed on each sampling expedition on the downcurrent side of the platform using a Hydrobotics Orpheus or Deep Ocean Engineering HD2 ROV. Visual surveys done with ROVs were recorded on videocassette and the point counts performed later. Species composition data from the visual point counts were then applied to the quantitative abundance estimates derived from the hydroacoustics data to estimate fish abundance by species.

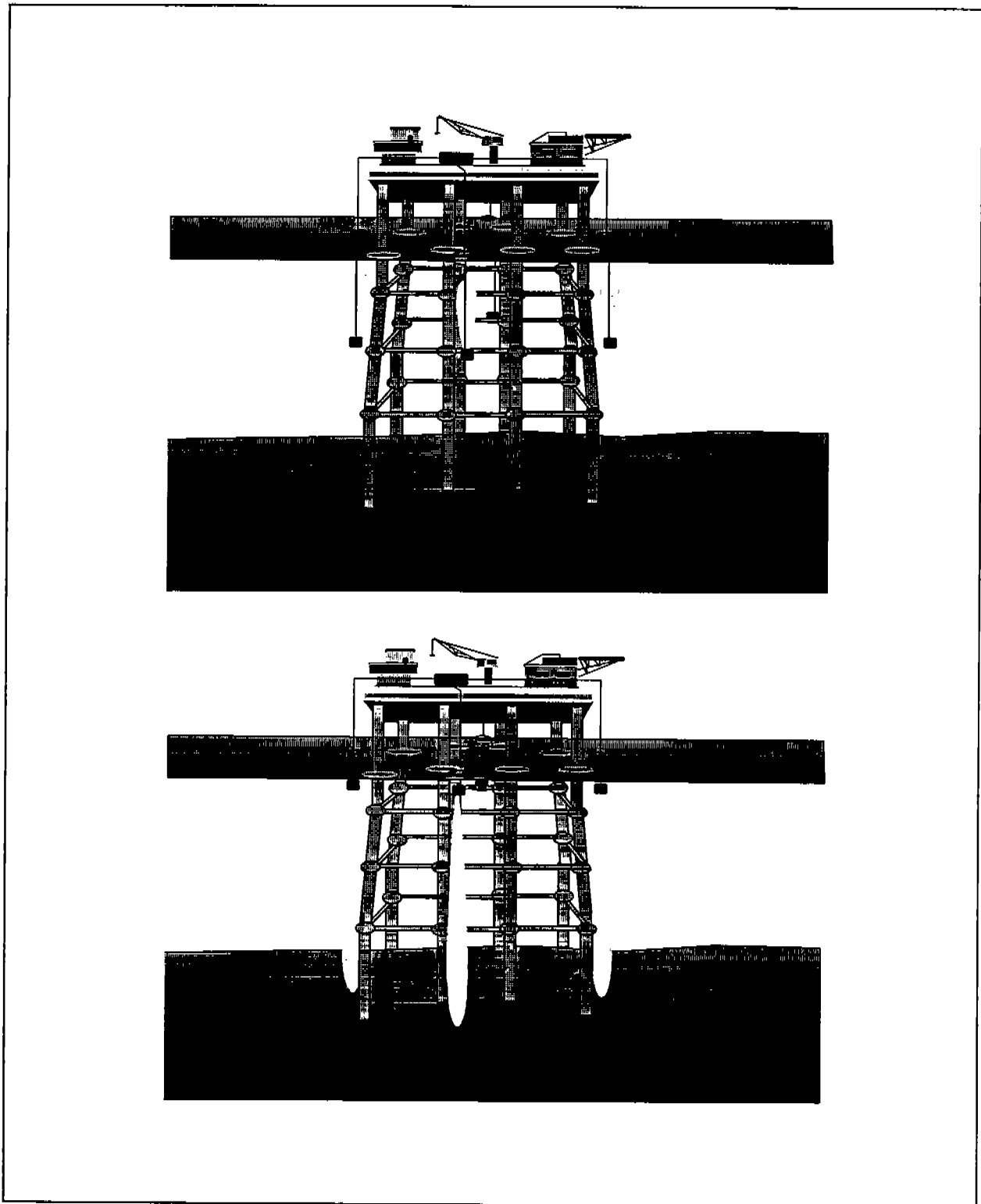

Figure 2E.5. Schematic view of stationary hydroacoustic transducer deployment to measure *in situ* target strength and density of fishes throughout the water column on each side of the platform for the three study sites.

## Data Analysis

Fish density data (number of fish·m<sup>-3</sup>) from echo integration analysis contained a large number of zero values, similar to catch data from traditional fisheries sampling techniques (Pennington 1983; 1985; Shaw *et al.* 1985; Stanley and Wilson 1995; 1996; 1997). Therefore, hydroacoustic density data were transformed by  $\log(\text{density} + 1)$  to approximate the normal distribution.

Separate randomized block ANOVAs (SAS Institute 1986) were performed with vertical and horizontal and  $\log(\text{density} + 1)$  of density data on depth, time of day (TOD), quarter and their interactions, blocking on side of the platform to examine differences due to these variables. Tukey's studentized range tests (Ott 1982) were used to compare the means of significant variables for vertical and horizontal analyses. Statistical tests were reported as significant at the  $\alpha \leq 0.01$  level.

The total abundance estimates at the platform were calculated by determining the near-field area of influence of the platform, then multiplying mean density values (number of fish·m<sup>-3</sup>) for each month and platform side by the volume of water on each side of the platform. Fish density in the center of the platform, not measured with acoustics due to interference by structural members, was assumed to be the average of the density estimates of the four sides of the platform. Fish abundance in the center of the platform was calculated by multiplying the estimated fish density of the center by the volume of water in the center of the platform.

## RESULTS

Dual beam hydroacoustics revealed several differences between the sites that added to our understanding of the function of platforms as artificial reefs. A significant near field area of influence was detected at all sites. GI94 and ST54 fish densities from 2-18 m were significantly greater than those from 18-80 m, while at GC18 a 10 m area of influence was documented as densities were significantly higher from 2-10 m than from 10-80 m (Table 2E.2, Figure 2E.6). For the purposes of describing an area of influence of the platform, we chose a cutoff where density dropped significantly therefore area of influence at GI94 and ST54 was 18 m and 10 m at GC18. Horizontal fish density varied between platforms, but was consistently higher adjacent to the platform (Figure 2E.6) and then dropped to densities typical of the open waters of the northern Gulf of Mexico after a distance of approximately 50 m based on acoustic transect surveys by Morgan (1996). The relationship between horizontal fish density and distance from the platform at GC18 was not clearly defined in comparison to sites on the continental shelf as density did decline with distance but the decline was not as rapid (Figure 2E.4). This is likely due to the change in species composition and water clarity between sites on the continental shelf and on the slope. Horizontal fish density also varied significantly with platform side, season, and time of day at GI94 and ST54 while at GC18 significant differences were noted only with time of the day (Table 2E.2).

Differences in vertical fish densities were observed throughout the study and at all sites. Significant differences were found in vertical fish densities between sides of the platform and depth at all of the sites; season at ST54 and GI94; season \* depth at ST54 and TOD \* depth at GC18 (Table 2E.3). The most dramatic differences in density observed were with respect to side of the platform and depth.

Table 2E.2. Randomized block analysis of variance of horizontal fish densities at Grand Isle 94, Green Canyon 18 and South Timbalier 54 petroleum platforms.

<b>Horizontal Fish Density Green Canyon 18</b>					
<b>Source</b>	<b>DF</b>	<b>SS</b>	<b>MS Square</b>	<b>F</b>	<b>Prob &gt; F</b>
Model	399	9.3624	0.0234	7.40	0.0001
Error	1960	6.2131	0.0031		
Total	2359	15.5756			
<b>Variables</b>	<b>DF</b>	<b>Type III SS</b>	<b>MS</b>	<b>F</b>	<b>Prob &gt; F</b>
Platform side	3	2.1530	0.7177	39.81	0.0001
Season	2	0.0253	0.0127	0.70	0.4959
Diel	3	0.7520	0.2417	13.41	0.0001
Distance	9	0.0884	0.0100	0.55	0.8409
Season*Diel	4	0.1833	0.0458	2.54	0.0399
Season * Distance	18	0.4898	0.0272	1.51	0.0850
Diel * Distance	27	0.2960	0.0109	0.61	0.9350
<b>Horizontal Fish Density Grand Isle 94</b>					
<b>Source</b>	<b>DF</b>	<b>SS</b>	<b>MS</b>	<b>F</b>	<b>Prob &gt; F</b>
Model	479	436.10	0.91	33.31	0.0001
Error	2300	62.86	0.03		
Total	2779	498.97			
<b>Variables</b>	<b>DF</b>	<b>Type III SS</b>	<b>MS</b>	<b>F</b>	<b>Prob &gt; F</b>
Platform side	3	28.74	9.58	27.77	0.0001
Season	2	143.51	71.76	207.95	0.0001
Diel	3	21.22	7.08	20.50	0.0001
Distance	9	21.85	2.43	7.04	0.0001
Season*Diel	4	40.82	6.80	19.71	0.0001
Season * Distance	18	38.638	2.15	6.22	0.0001
Diel * Distance	27	1.51	0.06	0.16	1.0000
<b>Horizontal Fish Density South Timbalier 54</b>					
<b>Source</b>	<b>DF</b>	<b>SS</b>	<b>MS</b>	<b>F</b>	<b>Prob &gt; F</b>
Model	189	89.23	0.47	11.75	0.0001
Error	766	25.43	0.04		
Total	955	114.66			
<b>Variables</b>	<b>DF</b>	<b>Type III SS</b>	<b>MS</b>	<b>F</b>	<b>Prob &gt; F</b>
Platform side	3	5.66	0.78	18.45	0.0001
Season	1	22.34	2.43	12.34	0.0001
Diel	3	13.44	1.22	6.77	0.0001
Distance	9	12.22	2.56	7.34	0.0001
Season*Diel	3	16.45	3.45	11.21	0.0001
Season * Distance	9	14.56	1.56	7.43	0.0001
Diel * Distance	27	1.45	0.89	0.22	0.987

Table 2E.3. Randomized block analysis of variance of vertical fish densities at Grand Isle 94, Green Canyon 18 and South Timbalier 54 petroleum platforms.

Vertical Fish Density Green Canyon 18					
Source	DF	SS	MS	F	Prob > F
Model	479	40.749	0.085	2.98	0.0001
Error	2658	75.847	0.029		
Total	3137	116.596			
Variables	DF	Type III SS	MS	F	Prob > F
Platform side	3	0.584	0.194	3.48	0.0161
Season	2	0.356	0.178	3.19	0.0424
Diel	3	0.409	0.136	2.44	0.0643
Depth	9	11.345	1.261	22.56	0.0001
Season*Diel	4	0.182	0.030	0.54	0.7747
Season * Depth	18	1.590	0.089	1.59	0.0605
Diel * Depth	27	3.540	0.131	2.35	0.0002
Vertical Fish Density Grand Isle 94					
Source	DF	SS	MS	F	Prob > F
Model	502	100.742	0.200	33.99	0.0001
Error	2553	15.074	0.006		
Total	3055	115.817			
Variables	DF	Type III SS	MS	F	Prob > F
Platform side	3	19.894	6.631	73.39	0.0001
Season	2	26.299	13.149	145.53	0.0001
Diel	3	0.461	0.153	1.70	0.1667
Depth	9	3.282	0.298	3.30	0.0002
Season*Diel	4	0.392	0.065	0.72	0.6312
Season * Depth	18	11.243	0.562	6.22	0.0001
Diel * Depth	27	0.706	0.021	0.24	1.0000
Vertical Fish Density South Timbalier 54					
Source	DF	SS	MS	F	Prob > F
Model	167	56.78	0.34	21.52	0.0001
Error	852	13.34	0.016		
Total	1019	70.12			
Variables	DF	Type III SS	MS	F	Prob > F
Platform side	3	4.56	0.87	18.78	0.0001
Season	1	12.48	1.77	33.56	0.0001
Diel	3	0.58	0.98	0.65	0.7432
Depth	4	15.67	2.34	12.23	0.0001
Season*Diel	3	0.78	0.09	0.68	0.7712
Season * Depth	4	3.45	1.43	3.21	0.0034
Diel * Depth	12	0.98	0.07	0.61	0.6754



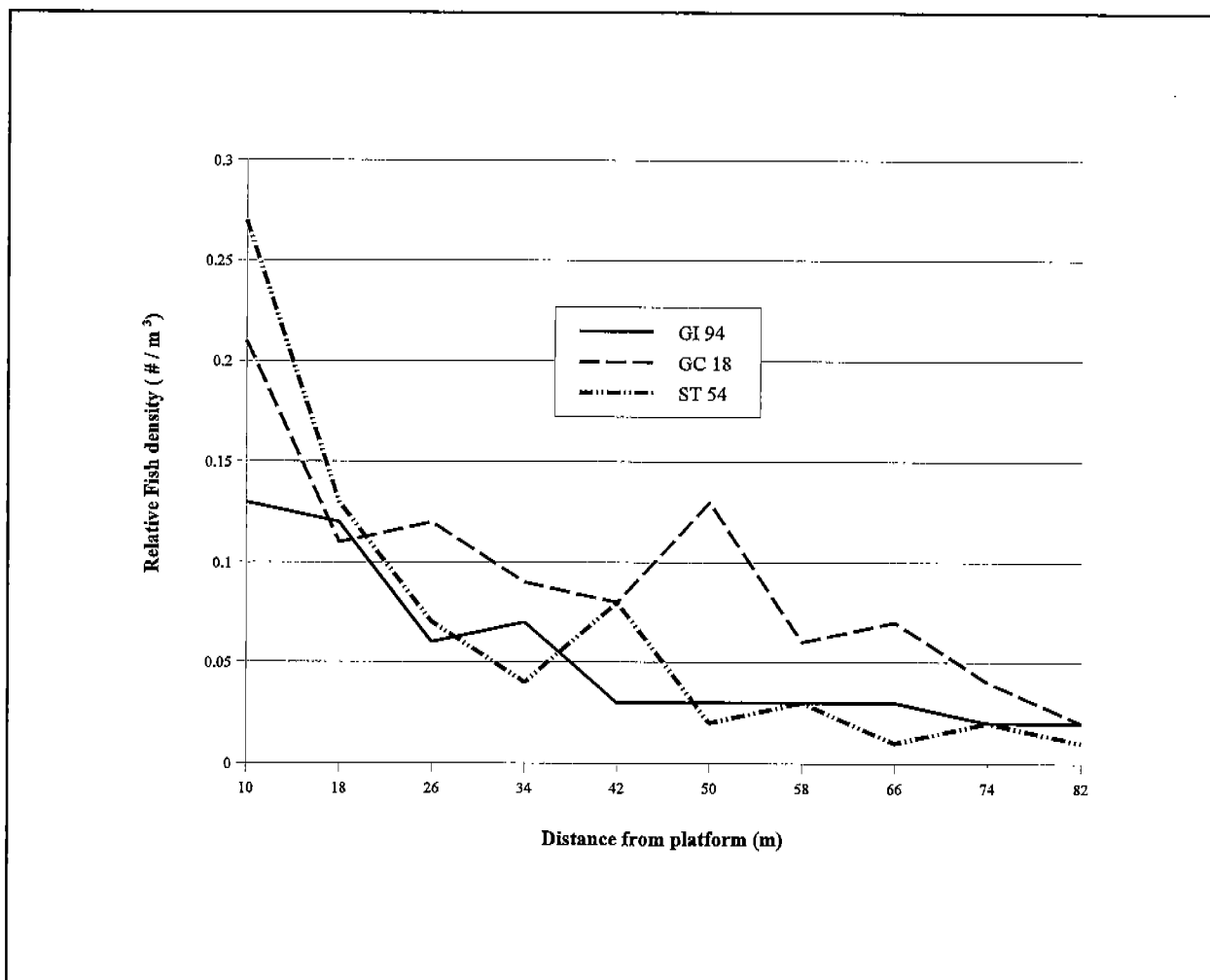

Figure 2E.6. Mean relative horizontal fish density to a distance of 82 m from petroleum platforms Green Canyon 18 (GC18), Grand Isle 94 (GI 94) and South Timbalier 54 (ST 54).

Fish density varied at each site from side to side although a consistent pattern was not observed at any of the sites. The greatest differences between sides were observed at GI94 and ST54 where fish density varied by up to a factor of 8 with side, reinforcing the importance of sampling on all sides of the platform to obtain accurate estimates of fish abundance at a site.

The most striking result of the study was the difference in fish density with depth between the three sites. The fish density at GI94 and ST54 fish density was fairly uniform throughout the water column, although significantly ( $P < 0.05$ ) higher densities were found immediately adjacent to the surface and the bottom (Figure 2E.7). However, at GC18 we observed a dramatic decrease in fish density with depth and below 100 m fish density was essentially zero (Figure 2E.8). Fish density at GC18 was significantly higher from 0 to 60 m 88% of the fishes found at the site were found above 60 m. Also densities varied with position as on the continental shelf, (GI94 and ST54) sites on the shelf had observed densities that were 4 to 8 times higher than GC18 which is on the continental slope.

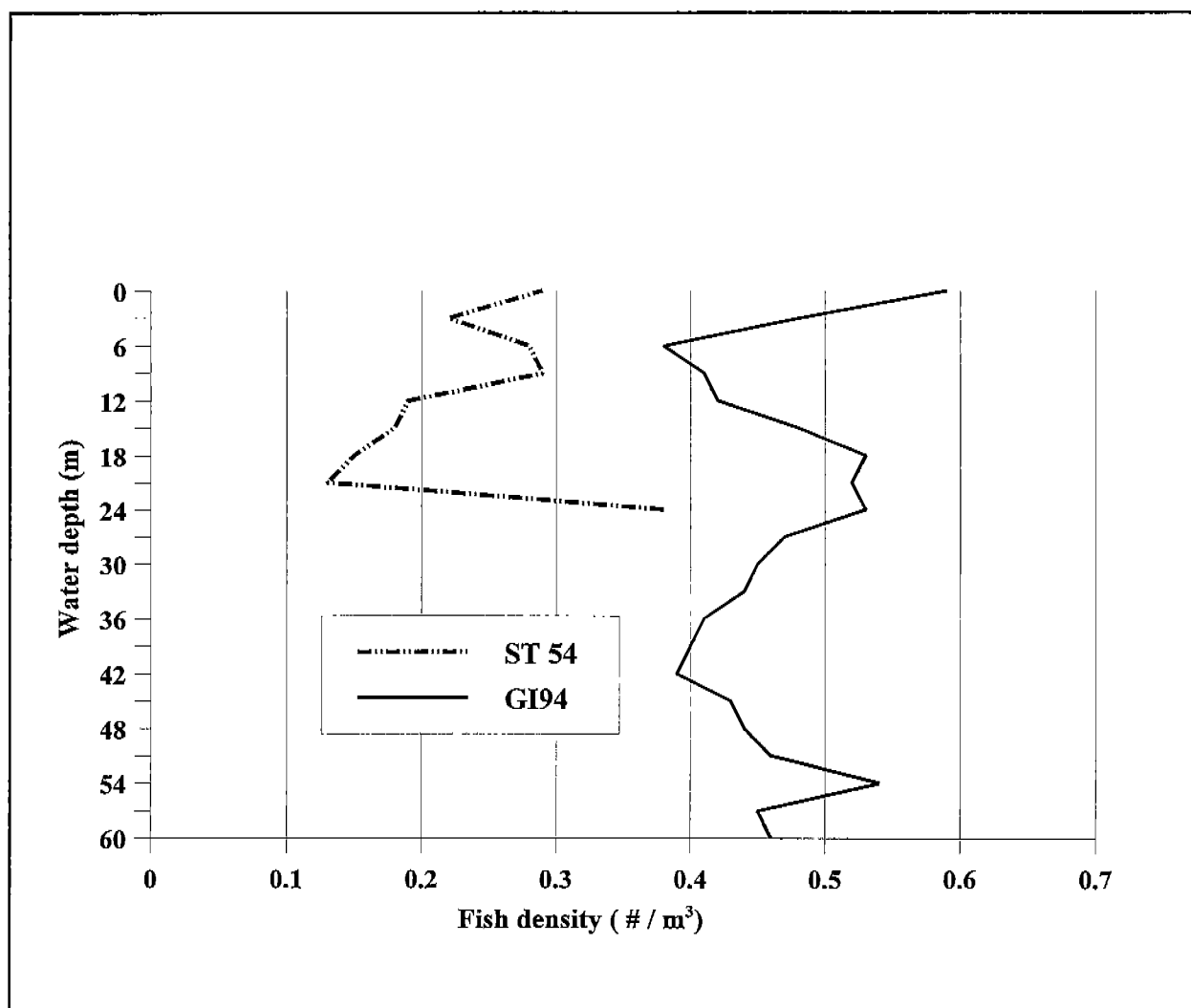

Figure 2E.7. Mean fish density by depth at petroleum platforms Grand Isle 94 (GI 94) and South Timablier 54 (ST 54).

Since the near field area of influence was defined and densities were known throughout the water column the total abundance of fishes associated with each platform was estimated. Average estimated abundance (with 95% CI) at each side over the study period was 26,347 ( $\pm 3636$ ) at GI94, 13,444 ( $\pm 4578$ ) at ST54 and 11,224 ( $\pm 2618$ ) at GC18.

Species composition varied with sites. Visual point count surveys detected 18 species at GI94, 14 at GC18 and 10 at ST54 (Table 2E.4). Despite the large number of fishes found at each site, 6-7 species constituted over 95% of all the fishes observed at each site (Table 2E.4). Species composition was dominated by a single species at each site with an individual species constituting over 40% of the observed fishes at a site (Table 2E.4). The dominant species changed with site and the most common species observed at each site included: Atlantic spadefish (*Chaetodipterus faber*) at ST54, blue runner (*Caranx crysos*) at GI94 and creole fish (*Paranthias furcifer*) at GC18 (Table 2E.4). The only fishes found at all three sites were blue runner and gray triggerfish (*Balistes*

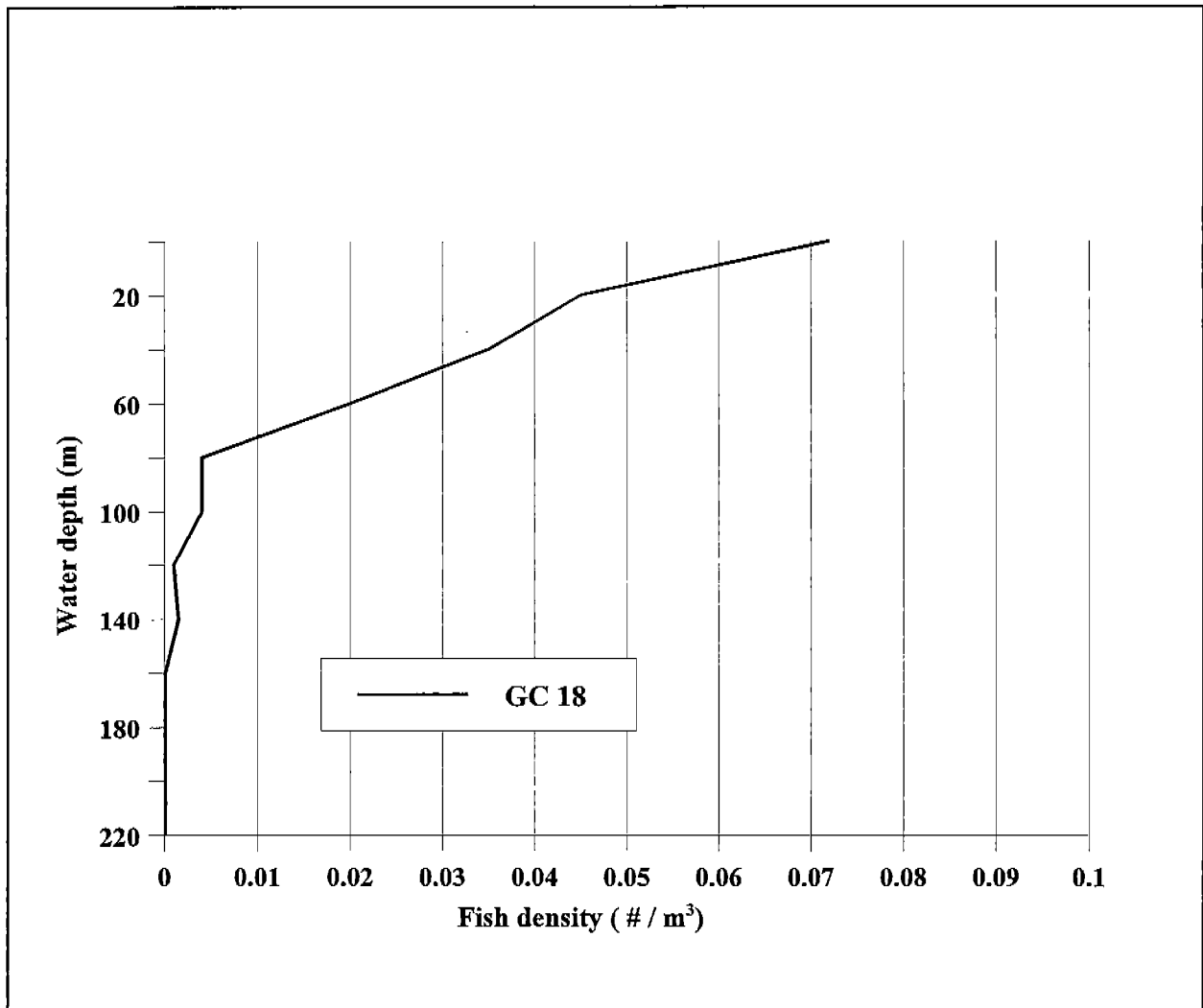

Figure 2E.8. Mean fish density by depth at the petroleum platform Green Canyon 18 (GC 18).

*capricus*) (Table 2E.4). The most common fishes observed by site were (in order of numerical dominance): Atlantic spadefish, red snapper (*Lutjanus campechanus*), blue runner, sheephead (*Archosargus probatocephalus*), blue fish (*Pomatomus saltatrix*), and gray snappers (*Lutjanus griseus*) at ST54; blue runner, red snapper, gray triggerfish, Bermuda chub (*Kyphosus sectatrix*), gray snapper, and scamp (*Mycteroperca phenax*) at GI94; creole fish, greater amberjack, almaco jack (*Seriola rivoliana*), blue runner, horse-eye jack (*Caranx latus*), and Bermuda chub at GC18 (Table 2E.4).

## DISCUSSION

This study continues to demonstrate the utility of merging hydroacoustics and visual survey techniques to study the assemblage of fishes associated with petroleum platforms with potential use at natural and other artificial reefs. The combination of these techniques allows for the measurement of the area of influence of these defacto artificial reefs, estimates of abundance and species composition throughout the water column and over long time periods. Our results reiterate the

Table 2E.4. Species composition of fishes from visual point surveys and estimated number of fish at South Timbalier 54, Grand Isle 94 and Green Canyon 18 petroleum platforms.

Species	South Timbalier 54 Percent Frequency (Estimated number)	Grand Isle 94 Percent Frequency (Estimated Number)	Green Canyon 18 Percent Frequency (Estimated Number)
Almaco jack	-	0.1 (28.7)	9.1 (1021.4)
Atl. Spadefish	39.6 (5323.8)	-	-
Bar jack	-	0.2 (57.5)	3.5 (392.8)
Barracuda	-	0.5 (143.7)	4.4 (493.9)
Bermuda chub	-	1.1 (316.1)	5.3 (594.8)
Black jack	-	-	0.9 (101.0)
Blackfin tuna	-	-	5.2(583.2)
Bluefish	8.1 (1088.9)	-	-
Blue runner	18.2 (2446.8)	86.6 (24883.4)	7.5 (1425.6)
Cobia	0.1 (13.4)	0.1 (28.7)	-
Creole fish	-	0.2 (57.5)	44.4 (4983.6)
Gray triggerfish	1.3 (174.7)	2.5 (718.3)	1.2 (134.2)
Greater amberjack	-	0.7 (201.1)	9.4 (1055.1)
Horse-eye jack	-	-	5.7 (639.8)
Jack crevalle	0.9 (120.9)	0.7 (201.1)	-
Lookdown	-	1.2 (344.8)	-
Mangrove snapper	2.9 (389.9)	0.9 (258.6)	-
Rainbow runner	-	0.1 (28.7)	0.2 (22.4)
Red snapper	19.2 (2642.3)	4.4 (1264.3)	-
Redfish	0.3 (40.3)	-	-
Scamp	-	0.7 (201.1)	1.1 (123.4)
Sheepshead	14.5 (1949.4)	-	-
Tarpon	0.1 (13.4)	-	-
Vermillion snapper	-	0.1 (28.7)	-
Yellowfin grouper	-	0.1 (28.7)	-
Yellowtail snapper	-	-	1.0 (112.2)
<b>Total</b>	<b>13,444</b>	<b>28,734</b>	<b>11,224</b>

variability in the abundance of fishes associated with petroleum platforms and artificial reefs observed in earlier studies. Our results are similar to those from platforms and artificial reefs in relatively shallow water as density changes with depth (Rooker *et al.* 1997; Shinn and Wickland 1989; Chang 1985), however no research has examined the density of fishes at deepwater artificial reefs. The results from GC 18, a site on the continental slope with a water depth of 219 m, revealed extremely low fish densities below 100 m. These findings have serious implications for artificial reef programs especially in the GOM, because if habitat is not maintained in the upper water column, then the structure's function as an artificial reef is questionable. In support of our conclusions previous research has shown that species richness in the Pacific is negatively connected with depth, (Stevens 1996) and bottom trawl data from the shelf break in the GOM (water depth > 110 m) documented the presence of 69 species however, low abundances of all species were common found and few reef dependent species were captured (Chittenden and Moore 1977).

Structure size has also shown to affect fish density; we observed a higher fish density at the mid-size platform, which is consistent with results from our earlier research (Stanley and Wilson 1991). Previous studies have shown fish abundance is directly correlated with reef size to a maximum reef volume of 4,000 m<sup>3</sup> (Ogawa *et al.* 1977) or 25,000 - 50,000 ft<sup>2</sup> (Rousenfell 1972). The size of the platform with the highest density and abundance in this study while larger in reef volume than the optima, due to the open construction of platforms, is comparable to the optimal surface area reported by Rousenfell (1972). The largest platform (GC 18) in this study while 3 to 10 times larger than the others in this research had the lowest densities and abundances observed and this anomaly is likely due to the location and water depth of the site.

Differences in species composition between the 3 sites of this study reinforce the "coastal, offshore and bluewater" fish assemblages at platforms described by Gallaway (1981) and Gallaway and Lewbel (1982). While there was some overlap between "adjacent" sites, there was little species overlap between all three as only 2 species gray triggerfish and blue runner were found at all sites, demonstrating the impact of depth, environmental and ecological factors on species assemblage at platforms. Depth would appear to be the most important factor in explaining the assemblage of fishes at a site as species composition from this research was similar to those of sites of similar depths by Sonnier *et al.* (1976), Gallaway (1981), Continental Shelf Associates (1982), Gallaway and Lewbel (1982), Stanley and Wilson (1996; 1997) and Rooker *et al.* (1997). The differences in species composition between this and earlier findings are likely due to variability in time and geography between this and earlier research (Continental Shelf Associates 1982; Gallaway and Lewbel 1982; Putt 1982; Scarborough-Bull and Kendall 1987; Stanley and Wilson 1996; 1997).

Hydroacoustics again illustrated its effectiveness in defining "area of influence" of the platform or the size of the artificial reef to the fish assemblage. As we defined it, the area of influence extended 10 - 18 m beyond the physical size of the platform varying with site. This is consistent with earlier research by Stanley and Wilson (1996, 1997) and Gerlotto *et al.* (1989). Additionally it would appear that the effect of platforms on fish abundance is localized as after a distance of 30 - 50 m fish density decreased to levels found in the open waters of the northern GOM by Morgan (1996).

This research confirms the variability of fish assemblages associated with petroleum platforms and reinforces the need to sample on each site and throughout the water column to obtain an accurate estimate of fish abundance. It also demonstrates the importance of petroleum platforms to the marine environment of the northern GOM as illustrated by the high abundance of fishes found at the sites. Despite the variance observed between sites 10,000 to 30,000 fishes were found at site at any one time and since over 1,500 platforms are found in similar water depths it is clear that these structures impact the fisheries of the region.

#### ACKNOWLEDGMENTS

The authors wish to thank Mobil USA Inc., Exxon Company USA, the Minerals Management Service, and the Louisiana Department of Wildlife and Fisheries for supporting this research program. We would especially like to thank the staff of the petroleum platforms South Timbalier 54, Grand Isle 94 and Green Canyon 18 for their help and tolerance throughout the research project.

#### REFERENCES

- Avanti Inc. 1991. Environmental assessment for the regulatory impact analysis of the offshore oil and gas extraction industry proposed effluent guidelines. Volume 1 - Modeled impacts. U.S. EPA Contract No. 68-C8-0015. 225 p.
- Bortone, S.A., and J.J. Kimmel. 1991. Environmental assessments and monitoring of artificial habitats, p. 177-236. *In* W. Seaman, Jr. and L.M. Sprague [ed.] *Artificial Habitats for Marine and Freshwater Fisheries*. Academic Press, New York, New York. 285 p.
- Bohnsack, J.A., and S.P. Bannerot. 1986. A stationary visual technique for quantitatively assessing community structure of coral reef fishes. NOAA Tech. Rep. NMFS 41:1-15.
- Brock, R.E. 1982. A critique of the visual census method for assessing coral reef fish populations. *Bull. Mar. Sci.* 32:269-276.
- Chang, K. 1985. Review of artificial reefs in Taiwan: emphasizing site selection and effectiveness. *Bull. Mar. Sci.* 37:143-150.
- Chittenden, M.E. Jr. and D. Moore. 1977. Composition of the ichthyofauna inhabiting the 110 m bathymetric contour of the Gulf of Mexico, Mississippi River to the Rio Grande. *N.E. Gulf Sci.* 1:106-114
- Continental Shelf Associates. 1982. Study of the effect of oil and gas activities on reef fish populations in Gulf of Mexico OCS area. OCS Report MMS 82-10. New Orleans, Louisiana. US DOI, MMS, Gulf of Mexico OCS Region.

- Gallaway, B.J., and G.S. Lewbel. 1982. The ecology of petroleum platforms in the northwestern Gulf of Mexico: A community profile. USFWS Office of Biology Services, Washington, D.C. FWS 10BS-82/27. Openfile report 82-03.
- Gallaway, B.J., L.R. Martin, R.L. Howard, G.S. Boland, and G.D. Dennis. 1981. Effects on artificial reef and demersal fish and macrocrustacean communities. Pp. 237-299 in B.S. Middleditch, (ed.). Environmental effects of offshore oil production: The Buccaneer gas and oil field study. Marine Science Volume 14. Plenum Press. New York, New York.
- Gerlotto, F., C. Bercy, and B. Bordeau. 1989. Echo integration survey around offshore oil extraction platforms off Cameroon: Observations of the repulsive effect on fish of some artificially emitted sounds. *Proceedings of the Institute of Acoustics* (19):79-88.
- Love, R.H. 1971. Dorsal aspect target strength of an individual fish. *J. Acoust. Soc. Am.* 62:1397-1403.
- Morgan, T.C. 1996. Hydroacoustic survey of fish distribution and abundance around an artificial reef and a standing platform in the northern Gulf of Mexico. M.Sc. Thesis. Louisiana State University. 26p.
- Ogawa, Y., Takeuchi, S. and Hatton, S. 1977. An estimate for the optimum size of artificial reefs. *Bull. Jpn. Soc. Fish. Oceanogr.* 30:39-45.
- Ott, L. 1982. An introduction to statistical methods and data analysis. 2<sup>nd</sup> edition. Duxbury Press. Boston, MA. 774 p.
- Pennington, M. 1983. Efficient estimators of abundance for fish and plankton. *Biometrics* 39:281-286.
- Pennington, M. 1985. Estimating the relative abundance of fish from a series of trawl surveys. *Biometrics* 41:197-202.
- Putt, Jr., R.E. 1982. A quantitative study of fish populations associated with a platform within Buccaneer oil field, northwestern Gulf of Mexico. M.Sc. Thesis. Texas A&M University. College Station, Texas.
- Reggio, V.C. Jr. 1987. Rigs-to-reefs: the use of obsolete petroleum structures as artificial reefs. OCS Report/MMS87-0015. New Orleans, LA. U.S. Department of Interior. Minerals Mgmt. Service. 17p.
- Rooker, J.R., Q.R. Dokken, C.V. Pattengill and G.J. Holt. 1997. Fish assemblages on artificial and natural reefs in the Flower Garden Banks National Marine Sanctuary. *Coral Reefs*. 16:83-92.
- Sale, P.F., and W.A. Douglas. 1981. Precision and accuracy of visual census technique for fish assemblages on coral patch reefs. *Env. Biol. Fish.* 6:333-339.

- SAS Institute Incorporated. 1986. SAS user's guide: Statistics. Version 6. SAS Institute. Cary, NC. 1290 p.
- Scarborough-Bull, A. and J.J. Kendall Jr. 1994. An indication of the process: Offshore platforms as artificial reefs in the Gulf of Mexico. *Bulletin of Marine Science*. 55:1086-1098.
- Shaw, R.F., J.H. Cowan, Jr., and T.L. Tillman. 1985. Distribution and density of *Brevoortia patronus* (Gulf menhaden) eggs and larvae in the continental shelf waters off western Louisiana. *Bull. Mar. Sci.* 36:96-103.
- Shinn, E.A., and R.I. Wicklund. 1989. Artificial reef observations from a manned submersible off southeast Florida. *Bull. Mar. Sci.* 44:1051-1057.
- Sonnier, F., J. Teerling, and H.D. Hoese. 1976. Observation on the offshore reef and platform fish fauna of Louisiana. *Copeia* 1976: 105-111.
- Stanley, D.R., and C.A. Wilson. 1997. Seasonal and spatial variation in abundance and size distribution of fishes associated with a petroleum platform in the northern Gulf of Mexico. *Canadian Journal of Fisheries and Aquatic Sciences*. 54:1166-1177.
- Stanley, D.R., and C.A. Wilson. 1996. The use of hydroacoustics to determine abundance and size distribution of fishes associated with a petroleum platform. *International Council on the Exploration of the Sea, Journal of Marine Science* 202: 473-475.
- Stanley, D.R., and C.A. Wilson. 1995. Detection of the effect of scuba divers on fish density and target strength utilizing dual-beam hydroacoustics. *Transactions of the American Fisheries Society* 124: 946-949.
- Stevens, G.C. 1996. Extending Rapoport's rule to Pacific marine fishes. *J. Biogeogr.* 23:149-154.
- Stanley, D.R., and C.A. Wilson. 1991. Factors affecting the abundance of selected fishes near oil and gas platforms in the northern Gulf of Mexico. *Fishery Bulletin* 89: 149-159.
- Wilson, C.A., and D.R. Stanley. 1991. Technology for assessing the abundance of fish around oil and gas structures. Pp. 115-119 in M. Nakamura, R.S. Grove and C.J. Sonu, editors. *Recent advances in aquatic habitat technology*. Southern California Edison Company. Environmental Research Report Series 91-RD-19.
- Witzig, J. 1986. Fishing in the Gulf of Mexico 1984 marine recreational fishing results. *Proceedings: Sixth annual Gulf of Mexico Information Transfer Meeting*. OCS Study MMS86-0073. New Orleans. U.S. Department of the Interior. Minerals Mgmt. Service. Pp.103-105.
-



David Stanley received his B.Sc. degree from University of Guelph, Ontario, Canada, and his M.Sc. and Ph.D. from Louisiana State University where he developed a new methodology to quantify accurately the number and species of fishes associated with petroleum platforms and artificial reefs. By using two complementary techniques, dual beam hydroacoustics and point count visual surveys, precise estimates of the species abundance of these sites are now possible. He is now employed as a post-doctoral research associate at LSU. His research is focused on how the addition of 4,000 platforms impacts the dynamics of marine fish populations in the Gulf of Mexico. He is also interested in the function of artificial reefs.

### **UTILIZATION OF FOULING COMMUNITY ELEMENTS BY REEF FISHES AT A PLATFORM ARTIFICIAL REEF IN THE NORTHWESTERN GULF OF MEXICO**

Mr. Carl R. Beaver  
Dr. Quenton R. Dokken  
Mr. Terry E. Riggs  
Center for Coastal Studies  
Texas A&M University, Corpus Christi

Early researchers noted that artificial structures affect marine habitats in two ways. First, the structure serves to increase production in areas where settlement and development of hard-bottom benthic communities is unlikely. Because most marine organisms disperse using a planktonic larval stage, substrate within the photic zone, such as that provided by oil and gas production platforms, facilitates the development of hard-bottom biofouling assemblages that are not usually found on the surrounding soft bottom (Gallaway and Lewbell 1982). These hard-bottom communities are assumed to provide at least some energy for the growth and development of an associated fin fish community. Conversely, others claim that artificial reef structures only attract and concentrate fishes and that no net increase in total number of fishes in the body of water is realized (Bohnsack 1989, Polovina 1989). Although most artificial reef researchers currently view the attraction vs. production debate as reflecting a continuum that varies with environmental conditions throughout the life of the structure, our understanding of the dynamics of these reef systems is rudimentary at best.

A lack of understanding of the dynamics and productivity of artificial reefs is of significant concern when fishery managers are faced with management decisions stemming from increased fishing pressure on dwindling fish stocks. Prior to the creation of federal and state artificial reef programs, federal and international law required that all production platforms be removed at the end of their productive lives. This would result in the potential loss of significant portions of hard-bottom habitat in Gulf waters.

To support the development of management priorities, it is necessary that the biological/ecological contributions of platform reefs to the overall biomass of fishery-targeted species in the Gulf of

Mexico be determined through comprehensive quantitative study of population dynamics and the governing biological, and ecological factors impacting population densities.

The objective of this study is to evaluate the contribution of a platform fouling community and associated fauna to the diets of selected reef fishes.

## METHODS

Data pertaining to fouling community composition and gut contents of selected fin fishes was collected quarterly for eight quarters from the British Petroleum Exploration platform East Breaks 165A located at 94° 19' W, 27° 49' N. Fouling-community development was quantitatively assessed seasonally by examination of biomass samples collected at randomly selected depths. One hundred (100) cm<sup>2</sup> samples of the fouling community were scraped from the structure and placed in plastic bags. On the surface, samples were drained of most of the seawater and preserved in a 45% isopropyl alcohol solution for later examination in the laboratory. Fouling community samples were identified and divided into selected prey items and non-selected community components.

Diets for three species of resident reef fishes were reconstructed from data obtained through analysis of stomach contents. Mean stomach contents for each species was determined seasonally. Fishes were collected quarterly by spear and hook and line. The entire gastrointestinal tract was removed and the contents preserved for laboratory analysis. Prey items were identified to the lowest possible taxon, counted, and volume determined by volumetric displacement of water. Prey items were then dried at 60 C until a stable weight was obtained. Prey items were assigned to the fouling community, soft bottom community, plankton or classified as unknown, according to the scheme of Ruppert and Fox (1988). The sample number of fishes of a particular species was considered adequate when the slope of a line plot of the number of diet elements (B) versus the number of samples (N) approached an asymptote, suggesting additional sampling would provide no significant additions to the diet.

## RESULTS

Although significant seasonal variation in abundance was determined for several non-selected elements of the fouling community, only five selected elements showed significant seasonal variation in abundance. The stalked hydroid *Bouganvillia* sp. and the amphipods *Corophium* sp. and *Equilibrius* sp., all elements of the diet of the fin fish *Paranthias furcifer*, showed significant decreases in abundance during the first quarter of each year, while for the same period the amphipods *Gammarus* sp and *Caprella* sp. displayed a marked increase in abundance. Non-selected elements of the fouling community showing significant seasonal decreases in abundance during the first quarter were the sponge *Neofibularia nolitangere*, the anthozoan *Carejoa riisei*, and the polychaete *Filograna huxleyi*.

The three species of resident reef fishes selected for stomach content analysis were the gray triggerfish, *Balistes capriscus*, Rock hind, *Epinephelus adscensionis*, and the creole fish, *Paranthias furcifer*. Diets for both *B. capriscus* and *E. adscensionis* showed no significant seasonal variation

between food items selected. *P. furcifer* however, showed significant diel ( $P = 0.001$ ) and seasonal ( $P = 0.001$ ) variation in diet elements.

*Balistes capriscus* diet consisted of 64-82% ( $n = 70$ ,  $SD = 24$ ) by weight fouling community organisms including the barnacle *Balanus sp.*, the bivalves, *Isognomon radiatus* and *Pinna carnea*, and 20-25% fouling community associates such as *Stenorhynchus seticornis*, the amphipods *Equilibrius sp.* and *Caprella sp.* and the echinoderm *Eucidaris tribuloides*. Although *B. capriscus* diet would periodically shift from one fouling community element to another, at no time during the study period was a significant shift to elements from a habitat other than the fouling community observed.

*Epinephelus adscensionis* diet consisted of 93-98% ( $n = 95$ ,  $SD = 4.5$ ) by weight fouling community associates. Common diet elements of this species include the crustaceans *Stenorhynchus seticornis* and *Neopanope texana* as well as two species of blenny, *Hypsoblennius invemar*, the tessellated blenny, and *Parablennius marmoratus*, the seaweed blenny.

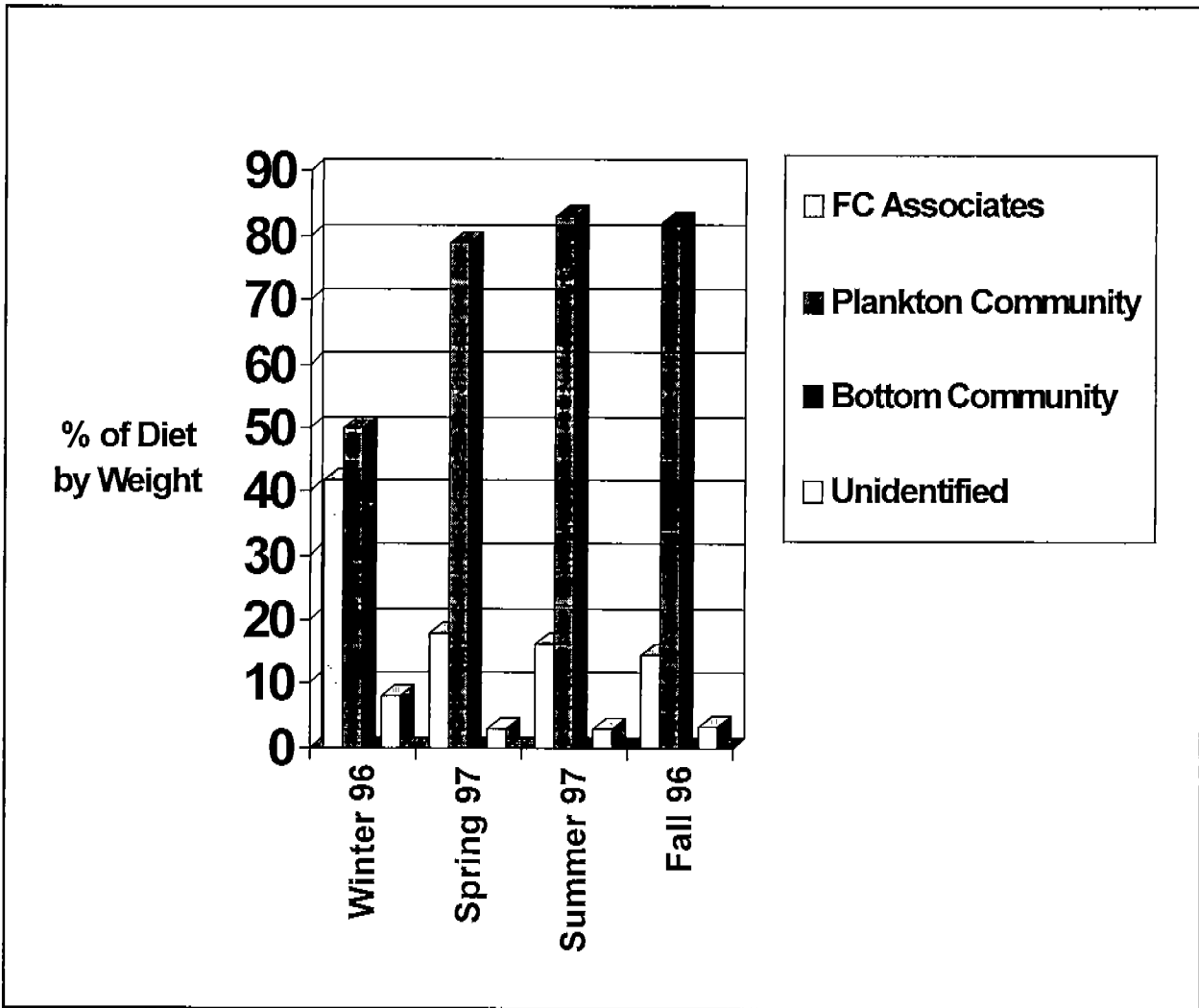

Figure 2E.9. Seasonal mean stomach contents by habitat for *Paranthias furcifer*.

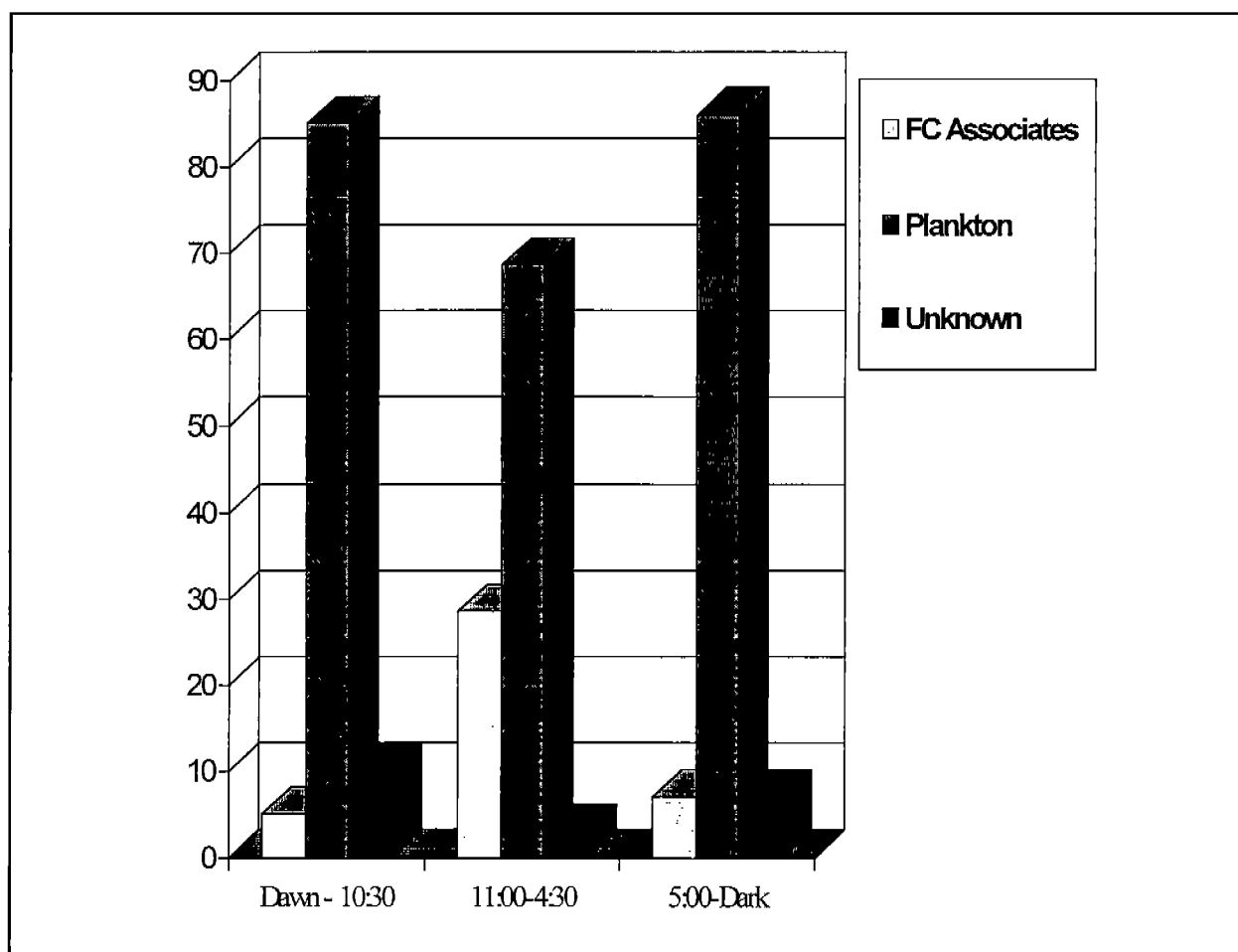

Figure 2E.10. Mean daily stomach content (percentage by weight) by habitat for *Paranthias furcifer*.

*Paranthias furcifer* diets during all seasons were dominated by planktonic organisms including copepods, mysid shrimp, ostracods and larval forms of several crustaceans (Figure 2E.9). Benthic amphipods of the genera *Corophium*, *Caprella*, and *Gammarus* and the stalked hydroid *Bouganvillia inequalis* comprised the majority of fouling community organisms found in the stomachs of *P. furcifer*.

*Paranthias furcifer* stomach content suggests diel as well as seasonal variation in feeding habits. A feeding shift from predominantly planktonic organisms to a mixed diet of plankton and fouling community elements can be seen in daily feeding patterns (Figure 2E.10). From daylight to approximately 10:30 a.m. *P. furcifer* was observed feeding high in the water column at the periphery of the platform structure. Specimens taken during this period were found to have high concentrations (~80% by weight) of planktonic organisms in the gut while fouling community associates comprised < 5% of gut contents. During the period of highest light intensity from approximately 11:00 a.m. until 4:30 p.m., *P. furcifer* were found to be schooling within the platform boundaries near areas of extensive horizontal structure. Specimens taken during this period were found to have increased

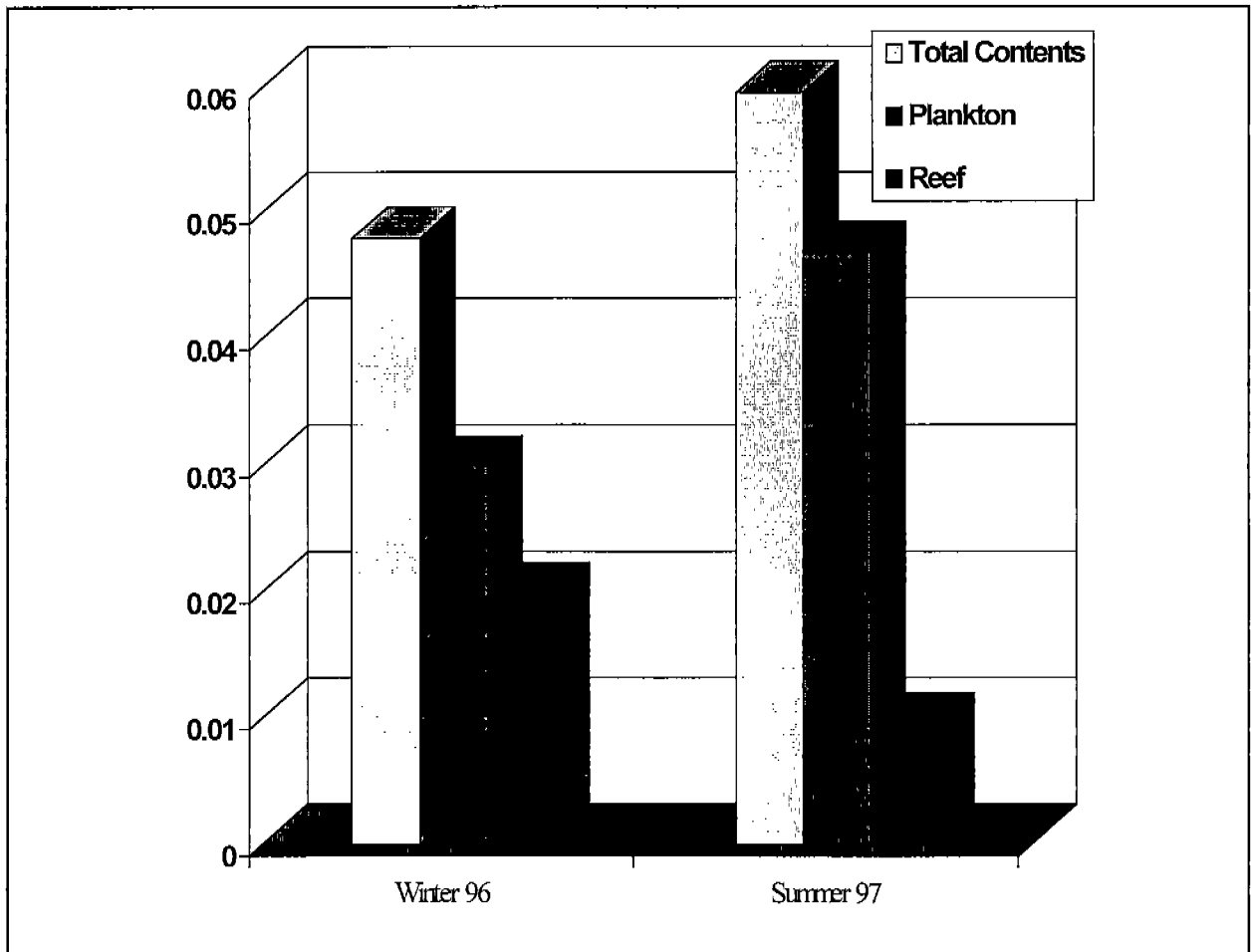

Figure 2E.11. Seasonal mean weight of stomach contents in grams by habitat for *Paranthias furcifer*.

concentrations of fouling community associates (~28% by weight) in the gut and reduced concentrations of planktonic organisms (~67%). During the period of dusk, *P. furcifer* was again observed feeding high in the water column at the periphery of the platform structure. Specimens taken during this period were found to have stomach contents comprised of approximately 86% plankton by weight and 7% fouling community associates.

Seasonal differences in percent composition by weight of stomach contents in *P. furcifer* were not significant for all spring, summer and fall quarters. Percent composition by weight was significantly different ( $P=0.0001$ ) for the winter 1996 quarter (Figure 2E.11). Stomach contents during the winter quarter showed a significant increase in the percent of fouling community associates and a significant decrease in the percent of planktonic organisms present.

## DISCUSSION

It is clear from this study that elements of the fouling community do contribute significantly to the diet of certain reef fishes. The amount of the contribution varies with species and is dependent on the effect of daily and seasonal environmental conditions on both prey and predator.

The observed winter time decreases in populations of *Corophium* and increases in gammarid and caprellid amphipods is consistent with observations of George and Thomas (1979). Increased abundance of gammarid and caprellid amphipods during the winter is reflected in increased percent composition of these species in the stomachs of *P. furcifer* for the same period.

Seasonal decreases in percent composition of planktonic diet elements are likely related to decreased availability of preferred diet elements and or a wider dispersion of plankton due to increased wave action during the winter. Increases in abundance of gammarid and caprellid amphipods may serve to offset the loss preferred planktonic diet elements, possibly maintaining population levels through the winter.

Observed diel feeding habits of *P. furcifer* seem to be related to light levels and predation pressure. *Paranthias furcifer* is a sight feeder that commonly forages widely for plankton high in the water column just outside the boundaries of the platform structure when light levels are low at dawn and dusk. As light levels increase, *P. furcifer* retreats to the horizontal sections within the platform structure presumably to avoid predation. As this species is reluctant to stray far from the structure until light levels decrease, reduced quantities of food in the gut during periods of greatest light intensity are most likely a consequence of interspecific competition for limited quantities of prey items. The observed increase in fouling community elements in the stomachs of *P. furcifer* during midday is a consequence of continued foraging of the species within the platform structure where abundances of these elements are greatest.

Although *P. furcifer* has been observed grazing on elements of the fouling community during midday, it appears that some fouling community diet elements are captured in the water column as they are swept away from the structure by water currents. This would likely explain the presence of the stalked hydroid *Bougarvillia inequalis* in the stomachs of *P. furcifer*.

The more a platform structure functions to promote secondary and tertiary productivity, aiding the transport of this productivity to higher trophic levels, the more it functions as a productive unit. It is clear that the secondary productivity of the fouling community is of significant importance to the diets of certain reef fishes. The level of this significance is determined by the environmental factors affecting both the levels of productivity and the ability of the fishes to utilize it.

To maximize the effectiveness of artificial reefs as enhancements to ecosystem and fisheries health a comprehensive understanding of the dynamics of these reef systems is required. The research described herein provides insights into the impact of artificial reefs on the cycling of nutrients and energy in the Gulf ecosystem.

## REFERENCES

- Bohnsack, J.A. 1989. Are high densities of fishes at artificial reefs the result of habitat limitation or behavioral preference? *Bull. Mar. Sci.* 44:631-645.
- Gallaway, B.J., and G.S. Lewbell. 1982. The ecology of petroleum platforms in the northwestern Gulf of Mexico: a community profile. U.S. Fish Wildl. Serv., Gulf of Mexico OCS Reg.Off., Open-file Rept. 82-03. 93 p.
- George, R.Y. and P.J. Thomas. 1979. Biofouling community dynamics in Louisiana shelf oil platforms in the Gulf of Mexico. *Rice University Studies* 65: 554-574.
- Polovina, J.J. 1989. Artificial reefs: nothing more than benthic fish aggregators. *Calif. Coop. Oceanic Fish. Invest. Rep.* 30: 37-39.
- Ruppert, E.E and R.S. Fox. 1988. *Seashore animals of the southeast: a guide to common shallow water invertebrates of the southeastern Atlantic Coast.* Univ. South Carolina Press, Columbia, South Carolina.

---

Carl Beaver is a research assistant at the Center for Coastal Studies at Texas A&M University. His areas of interest are artificial and natural reef ecology, reef monitoring and fisheries management. Mr. Beaver received his B.S. in biology from Corpus Christi State University, his M.S. from Texas A&M, Corpus Christi, and is a Ph.D. candidate in the Department of Wildlife & Fisheries Sciences at Texas A&M University.

Dr. Quenton Dokken is the Associate Director of the Center for Coastal Studies at Texas A&M University, Corpus Christi. Dr. Dokken's interests are in artificial reef ecology and dynamics, fisheries management, and ecosystem sustainability. He earned both B.S. and M.S. degrees in biology from Corpus Christi State University and a Ph.D. in Wildlife & Fisheries Sciences from Texas A&M University.

Terry Riggs is a graduate research assistant with the Center for Coastal Studies. Mr. Riggs is interested in invertebrate communities associated with artificial and natural reefs. He earned his B.S. from Texas A&M University, Corpus Christi.

## FISHERIES IMPACTS OF UNDERWATER EXPLOSIVES USED IN PLATFORM SALVAGE IN THE GULF OF MEXICO 1993-1997

Mr. Gregg Gitschlag  
Galveston Laboratory  
Southeast Fisheries Center

### INTRODUCTION

There are more than 4,000 oil and gas structures in the Gulf of Mexico. On average, about 100 removals occur each year although this number will be exceeded in 1997. Plastic explosives, primarily Comp-b and C-4, are used to sever structural members and well conductors in about two-thirds of these removals with mechanical techniques used in the remaining salvage operations. Minerals Management Service regulations (30 C.F.R. Part 250.143; National Research Council 1996) require structures be removed to a depth of 5 m (15 ft) below the mudline. Explosives are typically placed inside the hollow pilings and generally do not exceed 50 lb in weight (Gitschlag & Herczeg 1994). Offshore platforms serve as excellent artificial reef habitat which attract a vast array of marine life (Dugas & Fischer 1979; Hastings *et al.* 1976; Lewbel *et al.* 1987; Scarborough-Bull 1989; Sonnier *et al.* 1976; Stanley & Wilson 1990). Fish and other marine life in close proximity to the structure can be severely impacted by the use of explosives during the removal process. This report discusses preliminary results of assessments of fishery impacts conducted at eight platform removals between August 1993 and July 1997.

### METHODS

After explosives were detonated, moribund fish either floated to the sea surface or sank to the sea floor. To estimate the number and species of fish fatally impacted by explosives, we attempted to collect all the moribund fish which floated up to the sea surface. Field personnel operating from inflatable boats used dip nets to perform this task. Recovering dead fish from the sea floor was much more difficult and required SCUBA divers. Due to the large impact zone it was not feasible to attempt recovery of all moribund "sinkers." A sample of these "sinkers" was collected using three techniques: line transect surveys, circular surveys, and sampling frames placed beneath the platform. To increase efficiency, procedural modifications were made early in the study and only final sampling protocols are described here (Figure 2E.12). Twenty-four circular surveys measuring 6.7 m (22 ft) in diameter and four 100 m (328 ft) transect lines were sampled. At one platform (WC172), 200 m (656 ft) transect lines were surveyed. Divers collected discrete samples of moribund fish in 25 m (82 ft) increments along the transect line. Sampling width was either 1 or 2 m (3 or 6 ft) on either side of the line depending on visibility. Sampling frames constructed of PVC pipe were placed beneath the platform. Although frame dimensions varied due to obstructions encountered on the sea floor, the total area sampled generally covered 20-30% of the footprint area beneath the platform. Extremely small fish such as blennies, which live inside dead barnacles encrusting the structural members of the platform were not targeted for collection.



Fish mortality was estimated by multiplying fish density (number of fish in sample divided by area sampled) by total area for each region of interest (e.g. 0-25 m radius around the platform, 25-50 m, 50-75 m, etc. for transect line analysis). Similar procedures were applied to data collected from circular surveys and sampling frames. The total estimated mortality at a study site was calculated by adding the estimated fish mortalities at the surface, beneath the platform and in open water around the platform to a maximum distance of 100 m. The transect and circular survey techniques served as duplicate estimators for mortality in the open water area.

## RESULTS

From 1993-1997, an assessment of fisheries impacts due to underwater explosives was conducted at eight platform removals which occurred during the months of May, June, July, August and September. Study sites spanned the Louisiana coast from the western border to the Mississippi delta. Water depths ranged from 14-36 m (45-118 ft). All platforms had 4 pilings except for one 24-pile structure. The weight of explosives used per site was 160-640 lb. Structures varied in age from 12-39 years. Total mortality estimates were calculated for seven of the eight platform removals studied. At the deepest platform, the sea floor sampling by divers did not begin until 50 hours after the first of two detonation sequences because the platform owner would not allow sampling until the structure had been toppled in place and the salvage barge departed the site. Although surface mortalities were

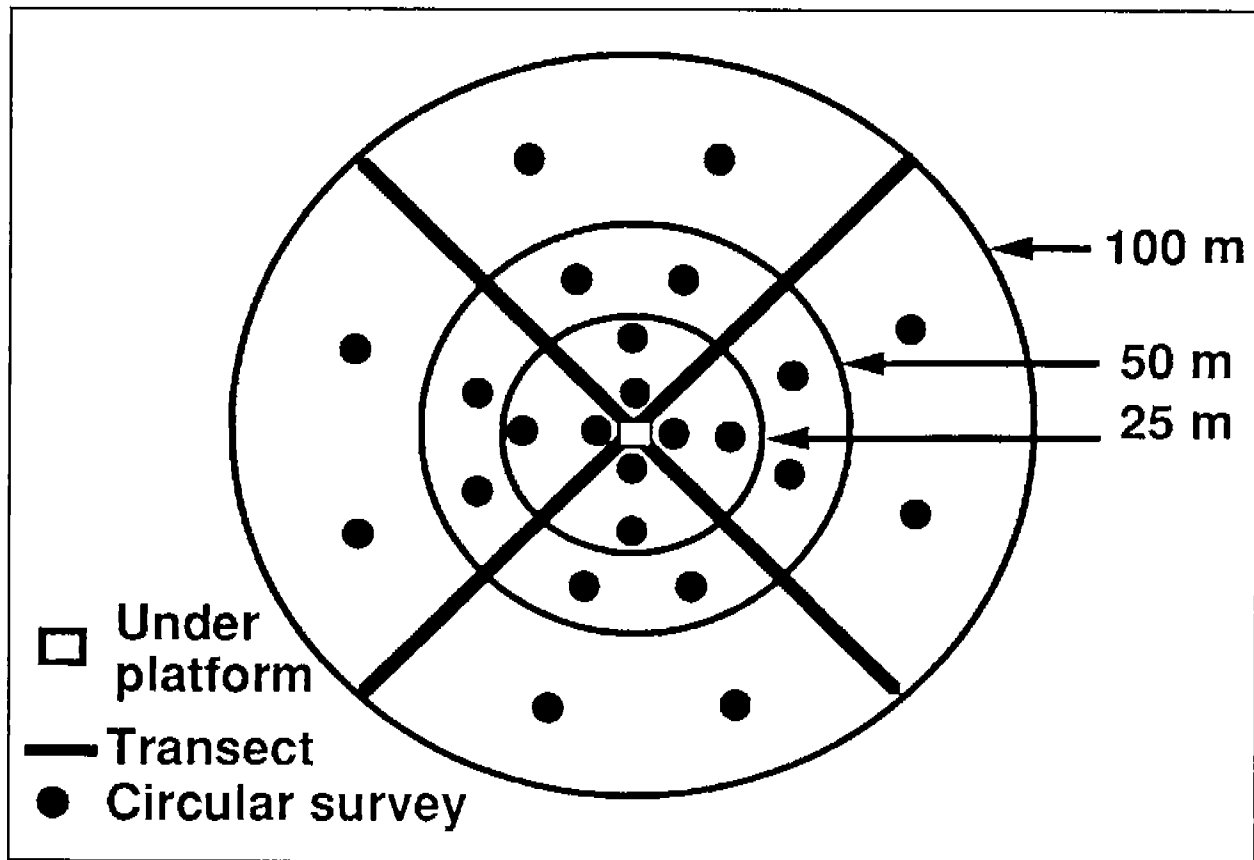

Figure 2E.12. Final sampling design.

collected using standard protocols, due to a combination of foregoing and other factors— zero visibility on the sea floor, an extremely large amount of debris around the platform resulting in entanglement of divers, strong currents and rough seas—insufficient data were collected from the sea floor to provide estimates of fish mortality.

Total estimated mortality ranged from less than 2,000 to 6,000 fish at individual platforms (Table 2E.5) which appears small when compared with estimates from other sources of fish mortality such as trawl bycatch. Very small fish less than about 8 cm are not routinely collected by divers. Blennies account for most of these mortalities. However, during removal of the platform in West Cameron Area Block 181, an abundance of small, dead fish other than blennies were encountered. These carcasses were painstakingly collected from one of the sampling frames placed beneath the platform. A mortality estimate was calculated assuming uniform density of these fish in the footprint area of the structure. Results indicated an estimated 6,400 mortalities of small fish, primarily vermilion snapper (6,100 mortalities), measuring less than 8 cm. Note that this figure does not include any estimate for the area outside of the platform footprint.

Fish species with the highest estimated mortality included Atlantic spadefish, blue runner, red snapper, and sheepshead. Estimated mortality at seven study sites ranged from 500-2,500 for spadefish, 0-1,500 for blue runner, 0-1,300 for red snapper, and 100-1,100 for sheepshead. Combining the results from these seven platforms yielded a total estimated kill of 9,534 spadefish, 4,187 blue runner, 3,961 red snapper, and 3,450 sheepshead. These four species accounted for approximately 90% of the combined estimated fish mortality at these five study sites.

Prior to the detonation of explosives, a fish tag and release study was conducted. Although all captured species were tagged and released, red snapper was by far the most numerous. Typical recovery rates for tag-release studies of fish are about 5%. The percentage of tagged fish that were

Table 2E.5. Estimated fish mortality.

Depth ft	Size	Age	LBS Expl	Depth (ft) BML	Est. Fish Kill
45	24 pile	39	640	20-30	1500-1900+
48	4 pile	23	300	20	2000-2300
48	4 pile	19	210	16-20	2600-2900
55	4 pile	12	350	15	2200-4700
58	4 pile	33	160	20	4700-6000+ (6400 <8cm)*
82	4 pile	16	380	20	4300-5000
92	4 pile	17	350	13-25	3000

\* Under platform

recovered after detonations was 19%, 20%, 41%, 48%, and 64% at our successful study sites (Table 2E.6). Too few fish were tagged at the other three sites to estimate population size. High recovery rates indicate the large impact of underwater explosives on the fish population at platform removals.

Table 2E.6. Red snapper tag-recovery study.

Site	# tagged	# dead with tags	% recovery	Water depth (ft)
WD 30	0	0	0	45
WC 172	132	84	64	48
WC 173	172	32	19	48
SS 158	4	0	0	55
WC 181	298	60	20	58
SMI 23	44	18	41	82
ST 146	117	56	48	92

Data from the red snapper tag-release study conducted at WC 181 during summer 1997 were especially interesting. Field work was interrupted for a week due to bad weather. Three estimates of the pre-detonation population size of red snapper were calculated using data for fish tagged during the first cruise, the second cruise, and both cruises combined. Results were similar (1,142; 936; and 1,048, respectively) indicating consistency between the two cruises. It is interesting to note that post-detonation recovery rate of tags was about 5% higher for the second cruise than for the first cruise.

A summary of all red snapper population and mortality estimates to date is shown in Table 2E.7. Population estimates ranged from about 500-1,900 for those platforms where sufficient numbers of

Table 2E.7. Red snapper population and mortality estimates.

Site	% tag recov.	Pop. est.	Mortality est.	% mortality	Water depth (ft)
WD 30	-	-	-	-	45
WC 172	64	400	500	73	48
WC 173	19	1100	700	66	48
SS 158	0	-	300	-	55
WC 181	20	1000	900	90	58
SMI 23	41	1900	1200	61	82
ST 146	48	500	300	57	92

fish were tagged. The percent of the population killed by blasting activity was calculated by dividing estimated red snapper mortality by estimated population size. Results ranged from 57-90%. Actual mortality is probably higher due to artifacts inherent in tag-recapture studies.

Length-frequency analysis was conducted on moribund red snapper collected from seven study sites grouped together. Mean size of floaters was significantly ( $P=0.006$ ) greater than that of sinkers by 1.9 cm. When this analysis was repeated for data partitioned by water depth either less than or greater than 18 m (60 ft), results indicated a greater difference between means of floaters and sinkers in deeper water with a mean difference in total lengths of 6.2 cm vs only 1.6 cm in shallower depths. It is interesting to note that 68% of the moribund red snapper collected during the entire study were under the minimum legal size limit of 38 cm (15 in). Using next year's limit of 41 cm (16 inches) total length the percentage increases to 77%.

Many factors affect fish mortality, which occurs during the explosive removal of offshore structures. The list may include but is not limited to such things as water depth, water temperature, salinity, oxygen concentration, season, structure size and age, number of nearby structures, amount of explosives used, placement and configuration of explosives, and sediment characteristics.

Recent attention to the biological impacts of explosive platform salvage has resulted in discussion of potential methods for mitigation. For various reasons none have received overwhelming support. Topics include attracting or repelling fish out of the impact zone and using bubble curtains or mats to dampen the effect of the blast. Special shaped charges that can dramatically reduce charge weight and subsequent blast over-pressure have been developed. Although additional research is required, this new technology in the area of configured explosives may prove very beneficial to the fish populations and other marine life which occur at offshore oil and gas structures.

In conclusion, impacts of underwater explosives on fish appears small in terms of total numbers when compared to other sources of mortality such as trawl bycatch. High variance in mortality estimates is probably due to small sample size as well as natural variability between fish populations present at platforms. However, certain species and size ranges may be impacted more than others. At one platform where small (< 8 cm) vermilion snapper were found and collected, mortality of this one size range for this one species was estimated in excess of 6100 which was more than the total mortality estimate for the entire population of (larger) fish at that structure.

#### REFERENCES

- Dugas, R., V. Guillory and M. Fischer. 1979. Oil rigs and offshore sport fishing in Louisiana. *Fisheries*, 4(6):2-10.
- Gitschlag, G. R. and B. A. Herczeg. 1994. Sea turtle observations at explosive removals of energy structures. *Marine Fisheries Review*, 56(2):1-8.
- Hastings, R. W., L. H. Ogren, and M. T. Mabry. 1976. Observations on the fish fauna associated with offshore platforms in the northeastern Gulf of Mexico. *Fisheries Bulletin*, 74(2):387-402.

Lewbel, G. S., R. L. Howard and B. J. Gallaway. 1987. Zonation of dominant fouling organisms on northern Gulf of Mexico petroleum platforms. *Marine Environmental Research*, 21:199-224.

National Research Council. 1996. An assessment of techniques for removing offshore structures. National Academy Press, Washington, D.C., 76 pp.

Scarborough-Bull, A. 1989 Some comparisons between communities beneath petroleum platforms off California and in the Gulf of Mexico. Fourth International Conference on Artificial Habitats for Fisheries, Rigs-to-Reefs Special Session, pp. 47-50.

Sommer, F., J. Teerling and H.D. Hoese. 1976. Observations on the offshore reef and platform fish fauna of Louisiana. *Copeia*, 1:105-111.

Stanley, D.R. and C.A. Wilson. 1990. A fishery-dependent based study of fish species composition and associated catch rates around oil and gas structures off Louisiana. *Fisheries Bulletin* 88:719-730.

---

Gregg Gitschlag has worked for NOAA's Southeast Fisheries Center, Galveston Laboratory for the past 20 years as an oceanographer and fishery biologist. His research interests include sea turtle behavior and migration as well as recreational and commercial impacts on red snapper. Mr. Gitschlag completed his B.S. in zoology at the University of Michigan and his M.S. in biological oceanography at Florida State University.

**CUMULATIVE ECOLOGICAL SIGNIFICANCE OF OIL AND GAS STRUCTURES  
IN THE GULF OF MEXICO: A GULF OF MEXICO FISHERIES HABITAT  
SUITABILITY MODEL—PHASE II MODEL DESCRIPTION**

Dr. Benny Gallaway  
Mr. John G. Cole  
LGL Ecological Research Associates, Inc.

**INTRODUCTION**

On the order of 4,500 platforms have been placed in the Gulf since 1938 and are characterized by extensive biological communities (e.g. Gallaway and Lewbel 1982). Petroleum platform reefs differ from natural reefs in a number of significant ways, but two of the primary differences are that platforms span the entire water column and many, if not most, occur in areas where natural reefs are absent. It may prove more ecologically accurate to consider platform reefs as a new and distinct habitat rather than to assume that they are merely additions to existing reef systems. In either case,

they have, over the decades, become a familiar, productive and highly valued environment. After several decades, many of the offshore oil and gas fields areas are being exhausted, and the platforms required to be removed. These removals have engendered a new controversy—what will the Gulf be like when the platforms are gone?

LGL Ecological Research Associates, Inc. (LGL) was awarded National Biological Service (NBS—NBS is presently equivalent to the Biological Resources Division of the U.S. Geological Survey, U.S. Department of the Interior.) Contract No. 1445-CT96-0005 on 27 February 1996 to conduct a study addressing the above-stated question. The project team composition also includes representatives of Science Applications International Corporation, Inc. (SAIC) and Louisiana State University (LSU). The purpose of the study was to model the cumulative ecological significance of offshore oil and gas structures in the Gulf of Mexico, with the particular goal of providing a qualitative or semi-quantitative index to the effects of structure removals and/or relocation. The models were developed for use by the Minerals Management Service (MMS) for evaluating effects of platform removals and making management decisions.

## METHODS

We approached the problem from a habitat perspective, using Habitat Evaluation Procedures (HEP) developed by the U.S. Department of the Interior (USDI) (1980, 1982) to develop Habitat Suitability Index (HSI) models for key species. HSI models require a numerical rating of habitat under pre- and post-scenarios. An HSI is a unitless number bounded by 0 and 1, where 0 indicates unsuitable habitat and 1 indicates optimum habitat. Phase I of this study was dedicated to gathering the information necessary to develop the HSI models for the species or guilds in question. Development and use of HSI models require a clear understanding of environmental conditions in the modeled region and the habitat requirements of the species being evaluated.

The HSI modeling procedure we used consisted of five basic steps:

1. definition of system boundaries;
2. selection of marine guilds or evaluation species;
3. a determination of the total area and types of available habitats;
4. development of suitability indices for habitats and determination of the overall HSI for available habitat;
5. prediction of past HSI's for areas where platforms had been removed.

The data and/or information needed for this project included the geographic distributions of physical habitat type (platforms, reefs, etc.), habitat variables of consequence (e.g., temperature, salinity, dissolved oxygen), and abundance of key organisms in the northern Gulf, all of which are necessary to model the relative value of regional habitats and develop the suitability index relationships.

The databases used in the model that were already available in a Geographic Information System (GIS) coverage or that were obtained during Phase I by LGL are identified in Table 2E.8. In the

Table 2E.8. GIS coverages and Oracle tables held by LGL.

<b>Coverage</b>	<b>Coverage Source, Data Source</b>
Shoreline Map, Gulf of Mexico (GOM)	NMFS
Statistical Area Map, GOM	NMFS
Statistical Area/Depth Zone Map, Western GOM	LGL, NMFS
Bathymetry, GOM	MMS
Dead Zones, 85, 86, 90-95, GOM	LGL, LUMCON
NMFS Shrimp Bycatch, GOM	
Characterization	
Turtle data	LGL, NMFS
Station data	LGL, NMFS
Evaluation	
Turtle data	LGL, NMFS
Station data	LGL, NMFS
NMFS Shrimp Catch, GOM	
White, 86-96	LGL, NMFS
Brown, 86-96	LGL, NMFS
Pink, 86-96	LGL, NMFS
Other, 86-96	LGL, NMFS
Shrimp Boat Aerial Surveys, 1994, GOM	LGL, USCG
NMFS Shrimping Effort, 82-96, GOM	LGL, NMFS
NMFS Shrimp Boat Observer Data	
Henwood and Stuntz	
Turtle data	LGL, NMFS
Effort data	LGL, NMFS
TED Studies	
1. Turtle data	LGL, NMFS
Effort data	LGL, NMFS
2. Turtle data	LGL, NMFS
Effort data	LGL, NMFS
STSSN Turtle Strandings, 86-94, 80-95 GOM	LGL, NMFS
TAMU Turtle Satellite Tracks	LGL, TAMU
TAMU Turtle Radio Tracks, GOM	LGL, TAMU
Platforms in Federal Waters, GOM	MMS
Platforms in State and Federal Waters, GOM	LGL, NMFS, USCG
Removed Platforms, GOM 86-94	LGL, NMFS, MMS
Artificial Reef Permit Areas, GOM	MMS
Artificial Reef Planning Areas, GOM	MMS
Artificial Reef Sites, GOM	MMS
Topographic Features, Western GOM	MMS
Pinnacle Features, GOM	MMS
SEAMAP (1972-1996)	NMFS
Fall Groundfish Survey	NMFS
Offshore and Nearshore "Hang" Books	Texas A&M Sea Grant

workshops, the group developed a preliminary list of potential evaluation species or guilds that might be modeled if sufficient data were available, and habitat factors of likely significance to these species.

The Phase I bibliographic search resulted in sufficient data to produce species accounts for 11 reef fish (Table 2E.9). Data were available to build suitability index relationships for adults for four of the species. Those four species, along with two others (grouper, other snapper) were then modeled and resulting HSI values mapped. Some data existed for three other listed species, Atlantic spadefish, king mackerel, and sheepshead, but not enough data to calculate the suitability index relationship. Seven species/ages subject to capture in trawls were also modeled and mapped.

Table 2E.9. Fish species accounts from Phase I and model species from Phase II.

---

Species Accounts (Bold if also modeled)

**Red Snapper**

**Cobia**

Bluefish

King Mackerel

Sheepshead

Atlantic Spadefish

Gray Snapper

Great Barricuda

**Gray Triggerfish**

Blue Runner

**Greater Amberjack**

Modeled Only

Grouper

Other Snapper

Juvenile and Trawl Species Modeled in Prey Model

Red Snapper

Vermilion Snapper

Brown Shrimp

White Shrimp

Gulf Flounder

Atlantic Croaker

Trachypenaues

---



## RESULTS

Habitat suitability indices were developed for 560 model cells located west of 87 degrees west longitude in the nearshore Gulf of Mexico for seven species/ages subject to catch in trawls, and six adult reef fish species. Each cell is ten minutes of latitude tall (11.57 miles) by ten minutes of longitude wide (11.15 miles), forming an area of approximately 129 square miles (total model area 72,240 square miles). The number of high quality habitat cells (defined as HSI  $\geq 0.5$ ) ranged from juvenile Atlantic croaker with 150 (26.8% of the available cells) to adult Cobia with 46 (8.2%) with a mean value of 110.6 (19.8%).

Combining HSI values for all adult reef fish species in each of the cells results in 57 (10.2%) overall high quality habitat cells (combined cell value  $\geq 3$ ); combining trawlable species produce 83 (14.8%). Two hundred six (36.8%) of the cells represent high quality habitat to at least one of the adult reef fish species, whereas 365 (65%) of the cells represent high quality habitat to at least one of the trawl species. When cell HSI values are combined for all thirteen species 42 (7.5%) are overall high quality habitat cells (combined cell value  $\geq 6.5$ ) and 406 (72.5%) are high quality habitat for at least one species.

Comparative maps of HSI values for the modeled trawl species and adult reef fish are included in Figures 2E.13 and 2E.14, respectively. The maps for trawl species show distinct groupings of nearshore species (white shrimp, gulf flounder, and Atlantic croaker), offshore species (vermillion snapper), and middle grounds species (red snapper and brown shrimp). Overall distribution of the adult reef fish also shows offshore species (grouper and other snapper), and middle ground species (red snapper, triggerfish, amberjack, and cobia).

A red snapper platform removal assessment was constructed by adding back the 720 structures removed during 1986 - 1994 to the 230 models cells where they were originally located and running the model for adult red snapper. The mean HSI value was significantly higher (2.6%) than that produced by the model after the platforms were removed. Although 132 cells are estimated to have decreased HSI values as a result of the removals (average 5.7%, maximum 38.7%), only 15 cells changed quartile categories, each moving down one value category. Maps reflecting both cases are provided in Figure 2E.15.

The platform assessment model was used to calculate the number of platforms that could be removed from a cell before it would cause a change in the HSI quarter value. By definition all of the platforms in the lowest quarter cells (approximately 1600) could be removed, since the cell quarter could not be reduced. For the other three quarters the model estimates that 40.8% could be removed from the second quarter, 26.9% from the third quarter, and 66.5% from the highest quarter.

The number of platforms that could be removed without changing the HSI quantile for a given area was a surprising outcome of this analysis. This unexpected result is, however, in agreement with the relative amount of hard-substrate habitat provided by platforms (0.4% of the total) as compared to natural sources and other bottom obstructions (Galloway *et al.* 1997). In contrast, petroleum platform habitat differs from natural reef habitat in that it spans the entire water column. This feature extends

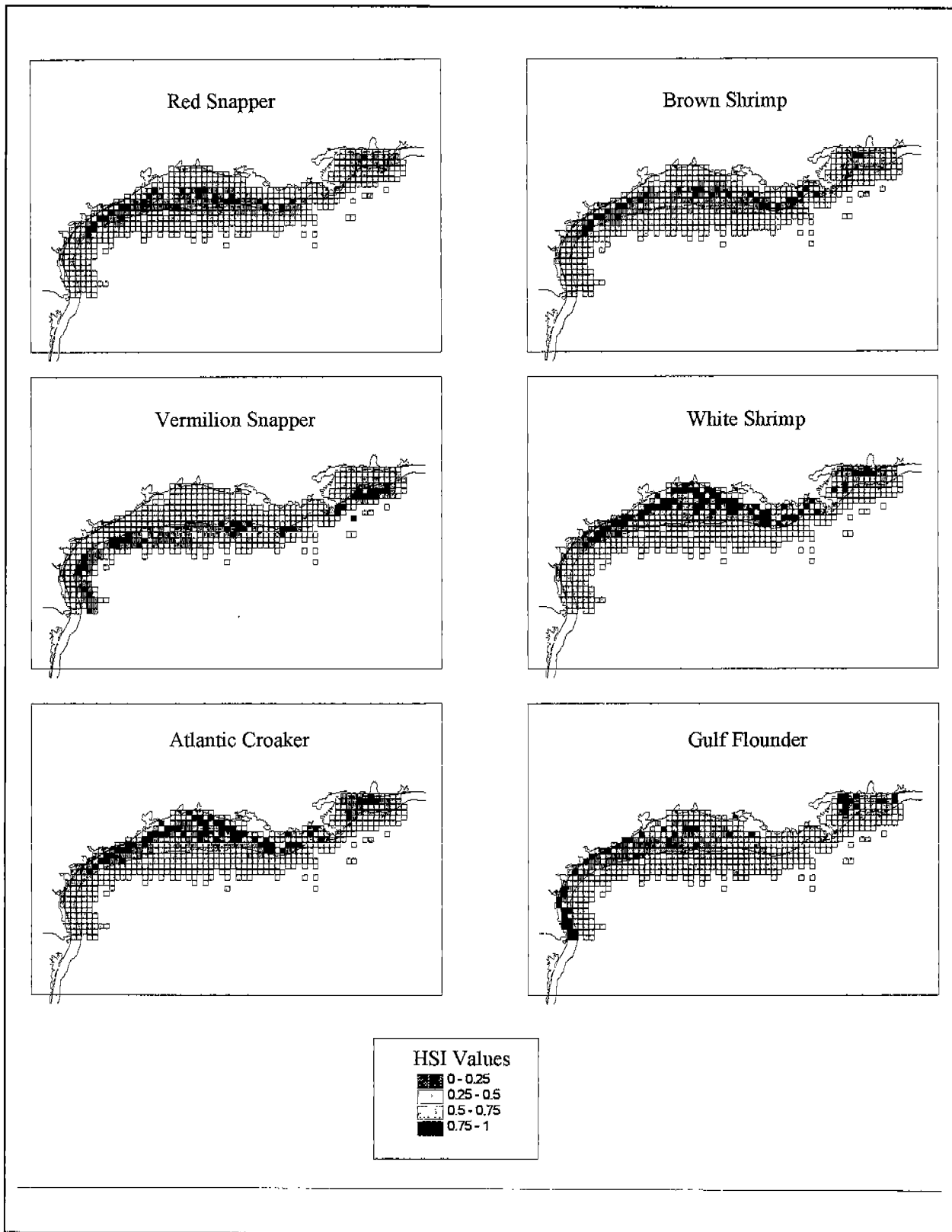

Figure 2E.13. Habitat suitability indices for trawlable ages.

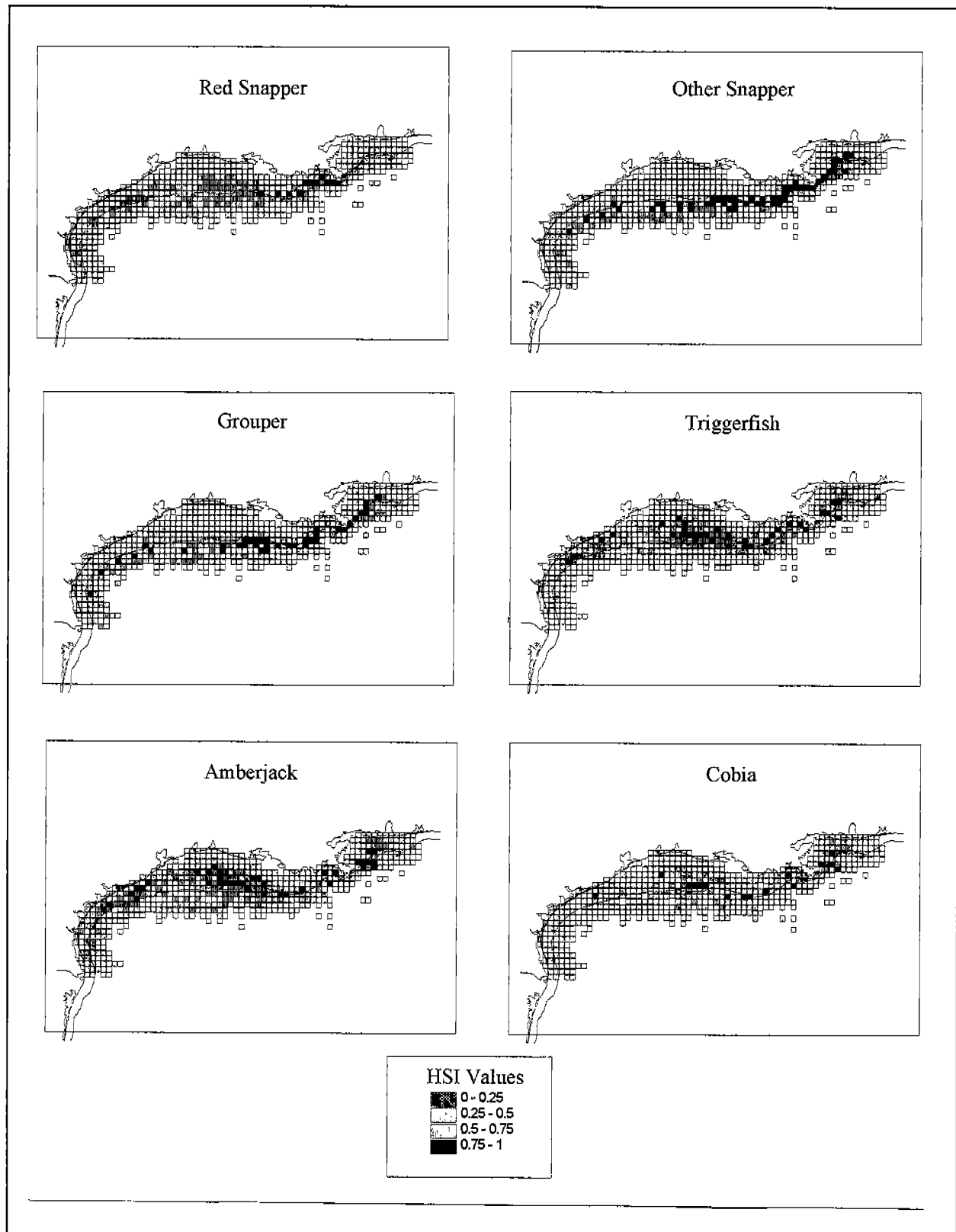

Figure 2E.14. Habitat suitability indices for adult reef fish.

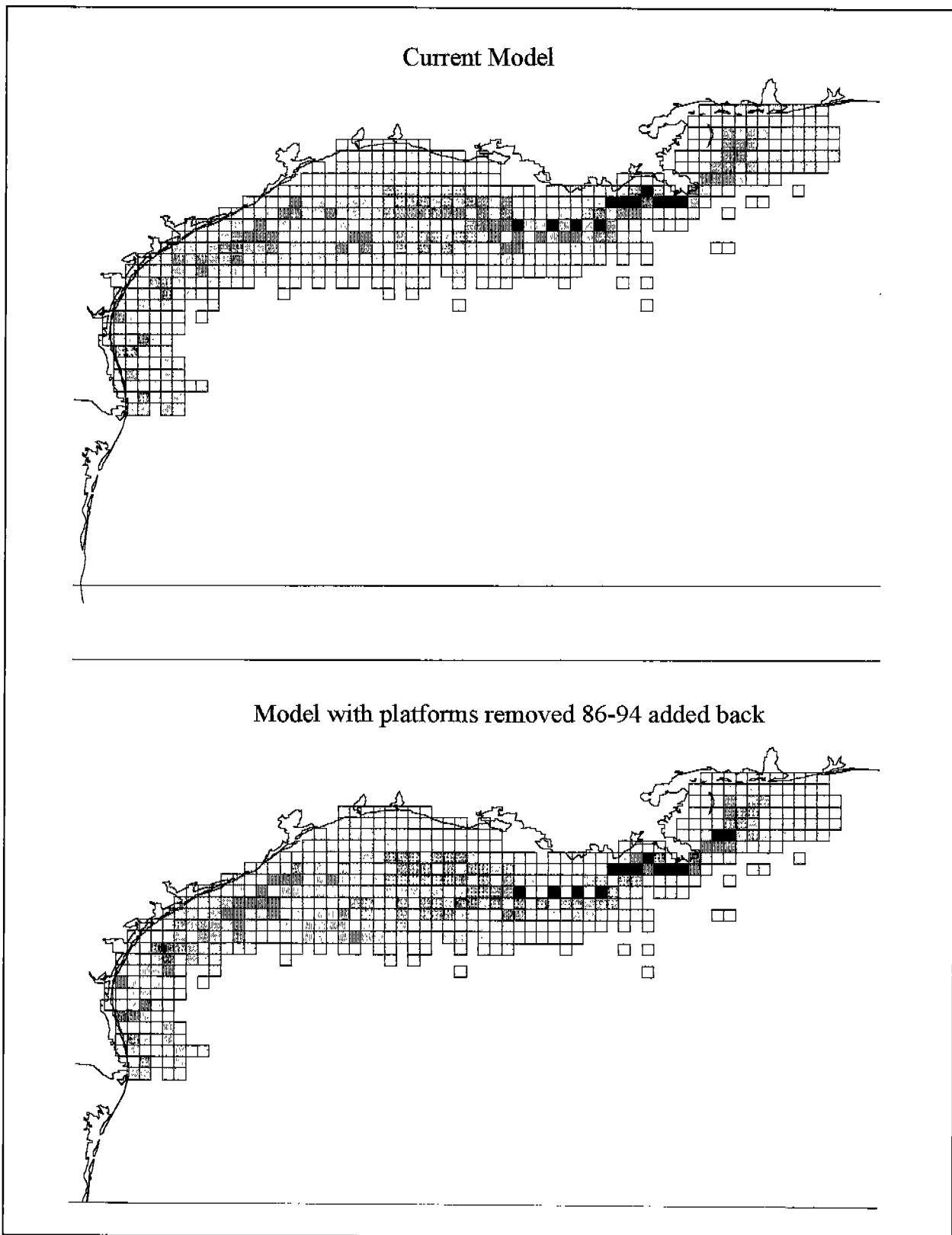

Figure 2E.15. Red snapper platform removal assessment.

hard bottom refuge into the water column when bottom water conditions are stressful to resident biota (e.g., hypoxia). We attempted to model this feature by making platforms ten times more valuable than natural bottom reefs. Even with this weighting, platform removal has far less than the anticipated effect on habitat-quality.

Stanley (1994) estimated that on the order of 5,307 (95% CI = 2,756) red snapper occurred during the fall to winter period of 1992 on a West Cameron platform. Render (1995) shows that these fish were almost all <2 years of age. We made the assumption that most juvenile red snapper during winter would occur between 10 and 20 fm. Within this area, Stanley's data files show a total of 820 platforms of which 465 are of a size equivalent to his study site where the population estimates were made. Thus, these 465 sites might be expected to harbor on the order of 2.5 million late age 1 or early age 2 red snapper (95% CI = 1.2 to 3.7 million fish). For the 355 four-legged or smaller platforms, we arbitrarily assumed a population size one-fourth the major platform estimate, or 1,327 fish. This yields an additional 0.5 million fish for an estimated total of 3 million age 2 red snapper (95% CI = 1.7 to 4.2 million) at the beginning of the year in 1992. Goodyear (1995) estimated the total Gulf population of age 2 red snapper at the beginning of 1992 was 4.2 million fish, assuming a natural mortality rate of 0.1 (Table 98, page 147). Assuming both estimates are correct, the available data would indicate that over 70% of the age 2 red snapper population occur at petroleum platforms during winter with the 95% CI being between 40 and 100%. If this is true, then the platforms are much more valuable than their proportional area would suggest. However, one or both of the standing stock estimates (platform and total) could be in error.

Goodyear (1995) estimated that there would have been 8.0 million age 2 red snapper at the beginning of 1992 if natural mortality (M) was 0.2 instead of 0.1 (Table 108, page 157). An estimate of M = 0.2 agrees with the findings of Manooch *et al.* (1997) who concluded that the level of M for the red snapper along the southeastern coast of the U.S. was probably above 0.2 but below 0.3 per year. If the standing stock was 8.0 million fish, the mean fraction of the standing stock at platforms would have been on the order of 38%. Again, even at this level, platforms appear to be more valuable habitat than indicated by their area alone.

Above, we assumed that numbers of red snapper at a four-legged platform were the same as at a smaller caisson and did not attempt to estimate directly the relative numbers at natural habitats representing over 99.5% of the available hard substrate habitat in the western Gulf (Parker *et al.* 1983). Likewise, we did not consider any environmental conditions other than depth. In an attempt to refine this, we calculated an alternative estimate of the age 2 standing stocks at all habitats taking into account the model relationships between abundance and the environment.

Using Stanley's estimate of 5,307 red snapper at a major platform located in favorable habitat as a starting point, we estimated the number of snapper at four leg platforms and caissons to be 1,327 and 332, respectively. Then, using Stanley's calculation of percentage of platforms represented by each of the types (major 49%, four leg 11.7%, and caisson 39.3%) we estimated the composition of platforms and the potential number of snapper residing at the platforms within each model cell. This number was then multiplied by the environmental suitability factor from the model to calculate total number of red snapper associated with platforms in the cell. We speculated that hangs provided an

index to natural habitat and non-platform artificial habitats and that, on average, the number of snapper associated with a hang (mostly small structures) is the same as that at a caisson, 332. Using the number of hangs located in each cell, and the mean number of hangs in all cells for cells east of 89.5 degrees West Longitude (where we have no data on hangs), we calculated the potential number of snapper at hangs for each cell. This number was also multiplied by the environmental suitability factor to calculate the total number of age 2 red snapper associated with hangs in each cell. This procedure produced an estimate of 8.09 million total age 2 red snapper in the Western Gulf, 5.57 million (69%) associated with platforms and 2.52 million associated with hangs. This total estimate corresponds with that of Goodyear (1995) for  $M = 0.2$ , and suggests platforms are high-value habitats when temperature-salinity-depth conditions are likewise favorable.

#### REFERENCES

- Galloway, B.J. and G.S. Lewbel. 1982. The ecology of petroleum platforms in the north-west-ern Gulf of Mexico: a community profile. U.S. Fish and Wildlife Service, Office of Biological Services, Washington, D.C. FWS/OBS-82/27. Bureau of Land Management, Gulf of Mexico OCS Regional Office, Open-File Report 82-03. xiv + 92 pp.
- Galloway, B.J., and 7 co-authors. 1997. Cumulative ecological significance of oil and gas structures in the Gulf of Mexico: Information search, synthesis, and ecological modeling. Phase I Final Report. National Biological Service Information and Technology Report USGS/BRD/CR--1997-0006. iv + 127pp.
- Goodyear, C.P. 1995. Red Snapper in U.S. waters of the Gulf of Mexico. NOAA NMFS Southeast Fisheries Science Center, Coastal Resources Division Contribution MIA-95/96-05.
- Manooch, C.S. III, J.C., Potts, D.S. Vaughn, and M. Burton. 1997. Population assessment of the red snapper from the southeastern United States. National Marine Fisheries Service. Beaufort Laboratory. 84 p.
- Parker, R.O., Jr., D.R. Colby, and T.P. Willis. 1983. Estimated amount of reef habitat on a portion of the U.S. South Atlantic and Gulf of Mexico continental shelf. Bulletin of Marine Science 33:935-940.
- Render, J.H. 1995. The life history (age, growth and reproduction) of red snapper (*Lutjanus campechanus*) and its affinity for oil and gas platforms. Ph.D. dissertation, Louisiana State University.
- Stanley, D.R. 1994. Seasonal and spatial abundance and size distribution of fishes associated with a petroleum platform in the northern Gulf of Mexico. Ph.D. dissertation, Louisiana State University.

USDI (U.S. Department of the Interior, Fish and Wildlife Service). 1980. Habitat Evaluation Procedures (HEP). ESM 102. U.S.D.O.I. Fish & Wildlife Service, Division of Ecological Services.

USDI (U.S. Department of the Interior, Fish and Wildlife Service). 1982. Habitat Suitability Index Models: Appendix A. Guidelines for riverine and lacustrine applications of fish HSI models with Habitat Evaluation Procedures. U.S. Department of the Interior, Fish & Wildlife Service. Division of Ecological Services, FWS/OBS-82/10.A. 53 pp.

---

Dr. Benny J. Gallaway has worked at LGL Ecological Research Associates, Inc. for the past 23 years and serves as President and Senior Marine Ecologist for the firm. Dr. Gallaway received his Ph.D. from Texas A&M University and has in excess of 40 publications in the peer-reviewed literature. He also serves as a Visiting Professor with the graduate faculty of the Department of Wildlife and Fisheries Sciences, Texas A&M University.

Mr. John G. Cole has worked at LGL Ecological Research Associates, Inc. for the past 19 years and currently serves as Executive Vice President and Senior Analyst for the firm. He has served as a system programmer, data manager, and data analyst on many large, multi-disciplinary research projects while at LGL. His education and training as a Certified Public Accountant contributed to his role as an information manager and information problem solver. He programs regularly in several languages (C, Dibol, Cobol), using several data base management systems (ORACLE, ARC-INFO, SAS), on several operating systems (VMS, Windows, Macintosh).

## SESSION 2F

ENVIRONMENTAL AND SOCIOECONOMIC INFORMATION IN  
DEEP WATERS OF THE GULF OF MEXICO

Co-Chairs: Dr. Robert M. Avent  
Dr. William Schroeder

Date: December 17, 1997

Presentation	Author/Affiliation
Introduction: Overview and Focus	Dr. Robert M. Avent Environmental Studies Section Minerals Management Service Gulf of Mexico OCS Region
Trends in Deep Water Oil and Gas Development—Government Management Implications	Mr. J. Hammond Eve Minerals Management Service Gulf of Mexico Regional OCS Office
Industry Deepwater Environmental Research Interests for the Remainder of the Century (Manuscript not submitted)	Dr. Jim Ray Shell Oil Company
Status of Environmental and Physical Oceanography Information on the Continental Slope in the Gulf of Mexico—Results of a Workshop	Dr. Robert S. Carney Coastal Marine Institute Louisiana State University
The Status of Environmental and Socioeconomic Information in the Deep Waters of the Gulf of Mexico—Results of a Workshop	Dr. Charles M. Tolbert Louisiana State University





## INTRODUCTION: OVERVIEW AND FOCUS

Dr. Robert M. Avent  
Environmental Studies Section  
Minerals Management Service  
Gulf of Mexico OCS Region

The MMS began field studies of the deep sea in 1983 with the initiation of a major, multidisciplinary field investigation called the "Northern Gulf of Mexico Continental Slope Study" (NGMCS). This effort lasted for two full field seasons, 1983 through 1985, and the Year IV final report (LGL, Inc. 1988) synthesized all of the information. The study placed initial sampling stations on transects in all three MMS Gulf of Mexico Planning Areas in depths from 300 m to nearly 3,000 m. Station placement started with a view of zonation according to a scheme provided by Pequegnat in an earlier, MMS-funded data synthesis. Faunal analyses generally confirmed his findings and the patterns of zonation were further correlated with various predictable variations in hydrography, physiography, and sediment types. Later sampling was designed to investigate biological, chemical, sedimentary, and hydrographic variability across the northern Gulf from west to east in between the original transects.

In late 1984, Texas A&M University researchers, conducting separate research, recognized chemosynthetic species in dredge and trawl tows from an acoustic "wipe-out" area known to have sediments containing oil, gas hydrates, and hydrogen sulfide. The MMS responded to this discovery by providing limited funding to our own ongoing NOGMCS program for initial surveys using a *Johnson-Sea-Link* research submersible of the harbor branch oceanographic institution in September 1986. Six successful dives were made on two stations in the Green Canyon lease area (one later to be known as "Bush Hill"). These observations were the first that directly demonstrated the potential magnitude of the communities, their faunal composition, spatial variability, and density. The dives also revealed some unusual geological microhabitats for the animals.

The MMS recognized the potential importance of these communities and their implication in the management of the petroleum industry. The government concluded that protective measures and additional high-resolution data were needed. In December 1988, the MMS issued a notice to lessees that required "...avoidance or protection of chemosynthetic communities and avoidance of shallow hazards..." It required that, in depths greater than 400 m, the operator must (1) modify the application to relocate the operation, (2) provide additional photographic or videotape information, and/or (3) otherwise ensure that the operation does not impact a community (e.g., the precision placement of anchors, chains, pipelines, and templates).

Following these developments, the MMS funded two chemosynthetic ecosystem studies through the TAMU (primary contractor), the second of which is currently in the data analysis phase.

The recent intense oil and gas activity in deepwater (defined as 1,000 feet, or ~300 m) has required some rethinking about the status and adequacy of information on the Gulf of Mexico continental

slope. So, in April 1997 the MMS conducted a workshop in New Orleans in cooperation with the Louisiana State University. Because of the immediate need for expert guidance in future multidisciplinary studies programs, the MMS incorporated all disciplines believed to need additional attention. The workshop covered physical oceanography, geological hazards, ecology (primary benthic), and socioeconomic issues.

---

Dr. Avent works for the Minerals Management Service in the Environmental Studies Section, Gulf of Mexico and Atlantic Outer Continental Shelf Region. Prior to taking his current position in 1981, he served with the National Marine Fisheries Service, the Texas Parks and Wildlife Department, two consulting firms, and the Harbor Branch Oceanographic Institution. He received his M.S. and Ph.D. degrees in biological oceanography at Florida State University in 1970 and 1973.

## TRENDS IN DEEP WATER OIL AND GAS DEVELOPMENT—GOVERNMENT MANAGEMENT IMPLICATIONS

Mr. J. Hammond Eve  
Minerals Management Service  
Gulf of Mexico Regional OCS Office

Recent oil and gas leasing has experienced a renewed explosion of activity, especially in the deeper waters of the Gulf of Mexico. This situation has presented the Minerals Management Service (MMS) with new challenges and opportunities to streamline and improve ways of doing business with the public, the industry, federal agencies, and other entities.

A few statistics (as of December 1997) will illustrate the rapid acceleration of activity:

- The 1995 Central Gulf of Mexico (CGOM) Lease sale was the fourth largest in the history of the OCS Lease Program (now over 40 years old);
- That same year the Western Gulf of Mexico (WGOM) Lease Sale was the largest in five years;
- The 1996, both the CGOM and the WGOM Lease Sales were the second largest in the Program; and
- Both of the 1997 CGOM and WGOM Lease Sales broke all existing records.

In fact, since 1992, blocks leased in both the Central and Western Planning Areas have increased annually from 204 (total) in 1992 to 1778 (total) in 1997. This increase is notable in itself; but what is even more remarkable has been the extraordinary acceleration of activity in deeper and deeper waters. The MMS has attributed this deepwater initiative largely to the passage of the Deep Water Royalty Relief Act of 1996. This legislation, put into effect immediately for Sale 157 (March 1996) was enacted to offer the oil and gas industry incentives to lease and develop large deep-water petroleum reserves by reducing or eliminating early royalties due the Treasury, thus offsetting the extreme costs to operate far offshore and in very deep waters. Under the Act, royalties were reduced according to a scale depending on depth of operation (see Table 2F.1).

The effects of the act are apparent: there were some moderate increases in bidding in “shallow” water from 200 to 800m deep. But after the act came into effect, bidding activity in the deepest, most remote areas increased dramatically. Similar patterns were seen in the WGOM Planning Area as well. Some of the leases in both areas are in truly deep water—well over 2,000 m deep. As of 1997, at least 29 drilling rigs were operating in deep water (by our working definition, at least 1,000 ft or 305m), twelve of these were in depths greater than 3,000ft (915m) and one was up to 1.2 miles deep (6,627ft, 2,020m). It is likely that the numbers of deep rigs might have been larger if their supply were adequate.

Table 2F.1. Pre- and Post Royalty Table Relief Leasing Activity (1994-1997). Blocks Receiving Bids, CGOM.

Water Depth (m)	Pre-Relief		Post-Relief	
	1994	1995	1996	1997
0-200	313	387	453	412
200-400	7	23	29	33
400-800	15	38	41	52
>800	40	140	401	535

Virtually every measure of deep-water activity shows rapid growth, as the following examples illustrate. Between 1985 and 1996 (the last year for which data are available), the deep-water production in the Gulf of Mexico has risen steadily from about 2% to over 17% of the total OCS energy. The MMS has projected that by the year 2000 the number of deep-water fields with proven reserves will have risen to 36 from a total of only 13 in 1991. In only five years, from 1995 to 2000, the deepwater production rate will have doubled from 945,000 to about 1.9 million barrels per day.

Necessarily, many technological changes have been required for the move into deepening waters. The stationary towering platforms typical of the continental shelf (<200m) become impractical and prohibitively expensive on the continental slope. Here they are replaced with semisubmersible and tension leg platforms, spar platforms, and floating production systems. In the not-too-distant future it might be practical to install floating production, storage, and offloading (FPSO) systems in the Gulf, once technological and environmental concerns are met. New deepwater high resolution seismic survey methods and technologies have improved the accuracy in the delineation of and production estimates of petroleum reservoirs. The above technologies have been improved with the development of extremely accurate and precise navigational technology and station-keeping ability. Computer assisted dynamic positioning allows drillships and pipelaying barges to do their respective jobs. Remotely operated vehicles (ROVs), customized underwater robotics and tools, one-atmosphere diving suits, and seafloor automation have virtually eliminated the need for expensive and potentially hazardous manned submersibles and diver decompression systems.

Deep operations are typically remote from shore and from each other. They are subject to differing environmental conditions, from deep and surface water currents to potential geological hazards. The potential environmental impacts of the petroleum industry are now well within the range of true deep-sea biological communities and habitats, including sensitive, fragile chemosynthetic communities. Many deep-water plays are expected to produce at very high daily rates from very large reservoirs. In fact, the decision to develop an oil field is a function of the size of the reservoir and

other major economic determinants, such as the cost of development and operation and the stability of oil and gas prices. The Gulf of Mexico is also attractive to the international oil and gas community for its political stability.

The move onto the continental slope requires a number of operational, logistical, and support considerations. It requires an increase in pipeline construction and capacity, and new, immense pipelaying barges with new pipe handling capabilities and positioning technologies. The emplacement of seafloor and midwater structures requires increasingly large, complex and specialized vessels and methods. The remoteness, low density, and large size of the new operations require upgraded, large, fast supply vessels and land-based transportation and storage support infrastructure. They further require a large, well-trained, and more sophisticated pool of workers and all of the needed (but sometimes overlooked) social infrastructures such as schools, utilities, transportation, and housing.

All of the new deep-water bidding, reservoir development, and deployment of new technologies have resulted in new regulatory considerations for the Minerals Management Service. Among these are the development of Environmental Impact Statements and Assessments to address many new environmental issues and public concerns; the modification or implementation of environmental, safety and engineering regulations; and the funding of new scientific and socioeconomic studies. (The final two papers in this session are overviews of the recommendations made for new deepwater-related studies from an MMS-funded deep-water workshop held in New Orleans in April 1997.) Throughout these processes, the MMS must consider industry costs, and the extended lead times for large and complex projects.

Finally, MMS must accommodate the flurry of recent offshore activity for all of its varied customers. The inevitable increase in internal workloads and the many new issues that must be faced are requiring the development of better and more efficient ways of doing business, challenging of old models and ideas, and the maintenance of excellence in its dealings and its staff.

## STATUS OF ENVIRONMENTAL AND PHYSICAL OCEANOGRAPHY INFORMATION ON THE CONTINENTAL SLOPE IN THE GULF OF MEXICO—RESULTS OF A WORKSHOP

Dr. Robert S. Carney  
Coastal Marine Institute  
Louisiana State University

### INTRODUCTION

As the offshore oil and gas industry progressively moves down the continental slope, industry and the Minerals Management Service (MMS) face a variety of new information needs. This presentation is a brief summary of the proceedings of a workshop addressing such issues held in April of 1997. First, due to limitations of time and money the workshop was broad-based. Therefore some important topics were not explored in depth and others left almost unexplored. Potential fisheries conflicts and uncertainty about operational hazards are two such topics. Second, the information reported here is already out of date. MMS is progressing rapidly on preliminary recommendations issued in May of 1997.

### WORKSHOP PROCEEDINGS

The stage for group discussions was set by plenary speakers. Mr. Chris Oynes, Director MMS Gulf Region, outlined general information needs. Mr. Paul Hays of Texaco and Dr. James Ray of Shell provided industry perspective. Technical overviews were presented by Dr. Harry H. Roberts for geology and geohazards, Dr. Worth Nowlin for physical oceanography, Dr. Gilbert Rowe for biology, and Dr. F. Larry Leistritz for socioeconomics. Following plenary presentations, the workshop broke into individual sessions: biology chaired by R.S. Carney and Bob Avent, geology (a subgroup with biology) chaired by Harry Roberts, physical oceanography chaired by Steve Murray and Alexis Lugo-Fernandez, and socioeconomics chaired by Charles Tolbert and Harry Luton. In addition there were two *ad hoc* breakout groups which addressed operational issues and fisheries conflicts.

### SOCIOECONOMICS WORKING GROUP OVERVIEW

There is a minimal base of existing knowledge about deep water operations effects. There was a broad consensus among those present that efforts to obtain industry and labor force information should begin immediately. In the process of fulfilling these information needs, researchers would necessarily collect data on infrastructure and community capacity. Such large-scale industry and labor force analyses are beyond the scope of CMI-type funding and should be solicited directly by MMS. Timing is critical; despite the recent upswing in industry activity, an opportunity exists to establish an early baseline of industry and labor force data. Most previous socioeconomic studies in the GOM region have necessarily been *post facto*. A timely addressing of these issues would enhance the caliber of GOM socioeconomic research.

## PHYSICAL OCEANOGRAPHY WORKING GROUP OVERVIEW

This is a considerable information base, some in universities and some proprietary. A consensus was reached on a three-pronged plan of recommendations:

First, a considerable body of data resides in MMS, university and industry archives and reports that remain in an unsynthesized form. This historical data base on slope observations should be inventoried, compiled (on CD), and synthesized into a summary report.

Simultaneously, a dynamic model/data synthesis system should be developed to interpret of available data to identify important processes on the slope. This numerical model should be capable of assimilating the satellite altimetry and other remote sensing and field observations. This model will be used for a diagnostic tool to understand historical data sets and act as a guide for future intensive observations on the slope.

The third component is an intensive observation plan to determine the characteristics of motions on the Louisiana-Texas slope. Two dynamically distinct sites should be investigated: (a) the central GOM slope off western Louisiana, which is affected by smaller scale cyclones and anticyclones that have arisen presumably from interactions of the large anticyclonic eddies released by the Loop Current, and (2) the western GOM slope off south Texas, the "eddy graveyard" region, where decay of Loop Current eddies lead to generations of intensive cyclone-anticyclone pairs, referred to as modons. The field observation program should be flexible and innovative, given the mobility of features observed in this area. Extensive use of moored ADCPs, conventional current meters, IES (inverted echo sounder), temperature chains, and aerial XBT surveys will need to be combined with ship-bound hydrographic and ADCP surveys. A series of pilot moorings and interaction with the "data synthesis system" will help determine final array design, which we estimate entails approximately 30 moorings.

Embedded in this observation program must be smaller scale studies aimed at characterizing the flow fields associated with the rough topography (e.g., the ubiquitous narrow canyons that cut the outer slope) and measurements aimed at the thermal and dynamical properties of the bottom boundary layer, which is of extreme concern to benthic ecology/biology.

## GEOLOGY AND GEOHAZARDS WORKING GROUP

There is a very substantial information base, most of which is proprietary. The Geohazards Subgroup acknowledge that the northern-to-western Gulf of Mexico continental slope is perhaps the most complex continental slope environment in today's ocean. It is also the most active deepwater frontier for oil and gas production in the world and the production frontier is moving deeper at a rapid pace. Therefore, both operational and regulatory groups are presented with formidable challenges as hydrocarbon exploration and production proceeds in this little-studied deepwater setting. Characteristics of the slope surface that present difficulties in both a geohazards and regulatory context are (a) steep local slopes; (b) variable sediment types; (c) complex faulting; (d) a variety of types of mass movement; (e) areas of lithified sea floor and mounded carbonates; (f) gas hydrates



at or near the sea floor; (g) mudflows and mud volcanoes; and, (h) protected benthic communities (chemosynthetic communities) associated with a spectrum of hydrocarbon venting and seepage area. Within this complex matrix of surficial geologic features and conditions characterizing the deepwater slope environment, the Subgroup tried to prioritize the subject areas for future MMS research support on the basis of (a) state of present knowledge and (b) risk to man's operations.

#### THE BIOLOGY WORKING GROUP

Due to the great diversity of possible topics and the limited scope of the meeting, the primary focus was on the benthos. It is acknowledged that the upper ocean systems must be considered at some time in the future. For the benthos there is a fair existing information base already gathered by MMS. In the Gulf of Mexico this is based on the work of Willis Pequegnat, the Northern Gulf of Mexico Continental Slope Study, and the Chemosynthetic Community Studies. For the Atlantic, MMS is also the primary source of new information on the deep benthos.

Since MMS has already made a major investment in studying the deep ecology of the Gulf, future emphasis should be placed on filling in the gaps and addressing specific impacting activity. It was the opinion of the group that previous studies had not provided a sufficient, process-oriented, ecological overview. Prior to that, however, joint projects should be undertaken with industry looking at effects in experimental systems deployed at operation sites.

---

Dr. Robert Carney began his oceanographic study of the deep Gulf of Mexico as a student of Pequegnat at Texas A&M in 1967 and has returned to that original interest during eleven years at Louisiana State University. At LSU he serves as director of the Coastal Marine Institute, a researcher in the Center for Coastal Ecology, and an associate professor in the Department of Oceanography and Coastal Sciences. Dr. Carney received his BS in zoology from Duke University, a Master's in oceanography from Texas A & M, and a Ph.D. in the same field at Oregon State.

## THE STATUS OF ENVIRONMENTAL AND SOCIOECONOMIC INFORMATION IN THE DEEP WATERS OF THE GULF OF MEXICO—RESULTS OF A WORKSHOP

Dr. Charles M. Tolbert  
Louisiana State University

### WORKSHOP OVERVIEW

Participants at the workshop included Co-Chairs: Harry Luton of MMS and Charles Tolbert of LSU. Also in attendance were more than 30 others representing universities, state agencies, a local port authority, MMS staff, and present and past members of the Scientific Advisory Committee.

During the first afternoon session, key issues areas were identified and breakout groups were formed. The groups worked throughout the second day until the late afternoon. Then the entire group was reconvened and terms of a summary report were discussed. Tolbert then developed a concluding report for a closing plenary session on the following morning.

Breakout groups were formed around three issue areas: industry, labor force, and infrastructure. Information needs for each issue area are outlined below.

The aim of the socioeconomic portion of the workshop was to identify information needs that--when filled--would improve assessment, prediction, and projection.

### SOCIOECONOMIC CHALLENGES

#### Onshore and Shallow Water

There was a broad consensus that we have entered a period of increased oil and gas industry activity on land and on the OCS. New technologies and price stability have sparked widespread renewed interest in earlier discoveries and existing facilities. This activity has caused a skilled labor shortage, producing some historically low unemployment rates and tight labor markets in some areas. There is also some resistance to reentering oil and gas work due to the large number of workers who experienced the last boom and bust episode in the Gulf of Mexico. These onshore and near-shore factors must be taken into account in any assessment of deepwater development activity.

#### Deepwater

Many in the socioeconomic workshop believed that a deepwater boom was also underway. At this time, the initial impacts appear to be concentrated in a few deep-port areas. One key feature of deepwater development appears to be an accelerated tempo of leasing, exploration, and production. In addition, there are important technological differences that will affect socioeconomic outcomes.

### INDUSTRY INFORMATION NEEDS

One breakout group addressed the key issue area of the industry. Research should commence at once on the industry's employment and training needs, diversity of products and services, purchases and inputs, logistic support sites, alliances, unfilled industry needs in terms of personnel and supplies, fabrication facilities, labor sources, and economic impact (direct and indirect).

### INFRASTRUCTURE INFORMATION NEEDS

Another breakout group focused on the need for information on the effects of deepwater development on local infrastructure. Research is urgently needed at the community level that inventories effects on roads, water, waste disposal, public education, medical and health facilities, public safety, port facilities, and recreation. Similarly, research is needed on available facilities for supporting oil and gas development (e.g., shipyards, pipeyards, and terminals). Research is also required on local material and personnel requirements as they relate to deepwater development.

### LABOR FORCE/HUMAN FACTORS INFORMATION NEEDS

A third breakout group centered its attention on the labor force and impact of deepwater development on workers and their families. Detailed data collection should begin at once on matters such as number and location of workers, work histories, demographics, residential histories, job recruitment, reasons for leaving industry, work environment and scheduling, migration and commuting, effects of offshore work schedules on families, social networks and social support systems.

### RELATED INFORMATION NEEDS

Associated with these three key issue areas are a number of other information needs. These include enhanced projections and modeling procedures, elements of successful community planning, case studies of deepwater project, racial/ethnic diversity and culture conflict, new or different problems for public assistance, environmental justice, and dispersion of impacts and benefits across communities, states, and regions.

### SUGGESTED ACTION PLAN

There was a broad consensus among those present that efforts to obtain industry and labor force information should begin immediately. In the process of fulfilling these information needs, researchers would necessarily collect data on infrastructure and community capacity. Such large-scale industry and labor force analyses are beyond the scope of CMI-type funding and should be solicited directly by MMS. Timing is critical; despite the recent upswing in industry activity, an opportunity exists to establish an early baseline of industry and labor force data. Most previous socioeconomic studies in the GOM region have necessarily been *post facto*. A timely addressing of these issues would enhance the caliber of GOM socioeconomic research.

---

Charles M. Tolbert, Ph.D., is Professor of Sociology and Rural Sociology, LSU, and Senior Research Scientist with the Louisiana Population Data Center. He has extensive experience with socioeconomic and demographic analyses. He is a longstanding member of a U.S.D.A. regional research project on nonmetropolitan labor market areas. Tolbert is the author (with Glenna Colclough) of *Work in the Fast Lane: Flexibility, Divisions of Labor, and Inequality in High-Tech Industries* (Albany, NY: State University of New York Press, 1992). He developed a methodology that identifies labor market areas in the United States, and his work provided the basis for special 1980 and 1990 data files produced by the U.S. Bureau of the Census. Tolbert's research has been funded by the National Science Foundation, U.S. Departments of Agriculture (Economic Research Service), Commerce (Economic Development Administration, National Marine Fisheries Service), Interior (Minerals Management Service), Labor (Employment and Training Administration), as well as the Louisiana Universities Marine Consortium (LUMCON) and the Louisiana Office of Community Services. His research has appeared in leading social science journals, including the *American Sociological Review*, *American Journal of Sociology*, *Rural Sociology*, *Social Forces*, *Social Science Quarterly*, *Environment and Planning A* and in policy outlets such as *American Demographics*. Tolbert's methodological interests include quantitative methods for temporal and spatial analyses as well as GIS applications. Among his teaching assignments at LSU is an advanced graduate seminar entitled "Regression over Time and Space."



## SESSION 2G

**U.S. - MEXICO NATURAL RESOURCES  
(WITH EMPHASIS ON LAGUNA MADRE)  
PART II**

Co-Chairs: Mr. Howard Ness  
Ms. Maria Pia Gallina

Date: December 17, 1997

Presentation	Author/Affiliation
Perspective on the Coastal Zone of Tamaulipas <p style="text-align: center;">and</p> Perspectivas de la Zona Costera de Tamaulipas	Dr. Sóstenes E. Varela Fuentes M.C. Jorge A. Adame Garza Dr. Pedro Carlo Estrada Autonomous University of Tamaulipas
Neotropical Migratory Birds at Padre Island National Seashore, Texas	Mr. Darrell L. Echols U.S. National Park Service
Impactos Potenciales de la Construcción del Canal Tamaulipeco en Laguna Madre, Tamaulipas <p style="text-align: center;">and</p> Potential Environmental Effects on Laguna Madre of Tamaulipeco Channel Dredging	Dr. Laura Muñoz Palacios Universidad Autónoma de Tamaulipas, México.
Beach Garbage: Point Source Investigation Padre Island National Seashore, Texas	Mr. John E. Miller U.S. National Park Service Dr. Edward R. Jones Texas A&M University-Corpus Christi
U.S. Fish & Wildlife Service's Involvement in the Laguna Madre	Ms. Robyn A. Cobb U.S. Fish and Wildlife Service



## PERSPECTIVE ON THE COASTAL ZONE OF TAMAULIPAS

Dr. Sóstenes E. Varela Fuentes  
M.C. Jorge A. Adame Garza  
Dr. Pedro Carlo Estrada  
Autonomous University of Tamaulipas

### INTRODUCTION

The state of Tamaulipas has a surface area of 79,384 km<sup>2</sup> and is the seventh largest state in the country. The economy is principally sustained by agriculture and cattle raising in the Soto la Marina, Aldama and San Fernando districts in which forestry, fishing and aquaculture are also developed, although the latter is still in the beginning stages. Among the secondary activities, the manufacturing industry stands out, especially in the border districts of Matamorros and Reynosa, which have important industrial fabrication plants, and Altamira, which has become the seat of an industrial plant in the process of notable growth.

On the northeastern coastal plain of the state there are 430 Km of coastline whose estuary features, access and productivity sustain the fishing activity, occupying seventh place at a national level with respect to catch volume. Likewise, this area has the technology and experience for the production of 26 species of commercial interest, of which crustaceans such as shrimp and lobsters, mollusks such as eastern oysters and clams, and species of quality and common fish stand out for their high value.

The coastal plain also has extensive surface areas containing resources such as hydrocarbons, ecosystems categorized with high productive potential, areas with exceptional landscape value for recreation and tourism, as well as those with high ecological value for the conservation of bird fauna. These characteristics convert the coastal region into an area of high economic potential whose integration into the state development process transforms it into a strategic zone.

The state of Tamaulipas has the second largest lagoon-coastal system at the national level. In the northern basin of the Laguna Madre, there is a considerable variety of coastal ecosystems. These systems show alterations due to several human activities that cause problems in the coastal area of Tamaulipas, such as hypersalinization of a natural origin and contamination from industrial waste in the bodies of water and ground in the region belonging to the Matamoros district; the degradation of the soil due to an excess of agrochemicals, mud clogging and contamination from pesticides in lagoons and estuaries, and increased growth in human establishments on the coast of the San Fernando district; increased mud clogging of lagoons, over-exploitation of aquatic resources in Soto la Marina and contamination from foreign industrial waste in the Laguna de San Andrés.

These dynamics require integrated attention through the development and application of the necessary technologies for better use of natural resources, as well as for the regulation of productive activities which cause changes in the environment, orienting them to levels which make them



compatible among themselves and with their environment. It is also necessary to keep in mind that in the world economic framework, the Gulf of Mexico will be a required element for analysis of aspects of the environmental border, management and health of shared ecosystems and international ecological regulations.

#### PRESENT CONDITION AND PROSPECTS FOR ECONOMIC ACTIVITIES DEVELOPED IN THE COASTAL REGION: PRIMARY SECTOR

The coast of Tamaulipas shows a balanced development of the primary sector between cattle raising, agriculture and fishing, with forestry limited to the exploitation of low quality tropical forest species (SARH 1991).

Agriculture is developed in the coastal zone from Río Soto la Marina to Matamoros, with irrigation agriculture being predominant. Cattle raising is extensive and takes place toward the south of Río Soto la Marina, where the best soils and climate are found.

Fishing is an activity developed along the entire littoral of Laguna Madre and is an art, with a large diversity of captive species including fresh as well as salt water organisms, with aquaculture in its beginning stages of development (FMVZ1993). The total population dedicated to agriculture, cattle raising, hunting and fishing is 27,713 people which represents 18% of the population located in the coastal districts of Tamaulipas (INEGI1990).

#### Agriculture

The districts located in the coastal region of Tamaulipas have 924,127 hect. of cultivable land, which represents 38% of the total of the state. The state of Tamaulipas is distinguished at the national level for being the number one producer of sorghum with 770,067 hect. planted and a total production of 2,447,584 tons (INEGI 1993). In this region, seasonal agriculture predominates on an extension of 797,068 hect., which represents 86% of the total in the area. Thereafter, the San Fernando and Aldama districts have 63% on 505,376 hect.

Irrigation agriculture represents only 8% of the cultivable land of the area, with development principally in the Matamoros and Soto la Marina districts, which occupy 66,971 hect. and 7,446 hect., respectively. A combination of irrigation and seasonal agriculture is also seen in these districts.

During the last 30 years, the state of Tamaulipas has been the leader in making the most dramatic changes in the use of soil in Mexico, replacing crops such as cotton and corn, as well as using important forest areas for growing sorghum (Pérez-Espejo 1988), which has resulted in the intensification of Aeolic erosive processes, causing the formation of real erosion pathways (SARH 1989). As stated, the agriculture developed in the Laguna Madre region is very intense due to the introduction of agrochemicals which are distributed and mainly found in water and soil (INEGI 1996).

### Cattle Raising

Toward the south of Laguna Madre, cattle raising activity predominates. The districts located in this area support 3,251,438 head of cattle, which make up 34% of the total of the state. In this region, bovine cattle predominate with 473,612 head (Creole races of the region with some cross-breeding with Cebú and Charoláis), which represent 42% of the state total. Of these, the Soto and Marina districts support 80%.

There are three variants in livestock production systems. The first is breeding and fattening of extensive bovine livestock; the second is a dual purpose (meat and milk) system; and the third is an intensive production of goat and equine livestock and a small-scale production of milk. Likewise, breeding of yard birds for eggs and pigs exists on a small scale.

### Forestry

The exploitation of the forest along the coast is of a domestic nature. Extraction exists only for making agricultural fences, wooden posts and rural construction; nevertheless, these activities have contributed to the deforestation of the lower thornscrub (UAT 1994). As a result of this kind of practice, the surface areas of the ecosystems have been reduced, affecting innumerable plant and animal species, of which birds are the most impacted. (DUMAC 1993).

### Fishing

The state of Tamaulipas has important natural resources which make wide development of fishing production possible. It has 485 Km of littoral with abundant lagoons, channels and rivers which have allowed the wide development of fishing activities. For this reason, this sector is very important in the local and national economy.

The importance of fish production in Laguna Madre is marked by its significant contribution of 40.35% to the state catch volume, which represents 20.57% of the state fish production, reaching 60 million (Secretariat of State Fishing 1990).

The most recent information indicates that the fish production volume of the Laguna Madre increased by 50% from 1980 to 1990, which was 6,897,600 to 13,630,237 Kgs. Previous data reveal that the marine infrastructure activities initiated in 1972, such as artificially opening the mouths and jetties and dredging activities, have provided conditions for better and more sustained fish production, thereby assuring a permanent source of work. Table 2G.1. (S.D.A.F. and P. General Fishing Management 1996)

According to DUMAC (1993) in the area of study, the intensity of catches has caused several points along the coast, as is the case with Laguna Madre, to be saturated with nets and lines, thus indicating a big fishing movement.

Table 2G.1. Volume of Fish Production in Tamaulipas per Catch of the Main Species (S.D.A.F. and P. General Fishing Management 1996).

<b>Species</b>	<b>Volume (Kg)</b>
Shrimp	10,943,491
Striped mullet	4,966,843
Crab	3,016,707
Tilapia	1,915,337
Carp	1,746,267
Eastern oyster	7,737,763
Sea trout	1,219,780
Dogfish	936,240
Shark	703,469
Huachinango	561,305
Catfish	450,303
Red drum	215,113
Croca	173,199
Bass	99,417

#### Aquaculture

Another activity of great economic importance is aquaculture, which is developed in the following areas: Río Tigre, Laguna Mar Negro, Carbonera, Media Luna, Barra del Tordo, Laguna de San Andrés, Río Barberena, Laguna de Morales, Río Soto la Marina, Río Tepehuajes, Higuierillas, El Mezquital, Laguna Madre, El Carrizal, Estero Almagre and Enramadas.

The main species farmed in the area of study are: the eastern oyster, catfish, shrimp, and tilapia as shown in Table 2G.2.

Table 2G.2. Main Aquatic Species Produced in Tamaulipas (SEMARNAP 1996).

<b>Species</b>	<b>Type of Farming</b>
Shrimp	Semi-intensive
Eastern oyster	Extensive
Catfish	Intensive and Semi-intensive
Tilapia	Intensive and Semi-intensive

There is also a rural aquaculture program whose main function is to supply breeding in reservoirs, as well as to conduct studies for those purposes, carrying them out through surveys of interested groups.

The species used most for involved districts in the area of study are Tilapia, sea bass, catfish, carp, garfish, and shrimp. The production volume of breeding in 1996 of various sea farming centers in Tamaulipas is shown in Table 2G.3.

Table 2G.3. Breeding production in seafood farming centers in Tamaulipas 1996 (S.D.A.F. and P. General Fishing Management 1996).

<b>Breeds</b>	<b>Total (thousands)</b>
Catfish	1,445.0
Garfish	454.4
Sea bass	278.6
Tilapia	1,698.0
Shrimp larva	11,817.0
Lobster	160.0

The Laboratorio Unidad Marina (Marine Unit Laboratory) is located in the district of Soto la Marina, the only breeding production center of the shrimp *Penaeus vanameii*, which comes from the Pacific (Contreras-Yañez 1993). In the area of study, farming of aquatic organisms has begun to develop satisfactorily, mainly the intensive and semi-intensive shrimp/fattening breeding farms. As of 1996 there were six production centers in operation (S.D.A.F. and P. 1997).

## SECONDARY SECTOR

### Conversion Industry

Basically there are two areas recognized as having industrial activity, which are located in the extreme north and south. To the north is the Parque Industrial Reynosa - Matamoros, where the factories are important. In the southern region are the Puerto y Corredor Industrial Altamira (Altamira Port and Industrial Corridor), where a large number of industries are dedicated to designing and processing various products in different petrochemical lines.

On the other hand, oil-related activities are developed in the cities of Reynosa, Altamira, and Ciudad Madero.

In the southern region, there are four industrial complexes bordering the Puerto y Corredor Industrial Altamira, all of which are of a petrochemical nature, in addition to the refinery in Ciudad Madero, on the bank of the Pánuco river (CANACINTRA 1993; AISTAC 1993).

The electricity-generating industry is developing in the Altamira district, affecting the area of study since the thermoelectricity established there is discharged into the Champayán lagoon (INEGI 1996).

Regarding the extractive industry, only salt is extracted, and this takes place on the continental bank of the Laguna de San Andrés and to the North of Laguna Madre. The districts dedicated to salt extraction are the following: Aldama (4,800 tons), Altamira (18,000 tons), Matamoros (100,000 tons) and Soto la Marina (200 tons) (INEGI 1996).

Port activity is developed on a small scale since there are only small-scale fishing ports, the majority of which do not have a loading dock adequate for other types of trade. The most important ports are located to the south and are the Puerto Industrial de Altamira and the Puerto de Tampico, where various kinds of merchandise are unloaded (Grains, Metals, Fabricated Merchandise, Minerals, Chemical Products, etc.).

## TERTIARY SECTOR

### Communication and Transportation

In general, the communication system within the area of study is reduced since there are only six stretches of paved highways going to the coast:

1. Matamoros-Playa Bagdad
2. Matamoros-Mezquital
3. San Fernando-Carbonera-Punta de Piedra
4. Soto la Marina-La Pesca
5. San José de las Rusias-Tepehuajes
6. Aldama-Barra del Tordo

These provide suburban transportation from the capital district to the populated towns from the different access routes, with the exception of San José de las Rusias to Tepehuajes. On the lagoons, littorals and rivers, transport is carried out on boats with outboard motors, which are also used in catching activities.

Regarding people who work in transportation and communications, there are 6,373 people. This figure represents 4.12% of the occupied area of the coastal districts.

## TOURISM

Because of its excellent geographic location, as well as the existence of natural beauty, among which are beaches and systems where hunting and fishing take place, it can be said that the state has an important potential for tourism (DUMAC 1996).

This possibility, within the area of study, is not very developed, principally due to the lack of adequate methods of communication which, combined with the rainy season and north winds, does not offer a year-round climate favorable to a steady stream of visitors at any significant level of tourism.

Tourism activities in the Altamira district are based mainly on sport fishing and beach areas. It is worthwhile mentioning that the industrial corridor affects large areas where tourism activities could be planned.

In Aldama, tourism is concentrated in Barra del Tordo, where a private area of foreign capital and fishing exist.

Tourism activity in the southern region is defined by the La Pesca tourism megaproject. It has an approximate area of 300 hect. on the FONATUR Master Development Plan. The La Pesca megaproject is designed to be the main foundation for the development of tourism in the state of Tamaulipas. The project encompasses an Ecological Reserve area of 3,500 hect. to be used for the conservation of natural resources in the area. It is also considered to be an urban rearrangement for the settlements on the shores of the Soto la Marina river due to the fact that in this area there are an important number of irregular settlements.

The La Pesca-Carbajal camp, which is located in the San Fernando District, has sport fishing activities in which North Americans are the main participants. In Matamoros, only the beginning stages of tourism development of Playa Bagdad are being considered.

## ENVIRONMENTAL PROBLEMS CAUSED BY ECONOMIC DEVELOPMENT ACTIVITIES IN THE COASTAL REGION

### Primary Sector: Agriculture and Livestock Industry Activities

The general framework of these activities has been developed in soils having an average potential for agriculture and a high average for livestock. The pressure that the agriculture and livestock industry exerts on the use of soil, especially in agricultural regions such as San Fernando and fishing areas such as Aldama, has resulted in the development of these activities on 86,749.1 hect. of unfit soil, causing increased erosion, especially in the agricultural regions which originally are fit for wildlife development.

It is likely that the agricultural border limit has been reached since the grounds dedicated to this activity suffer a gradual deterioration process; likewise, the agricultural practices in the area confront serious optimum production problems and the level of available water for agricultural purposes shows a tendency toward decreasing the irrigated land, which means that irrigation agriculture has reached its growth limit. Nevertheless, when the activities occur under intensive irrigation conditions, they have supported a gradual salinization of the soils. (Proyectos Biotecnológicos 1994).

Additionally, there are 70,693.8 hect. for agricultural use which are designated as fit for wildlife, increasing the agriculture and livestock border toward lands which are not fit for such use,

eliminating important areas where the lower deciduous forest predominated. The livestock practices lack adequate utilization techniques and exert over-exploitation of the soil because of improper management of grazing fields.

On the other hand, it is estimated that in 1996 approximately 20 tons of pesticides were used, mainly, organic phosphates, carbamates, pyrethroids and some inorganic ones. Their improper use causes product accumulation in the soil, which results in secondary effects to the quality of underground water and to health, due to bioaccumulation in the final products. (INEGI 1996)

### Forest Activities

Within the area of study there is no commercial exploitation of the resource since the kind of vegetation present does not sustain wood species. Therefore, only an informal extraction of certain species is done to cover domestic needs, which has caused a decrease in the resource, since there are no management practices in place for its sustained development.

### Fishing and Seafood Farming Activities

Various economic activities are being carried out in the area of study. Nevertheless, fishing and seafood farming are important aspects. Presently, their utilization is regulated exclusively by market criteria without considering conservation or protection criteria. Therefore, an analysis of the current fishing effort and conditions of seafood farming activity is required (FMVZ 1994).

The fishing effort is mainly oriented to catching shrimp during a five-month period, second to fishing and third, to catching eastern oysters and crabs. The type of boat limits the concentration of efforts to within the lagoons and along a small fringe of the coast, thereby reducing the catch area, and thus causing over-exploitation (UAT 1994).

The estuary ecosystems are places of important processes for the repopulation and reproduction of aquatic organisms, and the fact that 96% of the fleet is by the water's edge makes it evident that the limits and productive capacity of said organisms have already been exceeded.

Regarding the change in water quality due to anthropogenic activities, the effects of dumping industrial water, mainly by emptying heavy metals into Laguna el Barril, Laguna Madre and Laguna San Andrés, are well known (UAT 1994).

In addition, the return agricultural waters originating in the areas located in the study area adversely affect the development of aquatic species (DUMAC 1993).

Regarding the fish populations, which are considered to be the most sensitive to the pesticides, the main effects are death through direct exposure, indirect death through starvation brought about by the destruction of organisms which serve as food and by the change in respiratory rhythm. Chronic exposure causes damage to the liver, kidneys and gills, loss of appetite, restricted growth, low resistance to illnesses and a change in the metabolism of salts (Martínez 1982).

Common agrochemicals used in the basin of the Barberena and Tigre rivers are: Lorsban, Parathion Metílico 720, Bolstar, Curacrón, Orthene, Selexone, Azínfos metil, Gusatión, Metamidofos, Arrivo, Ambush, Pounce 500, Talcord, Lannate, Vydate, Pirmor, Furada, Thionex, Thiodán and Endosulfan. The probable concentrations found in the lagoon systems depend on the kind of products used as well as their quantity and the frequency with which they are used (Proyectos Biotecnológicos, [Biotechnological Projects 1994]).

## SECONDARY SECTOR

The coast of Tamaulipas shows the influence of two great rivers, the Bravo and the Pánuco, which are used as spillways from urban and industrial areas along the entire course up to the mouths. Environmental deterioration is caused by industrial activities located in the area, which mainly have repercussions in the contamination of bodies of water in the coastal lagoon system and in permanent streams and rivers. The records of Castillo (1993) are indicative of the amounts which, because of the proximity to Puerto Industrial de Altamira in the San Andrés Lagoon (Table 2G.4), have recorded levels of heavy metal contamination in sediments, presumably transported by marine currents. On the other hand, high levels of lead have been detected at the mouth of the Pánuco River.

Table 2G.4. Levels of heavy metals detected in sediments of the San Andrés lagoon. Vazquez (1990).

<b>Element</b>	<b>Amount</b>
Lead	8.85mg/l
Cadmium	2.76 mg/l
Zinc	3.184 mg/l
Copper	48.28 mg/l
Manganese	27.45 mg/l
Iron	64.50 mg/l

Another source of water contamination is the area under the influence of the Río Bravo, which drains waste to the sea generated in the Matamoros-Reynosa Industrial Park where neighboring bodies of water are entirely under its influence and which presently has a waste water treatment plant.

## TERTIARY SECTOR

The waters of the coastal lagoons and continental platform are affected by coliform bacteria since humans live on the water's edge and, without any urban services, fecal material is deposited outdoors. Although there is no periodical information regarding the contamination process, it implies that the levels of coliforms usually increase during the rainy seasons, given the run off of sediments toward the aquifer containers, with the following kinds of fecal bacteria having been in lagunal waters and from the continental platform (UAT 1994).



Based upon the work performed by several institutions, it can be confirmed that all the river edge communities have a negative effect due to dumping fecal material in the aquatic environment. This condition increases during the months of July, August and September and is even worse during December and January, the months during which the summer rains occur, which are characteristic of the entire coast of Tamaulipas, and to the amount of winter rains.

### ECOLOGICAL ORDER CRITERIA

For the purpose of obtaining and maintaining the ecological balance within the specified area, several regulatory criteria have been set forth. These criteria are directed toward prevention and reorientation of what is considered to be the root of the environmental problem in each of the economic activities, for the purpose of regulating use soil and managing the natural resources in accord with definite policies, which are stated in the studies document specializing in aquaculture and ecological order in the state of Tamaulipas, Chapter V, Strategy (Proyectos Biotecnológicos 1994).

#### Program: Cattle-raising Utilization: Regulation of Cattle-Raising Activities

The services and actions included in this specific program are for the purpose of regulating cattle-raising activities by diminishing the intensive use of over-exploited lands, as well as promoting the use of appropriate techniques to avoid exhausting the resource. Another objective is to set forth alternative utilization plans, different from those commonly used and based upon diversified use of the lands.

In this way, the services set forth are focused upon monitoring the change of land usage in activities that will mean greater intensity of utilization, financing to support field production through research and technological innovation appropriate for the area, and worker training to improve the plan utilized for applying the tick-spraying baths.

#### Program: Protection of Natural Resources: Management of Protected Areas

A package of necessary works and services is proposed for the area designated as a Protected Area with the purpose of achieving the proper performance from the turtle camps. Thus, the need to strengthen the existing infrastructure at these camps is set forth and to guard against acts of plundering or improper management of the ecosystem, such as the illegal capture of turtle eggs and the alteration of the nesting sites. The sites where it is necessary to keep in mind the aspects which this program encompasses are located in the Soto la Marina and Aldama districts.

#### Program Conservation And Restoration of Natural Resources: Management of Conservation Areas

This program addresses lands where remains of natural vegetation or of moderately well conserved communities are present but which, because of their size, do not merit protection. These areas are currently under pressure to be used in productive activities such as seasonal agriculture or extensive

cattle raising. The program proposes a series of services and actions to achieve their preservation and utilization in activities which do not endanger their permanence. Actions for monitoring ground clearing are included for agricultural purposes, promoting gradual change for ground use through forest cultivation activities or to designate them for the reproduction of wildlife.

On the other hand, the program includes protection of wild fauna, regulating its cultivation for hunting purposes and applying corresponding penalties when there is no authorization to hunt them (furtive hunting). In the case of migratory birds, it is suggested that the nesting sites of these species be specified by posting location and warning signs prohibiting alteration of their present conditions as well as by providing an ample information program to make the public aware of the importance of the wealth of the Laguna Madre as a nesting and reproduction habitat of resident and migratory birds.

In the case of aquatic resources, the importance of both monitoring the activities of sport fishing and penalizing unauthorized catch in sites that are natural seafood farming reservoirs is specified in the program.

#### Fishing Program: Research

The purpose of this program is to achieve rational utilization of the fishing resources in the region by regulating catch, by promoting seafood farming utilization, research for the development of proper catch technology, awareness of the fishing and seafood farming potential of the area and specific studies for introducing the cultivation of non-conventional species.

Development of specific studies the dynamics of the estuary and lagoon ecosystems will be the basis for conservation and rational utilization of the existing aquatic resources as well as the potential utilization of species not currently utilized.

#### FISHING UTILIZATION

The program's main objective is to promote the fishing activity of the region through the development of a supportive infrastructure, various promotional activities, and advice on the creation of cooperatives or companies which spearhead fishing activity.

#### SPECIFIC PROGRAM: FISHING PROMOTION

The program's objective is to achieve seafood farming development in the area since presently it is considered to be an under-utilized resource in the region. For this purpose, the establishment of oyster farms and semi-intensive and intensive cultivation programs are promoted such as the installation of floating cages, ponds for cultivating shrimp, crawfish and other sea crops, as well as seafood farming development of non-conventional species such as *Artemia salina*, snail, algae and molting crab. On the other hand, the program seeks to establish laboratories for seed and shrimp post-larvae production, molting crab and crawfish, as well as repopulating bodies of water with proper conditions for aquatic life and the organization of workers.

## CONCLUSIONS

Subsequent to the detected problem, the following studies and projects are set forth as alternative solutions:

- A. Study of the discharges originating from the urban-industrial regions of Matamoros and Altamira as well as the districts of neighboring Riego.
- B. Studies of contamination in the Laguna Madre caused by rain systems and the Gulf of Mexico. Projects to make the contamination less severe.
- C. Study of the dynamics of coastal dunes and sand hauling. Projects to stop desertization caused by these phenomena.
- D. Periodic studies on the desiccation and hypersalinization processes.
- E. Studies for the recovery of saline soils.
- F. Studies pertinent to the diversification of the agricultural farming standard.
- G. Study to establish a treatment plant for industrial waste waters in the northern area.
- H. Study to establish a plant for treating solid wastes, including those classified a hazardous.
- I. Study to establish a monitoring network to generate necessary information to maintain and conserve the characteristics of the seagrass meadow area.
- J. Study to stabilize the Sea - Lagoon connection mouths and the effect on fishing production.
- K. Periodic studies on the environmental impact of current fishing practices, dredging and mud clogging of the Sea - Lagoon connections and the reduction of the identified impacts
- L. Study to identify and follow up on the factors which affect the fishing and seafood farming potential of the area.
- M. Study of the productivity and dynamics of seafood farming reservoir populations.
- N. Study of species commercially important to Laguna Madre. Project for regulating the catch and populational balance of the associated fauna.
- O. Prospective study for managing non-conventional seafood farming species.

## REFERENCES

- Castillo, H.C. 1992 Governing Plan for the use of cattle raising and forest lands in the northern area of the state of Tamaulipas. SARH. Tamaulipas, Mexico. 286 pp.
- DUMAC 1993. Eco-geographical diagnosis for the management and conservation of the Tamaulipecan Laguna Madre through Landstat TM satellite images.
- DUMAC 1996. Study of environmental education and study of aquatic vegetation of Laguna Madre, Tamaulipas.
- School of Veterinary Medicine and Zootechny (FMVZ) 1994. Study of fishing and seafood farming potential and primary productivity of the Tamaulipecan coastal area of Ciudad Victoria, Tam., Mexico. 188 pp.
- INEGI. 1990. XI Census of Population and Housing. Definite results. Information by locality. Tamaulipas, Mexico. 264 pp.
- INEGI. 1993. Yearbook Statistics of the State of Tamaulipas. Tamaulipas, Mexico. 338 pp.
- INEGI. 1996. Yearbook Statistics of the State of Tamaulipas. Tamaulipas, Mexico. 414 pp.
- INEGI. 1996. Census of Population and Housing 1995. Preliminary results. Mexico, D.F. 301 pp.
- Martínez, M.R. 1982. Current problem of the Laguna Madre of Tamaulipas which hinders the development of aquacultural practices and possible solutions.
- Biotechnological Projects, S.A. de C.V. 1994. Specialized studies in Aquaculture and Ecological Order in the State of Tamaulipas, (UAT) 1994. Governor of the State of Tamaulipas. Secretariat of Fishing and Secretariat of Social Development.
- Secretariat of Fishing. 1991. Integral study of Laguna Madre, Tamaulipas for opening and stabilization of mouths, entrance canals and intersecting canal. 426 pp.
- Autonomous University of Tamaulipas (UAT) 1994. Evidence of Environmental Impact specific to Tamaulipecan Intracoastal Canal project. Governor of the State of Tamaulipas. Secretariat of Industrial, Commercial and Tourist Development. General Board of Canal and Coastal Infrastructure.
- Vazquez, E.A. 1990. Trace and heavy metals in the oyster *Crassostrea virginica* in San Andrés Lagoon, Tamaulipas.

## PERSPECTIVAS DE LA ZONA COSTERA DE TAMAULIPAS.

Dr. Sóstenes E. Varela Fuentes  
MC. Jorge A. Adame Garza  
Dr. Pedro Carlos Estrada  
Universidad Autónoma de Tamaulipas

### INTRODUCCION

El estado de Tamaulipas cuenta con una superficie de 79,384 Km<sup>2</sup> que lo ubica en el séptimo lugar entre los estados más grandes del país. Su economía se sostiene principalmente de la agricultura y la ganadería en los municipios de Soto la Marina, Aldama y San Fernando en los que se desarrolla también la silvicultura, la pesca y la acuicultura, aunque esta última es todavía incipiente. Entre las actividades secundarias sobresalen la industria manufacturera, especialmente en los municipios fronterizos de Matamoros y Reynosa, que cuentan con importantes plantas maquiladoras industriales y Altamira que se ha convertido en asiento de una planta industrial en proceso de crecimiento notable.

En la planicie costera nororiental del estado, existe 430 Km de litoral cuyas características estuarias, acceso y productividad sostienen la actividad pesquera, ocupando el séptimo lugar a nivel nacional en lo que respecta al volumen de captura. Así mismo la entidad cuenta con la tecnología y experiencia para la producción de 26 especies de interés comercial de las que sobresalen por su alto valor los crustáceos como el camarón y langostino, los moluscos como el ostión y almejas y especies de escamas finas y corrientes, varias de ellas características de la entidad.

La planicie costera cuenta también con extensas superficies en las que se encuentran recursos tales como los hidrocarburos, ecosistemas catalogados como de alto potencial productivo, áreas de excepcional valor paisajístico para la recreación y el turismo, así como aquellas consideradas como de alto calor ecológico para la conservación de la avifauna. Estas características convierten a la región costera en una region de alto potencial económico cuya integración al proceso de desarrollo estatal la transforman en una región estratégica.

El estado de Tamaulipas cuenta con el segundo sistema lagunar-costero de mayor extensión a nivel nacional, La Laguna Madre; en la cuenca septentrional de la laguna se encuentra una considerable variedad de ecosistemas costeros que presentan alteraciones a causa de distintas actividades humanas. En la zona costera de Tamaulipas, se presentan problemas, tales como la hipersalinización de origen natural y contaminación por residuos industriales en los cuerpos de agua y suelo de la región perteneciente al municipio de Matamoros; la degradación de los suelos por exceso de agroquímicos, el azolvamiento y contaminación por pesticidas en lagunas y esteros, así como el crecimiento acelerado de los asentamientos humanos en la costa del municipio de San Fernando; el azolvamiento acelerado de lagunas y sobre-explotación de los recursos acuáticos en Soto la Marina y la contaminación por residuos industriales foráneos en la Laguna de San Andrés.

En este contexto, la dinámica que se prevé exige atender de manera integral estos problemas, a través del desarrollo y aplicación de las tecnologías necesarias para el mejor aprovechamiento de los recursos naturales, así como por la regulación de las actividades productivas que ocasionen alteraciones al medio ambiente, orientándolas hacia niveles que las hagan compatibles entre sí y con su entorno. Además, es necesario tener presente que en el marco de la economía mundial, el Golfo de México será un elemento obligado de análisis para los aspectos ambientales fronterizos, el manejo y la salud de los ecosistemas compartidos y la normatividad ecológica internacional.

## SITUACION ACTUAL Y PERSPECTIVAS DE LAS ACTIVIDADES ECONOMICAS DESARROLLADAS EN LA ZONA COSTERA

### Sector Primario

La costa de Tamaulipas muestra un desarrollo del sector primario bastante equilibrado entre la ganadería, la agricultura y la pesca, quedando la silvicultura como una actividad limitada a la explotación de especies forestales tropicales, tipificadas como de calidad baja (SARH 1991).

La agricultura se desarrolla en la zona costera desde el Río Soto la Marina hasta Matamoros, predominando la agricultura de riego. La ganadería es de tipo extensivo y se presenta hacia el sur del Río Soto la Marina, en donde se encuentran los mejores suelos y clima.

La Pesca es una actividad que se desarrolla a lo largo de todo el litoral de la Laguna Madre y es de naturaleza artesanal, con una amplia diversidad de especies de captura y que incluye tanto organismos de agua dulce como marinos, estando la acuicultura incipiente en su desarrollo (FMVZ 1993). El total de la población dedicada a la agricultura, ganadería, caza y pesca es de 23,713 personas que representan el 18% de la población ocupada en los municipios costeros de Tamaulipas (INEGI 1990).

### Agricultura

Los municipios ubicados en la zona costera de Tamaulipas aportan 924,127 has de superficie cultivable, lo cual representa el 38% del total del estado. El estado de Tamaulipas se distingue a nivel nacional por ser el productor número uno de sorgo con 770,067 has sembradas y una producción total de 2,447,584 tons (INEGI 1993). En esta región, predomina la agricultura de temporal, realizándose en una extensión de 797,068 has que representan el 86% del total en la zona. De ésta, los municipios de San Fernando y Aldama aportan el 63% con 505,376 has.

La agricultura de riego representa sólo el 8% de la superficie cultivable de la zona, desarrollándose principalmente en los municipios de Matamoros y Soto la Marina, los cuales aportan 66,971 has y 7,446 has respectivamente. Una combinación de riego y temporal se realiza también en estos municipios.

El estado de Tamaulipas ha sido protagonista, en los últimos 30 años de los cambios de uso de suelo más espectaculares en México, sustituyéndose cultivos como el algodón y maíz, así como

importantes áreas forestales por el cultivo de sorgo (Pérez- Espejo 1988). Lo anterior a traído como consecuencia la intensificación de los procesos erosivos de tipo eólico llegando a formarse verdaderos corredores de erosión (SARH, 1989). Como se menciona la agricultura desarrollada en la región de la Laguna Madre es muy intensa por lo que se introduce una gran cantidad de agroquímicos que se distribuyen y se encuentran principalmente en agua y suelo (INEGI 1996).

### Ganaderia

Hacia el sur de la Laguna madre predomina la actividad ganadera. Los municipios ubicados en esta zona aportan 3,251,438 cabezas, las que constituyen el 34% del total del estado. En esta región predomina el ganado bovino con 473,612 cabezas (razas criollas de la región con algún grado de cruce con Cebú y Charoláis) las que representan el 42% del total estatal. De éstas, los municipios de Soto la Marina y Aldama aportan el 80%.

Se pueden encontrar tres variantes en los sistemas de producción ganadera. El primero trata de una producción de cría y engorda de ganado bovino tipo extensivo; el Segundo es un sistema de doble propósito (carne y leche) y el tercero una producción de ganado caprino y caballar de tipo intensivo y a pequeña escala para la producción de leche. De la misma forma, existe una crianza a pequeña escala de aves de corral para postura y cerdos.

### Silvicultura

La explotación forestal de la costa es de tipo doméstica. Únicamente existe extracción para la fabricación de cercos en la agricultura, postería y construcción rural; sin embargo, estas actividades han contribuido a la deforestación de la selva baja espinosa (UAT 1994). Como consecuencia de este tipo de prácticas, se han reducido las superficies de los ecosistemas, afectando un sinnúmero de especies vegetales y animales de los cuales, las aves son las que más se ven impactadas (DUMAC 1993).

### Pesca

El estado de Tamaulipas posee importantes recursos naturales que posibilitan un amplio desarrollo de la producción pesquera, cuenta con 485 Km. de litoral y con abundantes lagunas, presas y ríos que han permitido desarrollar en forma amplia las actividades pesqueras. Por lo anterior este sector constituye una actividad de gran importancia en la economía local y nacional.

La importancia de la producción pesquera de la Laguna Madre queda señalada mediante la significativa participación del 40.35% del volumen estatal de captura, lo que representa el 20.57% del valor de la producción pesquera estatal que asciende a 60 millones (Secretaría de Pesca Estatal 1990).

Los datos más recientes apuntan que el volumen de producción pesquera de la Laguna Madre se incremento en un 50% de 1980 a 1990 la cual fué de 6,897,600 a 13,630,237 Kgs. los datos anteriores revelan que las obras de infraestructura marítima iniciadas en 1972 como la apertura

artificial de las bocas las escolleras y obras de dragado han proporcionado las condiciones para una mejor y más sostenida producción pesquera con lo cual se asegura una fuente permanente de trabajo. Cuadro 2G.5 (S.D.A.F. y P. Dirección General de Pesca 1996).

Cuadro 2G.5. Volumen de la Producción pesquera por capturar de las principales especies en Tamaulipas (S.D.A.F. y P. Dir. General de Pesca 1996).

Especie	Volumen (Kg)
Camarón	10,943,491
Lisa	4966843
Jaiba	3,016,707
Tilapia	1915337
Carpa	1,746,267
Ostión	7,737,763
Trucha	1,219,780
Cazón	936,240
Tiburón	703,469
Huachinango	561,305
Bagre	450,303
Corvina	215,113
Croca	173,199
Robalo	99,417

De acuerdo con DUMAC,1993 en el área de estudio, la intensidad de las capturas ha provocado que diversos puntos de la costa, como es el caso de la Laguna Madre, se encuentran saturados de redes y líneas, manifestándose así un gran movimiento pesquero.

#### Acuicultura

Otra actividad de gran importancia económica es la acuicultura, la cual se desarrolla en las zonas siguientes: Río Tigre, Laguna Mar Negro, Carbonera, Media Luna, Barra del Tordo, Laguna de San Andrés, Río Barberena, Laguna de Morales, Río Soto la Marina, Río Tepehuajes, Higuierillas, El Mezquital, Laguna Madre, El Carrizal, Estero Almagre y Enramadas.

Las principales especies cultivadas en el área de estudio son el ostión, bagre, camarón y tilapia como se aprecia en el cuadro 2G.6.



Cuadro 2G.6. Principales Especies Acuicolas Producidas en Tamaulipas. (SEMARNAP 1996).

<u>Especie</u>	<u>Tipo de Cultivo</u>
Camarón	Semi-intensivo
Ostión	Extensivo.
Bagre	Intensivo y Semi-intensivo
Tilapia	Intensivo y Semi-intensivo

Existe además un programa de acuacultura rural, cuya función principal es abastecer de crías a embalses, así como la realización de estudios para esos fines, llevándose a cabo por medio de solicitudes de los núcleos poblacionales interesados.

Las especies que más se manejan para los municipios involucrados en el área de estudio son Tilapia, lobina, bagre, carpa, catan y camarón. Los volúmenes de producción de crías en 1996 de los diversos centros acuícolas que existen en Tamaulipas se presentan en el cuadro 2G.7.

Cuadro 2G.7. Producción de Crías en los Centros Acuícolas de Tamaulipas, 1996 (S.D.A.F.y P. Dirección General de Pesca 1996).

<u>Crías</u>	<u>Total (miles)</u>
Bagre	1,445.0
Catan	454.4
Lobina	278.6
Tilapia	1,698.0
Larva de Camarón	11,817.0
Langostino	160.0

En el municipio de Soto la Marina se localiza el Laboratorio Unidad Marina, único centro de producción de crías de camarón *Penaeus vanameii*, proveniente del Pacífico (Contreras-Yañez 1993). En el área de estudio, los cultivos de organismos acuáticos han empezado a desarrollarse satisfactoriamente, principalmente las granjas de engorda de camarón con cultivos intensivos y semi-intensivos. Hasta 1996 se contaba con seis centros de producción en operación (S.D.A.F. y P. 1997)

## SECTOR SECUNDARIO

### Industria de la Transformación

Básicamente se reconocen dos zonas con actividad industrial, las cuales se sitúan en los extremos norte y sur de la entidad. Al norte, se ubica el Parque Industrial Reynosa - Matamoros, en donde destacan de manera importante las maquiladoras. En la zona sur se encuentran el Puerto y Corredor Industrial Altamira, con un gran número de industrias dedicadas a la elaboración y procesamiento de diversos productos, en diferentes ramas de la petroquímica.

Por otra parte se desarrolla actividad petrolera en las ciudades de Reynosa, Altamira y Cd. Madero.

En la región sur, existen cuatro complejos industriales aledaños al Puerto y Corredor Industrial Altamira, todos ellos de índole petroquímica, además de la refinería de Cd. Madero, en la margen del río Pánuco (CANACINTRA 1993; AISTAC 1993).

La industria de la generación de eléctrica se desarrolla en el municipio de Altamira, afectando el área de estudio, ya que la termoeléctrica ahí instalada descarga en la laguna de Champayán (INEGI 1996).

En lo que se refiere a la industria extractiva, únicamente existe extracción de sal y se desarrolla en la margen continental de la Laguna de San Andrés y al Norte de la Laguna Madre. Los municipios que se dedican a la extracción de sal son los siguientes: Aldama (4,800 ton), Altamira (18,000 ton), Matamoros (100,000 ton) y Soto la Marina (200 ton) (INEGI 1996).

La actividad portuaria se desarrolla a pequeña escala, ya que sólo se tienen puertos pesqueros de pequeña envergadura de los cuales la mayoría no posee un muelle de arribo adecuado para otro tipo de mercancía. Los puertos de altura más importantes se ubican al sur y son el Puerto Industrial de Altamira y el Puerto de Tampico con desembarco de diversas mercancías (Granos, Metales, Mercancía maquilada, Miinerales, Productos químicos, etc.).

## SECTOR TERCIARIO

### Comunicaciones y Transportes

En general el sistema de comunicaciones dentro del área de estudio es reducido, ya que sólo existen seis tramos carreteros pavimentados que van a la costa:

- 1) Matamoros—Playa Bagdad
- 2) Matamoros—Mezquital
- 3) San Fernando—Carbonera-Punta de Piedra
- 4) Soto la Marina—La Pesca
- 5) San José de las Rusias—Tepehuajes
- 6) Aldama—Barra del Tordo

En ellas existe transporte suburbano de la cabecera municipal a los poblados terminales de las diferentes vías de acceso, con excepción de San José de las Rusias a Tepehuajes. Dentro de las lagunas, litorales y ríos, el traslado es realizado en lanchas con motor fuera de borda, las cuales también son utilizadas en las labores de captura.

En cuanto a las personas que se dedican a trabajar en transporte y comunicaciones, ésta es de 6,373 personas, que representan el 4.12% de la población ocupada de los municipios costeros.

### Turismo

La excelente ubicación geográfica de la entidad, así como la existencia de bellezas naturales entre los que se encuentran playas y sistemas donde se practica la caza y la pesca, permiten afirmar que el estado cuenta con un importante potencial turístico (DUMAC 1996).

Este rubro, dentro del área de estudio se encuentra poco desarrollado, principalmente por la falta de vías de comunicación adecuadas, que aunado al tipo de clima durante la época de lluvias y nortes, no favorecen una temporada anual completa para la permanencia de visitantes de cualquier índole turística.

Las actividades turísticas en el municipio de Altamira se basan principalmente en la pesca deportiva y zonas de playa; cabe mencionar que el corredor industrial afecta grandes áreas donde podría planearse la actividad turística. En Aldama, el turismo se concentra en Barra del Tordo, donde se encuentra un área privada de capital extranjero y se lleva a cabo la pesca.

La actividad turística en la zona sur ésta definida por el megaproyecto turístico de La Pesca, al sur de ésta población. Cuenta con un área aproximada de 300 has. consideradas en el Plan Maestro de Desarrollo del FONATURE. El megaproyecto La Pesca está diseñado para ser el principal polo de desarrollo turístico del estado de Tamaulipas. Dentro del proyecto se considera una zona de Reserva Ecológica de 3500 has. la cual está destinada para la preservación de los recursos naturales de la zona. Así también se considera un reordenamiento urbano para los asentamientos de los márgenes del río Soto la Marina, lo anterior debido a que en esta zona existe una importante cantidad de asentamientos irregulares.

En el Municipio d San Fernando, se encuentra el campamento La Pesca-Carbajal, donde se realizan actividades de pesca deportiva, siendo los principales usuarios de nacionalidad norteamericana. Para Matamoros, sólo se contempla el incipiente desarrollo turístico de Playa Bagdad.

## PROBLEMATICA AMBIENTAL GENERADA POR LAS ACTIVIDADES ECONOMICAS DESARROLLADAS EN LA ZONA COSTERA

### Sector Primario: Actividades Agropecuarias

El marco general de estas actividades se han desarrollado en suelos con potencial medio para la agricultura y de medio alto para la ganadería. La presión que ejerce la actividad agropecuaria sobre

el uso del suelo, especialmente en regiones agrícolas como San Fernando y Pecuarias como Aldama, ha provocado que se desarrollen estas actividades en 86,749.1 has de suelos no aptos para ello, originando un incremento de la erosión, especialmente en las áreas agrícolas que originalmente son aptas para el desarrollo de la vida silvestre.

Es probable que se ha llegado al límite de la frontera agrícola puesto que los suelos dedicados a esta actividad sufren un proceso paulatino de deterioro, así mismo en la zona las prácticas agrícolas enfrentan serios problemas de optimización productiva y el nivel de disponibilidad de agua para el abasto agrícola muestra una tendencia hacia la disminución en la superficie regada, lo cual significa que la agricultura de riego ha llegado a su límite de crecimiento. Sin embargo cuando las actividades se efectúan en condiciones intensivas de riego han propiciado una paulatina salinización de los suelos (Proyectos Biotecnológicos 1994).

Adicionalmente existen 70,693.8 has de uso agrícola catalogadas como aptas para la vida silvestre incrementando la frontera agropecuaria hacia terrenos que no presentan aptitud de uso para ese fin, eliminando importantes superficies donde predominaba la selva baja caducifolia.

Las prácticas pecuarias adolecen de técnicas adecuadas de aprovechamiento ejerciendo una sobreexplotación del suelo por un manejo inadecuado de potreros, lo cual conduce al agotamiento de la fertilidad del suelo al afectar adversamente su estructura.

Por otra parte se estima que durante 1996 se aplicaron aproximadamente 20 ton. de pesticidas predominando los organofosforados, carbamatos, piretroides y algunos inorgánicos. Su uso inadecuado provoca acumulación de productos en suelo, ocasionando efectos colaterales a la calidad del agua subterránea y a la salud, por bioacumulación de ésta en los productos finales (INEGI 1996).

#### Actividades Forestales

Dentro del área de estudio, no existe una explotación comercial de recurso debido a que el tipo de vegetación presente no sustenta especies maderables. En este sentido solo se realiza una extracción informal de ciertas especies para cubrir necesidades de carácter doméstico, lo cual ha llevado a una disminución del recurso, ya que no se realiza ninguna práctica de manejo para su desarrollo sostenido.

#### Actividades Pesqueras y Acuícolas

En el área de estudio se llevan a cabo diversas actividades económicas, sin embargo parte importante son los aspectos pesqueros y acuícolas. Actualmente su aprovechamiento está regido por criterios de mercado exclusivamente, sin que sean considerados criterios de conservación o protección, por lo que se requiere un análisis del esfuerzo pesquero actual y de las condiciones de la actividad acuícola (FMVZ 1994).

El esfuerzo pesquero se orienta principalmente a la captura de camarón durante un período de cinco meses, en segundo término se encuentra la pesquería de escama y en tercer lugar la captura

de ostión y jaiba. El tipo de embarcación obliga a concentrar esfuerzos dentro de las lagunas y una pequeña franja de la costa, lo cual reduce el área de captura, hasta llegar a la sobrexplotación (UAT 1994).

Los ecosistemas estuarinos son sitios de importantes procesos de repoblamiento y reproducción de organismos acuáticos y el hecho de que el 96% de la flota sea ribereña, pone en evidencia que los límites y capacidad productiva de estos han sido ya rebasados.

En cuanto a la alteración de la calidad del agua por las actividades antropogénicas, se conocen las afectaciones que se tienen por las descargas de aguas industriales principalmente por vertimiento de metales pesados en la Laguna el Barril, la Laguna Madre y la Laguna San Andrés (UAT 1994).

Adicionalmente, las aguas de retorno agrícola provenientes de las zonas ubicadas en el área de estudio afectan adversamente el desarrollo de las especies acuáticas (DUMAC 1993).

En cuanto a las poblaciones de peces, éstos se consideran como los más sensibles a los plaguicidas siendo los principales efectos la muerte directa por exposición, muerte indirecta por inanición provocada por la destrucción de organismos que sirven de alimento y la alteración del ritmo respiratorio. Las exposiciones crónicas, causan daños al hígado, riñones, branquias, pérdida de apetito, crecimiento restringido, baja resistencia a enfermedades y modificación en el metabolismo de sales (Martínez 1982).

En la cuenca de los ríos Barberena y Tigre los agroquímicos que se emplean comúnmente son Lorsban, Parathion Metílico 720, Bolstar, Curacrón, Orthene, Selexone, Azínfos metil, Gusatión, Metamidofos, Arrivo, Ambush, Pounce 500, Talcord, Lannate, Vydate, Pirimor, Furada, Thionex, Thiodán y Endosulfan. Las concentraciones probables que pueden encontrarse en los sistemas lagunares, dependerán de los tipos de productos utilizados, así como de su cantidad y frecuencia con que se emplean (Proyectos Biotecnológicos 1994).

## SECTOR SECUNDARIO

La costa de Tamaulipas presenta la influencia de dos grandes ríos, el Bravo y el Pánuco los cuales son utilizados como vertederos de zonas urbanas e industriales a lo largo de todo su recorrido hasta su desembocadura. El deterioro ambiental provocado por las actividades industriales ubicadas en el área, repercuten principalmente en la contaminación de los cuerpos de agua del sistema lagunario costero, en los arroyos permanentes y ríos. Los registros de Castillo (1993), es indicador de las cantidades que por la proximidad con el Puerto Industrial de Altamira, en la Laguna de San Andrés se han registrado niveles de contaminación en sedimentos con metales pesados, presumiblemente transportados por las corrientes marinas. Por otra parte, en la desembocadura del río Panuco se han detectado niveles altos de plomo en organismos sésiles.

Cuadro 2G.8. Niveles de metales pesados detectados en sedimentos de la laguna de San Andrés, Vazquez (1990).

Elemento	Cantidad
Plomo	8.85 mg/l
Cadmio	2.76 mg/l
Zinc	3.184 mg/l
Cobre	48.28 mg/l
Manganeso	27.45 mg/l
Fierro	64.50 mg/l

Otra fuente de contaminación de agua es el área bajo influencia del Río Bravo, que drena hacia el mar los desechos generados en el Parque Industrial Matamoros-Reynosa por lo que los cuerpos de agua aledaños, quedan enteramente bajo su influencia y actualmente se cuenta con una planta tratadora de aguas residuales.

#### SECTOR TERCIARIO

Las aguas de las lagunas costeras y plataforma continental, se ven afectadas por bacterias coliformes al existir asentamientos humanos en las márgenes, sin contar con servicios urbanos, depositándose las materias fecales al aire libre. Aunque no se cuenta con datos periódicos acerca del proceso contaminante, se infiere que los niveles de coliformes normalmente aumentan durante la época de lluvias, dado el escurrimiento de sedimentos hacia los vasos acuíferos, habiéndose detectado las siguientes especies de bacterias fecales en aguas lagunares y de la plataforma continental (UAT 1994).

Con base en los trabajos realizados por diversas instituciones, se puede afirmar que todas las comunidades ribereñas tienen influencia negativa por el aporte del material fecal al medio acuático, condición que aumenta durante los meses de julio, agosto y septiembre y de una manera más sensible durante diciembre y enero, meses que corresponden al régimen de lluvias de verano, característico de toda la costa de Tamaulipas ya la proporción de lluvias invernales.

#### CRITERIOS DE ORDENAMIENTO ECOLOGICO

Con la finalidad de asegurar la obtención y mantenimiento del equilibrio ecológico dentro del Área de Ordenamiento se han planteado diversos criterios de regulación dirigidos hacia la prevención y reorientación de lo que se considere como el origen de la problemática ambiental en cada una de las actividades económicas con la finalidad de regular el uso del suelo y dar un mejor manejo a los

recursos naturales de acuerdo a políticas definidas, lo cual esta plasmado en el documento Estudios especializados de acuacultura y ordenamiento ecológico en el estado de Tamaulipas en el Capitulo V Estrategia (Proyectos biotecnológicos 1994).

#### PROGRAMA: APROVECHAMIENTO AGROPECUARIO

##### Programa Específico: Regulación de las actividades Agropecuarias.

Los servicios y acciones que incluye este programa específico tiene como finalidad el de regular las actividades agropecuarias disminuyendo la intensidad de uso en los terrenos sobre-explotados, así como fomentando el uso de técnicas adecuadas para evitar el agotamiento del recurso. Otro objetivo es plantear esquemas de aprovechamiento alternativos, diferentes a los comunmente utilizados y que se basan en la utilización diversificada de los terrenos.

De esta manera los servicios que se plantean estan enfocados a vigilar el cambio de uso de suelo en actividades que signifiquen una mayor intensidad de aprovechamiento, financiamiento para apoyar la producción del campo a través de la investigación e innovación tecnológica apropiada para la zona, también incluye capacitación a productores mejorar el esquema utilizado para la aplicación de los baños garrapaticidas.

#### PROGRAMA: PROTECCION DE RECURSOS NATURALES

##### Programa Especifico: Manejo de Areas Protegidas

Para la zona que se ha definido como área de Protección se propone un paquete de obras y servicios que son necesarios efectuar con la finalidad de lograr el funcionamiento adecuado de los campamentos tortugueros. Así se plantea la necesidad de reforzar la infraestructura existente en éstos y vigilar que no se efectúen acciones de depredación o manejo inadecuado del ecosistema tales como captura ilegal de huevos de tortuga y alteración de los sitios de anidación. Los sitios donde es necesario tomar en consideración los aspectos que comprende este programa son en los Municipios de Soto la Marina y Aldama.

#### PROGRAMA CONSERVACION Y RESTAURACION DE LOS RECURSOS NATURALES

##### Programa Especifico: Manejo de Zonas de Conservación

Este programa va dirigido a terrenos donde se presenten relictos de vegetación natural o de comunidades medianamente bien conservadas, pero por su extensión no ameritan ser protegidas. Estas porciones actualmente presentan presiones para ser utilizadas en actividades productivas como la agricultura de temporal o ganadería extensiva, el programa propone una serie de servicios y acciones para lograr su preservación y la utilización en actividades que no comprometan su permanencia. Así se incluyen las acciones de vigilancia del desmonte para fines agrícolas, fomento al cambio paulatino de uso de suelo por actividades de aprovechamiento forestal o destinarlos a la reproducción de la vida silvestre.

Por otra parte el programa incluye protección a la fauna silvestre, regulando su aprovechamiento para fines cinegéticos y aplicando sanciones correspondientes cuando no exista autorización para su caza (caza furtiva). En el caso de las aves migratorias se sugiere la determinación de los sitios de anidación de estas especies (establecer señalamientos de ubicación y advertencia de no alteración a sus condiciones actuales así como un amplio programa de divulgación que incida en concientizar a la población de la importancia de la riqueza de la Laguna Madre, como habitat de anidación y reproducción de aves migratorias y residentes.

En el caso de recursos acuáticos se determina la importancia de vigilar las actividades de pesca deportiva y sancionar la captura no autorizada en sitios que constituyen reservorios naturales acuícolas.

### PROGRAMA PESQUERO

Este programa tienen como finalidad lograr el aprovechamiento racional de los recursos pesqueros en la región, regulando la captura, fomentando el aprovechamiento acuícola, promoviendo la investigación para el desarrollo de tecnología adecuada de captura, el conocimiento del potencial pesquero y acuícola de la zona y estudios específicos para la introducción de cultivos con especies no convencionales.

#### Programa Específico: Investigación

Desarrollo de estudios específicos para conocer de manera adecuada la dinámica de los ecosistemas estuvarianos y lagunarios de la zona lo cual será la base de la conservación y aprovechamiento racional de los recursos acuáticos existentes. Así como el aprovechamiento potencial de especies actualmente no utilizadas.

#### Programa Específico: Aprovechamiento Pesquero

El programa tiene como finalidad lograr el desarrollo acuícola en la zona ya que se considera que actualmente ello constituye un recurso sub-utilizado en la región. Con este fin, se promueve el establecimiento de parques ostrícolas y de programas de explotación semi e intensiva como la instalación de jaulas flotantes, estanques para la explotación de camarón, langostino y otros maricultivos. Así como el desarrollo acuícola de especies no convencionales como *Artemia salina*, caracol, algas y jaiba mudada. Por otra parte considera el establecimiento de laboratorios para la producción de semilla y postlarvas de camarón, jaiba mudada y langostino, así como el repoblamiento de cuerpos de agua con condiciones adecuadas para la vida acuática y la organización de productores.

### CONCLUSIONES

Posterior a la problemática detectada, se plantea la realización de los siguientes estudios y proyectos como alternativas de solución a la misma.



- A) Estudio de las descargas provenientes de las regiones urbano-industriales de Matamoros y Altamira, así como de los distritos de Riego aledaños.
- B) Estudios de contaminación en la Laguna Madre causada por los sistemas pluviales y del Golfo de México. Proyectos para su mitigación.
- C) Estudio de la dinámica de las dunas costeras y arrastre de arena. Proyecto para el freno de la desertización causado por estos fenómenos.
- D) Estudios periódicos de los procesos de desecación e hipersalinización.
- E) Estudios para la recuperación de los suelos salinos.
- F) Estudios tendientes a la diversificación del patrón de cultivos agrícolas.
- G) Estudio para el establecimiento de una planta para tratamiento de aguas residuales industriales en la zona norte.
- H) Estudio para el establecimiento de una planta para el tratamiento de residuos sólidos, incluyendo aquéllos catalogados como peligrosos.
- I) Estudio para el establecimiento de una red de monitoreo tendiente a generar la información necesaria para mantener y conservar las características de la zona de pastos marinos.
- J) Estudio para la estabilización de las bocas de comunicación Mar-Laguna y de su efecto en la producción pesquera.
- K) Estudios periódicos del impacto ambiental ocasionado por las artes de pesca actuales, el dragado y azolve de las comunicaciones Mar-Laguna y mitigación de los impactos identificados.
- L) Estudio para la identificación y seguimiento de los factores que afectan el potencial pesquero y acuícola de la zona.
- M) Estudio de la productividad y dinámica de poblaciones de los reservorios acuícolas.
- N) Estudio de las especies comercialmente importantes de la Laguna Madre. Proyecto para el ordenamiento de la captura y el equilibrio poblacional de la fauna asociada.
- O) Estudio prospectivo para el manejo de especies acuícolas no convencionales.

## BIBLIOGRAPHIA

- Castillo, H.C. 1992 Plan Rector para el uso de terrenos agropecuarios y forestales para la zona norte del estado de Tamaulipas. SARH. Tamaulipas, México 286 pp.
- DUMAC 1993. Diagnostico eco-geográfico para el manejo y conservación de la Laguna Madre Tamaulipeca a través de imágenes de satélite Landsat TM.
- DUMAC 1996. Estudio de educación ambiental y estudio de la vegetación acuática de la Laguna Madre, Tamaulipas.
- Facultad de Medicina Veterinaria y Zootecnia (FMVZ) 1994. Estudio del potencial pesquero y acuícola 37 productividad primaria de la zona costera de Tamaulipas. Cd. Victoria, Tam., México. 188 pp.
- INEGI 1990. XI Censo de Población y Vivienda. Resultados definitivos. Datos por localidad. Tamaulipas. México. 264 pp.
- INEGI 1993. Anuario Estadístico del Estado de Tamaulipas. Tamaulipas. México. 338 pp.
- INEGI 1996. Anuario Estadístico del Estado de Tamaulipas. Tamaulipas. México. 414 pp.
- INEGI 1996. Censo de población y Vivienda 1995. Resultados preliminares. México, D.F. 301 pp.
- Martínez, M.R. 1982. Problemática actual de la Laguna Madre de Tamaulipas, que impide el desarrollo de las prácticas acuaculturales y soluciones posibles.
- Proyectos Biotecnológicos, S.A. de C.V. 1994. Estudios Especializados en Acuicultura y Ordenamiento Ecológico en el Estado de Tamaulipas. Gob. del Edo. de Tam. Secretaría de Pesca y Secretaría de Desarrollo Social.
- Secretaría de Pesca. 1991 Estudio integral de la laguna madre, Tamaulipas para la apertura y estabilización de bocas, canales de penetración y canal de interconexión. 426 pp.
- Universidad Autónoma de Tamaulipas (UAT) 1994. Manifestación de Impacto Ambiental. Modalidad específica para el proyecto Canal Intracostero Tamaulipeco. Gob. del Edo. de Tam. Secretaría de Desarrollo Industrial, Comercial y Turístico. Dirección General de Infraestructura Canalera y Costera.
- Vazquez, E.A. 1990. Trace and heavy metals in the oyster *Crassostrea virginica* in San Andrés Lagoon, Tamaulipas

## NEOTROPICAL MIGRATORY BIRDS AT PADRE ISLAND NATIONAL SEASHORE, TEXAS

Mr. Darrell L. Echols  
U.S. National Park Service

### INTRODUCTION

Each year millions of birds migrate between North and South America during the spring and fall months. These migrants include species of waterfowl, shorebirds, raptors, and songbirds. Neotropical birds, which are songbirds that occur in the "New World," include species such as tanagers, orioles, buntings, warblers, thrushes, and hummingbirds. Unfortunately, the populations of most neotropical migrants are in a severe state of decline. Populations that were either stable or increasing in the 1960s and 70s have started declining in the 80s and 90s. It is estimated that these declines are averaging between 2 and 4% each year and some species have showed as much as a 60% decline over the past 10 years.

The primary reason for the declines in bird populations is the loss of essential habitat in both North and South America. Additional factors influencing their decline include the use of pesticides, losses of food sources due to larger, non-migratory species, and capturing for the pet trade (Fenwick 1997). However, efforts are underway to gather important data on the use of habitats by different migrant species and help protect these important habitats. Padre Island National Seashore (PAIS) has such an effort in place.

Padre Island National Seashore can be found near the southern tip of Texas and is located along the Central Flyway for migration. As such, PAIS provides some of the first habitat available to migratory birds that cross the Gulf of Mexico and is a haven during storms for those birds that follow the coast line during their migration. Habitat on the PAIS is, thus used for shelter and a source for food for a large number of neotropical migrant species.

Beginning in 1993, PAIS initiated an inventory and monitoring project to determine the diversity and abundance of the neotropical migrants occurring in the park. These surveys have indicated the park's significance as a refuge for migratory species. However, in the spring of 1997, the park enhanced its efforts for monitoring migrants. With this survey, the park continued monitoring the diversity of neotropical migrants but started investigating the use, by these migrants, of various park habitats (Chaney *et al.* 1997).

### METHODS AND RESULTS

Two areas were selected to provide information on the use of different habitats. Each area contained the same types of sub-habitats that included dunes, grasslands, and wetlands. However, one area was severely affected by a fire in July of 1996. Species diversity and abundance was determined by banding birds using mist-nets and by conducting transect counts.

## Banding

Since mist nets require tall vegetation to be effective, the burned area would not support the placement of mist nets but would, however, allow comparison using transect counts. A total of 15 mist nets were erected. Five mist nets were placed in partially vegetated dune habitat dominated by mesquite (*Prosopis glandulosa*) and black willow (*Salix niger*) and five mist nets were placed in wetland habitat that was dominated by black willow. Five additional nets were placed near the park's Ranger Station to offer comparison of bird use near park structures and development.

Nets were opened at or near dawn on sampling days and monitored for an entire day between 26 March and 11 May for a total of 13 banding-days. Banding efforts coincided with a series of southward moving air masses from Canada. All mist nets were checked for birds at least every 30 minutes. Captured birds were identified, aged (where possible), sexed (where possible), weighed, wing cord measured, tarsus measured, and banded. Photographic records were kept of many species.

Over the course of 13 banding-days, a total of 839 birds representing 81 species were banded. The vast majority of these birds lacked any evidence of fat. The Baltimore Oriole was the most frequently caught bird accounting for 11% of all banded birds. Overall, 10 of the 81 species included: Baltimore Oriole, Swainson's Thrush, Indigo Bunting, Magnolia Warbler, Northern Waterthrush, American Redstart, Hooded Warbler, Orchard Oriole, Tennessee Warbler, and Yellow-breasted Chat and accounted for 53% of all banded birds.

The dune habitat provided 347 birds representing 60 species with the Baltimore Oriole accounting for 20% of the birds banded. The wetland habitat produced 334 birds and 61 species. The most commonly caught species, however, was the Northern Waterthrush, which accounted for 9% of the banded birds. At the PAIS Ranger Station, 120 birds from 37 species were netted and banded. The lower numbers from this site resulted from not opening the nets on certain days when banding took place at the dune and wetland sites. The most frequently caught bird at the Ranger Station was the Indigo Bunting, which accounted for 18% of the total catch.

Despite the habitat differences between the dunes and wetlands, there were no significant differences in either the number of species or in the number of birds banded. Comparisons among the numbers of birds banded at the dune and wetland were not compared with the Ranger Station site because of the discrepancies in times that the nets were opened at the Ranger Station site.

Three weather fronts, occurring between 12 and 10 May, pushed down the majority of birds netted. The 12 April front produced the greatest species diversity and the greatest warbler diversity. The 26 April front resulted in the largest abundance of birds totaling 312 being netted. Twenty-three species of wood warblers were banded during the study. Chronologically, the Yellow-rumped Warbler was the first to be netted. These were followed by the Black-and-White Warbler and Hooded Warbler which first appeared during the second front. The third front yielded the first Northern Waterthrush, Worm-eating Warbler, and Yellow-throated Warbler.

Perhaps the most notable bird netted this year was a male Black-capped Vireo caught on 13 April. This bird is believed to be the first report of this species on the Padre Island National Seashore, the first in Kleberg County, and the first record for the Coastal Bend. The survey also recorded a Varied Bunting, which has not been recorded within the park before. However, it was not caught and consequently, not banded.

### Transects

Two groups of three line-transects were established near the Bird Island Basin area of the park. One group was located in the burned study area and the other group was located in the unburned study area. Each line transect covered 200 m and were established in a (1) grassland habitat, (2) a partially vegetated sand dune habitat, and (3) a wetland habitat. Birds observed within 25 m of the observer were recorded. Thus, each transect belt encompassed an area of 10,000 m<sup>2</sup> or one hectare. Transects were sampled by foot on 12 days. Records of species and the numbers of individuals of each species were maintained. Although an initial attempt was made to walk each habitat transect at a constant rate, the enormous number of birds that appeared during the fallouts made this impossible. Consequently, data collected was standardized to allow statistical analysis.

A total of 1,143 birds encompassing 98 species was counted on the transects. In the burned transects, 356 birds including 58 species were observed, while 787 birds and 86 species were encountered on the unburned. However, there were only 2,456 observation minutes devoted to the burned transects and a total of 10,247 minutes in the unburned areas. The discrepancy in observation minutes resulted from an effort to record and identify all birds observed. The burned transects were dominated by the Eastern Meadowlark, and the unburned area was dominated by the American Redstart.

Birds were encountered at a higher rate, on average, in the wetlands than in either the dune or grassland sites. No statistical differences were seen between the burned and unburned areas with regards to the number of birds encountered or the species seen within the grassland and wetland habitats. However, there were significantly more species encountered between the unburned dune and the burned dune habitat.

Despite the general lack of statistical distinction between the burned and unburned sites, nearly three-fourths of the birds (77%) that were observed only within one of the two treatment areas were found in the unburned locality. Most of these birds were neotropical migrants; all warbler species were encountered in the unburned area and only nine were observed in the burned area. Moreover, in the unburned habitat most species encountered were neotropical migratory species such as the American Redstart and Common Yellowthroat. However resident bird species such as the Eastern Meadowlark and Lesser Yellowlegs were seen in the burned habitats.

### SUMMARY

Weather patterns during the spring of 1997 facilitated a series of fallouts for migratory birds that were greater than those of the past several years. The number of individual birds banded and the species diversity clearly indicate the value of PAIS as a haven or stopover for migratory species. The

overwhelming absence of fat in these migratory species further underscores the importance of stopover sites, such as the PAIS.

Although, the transect data supports the notion that burned habitats are not as readily used by neotropical migrants, this was probably due to many of the trees in the burned habitat being void of vegetation and what little vegetation that was present did not offer enough protection or sufficient amounts of food. The differences between the burned and unburned habitats, point out the importance of tree structure to migratory bird species and indicate the need to protect this vegetation. Although wildfire is an important aspect of ecology, protection of avian habitat is necessary. The development of a re-vegetation program is being undertaken to allow park management to enhance areas that have been impacted by fire.

The importance of PAIS as a bird area is clearly evident. First, with over \$5 billion being spent each year either watching birds or supporting the birding industry, it is clear that birding has become an important recreational activity. Padre Island National Seashore provides an important recreational area not only because it is a National Park but also, because of the high abundance and species richness of the birds that occur here. Secondly, with the decline in neotropical bird populations worldwide, PAIS provides the necessary habitat for the protection, food, water, and rest needed for migration.

#### REFERENCES

- Chaney, A.H., S.A. Smith, and G.W. Blacklock. 1997. Habitat Use and Species Diversity of Neotropical Bird Species During the 1997 Spring Migration on the Padre Island National Seashore. U.S. Dept. of the Interior, National Park Service, Padre Island National Seashore, Corpus Christi, Tex. 92 pp.
- Fenwick, G.W. 1997. Bird's Eye View, p 2.. *In* Bird Conservation, Washington, D.C.: American Bird Conservancy.

## IMPACTOS POTENCIALES DE LA CONSTRUCCION DEL CANAL TAMAULIPECO EN LAGUNA MADRE, TAMAULIPAS

Dr. Laura Muñoz Palacios  
Universidad Autónoma de Tamaulipas, México

Se presenta un modelo conceptual que permite analizar algunos aspectos de la sustentabilidad del proyecto de construcción del Canal Intracostero Tamaulipeco (CIT), en la Laguna Madre de Tamaulipas, enfatizando los aspectos ecológicos que presumiblemente podrían ser más impactados a causa del desarrollo de este proyecto.

Existe un amplio consenso de que este canal de navegación, es prioritario para el Estado de Tamaulipas, para la región del Golfo de México y para el país, en relación a las garantías económicas en que se finca la propuesta, ya que se pretende establecer contacto mediante una vía de comunicación pluvial con el área comercial más importante del mundo.

En el contexto actual de desarrollo sustentable, es importante considerar que la región costera tamaulipeca presenta ecosistemas lagunares cuyas características de vulnerabilidad de impacto son en extremo susceptibles ya que por ejemplo, la región que comprende la Laguna Madre, contiene a uno de los humedales más importantes por su extensión y productividad a nivel internacional; constituye una zona de paso obligado de descanso y alimentación, en las migraciones de aves neárticas hacia la zona neotropical; es la reserva de aves playeras de humedales más importantes de América; contiene una gran biodiversidad florística y faunística con endemismos y especies en estatus de protección (Escofet 1995).

Los aspectos de mayor importancia que surgen como ejes directrices de la problemática ambiental relacionada con el CIT son: 1) la interconexión de cuerpos de agua con diferente integridad ecológica; (2) dragado y disposición de los sedimentos; y (3) las implicaciones socioeconómicas.

En este trabajo se particulariza en los impactos potenciales de la mezcla de masas de agua de diferente calidad al ser interconectados no menos de seis ecosistemas costeros distribuidos a lo largo de los 439 km de la costa tamaulipeca sobre la que se ha proyectado la construcción del canal.

En el modelo conceptual (Escofet *et al.* 1995), se proponen diferentes escenarios posibles del riesgo resultante de la mezcla de aguas de diferente integridad ecológica (Figure 2G.1).

Las dos alternativas para las que la mezcla es irrelevante son los casos cuando existiera integridad ecológica en todos los cuerpos de agua que se mezclen, y cuando se presentara depresión en la integridad ecológica debido a un solo agente.

Aquí son prioritarios los riesgos implicados con la homogenización de parámetros hidrológicos como salinidad, temperatura, gases disueltos, nutrientes, turbidez, etc, y el encuentro de poblaciones o especies anteriormente aisladas.

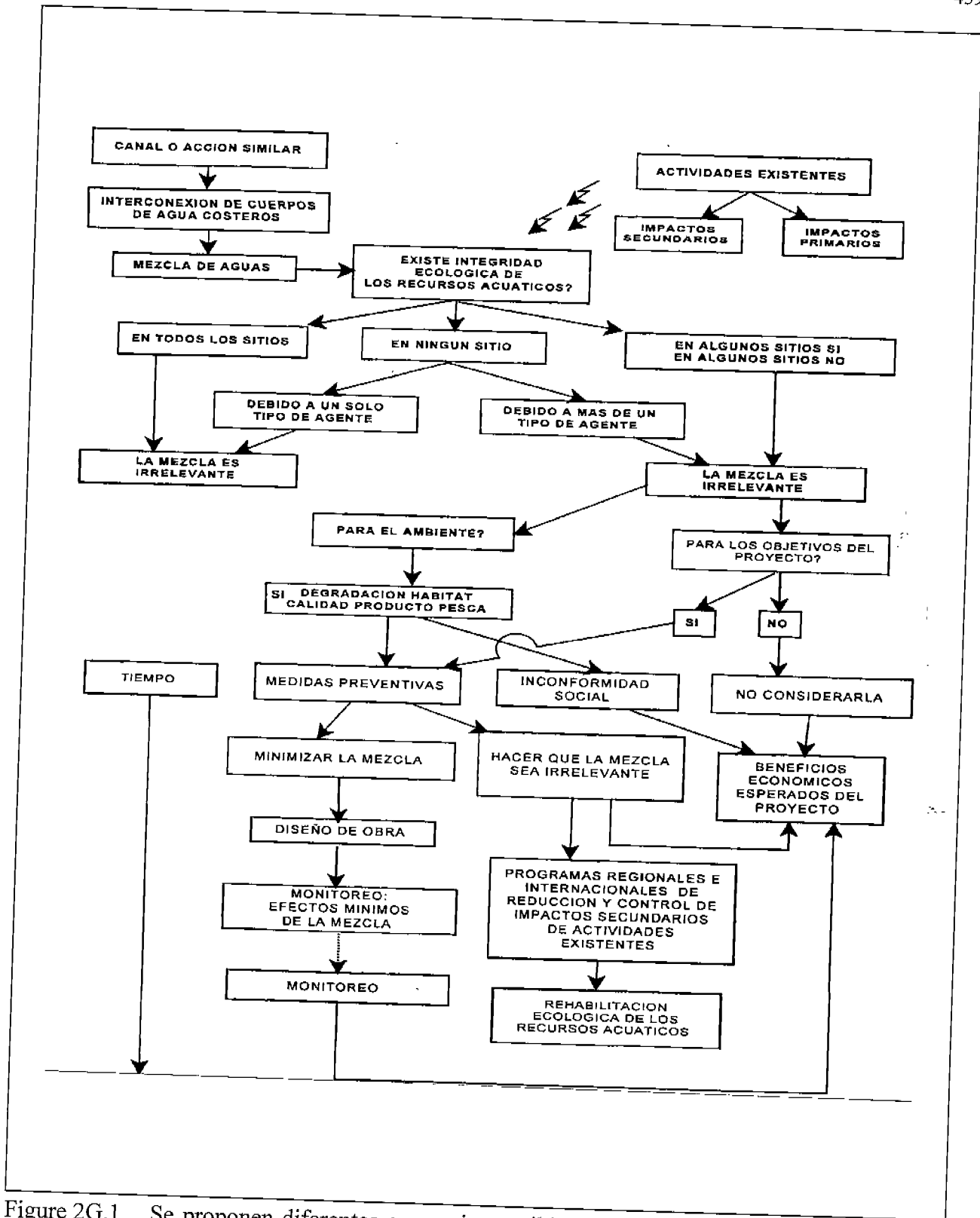

Figure 2G.1. Se proponen diferentes escenarios posibles del riesgo resultante de la mezcla de aguas de diferente integridad ecológica.



Estos escenarios serían escasamente probables ya que existe un escenario costero deteriorado por impactos secundarios de las actividades ya existentes, situación que se hace patente en la baja calidad de las aguas en la mayoría de los cuerpos que se interconectarán.

Los sectores localizados hacia ambos extremos de la Laguna Madre (límites de los ríos Pánuco y Bravo) contienen masas de agua con alta contaminación y solo algunos sectores con mejor calidad de agua se localizan hacia el centro de la región (Escofet, 1995).

Por otra parte, la relevancia es determinante cuando no existate integridad ecológica (debido a la presencia de más de un agente) en ninguno de los cuerpos de agua que se homogenizarán; y cuando existe integridad ecológica solo en algunos sitios.

Estos son los casos probables de mayor riesgo y por lo tanto de gran relevancia, y están relacionados con los impactos secundarios de las actividades humanas emplazadas sobre las cuencas (efluentes, emanaciones, vertimientos), los cuales llegan a los cuerpos de agua en forma indiscriminada, sin tratamiento, e inciden negativamente sobre los mismos.

Bajo estas condiciones, si la interconexión permite una mezcla importante en proporción al volumen total el resultado será un deterioro generalizado de la integridad ecológica de los recursos acuáticos en la región del proyecto.

Si para los objetivos del proyecto esta situación no se considerara relevante, aún cuando los efectos previsibles por la depresión de la integridad ecológica de las aguas se manifestara como degradación de hábitat, reducción en la calidad de los productos pesqueros o el volumen de los mismos, se podrían desencadenar circuitos de inconformidad social.

Para evitar y enfrentar esta posibilidad en el modelo se plantean acciones preventivas, tanto de corto, como de mediano y largo plazo.

En el plazo inmediato, se recomienda la modificación al diseño del proyecto a fin de reducir el mínimo la mezcla de aguas, para favorecer un patrón de circulación con rápido desplazamiento de las aguas deterioradas hacia el mar abierto, donde la dilución a gran escala permitiera una amortiguación de sus efectos.

En el mediano y largo plazo es necesario implementar programas dirigidos a corregir la raíz del problema, propiciando que las actividades preexistentes reduzcan las emanaciones, vertimientos no tratados y desechos.

Mediante el modelo se pretende presentar una descripción realista de la calidad ambiental del sitio para el que se proyecta el Canal Intracostero Tamaulipeco.

## BIBLIOGRAFIA

Escofet, A. 1995. Reporte Técnico de la revisión del proyecto de Resolución de la MIA del Canal Intracostero Tamaulipeco, CiCESE, 14 pp.

Escofet, A. Merino, M., Gold, G., 1995. Propuesta de manejo de los riesgos implicados en la interconexión de cuerpos de agua costeros. (*En prensa*), 6 pp.

---

Dr. Laura Muñoz, ha trabajado en la Universidad Autónoma de Tamaulipas, México, durante los pasados 15 años en el departamento de Ingeniería Ambiental de la Unidad Académica Multidisciplinaria Reynosa- Rodhe (UAMRR). Ha sido maestro en asignaturas de ecología, matemáticas y contaminación. Sus áreas de interés en investigación son la administración de la zona costera además de implementación de la educación ambiental en instituciones de educación superior. Dr. Muñoz, estudió la carrera en Oceanología en la Universidad Autónoma de Baja California y la Maestría en Ciencias en el Centro de Investigación y Educación superior de Ensenada (CICESE) y la maestría en Educación Superior en la Universidad Autónoma de Tamaulipas.

### POTENTIAL ENVIRONMENTAL EFFECTS ON LAGUNA MADRE OF TAMAULIPECO CHANNEL DREDGING

Dr. Laura Muñoz Palacios  
Autonomous University of Tamaulipas, Mexico

This paper addresses the potential impact on Laguna Madre of the construction of a channel that will join the bodies of water across approximately 439 kilometers of the Tamaulipeco littoral.

The coastal lagoons of Mexico are characterized by a high biodiversity, high primary and secondary production, high exchange of organic material, several high areas of salinity and specific botanical adaptations. In reference to the Gulf of Mexico, large bodies of water have been found with these characteristics. U.S. ecological studies are very complete, and projections can be made regarding what is supposed to happen in the future. In Mexico, we would like to work in a similar way, but our chances are limited.

All the coastal lagoons in Mexico are affected by contamination from industrial developments on their borders. In addition, in recent years, agricultural contamination has also been a problem, as has the careless exploitation of resources.

The construction of an intracoastal channel has been planned which would not only join the Laguna Madre, but all the estuaries and other lagoons which are found on the Tamaulipeco littoral coastal

zone. The Laguna Madre has importance in addition to all the characteristics of the coastal lagoons.

The Laguna Madre is found in the Tamaulipeco littoral coastal zone which neighbors Texas. The Laguna Madre is one of the most important wetlands internationally because of its size and productivity. The Laguna Madre is a mandatory stopover area for rest and food in the immigration of Antarctic birds to a neutral tropical zone and is one of the reserves of beach birds from the most important wetlands in America. It has a great biodiversity of flora (280 species) and fauna (376 species), with a large number of endemic species protected by law. It is one of the northernmost forests of mangrove trees and pine trees in the Mexican Republic. It functions as an overflow aquifer and container of flood waters and filters polluted waters from the waters of the region. In addition, it is home to the Kemp's Ridley sea turtle, finding a protected area for which is a key conservation issue.

The project will interconnect all the bodies of water of that region. The objectives of this super project are commercial development, the push toward the future, and the uniting of 439 kilometers of rain runoff in the state of Tamaulipas with the 45,000 kilometers of rain runoff from the United States.

The channel will be built along the Tamaulipeco littoral, taking advantage of the lagoon area and the natural inlets. The goals are to utilize the navigational (runoff) channel for transportation of coastal trade; improve electrical and agricultural productivity; open mouths and sand bars which assure the connection between the sea and the lagoon; develop of integral tourist areas; develop the main border cities of the state; foster activities which transport raw materials; optimize the present infrastructure of coastal and railway transportation; foster national and international tourism; minimize transportation costs; establish contact with the most important commercial area in the world; establish, open or discourage current impact conditions caused by the lagoon systems of the state and by hypersalinity, evaporation, and other factors.

The project poses three potential environmental problems. The first of these is interconnecting bodies of water of ecologically different integrity. The second is dredging and exposing sediments. It will be necessary to dredge a channel of approximately four meters in depth, 439 kilometers in length and 30 meters wide. Therefore, all the sediments will be deposited on one side. The third is socioeconomic, involving problems that would originate from land ownership in areas places where the work is projected, and the ranches or farming properties used for cultivation, cattle raising and agricultural activities.

The interconnection of bodies of water of ecologically different integrity is considered the most delicate impact of the project. A committee of scientists from all the main centers and research institutes of the Mexican Republic were called together by the National Institute of Ecology and by the project management team and conducted and concluded, among many other things, that interconnecting the waters would be the most drastic area of impact.

The SIG will be built at a coastal site where secondary effects from existing activities have already lower quality in some of the systems to be interconnected. There are sectors with high pollution in

the water toward both extremes of the Laguna Madre, such as the shores of the Bravo and Panaco Rivers.

Definite studies have shown the presence of high pollution originating from the salt marsh area of the Rio Bravo. This pollution results from industrial and urban development in the area and the inadequate treatment of the flowing water in the Rio Bravo and in the lagoons located in this area. The contaminating presence of hydrochemicals has also been detected in the central area of the Laguna Madre. The southernmost area also has a high contamination due to industrial development in the Alta Mira area.

These bodies of water, each with its pre-existing concentrations of contamination, would be connected by the channel. Their connection would give rise to a negative incident because of the increase and broad reach of lower quality waters interconnecting no less than six coastal ecosystems along 439 kilometers of the Tamaulipeco coast.

To mix the waters, which will result from the construction of the channel, it is necessary to answer a key question: Do the aquatic resources have the ecological integrity to be connected? There are three possible answers. In the first scenario, ecological integrity would exist at all the sites to be interconnected. This case would be the ideal, and the mixture would be irrelevant. Nevertheless, existing activities have demonstrated the presence of secondary factors which make this case impossible.

In the second scenario, the ecological integrity of any site would be depressed by only a single agent. In this case, the pollutant can be detected and corrected; thus, the mixture is irrelevant.

In the third scenario there would be a site with ecological integrity and others without it. Apparently this case is the most likely one for the construction of the SIG. We are, however, working hypothetically. As for now, if mixture is relevant, we should ask ourselves whether it is relevant for the environment, or for the goals of the project?

If the mixing is considered relevant for the environment only and ecological integrity exists at some sites but not at others, a degradation of the habitat would arise with repercussions on the quality of fish products. This is very important for the communities that live in the Laguna Madre area and in all the Tamaulipas littoral as 20,000 families depend on the aquiculture of the area. Therefore, if there is mixture that would deteriorate, the whole lagoon or coastal littoral would be affected. These social circuits are important, given that their ability to affect environmental development activities has been seen to increase lately as environmental legislation has strengthened the power of non-environmental groups. In the event that the mixture is considered relevant to the goals of the project, there would be damage to fishing in the habitat, and the long-term economic benefits of the project could perhaps be affected.

Nevertheless, these effects could result from the project, and proposals to minimize or correct them must be included in the design level of the work. A monitoring program must be put in place to

ensure that minimal degradation of the habitat occurs and that the economic benefits of the project do not suffer.

Another way to prevent habitat degradation is that the mixture, if it is irrelevant, should be implemented by regional programs in places where already affected by existing activities. This alternative involves cleaning those areas that are up to now have been affected by residue of some kind. Over time, this is very important.

## **BEACH GARBAGE: POINT SOURCE INVESTIGATION PADRE ISLAND NATIONAL SEASHORE, TEXAS**

Mr. John E. Miller  
U.S. National Park Service

Dr. Edward R. Jones  
Texas A&M University–Corpus Christi

### INTRODUCTION

Padre Island is a barrier island located on the southeastern coast of Texas. Created by the Congress of the United States in 1962, Padre Island National Seashore (PINS) is the longest undeveloped barrier island beach in the United States and is visited annually by over 1 million people. Although similar in many ways to other National Seashores, Padre Island National Seashore is atypical because of the large quantity of marine debris that washes onto its shoreline (Miller *et al.* 1995). Historically, this was not the case, and Padre Island was known as the Texas Rivera because its lovely, relatively uncluttered, beaches. However, with the increased use of non-degradable plastics by all sectors of society, beach debris has increased. In 1988, it was estimated that Padre Island National Seashore received about 580 tons of marine debris per year—over 10 tons per mile (Cottingham 1988).

An international treaty known as MARPOL prohibits dumping at sea. The treaty was established in 1973; was ratified by the United States in 1987 and, has been in effect for the United States since 31 December 1988. Annex V of MARPOL specifically prohibits dumping plastics by vessels at sea. As of May 1996, 79 countries had ratified MARPOL Annex V (Sheavly 1996). However, because approximately 90% of all shoreline garbage items found at Padre Island National Seashore are made of plastics, we question whether the MARPOL Annex V regulations are working.

Sadly, the myriad problems associated with marine and beach garbage are not restricted to Padre Island National Seashore. From 1986-1996, volunteers participating in the Annual Texas Coastal Cleanup removed almost 4,000 tons of garbage from state beaches (S. Besteiro pers. comm.).

Additionally, the Center for Marine Conservation estimated that approximately 1.5 million tons of garbage were removed by volunteers during their national shoreline cleanup in 1996 (Sheavly *et al.* 1997).

Today's beach-goers must not only be fearful of coming into contact with various types of hazardous materials that might result in severe bodily trauma, but they must also tolerate the offensive visual intrusion of a garaged-strewn beach (Faris and Hart 1995). Additionally, thousands of oceanic and terrestrial wildlife creatures are maimed or killed worldwide each year from entanglement or ingestion of marine and shoreline garbage (Cottingham 1988; EPA 1994; Marine Mammal Commission 1994; Faris and Hart 1995; Miller *et al.* 1995).

## METHODS AND RESULTS

Since 1988, we have collected data on types and quantities of debris that have washed onto park beaches. These efforts are a component of a national program monitoring the effectiveness of environmental programs and international treaties in reducing marine debris.

Beginning in 1994, we initiated the PINS Marine Debris Point Source Investigation. This labor intensive research project has required daily cataloging and removal of 43 debris items from 16 miles of shoreline within Padre Island National Seashore. This monitoring effort was initiated to obtain data required to fill many of the gaps existing in scientific knowledge related to developing research methodologies, understanding trends, and identifying point source polluters. We have demonstrated that our methods for monitoring marine debris can aide in identifying probable point sources of marine debris. We also believe that this valuable information can be used for improving the management of marine resources of Texas and the nation.

Upon completion of this year's research season, in March 1998, we will have obtained over 1000 days of marine debris data, with the vast majority of these days being consecutive. During this effort, we surveyed over 16,800 miles of shoreline. The PINS Marine Debris Point Source Investigation represents one of the first long-term, comprehensive, marine debris research projects initiated in the United States.

In 1997, we expanded the overall research project to include an increase in the number of debris items collected (from 43 to 75), an analysis of ecosystem impacts related to the use of heavy equipment to clean debris from the shoreline, a sociological study of people's perceptions of beach garbage, and a comprehensive statistical analysis of the debris data collected from February 1994 to March 1996.

Because the Padre Island National Seashore data are so extensive, both temporally and spatially, they provide a unique opportunity to investigate fundamental statistical questions related to the collection and general analysis of beach debris data. These questions can be broadly grouped into two categories: 1) survey design, and 2) data analysis. Issues related to the design of marine debris surveys include:

1. What is the magnitude of spatial and temporal variation in the PINS data?
2. Is temporal variation larger than spatial variation?
3. Is the spatial distribution of marine debris along the PINS shoreline homogeneous?
4. How frequently should debris data be collected?
5. Can factor analysis be used to identify sources of marine debris?
6. What is the best variable statistically to evaluate temporal changes in the amount of debris washing onto a shoreline?

However, the analyses of these data are complicated by a general lack of good research into statistical models for evaluating marine debris data. Published statistical reports of the analysis of marine debris data use standard techniques of analyses of variance and repeated measures analysis. The validity of these analyses depends strongly upon the statistical model assumed for these data.

Until now, because of an absence of adequate data, it has been impossible to statistically evaluate the assumptions of these analyses. Many marine debris surveys collect data at varying sites and times, often on a relatively infrequent basis. Surveys conducted annually or even monthly may be inadequate for evaluating temporal changes. Moreover, such data are likely inadequate for identifying point sources of debris. Events that are associated with point sources of debris are likely to be seasonal, and a monthly or annual survey will not provide adequate statistical identification of this source, at least for many years. The PINS database, however, allows for an evaluation of these assumptions, and for either improvement of these analyses or the development of new methods for modeling marine debris data.

Data analysis has indicated that debris trends can be tracked both temporally and spatially and preliminary statistical analysis suggests that temporal variation is much larger than spatial variation along the PINS shoreline. Preliminary statistical data analysis using four variable correlations indicates that the correlation between sampling locations falls rapidly and seems to plateau at between 8 and 10 miles. This suggests that optimum sample spacing for PINS would be every 8 to 10 miles. It appears that statistical autocorrelations can be used as a key to designing an optimum sampling scheme. These data indicate that the temporal autocorrelation functions dies out rapidly and, at 8 days, the autocorrelation drops to nearly zero, then it rises slightly and falls again to zero. These data indicate that at 30 days-and-beyond the autocorrelation is essentially zero. This implies that data can not be used to predict debris beyond a month. Moreover, any prediction beyond a week is going to be inaccurate.

Additionally, statistical analysis has allowed us to plot point source debris items over time. We have also been able to develop a regression model indicating that increased commercial shrimping effort within waters adjacent to our survey area directly correlates with increased numbers of specific types of debris items being washed onto the adjacent shoreline.

Our marine debris surveys for the 1997-98 year ends on 1 March 1998. After that time, we will prepare and issue a comprehensive report detailing the completed PINS research from February 1994 through March 1998.

For the 1998-99 field season, we are proposing to 1) continue debris data collection, 2) initiate a research contract to determine how other types of heavy equipment may impact on the beach ecosystem, 3) analyze the 1997-98 field data, in relationship to the 1994-95 and 1995-96 data, and, 4) initiate a contract with researchers at Matagorda Island and Mustang Island, Texas, to collect debris data related to identifying point source impacts over an 80-mile section of the Texas shoreline.

### SUMMARY

Since 1988, park researchers have collected data on types and quantities of debris that have washed onto park beaches. These efforts are a component of a national program monitoring the effectiveness of environmental programs and international treaties in reducing marine debris.

Beginning in 1994, park researchers initiated the PINS Marine Debris Point Source Investigation. This labor intensive research project has required daily cataloging and removal of 43 debris items from 16 miles of shoreline within Padre Island National Seashore. Upon completion of this year's research season, in March 1998, park scientists will have obtained over 1,000 days of marine debris data, with the vast majority of these days being consecutive. During this effort, park researchers surveyed over 16,800 miles of shoreline. The PINS Marine Debris Point Source Investigation represents one of the first long-term, comprehensive, marine debris research projects initiated in the United States.

Because the Padre Island National Seashore data are so extensive, they provide a unique opportunity to investigate fundamental statistical questions related to the collection and general analysis of beach debris data. Preliminary data analysis has indicated that debris trends can be tracked both temporally and spatially and preliminary statistical analysis suggests that temporal variation is much larger than spatial variation along the PINS shoreline. It appears that statistical autocorrelations can be used as a key to designing an optimum sampling scheme.

Additionally, statistical analysis has allowed us to plot point source debris items over time. We have also been able to develop a regression model indicating that increased commercial shrimping effort within waters adjacent to our survey area directly correlates with increased numbers of specific types of debris items being washed onto the adjacent shoreline.

### REFERENCES

- Cottingham, D. 1988. Persistent marine debris: challenge and response: The federal perspective. Alaska Sea Grant Program, U.S. Dept. of Commerce, National Oceanic and Atmospheric Administration, Office of Sea Grant and Extramural Programs, Fairbanks, Alaska. 41 pp.
- Faris, J. and K. Hart. 1995. Seas of Debris: A Summary of the Third International conference on Marine Debris. UNC-SG-95-01. North Carolina Sea Grant College Program. 54 pp.



- Miller, J, S. Baker, and D. Echols. 1995. Marine Debris Point Source Investigation: 1994-1995. U.S. Dept. of the Interior, National Park Service, Padre Island National Seashore, Corpus Christi, Tex. 40 pp.
- Sheavly, S, R. Bizot, and R. Randall. 1997. 1996 International Coastal Cleanup, U.S. results. Center for Marine Conservation, Washington, DC. 102 pp.
- Sheavly, S. 1996. 1995 International Coastal Cleanup, U.S. results. Center for Marine Conservation, Washington, DC. 92 pp.
- Besteiro, S. personal communication in 1997. Texas Adopt-A-Beach Program. Texas General Land Office, Austin, Tex.
- U.S. Environmental Protection Agency. 1994. Status of efforts to control aquatic debris. EPA-842-K-94-002. U.S. EPA, Oceans and Coastal Protection Division, Washington, DC.
- Marine Mammal Commission. 1995. Annual report to Congress, 1994. Washington, DC. 270 pp.

---

John Miller has been with the U.S. National Park Service for the past 18 years and is currently the Chief of the Division of Science, Resources Management and Interpretation at Padre Island National Seashore. Mr. Miller received his B.S. degree in Biology and M.S. degree in Forestry from Stephen F. Austin State University. Mr. Miller is enrolled in a Ph.D. program at Texas A&M University and has been actively involved in marine debris research for the past eight years.

### **U.S. FISH & WILDLIFE SERVICE'S INVOLVEMENT IN THE LAGUNA MADRE**

Ms. Robyn A. Cobb  
U.S. Fish and Wildlife Service

The U.S. Fish & Wildlife Service is responsible for conserving, enhancing and protecting fish and wildlife and their habitats for the continuing benefit of people via federal programs relating to wild birds, endangered species, certain marine mammals, and inland sport fisheries. In the south Texas area, trust responsibilities for the agency include migratory birds, listed threatened, endangered and candidate species, and their habitats. Habitats of concern in this region include wetlands, coastal prairie, dense native brush communities known as Tamaulipan thornscrub, and remnant riparian corridors along waterways.

Due to its location where temperate and tropical climates come together, the south Texas coastal zone supports a multiplicity of plant and animal communities. Much of the flora and fauna are shared with Mexico and indeed a number of species reach their most northern distribution in south Texas. The wide variety of plant and animal life native to this region, extensive loss of native plant communities to agricultural endeavors in the last 100 years in the lower "valley" of the Rio Grande, and the more recent explosion of residential and light industrial growth in south Texas, all factor into the region's high number of federally listed species. Among the endangered & threatened animals of the southern Texas coastal zone are ocelots, jaguarundis, West Indian manatees (very rare and incidental), brown pelicans, piping plovers, northern aplomado falcons, American peregrine falcons, and five species of sea turtles, although the green and Kemp's ridley are most closely associated with the lagoon environments. Four plant species are also listed as threatened or endangered in counties bordering the Laguna Madre, but none are closely linked with the lagoon itself.

Conservation of migratory and resident birds and their habitats constitutes a major agency interest along the south Texas coast. The coastline of the Laguna Madre acts as funnel for many migratory neotropical species, providing shelter and food as these birds move north and south. The lagoon and associated complex of inland depressional wetlands on both the islands and mainland provide rest stops and overwintering areas for large numbers of waterfowl. The Laguna Madre of Texas and Tamaulipas, Mexico is famous for supporting a large percentage of the continental redhead duck population during winter months. The bay also attracts other diving ducks such as canvasbacks, lesser scaup and buffleheads. The diverse dabbling duck assemblage includes three species of teal, wigeon, gadwalls, other duck species and American coots. The Laguna Madre hosts high numbers of shorebirds, particularly in fall and spring migration, although some species overwinter there as well. The Texas coast held the greatest numbers of piping plovers accounted for during a 1991 international census for this species on its winter grounds and the majority of these birds were found along Laguna Madre shorelines. In addition to the variety of plover species, a large number of other shorebirds species pass through this area in abundance. Also of special interest are the peregrine falcons, both Arctic and American subspecies, for which Padre Island is a major staging area. The northern aplomado falcon was extirpated from south Texas in the early-to-mid 1900s but has been reintroduced within the last ten years at the Laguna Atascosa National Wildlife Refuge. The numbers and diversity of neotropical migrant songbirds circumnavigating the Gulf along the Texas coast is phenomenal, with Laguna Atascosa NWR having the highest species count in the nation. Twenty-six species of nesting herons, egrets, roseate spoonbills, laughing gulls and terns use approximately 50 islands in the Laguna Madre as rookeries.

The Texas coast has a variety of wetland habitats ranging from isolated inland depressional fresh-to-brackish ponds, to intertidal marsh, unvegetated wind tidal flats, submerged aquatic vegetation (seagrasses) and open water areas with unvegetated bottoms. The Laguna Madre itself is so shallow that seagrasses have been able to thrive and colonize most of its bottom except for dredged channels such as the Gulf Intracoastal Waterway (GIWW) and areas adjacent to the channels. Although five species of seagrass can be found in the Laguna Madre, shoalgrass (*Halodule wrightii*) predominates in the Upper Laguna Madre as it formerly did in the Lower Laguna. The redhead duck relies on shoalgrass rhizomes for the vast majority of its winter diet and since over 40% of all redheads overwinter in portions of this lagoon system, the amount and distribution of this

seagrass species is a major concern. In the last few decades the coverage and distribution of shoalgrass has begun to shrink and shift as other species move into areas where shoalgrass has been lost.

The intertidal margins of most of the northern and mid-regions of the Laguna Madre support a community of halophytes including glassworts, saltwort, and other salt-loving species, but lack smooth cordgrass or other tidal marsh species which are not adapted to the highly saline conditions in these regions of the system where circulation and exchange with the Gulf of Mexico are most limited. At the more southern reaches of the Laguna Madre, near the city of South Padre Island and around the area of the Brazos Santiago Pass, smooth cordgrass becomes a major component of the intertidal marsh.

The vast areas of wind tidal flats in the Laguna Madre are a unique feature of this system. These huge expanses of unvegetated intertidal flats result from the hypersaline conditions and small tidal range and the largely wind-controlled inundation regimes of the flats. The way that water moves onto and off of the flats is dictated mostly by prevailing winds from the southeast during most of the year, although strong winds push water from north to south in conjunction with cold fronts or "northers." The presence of the threatened piping plover and the associated maritime guild of shorebirds on the flats is closely tied to these inundation patterns.

Native upland habitats of interest include coastal prairie, the greatest remaining expanse of which is probably found on the barrier islands. Coastal prairie also occurs on the mainland adjacent to the Laguna, but it has been more affected by human influences such as grazing and fire suppression, and invasion by introduced plant species. Native grasslands interspersed with an occasional yucca historically supported the northern aplomado falcon. Woody plant communities represented by dense Tamaulipan thornscrub or live oak woodlands harbor the endangered ocelot and jaguarundi as well as providing cover and forage for the colorful assemblage of migratory passerines which circumnavigate the Gulf along this part of the Texas coast.

Four programs of the USFWS, Ecological Services (ES), Refuges, Fisheries Resources, and Law Enforcement, function along the south Texas coast, including in & around the Laguna Madre. An Ecological Services office located in Corpus Christi reviews U.S. Army Corps of Engineers permit applications for projects involving fills in waters of the U.S. Among the most common concerns of ES staff biologists for Laguna Madre wetlands are adverse impacts to seagrasses from channel projects or overwater structures, impacts to tidal flats and intertidal marsh from siting of residential or industrial structures along shorelines or roads through marshes, and the as yet unknown, unquantified impacts to seagrasses and other wetlands from recent intensive, widespread, 3-D seismic explorations. In the Laguna Madre, as in other Texas bays, tracking impacts from nationwide permits is a priority need since activities permitted under these nationwides are assumed to be minor and are not closely monitored. Cumulative losses/impacts to Laguna Madre wetlands have not been assessed.

EC staff are members of the Corps of Engineers Interagency Coordination Team, the purpose of which is to recommend and review Laguna Madre studies to obtain the information needed to

adequately update the original EIS for the Gulf Intracoastal Waterway. In the Laguna Madre, maintenance dredging and disposal of dredged material has been implicated in the decline in seagrass coverage and changes in species composition. Piping plover use of dredged material disposal areas, or loss of use from disposal practices, is also being investigated in association with this interagency team effort.

Under Section 7 of the Endangered Species Act, all federal agencies must consult with the Service on projects they plan to fund, permit or undertake so as to avoid adverse impacts to threatened and endangered species. In and around the Laguna Madre, Section 7 consultations most frequently involve protection of habitat for piping plovers, brown pelicans, and the two endangered cats. A large percentage of the COE Section 10/404 permit applications for projects proposed for the Laguna Madre also entail Section 7 consultation for piping plovers. Dredged material disposal practices in the Laguna Madre have created a series of islands, many of which are used by nesting waterbirds. However, disposal has also impacted large areas of tidal flats as leveed disposal cells were built at the margins of these flats. In some cases, the dredged material has eroded onto the flats, increasing the elevation and sometimes changing the tidal flat to a transitional halophytic marsh. Additionally, the construction of disposal cells has changed tidal circulation patterns across the flats. An example of this is seen at the Horse Island area of Laguna

Atascosa NWR, where apparent succession to a halophyte marsh may change the availability of foraging areas which currently get a high degree of use by shorebirds and waders. An ongoing U.S. Geological Service Biological Resource Division research project, funded by the Service, is investigating the changes in the tidal flat wrought by placement of dredged material. Results of this study will help the refuge in deciding whether to undertake restoration activities.

Since before 1997, brown pelicans had not nested on Laguna Madre islands for decades, activities affecting colonial waterbird rookery islands did not have listed species concerns. However, during this past nesting season small groups of nesting pelicans used two separate islands in the southern lagoon. In recent years, a Section 7 consultation involved brown pelicans and the Queen Isabella causeway between the mainland and South Padre Island. A combination of factors created conditions that brought number of pelicans down onto the road surface as they attempted to fly over the bridge, and many were subsequently killed by cars. Among these interacting factors were pelicans foraging south of and roosting north of the bridge/causeway, design of the bridge itself, and adverse weather conditions associated with strong "northers" (wind direction and strength, and poor visibility). The Service and the Texas Department of Transportation worked to resolve the hazards to the birds and to motorists, who risked their own safety to help the birds, by installing lighted message boards at both entrances to the bridge, other signs to alert drivers to impending problems with pelicans, and by developing a response plan.

Although ocelots and jaguarundis are not aquatic mammals, these endangered cats occupy dense thornscrub brush which grows on the south Texas mainland adjacent to the Laguna Madre. Ecological Services biologists often work with the Texas Department of Transportation and other agencies involved in developing infrastructure for development in areas bordering the Lower Laguna Madre to assure that existing habitat for the cats is protected. Along with habitat protection, project planning includes consideration for installation of culverts and fencing to direct the cats under the

roads through the culverts, since collision with cars is the most frequent cause of mortality for ocelots.

Contaminant concerns in the Laguna Madre include nutrients, pesticides and heavy metals. In 1995, Service biologists from ES and Fisheries conducted a contaminants study in the Arroyo Colorado, a major tributary to the Lower Laguna Madre. Sampling methods included a new technique using semipermeable membrane devices to detect low levels of contaminants in the water column. Results failed to show any significant levels of contamination. These results may have been due in part to the timing of the study, which occurred during a drought when runoff from the Arroyo's drainage was negligible. The Ecological Services office is currently in Section 7 consultation with the Environmental Protection Agency and a consortium of mariculturists working to obtain a permit for effluent discharges from shrimp farming operations. At least three large shrimp/fish farms are located within the watersheds of the Lower Laguna Madre. Effluent nutrient levels, and exotic shrimp disease and escapement are high profile issues along the entire Texas coast.

Biologists from Ecological Services, Fisheries, and Refuges participate yearly in the annual census of colonial waterbird nesting pairs. Traditionally, Service biologists have helped with counts in both the northern and southern portions of the Laguna Madre. In 1997, Service biologists removed small areas of vegetation on Tern Island in the upper lagoon to restore bare ground for the large Royal Tern/Sandwich Tern colony which historically used this island. The Service has used cooperative agreements with Audubon to fund management and signage of rookery islands in all the Texas bays, including the Laguna Madre.

Two national wildlife refuges, Laguna Atascosa NWR and the Lower Rio Grande Valley NWR, have holdings along the shores of the Laguna Madre. Laguna Atascosa was established in 1946 for conservation of redhead ducks. Since that time, this refuge has become noted for its diversity of wildlife and is the focal area for research on the remaining population of ocelots in the United States. The refuge has a cat biologist who tracks movements, home range, survival and reproductive success of radio-collared cats. Texas A & M University's Caesar Kleberg Wildlife Research Institute conducts ocelot ecology research projects at the refuge as well.

Most of the one hundred and ten northern aplomado falcon releases along the Texas coast in the last ten years by the Peregrine Fund, took place at Laguna Atascosa. This reintroduction effort has produced at least one pair of nesting falcons since the inception of the releases. Survival of the released falcons is monitored, at least for short periods of time, and food habits have been studied along with a contaminants analysis of prey items.

Laguna Atascosa actively manages water levels in some refuge wetlands, using water control structures to impound fresh and brackish water and to allow drawdowns which help to maintain food and water sources for resident wildlife, migratory birds and fish. The refuge has built a pipeline to bring in fresh water purchased from a neighboring irrigation district in order to maintain some wetlands in times of drought. Refuge biologists and academics carry on research projects and monitoring of plant and animal life in refuge wetlands.

Both refuges survey plants and animals and compile species lists. The CKWRI is presently doing a neotropical migrant songbird survey on Laguna Atascosa by mist netting during spring migration. This information will be used to add to the knowledge of species composition, abundance and habitat use/preference on the refuge.

The LRGV NWR is building a wildlife corridor paralleling the Rio Grande to conserve and restore the unique plant and animal communities of this region. As part of this effort, the refuge acquired a conservation easement, the Loma Preserve, located in South Bay, the most southern portion of the Laguna Madre. The LRGV NWR is now in the process of purchasing approximately 12,000 acres in South Bay, between the Brownsville Ship Channel and the Rio Grande. This refuge acquisition will help to protect South Bay habitats including black mangrove marshes, algal flats, fisheries habitat, lomas, and Gulf beach.

The Service's Texas Fisheries Resources Office, located in Corpus Christi, is in its fourth year of investigating the range extension of the non-native brown mussel (*Perna perna*) in Texas bays & the lagoon. This exotic mussel was first detected in the northern Gulf on jetties near Port Aransas, Texas. Service fisheries biologists have since then discovered the brown mussels on navigation buoys and markers, the primary hard substrates in the Laguna Madre. The mussel is present on the buoys from the Brazos Santiago Pass at South Padre Island, north to the Port Mansfield Pass.

From 1990 through 1997 a monospecific golden algae bloom persisted in the Laguna Madre. Although this brown tide did not result in adult fish kills, laboratory and field research by the University of Texas, Marine Science Institute indicated that larval fish distributions were negatively affected by the bloom. Fisheries Resources provided additional funding to UTMSI to examine larval fish and egg mortality related to the brown tide.

Fisheries Resources monitors fish populations on all the coastal national wildlife refuges. Sampling of fish populations is done at least three times per year using gill nets, seines and trawls, particularly above and below water-control structures. This emphasis allows data collection and analysis to produce results targeting management actions at the structures.

Fish & Wildlife Service law enforcement activities in the Laguna Madre and adjacent areas target illegal hunting of waterfowl and doves. Special agents help with protection of listed species on the mainland by responding to calls and investigating mortalities. Service special agents work closely with the Park Service's Padre Island National Seashore to intercept poachers entering PINS bayshore habitats by boat and killing game animals, and also help thwart illegal gill netters. They also assist with protection of listed species and their habitats on PINS and help to obtain restitution for habitat restoration. The Laguna Madre serves as a "thoroughfare" for smuggling, including smuggling of illegally obtained wildlife such as parrots. Special agents work with other law enforcement agencies to stop these and other smuggling activities.

In summary, the Fish & Wildlife Service works to conserve natural resources in the south Texas coastal region through all their programs. Within the last five years, the agency has emphasized an ecosystem approach to managing trust responsibilities. Implementation of this approach has come

through formation of a Service Texas Coast Ecosystem Team comprised of representatives from Refuges, Ecological Services, Fisheries Resources and Law Enforcement. The team meets regularly to discuss resource issues, seek solutions, and advocate development of partnerships with those outside of the agency to undertake habitat, research, and education projects to meet Service goals.

## SESSION 1H

### HISTORY AND STATUS OF THE MANTEO PROJECT

Co-Chairs: Mr. Hammond Eve  
Ms. Kim Crawford

Date: December 18, 1997

Presentation	Author/Affiliation
Introduction: History and Status of the Manteo Project	Mr. Hammond Eve Minerals Management Service Gulf of Mexico OCS Region Ms. Kim Crawford N. C. Department of Coastal Management
History and Status of the Atlantic Area Leases	Mr. Alvin L. Jones Minerals Management Service Gulf of Mexico OCS Region
North Carolina's Coastal Energy Policies: A Framework for Reviewing OCS Proposals	Ms. Kim Crawford N. C. Division of Coastal Management
Looking for the Lodestar in the Shifting Sands of the Manteo Unit	Mr. Daniel F. McLawhorn North Carolina Department of Justice
Manteo Prospect: How It Can Be Done?	Mr. David Duplantier Chevron, U. S. A.
Bathymetric and Physical Oceanographic Description of the Manteo Lease Area	Dr. Larry Atkinson Ms. Lorraine Heilman Center for Coastal Physical Oceanography Old Dominion University Dr. Tom Curtin Office of Naval Research
A Review: Findings of the North Carolina Environmental Sciences Review Panel (ESRP)	Dr. William H. Lang Minerals Management Service Gulf of Mexico OCS Region
Coastal North Carolina Socioeconomic Study Program	Dr. John S. Petterson Impact Assessment, Inc.



A Review: Findings of the North Carolina  
Environmental Sciences Review Panel  
(ERSP)

Dr. Robert J. Diaz  
Mr. G. Randall Cutter  
Virginia Institute of Marine Science  
Dr. James A. Blake  
ENSR

## **INTRODUCTION: HISTORY AND STATUS OF THE MANTEO PROJECT**

Mr. Hammond Eve  
Minerals Management Service  
Gulf of Mexico OCS Region

Ms. Kim Crawford  
N. C. Department of Coastal Management

There have been 10 oil and gas Outer Continental Shelf (OCS) lease sales along the Atlantic seaboard; five of these sales have been in the mid-Atlantic Area. Twenty-five leases are still active, including Blocks 467 and 510 in what is referred to as the Manteo Unit. The Manteo Unit is located approximately 40 miles due east of North Carolina and approximately 45 miles east-northeast of Cape Hatteras.

Under the current economic environment and with recent advances in technology, Chevron, U.S.A., has announced that it may propose to drill a single exploratory well in either Block 467 or 510. In light of this announcement, this ITM session was put together by representatives of MMS, Chevron, and the State of North Carolina to initiate discussion and promote understanding among the various stakeholders. This session also served the secondary function of helping to identify the issues and participants and to develop more fully the agenda for a series of much more extensive discussions to occur 4-5 February 1998, at an NC/MMS Technical Workshop in Raleigh, North Carolina.

## **HISTORY AND STATUS OF THE ATLANTIC AREA LEASES**

Mr. Alvin L. Jones  
Minerals Management Service  
Gulf of Mexico OCS Region

### **INTRODUCTION**

There have been 10 oil and gas lease sales in the Atlantic OCS Area. The Mid-Atlantic Planning Area has hosted five oil and gas sales, inclusive of Re-Sale 2. Out of the 9,240 tracts that have been offered in the entire Atlantic Area, 433 tracts have been leased by the Minerals Management Service (MMS) to qualified exploration companies. Oil companies have drilled 49 exploratory wells in the Atlantic Area, with the bulk of the exploratory drilling (32 wells) occurring in the Mid-Atlantic Planning Area. Although no leasing activities have occurred in the Atlantic Area since Sale 78, there are still active leases offshore North Carolina in the geological structure within the Manteo Unit known as the Manteo Prospect. These leases are of interest to exploration companies for the oil and gas resources that may exist there.

## SALE HISTORY OF THE ATLANTIC LEASES

There are 25 active leases in the Atlantic Area (formerly known as the Atlantic OCS Region). All 25 active leases are considered to be offshore North Carolina (Figure 1H.1) and are a result of two oil and gas lease sales, numbers 56 and 78, which were held in the South Atlantic Planning Area. The bottom boundary of the Mid-Atlantic Planning Area was lowered in March 1982 from 36°30' N. latitude downward to 35° N. latitude (Fred Gray, pers. comm., 1997). Thus, twenty-four of the 25 active leases now reside in the Mid-Atlantic Planning Area (Figure 1H.1).

### Sale 56

Oil and Gas Lease Sale 56 was held for tracts in the South Atlantic Planning Area on 4 August 1981. Successfully awarded leases became effective on 1 September 1981 for an initial lease term of 10 years. There were 285 tracts offered. 120 bids were received on 54 tracts. MMS accepted 47 bids and rejected 7. The total High Bid Amount accepted by MMS was \$342,766,174. Of the 47 bids accepted, 20 are active, 19 of which are within the Manteo Unit, inclusive of Blocks 467 and 510 (Figure 1H.2).

### Sale 78

Oil and Gas Lease Sale 78 was also held for tracts in the South Atlantic Planning Area on 26 July 1983. Successfully awarded leases became effective on 1 September 1983, for an initial lease term of 10 years. There were 3,582 tracts offered and 12 bids were received on 11 tracts. MMS accepted 11 bids and rejected none. The total High Bid Amount accepted by the MMS was \$13,362,040. Of the 11 bids accepted, 5 are active, 2 of which are within the Manteo Unit (Figure 1H.3).

## STATUS OF THE ACTIVE LEASES

Of all active Atlantic leases, 20 resulted from Sale 56 and 5 resulted from Sale 78. Of the 21 Manteo Unit leases, 19 resulted from Sale 56 (Figure 1H.2) and two resulted from Sale 78 (Figure 1H.3).

The 25 active Atlantic Leases have been or are under a Suspension of Operations (SOO). Blocks that comprise the Manteo Unit have been subjected to a SOO four times. Lease blocks outside the Manteo Unit have been under a SOO once.

### Suspension of Operations for Leases within the Manteo Unit

Those 21 leases that make up the Manteo Unit were first put under a SOO:

- through a request by the lessees during December 1989;
- through a citation of the language in the Memorandum of Understanding (MOU) signed in July 1989 by the State of North Carolina, Mobil, and MMS; and
- through the first SOO issued by MMS, retroactive to 1 September 1989 on those leases that became the Manteo Unit.

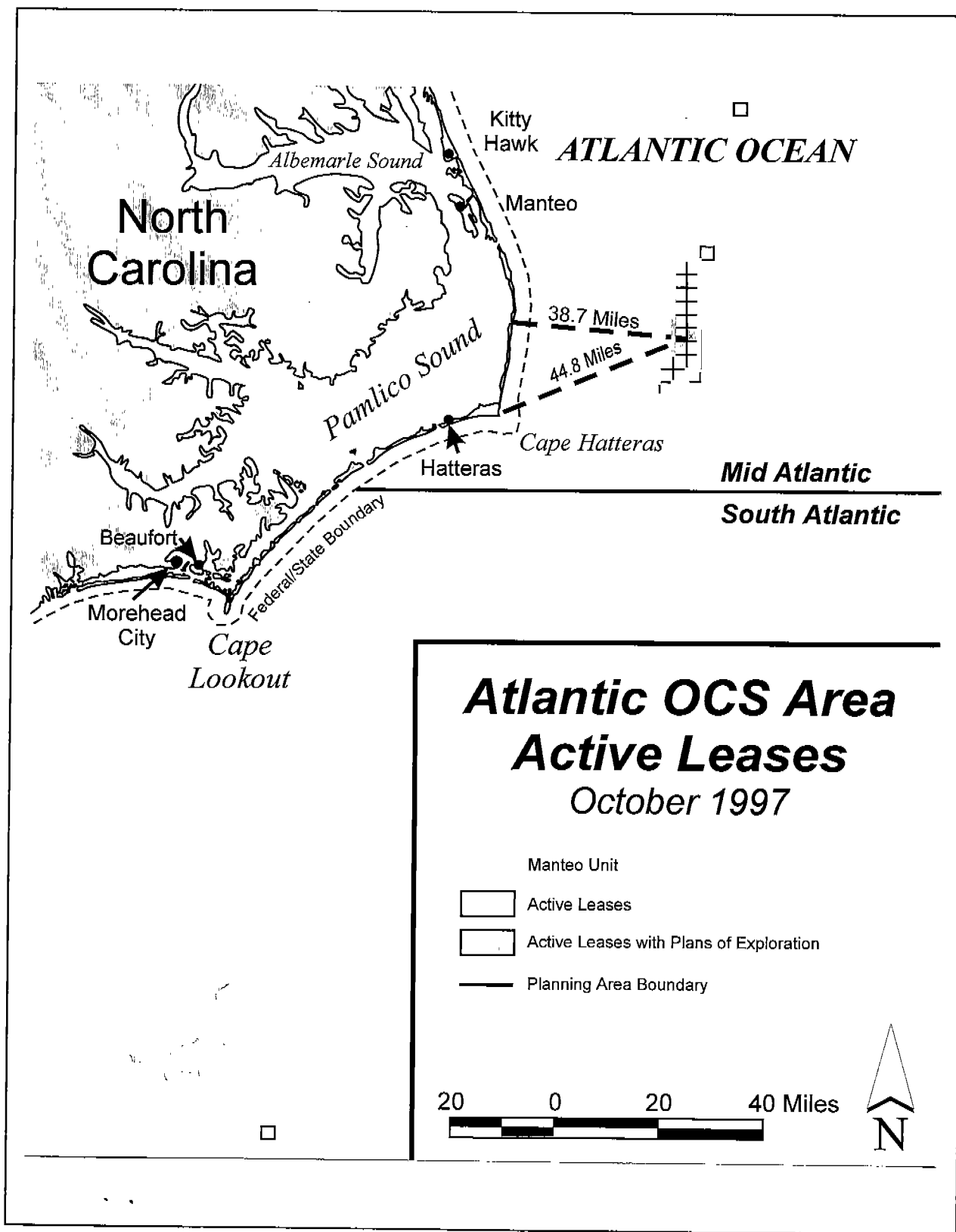

Figure 1H.1. Atlantic Area leases (24 in Mid Atlantic and 1 in South Atlantic).

# Manteo Unit

Total Bonus Bid: \$296,294,000

AH = Amerada Hess Corp.

CH = Chevron USA Inc.

CO = Conoco Inc.

MA = Marathon Oil Co.

MO = Mobil Oil Exploration and  
Production Southeast Inc.

OX = Oxy USA Inc.

SH = Shell Offshore

UN = Union Oil Company of Calif.

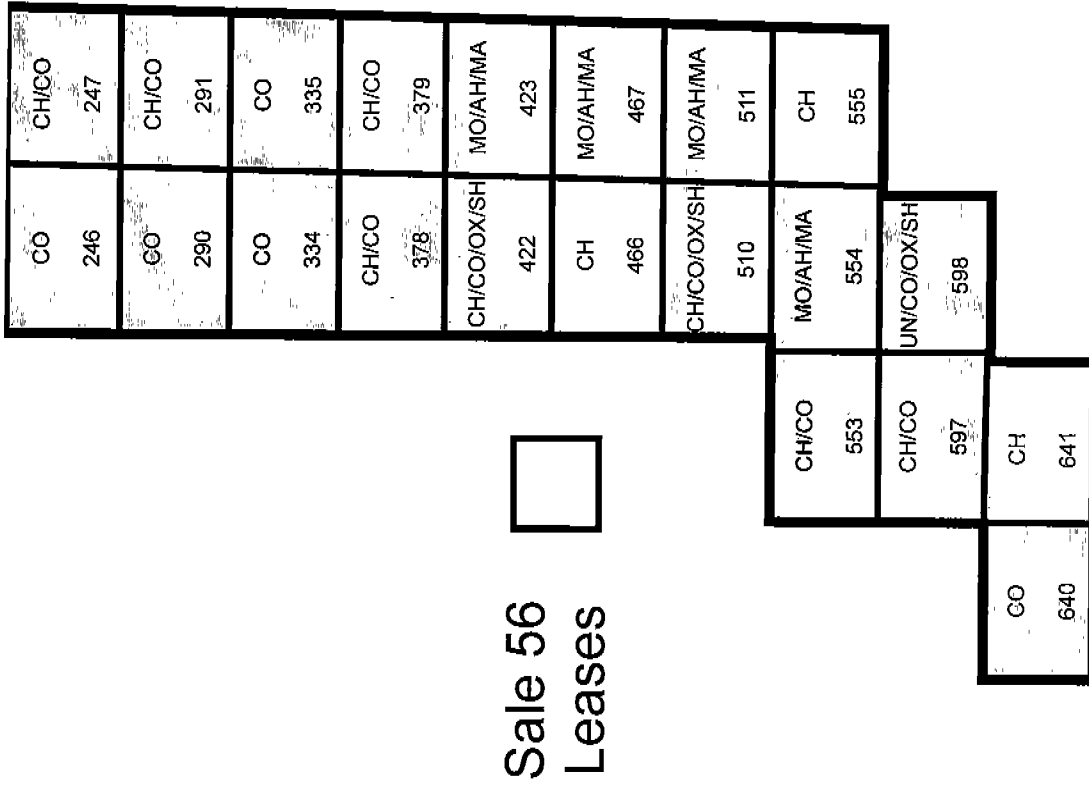

Figure 1H.2. Sale 56 leases within the Manteo Unit.

# Manteo Unit

Total Bonus Bid: \$296,294,000

AH = Amerada Hess Corp.

CH = Chevron USA Inc.

CO = Conoco Inc.

MA = Marathon Oil Co.

MO = Mobil Oil Exploration and  
Production Southeast Inc.

OX = Oxy USA Inc.

SH = Shell Offshore

UN = Union Oil Company of Calif.



Figure 1H.3. Sale 78 leases within the Manteo Unit.

The second SOO occurred as a result of the Oil Pollution Act (OPA) of 1990, signed on 18 August 1990. The third SOO occurred as a result of the OPA '90 and the Environmental Studies Review Panel Recommendations, signed on 8 June 1992. The fourth and current SOO was requested by the Designated Operator of the Unit, Mobil, on 21 February 1995. MMS approved the request in June 1995 retroactive to 10 November 1994.

As part of the Conoco Settlement Agreement, the Manteo Unit will not be allowed to expire until the Unit has acquired all needed permits and two drilling seasons up to a flexible deadline of the year 2002 (per the 1989 MOU). Further, since Mobil and Marathon did not partake of the Conoco Settlement, there will still be a continuance of the SOO until there is a final, nonappealable decision in the suit filed by Mobil against the Secretary of Commerce's decision.

#### Suspension of Operations for Leases outside the Manteo Unit

Leases outside the Manteo Unit were put under a SOO as a result of the OPA '90, signed on 18 August 1990. On 26 April 1996, the SOO on those leases outside the Manteo Unit was terminated in conjunction with the repealing of the Outer Banks Protection Act (OBPA) of 1990. At that time (April 1996), there were 26 leases outside the Manteo Unit, and 20 of the non-Manteo Unit leases expired on 10 May 1997, after the OBPA was repealed. Two other non-Manteo Unit leases expired in July and August 1997, which brings us to our current total of 25 active leases in the Atlantic Area.

The new expiration dates for those four leases outside the Manteo Unit are listed in Table 1H.1.

Table 1H.1. Expiration dates for the four leases outside the Manteo Unit.

Lease No.	OPD	Block	New Expiration Date
A 0220	NJ 18-11	777	Under Appeal (5/10/97)
A 0445	NI 18-2	204	05/11/99
A 0447	NI 18-2	599	05/11/99
A 0450	NI 18-10	479	05/11/99

#### PLANS OF EXPLORATION

Two Plans of Exploration (POE's) are on file for 2 of the 25 active Atlantic leases; both are for blocks within the Manteo Unit.

- Chevron, as Designated Operator of Block 510, has an Approved POE (approval date, 07/12/82) with Coastal Zone Consistency concurrence from North Carolina on file with the MMS; and

- Mobil, as Operator of Block 467, has a POE on file that was “deemed Approvable” by the MMS; however, at that time, the OBPA of 1990 prohibited approval of Mobil’s POE.

#### LITIGATION

The State of North Carolina denied consistency on the National Pollution Discharge Elimination System permit in July 1990 and on Mobil’s POE for Block 467 in November 1990. Mobil appealed to the Secretary of Commerce, who held for North Carolina in 1994. The Secretary of Commerce’s decision was based on lack of sufficient information.

Mobil promptly appealed to the Federal District Court. In 1996, the case was sent back to Commerce for a decision on reopening the appeal. The remand was based on the existence of two MMS studies submitted to Commerce late in the decision process but not considered prior to the issuance of their decision. To date, Commerce has not decided whether to reopen the case.

Mobil and Marathon, who did not partake Conoco Settlement Agreement, held out for damages. The Court of Federal Claims determined that Mobil and Marathon were entitled to restitution of their bonuses paid for interests in five OCS oil and gas leases offshore North Carolina, and awarded Mobil and Marathon approximately \$160 million. The Court found that the leases had been breached by the passage of the OBPA. The MMS promptly appealed that decision, and to date there has been no decision on the appeal.

#### OWNERSHIP PATTERNS:

The following nine Companies hold rights to active leases in the Atlantic Area (Figures 1H.4 and 1H.5):

- AMERADA HESS CORPORATION: with interests in 4 leases within the Unit and 1 lease outside the Unit;
- AMOCO PRODUCTION COMPANY: with interests in 3 leases outside the Unit;
- CHEVRON U.S.A. INC.: with interests in 11 leases within the Unit;
- CONOCO INC.: with interests in 14 leases within the Unit;
- MARATHON OIL COMPANY: with interests in 4 leases within the Unit and 1 lease outside the Unit;
- MOBIL OIL EXPLORATION & PRODUCTION SOUTHEAST INC.: with interests in 4 leases within the Unit and 1 lease outside the Unit;
- OXY USA INC.: with interests in 3 leases within the Unit;
- SHELL OFFSHORE INC.: with interests in 3 leases within the Unit; and
- UNION OIL COMPANY OF CALIFORNIA; with interests in 1 lease within the Unit.



**The New Expiration Dates for those Active Leases outside the Manteo Unit will be:**

Owner	Lease	OPD	Block	New Expiration Date	Sale
MO/MA/AH	0220	NJ 18-11	777	Under Appeal (April 1997)	56
Amoco	0445	NI 18-2	204	05/11/99	78
Amoco	0447	NI 18-2	599	05/11/99	78
Amoco	0450	NI 18-10	479	05/11/99	78

Figure 1H.4. Atlantic Area owners of leases outside the Manteo Unit.

# Mid-Atlantic Planning Area Manteo Area Map

Total Bonus Bid: \$296,294,000

AH = Amerada Hess Corp.

CH = Chevron USA Inc.

CO = Conoco Inc.

MA = Marathon Oil Co.

MO = Mobil Oil Exploration and  
Production Southeast Inc.

OX = Oxy USA Inc.

SH = Shell Offshore

UN = Union Oil Company of Calif.

CO	\$217,000	246	8/31/91	CH/CO	\$456,000	247	8/31/91
CO	\$217,000	290	8/31/91	CH/CO	\$456,000	291	8/31/91
CO	\$515,000	334	8/31/91	CO	\$623,000	335	8/31/91
CH/CO	\$2,340,000	378	8/31/91	CH/CO	\$6,840,000	379	8/31/91
CH/CO/OX/SH	\$8,120,000	422	8/31/91	MO/AH/MA	\$28,512,000	423	8/31/91
CH	\$16,600,000	466	8/31/91	MO/AH/MA	\$103,775,000	467	8/31/91
CH/CO/OX/SH	\$26,374,000	510	8/31/91	MO/AH/MA	\$33,130,000	511	8/31/91
CH/CO	\$650,000	553	8/31/91	CH	\$1,234,000	555	8/31/93
CH/CO	\$3,600,000	597	8/31/91	UN/CO/OX/SH	\$7,515,000	598	8/31/91
CO	\$217,000	640	8/31/91	CH	\$1,276,000	641	8/31/91

Figure 1H.5. Manteo Unit lease owners, bonus bid amount, and original effective dates.

## SUMMARY

There are 25 active leases in the Atlantic Area. Twenty-one leases comprise the Manteo Unit, inclusive of Blocks 467 and 510. Two POE's are on file with the MMS for Blocks 467 and 510. All Manteo Unit leases are under a Suspension of Operations at this time, and Mobil is still awaiting the Department of Commerce's decision on whether it will reopen the file and admit the two MMS-funded studies into their case.

---

Mr. Alvin Jones has worked as a geologist and geophysicist in MMS's Gulf, Atlantic, and Pacific OCS Regions. He served as a Leasing Specialist for the Atlantic OCS Region and as a Contracting Officer's Technical Representative for several MMS Environmental Studies Contracts in the Atlantic Area. He earned his B.S. in Geology from Elizabeth City State University, North Carolina, and has continued his education at Old Dominion University, Woods Hole Oceanographic Institution, and the University of New Orleans. Mr. Jones was Honorably Discharged from the U.S. Marine Corps.

### **NORTH CAROLINA'S COASTAL ENERGY POLICIES: A FRAMEWORK FOR REVIEWING OCS PROPOSALS**

Ms. Kim Crawford  
N.C. Division of Coastal Management

#### WHAT THE STATE LEARNED FROM MOBIL'S DRILLING PROPOSAL

Mobil Exploration & Producing U.S. Inc. notified North Carolina in 1988 that it intended to drill up to seven exploration wells in the Manteo Exploration Unit, an area off the state's coast comprising 21 blocks leased by eight oil companies in 1981 and 1983. Although Chevron U.S.A. Production Company, one of the companies holding leases, had submitted a plan of exploration for Manteo Block 510 in 1982, the state made no efforts in the intervening years—from 1982 to 1988—to address possible weaknesses in its enforceable policies to review an exploration proposal.

North Carolina geared up quickly in late 1988 to early 1989 to review Mobil's exploration proposal by hiring legal and policy specialists to research issues and develop policy options for responding to the proposal. Although the state successfully negotiated a Memorandum of Understanding with Mobil and the Department of Interior's Minerals Management Service (MMS) for an expanded environmental review of the proposal, there was some confusion over which components of the N.C. Coastal Management Program would be used to review Mobil's exploration plan for federal consistency.

In 1990 the state found Mobil's exploration plan and discharge permit for Block 467 inconsistent with its coastal program due to inadequate information. Neither Mobil nor the federal government provided

information to address the state's concerns regarding potential environmental and socio-economic impacts. The proposal for Block 467 is still under federal appeal and in litigation.

### THE N.C. COASTAL MANAGEMENT PROGRAM AND COASTAL ENERGY POLICIES

The applicable components of the N.C. Coastal Management Program for reviewing OCS activities for federal consistency (Table 1H.2) include: goals set forth in the N.C. Coastal Area Management Act; administrative rules found in Title 15, Chapter 7 (approved by the Department of Commerce, NOAA); a network of other state agencies' enforceable policies; and the latest federally approved local land use plans for any coastal towns or counties where energy facilities might be sited.

The N.C. Coastal Resources Commission, which has rule-making authority to implement the goals of the N.C. Coastal Area Management Act, adopted coastal energy policies, as rules, in 1979. These policies defined "major energy facilities" and identified areas that should be avoided to the "maximum extent practicable." One area of confusion was that there were additional criteria for determining federal consistency cited in the state's 1979 amendments to its coastal program that had not been codified, although the commission clearly intended these policies to be enforceable for federal consistency.

The energy policies adopted in 1979 did not expressly define major energy facilities to include drill ships, platforms, or onshore support structures—structures that have the potential to cause environmental and/or economic impacts due to their size and/or function. Nor did the policies require locating onshore facilities in a manner to protect the scenic and visual qualities of coastal areas, although this is a primary goal stated in the N.C. Coastal Area Management Act.

### STRENGTHENING THE STATE'S COASTAL ENERGY POLICIES

In 1991 the Department of Commerce's National Oceanic and Atmospheric Administration (NOAA) established the Coastal Zone Enhancement Grants Program to enable states to improve their coastal programs in several areas, including ocean resources planning. The N.C. Division of Coastal Management received funding through this program from 1992 to 1997.

The division formed the N.C. Ocean Resources Task Force in 1993 to review a range of ocean issues and to provide recommendations to the division and the Coastal Resources Commission. The state also contracted with the N.C. Sea Grant College Program to conduct an independent analysis of the state's ocean policies. The task force used Sea Grant's ocean management study as the basis for many of its recommendations.

The task force recommended that the Coastal Resources Commission amend the coastal energy policies to provide greater protection to sensitive natural resources of the coastal area and to clarify the state's information needs for consistency reviews of OCS proposals. The task force's recommendations also included draft language for the commission's consideration.

Table 1H.2. Components of the North Carolina Coastal Management Program for Reviewing OCS Activities.

---

### **COMPONENTS OF THE NC CMP FOR REVIEWING OCS ACTIVITIES**

#### **NC Coastal Area Management Act (NCGS 113A-100)**

*Examples of applicable goals:*

- Protect beaches, dunes and estuarine systems
- Preserve and enhance water quality
- Insure orderly and balanced use of coastal resources
- Protect natural resources, water use, scenic vistas, fish and wildlife
- Preserve historic, cultural and scientific aspects of the coastal area

#### **Administrative Rules Found in Title 15, Chapter 7 (NC Administrative Code)**

*Some highlights of Coastal Energy Policies:*

- Defines major energy facilities
- Lists information to be included in an impact assessment
- Lists sensitive areas to be avoided to maximum extent practicable: areas with high biological or recreational value, offshore reefs, rock outcrops, wetlands, primary nursery areas, anadromous fish spawning areas, submerged archaeological resources, etc.
- Requires avoidance of nesting and spawning periods
- Requires specific information to be included in an Oil Spill Contingency Plan (pursuant to federal regulations)
- Protects scenic and visual qualities of coastal areas
- Requires restoration of coastal areas when facilities are abandoned

#### **Network of other state agencies' applicable, enforceable policies and guidelines referenced in program documents**

*Examples:*

- Divisions of Air and Water Quality (e.g. air and water quality standards)
- Division of Marine Fisheries (e.g., rules protecting fish spawning areas/life cycles)
- Division of Cultural Resources (e.g., rules to protect archaeological resources)

#### **Federally approved local land use plans for coastal towns or counties**

- For Chevron/Mobil Proposals: Dare, Hyde, and Carteret County Land Use Plans; Beaufort, Morehead City Land Use Plans)
-

The Coastal Resources Commission adopted amendments to the energy policies in November 1996. Due to new administrative procedures adopted by the state legislature in 1995, which provide for additional legislative review and oversight, the rules would not have become effective until August 1998. However, because of heightened concern over Chevron's announcement earlier this year that it intended to submit a new exploration proposal for the Manteo Unit, Governor James Hunt signed Executive Order 121 on November 3, 1997, putting the rules into effect immediately. The rules have been formally submitted to NOAA for inclusion in the N.C. Coastal Management Program.

The amended rules clarify for the applicant the information necessary for the state to conduct a consistency review. The rules identify specific sensitive areas (such as wildlife refuges, offshore reefs, hard bottom areas, submerged aquatic vegetation beds, anadromous fish spawning and nursery areas, and sea turtle nesting beaches) that should be avoided when locating energy facilities, require mitigation where impacts to coastal resources cannot be avoided, and restoration of sites when facilities are abandoned. Support facilities, drill ships, and platforms are defined as "major energy facilities" and must, therefore, meet the siting requirements that are listed.

The N.C. Coastal Management Program also incorporates local land use plans that have been approved for consistency by the Department of Commerce/NOAA. During the Mobil review, two oceanfront counties closest to the Manteo Unit—Dare and Hyde—expressed strong concerns about the possible impacts of processing facilities, refineries, drilling platforms, or support bases along pristine areas of the Outer Banks, an area that is renowned for fishing and tourism. Both counties amended their land use plans in 1989 specifically to prohibit the siting of energy facilities. (Hyde County amended its plan to prohibit energy facilities on the outer banks portion of the county; the prohibition does not apply to inland areas.) These land use plan amendments were approved by NOAA, which concurred that energy facilities would not be compatible uses in these two particular areas. Any new OCS proposals would have to be consistent with these amended land use plans.

#### N.C.'s PROCESS FOR REVIEWING CHEVRON'S EXPLORATION PROPOSAL

Chevron has notified the state that it would like to submit a plan of exploration to drill by the summer of 2000 on either Block 467 or 510 in the Manteo Unit. The N.C. Department of Environment and Natural Resources is preparing to conduct a rigorous review of a new exploration proposal. The consistency review will be coordinated by the Division of Coastal Management, using the amended coastal energy policies as the primary guide.

In coordination with the Minerals Management Service, the state has invited a number of key university scientists, federal and state agency experts to participate in a technical workshop in February 1998 to help identifying scientific information and studies that the state will need for reviewing an OCS exploration proposal. In addition, the department will form an advisory group to the secretary and the governor comprising several members from the three environmental regulatory commissions (Marine Fisheries, Coastal Resources, and Environmental Management), as well as representatives from Dare and Carteret Counties.

Once an exploration plan is formally filed by Chevron, there will be deadlines for the state to comment and review the proposal. The state is committed to conducting a very public and thorough review of the proposal. The state has asked the federal government and Chevron to provide the same level of information that it requested during the Mobil plan review.

---

Kim Crawford, ocean policy specialist for the North Carolina Division of Coastal Management, has represented North Carolina on the MMS OCS Policy Committee since 1993. She has worked on OCS oil and gas issues for over eight years, and has coordinated the development of the state's ocean resources management plan. She received her bachelor's degree from Wake Forest University and a Master of Public Administration degree from the University of North Carolina at Chapel Hill.

## **LOOKING FOR THE LODESTAR IN THE SHIFTING SANDS OF THE MANTEO UNIT**

Mr. Daniel F. McLawhorn  
North Carolina Department of Justice

(Any opinions expressed in this paper are solely those of the author and not his employer, the North Carolina Department of Justice. This paper does not represent, and may not be cited as, an opinion of the Attorney General's Office of the North Carolina Department of Justice.)

The pending proposal by Chevron to drill an exploratory well offshore North Carolina presents several extraordinary legal issues. These new legal issues, the unresolved legal issues pending from the Mobil proposal to drill, and the two potential drilling scenarios presented by Chevron, make it even more difficult to define the legal position of the State vis-a-vis the present proposal. Because the factors that can influence the State's policy decision are regularly shifting, it is impossible to find a legal lodestar by which the State can prevail with its position decision—a source of constant quest for the State's attorneys in the Mobil/Chevron case.

### **CURRENT LEGAL STATUS**

North Carolina denied the CZMA (Coastal Zone Management Act) consistency certifications submitted by Mobil for its exploration plan and for its NPDES permit application on November 19, 1990, and July 17, 1990, respectively. As a consequence, the exploration plan and NPDES permit application, and the accompanying environmental documentation, were never made the subject of final agency decisions by the respective federal agencies. The state founded its consistency certification denials on a lack of adequate information. For the NPDES permit, the findings were made pursuant to 15 CFR §§ 930.54(e), -.58, -.60(a), and -.64(d). For the Plan of Exploration, the findings were made pursuant to 15 CFR §§ 930.56(b), -.58, -.75(b), -.77(b), and -.79(c).

Mobil sought Secretarial review of the consistency denials. While the Secretarial review was being conducted, the Secretary of Interior was conducting studies which responded to two of the information topics cited by North Carolina in its denials. The Secretary of Interior determined that studies on the remaining topics could be delayed until during and after the drilling of the exploration well. By the time the studies were released, the Administrative Record (AR) had been closed. While no party to the dispute requested the studies be added to the AR, the Secretary of Interior delivered a copy of the studies to the Secretary of Commerce about six weeks before the final agency decisions issued.

The Secretary of Commerce upheld North Carolina's consistency denials but narrowed the grounds for the denials. The Secretary's bases for upholding the denials relied on the lack of information for two subjects. These were the same issues addressed in the studies conducted by the Minerals Management Service after the consistency appeals were filed. On judicial review, Chevron and Conoco intervened and joined in the motion by Mobil to supplement the AR with these two studies.

In April 1996, the district court entered an order requiring the Secretary of Commerce to determine whether the AR should be enlarged to include the two studies. The parties to the litigation agreed to a delay in responding to the court so the potential for resolution by settlement could be discussed. No formal response has been filed, and the litigation remains on hold.

#### NEW LEGAL ISSUES

The Chevron proposal to drill an exploratory well will presumably present several new legal issues. In the first instance, Chevron cannot state with certainty the lease block on which it intends to submit an application for an exploration well. The two potential blocks are 467 and 510. Block 467 was the subject of the Mobil application. Block 510 is adjacent to Block 467; the two blocks touch at a corner. The potential drilling locations are approximately one mile to one and a half miles apart. Chevron is the lessee of Block 510, but not of 467. The question of whether 467 will be available will be determined, in part, on the outcome of a litigation now on appeal between Mobil and the United States.

Regardless of the block, North Carolina will insist on a comprehensive analysis of the potential impacts from the exploration and delineation phase of the activities. At the outset, it must be understood that the Manteo Block is a frontier area in all senses, including the State's level of understanding of potential impacts of drilling. There being no history of offshore drilling in the vicinity of the Outer Banks, the information base and level of public discourse needed to reach assurance of consistency with the North Carolina coastal management plan is probably deeper and larger than might be customary off other coasts. North Carolina's Secretary of Environment and Natural Resources has put Chevron on notice that Chevron will be held to the same level of information deemed necessary for a state decision on the merits of consistency certifications as was applied to the Mobil applications. Those information requirements were specified in rules adopted by the Coastal Resources Commission in November 1996 and put into effect by Executive Order of the Governor on November 3, 1997. The rules generally reflect the information required from Mobil through the Memorandum of Understanding.

The separate legal issues presented by the two blocks are the subject of the remainder of this paper.



## BLOCK 467

The pending judicial review is concerned with the adequacy of the information submitted by Mobil in conjunction with its coastal consistency certifications. That information was pertinent to the particular exploration plan and NPDES permit application submitted by Mobil. It is particularly significant to note that neither of those documents has been found consistent with the North Carolina coastal zone management plan. Thus, from a legal perspective, Block 467 offers no benefit to Chevron unless and until the consistency objections are removed or overcome.

A second set of issues will be raised should Chevron submit modifications to the exploration plan and NPDES permit application as presented by Mobil. Since the consistency certifications were for a different, albeit related proposal, the consistency certifications will at a minimum require supplementation. However, the OCRM rules do not provide for supplementation of consistency determinations. It will be North Carolina's position that supplementation causes the State again to have an opportunity to review the projects for consistency and to issue a new consistency certification decision.

The Block 467 issues can also be addressed through a settlement of the pending lawsuit. In those discussions, North Carolina has demanded a new opportunity to make its consistency decision. In addition to the information developed through the Environmental Report issued before the consistency decisions were made, a substantial volume of additional information was developed afterwards and much of it was made a part of the AR. This will be an especially important issue should the court or the parties, through the settlement, decide to make the two MMS studies a part of the AR, as Mobil and Chevron have requested. Of course, the expanded record for a new drilling proposal by Chevron would also have to address any modifications made to the existing applications by Chevron.

For Block 467, another set of issues exists regarding the adequacy of the existing NEPA documentation. Shortly after the project was announced as an exploration well plus the delineation wells, Mobil scaled it down to the exploration well only. Mobil contended, with the concurrence of the MMS, that it could segment the project and submit a second application for the delineation wells. Nothing prevents segmentation of the permits, but the NEPA doctrine against piece-mealing should prevent the environmental assessment from being so narrow. The EA prepared by MMS for the Mobil proposal was limited to the exploration well and did not address the delineation phase of exploration. Because the Record of Decision (ROD) for the EA was not issued, North Carolina was not able to challenge the EA. Under the Council of Environmental Quality regulations, a NEPA decision is not final until the ROD issues. 40 C.F.R. §1505.2. Additionally, the MMS has been barred from issuing the permit by the consistency objection. A challenge to the EA/FONSI will be premature until the ROD for the EA and the permit decision are issued by MMS.

A second NEPA issue is raised by the potential for a Secretarial override of the North Carolina consistency objections. To override consistency determinations by the state, the Secretary exercises executive power and may override for reasons other than an error by the state in its decision. Because of that independent power, North Carolina concludes the Secretary must comply with NEPA before he can override the state's consistency determinations. The AR does not include a NEPA document,

the state is not aware of any NEPA document prepared in conjunction with the consistency certification review. Thus, another potential issue is whether the Secretary has met his NEPA responsibilities if he undertakes to override the state's consistency determinations.

### BLOCK 510

In 1982, Chevron submitted a consistency certification for an exploration plan for Block 510. North Carolina approved the certification. The OCRM has opined that once consistency certification has been issued, it cannot be revoked or withdrawn. This agency interpretation by NOAA has not been the subject of a judicial construction and may provide an opportunity for challenge. In addition, North Carolina considers the prior consistency certification to have been limited to the plan submitted and to the approved state coastal zone management plan then existing. North Carolina contends the certifications would not apply to modified versions of those previously submitted plans. Thus, the first legal issue is the value or benefit that Chevron can obtain from the prior consistency certifications for its new proposal to drill an exploratory well in the same block.

A second set of issues is presented by the NEPA documentation. That will surely require a supplement. It is unclear whether the exploration plan approval and NPDES permit were ever issued. If they were not issued or the prior NPDES and POE approvals have expired, then new applications as well as NEPA documentation will be required. If they were issued, supplementation may be required. If so, North Carolina should be expected to contend that a new consistency certification is required for the revised applications.

### SUMMARY

There are relatively few legal tools available to states in their review of oil and gas exploration and delineation plans. The unusual legal circumstances surrounding the two blocks where Chevron wishes to drill off-shore North Carolina have created variations on the normal themes encountered for such approvals. The factual variables make it difficult, if not impossible, to predict what legal issues will ultimately confront the parties to this matter. Given the history of the case, chances are they will be intriguing regardless of which issues sift out as the sands shift. The task for the author and other members of the Attorney General's staff continues to be finding the legal lodestar in these shifting sands which will guide the State's consistency determination and other actions towards a fair, effective resolution of the Chevron proposal—a resolution that truly accords with the coastal management policies of the state.

---

Dan McLawhorn is a Special Deputy Attorney General in the North Carolina Attorney General's office. He has been assigned since 1991 to the Special Litigation Section, a unit created by the Attorney General to handle complex litigation with the potential for substantial impacts on the State. His areas of specialization include environmental law and state constitutional issues, especially separation of powers. Previously, Mr. McLawhorn was head of the Environmental Protection Section of the North Carolina Attorney General's Office, the section that advises and represents state agencies

responsible for enforcement of the environmental laws in North Carolina. Earlier, Mr. McLawhorn was the head of the Administrative Law Section of the Attorney General's Office. For more than fifteen years, he has been involved with administrative law and environmental law in North Carolina. In 1990, he was elected vice chair of SEEN. Mr. McLawhorn also has participated in the sections of the North Carolina Bar Association concerned with environmental law and administrative law. He is a past chair of the Administrative Law Section and the Environmental and Natural Resources Law Section. He is a member of the Continuing Legal Education Committee of the NCBA. Mr. McLawhorn graduated from Davidson College in 1970 and the University of North Carolina School of Law in 1974.

### **MANTEO PROSPECT: HOW IT CAN BE DONE?**

Mr. David Duplantier  
Chevron, U. S. A.

Chevron participated in the MMS Information Transfer Meeting on 18 December 1997 in New Orleans and a Technical Workshop in North Carolina on 4 February 1998 to explain how a well would be drilled off the coast of North Carolina. The focus of Chevron's presentations was the geologic nature of the prospect. Participants in these two proceedings included state and federal agencies as well as members of the scientific community.

### **PLAN OF ACTIVITY FOR THE MANTEO PROSPECT**

Chevron plans to drill one exploratory well, likely at the Manteo Block 510 site, a location and activity previously approved by North Carolina when a Plan of Exploration was submitted in 1982. The exploratory well will be drilled using a dynamically positioned drilling vessel. The activity will take approximately 110 days and will be located in about 2,200 feet of water nearly 40 miles from the North Carolina coast. The prospect is a Late Jurassic–Early Cretaceous shelf-edge carbonate reef that lies between 11,000 and 15,000 feet below the seafloor. Chevron would like to spud the well in spring/summer of the year 2000 and use the port of Morehead City as a shorebase for its activity.

Chevron's Deep Water Group out of New Orleans, Louisiana will manage the activity with all the necessary professional disciplines working together as a team. While this activity will be the first well drilled by an oil company in the federal waters off the coast of North Carolina, oil exploration is not new to the state. In addition, the state has previously reviewed other exploratory wells. One such activity was proposed by Mobil in 1990 approximately 5,900 feet away from the Chevron location. This proposal was the subject of intense review by state and federal agencies.

Chevron met with the state on two occasions in 1997 and participated in the two forums noted above. Chevron now plans to submit written documentation in late 1998 (November/December) to allow the MMS to issue the necessary permits for the drilling of one exploratory well at the Manteo Site. If any

discovery of commercial hydrocarbons is encountered, it will open an entirely new process of regulatory review which must be completed before any gas or oil is produced. Such production can only happen if the exploratory phase is allowed to go forward and is successful.

## GEOLOGIC PROSPECT

The Manteo Prospect is a Late Jurassic– Early Cretaceous barrier reef and platform carbonate complex that was deposited on the paleo shelf-edge roughly 130 to 140 million years ago. This shelf margin carbonate trend rims the North American continent from Newfoundland to Yucatan and has produced numerous fields around the Gulf of Mexico. These fields, which include MP 253/254, Waveland, Black Lake, Fairway, Alabama Ferry, and Stuart City in the U.S. and Golden Lane, Poza Rica, Reforma, and Campeche in Mexico have estimated recoverable reserves of over 17 billion barrels of oil or equivalent gas. The Manteo prospect consists of three target reef facies: reef core, fore-reef, and back-reef, with most of the reserves expected in the reef core facies.

The Manteo prospect is defined by a 0.5 mile (dip) by 1.5 mile (strike) seismic data grid consisting of five separate 2-D speculative and proprietary seismic surveys that were recorded between 1976 and 1981. This data identifies a large structural culmination of the shelf margin carbonate trend that encompasses several OCS blocks, including Manteo blocks 510 and 467. The prospective reef complex lies below the present day shelf break at a depth of approximately 11,500' subsea. Water depths vary dramatically across Manteo block 510, from less than 300' in the northwest to over 3800' in the southeast. The proposed well is located in the northeastern portion of block 510 in 2132' of water. From this location we anticipate encountering the reef complex at or near its structural crest.

A similar barrier reef and platform carbonate complex was tested by Shell in the mid 1980s in the Wilmington Canyon area approximately 250 miles NNE of the Manteo prospect. Shell's back-reef facies test found poor quality reservoir rock while its reef core facies test found almost 2000' of good quality reservoir rock. Neither well encountered hydrocarbons; thus, it is widely believed that in the Wilmington Canyon area the Lower Cretaceous–Jurassic source rocks were probably immature. This hydrocarbon maturation problem is less likely to exist in the Manteo area where the potential source rocks are buried nearly 5000' deeper than in the Wilmington Canyon area.

The Manteo Prospect is a true wildcat. When one considers the four key elements of risk for finding hydrocarbons (reservoir, trap, source rock, and migration pathways), the existing data and information show that the probability of finding hydrocarbons, in any amount, is roughly 1 in 15 or 7%. When this probability is coupled with the expected reserves distribution, it further reduces the chance of a commercial discovery by a factor of two. Risky as it may be, the Manteo prospect is very important because of the enormity of the prospect's reserves potential. Manteo's expected value reserves of nearly 1.5 billion barrels of oil or equivalent gas would make it the largest domestic hydrocarbon discovery since Prudhoe Bay and more than twice the size of the largest field discovered in recent times in the deep waters of the Gulf of Mexico. Source rock studies are inconclusive, as to the type of hydrocarbons that may be present in the Manteo prospect; therefore, reserve numbers are quoted in barrels of oil or equivalent gas terms.

The expected reservoir conditions (i.e., formation pressure, temperature, and depth) of the Manteo prospect are well within the conventional drilling realm. The expected bottom hole conditions of this well will be very similar to many wells that are currently being drilled with existing technology. The Manteo block 510 well is designed to reach a total vertical depth of at least 15,000 feet subsea, and withstand bottom hole temperature and pressure conditions of 200° F and 7,000 psi, respectively. This compares to wells currently being drilled in the Gulf of Mexico to depths greater than 25,000 feet subsea, with bottom hole temperatures and pressures in excess of 425° F and 12,000 psi, respectively.

## DRILLING TECHNOLOGY

The major factors that will affect Chevron's exploratory drilling activity are physical oceanography (current, wind and waves) and drilling vessel capability. The technology that exists and the activity of industry today in areas all over the world support Chevron's ability to perform the exploratory activity proposed for the Manteo Prospect with minimal impact on any land or water resources. A great deal of data has been collected on the physical and oceanographic conditions constituting the area of the Manteo Prospect. This work has been done by various state and federal agencies in conjunction with the academic and scientific communities.

Drilling vessels in operation today have station keeping ability to withstand winds as high as 65 knots, currents up to 4 knots, and tremendous wave forcing. The next generation of drilling vessels being built will have even greater operational capabilities. Most importantly, drilling activities can be shut down within a short period of time and a rig can be moved to a less hostile environment until working conditions improve. This ability to suspend or commence operations in the same location at various times based on operating conditions can be performed with minimal impact.

Chevron and others in the industry must explore in deep water and in previously untested areas to replenish reserves. Some of these areas, such as Manteo, experience high currents for which riser technology has developed dramatically. Special tools keep drilling assembly in place so that work can continue during periods of high current. Special equipment on board the drilling rig allows the proper position to be maintained for continuous drilling operations. The station keeping is provided by the latest dynamic positioning technology that utilizes satellite navigation and onboard thrusters to position the vessel. This technology eliminates the need to anchor the vessel to the seafloor. Conditions similar to the Manteo Area exist off Brazil, in the Gulf of Mexico and in the North Sea, where industry has successfully explored for and produced oil and gas resources.

Advances in drilling technology have allowed drilling ships to evolve in a manner that reduces environmental impacts. These ships have grown to allow for drilling in remote areas with minimal support needed from onshore. Most supplies and equipment required to drill the Manteo exploratory prospect will be on the vessel when it arrives on location. The only significant support needed will be to transfer crews working extended shifts of up to 14 days duration. This ability reduces the need for (crew or work) boat support, thereby eliminating additional boat traffic in the area.

All discharges will take place in compliance with strict guidelines for permits developed by MMS and EPA and other federal agencies. Chevron will need an operating drilling permit issued by MMS

as well as an NPDES (National Pollutant Discharge Elimination System) permit and air permit issued by EPA. The permitted activity will be performed in conjunction with consultation by lead agencies with all other state and federal agencies.

Chevron, the Federal Government, and the State of North Carolina have invested considerable resources in evaluating the Manteo Area. Chevron believes the drilling of one exploratory well in this area and the minimal impact expected from that activity necessitates this activity go forward.

---

David Duplantier has been employed by Chevron in its Law Department for the past 12 years and is currently Senior Counsel in the New Orleans Office. Since 1991, he has been actively involved in Chevron's permitting and regulatory process in areas off the coasts of Alabama, Florida, and North Carolina. Before working at Chevron, Mr. Duplantier served a three-year term as a Schedule C White House appointee to Commissioner Oliver G. Richard at the Federal Energy Regulatory Commission as a policy and legal advisor. Mr. Duplantier received a Bachelor of Science in finance from Louisiana State University in 1975, and a law degree from Loyola University in New Orleans in 1978.

## **BATHYMETRIC AND PHYSICAL OCEANOGRAPHIC DESCRIPTION OF THE MANTEO LEASE AREA**

Dr. Larry Atkinson  
Ms. Lorraine Heilman  
Center for Coastal Physical Oceanography  
Old Dominion University

Dr. Tom Curtin  
Office of Naval Research

The waters off Cape Hatteras exhibit some of the most energetic coastal dynamics anywhere. Here the broad shelves of the Middle and South Atlantic Bight narrow nearly isolating shelf waters north and south of Cape Hatteras from each other. Offshore, one of the strongest current in the ocean, the Gulf Stream, moves northward. In addition to that variability in the large-scale current regime, both winter storms and tropical hurricanes are prevalent in the region. In this paper we discuss the physical oceanographic properties at the Manteo site and their variability.

### **BATHYMETRY OF THE REGION**

The bathymetry of the area (Figure 1H.6) is complex. A key feature of the area is the steep slope rising from the continental rise. The slope shallows to about 50 m where it transitions to the continental shelf at the shelf break. The steepness of the slope and the abruptness and shallowness

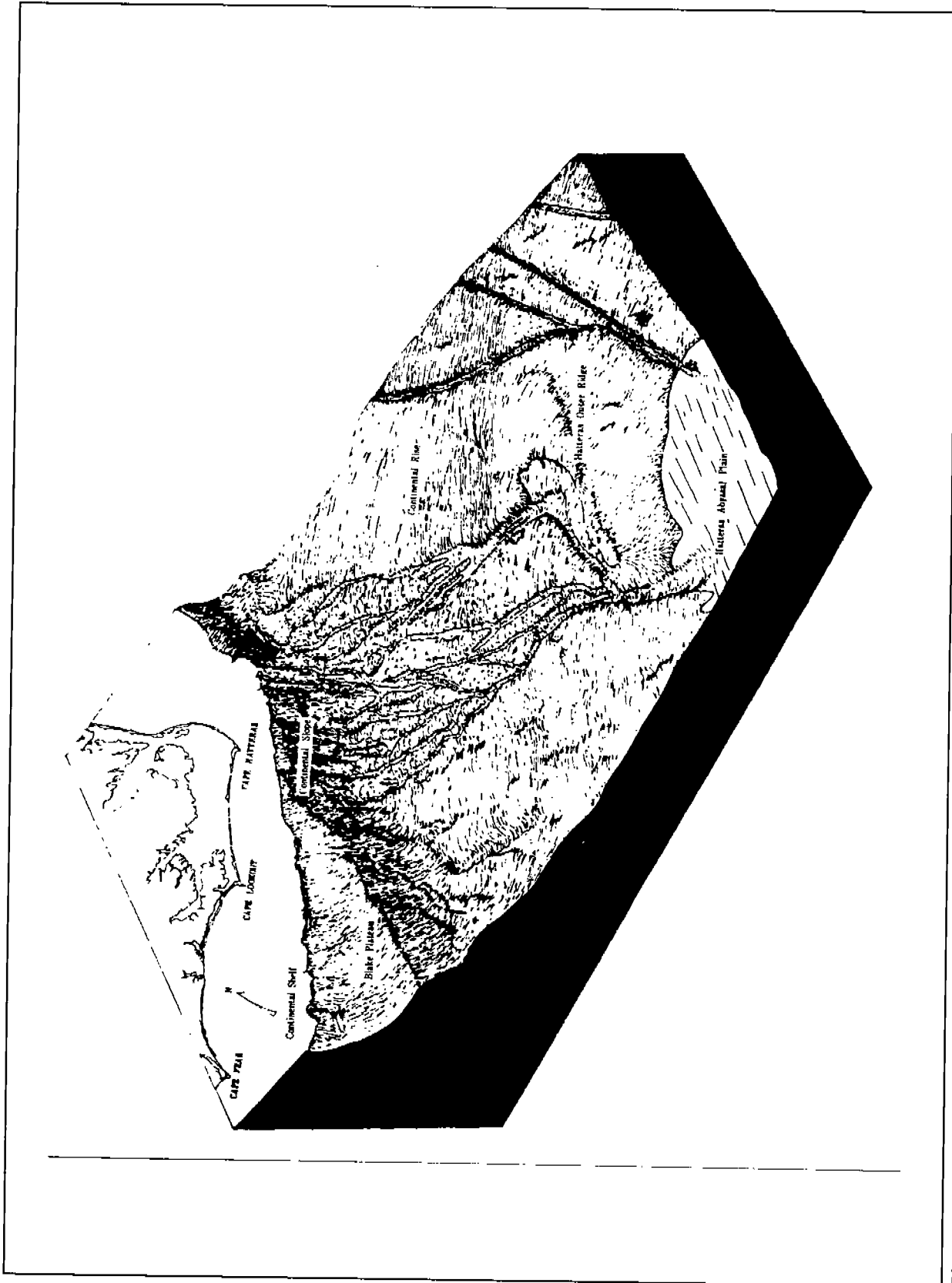

Figure 1H.6. Bathymetry of Cape Hatteras region. From Emery and Uchupi (1972).

of the shelf break have some impact on the physical oceanography. This pattern is consistent from Cape Canaveral to well north of Cape Hatteras, with the shelf break gradual deepening from south to north.

The key feature on the shelf is the abrupt change in direction of the coastline at Cape Hatteras. North of Cape Hatteras the coastline trends N/S and is broken only by one large and one small inlet until Chesapeake Bay. South of Cape Hatteras a series of capes break the alongshore patterns. The shoals extending offshore from the Capes nearly reach the shelf break, thus impeding alongshore flow. River inflow to the region occurs at Chesapeake Bay Entrance and at the inlets through the barrier islands where freshwater in the North Carolina Sounds escapes to the ocean. River flow is a minor source of variability in the region.

### PHYSICAL OCEANOGRAPHY

There are two dominant sources of variability in the region: wind and the Gulf Stream. The Gulf Stream, one of the world's largest and fastest open ocean currents, meanders northward along the continental slope shedding eddies and filaments over the shelf. Additionally the area is where extreme atmospheric cyclogenesis occurs when the warm waters of the Gulf Stream provide moisture to developing extra-tropical cyclones. Thus, this area is the confluence of two very large and highly variable forces. The Diamond Shoals Light off Cape Hatteras is near the Manteo site providing an excellent source of weather and climate data.

### CLIMATE

Mean monthly data are shown in Figure 1H.7. Mean monthly winds off Cape Hatteras are controlled by the strength of the Bermuda High and the passage of storms. The strengthening and weakening of the Bermuda High in relation to barometric pressure over the continent results in northward winds during the summer and southward winds during the winter. Storms and shorter term variability in the large pressure systems causes the variability we observed. The following statistical summaries are from the Diamond Shoals Light Station. Because this station is on the shelf, nearer land, the summaries are not exactly what one would expect at the Manteo, site but they would be close.

The mean monthly wind reaches a minimum of 12.6 knots in August and a maximum of 18.9 knots in January. Importantly the range in wind speed is highest in August, with September following closely. This is caused by the occurrence of hurricanes, a topic to be discussed later.

The mean monthly averaged air temperatures are no doubt slightly lower in mean and range than what would be observed farther offshore. Nevertheless, the range in mean and the absolute range is rather large:  $-10^{\circ}\text{C}$  to  $30^{\circ}\text{C}$ .

Mean monthly sea water temperature will be much lower in the winter than the Manteo site because of the influence of the Gulf Stream offshore. At DSLS the temperatures range from about  $4^{\circ}\text{C}$  to  $30^{\circ}\text{C}$  with extreme ranges in the winter months. This range extreme is because of the incursion of both cold nearshore waters and warm offshore water to the DSLS site.



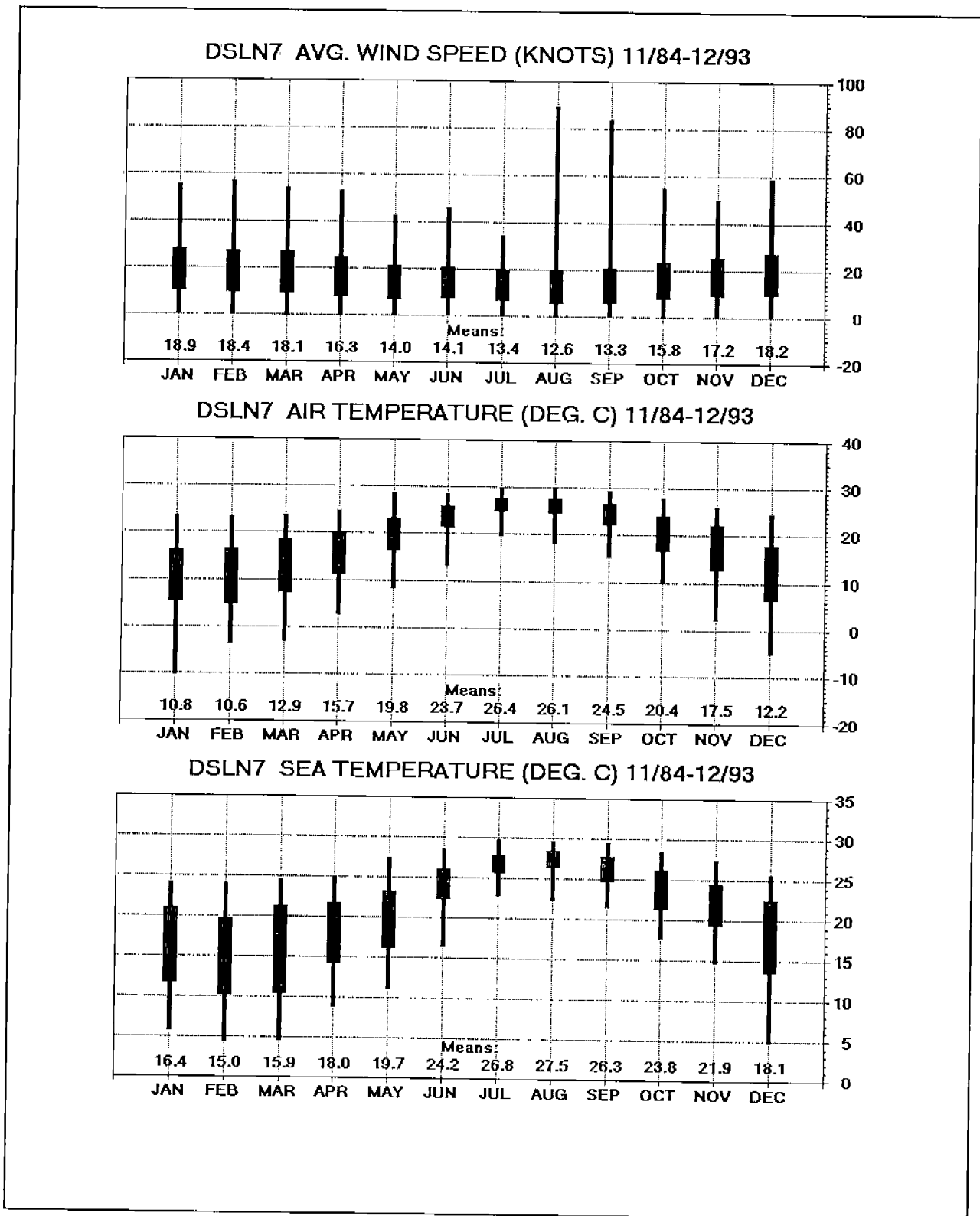

Figure 1H.7. Mean monthly data from Diamond Shoals Light Tower. Data from National Data Buoy Center.

Surface salinity data are not as available as other data. Surface salinity is low in coastal water and the high salinity water of the Gulf Stream. While not necessarily part of the climatology, it should be noted that low salinity water from the SE United States and the Gulf of Mexico is occasionally found off Cape Hatteras in the Gulf Stream front (Atkinson and Wallace 1975; Ortner *et al.* 1995). The drift of buoys from the mouth of the Mississippi River to the region shows the potential for water from the northern Gulf of Mexico to reach the Manteo region (Ortner *et al.* 1995).

## WEATHER

Weather in the region is affected by the passage of cold and warm fronts, lows from either the south or west, and hurricanes. The two forces of concern are the wind stresses and the heat fluxes. Winter storms occur 2 to 5 times per year. Low pressure systems develop in the southeast U.S. and travel northward. When they pass over the warm Gulf Stream waters, water vapor and heat provide the energy for what is called explosive cyclogenesis. The strong southwestward winds combined with low air pressure can cause significant storm surge along the coast with accompanying coastal erosion. Sea states during these events are extreme.

Hurricanes pass the area in August and September, following the Gulf Stream northward, and passing very close to the Manteo region.

## GULF STREAM

The typical position of the Gulf Stream track is shown in Figure 1H.8. This sea surface temperature image shows the flow of warm water out of the Gulf of Mexico through the Straits of Florida. As the Gulf Stream courses north, it hugs the continental slope except off South Carolina, where a ridge deflects it offshore then onshore again. Off Cape Hatteras the Gulf Stream leaves the coast and begins its trip across the Atlantic. The importance of Cape Hatteras is obvious as it is the point where the Gulf Stream starts to interact with the colder waters moving southward from Nova Scotia and Labrador.

A more detailed view of the region (Figure 1H.9) shows the southward movement of water along the coast and the northward movement of warm Gulf Stream water to the northeast. Note the penetration of cool shelf water around Cape Hatteras and into Raleigh Bay. Also note the arrows indicating the apparent entrainment of shelf water into the Gulf Stream.

## COASTAL CURRENTS

Drifters were released both at the Manteo site and in coastal waters inshore from the site. The drifters followed many different trajectories depending on the release location, and wind direction and speed (Berger *et al.* 1995). Drifters released in the coastal waters tended to stay in coastal waters as would be expected. Drifters released farther offshore followed a variety of tracks with some finally finding the coastal current.

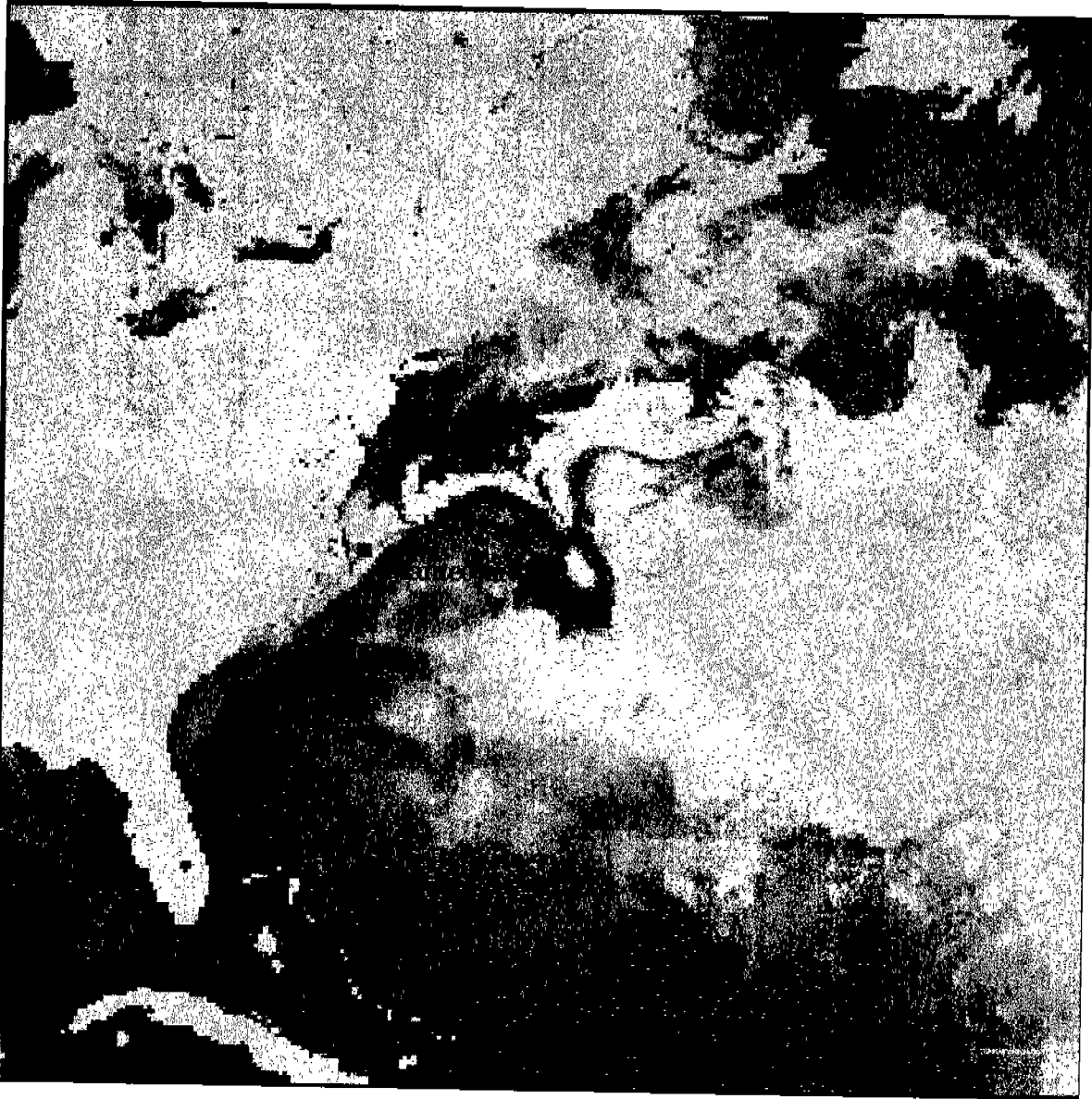

Figure 1H.8. Surface temperatures image in the western North Atlantic showing location of Manteo site. The Gulf Stream shows as dark while cooler waters are lighter greys and cold shelf water is dark again. Figure from NOAA Northeast Coastwatch Center.



Figure 1H.9. Surface temperature on December 3, 1997 in Cape Hatteras region. Directions of inferred currents indicated. Warm waters are light and cold waters are dark. Figure from NOAA Northeast Coastwatch Center.

As noted in the SAIC (1990) report "None of the drogued drifters released outside the nearshore region were recovered ashore in the Cape Hatteras region: while seven were found beached in England (1), France (3), the Canary Islands (1), and the Bahamas (2) 14 to 35 months after deployment."

#### SUMMARY

The atmospheric and oceanographic characteristics of the region is quite well known. The principle processes are understood in both conceptual and quantitative ways. The Gulf Stream and its eddies and meanders are the dominate oceanic feature while wind forcing of coastal waters are important further on shore. Atmospheric conditions are controlled by basin scale pressure systems and synoptic scale storms.

#### ACKNOWLEDGMENTS

The authors thank the Minerals Management Service, Department of the Interior, for the invitation to present this paper. The research was supported by the Office of Naval Research, the Center for Coastal Physical Oceanography, Old Dominion University and the Slover Endowment.

#### REFERENCES

This is meant to be a resource of papers relevant to the physical oceanography of the region, not just ones referred to in this paper:

- Atkinson, L. P. 1976. Modes of Gulf Stream intrusions into the South Atlantic Bight shelf waters. *Geophys. Res. Lett.*, 4(12): 583-586.
- Atkinson, L. P., T. N. Lee, J. O. Blanton, and W. S. Chandler. 1983. Climatology of southeastern United States continental shelf waters. *J. Geophys. Res.*, 88(C8): 4705-4718.
- Atkinson, L. P., J. L. Miller, T. N. Lee, and W. M. Dunstan. 1996. Nutrients and chlorophyll at the shelf break off the southeastern United States during the Genesis of Atlantic Lows Experiment: Winter 1986. *J. Geophys. Res.*, 101(C9):20565-20578.
- Atkinson, L. P., E. Oka, S. Y. Wu, T. J. Berger, J. O. Blanton, and T. N. Lee. 1989. Hydrographic variability of southeastern United States shelf and slope waters during the GALE experiment:1986. *J. Geophys. Res.*, Vol. 94, No. C8, pp. 10,699-10,713.
- Atkinson, L. P. and L. J. Pietrafesa. 1980. A flushing model of Onslow Bay, North Carolina, based on intrusion volumes. *J. Phys. Oceanog.*, 10(3): 472-474.
- Atkinson, L. P., J. J. Singer, and L. J. Pietrafesa. 1980. Volume of summer subsurface intrusions into Onslow Bay, North Carolina. *Deep-Sea Res.*, 27A: 421-434.

- Atkinson, L. P. and T. E. Targett. 1983. Upwelling along the 60-m isobath from Cape Canaveral to Cape Hatteras and its relationship to fish distribution. *Deep-Sea Res.*, 30(2A): 221-226.
- Atkinson, L. P. and D. Wallace. 1975. The source of unusually low surface salinities in the Gulf Stream off Georgia. *Deep-Sea Res.*, 22: 913-916.
- Bane, Jr., J. M. and K. E. Osgood. 1989. Wintertime air-sea interaction processes across the Gulf Stream. *J. Geophys. Res.*, 94:8, 10,755.
- Berger, T. J., P. Hamilton, R. J. Wayland, J. O. Blanton, W. C. Boicourt, J. H. Churchill and D. R. Watts. 1995. A physical oceanographic field program offshore North Carolina, Final Synthesis report. OCS Study MMS 94-0047. U.S. Department of the Interior, Minerals Mgmt Service, Gulf of Mexico OCS Region, New Orleans, La. 345 pp.
- Bower, Amy S. 1989. Potential Vorticity Balances and Horizontal Divergence along Particle Trajectories in Gulf Stream Meanders East of Cape Hatteras. *J. Phy. Oceanogr.* v 19 n 11 1669.
- Churchill, J. H. and P. C. Cornillon. 1991. Water Discharged From the Gulf Stream North to Cape Hatteras. *Journal Geophys. Res.*, v 96 n 12 22227.
- Churchill, J.H. and P. C. Cornillon. 1991. Gulf Stream water on the shelf and upper slope north of Cape Hatteras. *Cont. Shelf Res.*, 11:5, 409.
- Cornillon, P. and A. Gangopadhyay. 1991. Why does the Gulf Stream leave the coast at Cape Hatteras? *Maritimes.* v 35 n 1 13.
- Davis, R. E. and R. Dolan. 1993. Nor'easters. *American Scientist*, 81:429-439.
- Dunstan, W. M. and L. P. Atkinson. 1976 Sources of new nitrogen for the South Atlantic Bight. pp. 69-78 in M. Wiley, ed. *Proceedings of 3rd International Estuarine Research Conference*, Galveston, Texas.
- Emery, K. O. and E. Uchupi. 1972. *Western North Atlantic Ocean: topography, rocks, structure, water, life and sediments.* AAPG. 532 pp.
- Huang, C-Y. and S. Raman. 1992. A Three-dimensional numerical investigation of a Carolina coastal front and the Gulf Stream rainband, *J. Atmospheric Sci.* 49:7, 560.
- Gawarkiewicz, G., T. M. Church, G. W. Luther. 1992. Large-Scale Penetration of Gulf Stream Water Onto the Continental Shelf North of Cape Hatteras. *Geophys. Res. Lett.*, v 19 n 4 373.
- Gawarkiewicz, G., R. K. McCarthy, and Kenneth Barton. 1990. A Gulf Stream-derived pycnocline intrusion on the Middle Atlantic Bight shelf. *J. Geophys. Res.*, 95:12, 22,305.

- Glenn, S. M. and C. C. Ebbesmeyer. 1994. Observations of Gulf Stream frontal eddies in the vicinity of Cape Hatteras. *J. Geophys. Res.*, 99, 3, 5047.
- Glenn, S. M. and C. C. Ebbesmeyer. 1994. The structure and propagation of a Gulf Stream frontal eddy along the North Carolina shelfbreak. *J. Geophys. Res.* 99, 3, 5029
- Hofmann, E. E., L. J. Pietrafesa, J. M. Klinck, and L. P. Atkinson. 1980. A time-dependent model of nutrient distribution in continental shelf waters. *Ecological Modeling*, 10: 193-214.
- Kim, H. H., C. R. McClain, L. R. Blaine, W. D. Hart, L. P. Atkinson, and J. A. Yoder. 1980. Ocean chlorophyll studies from a U-2 aircraft platform. *J. Geophys. Res.*, 85(C7): 3982-3990.
- Lee, T. N., E. Williams, J. Wang, R. Evans, and L. P. Atkinson. 1989. Response of South Carolina Continental Shelf Waters to Wind and Gulf Stream Forcing during Winter of 1986. *J. Geophys. Research*, Vol. 94, No. C8, pp. 10,715-10,754.
- Lee, T. N., J. Yoder, and L. P. Atkinson. 1991. Gulf Stream Frontal Eddy Influence on Productivity of the Southeast United States Continental Shelf. *J. Geophys. Res.*, Vol. 96, No. C12, 22,191-22,205.
- Lillibridge III., J.L., G. Hitchcock, and T. Rossby. 1990. Entrainment and Mixing of Shelf/Slope Waters in the Near-Surface Gulf Stream. *J. Geophys. Res.*, 95:8, 13,065.
- Manning, James P. and D. R. Watts. 1989. Temperature and Velocity Structure of the Gulf Stream Northeast of Cape Hatteras: Modes of Variability. *J. Geophys. Res.*, v 94 n 4 4879.
- Marmorino, G.O. and C. L. Trump. 1994. A salinity front and current rip near Cape Hatteras, North Carolina. *J. Geophys. Res.*, v 99 n 4 7627
- Mied, Richard P., Colin Y. Shen, Gloria J. Lindemann. 1996. Frontogenesis with ageostrophic vertical shears and horizontal density gradients: Gulf Stream meanders onto the continental shelf, *J. Geophys. Res.*, 101:8,18079.
- Miller, J. L. 1994. Fluctuations of Gulf Stream frontal position between Cape Hatteras and the Straits of Florida. *J. Geophys. Res.*, 99/C3, 5057-5064.
- Ortner, P. B., T. N. Lee, P. J. Milne, R. G. Zika, E. Clarke, G. P. Podesta, P. K. Swart, P. A. Tester, L. P. Atkinson, W. R. Johnson. 1995. Mississippi River flood waters that reached the Gulf Stream. *J. Geophys. Res.*, 100, C7, 13595-13602.
- Paffenhöfer, G. A., D. Deibel, L. P. Atkinson, and W. M. Dunstan. 1980. The relation of concentration and size distribution of suspended particulate matter to hydrography in Onslow Bay, North Carolina. *Deep-Sea Res.*, 27A: 435-447.

- Pietrafesa, L. J., J. O. Blanton, and L. P. Atkinson. 1978. Evidence for deflection of the Gulf Stream at the Charleston Rise. *Gulf Stream*, 4(9): 3,6-7.
- Pelegri, J.L. and G. T. Csanady. 1991. Nutrient Transport and Mixing in the Gulf Stream. *J. Geophys. Res.*, 96:2, 2577.
- Pickart, Robert S, and W. D. Watts. 1990. Deep Western Boundary Current variability at Cape Hatteras. *J. Mar. Res.*, 48 n 4 765.
- SAIC. 1990. Characterization of currents at Manteo Block 467 off Cape Hatteras, NC. SAIC Report 90/1131 to Mobil Exploration and Producing Services.
- Savidge, D. J. O. Blanton, T. N. Lee. 1992. Influence of an Offshore Shift in the Gulf Stream on Waters of the South Carolina continental shelf. *J. Geophys. Res.*, 22:10, 1085.
- Singer, J. J., L. P. Atkinson, J. O. Blanton, and J. A. Yoder. 1983. Cape Romain and the Charleston Bump: Historical and recent hydrographic observations. *J. Geophys. Res.*, 88(C8): 4685-4697.
- Singer, J. J., L. P. Atkinson, and L. J. Pietrafesa. 1980. Summertime advection of low salinity surface waters into Onslow Bay. *Est. Coastal Mar. Sci.*, 11: 73-82.
- Stefansson, U., L. P. Atkinson, and D. F. Bumpus. 1971. Hydrographic properties and circulation of the North Carolina shelf and slope waters. *Deep-Sea Res.* , 18: 413-420.
- Stefansson, U. and L. P. Atkinson. 1971. Nutrient-density relationships in the western North Atlantic between Cape Lookout, North Carolina, and Bermuda. *Limnol. Oceanog.*, 16: 51-59.
- Stefansson, U., and L. P. Atkinson. 1971. Relationship of potential temperature and silicate in the deep waters between Cape Lookout, North Carolina, and Bermuda. *J. Mar. Res.*, 29: 306-318.
- Vazquez, J. 1990. Sea Level Variabilities in the Gulf Stream Between Cape Hatteras and 50 degrees W: A Geostat Study. *J. Geophys. Res.*,v 95 n 10 17957.
- Vazquez, Jorge . 1993. Observations on the Long-Period Variability of the Gulf Stream Downstream of Cape Hatteras. *J. Geophys. Res.*, v 98 n 11 20133.
- Walsh, J. J. 1994. Particle export at Cape Hatteras. *Deep-sea research. Part II, Topical studies in Oceanography*, v 41 n 2 / 3 603.
- Welsh, E.B., N.G. Hogg, and R.M. Hendry. 1991. The relationship of low-frequency deep variability near the HEBBLE site of Gulf Stream fluctuations. *Mar. Geo.* 99:3, 303.



- Wood, A. M., N. D. Sherry, and A. Huyer. 1996. Mixing of chlorophyll from the Middle Atlantic Bight cold pool into the Gulf Stream at Cape Hatteras in July 1993. *J. Geophys. Res.*, 101:9, 20579.
- Yoder, J. A., L. P. Atkinson, S. S. Bishop, E. E. Hofmann, and T. N. Lee. 1983. Effect of upwelling on phytoplankton productivity of the outer southeastern United States continental shelf. *Cont. Shelf Res.*, 1(4): 385-404.
- Vukovich, F. M. 1994. Variations of the Gulf Stream's North Wall East of Cape Hatteras. *Remote sensing of environment*. v 47 n 3 303.

---

Dr. Larry Atkinson has been at Old Dominion University since 1985 and is now the Slover Professor of Oceanography. In 1992 he and others established the Center for Coastal Physical Oceanography. His research interests mainly concern the interaction of coastal and ocean waters. He has served on several MMS committees including several years as Chair of the OCS Advisory Board's Scientific Committee. He received his B.S. and M.S. in oceanography from the University of Washington and his Ph.D. from Dalhousie University.

Dr. Thomas Curtin has been at the Office of Naval Research since 1984 and is now the Manager of the Ocean Modeling and Prediction Program. Previously, he has managed the Arctic and Physical Oceanography Programs at ONR and was an assistant professor at North Carolina State University. His research interests include ocean frontal dynamics, coastal oceanography and coupled sampling-modeling systems. He has developed several joint programs with MMS in Alaska, California and the Gulf of Mexico. He received a B.S. from Boston College in physics, M.S. from Oregon State University and Ph.D. from University of Miami in physical oceanography.

Ms. Lorraine Heilman has been at Old Dominion University since January 1997 as a research associate with Dr. Atkinson. Her current projects include using ADCP's to study tidal processes in the Chesapeake Bay and James River. She received a B.A. in mathematics from Franklin and Marshall College and M.S. from State University of New York at Stony Brook in marine environmental science.

## A REVIEW: FINDINGS OF THE NORTH CAROLINA ENVIRONMENTAL SCIENCES REVIEW PANEL (ESRP)

Dr. William H. Lang  
Minerals Management Service  
Gulf of Mexico OCS Region

### INTRODUCTION

Since the initial Outer Continental Shelf (OCS) Lease Sale held on 4 August 1981, the leased group of blocks now known as the Manteo Prospect has been the subject of numerous negotiations, understandings, suspensions, disagreements, prohibitions, and legal actions. During this nearly 17-year period, numerous studies have improved information available for the North Carolina OCS, and deep water drilling technology has made often amazing advances; nevertheless, the fundamental concerns and disagreements remain relatively unchanged.

With this in mind, it is quite appropriate to revisit the findings of a congressionally mandated panel of renowned scientists, the North Carolina Environmental Sciences Review Panel (ESRP). In 1990, they were given the task of assessing the adequacy of information to allow reasoned decisions by the Secretary of Interior on permitting Manteo exploratory drilling and potential development and production phases that could follow. This presentation will highlight the ESRP's report to the Secretary of the Interior and also the Department of the Interior's (DOI's) response to these findings in a report to Congress.

### THE PANEL

The Oil Pollution Act of 1990, in a section cited as the Outer Banks Protection Act (OBPA), created the ESRP. The review panel was to be composed of five members: a marine scientist selected by the Secretary of the Interior, a marine scientist selected by the Governor of North Carolina, and three scientists—one each from the disciplines of physical oceanography, ecology, and social sciences—selected jointly by the Secretary and the Governor from a list developed by the National Academy of Sciences.

The Governor selected Dr. John Costlow, Duke University, and the Secretary selected Dr. John Teal, Woods Hole Oceanographic Institution (WHOI). Joint selections were Dr. Kenneth Brink, WHOI; Dr. Charles Peterson, University of North Carolina - Chapel Hill; and Dr. Michael Orbach, East Carolina University. Dr. Costlow was elected Chairman of the ESRP at the first meeting, 28 January 1991. The Panel was formed under the Federal Advisory Committee Act and Dr. Andrew Robertson, Department of Commerce, served as the Federal Coordinator.

The Panel was charged by the OBPA with two tasks: (1) assessing the adequacy of the available physical oceanographic, ecological, and socioeconomic information to enable the Secretary to fulfill his responsibilities under Outer Continental Shelf Lands Act (OCSLA) and (2) identifying any

additional information deemed essential to enable the Secretary to carry out these assigned responsibilities.

Fundamental to the panel formation and charge, the OBPA also prohibited the Secretary of the Interior from proceeding with a number of actions relative to development of oil and gas resources offshore North Carolina for which he is responsible under the OCSLA. Actions prohibited included (1) conducting a lease sale; (2) issuing any new lease; (3) approving any exploration plan; (4) approving any development and production plan; (5) approving any application for permit to drill; and (6) permitting any drilling. The prohibition on these actions was mandated to remain in effect until the later of: (1) 1 October 1991 or (2) 45 days of continuous session of the Congress following the submission of a written report from the Secretary certifying that the information available to him is sufficient to carry out his responsibilities under the OCSLA.

In the written report, the Secretary was required to take into consideration findings and recommendations of the ESRP, and to include a detailed explanation of any differences between his certification of sufficient information and the findings and recommendations of this group.

#### THE REVIEW PROCESS

The Panel first convened on 28 January 1991. This and six subsequent Panel meetings were devoted to discussing and reaching agreement on the functioning of the group, an appropriate definition for adequacy of information, the scope and structure of the required report, conclusions regarding adequacy of information, and recommendations for implementing additional studies. To develop the report, individual Panel members carried out extensive reviews of available information, developed draft sections, and contributed to detailed discussions regarding revisions. All conclusions presented in the report were thoroughly considered at one or more Panel meetings. Unless specifically indicated, the conclusions and recommendations presented in the report represent the unanimous decision of the Panel members. All meetings were announced in the *Federal Register* and were open to the public.

The Panel was directed to consider the adequacy of information for making decisions regarding oil and gas leasing, exploration, and development on the lands of the OCS offshore North Carolina. In 1991, there were 53 lease blocks in this area with active leases for oil and gas resource identification and development. Additional lease blocks were under consideration for leasing as part of a proposed 5-year (1992-1997) program of lease sales. There was also one request pending for approval of a plan for drilling one exploratory well in Manteo Area Block 467 (the Manteo site). This site proposed drilling to test for oil and gas resources, not only in Block 467, but also in a wider, unitized Exploration Unit that includes this block and 20 other contiguous leased blocks (the Manteo Unit). Given the strong interest and public concern regarding this proposed exploratory well, the Panel especially focused on assessing the adequacy of information in the documents (U.S. DOI, 1992a; 1992b) that were developed by MMS specifically to support decision-making regarding oil and gas resource development for this site.

The Panel's report also included a separate, broader and more general consideration of the adequacy of information for the other parts of the OCS offshore North Carolina, especially areas south of Cape Hatteras.

The National Research Council (NRC, 1989) evaluated the adequacy of the existing environmental information to support decision-making regarding development of oil and gas resources on the OCS of Florida and California. This NRC report uses a definition that judges adequacy on the basis of the *completeness* and *scientific rigor* of the available information. The Panel concluded that it was appropriate to adopt a consistent definition that judges adequacy using the same two elements. In addition to the reputation of the NRC, it was also noted that a major motivation for establishing the ESRP was that the North Carolina OCS area was not included in the NRC review. Thus, it was particularly fitting to apply the same standards to North Carolina.

### ADEQUACY FINDINGS

In addition to considering adequacy of information for both the Manteo area and the broader North Carolina OCS, the ESRP addressed information needs relative to OCS operational phases. The phases are sequential steps, each requiring additional business and regulatory decisions and are defined in Interior documents (DOI, 1986; 1987):

- 1) Leasing
- 2) Exploration/delineation
- 3) Development/production
- 4) Post-production

While the Panel readily accepted the logic that different types and escalating levels of information are required at each operational phase, they expressed concern over "the widespread perception that once a lease is sold all subsequent phases of exploitation ...will necessarily follow if the lessee requests the appropriate permits." The Panel ultimately accepted the logic of phased information needs and presented findings within this context. They nevertheless also noted that if the perception were indeed true, this "implies a need for more intensive and extensive information gathering and impact analysis at the preleasing stage... ."

A very generalized summary of the ESRP adequacy findings is that some degree of inadequacy was found in all areas and, depending on the discipline-geographic area-development phase combination, the specific Panel evaluation ranged from readily correctable information needs to totally nonexistent information. By discipline, information was most inadequate for socioeconomics, followed by ecology, and physical oceanography. Not surprisingly, available information was best for the Manteo site. Information needs increased for both the North Carolina OCS beyond the Manteo site and for the later phases of operation at the Manteo site.

For the Manteo area, the Panel summarized their findings as follows:

“General information relating to the physical oceanography and ecology in the vicinity of Manteo Block 467 has been presented in the DOI decision documents for oil and/or gas resource development at this site. However, this information is not sufficiently quantitative or process-oriented to provide an adequate understanding of potential impacts related to such development. Socioeconomic information for all phases of developmental activity ranges from inadequate to non-existent.

Although adequate in many respects for providing needed physical oceanography information, the present OSRA model is deficient in several aspects, including the failure to account for effects of short-term fluctuations in Gulf Stream dynamics. Simple estimates of errors associated with known current variability can make OSRA adequate for decision-making for exploration, however. Information is inadequate relating to flow over the shelf north of Cape Hatteras, how oil from a spill at the Manteo Site may tend to concentrate along the Gulf Stream front, and how oil would disperse from the site of a potential pipeline rupture or tanker accident away from the drill site. With regard to the behavior of oil within the surf zone, the inlets, or the estuarine systems enclosed within the barrier islands, information is not as good as desirable, but it is adequate to assume that oil which approaches the coast will either beach or enter an estuary. Adequate information is presented on the fates and effects of drilling muds and cuttings as well as the secondary release of small amounts of contaminants from platforms or vessels.

A number of inadequacies of ecological information were identified in the DOI decision documents relating to all phases of exploitation of oil and gas resources. These result from incomplete ecological information and flawed interpretations rather than from failure to incorporate available information within the documents. Major inadequacies include absence of understanding of; (1) how physical/biological couplings drive intense utilization by top carnivores near the Manteo site, especially in the highly productive area identified as “the Point”; (2) the role of the Gulf Stream Sargassum community as vital habitat, not only for the reproduction and young of a number of recreationally and commercially important fishes, but also for juveniles of the five species of turtles identified in the Endangered Species Act; (3) the potential impacts of development on the benthic community adjacent to the Manteo Site; (4) impacts of an oil spill on the overwintering striped bass populations along the shallow waters off the Outer Banks; and (5) the mechanisms of transport, deposition, and impact of spills on the large offshore shoals found at the North Carolina capes.

Within the socioeconomic presentations in the DOI decision documents, there is little or no attempt to establish connections among social scientific variables or between these and physical and natural scientific properties or to analyze such relationships. For example, the effect of OCS-related activities on specific fish stocks, specific recreational or commercial fishermen who exploit such fish stocks, and the communities and industries that are dependent upon such activity are not fully characterized or analyzed. The potential impact of changing perceptions and attitudes concerning the marine and coastal environment on behavior patterns are another example of such relationships that are not fully characterized or analyzed. The general assumption contained within the DOI decision documents is one of “no significant impact,” a conclusion which may be warranted for certain aspects of the exploration/delineation phase, but is not justified beyond this

for the development/production phase nor, for that matter, for the exploration/delineation phase as a whole. All OCS activity, especially during development and production such as has occurred in Alaska, Louisiana, and California, has a significant impact on the human environment including socioeconomic systems (Pettersen *et al.* 1983; Wolf 1991; Yarle 1983). Whether or not we judge this impact to be, on balance, positive or negative is not the point here; the point is that there are significant impacts which must be adequately characterized and analyzed. Virtually all of the analyses relating to the costs and benefits of the proposed OCS activities do not warrant the conclusions presented in the DOI documents.”

The ESRP findings continued with additional comments on the broader North Carolina OCS, the essence being that information is generally less adequate because these areas are less well studied. They also noted difficulties in projecting all information needs without results of initial studies and if OCS activities proceeded beyond exploration. Additionally, site-specific issues, including questions concerning appropriate monitoring studies, can be expected to arise, but these cannot be identified in advance of completion and analysis of recommended studies associated with the leasing phase and of further information on specific sites.

#### RECOMMENDED STUDIES

The Panel’s determination of “additional information deemed essential” to carry out the Secretary’s OCS responsibilities logically is mostly a reflection of information found inadequate. Interestingly, they did not list information topics but, in a sense, added an additional step by recommending specific studies.

In language from the Panel’s executive summary, recommended studies for the Manteo area are:

##### Physical Oceanography

- (1) Development of improvements in OSRA specifically designed to provide better current field estimation and to better account for the effects of Gulf Stream meanders and cold dome eddies. Such improvements are currently under development.
- (2) Development of OSRA submodels focusing on the nearshore regions of barrier islands, inlets, and estuarine regions inshore of the Outer Banks. Such an improvement is desirable, but not likely to be available in the near future.
- (3) Major field efforts to characterize the current fields of the northern North Carolina shelf and of the region south of Cape Hatteras between the shelf and the Gulf Stream. The former study is underway and the second is only required if oil and gas developmental activities are to take place south of the Manteo block.

##### Ecology

- (1) A survey of the benthic community in the area of the Manteo site to determine the geographic extent of the unusual aggregation of organisms in this region and, depending upon the extent,

further studies to determine the recovery rate of these organisms if covered by drilling discharges. The survey portion should be undertaken immediately and should be completed before exploration begins.

- (2) Development of an understanding of the oceanographic and ecological processes acting on the North Carolina continental shelf and slope, largely to explain the functional basis for the distinctively intense use in the area of "the Point" by higher trophic level consumers. These studies should be initiated immediately and completed before delineation, but the initial exploration need not be delayed.
- (3) An investigation on the dynamics of the Sargassum community focusing on the degree to which it represents a major habitat for sea turtles and in the recruitment of commercially and recreationally important pelagic fishes. This study should begin immediately and be completed before delineation.
- (4) Monitoring studies to determine possible increases in hydrocarbon levels within several indicator organisms, including Sargassum, one or two associated animals, and the Wilson's storm petrels.

#### Socioeconomics

- (1) Base case characterization analyses for the Manteo area. These should include not only standard aggregate data base analyses, but also characterization of the structure of relevant industries and the relationships among the private and public sector entities potentially affected by development of oil and gas resources in this area.
- (2) Community studies involving the communities most likely to be affected by development at the Manteo site. These studies should cover the sociocultural variables necessary for developing a contextual understanding of the role and effect of potential OCS activities in these communities.
- (3) Pre-OCS activity perceptions of environmental conditions and values associated with potential oil and gas development at the Manteo site.
- (4) Infrastructural impacts of development at the Manteo site including consideration of the impacts on all potentially affected areas related to revenue sources, distribution of financial burdens, and certain sociopolitical variables.
- (5) Design of a comprehensive, longitudinal socioeconomic monitoring program which should be implemented prior to the issuance of drilling permits.

These recommended studies are focused primarily on the needs for socioeconomic information to support the leasing and exploration phases. For the development/production phase, similar

studies will be needed, but ones that are significantly increased in the breadth and depth of the geographical areas and magnitude of impacts considered.

Socioeconomic studies are also recommended specifically for the post-production phase; these should be designed to consider questions about the maintenance of the infrastructure developed because of OCS production, the displacement effects for employees of related industries, and the restoration or replacement of predevelopmental activities and human environments.

For other areas of the North Carolina OCS, the panel made a generic recommendation to initiate expanded versions of most of the studies listed for Manteo. For physical oceanography and ecology six additional studies were specified:

#### Physical Oceanographic Studies

- (1) Detailed assessments using OSRA calculations and an evaluation of their potential errors for all sites under consideration for leasing (required for leasing phase);
- (2) Current meter measurements at potential drilling sites and at locations away from these sites that will provide improved information with which to estimate the fate of spills both at the sites and from service vessels along their paths to the sites (required for exploration phase); and
- (3) Expanded shelf circulation studies of the region through which gas and/or oil will be transported from producing wells (required for development phase). (This item may be unnecessary if OSRA is proven to incorporate realistic time-varying subsurface currents.)

#### Ecology Studies

- (1) The development of a better understanding of the relation between cross-shelf water movements and the reproductive success of estuarine-dependent fishes and shellfish that use the shelf for reproduction;
- (2) A survey of the seasonal patterns in distribution and abundance of seabirds in relation to circulation patterns; and
- (3) An expansion of the ongoing South Atlantic assessment of the occurrence of marine mammals and sea turtles to include all of the area offshore North Carolina.

Again, the panel noted that the unknowns of initial study results and future site-specific OCS activities would most likely generate additional study requirements. A final recommendation was for MMS to use a Geographical Information System to manage North Carolina OCS information.



## SECRETARY LUJAN'S REPORT TO CONGRESS

On 27 January 1992, MMS issued a news release announcing completion of the ESRP study. Dr. Costlow was quoted, "On the basis of our review the probability of any significant environmental effects from a single well is extremely low." By this press account, only two studies were recommended prior to drilling the first exploratory well. Dr. Costlow's statement was: "We have recommended only socioeconomic studies and an expanded survey of bottom-dwelling organisms in the vicinity of the Manteo drillsite prior to drilling the first exploratory well." Secretary Lujan noted "no exploratory well proposal has been studied as extensively and thoroughly as this one."

A special information attachment to the news release provided details on the recommended socioeconomic studies and benthic survey. MMS noted that other studies were recommended, specifically ecology studies of the "Point" and Saragassum seaweed community studies, but noted that need for these efforts would be evaluated after the results of the first exploratory well became known.

On 6 April 1992, DOI issued a news release announcing submission of Secretary Lujan's report to Congress. The DOI report expanded on the initial MMS assessment of the ESRP report and concurred with the conduct of two studies prior to any exploratory drilling:

Baseline socioeconomic data, such as the information requested by this report, is usually not collected until after drilling the first exploration well. However, in this particular case, after reviewing the Panel's findings, I have decided to conduct those studies prior to drilling the proposed Mobil well. I also believe that the Panel's recommendation for a determination of the geographic extent of biological communities in the vicinity of the well site has merit. That study will also be done before any drilling activity."

In his report to Congress, Secretary Lujan noted that "the Panel's definition of adequacy, while defensible from a strictly scientific point of view, was far more restrictive and narrow than my charge under the OCSLA and the more management oriented approach implied in the Outer Banks Protection Act (OBPA)." In spite of scientific gaps identified by the ESRP, "the information that currently exists is adequate to allow me to make a reasoned decision about the activities presently proposed to take place offshore North Carolina [exploratory well]." The Secretary certified, in compliance with Section (c)(3)(A)(ii)(I) of the OBPA, that sufficient information exists at present to consider approval of exploratory activities.

However, after stating that no additional information is legally required, the Secretary added a consideration:

"...since the ESRP requests for these limited socioeconomic and biological studies are reasonable from a scientific perspective and will undoubtedly add to our information base, I will not issue a permit, approve the exploration plan, or allow any drilling until the studies have been completed."

## REFERENCES

- DOI (U.S. Department of the Interior), 1992a. Interior Secretary Lujan Submits North Carolina Environmental Sciences Review Panel Report to Congress. Press Release, 2 April 1992, 2 pp.
- DOI (U.S. Department of the Interior), 1992b. Report to Congress on Findings of the North Carolina Environmental Sciences Review Panel. Unpublished document, 6 pp.
- DOI (U.S. Department of the Interior), 1986. Managing oil and gas operations on the Outer Continental Shelf. U.S. Department of the Interior, Minerals Management Service, Washington, DC MS 646, 60 pp.
- DOI (U.S. Department of the Interior), 1987. Leasing energy resources on the Outer Continental Shelf. U.S. Department of the Interior, Minerals Management Service, Washington, DC. MS 645. 49 pp.
- ESRP, 1992. Report to the Secretary of the Interior from the North Carolina Environmental Sciences Review Panel as Mandated by the Oil Pollution Act of 1990. Unpublished 83 pp document.
- MMS, 1992. North Carolina Environmental Sciences Review Panel Completes Study. News Release, 27 January 1992, 2 pp with 2 page Special Information attachment.
- NRC (National Research Council), 1989. The Adequacy of Environmental Information for Outer Continental Shelf Oil and Gas Decisions: Florida and California. National Academy Press, Washington, DC, 86 pp.
- Petterson, J.S., L.A. Palinkas, B.M. Harris, A. Downs, and B. Holmes. 1983 Alaska OCS Social and Economic Studies Program, Executive Summary. Unalaska: Ethnographic Study and Impact Analysis. Prepared by Impact Assessment, Inc. for U.S. Department of the Interior, Minerals Management Service, Alaska OCS Region. Technical Report 92.
- Wolf, C. P. 1991. Socioeconomic Impact Assessment of OCS Oil and Gas: A Preliminary Bibliography. Social Impact Assessment Center, New York, NY. 20 pp.
- Yarle, S. (ed.). 1983. Alaska Symposium on the Social, Economic and Cultural Impacts of Natural Resource Development. University of Alaska, Department of Conferences and Institutes, Fairbanks, AK.

---

Dr. William Lang is an oceanographer in MMS's Gulf of Mexico Region Environmental Studies Section. He received his B.S. from Lafayette College (1971), his M.S. from Rutgers University (1973), and his Ph.D. from the University of South Carolina (1977). Dr. Lang joined the Bureau of Land Management's New York OCS Office prior to MMS's creation in 1982. He worked on many

Atlantic Region studies funded to provide pre-lease sale information. His primary duties at MMS have dealt with protected species issues and information management.

## **COASTAL NORTH CAROLINA SOCIOECONOMIC STUDY PROGRAM**

Dr. John S. Petterson  
Impact Assessment, Inc.

### INTRODUCTION

The Oil Pollution Act (OPA) of 1990 directed the Secretary of the Interior, in cooperation with the State of North Carolina, to create a panel to assess existing information necessary for the Secretary to make decisions regarding permitting, leasing, exploration and development offshore North Carolina. In response to this requirement, the Environmental Sciences Review Panel (ESRP) was appointed in December 1990. The panel was specifically charged with assessing existing information for its value in determining the potential impacts of offshore oil and gas exploration and production and with identifying areas in which such information is inadequate or absent. After a series of deliberations and public hearings during 1991-1992, this panel submitted its recommendations to the Secretary of Commerce identifying the two areas in greatest need of additional study: (1) benthic oceanographic studies; and (2) socioeconomic studies.

The Minerals Management Service (MMS) initiated, in 1992, a Cooperative Agreement with East Carolina University (ECU) designed to address the socioeconomic shortcomings identified in the ESRP report. The Coastal North Carolina Socioeconomic Study (CNCSS) program was a product of this Agreement. The study was under the lead of ECU (John Maiolo) and implemented by Impact Assessment, Inc. (IAI) under my direction. The study was carried out between August 1992 and September 1993. The project involved the work of 18 researchers, a commitment of over 8 man-years, and a cost of approximately \$750,000. Field data collection was carried out from a field headquarters and four satellite field offices (which also served as residences during the study period).

A National Peer Review Committee (consisting of Profs. Russell Bernard, Larry Leistritz, and Robert Trotter) was established to ensure that the study goals were achieved. Designated members of the former ESRP were recruited as oversight to ensure all of the recommendations were addressed (Profs. Michael Orbach and John Costlow).

### RESEARCH OBJECTIVES

The CNCSS was designed to collect, analyze, and disseminate information about socioeconomic and sociocultural conditions along those portions of the North Carolina Coast susceptible to the potential effects of exploratory drilling at the Manteo Prospect. The Manteo Prospect is located in waters some

2,690 feet deep thirty-eight miles east of Salvo in a geologic zone thought to have a reasonable potential for discovery of natural gas or oil.

The objectives of the CNCSS were to document conditions in the study area for a wide array of variables traditionally used as indicators of socioeconomic and sociocultural status. This information was intended to provide the sponsor with a “snapshot” of current sociocultural and socioeconomic conditions and trends within these areas. The information was to assist decision-making processes undertaken by the federal government, assist county and local governments in planning activities, and provide a means of monitoring and measuring change in the study area should OCS activity in North Carolina proceed.

The North Carolina ESRP was concerned that there was a lack of comprehensive socioeconomic studies in North Carolina. Connections or relationships among social scientific variables or between those and physical and natural scientific properties had not been fully characterized or analyzed. The panel also noted the lack of attitudinal or perceptual data or information. The following recommendations, made by the panel, constitute the study objectives and what the panel considered to be an adequate information supplement for the leasing state at the Manteo Prospect:

- Base case characterization analysis should be carried out to include standard aggregate variables as population, employment, and economic activity; characterization and structure of relevant industries; and characterization of the relationships among private and public sector entities in the affected areas.
- Detailed community studies should be done on the communities most likely to be affected by OCS development. These studies should include sociocultural variables, such as cultural traditions and psychosocial conditions, necessary to contextualized understanding of the role and effect of potential OCS activities in these communities. The central purpose of this work would be to gain an understanding of how these communities function as coherent social, economic, cultural, and political systems.
- Aesthetic and perceptual issues studies should be performed for representative portions of the potentially affected populations. This research should be concerned with the perceptions of environmental conditions and values.
- Infrastructure studies should be performed in the potentially affected communities, focusing on the potential for changes in local and regional economic and political relationships.
- Comprehensive longitudinal socioeconomic monitoring should be designed based upon base case characterization established socioeconomic variables. The variables should cover all of the above issue categories.

This research effort was explicitly not intended to be an “impact assessment” or “impact analysis.” This effort, rather, provides the foundation upon which future impact assessments, if OCS activities proceed, may be based. The County and Communities Studies provide a qualitative and quantitative description of a range of socioeconomic and sociocultural indicators or variables needed to establish

the context within which OCS-related changes could occur. The companion Socioeconomic Monitoring Plan provides a template for tracking change in a subset of these variables that, in the informed opinion of research team, will likely be (1) potentially responsive to OCS-related activities; (2) socioeconomically and socioculturally significant at the community and/or regional level; and, (3) “tractable” (relating to information that is both quantifiable and that can be efficiently obtained).

## METHODOLOGY

A combination of research methods was employed to satisfy the informational inadequacies identified by the ESRP. These methods include secondary source research (to assess and compile existing data) and observation and interviews (to compile new data). An interim report entitled Final Research Design/Guide to Field Investigations was prepared to describe the overall technical approach employed to implement the CNCSS including a description of field methods, logistics, analytic approaches, study integration, and study time frame.

Secondary data collection involved traditional literature reviews, including available gray literature, source materials produced by the State, counties, and local communities, as well as previously collected materials obtained by the field staff. The principal focus of the data collection effort, given the dearth of available information, was on primary data collection in the potentially affected counties and communities. This information was collected by means of observation (e.g., direct observation, participant observation, non-reactive observation), interviews (e.g., open-ended interviews with key persons or reputational leaders). In addition, a broad array of methods employed to elicit public perception of the key characteristics and risks associated with living in coastal North Carolina communities. These methods included several “free-listing” techniques to establish: (1) quality of place; (2) uses of the environment; and (3) perception of change. Additional data collection techniques employed to provide consistent measures of perceptions included pile-sorting for various environmental and social measures. These data were then subjected to a wide range of analyses, relying on multi-dimensional scaling, hierarchical clustering, cultural consensus modeling, and other statistical approaches.

The resulting final report, Coastal North Carolina Socioeconomic Study Final Technical Report, for the U.S. Department of the Interior, Mineral Management Service, Atlantic OCS Region, by East Carolina University and Impact Assessment, Inc. (1993), consisted of the following five volumes:

- Volume I, Executive Summary—MMS 93-0052 (21 pp);
- Volume II, Base Case Characterization: County Studies—MMS 93-0053 (290 pp);
- Volume III, Base Case Characterization: Community Studies—MMS 93-0054 (408 pp);
- Volume IV, Pile Sort Data and Analysis—MMS 93-0055 (630 pp); and
- Volume V, Socioeconomic Monitoring Design and Methodology—MMS 93-0056 (31 pp).

## CONCLUSIONS AND RECOMMENDATIONS:

A number of conclusions can be drawn and recommendations made from the results of this and earlier MMS socioeconomic studies.

- Small differences in change agent can result in big differences in social effects (e.g., Mobil indication that one potential scenario might result in direct transshipment of discovered oil/gas by underwater pipeline directly to Virginia).
- Unique characteristics of affected community (e.g., size, economic adaptation, occupational orientation, seasonality, etc.) can result in acute sensitivity to particular source of development or change. For example, some communities (or neighborhoods, or regions), by reason of their histories, social, or economic organization,<sup>1</sup> are particularly sensitive to minuscule perturbations of their local social, economic, or physical environment. These highly sensitive populations can suffer disproportionate effects from seemingly minor initial factors. For example, smaller Native villages oiled by the 1989 Exxon Valdez spill continue to suffer the social effects and legal turmoil representing one of the more pernicious legacies.
- Socioeconomic and social effects of development-related changes need not be physically contiguous nor contemporaneous. A change in employment, or an active development, in one location could have immediate ramifications for more distant communities that are the sources of employees. The effects of a major development in Beaufort might have a greater impact on Hatteras than on Morehead City. Simply stated, we need to be alert to disproportionate geographic distributional effects.
- One needs to view social change as a process that occurs in gradual steps over an extended period of time—not as synchronous events. One needs carefully to consider preexisting conditions in the particular communities, at particular points in their evolution, in relation to the precise intervening variable (e.g., on-shore oil support activities), to evaluate potential effects. The cumulative effect of a particular set of changes (e.g., those associated with on-shore or off-shore oil development) is the result of hundreds of interrelated (sometimes directly, sometimes indirectly related) events that give rise to a particular outcome. At issue isn't simply the construction and operation of an onshore facility (i.e., a synchronic event), but the whole cycle of effects (e.g., associated employment, education, public service, impacts as well as the ultimate termination of the facility and workforce).
- Perceptions of “anticipated” development can have more severe impacts on a community than actual development. The preparatory activities, in advance of any development, can be disturbing to a community, even if, ultimately, none of the actual development occurs.
- Unanticipated and unpredictable future events may dwarf effects predicted in association with OCS development. Hurricanes, floods, recreation/retirement home construction, potable water problems, sewage treatment issues, depending on their timing, can entirely displace (at least for some time) OCS-related risk issues.

---

<sup>1</sup>Socioeconomic systems of this area are heavily dependent upon utilization of marine resources and access to a maritime environment perceived as relatively pristine. The character of this dependence varies considerably depending on the mix of a community's or region's reliance on tourism, commercial or recreational fisheries, military activity, or retirement or other transfer income sources.

- A key focus of future studies should be on threshold effects. At what point does a social change become unacceptable? We know, for example, that some socioeconomic impacts are so small that no effort to measure them would be successful, and that community awareness and concern with these changes is minimal. We are also aware that major developments, especially those where little planning has taken place, will result in a broad range of dramatic impacts to a community—impacts that are obvious to everyone. This is the basic continuum along which all development takes place. Our task, and the task of the MMS and its study program, is to identify those social, psychological, and economic factors that shift the “threshold” in one direction or another. That is, we are looking for those factors that in one community may give rise to adamant public resistance, serious economic dislocation, and political opposition where similar development in another community might be met with enthusiasm and active participation.
- Another key objective should be to develop a clear understanding of the characteristics of causal agents in relationship to the characteristics of the recipient community. Oil development is far from a monolithic process. It is an amalgam of hundreds of separable, sometimes independent, but normally interrelated, events that occur over time. The operation of exploration vessels, support crews, base construction, logistical support operations, transportation, construction and prefabrication sites, and related/ancillary enterprises, etc., all function independently with their own local and larger impacts to communities depending on their unique characteristics—demographic, social, economic, transportation, environmental and other idiosyncratic factors. Moreover, sometimes casual or minor changes in the characteristics of the causal agent can markedly alter the range of potential social impacts. As mentioned above, a decision to transport recovered oil by pipeline to Virginia would radically change the potential impact alternatives that might otherwise need to be considered for coastal North Carolina communities.
- MMS has developed a sufficient understanding of the regional and state-level changes that occur in association with OCS-related activities. These general level social and economic variables can be routinely and inexpensively maintained. They cannot, however, reflect the actual, sometimes dramatic, changes that can occur in particular locations, communities, or under compressed time schedules. It will be communities that bear the most adverse effects of OCS development. If the unique and particularistic historical and current social organization of a community determines the social impact of OCS development, measures of these social characteristics will serve as: (1) the most accurate and useful indicators of susceptibility and predictors of likely public response (or for planners intent on minimizing impact or maximizing positive effects); and (2) the most accurate measure of impacts that do occur as development proceeds.
- While MMS has done an admirable job of working to broker more acceptable development of U.S. coastal resources, it cannot escape the inherent conflict embedded in its mission statement of both promoting the sale or lease of national resources at the best possible price and its fiduciary obligation to protect the interests of those populations most affected by the activities associated with development of those leases. MMS must always be seen as an

agency representing the larger “public” (i.e., “national”) interests, while recognizing the fact that the most serious adverse effects of that development are invariably absorbed by the coastal communities that bear the direct effects. It is for this reason that we would encourage closer coordination between proponents (oil companies) and the potentially affected coastal communities and pertinent state agencies—a less adversarial model more akin to the Canadian approach. This approach would go a long way to ensuring more palatable and, in the future, more acceptable forms of development. Creative thinking industry representatives and community representatives, and even outside NGOs, could constructively sit down to discuss issues candidly. This is not to suggest that the fiduciary obligation of the MMS should be, in any way, lifted. As the “experts,” they know from experience where the pitfalls are likely to be found, where communities need to be most careful in accepting, or most concerned with understanding, development likely to occur in association with oil development. As a complex process, communities inexperienced in dealing with such development should not be left to their own devices, each time reinventing their responses to problems in a series of predictable confrontations between an experienced proponent and an inexperienced community (where industry strategies have been well tested and the outcome entirely predictable). From this perspective, MMS would then need to be most concerned with ensuring that communities have available the most knowledgeable support staff, committed to the protection of those populations most susceptible to potential impacts.

---

John S. Petterson received his Ph.D. in anthropology from the University of California, San Diego. He is President of Impact Assessment Inc., and has served as Principal Investigator on the “Economic, Social, and Psychological Impacts of the Exxon Valdez Oil Spill” and the “Socioeconomic Impact Assessment of the Proposed High-Level Nuclear Waste Repository” for both the Hanford, Washington and Yucca Mountain, Nevada sites. Dr. Petterson has also served in the dual role of project manager and principal investigator on successive social, economic, and cultural studies in support of USDO, BLM, USFS, North Pacific Fishery Management Council, USFWS socioeconomic impact assessments (SIA), including over a dozen major MMS socioeconomic studies, since the formation of IAI in 1981. Dr. Petterson recently served as co-Principal Investigator on the Congressionally-mandated study, under the Oil Pollution Control Act, which required the Department of the Interior to address specific informational shortcomings in its study program for planned oil development off the coast of North Carolina. The product of this MMS effort was a 4-volume report entitled “Coastal North Carolina Socioeconomic Study” which provided base case and baseline assessments of commercial and recreational fishing conditions and adaptations, as well as infrastructure, social, cultural, and economic conditions in northern coastal North Carolina counties, and detailed community studies of six principal coastal communities.



## A REVIEW: FINDINGS OF THE "BENTHIC STUDY OF THE CONTINENTAL SLOPE OFF CAPE HATTERAS, NORTH CAROLINA"

Dr. Robert J. Diaz  
Mr. G. Randall Cutter  
Virginia Institute of Marine Science

Dr. James A. Blake  
ENSR

### INTRODUCTION

The need to develop reliable domestic sources of petroleum and natural gas has led to increasing interest in exploration of the continental shelf and slope off the U.S. East Coast. A number of leased blocks on the continental slope off Cape Hatteras, North Carolina, have been evaluated for their potential as possible petroleum exploration sites with the possibility that exploratory well may be drilled in the near future. The possibility of extracting oil and gas from the continental slope, particularly in the area off Cape Hatteras, has raised a number of environmental concerns that could not be addressed from existing data.

During the MMS Atlantic continental slope and rise program, the benthic fish and invertebrate communities off the Cape Hatteras continental slope were found to be different from others on the Atlantic continental slope. These differences encompass species composition, abundance, and biomass. Blake *et al.* (1985, 1987) surveyed 15 sites on the continental slope and rise off the North Carolina coast and found highest abundances and biomass in the area of Manteo lease block 510, a site adjacent to Manteo 467. Other investigators (Schaff 1991, Schaff *et al.* 1992, Ross and Sulak 1992, Sulak 1992) who concentrated their sampling in this area confirmed these results. Overall, the abundance and biomass of macrobenthic infaunal was about 10 and 6 times higher, respectively, and fish abundance was about 6 times higher than at other slope areas.

Because of the potential environmental impacts associated with development and production activities, the Oil Pollution Act of 1990 mandated that a panel of experts be convened. This panel, North Carolina Environmental Sciences Review Panel (NCESRP), was to consider whether the available scientific information was adequate for making decisions about oil and gas leasing, exploration, and development off North Carolina. The NCESRP (1992) report to the Secretary of the Interior made several recommendations on the information needed to understand the basic ecology of the leased areas. Among them was the recommendation that the spatial extent of the benthic community found within some of the lease blocks should be determined before any exploration or development activity occurred off Cape Hatteras. The present study was developed by the Minerals Management Service to determine the aerial extent of the community found by Blake *et al.* (1985, 1987). Results of our effort were published as a special issue of Deep-Sea Research Part II (Diaz *et al.* 1994a) which included a CD-ROM with data and selected bottom images (Cutter *et al.* 1994a).

## METHODS

The study area (Figure 1H.10) was defined based on output of the Offshore Operators' Committee (OOC) model which predicted the dispersion and accumulation of drilling muds and cuttings over the seafloor (Brandsma 1990). This model predicted areas that would receive as little as 0.1 mm of deposition. After calculating the area of the seafloor that would likely receive any deposition, the initial area to be sampled was expanded 15 km to the north and 15 km to the south of the proposed drill site (Figure 1H.11).

The field work was conducted on the R/V *Endeavor* cruise EN-241 from 26 August to 6 September 1992. The sampling consisted of six cross-shelf transects running approximately east-west nearly perpendicular to the isobaths (Figure 1H.11). We also re-sampled two historical stations (SA9 and SA10), previously sampled by Blake *et al.* (1987), to evaluate long-term changes in the benthic community. On each transect (A through F), a single box core was collected at the 600, 800, and 1,500 m. Surface and sediment profile camera images were taken at these stations and also at a 1,000 m. A camera sled was deployed on each transect starting at the deep (about 1,800 m) end and towed to shallow water (as shallow as 120 m). A summary of data collected, along with references to detailed methods, can be found in Table 1H.3.

Preliminary evaluation of surface and sediment profile camera images at sea allowed us to reevaluate the placement of stations and transects. Data from the preliminary image evaluation, combined with the visual observation on the box cores, indicated that the sediments and benthic community were similar at all the transects that we had established. We replaced the camera sled tow on Transect C with two short transects approximately 10 and 22 km north of Transect A (1 and 1A, Figure 1H.11).

## RESULTS AND DISCUSSION

### Sediments and Sedimentation Rates

Excluding the 2,000-m station which was likely recently disturbed, the sedimentation rate at the study area was estimated to range from 0.3 to 1.8 cm yr<sup>-1</sup>. These are 25 to 100 times higher than the holocene sedimentation rates on the slope off the Atlantic coast (Emery and Uchupi 1972). In fact, they are comparable to, or higher than, estuarine rates. However, the rate of sediment accumulation over the entire study site was highly variable. The towed camera sled showed a wide diversity of bottom types including bare outcrops, sediment-draped outcrops, and erosional and depositional surfaces. Areas on the slope with high rates of sediment input would be expected to experience local oversteepening and periodic slope failure.

Evidence for this was present on all of the towed camera transects. Many steeply sloping outcrops were observed with an apparently thin cover of soft sediment. Some of these surfaces showed evidence of recent soft sediment flows in the form of erosional "rivulets." Depositional sites for turbidites, debris flows, and massive slump blocks were recognized in bottom photographs by their undulating topography, mud clasts projecting above an otherwise planar depositional surface of fine

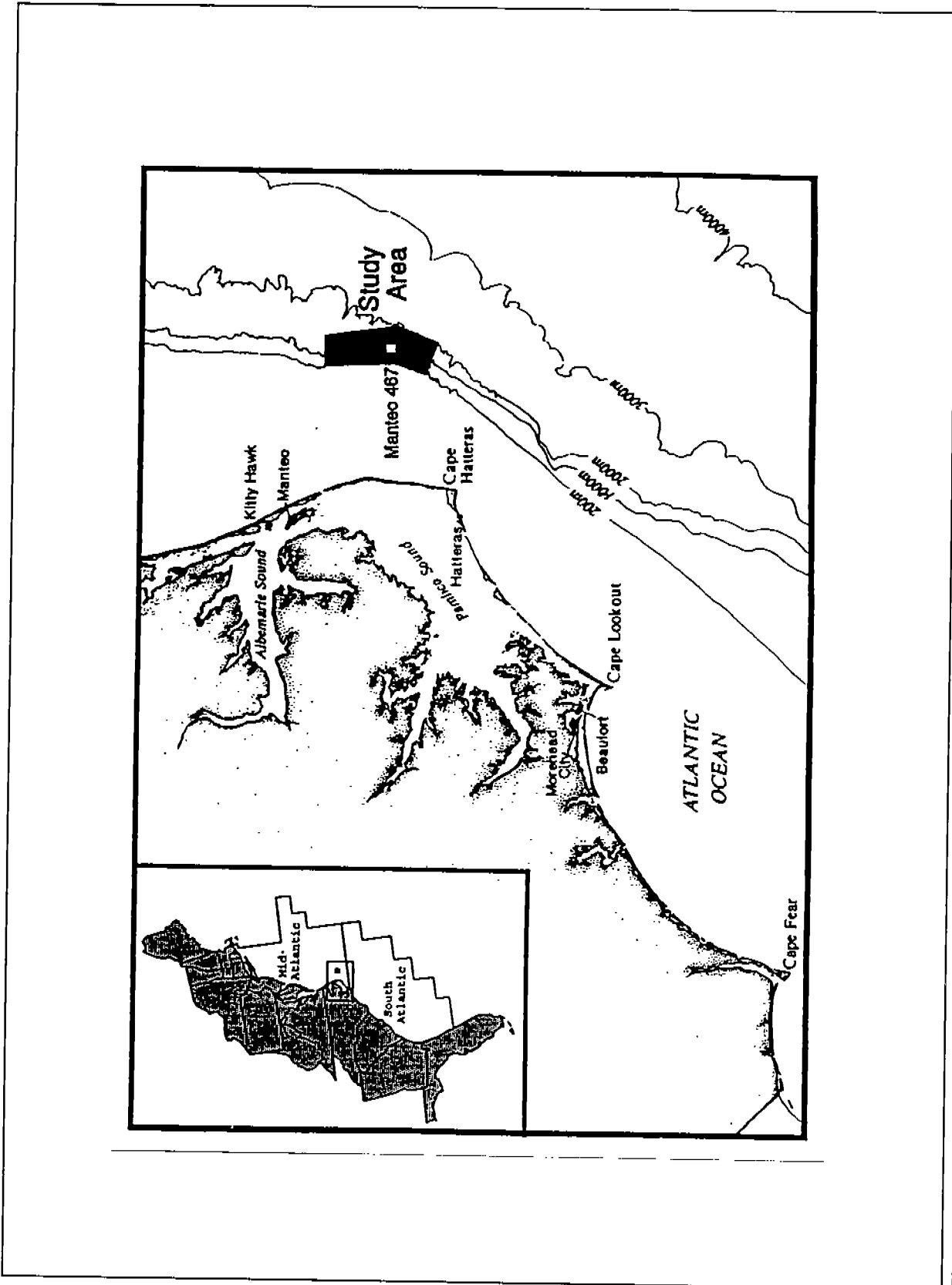

Figure 1H.10. Location of the study area off Cape Hatteras, North Carolina.

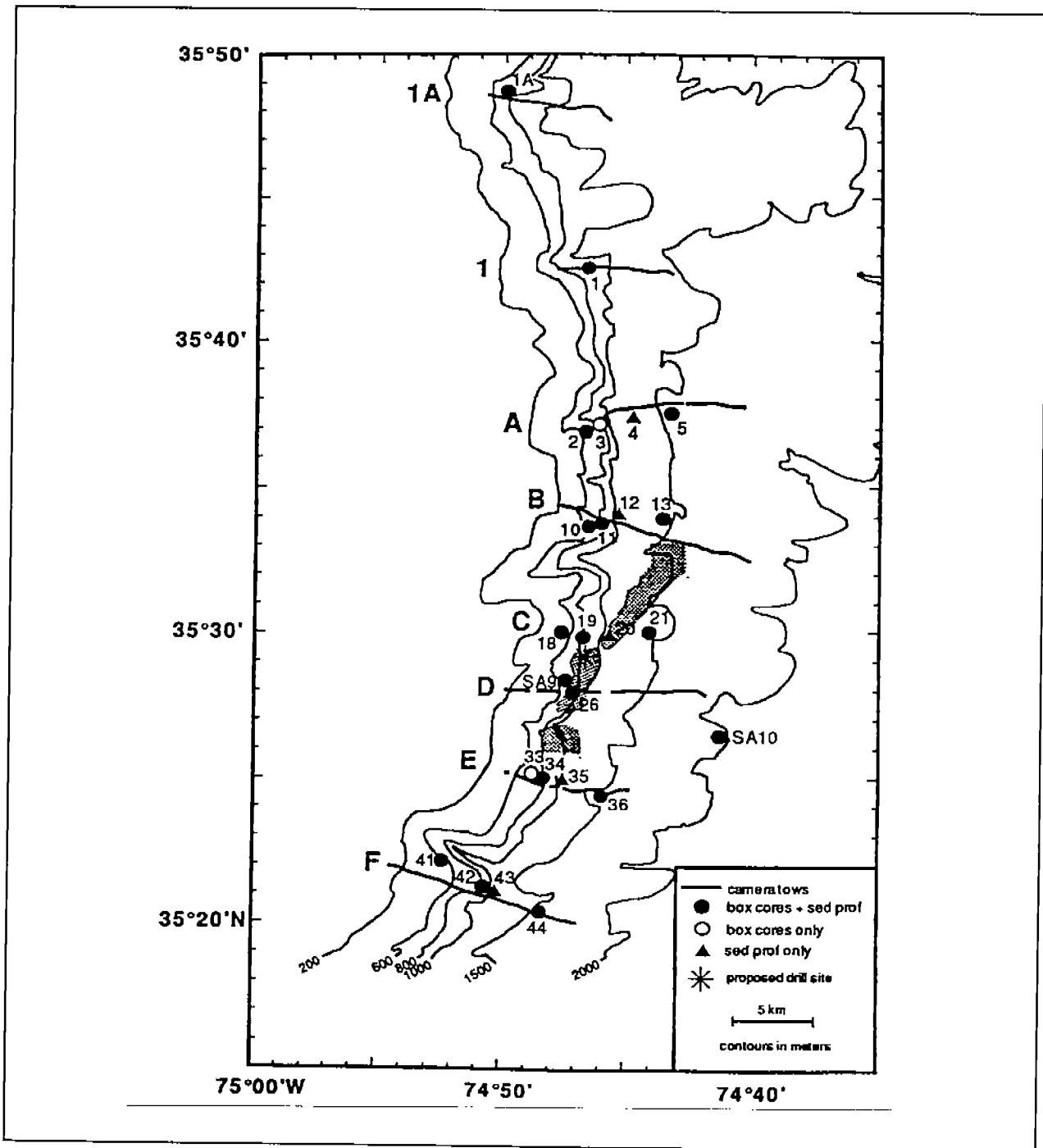

Figure 1H.11. Location of sampling stations on the continental slope off Cape Hatteras. Overlay onto the station locations is the predicted dispersion and deposition patterns (stippled area) from the Offshore Operators' Committee model (Brandsma 1990). The stippled area represents deposition of 67 to 75% of the simulated discharge of 4,000 barrels of drilling muds and cuttings (approximately what the drilling of the exploratory well will generate). The remainder of the material did not settle to the bottom within the model boundaries.

Table 1H.3. Summary of data collected on the continental slope off Cape Hatteras, North Carolina, in the vicinity of Manteo 467 on R/V Endeavor cruise EN-241, 26 August to 6 September 1992.

---

<b>Box-Core - 0.16 m<sup>2</sup> BX-640 Ocean Instruments, Divided into 16 10x10 subcores.</b>	
Chlorophyll a	Cahoon <i>et al.</i> 1994
Viable diatoms	Cahoon <i>et al.</i> 1994
Fatty acids	Harvey 1994
Inorganic carbon	Blair <i>et al.</i> 1994
Organic carbon	Blair <i>et al.</i> 1994
Sediment grain-size	Diaz <i>et al.</i> 1994b
Carbonate	Diaz <i>et al.</i> 1994b
Nitrogen	Blair <i>et al.</i> 1994
Pb-210	DeMaster <i>et al.</i> 1994, Diaz <i>et al.</i> 1994b
X-Rays	Diaz <i>et al.</i> 1994
Macrofauna (300 um)	Blake and Hilbig 1994
Foraminifera	Cutter <i>et al.</i> 1994b
 <b>Sediment Profile and Vertical Surface Cameras - Benthos Models 3731 and 372</b>	
Surface features	Diaz <i>et al.</i> 1994b
Subsurface features	Diaz <i>et al.</i> 1994b
Apparent mixed layer depth	Diaz <i>et al.</i> 1994b
 <b>Towed Camera Sled - Oblique Surface Images - Benthos Model</b>	
Megafauna	Hecker 1994
Geological features	Hecker 1994

---

sediment, and the presence of relatively featureless sediment surfaces that have not had a chance to be disturbed by organisms.

Average accumulation rate of organic carbon was estimated to be 67 g C m<sup>-2</sup> yr<sup>-1</sup>, comparable to that found by Schaff *et al.* (1992) at a nearby site. This flux of organic matter is about 35 to 85% lower than that found in productive estuaries (Welsh *et al.* 1982). Annual phytoplankton productivity for 45 estuarine systems had a mean of 190 g C m<sup>-2</sup> yr<sup>-1</sup> (Boynton *et al.* 1982). The average concentration of fatty acids in slope sediments off Cape Hatteras (27 mg g<sup>-1</sup> dry wt.) falls within the range reported for estuarine sediments (10-35 mg g<sup>-1</sup> dry wt., Farrington *et al.* 1977) but is less than concentrations found in sediments underlying more intensive and persistent upwelling zones (765 mg g<sup>-1</sup> dry wt., Smith *et al.* 1983).

The concentration of chlorophyll-*a* in the sediments at the study site appeared to be higher than average for slope sediments that do not underlay upwelling regions. The values were intermediate between those recorded for sediments underlying intensive upwelling regions (Blake *et al.* 1992) and estuarine values (Boynton *et al.* 1982). Because the decomposition rates of chlorophyll-*a* are high, the supply of plant cells to the bottom must be very high to support observed concentrations.

### Biological Communities

The infaunal organisms taken from box cores included approximately 280 species of invertebrates, 45% of which were annelid worms. Molluscs (20%), crustaceans (17%), echinoderms (6%), and a variety of miscellaneous taxa comprised the rest of the fauna. The majority of individuals, however,

consisted of six taxa: the oligochaetes *Limnodriloides medioporus* and *Tubificoides intermedius*, and the polychaetes *Scalibregma inflatum*, *Aricidea quadrilobata*, *Cossura* spp., and *Tharyx kirkegaardi*. Infauna total density off Cape Hatteras was very high and resembles shallower continental shelf locations such as the mud patch near George's Bank (Neff *et al.* 1989). Blake *et al.* (1987) and Schaff *et al.* (1992) also found infaunal densities on the continental slope to be highest off Cape Hatteras.

Diversity indices at the upper slope (600-800 m) stations were consistently lower than values from upper slope communities recorded elsewhere off North Carolina and Massachusetts (Blake *et al.* 1987, Maciolek *et al.* 1987a,b). One factor which may limit the success of many species on the Cape Hatteras slope is the nature of the carbon supply. The infaunal species most common on the Cape Hatteras slope are typically rare in the deep sea.

The benthic megafauna included at least 35 species of fish, 18 species of alcyonarians and anemones, 17 species of echinoderms, and a variety of crustaceans, worms, molluscs, and other organisms. The species most characteristic of the megafaunal assemblages were the foraminiferan *Bathysiphon filiformis*, the eelpouts *Lycenchelys verrilli* and *Lycodes atlanticus*, the witch flounder *Glyptocephalus cynoglossus*, and the anemone *Actinauge verrilli*. The quill worm *Hyalinoecia artifex* was locally abundant, especially in the upper slope of the two northern transects. Burrowing anemones were locally abundant at depths above 1,000 m. The fauna on the lower slope (>1,600 m) was dominated by brittlestars and sea pens. Most of the photographs also showed numerous instances of Lebensspuren such as tracks and trails, burrow openings and pits caused by deep-burrowing deposit feeders, excavations caused by fish and crustaceans, and the surficial tubes of infaunal organisms.

The high densities of predators, such as eelpouts, witch flounder, and quill worms are likely related to the high densities of potential infaunal prey. High abundances of filter feeding megafauna, such as *Actinauge verrilli*, *Bathysiphon filiformis*, and burrowing anemones, are probably related to high concentrations of suspended solids seen in many bottom images. High densities of the surface deposit feeding holothurian *Peniagone* sp., found on the lower slope of Transect D, also indicate a high organic flux. This species is known to occur in dense aggregations that migrate toward organic rich areas. Large deep-burrowing polychaetes were found in the box cores, and evidence of their activity dominated sediment surface and profile images.

Geographically, results of the 1992 survey suggest that the area encompassed by the dense faunal assemblages extends to most of the continental slope area off Cape Hatteras. The distance between 1A in the north and Transect F in the south is approximately 50 km (Figure 1H.11). While the fauna was patchy and exhibited some depth zonation, community structure parameters were similar over the entire length of the study area. We know, however, that these assemblages are not found in the vicinity of the Hatteras Canyon (Blake *et al.* 1985).

## SUMMARY AND CONCLUSIONS

### Physical Habitat

The data all point a high input rate of sediment and organic matter of natural origin (Table 1H.4). The location of Cape Hatteras on the Atlantic Coast and its geomorphology combine to funnel material moving southward along the outer shelf onto the slope environment near the study site. Within the study area there were no depth-related gradients in grain-size distributions, sediment chemistry, or sedimentation rates. In part, this was due to topographic irregularities which tend to break-up the bottom into a diverse mosaic of patchy and discontinuous habitats of varying age and stability. Also, the size of the study area was too small to detect broad scale regional gradients.

Table 1H.4. Summary of sedimentary characteristic on the continental slope off Cape Hatteras, North Carolina, in the vicinity of Manteo 467. Estimated sediment accumulation for Station SA-10 was an outlier, possibly related to a recent sediment disturbance, and is presented separately (as values in parentheses).

Parameter	Mean $\pm$ Standard Error
Fine Sand-Coarse Silt	33.0 $\pm$ 2.0%
Sediment Accumulation Rate	0.98 $\pm$ 0.14 cm yr <sup>-1</sup> (0.05 SA-10)
Sediment Mixed Layer Depth	12 $\pm$ 1 cm
Carbonate	16.6 $\pm$ 0.7%
Carbonate Flux	1133 $\pm$ 305 g CO <sub>2</sub> m <sup>2</sup> yr <sup>-1</sup> (58 SA-10)
Organic Carbon	1.04 $\pm$ 0.04%
Organic Carbon Flux	66.7 $\pm$ 12.8 g C m <sup>2</sup> yr <sup>-1</sup> (4 SA-10)
Organic Nitrogen	0.13 $\pm$ 0.01%
C:N Ratio	9.5 $\pm$ 0.1
Chlorophyll <i>a</i>	0.75 $\pm$ 0.15 mg g <sup>-1</sup> dry wt.
Total Fatty Acids	18.7 $\pm$ 3.5 mg g <sup>-1</sup> dry wt. (5.6 $\pm$ 1.0 SA-10)
Polyunsaturated Fatty Acids	1.5 $\pm$ 0.6 mg g <sup>-1</sup> dry wt. (0.4 $\pm$ 0.2 SA-10)

The organic matter found in the study site's sediments appeared to be derived from both terrestrial and marine sources, and reflected the complicated interactions between sources, degradation pathways, and transport mechanisms. While the supply of organic matter was large, only a small fraction of it was composed of easily digested and highly nutritious smaller molecules (polyunsaturated fatty acids). The majority of the organic matter was refractory which suggests that it is substantially reworked either

during transport through the water column or at the sediment-water interface. Subsurface deposit feeders adapted to make use of this more refractory organic matter dominate the infauna in terms of both numbers and biomass. Their unusually high abundance was apparently directly related to the magnitude of carbon flux into the area and the sediment grain size, which was optimal for both tube building and burrowing. The sediments were almost completely reworked biologically, a good indicator of the high level of infaunal activity.

#### Benthic Community Characterization and Distribution

The infaunal community was characterized by higher-than-average densities and lower-than-average species richness and species diversity for continental slope areas (Table 1H.5). The infaunal community was also numerically dominated by ten species. Densities of total benthic megafauna were only slightly elevated for continental slope areas (Figure 1H.12). However, densities of the four top dominant megafaunal species were much higher than average (Figures 1H.13 and 1H.14). The megafaunal and infaunal communities that populate the continental slope off Cape Hatteras appear well adapted to coping with the dynamic nature of the physical environment. These communities, in turn, provide the trophic base that supports large populations of demersal fish.

Table 1H.5. Summary of benthic community characteristics on the continental slope off Cape Hatteras, North Carolina, in the vicinity of Manteo 467. Infaunal parameters are for 16 box core stations.

Parameter	Mean $\pm$ Standard Error
Total Infauna Density	30,968 $\pm$ 5,152 individuals m <sup>2</sup>
Total Species/0.09 m <sup>2</sup>	63.3 $\pm$ 5.0
Species/750 Individuals	45.7 $\pm$ 5.0
H' Diversity	3.2 $\pm$ 0.2
Top 10 Dominant Taxa	64-97% (range)



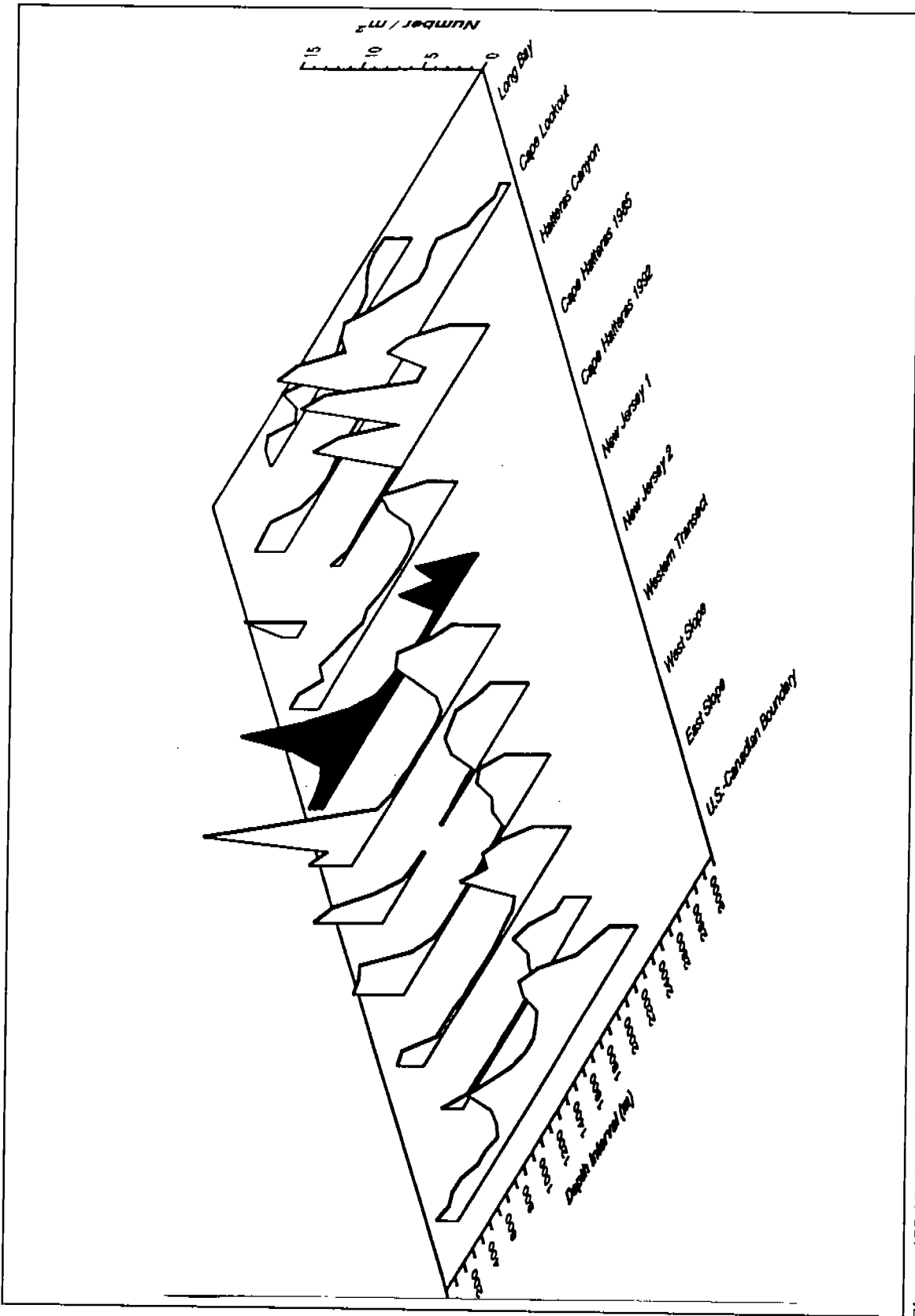

Figure 1H.12. Density of total megafauna with depth at 10 locations on the eastern U.S. continental margin. Data for these locations were collected for studies described in Hecker *et al.* (1983), Hecker (1990), and Blake *et al.* (1985, 1987). Data from the present survey are shaded (Cape Hatteras 1992).

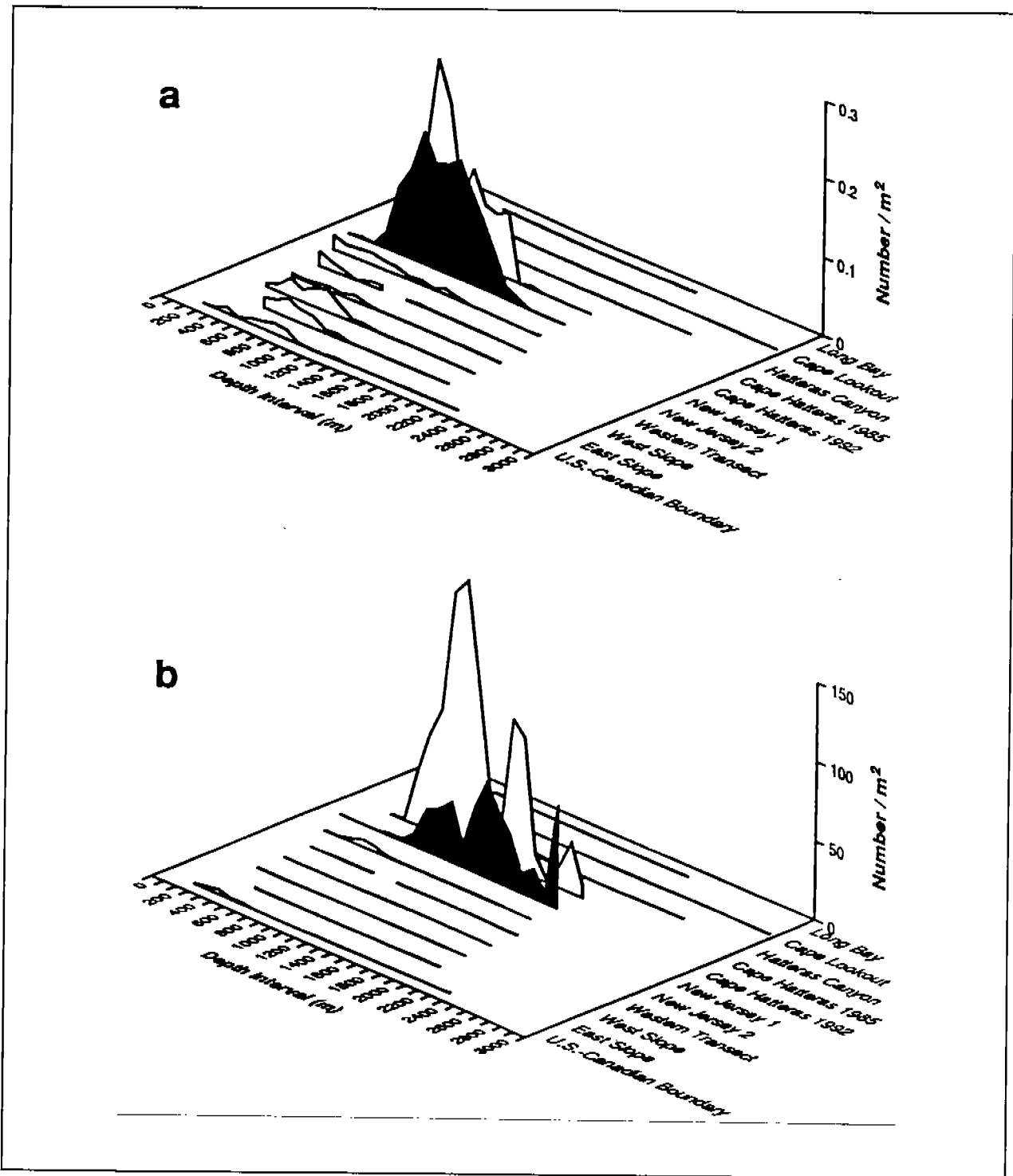

Figure 1H.13. Density of (a) the wolf eelpout *Lycenchelys verrilli* and (b) the anemone *Actinauge verrilli* with depth at 10 locations on the eastern U.S. continental margin. Data for these locations were collected for studies described in Hecker *et al.* (1983), Hecker (1990), and Blake *et al.* (1985, 1987). Data from the present survey are shaded (Cape Hatteras 1992).

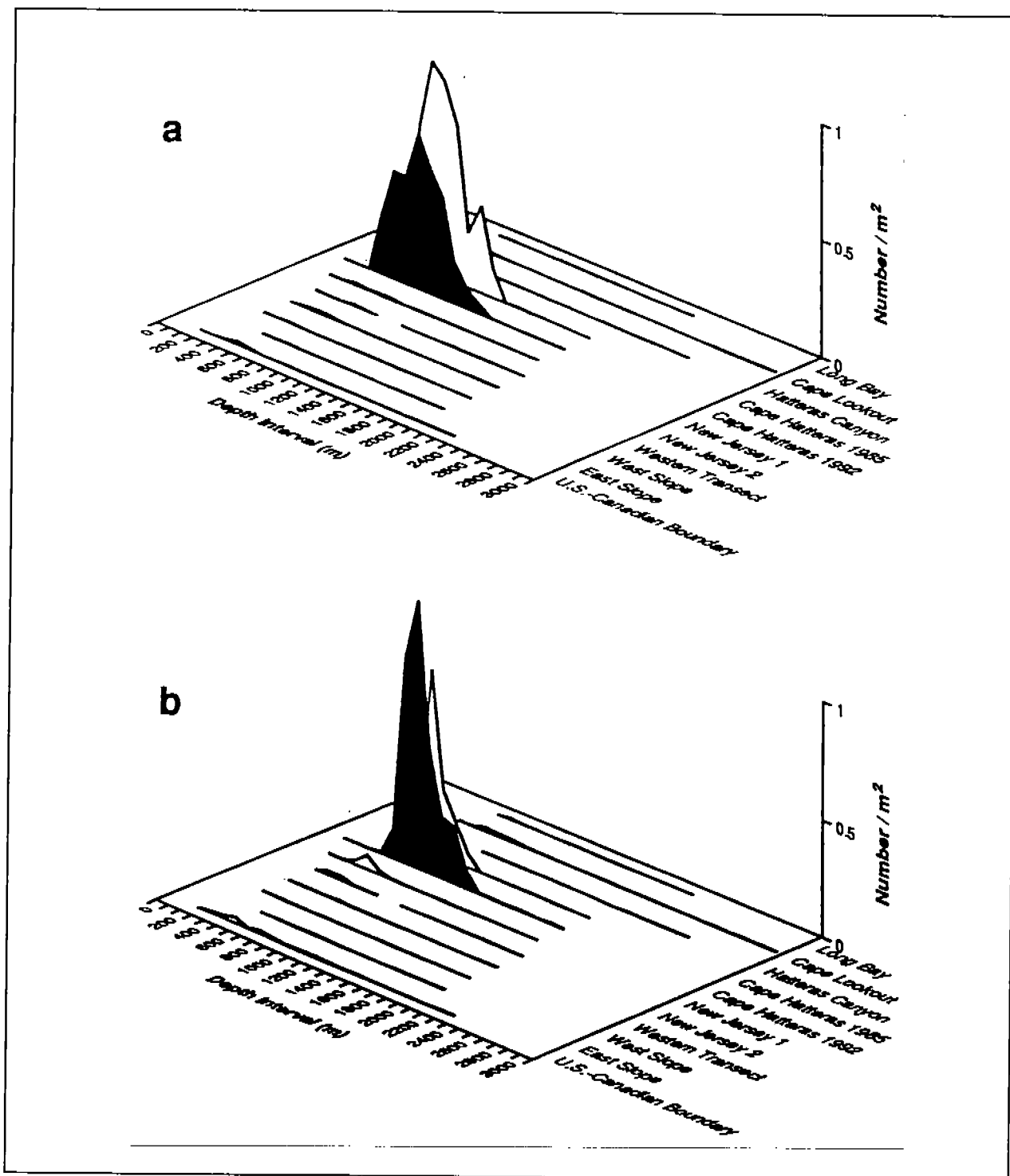

Figure 1H.14. Density of (a) the witch flounder *Glyptocephalus cynoglossus* and (b) the foraminiferan *Bathysiphon filiformis* with depth at 10 locations on the eastern U.S. continental margin. Data for these locations were collected for studies described in Hecker *et al.* (1983), Hecker (1990), and Blake *et al.* (1985, 1987). Data from the present survey are shaded (Cape Hatteras 1992).

The communities were present throughout the study area, but the relative abundances of the major species varied down to the smallest scales measured (meters for the megafauna and kilometers for the infauna). Latitudinal differences were most obvious in the megafauna. The northern part of the study area (1A and 1) differed somewhat from the rest. Depth-related zonation was most obvious in the megafauna with faunal breaks at 400-500 m, between 800 and 1,200 m, and at 1,600 m. For infauna the upper slope (600 m) was dominated by oligochaetes and the middle slope (800-1,400 m) by the polychaete *Scalibregma inflatum*. The boundaries of these unusual communities are at least from 35° 20' to 35° 50' north latitude (about 50 km) and from depths of 600 to 1,500 m, and possibly to 2,000 m depth. The minimum area occupied by these communities, within the study area, is estimated to be about 500 km<sup>2</sup> to the 1,500-m isobath and 900 km<sup>2</sup> to the 2,000-m isobath.

The data indicate that the unusual infauna and megafaunal communities are distributed throughout the study area. Conservatively, these communities occupied a north-south distance of at least 50 km and a depth range of 600 to 1,500 m, and likely to 2,000 m.

#### REFERENCES

- Blair, N.E., G.R. Plaia, S.E. Boehme, D.J. DeMaster and L.A. Levin. 1994. The remineralization of organic carbon on the North Carolina continental slope. *Deep-Sea Research II* 41:755-766.
- Blake, J.A. and B. Hilbig 1994. Dense infaunal assemblages on the continental slope off Cape Hatteras, North Carolina. *Deep-Sea Research II* 41:875-900.
- Blake, J.A., B. Hecker, J.F. Grassle, N. Maciolek-Blake, B. Brown, M. Curran, B. Dade, S. Freitas, and R.E. Ruff. 1985. Study of biological processes on the U.S. South Atlantic slope and rise. Phase 1. Benthic characterization study. Final report. Prepared for U.S. Department of the Interior, Minerals Management Service, Washington, DC, under Contract No. 14-12-0001-30064. 142 pp. + Appendices 1-4.
- Blake, J.A., B. Hecker, J.F. Grassle, B. Brown, M. Wade, P.D. Boehm, E. Baptiste, B. Hilbig, N. Maciolek, R. Petrecca, R.E. Ruff, V. Starczak, and L. Watling. 1987. Study of Biological Processes on the U.S. South Atlantic Slope and Rise. Phase 2. Final Report. Prepared for the U.S. Department of the Interior, Minerals Mgmt Service, Washington, DC, under Contract No. 14-12-0001-30064. 415 pp. + Appendices A-M. NTIS No. PB87-214-359.
- Blake, J.A., J.A. Muramoto, B. Hilbig, and I.P. Williams. 1992. Biological and sedimentological investigation of the seafloor at the proposed U.S. Navy ocean disposal site. July 1991 survey (R/V *Wecoma*). Benthic biology and sediment characterization. Report prepared for PRC Environmental Management, Inc. by Science Applications International Corporation, under Navy CLEAN Contract No. N62474-88-D-5086. *iii* + 130 pp. + Appendices A-D.
- Boynton, W.R., W.M. Kemp and C.W. Keefe. 1982. A comparative analysis of nutrients and other factors influencing estuarine phytoplankton production. pp. 69. *In*: V.S. Kennedy (ed.). *Estuarine Comparisons*, Academic Press, New York.

- Brandsma, M.G. 1990. Simulation of benthic accumulations of mud and cuttings discharged from Mobil Oil Corporation well, Manteo area, block 467, Cape Hatteras, North Carolina. Appendix N-4 *In*: Mobil. Exploration plan, Manteo area block 467, offshore Atlantic. Vol. III. Mobil Exploration and Producing Inc., Dallas, Texas.
- Cahoon, L.B., R.A. Laws and C.J. Thomas. 1994. Viable diatoms and chlorophyll *a* in continental slope sediments off Cape Hatteras, North Carolina. *Deep-Sea Research II* 41:767-782.
- Cutter, G.R., Diaz, R.J. and J.A. Blake. 1994a. Deep-Sea Research II: CD-ROM Appendix. *Deep-Sea Research II* 41:981-982.
- Cutter, G.R., R.J. Diaz and J. Lee. 1994b. Foraminifera from the continental slope off Cape Hatteras, North Carolina. *Deep-Sea Research II* 41:951-964.
- DeMaster, D.J., R.H. Pope, L.A. Levin and N.E. Blair. 1994. Biological mixing intensity and rates of organic carbon accumulation in North Carolina slope sediments. *Deep-Sea Research II* 41:735-754.
- Diaz, R.J., J.A. Blake and G.R. Cutter (editors). 1994a. Input, accumulation and cycling of materials on the continental slope off Cape Hatteras. *Deep-Sea Research II* 41(4-6).
- Diaz, R.J., G.R. Cutter and D.C. Rhoads. 1994b. The importance of bioturbation to continental slope sediment structure and benthic processes off Cape Hatteras, North Carolina. *Deep-Sea Research II* 41:719-734.
- Emery, K.O. and E. Uchupi. 1972. Western North Atlantic Ocean: Topography, rocks, structure, water, life, and sediments. *Memoirs Am. Assoc. Petrol. Geol.* 17:1-532.
- Farrington, J.W., S.M. Henrichs and R. Anderson. 1977. Fatty acids and Pb-210 geochronology of a sediment core from Buzzards Bay, Massachusetts. *Geochim. Cosmochim. Acta* 41:289-296.
- Harvey, H.R. 1994. Fatty acids and sterols as source markers of organic matter in sediments of the North Carolina continental slope. *Deep-Sea Research II* 41:783-796.
- Hecker, B. 1990. Variation in megafaunal assemblages on the continental margin south of New England. *Deep-Sea Res.* 37:37-57.
- Hecker, B. 1994. Unusual megafaunal assemblages on the continental slope off Cape Hatteras. *Deep-Sea Research II* 41:809-834.
- Hecker, B., D.T. Logan, F.E. Gandarilles and P.R. Gibson. 1983. Megafaunal assemblages in Lydonia Canyon, Baltimore Canyon, and selected slope areas. *In*: Canyon and slope processes study, Vol. 3, Final report. Prepared for U. S. Department of the Interior, Minerals Mgmt Service, Washington, DC under Contract No. 14-12-001-29178. 140 pp.

- Maciolek, N., J.F. Grassle, B. Hecker, P.D. Boehm, B. Brown, W.B. Dade, W.G. Steinhauer, E. Baptiste, R.E. Ruff and R. Petrecca. 1987a. Study of biological processes on the U.S. Mid-Atlantic slope and rise. Final report. Prepared for U.S. Department of the Interior, Minerals Mgmt Service, Washington, DC, under Contract No. 14-12-0001-30064. 310 pp. + Append. A-M.
- Maciolek, N., J.F. Grassle, B. Hecker, B. Brown, J.A. Blake, P.D. Boehm, R. Petrecca, S. Duffy, E. Baptiste and R.E. Ruff. 1987b. Study of biological processes on the U.S. North Atlantic slope and rise. Final report for U.S. Department of the Interior, Minerals Mgmt Service, Washington, DC, Contract 14-12-30064, 362 pp. + Append. A-L.
- Neff, J.M., M.H. Bothner, N.J. Maciolek and J.F. Grassle. 1989. Impacts of exploratory drilling for oil and gas on the benthic environment of George's Bank. *Mar. Environ. Res.* 27:77-114.
- North Carolina Environmental Sciences Review Panel. 1992. Report to the Secretary of the Interior from the North Carolina Environmental Sciences Review Panel as mandated by the Oil Pollution Act of 1990. 83 pp.
- Ross, S. and K. Sulak. 1992. An unusual fish community on the middle continental slope off Cape Hatteras, North Carolina. American Society of Ichthyologists and Herpetologists (ASIH) 72nd Annual Meeting, University of Illinois, Champaign-Urbana, Illinois, Abstract No. 303.
- Schaff, T. 1991. Spatial heterogeneity of continental slope benthos off the Carolinas. M.S. Thesis, North Carolina State University, Raleigh, NC.
- Schaff, T., L. Levin, N. Blair, D. DeMaster, R. Pope and S. Boehme. 1992. Spatial heterogeneity of benthos on the Carolina continental slope: Large (100 km)-scale variation. *Mar. Ecol. Prog. Ser.* 88:143-160.
- Smith, D.J., G. Eglinton and R.J. Morris. 1983. The lipid chemistry of an interfacial sediment from the Peru Continental Shelf: Fatty acids, alcohols, aliphatic ketones and hydrocarbons. *Geochim. Cosmochim. Acta* 47:2225-2232.
- Sulak, K. 1992. Demersal fish fauna on the continental slope in the vicinity of "the Point." pp. 135-138. *In: Proceedings Fourth Atlantic OCS Region Information Transfer Meeting, Wilmington, NC, September 1991. U.S. Dept. Interior, Minerals Management Service, Herndon, Virginia.*
- Welsh, B.L., R.B. Whitlatch and W.F. Bohlen. 1982. Relationship between carbon sources as a basis for comparing estuaries in southern New England. pp. 53-67. *In: V.S. Kennedy (ed.). Estuarine comparisons. Academic Press, New York.*

---

Dr. Robert Diaz, Professor of Marine Science, has been with the Virginia Institute of Marine Science for 30 years. His research interests are in coastal and estuarine benthic pelagic coupling and remote

sensing of bottom habitats. Dr. Diaz received his B.S. in biology from LaSalle College and his M.S. and Ph.D. from the University of Virginia. In 1996 he was awarded a Doctor Honoris Causa from Gothenburg University, Sweden, for his contributions to benthic ecology.

G. Randall Cutter, III has six years' experience in environmental assessment and computer applications. He is a marine scientist at the Virginia Institute of Marine Science. Mr. Cutter received his B.S. in environmental sciences from the University of Virginia. His research interests are in developing new remote sensing techniques for characterizing benthic landscape. Mr. Cutter is experienced in multimedia and editor of the first CD-ROM to be published with a regular issue of a scientific journal (*Deep-Sea Research Part II*, Vol. 41, 1995).

Dr. James A. Blake is a deep-sea benthic ecologist and marine invertebrate zoologist with an expertise in polychaete systematics and phylogeny with more than 100 published articles on these subjects. He has been both a university professor and consultant with private industry. He has managed previous benthic surveys at Cape Hatteras and elsewhere on the North Carolina coast for MMS.

## SESSION 1J

## U.S. – MEXICO OFFSHORE ENERGY ISSUES

Chair: Ms. Marvene O'Rourke  
 Co-Chair: Dr. Alexis Lugo-Fernández

Date: December 18, 1997

Presentation	Author/Affiliation
Circulation of the Western Gulf of Mexico and Its Implication on the Oil and Gas Industries	Dr. Víctor M. V. Vidal Lorandi Dr. Francisco V. Vidal Lorandi National Polytechnic Institute of Mexico Oceanographic and Ocean Engineering Research Center
Building Ocean Science Partnerships: The United States and Mexico Working Together	Dr. Víctor M. V. Vidal Lorandi Dr. Francisco V. Vidal Lorandi National Polytechnic Institute of Mexico Oceanographic and Ocean Engineering Research Center
Science and Technology Cooperation with Mexico: Marine Sciences and Natural Resources	Dr. Paul C. Maxwell U.S. Embassy, Mexico City
Offshore Oil & Gas Issues for Deepwater: U.S. Industry Perspective	Mr. Peter K. Velez Shell Deepwater Development Inc.
Offshore Oil & Gas Policy Issues: the U.S. Perspective	Mr. Chris C. Oynes Regional Director Minerals Management Service Gulf of Mexico OCS Region
MEXUS Plan: Mexico/U.S. Bilateral Response Plan	Mr. Daniel Whiting Commander, U.S. Coast Guard Marine Safety Office





## CIRCULATION OF THE WESTERN GULF OF MEXICO AND ITS IMPLICATION ON THE OIL AND GAS INDUSTRIES

Dr. Víctor M. V. Vidal Lorandi  
Dr. Francisco V. Vidal Lorandi  
National Polytechnic Institute of Mexico  
Oceanographic and Ocean Engineering Research Center

### INTRODUCTION

The Gulf of Mexico constitutes an excellent laboratory for the study of major oceanographic processes and the extrapolation of these studies to other parts of the world's oceans. The total area covered by the Gulf of Mexico is  $1.5 \times 10^6$  km<sup>2</sup>; it encloses a water volume of  $2.3 \times 10^3$  km. Its size is 60% of the Mediterranean Sea, considering its average depth of 1,500 meters. The Gulf's east-west dimension is 1,600 km. The western part of the Gulf has a north-south extension of 1,300 km, while its central and eastern portions each average about 900 km. The central Gulf, encompassed by the Sigsbee Deep, has an average depth of 3,000 m.

Given its location, the Gulf of Mexico is readily accessible to U.S. and Mexican oceanographers and other scientists. Major research efforts, some of them carried out jointly, have been conducted by Mexico and the United States during the last three decades. These studies have yielded important discoveries into the physical oceanographic processes that control the general circulation and water mass exchange in the Gulf of Mexico. Study topics have included coastal processes, tides, the Loop Current and associated rings, and the effects of tropical storms, among others. *In-situ* measurements coupled with satellite observations have provided much needed information for the modeling of the Gulf's hydrodynamic processes, coastal phenomena, tropical storms, and meso-scale eddies. Although numerical modeling of phenomena in the Gulf of Mexico has achieved good results, there is still much to be done. In particular it is important to evaluate which information needs to be included in the numerical models, how that is to be achieved, and what additional knowledge will be required for future modeling enhancements, which it is hoped, will yield, when coupled to real time observations, a nowcast/forecast capability for the Gulf's dominating physical processes. This oceanographic nowcast/forecast capability would be, the oil and gas industries' much sought but elusive Gulf of Mexico Regional Observing System (ROOS).

### REQUIRED REGIONAL STUDIES FOR A ROOS

A functional Regional Observing System for the Gulf of Mexico should ideally be structured to aid the operational oil and gas industries in responding to the following basic oceanographic issues that are critical to the building of a functional nowcast/forecast capability:

1. Spatial and temporal distributions of hydrography and currents in the Gulf of Mexico and the Yucatan and Florida Straits;
2. Controlling factors that determine the northward intrusion of the Loop Current;

3. Loop Current ring generation periodicity;
4. Ring translations and the distribution of relative vorticity within the Gulf;
5. Ring-slope and ring-ring interactions;
6. Ring collisions and the formation of along-shelf current jets;
7. Origin of the Gulf's western boundary current (wind driven or a result of decay of colliding Loop Current rings in the western Gulf?);
8. Ring subdivisions and angular momentum conservation, the proliferation of cyclonic-anticyclonic pairs and their influence on the mass-volume exchanges between the Gulf's continental shelf and oceanic waters;
9. Water mass formation and mixing in the Gulf, the relative influence of wind driven vs. ring-slope and ring-ring interactions;
10. Vertical transport balance associated with the distribution of relative vorticity and its influence on the intermediate and deep mean circulation of the Gulf.

Although these operational-oceanographic questions are focused on processes occurring in the Gulf of Mexico, they are also relevant to the understanding of physical phenomena generic to the world's oceans, namely: eddy shedding, carbon dioxide removal and climate change, western boundary currents, weather effects, sea level rise, etc.

What follows is a brief discussion of some of the regional studies listed above which need to be addressed jointly by Mexican and U.S. oceanographers establishing a binational Regional Observing System for the Gulf of Mexico.

#### SPATIAL AND TEMPORAL DISTRIBUTIONS OF HYDROGRAPHY AND CURRENTS IN THE GULF OF MEXICO AND THE YUCATAN AND FLORIDA STRAITS

Given the widespread exploitation of the Gulf's natural resources by both the US and Mexico it becomes essential, both from the operational and scientific perspectives, to understand its hydrodynamics. Hence the Gulf's spatial and temporal distributions of hydrography and currents should be monitored on a continuous basis. This endeavor would ensure a complete Gulf coverage which, in turn, would permit construction of a time series evolution of the Gulf's baroclinic and barotropic circulation. This knowledge is crucial as ground-truth for both satellite altimetry measurements and for the calibration/validation of numerical models that are being developed to reproduce the Gulf's circulation.

Mexico and the U.S. have cooperated extensively in studying the Gulf of Mexico. Recently (1984-1989) the Latex Program, sponsored by the U.S. Minerals Management Service, provided an excellent platform for binational cooperation. A similarly structured program sponsored jointly by Mexico and the U.S., through specific funds for binational environmental studies, would provide full oceanographic coverage of the Gulf of Mexico and should receive the highest priority. The scientific knowledge and technological benefits that would be derived from such a program would provide both Mexico and the U.S. with the operational oceanography required adequately to manage the Gulf of Mexico.

## CONTROLLING FACTORS THAT DETERMINE THE NORTHWARD INTRUSION OF THE LOOP CURRENT AND ITS RING-SHEDDING PERIODICITY

The hydrodynamic response of the Gulf of Mexico, including its two connecting straits, is predominantly baroclinic. This is particularly true within the Loop Current as well as within the Gulf's ring dominated upper (0 to 1,000 dbar) layer (Science Applications (SAIC) 1988). Below 1,000 dbar the hydrodynamic response, although strongly influenced by ring translations and the propagation of topographic Rossby waves (Hamilton 1990), is overwhelmingly barotropic. At depths below 1,500 meters, the range of potential temperature, salinity and density in the Gulf is 4.02 to 4.06 °C, 34.970 to 34.988 psu, and 27.757 to 27.762 mg/cm<sup>3</sup>, respectively (Nowlin 1972; Vidal *et al.* 1994d). Hence, density gradients are too weak to generate a significant baroclinic signal; this explains the vertical uniformity of deep-baroclinic currents in the Gulf. The measured time-series velocities are essentially the barotropic component (SAIC 1988).

Both the upper baroclinic and the lower barotropic layers in the Gulf are strongly affected by fluctuations of the Loop Current and its westward propagating anticyclones. There is evidence that the deep water fluctuations become progressively more decoupled from upper layer currents as the topographic Rossby waves and warm eddies propagate into the western Gulf basin (Hamilton 1990). Given the previous it becomes essential, for the proper understanding and modeling of the Gulf's ring-forcing hydrodynamics, to investigate the factors that control the Loop Current's northward penetration into the Gulf, its variability and its ring-shedding periodicity. This knowledge is crucial to adequately defining the initial conditions of numerical models and in the understanding of the Gulf basin's hydrodynamic response to the propagation of topographic Rossby waves.

## RING TRANSLATIONS AND THE DISTRIBUTION OF RELATIVE VORTICITY WITHIN THE GULF; RING-SLOPE AND RING-RING INTERACTIONS; RING COLLISIONS AND THE FORMATION OF ALONG-SHELF CURRENT JETS

The circulation in the Gulf of Mexico is dominated by anticyclonic rings shed from the Loop Current (Ichiye 1962; Cochrane 1972; Elliott 1982; Lewis and Kirwan 1985). Recent Lagrangian studies have described and analyzed the western translations of Loop Current rings within the Gulf (Kirwan *et al.* 1984a, b; SAIC 1988).

Elliott (1982) used historical, quasi-synoptic data sets to establish the separation and movement of three anticyclonic rings into the western Gulf and calculated westward translation speeds of 2.1 km/day, ring radii of 183 km, and ring lifetimes of about 1 year. The mean heat and salt input per unit ring surface area, introduced by these rings into the western Gulf, is of the order of  $7 \times 10^5$  Joules/cm<sup>2</sup> and 17 g/cm<sup>2</sup>, respectively (Elliott 1982). The intensity of their anticyclonic circulation, with swirl velocities of 50-75 cm/s, indicates that Loop Current rings also transport a considerable amount of angular momentum into the western Gulf (Kirwan *et al.* 1984a, b).

Current measurements made by Brooks (1984), over the continental shelf-slope in the northwestern Gulf, indicate that the influence of hurricane-induced currents on the hydrographic and current variability in the western Gulf is considerably less than that contributed by a ring migrating

northward along the western Gulf boundary. The same situation persists in the western Gulf during the winter season, wherein colliding anticyclones propagate unimpeded during the northerly wind stress season (Vidal *et al.* 1988, 1992).

On going research on the circulation of the western Gulf has incorporated numerical modeling of (1) Loop Current intrusions and eddy shedding (Hurlburt and Thompson 1980, 1982; Dietrich and Lin 1994); (2) interactions of Loop Current anticyclones with bottom topography and the western Gulf boundary (Smith and O'Brien 1983; Smith 1986; Shi and Nof 1993, 1994); (3) analyses of satellite infrared imagery and hydrography (Vukovich *et al.* 1979; Brooks and Legeckis 1982; Vukovich and Crissman 1986; Biggs and Muller-Karger 1994); (4) Lagrangian measurements from satellite positioning of surface drifters seeded within Loop Current rings (Kirwan *et al.* 1984a, b; Lewis and Kirwan 1985; SAIC 1988; Lewis *et al.* 1989); (5) regional hydrography and baroclinic circulation studies (Nowlin 1972; Molinari *et al.* 1978; Elliott 1979, 1982; Merrell and Morrison 1981; Merrell and Vázquez 1983; and Worley 1986; Vidal *et al.* 1988, 1990, 1992, 1994a, b, c); and (6) satellite altimetry measurements (Forristall *et al.* 1990; Leben *et al.* 1990; Biggs *et al.* 1996).

These studies have described the translation tracks of anticyclonic rings within the eastern, central and western Gulf, their hydrography, baroclinic circulation's, ring-ring interactions, and ring interactions with topography. Despite the new information provided by these research efforts, there is still much to be learned about the nature of anticyclonic Loop Current rings and their influence on the hydrography and circulation of the central and western Gulf. If anything can be derived from these studies, it is that a continuing and permanent monitoring effort, along these types of observations, is crucial to the management of the oil and gas industries' exploration and exploitation endeavors. And probably constitutes the basic structure for a Regional Observing System in the Gulf of Mexico.

#### ORIGIN OF THE GULF'S WESTERN BOUNDARY CURRENT (WIND DRIVEN OR RESULT OF THE DECAY OF COLLIDING LOOP CURRENT RINGS) IN THE WESTERN GULF?

The occurrence of a western boundary current in the Gulf of Mexico has been addressed by Sturges and Blaha (1976), Blaha and Sturges (1981) and Sturges (1993). Although it has been thought for decades that the mean circulation in the western Gulf of Mexico is a large anticyclone (Sturges 1993), in reality, the general circulation of this water mass is far more complex than has been assumed. Figure 1-3 of Nowlin (1972) clearly depicts the complexity of the Gulf's baroclinic circulation. In it one sees the unmistakable and widespread distribution of cyclonic- anticyclonic ring pairs. Recently it has been shown that anticyclones collide frequently with the western Gulf boundary, whence they subdivide and proliferate as cyclonic-anticyclonic ring pairs and triads (Vidal *et al.* 1988, 1990, 1992, 1994a, b, d).

Sturges and Blaha (1976) and Blaha and Sturges (1981) have postulated that the curl of the wind stress should drive the mean circulation in the Gulf and that the net result of this wind forcing should be a Gulf Stream-like western boundary current. A recent paper by Sturges (1993) examined the relative importance of the wind stress curl and detached Loop Current (hereafter referred to as LC)

rings as precursors of the Gulf's western boundary current. His work focused on the annual cycle of the estimated flow as deduced from a compilation for ship's drift data. Sturges' (1993) analyses of this new data set reveal a western boundary current with a yearly cycle. The response between the surface flow and wind curl at the annual period is baroclinic and extends to a depth of about 1,000 meters. The current's flow along the western Gulf boundary is strongest in July and weakest in October. This annual variability could be driven by the annual wind cycle, large-scale wind curl and local Ekman pumping (Sturges 1993).

A major conclusion of Sturges (1993) pertains to the relative influence that LC rings have on the formation and annual cycle of the Gulf's western boundary current. He concludes that given the rings' loss of fluid, as they interact with the Gulf's western boundary, they tend to dissipate rapidly (e-folding decay time of about 70 days), and hence LC rings do not contribute significantly to the formation of the western Gulf anticyclonic current. Elliott's (1979, 1982) reported ring lifetimes (1 year) are important within the Gulf's interior but not applicable once the rings interact with the shelf-slope boundary (Sturges 1993). Furthermore, since the rings shed from the LC have no significant annual periodicity they make no significant contribution to the long-term annual signal (Sturges 1993).

Contrary to Sturges' (1993) deductions, Elliott's (1979, 1982) fundamental work on anticyclonic rings and the energetics of the circulation of the Gulf established the dominant role that LC rings have on the Gulf's general circulation, including the western Gulf. Vidal *et al.* (1988, 1989, 1990, 1992 and 1994a, b, c, d) have reported on field measurements which give clear evidence that the principal decay process of anticyclonic rings in the western Gulf is via mass-volume shedding associated to their collisions with the continental slope. These collision events give rise to cyclonic-anticyclonic triads whose e-folding decay times are far greater than 70 days (Vidal *et al.* 1989, 1994a, d). This is in agreement with the observed residence time of colliding anticyclones in the western Gulf which exceeds 6 months (Lewis and Kirwan 1985; SAIC 1988).

From the previous discussion it is evident that there is controversy as to the origin of the western boundary current in the Gulf of Mexico. Is it primordial wind and/or ring driven? Detailed measurements and analyses on the evolution of ring-slope interactions, as well as of long-term currents and wind-stress meteorology in the western Gulf, are crucial to resolve this important oceanographic question which has critical repercussions in the operational management of the Gulf of Mexico, and analogues in other oceanic regions of the world.

## CONCLUSIONS

Despite the new information provided by the previously enumerated studies, there is still much to be learned about the oceanographic nature of the Gulf of Mexico if we are to properly manage its resources. Propagating anticyclonic Loop Current rings, ring-ring interactions, and ring-slope collisions constitute the most energetic sources of momentum transfer within the gulf. Their influence on the hydrography and circulation of the central and western Gulf is preponderant, hence a constant monitoring effort of the Gulf's relative vorticity distribution appears to be mandatory if we want to exercise a sustainable management in the exploitation of its resources. Further research

and continuing monitoring efforts are required for the establishment of a true Gulf of Mexico-Operational Oceanographic knowledge. Some crucial questions that need to be answered are (1) What is the nature and hydrodynamic response of the Gulf's surface, intermediate and deep water mass transports to ring translations and ring-shelf collisions? (2) How do these ring migrations and ring-shelf interactions affect the Gulf's local, regional and basin wide circulations? (3) To what extent are they responsible for the conversion of 30 Sv ( $1 \text{ Sv} = 10^6 \text{ m}^3/\text{s}$ ) of Caribbean Subtropical Underwater to Gulf Common Water (GCW)? (4) On their westward travel, do rings transfer angular momentum to the surrounding water, induce geostrophic turbulence, and generate cyclonic circulations and vortex pairs on their peripheries? (5) Do rings coalesce? (6) Do they dominate the surface and deep circulation of the central and western Gulf and control its surface, intermediate and deep water mass exchange and residence times? (7) How do they affect the vertical and horizontal distribution of hydrographic properties, micronutrients and planktonic organisms? (8) Does the coupled translation and vorticity of anticyclonic and cyclonic rings determine the location of upwelling and downwelling regions in the Gulf and constitute a natural pumping mechanism that controls the primary productivity and  $\text{CO}_2$  exchange/removal between ocean-atmosphere and surface and deep waters? (9) If anticyclonic Loop Current rings collide against the western gulf boundary, do they generate western boundary currents and current jets parallel and normal to the shelf break, respectively? (10) If these current jets exist, do they constitute a primary and efficient exchange mechanism between the western Gulf's continental shelf and offshore waters? These are crucial operational-oceanographic questions which, when adequately answered, should enhance our ability to understand and manage the Gulf of Mexico. Ideally, these questions need to be addressed by both Mexican and U.S. scientists through a binational funding effort.

#### REFERENCES

- Blaha, J., and W. Sturges. 1981. Evidence for wind-forced circulation in the Gulf of Mexico. *J. Mar. Res.*, 9(4) 711-734.
- Biggs, D.C., and F.E. Muller-Karger. 1994. Ship and satellite observations of chlorophyll stocks in interacting cyclone-anticyclone eddy pairs in the western Gulf of Mexico. *J. Geophys. Res.*, 99(C4), 7371-7384.
- Biggs, D.C., G.S. Fargion, P. Hamilton, and R.R. Leben. 1996. Cleavage of a Gulf of Mexico Loop Current eddy by a deep water cyclone. *J. Geophys. Res.*, 101(C9), 20629-20641.
- Brooks, D.A. 1984. Current and hydrographic variability in the northwestern Gulf of Mexico. *J. Geophys. Res.*, 89(C5), 8022-8032.
- Brooks, D.A., and R.V. Legeckis. 1982. A ship and satellite view of hydrographic features in the western Gulf of Mexico. *J. Geophys. Res.*, 87(C6), 4195-4206.
- Cochrane, J.D. 1972. Separation of an anticyclone and subsequent developments in the Loop Current (1969), pp. 91-106. In L. R. A. Capurro and J. L. Reid. *Contributions on the Physical*

- Oceanography of the Gulf of Mexico. Texas A&M Univ. Oceanogr. Stud., vol. 2, Gulf, Houston, Texas.
- Dietrich, D.E., and C.A. Lin. 1994. Numerical studies of eddy shedding in the Gulf of Mexico. *J. Geophys. Res.*, 99(C4), 7599-7615.
- Elliott, B.A. 1979. Anticyclonic rings and the energetics of the circulation of the Gulf of Mexico. Ph.D. Thesis. Texas A&M Univ., College Station, 188 pp.
- Elliott, B.A. 1982. Anticyclonic rings in the Gulf of Mexico. *J. Phys. Oceanogr.*, 12, 1292-1309.
- Flierl, G.R. 1977. The application of linear quasigeographic dynamics to Gulf Stream rings. *J. Phys. Oceanogr.*, 7, 365-379.
- Flierl, G.R. 1984. Rossby wave radiation from a strongly nonlinear warm eddy. *J. Phys. Oceanogr.*, 14, 47-58.
- Forristall, G.Z., K.J. Schaudt, and J. Calman. 1990. Verification of Geosat altimetry for operational use in the Gulf of Mexico. *J. Geophys. Res.*, 95(C3), 2985-2989.
- Hamilton, P. 1990. Deep currents in the Gulf of Mexico. *J. Phys. Oceanogr.*, 20, 1087-1104.
- Hofmann, E.E., and S. Worley. 1986. An investigation of the circulation of the Gulf of Mexico. *J. Geophys. Res.*, 91(C12), 14221-14236.
- Hurlburt, E.H., and J.D. Thompson. 1980. A numerical study of Loop Current intrusions and eddy shedding. *J. Phys. Oceanogr.*, 10, 1611-1651.
- Hurlburt, E.H., and J.D. Thompson. 1982. The dynamics of the Loop Current and shed eddies in a numerical model of the Gulf of Mexico. In J. C. J. Nihoul. *Hydrodynamics of Semi-enclosed Seas*. Elsevier Science, New York.
- Ichiye, T. 1962. Circulation and water mass distribution in the Gulf of Mexico. *Geofis. Int.*, 2, 47-76.
- Kirwan, A.D., Jr., W.J. Merrell, Jr., J.K. Lewis, and R.E. Whitaker. 1984a. Lagrangian observations of an anticyclonic ring in the western Gulf of Mexico. *J. Geophys. Res.*, 89(C3), 3417-3424.
- Kirwan, A.D., Jr., W.J. Merrell, Jr., J.K. Lewis, R.E. Whitaker, and R. Legeckis. 1984b. A model for the analysis of drifter data with an application to a warm core ring in the Gulf of Mexico. *J. Geophys. Res.*, 89(C3), 3425-3438.
- Leben, R.R., G.H. Born, J.D. Thompson, and C.A. Fox. 1990. Mean sea surface variability of the Gulf of Mexico using Geosat altimetry data. *J. Geophys. Res.*, 95(C3), 3025-3032.



- Lewis, J.K., and A.D. Kirwan. 1985. Some observations of ring topography and ring-ring interactions in the Gulf of Mexico. *J. Geophys. Res.*, 90(C5), 9017-9028.
- Lewis, J.K., A.D. Kirwan, and G.Z. Forristall. 1989. Evolution of a warm core ring in the Gulf of Mexico: Lagrangian observations. *J. Geophys. Res.*, 94(C6), 8163-8178.
- Molinari, R.L., J.F. Festa, and D.W. Behringer. 1978. The circulation in the Gulf of Mexico derived from estimated dynamic height fields. *J. Phys. Oceanogr.*, 8, 987-996.
- Nowlin, W.D., Jr. 1972. Winter circulation patterns and property distributions, pp. 3-53. In L.R.A. Capurro and J.L. Reid. *Contributions on the Physical Oceanography of the Gulf of Mexico*, Vol. 2. Texas A&M Univ. Oceanogr. Stud., Gulf Publ. Co., Houston, Texas.
- Science Applications International Corporation. 1988. Gulf of Mexico physical oceanography program, Final Report: Year 3, Vol. II, Tech. Rep., MMS contract No. 14-12-0001-29158, OCS Report/MMS 88-0046, 241 pp.
- Shi, C., and D. Nof. 1993. The splitting of eddies along boundaries. *J. Mar. Res.*, 51, 771-795.
- Shi, C., and D. Nof. 1994. The destruction of lenses and generation of vortices. *J. Phys. Oceanogr.*, 24(4), 1120-1136.
- Smith, D.C., IV. 1986. A numerical study of Loop Current eddy interaction with topography in the western Gulf of Mexico. *J. Phys. Oceanogr.*, 16, 1260-1272.
- Smith, D.C., IV, and J.J. O'Brien. 1983. The interaction of a two layer isolated mesoscale eddy with bottom topography. *J. Phys. Oceanogr.*, 13, 1681-1697.
- Sturges, W. 1993. The annual cycle of the western boundary current in the Gulf of Mexico. *J. Geophys. Res.*, 98 (C10), 18,053-18,068.
- Sturges, W., and J.P. Blaha. 1976. A western boundary current in the Gulf of Mexico. *Science*, 192, 367-369.
- Vidal, V.M.V., F.V. Vidal, and J.M. Perez-Molero. 1988. *Atlas Oceanográfico del Golfo de México*, Vol. 1. Inst. de Invest. Electr., Cuernavaca, Morelos, México. 415 pp.
- Vidal, V.M.V., F.V. Vidal, J.M. Perez-Molero, A. Hernández, R. A. Morales, E. Suárez and E. Meza. 1989. Informe Final de las Campañas Oceanográficas ARGOS realizadas en el Golfo de México 1984-1988, Rep. IIE/13/1926/I 14/F. Inst. de Invest. Electr., Cuernavaca, Morelos, México. 280 pp
- Vidal, V.M.V., F.V. Vidal, and A. Hernández. 1990. *Atlas Oceanográfico del Golfo de México*, Vol. 2. Inst. de Invest. Electr., Cuernavaca, Morelos, México. 707 pp.

- Vidal, V.M.V., F.V. Vidal and J.M. Pérez-Molero. 1992. Collision of a Loop Current anticyclonic ring against the continental shelf slope of the western Gulf of Mexico. *J. Geophys. Res.*, 97(C2), 2155-2172.
- Vidal, V.M.V, F.V. Vidal, E. Meza, A. Hernández, L. Zambrano, D.C. Biggs, and K.J. Shaudt. 1994a. Formation of a western boundary current in the Gulf of Mexico from decay of Loop Current anticyclonic rings (abstract), *Eos Trans., AGU*, 75(3), 223.
- Vidal, V.M.V., F.V. Vidal, and A. Hernández, E. Meza, and J.M. Perez-Molero. 1994b. Baroclinic flows, transports, and kinematic properties in a cyclonic-anticyclonic-cyclonic ring triad in the Gulf of Mexico. *J. Geophys. Res.*, 99(C4), 7571-7597.
- Vidal, V.M.V., F.V. Vidal, E. Meza, A. Hernández, L. Zambrano. 1994c. Winter water mass distributions in the western Gulf of Mexico affected by a colliding anticyclonic ring. *J. Oceanogr.*, 50(5), 559-588.
- Vidal, V.M.V., F.V. Vidal, and A. Hernández, E. Meza, and L. Zambrano. 1994d. *Atlas Oceanográfico del Golfo de México, Vol. 3*. Inst. de Invest. Electr., Cuernavaca, Morelos, México. 586 pp.
- Vukovich, F.M. 1995. An updated evaluation of the Loop Current's eddy shedding frequency. *J. Geophys. Res.*, 100(C5), 8655-8659.
- Vukovich, F.M., and B.W. Crissman. 1986. Aspects of warm rings in the Gulf of Mexico. *J. Geophys. Res.*, 91(C2), 2645-2660.
- Vukovich, F.M., B.W. Crissman, M. Bushnell, and W.J. King. 1979. Some aspects of the oceanography of the Gulf of Mexico using satellite and in situ data. *J. Geophys. Res.*, 84C12), 7749-7768.

## **BUILDING OCEAN SCIENCE PARTNERSHIPS: THE UNITED STATES AND MEXICO WORKING TOGETHER**

Dr. Víctor M. V. Vidal Lorandi  
Dr. Francisco V. Vidal Lorandi  
National Polytechnic Institute of Mexico  
Oceanographic and Ocean Engineering Research Center

The United States and Mexico are neighbors, major trading partners and political allies. They share adjacent coastal and oceanic areas in the Pacific and Gulf of Mexico. Both nations recognize that the oceans are crucial for human welfare, and that the health of the Oceans and our intelligent use of oceanic resources depends on our understanding of their nature. Thus, both the United States and Mexico conduct intensive oceanographic research, albeit differentially given their particular cultural, political, geographical and economical realities. Nonetheless, both nations recognize that oceanography is basically an “observational science,” that all oceanographic disciplines need sustained large scale, long term observations, and that the oceans are a continuum. They also recognize that unfortunately national political boundaries exist that limit our nation’s exploration in another’s seas. Consequently, they recognize that the effective global exploration of the oceans can only be achieved through joint cooperative ventures.

There are many examples of marine concerns affecting both the United States and Mexico. These concerns include oil and gas development, tourism and commercial development, commercial and recreational fisheries management, water quality, biological diversity, coastal zone management, protection of marine birds and mammals, to cite a few.

In the past, the United States and Mexico have collaborated relatively little on oceanic issues, and their collaboration has, for the most part, been limited to a single scientist to scientist basis. Exceptions have been the CALCOFI, MEXUS-PACIFICO and MEXUS-GOLFO programs. More recent examples are the TAMU-UNAM, TAMU-MEXICAN NAVY, and EPOMEX-LSU cooperative research programs. However, the truth of the matter is that both the U.S. and Mexican governments have only focused minor attention on oceanic cooperation.

Some of the reasons for such limited binational cooperation in ocean sciences are language barriers, differential economic development, differential development of scientific infrastructure, differential development of human resources, disproportional funding, differential administrative bureaucratic capacities, and the radically different way in which science is conducted in each country.

U.S. scientific development is well advanced while Mexico’s is only incipient. In the United States there are approximately 2,200 Ph.D. ocean scientists working in approximately 115 major institutions and university departments. While in Mexico there are less than 100 Ph.D. oceanographers working in 20 major institutions and university departments. Actually, Mexico only has approximately 6,000 recognized scientists in all disciplines.

U.S. scientists are relatively well-funded in comparison to Mexican scientists. In 1995 the National Science Foundation (NSF), Office of Science Development (OSD) spent \$192.8 million U.S. dollars on oceanographic research, while Mexico's CONACYT spent only \$850,000 U.S. dollars. There exist also enormous differences in the salaries earned by U.S. and Mexican ocean scientists. On the average, a U.S. oceanographer with a Ph.D. conservatively earns \$40-60 thousand dollars per year, while a Mexican Ph.D. ocean scientist earns approximately of \$10-20 thousand U.S. dollars per year.

Examples of significant oceanographic research to be conducted cooperatively between the United States and Mexico in the Gulf of Mexico are: (1) design and implementation of their corresponding regional ocean observing systems; (2) study of the surface, intermediate and deep circulation of the Gulf of Mexico, and the corresponding links between physical processes and the biological processes, continental weather, and natural hazards; (3) research related to oil and gas exploitation and development; (4) impacts of oil and other pollutants on marine organisms and humans; (5) ecology of hydrocarbon and saline seeps; (6) habitat destruction and changes in biological diversity due to anthropogenic activities, and; (7) marine natural products chemistry.

These and other scientific investigations can only be conducted if several binational actions are first taken to improve collaborative oceanic research between the United States and Mexico. It is imperative that each country provide adequate funding for research independently.

The plans are for Mexico to increase its investment in science from the current 0.33% to 1% of its GNP. In 1998 Mexico plans to raise its investment in science from 0.33% to 0.5% of its GNP. However, it is not known how much of this investment will go to ocean science research. Currently, Mexico does not have priorities for the development of the different scientific disciplines.

An effort should be made by the governments of both the United States and Mexico to guarantee meaningful and well-paid jobs for all its scientists, including oceanographers. Currently, the U.S. is educating more Ph.D. oceanographers than it can hire. The situation is different in Mexico, where a critical shortage of Ph.D. oceanographers are urgently required. However, in Mexico there is a serious salary problem: its scientists are critically underpaid. The governments of both nations need to balance the rate at which meaningful, well-paid jobs are created with the rate at which Ph.D. oceanographers are produced.

Support for joint U.S.-Mexico research, including large international ocean science programs, such as WOCE, JGOFS, Ocean Drilling Program (ODP), Land-Ocean Interactions in the Coastal Zone (LOICZ), GLOBEC is fundamental for improving collaborative oceanic research between the United States and Mexico. Currently, Mexico does not participate in any such large, global, international research programs. Consequently, Mexican scientists are isolated and far away from the mainstream of first class, global oceanographic research, and the impact of their research, however meaningful and original, cannot be felt.

The effective participation of Mexican oceanographers in any international regional and/or global research experiment depends almost entirely on their scientific quality. Yet, Mexican ocean scientists are forced to work in extremely deficient conditions, with very poor infrastructure, and without

adequate technical support. Consequently, an honest and decisive effort must be made to strengthen Mexican human scientific resources. It is urgent that Mexican technical capacity be strengthened, especially in terms of marine electronic and mechanical engineers, ocean science technicians, and data analysts. It is also imperative for all to recognize that ships constitute the foundation upon which oceanographic research rests. Consequently, both the United States and Mexico must invest in balanced funding for research and ship construction and operations.

Both the Academia Mexicana de Ciencias (AMC) and the National Academy of Sciences of the United States (NAS), through its National Research Council (NRC), and Ocean Studies Board (OSB), have an important role to play in fostering the development of collaborative U.S.-Mexican ocean science. Increasingly regular AMC-NAS (NRC-OSB) consultations and developing interacademy projects are indispensable to help achieve this goal. The AMC should create its "Ocean Studies Board", analogous to that of the NAS (NRC-OSB).

Increasing communications between United States and Mexico oceanographers is also imperative. They should plan to organize joint symposia and workshops to discuss their research findings and to identify new regional and global research topics of mutual interest. Also, more effort is needed to promote and support binational scientific and technical exchanges for education and training, including adjunct professorships, sabbaticals, and short courses.

Removal of cultural barriers and promotion of respect for the laws of both nations and their cultural differences, are ultimately necessary for effective bilateral cooperation, be it scientific or otherwise. These goals can best be achieved through genuine bilateral educational opportunities. U.S. scientists should learn Spanish, and Mexican scientists should learn English. In addition, we must encourage U.S. students to attend Mexican universities and create incentives and publishing opportunities for Mexican ocean scientists. Mexican scientific journals should be translated into English, French and Japanese, and distributed worldwide. Furthermore, the number of Mexican ocean scientists on the editorial and referee boards of U.S. journals and in the committees of scientific unions must be increased.

Mexico's scientific bureaucracy should be modernized. Mexican scientists not only find it extremely difficult to procure funding, but once they get it, they generally face an intricate, stifling bureaucracy which impedes the effective access to the funds and their expenditure. This primitive scientific administrative bureaucratic system impedes the realization of many important scientific projects, makes Mexican science uncompetitive, and discourages all but the most stubborn. Also, in Mexico there is no single agency responsible for marine affairs. Responsibility for ocean affairs, including ocean sciences, is dispersed among many government offices, and there are no clear specifications of functions and missions. There is no government agency in Mexico charged with regular, long-term ocean observation. For this reason, no national oceanographic data gathering or ocean policies programs exist and decisions are made superficially or not at all. Furthermore, coordination of international marine policy affairs is extremely difficult. It is important that the Mexican Federal Government create a new agency or a department within an existing agency, responsible for marine affairs, including ocean sciences and technology.

Finally, U.S. ocean scientists must recognize the benefits and pleasures of working with Mexican scientists on equal terms, equal normalized funding, in a friendly, tolerant, understanding and respectful working environment. U.S. science is conducted in a fiercely competitive environment which stresses human relationships. The recognition, understanding and acceptance of the asymmetries that exist between the United States and Mexico, and of their cultural, political and economic differences, is a must for achieving a respectful bilateral ocean science collaboration between the United States and Mexico.

## **SCIENCE AND TECHNOLOGY COOPERATION WITH MEXICO: MARINE SCIENCES AND NATURAL RESOURCES**

Dr. Paul C. Maxwell  
U.S. Embassy, Mexico City

### OVERVIEW OF THE U.S. – MEXICO SCIENCE & TECHNOLOGY RELATIONS

Of the six priority areas identified by the U.S. Embassy in Mexico City, three of them fall either entirely or partly into the preview of the Environment, Science, & Technology (EST) Office. These are:

- Trade—standards, high-tech. technology transfer, environmental technology, energy.
- Environment—border issues, Border 21, environmental health, conservation, biodiversity, climate change, etc.
- Other (education & science)—Globe, LMT, Popo, Materials, Basic Science & Technology (S&T).

EST issues remain a major focus of the Binational (BNC) meetings. These are binational Ministerial/Cabinet level, annual meetings held alternately in both of our capitals. Four out of fourteen subgroups of the Commission are focused on environment, science and technology issues. These are Environment/Natural Resource, Health, Marine Resources and S&T, whereas, three other subgroups—Energy, Trade and Commerce, and Political—are closely related. Many EST issues actually predate the BNC itself, going back to the 1972 Global S&T Agreement, which is still in force, and to Mixed Commission Meetings established in the 70s, which still meet as preliminary working meeting to the BNC itself. The latest BNC, held in May 1997, featured four U.S. cabinet secretaries, including Secretary Albright, ten agency heads, and numerous other high ranking individuals. This meeting, held just prior to President Clinton's visit to Mexico, served as a take-off point for those presidential discussions.

### ESTIMATED ANNUAL U.S. S&T FUNDING FOR MEXICO:

The United States currently spends approximately \$28 million on S&T cooperation with Mexico annually. These funding levels represent only the U.S. portion of the collaboration and, then, only

that part paid by the U.S. federal government. It does not incorporate all the activities with state institutions or the private sector nor the contributions being made by Mexico. Total collaborative efforts likely exceed \$70 million annually and can be expected to increase.

#### ESTIMATED MEXICAN FEDERAL FUNDING FOR S&T (1997)

Based on recent testimony to the Mexican Congress by Conacyt, Mexico's NSF equivalent, total federal Mexican expenditures for S&T (1997) is estimated to be about \$1.43 Billion or roughly 1.5% of the total federal budget as compared to approximately 5% for the United States. The large amount attributed to education in this graph (52.4%) is a little misleading in that this includes salaries, scholarships, fellowships, etc. in addition to straight Research & Development (R&D) (see Figure 1J.1). Conacyt itself is found within the education portion of the budget and represents about 15% of the total (~\$214 million). As seen in the graph, energy, mostly originating in PEMEX and CFE (Central Federal de Electricidad), represents about a third of the S&T expenditures.

#### MEXICO'S R&D AS A PERCENTAGE OF GNP

While Mexico has a relatively large number of scientists and engineers dedicated to R&D—approximately 20,000—80% of which are focused on physical and engineering sciences, at .031% they remain well below the total investment in R&D compared to a number of other countries as represented by a percentage of their total GNP (see Figure 1J.2). Even countries such as Brazil and Chile are investing roughly twice as much in R&D as Mexico. This deficit in R&D financing has been recognized by Mexico's science leadership who are trying to double this investment to 0.7% in the next five years.

#### FINANCING BY SECTORS FOR DIFFERENT COUNTRIES:

In looking at the contribution to financing R&D, Mexico (along with other developing countries such as Chile) relies heavily on government contributions and relatively little on industry and the private sector. Mexico's industry contribution amounts to only 18%; this figure compares to that of OECD countries or the U.S., which contribute 35% to 60% respectively see Figure 1J.3). This is particularly important as one looks to R&D as an economic driver in a world of ever-greater dependence on high technology industries. In the United States, for instance, more than two-thirds of the recent economic growth has been attributed directly to R&D investments.

#### ENERGY S&T (1996)

Looking specifically at the energy sector in Mexico, we see that the primary supporter of energy S&T (amounting to approximately \$484 million) comes, not surprisingly, from the petroleum sector (66%), followed by electrical (15%), nuclear (11%) and other (renewable energy) (see Figure 1J.4). Given the political and economic importance of PEMEX and its related petroleum based industries, it appears likely that this dominance by the petroleum sector for energy R&D will continue. This has obvious implications as Mexico and other countries, including the U.S., examine their energy

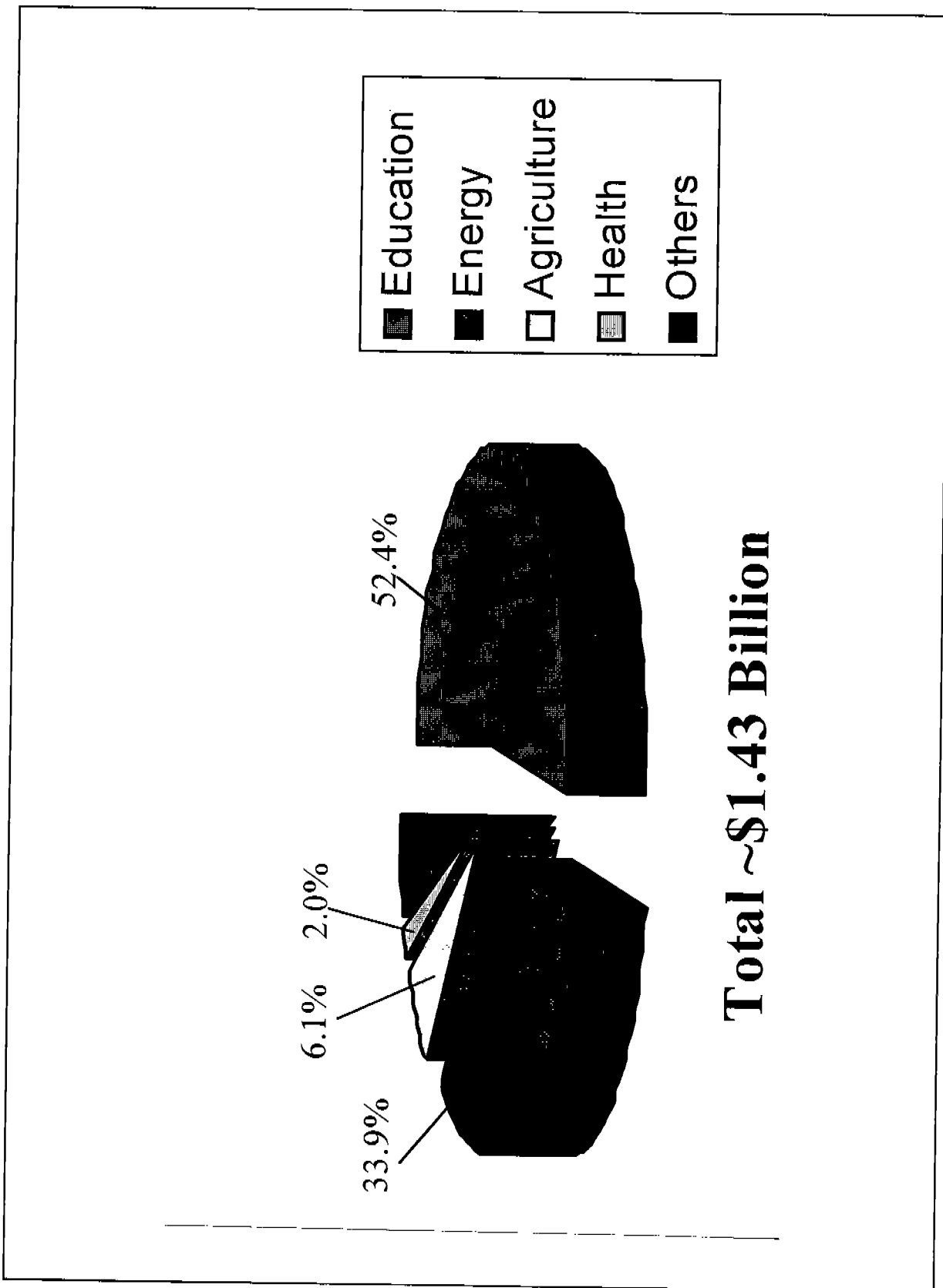

Figure 1J.1. Estimated Mexican federal funding for Science & Technology, 1997.



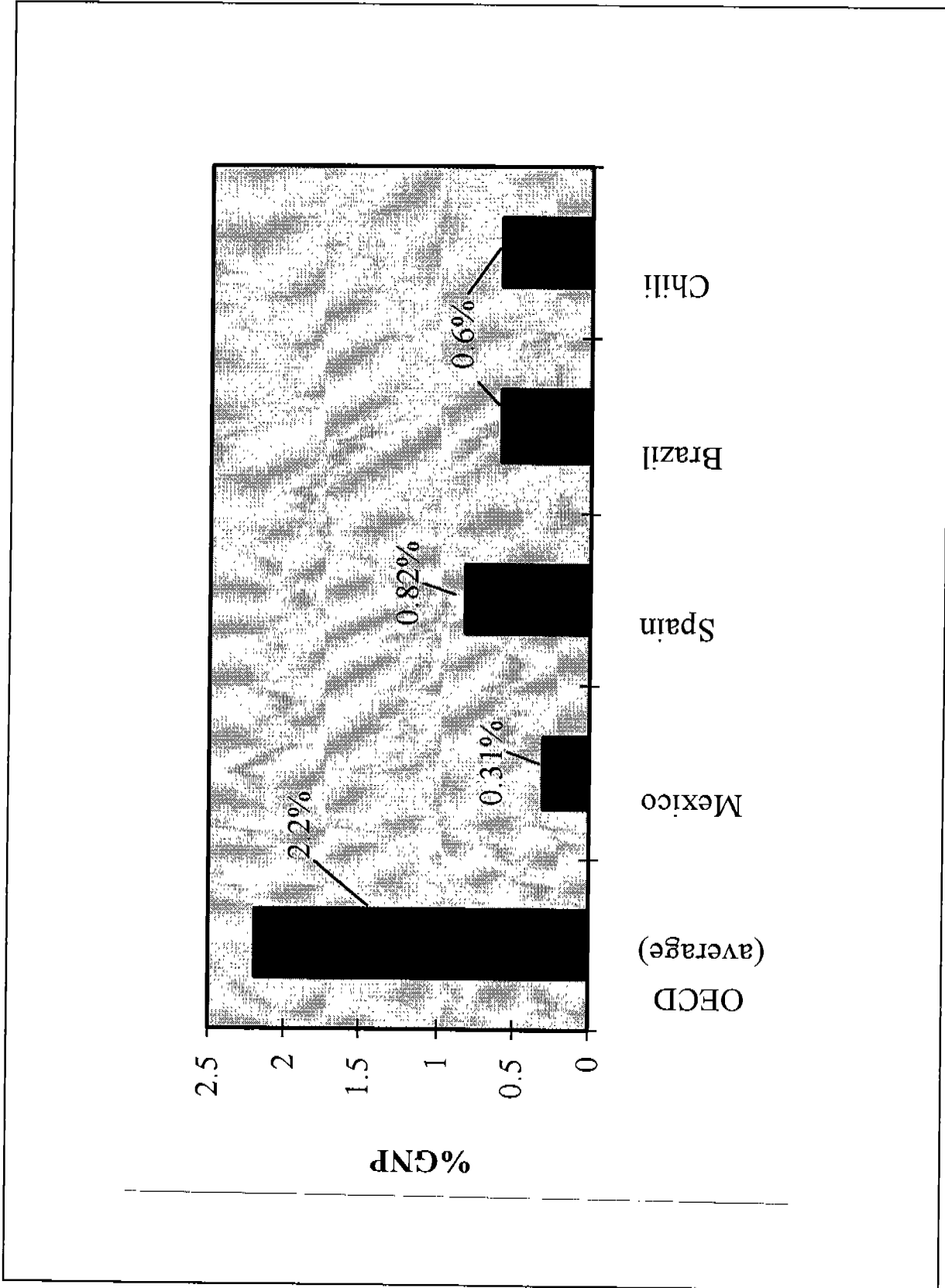

Figure 1J.2. Research & Development as percentage of GNP.

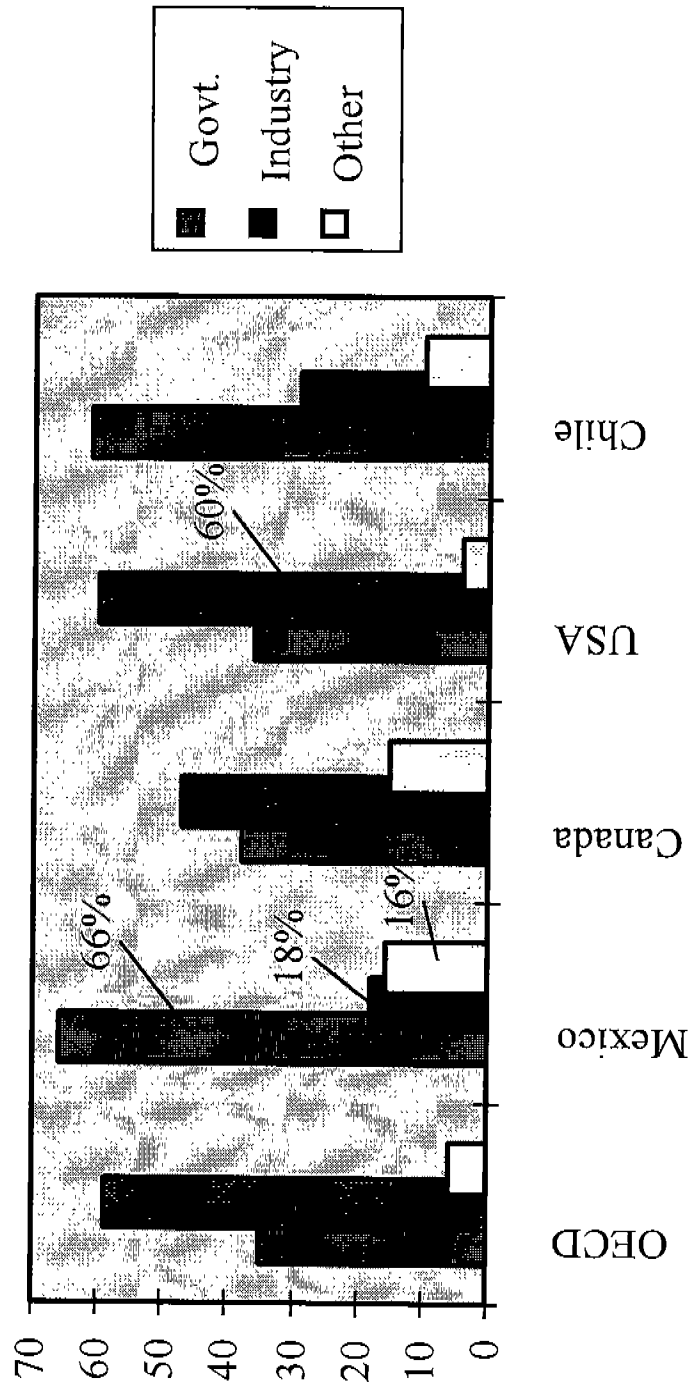

Figure 1.J.3. Financing by sectors, different countries.

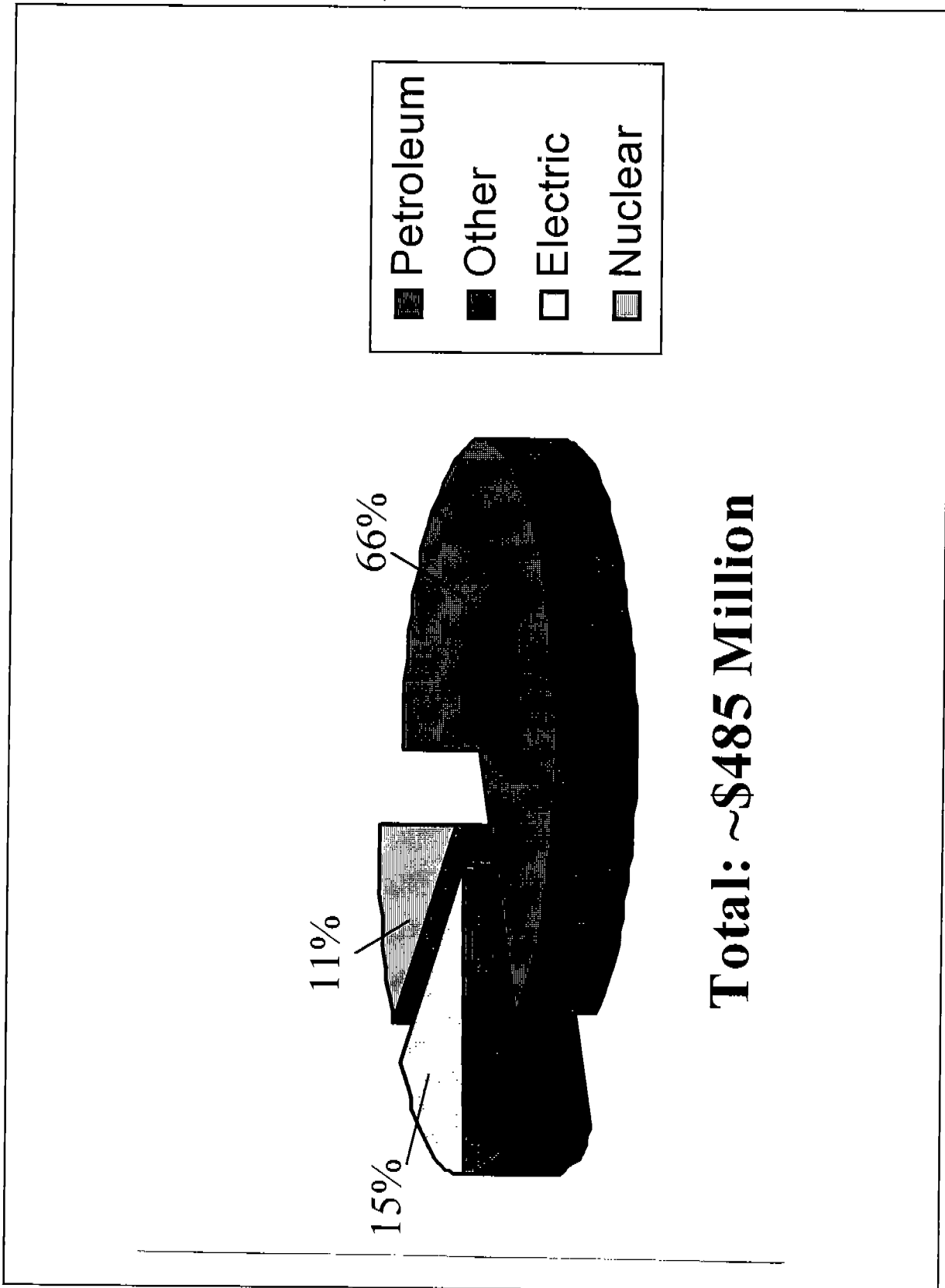

Figure 1J.4. Energy Science & Technology, 1996.

policies in an era of global warming and climate change. As one example, Mexico has already committed to switching to gas in lieu of coal-fired power plants in the next decade.

## MARINE SCIENCES AND NATURAL RESOURCE ISSUES

By far the biggest concern in our Mexico City EST Office is marine resource conservation and management. The tuna-dolphin issue, which I will focus on in more detail momentarily, has been a major source of concern politically and economically for the past decade or more. Of almost equal importance economically—worth approximately \$300 million per year to Mexico's shrimp industry—is the issue of shrimp-turtles, in which U.S. and world concern for marine turtle conservation has led to imposition of new world-wide regulations to protect this endangered marine animal. Introduction of "Turtle Excluder Devices" (TEDS) has had a significant impact on protecting sea turtles accidentally caught by shrimp trawlers throughout the world. Less well-known but of growing importance to the marine science community are the problems of the declining stocks of sharks world-wide, the vaquita porpoise of the Gulf of California and issues of by-catch associated with other fishing technologies. Through agreements and annual consultations with the binational Mexus Gulf and Pacific meetings, we are collaborating closely with Mexico in these marine conservation issues, as well as in such areas as aquaculture, binational and international management cooperation and law enforcement cooperation. We have been particularly pleased with advances we have made in law enforcement cooperation with Mexico relative to seafood sanitation and the protection of endangered marine animals and fish.

## THE TUNA-DOLPHIN ISSUE

As noted above, the tuna-dolphin issue has been of primary importance in our bilateral relationship, ranking high on the agenda not only our of annual BNC meetings, but in the personal meetings between our two Presidents. Mexico's sensitivity to this issue goes back to the so-called "Tuna wars" of the mid-1980s when we sought to regulate the export of tuna caught by Mexican fishermen into the U.S. market. Mexican exports of yellowfin tuna to the United States were banned in 1991 under provisions of the U.S. Marine Mammal Protection Act (MMPA). Subsequent amendments to the MMPA in 1992 added a new element by banning the sale in the United States of any tuna caught in the eastern Pacific Ocean using the technique of "setting on dolphins." Through strong cooperative efforts by Mexico and other fishing countries, total annual dolphin mortality in the eastern Pacific has been reduced from more than 100,000 a decade ago to less than 3,000 in recent years. In recognition of this success, Congress last year passed legislation to remove the embargoes for countries participating in a legally binding dolphin conservation agreement once that agreement has been negotiated and enters into force. The legislation also calls for a study of the current fishing practices on the health of dolphin populations in the eastern Pacific Ocean. Unless the Secretary of Commerce determines as a result of that study that current fishing practices are having a significant adverse impact on dolphin populations, the current MMPA definition of "dolphin-safe" tuna will change to allow tuna harvested under the international agreement to wear the dolphin-safe label. The Secretary must make a preliminary determination on this matter by March 1999.

## RELATED ISSUES OF CONCERN—POTENTIAL PROBLEM AREAS

## Law of the Sea

As already noted many of our problems and concerns go back many years. The position taken in the early 1980s by the United States regarding the law of the Sea continues to be a source of irritation even today. As I will illustrate in a moment, these long-standing issues are influencing our ability to work collaboratively, even when the politics and policies are strongly aligned.

## Marine Boundary

One recent plus has been the resolution of the 21-year-old Marine Boundary treaty, with the ratification by the U.S. Senate and the exchange of notes by the Presidents this past November. One outstanding issue remains: the “donut hole,” an undefined area in the western part of the Gulf which has a high potential for oil but also a high potential for problems in our bilateral relationship. It is now obtaining a high degree of negative publicity in Mexico, especially with an opposition-controlled lower house of the Mexican Congress. Happily, Interior Secretary Babbitt recently agreed to suspend U.S. actions to lease portions of the “donut hole” and to begin discussions on the final disposition of this international territory as early as next March.

## Permitting and Sovereignty Issues

Permitting marine research in Mexico remains a problem, no doubt going back to ill will generated by our difference on the Law of the Sea. Mexico demands six months for each vessel permit, often taking even more time despite advance agreements by both governments’ technical agencies on the actual research itself. This not only causes costly delays (~\$20,000 to \$30,000 per day per boat) but confusion and further ill will in actually trying to conduct the research once the permits are provided. A recent set of incidents illustrates this problem.

SOVEREIGNTY AND IMMUNITY: THE *OREGON II* AND  
*DAVID STAR JORDAN* INCIDENTS

In late August and early September in two separate incidents, two U.S., state-owned research vessels—the *Oregon II* and the *David Star Jordan* were stopped by the Mexican navy and boardings “requested,” presumably as part of Mexico’s drug interdiction efforts. Both vessels had appropriate permits to conduct research in Mexican waters (although the *Oregon II* was mistakenly in the wrong area allowed by their permit) and both had Mexican government scientists on board who were participating in the research. While the *Oregon II* refused to be boarded as a “sovereign, immune” vessel, the *David Star Jordan* accepted under protest. The *Oregon II* left Mexican waters and the *DSJ* curtailed its activities and disembarked its Mexican colleagues at the nearest port.

These boardings were protested at the highest levels on both sides, the Mexican navy and the GOM initially not recognizing the claims of sovereign and immune status of our research vessels. After much discussion at very high levels and after having identified the appropriate international legal

treaties recognized by both governments for appropriate citation, the GOM now appears ready to accept the status of these vessels as claimed. As noted above, the Tuna-Dolphin legislation passed by the U.S. Congress calls for research on the impact of current fishing methods on the “health” of dolphins accidentally caught and then released. That work will be conducted by NOAA, using state-owned vessels such as the *Oregon II* or *DSJ*. Failure to finally resolve the sovereignty issue by early next year could have a negative impact on the implementation of the hard fought and hard won Tuna-Dolphin legislation.

#### THE FUTURE: POSSIBLE AREAS FOR R&D COOPERATION

Despite what was indicated in the previous discussion regarding issues of continuing concern, we are making progress in marine research cooperation. Recent discussions with the head of the Instituto Mexicano de Petroleo (IMP) suggest that collaborative research (in addition to purely basic research supported through Conacyt) can go forward. However, this research will only be possible, at least for now, in “non-sensitive” areas. Suggested topics include:

- Corrosion: general, basic and applied research as related to platforms, piping and other support marine infrastructures.
- Oil Rigs and Platforms: the issue of aging oil rigs and platforms and other marine structures.
- Marine Safety and Environment: safety and environmental issues, especially oil spill containment technology.
- Basic research such as hydrographic research on ocean currents and temperatures.

Our ability to conduct or enlarge on marine mineral research will depend on the ongoing discussions with issues such as ship sovereignty and the resolution of the “donut hole” issue. Assuming good will continues on both sides regarding these issues, our collaborative activities should continue to be positive and to grow.

#### A PRESIDENTIAL PERSPECTIVE

To conclude, let me quote from the speech made by President Clinton during his historic speech at the National Auditorium in Mexico City in May 1997:

“Trade, education and the environment are critical pieces of the greater mosaic of our relationship, designed to turn our 2,000-mile border into the vibrant source of growth and jobs and open exchange.... Over the long run, *the development of democracy and a prosperous economy require the sustainable development of our natural resources.*”

I’ve underscored the particular attention he gave to the importance of sustainable development of our natural resources for the continued development of democracy and the economic growth of both countries. His words provide sage guidance to directing our collaborative marine science research efforts into the twenty-first century.

## OFFSHORE OIL & GAS ISSUES FOR DEEPWATER: U.S. INDUSTRY PERSPECTIVE

Mr. Peter K. Velez  
Shell Deepwater Development Inc.

Various opportunities and challenges face the U.S. oil and gas industry in deepwater, especially in the Gulf of Mexico. These opportunities have occurred in three different phases over the last 10 years.

In 1992, our forecasts were for downward profits, downward prices, downward production. Between 1992 and 1997, deepwater discoveries, higher prices, and new technologies led us to a more optimistic view.

The future, beyond the year 2000, is more difficult to see. While some signals point to continuing reasons for optimism, others seem to point the other way.

In the acreage in the Gulf with water depths of 1,500 feet and deeper, we have almost 50 companies with leases, about 3,200 leases, in fact (see Figure 1J.5). The lease activity has been shifting toward the deepwater side, and even toward ultra-deepwater. As far back as 1990, only about 15% of the leases were in water deeper than 5,500 feet. Almost half the acreage in the last lease sale, however, was acquired in 5,500 feet of water (essentially, depths greater than one mile) (see Figure 1J.6).

Many leases continue to go down in shallow water; in the water depth level of 1,500 feet to about 2,500-3,000 feet, the number of leases is fairly narrow because of the quick drop-off in the Gulf. We've also seen a big increase in the water depth of development.

Fifty years ago, companies moved into 15 feet of water and thought that was deep; they moved later into 100 feet of water and thought that was as deep as it was going to go. In 1978, which was only 20 years ago, we installed a platform called Cognac in 1,025 feet of water. It took 10 years from there, essentially, to move into a fixed platform in 1,350 feet of water, which is about the maximum for a fixed platform.

Conoco installed Juliet in a little bit under 2,000 feet of water in 1989, and in 1993, PetroBraz in Brazil installed their Marlin. From there on, we've done a fairly quick acceleration, and now we have Augur in a little over 2,800 feet of water, Mars in a little over 2,800 and Ram/Powell in close to 3,000 feet of water.

In addition to that, PetroBraz installed some subsea wells even a little deeper than that in 1994 and in the Gulf of Mexico in offshore Brazil, Shell in the Gulf and PetroBraz in offshore Brazil, installed subsea wells in greater than a mile of water. Ours was Mensa in 5,300 and Marlin beat that by a couple hundred feet (see Figure 1J.7).

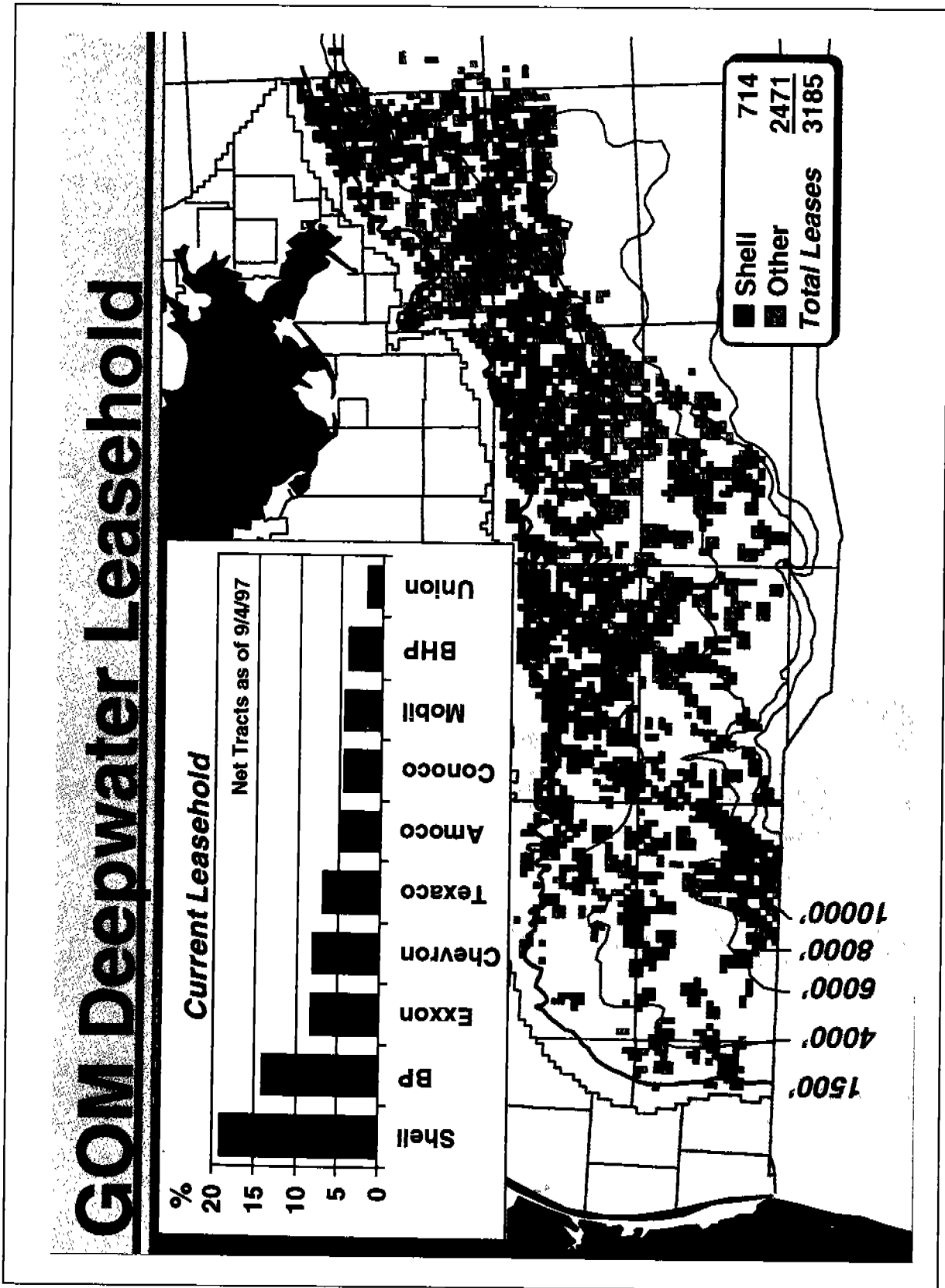

Figure 1J.5. Gulf of Mexico (GOM) deepwater leasehold.



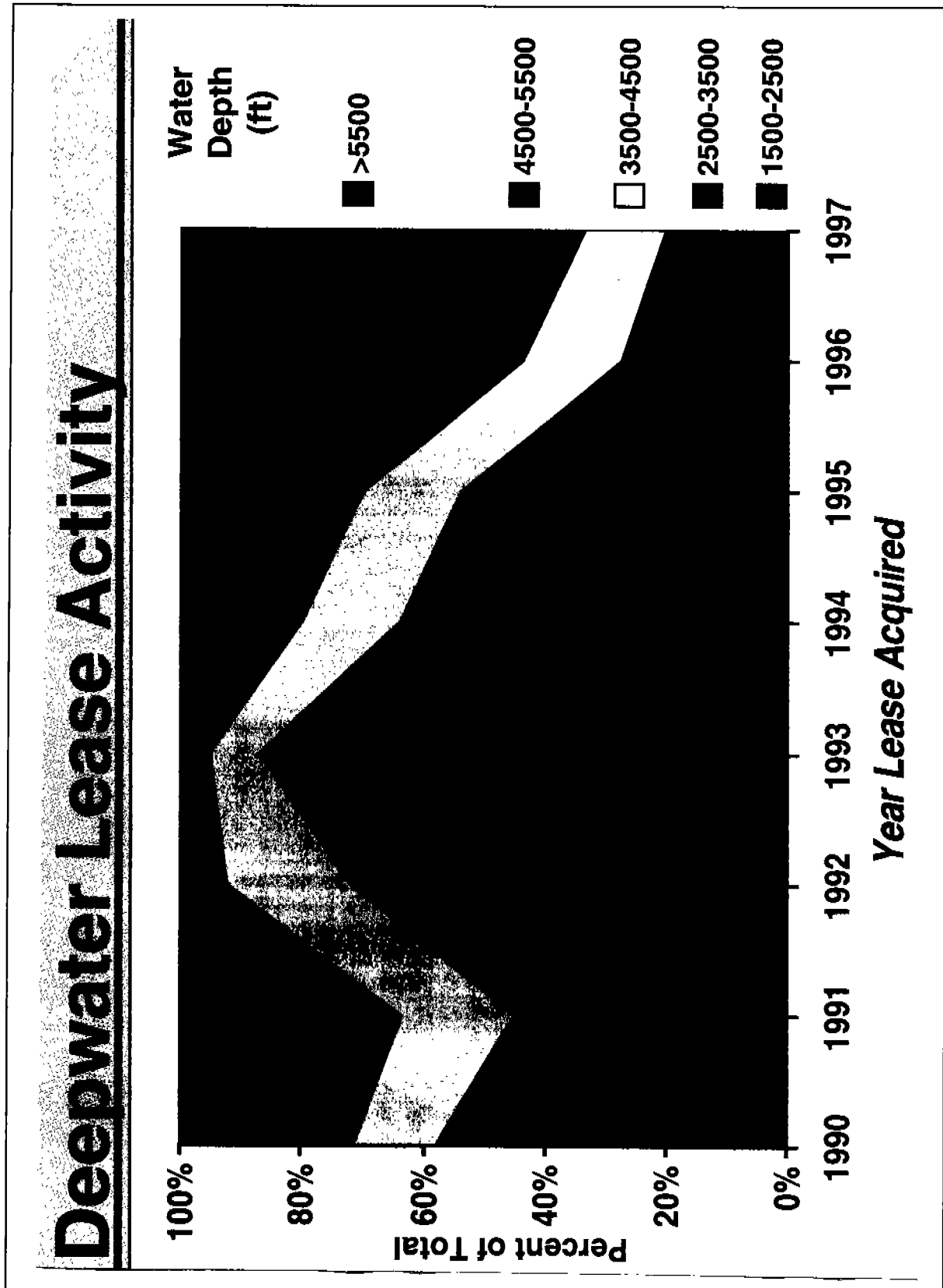

Figure 1J.6. Gulf of Mexico OCS deepwater lease activity.

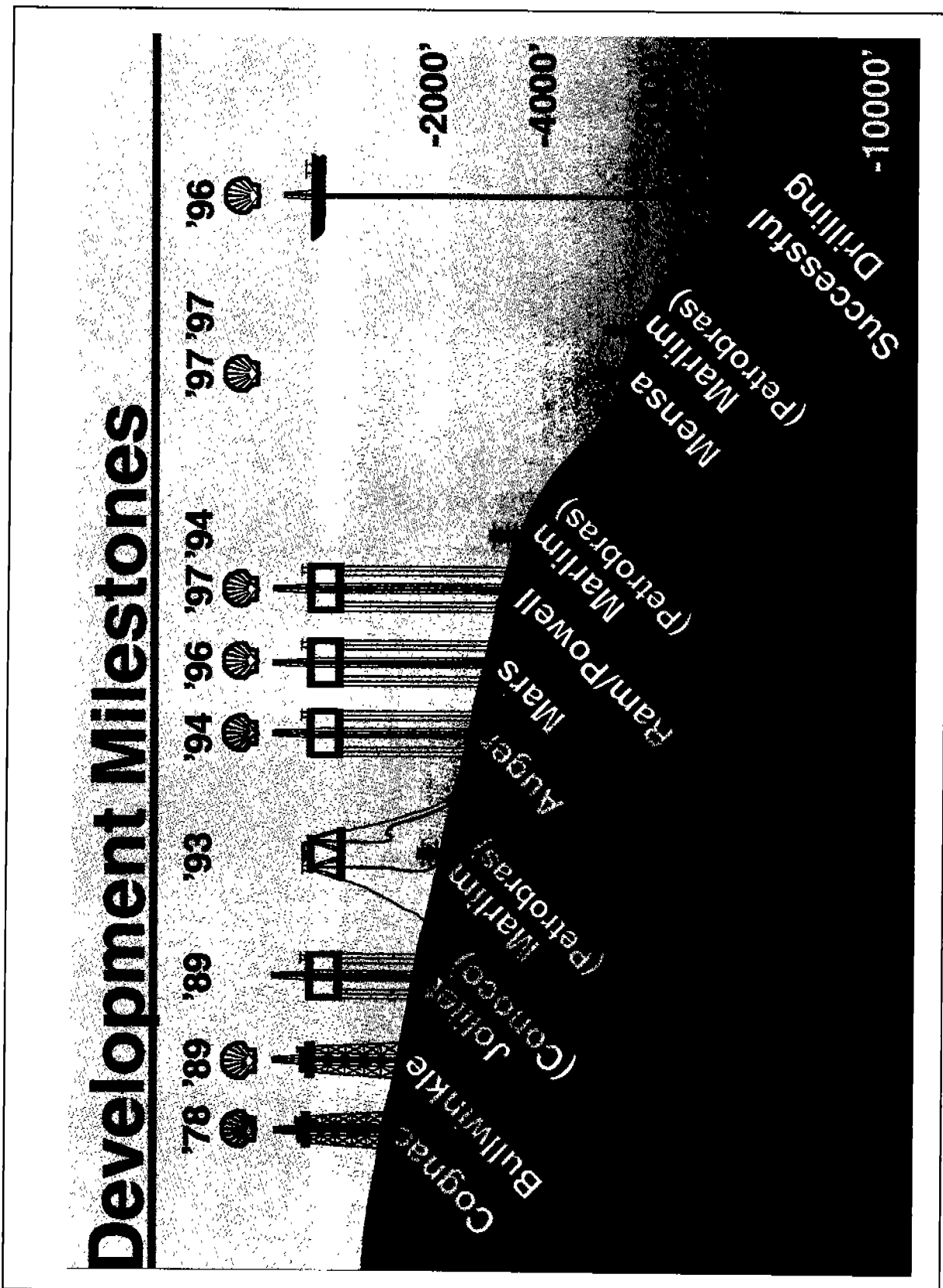

Figure 1.J.7. Deepwater development milestones.

In addition, in 1996 Shell and three other partners drilled a well in 7,600 feet of water, or about a mile and a half deep. Obviously, the last 20 years have witnessed an acceleration into deeper and deeper water, considerable development and technology, and discoveries in this area that have required the development of technology.

To date, there are about 44 confirmed discoveries in deepwater in the Gulf of Mexico greater than 1,500 feet of water. These sites are estimated to amount to about 4 to 5 million barrels of production, which make them major discoveries.

These sites are spread out throughout the Gulf, though many cluster around the shallower water depths of what we call deepwater (see Figure 1J.8). Various companies are involved these developments: Shell, Oryx, BP, Chevron, Conoco, Enserch, and others (see Figure 1J.9). In some cases, the development of technology has been done cooperatively between companies; in others, it has been done by the individual companies.

There has been a lot of technological innovation, and there's still more technology to be developed with time. Fixed platforms are good for about 1,300, 1,400, maybe even 1,500 feet of water. Past that, they become essentially uneconomical because of weight and considerations on tow-outs. From there, structures similar to Exxon's Lena are the next step, with a water depth range for about 4 or 5,000 feet.

Floating production systems come in a couple of types. One is like the Oryx Spar, which is essentially a big cork bobbing in the water, anchored to the sea floor or a floating production-type system which may either have a pipeline departing or going into a tankard for offloading, again, anchored to the sea floor. The other is what we call a tension-leg platform. These very large structures are anchored by tendons to the sea floor and can extend up to about 8,000 or 9,000 feet.

In 1994, offshore production from deepwater was very small, about 50,000 barrels. We see that number going, by the year 2,000, to about 1.2 million barrels per day, almost double present production in the other part of the Gulf of Mexico, with oil about two-thirds of the mix, and gas about one-third (see Figure 1J.10).

Shell's first deepwater TLP was the Augur TLP (see Figure 1J.11). It's located in 2,860 feet of water, was installed in 1994 and had first production in 1994. Total ultimate capital cost is about \$1.2 billion. As you can see, there are high costs involved with these deep structures. Some of the costs come down depending on the system, but a system like this, costs close to about a billion dollars right now; reserves, about 227 million barrels equivalent.

The structure is almost 300 feet from edge to edge, about the length of a football field. The legs are 84 feet in diameter, so you could pick up most houses and put them inside one of the columns. The bolts are typically about 270 feet long to support deepwater operations. We have about 11 wells producing; the highest rates have achieved about 110,000 barrels per day/325 million cubic feet a day (see Figure 1J.12).

# Deepwater Discoveries

**44 Confirmed Discoveries**  
**Estimated 4 - 5 BBE Announced**  
**Development Plans Publicized on**  
**at Least 24 Projects (>1500' WD)**

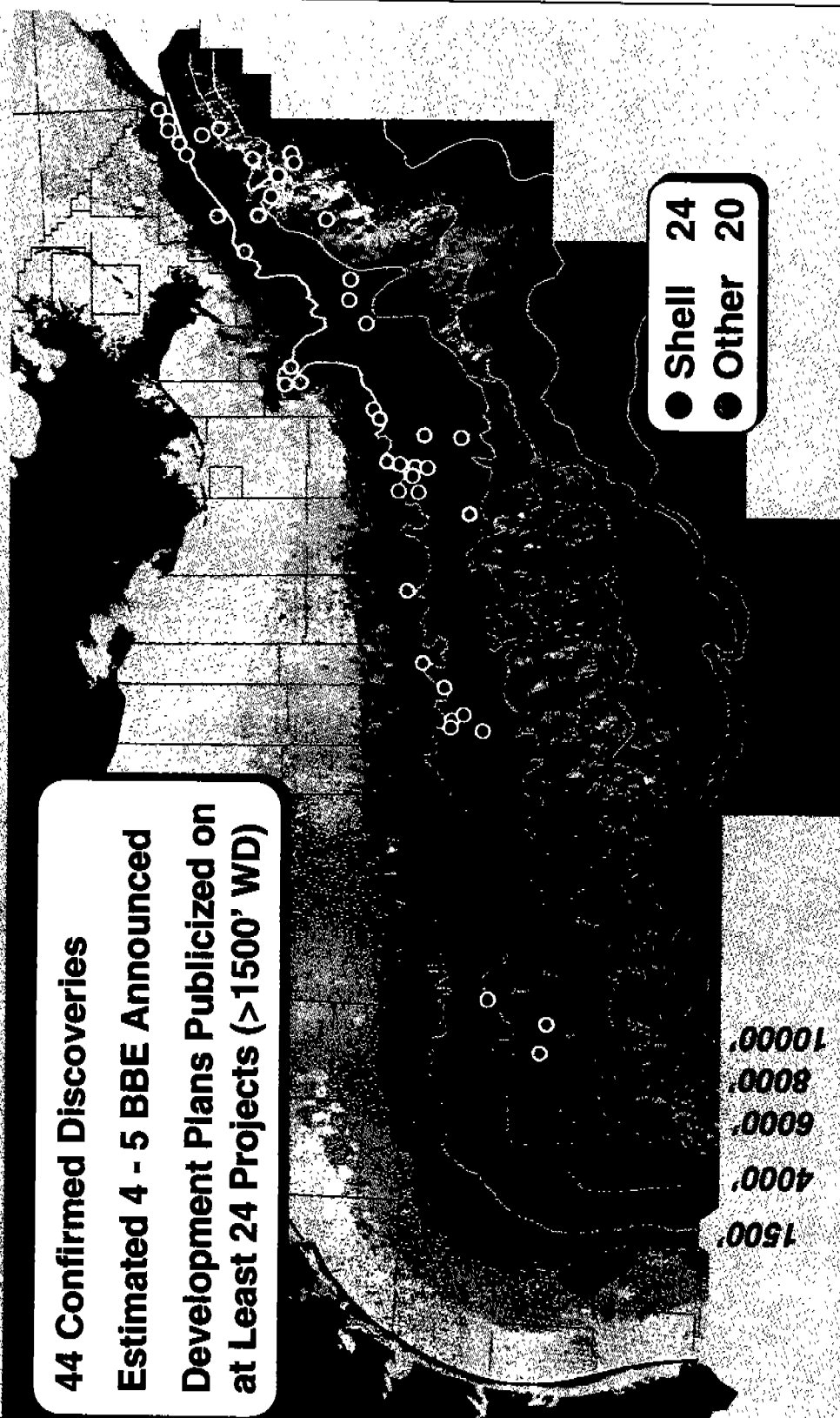

● Shell 24  
○ Other 20

1500'  
4000'  
6000'  
8000'  
10000'

Figure 1J.8. Deepwater discoveries.

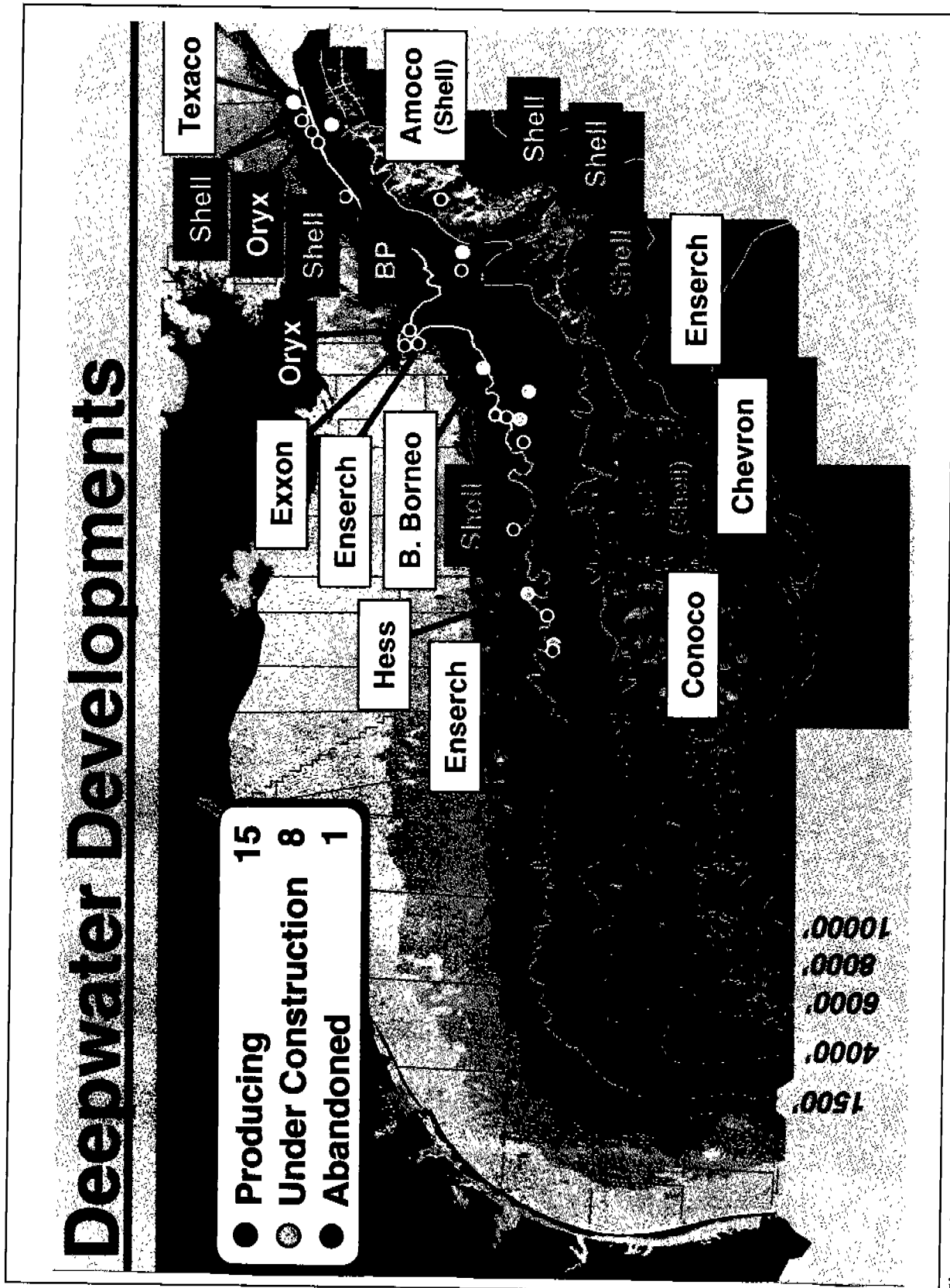
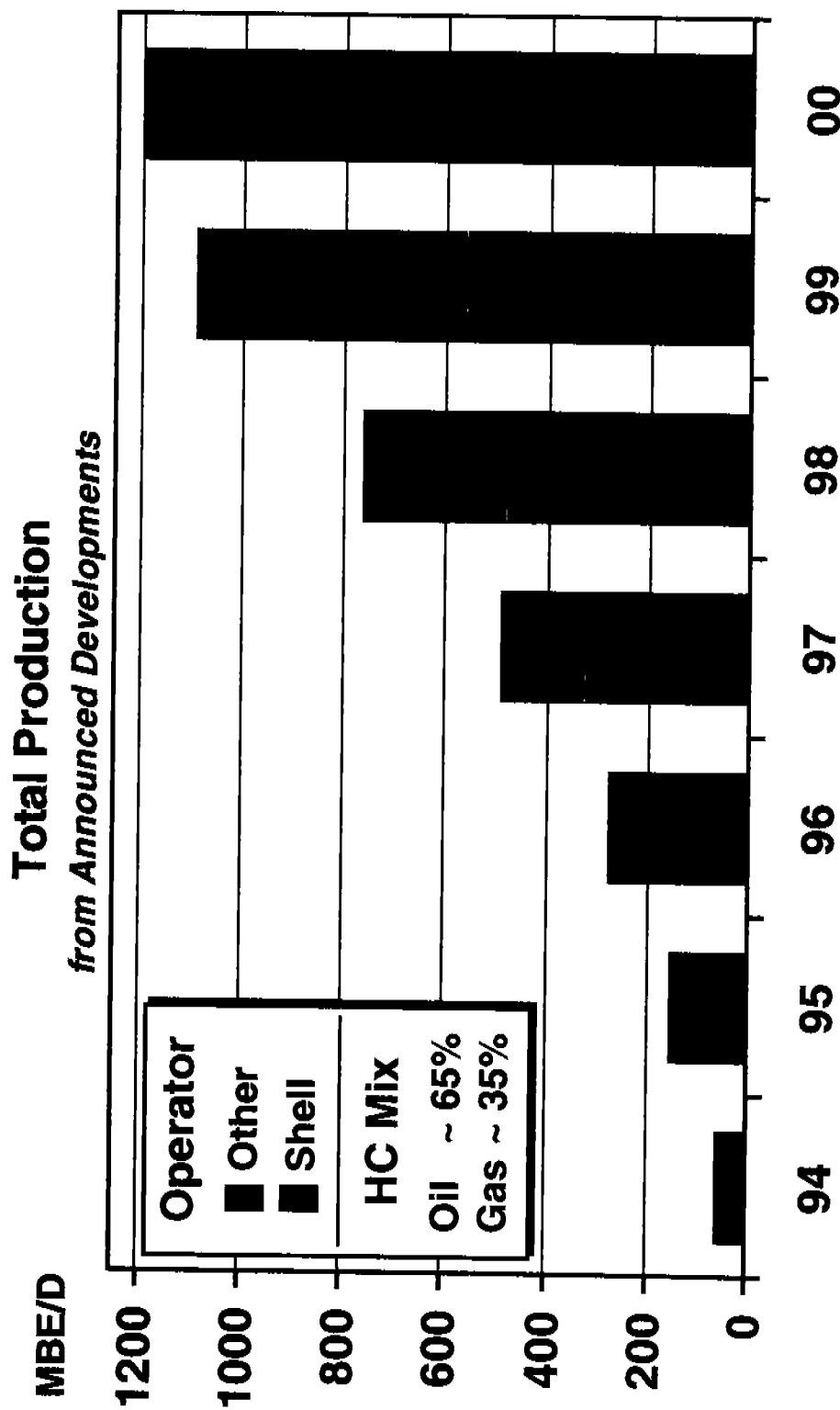

Figure 1J.9. Deepwater developments.

# Deepwater GOM Production



Source: Goldman Sachs, MMS, Shell 97 OP

Figure 1J.10. Deepwater GOM production.

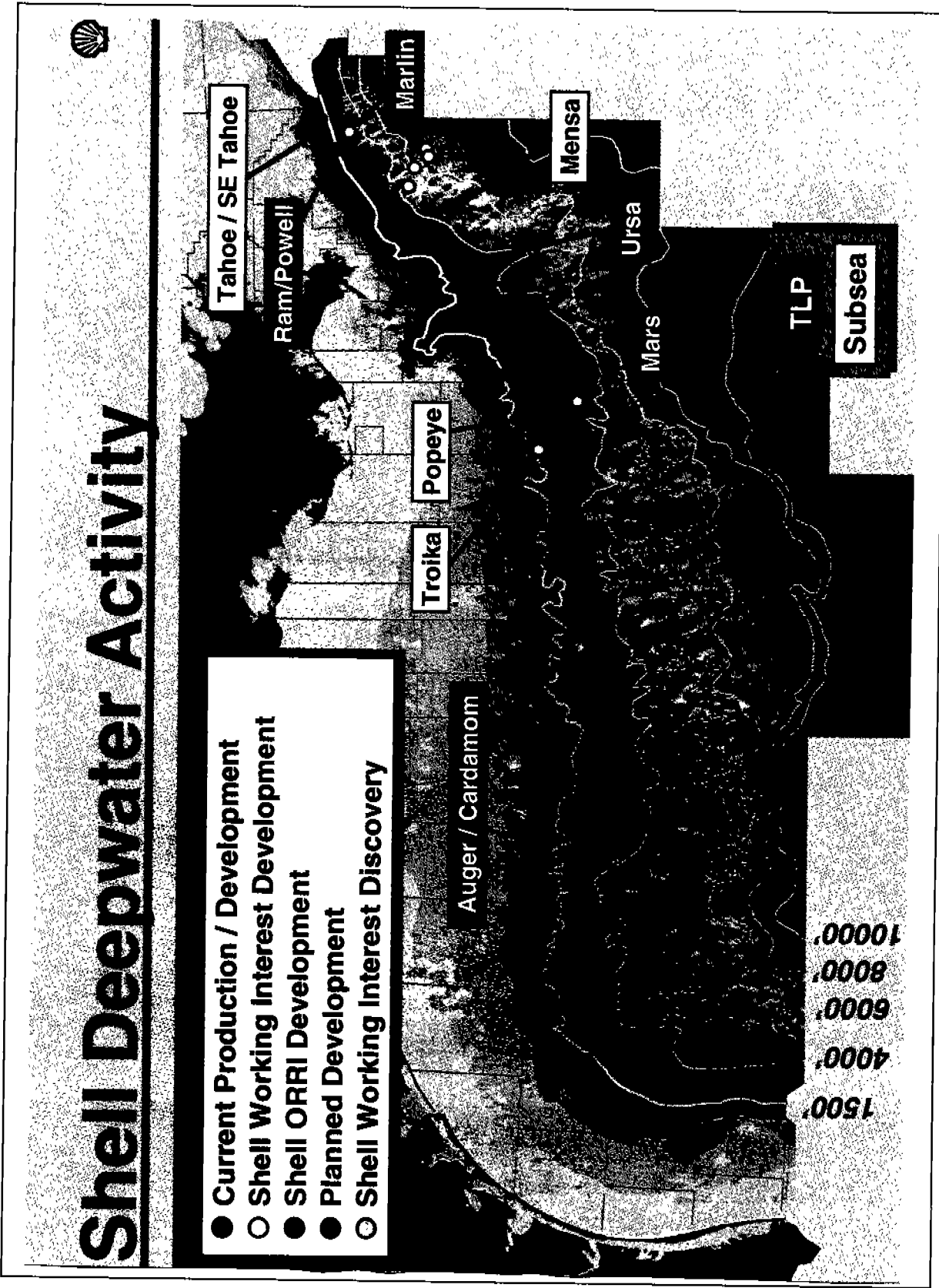

Figure 1.J.11. Shell deepwater activity.

# Auger Summary



- **11 Wells Producing**
- **Highest Rates Achieved:**  
109,850 BBL/Day  
327.4 MMCF/Day
- **Record GOM Oil Well Rate**  
21,752 BBL/Day
- **Total Production to Date:**  
75 MMBO  
174 BCFG
- **Auger Out-Step Program Underway**  
In-field Additions  
Satellite Tie-back Developments

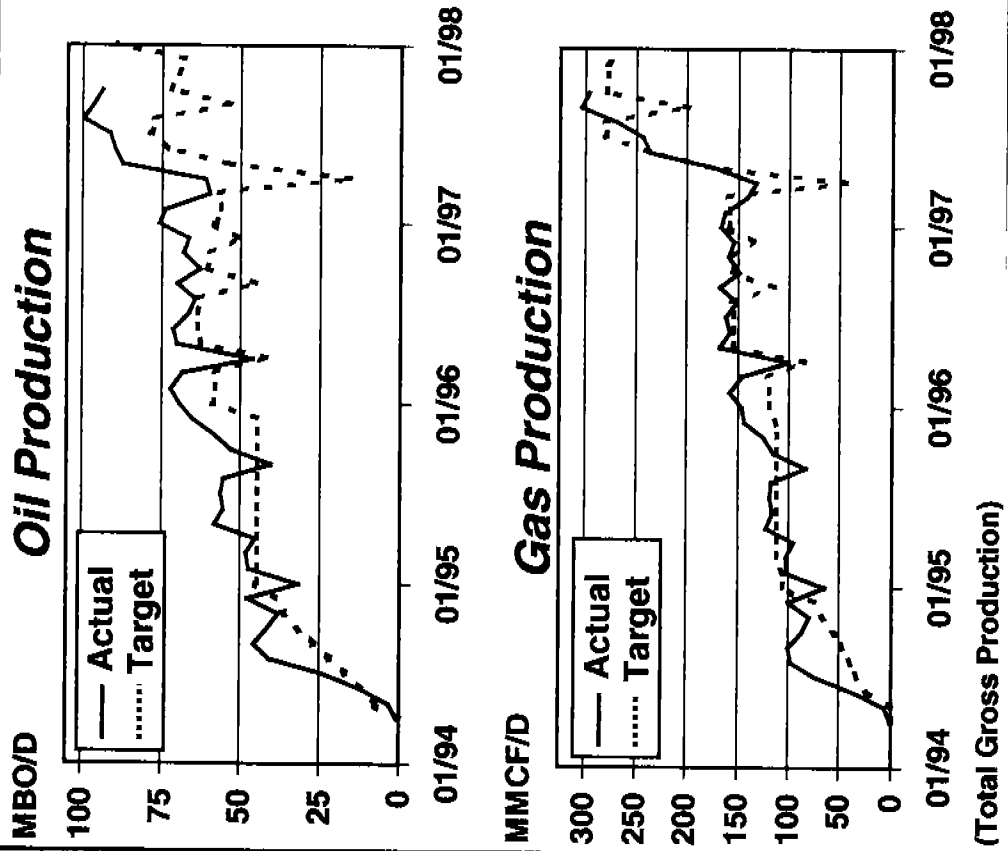

Figure 1J.12. Auger summary.



In the past, a well that produced over 1,000 barrels per day was a great well in the Gulf of Mexico. I remember when I was a production superintendent. I was over Cognac, which at that time was a great platform, and we had a well that produced 4,000 barrels per day. I used to tell the lease operator, you need to sleep next to this well to make sure that it keeps flowing all the time.

So now you have to keep about 11 people sleeping next to some of these wells to make sure that they stay in production. The production to date is about 75 million barrels and about 175 BCF of gas.

The second one that we put in was Mars (see Figure 1J.13). It is similar to Augur, but a bit smaller perhaps 30 or 40 feet less in width than Augur itself. We expanded our facility capacity during the construction phase. From 100,000 barrels per day, we went up to 140,000. We now have 11 wells completed. They produce 122,000 barrels per day and a 125 million cubic feet of gas per day (see Figure 1J.14).

Ram/Powell is our third one (see Figure 1J.15). It is similar to Mars, but has some additional enhancements. It's in 3,200 feet of water; its estimated gross recovery is 250 million barrels equivalent (see Figure 1J.16). We're working on expansion to increase the amount of gas we can put through it, and we're still working on the well completion program.

We've learned a lot as we've moved from model series 001 like Augur to series 003, like Ram/Powell. We've learned that there's a lot of opportunity for improvement and a lot of savings to be made, not in the range of \$500,000 to \$1 million, but in some cases, \$20-40 million in savings.

We see four categories of future challenges (see Figure 1J.17). First, we see intensified competition. A lot of people see the opportunities in deepwater and would like to get in.

The next challenge is globalization. Other areas of the world are considering the opportunities that deepwater has generated in the Gulf of Mexico. So they are looking at how they can develop their natural resources in the same way. We need to determine at what pace that development should go on.

The third challenge is new technology. Even though we have developed a lot of new technology, refined new technology, and planned future technological advances, much still needs to be developed in this area.

The fourth challenge involves societal expectations. The public, government agencies, and other individuals have concerns about development of natural resources. We have to listen to these concerns and understand them so that as developments happen, these concerns are taken into consideration.

We also foresee technical and operational challenges. First, there is the issue offshore deepwater drilling. Drilling has already occurred up to 7,600 feet. Some rigs are being constructed right now to expand that to a 10,000-foot water depth, and there is still a lot of work that needs to be done in that area.

# Mars on Location

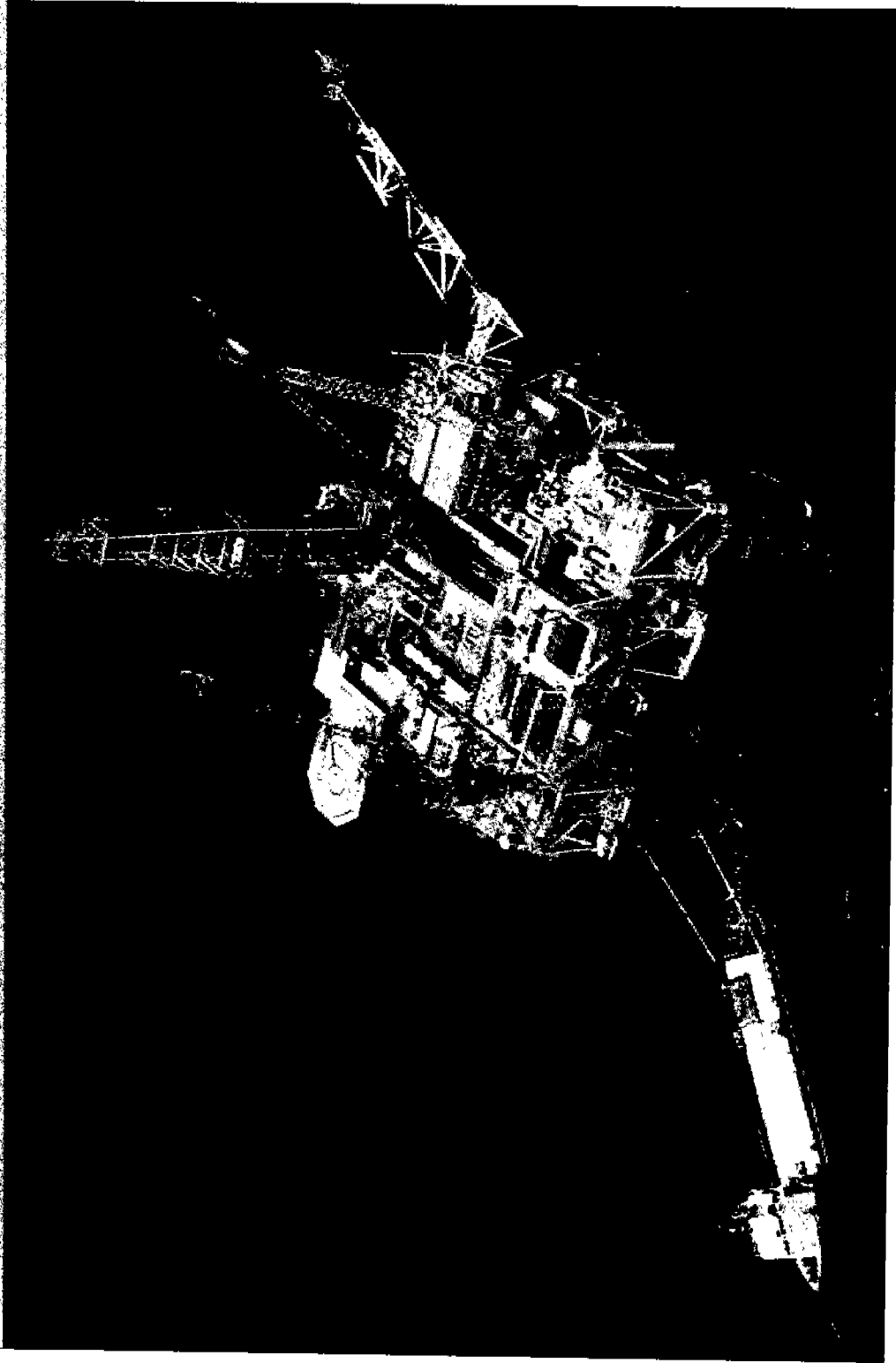

Figure 1J.13. Mars on location.

# Mars Summary



- **Facility Capacity 140 MBO/D and 140 MMCF/D (Original Design Capacity 100 MBO/D and 110 MMCF/D)**
- **10 Wells Completed**  
9 TLP Wells & 1 Subsea Well
- **Highest Rates to Date:**  
111,778 BBL/Day  
112.8 MMCF/Day
- **Well Rates in Excess of 17,000 BBL/D**
- **Well Completion Program Continues**

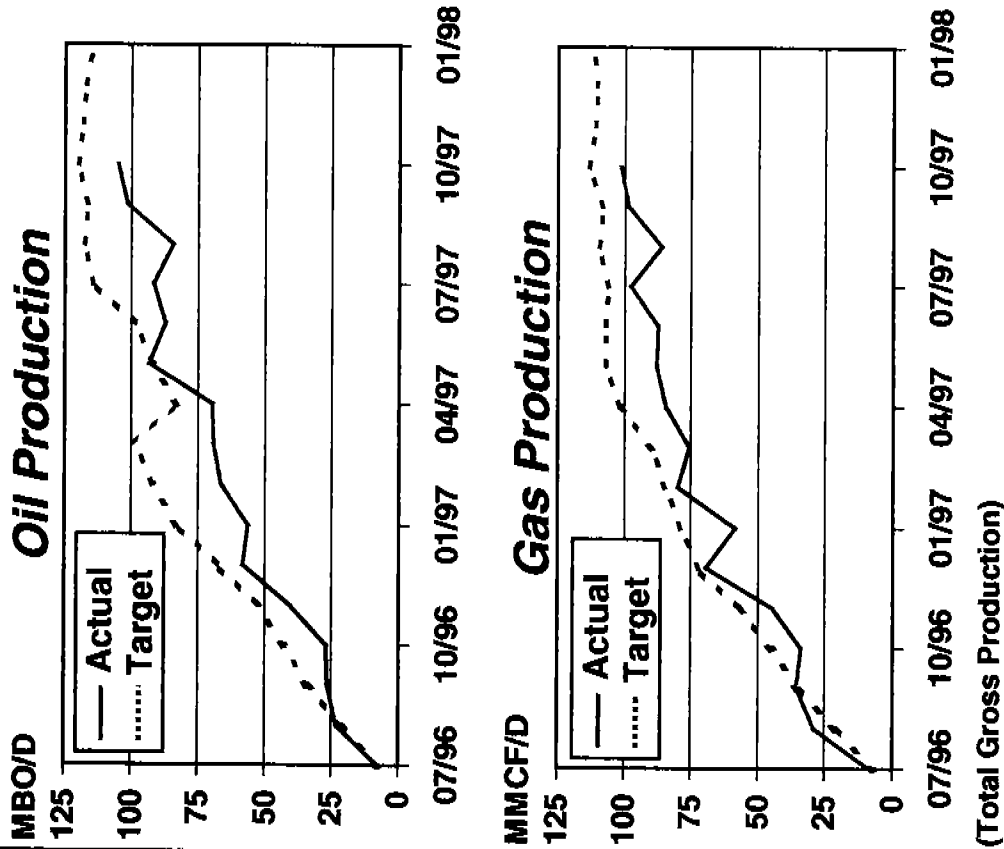

Figure 1J.14. Mars summary.

# Ram/Powell



Figure 1J.15. Ram/Powell.



# Ram/Powell Summary

- Water Depth 3,214 ft.
- Estimated Gross Recovery 250 MMBE
- 20-Slot TLP
- Facility Capacity 60 MBO/D and 200 MMCF/D (Expansion Project Underway to Enable 260 MMCF/D)
- 4-Well Pre-drill Program
- First Production 9/6/97
- Well Completion Program Continues

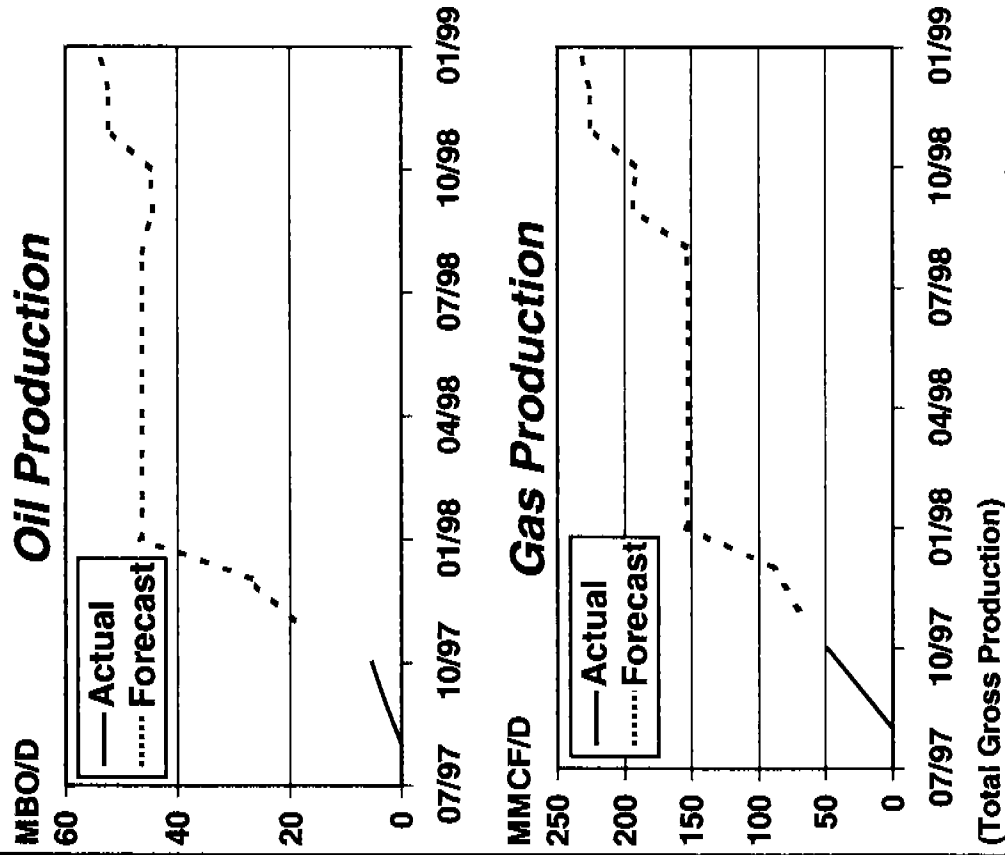

Figure 1J.16. Ram/Powell summary.



Figure 1J.17. Forces changing in the future.

Second is a long-term performance of high rate, high ultimate wells. The short-term performance has been great, but we need to see what the long-term performance is and ensure that we're able to maintain the rates. We also need to determine when the rate decline is a natural rate decline, or when the rate decline is a problem associated with the well itself.

Subsea systems are an area of continual expansion, particularly in terms of high pressure systems for high pressure wells placed in a subsea development. A lot of the work has been done with normal pressure-type wells. Work is already going on in this area, but additional work is considered. For subsea wells, we also have the cold flow long offset subsea wells, and I showed you in the Mensa example, where you're flowing 68 miles from the well, your sea floor temperatures are a lot different than when you're in 200 feet of water, so that has to be taken into account, and when you start talking about oil, start talking about paraffin, water, that you could have hydrate problems, things like that need to be considered.

To rework subsea wells typically requires \$20 or \$30 million a piece to drill because of the cost of the rig and the vessels associated with it.

Shallow water flow problems are issues that also have to be considered. In this area, the sea floor characteristics are quite different from those on the shelf; therefore, problems can arise not only while drilling the well, but in the foundation of the structure or subsea well put in place.

Trying to service these structures as we serviced our previous structures with smaller boats would create problems, not only with the capacity of the boats, but also with the kind of seas in which they could operate offshore.

Finally, but probably as important as anything else, is to ensure that we have adequately trained staff. A company cannot put a TLP up as they do a typical shallow-water platform and then move people to it to work. Workers on these platforms must be really familiar with the system and have years of experience working with it.

As usual, we have no control over the price environment in which we have to sell our product. So the anticipated low-price environment is always looming in front of us, and when considering a billion-dollar development, this possibility causes one to think: What will happen if the price drops and you already are three-quarters through the construction of a large project like this?

We have all felt the impact of increasing costs of materials and services in some things, 50 percent over the last three years, in some, more than 100 percent.

We want to make sure that everybody participating in the process is making a fair profit, but at that same time, we want to do everything we do in a safe and environmentally sound manner. One major accident from any of us will impact not only that company, but everybody, and by everybody, I don't only mean just the companies operating in the Gulf, but the industry as a whole, and also the regulating agencies.

We need to maintain environmental safety as our number one priority. If we can do this right, a lot of other things will also fall into place, but if we slip here, regardless of what else we do, we will feel pressure from the safety and environmental side and from the public.

In summary, we see huge opportunities in the future of deepwater development, opportunities that can be profitable if we work together. We need to work together with the regulating agencies so that we can all come back to meetings like this in the year 2000 and say, we're still looking at growth opportunities, seeing resources as far as we can see.

## **OFFSHORE OIL & GAS POLICY ISSUES: THE U.S. PERSPECTIVE**

Mr. Chris C. Oynes  
Regional Director  
Minerals Management Service  
Gulf of Mexico OCS Region

There has been tremendous growth in exploration in the U.S. Gulf of Mexico. In 1986 there were 4,300 leases in the Gulf of Mexico on the U.S. side. Today, there are about 7,300. That's about a 70% increase.

Now, there are approximately 200 exploratory wells being drilled in the U.S. side of the Gulf of Mexico; of those 200, about 30 are in water depths of 1,000 feet or greater, or what some people would call deepwater. That figure represents an all-time high for deepwater drilling.

At the same time, the Gulf's contribution to the U.S. national energy supply is truly remarkable. Production in the federal portion of the U.S. OCS area amounts to about 25% of the nation's gas supply, or about 5 trillion cubic feet per year, and about 11% of the nation's oil supply, about 380 million barrels. Those figures are estimates for the end of 1997.

There are currently 3,800 producing platforms in the Gulf of Mexico, of which several are major structures. More importantly, there are now some 130 different companies operating in the Gulf of Mexico. While the deepwater production is certainly growing in the Gulf, the production levels in the shallow water areas must not be overlooked. Those production figures are going to be maintained pretty steadily for the next few years.

Gulf of Mexico oil production in 1995 was about 945,000 barrels per day, just under 1 million. In a report by MMS in February 1997, it was projected that production would rise to about 1.9 million barrels of oil per day by the year 2000. That projection was recently moved forward to the year 2002. That's almost a doubling of oil production in the Gulf. None of us has grasped the strategic significance of how



much more oil that is going to be and what its impact on the nation is going to be. If oil production is going to double, 20% or more of the nation's oil supply could be coming from the Gulf of Mexico.

In March 1997, MMS conducted the largest sale in the history of the entire OCS program. This was the Central Gulf Sale 166 (see Figure 1J.18). There were 1,032 tracts bid on in that sale, 535 of which were in water depths over 800 meters. In August of this year, we also held another very large sale (see Figure 1J.19) of the western Gulf sale, and for the western Gulf sales which have been held annually since 1983, this was the largest. It again broke all the records for that side of the Gulf of Mexico.

This sale also involved tremendous amounts of ultra-deepwater leasing. As noted previously, with the growth into deepwater, the amount of activity—both in terms of leasing, exploratory wells, and production systems, either under construction or installed—has been dramatic in recent years.

MMS holds two sales every year, one in the central Gulf, one in the western Gulf. The last four have been record breakers. Each one has set new records in terms of tracts bid on and number of bids received. The sales in the two years previous to those four record-breaking sales also showed very, very high leasing rates. In the central Gulf sale held in March 1997, several groups bid in the shallower water, and a huge concentration of bidding occurred in the deeper water areas.

In the western Gulf sale held in August 1997, a similar pattern is observable: still quite a bit of bidding in the shallow waters and then heavy bidding in the deepwater and the ultra-deepwater. In this area, we're talking about 10,000 feet of water—very, deep exploratory activity.

In the western Gulf sale, there were about 800 tracts to bid on; 603 of those were in 800 meters of water or greater—very, very ultra-deepwater. But we've also had a continuing level of shallow water activity, in the western and central Gulf. So the shallow water leasing development has not slacked off. It's still very strong.

The Royalty Relief Bill caused a huge escalation in deepwater bidding (see Table 1J.1). In 1995, we had 74 tracts bid on in 800 meters of water. In 1996, when the Royalty Relief Bill took effect, that number increased dramatically with 500 and 800 tracts leased in the central and western Gulf, and then a huge ramp—up to 1,500, and then to 1,800 in 1997 (see Figure 1J.20).

We're concerned that this huge escalation in leasing has, in effect, caught us short on environmental data. So we're concerned that our knowledge of environmental conditions and various species in deepwater has not kept pace with where the leasing is, where the exploration is, and where the production is starting to come at ever-faster speeds.

We held a workshop in April of 1997 to assess where we were and to develop a research plan. Those results will soon be issued as a publication. We also asked the Congress for money over and above our existing environmental studies budget, \$1.5 million, which we got in this year's base. As of last October, we had an additional \$1.5 million to apply toward deepwater environmental research.

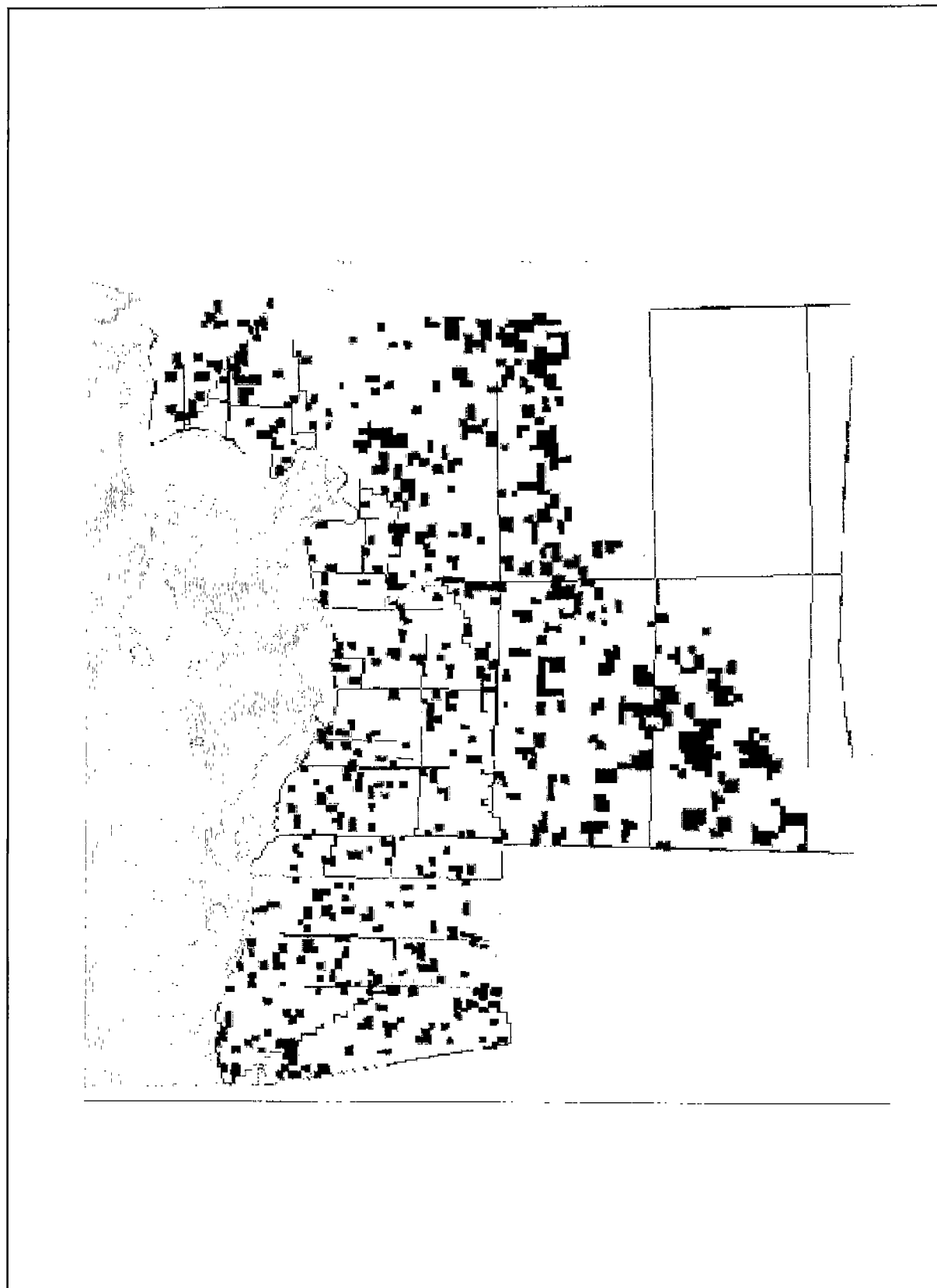

Figure 1.J.18. Lease Sale 166 central planning area.

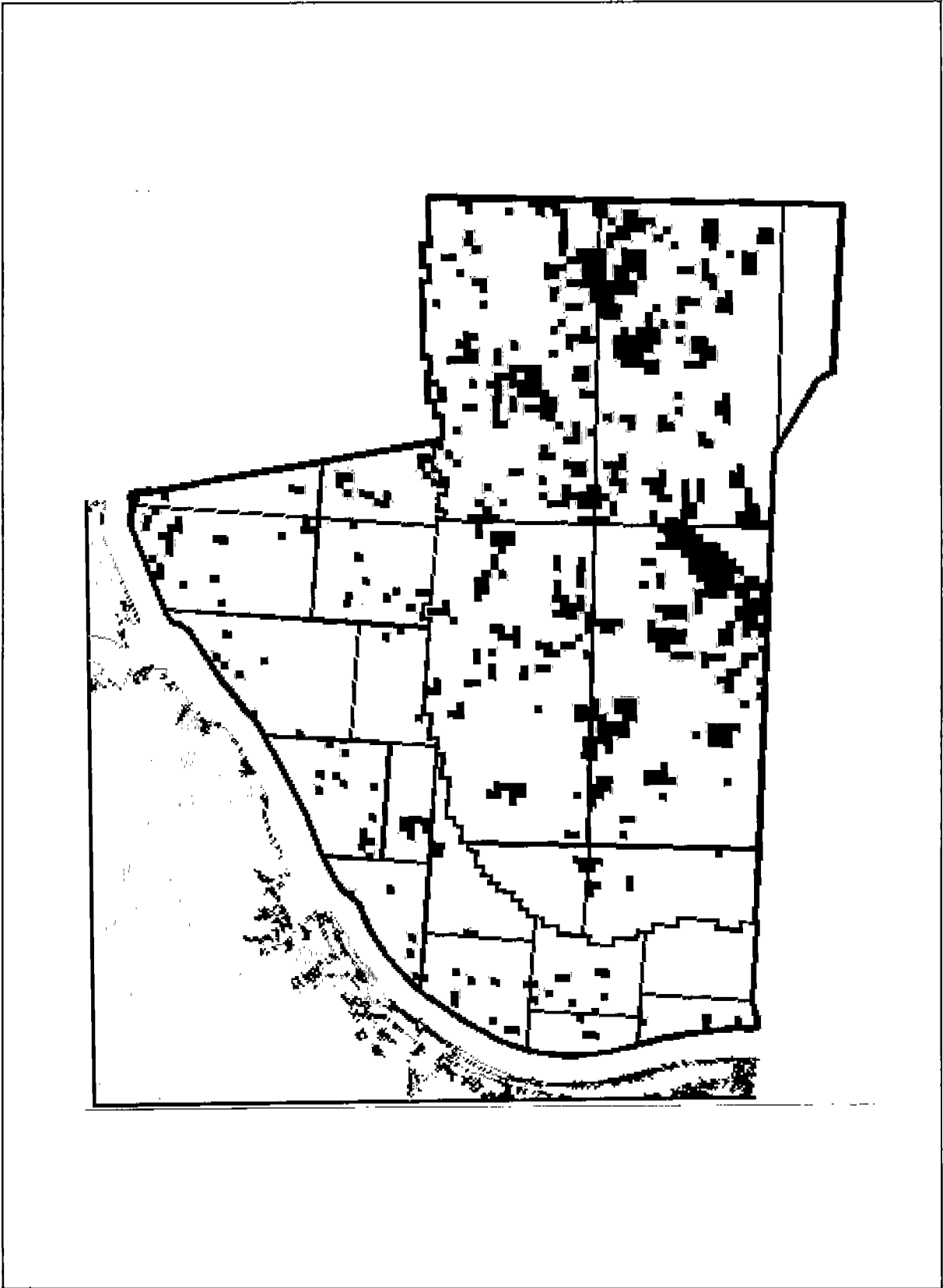

Figure 1J.19. Western Gulf of Mexico Lease Sale 168 tracts receiving bids.

# Leasing Activity in the Gulf 5 Year Look Back

*Total Leases Issued*

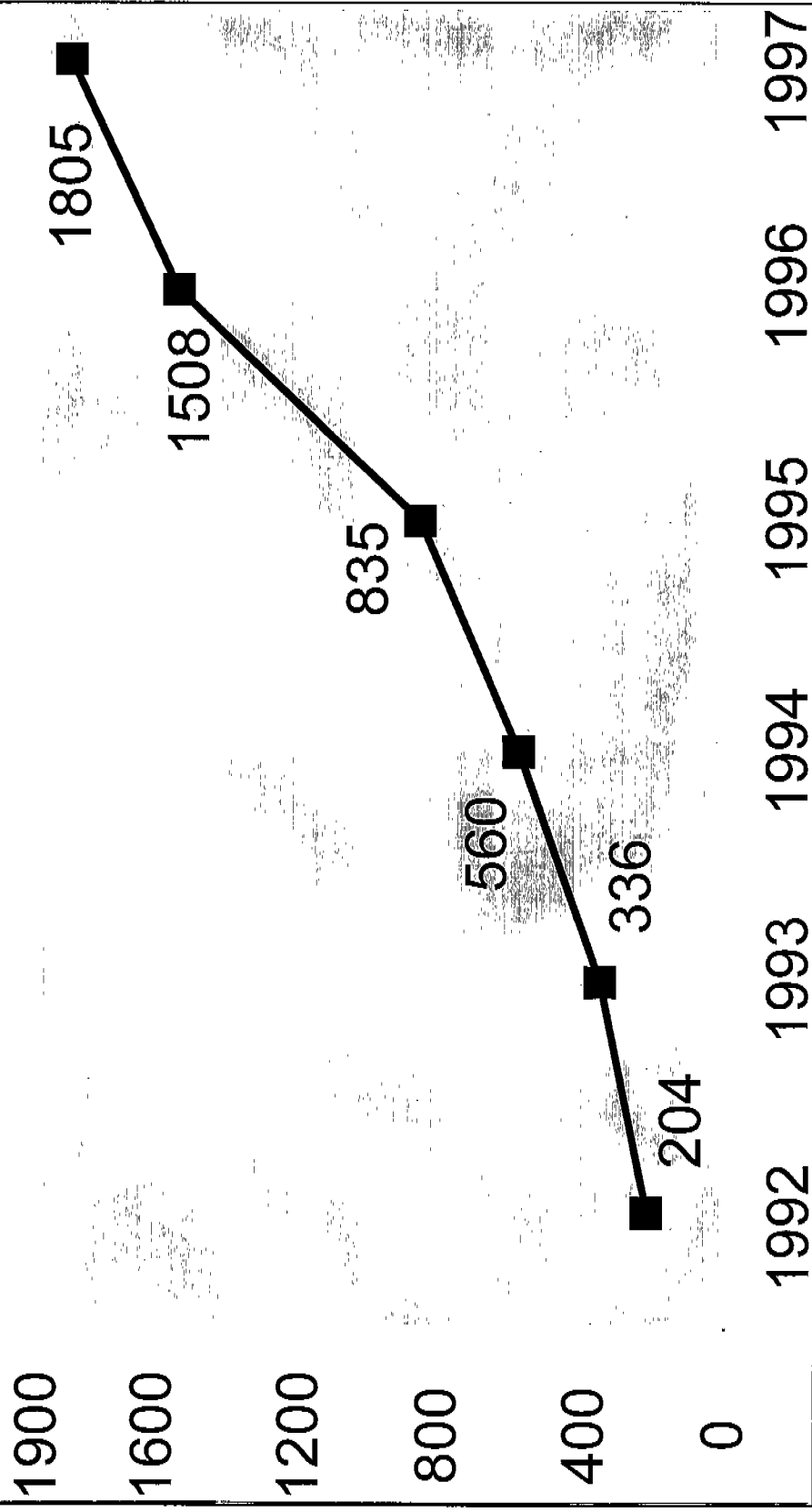

Figure 1J.20. Leasing activity in the Gulf from 1992-1997.

Table 1J.1. Western Gulf of Mexico sales comparison of blocks receiving bids before and after royalty relief.

Water Depth	1994	1995	1996	1997
	Sale 150*	Sate 155*	Sale 161**	Sale 168**
0-200m	177	129	184	130
200-400m	11	27	40	19
400-800m	13	45	72	52
800+m	9	74	321	603

\* No royalty relief  
\*\*Royalty relief

In the scientific community, \$1.5 million is a drop in the bucket. These funds allowed us to augment our environmental studies budget, but to do serious research, we're going to need a lot more money.

With the need for substantially more funds, we will have to look for new ways of cooperating with industry to piggy-back on work they're doing in the deepwater environmental areas.

In addition to financial concerns, we need to consider how we'll handle problems that occur in depths of greater than 4,000 feet. How are we going to mobilize if there is a uncontrolled flow, a blow-out from one of those wells? How will we deal with the oil as an environmental hazard? How do we prevent it from getting on the beach? How do we make it go away, get rid of it, disperse it, or deal with its toxic effects? How will we find a way to control that well flow:

We've had some discussions along this line, that with rigs—deepwater rigs in such tight supply—an uncontrolled flow may indicate that the rig drilling the well in the first place is either damaged or otherwise not available. That means you have to get another rig; but if all the rigs are in use, this presents a problem. How do you tap some other company to say, "You can't drill your well; we need to go control this safety problem and get that rig there quickly, very quickly, with the right equipment to deal with the problem"? These and other questions have to be addressed. We're talking through these issues with industry right now.

One of the questions that needs to be raised is how we'll keep pace with the developing technology and involved in how that new technology is developed to deal with a myriad of problems. We'll need to evaluate new production modes.

We'll also need to ensure that safe and effective transportation of that oil and gas from deepwater is used, and we'll have to consider how to effectively regulate a very dynamic and changing industry. With all the changes in the industry and in technology, MMS has been considering moving from, a prescriptive regulatory system to a more performance-based system. We've been considering how we might approach this change. Several questions arise: Do we use industry consensus standards? Do we use industry best practices? How do we hold a company accountable for doing what they said they were going to do? What do we do with companies designated as the operator when the contractor is the one doing the real work and maybe not doing it the proper way?

If there's one comforting thought in all of this, we know that we're not facing these problems alone. In September 1997 several of us from MMS had the rare opportunity to meet with some regulators from other countries.

We met with fellow regulators of offshore oil and gas from Australia, Canada, Norway, and the United Kingdom. This was a meeting in Aberdeen, Scotland, and we found, very comfortably, that these other regulators had the same kinds of questions and concerns and problems. So it's clear that we're all working on some of the same things.

---

Chris Oynes was named Regional Director for the Gulf of Mexico OCS Region of Minerals Management Service (MMS) in January 1995. He served as the Acting Regional Director for a period of time and, prior to that, was the Deputy Regional Director in the Gulf of Mexico for eight years. As the Regional Director, Mr. Oynes manages the leasing of OCS lands for oil and gas and other mineral development and supervises the regulations of operations on those leases that involve 3,700 platforms. Mr. Oynes holds a Juris Doctor degree from George Washington University, and he has 20 years of federal experience related to developmental and operational activities associated with energy matters.

## MEXUS PLAN: MEXICO/U.S. BILATERAL RESPONSE PLAN

Commander Daniel Whiting  
U.S. Coast Guard  
Marine Safety Office

### ABSTRACT

The Agreement of Cooperation Between the United States of America and the United Mexican States Regarding Pollution of the Marine Environment by Discharges of Hydrocarbons and other Hazardous Substances, signed in Mexico City in 1980, provides the foundation for cooperation in response to pollution incidents that pose a threat to the waters of both countries. Under the 1980 Agreement, the MEXUS Plan identifies the Joint Response Team, defines the role of the On-Scene Coordinator, provides a mechanism for rapid incident notification, designates joint operations centers, and lists communications protocols that would be needed to coordinate the response to pollution incidents affecting both countries.

### DISCUSSION

The Agreement of Cooperation Between the United States of America and the United Mexican States Regarding Pollution of the Marine Environment by Discharges of Hydrocarbons and other Hazardous Substances, signed in Mexico City in 1980, provides the foundation for cooperation in response to pollution incidents that may pose a threat to the waters of both countries. The 1980 Agreement requires the development of a bilateral response plan to predesignate On-Scene Coordinators, the Joint Response Team, response coordination centers, rapid notification protocols, and communications procedures.

The MEXUS Plan—Mexico/U.S. Joint Contingency Plan—was developed by a planning team that included representatives from both the Mexican Navy and the U.S. Coast Guard (see Figure 1J.21). The Mexican Navy planning team members included officials from Mexican Naval Headquarters in Mexico City, the First Mexican Naval Zone in Tampico, and the Second Mexican Naval Zone in Ensenada. U.S. Coast Guard planning team members included the U.S. Coast Guard Headquarters Office of Marine Safety Response Operations, the Eighth Coast Guard District in New Orleans, and the Eleventh Coast Guard District in San Francisco (see Figure 1J.22).

The MEXUS Plan is organized as a single, national level plan, with geographic annexes covering the details of pollution response information for the coasts of the Pacific Ocean and the Gulf of Mexico. The geographic annex for the Pacific Coast is termed the MEXUSPAC Annex, and the annex for the Gulf of Mexico is named MEXUSGOLF Annex ("GOLF" is used to refer to the Spanish pronunciation of "Golfo de Mexico"). Key features of the MEXUS Plan include

- ICS Format: The MEXUS Plan and the geographic annexes are organized using the functional areas of the Incident Command System, including Command, Operations,

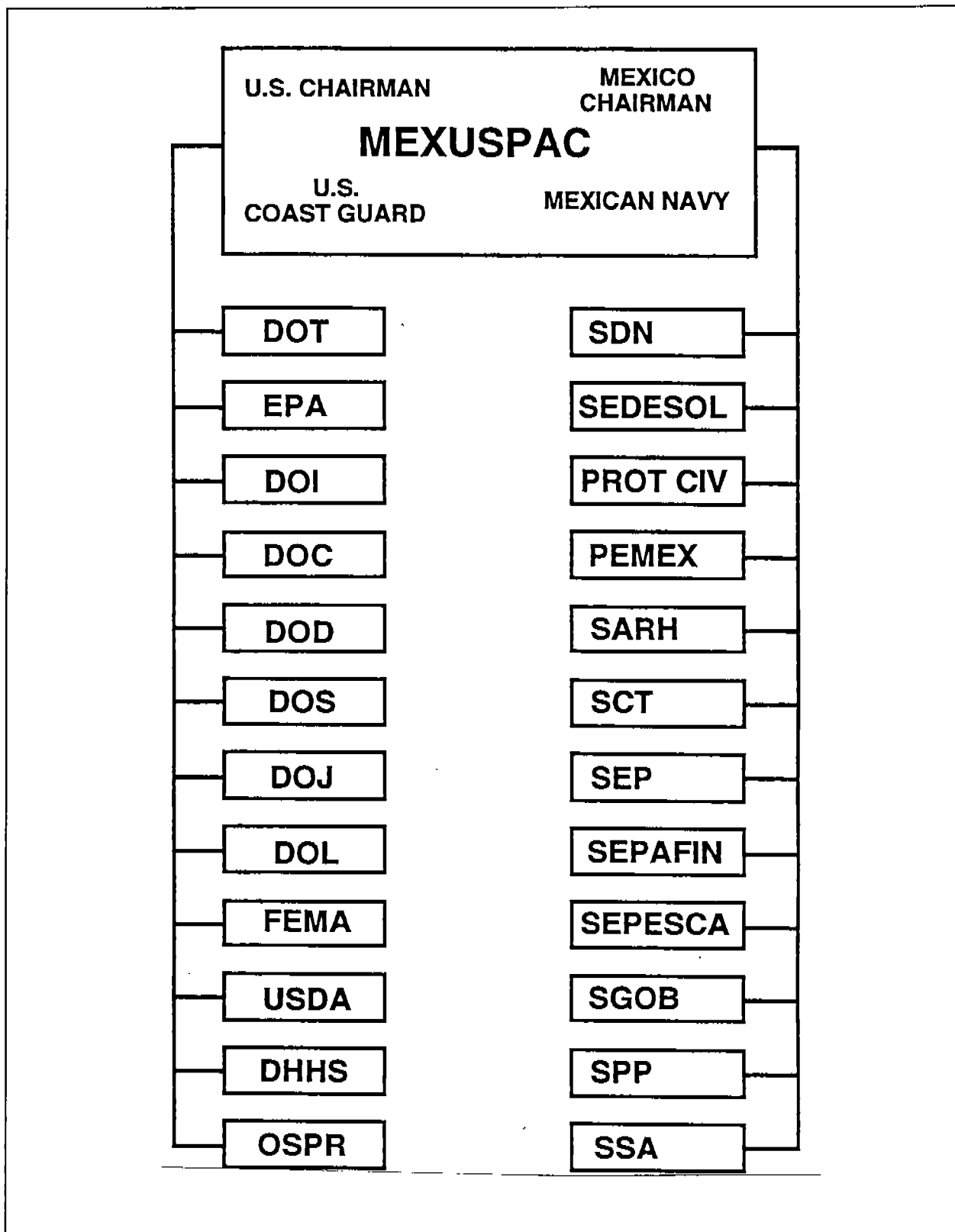

Figure 1J.21. MEXUS Plan participating agencies.



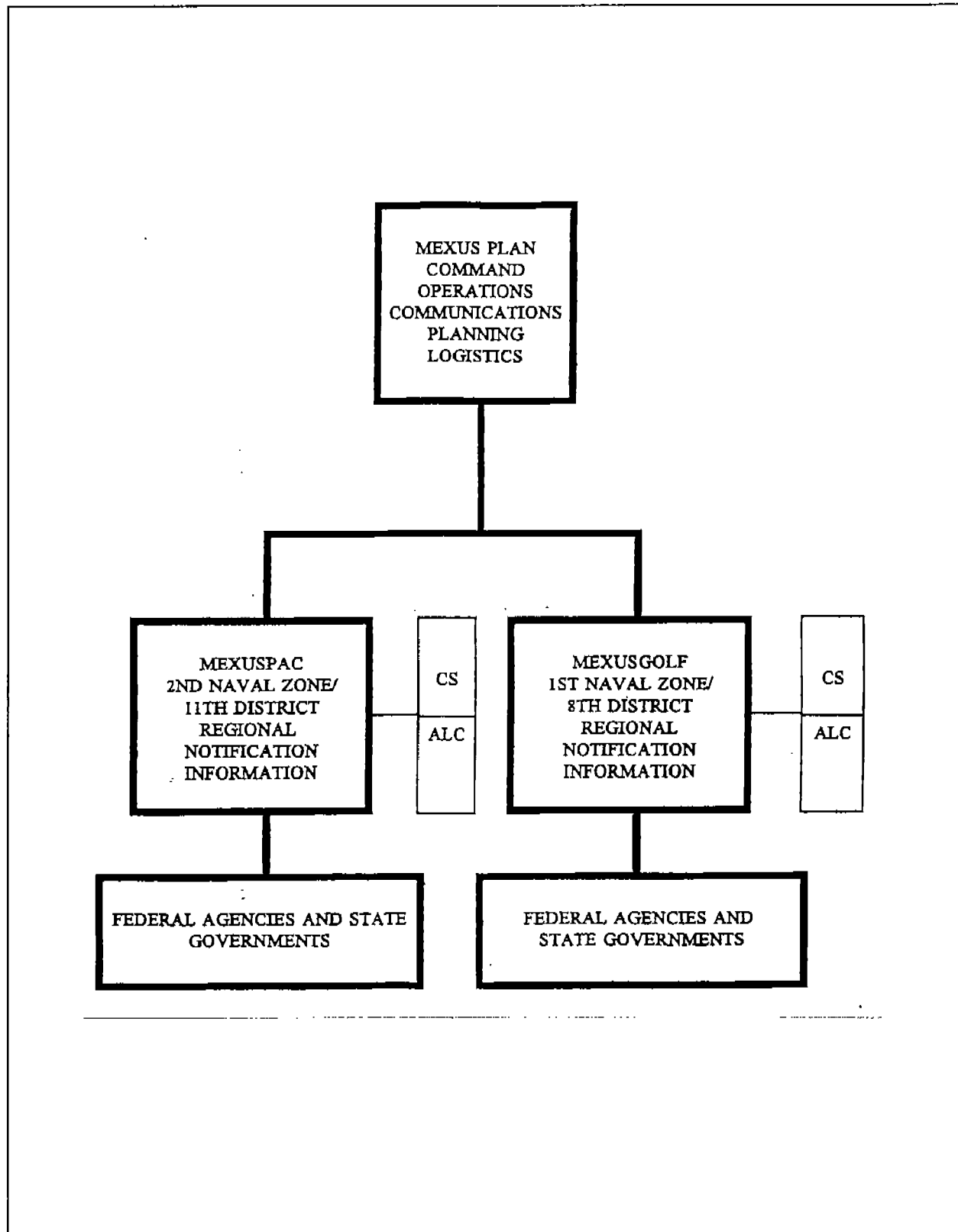

Figure 1J.22. MEXUS planning concept.

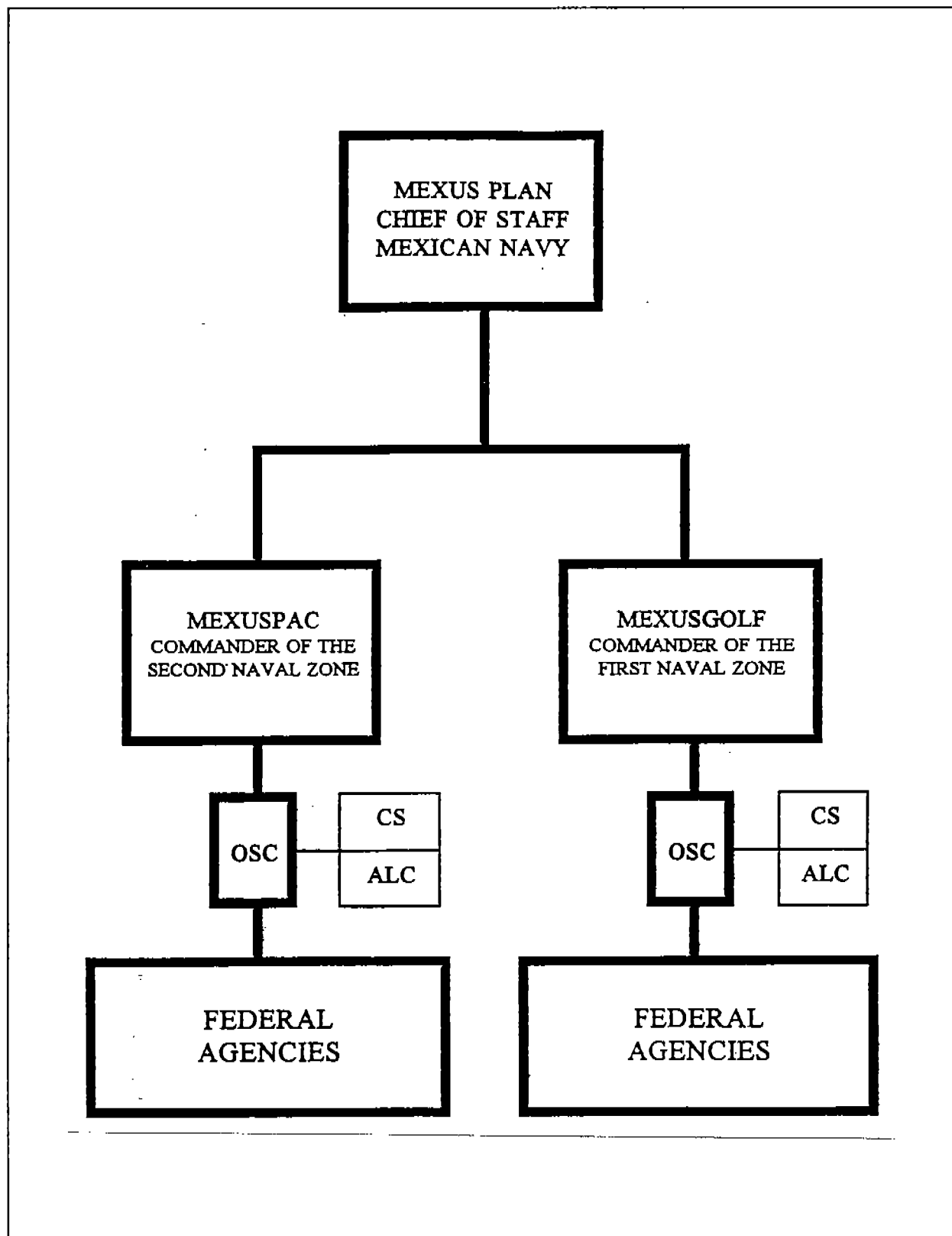

Figure 1J.23. Mexican Joint Response Team.

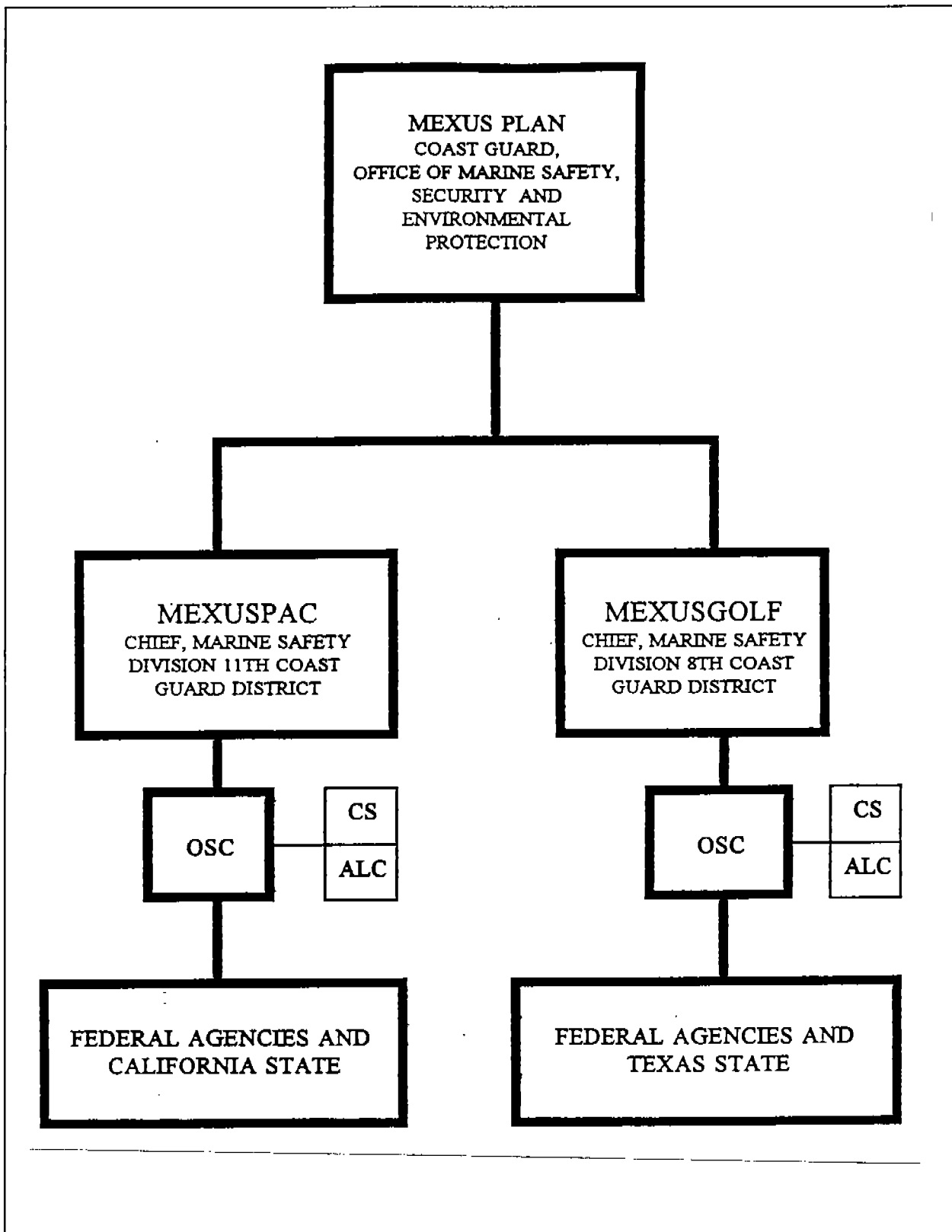

Figure 1J.24. United States Joint Response Team.

Planning, and Logistics. The Finance section was identified by the planning team as an area which required further development

- On-scene Coordinator: The central role of the On-Scene Coordinator (OSC), as defined by the National Contingency Plans of each country, is recognized in the MEXUS Plan.
- Joint Response Team: The predesignated federal and local agencies which comprise the Joint Response Team (JRT) are listed, and their functions identified. The JRT is recognized as a support organization to the OSC, which does not have operational responsibilities (see Figures 1J.23 and 1J.24).
- Advisory and Liaison Coordinators: The exchange of Advisory and Liaison Coordinators (ALC's) is identified as a primary operational objective. Advisory and Liaison Coordinators report to the OSC in the location where a pollution incident has occurred and are responsible to coordinate the exchange of information between the OSC and Joint Response Team.
- Response Coordination Centers: Predesignated Response Coordination Centers (RCC) are identified in the locations with the highest probability for pollution incidents.
- Rapid Notification: Five Rapid Notification Protocols are defined to facilitate immediate notification of incidents which may require bilateral response coordination. These five protocols are designed to be referenced or faxed as the first notification of a pollution incident, and would be followed with incident specific confirmation messages.
- Communications Procedures: Message formats for operational coordination during an incident, including formal initial notification, initiation of joint regional coordination, operational coordination, and termination of joint regional coordination.
- Customs and Immigration Procedures: Specific customs and immigrations procedures and points of contact for each country are provided in each of the geographic annexes.
- Exercises and Meetings: The goal of maintaining the MEXUS Plan through exercises and regional meetings is clearly stated.

The MEXUS Plan draws upon the 1980 Agreement, the International Maritime Organization (IMO) International Convention on Oil Pollution Preparedness, Response and Cooperation (OPRC 90), and the National Interagency Incident Management System (NIIMS) Incident Command System (ICS). The layout of the MEXUS Plan gives both the Spanish and the English interpretation of each planning topic in a parallel, side-by-side format, intended to provide a quick reference in either language. Elements of the MEXUS Plan were exercised at Corpus Christi, Texas in 1995, and at a Joint Response Team exercise in Ensenada, Baja California, Mexico in 1996. These opportunities for pollution response agencies from both Mexico and the United States to work together during simulated incidents validated the basic concepts of the MEXUS Plan and provided valuable feedback to improve the details of the MEXUSPAC and MEXUSGOLF Annexes.

---

Commander Daniel Whiting serves as the Chief, Port Operations at Marine Safety Office New Orleans. He graduated in 1978 from the Coast Guard Academy and has served as navigator aboard USCGC *Sagebrush* (WLB 399), commanding officer of LORAN-C Station Kure Island, Marine Science Technician School Chief, Port Operations at MSO San Juan, Puerto Rico, and Chief, Eleventh District Response Advisory Team.



## SESSION 1K

**GULF OF MEXICO COASTAL AND MARINE ENVIRONMENTAL  
MONITORING, PART I**

Chair: Dr. Richard Defenbaugh

Co-Chair: Mr. Joe Perryman

Date: December 18, 1997

Presentation	Author/Affiliation
Introduction	Dr. Richard Defenbaugh Minerals Management Service Gulf of Mexico OCS Region
Project Summary: Monitoring Health of Gulf of Mexico Living Aquatic Resources	Ms. Susan Cox Dr. Quenton Dokken Center for Coastal Studies Texas A&M University-Corpus Christi
An Integrated Coastal Monitoring Program for the Gulf of Mexico	Dr. Eugene P. Meier Gulf of Mexico Program
Integrated Coastal Management Approaches in Campeche, Southern Gulf of Mexico: The Need for Designing Monitoring Programs	Ms. Evelia Rivera-Arriaga Center for the Study of Marine Policy University of Delaware Mr. Jose Luis Rojas-Galaviz Mr. David Zarate-Lomeli 2 Centro de Ecologia, Pesquerias y Oceanografia del Golfo de Mexico (EPOMEX) Univrsidad Autonoma de Campeche Campeche, Mexico
Southeast Area Monitoring And Assessment Program (SEAMAP): A State/Federal Cooperative Data Collection Program for the Southeast United States	Mr. David M. Donaldson Gulf States Marine Fisheries Commission
Monitoring at the Flower Gardens: History and Status	Dr. Stephen R. Gittings Flower Garden Banks National Marine Sanctuary



## INTRODUCTION

Dr. Richard Defenbaugh  
Minerals Management Service  
Gulf of Mexico OCS Region

The general theme of these two sessions was information sharing by invited speakers regarding existing or planned environmental monitoring, throughout the Gulf of Mexico. For these sessions, "monitoring", was generally taken to mean either: (1) recurrent sampling and analyses over time, so that time-series data are developed for a given area; or (2) event-specific studies to assess environmental impact. Our underlying interest in monitoring studies is the wealth of data that are routinely gathered by State or Federal agencies, or academic or industry researchers, that may be available for broader environmental analysis if properly aggregated and integrated. Speakers representing a variety of perspectives (academic; regulatory; international; and resource management) were invited, to describe projects that represent various scales of place and time (both local to regional scale; and event-specific to long-term duration), and for differing purposes.

Early in the session planning process we learned of two efforts, well along, which worked towards the session goals. Project managers for those two efforts were invited to share their visions and accomplishments: Dr. Quenten Dokken of Texas A&M University at Corpus Christi was invited to present an overview of the Large Aquatic Resource Survey Project, a questionnaire/survey based database of Gulf-wide monitoring efforts, with particular attention to the range of on-going monitoring projects identified, their nature, and data that may be available from those projects. And Dr. Eugene Meier of the Gulf of Mexico Program Office was invited to present his concept for an integrated coastal monitoring program for the Gulf of Mexico, based on cooperative and synergistic coordination of existing monitoring programs performed by various agencies or organizations.

Since the 1997 Information Transfer meeting was a "bi-national" U.S./Mexico endeavor, Ms. Evelia Rivera Arriaga was invited to share her understanding of integrated coastal management approaches in the coastal area of Campeche, Mexico, including a proposal for broad-scale environmental monitoring.

Two presentations were invited on projects which have developed long time-series of data: Mr. Dave Donaldson of the Gulf States Marine Fisheries Commission was invited to share information on SEAMAP (Southeast Area Monitoring and Assessment Program), a State-Federal cooperative fisheries data collection effort; particularly, the geographic scope and duration, and program accomplishments. And, Dr. Steve Gittings of the Flower Garden Banks National Marine Sanctuary was invited to present an overview of monitoring studies at the Flower Garden Banks, including general objectives and scope of the monitoring studies performed, general findings as to the health of the communities at the bank, and perspectives on the value of a long-term monitoring record.

Conversely, Dr. Randall Davis of Texas A&M University and Dr. Keith Mullin of the National Marine Fisheries Service were invited to share preliminary findings and general information on a



cooperative academic Federal project of only a fairly short duration, but of a broad geographic scope to survey the occurrence, distribution, and behavior of marine mammals in the Gulf of Mexico.

To represent regulatory monitoring, Mr. Joe Daly of the Environmental Protection Agency (EPA) was invited to share his plans for studies to monitor the ambient environmental effects of discharges of drill cuttings carrying synthetic-based drilling fluids, including his thoughts on how study findings can be used in EPA's regulatory process. And Dr. Benny Gallaway and Ms. Debra Beaubien of BP Exploration were invited to share their findings of BP's studies at a synthetic drilling fluid discharge site in the Gulf of Mexico, especially observations of the fate and/or effects of the discharged synthetic drilling fluids.

And lastly, to represent monitoring studies at the frontiers of science and technology, Dr. Ian McDonald of Texas A&M University's Geophysical and Environmental Research Group was invited to share information on objectives, approaches, and recent findings of studies of the natural stability and change in deepwater chemo synthetic communities in the Gulf of Mexico.

The presentations were all successful in sharing information on this interesting mix of monitoring efforts: short-term and long-term; site-specific to broad-scale; to support academic, resource management, or regulatory purposes, and to expand our understanding of the living marine resources of the Gulf of Mexico.

---

Dr. Richard Defenbaugh is Deputy Regional Supervisor for Leasing and Environment within the MMS Gulf of Mexico OCS Regional Office. His duties are to support and assist the Regional Supervisor in management of the Office of Leasing and Environment for the MMS Gulf of Mexico OCS Region. The mission of the Office includes planning and conducting OCS Lease Sales; preparing sale-specific environmental impact statements; performing post-sale environmental assessments on all oil and gas activities permitted offshore by the MMS; and planning and managing the Environmental Studies Program for the Gulf of Mexico. His graduate work at Texas A&M University on the natural history and ecology of Gulf of Mexico estuarine and continental shelf invertebrates led to a M.S. in 1970 and a Ph.D. in 1976. He began his career in the Federal service in the Bureau of Land Management's New Orleans OCS Office in 1975 as an environmental studies project officer, then as an environmental analyst. He served as Chief, Environmental Studies Section from October 1981 to September 1991, at which time he moved to the position of Deputy Regional Supervisor for Leasing and Environment. He served as Acting Regional Supervisor from July 1993 until October 1995. Professional interests revolve around natural resource management, management of offshore oil and gas activities, and marine ecology.

## PROJECT SUMMARY: MONITORING HEALTH OF GULF OF MEXICO LIVING AQUATIC RESOURCES

Ms. Susan Cox  
Dr. Quenton Dokken  
Center for Coastal Studies  
Texas A&M University-Corpus Christi

Scientists have long sought to provide accurate scientific assessments of the environmental ramifications of human activities (Osenberg and Schmitt 1996). However, there remains considerable uncertainty about the environmental consequences of many human-induced impacts, particularly in marine habitats (National Research Council 1990, 1992). As we face an ever increasing number of environmental challenges stemming from human population growth, it is critical that we achieve a better understanding and ability to monitor and predict the impacts of human activity.

The project summarized here has three objectives: 1) to assemble a catalog of current strategies and methodologies being used to measure and monitor "health of aquatic living resources" in the Gulf of Mexico; 2) to promote development of a consensus on a definition of "health of living aquatic resources"; and 3) to develop recommendations for short- and long-term monitoring of the health of living aquatic resources of the Gulf of Mexico. The project is funded by the Gulf of Mexico Program (Stennis Space Center, Mississippi).

### METHODS

A survey and subsequent workshop were conducted to initiate efforts to describe the "health" of living aquatic resources in the Gulf of Mexico. Respondents and participants represented a diverse collection of interests and professional expertise and/or affiliations. These efforts resulted in a catalog of current measurement and monitoring programs, and the development of working definitions of "ecosystem health" and "health of living aquatic resources." In addition, strategies for long-term monitoring efforts were considered and discussed.

#### Survey

To begin developing a monitoring strategy, a survey of questions monitoring the health of a large marine ecosystem was developed and distributed to a group of approximately 400 participants (scientists and resource managers) located within the five Gulf state region and Mexico. The list of participants included representatives from resource management, research professionals, industry, agricultural, fisheries, and conservation groups.

The survey assessed opinions of ecological monitoring priorities and to build a catalog of active monitoring programs. The survey consisted of 31 questions addressing prioritization of potential

biotic and abiotic parameters in addition to listing ecosystems and/or habitats that should be monitored as indicators of "health of living aquatic resources." The results of the survey were

synthesized and presented for discussion at a workshop held 7-8 February 1996 in New Orleans, Louisiana.

### Workshop

A workshop to discuss results of the survey and to invite ideas, critical review and conclusions was held. Survey results were distributed and reviewed by a select group of scientists and resource managers. A priority objective of the workshop was to arrive at consensus definitions for "health" of living aquatic resources and ecosystems.

### RESULTS

Out of the 400 questionnaires distributed, 56 were returned. Responding group affiliation was government 56% (30), academia 36% (20), and private 11% (6). Regional response was highest from Texas, followed by Florida, Louisiana, Alabama, Mississippi, and Mexico.

Survey respondents recommended a wide spectrum of ecosystem components/parameters to consider as indicators of living aquatic resources and ecosystem "health" (Table 1K.1). The benthic community, wetlands/marsh/estuary/bay ecosystems, biodiversity, and nutrients were the most frequently recommended indicators of "health" to be monitored (Table 1K.2). Survey respondents were divided as to the utility of fisheries landings as indicators of "health." The group strongly recommended that monitoring efforts cover a diversity of ecosystems/habitats and span the trophic structure. Decomposers, primary producers, intermediate consumers, and apex consumers were recommended as appropriate indicators of "health."

Questions 19 through 31 addressed methodologies currently being utilized for monitoring purposes throughout the Gulf. The answers were categorized as follows:

1. Institution/Agency
2. Project
3. Technology utilized
4. Data Geographical Range
5. Funding Source
6. Project Longevity
7. Project Integration

Data from each of these eight categories was entered into Microsoft Access (version 7.0), an interactive relational database management system for Microsoft Windows. This program allows the user to organize, locate and present the information via graphs, tables, and reports within a relational database management system (RDBMS).

Each institution/agency was assigned an identification number and along with information from each of the remaining seven categories was compiled into a table. Information from each of these categories is stored once and then updated from any location, and restructured according to user-defined needs (Figure 1K.1). Instructions explaining the organization, operation, and potential uses of the relational database are currently being developed.

**Table 1K.1. Survey response, recommended indicators of “health of living aquatic resources.”**

	<b>BIOTIC</b>	<b>ABIOTIC</b>
Seagrass	Vascular plants	Nutrient levels
Benthic inverts	Turtles	Contaminants
Phytoplankton diversity	Spotted sea trout	Salinity
Zooplankton	Saline Mangrove	Over-fishing of resources
Shrimp	Oligohaline habitats in tributaries	Turbidity (including light attenuation)
Reef Fish	Water clarity for seagrass growth	Temperature
Wetlands	Submerged aquatic vegetation	Sediment parameters
Menhanden	Coastal Migratory spp.	River discharge rate (freshwater inflow)
Blue Crab	Oceanic Migratory spp.	Dissolved oxygen
Corals	Fish abundance's	DOC/POC
Bird population size	Redfish	pH
Fish tissue condition	Striped mullet	Wetland loss/creation/erosion
Shark population size	Crustaceans	Loss of substrate
Salt marsh acreage	Bottom fish diversity & abundance	Water column
Oysters/Clams	Tertiary producers	Habitat loss
Resident Fishes	Red Snapper	Nitrogen
Resident macrocrustaceans		Water movement
Bay Anchovy		Human use
Protozoans		
Planktonic crustaceans		
Marine Mammals		
Molluscs		
Tuna		
Trout		
Plankton		
Keystone species		
Bio-sensitive fish species		

The final report on *The Health of Living Aquatic Resources and Existing Tools for Measurement* will include each participant's response to questions 19 through 31 in their entirety. This information will also be accessible through electronic mail through our website - <http://www.sci.tamucc.edu/ccs>.

Table 1K.2. Responses to survey on Health of Living Aquatic Resources (LARS) and Existing Tools for Measurement.

QUESTION	YES	NO	NO RESPONSE
* Should fisheries landings (sport and commercial; total catch and/or catch per unit effort) be used as indicators of LARS?	36	20	0
* Should non-living (i.e. abiotic) parameters such as geology, water chemistry, habitat modification, etc. be monitored as indicators/predictors of LARS?	51	3	2
* Should ecosystems/habitats be monitored as indicators of LARS	50	0	6
* Should some level of monitoring effort be conducted in each of the areas described in ecosystems/habitats?	46	6	4
* Do you or your agency, institution, or group measure or monitor biotic and/or abiotic parameters that relate to LARS?	45	7	4
	HIGH PRIORITY		LOW PRIORITY
Potential species indicators of LARS.	Benthos		Whales
Potential biotic population level indicators of LARS.	Biodiversity		Secondary productivity
Potential abiotic indicators of LARS.	Nutrients		Changes in management regulations
Priority systems regarding monitoring efforts of LARS.	Wetland/ Marsh/ Estuary/Bay		Blue water > 60 m
Prioritize potential species indicators of LARS.	Benthic Community		Whales
Prioritize potential biotic population level indicators LARS.	Biodiversity		Secondary Productivity
Prioritize the following potential abiotic indicators of LARS.	Nutrients		Changes in management regulations
Rank systems regarding priority of monitoring efforts.	Wetland/ Marsh/ Estuary/Bay		Blue Water>60m

ID:	18	Project longevity:	A very long time
Institution/Agency:	Department of Commerce, National Oceanographic and Atmospheric Administration	Funding source:	Federal; Agency budgets as determined by Congress
Project:	Fishery research; surveys, landings surveys, biological data, environmental data, contaminant data, economic data (Southeast Regional Office); Salinity, temperature, tide level, DO (Galveston Laboratory)		
Technology:	Trawls, gill nets, longlines, purse seines, aerial surveys, plankton nets, water samplers		
Information access:	Digital accessible in report, listing, tape, disc, other data communication; data exist from 1950's to present; data is used for fisheries research and management and conservation of living marine resources; modeling, public information		
Geographical range:	Coastal and offshore waters throughout the Gulf of Mexico		
Project integration:	Yes; cooperatively with all state finery management and research agencies, most coastal university marine science investigators, many Federal agencies such as USFWS, MMS, COE, EPA		

Figure 1K.1. Example of Relational database management system (RDBMS - Microsoft Access 7.0) form integrating monitoring information synthesized from survey on Health of Living Aquatic Resources and Existing Tools for Measurement: Interim Report.

The workshop was used as a platform to consider, discuss, and develop consensus for definitions of the “health” of a living aquatic system.

Health of a Living Aquatic Resource to be defined as

...healthy when its population density, biomass, and integrity are sustainable at levels not significantly different from historical accounts. Patterns of abundance and natural and anthropogenic forces (including natural mortality, disease, ecosystem health, and harvest pressure) should remain stable across long-term time frames (historical, current, and future).

Ecosystem Health to be considered “healthy”

...when it is characterized by a persistence of productivity and integrity not significantly different from historical patterns and is in balance with natural and anthropogenic forces (current and future). Productivity and integrity will be spatially and temporally measured in terms of bio-diversity, biomass, structure, function, resiliency, aesthetic, and value.

## DISCUSSION

The “health” of a living resource is inseparable from the “health” of the ecosystem in which it resides. It is important to recognize that humans, requiring natural resources to maintain life and quality of life, have to make value judgments of acceptable compromises of health of the natural system and its living components.

The challenge is to apply management to a degree that assures health, productivity and sustainability of the living resource (Figure 1K.2). Continuous long-term measurement and monitoring data is required to accomplish this goal. Under ideal conditions, monitoring a diverse suite of indicators would be undertaken to obtain the most comprehensive picture and model. In reality, budget limits, time restraints, and technological limitations force scientists and resource managers to seek the most cost efficient, timely, responsive, and socioeconomically acceptable indicator(s) for which tested methodologies of measurement exist.

The health of water resources can be assessed by evaluating the degree to which waters support the associated biota. Important biotic indicators as defined by the participants include seagrasses, benthos, fish and other uses as well as the preservation of future options for the use of these resources. A priority issue in the Gulf of Mexico and to many of the institutions and agencies surveyed is nutrient loading resulting in anoxic conditions or “hypoxia.” Research during the past decade suggests that variations in the nutrient-enriched waters of the Mississippi and Atchafalaya

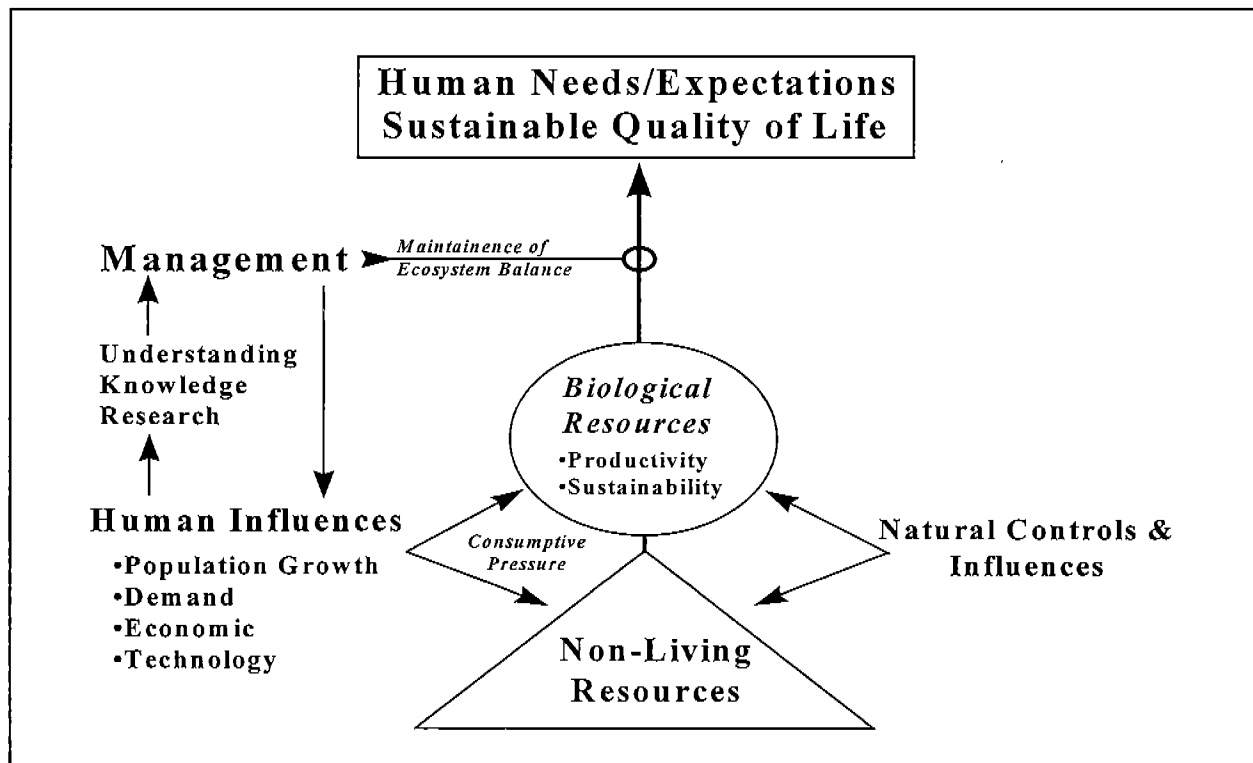

Figure 1K.2. Balance of ecosystem health, integrity, and productivity (after Dokken *et al.* 1997).

Rivers are highly correlated with spatial and temporal variations in a zone of persistent low dissolved oxygen concentrations that occurs on the Louisiana coastal shelf in summer months (Rabalais *et al.* 1994).

Large scale environmental problems require a change in approaches to environmental protection and management. The development of a consensus definition of ecosystem health allows scientists and resource managers to assess the conditions of our ecological resources at the regional and national levels from a standardized reference point. Meeting monitoring needs by simply aggregating data from many individual, local, short-term monitoring networks has proven difficult and ineffective (Hren *et al.* 1990).

No single "keystone" species or habitat parameter will suffice as an indicator (Table 1K.1). To accurately reflect current status and short- and long-term trends, a suite of indicators will have to be measured and monitored. It is likely that varying indicators, particularly biological indicators, will be employed within the varying geographic and climatic regimes of the Gulf of Mexico. Once the parameters to be measured and modeled are selected, a long-term program for data collection must be implemented, including a system for data management and distribution (Figure 1K.1).

The technology for measurement of indicators must be accurate, cost effective, and resistant to modification. It must be responsive to short- and long-term changes, and ideally reported in or near real time. Since the "ability to sustain" a balanced biotic community is the best indicator, effective monitoring programs should assess "biotic integrity." Standard monitoring guidelines followed by appropriate management strategies is critical to the future sustainability and productivity of the Gulf of Mexico.

#### REFERENCES

- Dokken, Q.R., E. Meier, and H. Kumpf. 1997. Models and mass balance calculations for the Gulf of Mexico: Workshop, Metairie Louisiana. 92 pp.
- Hren, J., C.J. Oblinger Childress, J.M. Norris, T.H. Chaney, and D.N. Myers. 1990. Regional water quality: evaluation of data for assessing conditions and trends. *Environ. Sci. Tech.* 24(8):1122-1127.
- National Research Council. 1990. Managing troubled waters: the role of marine environmental monitoring. National Academy press, Washington, DC.
- National Research Council. 1992. Assessment of the U.S. outer continental shelf environmental studies program. II. Ecology. National Academy press, Washington, DC.
- Osenberg, C.W. and R.J. Schmitt (eds.). 1996. Detecting ecological impacts caused by human activities. Academic Press, Inc. San Diego, California. 401 pp.



Rabalais, N.N., R.E. Turner, W.J. Wiseman, W.J. Justic, D. Dortch, and B.S. Gupta. 1994. Hypoxia on the Louisiana shelf and system responses to nutrient changes in the Mississippi River: A brief synopsis, in National Oceanic and Atmospheric Administration, nutrient-enhance coastal ocean productivity. Proceedings 1994 Synthesis Workshop. Baton Rouge, Louisiana.

## **AN INTEGRATED COASTAL MONITORING PROGRAM FOR THE GULF OF MEXICO**

Dr. Eugene P. Meier  
Gulf of Mexico Program

### INTRODUCTION

#### The Gulf of Mexico

The Gulf of Mexico is the ninth largest body of water in the world. Its drainage system covers more than 60% of the United States; and, its U.S. coastline is approximately 1,631 miles. Bordered on three sides by the U.S. (five states), the Gulf of Mexico is truly America's Sea!

With Mexico and Cuba on its western and southern borders, the Gulf is shared by the international community for a variety of resources and services including transportation, fisheries, natural resources, and recreation. Its diverse and productive ecosystem is very important to the U.S. economy. Its coastal wetlands serve as essential habitat for a large percentage of the Nation's migrating waterfowl. Gulf estuaries serve as a nursery for estuarine-dependant commercial and recreational fisheries. Significant petroleum and natural gas reserves are in Gulf waters. The second largest marine transport industry in the world is located in the Gulf, where approximately 45% of U.S. shipping tonnage passes through Gulf ports. Millions of people depend upon the Gulf of Mexico to earn a living. Millions more flock to its shores and waters for entertainment and relaxation.

The resulting increase in population means increased demands on Gulf resources. The large Gulf watershed adds stress to the ecosystem via environmental problems associated with runoff of pesticides, fertilizers, toxic substances and trash. Potential indicators of the impact of these pressures on the Gulf ecosystem are

- increasing occurrences of fish kills and toxic "red tides";
- a growing zone of hypoxia along the coast of Louisiana;
- closure of more than half of the coastal shellfish-producing areas;
- introduction of harmful non-indigenous species;
- loss of valuable coastal wetlands and shorelines; and
- accumulation of marine trash along Gulf shores and in its waters.

These concerns cannot be addressed in a piecemeal fashion by any one agency. The resources needed to address them are too great. A coalition/partnership of organizations is required to effectively garner the resources to stabilize and protect the Gulf ecosystem.

### The Gulf of Mexico Program (GMP)

In response to public concern about the state of the Gulf, the Environmental Protection Agency has sponsored such a partnership with the Gulf of Mexico Program (GMP). The GMP is a partnership of federal, state, local and private agencies and organizations aligned to provide a broad geographic focus on the major environmental issues in the Gulf before they become irreversible, or too costly to correct. This partnership has provided

- a mechanism for addressing complex problems that cross the federal, state, and international jurisdictions of the ecosystem;
- better coordination among the partners, thereby increasing their effectiveness and efficiency in management and protection of Gulf resources;
- a regional perspective to obtain the information and research needed for effective management decisions; and
- a forum for all constituents to participate in the solution process.

Through its partnerships, the GMP has made significant progress in defining the issues and organizing a program to address them. Action Agendas have been written to characterize the eight issue areas initially identified as GMP concerns:

- *Habitat Degradation* of such areas as coastal wetlands, seagrass beds, and sand dunes;
- *Freshwater Inflow* changes resulting from reservoir construction, diversions for multiple uses, and modifications to watersheds that alter runoff patterns;
- *Nutrient Enrichment* resulting from such sources as municipal waste water, storm water runoff, industrial effluent, and agriculture practices;
- *Toxic Substances & Pesticides* contamination originating from industrial, urban, and agricultural sources;
- *Coastal & Shoreline Erosion* caused by natural and human-related activities;
- *Public Health* threats from swimming in and eating seafood products coming from contaminated water;
- *Marine Debris* from land-based and marine recreational and commercial sources; and
- Sustainability of the *Living Aquatic Resources* of the Gulf of Ecosystem.

The GMP is now focusing its limited resources on actions to address specific problems that have emerged from this characterization process. The current focus is on

- Protection the Gulf from the deleterious effects of *nutrient enrichment*, as indicated by a zone of hypoxia along the Louisiana coast, with emphasis on the most significant contributing sources. This hypoxia zone represents one of the largest zones of oxygen-deficient bottom waters in the Western Atlantic Ocean. It is characterized by low densities of fish and shellfish

with other less mobile organisms dying or severely stressed. The immediate focus for action is reducing the extent of the hypoxia zone by reducing the input of nutrients from the Mississippi River system.

- Prevent adverse *public health* effects from the consumption of raw shellfish harvested from the Gulf by increasing the number of shellfish beds available for safe harvesting by 10%. The Gulf of Mexico is the top shellfish-producing region in the nation. However, over half of the nine million acres of shellfish growing waters in the region have regulatory limitations on harvest. Recognizing the importance of shellfish bed closures as an indicator of potential decline in coastal water quality, the GMP has identified *restoration of shellfish* acreage as one of its top environmental objectives.
- Protect and restore *critical Gulf habitats*, including coastal wetlands, submerged aquatic vegetation, important upland areas, and marine/offshore areas. Gulf of Mexico coastal wetlands serve as essential habitat for migrating waterfowl, provide year-round nesting and feeding grounds for shorebirds, and are critical habitat for endangered species. Many of the estuarine-dependent commercial and recreational fisheries depend on coastal wetlands and submerged aquatic vegetation. The GMP focus is on community-based efforts to protect and restore coastal wetlands and submerged aquatic vegetation.
- Reduce the impact of human activities on important fisheries, including mortality caused by pollution and through the *introduction of* undesirable, *non-indigenous organisms* (e.g., shrimp virus from aquaculture, biological pollutants from ship ballast, zebra mussel, etc.). Given the potential ecological and economic impacts associated with non-indigenous species, the GMP plans to bring greater regional attention to this issue. The GMP will initiate innovative technological approaches for the prevention and treatment of exotics and also provide a regional perspective as national policies are developed.

The GMP also has three committees to assist with broader operational issues that cross these focus areas:

- *the Public Education and Outreach Committee* to encourage and support public understanding, coordination, cooperation and action in addressing environmental issues in the Gulf;
- *the Data & Information Transfer Committee* to help provide access to, and encourage sharing of, data and information Gulf wide; and
- *the Monitoring, Modeling and Research Committee (MMRC)* to define and support the monitoring, modeling and research requirements of the GMP. This operating committee was approved in October, 1997 and will become operational during 1998.

The purpose of this paper is to describe the monitoring plans and goals of the GMP and the potential role of the Monitoring Sub-committee of the MMRC in meeting those goals.

## MONITORING THE GULF ECOSYSTEM

### Monitoring Requirements

A comprehensive set of baseline data is needed to assess the status and trends in the health of the Gulf of Mexico ecosystem. Monitoring will also be required to provide the data needed for planning and implementing actions to address the four GMP focus areas. Management at all levels in the Gulf region need monitoring data to support important decisions in protection of the environmental health and economic sustainability of the ecosystem. Monitoring data are required to drive models used by scientists to understand and describe existing problems, and by management to predict how these problems will change under various management scenarios. Finally, monitoring will be required to follow up on management decisions and assure that the actions taken are achieving the desired outcomes.

Two levels of monitoring are required. The first is routine status and trends monitoring to be able to describe the “State of the Gulf” and how it is changing. The other level is the issue-specific monitoring activities focused on specific concerns identified in the ecosystem.

### Current Monitoring in the Gulf

There are numerous monitoring programs and activities at the state, local and private level that collect data to support their own objectives. In many cases, the data are collected in response to federal and state regulatory requirements. In other cases, local communities and environmental interest groups are simply interested in knowing the status of the environment in their “backyard.” This includes the volunteer monitoring programs that have been supported in the states by the Environmental Protection Agency. Each of the National Estuary Programs in the Gulf have developed, or are developing, their own monitoring strategy to characterize and observe status and trends in the conditions of their estuaries. There are also research efforts that include a monitoring component to provide the data needed for the research project.

These individual monitoring activities are not coordinated. It is likely that these monitoring efforts duplicate each other, could be done more cost-effectively, or could generate more information with a better sampling or cooperative design. One example is state monitoring in response to Section 305 (b) of the Federal Water Pollution Control Act (PL92-500). In some cases, sampling sites are selected for ease of access (such as river bridges); however, these sites may represent only a small percentage of the streams in the watershed. There are also many examples of the private sector collecting samples at the same locations, and for the same analyses, as federal, state and local groups. Improved planning and coordination could help to time or space these samples such that each organization obtains the information it needs, while the combined set of samples and analyses can be used to gain much more information about the water body or area being sampled. Common analytical techniques, timing, and terminology will also improve consistency in the data and comparability between groups as the data are analyzed.

## GMP Response

The GMP has recognized the need for a coordinated cooperative monitoring program in the Gulf region. The desired outcome of the monitoring effort within the GMP is not to establish a new monitoring program but to make more efficient use of the time, energy, and resources being devoted to monitoring efforts by GMP Partners in the Gulf ecosystem. The goal is to integrate existing federal, state, local, and private sector monitoring activities in a cooperative effort to provide monitoring data to meet the needs of the individual programs, but will also be useful at a regional scale. The integrated effort will be implemented in a cooperative manner that will enhance the efficiency and effectiveness of the individual monitoring programs, while also providing data for use by the GMP at the regional scale. While enhancing the individual monitoring programs, this integrated effort will help the GMP and its partners:

- identify and characterize emerging threats to the health of the Gulf ecosystem and the people who live there;
- compare and rank risks from these threats to the ecosystem;
- support policy, budget and program decisions in response to these threats;
- track progress of actions taken to respond to these threats; and
- inform the public on the health of the ecosystem they live in and use.

The initial activity will focus on simple monitoring objectives to demonstrate the concept and allow existing monitoring programs to become comfortable with working with one another. The ultimate goal is an integrated ecosystem monitoring program that will allow the GMP to respond to regional issues in the Gulf and to describe the “State of the Gulf” based on scientifically proven indicators of ecosystem health. The program will start with the five U.S. Gulf states, but will eventually include the whole ecosystem, i.e., the coastal zones of Mexico and Cuba.

### Monitoring Sub-Committee

Integration of monitoring activities across the five Gulf states will require input and buy-in from the individual monitoring entities. To facilitate this, the GMP is organizing a monitoring sub-committee under the MMRC to provide a forum for

- discussion of the benefits of a partnership with the regional effort;
- definition of the monitoring requirements at the regional ecosystem level;
- identification and coordination of past, current, and planned monitoring activities that could be used at the regional scale;
- development of a strategy to integrate the individual monitoring activities at the regional scale; and
- assisting individual partners with their monitoring requirements.

This sub-committee will also coordinate the monitoring requirements of the GMP with its partnership and the monitoring community. It will provide advice and recommendations on the monitoring needs and activities of the GMP. As requested by GMP Management, ad hoc Work

Groups will be formed to address specific monitoring issues, goals and objectives of the GMP. The initial goal of the sub-committee is to help the GMP design and implement an integrated coastal monitoring program for the Gulf of Mexico.

#### GMP Monitoring Plan

With help from the sub-committee, the GMP will develop a coordinated monitoring and assessment plan for the Gulf of Mexico ecosystem. The plan will define the projects to be implemented through the GMP to

- identify past, current and planned monitoring activities in the Gulf ecosystem that can be applied to regional issues;
- identify or develop indicators to describe the "State of the Gulf";
- identify, coordinate and gain support for standard monitoring methods across the Gulf ecosystem;
- design and implement an integrated coastal monitoring program that will help the GMP describe the "State of the Gulf;" and
- provide data to support GMP response to key issues in the Gulf ecosystem.

The expected outcome of this plan is the development of a cooperative integrated monitoring program for the Gulf of Mexico ecosystem and a common data management system that is accessible and usable by any participant in the program.

---

Eugene Meier was born on 3 October 1942. He received his B.S. degree in chemistry from Texas A&M University in 1965 and his Ph.D. in analytical chemistry from the University of Colorado in 1969. Prior to joining EPA, Dr. Meier was Research Area Manager for Pesticide Management Research with the Environmental Protection Research Division of the U.S. Army Medical Bioengineering R&D Laboratory. He joined EPA at the Environmental Monitoring Systems Laboratory-Las Vegas in 1978. During his 15-year tenure with the laboratory, he held numerous senior management positions as director of several divisions and as Acting Deputy Director of the laboratory. He also held lead positions in the Acid Deposition Research Program and the Environmental Monitoring and Assessment Program. Dr. Meier is currently assigned to the National Exposure Research Laboratory and stationed at the Stennis Space Center, Mississippi, as the EPA's ORD Liaison to the GMP.

## INTEGRATED COASTAL MANAGEMENT APPROACHES IN CAMPECHE, SOUTHERN GULF OF MEXICO: THE NEED FOR DESIGNING MONITORING PROGRAMS

Ms. Evelia Rivera-Arriaga  
Center for the Study of Marine Policy  
University of Delaware

Mr. Jose Luis Rojas-Galaviz  
Mr. David Zarate-Lomeli  
2 Centro de Ecologia, Pesquerias y Oceanografia del Golfo de Mexico (EPOMEX)  
Universidad Autonoma de Campeche  
Campeche, Mexico

### INTRODUCTION

The government of the State of Campeche considers environmental issues a political priority. Efforts towards integrated coastal management in Campeche are still at the early stage of development. The first step towards the management of the coastal zone have been taken through two legal instruments: the Protected Areas System of the federal government and the Special Zones for Protection of the state government. This ensures the protection of the still healthy coastal ecosystems of the state. The development of coastal management plans for these protected areas was the second step towards the conservation and sustainable use of the coastal and marine natural resources.

This paper describes the current situation of the coastal zone in Campeche. The first part considers the ecology and socioeconomic characteristics and provides an environmental diagnosis of the coastal zone with emphasis on the oil and gas current and future activities. The second part summarizes the legal framework for national coastal management and the current management efforts for the shoreline of Campeche. The third part draws the attention to the necessity of designing monitoring plans which may ultimately provide substantial information to appropriately redirect and refocus environmental management policies to meet the health and quality goals for the coastal ecosystems and natural resources in the most cost-effective manner. Finally the conclusion addresses the need for designing monitoring programs for the coast of Campeche.

### THE COAST OF CAMPECHE

#### Ecology and Socioeconomic characteristics

The state of Campeche is located in the southern of the Gulf of Mexico. The biodiversity in its coastal zone includes endemic species for the region, local and migratory fauna with at least 200 families and a total of 958 vertebrates, and 132 families of invertebrates with 510 species. The flora is composed of 84 families with a total of 374 species (Rivera-Arriaga *et al.*) According to its

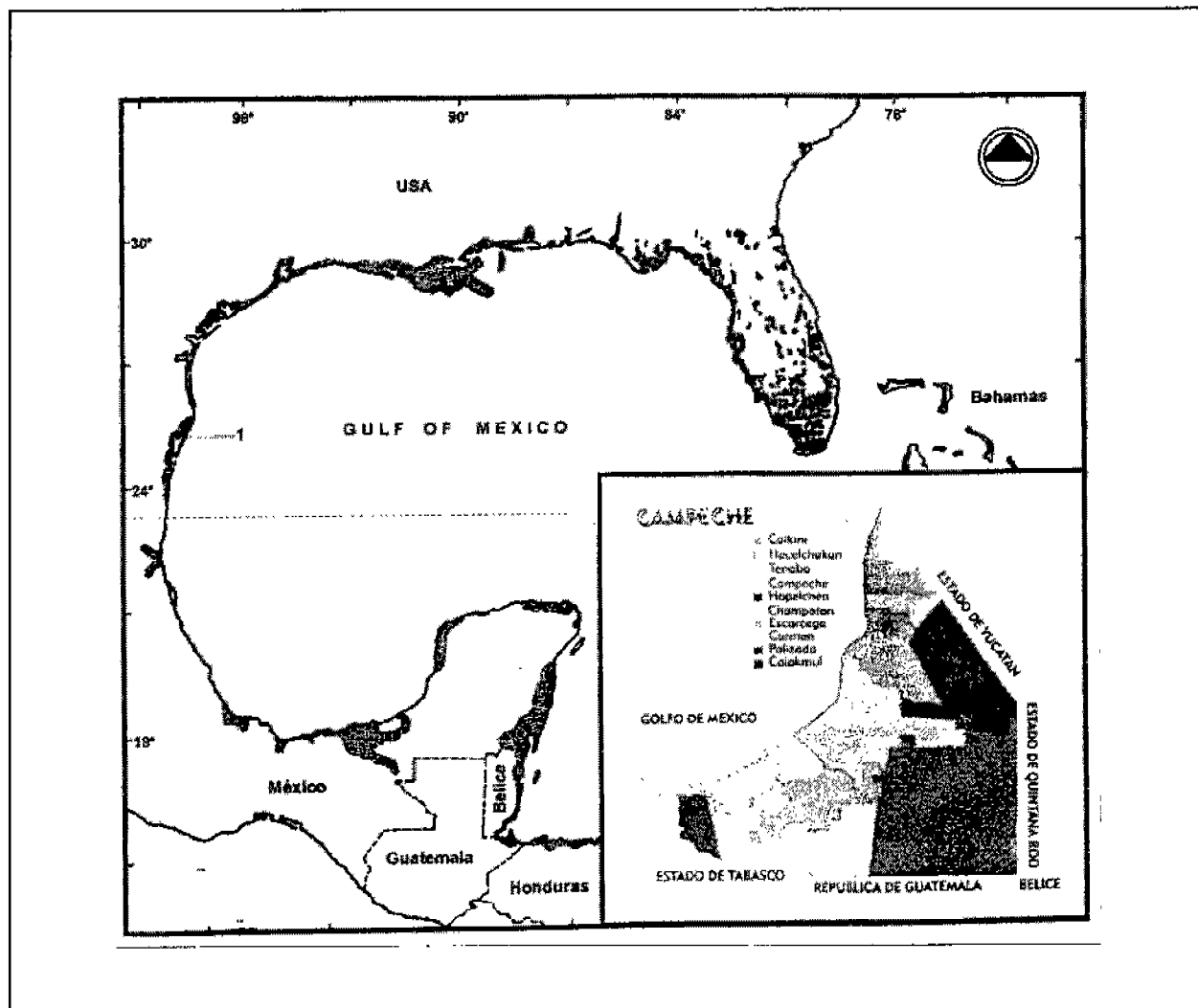

Figure 1K.3. The two regions of the coast of the state of Campeche.

ecological and socioeconomic characteristics, the 412.62 km long coast can be divided into two regions (Lara-Dominguez *et al.* 1991) (Figure 1K.3):

1. The northern region is located between the Estuary of Celestun and the Champoton River. Due to its hydrological underground water pattern and permeable soil prone to floods, the characteristic vegetation in the northern region is fringe mangroves and “petenes.” The petenes are always associated with a freshwater sinkhole or “cenote,” and the petenes are “islands” of trees that grow surrounded by a matrix of freshwater, brackish or marine marshes on this part of the coast, Campeche City is located with 170,000 inhabitants and two small fishing villages: Lerma (1,000 inhabitants) and Isla Arena (500 inhabitants); and small towns of Mayan people at 8 km from the coast and up. The main economic activities in this region are commerce, artisanal fisheries, salt extraction and handcrafts construction.



2. The southern region covering from the Champoton River to San Pedro and San Pablo Rivers is characterized by marshy soils and the delta of the Grijalva-Usumacinta Rivers as well as the rivers Chumpan, Candelaria and Mamantel (with a total annual discharge of 6,000 millions of cubic meters per year). The main ecosystem of this region is Laguna de Terminos, a coastal lagoon associated with important wetlands and estuarine-lagoon systems, and whose primary and secondary activities support 24% of the fisheries' national production. In this southern region, there are several towns and small villages and El Carmen City (1,000,000 inhabitants). The two principal socioeconomic activities in this region are: fisheries (70% artisanal), and oil and gas exploration and exploitation in the marine and coastal zones (with the 70% of oil and 30% of gas of the national production).

### Environmental Diagnosis

The coastal state of Campeche is negatively affected by human activities and settlements occurring mainly in the southern region, those that are carried out in the marine zone, or in the hydrological inland basin. The main problems are:

- Sewage dumped without treatment in the coastal zone (240 fecal coliforms/100 ml in waters of Laguna de Terminos) (Chang and Barrera-Escorcía 1996).
- Agricultural activities as well as disease prevention procedures utilize pesticides that are dumped directly into the water or are transported by run offs ( DDT in Candelaria River had an average of 9,716 kg per active ingredient; and Propanil in Palizada River had 16, 130 kg per active ingredient) (Benitez and Barcenás 1996).
- Fish resources stocks have been dramatically depleted mainly due to overcapitalization, overexploitation, loss of habitats (shelter, nurishment and spawning areas), and displacement of fishing areas by oil and gas activities and pollution.
- Heavy metals in Laguna de Terminos has 172.0 ppm levels of copper in oysters, and 33.9 ppm of lead and 47.0 ppm of chromium in sediments (Zarate-Lomeli *et al.*, in press).
- Oil and gas activities are concentrated in the southern region of the state, and can be divided into marine and coastal activities. In the marine region oil and gas exploration and exploitation have induced pollution problems for 300 tons x 10<sup>3</sup> per year of SO<sub>2</sub> emissions to the air (Bravo and Torres 1996); hydrocarbons in Laguna de Terminos are higher than 48 ppm, meanwhile pitch and coal tar registered in the Bank of Campeche is 209.6 g/m; in marine sediments the average of hydrocarbons is 61 ppm (Botello *et al.* 1996). Meanwhile, in the coastal zone the average concentration of pitch and coal tar is 1 g/m (Botello *et al.* 1996). Other negative impacts in the coast for oil and gas activities are: air pollution, loss of habitats (mainly vegetation) due to clearing wetlands areas and dredging channels, with the consequent erosion, salty soils and flooding problems, disturbance and/or displacement of fauna by noise pollution.

Current situation: Oil and Gas. In the Sound of Campeche, there are three fields: Akal, Nohoch and Chac, composing the Complejo Cantarell, located 75 kilometers from the coast. The development of Cantarell began in 1979; it has a current production of 1.1 millions of oil barrels per day (mbd), and 450 millions of cubic feet of gas per day. During 1997 Complejo Cantarell has been modernized

with an economic investment of \$825 millions dollars (Pemex 1996). And it has an expansion with the inclusion of two new fields: Kanaab and Manik, as well as the expansion of the field Escuintle in the southern Gulf of Mexico. Currently Pemex is evaluating the reserves in those sites.

Future development: Oil and Gas. Next year Pemex will begin the development of deep-sea oil and gas activities (more than 450 meters depth). For this purpose Pemex will invest about \$6,876.5 million. The new explorations aim to increase the current production by 4.9 mbd oil and 1.9 millions of cubic feet for the year 2004 (Yah Vela 1997).

Nitrogen Plant: Last November, the National Institute of Ecology (INE) authorized the construction of the largest plant for obtaining, compressing, and supplying nitrogen in the Cantarell field in the Atasta Peninsula in Campeche.

## THE COASTAL MANAGEMENT APPROACH

### National Scope

Management of the coastal zone and its natural resources in Mexico involves several governmental agencies as well as the enforcement of various legal instruments at federal, regional, state and local levels. In that regard, international legislation provides accurate guidelines to prevent and control deterioration of coastal and marine ecosystems and resources. The laws and ordinances that rule the oceans and coastal zones are based on the article 27 of the Political Constitution of the Mexican United States. This article considers the provisions of the III Law of the Sea Convention in relation to the territorial sea and the exclusive economic zone as well as their resources. However, significant gaps are apparent with respect to issuance and enforcement of relevant specific standards in the coastal zone. The main legal instruments applied to manage the coastal zone are described in Table 1K.3.

The challenge is to achieve an integrated coastal management (ICM), understanding ICM as: “a continuous and dynamic process by which decisions are taken for the sustainable use, development, and protection of coastal and marine areas and resources...” (Cicin-Sain and Knecht 1997).

According to the National Environmental Program (NEP) 1995-2000 of the Ministry of Environment, Natural Resources and Fisheries (SEMARNAP), this challenge is met based on the political instruments available in the Mexican Laws, appealing to social commitment and intergenerational equity.

### Coastal Management in Campeche

Currently, two-thirds of the coast of Campeche are already protected under the NEP and in coordination with state government, state environmental agencies, research institutions, universities, and the people of Campeche:

Table 1K.3. Legal instruments consider for the coastal management in Mexico (Saavedra 1996; Zarate-Lomeli *et al.*, in press).

Legal Instruments	Description
1) National Development Plan and Sectorial Development Plans	Plans are defined each six years, corresponding to the government term
2) Ecological Ordinance	Process to evaluate and program the use of soil, natural resources, and economic activities
3) Environmental Impact Assessment	Process through which the Ministry of Ecology, Natural Resources and Fisheries (SEMARNAP) establishes conditions for public and private projects
4) Mexican Official Norms	Conditions, allowed limits, and parameters, based on international standards, that should be met in every project or economic activity
5) Protected, Natural Areas	Federal System that joins those areas needing protection, conservation, or restoration
6) Federal Maritime-Terrestrial Zone	Zone of littoral exclusion determined by a strip of 20 m adjoining the marine littoral.
7) Self-regulation and Environmental Audits	Voluntary instruments of environmental self-regulation that ensure that the industrial production processes meet the environmental legislation and the Mexican Official Norms
8) Ecological Research and Training and Education	Instrument for strengthening the training and education of managers, officials from the government, and public in general
9) Economic Instruments	Normative and administrative mechanism of fiscal, financial or market character, through which people take on benefits and environmental costs from their economic activities outputs, giving them incentives to carry out actions in favor of the environment
10) Environmental Regulation of Human Settlements	Set of dispositions oriented towards planning and urban development

1. In the southern coastal region: the Protected Area for the Flora and Fauna of the Laguna de Terminos Region, decreed by the Federal Government on 5 June 1994, including 705 thousand hectares
2. In the northern coastal region: the Special Zone for the Protection of Flora and Fauna of the Area "Los Petenes", decreed by the State Government on 4 June 1996, and submitted to the Federal Government for its inclusion in the Natural Protected Areas System, including 382,396 hectares.

Both areas have developed an integrated coastal management (ICM) plan through a process that included public meetings with the participation of the governmental officials of the different levels (local, state and federal), and with representatives of each one of the involved economic sectors, such as fisheries, tourism, oil and gas, agriculture, livestock, indigenous people, and environmental groups. The ICM plan for Laguna de Terminos was approved by the National Institute of Ecology (INE) and is currently in its implementation phase. Meanwhile, the ICM plan for the Area of Los Petenes has recently been submitted to the INE for its approval. The main objectives of both ICM plans are in accordance with the general objective of the NEP: "the conservation and sustainable use of the natural resources."

#### THE NEED TO ESTABLISH A MONITORING PROGRAM IN THE COAST OF CAMPECHE

In the program management structure of both protected areas are Scientific and Technical and Citizens Advisory Committees in charge of the design of scientifically defensible monitoring programs. The monitoring programs are intended to evaluate the effectiveness of recommended management actions on key ecosystems and resources critical to the long-term success of the ICM plans for Laguna de Terminos region and Los Petenes region. The implementation of a monitoring program in both coastal regions is a complex process that can be started in the two coastal protected areas management plans. The results of the monitoring plans will give the authorities of the region the substantial information to appropriately redirect and refocus environmental management policies to meet the health and quality goals for the ecosystem and its natural resources in the most cost-effective manner.

#### Proposal for Regional Monitoring Programs

The objective of designing a monitoring program is to develop statistically robust and scientifically defensible designs for a variety of natural resource monitoring programs to be implemented in the coastal zone of Campeche. Crucial information the design can provide that could help characterize, evaluate and determine the effects of integrated management pursued in both protected areas and on the resources, and at the same time to determine the level of vulnerability of these ecosystems and resources.

Given the ecological characterization and the diagnosis of this region, there are seventeen monitoring targets that the authors propose to be developed. They are divided into five general categories and outlined in Table 1K.4.

Table 1K.4. The five categories of proposed regional monitoring programs.

1. Water quality	2. Air quality	3. Habitat quality	4. Harvestable / Nonharvestable Resources	5. Quality of Life
Nutrients: Sewage and runoffs	Acid rain (wet and dry)	Loss of area	Abundance and distribution of fishing resources and waterfowl	Determine the public perception of the relationship quality of life-environmental quality issues
Pollutants: temperature, heavy metals, bacteriological, hydrocarbons, agrochemicals	Gas emissions	Loss of functions	Maintain the biodiversity of the region	Determine the public environmental and economic concerns
Sediments	Acid rain	Alteration and Restoration	Decrease the percent of living resources with contaminant tissue concentrations greater than critical values for human consumption	Determine the public monitoring actions
Alteration of hydrological patterns for human activities	Temperature and air humidity	Sea level rise	Rate of deforestation	Determine the public perception towards the sectorial management

### CONCLUSIONS

- To better achieve the need for designing and implementing monitoring programs in the coast of Campeche, it would be important to review other successful programs such as Chesapeake Bay, Delaware Bay, Tampa Bay.
- Coordinate actions with Pemex, the federal and state institutions, and the public and private sectors for the design and implementation of this program.
- Consider the acquisition of the necessary equipment as well as the reinforcement of the existent laboratories and institutions for the analysis and process of environmental data.
- Identify the existent monitoring to establish a coordinate action for the coast of Campeche to optimize economic resources and time frameworks and avoid duplications.

- Identify the existent monitoring to establish a coordinate action for the coast of Campeche to optimize economic resources and time frameworks and avoid duplications.
- Generate and disseminate information about the monitoring actions in order to build consensus, widening public participation and eliciting commitment and responsibility.

#### OTHER MONITORING EFFORTS IN THE REGION

- The Scientific Station “El Carmen” of the Institute of Marine Sciences and Limnology (ICMyL) of the National University of Mexico (UNAM), has been working in the area for at least 20 years collecting data of aquatic organisms, mangroves forests, seagrass beds, freshwater vegetation, and hydrology. Other laboratories of the ICMyL have been working in physical and chemical components of the ecosystems of the region such as geology, sediments, and oceanography.
- The institute of Geography of the UNAM has been working on GIS and remote sensing approaches addressing sea level rise issues, among others.
- The University Autonomus Metropolitana (UAM) in Iztapalapa and in Xochimilco, have been working for at least 10 years in the region, collecting data of aquatic organisms and mangroves.
- The Research Center for Advanced Studies (CINVESTAV) in Merida has been working in the area for at least 10 years collecting data on land-base pollution and aquatic organisms.
- The Colegio de la Frontera Sur has been collecting data for at least 15 years on water fowl and vegetation.
- The Center of Ecology, Fisheries and Oceanography of the Gulf of Mexico (EPOMEX) of the University Autonomus of Campeche has been working in the region for at least 20 years, collecting data on aquatic organisms, mangrove ecosystems, seagrass beds, artisanal fisheries, GIS and remote sensing data. And for five years the center has been coordinating a monitoring activity in marine and land debris in beaches.
- The Institute of Statistics, Geography and Information (INEGI) has a permanently monitoring program for the socioeconomical issues.
- The Mexican Institute of Oil (IMP) of Pemex has a monitoring program for the marine area since 1979 (after the Ixtoc-I oil spill). Another monitoring program has been implemented in coordination with the UNAM. Additionally, Pemex activities and facilities are under the frequent supervision of the Mexican environmental authorities.

## REFERENCES

- Benitez, J.A. and C. Barcenas. 1996. Sistemas fluvio-fagunares de la Laguna de Terminos: Habitats criticos susceptibles a los efectos adversos de los plaguicidas, p. 187-201. *In*: A.V. Botello, J.L. Rojas Galaviz, J.A. Benitez, D. Zarate-Lomeli (eds.). Golfo de Mexico, Contaminacion e Impacto Ambiental: Diagnostico y Tendencias. Universidad Autonoma de Campeche. EPOMEX Serie Cientifica 5, 666 p.
- Botello, A.V., A. Ponce V., and S.A. Macko. 1996. Niveles de Concentracion de hidrocarburos en el Golfo de Mexico, p. 225-253. *In*: A.V. Botello, J.L. Rojas Galaviz, J.A. Benitez, D. Zarate-Lomeli (eds.). Golfo de Mexico, Contaminacion e Impacto Ambiental: Diagnostico y Tendencias. Universidad Autonoma de Campeche. EPOMEX Serie Cientifica 5, 666 p.
- Bravo Alvarez, H., and R. Torres Jardon. 1996. Caracteristicas fisicoquimicas y fuentes de contaminantes atmosfericos, p. 409-422. *In*: A.V. Botello, J.L. Rojas Galaviz, J.A. Benitez, D. Zarate-Lomeli (eds.). Golfo de Mexico, Contaminacion e Impacto Ambiental: Diagnostico y Tendencias. Universidad Autonoma de Campeche. EPOMEX Serie Cientifica 5, 666 p.
- Cicin-Sain, B. and R. Knecht. 1998. ICM <<http://www.udel.edu/CSMP>>
- A.L. Lara-Domínguez, G. Villalobos Zapata, E. Rivera-Arriaga, A. Yáñez-Arancibia. 1992. Caracterización Ecológica de la Zona Costera del Estado de Campeche. Informe Técnico Final. Proyecto 902466, Convenio C90-01-0551 de la SEP/DGICSA-UAC.
- PEMEX. 1996. Comunicados de Prensa y Documentos, Petroleos Mexicanos. Boletin 300/96 - 4 de septiembre de 1996. Proyecto Cantarell. <<http://www.pemex.com/nbol300.html>>
- Rivera-Arriaga, E., G.J. Villalobos-Zapata, A. L. Lara-Domínguez, A. Yáñez-Arancibia, J.W. Day, Jr., Biodiversidad de la Región de la Laguna de Términos (*In preparation*)
- Saavedra Vazquez, T. 1996. Normatividad en Zonas Costeras, p. 605-640. *In*: A.V. Botello, J.L. Rojas Galaviz, J.A. Benitez, D. Zarate-Lomeli (eds.). Golfo de Mexico, Contaminacion e Impacto Ambiental: Diagnostico y Tendencias. Universidad Autonoma de Campeche. EPOMEX Serie Cientifica 5, 666 p.
- Wong, Ch.I. and G. Barrera Escorcia. 1996. Niveles de contaminacion microbiologica en el Golfo de Mexico, p. 383-397. *In*: A.V. Botello, J.L. Rojas-Galaviz, J.A. Benitez, D. Zarate-Lomeli (eds.) Golfo de Mexico, Contaminacion e Impacto Ambiental: Diagnostico y Tendencias. Universidad Autonoma de Campeche. EPOMEX Serie Cientifica, 5. 666 p.
- Yah Vela, S.L. 01/12/1997. Diario El Sur de Campeche, <<http://www.elsur.com.mx/local/loc17.htm>>
- Zarate-Lomeli, D., T. Saavedra Vazquez, J.L. Rojas Galaviz, A. Yanez-Arancibia and E. Rivera-Arriaga, (*in press*). Problems and requirements for an integrated management in the Mexican

coastal zone of the Gulf of Mexico and Caribbean, *In: A. Yanez-Arancibia (ed). ICM in Latin America, Special Issue. Elsevier.*

---

Evelia Rivera-Arriaga has worked at the University of Campeche for the past eight years and serves as Full Professor and Researcher at the EPOMEX Center and at the Faculty of Biological Sciences of this institution. Her area of research interest is the ecology and management of coastal ecosystems. Rivera-Arriaga received her B.S. from the National University of Mexico and currently is a graduate student of the Marine Policy Program of the University of Delaware in her first year of Ph.D. program.

Jose Luis Rojas-Galaviz has worked at the University of Campeche for the past eight years and serves as Full Professor and Researcher at the EPOMEX Center. He is advisor of the state Governments of Campeche and Quintana Roo in environment and coastal management issues and in capacity building processes. His areas of research interest are the ecology and legal and policy aspects of management of coastal ecosystems and impact of environmental assessment. Professor Rojas-Galaviz received his B.S. and his M.S. from the National University of Mexico.

David Zarate-Lomeli has worked at the University of Campeche for the past eight years and serves as Full Professor and Researcher at the EPOMEX Center and at the Faculty of Biological Sciences of this institution. Currently he is the Chief of the Area of Pollution and Environmental Assessment. His areas of research interest are the ecology and legal aspects of the impact environmental assessment and coastal management. M.S. Zarate-Lomeli received his B.S. and his M.S. from the National University of Mexico (UNAM).



**SOUTHEAST AREA MONITORING AND ASSESSMENT PROGRAM (SEAMAP):  
A STATE/FEDERAL COOPERATIVE DATA COLLECTION PROGRAM  
FOR THE SOUTHEAST UNITED STATES**

Mr. David M. Donaldson,  
Gulf States Marine Fisheries Commission

INTRODUCTION

The Southeast Area Monitoring and Assessment Program (SEAMAP) is a state/federal/university program for collection, management and dissemination of fishery-independent data and information in the southeastern United States. The program consists of three operational components, SEAMAP-Gulf of Mexico, which began in 1981, SEAMAP-South Atlantic, implemented in 1983 and SEAMAP-Caribbean, formed in 1988.

Activities and operations of each SEAMAP component are wholly defined by the respective managing units: the SEAMAP-Gulf Subcommittee of the Gulf States Marine Fisheries Commission's Technical Coordinating Committee, the SEAMAP-South Atlantic Committee of the Atlantic States Marine Fisheries Commission's South Atlantic State-Federal Fisheries Management Board, and the SEAMAP-Caribbean Committee of the Puerto Rico Sea Grant College Program. The Gulf and South Atlantic committees consist of designated representatives from each member state and NMFS and the Gulf of Mexico and South Atlantic Fishery Management Councils. In addition, the SEAMAP-South Atlantic committee includes a representative from the Atlantic States Marine Fisheries Commission (ASMFC). The Caribbean component consists of members from Puerto Rico Department of Natural and Environmental Resources, Virgin Islands Division of Fish and Wildlife, Puerto Rico Sea Grant College Program, NMFS, U.S. Fish and Wildlife Service, and Caribbean Fishery Management Council. Each committee meets yearly to review operations, examine priorities, and plan future activities. Daily operations are carried out by the respective SEAMAP coordinators, assisted by staffs of the two Commissions and Puerto Rico Sea Grant College Program and personnel associated with the SEAMAP Information System, SEAMAP Archiving Center and SEAMAP Invertebrate Plankton Archiving Center (SIPAC).

METHODS AND RESULTS

The resource surveys conducted by SEAMAP address distinct regional needs and priorities and provide information concerning the marine resources. The focus of this paper will be on the Gulf of Mexico since the majority of the sampling activities are conducted in the Gulf. One of the major goals of SEAMAP is the utilization of standard sampling gears and methodologies. For trawl surveys, sampling activities occur during both day and night and the stations are randomly selected and stratified by depth. The majority of vessels use a standard 40-ft otter trawl. The exception is Texas vessels, which use only 20-ft nets due to the small size of the vessels. Trawls are towed perpendicularly to depth contours and covered the entire depth stratum and are towed for a minimum of 10 minutes and maximum of 60 minutes. All fish and invertebrates are identified, enumerated and

weighed. For plankton surveys, the stations arranged in a systematic grid [intervals of 30 miles (1/2 degree)]. There are two types of plankton gear used. The first is a bongo sampler which consists of two conical 61-cm nets with 333-micron mesh. Bongo tows are made obliquely from the surface to near bottom (or 200 m) and back to surface. The wire angle is maintained at 45 degrees. The other gear is a neuston sampler which consists of 948-micron mesh nets on 2 x 1-meter frames. This gear is towed at the surface for ten minutes.

In conjunction with each trawl and plankton station, environmental data also collected. The data collected include vessel, station, cruise, date, time, latitude/longitude, barometric pressure, wave height, wind speed and direction, air temperature, secchi depth, water color (Forel-Ule), surface chlorophylls and salinity, water temperature and dissolved oxygen from the surface, midwater and bottom.

The Spring Plankton Survey has been conducted for fifteen years. The purpose of the survey is to assess abundance and distribution of bluefin tuna eggs and larvae. Vessels sample offshore waters from the western edge of the West Florida Shelf to the Texas-Louisiana border. Standard SEAMAP environmental and plankton sampling methods are used.

The Reef Fish Survey has been conducted for six years and the purpose is to assess relative abundance and compute population estimates of reef fish. Sites are sampled from Brownsville, Texas to Key West, Florida. The objectives are to (1) assess relative abundance and compute population estimates of reef fish using a video/trap technique; (2) determine habitat using an echo sounder and video camera; (3) determine if bioacoustics assessment methodology can be applied to reef fish communities; (4) collect environmental data at each station; and (5) collect ichthyoplankton samples at selected reef sites. Stations are randomly-selected 100 m<sup>2</sup> sites and designated as "reef areas." The data are collected via a trap/video methodology which consists of a fish trap containing a video camera that is deployed onto the selected reef site. The analysis of video tapes occurs at the NMFS Pascagoula Laboratory.

The Summer Shrimp/Groundfish Survey has been conducted for fifteen years. The goals of the survey are to (1) monitor size and distribution of penaeid shrimp during or prior to migration of brown shrimp from bays to the open Gulf; (2) aid in evaluating the "Texas Closure" management measure of the Gulf Council's Shrimp Fishery Management Plan; and (3) provide information on shrimp and groundfish stocks across the northern Gulf of Mexico from inshore waters to 50 fm. The sampling strategy is to work from the eastern Gulf to the Texas/Mexico border, in order to sample during or prior to migration of brown shrimp from bays to the open Gulf area.

The Fall Plankton Survey has occurred for nine years, but there was no sampling in 1985. The purpose of the survey is to assess abundance and distribution of king mackerel and red drum eggs and larvae. Vessels sample from Florida Bay to Brownsville, Texas.

The Fall Shrimp/Groundfish Survey has been conducted for fifteen years. Vessels sample waters from Mobile, Alabama to the U.S.-Mexican border. The objectives are to (1) sample the northern Gulf of Mexico to determine abundance and distribution of demersal organisms from inshore waters

to 60 fm; (2) obtain length-frequency measurements for major finfish and shrimp species to determine population size structures; (3) collect environmental data to investigate potential relationships between abundance and distribution of organisms and environmental parameters; and (4) collect ichthyoplankton samples to determine relative abundance and distribution of eggs and larvae of commercially and recreationally important fish species.

Information is provided to user groups via three systems: SEAMAP Information System, SEAMAP Archiving Center, SEAMAP Invertebrate Plankton Archiving Center. The SEAMAP Information System is a decentralized system which contains all biological and environmental data from SEAMAP surveys. The data from SEAMAP-Gulf surveys from 1982-1996 has been entered, edited and verified and are available to interested personnel from SEAMAP Data Manager. SEAMAP participants can locally access SEAMAP data as well as use the data request mechanism for data sets too large for economical downloading via the internet. Other users can submit the data request to the SEAMAP Subcommittee through the SEAMAP Coordinator for approval. The SEAMAP Archiving Center is managed in conjunction with the Florida Department of Environmental Protection. The larval fish and fish egg samples which are collected during SEAMAP plankton surveys are sorted to the family level and archived and available for loan to researchers. The current archived samples represent 18 orders, 125 families, 234 genera and 244 species. The SEAMAP Invertebrate Plankton Archiving Center is housed at the Gulf Coast Research Laboratory and was established to retain "back-up" plankton collection. The purpose of this center is to provide curation and management of zooplankton samples. These samples are also available for loan to interested personnel.

The SEAMAP regularly publish documents which include Real-Time Mailouts which are weekly distribution of plots of station locations and catch rates of shrimp, squid and dominant finfish species as well as penaeid shrimp length frequencies, sampling parameters and environmental conditions collected during Summer Shrimp/Groundfish Survey; SEAMAP Marine Directory which provided inventories of marine agency contacts concerned with fishery research in the Gulf of Mexico, and summaries of information these organizations collect such as target species, types of fishery-independent sampling gear and platforms, annual sampling effort, and other materials; SEAMAP Subcommittee Report to the GSMFC Technical Coordinating Committee which is a detailed summary of program accomplishments, survey activities, material collected, data dissemination, budget information, and future activities; Annual Report of the SEAMAP Program which summarizes the activities and proposed events for the SEAMAP-Gulf, South Atlantic, and Caribbean components; and the Environmental and Biological Atlas of the Gulf of Mexico which is a compilation of information obtained from the SEAMAP surveys including catch rates of shrimp and finfish, abundance and distribution of plankton in the Gulf of Mexico and environmental data from all surveys.

## SUMMARY

Fishery-dependent data tell you where you've been, relative to the status of the fishery stocks, and fishery-independent data tell you where you are and where you will be in regard to the status of the fishery stocks. Fishery-independent data is not biased by management regimes, price of the product, weather, or reliability and accuracy of the fisherman/dealer. The SEAMAP is an important program

for providing fishery-independent data. As management regimes and regulations become more stringent, the importance of fishery-independent data increases and becomes a criterion for sound management of the fisheries resources in the Gulf of Mexico.

---

David M. Donaldson works for the Gulf States Marine Fisheries Commission as the SEAMAP and RecFIN(SE)/ComFIN coordinator. He has a Bachelor of Sciences ('86) in marine biology and a Master of Agriculture ('90) in recreation and resource development from Texas A&M University. He currently coordinates and plans SEAMAP fishery-independent surveys by scheduling meetings of the SEAMAP, provides liaison between state agencies and NMFS, and assists in the preparation of SEAMAP planning documents. He also manages and disseminates SEAMAP data and information by providing SEAMAP participants, other state/federal organizations, university researchers, and the fishing industry with timely survey data on resource species composition, distribution and abundance, and environmental data.

## **MONITORING AT THE FLOWER GARDENS: HISTORY AND STATUS**

Dr. Stephen R. Gittings  
Flower Garden Banks National Marine Sanctuary

### INTRODUCTION

In the last five to ten years, scientists throughout the world have begun to advocate the establishment of mapping and habitat monitoring programs for coral reefs. This is in response to alarmingly rapid deterioration of some of the world's coral reefs the recognition of a need to determine the distribution of coral reefs, and the level of natural temporal variability experienced by coral reef ecosystems, as well as to track their condition (Eakin 1997). A number of initiatives have either begun or are in development, such as the International Coral Reef Initiative, the Global Coral Reef Monitoring Network, Caribbean Coastal Marine Productivity Program, and ReefCheck.

For many reefs, however, these efforts come at a time following their initial demise, making it impossible for researchers and resource managers to know how the reefs might have appeared when healthy. Nor can they determine how naturally variable the healthy ecosystem might have been. Few coral reefs in the world have had the luxury of long-term monitoring programs that established this fundamental information. Even in developed countries, long-term programs are not common. For example, several monitoring programs have been initiated in the Florida Keys, but only in the last five years or so.

This paper focuses on the benthic monitoring program on the reefs of the East and West Flower Garden Banks, located about 175 km SSE of Galveston, Texas. The program had its roots in the

early 1970s. This paper summarizes the history and findings of these studies and offers information from other investigations related to the condition of these isolated coral reefs. Recommendations on the future direction of the program are also made.

## HISTORY OF MONITORING AT THE FLOWER GARDENS

The first quantitative data on coral and other sessile invertebrate cover at the Flower Gardens were collected 25 years ago (1972), in 27 quadrants, each measuring 12 m<sup>2</sup> (Bright and Pequegnat 1974). Funded by the Marine Biomedical Institute of the University of Texas, the data provided a baseline against which future information could be compared, particularly considering the anticipated placement of hydrocarbon production facilities and designation as a national marine sanctuary (which happened 18 years later).

The first regularly collected data on benthic communities occurred in 1978 (Viada 1980) and continued through 1983 (Continental Shelf Assoc., Inc. [CSA] 1985). This work was related to the drilling activities of Mobil Exploration and Producing U.S., Inc. within 1.7 km of the coral reefs on the East Flower Garden Bank. Industry sponsorship of the monitoring program was required by the Minerals Management Service because the activity was within the “shunting and monitoring zone” established by MMS (then part of the Bureau of Land Management) in 1974. Within this zone, operators were required to shunt cuttings through a downpipe that terminated within 10m of the seabed. They were also required to sponsor pre- and post-drilling surveys to evaluate the fate and effects of their discharges on the sensitive biological assemblages inhabiting the nearby banks.

With the commencement of production operations within this zone, also called the “1-Mile Zone,” MMS required operators to conduct regular monitoring of the fate of produced water discharges. This involved chemical analysis of sediments taken from the vicinity of the platforms, but did not involve biological collections from either bank.

Following the completion of the study by CSA for Mobil in 1983, and because no new activity was proposed for the 1-Mile Zone, no further benthic monitoring was conducted at the Flower Gardens for nearly six years. There was, however, one sampling effort, funded by the National Oceanic and Atmospheric Administration (NOAA), to investigate the fate of an area of the East Flower Garden Bank damaged in 1983 by an anchored tug and barge (Gittings and Bright 1986).

In consultation with academia and industry, MMS developed a comprehensive benthic monitoring program for the Flower Gardens in the late 1980s. Between 1988 and 1992, they issued a contract to Texas A&M University (TAMU) for the first three years of work on this program (later contracts were awarded to CSA and TAMU at Corpus Christi). The sampling program has remained in place, with some modifications, ever since.

In 1993, the requirement for produced water monitoring around platforms was removed following consultation between MMS, other federal agencies, and academia. It was determined that the monitoring protocols were inadequate to provide useful information on the fate of this material. MMS decided to request Environmental Protection Agency (EPA)-required discharge monitoring

data from platforms rather than require separate monitoring by industry. MMS also initiated a two-year study called the “Gulf of Mexico Offshore Operations Monitoring Experiment,” which would more accurately measure the areal extent of contamination in sediments and assess sub-lethal responses of benthic organisms to exposure in the vicinity of one production platform near the East Flower Garden Bank. The study would eventually demonstrate that shunting did in fact localize contamination to within about 75 m of the platform (Kennicutt 1994).

Since the designation of the Flower Gardens Sanctuary, MMS and NOAA have shared the costs of benthic monitoring at the Flower Gardens. In partnership with other organizations, the Sanctuary also supports additional monitoring efforts (e.g. reef fish) and other studies related to community condition. Through permitting authority under the National Pollutant Discharge Elimination System (NPDES), EPA requires routine monitoring of produced water discharge levels and toxicity.

Benthic data collected over the years at the Flower Gardens have included coral cover, diversity, evenness, relative abundance, accretionary and encrusting growth rates. Cover and abundance data have been collected along transects and at repetitive stations using a variety of methods. Repetitive stations are also used to monitor coral disease frequency and the fate of bleached corals. Growth data have been collected using repetitive photography and using sclerochronology. Studies conducted during drilling operations also included evaluations of sedimentation levels, analysis of sediments and drilling fluids, tissue burden measurements, vertical profiling, and current meter deployments (CSA 1985). In recent years, instruments have been installed to measure temperature (since 1990) and light (since 1995) on a continual basis, and water quality measurement devices are currently being tested (since 1996).

Studies that augment the MMS/NOAA monitoring program at the Flower Gardens include reef fish censuses and trophic studies (Pattengill *et al.* 1997), elasmobranch surveys, sea turtle tagging and tracking, recruitment studies, annual observations and experiments related to mass coral spawning, and studies on historical water quality and paleoclimate (both using coral cores).

#### STATUS OF THE FLOWER GARDENS REEFS

Table 1K.5 shows total coral cover at the East and West Flower Gardens and presents data from all benthic studies for which quantitative data on corals have been collected. It includes data from the 27 quadrats sampled in 1972 and 440 random transects photographed since 1978. Cover averages 47.3% (45.4 at the West Bank, 49.0 at the East Bank) and has probably not changed significantly on the banks in over 25 years. Gittings *et al.* (1992c), and data collected by CSA (USDO/MMS 1996) showed that cover for individual species of corals on the Flower Gardens did not change significantly between 1978 and 1995.

Figure 1K.4 shows data on accretionary growth at the Flower Gardens over the last 85 years. No significant temporal trends are evident, and recent data suggest that corals have been growing at or above mean rates for the last decade or so.

Table 1K.5. Measurements of percent coral cover (all species combined; mean  $\pm$  95% confidence interval, if available) by various investigators working at the East and West Flower Garden Banks since 1972.

Year	West Flower Gardens	East Flower Gardens	Notes/Source
1972	38.3 $\pm$ 8.0	-	Bright and Pequegnat 1974
1978-1979	-	51.5 $\pm$ 7.0	CSA-A Site; Viada 1980
1978-1979	-	62.2 $\pm$ 5.5	BLM Site; Viada 1980
1980	55.4 $\pm$ 7.7	50.4 $\pm$ 5.3	Kraemer 1982
1983	-	55.3 $\pm$ 6.7	Gittings and Bright 1986
1985	-	49.4 $\pm$ 6.7	Gittings and Bright 1986
1989-1991	46.5 $\pm$ 1.9	46.0 $\pm$ 2.2	Gittings <i>et al.</i> 1992b
1992	48.2	40.2	CSA (USDOI/MMS 1995)
1994	37.2	51.2	CSA (USDOI/MMS 1995)
1995	46.7	56.6	CSA (USDOI/MMS 1995)

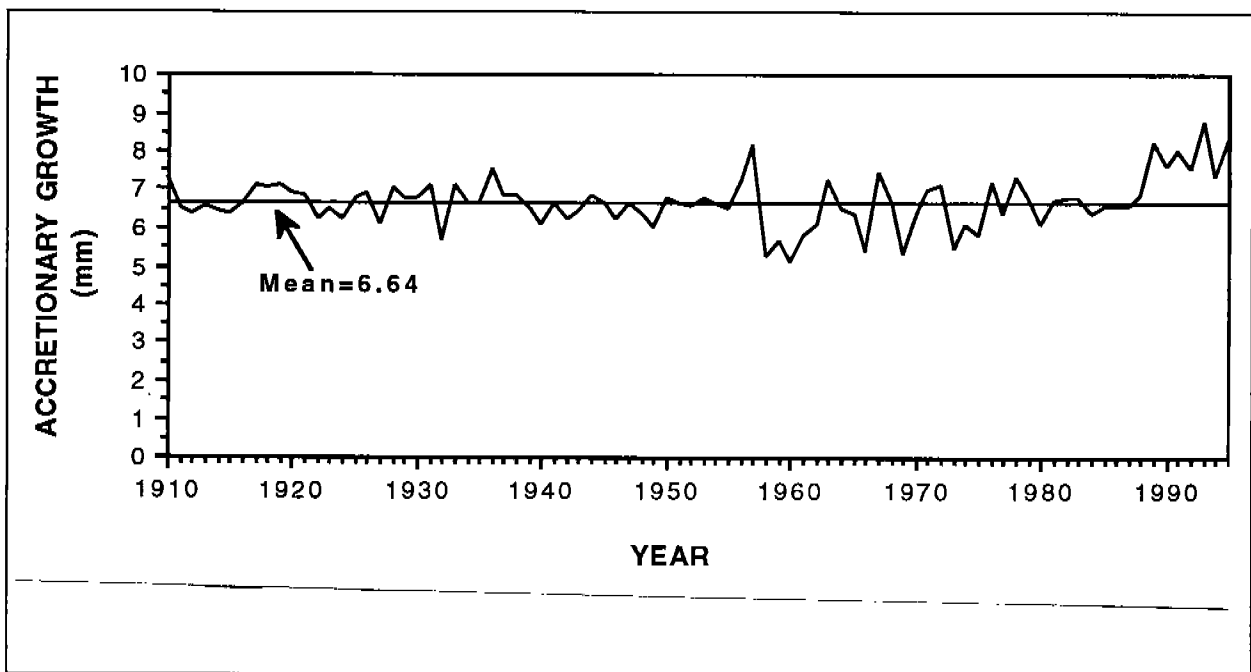

Figure 1K.4. Accretionary growth of corals, measured by averaging data from four separate cores of *Montastraea faveolata* at the East and West Flower Garden Banks (data from Gittings *et al.* 1992b and USDOI/MMS 1996).

Coral growth data have suggested that growth over exposed substrates exceeds tissue loss by a factor of between 1.5 and 1.8 (Gittings *et al.* 1992c). Data also indicate a low disease frequency among coral colonies (below 2%, between 1988 and 1992).

Neither coral community characteristics, based on data collected over the last 25 years, nor growth data, some of which goes back to 1910 (Gittings *et al.* 1992c), hint at significant upward or downward trends in environmental quality at the Flower Gardens. On the whole, the reef communities have so far remained largely unaltered by human activities. This is so despite numerous isolated insults to the reefs, including anchoring incidents (e.g. Gittings and Bright 1986) and minor damage caused by illegal fishing gear and tow cables.

The reefs have, however, experienced temporal change and some destructive activities. In 1983 and 1984, nearly all long-spined sea urchins in the Western Atlantic were killed by a water-borne pathogen that quickly spread through the region (Lessios *et al.* 1983). With the loss of this important herbivore, the Flower Gardens experienced an increase in algae cover of over 13% (Gittings and Bright 1986) over a one to two year period, posing a significant threat to coral colonies (algae cover was below 2.5% prior to that [CSA 1985]). But the ecosystem appeared to respond, apparently through increasing abundances of herbivorous fish, such as queen and stoplight parrotfish (Gittings *et al.* 1992b). Though algae levels fluctuate rapidly, they have generally remained low (below about 2%) since at least 1988.

Stress caused by coral bleaching has also been noted on the banks (Hagman and Gittings 1992), and is generally associated with anomalously warm summers when water temperatures rise above 30°C. In nearly every case, however, recovery of symbiotic algae followed, without coral tissue mortality (see also USDOI/MMS 1995).

The reefs have also experienced periodic invasion of exotic species. Reef fish censuses conducted since 1994 (Pattengill *et al.* 1997) have documented the immigration of yellowtail snappers and sergeant majors, species previously unknown or exceedingly rare on the banks. In both cases, it is likely that the presence of production platforms on the shelf edge, as well as mooring buoy placement, has enhanced migration for these species. The long term effects of these invasions remain to be determined.

Elasmobranch and turtle studies have demonstrated that the Flower Gardens may be critical habitat for hammerheads and some other sharks, which annually school over the banks; for juvenile manta rays, which frequent the banks and feed on plankton along the reef edges; and for turtles, some of which may live on the banks as sub-adults (Childs *et al.* 1996).

Spawning studies have shown that the Flower Gardens may have the most predictable and prolific spawning of any reefs in the Caribbean Province (Gittings *et al.* 1992a). The reefs provide enormous numbers of larvae that become available for recruitment of other natural or artificial reefs in the northwest Gulf of Mexico. It is not known to what extent spawning reflects reef health, but it is likely that community longevity can only be assured by the enhanced resilience provided by persistent reproduction.



## THE FUTURE OF MONITORING

The Flower Garden reefs provide important examples of the potential for compatibility between appropriately regulated hydrocarbon development and resource protection. Hydrocarbon production has been occurring for nearly 20 years in the immediate vicinity of the banks, yet the monitoring programs and related studies continue to attest to the apparent health of the ecosystem. Appropriate regulation by MMS in the early 1970s and vigilance by resource protection agencies and industry account for this success. It is vital, however, that monitoring continue, first to alert resource managers and operators when conditions change, and second, so that scientists and managers can be in a position to determine the cause of those changes. This is the only way to ensure objectivity and informed decision-making.

It is this author's opinion that it is time to again involve industry in the funding and oversight of monitoring at the Flower Gardens. The level of production around the Flower Gardens has risen dramatically over the past several years. The 4-Mile Zone currently contains 10 production platforms and approximately 161 km of pipeline (half of which are dedicated oil lines). There are 20 pipelines that either originate within, terminate within, or transit this zone. From 1984 to 1997, 13 pipelines were added to the 4-Mile Zone (K. Deslarzes, pers. comm.). Furthermore, it is more likely that an industry/government partnership would ensure continuity of the program, as well as provide for industry input on protocols and direction of the program, and ensure that all measures are being taken to address industry's need for relevant information related to the effects of their activities. Such a partnership would also remove barriers to emerging technologies that might otherwise be available through industry.

In my opinion, the highest quality monitoring program would be one that combines funding and expertise of federal agencies with resource protection authority over the Flower Gardens (NOAA, MMS and EPA), and operators in the 4-Mile Zone around the banks. A joint oversight group would make recommendations about program direction and other relevant issues.

## CONCLUSION

Thanks to thorough surveys conducted prior to industrial development, and long-term research efforts, more is known about the ecosystem of the Flower Garden Banks, and its condition, than most other geographically isolated coral reefs. Resource managers working on the Flower Gardens have seldom had to rely on subjective criteria on which to base management decisions. In nearly all cases, regulations have been based on interpretation of objective scientific data collected from the sites (Gittings *et al.* 1997).

Reliance of management on science is the life-blood of effective resource protection. The concept is not new, but even resource management authorities as established as the National Park Service have had difficulty implementing it (National Research Council 1992). It is critical that research and monitoring programs not only continue at the Flower Gardens, but that they evolve to address the challenges posed by changing patterns of use by industry, dive charters, fishers, and other visitors.

It is only through continued investigations of the banks and of related human activities that the goal of long-term protection can be realized.

#### REFERENCES

- Bright, T.J. and L.H. Pequegnat (eds.). 1974. Biota of the West Flower Garden Bank. Gulf Publishing Company, Book Division, Houston, Texas. 435 pp.
- Childs, J.N., E.L. Hickerson, and K.J.P. Deslarzes. 1996. Spatial and temporal resource use of the Flower Garden Banks by charismatic megafauna. Proc. 15th Information Transfer Meeting, December 1995. U.S. Dept. of Interior, Minerals Mgmt. Service, New Orleans, LA.. OCS Study 96-0056. pp 74-79.
- Continental Shelf Associates, Inc. 1985. Environmental monitoring program for Platform "A," Lease OCS-G-2759, High Island Area, South Extension, East Addition, Block A-389, near the East Flower Garden Bank. Rept. to Mobil Producing Texas and New Mexico, Inc., The Woodlands, TX. 353 pp. + appendices.
- Eakin, C.M., J.W. McManus, M.D. Spalding, and S.C. Jameson. 1997. Coral reef status around the world: Where are we and where do we go from here? Proc. 8th Int. Coral Reef Symp. 1:277-282.
- Gittings, S.R. and T.J. Bright. 1986. Assessment of coral recovery following an incident of anchoring damage at the East Flower Garden Bank, northwest Gulf of Mexico. Final Report to NOAA National Marine Sanctuaries Division. Contract No. NA85AA-H-CZ015. 45 pp.
- Gittings, S.R., G.S. Boland, K.J.P. Deslarzes, C.L. Combs, B.S. Holland, and T.J. Bright. 1992a. Mass spawning and reproductive viability of reef corals at the East Flower Garden Bank, northwest Gulf of Mexico. *Bull. Mar. Sci.* 51(3): 420-428.
- Gittings, S.R., G.S. Boland, K.J.P. Deslarzes, D.K. Hagman, and B.S. Holland. 1992b. Long-term monitoring at the East and West Flower Garden Banks. Final Rept. OCS Study/MMS 92-006. U.S. Dept. of Interior, Minerals Mgmt. Service, Gulf of Mexico OCS Regional Office, New Orleans, LA. 206 pp.
- Gittings, S.R., K.J.P. Deslarzes, D.K. Hagman, and G.S. Boland. 1992c. Reef coral populations and growth on the Flower Garden Banks, northwest Gulf of Mexico. Proc. 7th Int. Coral Reef Symp. 1:90-96.
- Gittings, S.R., C.L. Ostrom, and K.J.P. Deslarzes. 1997. Regulation by reason: Science and management in the Flower Gardens Sanctuary, northwest Gulf of Mexico. Proc. 8th Int. Coral Reef Symposium. 2:1967-1972.
- Hagman, D.K. and S.R. Gittings. 1992. Coral bleaching on high latitude reefs at the Flower Garden Banks, NW Gulf of Mexico. Proc. 7th Int. Coral Reef Symp. 1:38-43.

- Hudson, J.H. 1981. Growth rates of *Montastrea annularis*: a record of environmental change in Key Largo Coral Reef Marine Sanctuary, Florida. *Bull. Mar. Sci.* 31(2):444-459.
- Kennicutt, M.C., II, ed. 1994. Gulf of Mexico Offshore Operations Monitoring Experiment, Phase 1: Sublethal responses to contaminant exposure. Interim Rept., Year 1. OCS Study MMS 94-0005. U.S. Dept. of Interior, Minerals Mgmt. Service, Gulf of Mexico OCS Region, New Orleans, LA. 304 pp.
- Kraemer, G.P. 1982. Population levels and growth rates of the scleractinian corals within the *Diploria-Montastrea-Porites* zones of the East and West Flower Garden banks. M.S. Thesis, Texas A&M Univ., College Station, TX. 138 pp.
- Lessios, H.A., P.W. Glynn, and D.R. Robertson. 1983. Mass mortality of coral reef organisms. *Science* 182:715.
- National Research Council. 1992. Science and the National Parks. National Academy of Sciences, Washington, D.C. 122 pp.
- Pattengill, C.V., B.X. Semmens, and S.R. Gittings. 1997. Reef fish trophic structure of the Flower Gardens and Stetson Bank, NW Gulf of Mexico. *Proc. 8th Int. Coral Reef Symposium* 1:1023-1028.
- U.S. Dept. of Interior/Minerals Mgmt. Service. 1996. Long-term monitoring at the East and West Flower Garden Banks. Prepared by Continental Shelf Assoc., Inc. OCS Study MMS 96-0046. USDO, Minerals Mgmt. Service, Gulf of Mexico OCS Region, New Orleans, LA. 77 pp. + app.
- Viada, S.T. 1980. Species composition and population levels of scleractinian corals within the *Diploria-Montastrea-Porites* zone of the East Flower Garden Bank., northwest Gulf of Mexico. M.S. Thesis Dept. of Oceanography, Texas A&M University, College Station, TX. 96 pp.

---

Dr. Stephen R. Gittings has been Manager of the Flower Garden Banks National Marine Sanctuary since its designation in 1992. He has worked on the Flower Gardens since 1980. His expertise is in resource management, the establishment of coral reef monitoring programs, and in related areas of reef ecology. He earned a B.S. degree in biology at Westminister College (New Wilmington, Pa.) and M.S. and Ph.D. degrees in oceanography at Texas A&M University (College Station, Tex.).

## SESSION 2H

**COASTAL MARINE INSTITUTE, FATE & EFFECTS STUDY:  
A MINI SYMPOSIUM**

Co-Chairs: Dr. Robert Carney  
Dr. Pasquale Roscigno

Date: December 18, 1997

Presentation	Author/Affiliation
Introduction	Dr. Pasquale Roscigno Minerals Management Service Gulf of Mexico OCS Region
Determining the Fate of Oil and Gas Produced Water in an Open Water Estuarine System Using Salinity as a Conservative Tracer	Ms. Debra W. Woodall Dr. Robert Gambrell Dr. R. D. DeLaune Wetland Biogeochemistry Institute Center for Coastal, Energy and Environmental Resources Louisiana State University Dr. Nancy N. Rabalais Louisiana Universities Marine Consortium Mr. Charles B. Henry, Jr. Ms. Paulene O. Roberts Institute for Environmental Studies Center for Coastal, Energy and Environmental Resources Louisiana State University
Direct and Indirect Effects of Diesel Fuel on Microphytobenthos and Meiofauna in Saltmarsh Sediments	Dr. Kevin R. Carman Louisiana State University
The Influence of Petroleum Hydrocarbons on Marine Benthic Food Webs: Direct and Indirect Effects II	Dr. John W. Fleeger Louisiana State University

Development and Characterization of Sea  
Anemones as Bio-Indicators of  
Environmental Impact

Dr. Gary W. Winston  
Ms. L. M. Heffernan  
Department of Biochemistry  
Louisiana State University  
Dr. W. B. Stickle, Jr.  
Department of Zoology  
Louisiana State University

Biodegradation of Aromatic Heterocycles  
from Petroleum, Produced Water, and  
Pyrogenic Sources in Marine Sediments:  
Transformation Pathway Studies and  
Evaluation of Remediation Approaches  
(Manuscript not submitted)

Dr. W. James Catallo  
Louisiana State University

Use of Chemical Biomarkers for Identifying  
and Quantitating Oil Residues in the  
Environment

Mr. Charles B. Henry, Jr  
Dr. Edward B. Overton  
Institute for Environmental Studies  
Louisiana State University

## INTRODUCTION

Dr. Pasquale Roscigno  
Minerals Management Service  
Gulf of Mexico OCS Region

The MMS has tried to use the CMI to meet its needs for scientific information about the impacts of oil and gas activities on the marine ecosystems of the Gulf of Mexico. In the process, graduate students have been exposed to the exciting intellectual challenges found in studying the Gulf of Mexico. Another benefit is that faculty members have expanded their spheres of collaborations, both within and between academic disciplines, to try to answer the information needs of the MMS.

The MMS and LSU are confronted with the challenge of building a coherent program from a series of investigator-initiated studies. This mini-symposium is an acknowledgment of the success of this attempt. The papers presented here today are varied, but they all have benefited from close discussions and collaborations between LSU and the MMS. They all attempt to produce specific fundamental knowledge about issues of importance to the MMS.

Some studies were jointly proposed and integrated so that multifaceted issues were covered by investigators who collaborated closely on the experimental designs. Dr. Gary Winston's "Characterization of Sea Anemones as Bioindicators of Offshore Resource Exploitation" was originally proposed with two other projects proposed by Dr. John Fleeger and Dr. William Stickle. Dr. Stickle's work has been presented at previous ITMs. In all these cases, each study stands alone, but these studies were developed in a interdisciplinary environment that provides an enormous benefit in understanding a contaminant's effects on marine biota. The three studies together provide a basic understanding of the physiological components of biomarker responses and integrate both laboratory and field studies.

While these investigators focus on biomarker response at the biological and ecological levels, Dr. Edward Overton takes a complementary approach through his study: "Studying and Verifying the Use of Chemical Biomarkers for Identifying and Quantitating Oil Residues in the Environment." Finally, Ms. Debra Woodwell and Dr. Jim Catallo discuss Redox chemistry from two different perspectives.

---

Dr. Pasquale F. Roscigno is program manager for various research projects in the MMS Environmental Studies Program in New Orleans.

## DETERMINING THE FATE OF OIL AND GAS PRODUCED WATER IN AN OPEN WATER ESTUARINE SYSTEM USING SALINITY AS A CONSERVATIVE TRACER

Ms. Debra W. Woodall  
Dr. Robert Gambrell  
Dr. R. D. DeLaune  
Wetland Biogeochemistry Institute  
Center for Coastal, Energy and  
Environmental Resources  
Louisiana State University

Mr. Charles B. Henry, Jr.  
Ms. Paulene O. Roberts  
Institute for Environmental Studies  
Center for Coastal, Energy and  
Environmental Resources  
Louisiana State University

Dr. Nancy N. Rabalais  
Louisiana Universities Marine Consortium

### INTRODUCTION

Produced water, also known as waste water, oil field brine, or formation water, is a by-product of the production of oil and gas. As defined by the Louisiana Department of Environmental Quality (LDEQ) produced water is “the liquid and suspended particulate waste material generated by the processing of fluids brought to the surface in conjunction with the recovery of oil or natural gas from underground geologic formations or with underground storage of hydrocarbons” (LDEQ, 1989). The chemical composition of this waste water is dependent upon the underground geologic formation of origin. Most, however, are characterized by a variety of metals, hydrocarbons, radionuclides, and a great abundance of salts (Collins 1975).

Disposal methods of this waste water include discharging into surface waters from a point source. This disposal method has been practiced in the coastal environments of Louisiana since the mid 1920s (Woodall M.S. Thesis). Discharges to surface waters within Louisiana are governed by the LDEQ, Water Pollution Control Division. Presently, the LDEQ is acting under an emergency order to allow the continued discharge of oil and gas produced water in open water coastal systems until January 1999 (Hale 1997). Determining the fate and effect of such discharges, therefore, remains a major concern to many state and federal regulators.

The current field method used to determine the fate and effect of produced water in open water estuarine systems involves orienting sampling transects along major compass point directions (i.e., north, south, east, and west) extended from the point source discharge. The method of establishing a compass oriented transect (COT) was initially developed to assess the impact of drilling discharges assumed to disperse uniformly around a point source—a production platform—located in the “relatively monotonous benthic environment” of the Atlantic continental shelf (Robson *et al.* 1982; Carney 1987). It is possible, however, that this sampling design may be inappropriate for Louisiana’s complex hydrologic and geomorphologic estuarine systems, as well as for this non-uniformly dispersing pollutant.

The great abundance of salts found in produced water often results in a high density brine which sinks and can create a bottom plume. Boesch and Rabalais (1989) suggested that saline stratification in bottom waters may be used as a conservative tracer that will better enable the tracking of produced water. Tracking produced water and establishing a salinity stratification transect (SST) may provide a more accurate means of determining its fate and effect in open water estuarine systems.

Conventional CTD field instruments such as a Hydrolab have typically been used in past research to retrieve salinity data. Research completed by St. Pé (1990), however, concluded that produced water often formed a layer over the bottom sediments which was too thin to be measured with the Hydrolab. The conductivity/salinity sensor on a Hydrolab is located approximately 20 cm above the bottom of the instrument. A bottom plume thickness of less than 20 cm could, therefore, remain undetected. For the purposes of this research, a YSI Model 300 SCT was selected to retrieve salinity data, because its sensor could be lowered to within 1 - 2 cm of the sediment surface.

## RESEARCH OBJECTIVES

This research was designed to determine if a more accurate method than the COT approach could be established to detect the fate of produced water discharges in open water systems. There were two main objectives for this research project:

1. To determine if saline stratification in bottom and interstitial waters could be used to establish a SST;
2. To establish both a COT and a SST in an open water estuarine system determine which method was more accurate in detecting the fate of produced water.

To meet these objectives, the project was divided into two phases:

Phase 1. Preliminary field survey of two estuarine environments of small and large surface water areal extent to determine if produced water generated salinity stratification in bottom and interstitial waters could be detected;

Phase 2. Detailed field survey using both COT and SST methods at a produced water discharge site located in an open water estuarine system of greater surface water areal extent.

## PHASE 1

### General Research Design

The primary objective of the preliminary field survey was to determine if produced water salinity stratification in bottom and interstitial waters was present and could, therefore, possibly be used to establish a SST. A secondary objective was to understand the various factors that affect its presence. Because the coastal estuaries of Louisiana include a variety of hydrologic and geomorphologic settings, the preliminary field survey was designed to include two estuarine environments of small and large surface water areal extent. Field investigators from the LDEQ supplied a list of suggested



discharge sites along with a brief description of the discharge and the surrounding area. The two sites selected from this list for Phase 1 of the research included those discharging into a canal located in the Empire Oil and Gas Field, and a small, semi-enclosed bay located in the Manilla Village Oil and Gas Field.

The design strategy was to conduct the field surveys in order of increasing areal extent. This strategy allowed us to better understand the hydrodynamics of the effluent and affecting factors in the confines of the canal and then apply this knowledge to the small semi-enclosed bay. An additional purpose for this strategy was that it offered us the opportunity to modify the research design during the two preliminary field surveys as more was learned about the proper instruments and field methodology needed to detect the effluent. The experience gained and the data generated from the preliminary field surveys of Phase 1 were used for planning the detailed field survey completed in the Phase 2 study area containing the greater surface water areal extent—the small open bay.

### Empire Canal Site

The canal site selected was located at 29° 23' N and 89° 34' W in the Empire Oil and Gas Field (refer to Figure 2H.1). This site was stationed at the end of a 2.4 km long and approximately 15 m wide canal immediately east of (but not connected to) the Mississippi River. The canal was constructed in 1964 and has not been dredged since. Produced water has been discharged into this canal since the late 1960s. According to historic data, this site discharged approximately 8,000 barrels of produced water per day into the surface waters of this predominantly fresh water canal (Woodall M.S. Thesis; WP# 4231, OUTFL 001). Facility operators, however, suggested that at the time of our sampling, only 1,500 barrels of produced water were being generated and discharged daily into the canal. Analysis of the brine indicated a salinity of 97 ppt and an oil and grease content of 98 ppm.

### Sampling Station Selection

**Current Velocity Monitoring Stations.** The Empire Canal site was monitored for current velocity during the 25-hour period prior to field sampling. Two monitoring stations were established (indicated by an asterisk in Figure 2H.1). The first station was located 4 m from the discharge and later selected as the secondary sampling station of origin or secondary sampling station 1. The second monitoring station was located 8 m from the discharge (at approximately canal center) and later selected as initial sampling station A.

**Field Sampling Stations.** Field sampling stations in the canal were established using two approaches. Initially, sampling stations were established based on the single criteria of distance from discharge. To eliminate researcher bias, sampling stations were established by a researcher uninvolved with the present study but familiar with prior produced water research. The researcher established his first sampling station (station A) at a point similar to that which was used to measure current velocity during the 25-h period prior to field sampling. The researcher established all other sampling stations at approximately canal center. Although exact distances were not determined, each location was established at greater distances from the discharge (indicated by letters in Figure 2H.1). The



Figure 2H.1. Empire Canal Site. Sampling stations A through G were selected for initial sampling. Sampling stations 1 through 7 were selected for secondary sampling stations based on bottom water salinity stratification. Asterisks indicate stations selected for current monitoring.

researcher recorded depth and near-surface, mid-depth and bottom water salinity data. Sediment was collected for analysis of interstitial salinity and oil and grease concentrations.

A second approach for establishing field sampling stations involved similar distances, but only at points where salinity stratification could be detected. To initiate the sampling, a station of origin (sampling station 1) was established approximately 4 m from the discharge. This was the same station that was used to measure current velocity during the 25-h period prior to field sampling. To establish all other sampling stations, once the desired distance was realized, a small boat was paddled across the canal while dragging the salinity probe along the sediment-water interface. Secondary sampling stations were established at the point where salinity stratification could be detected (indicated by numbers in Figure 1). No elevated level of salinity was detected in conjunction with initial sampling station G; therefore, no secondary sampling station was established. With the exception of initial sampling station G and secondary sampling station 1 (station of origin), this method paired an initial sampling station to a secondary sampling station and served as a means to compare data. At each sampling station, depth and salinity data were recorded and sediment was collected for analysis of interstitial salinity and oil and grease concentrations.

#### Manilla Village Small, Semi-Enclosed Bay Site

The small, semi-enclosed bay site was located 29° 30' N and 89° 59' W in the Manilla Village Oil and Gas Field (refer to Figure 2H.2). Historic data (Woodall M.S. Thesis) indicated that the discharge began in 1984 (WP# 3070, OUTFL 001-2). Facility operators stated that 11,000 barrels of oilfield brine were discharged per day into the subsurface waters. Analysis of the brine indicated a salinity of 108 ppt and an oil and grease content of 366 ppm.

#### Sampling Station Selection

**Hydrographic and Current Velocity Monitoring Station Selection.** When approaching the greater surface water expanses at this site, it was decided to establish monitoring stations at locations that appeared to offer information regarding the hydrodynamics of the produced water plume. To accomplish this, a crude survey was completed of the site's bathymetric variants while noting the location of any salinity stratification. This was achieved by maneuvering a small motorized boat throughout the area while "walking" the depth stick with attached salinity probe across the sediment surface. Based on sampling station selection criteria, monitoring stations were established and marked with anchored buoys at four locations (indicated by numbers in Figure 2H.2). Station 1 was established approximately 4 m from the point source discharge. At the time of the survey, the depth of station 1 was approximately 2.15 m. Station 2 was situated at the greatest depth (approximately 1.9 m) of the eastern bay area that coincided with a natural channel entrance. This natural channel ran along the northeastern ends of the facility and exited through the northern portions of the study area. Station 3 was located in this exit and displayed the greatest depth (1.8 m) in the northern bay area. Station 4 was anchored west of the facility in an area exhibiting a depth greater than all other stations (2.20 m). Each station was monitored every two hours for a 25-h period. Hydrographic data were retrieved and current velocities were recorded .



Figure 2H.2. Manilla Village small, semi-enclosed bay site. Sampling stations are indicated by numbers.

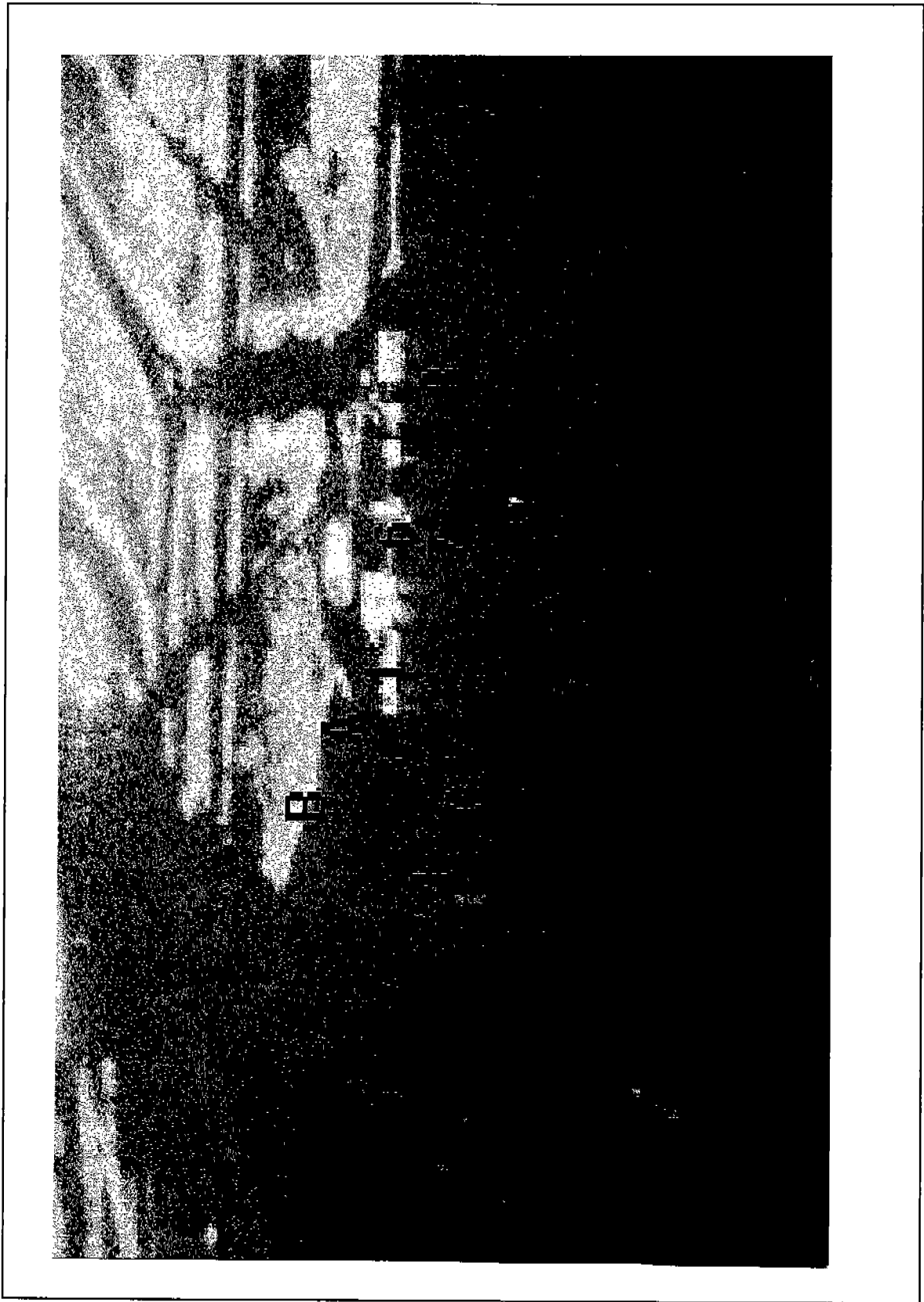

Figure 2H.3. Lake Washington small bay site. Sampling stations established using the COT method are indicated by letter. Sampling stations established using the SST method are indicated by number.

Field Sampling Stations. Field sampling stations in the small, semi-enclosed bay were established at locations similar to those established for hydrographic and current velocity measurements. Sediment was extracted for analysis of interstitial salinity and oil and grease concentrations.

## PHASE 1 RESULTS AND CONCLUSIONS

The data clearly indicated the presence of salinity stratification at the Empire site and the Manilla Village site and that the use of salinity as a conservative tracer served as a viable method to determine the fate of the produced water discharge. In addition, it was apparent that the density of the effluent had a profound influence on its behavior. At the Empire Canal site, current velocity measurements indicated that density differences resulting from the discharge of produced water created a plume current at a sampling station located 4 m from the discharge. The plume current at this location maintained a current heading and velocity independent of the canal's tidal current. Additionally, it was apparent that the greater density of the effluent caused it to flow as a stream across the bottom contours of the sediment and into the greater depths of the canal. Secondary sampling stations generally displayed these greater depths as well as a greater number and higher levels of contaminants than those displayed by initial sampling stations.

At the Manilla Village small, semi-enclosed bay site, the density of the effluent coupled with geomorphic and hydrologic factors greatly affected plume dilution and dispersion. A substantial and measurable plume was exhibited at all stations in the small, semi-enclosed bay. This might have indicated that the discharge volume exceeded the current's capacity to effectively dilute and disperse the effluent during the period of sampling. Observations and data suggested, however, that the "bowl-shaped" geomorphic depression resulting from depth variants effectively trapped the dense brine within the confines of the small, semi-enclosed bay while current velocities appeared to be too low to dilute and disperse the brine. Additionally, it was shown that the greater depths within the geomorphic depression maintained the greater plume depths.

Finally, there was strong evidence indicating that the instrument selected to detect salinity was critical to locating the plume in the canal. It was evident that the thin layer of the effluent stream, which remained within 1 - 2 cm of the sediment surface, would have been missed by conventional CTD field instruments (i.e., a Hydrolab). The YSI Model 300 SCT meter easily detected and tracked the fate of the plume.

## PHASE 2

### General Research Design

The primary objective of the detailed field survey was to establish a COT and a SST in an open water estuarine system to determine which method was more accurate in detecting the fate of produced water. The site selected for Phase 2 was a small bay located in the Lake Washington Oil and Gas Field. Method accuracy was confirmed by differentiating and comparing sediment contaminant levels because impacts by chronic point source discharges are more likely to be evident in the sediment. Analysis of sediment contaminants included interstitial salinity, oil and grease,

metals and radionuclides. Five extracts were analyzed by GC/MS for selected targeted ions indicative of oil pollution and by full scanning MS for general (semivolatile range) qualitative information. These extracts were taken from sediments associated with the 300 m sampling stations located on each oriented transect. A similar analysis was completed for the effluent.

### Lake Washington Small Bay Site

This production facility was located at the distal end of the Freeport Sulphur Canal at 29° 23' N and 89° 46' W in the Lake Washington Oil and Gas Field (refer to Figure 2H.3). Historic data indicated that this facility has been in constant production since 1965 (Woodall M.S. Thesis; WP# 2368, OUTFL 001). At the time of sampling, company officials stated that approximately 2,500 barrels per day were being generated and discharged into Rattlesnake Bayou. This bayou was situated immediately adjacent and parallel to the facility in a west-northwest and east-southeast direction. Analysis of the effluent indicated a brine salinity of 170 ppt and an oil and grease content of 68 ppm.

### Sampling Station Selection

Each transect method was limited for comparative purposes to a distance of 300 m extending from the point source discharge. A Trimble Differential GPS was used to record the location of each sampling station and determine its distance from the point source discharge. For the COT method, sampling stations were established 76, 152, and 300 m in the north, south, and west directions (indicated by letters in Figure 2H.3). Sampling stations were not established in the east direction due to the presence of marsh.

Sampling stations for the SST method were established at similar distances, but only at points where salinity stratification could be detected. Sampling station selection criteria for the SST method resulted in a transect located immediately adjacent and parallel to the facility and oriented in a west-northwest and east-southeast direction—similar to the location and direction of Rattlesnake Bayou. Salinity stratification was detected and sampling stations were established at 76, 152, and 300 m from the point source discharge in both directions. Additional sampling stations were established at 4 and 15 m from the discharge for analytical purposes (indicated by numbers in Figure 2H.3). At all sampling stations, depth and salinity data were recorded and sediment was collected for chemical analysis.

## PHASE 2 RESULTS AND CONCLUSIONS

Bottom water salinity concentrations determined for each method revealed expected differences between the COT and the SST stations. Concentrations of bottom water salinity at all COT sampling stations were similar to background bottom water salinity. Concentrations of bottom water salinity at all SST sampling stations were elevated above background.

Interstitial salinity concentrations, however, revealed unexpected results. Concentrations of interstitial salinity at all SST sampling stations were elevated above background. Interstitial salinity concentrations at three of the COT sampling stations (stations D, G, and H) also displayed elevated

concentrations of interstitial salinity. Field observations and a review of depths and sampling station locations suggested that these three stations were, most likely, situated within the confines of Rattlesnake Bayou and often associated with and affected by the produced water plume.

Results of the GC/MS analysis indicated that the abundance and range of selected aromatic hydrocarbons displayed petroleum influences in all extracts. The total targeted aromatic hydrocarbon (TTAH) concentrations varied from 0.33 ppm to 18 ppm (refer to Table 2H.1).

Table 2H.1. Total target aromatic hydrocarbons from the produced water and sediments of stations located 300 meters from the point source discharge on COT and SST transects with their corresponding Fossil Fuel Pollution Index value.

Station ID	TTAH (ppm)	FFPI**
Produced Water	0.33	0.9271
<u>COT</u>		
Station C	11.0	0.4845
Station F	4.7	0.7455
Station I	3.3	0.7011
<u>SST</u>		
Station 5	18.0	0.8017
Station 9	11.0	0.8204
** Modified Fossil Fuel Pollution Index (FFPI)		

The analyzed sediment extracts contained a mixture of combustion by-products and petroleum at various stages of environmental alteration. The Fossil Fuel Pollution Index (FFPI) value compares the petroleum contribution to the combustion contribution for all extracts (Boehm and Farrington 1984). Those results closest to 1 contained the highest abundance of petroleum. In the selected study site, the primary source of petroleum input was from the produced water point source discharge. The produced water extract contained the highest percentage of petroleum. Station C contained the greatest abundance of combustion by-products, greater than the oil content. Data indicated that the highest petroleum concentrations resulting from produced water input were not found along the standard coordinates used to establish the COT. The highest TTAH values and the most petroleum from produced water input were located at stations established using the SST method.



Further determination of method accuracy is planned through the differentiation and comparison of sediment contaminant levels of oil and grease, various metals, and radionuclides. Preliminary results do suggest, however, that using salinity stratification in bottom and interstitial waters to establish an SST provided a more accurate method in detecting the fate of produced water in this estuarine system.

#### REFERENCES

- Boehm, P.D. and J.W. Farrington. 1984. Aspects of polycyclic aromatic hydrocarbon geochemistry of recent sediments in the Georges Bank Region. *Environmental Science and Technology* 18:11, 840-845.
- Boesch, D.F. and N.N. Rabalais, editors. 1989. Environmental impact of produced water discharges in coastal Louisiana. Report to La. Div. Mid-Continent Oil and Gas Association. LUMCON, Chauvin, La. 287 p.
- Carney, Robert S. 1987. A review of study designs for the detection of long-term environmental effects of offshore petroleum activities, pp. 651-696. *In* D.F. Boesch and N.N. Rabalais. Long-term environmental effects of offshore oil and gas development. New York, N.Y.: Elsevier Science Publishing Co., USA.
- Collins, A.G. 1975. Geochemistry of oilfield waters. Developments in petroleum science 1. Elsevier Publishing Co., New York, 946 p.
- Hale, Douglas. 1997. Environmental Specialist Coordinator, Coastal Wetlands Permitting Section, Office of Water Resources, Department of Environmental Quality. Baton Rouge, Louisiana.: Personal Interview by Debra Woodall. January, 1997.
- LDEQ. 1989. Louisiana Department of Environmental Quality "Naturally-occurring radioactive materials associated with the oil and gas industry." An informational brief prepared for the Louisiana House of Representatives and Louisiana Senate Committees on Natural Resources by the Office of Air Quality and Nuclear Energy. Baton Rouge, La.
- Robson, D.S., C.A. Menzie and H.F. Mulligan. 1982. An environmental monitoring study to assess the impact of drilling discharges in the mid-Atlantic. II. An experimental design and statistical methods to evaluate impacts on the benthic environment. *In* EG&G, Environmental Consultants, A Study of Environmental Effects of Exploratory Drilling on the Mid-Atlantic Outer Continental shelf - Final Report of the Block 684 Monitoring Program. Prepared for Offshore Operators Committee, Exxon Production Research Company, by EG&G, Environmental Consultants, Waltham, Massachusetts.
- St. Pé, Kerry, editor. 1990. An assessment of produced water impacts to low-energy, brackish water systems in southeast Louisiana. Louisiana Department of Environmental Quality, Water Pollution Control Division. Baton Rouge, La.

Woodall, Debra W. *In press*. Determining the fate of oil and gas produced water in an open water estuarine system using salinity as a conservative tracer. M.S. Thesis. Louisiana State University, Baton Rouge, La.

---

Debra W. Woodall is a graduate student working toward her M.S. in oceanography and coastal sciences. She received a B.S. in geology from Louisiana Tech University in 1994 and a B.A. from Northeast Louisiana University in 1979. Research interests include environmental impact assessment of oil and gas operations.

Dr. Robert Gambrell is a professor in the Wetland Biogeochemistry Institute at Louisiana State University. Educated at Clemson and North Carolina State Universities, he came to LSU in 1974. His area of expertise is wetland soil processes and the environmental chemistry of wetland soils and sediment-water systems.

Dr. R.D. DeLaune has worked for Louisiana State University for over 25 years and serves as a Professor in the Wetland Biogeochemistry Institute. He received his Ph.D. from Wageningen University, The Netherlands. His research interests include wetland environmental chemistry and global biogeochemical cycles.

Dr. Nancy Rabalais is a professor at the Louisiana Universities Marine Consortium, LUMCON, where she has been since 1983. She graduated from the University of Texas at Austin with a Ph.D. in zoology in 1983. Her professional expertise includes continental shelf ecosystems, dynamics of low oxygen environments, and the effects of oil and gas operations.

Charles Henry has been a research associate in the Institute for Environmental Sciences at LSU since 1985 specializing in analytical chemistry. He is an LSU graduate, having received a M.S. in marine sciences. He is highly experienced in oil spill studies ranging from the Persian Gulf to the Exxon Valdez and the Mega Borg.

Paulene Roberts is a research associate for the Institute for Environmental Sciences at LSU. She graduated from the University of Alaska, Anchorage, receiving a B.S. in chemistry. Her area of expertise is analytical chemistry and has worked in the field of analytical and petroleum chemistry since 1990.

## DIRECT AND INDIRECT EFFECTS OF DIESEL FUEL ON MICROPHYTOBENTHOS AND MEIOFAUNA IN SALTMARSH SEDIMENTS

Dr. Kevin R. Carman  
Louisiana State University

### OBJECTIVES

The broad objective of this research is to determine the mechanisms by which diesel contaminants alter microphytobenthos and meiofauna in saltmarsh sediments. Specific objectives are to (1) determine if algal blooms in contaminated sediments are the result of altered nutrient availability in diesel-contaminated sediments, or of a reduction in meiofaunal grazing pressure; (2) determine if mortality of most meiofaunal copepods in contaminated sediments is from direct toxicity from diesel, development of anoxic conditions, or growth of toxic algae; (3) determine if *Cletocamptus deitersi* (a meiofaunal copepod) and nematodes thrive in contaminated sediments because of reduced competition from other species or exploitation of altered algal resources.

### APPROACH

Experiments were performed to determine the effects of diesel-contaminated sediment on microalgal-meiofaunal interactions. Microcosms of natural sediment were defaunated, then manipulated to control meiofaunal abundance and species composition, as well as diesel contamination. Comparison of defaunated microcosms vs. microcosms with meiofauna were used to determine if reduced grazing and/or altered nutrient availability causes algal blooms in diesel-contaminated sediments. Toxicity tests were used to determine interspecific differences in sensitivity to diesel and oxygen depletion. The potential influence of diesel contamination on competitive interactions between *Cletocamptus deitersi* and other copepods and between copepods and nematodes as a group was examined by determining grazing rates following experimental manipulation of relative abundances of meiofaunal taxa.

### PROGRESS

Experimental work has been completed concerning all three of the identified objectives.

#### Objective 1

Sediment microcosms from which grazers larger  $> 125 \mu\text{m}$  were removed demonstrated an increase in algal biomass that was equivalent to that of diesel-contaminated sediment. This result clearly implicates grazing as a primary control mechanism for benthic algal biomass. It is also possible that nutrient availability is altered in diesel-contaminated sediment, which could stimulate algal biomass under nutrient-limiting conditions. Thus, we performed microcosm experiments to determine the influence of diesel contamination on nitrogen ( $\text{NH}_4^+$ ) availability. Results indicate that the natural algal community is not nitrogen limited ( $\text{NH}_4^+$  additions did not stimulate growth), but that  $\text{NH}_4^+$  flux

from contaminated sediments is enhanced following approximately 14 days of exposure to diesel. All of the excess  $\text{NH}_4^+$  in contaminated sediments is removed by the rapidly growing algal assemblage. Collectively, our observations indicate that algal blooms in diesel-contaminated sediment are initially stimulated by release from grazing pressure; the increased algal biomass becomes N-limited over a period of 1-2 weeks, and a second phase of algal growth is supported by the enhanced flux of N from contaminated sediments.

#### Objective 2

Toxicity tests with several copepod species clearly indicate that the toxic effects of diesel and anoxia strongly interact: In general, copepods were much more sensitive to the effects of anoxia when exposed to diesel contaminants.

#### Objective 3

In diesel-contaminated sediments, most copepod species suffer high mortality, but *Cletocamptus deitersi* and nematodes do not; the latter taxa also exhibit enhanced grazing rates in contaminated sediments. Experimental simulations of this altered meiofaunal community show that enhanced grazing rates by *C. deitersi* and nematodes are a result of release from competition, and possibly a functional response to enhance food availability.

---

Kevin R. Carman received his Ph.D. in biological oceanography from Florida State University in 1989. He was a Postdoctoral Fellow at Louisiana State University from 1989-1991. He joined the faculty at LSU as an assistant professor in the Department of Zoology & Physiology in 1991, and is currently an Associate Professor in the Department of Biological Sciences at LSU. He serves as an editorial advisor for *Aquatic Microbial Ecology* and received the Basic Sciences Faculty Research Award at LSU in 1996.

## THE INFLUENCE OF PETROLEUM HYDROCARBONS ON MARINE BENTHIC FOOD WEBS: DIRECT AND INDIRECT EFFECTS II

Dr. John W. Fleeger  
Louisiana State University

The effects of PAH on an estuarine food web (microbes, meiofauna and fish) have been examined in a series of microcosm and laboratory experiments. The experiments involved adding poly-nuclear aromatic hydrocarbons (PAH) in the form of produced water and diesel fuel to mudflat sediments (Carman *et al.* 1995; Carman and Todaro, 1996; Gregg *et al.* 1997; Carman *et al.* 1997; Hinkle-Conn *et al.* 1998). The results of these studies suggest that the addition of PAH simultaneously causes direct effects (those associated with contaminant influences on survivorship or mortality) and indirect effects (effects due to an influence of PAH on other biota or physical factors). Indirect effects seem very likely in regard to observed changes in chlorophyll *a* content (as a measure of the microalgal community biomass) and in changes in meiofaunal community structure and grazing rate. This report focuses on additional experiments conducted to examine indirect effects on changes in the community structure and on grazing rate by meiofauna.

The experiments showed that abundance of meiobenthic copepods (especially *Coullana* sp. and *Pseudostenhelia wellsi*, which are typically co-dominants in Louisiana mudflat sediments) were significantly reduced in as little as seven days at PAH concentrations of about 50 ppm in experimental microcosms. However, one species, *Cletocamptus deitersi*, increases in abundance (Carman *et al.* 1997). Follow-up experiments were designed to determine if *Cletocamptus* is more tolerant of the high contaminant levels or if *Cletocamptus* is more tolerant of the combination of high contaminants and low oxygen.

Our previous experiments found that hypoxia is more likely to occur in microcosms with added PAH because PAH acts as an organic substrate for bacterial growth (Carman *et al.* 1996). Experiments were conducted using the techniques of Lotufo (Lotufo and Fleeger 1996; Lotufo 1997; Lotufo and Fleeger 1997), studies funded by MMS. 96-h LC<sub>50</sub> tests were conducted for *Coullana* sp., *Pseudostenhelia wellsi* and *Cletocamptus deitersi* using diesel fuel as the contaminant. In addition, these tests were conducted under conditions of normoxia (about 50% saturation) and near anoxia (near 0% saturation). The results are shown below (values are in ppm),

	“Normoxic”	“Anoxic”
<i>Cletocamptus</i>	138	42
<i>Pseudostenhelia</i>	79	<< 32
<i>Coullana</i>	112	63

and they suggest that *Pseudostenhelia wellsi* is very sensitive to the combination of contaminants and low oxygen. However, *P. wellsi* and *C. deitersi* have similar tolerances in normoxic and hypoxic conditions.

Life style may explain the lack of a difference in toxicological response given the significant mortality suffered by *Coullana* but not *C. deitersi* in microcosms. *Coullana* is a surface feeder, filtering algae as it settles from the water column but *C. deitersi* feeds on sediment diatoms near the sediment-water interface (Pace and Carman 1996). It seems likely that *Coullana* is exposed to contaminants by the addition of PAH in the form of contaminated sediments. Thus, the indirect effects of hypoxia appear to be important for one of the three species tested.

A second experiment tested for the effects of interspecific competition on grazing rates among meiofauna. Microcosm experiments showed that *Cletocamptus* grazing rates on microalgae increases after 14-28 d and that grazing rates for nematodes increases from 7-14 d. Because potential competitors are eliminated by PAH, it is possible that a release from interspecific competition (rather than direct contaminant effects) could be responsible. We removed ambient copepods from sediment cores by sieving the top 1 cm of field-collected cores through a 0.125 mm screen. Nematodes pass through this screen. Material passing through the screen was returned to the cores. Material retained was separated into two groups (half were microwaved to kill copepods and half were undisturbed) and then returned to the cores. Thus, some cores received living, ambient copepods and some dead copepods; no PAH were added. To some cores, a known number of living *Cletocamptus* were added.

Experiment 1 examined grazing rates by *Cletocamptus* with and without ambient copepods (mostly *Coullana* and *Pseudostenhelia*). Experiment 2 examined the influence of ambient copepods (again mostly *Coullana* and *Pseudostenhelia*) on grazing by nematodes, specifically the most abundant species *Ptycholaimellus* sp. *Ptycholaimellus* sp. typically comprises 30-60% of the nematode community at the study site. Cores were incubated for three days and then grazing rates were measured by the methods of Carman *et al.* (1997). Grazing rates for both *Cletocamptus* and *Ptycholaimellus* sp. increased without ambient copepods: for *Cletocamptus* with copepods, grazing was 5.15 ng chl/ind/6h and for *Cletocamptus* without copepods, grazing was 8.50 ng chl/ind/6h. For *Ptycholaimellus* with copepods, grazing was 1.13 ng chl/ind/6h and for *Ptycholaimellus* without copepods, grazing was 4.68 ng chl/ind/6h.

Thus, some of the increase in grazing rates may be explained by the release from interspecific competition for limiting food resources (benthic microalgae) that occurs when contaminants are added to microcosms. These experiments are preliminary, and future experiments will test for the confounding effect of increased food levels on grazing rates. A functional response is possible and increases in grazing may also be a function of higher food levels.

Our results suggest that indirect effects may be much more important than previously thought in contaminated sites. Hypoxia may combine with contaminants to heighten effects, and a release from competition may follow selective mortality associated with the addition of contaminants.

## REFERENCES

- Carman, K.R., J.W. Fleeger, J.C. Means, S. Pomarico and D.J. McMillin. 1995. Experimental investigation of the effects of polynuclear aromatic hydrocarbons on an estuarine sediment food web. *Mar. Environ. Res.* 40: 289-318.
- Carman, K.R., J.W. Fleeger and S. Pomarico. 1997. Response of a benthic food web to hydrocarbon contamination. *Limnol. Oceanogr.* 42: 561-571.
- Carman, K.R., J.C. Means and S. Pomarico. 1996. Response of sedimentary bacteria in a Louisiana salt marsh to contamination by diesel fuel. *Aquatic Microbial Ecology* 10: 231-241.
- Carman, K.R. and M.A. Todaro. 1996. Influence of polycyclic aromatic hydrocarbons on the meiobenthic- copepod community of a Louisiana salt marsh. *J. Exp. Mar. Biol. Ecol.* 198: 37-54.
- Gregg, J.C., J.W. Fleeger and K.R. Carman. 1997. Effects of suspended, diesel-contaminated sediment on feeding rate in the darter goby, *Gobionellus boleosoma* (Teleostei: Gobiidae). *Mar. Poll. Bull.* 34: 269-275.
- Hinkle-Conn, C., J.W. Fleeger, K.R. Carman and J.C. Gregg. 1998. The effect of sediment-amended polycyclic aromatic hydrocarbons on feeding behavior in juvenile spot (*Leiostomus xanthurus*: Pisces). *J. Exp. Mar. Biol. Ecol.* In press:
- Lotufo, G.R. 1997. Toxicity of sediment-associated PAHs to an estuarine copepod: effects on survival, feeding, reproduction and behavior. *Mar. Environ. Res.* 44: 149-166.
- Lotufo, G.R. and J.W. Fleeger. 1996. Toxicity of sediment-associated pyrene and phenanthrene to *Limnodrilus hoffmeisteri* (Oligochaeta: Tubificidae). *Environ. Toxicol. Chem.* 15: 1508-1516.
- Lotufo, G.R. and J.W. Fleeger. 1997. Effects of sediment-associated phenanthrene on survival, development and reproduction of two species of meiobenthic copepods. *Mar. Ecol. Prog. Ser.* 151: 91-102.
- Pace, M.C. and K.R. Carman. 1996. Interspecific differences among meiobenthic copepods in the use of microalgal food resources. *Mar. Ecol. Prog. Ser.* 143: 77-86.

---

John Fleeger has been associated with Louisiana State University since 1977, as Chair of the Department of Zoology and Physiology from 1991 until 1997 and currently as a professor and Associate Chair of the Department of Biological Sciences. He received his B.A. degree from Slippery Rock University, his M.S. from Ohio University, and his Ph.D. from the University of South Carolina.

## CHARACTERIZATION OF SEA ANEMONES AS BIOINDICATORS OF OFFSHORE RESOURCE EXPLOITATION

Dr. G. W. Winston  
Ms. L. M. Heffernan  
Department of Biochemistry  
Louisiana State University

Dr. W. B. Stickle, Jr.  
Department of Zoology  
Louisiana State University

This work characterizes the biochemical responsiveness of sea anemones for use in environmental monitoring programs. We have examined known stress-related parameters that can provide environmental managers, researchers and regulatory agencies with (1) sublethal, early warning detection signals of environmental stress, (2) a means of demonstrating, assigning and delineating zones of ecological impact from point- and nonpoint-source pollution; and (3) quantifiable biomarkers of integrative stress load and ecological health through characterization of biochemical responses with high potential for assessing the limits of natural and inadvertent stress.

A biomarker is a change in a biological response that can be related to an exposure to, or toxic effect of, an environmental chemical or chemicals (McCarthy and Shugart 1990). Detection and evaluation of biological changes caused by exposures to various chemicals are important with respect to the significance of contaminant exposure. Certain biological changes can indicate exposure to specific chemicals or adverse effects of exposures. A biological response can range from molecular (biochemical) responses, through behavioral responses, to changes in species composition effecting populations and ecosystems.

Biomarkers have potential for a number of applications that could benefit regulatory agencies. The use of biomarkers might be envisaged on several levels: (1) establishing cause associated with an observed malady in organisms, populations or communities; (2) documenting exposure to organisms, including the range and zones of delineation of that exposure; (3) documenting the effects (reversible or irreversible) caused by contamination to organisms, populations or communities.

The basis of biomarker research may have its roots in the biochemistry, physiology, behavior, systematics and population dynamics of organisms. These integrated relationships are illustrated in Table 2H.2 in the context of the limits of understanding that biomarker research can provide. Thus, for any given set of response parameters under any level of organization (biochemical, organismic, population or community), there is an inverse hierarchy of the sensitivity of the response and the ecological relevance of the response. Thus, information on the ecological relevance of a response may be at the sacrifice of sensitivity and vice versa.



Table 2H.2. Integrated Relationships of Biomarkers and Levels of Biological Organization.

	Biochemical	Organismic	Population	Community
Response Parameter	MFO	behavior	energy flow	abundance
	hsp	growth	interspecific interactions	diversity
	SOD	reproduction	abundance	
	DNA	survivorship		
Response Time	hrs	hrs/days	weeks/mos/ yrs	mos/ yrs

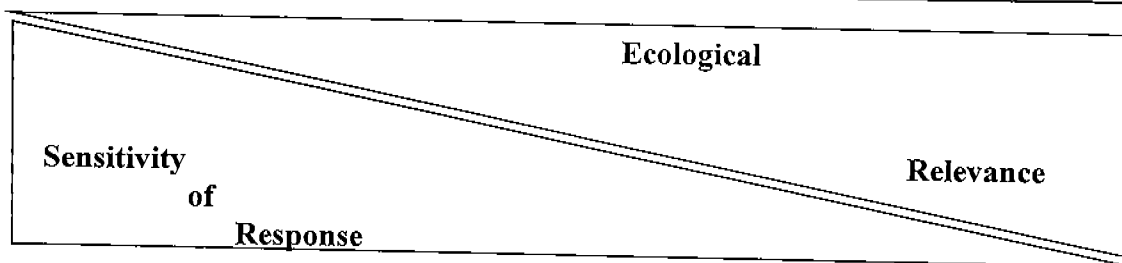

There are two major advantages of using biochemical level changes as biomarkers of environmental contamination; 1) they are generally the first responses to contamination that can be detected and quantified, and 2) biochemical changes can reflect both exposure and effect, i.e. a change in the biochemistry of an organism upon exposure to a chemical *is an effect*. Our research examined the responsiveness of two classes of proteins to organic and metal exposures. The first class of proteins are those of the *cytochrome P450-dependent microsomal monooxygenases*, a complex membrane-associated, multienzyme family of critical importance in both the detoxification and activation of xenobiotic chemicals. A classic feature of cytochromes P450 in many organisms is their induction by xenobiotic chemicals. Induction of P450 by chemicals involves *de novo* synthesis of mRNA and its translation to P450 protein. This ability to be induced by chemicals has prompted great interest in the characterization of cytochromes P450 as potential biomarkers for environmental pollutants (Stegeman *et al.* 1992). The other class is the *stress proteins* or *heat shock proteins*, which are also induced by various chemical agents and as well by other stress factors such as heat or oxidative stress. Growing evidence suggests that these proteins protect other proteins and nucleic acids from environmental damage. Their usefulness as biomarkers is therefore as determinants of the degree to which the organism is trying to protect itself from environmental stress (Sanders *et al.* 1990).

The present summary is of preliminary studies of the cytochrome P450 and heat shock protein response in certain species of sea anemones to the model polycyclic aromatic hydrocarbon, 3-methylcholanthrene and to Cd. All biomarkers of exposure and effect ultimately have to meet two

important criteria. First, the response must be of sufficient sensitivity to be detectable and quantifiable at environmentally relevant exposure levels. Secondly, the biomarker response be sustained over time. Before such criteria are met in field studies, it is necessary to identify whether certain chemicals can indeed elicit a biochemical response. To that end, initial studies used acute exposures to concentrations of toxicant that may be higher than in specific environmental situations but well below that which causes noticeable stress at the organismic level.

Sea anemones have several advantages as sentinels for pollution exposure; they actually inhabit oil platforms, are stationary (sessile), are ubiquitous and perhaps most importantly, can be easily cloned in the laboratory to generate genetically homogeneous populations thus, eliminating genetic variability in biomonitoring responses. Furthermore, because anemones have evolved to only the tissue level of development, biochemical responses in this organism reflect that of only a few cell types. By analogy, the response would be similar to an organism with one basic organ type. Thus, we could use the whole organism for biochemical assays rather than having to dissect organs and characterizing each within several species. Sea anemones in particular, through their action of pumping water throughout their bodies, are continually replenishing the body burden and thus, continually bioaccumulating pollutants.

Western blot (immunochemical) analysis of microsomal fractions *Aiptasia pallida*, *Anthopleura elegantissima* and *Bunodosoma cavernata* were studied to characterize the presence of specific antigenic proteins in microsomes of these anemone species (Figure 2H.4) Anti-trout P450 LMC2 (CYP 2K 1), a P450 isozyme involved in steroid and fatty acid metabolism, recognizes a very intense band in sea anemone microsomes (10 lig per well), at approximately 39 KDa in two of the species, i.e. *Anthopleura elegantissima* and *Bunodusoma cavernala*. *Aiptasia palluda*, contains a protein that is strongly recognized by anti-LMC2 at about 67 KDa with a fainter band also seen at about 50 KDa. Anti-LMC2 was also strongly immunoreactive with a protein in rat microsomes in the 50 KDa range, i.e. the expected range for cytochrome P450. These data suggest unique proteins in sea anemones with epitope regions similar to those of higher vertebrates, e.g., fish and mammals. Future studies will focus on the responsiveness of these proteins to xenobiotic challenge.

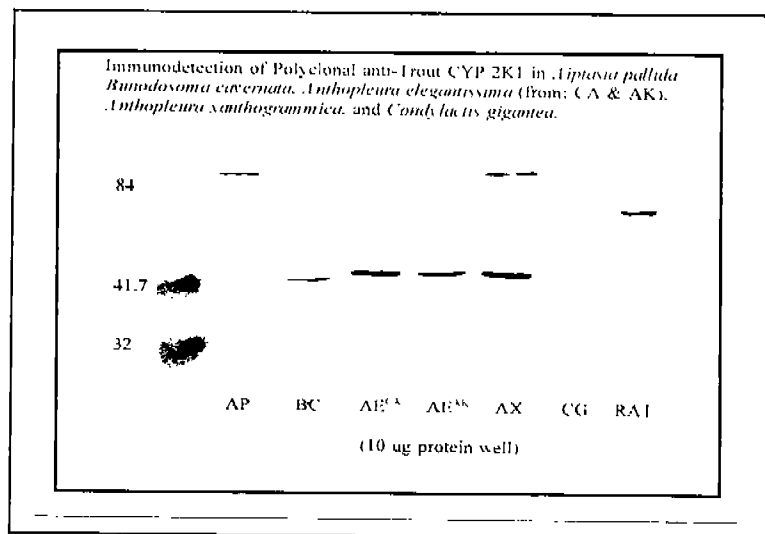

Figure 2H.4. Immunodetection of polyclonal anti-trout CYP2K1 in *Aiptasia pallida*, *Bunodosoma cavernata*, *Anthopleura elegantissima* (from: CA & AK), *Anthopleura xanthogrammica* and *Condylactis gigantea*.

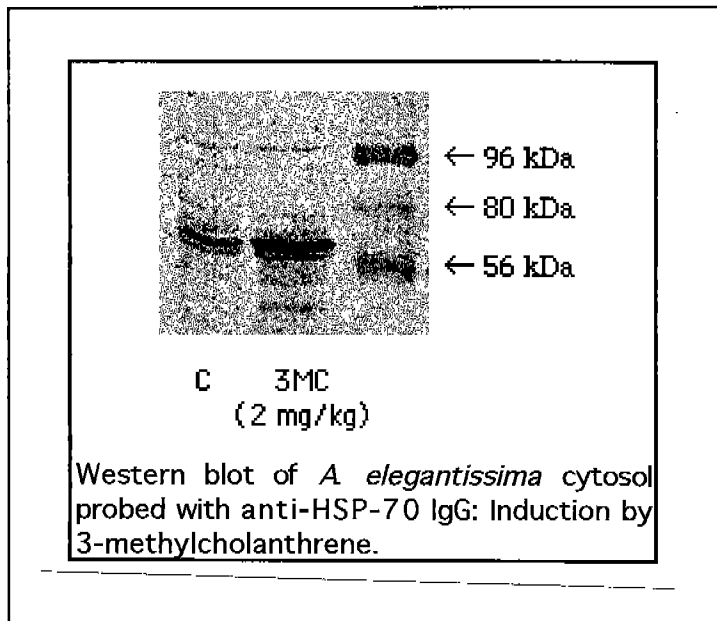

Figure 2H.5. Western blot of *A. elegantissima* cytosol probed with anti-HSP-70 IgG: Induction by 3-methylcholanthrene.

Analyses of cytosolic fractions were conducted to assess the presence of possible stress or heat shock proteins in these organisms. Results of these studies will help focus on target proteins as potential biomarkers of environmental contamination. Exposure of anemones to the model polynuclear aromatic hydrocarbon, 3-methylcholanthrene (3MC) and cadmium caused an increase in a protein band of approximately 70KDa which was recognized in anemone cytosolic fractions by a monoclonal anti-Heat Shock Protein 70 IgG (Figure 2H.5).

To the best of our knowledge, this is the first demonstration of induction by a polycyclic aromatic hydrocarbon and cadmium in the sea anemone. A protein of about 90KDa that cross-reacted with a monoclonal anti-heat shock protein 90 IgM was also present in anemone cytosol (data not shown), albeit this protein did not appear to be induced by exposure to either 3MC or cadmium. A striking result was the induction of an immunoreactive protein band of about 90 KDa by exposure to 25 and 250  $\mu\text{g/liter}$  of  $\text{CdCl}_2$  that was recognized by a monoclonal antibody raised against scup CYP 1A1. Cadmium also induced a protein of about 96 KDa that was recognized by a trout polyclonal antibody to CYP 3A1 (Figure 2H.6). This isoform is steroid-inducible in mammals. Further studies will explore the effects of metal exposure on these proteins.

Finally, incubation of benzo{a}pyrene (B[a]P) with microsomes from the intertidal sea anemone results in the production of oxidative metabolites of B[a]P consistent with an active P450-dependent MFO system (Figure 2H.7). These results are consistent with other studies describing cytochromes P450-catalyzed oxidations of B[a]P by marine invertebrates. Although the metabolic profiles observed in this study are likely

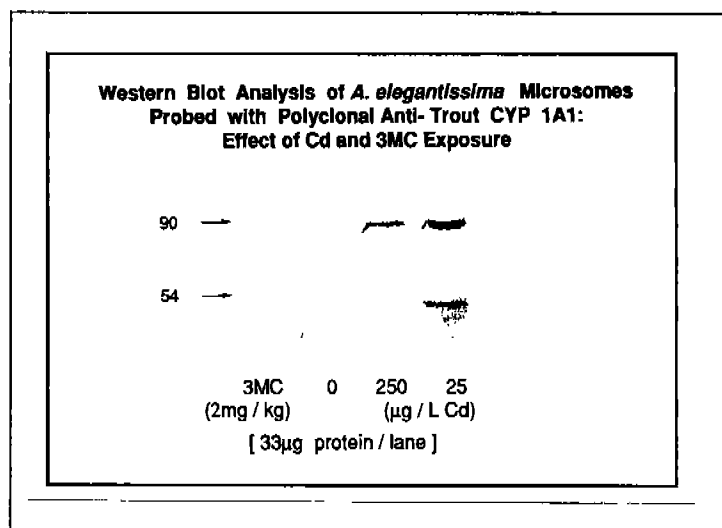

Figure 2H.6. Western blot analysis of *A. elegantissima* microsomes probed with polyclonal anti-trout CYP 1A1: effect of Cd and 3MC exposure.

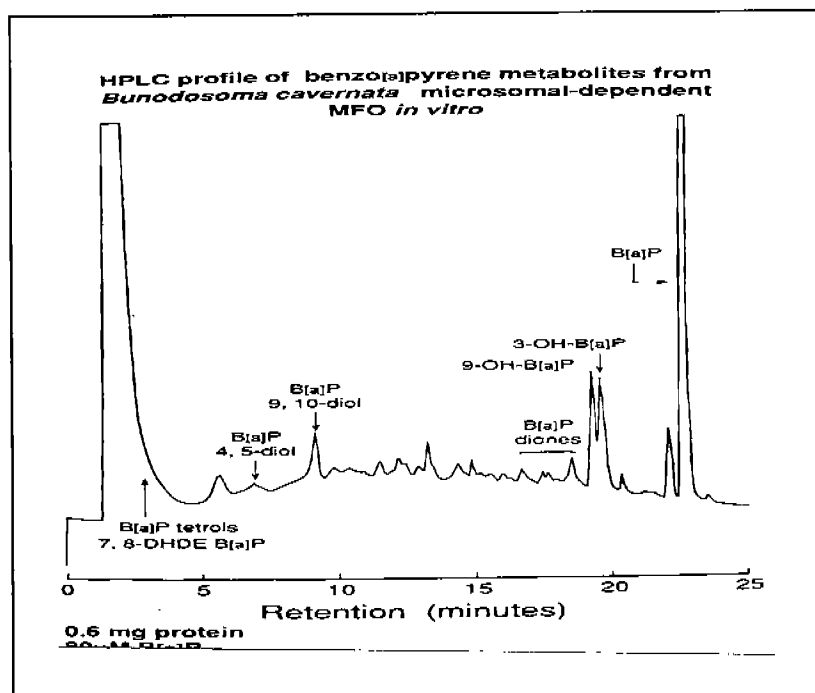

Figure 2H.7. HPLC profile of benzo[a]pyrene metabolites from *Bunodosoma cavernata* microsomal-dependent MFO *in vitro*.

unique to this species, these data strongly indicate a functioning cytochromes P450-dependent MFO system in *B. cavernata* and probably other species of anemones as well as other Cnidarians.

In conclusion, sea anemone species show significant potential as sentinel organisms with respect to biological endpoints. Although biochemical responses are the most rapid to obtain and the most sensitive, is recognized that they are of limited ecological relevance. Thus, a suite of biomarkers would promote the most comprehensive evaluation of the impact of environmental upsets, whether natural or inadvertent. This evaluation is important if regulatory agencies are to be able to assess the impact

of ecological perturbations on the higher levels of ecosystem development such as the population or community level. Conversely, ecosystem diversity has highly ecological relevance but suffers disadvantages in the time-frame to collect information and in the sensitivity of the response.

#### REFERENCES

- Livingstone, D.R. Responses of microsomal NADPH-cytochrome c reductase activity and cytochrome P-450 in digestive glands of *Mytilus edulis* and *Littorina littorea* to environmental and experimental exposure to pollutants: 46: 37-43. Mar. Ecol. Prog. Ser.
- McCarthy, J., and L. Shugart. 1990. Environmental Biomarkers. Chelsea, MI.: Lewis Publishers.
- Sanders, B.M. 1990. Stress proteins: Potential as multitiered biomarkers. pp. 165-191. In Shugart, L., McCarthy, J., (eds.), Chelsea, MI.: Lewis Publishers.
- Stegeman, J.J., M. Brouwer, R.T. Di Giuho, L. Forlin, B.A. Fowler, B.M. Sanders, and P.A. Van Veld. 1992. Molecular responses to environmental contamination: Enzyme and protein systems as indicators of chemical exposure and effect. pp.235-335. In Hugget, R.J., Kimerle, R.A., Mehrle, P.M., Jr., Bergman, H.L. (eds.). Chelsea, MI.: Lewis Publishers.

Dr. Gary Winston was recently appointed as Head of the Department of Toxicology at North Carolina State University, a position that followed 13 years in the Department of Biochemistry at Louisiana State University where he was Chairman from 1990 to 1997. His areas of research are xenobiotic and oxidative stress in marine and aquatic organisms and biomarkers of environmental contamination. He was an invited participant and facilitator to the NATO Advanced Research Workshop on Biological Markers, Netherlands Institute for Sea Research, Texel, the Netherlands, 1991. Dr. Winston received his B.S. in biology from the University of Florida, his M.S. in behavioral studies from Florida Atlantic University and his Ph.D. in biochemistry from the University of Nevada.

Ms. Linda Hefteman is a graduate student in the Department of biochemistry Ph.D. program at Louisiana State University. She received her B.S. in biology and biochemistry from the University of Maine.

Dr. William Stickle, Jr. has been a member of the faculty of the Department of Zoology and Physiology at Louisiana State University since 1972. His research interests include the effects of anoxia and hypoxia on bioenergetic processes in marine and estuarine organisms. He received his B.S. in biology at Slippery Rock State College, his M.S. in zoology from the University of South Dakota and Ph.D. in biology and physiology from the University of Saskatchewan.

## USE OF CHEMICAL BIOMARKERS FOR IDENTIFYING AND QUANTITATING OIL RESIDUES IN THE ENVIRONMENT

Mr. Charles B. Henry, Jr  
Dr. Edward B. Overton  
Institute for Environmental Studies  
Louisiana State University

### INTRODUCTION

Oil spills into marine environments have been recognized as major environmental insults for more than 30 years. The 1968 *Torrey Canyon* spill brought prospective to the large volumes of oil and potential environmental threat posed by the new "supertanker." In 1969, a production well blow out off the California coastal city of Santa Barbara caused another major spill in the marine environment, further highlighting environmental concerns generated by oil pollution. Since the 1960s, the list of major spills has coincided with advances in response technology and legal mandates such as bioremediation and the Oil Pollution Act of 1990. Advances in analytical chemistry over the same period have improved our ability to fingerprint and track the fate of spilled oil. As our ability to assess trace level oil pollution improves, matrix effects and multiple pollution sources complicate our attempts. New approaches such as hopane-normalization and self-normalizing fingerprint indexes have been proposed and utilized to some degree, but further validation is required. Validating new approaches to assess oil pollution is one element of a Minerals Management funded research project and the purpose of this technical update.

## DEFINING THE PROBLEM

In addition to high profile events such as the *Amoco Cadiz* and the *Exxon Valdez* tanker spills and the IXTOC well blow out, chronic oil discharges into the coastal marine environment occur from a variety of small spills and operational discharges associated with petroleum exploration, development and transportation. Other discharges result from non-point source run-offs and numerous natural seeps. It has been estimated that 5 million tons of oil are spilled into the oceans each year. Of this, only an estimated 6% is from tanker accidents such as the 1989 *Exxon Valdez*. The largest source of oil pollution is urban runoff. To further complicate the problem, the toxic components of oil, i.e., aromatic hydrocarbons (AH), are derived from oil, coal tar (creosote), and as the product of incomplete combustion (see Figure 2H.8). In this complex mix of pollution is often hidden an analytical problem: most analytical methods provide little or no discrimination between source and concentration values generated. The data is blindly accepted as real. When studying oil pollution in the marine environment, the analytical approach must be able to differentiate sources of contamination and quantify oil residues in complex environmental samples.

## PROJECT GOALS

When this study began, more accurate methods to identify and quantify spilled oil residues in the environment were being evaluated. Source identification, or source fingerprinting as it is commonly called, is based on the use of high resolution gas chromatography/mass spectrometry (GC/MS) analyses of selected components in oil and its residues. Quantifying oil and oily residues can be obtained from two methods. First, quantities of oil and oily residues can be directly measured as "Total petroleum hydrocarbons" using appropriate analytical methods. Because of the heterogeneous distribution of oil in aqueous systems, this method requires extensive replication before statistically valid results can be achieved. Second, oil quantities can be inferred by examining the distribution of selected hydrocarbon components remaining in the oily residues found in the environment. This method is based on the fact that not all components in oil are readily degraded by natural weathering processes. Therefore, if we compare the quantity of hydrocarbons remaining relative to the quantity of undegraded components, we can estimate the percent of residual oil remaining after environmental weathering. This latter method is known as biomarker normalization. While biomarker normalization shows great promise as a tool for both identifying spilled oil and quantifying environmental residues, it is not a perfect one and can, in contaminated systems, overestimate the actual percent degradation. A goal of this study is to refine the use of biomarkers as tools for oil spill identification and assessment and to verify the "state of the art" approach with both laboratory and field evaluation studies. An extensive literature review has been completed and, as a possible product from this evaluation, a manual to aid researchers in developing analytical chemistry approaches to investigate oil pollution in the marine environment is being generated.

---

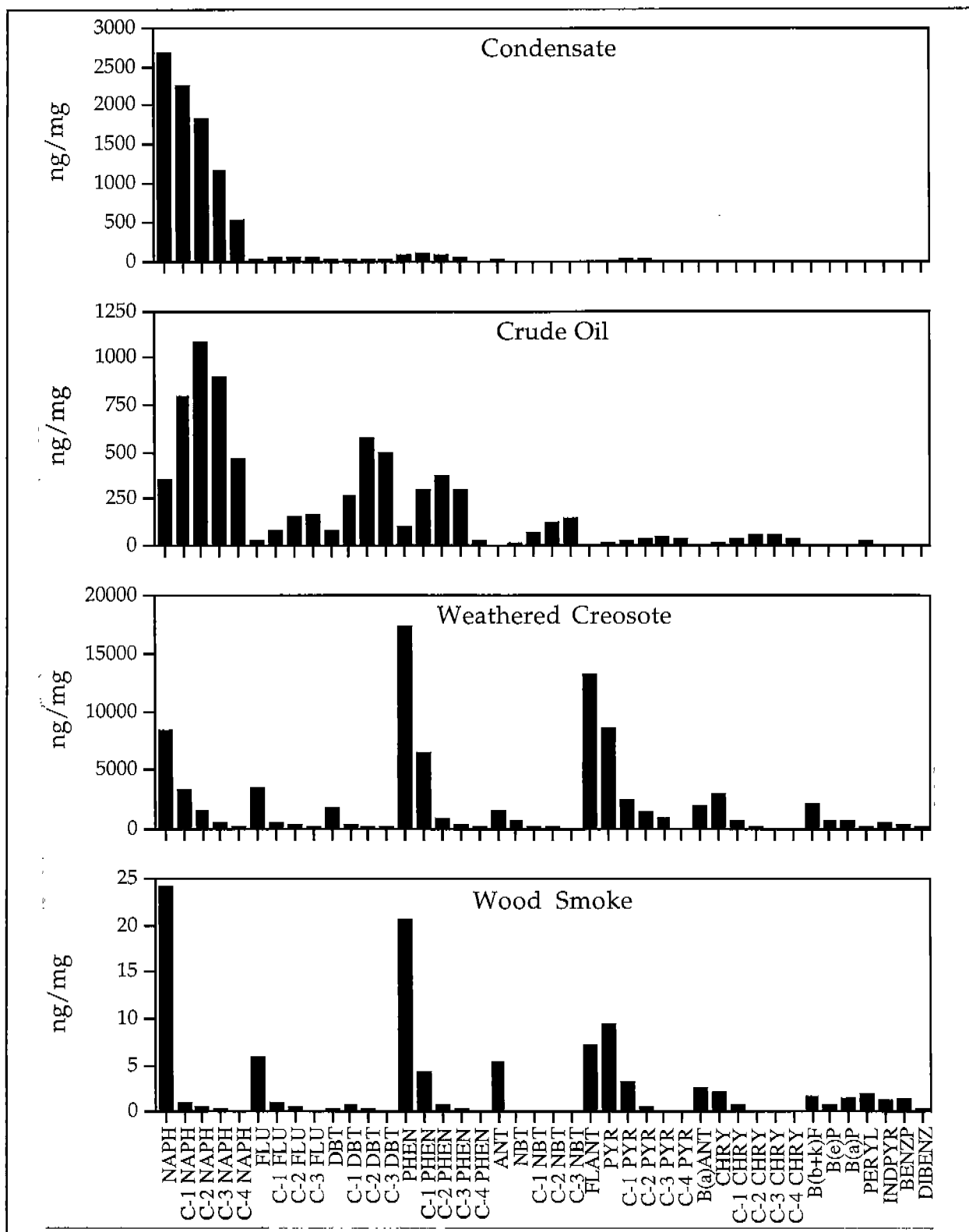

Figure 2H.8. AH profile comparison of a condensate oil, South Louisiana crude oil, a composite weathered creosote, and wood smoke.

Charles Henry has more than 13 years of experience applying analytical chemistry to investigate anthropogenic pollution in the marine environment. Working with NOAA and MMS, he has on-scene experience at more than 30 major spill incidents, including the 1989 Exxon Valdez oil spill, the 1991 Persian Gulf War, the 1992 Santa Clara hasmat event, and the 1995 Powell Anchorage incident near Anacortes, Washington.





## SESSION 2K

### GULF OF MEXICO COASTAL AND MARINE ENVIRONMENTAL MONITORING, PART II

Chair: Dr. Richard Defenbaugh

Co-Chair: Dr. Robert Avent

Date: December 18, 1997

Presentation	Author/Affiliation
GulfCet II: Marine Mammal Surveys in The Gulf of Mexico: The Texas A&M University Report	Dr. Jeff Norris Texas A&M University, Galveston
GulfCet II Surveys of Cetaceans and Sea Turtles	Dr. Keith D. Mullin Mr. Wayne Hoggard Southeast Fisheries Science Center National Marine Fisheries Service
Initial Monitoring at a Synthetic Drilling Fluid Discharge Site on the Continental Slope of the Northern Gulf of Mexico: The Pompano Development	Dr. Benny J. Gallaway LGL Ecological Research Associates, Inc. Ms. Debra K. Beaubien BP Exploration Inc.
United States Environmental Protection Agency Perspective: Monitoring the Ambient Environmental Effects of the Discharge of Drill Cuttings Carrying Synthetic-Based Drilling Fluids	Mr. Joseph Daly Environmental Protection Agency
Stability and Change in Gulf of Mexico Chemosynthetic Communities (CHEMO II): A Program Overview	Dr. Ian R. MacDonald Geochemical and Environmental Research Group Texas A&M



## **GULFCET II: MARINE MAMMAL SURVEYS IN THE GULF OF MEXICO: THE TEXAS A&M UNIVERSITY REPORT**

Dr. Jeff Norris  
Texas A&M University, Galveston

### INTRODUCTION

GulfCet II is a multifaceted project involving a large number of people and organizations whose goal is to study the cetaceans, birds, and marine turtles of the northern Gulf of Mexico. The field component of GulfCet II has now been completed.

In the GulfCet II program, we have continued our studies of cetaceans in the northern Gulf of Mexico to determine their seasonal and geographic distribution in areas potentially affected by oil and gas activities now or in the future. This program includes systematic aerial surveys and shipboard visual and acoustic surveys to document cetacean and sea turtle populations. Additional effort was designed to further characterize habitat and reveal cetacean-habitat associations. The work is intended as an eastward areal and temporal extension of the GulfCet I Program.

The study area includes the entire continental slope of the northern Gulf of Mexico (i.e., the continental slope north of 26° N latitude) between the 100- and 2,000-m isobaths. To date, we have conducted synoptic aerial and shipboard surveys of the entire study area using line-transects methods. We focused additional shipboard and aerial survey effort on the Eastern Planning Area, which was not included in the GulfCet I program and for which there is little information on cetacean abundance and distribution. Finally, we have conducted focal shipboard studies (e.g., south of the Mississippi River delta and along the edge of eddies) in order to better understand the effect of oceanographic features and prey availability on cetacean distribution.

There have been four cruises to date, two each by Texas A&M University and the National Marine Fisheries Service. The R/V Gyre has made cruises in October 1996 and August 1997, while the Oregon II made cruises in April-June 1996 and May-June 1997. This report concentrates on the results of the two Texas A&M University cruises aboard the R/V Gyre. Results from the hydrology, biological oceanography, acoustic survey, bird survey are described.

### SHIPBOARD HYDROGRAPHY

#### Methods

Using standard techniques, two sets of oceanographic data were gathered. (1) On station data: Temperature, salinity, oxygen, *in vivo* fluorescence, and water clarity were measured using a CTD outfitted with dissolved oxygen sensor, submersible fluorometer, and transmissometer. (2) Underway data: *Gyre's* 153 kHz ADCP will be run continuously to profile current velocity in 4-meter bins (8-

200 m) and XBTs will be dropped to profile subsurface temperature to 760 m. In addition, sea surface temperature, salinity, and chlorophyll fluorescence will be logged every two minutes.

## Results

The mesoscale circulation in the NE Gulf of Mexico is determined by the changing geometry of the Loop Current (LC) and of associated cold-core and warm-core mesoscale eddies. Throughout calendar year 1996, a broad area of cold-core circulation was located in the NE Gulf. This cyclone persisted in weekly and monthly altimetry maps as a region of negative sea surface height anomaly (SSH), depressed by 20 cm or more relative to the climatological mean surface. This cyclone was present January through December in the region 26-28 °N, 88-84 °W, even though for much of the year the northern edge of the LC extended north of 25 °N and even though the LC shed two eddies during 1996.

Previous work has documented that the 15 °C isotherm of the main thermocline is depressed to > 250 m in strong anticyclones and domes to < 150 m in strong cyclones. For all hydrographic surveys in 1996, the 15 °C depth map generally agreed very well with the SSH anomaly map. The shallowest 15 °C depths were in the interior of the cyclone (<140 m) and the deepest were in the inter of LC Eddy C (>340 m). These 200 m differences in 15 °C depth are equivalent to a > 60 dyn cm gradient in dynamic height between the interior of the two features (<90 dyn cm in the cyclone, to > 150 dyn cm in LC Eddy C). The geostrophic volume transports correspond to about 7 S of cyclonic transport for the cyclone and at least 17 S of anticyclonic transport for LC Eddy C. In the flow confluence 25.5 °N to 26.5 °N which separated the two features, geostrophic current velocity at the surface exceeded 2 knots (> 1m/sec).

Since Eddy C had separated from the Loop Current just two months before our October 1996 fieldwork, salinity of its subsurface maximum was markedly higher than in the subsurface maximum in the cyclone. Subsurface salinity of LC Eddy C exceeded 36.5 psu from about 100 m to 200 m, whereas subsurface salinity was < 36.5 psu throughout the upper 200 m of the cyclone. The presence of salinity was < 36.5-36.8 psu is diagnostic of the Loop Current origin of Eddy C: this Caribbean Underwater has been entrained by the Loop Current as it flowed into the Gulf from the NW Caribbean.

In the cyclone, where cool midwater domed close to surface so that temperature at  $z = 75$  m was < 19 °C, the mixed layer depth (MLD) was locally shallow. In contrast, north and south of this region MLD generally ranged 40-50 m deep. There was generally a highly predictable negative first order relationship between temperature and nutrient concentration. Thus, temperature is an excellent proxy for nitrate concentration, and in particular the depth of the 19 °C isotherm is a good estimation of the depth of the 10  $\mu$ M nitrate concentration. The submersible fluorometer data provide the best evidence that the depth of the deep chlorophyll maximum (DCM) is regulated by the nitracline depth: The DCM depth averaged 45 m more shallow in the cyclone than in LC Eddy C.

The hydrography of the northern Gulf was similar during the August 1997 R/V Gyre cruise, in that there was a CCR to the north of a recently shed WCR. Tandem altimetry data provided from CCAR

showed that in a five degree square between 26-30N and 86-90W there was a region of cyclonic circulation to the east and north of two anticyclonic Loop Current Eddies ("D" & "E"). This geometry was confirmed by tracking the depth of the 15C and 8C isotherms during the focal study, and by computing the dynamic height. The dynamic height gradient between Eddy E and the cyclone was 75 cm, which drove an east flowing current of 2-2.5 knots in the confluence between the two features. In a similar fashion, flow confluence created by the apposition of Eddy D with the cyclone entrained low salinity, high chlorophyll Mississippi River water and carried it some 60 nm offshore, where it was entrained into the flow confluence between Eddy E and the cyclone. This more productive River water was wrapped counterclockwise around the periphery of the cyclone.

## SATELLITE TELEMETRY

Continuous altimetric monitoring of the general circulation of the Gulf of Mexico from satellite altimeters is serving two primary purposes for GulfCet II. First, historical altimeter data are being used to map the circulation variability associated with mesoscale fronts and eddies to assist in the interpretation of visual and acoustic survey data collected during the GulfCet I and II programs. Second, near-real-time altimeter data are used for cruise planning and mesoscale mapping to free ship time from mesoscale surveying and allow ship resources to be directed toward biological and cetacean research during GulfCet II. In this interim report, we describe the coincident TOPEX/Poseidon and ERS 1 and 2 missions, and how altimeter data from these missions have been processed to produce the historical and near-real-time data products currently being used by GulfCet II investigators.

A climatology of the Gulf of Mexico sea surface height coincident with GulfCet I has been derived from the corrected sea surface height anomalies measured by TOPEX/Poseidon and ERS-1 satellite altimetry. Software to interpolate altimetric estimates of the general circulation at visual and acoustic sighting locations has been developed and tested. Close collaboration between the investigators has significantly streamlined the data archiving, processing and sharing of altimeter derived products coincident with GulfCet I surveys, which will expedite ongoing scientific collaboration during GulfCet II.

## BIOLOGICAL OCEANOGRAPHY

### Methods

Within the focal area and where possible within the EPA, we gathered biological oceanographic samples using a MOCNESS net system and active sonar and during the August 1997 Gyre cruise, an IKMT net system. While in the focal area, the MOCNESS system was towed 2 times each night. This schedule provided even sampling the Loop Current, continental slope, and cold-core ring. Tows were also made at night in the EPA when the ship is at the deep ends of track lines or over the continental slope. An active dual-frequency sonar was towed concurrently with the MOCNESS to acoustically locate aggregations of plankton/nekton, potential food stocks for cetaceans. Each tow lasts 2.5 hours. Processing of each tow involves sorting the samples, identifying the catch, archiving samples, computer entry of data, and readying the equipment for the next tow. A hull-mounted

ADCP will be run continuously throughout both legs of the cruise to measure acoustic backscatter from plankton/nekton in the upper 200 m of the water column.

## Results

In order to test the GulfCet Program's hypothesis that the distribution and abundance of cetaceans in the northern Gulf are positively correlated with spatial and temporal variations in regional food stocks of zooplankton and micronekton, the program has adopted a two-fold approach: acoustic estimation of nekton biomass and direct net sampling to both ground truth the acoustics and to provide specimens of cephalopods and midwater fishes for identification and biomass calibration.

Diel differences in biomass within the cyclone and the mouth of the Mississippi River areas were not significant. The lack of biomass fluctuation is due to the fact that the majority of the biomass is in the upper 200 m day or night. Diel vertical migration has been documented in the northern Gulf of Mexico previously.

The water column biomass was significantly greater in the cyclone than in Eddy C. This region is where the majority of the sperm whale sightings occurred. Unfortunately, this region was not sampled with the larger mouth-opening MOCNESS, so we cannot comment on cephalopod differences. In the upcoming 1997 cruise, we will remedy this situation by using an even larger mouth-opening trawl which will be towed every night.

## ACOUSTIC SURVEYS

### Methods

A new hydrophone array was used in the GulfCet II acoustic surveys. It is similar in design to the array used in GulfCet I, having multiple hydrophones variably spaced along a cable. The array is spectrally flat from 6 Hz to 18 kHz, (with approximately 183 dB re. 1  $\mu$ P at sensitivity 7.2 kHz. The array is considerably more sensitive and has a greater detection range, which in turn produces a larger number of acoustic contacts. Signals were recorded from the array onto both analog and digital tape recorders. Recordings were simultaneously made of signals just below 2,500 Hz, and those signals above 2,500 Hz. This frequency separation facilitated subsequent analysis of low frequency anthropogenic noise and biological signals, while maintaining a relatively quiet high frequency record of dolphin and sperm whale signals.

### Results

During the October 1996 R/V Gyre cruise, cetacean recordings were made along 13 transect legs in the EPA and focal area. We recorded 183 VHS tapes and 55 compact audio cassettes for a total of 205 hours. We noted 52 dolphin, 10 sperm whale contacts, and 33 low-frequency contacts. Later lab work will confirm the low-frequency signals. Of the concurrent visual and acoustic contacts, we have identified recordings from sperm whales, and bottlenose, pantropical spotted, clymene, spinner, and Atlantic spotted dolphins.

The average duration of a sperm whale acoustic contact was 133 minutes (SD = 159, range = 11-459). The geographic distance over which contacts were maintained averaged 15.26 NM range = 0.6-61.6). Seven of these contacts occur within the cold-core ring, however since only half of the ten contacts were in waters previously sampled during GulfCet I, it is premature to conclude that this distribution is a product of warm/cold core interactions or due to other factors, such as outflow of the Mississippi river or productivity closely tied to the continental shelf.

While sperm whales were detected in many of the same areas as during GulfCet I, they were also found in areas newly surveyed during GulfCet II. Water depths for acoustic contacts was never less than 600 m, which is consistent with GulfCet I. Deepest waters with sperm whale acoustic contacts exceeded 3,300 m.

We had a total of 53 acoustic contacts during the August 1997 cruise, from seven species including twenty pantropical spotted dolphin, nine sperm whale, and sixteen unidentified dolphins contacts. The distribution of these contacts suggests that sperm whales prefer CCR, while those dolphin species not found in shallow waters (i.e. bottlenose and Atlantic spotted dolphins) appear to use the confluences between WCR and CCR rings. This was confirmed in an analysis of sperm whale distributions during a GulfCet I cruise, where there were significantly more sperm whale contacts in CCR rings than by chance, whereas there were no significant difference for contacts in either WCR or in intermediate waters.

A preliminary analysis was begun on the influence of seismic exploration signals on the distribution and behavior of cetaceans in the northern gulf. The number of visual contacts during both visual and acoustic effort were counted within five hydrographic regions: WCR, CCR, their convergence zone, the northern periphery of the CCR (near the mouth of the Miss. River), and other (mostly in the EPA). Most effort was in the region typified as other, where there were nine contacts when there were no seismic signals and only a single contact in the presence of seismic signals. At the opposite extreme, in the CCR there were seismic signals during approximately 60% of the effort and there were five contacts in the presence of seismics and only a single contact in the absence of seismics.

The acoustic surveys provided preliminary information on sperm whale sounds as related to anthropogenic seismic sounds. Data from a limited sample suggested that sperm whales may differentially respond to seismic pulses by delaying their codas, so as not to be "interrupted," but did not seem to cease vocalizing completely. This suggests two apparently opposing positions: that sperm whales may be affected by seismic signals, but also suggests that this interference is not to the point where the animals vacate the area. Clearly, more detailed information and substantially larger data sets are required before accurate assessments of potential impacts of seismic noise on sperm whale vocal behavior can be determined.



## SEABIRD SURVEYS

### Methods

Seabirds were surveyed by three observers who rotated responsibilities so that two observers will be surveying during all on-effort times. Observations occurred from the flying bridge of the vessel from sunrise to sunset, except during rain, Beaufort sea state 6 or greater, and when the ship is stopped at hydrographic stations. The seabird surveys consisted of continuous strip transects. The survey area was measured off one side of the ship, sweeping from the bow to 90° off one side. The survey range extended 600 m from the side of the ship. Bird observation data included a distance range of the sighting from the ship, group size, flight direction, and other observed behaviors.

### Results

Three seabird surveys occurred during cruises conducted in the Northern Gulf of Mexico. From 17 April to 9 June 1996 surveys were conducted from the NOAA Ship *Oregon II* along the northern slope and oceanic Gulf, and northeast Gulf shelf and slope waters.. From 10 to 29 October 1996 surveys were conducted from the R/V *Gyre*. This survey was the first large-scale shipboard seabird survey to take place in the Gulf of Mexico during the month of October, a time of seabird migration in the area.

During the *Oregon II* spring cruise, 5,902 seabirds were recorded during 334.8 effort hours covering 6,401 km. Twenty-three seabird species were seen representing eight genera. Terns were the most abundant genera of seabirds seen during the cruise, at 69.93% of the total seabirds. The next most abundant group of seabirds was storm-petrels (16.72% of the total seabirds), followed by gulls (7.4% of total birds). Shearwaters (3.05%) and jaegers (2.07%) were seen in lesser numbers, together accounting for about 5.0% of the total birds. Gannets/boobies, frigatebirds, and tropicbirds combined amounted to less than 1% of the total seabirds.

Two-hundred and seventy-eight seabirds were counted from sixteen species and eight genera during the October 1996 R/V *Gyre* cruise. Terns were the most common genera, accounting for 46.04% of total birds, and gulls were the next most abundant genera, totally almost one quarter of birds seen. Jaegers were the third most commonly seen birds (13.67% of total birds). Shearwaters accounted for 8.63% of total birds seen. Together terns, gulls, jaegers, and shearwaters comprised over 90% of the total birds enumerated. Frigatebirds (4.32%), tropicbirds (1.44%), gannets/boobies (1.44%), and storm-petrels (1.08%) were also seen.

Seabird genera and species present in the Gulf of Mexico varied by season. The *Oregon II* data suggest terns, storm-petrels, and gulls were common in the Gulf during May and June. Jaegers and shearwaters were also present but in lower numbers. Tropicbirds, boobies/gannets, and frigatebirds were rarely seen in the Gulf during the spring.

Warm and cold-core eddies affected the distribution of seabirds, in both density and in species present or absent. No birds were seen inside the warm-core eddy. Levels of higher density, but low

diversity, were encountered in the boundary of the warm-core eddy; all of the sightings in the warm-core eddy edge region were Pomarine Jaegers. The frontal region between the eddies and interior of the cold-core eddy had increased density of seabirds, and seabird diversity (greater number of species).

Patterns of seabird distribution became more apparent when investigating species-specific relationships with the Gulf's features. Laughing Gulls were present in higher numbers near the coast, but were also located farther from the shore in two locations surrounding the cold-core eddy. Royal Terns had a greater affinity for the region near the mouth of the Mississippi, and were not seen more than 200 km from the shore. Laughing Gulls were encountered in lower densities than Royal Terns, but they were located in more transects than the Royal Tern. Royal Terns and Laughing Gulls are year-round residents of the Gulf. Pomarine Jaegers, a winter migrant, were the most pelagic of the seabirds seen in the October cruise, and were seen the farthest from shore of any of the seabirds. They were detected in three regions: The mouth of the Mississippi, inside the cold-core eddy, and in the periphery of the warm-core eddy.

There were 1,157 sightings of birds and 2,806 individual birds seen during the August 1997 Gyre cruise. Of that total, 2,536 were seabirds, representing 24 species. Black terns accounted for more than half of these birds, while band-rumped storm-petrels and frigatebirds were each 12%. Twenty-two mixed bird sightings were detected. Surface fish school activity was noted concurrent with seven of these mixed groups. Black terns, bridled terns, and sooty terns were present in most of the mixed flocks.

#### PRELIMINARY RESULTS FROM ANALYSIS OF SPERM WHALE BEHAVIOR

The GulfCet Program conducted two surveys during which significant effort was devoted to behavioral observation and photoidentification of sperm whales. During these surveys, three to five observers described aspects of group structure and behavior and recorded respiration times with the aid of 25 x 150 Fujinon "Big Eye" binoculars, smaller hand-held binoculars, and still and video cameras. Photoidentification was conducted from small (< 5 m) inflatable boats using 35 mm cameras equipped with 200 and 300 mm zoom lenses, as well as Hi-8 video. Opportunistic photographs were also taken from the main research vessels. The first such focal study was during GulfCet I aboard R/V *Pelican*, TIO Cruise 8, from 20-28 August 1994. This entire cruise was devoted to sperm whale observations. The second study occurred during a GulfCet II cruise aboard R/V *Gyre* (cruise 96-G06), on which two half-days (20 and 28 October 1996) were given to sperm whale observations. Photoidentification surveys were conducted at irregular intervals during the study, with major efforts on 23, 25, and 28 August, 1994 and 20, and 28 October, 1996. Effort concentrated on an area approximately 50 km southeast of the Southwest pass of the Mouth of the Mississippi River. Sperm whales were regularly seen in this area on nearly all GulfCet I cruises.

A total of 37 individual whales were identified during the 1994 and 1996 study periods. Most sightings of whales within the study area were in waters between 700 and 1,100 m. Four of the 37 identified individuals were resighted within a cruise, and four individuals were resighted in both 1994 and 1996. The distances between resightings of individuals sighted in both 1994 and 1996

ranged from 8.9 - 11.1 km. These data on sightings and movements of individually identified sperm whales suggest that a population of perhaps residential whales inhabit a limited region of the North Central Gulf of Mexico near the mouth of the Mississippi River..

Five sperm whales were measured photogrammetrically during the study using the following calculation:  $h's/f = h$ , where  $h'$  = image size,  $s$  = distance to the object,  $f$  = focal length of camera lens, and  $h$  = size of the object. Body sizes ranged from 6.6 - 10.4 m, and corresponded to typical lengths reported for females and young. On no occasion was the presence of an adult male noted. Results from this preliminary photogrammetry work therefore suggest that subgroups observed in the Gulf are primarily composed of females and their immature offspring.

---

Dr. Jeff Norris is the Principal Investigator on the Acoustical Survey component of GulfCet II. He has been chief scientist on 10 of the 13 GulfCet I and II cruises by Texas A&M vessels. His areas of interest are animal communication, bioacoustics, mammology, and conservation biology. He received his B.A. from Michigan State University, M.A. from San Diego State University, and his Ph.D. from the University of Florida.

## **GULFCET II SURVEYS OF CETACEANS AND SEA TURTLES**

Dr. Keith D. Mullin  
Mr. Wayne Hoggard  
Southeast Fisheries Science Center  
National Marine Fisheries Service

### **INTRODUCTION**

GulfCet II surveys were designed to study cetacean and sea turtle diversity, abundances, and spatio-temporal distributions in the northeastern Gulf of Mexico and are a continuation of the GulfCet I surveys of the north-central and northwestern Gulf (Hansen *et al.* 1996). The surveys focused on continental slope waters (100-2,000 m) between Mobile Bay and Tampa Bay and a portion of the continental shelf adjacent to the western Florida Panhandle. The continental shelf area overlapped the Minerals Management Service Destin Dome leasing area.

Shipboard surveys were completed in the northeastern Gulf during the spring and fall of 1996 and spring and fall of 1997. In the spring, surveys were also conducted in oceanic waters of the entire U.S. Gulf (waters >100 m deep) that overlapped the GulfCet I study area. Aerial surveys were designed to seasonally complement the ship surveys and were planned during the both the warm (summer) and cold (winter) oceanographic seasons over two years. The summer 1996, winter 1997 and summer 1997 aerial surveys have been completed. Results reported here are limited to the spring

and fall 1996 ship surveys, and the first two aerial surveys. The primary objectives of both the aerial and ship surveys were to: (1) estimate the minimum numbers of cetaceans and sea turtles (aerial surveys only) of each species in the study area, (2) determine when these species are present in the study area, (3) establish repeatable baseline estimates of cetacean and sea turtle abundance to compare with future estimates, and (4) determine how these species are distributed in the study area.

## METHODS

### Ship Surveys

Line-transect data were collected using standard ship survey methods similar to those used during GulfCet I (Buckland *et al.* 1993, Hansen *et al.* 1996). Two observers searched for cetaceans during daylight hours using 25X "bigeye" binoculars mounted on the ship's flying bridge. The third observer searched near the ship using unaided eye and recorded data which included position, species, group-size, bearing and radial distance of a sighting, and environmental conditions.

The first of two spring ship surveys was conducted from 17 April - 9 June 1996 from the NOAA Ship *Oregon II*. Legs 1 and 2 were conducted along a predetermined trackline throughout the oceanic U.S. Gulf whereas Leg 3 focused on the northeastern Gulf. During fall, from 10-29 October 1996, the R/V *Gyre* was used to conduct line-transect surveys in the north-central and northeastern Gulf. Two areas were surveyed, the northeastern Gulf and a focal area in the north-central Gulf which was chosen based on oceanographic considerations. The focal area was sampled by five tracklines oriented NW-SE, south of Louisiana and Mississippi. In the fall, tracklines were transited 24-hours per day to accommodate acoustic sampling.

### Aerial Surveys

Seasonal sampling intensity during aerial surveys of the northeastern Gulf was similar to that expended during GulfCet I. Systematic transects with a random start and that generally cross isobaths orthogonally, were uniformly spaced throughout the aerial survey area. Each season, the goal was to survey 58 transect lines totaling 6,133 km of on-transect effort, including 42 transect lines (total of 5,220 km) on the continental slope (waters 100-2,000 deep) and 16 transect lines on the continental shelf (waters <100 m deep).

A DeHavilland DHC-6 Twin-Otter with large concave windows on each side of the fuselage was used to survey transects. A window of 45-days and about 100 flight hours was allocated for each seasonal survey. Surveys were conducted from an altitude of 229 m (750 feet) and at a speed of 204 km/hour (110 knots). A pilot, co-pilot, and four observers participated in each flight. Data were entered on a computer. A suite of data characterizing survey conditions (e.g., sea state), effort status, and observer positions were updated throughout the day. When a cetacean group was sighted, the sighting angle was noted, a dye-marker was usually dropped to mark the position, and the aircraft was diverted to circle the group. Before continuing the transect, the species was identified and group-size was estimated.

## RESULTS

### Ship Surveys

During the 44 survey days in spring 1996, 6,401 transect km were surveyed, 235 cetacean groups were sighted on-effort, and at least 16 species were sighted. The most commonly sighted species were pantropical spotted dolphins (56 sightings), bottlenose dolphins (40), Risso's dolphins (31), sperm whales (24), and Atlantic spotted dolphins (21). These five species comprised about 65% of the identified sightings. The largest groups of Gulf cetaceans encountered to date were sighted and consisted of an estimated 750 spinner dolphins and 650 pantropical spotted dolphins in separate sightings. Group-sizes of other species were more typical of previous years (Table 2K.1). Cetaceans were encountered in all areas of the Gulf surveyed. Sightings were more common in some areas than others (e.g., near the Mississippi River delta). Bottlenose dolphins and Atlantic spotted dolphins were the only species sighted in continental shelf waters (e.g., Destin Dome lease area).

In total, 118 hours of on-effort visual surveys were conducted during the fall. At least 11 species were seen in 82 sightings. Forty-four sightings were on-effort and 38 off-effort (29 of the off-effort sightings were of sperm whales). On-effort, sperm whales and bottlenose dolphins were the most common species sighted with 12 sightings each. About 216 photo-id slides were taken of 45 sperm whales in 19 groups.

### Aerial Surveys

The first aerial survey was conducted during the summer season from 10 July -1 August 1996 and 58 proposed transect lines were surveyed (6,133 km). The second aerial survey was conducted during the winter season from 3 February- 21 March 1997. Due to poor weather, only 90% of the proposed effort was completed (5,529 km).

Previous studies of cetaceans in the northern Gulf indicate that only bottlenose dolphins and Atlantic spotted dolphins are commonly found on the continental shelf, whereas other species occur in oceanic waters. The results of the first two aerial surveys agree with this. Of 34 total sightings on the continental shelf, 28 were identified as bottlenose dolphins and four as Atlantic spotted dolphins. A similar number of sightings of each species were made during summer and winter on the continental shelf. On the continental slope, at least 13 species of cetaceans were identified. Seventy-nine and 71 cetacean groups were sighted on-effort during summer and winter, respectively. Overall, bottlenose dolphins were the most common species sighted on the continental slope (46 sightings), followed by pantropical spotted dolphins (25 sightings), Risso's dolphins (25 sightings), and dwarf/pygmy sperm whales (14 sightings). However, the number of sightings for some species was quite different for summer and winter. For example, from summer to winter, the number of dwarf/pygmy sperm whale groups decreased from 12 to 2, pantropical spotted dolphin groups declined from 17 to 8, whereas Risso's dolphin groups increased from seven to 18. Aerial survey sighting rates of cetacean groups on the continental slope of the northeastern Gulf have been more than two times the overall group sighting rate found during GulfCet I aerial surveys of the northwestern Gulf slope (Hansen *et al.* 1996). In general, cetacean groups were sighted throughout

Table 2K.1. Number of sightings (n) and mean group-size and water depth of species of cetaceans in the U.S. Gulf of Mexico sighted during spring 1996. The group-sizes and water depth distributions are typical of those found during the fall ship survey and, the summer and winter aerial survey. (False killer whales, rough-toothed dolphins, Fraser's dolphins and pygmy killer whales were sighted during aerial surveys or subsequent ship surveys.)

Species	Group-size (animals)				Water Depth (meters)		
	n	Mean	SE	Range	Mean	SE	Range
Bryde's whale	2	3.0	1.00	2-4	210	5	206-215
<i>Balaenoptera</i> sp.	1	1.0			215		
Sperm whale	24	1.9	0.25	1-5	1,850	227	547-3,428
Pygmy sperm whale	4	1.3	0.25	1-2	1,237	285	384-1,544
Dwarf sperm whale	4	4.0	0.82	2-6	697	112	458-888
<i>Kogia</i> sp.	8	1.8	0.53	1-5	663	142	411-1,538
Cuvier's beaked whale	2	2.5	1.50	1-4	1,393	182	1,212-1,575
<i>Mesoplodon</i> sp.	5	1.4	0.24	1-2	1,612	284	1,019-2,594
Unidentified Ziphiidae	3	1.3	0.33	1-2	2,193	220	1,797-2,557
Striped dolphin	3	43.7	18.35	21-80	715	301	410-1,316
Spinner dolphin	6	355.3	112.20	32-750	481	56	356-731
Clymene dolphin	8	77.0	13.55	15-150	1,926	240	1,130-3,057
Pantropical spotted dolphin	56	91.6	13.44	5-650	1,808	127	463-3,372
Atlantic spotted dolphin	21	19.9	3.41	4-70	107	16	22-222
<i>Stenella</i> sp.	1	2.0	428				
Bottlenose dolphin	40	15.4	4.52	1-172	212	26	30-702
<i>T. truncatus/S. frontalis</i>	10	2.5	0.52	1-5	128	68	22-719
Risso's dolphin	31	8.6	1.02	2-24	1,133	191	111-3,437
Killer whale	1	4.0			1,946		
Short-finned pilot whale	2	31.0	4.00	27-35	724	164	560-888
Melon-headed whale	1	125.0			1,038		
Unidentified dolphin	25	2.9	0.62	1-15	924	212	50-3,187
Unidentified small whale	5	1.4	0.40	1-3	1,049	561	124-3,196
Unidentified large whale	2	1.0	0.00	1-1	2,001	1,260	741-3,261
Unidentified odontocete	3	1.3	0.33	1-2	883	339	406-1,538

the entire study area. Certain species tended to be found over waters of different depths. Group-sizes varied among species.

Sea turtles were sighted 95 times. Continental shelf sightings were as follows: loggerheads—44 turtles, Kemp's ridley—2, unidentified chelonids—7, and leatherbacks 3. Continental slope sightings consisted of 22 leatherbacks, 15 loggerheads (all during winter) and two chelonids. Leatherback were generally sighted in the northern half of the study area during summer but during winter were concentrated in an area west of Tampa in southern half of the study area.

### SUMMARY

A total of 17 cetacean species were sighted during all ship and aerial surveys. By season, 16 species were sighted in spring, 12 in summer, nine in fall, and 11 in winter. Seven species were sighted in all four seasons and included the sperm whale, dwarf/pygmy sperm whale and striped, spinner, pantropical spotted, Atlantic spotted and bottlenose dolphins. Bryde's whale, Cuvier's beaked whale, *Mesoplodon* sp., Clymene dolphin and Risso's dolphin were sighted during three seasons. Cetaceans were sighted in all water searched. With one exception, bottlenose dolphins and Atlantic spotted dolphins were the only species sighted in the continental shelf study area.

Loggerhead and leatherback sea turtles were sighted during both summer and winter aerial survey. (Sea turtles are very difficult to see from a ship.) Leatherbacks were generally found in oceanic waters during both seasons. Loggerheads were found in shelf waters during both summer and winter and in oceanic waters during winter only.

At the completion of all GulfCet II field activities, density and abundance estimates for each of cetacean and sea turtle species sighted will be made for the entire study area, for each year, and for each season using line-transect methods (Buckland *et al.* 1993, Laake *et al.* 1993).

### REFERENCES

- Buckland, S. T., D.R. Anderson, K.P. Burnham, and J.L. Laake. 1993. Distance sampling: Estimating abundance of biological populations. Chapman and Hall, London. 446 pp.
- Hansen, L.J., K.D. Mullin, T.A. Jefferson and G.P. Scott. 1996. Visual surveys aboard ships and aircraft. Pages 55-132 *In* R.W. Davis and G.S. Fargion (eds). Distribution and abundance of marine mammals in the north-central and western Gulf of Mexico: Final Report. Volume II: Technical Report. OCS Study MMS 96-0027. U.S. Dept. of the Interior, Minerals Mgmt. Service, Gulf of Mexico OCS Region, New Orleans, LA. 357pp.
- Laake, J.L., S.T. Buckland, D.R. Anderson, and K.P. Burnham. 1993. DISTANCE™ users guide, version 2.0. Colorado Cooperative Fish and Wildlife Unit, Colorado State University, Fort Collins. 72 pp.
-

Keith D. Mullin has studied the distribution and abundance of cetaceans in the Gulf of Mexico since 1985 and is employed by the National Marine Fisheries Service in Pascagoula, Mississippi. He also teaches marine mammal biology at the Gulf Coast Research Laboratory in Ocean Springs, Mississippi. He received his Ph.D. in zoology from Mississippi State University.

Wayne Hoggard has conducted aerial and ship surveys of marine mammals and sea turtles in the Western Atlantic since 1980. He is employed by the National Marine Fisheries Service in Pascagoula, Mississippi. He received his B.S. in wildlife biology from the University of Tennessee.

## **INITIAL MONITORING AT A SYNTHETIC DRILLING FLUID DISCHARGE SITE ON THE CONTINENTAL SLOPE OF THE NORTHERN GULF OF MEXICO: THE POMPANO DEVELOPMENT**

Dr. Benny J. Gallaway  
LGL Ecological Research Associates, Inc.

Ms. Debra K. Beaubien  
BP Exploration Inc.

### **INTRODUCTION**

BP Exploration, Inc. (BP) installed an offshore oil and gas platform (Pompano Phase I) on the continental slope of the Gulf of Mexico in Minerals Management Service's (MMS) Lease Block Viosca Knoll 989 in August of 1994 (Figure 2K.1). A pre-drilling template had been installed at this 393-m deep (1,292 ft) jacket site in August of 1992, and 10 wells had been drilled prior to jacket installation. Production from Pompano Phase I began in October of 1994. Pompano Phase II commenced with the fabrication and installation of a 140' x 80' subsea template which was placed down in August of 1995 in MMS Mississippi Canyon Block 28. This site is some four miles downslope from Pompano Phase I, and is 565-m deep (1,860 ft). Drilling at this site began in October 1995 using a semi-submersible rig and continued through summer of 1997 when the rig was moved. Both sites are now in production and the two sites are connected by subsea pipelines (Figure 2K.1). Both installations are produced from the Pompano Phase I platform.

Water-based drilling fluids (WBFs) were used under most drilling circumstances encountered during this development. These fluids and associated cuttings were discharged on-site as allowed by the Environmental Protection Agency's (EPA) General Permit (GMG290000). Development at these sites, however, also required high-deviation drilling technology. Under these circumstances water-based fluids are inadequate, and either oil-based (OBFs) or synthetic-based drilling fluids (SBFs) are required. SBFs have been developed to replace OBFs in order to provide a "dischargeable" alternative. Because of their high cost, SBFs are separated from cuttings and are





returned to shore to be recycled for future use. The cuttings that occur during SBF drilling operations are discharged on-site and contain some SBF which adheres to them.

Drilling at the Pompano Phase II site was completed in July of 1997. The last discharge of SBF cuttings occurred in March of 1997. As the drilling rig was being decommissioned, BP recognized that a unique opportunity to investigate the effects of SBFs discharged into the deep Gulf as part of a two-year, multi-well development drilling program was represented. The unique features were the depth of the receiving water (565 m) and the existence of baseline information for this (and deeper) depths that had been gathered by MMS in the mid-1980's. All the previous information concerning the effects of SBFs in the marine environment had been based on studies conducted in waters less than 200 m. BP therefore elected to commit the attendant Remote Operated Vehicle (ROV) and provide the other resources necessary for obtaining samples of bottom sediments, macrofauna and megafauna using core samplers and video cameras, respectively. The purpose of these opportunistic seabed surveys was to contribute information that may help define the environmental effects of SBFs when discharged in deep water in conjunction with cuttings.

A sampling team was placed on the drilling rig positioned over the Pompano Phase II subsea template on 9 July and the planned compliment of samples was obtained over 10-11 July 1997. ROV sampling was restricted to an area within about 100 m (328 ft) of the perimeter of the subsea template. A cuttings pile, if present, was expected to be within this zone. Petrofree cutting piles occur because the SBFs are hydrophobic (Cranmer and Sande 1991), causing the cuttings to fall to the seabed with little drifting, at least at shallow water sites observed in the North Sea. However, in this instance, the receiving water was 565-m deep suggesting some drift might occur and a cuttings pile might not develop. The goals of this Pompano Phase II study were to document

- the size and extent of any associated cuttings pile following two years of a multi-well, development drilling program in the deep Gulf;
- the general appearance of the bottom as related to chemical activity and biodegradation processes;
- concentrations of Petrofree-LE (the SBF used) in sediments around the Pompano Phase II subsea drilling template; and
- densities of macrofauna and megafauna at the same locations.

The results of this study were compared to findings from the baseline continental slope studies conducted by MMS in the mid 1980s (e.g., Gallaway *et al.* 1988, Gallaway 1988, Pequegnat *et al.* 1990), and to laboratory and other field studies dealing with the effects of SBFs in general and Petrofree in particular. The results, as outlined below, suggest there are positive environmental effects resulting from SBF discharges in the deep Gulf.

## STUDY AREA AND METHODS

Sampling was restricted to an array of 15 locations around the Pompano Phase II subsea template (Figure 2K.2). The long axis of the template was along a compass bearing of  $45^\circ$  NE/ $225^\circ$  SW from the center of the template. This axis was along the line of prevailing currents which were believed to have a dominant flow from the northeast to the southwest. Sediment samples for chemical (Stations C1-2 to C1-6) and infaunal (C3-16 to C3-20) analyses were taken at 25-m (~76 ft) intervals down current (bearing  $225^\circ$ ) from the edge of the template to the end of the ROV tether (90 m or ~274 ft). This transect was also surveyed by flying the ROV along the transect a short distance above the bottom so that video cameras could record the species and numbers of megafauna encountered. Height above the bottom was maintained as uniformly as possible to provide a transect width of roughly one meter (3.04 ft). Position and exact location of sampling was determined using the ROV's navigation system, altimeter and sonar unit.

Sediment sampling was also conducted at 25-m intervals in the up-current direction (bearing  $45^\circ$ ) out to 75 m beyond the template edge; and to 50 m beyond the template in each of the cross-current directions (bearings of  $315^\circ$  and  $135^\circ$ ) (see Figure 2K.2). Each of these three transects also surveyed for megafauna using the ROV and video cameras out to a distance of 90-m beyond the template. In total, there were 15 sediment samples for chemical analysis, five sediment samples for infaunal (macrofauna) analysis and four video transects to determine densities of megafauna. Qualitative video surveys were also made along the pipelines which connects the Phase II subsea template to the Phase I Pompano Platform.

## RESULTS AND DISCUSSION

The general appearance of the bottom at this 565-m deep SBF discharge site in July 1997 suggested that intense chemical activity and biodegradation processes were in progress. The bottom appeared as a patchwork of tan, dark grey, and black sediments interspersed with white and orange mats that we assume reflected bacterial activity. Each of the 15 cores obtained was characterized by a thin (<1 cm) to several-cm thick layer of blackened surface sediments. The presence of hydrogen sulfide was confirmed by the odor of the blackened sediments. We encountered no evidence of a cuttings pile like those described in the North Sea literature. Rather, we encountered a thin veneer of cuttings dispersed over most of the bottom, albeit in a patchy fashion. In some areas, the cuttings appeared to be as much as 20 to 25 cm thick, but nowhere did we see piles or mounds of cuttings that were meters or tens of meters high. The absence of a distinct cuttings pile suggests that dispersal processes over the 565-m depth range were sufficient to override the hydrophobic effect on sinking.

A total of 6,057 bbls of Petrofree-LE was discharged during the drilling of six wells at this location (Figure 2K.3). The maximum discharge (2,026 bbls) was associated with the TB7 well drilled over the period 28 August to 16 September 1996. Prior to this date, 774 and 1,039 bbls of Petrofree had been discharged in the drilling of wells TB2 (10-19 July 1996) and, in late April through 21 May 1996, wells TB8 and TB5, respectively (Figure 2K.3).

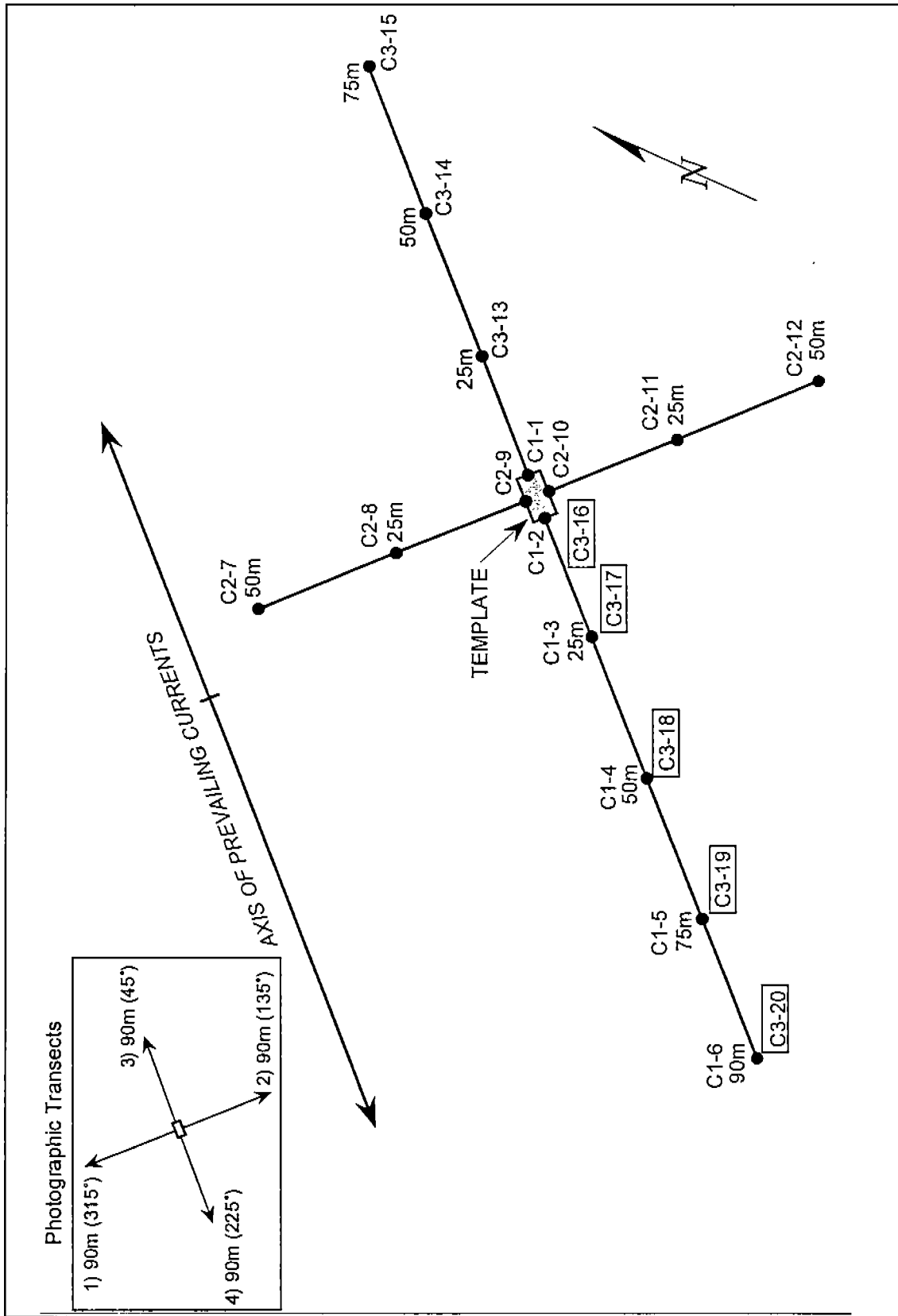

Figure 2K.2. Location where core samples and video transects (inset) were obtained around the Pompano Phase II subsea template, 10-11 July 1997. Sediment hydrocarbon samples were obtained at all sites. Sediment samples for infauna analysis were obtained only at sites C3-16 and C3-20.

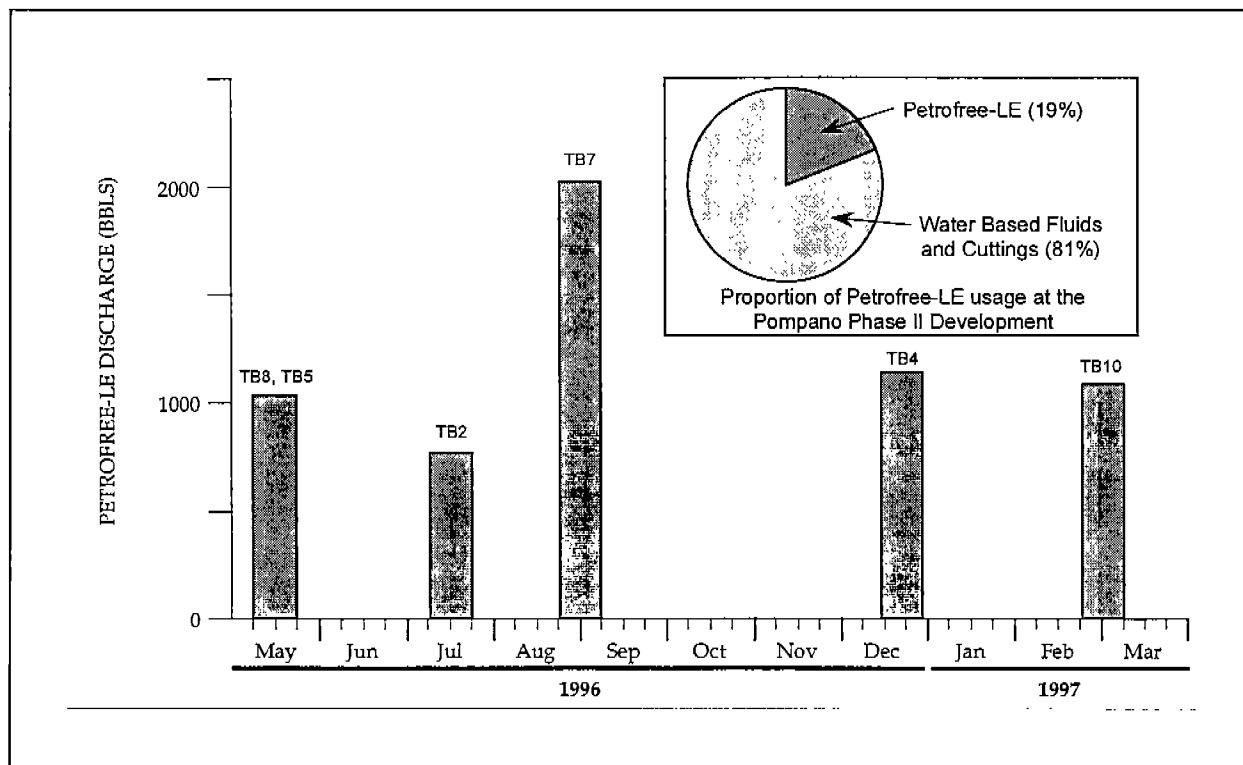

Figure 2K.3. Total volumes of Petrofree-LE discharged in conjunction with drilling of the Pompano Phase II site.

The maximum concentrations (up to 16.5% or 165,000 ppm) of Petrofree-LE we observed were between 50- and 75-m from the edge of the template to the northeast (Figure 2K.4), suggesting some transport of the cuttings as they dropped to the bottom after being discharged near the surface. The most recent discharge occurred in March of 1997, some four months prior to our sampling. Prior to March 1997, the last discharge had occurred in December of 1996, some seven months prior to our investigations. While biodegradation processes were evident, environmental concentrations of Petrofree-LE were still high in some areas surrounding the template, some four to seven months to possibly a year following the initial discharge of the cuttings.

The biological data (macrofauna and megafauna) were markedly different than what was expected based upon MMS sampling at similar depths on the Gulf of Mexico continental slope in the mid 1980s (Gallaway *et al.* 1988, Gallaway 1988, Pequegnat *et al.* 1990). Results of sampling along the 500-m isobath in the western Gulf showed macrofaunal densities to have been rather uniform, overall, averaging over 4,000 organisms/m<sup>2</sup> (Figure 2K.5, Gallaway 1988). On a seasonal basis, the density of macrofauna at MMS station C2 ranged from 6,695/m<sup>2</sup> in summer 1984 as compared to 2,105/m<sup>2</sup> in fall of 1984 and 3,632 in fall of 1983 (Gallaway *et al.* 1988). In contrast, the summer 1997 density of macrofauna at the Pompano site was 13,724 organisms/m<sup>2</sup>.

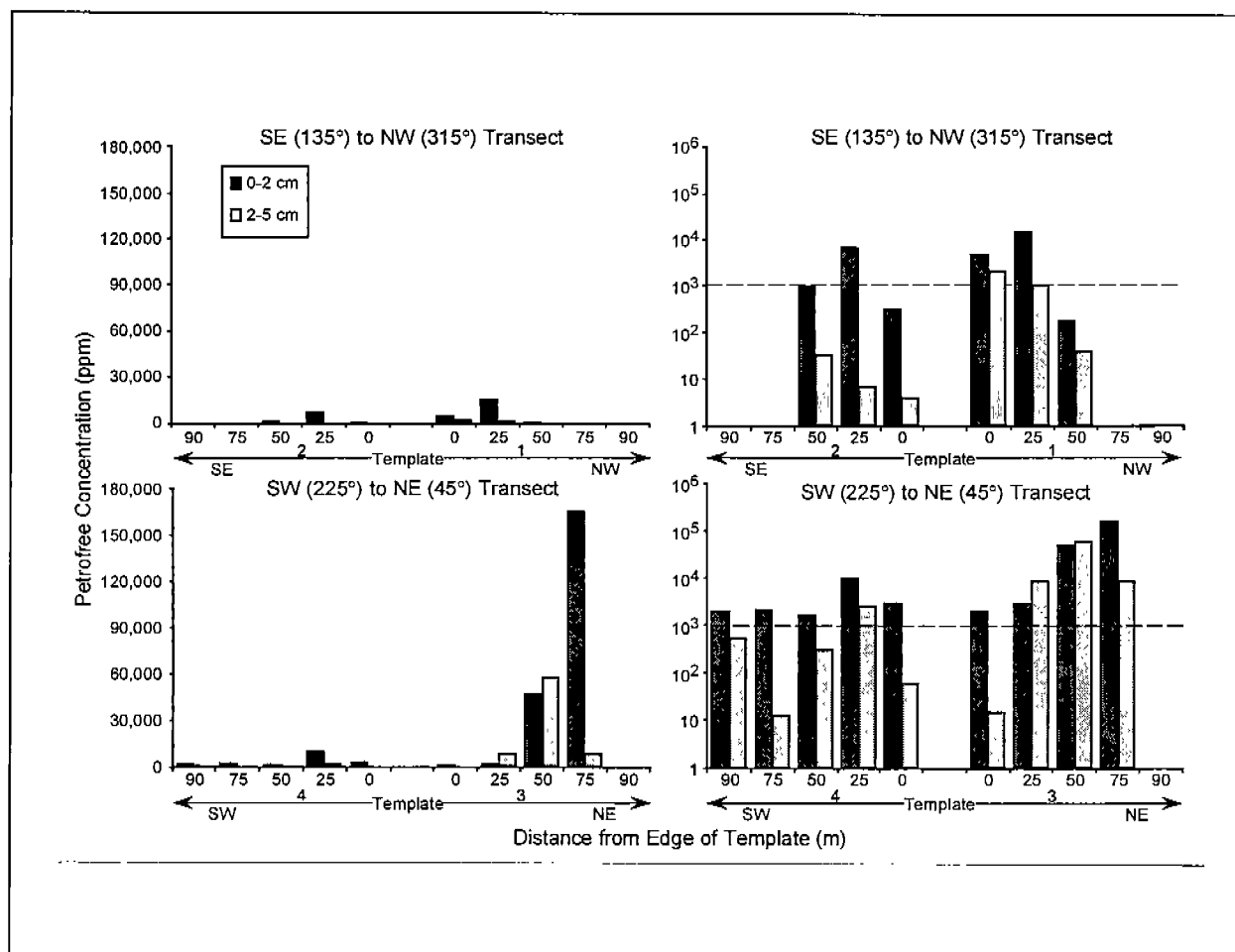

Figure 2K.4. Petrofree-LE concentrations measured in bottom sediments around the Pompano Phase II subsea template 10-11 July 1997. Panels on left show concentrations in absolute scale; panels on right in logarithmic scale.

The fish densities along the Pompano Development transects were roughly 3 to 10 times higher than fish densities estimated from photography at similar depths on the continental slope of the north-central Gulf during summer of 1985 (see Figure 2K.6). Additionally, the density of fish along the Pompano Development oil pipelines was yet an order of magnitude higher than densities on the surrounding bottoms. Likewise, there appeared (very obviously) to be higher densities of fish and invertebrates in association with all of the bottom structures at the development than on the surrounding bottoms. We believe part of the attraction to the pipelines might be a response to a possible thermal gradient related to the transport of hot oil in the pipes, at least over their initial lengths.

#### SUMMARY

Our observations concerning the effects of SBF cutting discharges associated with a two-year, multi-well development drilling program in the deep (565 m) Gulf of Mexico were:

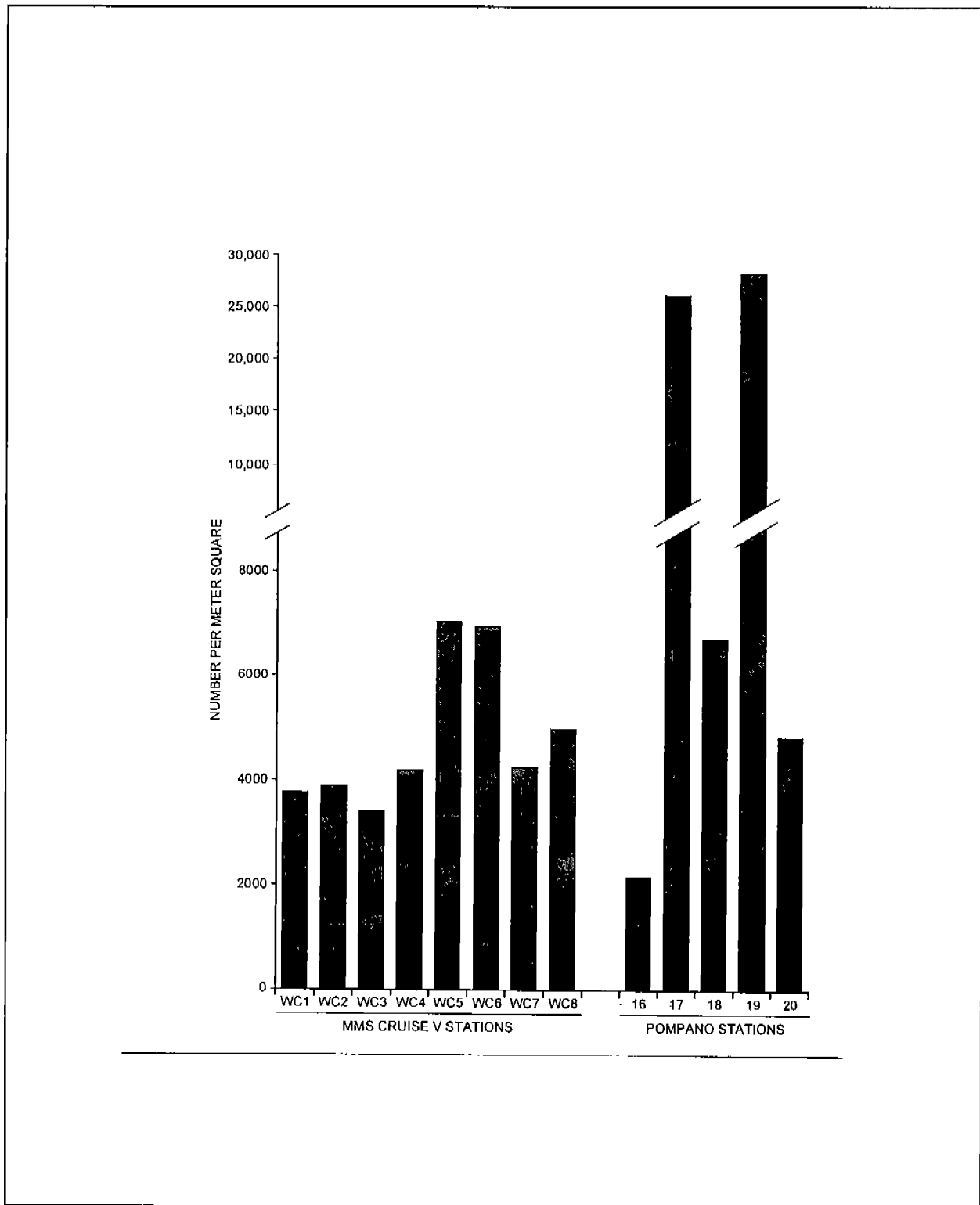

Figure 2K.5. Macrofaunal densities observed at eight MMS stations sampled during summer 1985 are compared to macrofaunal densities around the Pompano Phase II subsea template. Inset shows locations and depths of the MMS stations relative to Pompano Phase II.

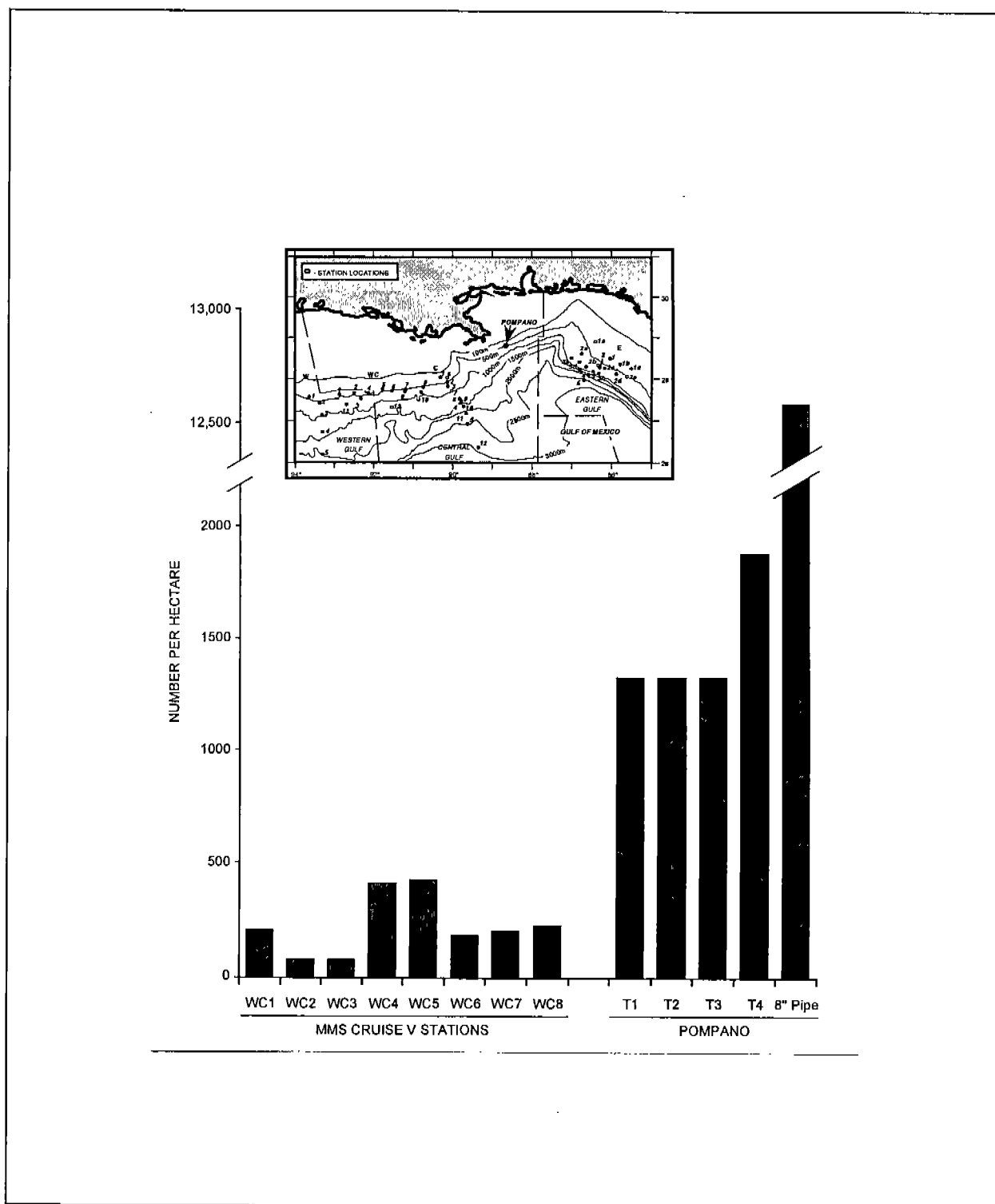

Figure 2K.6. Estimated densities of demersal fish based upon photographic transects. Data from eight MMS stations sampled during summer 1985 are compared to those from the Pompano Phase II subsea template sampled during summer 1997. Inset shows locations and depths of the MMS stations relative to Pompano Phase II.



Cuttings piles on the order of meters to tens of meters high were not present, maximum accumulations were on the order of 20 to 25 cm.

- The appearance of the bottom suggested intense chemical activity and active biodegradation.
- Concentrations of Petrofree-LE ranged up to 16.5%, but reflected no clear trends or gradients with distance from the drill site within the area sampled.
- Exceptional densities of macrofauna and megafauna were observed at the study site as compared to the baseline information.

Petrofree-LE concentrations 50 to 75 m (and perhaps further) northeast of the Pompano Phase II subsea template were still high in summer of 1997, some four months to as much as a year following discharge. The area was, however, also characterized by exceptional densities of macrofauna and fish as compared to results of previous studies conducted at similar depths within this region. We suggest that the area surrounding the drilling site may have initially been adversely impacted by discharge of cuttings with the impacts resulting from both burial and (perhaps) toxicity from high concentrations of Petrofree-LE. However, biodegradation processes are evident, and the vegetable-ester component of the SBF may serve as a source of energy and increase productivity. Overall, the deep sea benthic community is an energy-poor environment, with the energy constraints becoming more and more severe with increasing depth and distance from land (Rex 1983). The quality, rate, and pattern of energy input is generally considered to exert one of the most powerful selective forces acting on the deep-sea fauna. The high density and productivity of organisms observed around natural petroleum seeps has been stated to provide the exception proving the rule (Galloway 1988). The discharge of vegetable-ester-based SBFs and the corresponding exceptionally high densities of some organisms may offer yet another "exception demonstrating the rule."

#### REFERENCES

- Cranmer, G.J., and A. Sande. 1991. Summer report of seabed studies to verify degradation of Petrofree Ester. Summary of Seabed Survey Results from Well 7/12-9 and 2/7-22. BP Exploration.
- Galloway, Benny J. (Ed.). 1988. Northern Gulf of Mexico Continental Slope Study, Final Report: Year 4. Volume II: Synthesis Report. Final report submitted to the Minerals Mgmt. Service, New Orleans, LA. Contract No. 14-12-0001-30212. OCS Study/MMS 88-0053. 318 p.
- Galloway, Benny J., Larry R. Martin, and Randall L. Howard (Eds.). 1988. Northern Gulf of Mexico Continental Slope Study, Annual Report: Year 3. Volume II: Technical Narrative. Annual report submitted to the Minerals Mgmt. Service, New Orleans, LA. Contract No. 14-12-0001-30212. OCS Study/MMS 87-0060. 586 p.
- Pequegnat, W.E., B.J. Galloway, and L.H. Pequegnat. 1990. Aspects of the ecology of the deepwater fauna of the Gulf of Mexico. *American Zoologist* 30: 45-64.

Rex, M. A. 1983. Geographic patterns of species diversity in deep-sea benthos. Pages 453-472 *In*: G. T. Rowe (Ed.) *Deep-Sea Biology*, Chapter 11. John Wiley & Sons, New York. 560 p.

---

Dr. Benny J. Gallaway has worked at LGL Ecological Research Associates, Inc. for the past 23 years and serves as President and Senior Marine Ecologist for the firm. Dr. Gallaway received his Ph.D. from Texas A&M University and has in excess of 40 publications in the peer-reviewed literature. He also serves as a Visiting Professor with the graduate faculty of the Department of Wildlife and Fisheries Sciences, Texas A&M University.

Debra K. Beaubien has worked with BP Exploration Inc. (BP) for the past 20 years. She presently serves as Manager for Environmental External Affairs for BP's Gulf of Mexico business. She has managed large, multidisciplinary, environmental studies in both Alaska and the Gulf. One of her Gulf projects for BP, the Platforms for Research Program, has led to BP's receiving the MMS National CARE award in 1996 and the 1997 NOAA award for Excellence in Business Leadership in Coastal and Ocean Resource Management.

## **STABILITY AND CHANGE IN GULF OF MEXICO CHEMOSYNTHETIC COMMUNITIES (CHEMO II): A PROGRAM OVERVIEW**

Dr. Ian R. MacDonald  
Geochemical and Environmental Research Group  
Texas A&M

This 3.5-year program is a follow-up to the Chemosynthetic Ecosystem Study conducted during 1991-1994. CHEMO II was initiated in October of 1996 and is designed to aid MMS in the scientifically sound management of living resources found at hydrocarbon seeps on the northern Gulf of Mexico continental slope. An integrated, multi-disciplinary approach was needed to address the complex issues associated with the protection of this living resource. A team of experienced researchers was assembled to carry out the program under overall management by the Geochemical and Environmental Research Group of Texas A&M University (Table 2K.2). The program encompasses ecological studies at both regional and local spatial scales as well as an evaluation of temporal changes in these communities. A fundamental understanding of the processes that control the distribution, health, and succession of communities in these unique environments is necessary to forecast the potential effect of exploration and development of fossil energy reserves on the continental slope. This program encompasses studies at a community-ecology level and at a regional-geologic and oceanographic level. At the regional level, effort focuses on geological and geochemical processes that support communities and on circulation processes that maintain the genetic stability of communities on the slope. Two mega-sites were selected for a detailed

Table 2K.2. List of Principal Investigators and Scientific Review Board Members.

---

**Principal Investigators Not at Texas A&M University**

Dr. James M. Brooks  
TDI-Brooks Int'l. Inc.  
Industry Liaison for  
Geophysics and Geochemistry

Dr. Robert Carney  
Louisiana State University  
Trophic Relationships

Dr. Charles F. Fisher  
Pennsylvania State  
University  
Physiological Ecology

Dr. Steven Macko  
University of Virginia  
Trophic Relationships

Dr. Paul Montagna  
The University of Texas at  
Austin  
Statistical Design

Dr. Kimberlyn Nelson  
Pennsylvania State  
University  
Molecular Ecology and  
Genetics

Dr. Douglas C. Nelson  
University of California, Davis  
Microbial Ecology

Dr. Eric Powell  
Rutgers University  
Hystopathology and  
Community Health

**Scientific Review Board**

Dr. James Barry  
Monterey Bay Aquarium  
Research Institute

Dr. Cindy Lee Van Dover  
University of Alaska

Dr. William W. Schroeder  
The University of Alabama

**Texas A&M University Investigators**

**Department of Oceanography**

Dr. Samantha Joye  
Texas A&M University  
Electrochemistry

Dr. John W. Morse  
Texas A&M University  
Inorganic Chemistry

Dr. William Sager  
Texas A&M University  
Geophysics

**Geochemical and Environmental Research Group**

Dr. Norman L. Guinasso, Jr.  
Texas A&M University  
Physical Oceanography

Dr. Ian MacDonald  
Texas A&M University  
Program Manager,  
Imaging & GIS

Dr. Mahlon C. Kennicutt II  
Texas A&M University  
Deputy Program Manager,  
Environmental Chemistry

Dr. Roger Sassen  
Texas A&M University  
Hydrocarbon Chemistry

Dr. Gary A. Wolff  
Texas A&M University  
Data Management

---

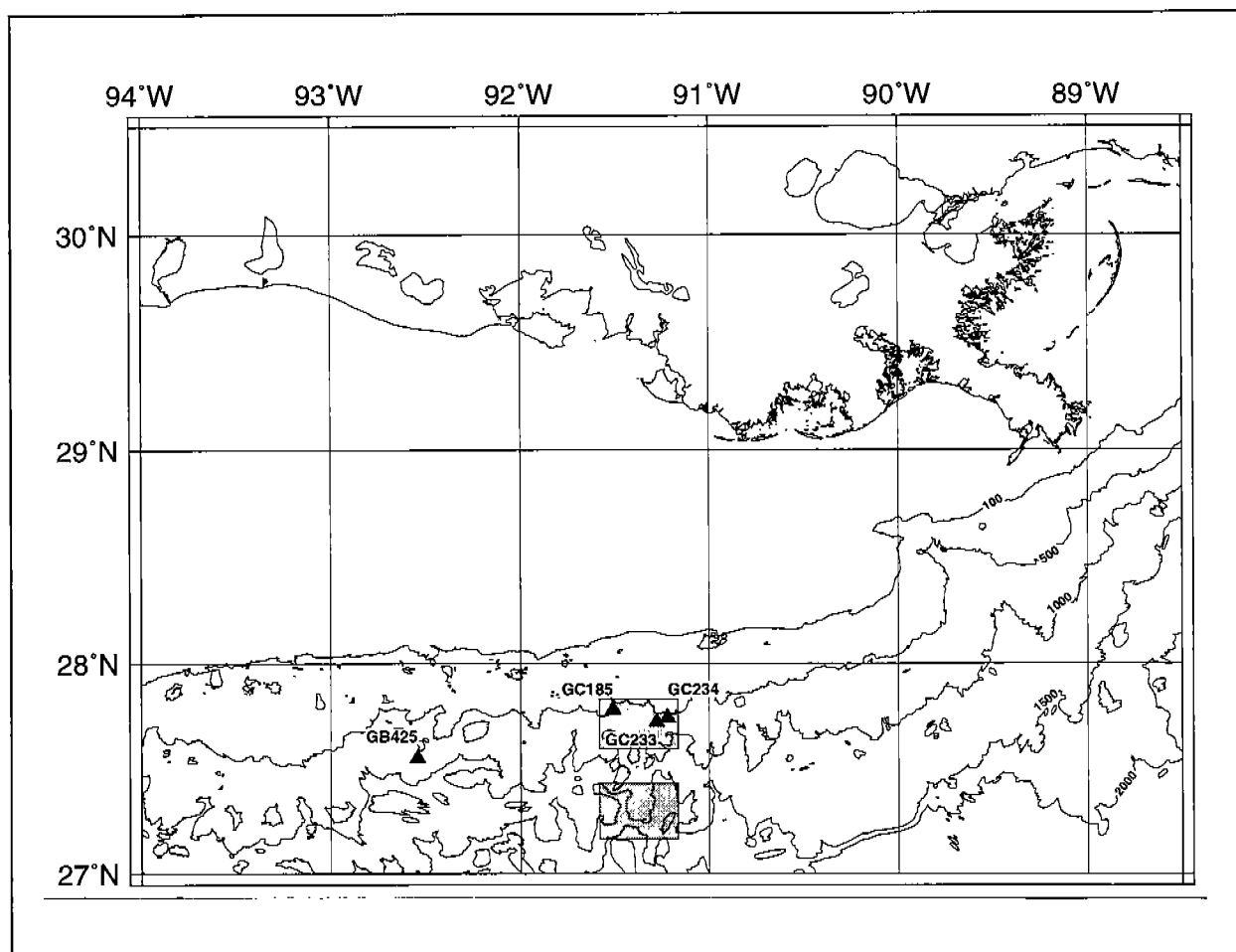

Figure 2K.7. Regional map of Gulf of Mexico showing sampling site locations (triangles) and mega-site regions for geophysical survey (shaded).

geophysical survey designed to test methods for remote detection of chemosynthetic communities (Figure 2K.7). These areas were surveyed in June of 1997 with use of a bathymetric-image side-scan sonar system (TAMU2) and a 3.5 kHz subbottom profiler. At the community level, effort focuses on the abiotic factors that control the distribution and abundance of major chemosynthetic and associated fauna and on the life history of these organisms. Four study sites have been selected for detailed study (Figure 2K.7). These sites represent examples of two basic styles of seepage, sediment diffusion and brine pooling and were visited during a 20-day research cruise with the submersible Johnson Sea Link in July of 1997.

#### HABITAT-FORMING PROCESSES AT GULF OF MEXICO HYDROCARBON SEEPS: THE CONCEPTUAL BASIS OF THE CHEMO II PROGRAM

The chemosynthetic habitat is a benthic environment in the deep ocean where geochemical enrichment produces high concentrations of electron donors—particularly sulfide or methane—and where oxygen-rich seawater is simultaneously available (Jannasch 1989). Two distinct processes,

hydrothermal venting and cold seepage, can function as geologic forcing mechanisms that generate a chemosynthetic habitat. At a hydrothermal vent (HTV), the interface is turbulent, which means reduced chemical compounds alternate with sea water in the effluent plume that discharges from a vent orifice and subsequently bathes the vent organisms (Hessler and Kaharl 1995). The interface between oxidizing and reducing conditions at a cold seep tends to be laminar; that is, some physical state maintains reduced compounds on one side of an interface and seawater on the other. By physically bridging this interface, the seep autotrophs access oxygen and chemosynthetic substrates.

The Gulf of Mexico hydrocarbon seeps are a major example of diversity and productivity in the cold CS habitat (Carney 1994; MacDonald *et al.* 1989). Satellite evidence demonstrates that seepage is active over a broad geographic range in the northern Gulf (Kornacki *et al.* 1994; MacDonald *et al.* 1993) so the potential scale of biological productivity is high (Figure 2K.7). Direct sampling of the seafloor by trawls, photo-sleds, and submersibles also indicates that chemosynthetic communities are common (Kennicutt II *et al.* 1988; MacDonald *et al.* 1996; Roberts and Aharon 1994); however, systematic survey of the entire region is cost-prohibitive, so a comprehensive census of total biological production derived from seeps will emerge only gradually.

At hydrocarbon seeps, sulfide is generated as a result of microbial consumption of hydrocarbons in the upper few meters of the sediment column. This compound supports the chemoautotrophic symbionts in tube worms and clams. Methane-oxidizing symbionts enable the seep mussel to utilize hydrocarbon gas directly. Duration of hydrocarbon migration ranges from millions to tens of millions of years (Sassen 1987). Chemosynthetic communities are dwarfed by the scale of the subsurface hydrocarbon system. They are ephemeral features compared to migration duration. Hydrocarbon production is unlikely to impact meaningfully survival of chemosynthetic communities, since it too is insignificant compared to total hydrocarbon system flux. Two fundamental styles of seepage occur at Gulf of Mexico hydrocarbon seeps: sediment diffusion and brine pooling. Much of the community level diversity in CS communities can be explained by examining the consequences of these processes.

### Sediment Diffusion

Many examples of sediment-diffusion hydrocarbon seeps were discovered on the upper continental slope in connection with energy prospecting when it was recognized that vertical migration of reservoir oils can produce high concentrations of high-molecular weight hydrocarbons in seafloor sediment (Anderson *et al.* 1983). In these habitats, mussels, clams and tube worms tap reduced compounds—methane and H<sub>2</sub>S—by extending body parts into the soil or by bathing their brachia (gills or plumes) in the steep diffusion gradient immediately above the interface (Figure 2K.8). Gas seeps and gas hydrates were also recognized as important components of the slope seep system (Brooks *et al.* 1984; Shipley *et al.* 1979).

The salient characteristics of the sediment diffusion habitat are abundant, highly-altered hydrocarbons, including thermogenic gas and high-molecular weight oils and tar (Behrens 1988; Kennicutt II *et al.* 1987), which are distributed through a broad sedimentary section overlying a fault or fault nexus (Reilly *et al.* 1996; Roberts and Aharons 1993). At the seafloor, a complex veneer

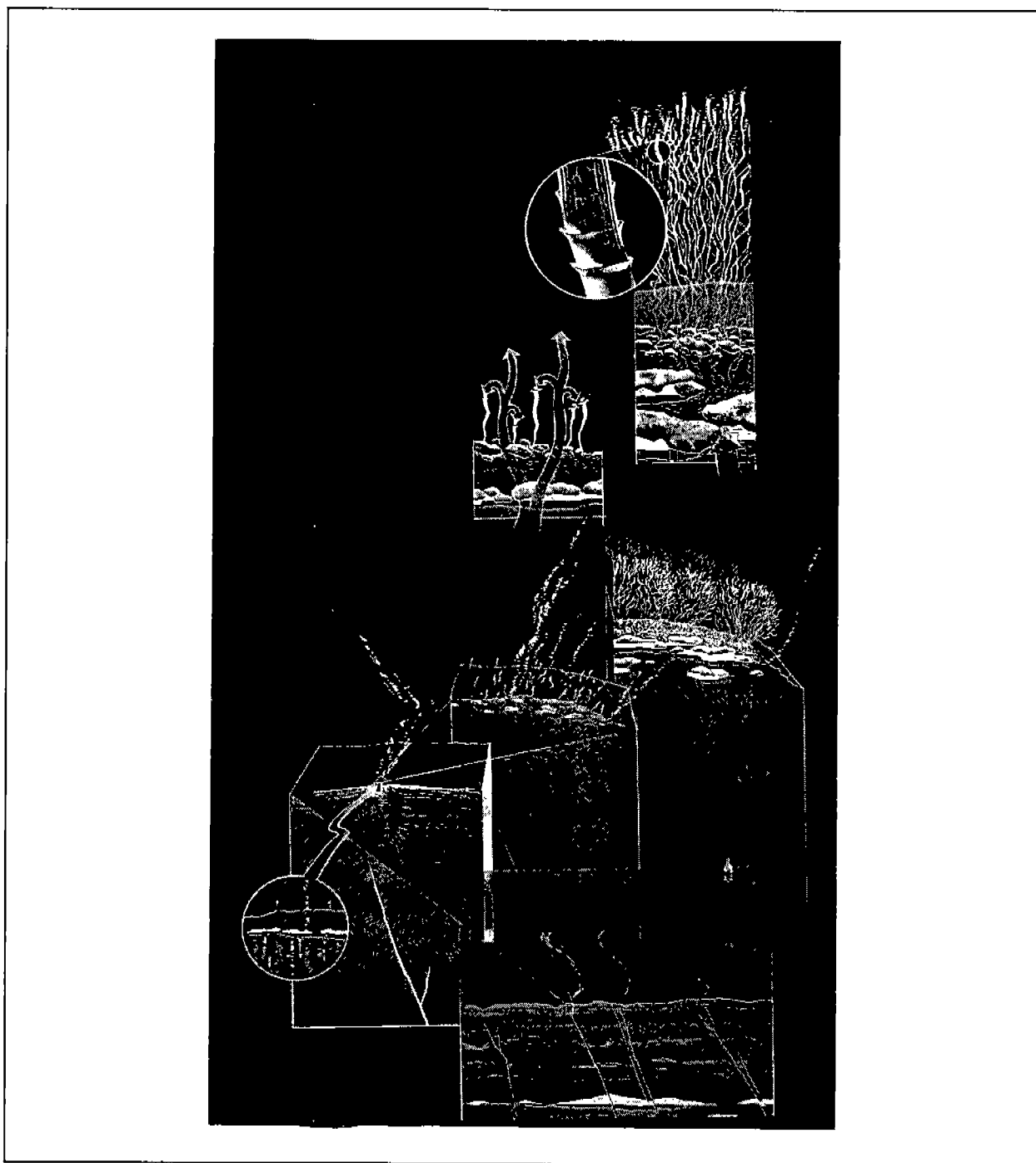

Figure 2K.8. Cartoon of the chemosynthetic community formation in a sediment diffusion habitat. Gas and oil migrate along fault planes that penetrate reservoirs—oil platform drawn to scale (lower), then diffuse through unconsolidated sediments approaching the seafloor (middle left). Formation of gas hydrate, layers of biota, and authigenic carbonate entrap hydrocarbons in uppermost sediment (middle right), facilitating microbial degradation of hydrocarbons and subsequent reduction of seawater sulfate to sulfides needed for tube worm symbiosis (upper right). (*Painting by Bruce Moser.*)

tends to entrap and further contribute to alteration of the seeping fluids. Roughly in order of greatest relative age, major components of this veneer are as follows—note that the citations provided refer to descriptions of the components, not their influence on habitat formation:

- Authigenic carbonates in the form of rubble and consolidated pavements (Roberts and Aharon 1994; Sassen *et al.* 1993),
- Extensive aggregations of vestimentiferans the "roots" of which extend into the upper sediment as virtually impenetrable tangles (Fisher 1995),
- Beds of bivalves including living mussels and/or clams and layers of shell (Callender *et al.* 1990; MacDonald *et al.* 1990a),
- Layers of gas hydrate, which can form extensive strata and entrap buoyant phases of hydrocarbons, but are subject to gradual dissolution and possible catastrophic failure under the influence of the bottom-water column (MacDonald *et al.* 1994).
- Mats of the sulfide-oxidizing bacteria, *Beggiatoa* (Larkin *et al.* 1994), which occur as pigmented and non-pigmented forms (Sassen *et al.* 1993)

Although there is good evidence for structural instability in rapidly forming seep habitats—particularly where mud volcanism produces massive fluid discharge (Neurauter and Roberts 1994; Roberts and Neurauter 1990), the formation of large chemosynthetic communities takes place in the context of increasing lithification and general seafloor stability (Roberts and Aharon 1994). The chemosynthetic fauna themselves will, with time, retard escape of hydrocarbons from the sediments (Sassen *et al.* 1994). CHEMO II sampling sites GC185 and GC234 are examples of sediment diffusion habitats.

### Brine Pooling

Strong brines are often associated with petroleum formations and natural seepage (Behrens 1988). Where brines discharge at the seafloor, their density tends to retain them as distinct fluids—pools on the seafloor. The awareness of brine-filled basins and seeps in the Gulf predates the discovery of chemosynthetic communities (Bright *et al.* 1980; Paull and Neumann 1987; Shokes *et al.* 1977). Serendipitous discovery of chemosynthetic fauna on the Florida Escarpment demonstrated the potential for brine as a carrier for reduced compounds (Cary *et al.* 1989; Paull *et al.* 1984). The significance of the pooling process became evident when a dense colony of Seep Mytilid Ia was discovered around the edges of a small, brine-filled crater (MacDonald *et al.* 1990b). Where brines pool on the seafloor, mussels can obtain methane by pulling in water through their inhalant siphons held just above the brine (MacDonald *et al.* 1990a). High concentrations of LMWHC are often dissolved in Gulf of Mexico brines, but the defining characteristics of the brine pooling habitat are an extremely sharp ( $\approx 1$  cm) interface between brine and sea-water and a level surface which allow a thin layer of brine to cover the sediment surface. Dense colonies of mussels can become established

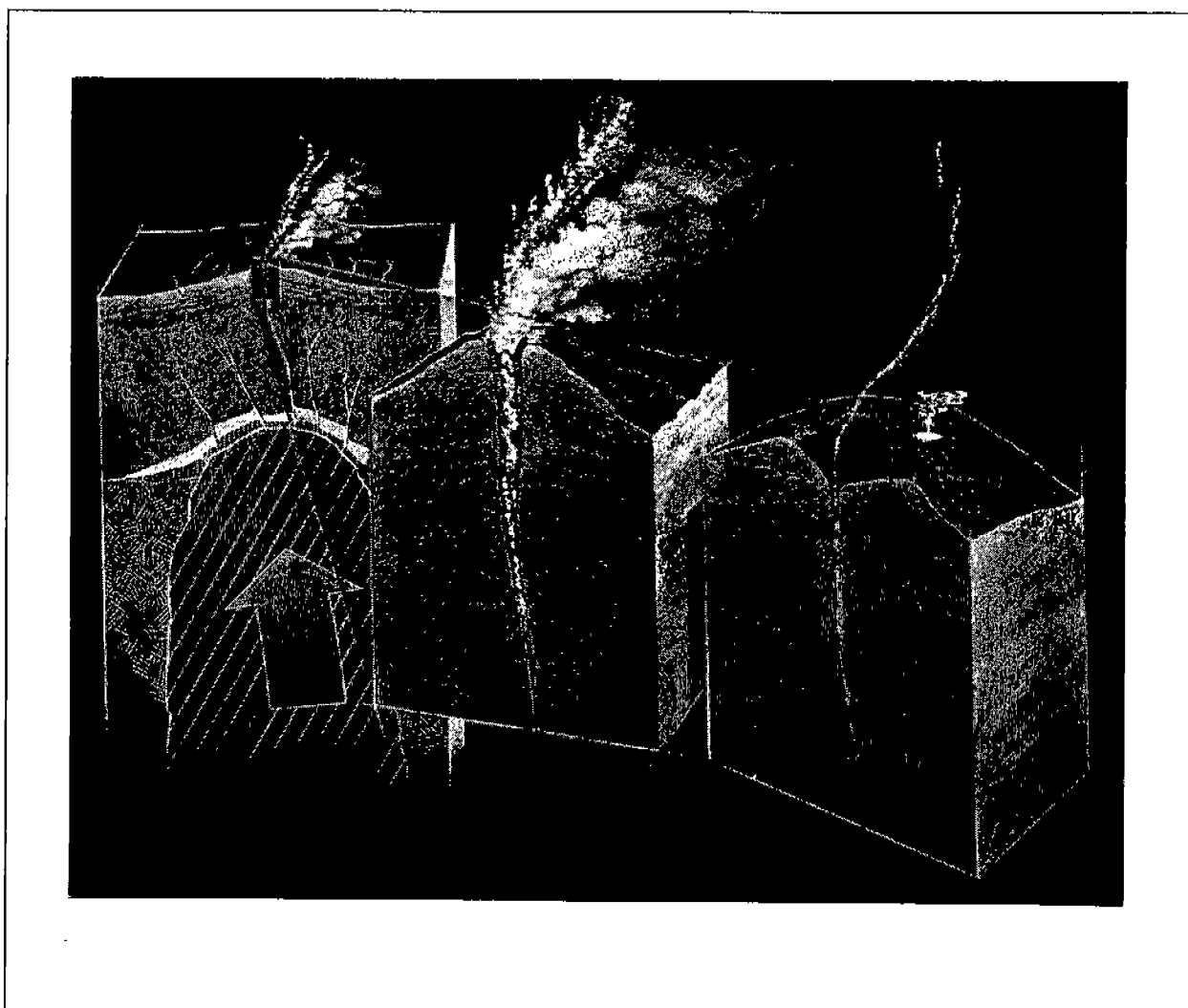

Figure 2K.9 Cartoon of the chemosynthetic community formation in a brine pooling habitat. Salt diapir pressurizes a shallow reservoir of methane—also known as a shallow gas hazard (left). Subsequent release of gas excavates a surface crater and diatreme (middle). High concentrations of methane are available to seep mussels around edges of brine pool formed by dissolution of salt—submersible drawn to scale (right). (*Painting by Bruce Moser.*)

in such layers of brine. Where the brine interface is less sharp, for example in the large brine pool filling Orca Basin, which has a meters-thick separation between seawater and saturated brine (Shokes *et al.* 1977), the mussels are unable to bridge the distance between anoxic brine and oxygen-rich seawater; consequently mussel communities appear to be absent (Brooks *et al.* 1990). The brine pooling habitat therefore results from either brine seeps on a nearly level slope, or the modification of a brine-filled pockmark that establishes a thin brine layer at the edges (Figure 2K.9). CHEMO II sampling sites GC233 and GB425 are examples of brine pooling habitats.



## GEOLOGIC STABILITY IN CHEMOSYNTHETIC COMMUNITIES

Geological evidence demonstrates that hydrocarbon and brine seepage persists in spatially discrete areas for thousands of years. These seeps are associated with migration conduits that connect the seafloor with sub-bottom reservoirs. It may be possible to categorize the geophysical and geochemical characteristics of the conduits in a way that will improve capacity for predicting where chemosynthetic communities occur. Defining the processes that determine the geological cycle of seepage, i.e. reservoir dynamics, large-scale halokinesis, sedimentation rates, etc., is largely beyond the scope of this program. It is possible, however, to make qualitative evaluations of the relative age of the primary study sites and to identify additional sites of various ages. This will improve prediction of community presence/absence and increase understanding of the long-term fate of communities.

## REFERENCES

- Anderson, R., K., R. Scalan, S., P. Parker, L., and E.W. Behrens. 1983. Seep oil and gas in Gulf of Mexico sediment. *Science*. 222. 619-621.
- Behrens, E.W. 1988. Geology of a continental slope oil seep, northern Gulf of Mexico. *American Association of Petroleum Geologists Bulletin*. 72 (2). 105-114.
- Bright, T.J., P.A. LaRock, R.D. Lauer, and J.M. Brooks. 1980. A brine seep at the east Flower Garden Bank, northwestern Gulf of Mexico. *Int. Revue ges. Hydrobiol.* 65. 321-335.
- Brooks, J.M., M.C. Kennicutt II, R.R. Fay, T.J. McDonald, and R. Sassen. 1984. Thermogenic gas hydrates in the Gulf of Mexico. *Science*. 223. 696-698.
- Brooks, J.M., D.A. Wiesenburg, H. Roberts, R.S. Carney, I.R. MacDonald, C.R. Fisher, J. Guinasso, N.L., W.W. Sager, S.J. McDonald, J. Burke, R., P. Ahron, and T.J. Bright. 1990. Salt, Seeps and Symbiosis in the Gulf of Mexico. *Eos*. 71. 1772-1773.
- Callender, W.R., G.M. Staff, E.N. Powell, and I.R. MacDonald. 1990. Gulf of Mexico hydrocarbon seep communities; V. Biofacies and shell orientation of autochthonous shell beds below storm wave base. *Palaios*. 5. 2-14.
- Carney, R.S. 1994. Consideration of the oasis analogy for chemosynthetic communities at gulf of Mexico hydrocarbon vents. *Geo-Marine Letters*. 14 (2/3). 149-159.
- Cary, C., B. Fry, H. Felbeck, and R.D. Vetter. 1989. Multiple trophic resources for a chemoautotrophic community at a cold water brine seep at the base of the Florida Escarpment. *Marine Biology*. 100. 411-418.
- Fisher, C.R. 1995. Toward an appreciation of hydrothermal vent animals: Their environment, physiological ecology, and tissue stable isotope values in Seafloor hydrothermal systems. (eds.)

- S.E. Humphris, R.A. Zierenberg, L.S. Mullineaux, and R.E. Thomson. American Geophysical Union. Washington, DC.
- Hessler, R.R., and V.A. Kaharl. 1995. The deep-sea hydrothermal vent community: An overview in Seafloor hydrothermal systems. (eds.) S.E. Humphris, R.A. Zierenberg, L.S. Mullineaux, and R.E. Thomson. pp. 72-84. American Geophysical Union. Washington, DC.
- Jannasch, H. 1989. Chemosynthetically sustained ecosystems in the deep sea in Autotrophic Bacteria. (eds.) H.G. Schlegel, and B. Bowien. pp. 147-166. Springer-Verlag. Berlin.
- Kennicutt II, M.C., J.M. Brooks, R.R. Bidigare, and G.J. Denoux. 1988. Gulf of Mexico hydrocarbon seep communities—I. Regional distribution of hydrocarbon seepage and associated fauna. *Deep Sea Research*. 35. 1639-1651.
- Kennicutt II, M.C., J. Sericano, T.L. Wade, F. Icazar, and J.M. Brooks. 1987. High-molecular weight hydrocarbons in the Gulf of Mexico continental slope sediment. *Deep-Sea Research*. 34. 403-424.
- Kornacki, A.S., J.W. Kendrick, and J.L. Berry. 1994. The impact of oil and gas vents and slicks on petroleum exploration in the deepwater Gulf of Mexico. *Geo-Marine Letters*. 14 (2/3). 160-169.
- Larkin, J., P. Aharon, and M.C. Henk. 1994. *Beggiatoa* in microbial mats at hydrocarbon vents in the Gulf of Mexico and warm mineral springs, Florida. *Geo-Marine Letters*. 14 (2/3). 97-103.
- MacDonald, I.R., G.S. Boland, J.S. Baker, J.M. Brooks, M.C. Kennicutt II, and R.R. Bidigare. 1989. Gulf of Mexico chemosynthetic communities II: spatial distribution of seep organisms and hydrocarbons at Bush Hill. *Marine Biology*. 101. 235-247.
- MacDonald, I.R., W.R. Callender, J. Burke, R.A., and S.J. McDonald. 1990a. Fine scale distribution of methanotrophic mussels at a Louisiana Slope cold seep. *Progress in Oceanography*. 25. 15-24.
- MacDonald, I.R., N.L. Guinasso Jr, J.M. Brooks, R. Sassen, S. Lee, and S. K.T. 1994. Gas hydrates that breach the sea-floor and interact with the water column on the continental slope of the Gulf of Mexico. *Geology*. 22. 699-702.
- MacDonald, I.R., N.L. Guinasso, S.G. Ackleson, J.F. Amos, R. Duckworth, R. Sassen, and J.M. Brooks. 1993. Natural oil slicks in the Gulf of Mexico visible from space. *Journal of Geophysical Research*. 98-C9. 16351-16364.
- MacDonald, I.R., I. Reilly, J.F., Guinasso, Jr., N.L., J.M. Brooks, R.S. Carney, W.A. Bryant, and T.J. Bright. 1990b. Chemosynthetic mussels at a brine-filled pockmark in the northern Gulf of Mexico. *Science*. 248. 1096-1099.
- MacDonald, I.R., J.F. Reilly Jr., S.E. Best, R. Venkataramaiah, R. Sassen, J. Amos, and N.L.

- Guinasso Jr. 1996. A remote-sensing inventory of active oil seeps and chemosynthetic communities in the northern Gulf of Mexico in Hydrocarbon migration and its near-surface expression. (eds.) D. Schumacher, and M.A. Abrams. pp. 27-37. Amer. Assoc. Petrol. Geol.
- Neurauter, T.W., and H.H. Roberts. 1994. three generations of mud volcanoes on the Louisiana continental slope. *Geo-Marine letters*. 14 (2/3). 120-125.
- Paull, C.K., B. Hecker, R. Commeau, R.P. Freeman-Lynde, C. Neumann, W.P. Corso, S. Golubic, J.E. Hook, E. Sikes, and J. Curray. 1984 . Biological communities at the Florida Escarpment resemble hydrothermal vent taxa. in *Science* . pp. 965-967 .
- Paull, C.K., and A.C. Neumann. 1987 . Continental margin brine seeps: their geological consequences. *In Geology* . pp. 545-548 .
- Reilly, J.F., I.R. MacDonald, E.K. Biegert, and J.M. Brooks. 1996. Geologic controls on the distribution of chemosynthetic communities in the Gulf of Mexico in Hydrocarbon migration and its near-surface expression. (eds.) D. Schumacher, and M.A. Abrams. Amer. Assoc. Petrol. Geol. Tulsa, OK.
- Roberts, H.H., and P. Aharon. 1994. Hydrocarbon-derived carbonate buildups of the northern Gulf of Mexico slope: A review of submersible investigations. *Geo-Marine Letters*. 14 (2/3). 135-148.
- Roberts, H.H., and P. Aharons. Cold seep carbonates of the northern Gulf of Mexico: a synthesis of submersible investigations. 1993. in American Association of Petroleum Geologists Annual Convention. pp. 172, New Orleans.
- Roberts, H.H., and T.W. Neurauter. 1990. Direct observations of a large active mud vent on the Louisiana continental slope. *American Association of Petroleum Geologists, Bulletin*. 74. 1508.
- Sassen, P. Grayson, and G. Cole. Hydrocarbon seepage and salt dome-related carbonate reservoir rocks of the U.S. Gulf Coast.. 1537.
- Sassen, R. 1987. Organic geochemistry of salt dome rocks, Gulf Coast salt basin. *In Academic Press, Inc.*
- Sassen, R., I. MacDonald, A. Requejo, N. Guinasso, M. Kennicutt II, S. Sweet, and J. Brooks. 1994. Organic geochemistry of sediments from chemosynthetic communities, Gulf of Mexico slope. *Geo-Marine Letters*. 1-21.
- Sassen, R., H.H. Roberts, P. Aharon, J. Larkin, E.W. Chinn, and R. Carney. 1993. Chemosynthetic bacterial mats at cold hydrocarbon seeps, Gulf of Mexico continental slope. *Organic Geochemistry*. 20 (1). 77-89.
- Shipley, T.H., M.H. Houston, R.T. Buffler, F.T. Shaub, K.J. McMillen, J.W. Ladd, and J.L. Worzel.

1979. Seismic evidence for widespread possible gas hydrate horizons on continental slopes and rises. *American Association of Petroleum Geologists Bulletin*. 63 (12). 2204-2213.

Shokes, R.F., P.K. Trabant, B.J. Preseley, and D.F. Reid. 1977. Anoxic, hypersaline basin in the northern Gulf of Mexico. *In Science* . pp. 1443-1446.

---

Dr. Ian R. MacDonald is an associate research scientist at the Geochemical and Environmental Research Group, Texas A&M University. He has 12 years of experience as an MMS contractor for offshore environmental concerns. His area of expertise is deep sea ecology and he is currently serving as program manager for the Stability and Change in Gulf of Mexico Chemosynthetic Ecosystems study. MacDonald received his Ph.D. in oceanography from Texas A&M University in 1990.



## INDEX TO AUTHORS

Adame Garza, MC. Jorge A. ....	440
Anuskiewicz, Dr. Richard J. ....	263
Atkinson, Dr. Larry ....	497
Avent, Dr. Robert M. ....	412
Barras, Mr. John ....	84
Battista, Mr. T. ....	71
Beaubien, Ms. Debra K. ....	675
Beaver, Mr. Carl R. ....	388
Benfield, Dr. Mark C. ....	361
Bezanson, Mr. David ....	88
Blake, Dr. James A. ....	524
Blanchard, Dr. Dallas A. ....	221
Bolden, Mr. James ....	359
Bourgeois, Mr. Pierre ....	84
Bryan, Dr. C. Hobson ....	224
Bull, Dr. Ann Scarborough ....	256
Burby, Dr. Raymond ....	224
Burchfield, Mr. Patrick ....	327, 339
Buschang, Mr. Steven G. ....	88
Caldwell, Dr. Jack ....	131
Calix, Mr. Arturo ....	203
Carman, Dr. Kevin R. ....	646
Carney, Dr. Robert S. ....	417
Carrasco-A., Mr. Miguel A. ....	327, 339
Chang, Mr. Joseph C. ....	100
Christensen, Mr. J.C. ....	71
Cobb, Ms. Robyn A. ....	468
Cole, Mr. John G. ....	400
Coleman, Dr. F.C. ....	299, 304
Collard, Dr. Sneed B. ....	41
Cope, Mr. Joseph S. ....	361
Cox, Ms. Susan ....	597
Crawford, Ms. Kim ....	477, 486
Curtin, Dr. Tom ....	497
Cutter, Mr. G. Randall ....	524
D'Souza, Mr. Richard ....	164
Dauterive, Mr. Les ....	273
Defenbaugh, Dr. Richard ....	595
DeLaune, Dr. R. D. ....	634
Dempre, Mr. Terry ....	256

Diaz, Dr. Robert J. . . . .	524
Diaz-F., Mr. Juan . . . . .	327, 339
Ditty, Mr. James G. . . . .	361
Dokken, Dr. Quentin R. . . . .	388, 597
Donaldson, Mr. David M. . . . .	620
Duplantier, Mr. David . . . . .	494
Echols, Mr. Darrell L. . . . .	454
Estrada, Dr. Pedro Carlo . . . . .	427, 440
Eve, Mr. J. Hammond . . . . .	411, 414, 477
Falgout, Mr. Ted M. . . . .	236
Fannin, Dr. Matthew . . . . .	238
Farooqi, Ms. Talat W. . . . .	361
Fitzhugh, Dr. Gary . . . . .	299, 304
Fleeger, Dr. John W. . . . .	648
Frazer, Mr. G. Ross . . . . .	187
Frisbie, Mr. Richard . . . . .	142
Froemer, Dr. Norman . . . . .	65
Fuentes, Dr. Sóstenes E. Varela . . . . .	427
Gallaway, Dr. Benny J. . . . .	400, 675
Gambrell, Dr. Robert . . . . .	634
Garza, M.C. Jorge A. Adame . . . . .	427
Gettleson, Dr. David A. . . . .	49
Gill, Ms. T.A. . . . .	71
Gitschlag, Mr. Gregg . . . . .	395
Gittings, Dr. Stephen R. . . . .	623
Gledhill, Mr. C. . . . .	304
Govoni, Dr. John J. . . . .	309
Grace, Mr. M.A. . . . .	304
Grimes, Dr. C.B. . . . .	299, 304
Guo, Dr. Jiemin . . . . .	238
Hahn, Ms. Kathy J. . . . .	100
Hamilton, Dr. Peter . . . . .	54
Handley, Mr. Lawrence R. . . . .	201, 206
Harris, Mr. Walter S. . . . .	88
Hartley, Mr. Steve . . . . .	84
Hays, Dr. Paul . . . . .	24
Heffernan, Ms. L. M. . . . .	651
Heilman, Ms. Lorraine . . . . .	497
Henkel, Ms. Heather . . . . .	59
Henry, Jr, Mr. Charles B. . . . .	634, 656
Hoggard, Mr. Wayne . . . . .	670
Holder, Jr., Mr. Samuel . . . . .	211
Hsu, Dr. S. A. . . . .	107
Hutzell, Dr. William T. . . . .	95

Irion, Dr. Jack B. . . . .	246, 267
Johnson, Mr. Chris . . . . .	78
Johnson, Ms. H.L. . . . .	71
Johnston, Dr. James B. . . . .	84, 201
Jones, Dr. Edward R. . . . .	464
Jones, Mr. William R. . . . .	84, 201
Jones, Mr. Alvin L. . . . .	477
Keithly, Dr. Walter . . . . .	238
Kelly, Dr. William R. . . . .	218
Koenig, Dr. C.C. . . . .	299, 304
Lamkin, Dr. John T. . . . .	309
Lang, Dr. William H. . . . .	509
Leistriz, Dr. F. Larry . . . . .	224
Leming, Mr. Thomas D. . . . .	309
Leo-P., Ms. Alma S. . . . .	327, 339
Logan, K. . . . .	348, 353
Lorandi, Dr. Francisco V. Vidal . . . . .	541, 550
Luton, Dr. Harry . . . . .	217
Lyczkowski-Shultz, Dr. Joanne . . . . .	293, 309
Malahy, Dr. Robert C. . . . .	29
Marquez-M., Dr. Rene . . . . .	327, 339
Maxwell, Dr. Paul C. . . . .	553
McIlwain, Dr. Thomas D. . . . .	284
McLawhorn, Mr. Daniel F. . . . .	490
McNally, Mr. Dennis E. . . . .	116
Meier, Dr. Eugene P. . . . .	604
Miller, Mr. John E. . . . .	464
Monac, Dr. M.E. . . . .	71
Mullin , Dr. Keith D. . . . .	670
Murdock, Dr. Steve H. . . . .	224
Norris, Mr. Henry . . . . .	78
Norris, Dr. Jeff . . . . .	663
Overton, Dr. Edward B. . . . .	656
Oynes, Mr. Chris C. . . . .	579
Palacios, Dr. Laura Muñoz . . . . .	458, 461
Peña-V., Mr. Jaime . . . . .	327, 339
Petterson, Dr. John S. . . . .	475, 518
Rabalais, Dr. Nancy N. . . . .	634
Regg, Mr. Jim . . . . .	6, 158
Rich, Mr. Harry I. . . . .	33
Richards, Dr. William J. . . . .	309
Richardson, Mr. G. Ed . . . . .	3, 15
Riggs, Mr. Terry E. . . . .	388
Rivera-Arriaga, Ms. Evelia . . . . .	610



Robb, Mr. Steve	201
Roberts, Ms. Paulene O.	634
Rogers, Dr. Robert	39
Rojas-Galaviz, Mr. Jose Luis	610
Roscigno, Dr. Pasquale	633
Ross, Dr. Steve W.	286
Rubec, Dr. Peter	78
Sanchez-P., Mr. Manuel	327, 339
Scalfano, Mr. David	96
Scanlon, Ms. K.	304
Schroeder, Dr. William W.	277
Schubert, Dr. Eric S.	224
Shaver, Ms. Donna J.	342
Shaw, Dr. Richard F.	361
Shihadeh, Dr. Edward	228
Singelmann, Dr. Joachim	240
Smith-Vaniz, Dr. William F.	286
Snyder, Mr. David B.	49
Stanley, Dr. David R.	372
Stickle, Jr., Dr. W. B.	651
Stumpf, Dr. Richard P.	59
Sturdevant, Mr. Lawnie	159
Sulak, Dr. Kenneth J.	286
Tesche, Dr. T. W.	116
Tessaro, Ms. María Pia Gallina	315, 319
Tetreau, CDR Guy A.	152
Thompson, Mr. M. John	208
Tolbert, Dr. Charles M.	228, 411, 420
Tootle, Dr. Deborah	228
Varela Fuentes, Dr. Sóstenes E.	439
Vásquez, Dr. M.A.	348, 353
Velez, Mr. Peter K.	562
Wayne, Ms. Lynda	66
Weaver, Mr. Douglas C.	286
Wetzel, Mr. Nicholas	245
Whiting, Commander Daniel	586
Wilson, Dr. Charles A.	372
Winston, Dr. G. W.	651
Woodall, Ms. Debra W.	634
Woodin, Dr. Marc	324
Yépez, F.	348, 353
Young, Mr. W. Scott	184
Yourk, Mr. Tom	251
Zarate-Lomeli, Mr. David	610

## ATTENDEES

THOMAS AHLFELD  
MMS - MAIL STOP 4041  
381 ELDEN ST  
HERNDON, VA 20170

ADNAN A. AHMED  
1201 ELMWOOD PARK  
NEW ORLEANS, LA 70123

DAN ALLEN  
SR ECOLOGIST  
935 GRAVIER ST  
NEW ORLEANS, LA 70112

ALEX ALVARADO  
1201 ELMWOOD PARK BLVD  
NEW ORLEANS, LA 70123

LARRY ANDERSON  
ACCT MGR  
801 WARRENVILLE RD  
M/C6018  
LISLE, IL 60532

RICHARD ARMSTRONG  
EXEC DIR  
PO BOX 51239  
NEW ORLEANS, LA 70123

JON BARFIELD  
ENVIRON SCIENTIST  
PO BOX 2563  
BIRMINGHAM, AL 35202

TIM BATTST  
G-IS SPEC  
1605 EAST WEST HWY  
SILVER SPRING, MD

JOSEPH BAYHI  
VOLUNTEER  
2733 AUDUBON ST  
NEW ORLEANS, LA 70125

BRIAN BEALS  
ENVION ENGINEER  
61 FORSYTH ST  
ATLANTA, GA 30383

SYLVIA BELLONE  
PO BOX 57089  
NEW ORLEANS, LA 70157

MARK C. BENFIELD  
LSU  
218 WETLAND RESOURCES  
BATON ROUGE, LA 70803

THOMAS J. BERGER  
615 OBERLIN RD  
SUITE 300  
RALEIGH, NC 27605

LOUISE A. BERNEY  
ASST CHIEF PORT OPS DEPT  
800 DAVID DR  
MORGAN CITY, LA 70380

DAVID BEZANSON  
GIS ANALYST  
1700 N CONGRESS  
AUSTIN, TX 78701

DOUGLAS BIGGS  
PROFESSOR  
DEPT OF OCEANOGRAPHY  
TEXAS A&M  
COLLEGE STATION, TX  
77843-3146

NEAL BLAIR  
ASSOC PROFESSOR  
MEAS  
NC STATE UNIV  
RALEIGH, NC 27695-8208

ROLFE BLIZZARD  
NC SENATE  
LEGISLATIVE BLDG  
RALEIGH, NC 27601-2808

GREG BOLAND  
SR RESEARCH ASSOC  
3012 HUMMINGBIRD CR  
BRYAN, TX 77807

WALTER BONORA  
1849 C ST NW  
ROOM 4257 (MS4230)  
WASHINGTON, DC 20240

DAVID BORNHOLDT  
12201 SUNRISE VALLEY DR  
RESTON, VA 20192

MARK A. BOUDREAUX  
SR ENG TECHNICIAN  
1555 POYDRAS ST  
NEW ORLEANS, LA 70112

JOHN BOURGEOIS  
700 CAJUN DOME  
LAFAYETTE, LA 70506

DARICE BREEDING  
PHYSICAL SCIENTIST  
1201 ELMWOOD PARK BLVD  
MS 5440  
NEW ORLEANS, LA 70123-2394

GARY BREWER  
BIOLOGIST  
NEW ORLEANS, LA

TODD A. BRIDGEMAN  
ASST SCI SUPPORT COORD  
C/O CDR EIGHTH DIST COAST  
GUARD  
501 MAGAZINE ST  
NEW ORLEANS, LA 70130

STEVE BROOKS  
OFFSHORE COMP COORD  
PO BOX 61707  
NEW ORLEANS, LA 70161

PAUL D. BROUSSARD  
PO BOX 60252  
NEW ORLEANS, LA 70160

MURRAY BROWN  
MMS - MAIL STOP 5440  
1201 ELMWOOD PARK BLVD  
NEW ORLEANS, LA 70123-2394

PATRICIA J. BRUCE  
REGULATORY SPECIALIST  
PO BOX 2967  
HOUSTON, TX 77252-2967

GERRY BRUER  
16052 ENGLISH OAKS AVE  
APT A  
BOWIE, MD 20716

DAVID BULL  
PHOTOGRAPHER  
6513 CARMEN ST  
METAIRIE, LA 70003

GREG BUNCH  
NEW ORLEANS, LA

DONALD R. CAHOON  
ECOLOGIST  
700 CAJUNDOME BLVD.  
LAFAYETTE, LA 70506

KATHY CAMP  
3624 WEST CHASE  
HOUSTON, TX 77042

KERRY J. CAMPBELL  
MGR GEOSCIENCE PROJECTS  
6100 HILLCROFT  
HOUSTON, TX 77081

JOHN CANDLER  
ENVIRON AFFAIRS MGR  
5950 NORTH COURSE DR  
HOUSTON, TX 77072

JOEL F. CARPENTER  
ENVIRON COORDINATOR  
375 NORTHRIDGE RD  
ATLANTA, GA 30350

WILL CARPENTER  
5525 MOUNES  
SUITE 102  
NEW ORLEANS, LA 70123

LYNARD CARTER  
OP-90 ENGINEER  
1201 ELMWOOD PARK BLVD  
MS 5250  
NEW ORLEANS, LA 70123

JOHN H. CARUSO  
UNIV EDUCATION COORD  
8124 HWY 56  
CHAUVIN, LA 70344-2110

RUSSELL L. CHAPMAN  
EXEC DIRECTOR  
E302 HOWE-RUSSELL  
GEOSCIENCE COMPLEX  
BATON ROUGE, LA 70803

DENNIS CHEW  
1201 ELMWOOD PARK BLVD  
MS 5410  
NEW ORLEANS, LA 70123

JOSEPH A. CHRISTOPHER  
1201 ELMWOOD PARK BLVD  
MS 5410  
NEW ORLEANS, LA 70123

JAMES CIMATO  
MMS - MAIL STOP 4041  
381 ELDEN ST  
HERNDON, VA 20170

ROGER CLAFF  
SR ENVIRON SCIENTIST  
1220 L ST NW  
WASHINGTON, DC 20005

ELAINE CLARK  
1201 ELMWOOD PRK BLVD  
MS 5440  
NEW ORLEANS, LA 70123

KIM COFFMAN  
381 ELDEN ST  
HERNDON, VA 20170

JOHN COLE  
1410 CAVITT ST  
BRYAN, TX 77801

MIKE CONNOR  
PROD ENGINEER  
1201 ELMWOOD PARK BLVD  
MS 5250  
NEW ORLEANS, LA 70123

JIM E. COOK  
OPERATION MANAGER  
1900 WEST LOOP SOUTH  
SUITE 1600  
HOUSTON, TX 77027

DAVID W. COOKE  
CHIEF RESOURCE STUDIES  
1201 ELMWOOD PARK BLVD  
NEW ORLEANS, LA 70123

CORT COOPER  
SR RESEARCH ASSOC  
6001 BOLLINGER CANYON  
RD  
SAN RAMON, CA 94583

J. KEITH COUVILLION  
REGIONAL LANDMAN -  
OFFSHORE  
PO BOX 60252  
NEW ORLEANS, LA 70160

DEBORAH CRANSWICK  
SR ENVIRO SCIENTIST  
1201 ELMWOOD PARK BLVD  
NEW ORLEANS, LA 70123

BILL CROW  
PO BOX 595-235  
DALLAS, TX 75359

RON CRUM  
PPM  
8550 UNITED PLAZA  
BATON ROUGE, LA 70809

CHARLIE CURLEE  
HES MGR  
PO BOX 53266  
LAFAYETTE, LA 70505

BRIAN CYBUL  
SALES ENGINEER  
3900 COLLINS RD  
SUITE 1011  
LANSING, MI 48910

SCOTT DAVIS  
 ENVIRON ENGINEER  
 ATLANTA FEDERAL CTR  
 61 FORSYTH ST SW  
 ATLANTA, GA 30303-3104

GARY DEMARSH  
 401 WHITNEY AVE  
 #412  
 GRETNA, LA 70056

KEN DESLARZES  
 1201 ELMWOOD PARK BLVD  
 NEW ORLEANS, LA 70123

ED DEWAILLY  
 MMS COORD  
 1550 ENERGY CTR  
 NEW ORLEANS, LA 70113

CINDY DEWITT  
 PO BOX 4587  
 HOUSTON, TX 77210

WILLIAM DEWITT  
 PO BOX 2180  
 HOUSTON, TX 77252-2180

JACK DICKSON  
 CONSULTANT  
 717 N HARWOOD  
 DALLAS, TX 75201

SUE DIEHL  
 CANAL ST  
 NEW ORLEANS, LA 70161

PAMELA DILIBERTO  
 CONTRACT SPEC  
 1201 ELMWOOD PARK BLVD  
 NEW ORLEANS, LA 70123

QUENTON DOKKEN  
 6300 CEAN DRIVE  
 CORPUS CHRISTI, TX 78412

DAVE DOUGALL  
 MGR ENV'T SAFETY  
 2950 N LOOP WEST #300  
 NEW ORLEANS, LA 77092

DANIELLE DOWDY  
 124 BEECH ST  
 PENSACOLA, FL 32506

KEITH DUPUIS  
 500 DALLAS ST  
 HOUSTON, TX 77002

DAVID J. DYE  
 ENVIRON SCIENTIST  
 PO BOX 2563  
 BIRMINGHAM, AL 35222

DAVID DYKES  
 SAFETY MGR  
 1 LEE CIRCLE  
 NEW ORLEANS, LA 70130

SHERRY EASTIN  
 135 REGENCY SQ  
 LAFAYETTE, LA 70508

CARYL FAGOT  
 1201 ELMWOOD PARK BLVD  
 NEW ORLEANS, LA 70123

DAGMAR FERTL  
 1201 ELMWOOD PARK BLVD  
 MS 5410  
 NEW ORELANS, LA 70123

RICHARD H. FILLON  
 PO BOX 60252  
 NEW ORLEANS, LA 70160

TIM FINNIGAN  
 6001 BOLLINGER RD  
 SAN RAMON, CA 94583

JOHN K. FORD  
 PO BOX 3628  
 TULSA, OK 74104

ROY FRANCIS  
 EXEC DIR  
 PO BOX 2048  
 NSU  
 THIBODAU, LS 70310

MIKE FRANK  
 CHIEF TECHNOLOGY  
 OFFICER  
 2950 N LOOP W.  
 SUITE 1050  
 HOUSTON, TX 77092

ROSS FRAZER  
 MGR REGULATORY AFFAIRS  
 1201 LOUISIANA  
 SUITE 3500  
 HOUSTON, TX 77002

HENRY FREEDENBERG  
 903 WEST TENNESSEE ST  
 TALLAHASSEE, FL 32304-7700

SANDI FURY  
 REGULATORY ADVISOR  
 935 GRAVIER ST  
 NEW ORLEANS, LA 70112

JOHN GEORGE  
 400 E KALISTE SALOOM RD  
 LAFAYETTE, LA 70508

TONY GEORGE  
 SENIOR GEOPHYSICIST  
 730 E. KALISTE SALOOM RD  
 LAFAYETTE, LA 70508

BOB GILLARD  
 1201 ELMWOOD PRK BLVD  
 MS 5440  
 NEW ORLEANS, LA 70123

AMY GILLESPIE  
 ASST ATTORNEY GENERAL  
 PO BOX 629  
 RALEIGH, NC 27602-0629

MARIA S. GOMEZ  
 REGULATORY/ENVIRON  
 TECH  
 1221 LAMAR ST 1200  
 HOUSTON, TX 77010

BEVERLY GONZALES  
 381 ELDEN  
 MS 4001  
 HERDON, VA 20170

MARK GRACE  
RESEARCH FISHERY  
BIOLOGIST  
PO DRAWER 1207  
PASCAGOULA, MS 39564

GERALD GRAU  
FISH/WILDLIFE ADMIN  
700 CAJUNDOME BLVD  
LAFAYETTE, LA 70506

LYNN GRIFFIN  
ENVRION ADMINISTRATOR  
3900 COMMONWEALTH BLVD  
TALLAHASSEE, FL 32399-3020

JIEMIN GUO  
RESEARCH ASSOC  
101 AG ADMIN BLDG  
LSU  
BATON ROUGE, LA 70803

TOM HAMILTON  
SR VICE PRES  
PO BOX 740010  
HOUSTON, TX 77274

GEORGE HAMPTON  
1201 ELMWOOD PARK BLVD  
NEW ORLEANS, LA 70123

JIM HANIFEN  
PO BOX 98000  
BATON ROUGE, LA  
70898-9000

KATY HARALAMPIDES  
NEW ORLEANS, LA

DANE HARDIN  
SR MARINE BIOLOGIST  
2155 LAS POSITAS CT #S  
LIVERMORE, CA 94550

STERLING HARRIS  
ANALYST  
1700 N CONGRESS  
AUSTIN, TX 78701

AJ HEIKAMP  
PO BOX 4870  
LAKE CHARLES, LA 70606

HOSSEIN HEKMATDOOST  
1201 ELMWOOD PARK BLVD  
MS 5114  
NEW ORLEANS, LA 70123

JOSEPH HENNESSEY  
PETROLEUM ENGINEER  
1201 ELMWOOD PARK BLVD  
MS 5232  
NEW ORLEANS, LA 70123

CHARLIE HENRY  
42 ATKINSON HALL  
BATON ROUGE, LA 70803

LARRY R. HENRY  
SR ENVIRON ADVISOR  
935 GRAVIER ST  
NEW ORLEANS, LA 70112

LARS HERBEST  
DIST SUPERVISOR  
1201 ELMWOOD PARK BLVD  
MS 5250  
NEW ORLEANS, LA 70123

DIRK HERKHOF  
381 ELDEN ST  
HERNDON, VA 22070

E.F. HERRIN  
SURVEY FOREMAN  
701 POYDRAS  
NEW ORLEANS, LA 70139

RON HILL  
FISHERY ECOLOGIST  
1315 EAST WEST HWY  
SILVER SPRING, MD 20910

WILLIAM HOSKING  
COORDINATOR  
4170 COMMANDER DR  
MOBILE, AL 36615

DON HOWARD  
1201 ELMWOOD PARK BLVD  
MS 5200  
NEW ORLEANS, LA 70123

DAVID W. HUGHES  
ASSOC PROFESSOR  
101 AG - ADMIN BLDG  
BATON ROUGE, LA 70810

CHERI HUNTER  
381 ELDEN  
MS 4001  
HERNDON, VA 20170

TOMMY HUTTO  
EMERGENCY RESPONSE  
COORD  
BOX 60193  
NEW ORLEANS, LA 70161

CHIJOKE IKONTE  
PETRO ENGINEER  
1201 ELMWOOD PARK BLVD  
NEW ORLEANS, LA 70001

MASAMICHI INOUE  
ASSOC PROFESSOR  
LSU  
BATON ROUGE, LA 70803

DAVID IZON  
PETRO ENGINEER  
1201 ELMWOOD PARK BLVD  
NEW ORLEANS, LA 70123

MELANIE JARREU  
3861 AMB CAFFERY #500  
LAFAYETTE, LA 70503

PERRY JENNINGS  
MMS INSPECTOR  
1201 ELMWOOD PARK BLVD  
MS 5250  
NEW ORLEANS, LA 70123

BONNIE JOHNSON  
ENVIRON SCIENTIST  
1201 ELMWOOD PARK BLVD  
NEW ORLEANS, LA 70123

CARLIANE JOHNSON  
GOV'T ANALYST  
1501 - THE CAPITOL  
TALLAHASSEE, FL 32399-0001

JAY JOHNSON  
SR MARINE  
OCEANOGRAPHER  
2155 LAS POSITAS CT #S  
LIVERMORE, CA 94550

WALTER JOHNSON  
MMS - MAIL STOP 4041  
381 ELDEN ST  
HERNDON, VA 20170

WILLIE JOHNSON  
600 CARONDELET  
8TH FLOOR  
NEW ORLEANS, LA 70130

ROBERT KELLY  
1201 ELMWOOD PARK BLVD  
MS 5114  
NEW ORLEANS, LA 70123

ROBIN KEMP  
WEB PRODUCER  
4522 LAUREL ST  
NEW ORLEANS, LA 70115

SALLY KENDRICK  
600 CARONDELET ST  
NEW ORLEANS, LA 70130

MAHLON C. KENNICUTT II  
DEPUTY DIRECTOR  
833 GRAHAM RD  
COLLEGE STATION, TX 77845

JAN KENNY  
OFFSHORE COORD  
401 WHITNEY AVE  
SUITE 412  
GRETNA, LA 70056

JOHN KENNY  
401 WHITNEY AVE  
#412  
GRETNA, LA 70056

PATRICK KENNY  
CONSULTANT  
PO BOX 385  
BELLE CHASSE, LA 70037

SARAH KLEIN-TOWER  
7495 BROMPTON  
HOUSTON, TX 77025

BRUCE KORKE  
1 CANAL ST  
NEW ORLEANS, LA 70130

MARK KROLOW  
DEEPWATER EXP TEAM  
LEADER  
935 GRAVIER ST  
NEW ORLEANS, LA 70112

HERB KUMPF  
ECOLOGIST/PROJ MGR  
3500 DELWOOD BEACH RD  
PANAMA CITY, FL 32408

KEVIN KUNKEL  
381 ELDEN ST  
HERDON, VA 20171

ROBERT KUZELA  
1201 ELMWOOD PARK BLVD  
NEW ORLEANS, LA 70123

BONNIE LA BORDE JOHNSON  
ENVIRONMENTAL SCIENTIST  
1201 ELMWOOD PARK BLVD  
MS 5422  
NEW ORLEANS, LA 70123-2394

ROBERT LABELLE  
381 ELDON ST  
HERNDON, VA 20170

PETE LAGIOVANE  
NAT GAS ANALYST  
1000 INDEPENDENCE AVE SW  
ROOM 3E028  
WASHINGTON, DC 20585

RONALD LAI  
MMS - MAIL STOP 4041  
381 ELDEN ST  
HERNDON, VA 20170

CONNIE LANDRY  
1201 ELMWOOD PARK  
MS 5430  
NEW ORLEANS, LA 70123-2394

SEDERA LANE  
PO BOX 60834  
NEW ORLEANS, LA 70161

CARLA LANGLEY  
1201 ELMWOOD PARK BLVD  
OFFICE OF REGIONAL DIR  
NEW ORLEANS, LA 70123

BOB LANZA  
DRILLING ENGINEER  
1201 ELMWOOD PARK BLVD  
MS 5250  
NEW ORLEANS, LA 70123

TOMMY LAURENDINE  
STRUCTURAL ENGINEER  
4844 W NAPOLEON AVE  
METAIRIE, LA 70001

STEVE LEDET  
1250 POYDRAS BUILDING  
NEW ORLEANS, LA 70113

BURNEY LEE  
SR SCIENTIST  
BLDG 500/1300  
150 W WARENVILLE RD  
NAPERVILLE, IL 60563

EDWARD LEE  
PRGM MANAGER  
600 CARONDELET ST  
NEW ORLEANS, LA 70130

GRIFF C. LEE  
PO BOX 70787  
NEW ORLEANS, LA 70172

LARRY LEISTRITZ  
PROFESSOR  
ND STATE UNIV  
FARGO, ND 58105

STEVE LEVERETTE  
TLP SYST. MGR  
1177 W LOOP SOUTH  
SUITE 1200  
HOUSTON, TX 77027

STEVE LITTLE  
PO BOX 61707  
NEW ORLEANS, LA 70161

HARLAN LOW  
SCOUT  
PO BOX 2967  
HOUSTON, TX 77252-2967

HAROLD LOYACANO

MICHAEL LYONS  
MGR ENVIRONMENTAL  
AFFAIRS  
801 NORTH BLVD  
SUITE 201  
BATON ROUGE, LA 70802

ROBERT MACHEN  
DIRECTOR  
14825 ST MARY'S LANE  
SUITE 245  
HOUSTON, TX 77079

JAMES MAHLUM  
SURVEY FOREMAN  
PO BOX 61933  
NEW ORLEANS, LA 70130

FRANK J. MANAGO  
770 PASEO CAMARILLO  
CAMARILLO, CA 93010

BRIAN MARCKS  
CONSISTENCY ANALYST  
PO BOX 44487  
BATON ROUGE, LA 70804

REX MARS  
VICE PRESIDENT  
12235 FM529  
HOUSTON, TX 77041

KAREN R. MARTIN  
ADMINS ASST  
1555 POYDRAS  
ROOM 483  
NEW ORLEANS, LA 70112

JEFF MATTSON  
GEOPHYSICIST  
935 GRAVIER  
NEW ORLEANS, LA 70112

KATHERINE MAZE  
FISHERIES BIOLOGIST  
3209 FREDERIC ST  
PASCAGOULA, MS 39567

JOHN MCCARTHY  
GEOPHYSICIST  
770 PASEO CAMARILLO  
CAMARILLO, CA 93015

KEITH MEEKINS  
GEOLOGIST  
381 ELDEN ST  
HERNDON, VA 20171

ARTURO MENDOZA  
MARINE BIOLOGY  
APDO. POSTAL 7  
CD. DEL CARMEN  
CAMPECHE MEXICO, MX  
24100

RICHARD B. MEYER  
STAFF ENVIRON ENGINEER  
ONE SHELL SQUARE  
NEW ORLEANS, LA 70161

NORMA W. MILES  
NC SENATE  
LEGISLATIVE BLDG  
RALEIGH, NC 27601-2808

CHRISTINE MIRE  
RESEARCH PHYSICIST  
CODE 7174 NAVAL RESEARCH  
LAB  
STENNIS SPACE CENTER  
STENNIS SPACE CTR, MS  
39529

MIKE MIRE  
SR REGULATORY SPECIALIST  
PO BOX 61933  
NEW ORLEANS, LA 70161-1933

JACK MOODY  
DIR ENERGY COASTAL DIV  
PO BOX 20307  
JACKSON, MS 39289

JOHN MOORE  
STAFF SAFETY ENGINEER  
701 POYDRAS  
NEW ORLEANS, LA 70123

DAVE MORAN  
1201 ELMWOOD PARK BLVD  
(MS 5440)  
NEW ORLEANS, LA 70123

ROBERT MORAN  
DIRECTOR - GOV'T AFFAIRS  
1120 G ST NW  
#900  
WASHINGTON, DC 20005

MIKE MORRIS  
PETRO ENGINEER  
1201 ELMWOOD PARK BLVD  
MS 5250  
NEW ORLEANS, LA 70123

JAVAD MORTAZAVI  
PO BOX 740309  
NEW ORLEANS, LA 70174

STEPHEN MURRAY  
PROFESSOR  
LSU  
BATON ROUGE, LA 70803

JACK A. NEWTON  
LAND CONSULTANT  
1608 PERSIMMON  
METAIRIE, LA 70001

HENRY NORRIS  
COORDINATOR  
100 8TH AVE  
ST PETERSBURG, FL 33701

JOAN NORRIS  
514 DUMAINE ST,  
#4  
NEW ORLEANS, LA 70116

ARLETTE C. NUNEZ  
SHALLOW HAZARD INT  
PO BOX 60833  
NEW ORLEANS, LA 70160-0833

CHARLES T. OCHELLO  
MGR - ENVIRON FIELD OPS  
201 ENERGY CENTER PKWY  
SUITE 100  
LAFAYETTE, LA 70503

MICHAEL ONG  
STRUCTURAL ENGINEER  
1201 ELMWOOD PARK BLVD  
NEW ORLEANS, LA 70123

PAUL ORLANDO  
PHYS SCIENTIST  
1305 EAST WEST HWY  
SILVER SPRING, MD 20910

JOEL ORTEGA  
GRAD STUDENT  
4700 AVE U  
BLDG 303  
GALVESTON, TX 77551

CHRIS OSTROM  
SR PRJ MGR  
1305 EAST WEST HWY  
SILVER SPRING, MD

RICK PACIORKA  
LT  
501 MAGAZINE ST  
NEW ORLEANS, LA 70130

JAMES PAQUIN  
PRESIDENT  
150 CLEVELAND AVE  
SLIDELL, LA 70458

MICHAEL E. PARKER  
SENIOR STAFF ENGINEER  
P.O. BOX 2180 RM. 4289EB  
HOUSTON, TX 77252-2180

WANDA PARLIER  
PO BOX 2880  
DALLAS, TX 75221

CHRIS PERLE  
G/S SPECIALIST  
1315 EAST WEST HWY  
SILVER SPRING, MD 20910

DOUGLAS PETER  
ARTIFICIAL REEF BIOLOGIST  
17629 EL CAMINO REAL  
SUITE 175  
HOUSTON, TX 77058

DENNIS PETERS  
SENIOR MARINE SCIENTIST  
630 C ANCHORS ST  
FT WALTON BEACH, FL 32548

LIZ PEULER  
1201 ELMWOOD PRK BLVD  
MS 5440  
NEW ORLEANS, LA 70123

CLAY PILIE'  
5630 ORLEANS AVE  
NEW ORLEANS, LA 70124

FRED PILTZ  
CHIEF ENVIRON STUDIES  
SECTION  
770 PASEO CAMARILLO  
CAMARILLO, CA 93010

LOULAN PITRE JR  
104 W 65TH ST  
CUT OFF, LA 70345

TERRY J. PREWITT  
PROFESSOR/ANTHROPOLOGY  
UNIVERSITY OF WEST  
FLORIDA  
DEPT OF ANTHROPOLOGY  
PENSACOLA, FL 32514

DAVE PROCQUET  
WORKOVER ENGINEER  
1201 ELMWOOD PARK BLVD  
MS 5250  
NEW ORLEANS, LA 70123

GAIL B. RAINEY  
1201 ELMWOOD PARK BLVD  
MS 5410  
NEW ORLEANS, LA 70124

JAMES RANDOLPH  
4700 AVE U  
GALVESTON, TX 77551

VILLERE REGGIO  
1201 ELMWOOD PARK  
NEW ORLEANS, LA 70123

JEFF RESTER  
HABITAL PROGRAM  
COORDINATOR  
P O BOX 726  
OCEAN SPRINGS, MS 39566

WILBON RHOME  
381 ELDEN ST  
(MS 4022)  
HERNDON, VA 20170

CARVER RICHARDS  
PO BOX 1967  
HOUSTON, TX 77251

HARRY H. ROBERTS  
PROFESSOR  
LSU  
BATON ROUGE, LA 70803

LARRY ROBERTS  
CHIEF - ENVIRONMENTAL  
STUDIES  
381 ELDEN ST  
HERNDON, VA 20170

VERNESSA ROBINSON  
PO BOX 60193  
RM 2039  
NEW ORLEANS, LA 70193

CAROL RODEN  
BIOLOGIST  
3209 FREDERIC ST  
PASCAGOULA, MS 39567



JOHN RODI  
MMS - MAIL STOP 5422  
1201 ELMWOOD PARK BLVD  
NEW ORLEANS, LA 70123-2394

CLAUDIA M. ROGERS  
ENVIRONMENTAL ANALYSIS  
1201 ELMWOOD PARK BKVD  
NEW ORLEANS, LA 70123

FRANK ROGERS  
600 BILLINGSPOUR RD  
PAULSBORO, NJ 08066

TERRY ROONEY  
PO BOX 4587  
HOUSTON, TX 77210

KATHERINE ROSS  
1201 ELMWOOD PARK BLVD  
MS 5114  
NEW ORLEANS, LA 70123

STEVE W. ROSS  
RESEARCH COORD  
7205 WRIGHTSVILLE AVE  
WILMINGTON, NC 28403

MARK ROUSE  
SR ENVIRON SCIENTIST  
1201 ELMWOOD PARK BLVD  
NEW ORLEANS, LA 70123

JOHN RULLMAN  
GOV'T/REGULATORY  
PO BOX 61707  
NEW ORLEANS, LA 70161-1707

FRED SABINE  
6700 WESTPORT  
HOUSTON, TX 77024

TIM SAMPSON  
1220 L NORTHWEST  
WASHINGTON, DC 20005

CHARLIE SANCHEZ  
ASSOC REGIONAL DIR  
PO BOX 1306  
ALBUQUERQUE, NM 87103

SCOTT SANDERS  
VP  
SAFETY/HEALTH/ENVIRON  
1360 POST OAK BLVD  
#500  
HOUSTON, TX 77056

KENT SATTERLEE  
STAFF ENVIRON ENGINEER  
PO BOX 61933  
NEW ORLEANS, LA 70471

R.J. SAVOY  
EHS PROFESSIONAL  
PO BOX 60252  
NEW ORLEANS, LA 70160

BILL SCAIFE  
ENVIRON SPEC  
1340 POYDRAS  
BOX 50879  
NEW ORLEANS, LA 70150

GLENN SCHAAF  
400 EAST KALISTE SALOOM  
RD  
LAFAYETTE, LA 70508

ED SCHICKTANZ  
EH&S MGR  
1600 SMITH  
SUITE 3600  
HOUSTON, TX 77002

TONY SEBASTIAN  
6889 CATINA ST  
NEW ORLEANS, LA 70124

GLENN SEKAVEC  
REGIONAL ENVIRON OFFICER  
PO BOX 649  
ALBUQUERQUE, NM 87103

ARVIND SHAH  
1201 ELMWOOD PARK BLVD  
MS 5210  
NEW ORLEANS, LA 70123

MALCOM SHARPLES  
16855 NORTHCHASE DR  
HOUSTON, TX 77060

ROBERT SIMMONS  
SE-ELIRT COORD  
PO BOX 61707  
NEW ORLEANS, LA 70161

LARRY SLASKI  
381 ELDEN ST  
MS 4050  
HERNDON, VA 20170

JONATHAN S. SMITH  
SR SURVEY SPEC  
701 POYDRAS ST  
NEW ORLEANS, LA 70139

KAREN SMITH  
REGULATORY  
PO BOX 61707  
NEW ORLEANS, LA 70161

BILL SMITH-VANIZ  
FLA-CARIBBEAN SCI CTR  
7920 NW 71ST ST  
GAINESVILLE, FL 32653

JOE SOUHLAS  
1201 ELMWOOD PARK BLVD  
NEW ORLEANS, LA 70123

ROBERT STECKLEY  
CONSULTANT  
108 CHERRY CREEK DR  
MANDEVEILLE, LA 70448

WILLIAM L. STEORTS JR.  
DIRECTOR ENVIRONMENTAL  
PROGS.  
445 PINEDA CT.  
MELBOURNE, FL 32940

LARRY STEWART  
1450 POYDRAS #2070  
NEW ORLEANS, LA 70112

ROBERT STEWART  
PRESIDENT  
1120 G STREET NW STE 900  
WASHINGTON, DC 20005

GREG STONE  
LSU  
BATON ROUGE, LA 70803

LARRY STRAATMANN  
COORD  
400 POYDRAS ST  
NEW ORLEANS, LA 70130

MICHAEL G. STRIKEMILLER  
MRKTING MGR  
58485 PEARL ACRES RD  
SUITE D  
SLIDELL, LA 70461

JO ANN SUTTON  
ONE SHELL SQ  
NEW ORLEANS, LA 70123

DAVID SZABO  
6100 HOLCROST  
HOUSTON, TX 77081

RALPH TATE  
MMS INSPECTOR  
1201 ELMWOOD PARK BLVD  
MS 5250  
NEW ORLEANS, LA 70123

MICHELE TETLEY  
MMS - MAIL STOP 4041  
381 ELDEN ST  
HERNDON, VA 20170

ROBERT THERIOT  
BUS DVPMT  
2901 N. I-10 SERVICE RD  
METAIRIE, LA 70002

EARL THOMPSON  
1201 ELMWOOD PARK BLVD  
MS 5210  
NEW ORLEANS, LA 70123

LYMAN THORSTEINSON  
909 FIRST AVE #800  
SEATTLE, WA 98104

LEE TILTON  
NEW ORLEANS, LA

WILFRED W. TIMES  
2471 PAIGE JANETTE DR  
HARVEY, LA 70058

JOHN P. TOWER  
MANAGER  
14950 HEATHROW FOREST  
PARKWAY  
#300  
HOUSTON, TX 77032

JON TRUXILLO  
PO BOX 44487  
BATON ROUGE, LA 70804

JERRY TULL  
381 ELDEN  
MS 4001  
HERDON, VA 20170

ROBERT TURPIN  
GRAD STUDENT  
PO BOX 95  
GULF BREEZE, FL 32562

NEIL VANDEVOORDE  
DRAT LEADER  
501 MAGAZINE ST  
NEW ORLEANS, LA 70130

STAN VASA  
SR RESEARCHER  
PO BOX 2625  
BIRMINGHAM, AL 35244

GERALD VETTER  
SR ENVIRON SCIENTIST  
1200 ST CHARLES AVE  
NEW ORLEANS, LA 70130

ARNOLD VILLARREAL  
701 POYDRAS  
NEW ORLEANS, LA

COERTE VOORHIES  
GEN MGR  
1100 POYDRAS  
NEW ORLEANS, LA 70156

VAN WADDELL  
615 OBERLIN RD  
#300  
RALEIGH, NC 27605

ANNE-BERRY WADE  
1849 C ST NW  
ROOM 4257 (MS4230)  
WASHINGTON, DC 20240

MICHAEL WAGUESPACK  
PROJECT MGR  
600 CARONDELET ST  
NEW ORLEANS, LA 70130

CHARLENE WALK  
STAFF ENGINEER  
1555 POYDRAS ST  
NEW ORLEANS, LA 70112

MIKE WALLACE  
1201 ELMWOOD PRK BLVD  
MS 5440  
NEW ORLEANS, LA 70123

BO WALTERS  
2950 N. LOOP W  
SUITE 1050  
HOUSTON, TX 77092

KATHRYN WASHBURN  
DIR INTERNATIONAL  
AFFAIRS  
1849 C ST NW  
MS 4426  
WASHINGTON, DC 20240

STEPHEN WEEMS  
ASSOC ENVIRON SCIENTIST  
PO BOX 2563  
BIRMINGHAM, AL 35202

JULIA WHITE  
NC SENATE  
LEGISLATIVE BLDG  
RALEIGH, NC 27601-2808

DENIS WIESENBURG  
ASSOC DIRECTOR  
BLDG 1103 ROOM 102  
STENNIS SPACE CTR, MS  
39529

JEFF WILLIAMS  
PRG COORDINATOR  
915 NATIONAL CENTER  
RESTON, VA 20192

CHUCK WILSON  
PROFESSOR  
LSU\COASTAL FISHERIES  
INST  
BATON ROUGE, LA 70803

MARK WITTEN  
ADVISOR - ENV/SAFETY  
935 GRAVIER ST  
NEW ORLEANS, LA 70112

RUSTY WRIGHT  
1201 ELMWOOD PRK BLVD  
MS 5231  
NEW ORLEANS, LA 70123

BRIAN E. WROBEL  
1450 POYDRAS  
NEW ORLEANS, LA 70112

JOSEPH YIP  
RESEARCH SCIENTIST  
BLDG 1103 RM 24313  
STENNIS SPACE CTR, MS  
39529

STEVE ZWAN  
NEW ORLEANS, LA



### **The Department of the Interior Mission**

As the Nation's principal conservation agency, the Department of the Interior has responsibility for most of our nationally owned public lands and natural resources. This includes fostering sound use of our land and water resources; protecting our fish, wildlife, and biological diversity; preserving the environmental and cultural values of our national parks and historical places; and providing for the enjoyment of life through outdoor recreation. The Department assesses our energy and mineral resources and works to ensure that their development is in the best interests of all our people by encouraging stewardship and citizen participation in their care. The Department also has a major responsibility for American Indian reservation communities and for people who live in island territories under U.S. administration.



### **The Minerals Management Service Mission**

As a bureau of the Department of the Interior, the Minerals Management Service's (MMS) primary responsibilities are to manage the mineral resources located on the Nation's Outer Continental Shelf (OCS), collect revenue from the Federal OCS and onshore Federal and Indian lands, and distribute those revenues.

Moreover, in working to meet its responsibilities, the **Offshore Minerals Management Program** administers the OCS competitive leasing program and oversees the safe and environmentally sound exploration and production of our Nation's offshore natural gas, oil and other mineral resources. The **MMS Royalty Management Program** meets its responsibilities by ensuring the efficient, timely and accurate collection and disbursement of revenue from mineral leasing and production due to Indian tribes and allottees, States and the U.S. Treasury.

The MMS strives to fulfill its responsibilities through the general guiding principles of: (1) being responsive to the public's concerns and interests by maintaining a dialogue with all potentially affected parties and (2) carrying out its programs with an emphasis on working to enhance the quality of life for all Americans by lending MMS assistance and expertise to economic development and environmental protection.

**Minerals Management Service  
Gulf of Mexico OCS Region**



**Managing America's offshore energy  
resources**

**Protecting America's coastal  
and marine environments**