

# TPF Preliminary Architecture Review

12-14 Dec. 2000

San Diego, CA



**Boeing-SVS, Inc.**

4411 The25 Way, NE Suite 350

Albuquerque, NM 87109

# TPF Preliminary Architecture Review (PAR)

San Diego, Dec. 13, 2000

# Outline of Presentation

- Executive Summary
- Team Overview
- Process
- Science Requirements and Derived Mission Performance Requirements
- Astrophysics
- Innovation in Star Suppression Techniques
- TPF Mission Architectures
- Technology Assessment
- Science Assessment
- Architecture Priority List
- Precursors
- Recommendations
- Phase II Plans and Next Steps

# Executive Summary

## Study Results and Recommendations

# Executive Summary

## Study Results and Recommendations

- **Science Requirements and Derived Performance Requirements**
- **Technical Innovations**
- **Architectures**
- **Precursors**
- **Recommendations**

# Science Requirements and Derived Performance Requirements

- Maximize observing spectral bandwidth
- Observe reflected light
- Require multiple revisits to confirm/characterize
- Precursor to determine frequency of earths among candidate stars
- True imaging enhances astrophysics potential

# Technical Innovations

- Generalized coronagraphy offers very high star rejection capability
- Pupil densification yields interferometric resolution with filled aperture sensitivity
- Apodized square aperture provides ultra-low diffracted light levels - may eliminate the need for nulling
- Rotational fixed pattern rejection suppresses residual star leakage

# Promising New Architectures

- Apodized square apertures promise cost effective, early TPF implementations focusing principally on planet detections and perhaps ultimately characterization
- Hyper-telescopes will carry out the TPF mission, and are scalable to larger, future missions even Planet Imager
- Laser Trapped Mirrors, a high risk but advancing steadily, may provide a new paradigm for ultra-large optics, ultra-low areal density optical systems in the far term



# Priority Ranking of Architectures

1. Apodized Square Apertures
2. Hypertelescope Imagers
3. Redundant Linear Arrays
4. Interferometric nullers (e.g., "Book Design")
5. Laser trapped mirrors
6. Occultors

# Apodized Square Apertures

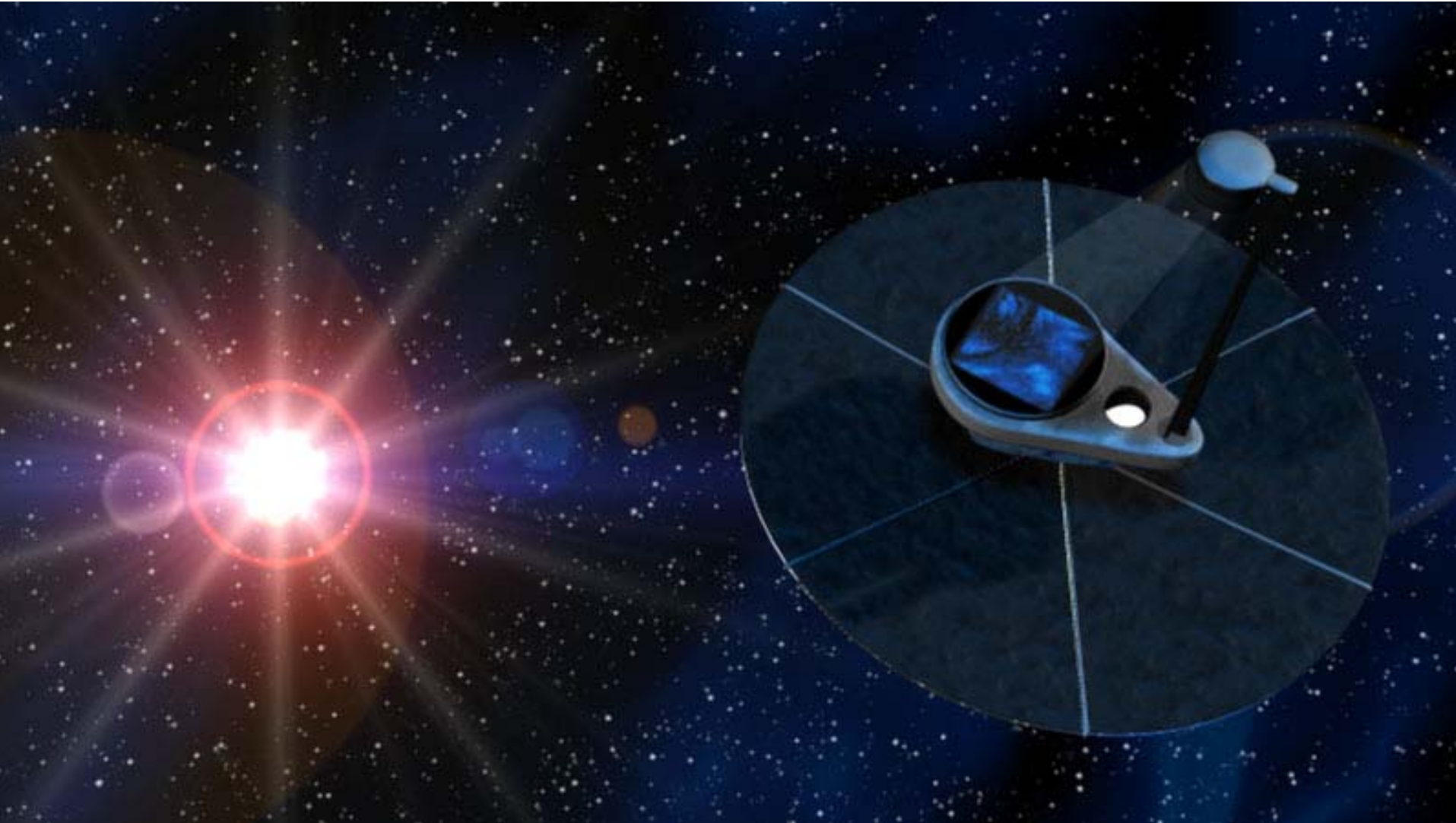

# Apodized Square Apertures

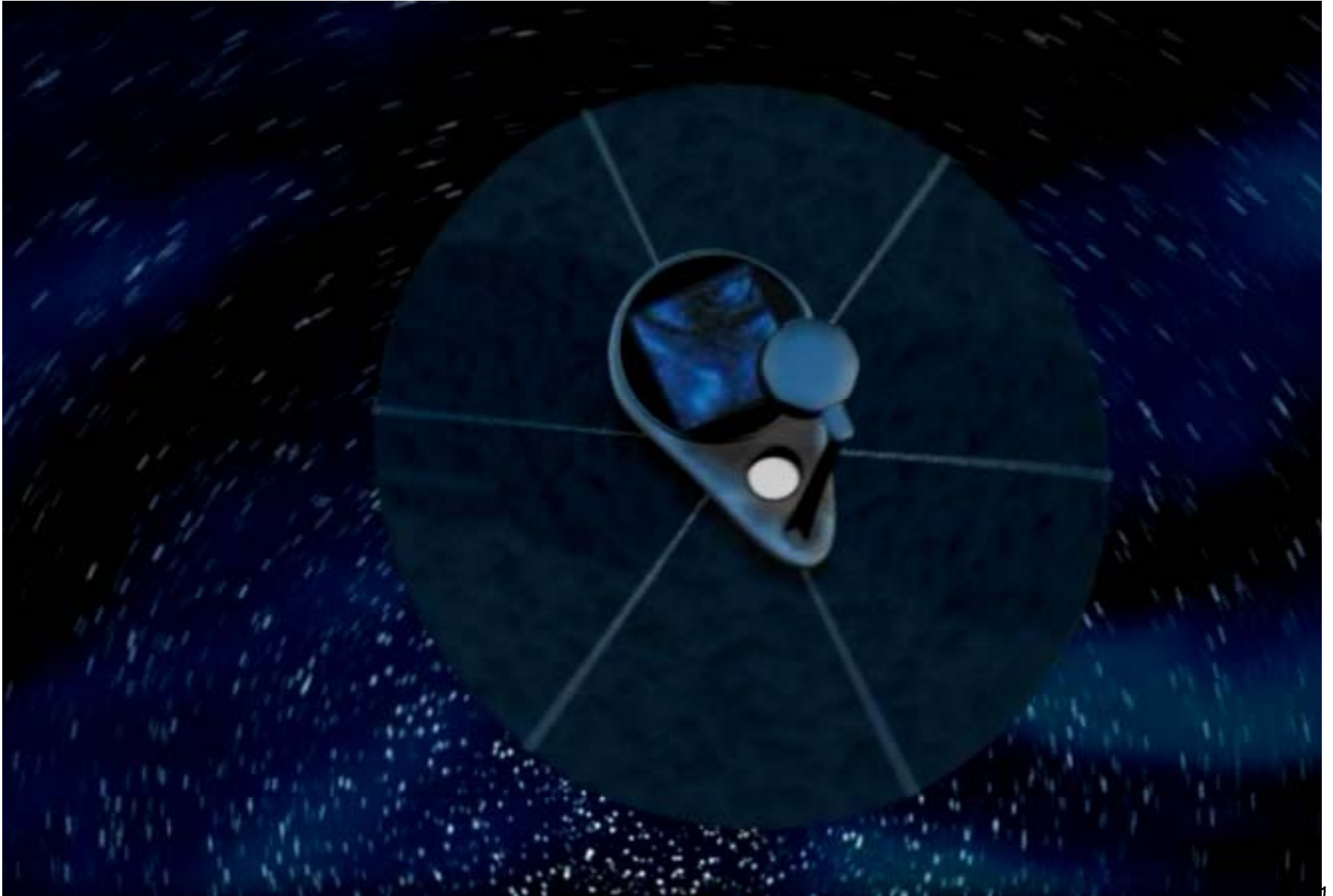

# Hypertelescopes

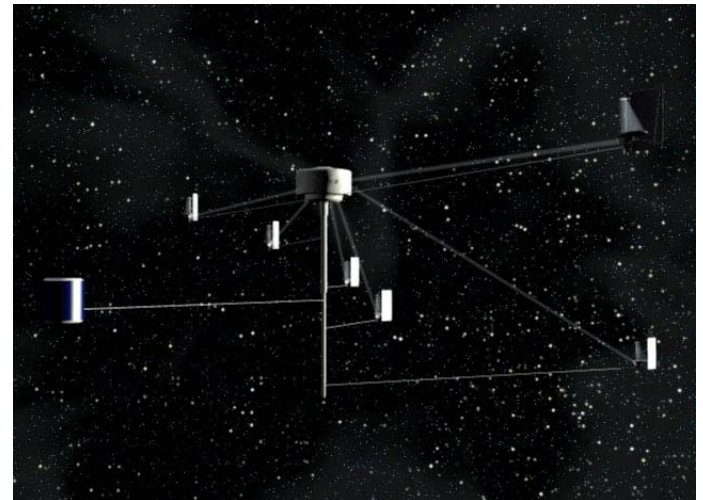
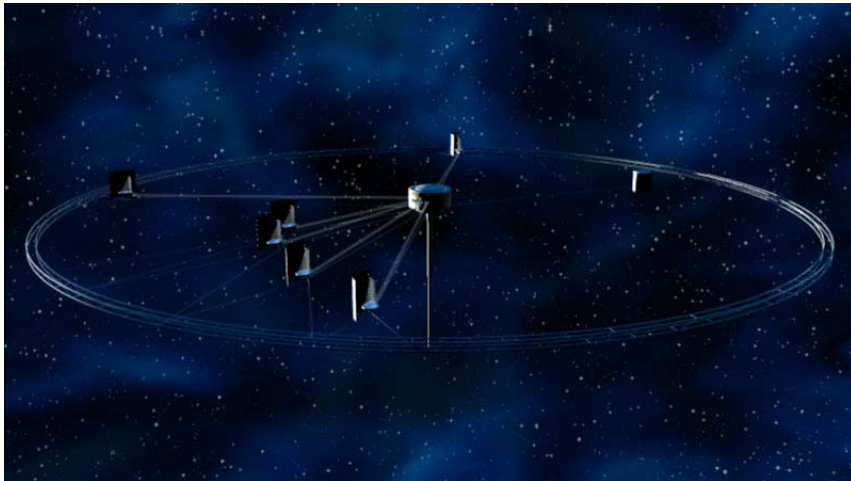
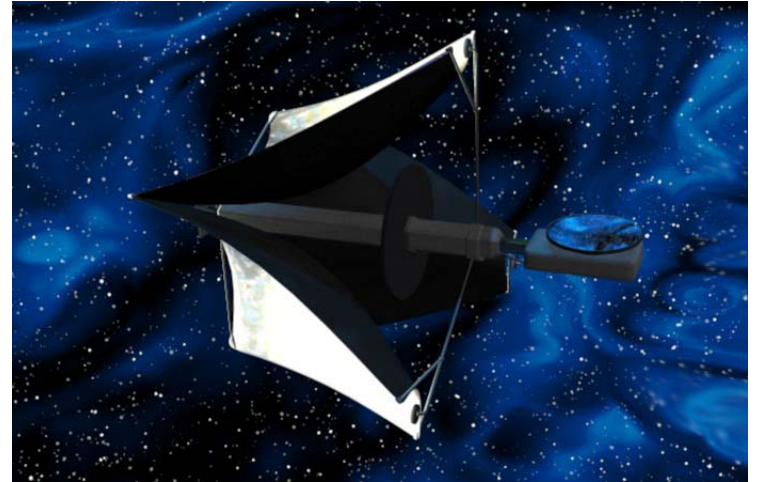
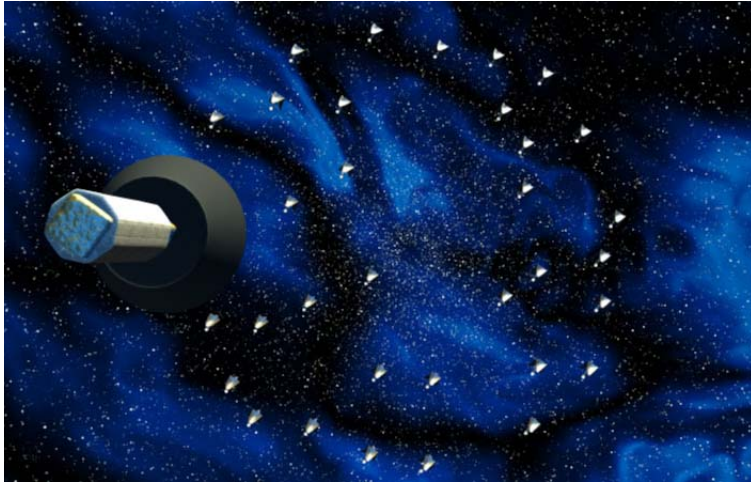



# Hypertelescope: Snapshot Imaging Array

QuickTime™ and a  
Sorenson Video decompressor  
are needed to see this picture.



# Hypertelescope: Rotational Imaging Array

QuickTime™ and a  
Sorenson Video decompressor  
are needed to see this picture.

# Precursors

- TPF Precursors (including ground-based programs) are *required* to determine the frequency of occurrence of earths among nearby stars
- “TPF-lite” missions can carry out part of the full TPF mission, and serve as scientific and technical precursors

# Recommendations

- We seek to focus our attention on Apodized Square Apertures in Phase 2 as it is our highest priority architecture
- We also seek to study Hypertelescopes in Phase 2 as it was a close 2<sup>nd</sup> in our priority
  - We have the inventor of the Hypertelescope on our team, Antoine Labeyrie
  - We have the principle architect of an alternative implementation of Labeyrie's densified pupil approach on our team along with his grad student, Francois Roddier and Olivier Guyon
- All other architectures are far less attractive for further study by this team



# Comparison of Concepts

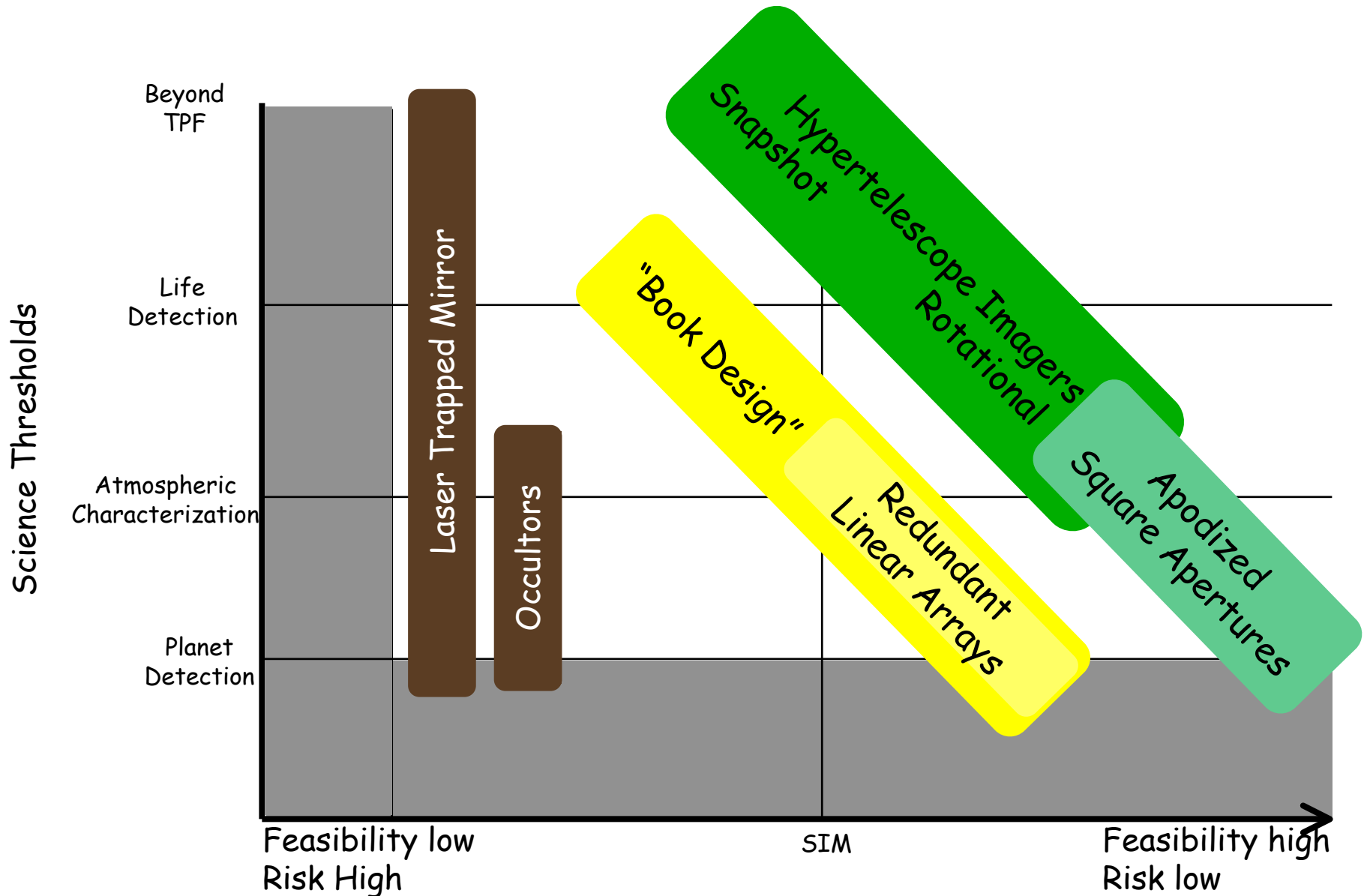

# Team Overview

# Our TPF Architecture Team

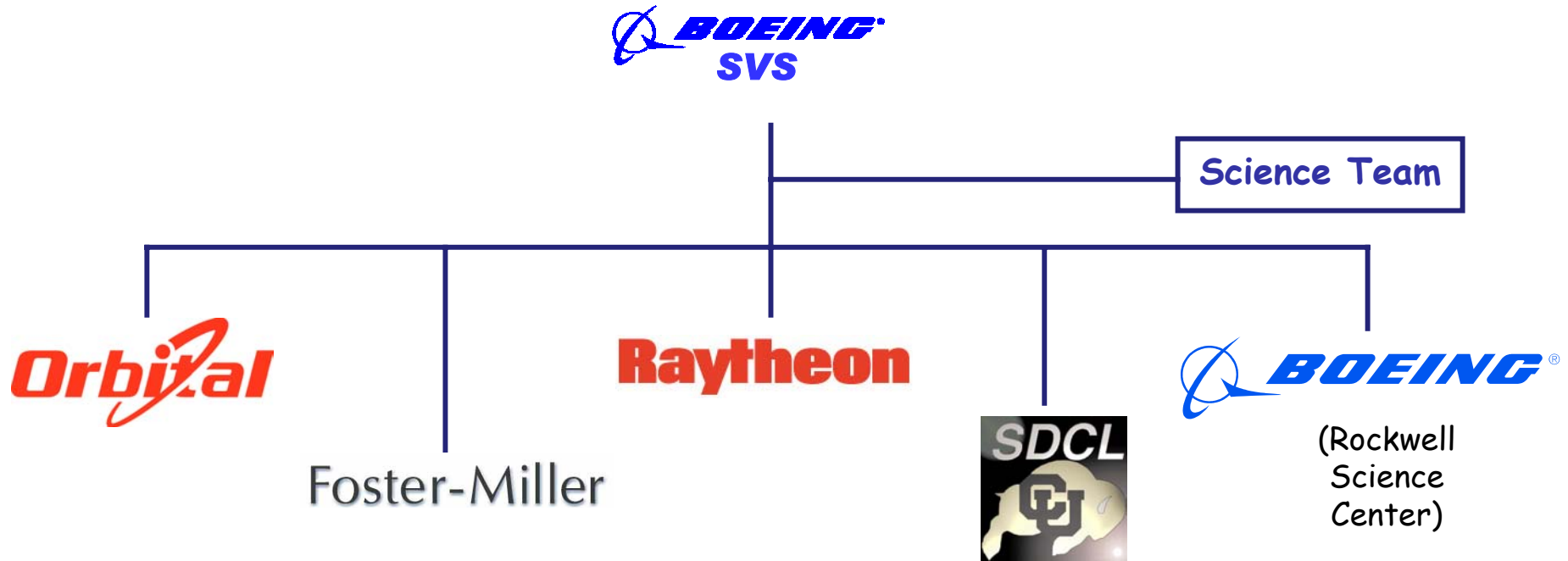



# Boeing -SVS Science Team (1 of 2)

Steve Ridgway, NOAO - Principal Scientist

- ABE, Lyu O.C.A.
- AIME, Claude U. Nice
- ARNOLD, Luc O.H.P.
- BACKMAN, Dana NASA-ARC/F&M
- BARGE, Pierre L.A.M.
- BAUDOZ, Pierre IFA
- BOCCALETTI, Anthony CalTech
- DANCHI, William NASA-GSFC
- DARGENT, Pascal L.A.M.
- DELEUIL, Magali L.A.M.
- DOHLEN, Kjetil L.A.M
- FAUCHERRE, Michel Montpellier
- FOURNIER, Jean Marc Rowland Inst.
- GEZARI, Dan NASA-GSFC
- GILLET, Sophie O.H.P.
- GUYON, Olivier I.F.A.
- HAN, Daesoo NASA-GSFC
- HARWIT, Martin Cornell
- KAISER, Robin C.N.R.S.



# Boeing -SVS Science Team (2 of 2)

Steve Ridgway, NOAO - Principal Scientist

- LABEYRIE, Antoine LISE
- LARDIERE, Olivier O.H.P.
- LEGRAND, Yann Unv. Rennes
- LOPEZ, Bruno O.C.A.
- LYON, Richard NASA-GSFC
- MALINA, Roger L.A.M.
- MERTZ, Lawrence Digiphase
- MOSELEY, Harvey NASA-GSFC
- MURPHY, Tim NASA-GSFC
- NISENSEN, Peter C.F.A.
- PAPALIOIOS, Cos CFA.
- RESTAINO, Sergio Phillips Lab
- RIAUD, Pierre OHP/Meudon
- RODDIER, Claude IFA
- RODDIER, Francois IFA
- ROUAN, Daniel D.E.S.P.A.
- SCHNEIDER, Jean DARC  
Meudon
- SOUMMER, Remi U. Nice
- STACHNIK, Bob Testex
- STAGUHN, Johannes Maryland
- TOWNES, Charles Berkeley
- VAKILI, Farokh O.C.A.

# Team Responsibilities

- **Boeing - SVS**
  - Program management, modeling and simulation lead, systems engineering lead, and study integration
- **Raytheon**
  - Optics concept development, space systems concept definition, systems engineering, modeling & simulation
- **Orbital**
  - Space mission concept development, space systems life-cycle costing, spacecraft engineering, orbit selection and launch vehicle analysis
- **Boeing**
  - Instrument concept development
- **Foster-Miller**
  - Technology road-mapping and assessment
- **University of Colorado**
  - Large space structures analysis and simulation
- **Science Team**
  - Concept formulation, architecture analysis, modeling and simulation, instrument design, science assessment

# Core Architecture Teams

- **Snapshot Hypertelescope imager:**
  - A. Labeyrie, O. Lardiere, P. Riaud, S. Gillet, A. Boccaletti, J. Schneider, L. Arnold, D. Rouan, K. Dohlen, P. Dargent, F. Vakili, L. Abe, B. Lopez
- **Rotational Hypertelescope imager:**
  - F. Roddier, O. Guyon, P. Baudoz
- **Redundant Linear Imager:**
  - C. Aime, B. Lopez, R. Soummer
- **Apodized Square Aperture:**
  - P. Nisenson, R. Lyon, D. Gezari
- **Laser Trapped Mirror:**
  - A. Labeyrie, R. Stachnik, J.M. Fournier

# Team Organization Chart

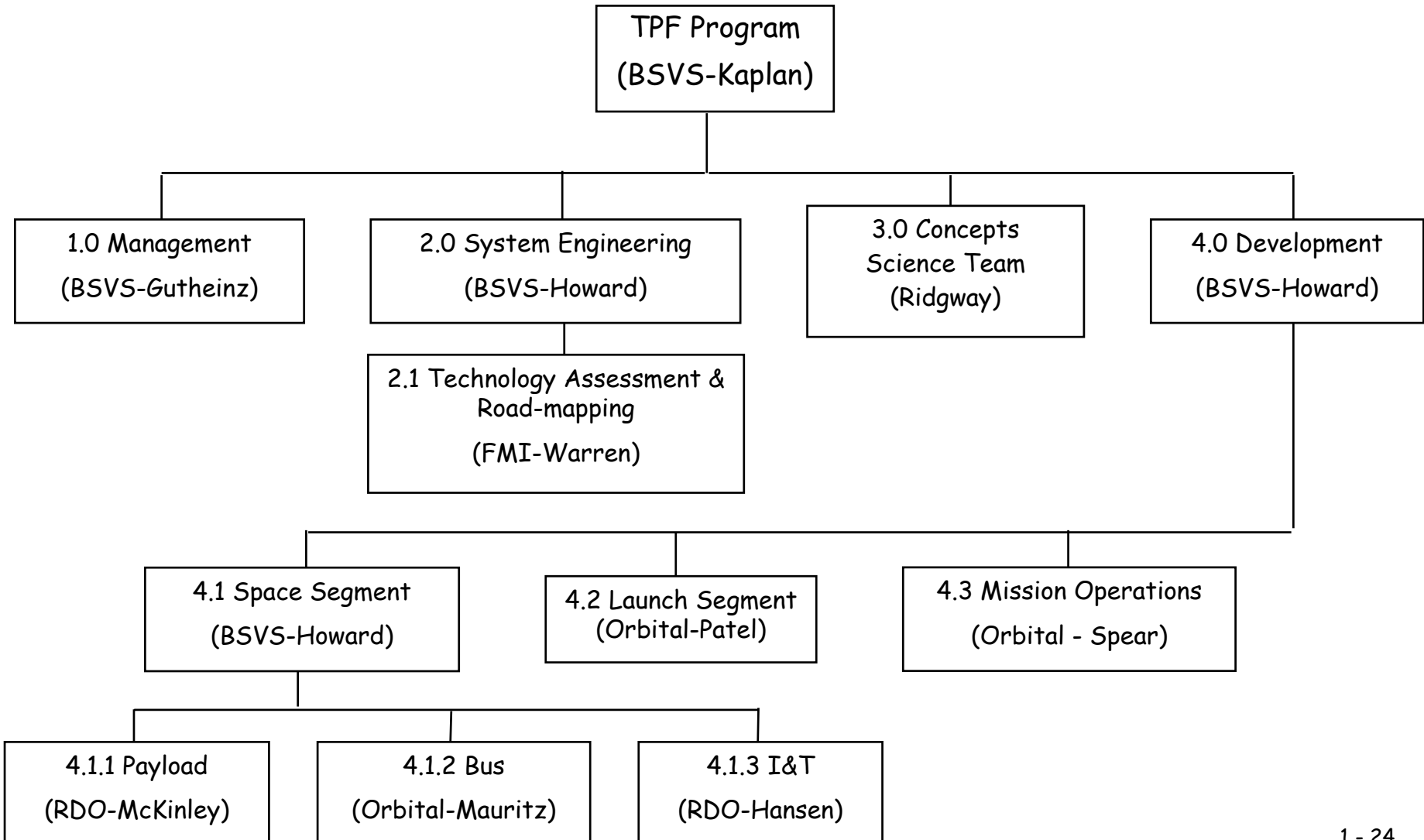



# Phase I Process

# Study Context, Objectives and Philosophy

- Make NO assumptions concerning ANY current or prior studies, scientific and technological pathfinders.
- Re-examine the scientific requirements in the light of current knowledge and develop performance requirements directly from them.
- Study the astrophysics potential of TPF, but astrophysics will not drive the performance specifications.

# TPF Phase I Methodology

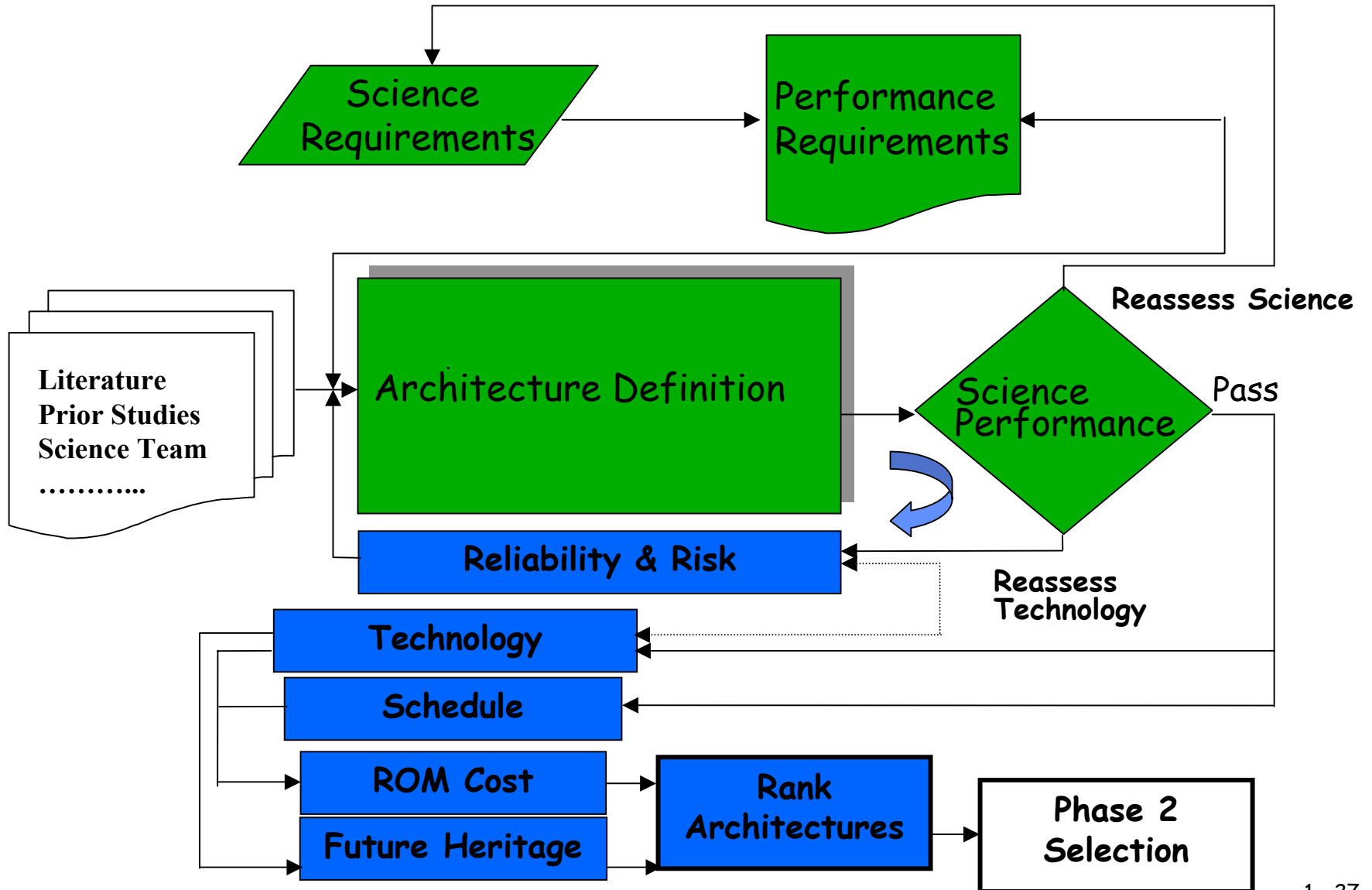

# Phase 1 Tasks

- Define each concept (top level) and identify the technology required
  - Develop a Technical Requirements Document (TRD) based on Science Goals and Requirements. This will be the basis for evaluating each concept.
- Use top-level analysis/simulations to evaluate how well each concept fulfills the requirements as defined in the TRD.
  - Rate each concept based on expected performance, estimated risk, cost, schedule
- Evaluate the technology risk for each concept

# Basis of Phase I Task Plans

- Several concepts are known
  - at both a detailed level (e.g., TPF Basic, Hypertelescope) and in much less detailed forms
- The "less detailed" concepts go through a "definition" phase
  - additional definition of required design features and methods to model/predict performance
- All concepts go through an "analysis" phase
  - not integrated modeling (yet) but detailed analytical calculations of performance against Science goals and expected design attributes of space systems
- Full Group meetings will be used to discuss, evaluate, & redirect work
- Detailed analysis to be done by dedicated concept teams asynchronously
- All concepts go through a screening & evaluation prior to Mid-Term

# SVS TPF Phase I Schedule

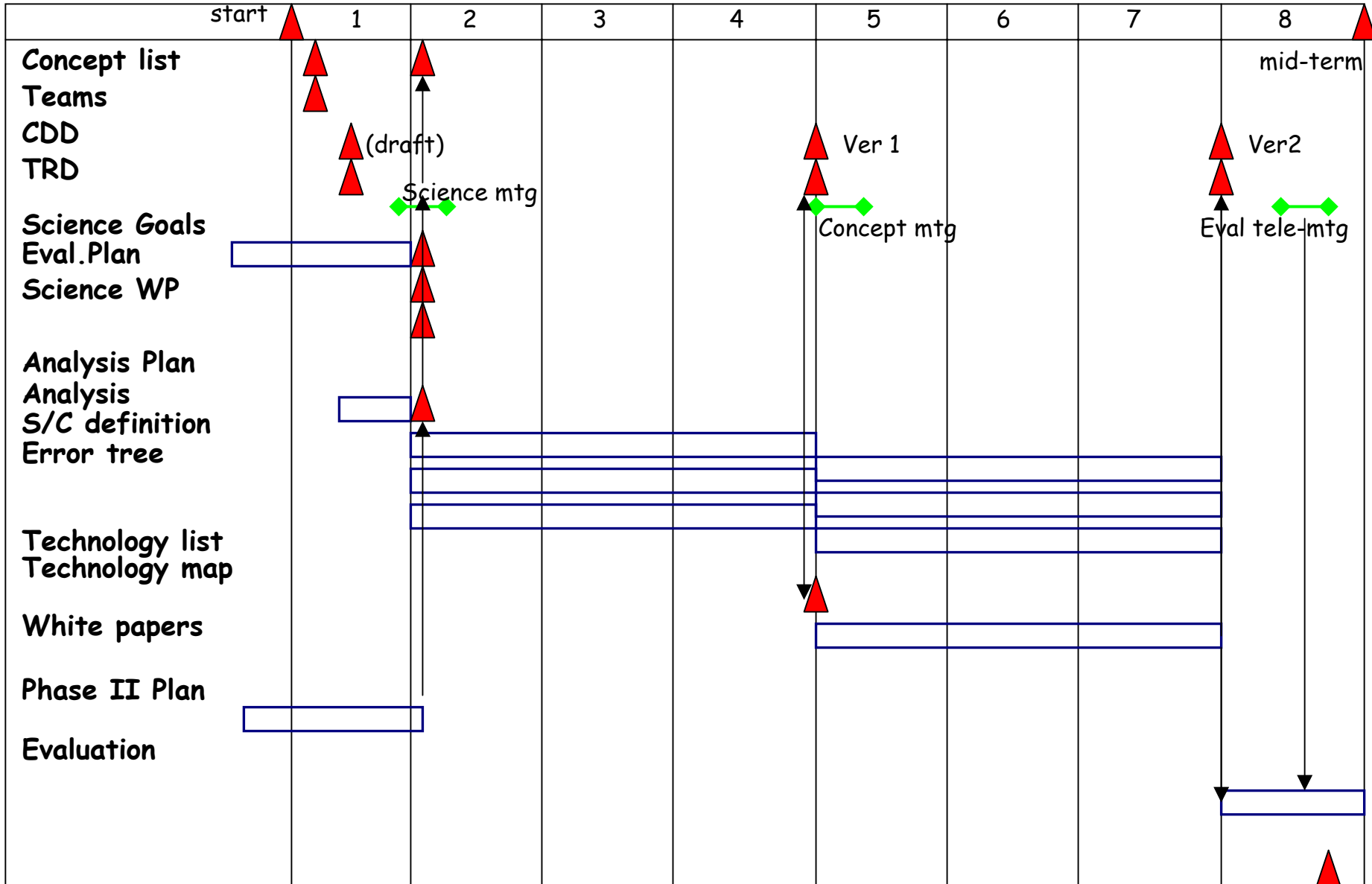

# First Science Team Meeting, in Annapolis, MD



# TPF Team at Pre-PAR Review @ OHP, France





# Science Requirements and Derived Mission Performance Requirements

# Assimilation of Requirements

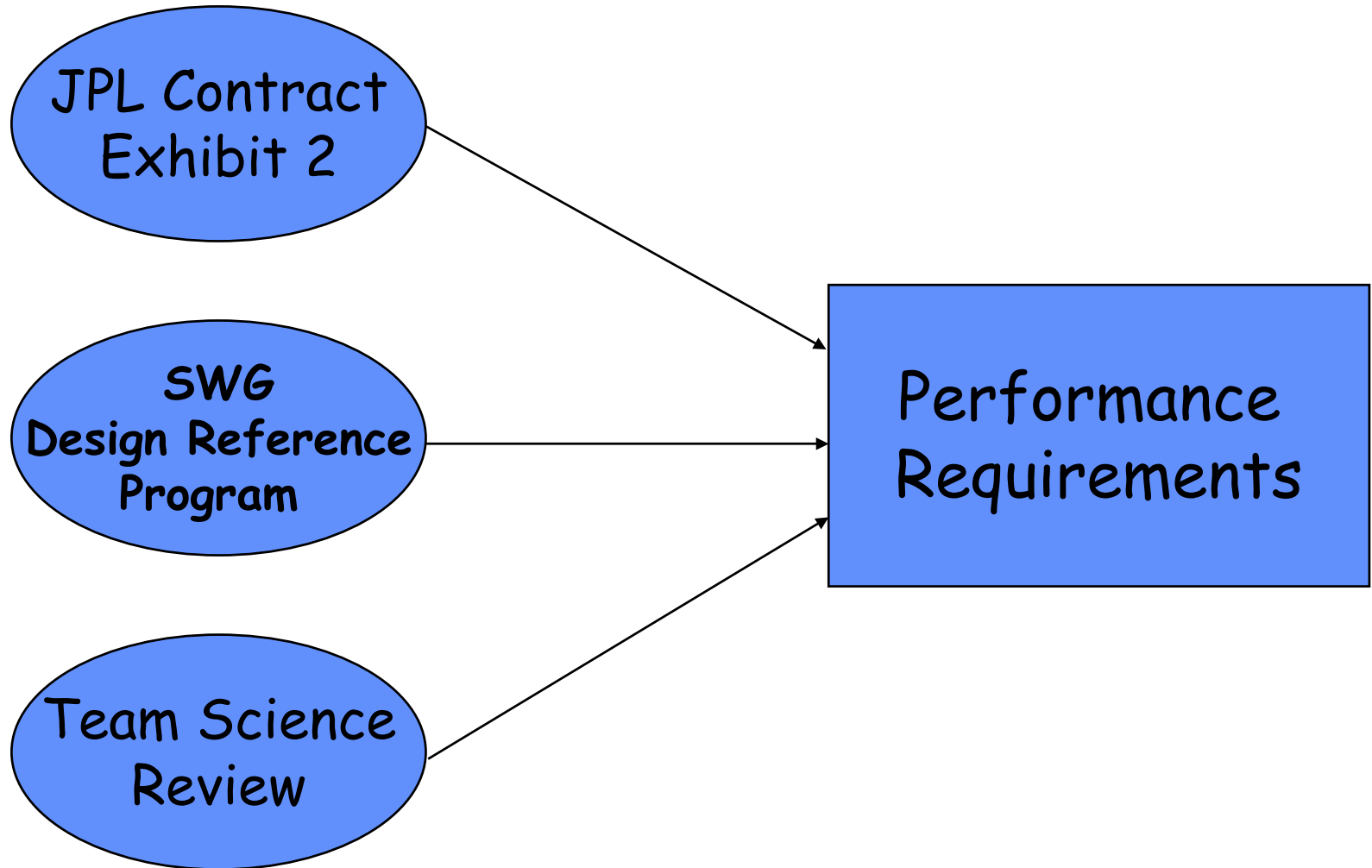

# Confusion - Background Galaxies

The probability of finding a background galaxy brighter than a standard earth within 1 AU of the central star is approximately independent of distance.

Probability at 0.5 microns	Probability at 2.2 microns	Probability at 6 microns	Probability at 15 microns
0.0025	~1	~1	<<1

The brightness distribution within faint galaxies is a major unknown, which will determine the instrument response to these background sources.

References: Hubble deep field; Metcalfe et al (Nature **383**, 236; Elbaz et al 2000; Oliver et al 1997.

# Confusion - Background Galaxies

Galaxy spectral distributions may have composite structure (stellar plus dust emission) which mimics planet spectra (reflected plus emitted).

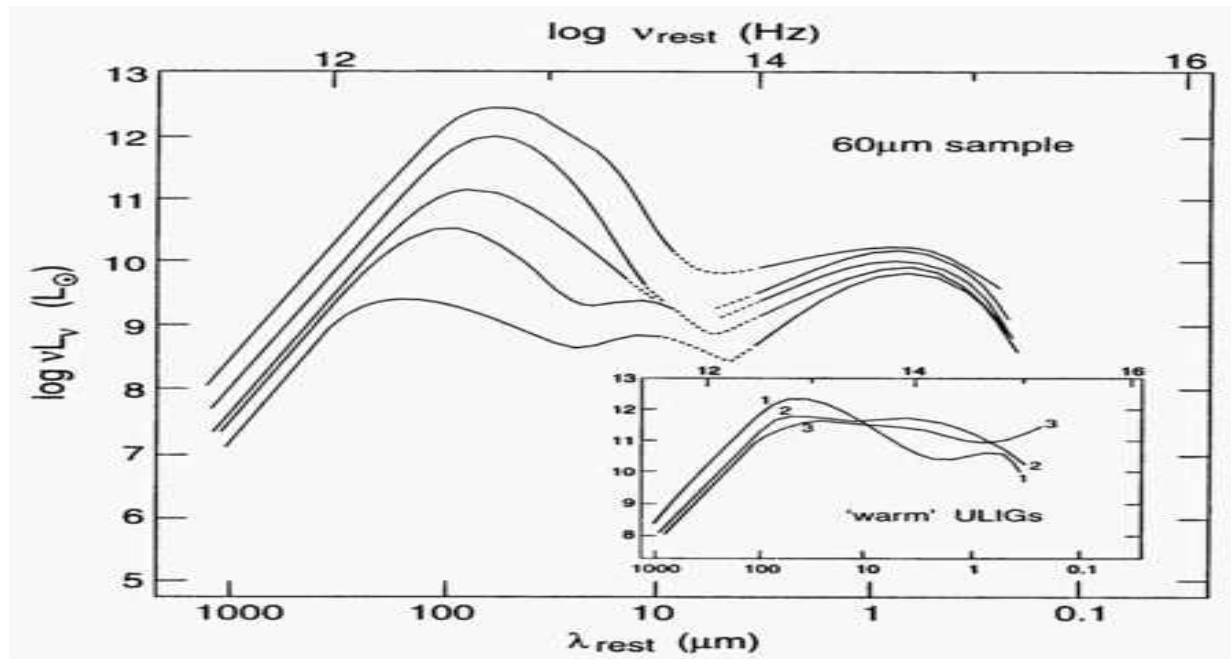

For a planetary system at 10 parsecs, in the galactic plane:

- At 0.5 microns, 0.2 star
- At 10 microns, 0.02 star

- brighter than a standard earth within the orbit of a standard Jupiter.

To identify stars, observe in both reflected and thermal spectral regimes, or obtain multi-epoch astrometry.

# Confusion - Asteroids

- Collision-dominated size distribution in the asteroid main belt -  $N \times 10^6 D^{-2.5}$
- Rapidly moving
- During average 1 hour exposure, an asteroid much brighter than earth at 10 parsecs will pass through the FOV.

Consider instrument response to bright, transient sources.

# Candidate Source Confirmation

- Background/foreground sources have apparent relative motions in same range as planets.
- Astrometric precision  $\sim(\lambda/D)/\text{SNR}$  poor for most candidates.
- Orbital parameters - Plane, axis, eccentricity, node, period.
- Candidate planets will have orbital periods over a range of 20-50X.
- Estimate 8 revisits required for confirmation plus preliminary orbital estimation.

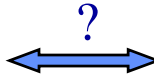

# Exo-system Imaging Confusion

Problem	Solution:
Comet dust tails	Flux vs. time
Earth-like planet + rings  Giant Planet	Flux vs time in visible
Binary Earth-like planet  Large Planet	High angular resolution

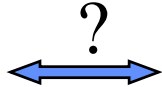

# Exo-system Confusion

- Exo-system Sources: Spectral confusion

	Solution:
<p>Silicate at <math>\sim 9.5 \mu\text{m}</math></p> <p style="text-align: center;">  <math>\text{O}_3</math> </p>	Spectral resolution $> 20$
<p><math>\text{NH}_3</math> at <math>\sim 9.6 \mu\text{m}</math> and 11-12 <math>\mu\text{m}</math></p> <p style="text-align: center;">  <math>\text{O}_3 + \text{silicates}</math> </p>	Spectral resolution $> 20$

For both sources of confusion:

Validate  $\text{O}_3$  signature with  $\text{O}_2$  signature at 760 nm

# Temperature Ambiguity

- Photometry may not indicate  $T_{eff}$ 
  - Dust/rings/companions may bias photometry
- Spectroscopy may not indicate  $T_{exc}$ 
  - Pressure/abundance ambiguity; blends; bad ID
- $T_{surface}$  likely not equal to  $T_{eff}$  or  $T_{exc}$
- Need broad wavelength coverage (reflected and emitted light) to model thermal budget
- May need reflected light to estimate depth of atmosphere and  $T_{surface}$

# IR vs. Visible Wavelength Trade-offs

	IR	Visible
Baseline	Bigger	Smaller
Mass	Heavier	Lighter
Temperature	Cryogenic	Ambient
Star:Planet Dynamic Range	$10^6$ to 1	$10^9$ to 1
Biomarkers	Yes	Maybe
Optical Tolerances	Easier	Harder

# Molecular Bands by Spectral Region

- Thermal (8-15 microns)
  - $CH_4$ ,  $CO_2$ ,  $H_2O$ ,  $NH_3$ ,  $O_3$ , particulates
- Thermal (3-8 microns)
  - $CH_4$ ,  $CO_2$ , C-H, CO,  $H_2O$ ,  $N_2O$
- Reflected (0.6-3 microns)
  - $CH_4$ ,  $CO_2$ ,  $H_2$ ,  $H_2O$ ,  $NH_3$ ,  $O_2$ , solids, liquids
- Each region has unique indicators

# Accessible Candidate Stars vs Baseline (1AU resolved at 14 $\mu\text{m}$ )

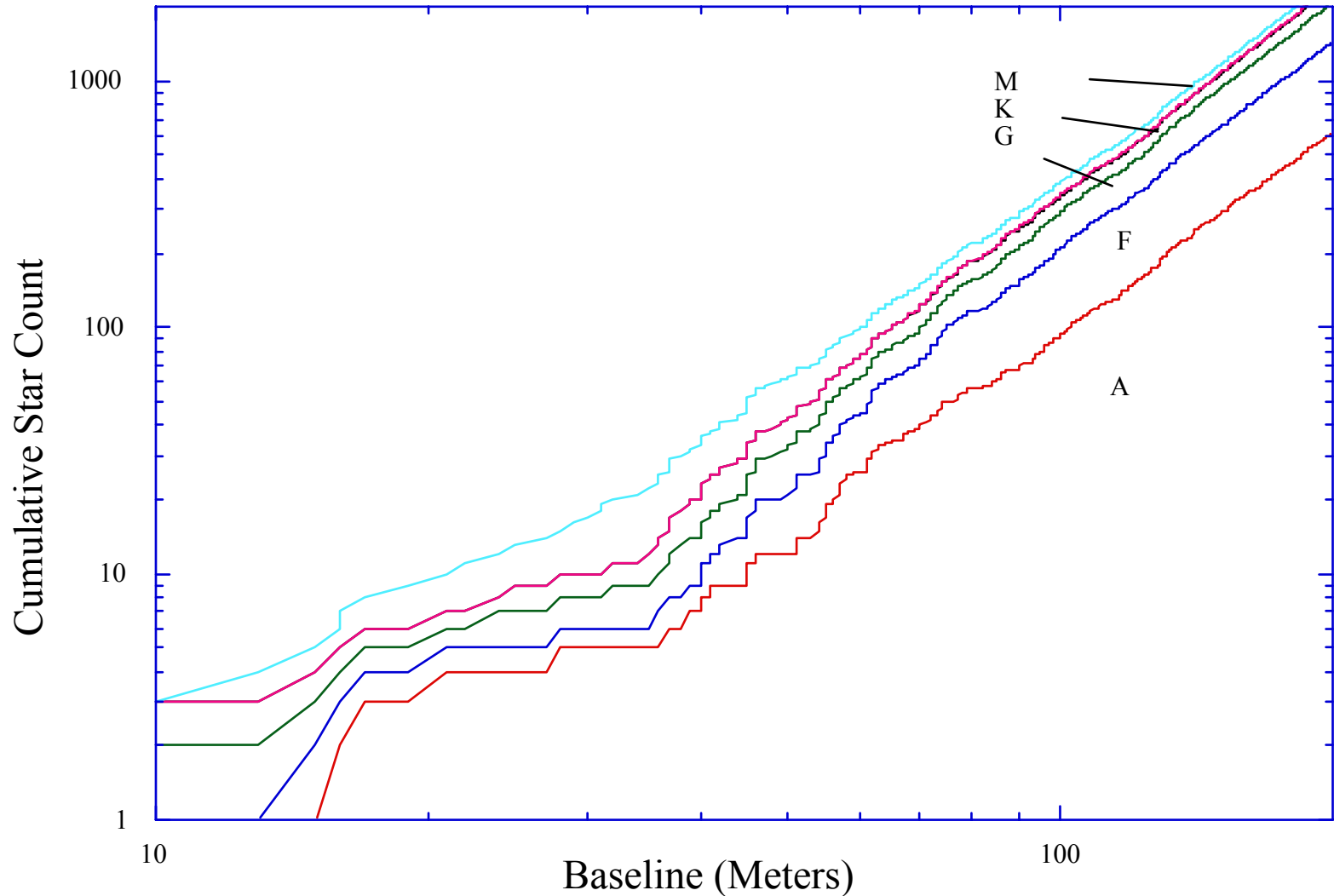

# Apparent Magnitude of Candidate Systems vs Baseline to Resolve

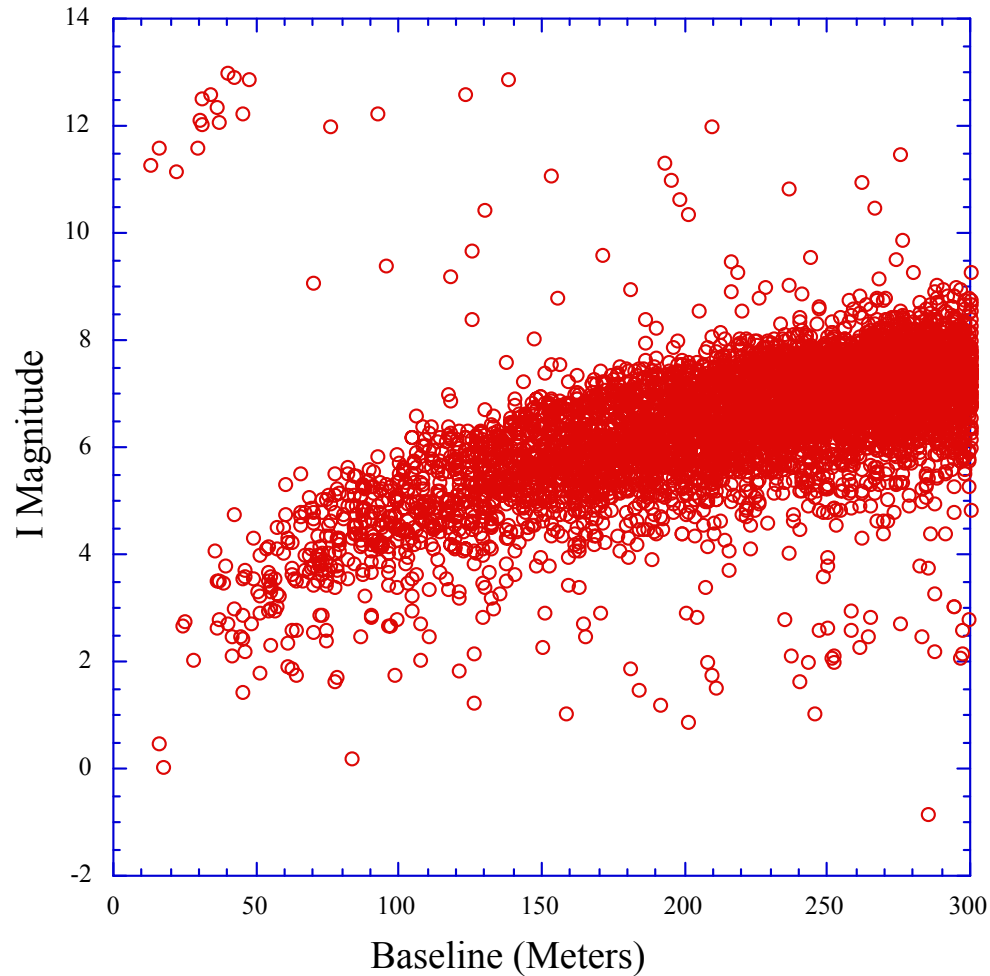

Parameters to compute total observing time from integration time and pointing time (example).

$T_{\text{point}}$		hr	The repointing time
$T_{\text{find}}$		hr	The integration time required to detect an earth at 10 pc
$T_{\text{temp}}$	$=T_{\text{find}}$	hr	The time required to obtain a temperature of an earth
$T_{\text{mol}}$	$=4*T_{\text{find}}$	hr	The time required to detect molecular bands in an earth
$T_{\text{life}}$	$=16*T_{\text{find}}$	hr	The time required to detect evidence of life in an earth
$N_{\text{tot}}$	300	stars	Number of stars to search for earths
$F_{\text{planet}}$	0.2	fraction	Fraction of candidate stars with planets
$F_{\text{hzone}}$	1	fraction	Fraction of stars with planets that have a planet in the habitable zone
$N_{\text{orbit}}$	8	observations	Repeat observations for planet orbits
$\text{Eff}$	1	fraction	Fraction of pointed time used for effective integration

# Sensitivity and Repointing Time

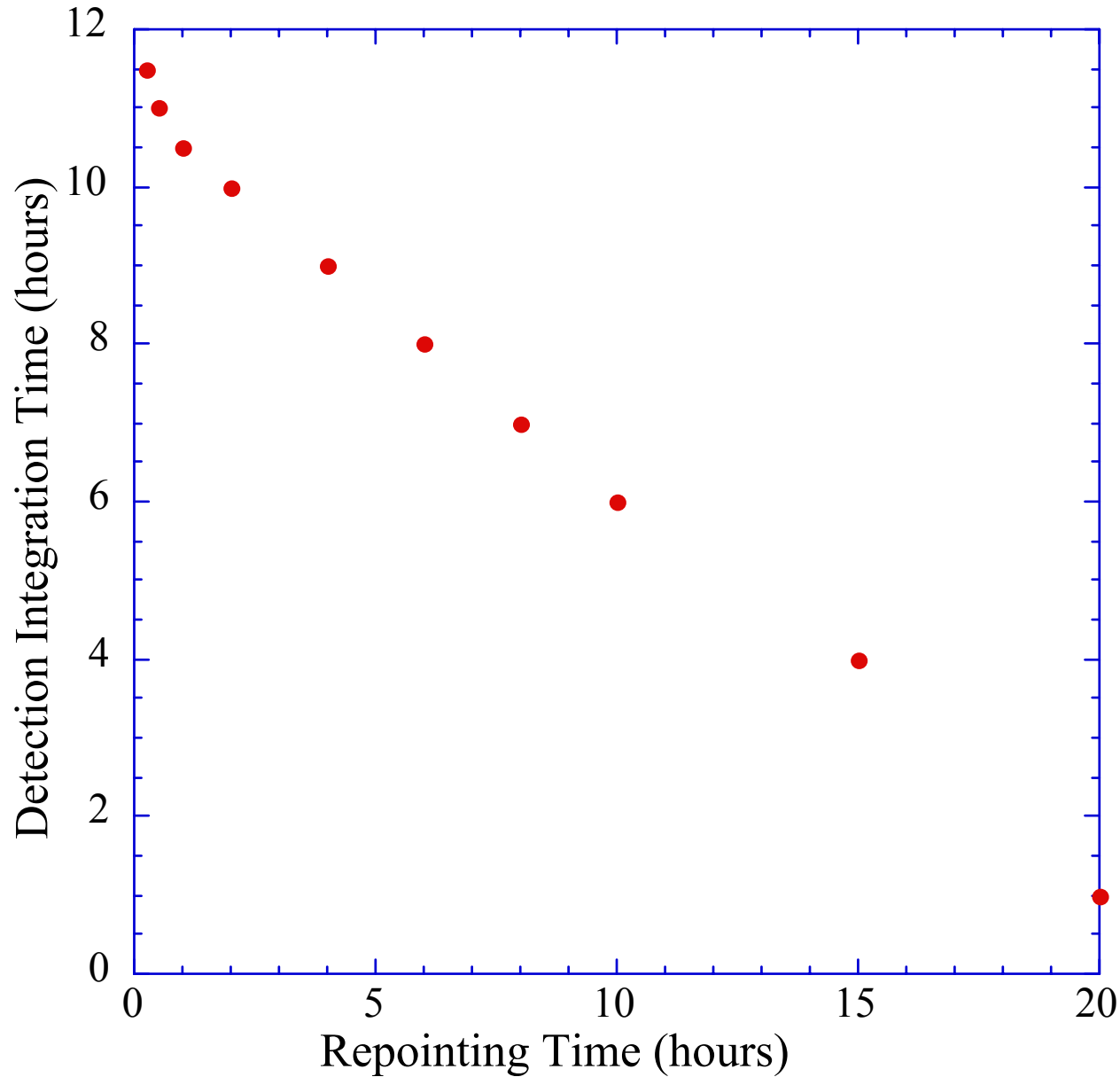



# Reasons for Observing the Planet Reflection Spectrum

- Discriminate background sources
- Detect false positives in exo-system
- Constrain planet area-albedo product
- Identify surface composition
- Photometric phase effects
  - Surface physical condition
- Alternate oxygen indicator
- Diurnal and annual photometric variations
  - Cloud cover
  - Seasonal vegetation

## Reasons for Preferring a True Imaging Architecture for TPF

- Not constrained to avoid low latitude stars (tolerate 5 mag contrast source at 2 arcsec)
- Exo-zodi no longer a limiting noise source except for extreme cases (eg, >200 SS).
- Distinguish planets from exo-zodi structures.
- Pixel by pixel background subtraction possible.
- Majority of interesting astrophysics programs require imaging capability.
- Minimal reconfiguration from planet search to general imaging.
- Potential fields of view much larger than required by TPF - possible astrophysics optimization.

## Science Precursors will Guide us to an optimal TPF implementation

- Current TPF requirements are dominated by the need for a significant null result.
- Precursors will establish the statistical frequency of candidate planets, and possibly actual candidates.
- Until the statistics are known, the TPF resolution requirement is unknown.
- The required resolution may easily change by 2X up or down, with possible enormous change in TPF scale and cost.

# Performance Requirements

*Spatial Resolution	<50 - 250 marcsec
*Spatial Coverage	1 - 5 arcsec
#Detection time	<10 hr/pointing
#Spectral coverage	Reflected and/or thermal
Spectral resolution	$\geq 3, 10, 20, 70$

	Infrared	Visible
*Sensitivity	0.2-5 $\mu\text{J}$	27-32 V
Dynamic range	$10^6$	$10^9$

\* Revisit science requirements with precursor results for frequency of earths among nearby candidate stars

# Architecture dependent (technical and scientific decisions)

# Astrophysics

Find Astrophysical Investigations Enabled  
by a TPF-like Observing Capability

# TPF Astrophysical Science

- Galaxies and quasars - nebulosity, lensing, dark matter.
- Globular cluster cores.
- Mass loss by evolved stars - supernova precursors.
- White dwarfs and the age of the galactic disk.
- Brown dwarf companions.
- Protostellar disks, asteroids, and planet formation

# Astrophysics - Host Galaxies for Quasars

- What fuels quasars?
- Did most galaxies contain quasars at one time?
- Are quasars born in mergers?

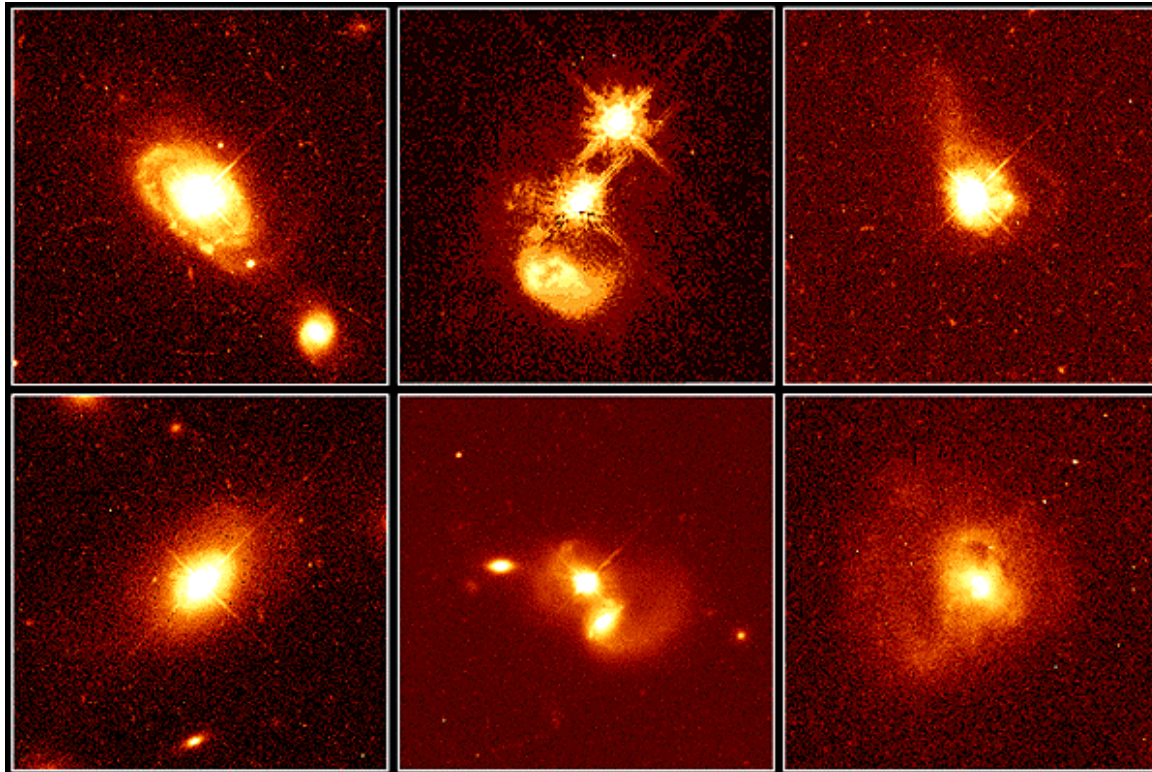

# Astrophysics - Nebulosity around Quasars, Blazars, AGN's

- Image foreground lensing galaxies.
- Determine intrinsic nebulosity.
- Are they powered by interstellar matter?

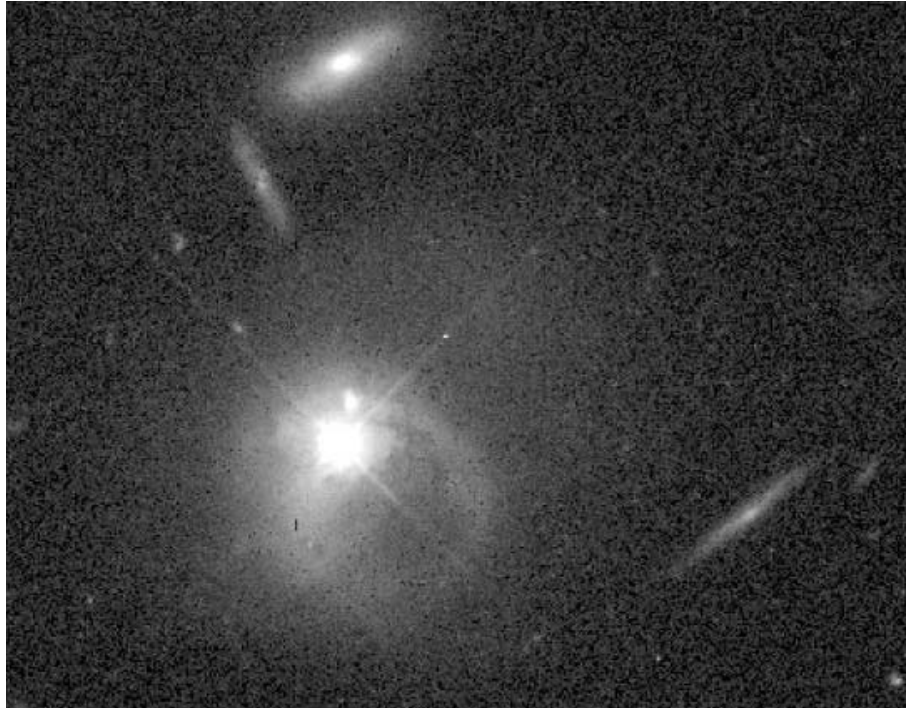



# Intrinsic Nebulosity

- Insight into the gas flow.
- Funneling of matter and barred galaxy structure.
- Faint jet structure will distinguish between models for formation of jets.

- Search for arcs or radial spokes in lensed sources.
- Need dynamic range of 7-10 magnitudes over 0.1-3 arcsec from bright QSO subimage.



- Determine masses of lensing sources.
- Must detect faint foreground galaxy against bright quasar.
- Determine nature of foreground galaxies and their red shifts.
- Mass distribution of lensing galaxies a key to the problem of dark matter.

- Stars interact - binaries stripped.
- Physical collisions and tidal interactions may produce a new range of unfamiliar stellar phenomena.

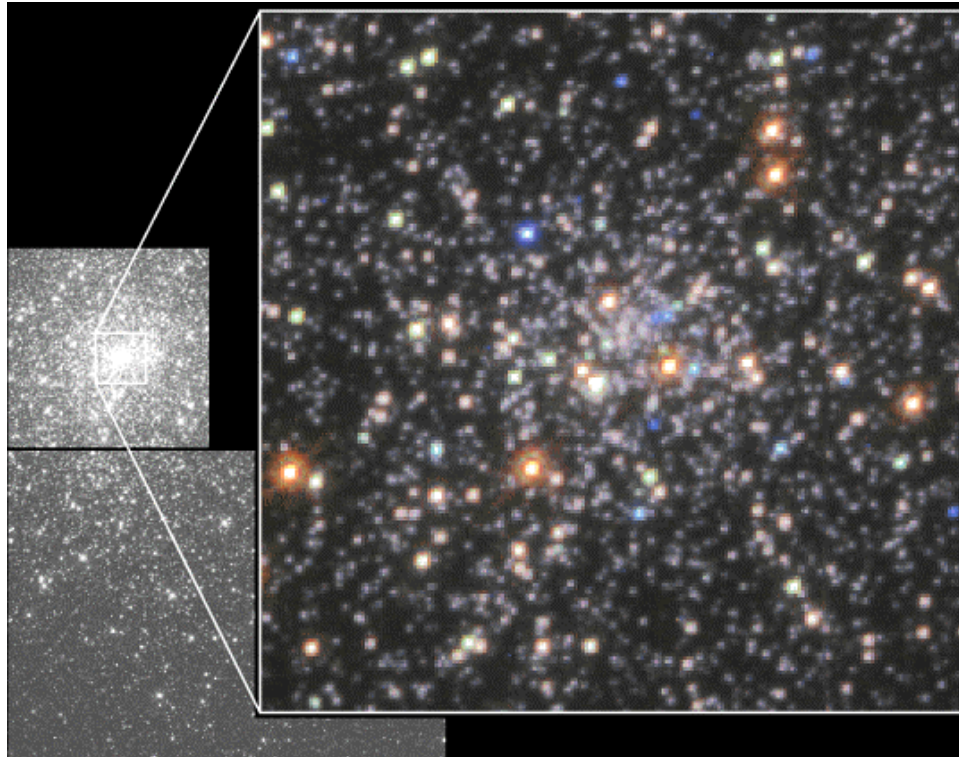

- Luminous blue variables eject mass before reaching supernova stage.
- Supernova expanding light sphere produces light echo which scans through ejecta shells.
- TPF central star rejection and high dynamic range reveal the sequence in which layers peeled off star.
- Inform modelers of the star's structure just before collapse.

## Mass Loss from Evolved Stars

- Complex structure of circumstellar shell records variations of stellar internal structure.
- TPF suppresses central star - time variability dissects mass-loss outflow and abundance history.



- Do white dwarfs in binary systems differ from solitary white dwarfs?
- Do they evolve differently?
- Age of galaxy's disk known from population density of white dwarfs. Search for more white dwarfs in nearby systems and secure better limits on disk age.

# Astrophysics - Brown Dwarf Companions

- Little is known about brown dwarf companion population.
- A natural counterpart to the search for planets.
- If brown dwarfs can form simultaneously with companion stars, could planets form simultaneously as well? This would refute a long-held view.



- Study the dynamical processes within circumstellar disks to form binary star and planets.
- Study gaps, tidal interactions, quenching of growth, eccentricities, migration.
- Natural counterpart to planet search - bears on frequency of occurrence of planets.
- TPF dynamic range, resolution, and field of view well matched to problem.

- How did the giant planets form? Apparently from an aggregation of comets and asteroids.
- Asteroid size/multiplicity distribution results from formation and interaction history.
- Records early stage of planet formation.
- Sensitivity/resolution requirement well matched to TPF.
- Natural counterpart to study of planetary system frequency and planet formation.

# Astrophysics Summary

- *A basic TPF planet detection and characterization mission will enable significant astrophysics with few or no additional requirements.*
- There are many exciting astrophysics topics requiring study of faint sources near bright sources in small fields of view.
- TPF architectures which fully image complex sources are distinctly superior to those which gather limited or indirect image information.

# Innovation in Star Suppression/Planet Detection

# Star Suppression Techniques

- **Nulling**
  - double dove
- **Generalized coronagraphy**
  - Achromatic coronagraphic imager
  - 2-d, 1-d, rectangular mask, phase knife
- **Pupil densification**
  - Direct imagery, coronagraphy, redilution
- **Square Aperture**
  - Shape, apodization
- **Rotational suppression of star leakage**
  - Concept, demonstration

# Double Dove Nuller

- A pair of modules, one being shown on the left, equivalent to reflective dove prisms.
- Assembling two modules as shown results in a zero-degree rotation interferometer, but with the image reverted. Rotating one module about the optical axis by 90 degrees provides 180-degree rotational shear.

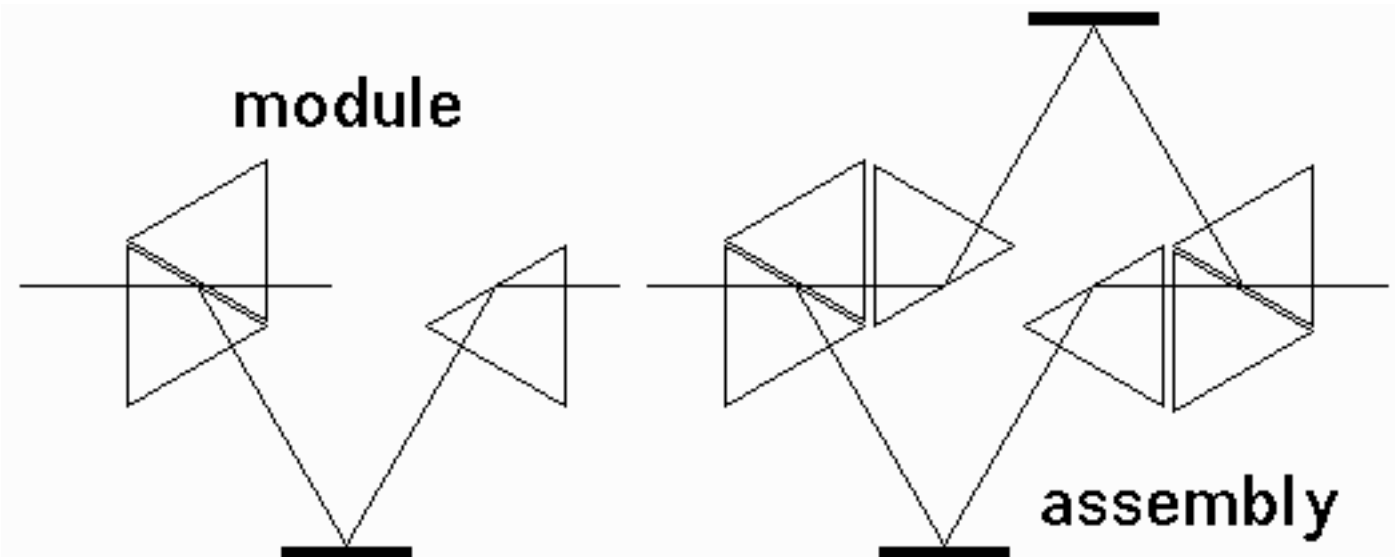

# Mertz - Double Dove Nuller

- Laboratory mockup

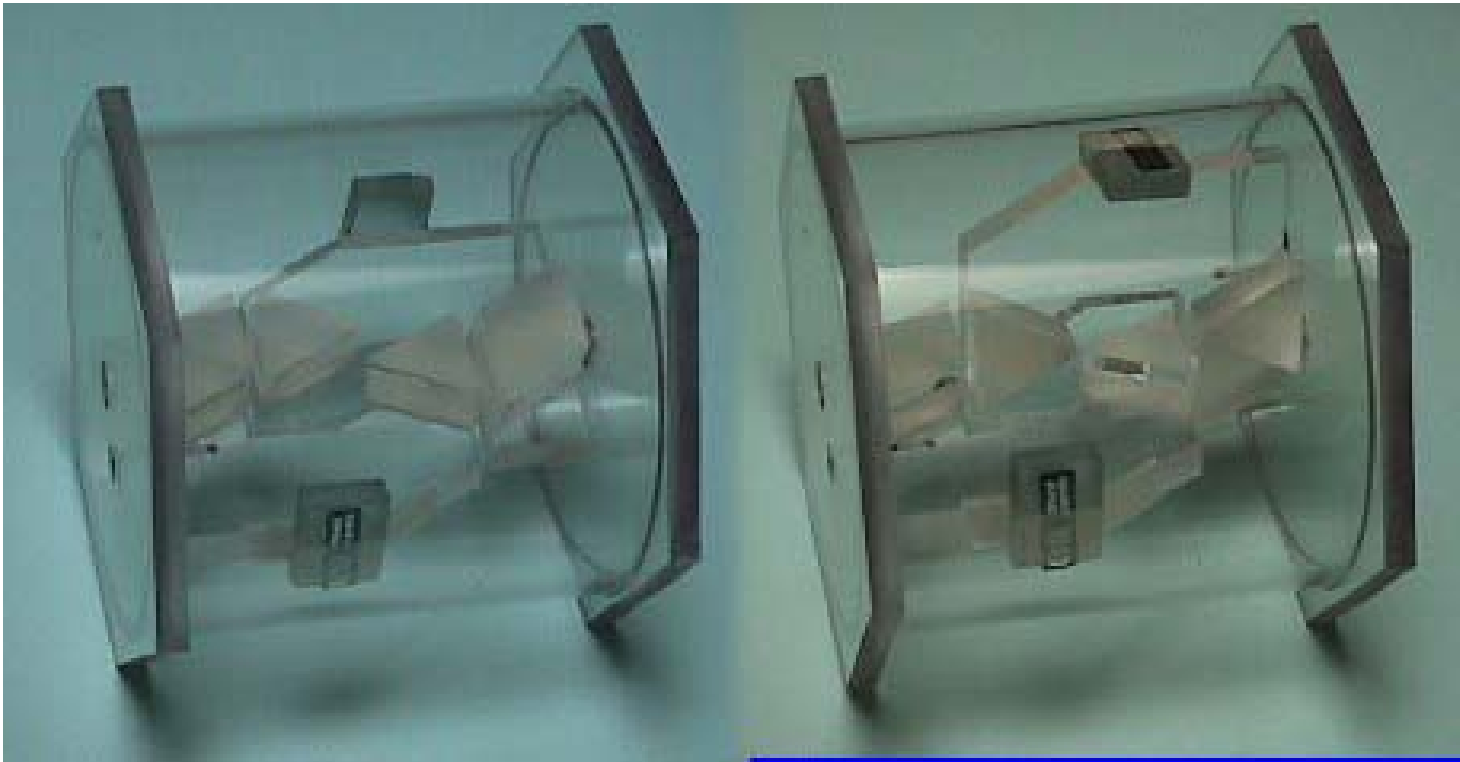

- Overview - generalization of classical coronagraphy
- 2-d Circular phase mask
- 1-d Spatial-spectral phase mask
- Rectangular mask
- Achromatized phase knife



# Nulling : Imaging coronagraphy vs. "classical" nulling

## □ Classical nulling

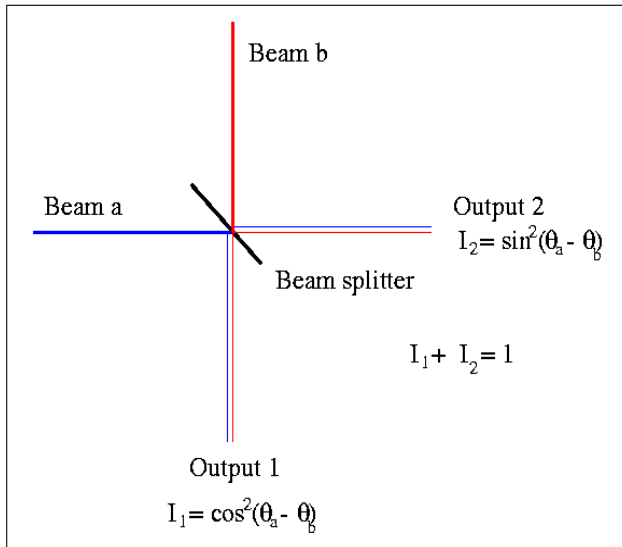

- Beams (one per aperture) are coherent
- One phase shift per beam
- One of the outputs is set to  $I=0$  for an on-axis point source
- The star light is found in the other outputs
- Number of outputs = number of input beams

## □ Imaging coronagraphy

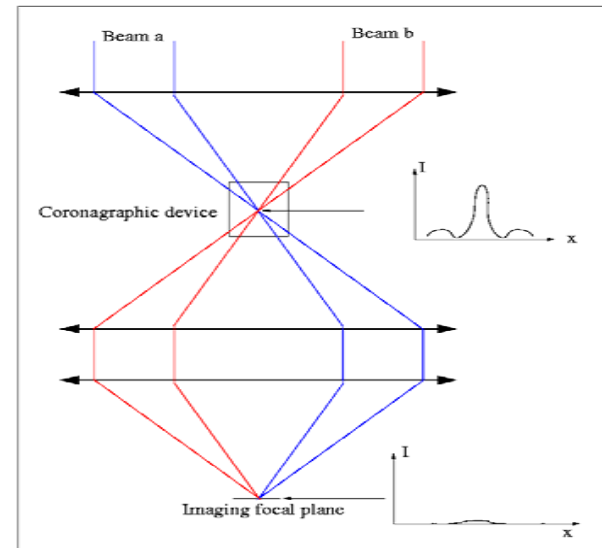

- Beams (one per aperture) are not coherent
- Without coronagraphy, no significant fraction of the field is usable (very small ring in the dark rings of the PSF)
- 2-step process : coronagraphy and then imaging
- Number of pixels in densified pupil mode = number of input beams

# Nulling : Imaging coronagraphy vs. "classical" nulling

## □ Classical nulling

- Easy to implement for small N
- Possibility of having deep nulls
  
- Hard to implement for large N
- Telescopes positions set by nulling
- Out of N outputs, only one is used. At best, the efficiency is 1/N.
- Small field of view

## □ Imaging coronagraphy

- Easy to implement for small and large N
- Any array configuration is possible
- Background subtraction made easy thanks to imaging : source and background are observed at the same time
- No light is wasted : all the photons reach the detector, no unused beams
- Better (u,v) plane coverage potential (rotation)
- Wide field of view (if rediluted exit pupil)
  
- Deep null harder to achieve

***Imaging coronagraphy is more efficient in terms of using the photons and offers more possibilities (calibration, (u,v) plane coverage).***

**Example of a 6 telescope rotating array.**

Signal modulated by rotation  
Planet observed  $1/N = 16\%$  of the time  
Noise N from background (exo-zodi, zodi) and star residuals is constant and observed 100% of the time. It is 16% of the total background/star residual leaks.

Planet moves on the detector with rotation, but is always observed.  
Noise N from background (exo-zodi, zodi) and star residuals is constant and observed 100% of the time. It is 16% of the total background/star residual leaks (this is the fraction of the field where the planet PSF is).

In this example, assuming the same nulling performance in both cases, the imaging coronagraph offers a gain of a factor of 6 in exposure time.

# Interferometric Nulling vs. Coronagraphic Nulling

## Interferometric nulling

- A discrete number of beams (one per telescope) interfere with various phase shifts. For each "pixel", a set of constant phase shifts is applied to each beam.
- Easy to implement with a small number of telescopes ( $N < 5$ )
- Few optical elements when  $N$  is small
- Constraints on the telescopes positions
- Requires a lot of optical elements and complexity when  $N$  is large
- Does not allow wide field imaging
- Few "pixels" used to map an image : need to use signal modulation
- Little redundancy of measurements makes it hard to correct for instrumental defects.

## Coronagraphic nulling

- A densified pupil is fed into a small telescope with a nulling coronagraph. The detector is a 2D array of pixels. The phase shift applied to the apertures is a continuous function of the pixel position.
- No increase of combining optical elements when  $N$  increases : easy to implement for any number of telescopes.
- No limitation of the field of view if rediluting the pupil.
- The nulling does not put constraints on the telescopes positions -> better  $(u,v)$  plane coverage possible.
- Self calibration, a lot of instrumental defects can be detected and corrected in the image.

# The Phase Mask nulling coronagraph

## □ Comparison with the Lyot Coronagraph

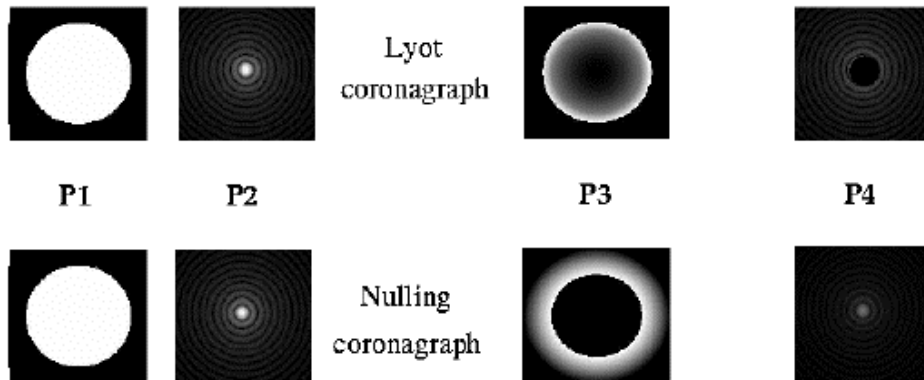
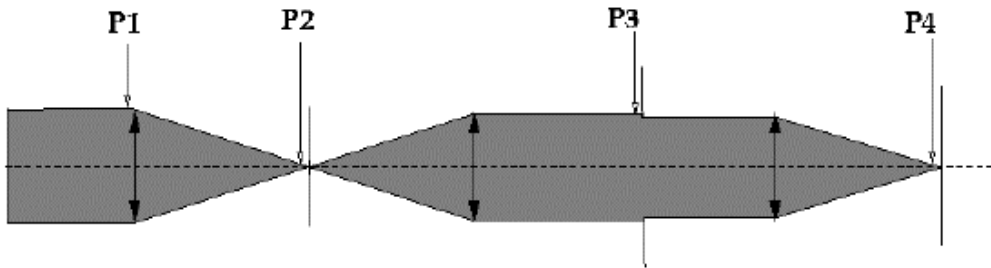

## Lyot Coronagraph

- Opaque mask in the focal plane
- Does not allow imagery close to the optical axis
- Low extinction/total throughput compromise (light loss with the pupil Lyot stop).

## Phase mask coronagraph

- Small (half the FWHM) phase-shifting mask in the focal plane
- Allows to get close (one FWHM or less) to the optical axis.
- No light loss for off-axis sources : all the light is diffracted out of the pupil plane for an on-axis point source.

# Phase Mask Nulling Coronagraph

- The phase mask shifts the phase of the light by half a period.
- The phase mask diameter is only 43% the diameter of the first dark Airy ring.
- Thanks to an apodization mask in the pupil (densified pupil), the extinction is total for an on-axis point source.
- This technique works with single and multiple pupils.

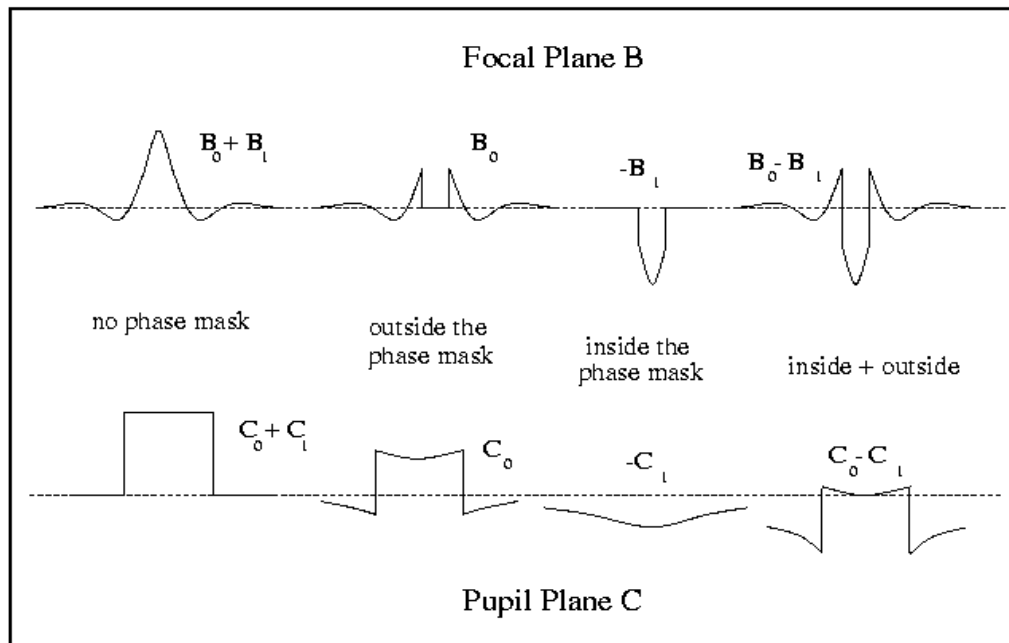
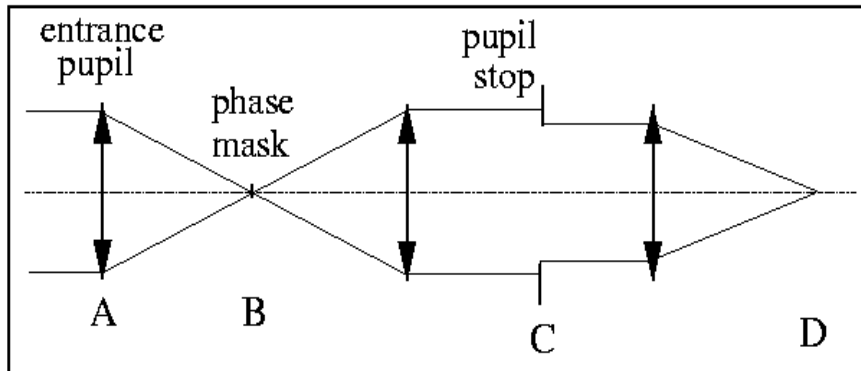

□ This coronagraphic technique has been successfully tested in a laboratory.

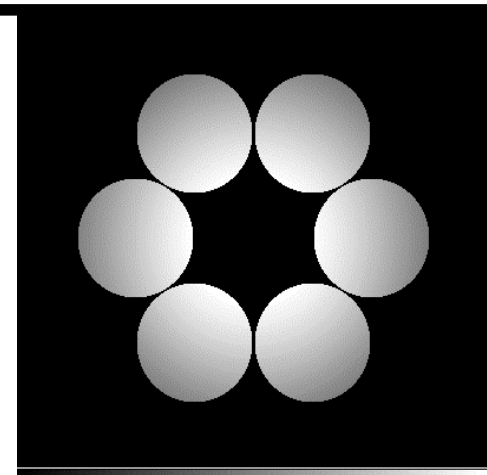

# Phase Mask nulling coronagraph Performance

## Chromaticity

The phase mask coronagraph is sensitive to chromaticity :

- 1 The Airy spot size varies with wavelength
- 2 The phase shift needs to be achromatic

### *Possible solutions*

(1) : use of a wavelength-dependent magnification optical device. Such a device has already been used at optical wavelength for white fringe imaging and white speckle imaging.

(2) : use of a multilayer phase mask. The materials and thicknesses are chosen to maintain a constant phase shift over a wide spectral range. Other possible solution : focal plane crossing produces an achromatic phase shift.

(1) and (2) : 1-D densified pupil with a spectrally dispersed PSF and a phase "slit" of varying width and depth.

## Extinction profile

Extinction residual in  $q^2$

This limits the extinction to  $10^5$  for an Earth-Sun system. This becomes a problem for detection planets in the habitable zone of cooler stars.

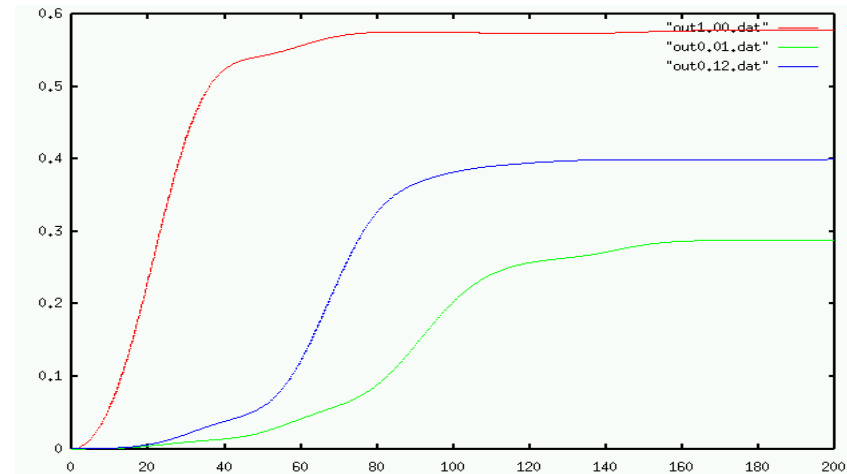

### *Possible solutions*

Use of a modified phase mask (Lyot-phase mask hybrid ?).

# Spectroscopy & Coronagraphy

- Easy dispersion in the direction perpendicular to the PSF fringes
- High spectral resolution achievable
- $X - \lambda$  recording using a classical 2D detector.
- Favorable for Phase Mask achromatisation  
(PM using mirror reflection Under study)

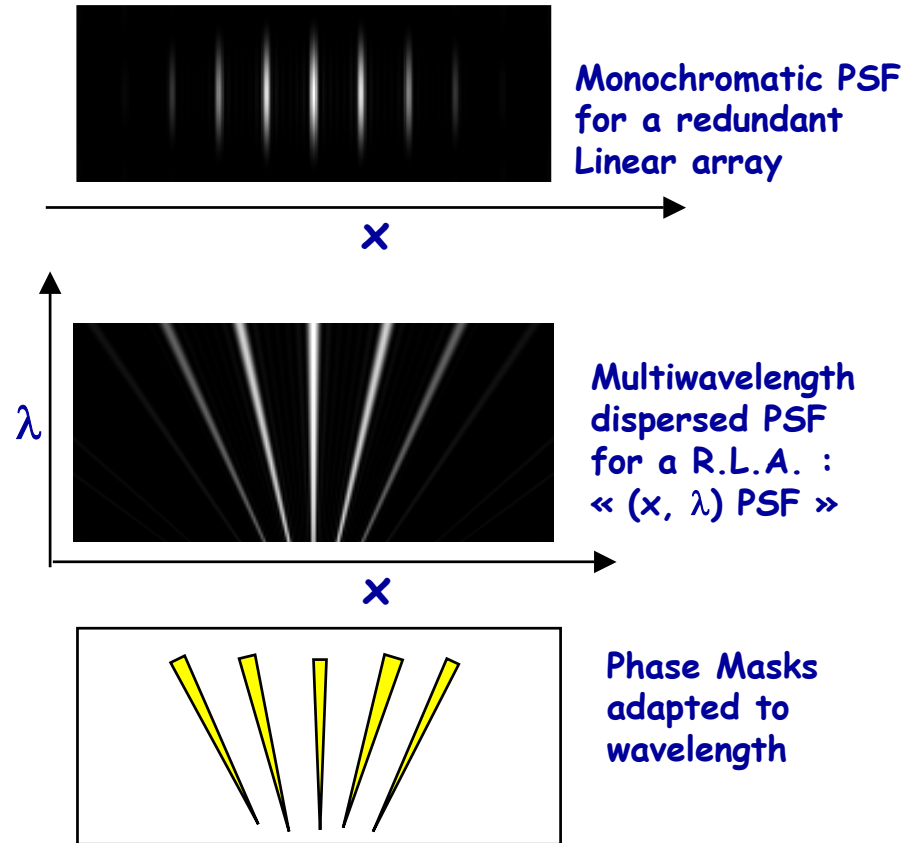

# Four Quadrant Phase Mask

(Rouan et al, PASP)

## Optical Layout

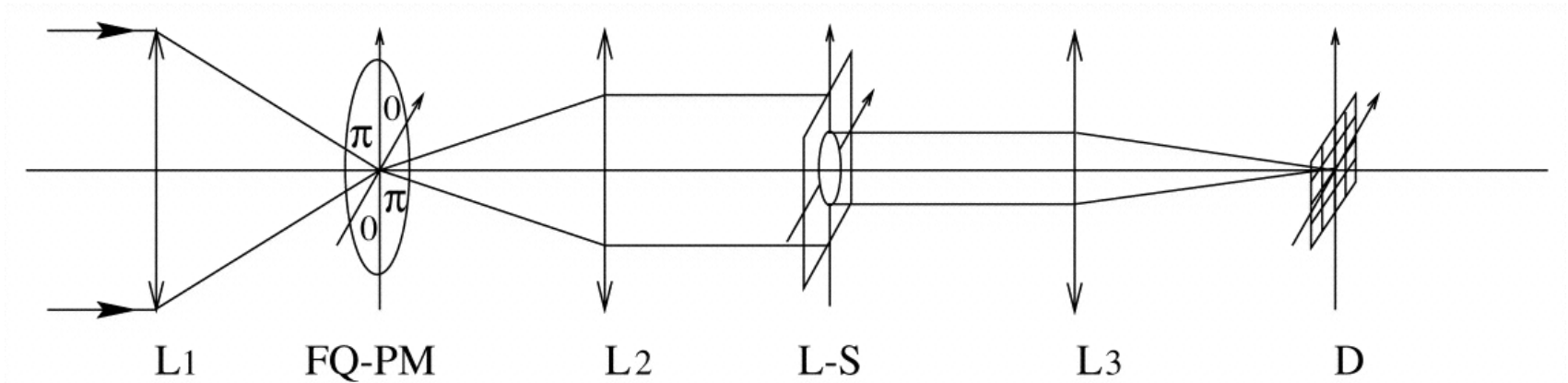



# Four Quadrant Coronagraph

(Rouan et al., 2000, Riaud et al, in preparation)

Optical layout

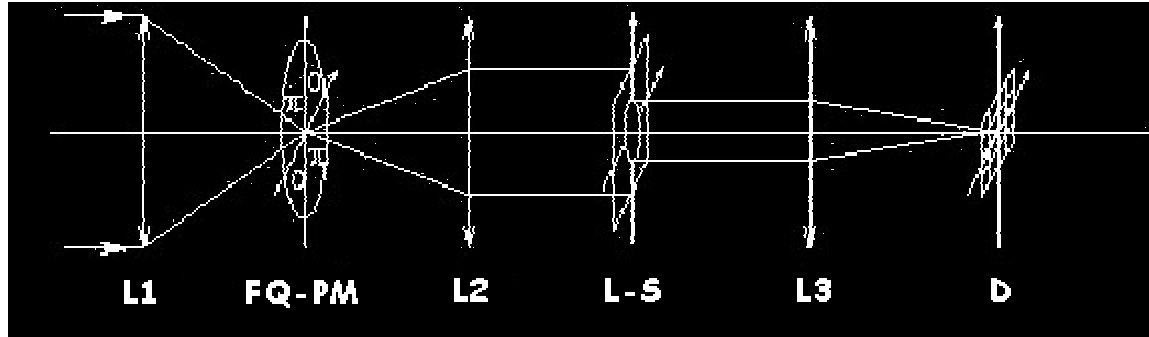

- Four quadrant phase-mask in the focal plane (Rouan 2000)
- High dynamic range  $\Rightarrow$  20mag. (with perfect optics)
- Resolution unaffected
- Broad-band operation with achromated phase mask requires a circularized pupil affected by guiding errors (null width  $\propto \theta^2$ )
- Pupil obscuration up to 10% tolerable

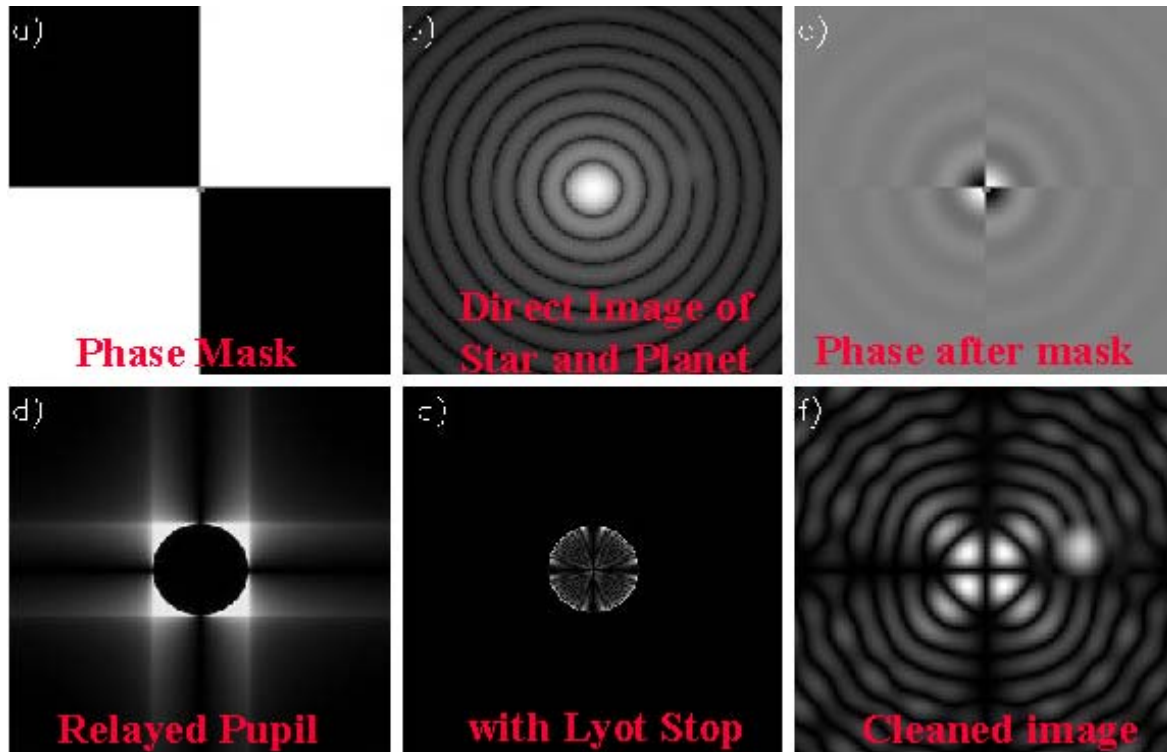

# Four Quadrant Phase Mask

## Radial Cut of Stellar Light Distribution

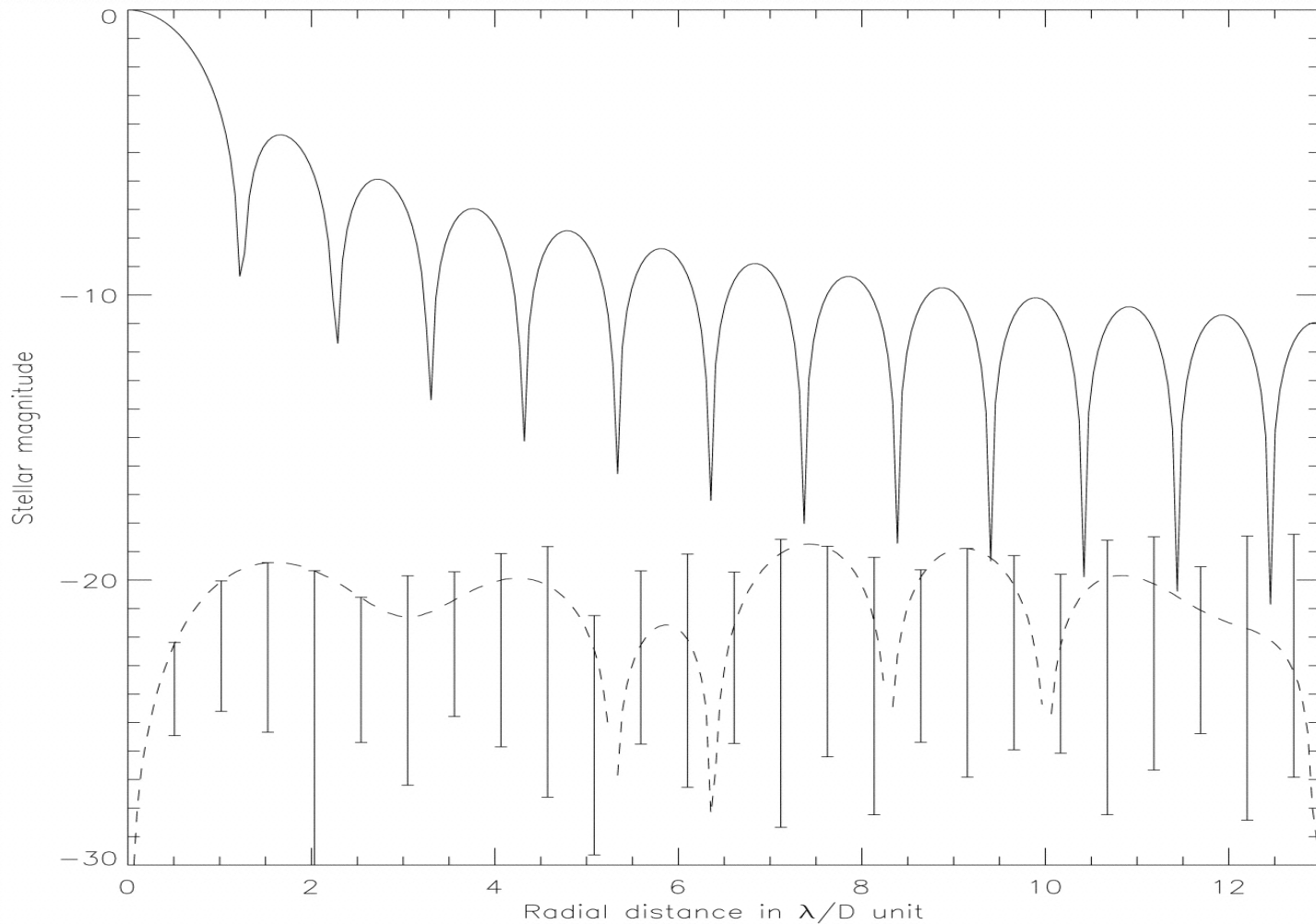

# Phase Knife Coronagraph: Principles

1<sup>st</sup> Phase Knife  
( $\pi$ -Shift)

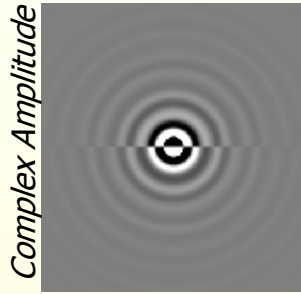
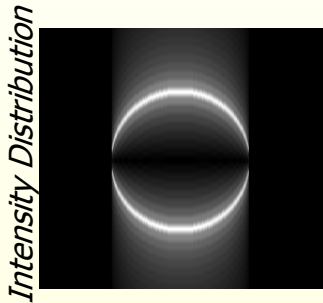

Image plane



Pupil plane

2<sup>nd</sup> Phase Knife  
( $\pi$ -Shift)

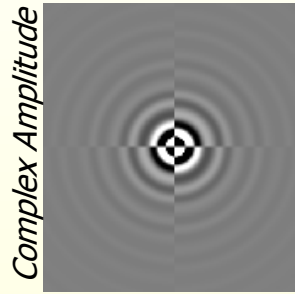
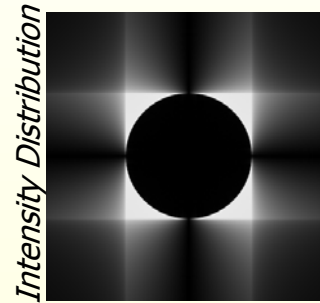
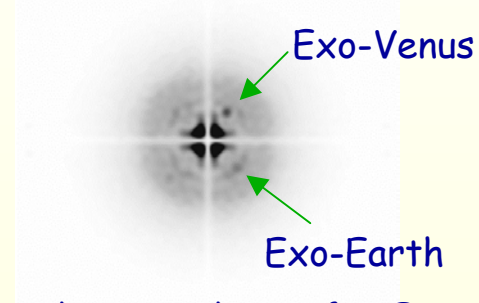

Image plane



Pupil plane

Final Image plane  
(Coronagraphic PSF)



Realistic Simulation of an Exo-Planetary System using PKC

Extinction Performance:

$10^{-6}$  at First Airy Ring

$10^{-5}$  Peak to Peak

$10^{-8}$

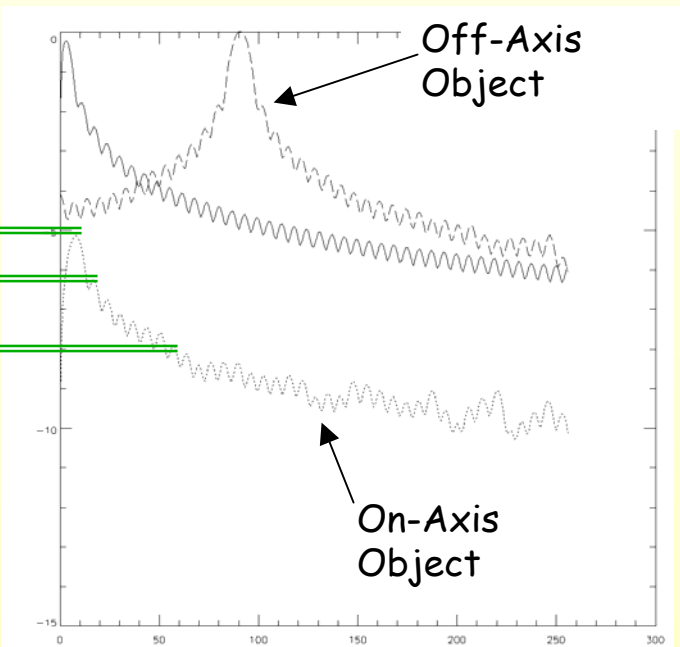

$\pi$ -Shifts are Wavelength Dependent,  
*i.e.* Chromatic

# Achromatic PKC: Optical Concept

*Solution for Solving the Chromatism Problem:  
Dispersing the Image Along the Phase Knives Directions*

⇒ Prismatic Phase Knife Allowing almost **Achromatic  $\pi$ -Shifts**

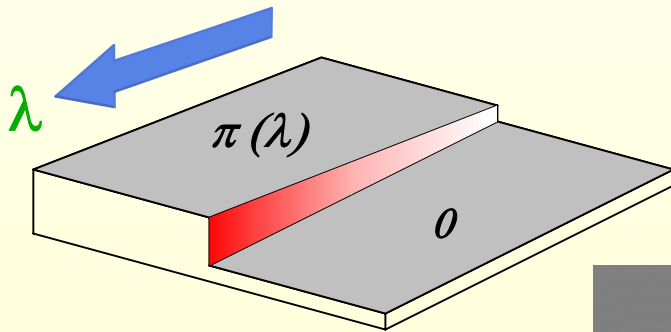

Initial Image Plane

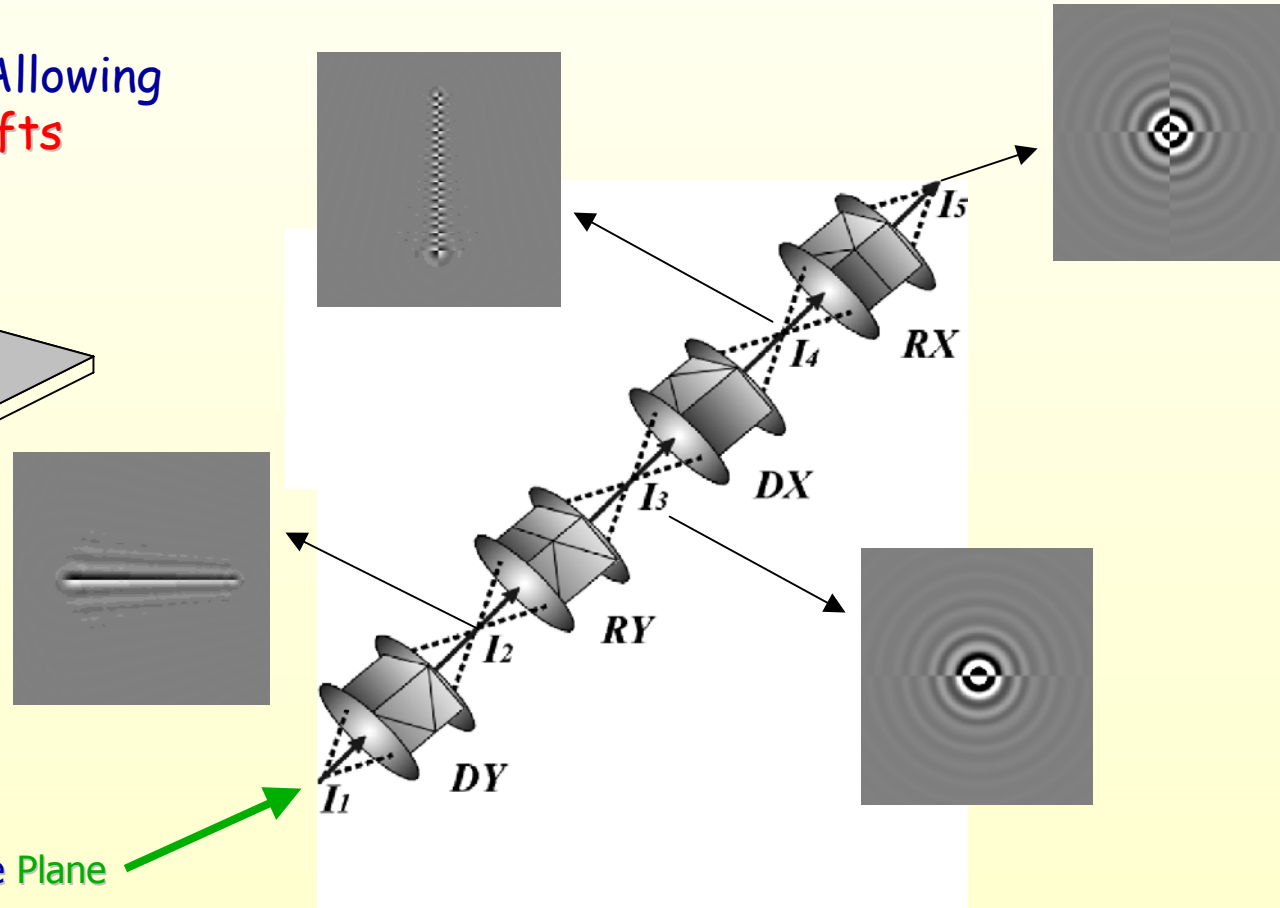

# Achromatic PKC

Extinction Profiles for Several Prismatic Phase Knives  
with Increasing Local Phase Variation

## Phase Knife Coronagraph:

- ⇒ High Extinction Performance
- ⇒ High Bandwidth Efficiency
- ⇒ Technological Readiness

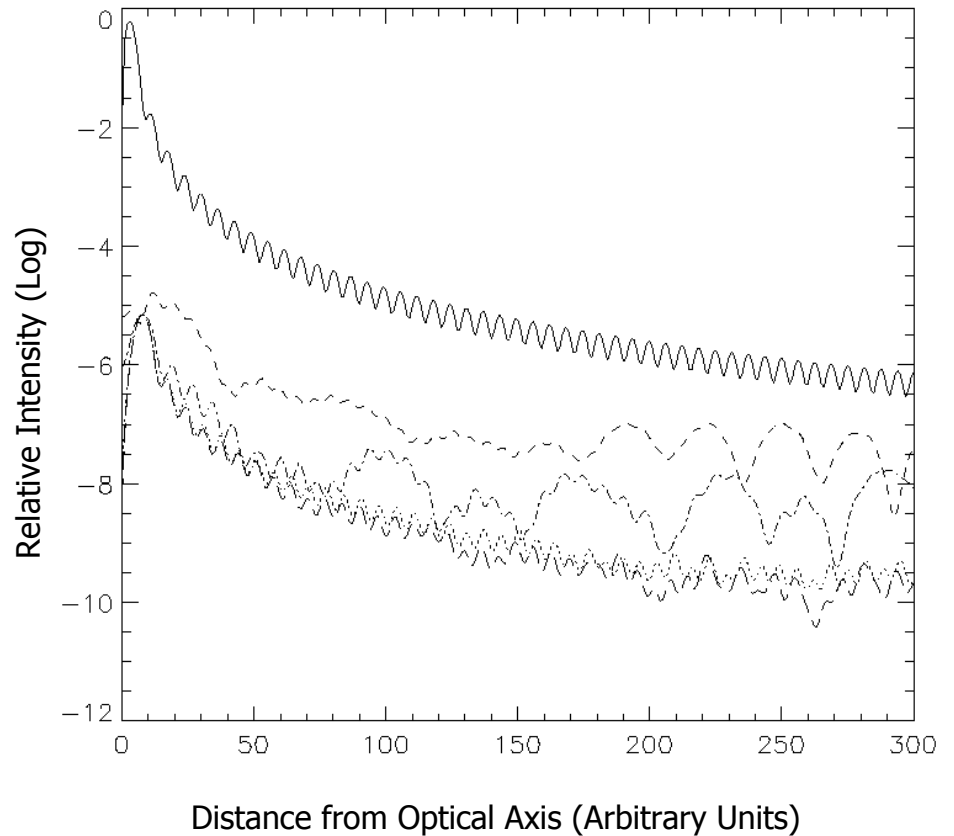

# Coronagraphic Techniques

Technique	Advantages	Disadvantages
Classical (Lyot)	Achromatic, Simple	Large dead zone,
Achromatic Interfero-Coronagraph	Achromatic, Simple	Moderate contrast gain
Circular phase mask	Small dead zone, Large contrast gain	Difficult achromatization, Variable phase element
Rectangular phase mask	Reduced tilt- error leakage, Large contrast gain	Variable phase element
Phase Knife	Achromatization Possible, Large contrast gain	Additional components

# Pupil Densification

# Principle of Densified-pupil imaging

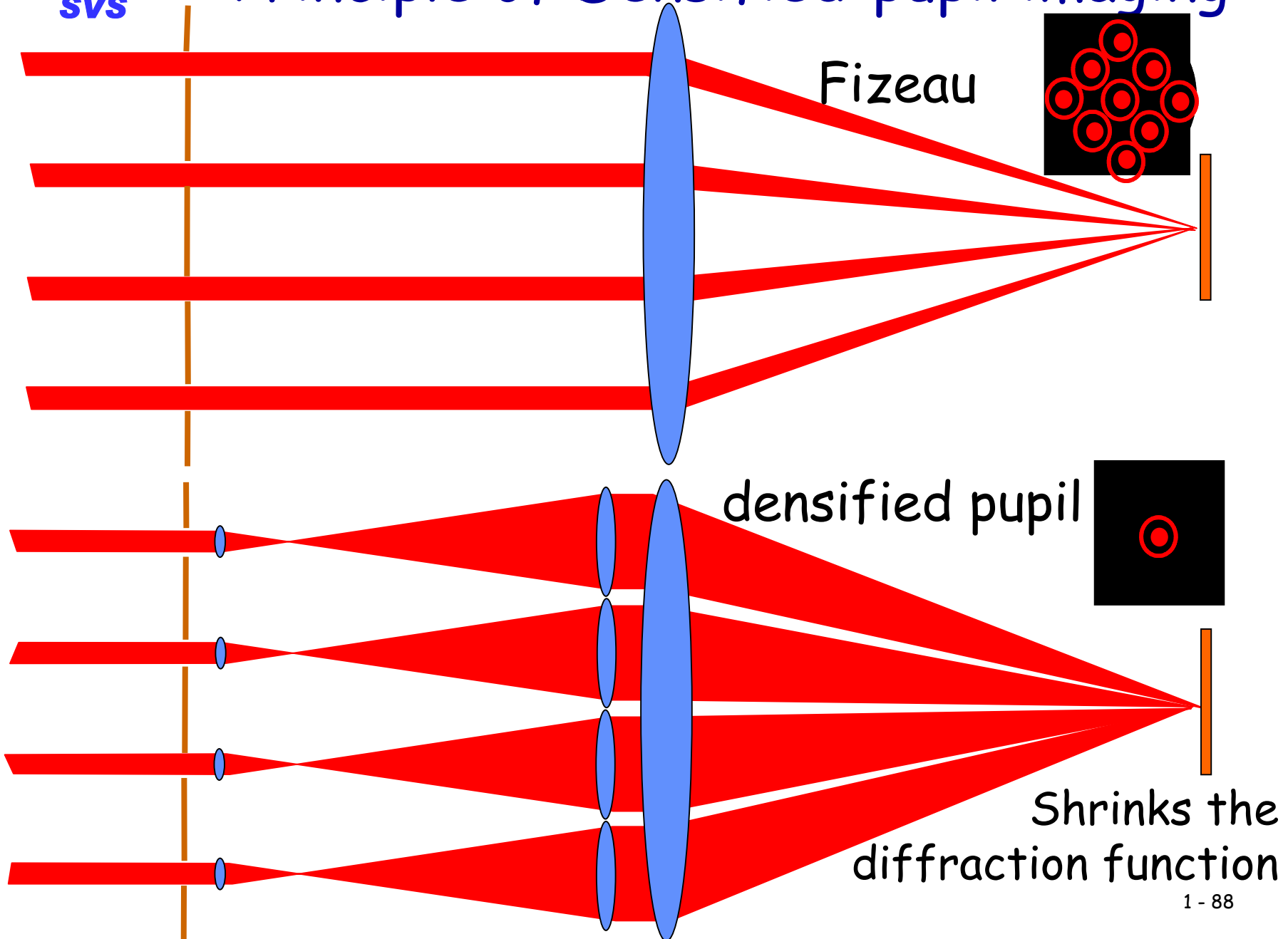



# Pupil Densifier: Principle

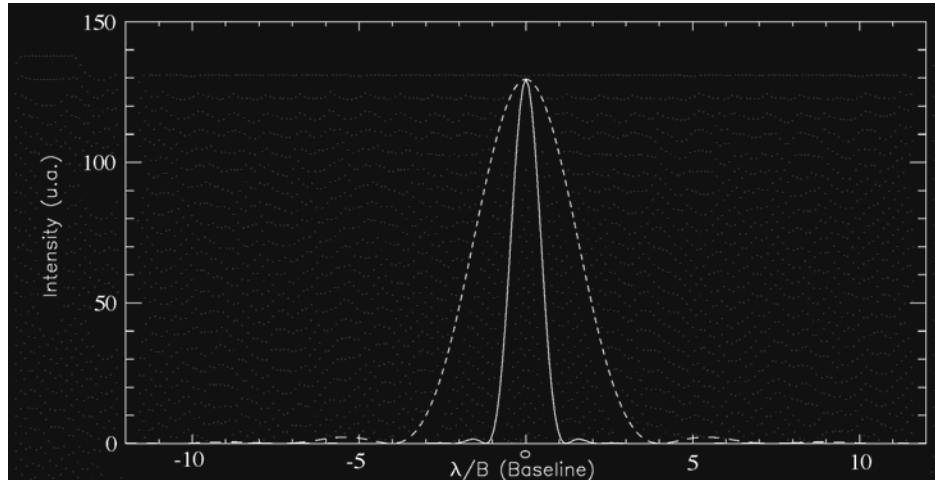
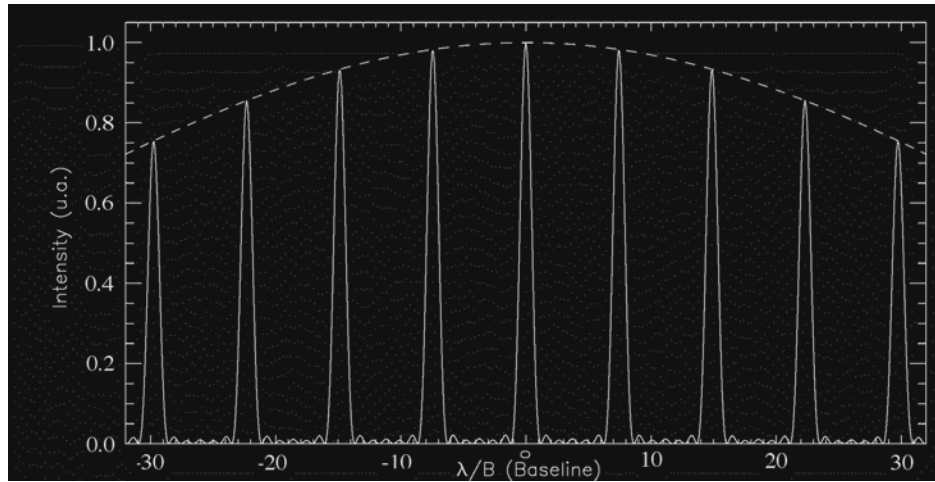
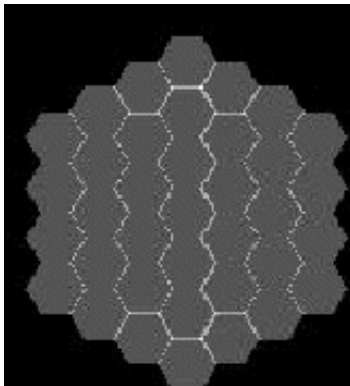
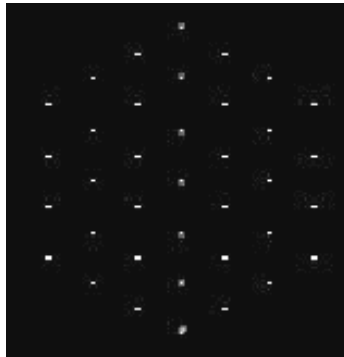

- Image is intensified with respect to Fizeau array
- Direct imaging becomes possible

# Imaging Properties of Densified Pupil

- Envelope of Fizeau image shrinks
- Image intensified
- Pseudo-convolution with object =  
(convolution)  $\times$  envelope
- Elementary sky field = spacing of grating orders  
(aperture considered as grating)
- Point/extended sources contrast higher than  
with beam-splitter (flat field) interferometry
- Filled exit pupil usable for generalized  
coronagraphy

# Fully Densified Pupil

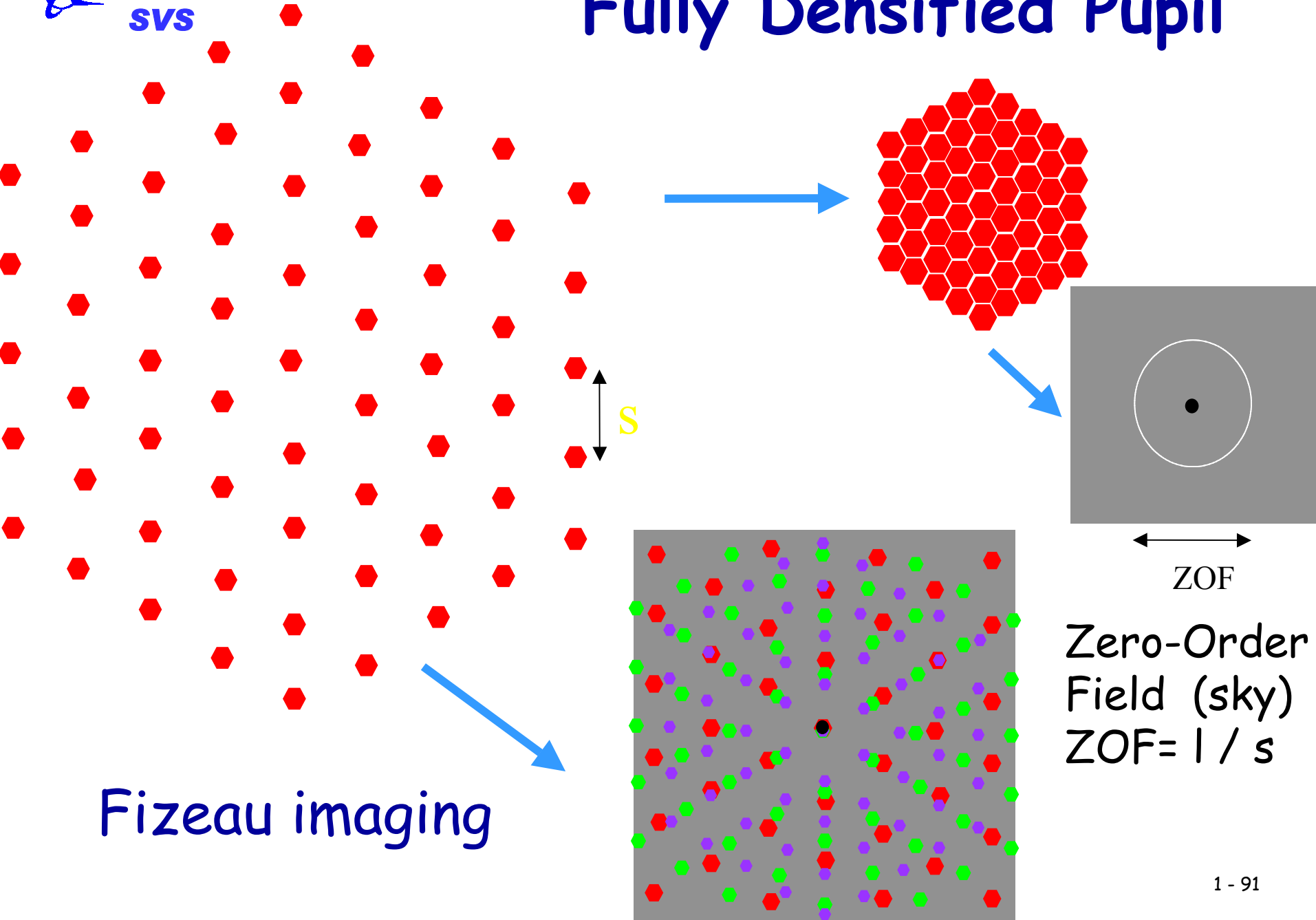

# Imaging beyond the Zero-Order Field:

Zero-Order Field  
 $ZOF = 1 / s$

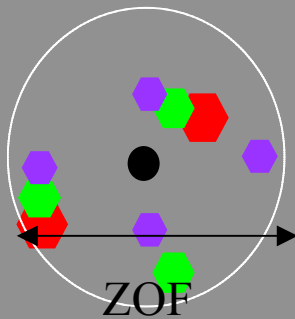

Sun ( nulled) with  
 Earth, Venus, Mars  
 image simulation  
 (Boccaletti et al. ,  
 2000, Icarus)

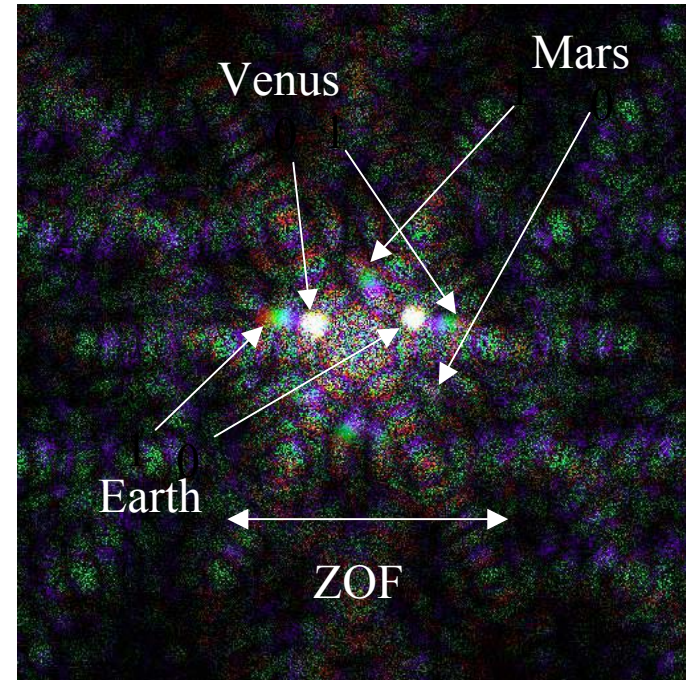

- Planets outside ZOF have a dispersed image in ZOF
- Extended image can be reconstructed if:
  - fewer than pN active pixels in object (OK for exo-planets)
  - multi-l camera (ex: STJ,... Courtès optics)

# Enlarged field

Earth, Venus, Mars image  
simulation (Boccaletti  
et al. , 2000, Icarus)

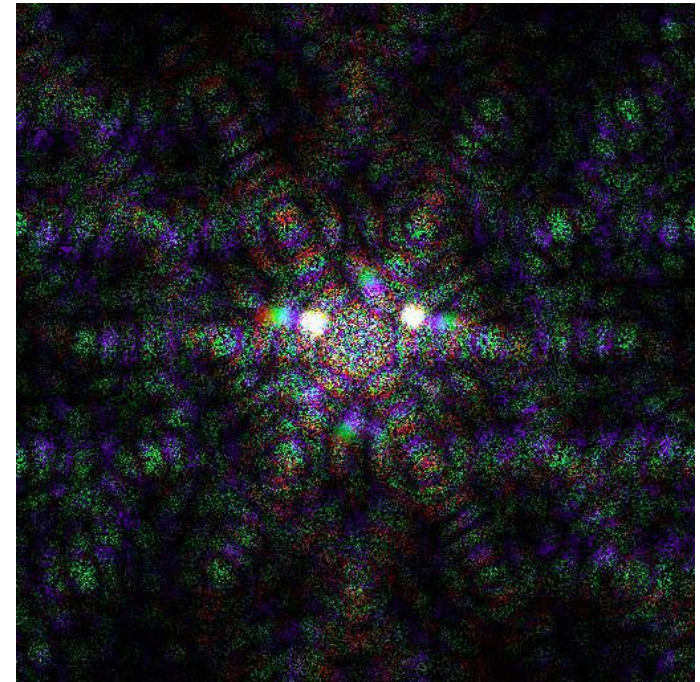

- Up to  $\pi N$  planets detectable in extended image
- $\pi N$  resels in Zero-Order Field ( ZOF)
- Up to  $N^2$  planets in Higher-Order Field ( HOF)
- Far-out planets are seen through the diffracted orders, dispersed

# Calculated diffraction patterns

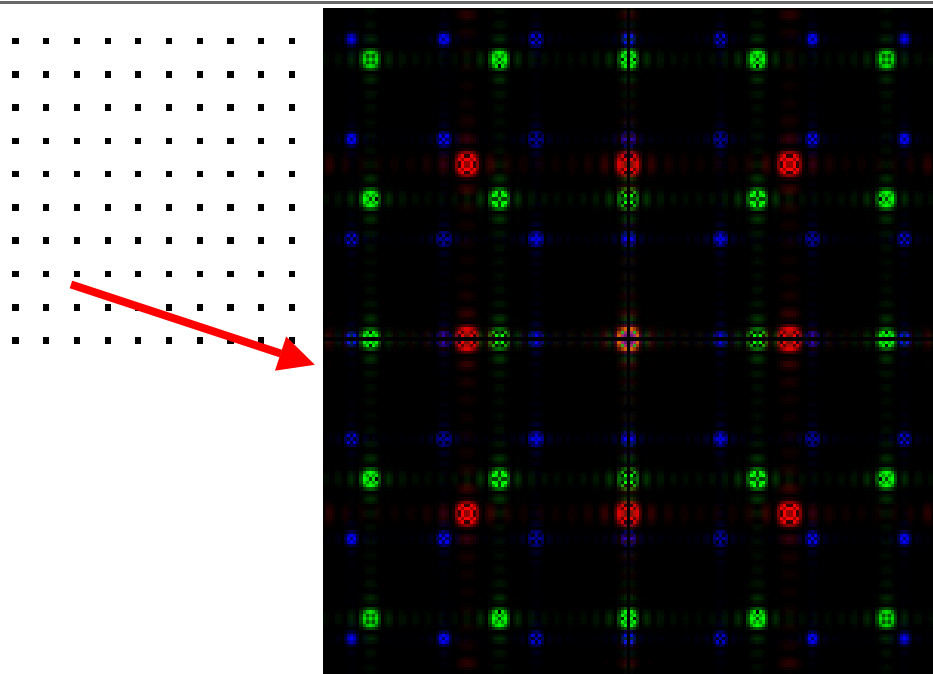

Diluted aperture

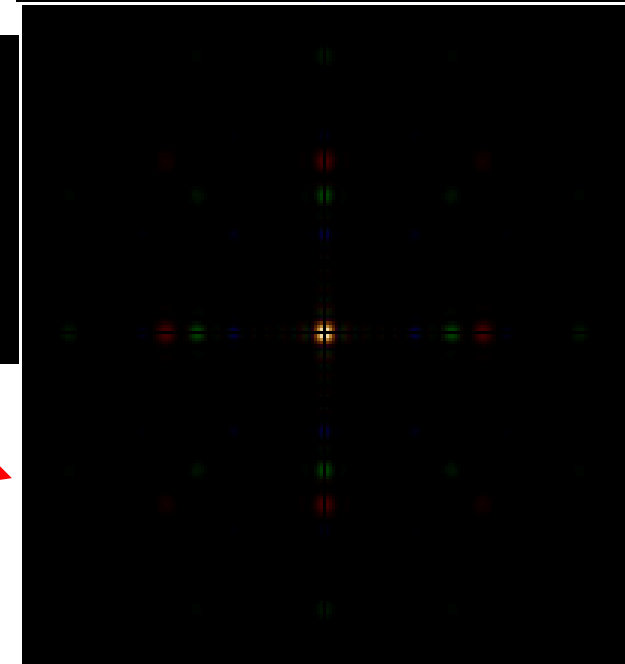
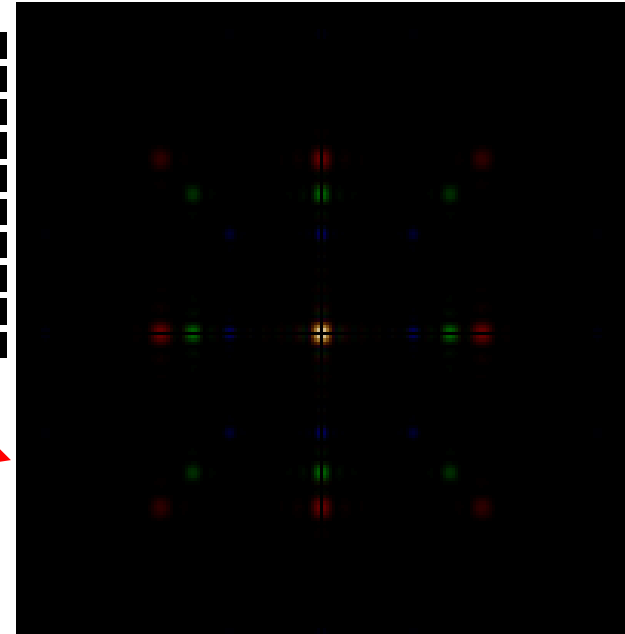
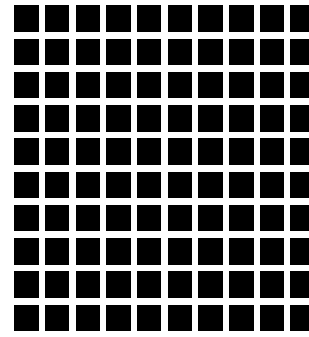

Dense  
aperture

# Multi-field Imaging with Hypertelescope

Sub-aperture's  
Airy radius

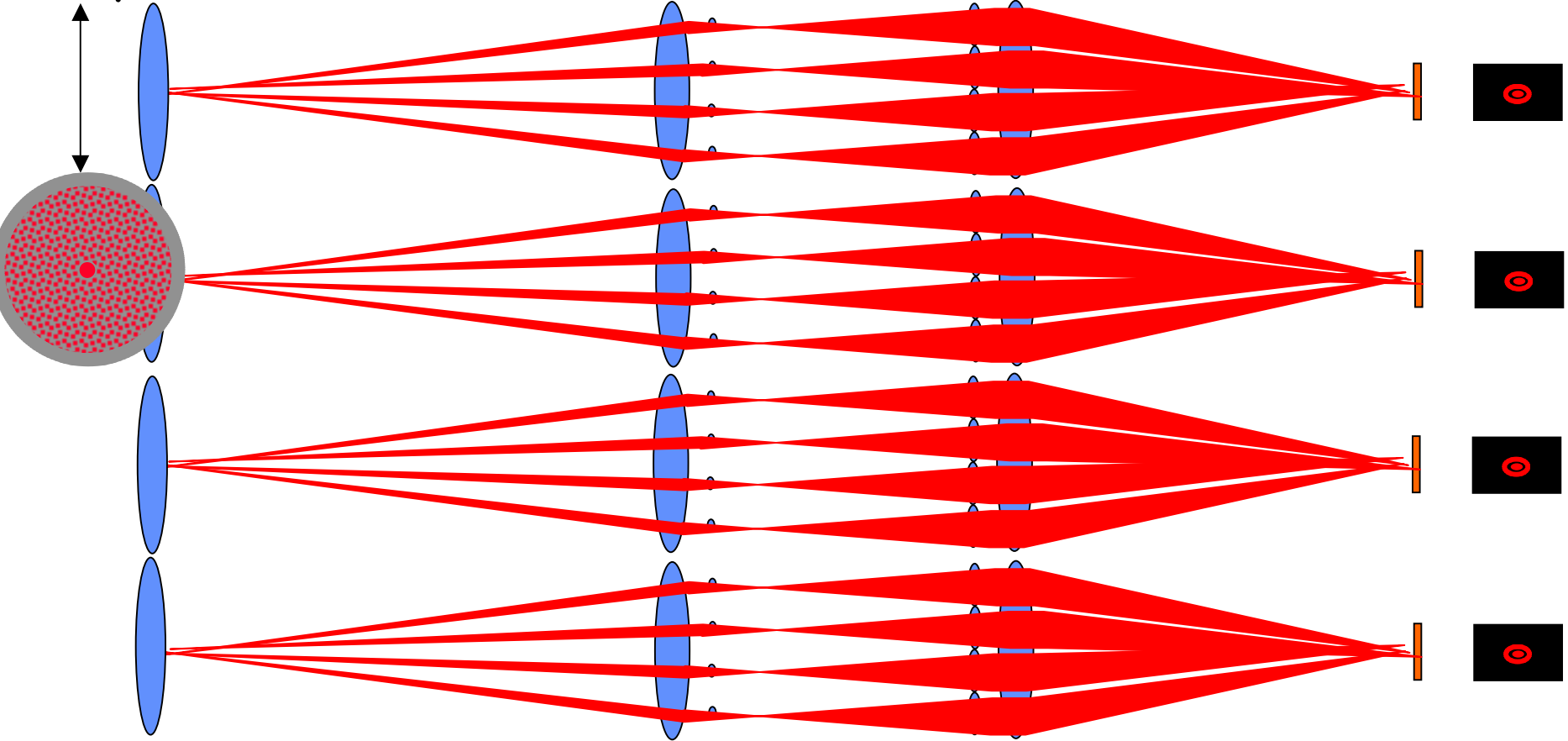

Fizeau focus

Array of densifiers

# Coverage of Multi-field Image

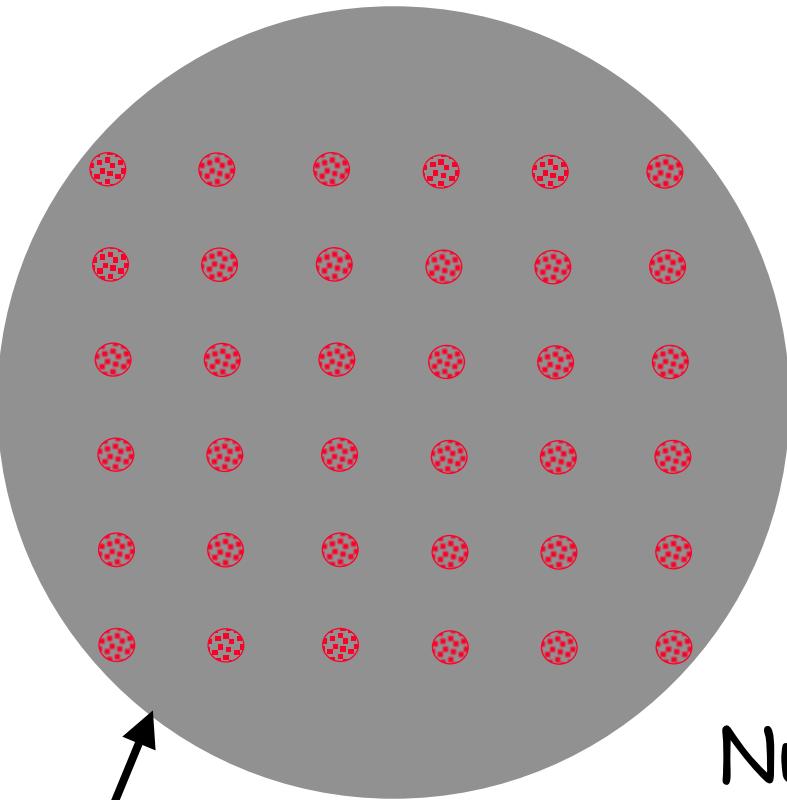

corrected Fizeau field  
(size F on sky)

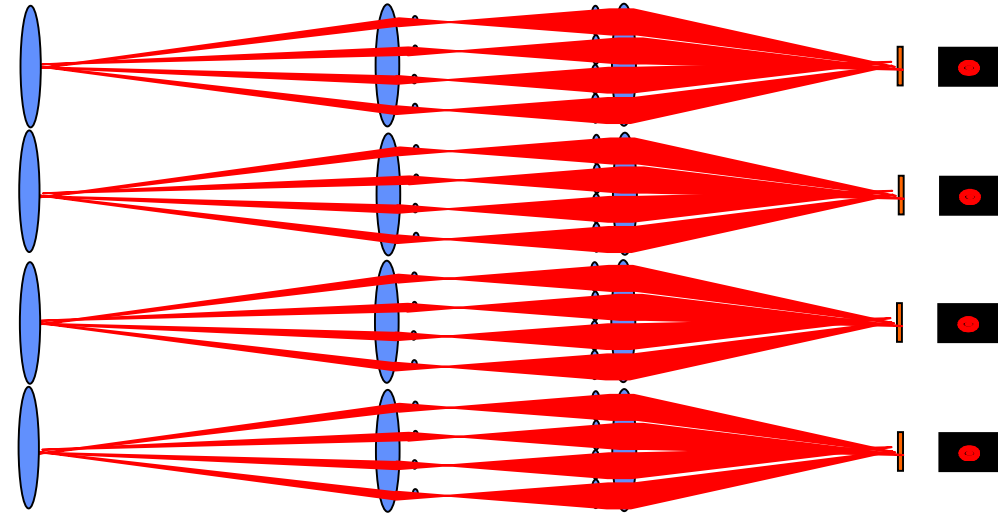

Number of fields =  $(F d / \lambda)^2$   
 relative coverage of sky area =  $N (d/D)^2$   
**Example: "exploded OWL"**  
 $N=10,000$ ;  $d=1\text{m}$ ;  $D=1\text{km}$   
 gives 10,000 fields and 1% coverage



# A limitation: inter-field crowding

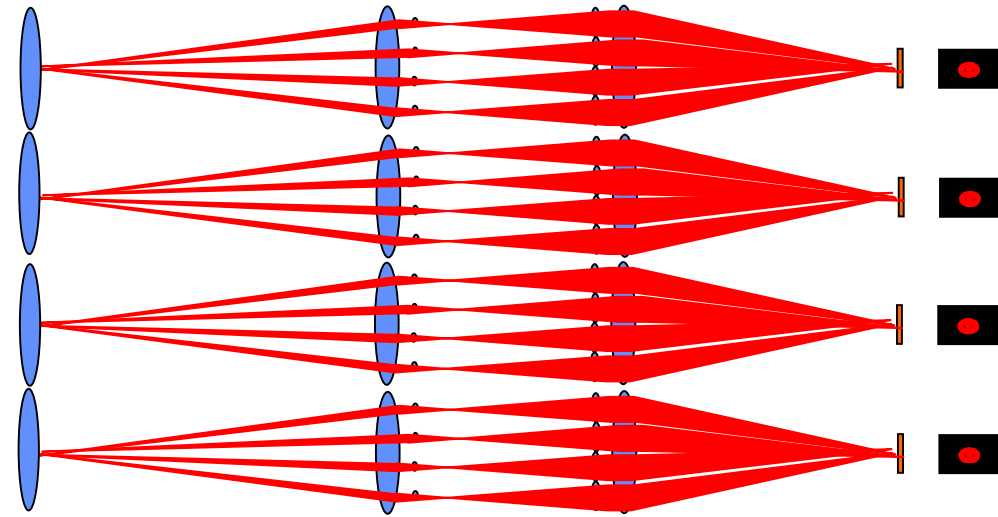
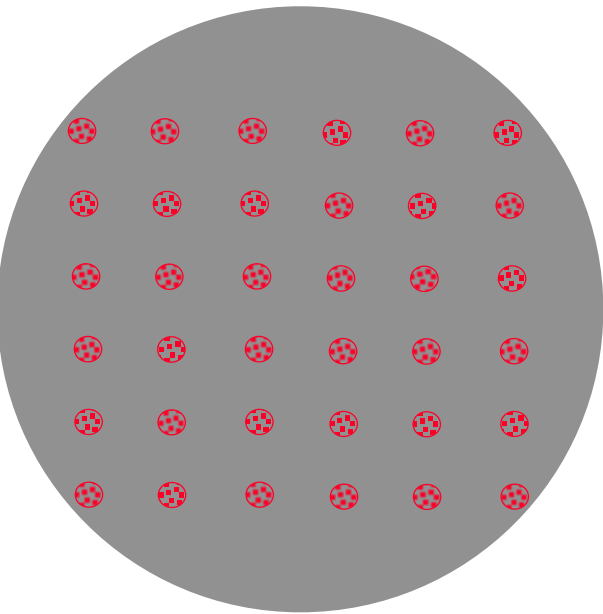

- Sources between fields are included in the limitation of  $N$  active resels per image
- They can be imaged directly, using the higher diffracted orders of the aperture considered as a grating

# Pupil Redilution

	Diluted Pupil	Densified Pupil
PSF	$\frac{D^2}{N d^2}$ Peaks	One single diffraction peak
FOV	limited by the optics can be several times $\frac{\lambda}{d}$	useful field of view is $\frac{\lambda}{D} \sqrt{N}$
	D maximum baseline N number of telescopes	d diameter of each telescope $\lambda$ wavelength

Makes coronagraphy difficult. Peaks are spectrally dispersed away from the optical axis.

The useful field of view is too small to efficiently detect planets unless the number of telescopes is  $> 20$ .

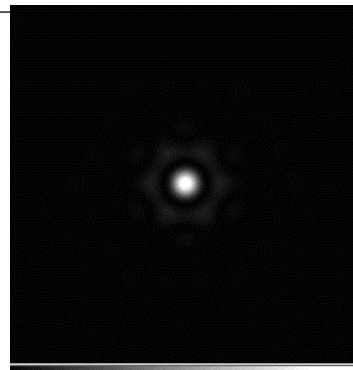
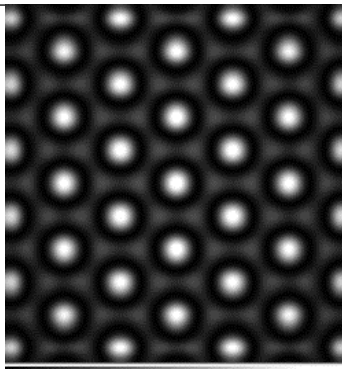

### Example

$N = 6, D = 60m, d = 2m$   
 150 diffraction peaks in the diluted pupil.  
 Field of view in the densified pupil is 3 Airy spot wide.

# Pupil Redilution

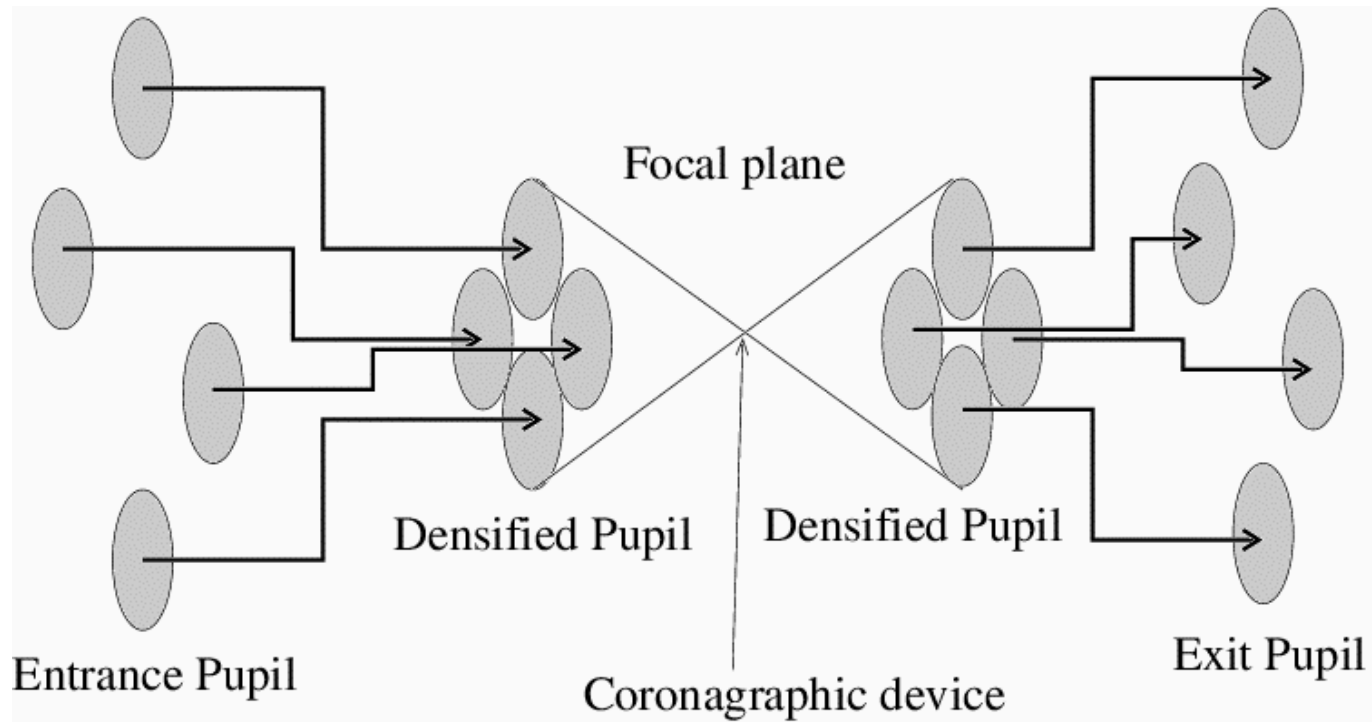

Pupil densification for the nulling coronagraph followed by pupil redilution allows a simple and efficient nulling as well as a large field of view.

# Apodized Square Aperture

# The Square Aperture

- Diffraction almost entirely perpendicular to the aperture edges - i.e., in only two directions.
- Diffraction in other directions suppressed.
- Square and other custom aperture shapes used or recommended by Hill and others for various astronomy or laboratory applications.

# Apodization

- A little used but classical optical technique.
- Employ a variable transmission aperture.
- Reduces the total light, and broadens the point spread function, but reduces the amplitude of the PSF outside the core.
- Apodize - from the Greek  $\alpha\pi\omicron\delta\iota$  - "no feet"

# Apodized Square Aperture

- Combines Hill's Square Aperture with Oliver's Apodization
- Apodize with Crossed Apodizing Functions
- Diffraction in Directions Around the Diagonals Down by More than  $10^9$
- This technique may be combined with or substitute for nulling and/or coronagraphy

# A square aperture with and without apodization

- Here is a square aperture with crossed Sonine apodization.
- Next to it is the two point image (100:1 contrast) with square aperture but no apodization.
- On the lower row, the 100:1 image with apodization and then  $10^6:1$  ratio with apodization.
- Apodization narrows the aperture and degrades the resolution, with a *significant* increase in dynamic range.

QuickTime™ and a  
GIF decompressor  
are needed to see this picture.



# Introduction of Random Phase Errors

- Consider the  $10^9:1$  contrast case with different amounts of random phase error added to the pupil over a 3000 Angstrom spectral band
- Even at  $1/60$  wave (at 1 micron wavelength) the "planet is still detectable.

QuickTime™ and a  
GIF decompressor  
are needed to see this picture.

# Circular Aperture with Apodization

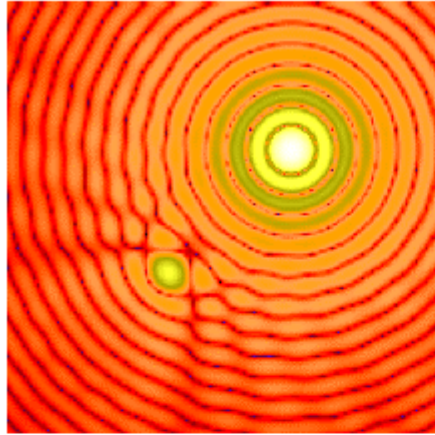

100:1 Star to Planet Ratio  
No Apodization

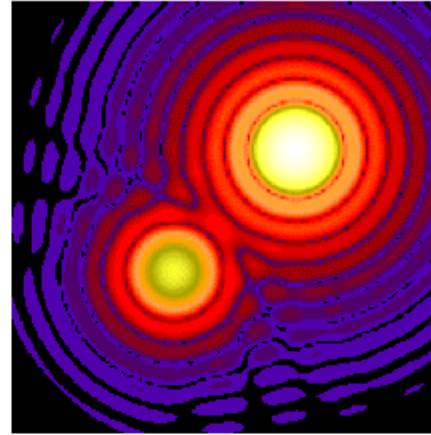

100:1 Star to Planet Ratio  
Sonine Apodization

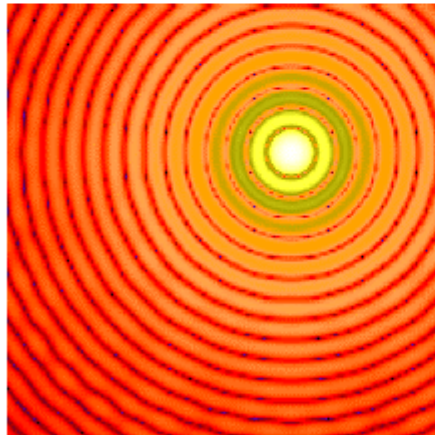

$10^9$ :1 Star to Planet Ratio  
No Apodization

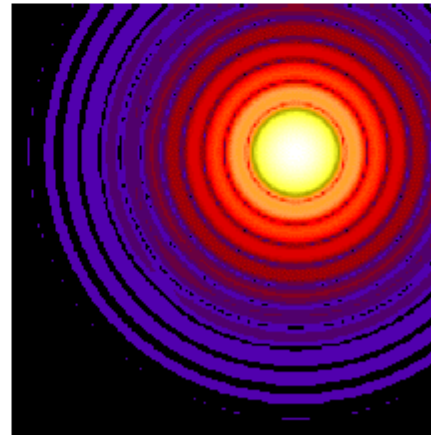

$10^9$ :1 Star to Planet Ratio  
Sonine Apodization

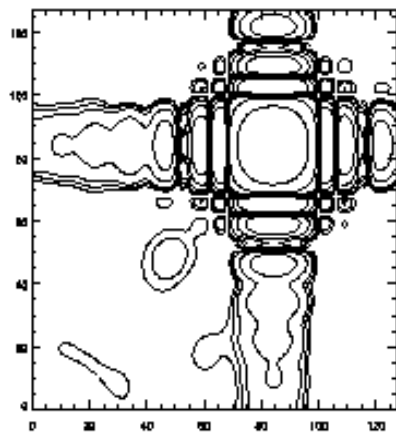

Sonine nu = 4, Transmission = 17.2%

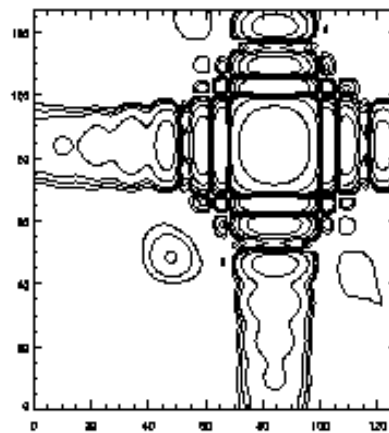

Sonine nu = 5, Transmission = 15.9%

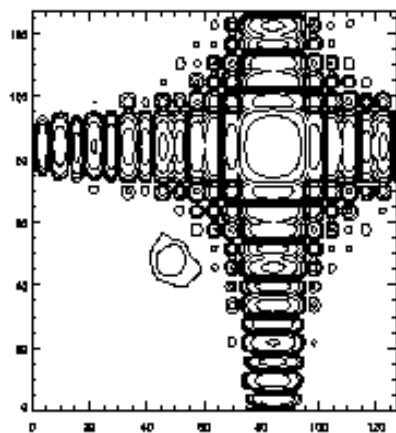

$\text{Cos}^2$ , Transmission = 19.4%

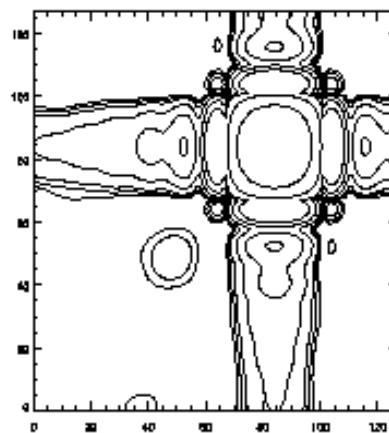

$\text{Cos}^4$ , Transmission = 14.6%

# Monochromatic Performance

- 1 - Circular Aperture no Apodization
- 2 - Square Aperture no Apodization
- 3 - Apodized Circular Aperture
- 4 - Apodized Square Aperture

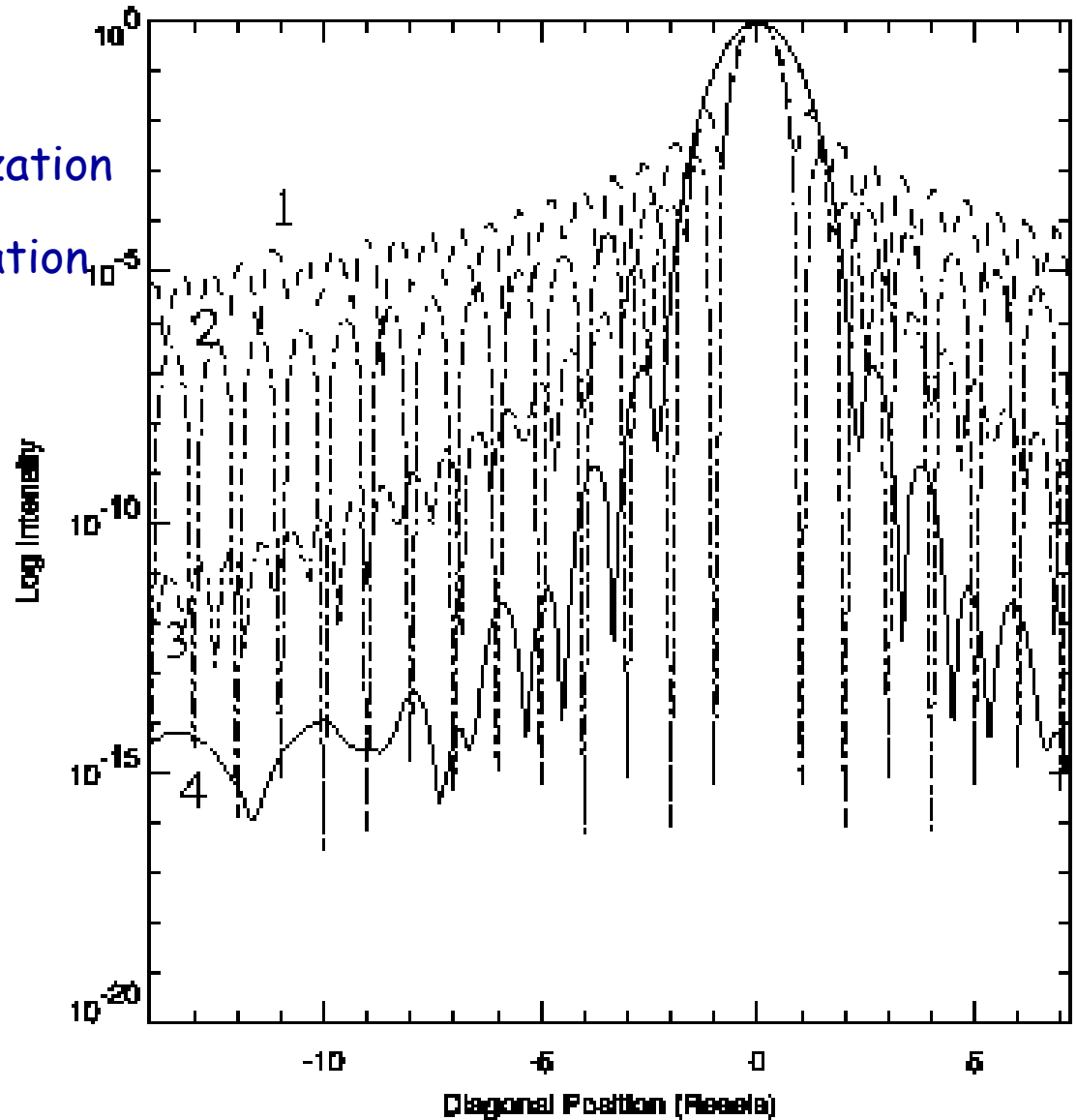

# Broadband Performance

- 1 - Circular Aperture no Apodization
- 2 - Square Aperture no Apodization
- 3 - Apodized Circular Aperture
- 4 - Apodized Square Aperture

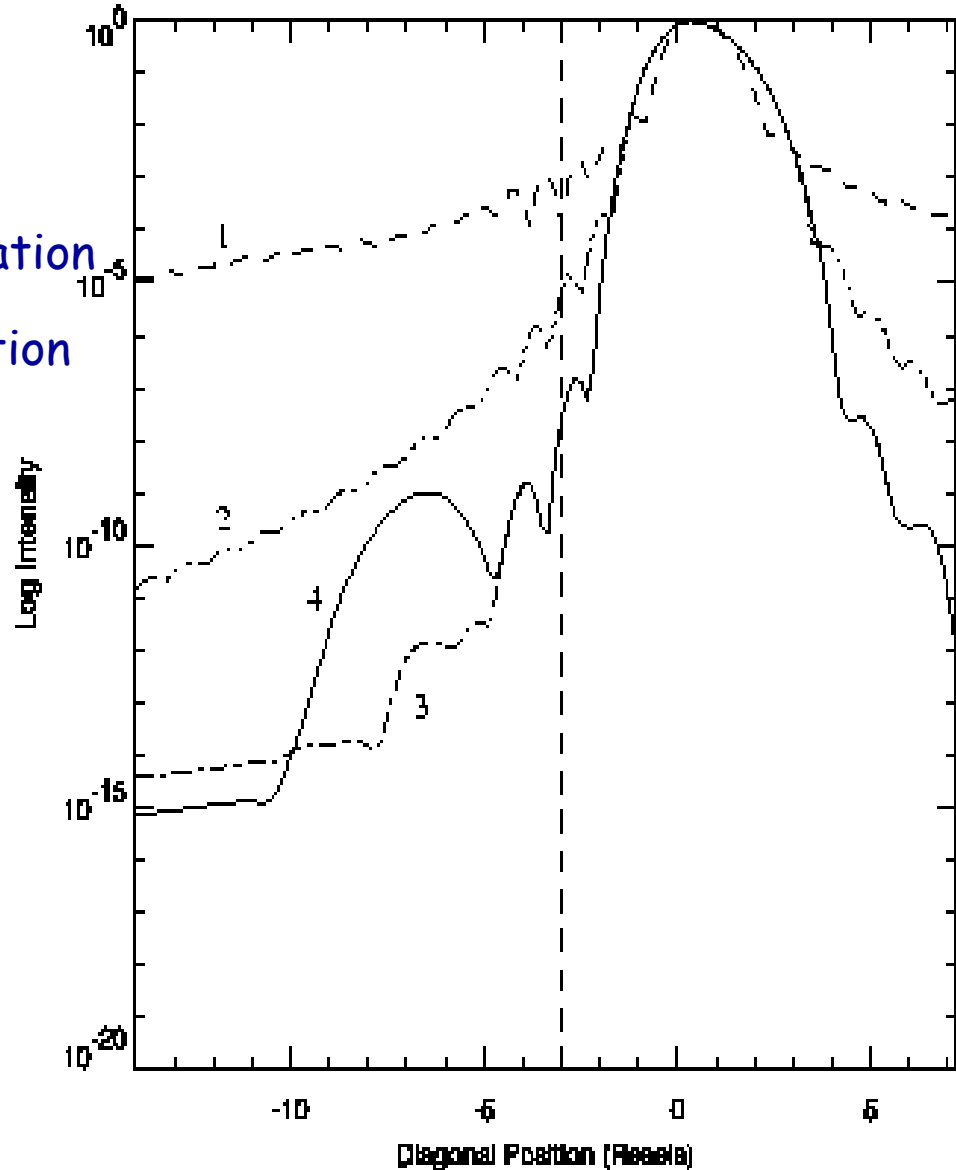

# Resolution

- Planet Must Be Resolved from Star by Several Airy ring radii.
- Smallest Dimension in Aperture Sets Widest Diffraction in PSF
- Rectangle, Cross or Separated Squares about same as Smallest Square
- Square Monolith Best - Edges in segments diffract and degrade DR

# Apodization Approaches

- Use Variable Reflective Coating on Primary
- Transmission Mask on Primary
- Reimage Primary and Use Transmission or Reflective Mask

# Experimental Tests

- Purchase Super-polished Spherical Mirrors
- Some Mirrors Coated, Some Uncoated
- Coat Uncoated Mirrors with Variable Reflective Coating
- Also Generate Apodizing Transmission Masks
- Test Dynamic Range with Pairs of Pt Sources



# Numerical Tests in Progress

- **Model High and Mid-Range Frequency Scattering**
- **Study Particulate Scattering**
- **Determine Possible Configurations**
- **Analyze Realistic Telescope Designs**
- **Determine Largest Practical Monolithic Aperture**
- **Study Clear vs Obscured Aperture**
- **Study the Effects of Segmentation for square and hexagonal segments.**

- May eliminate the need for nulling and/or a coronagraph
- Optically simple
  - *Few elements*
  - *Intrinsically achromatic*
- May work in the visible/near-IR part of the spectrum
  - Scientific advantages
  - Smaller, less costly missions

# Star Residual Suppression Using Imager Rotation

# Star residual suppression using interferometer rotation

- The PSF core will generally be surrounded by a quasi-static speckle-cloud structure
- Record multiple exposures at different telescope rotations.
- Rotate exposures to register the sky and compute the image median - this is the static PSF.
- Subtract stellar residual from each frame.
- Rotate and sum star-subtracted frames.
- Limited by - pointing and figure stability; photon noise.

# Star residual suppression using interferometer rotation

## *Coronagraphic nulling residuals*

- 1 Scattering by optics
- 2 Static phase and amplitude errors
- 3 Apparent diameter of the star
- 4 Chromaticity
- 5 Phase jitter

Residuals (1) to (4) are independent of the interferometer rotation.

Residuals (3) and (4) limit the nulling .

Thanks to the rotation of the imager, it is possible to separate the stellar light residual from the exoplanet light component.

*No need for a separate calibration star*

- "Perfect" calibration target
- No lost time for calibration
- Same spectra
- Same diameter
- Same brightness

# Star residual suppression using interferometer rotation

The detector is not rotating inside the interferometer : the sky orientation rotates on the detector as the interferometer rotates.

- The snapshot image of the star (disk) is constant.
- The image of the companion rotates around the optical axis.
- The residual light from the star can be obtained by a median of the snapshot images.
- This residual is subtracted in each individual frame before further processing
- The snapshots are then rotated to compensate for the rotation of the interferometer.

*This technique has already been successfully used to increase the S/N for detection of faint companions with ground-based imaging with adaptive optics.*

# Star Residual Suppression Using Interferometer Rotation

Detection of faint stellar companions with Hokupa'a on the Gemini North telescope (Alz-Az telescope).

Compensated images

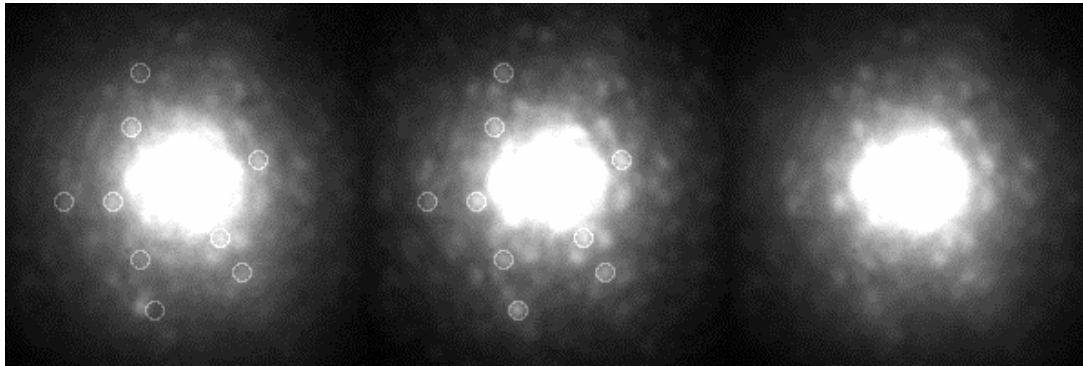

- 2 snapshots (left and middle) show a number of static speckles (circles). One of those speckles (lower circle) moves from frame to frame : this is the companion.
- A median of 13 frames (right) is the PSF used for subtraction.

- Left : uncompensated image (AO off)
- Middle : compensated image (AO on)
- Right : processed image using the technique described above.
- The previously unknown companion is 0.65" from the star and 5.8 mag fainter.

