

BSC

Design Calculation or Analysis Cover Sheet

1. QA: QA

2. Page 1 of 280
 259 D9
 3/11/08

Complete only applicable items.

3. System Monitored Geologic Repository	4. Document Identifier 000-PSA-MGR0-01100-000-00A
5. Title Seismic Event Sequence Quantification and Categorization Analysis	
8. Group Preclosure Safety Analyses	
7. Document Status Designation <input type="checkbox"/> Preliminary <input checked="" type="checkbox"/> Committed <input type="checkbox"/> Confirmed <input type="checkbox"/> Cancelled/Superseded	

B. Notes/Comments

Attachments	Total Number of Pages
Attachment A. Initial Handling Facility Analyses	113
Attachment B. Receipt Facility Analyses	193
Attachment C. Canister Receipt and Closure Facility Analyses	255
Attachment D. Wet Handling Facility Analyses	182
Attachment E. Intra-Site Operations and Balance of Plant Analyses	15
Attachment F. Subsurface Operations Analyses	29
Attachment G. Throughput Analyses	18 + CD
Attachment H. Passive Equipment Failure Analyses	25
Attachment I. Seismic Hazard Curve Analyses	5
Attachment J. SAPHIRE Model and Supporting Files	1 + CD

RECORD OF REVISIONS

9. No.	10. Reason For Revision	11. Total # of Pgs.	12. Last Pg. #	13. Originator (Print/Sign/Date)	14. Checker (Print/Sign/Date)	15. EGS (Print/Sign/Date)	16. Approved/Accepted (Print/Sign/Date)
	Initial Issue	1092 1095 D9 3/11/08	I-1	David Moore <i>[Signature]</i> Ernest Lindner	Robert Budnitz <i>[Signature]</i> See page 2	M. Frank <i>[Signature]</i> 3/11/08	M. Wisenbaur <i>[Signature]</i> 3/11/2008

Checker	Signature/Date	Section	Detailed Scope of Check
Robert Budnitz	See Page 1	Main body, Attachments A through F and Attachment H	
Nasser Dehkordi For Ajit Hiranadani	<i>Nasser Dehkordi</i> 3/11/08	Attachment I Hazard Curve	Checked compilation, given inputs and formula.
Shyang-Fenn (Alex) Deng	<i>SFF</i> 03/11/08	Attachment J	SAPHIRE output file
Jorge Monroe- Rammsy	<i>Jorge Monroe-Rammsy</i> 03.11.08	Attachment G Throughput Analyses	Checked input from engineering source.
Guy Rhoden	<i>Guy Rhoden</i> 3/11/08	DIRS Report	DIRS Report
Clarence Smith	<i>Clarence Smith</i> 3/11/08	Attachment G Throughput Analyses	Checked operations consistent/current.
DALET. DEKHEIMER	<i>DALET. DEKHEIMER</i> 3/11/08	EVENT CATEGORIZATION TABLES	SPECIFIC CHECK FOR CONSISTENCY WITH PREVIOUS CONSEQUENCE ANALYSES

DISCLAIMER

The calculations contained in this document were developed by Bechtel SAIC Company, LLC (BSC) and are intended solely for the use of BSC in its work for the Yucca Mountain Project.

CONTENTS

	Page
ACRONYMS AND ABBREVIATIONS	9
1. PURPOSE	12
2. REFERENCES	14
2.1 PROJECT PROCEDURES/DIRECTIVES	14
2.2 DESIGN INPUTS	14
2.3 DESIGN CONSTRAINTS	24
2.4 DESIGN OUTPUTS	24
3. ASSUMPTIONS	25
3.1 ASSUMPTIONS REQUIRING VERIFICATION	25
3.2 ASSUMPTIONS NOT REQUIRING VERIFICATION	25
4. METHODOLOGY	26
4.1 QUALITY ASSURANCE	26
4.2 USE OF SOFTWARE	27
4.3 APPROACH AND ANALYSIS METHODS	28
4.4 SPECIAL ISSUES	51
4.5 QUANTIFICATION OF SEISMIC EVENT SEQUENCES	61
4.6 EVENT SEQUENCE CATEGORIZATION, IDENTIFICATION OF ITS SSCS, DEVELOPMENT OF NUCLEAR SAFETY DESIGN BASIS, AND DEVELOPMENT OF PROCEDURAL SAFETY CONTROLS	70
5. LIST OF ATTACHMENTS	74
6. BODY OF ANALYSIS	75
6.1 SEISMIC HAZARD ANALYSIS RESULTS	76
6.2 SEISMIC FRAGILITY ANALYSIS RESULTS	84
6.3 THROUGHPUT, EXPOSURE TIME, AND PASSIVE EQUIPMENT FAILURE ANALYSIS FACTORS	116
6.4 INITIAL HANDLING FACILITY SEISMIC EVENT SEQUENCE ANALYSIS	123
6.5 SEISMIC EVENT SEQUENCE ANALYSIS FOR RECEIPT FACILITY	136
6.6 SEISMIC EVENT SEQUENCE ANALYSIS FOR CANISTER RECEIPT AND CLOSURE FACILITY	156
6.7 SEISMIC EVENT SEQUENCE ANALYSIS FOR WET HANDLING FACILITY (WHF)	187
6.8 SEISMIC EVENT SEQUENCE ANALYSIS FOR INTRA-SITE OPERATIONS	214
6.9 SEISMIC EVENT SEQUENCE ANALYSIS FOR SUBSURFACE OPERATIONS	222
6.10 IMPORTANT TO SAFETY STRUCTURES, SYSTEMS, AND COMPONENTS AND PROCEDURAL SAFETY CONTROL REQUIREMENTS	240
7. RESULTS AND CONCLUSIONS	255

FIGURES

	Page
4.3-1. Probabilistic Seismic Analysis and Event Sequence Categorization.....	30
4.3-2. Example Seismic Fragility Curve (Canister Transfer Machine Hoist in a CRCF).....	32
4.3-3. Typical Seismic Initiator Event Tree.....	37
4.3-4. Typical Seismic System Response Event Tree.....	39
4.3-5. Example WPHC Initiating Seismic Failure Fault Tree.....	42
4.3-6. Example WPHC Breach Seismic Fault Tree.....	43
4.3-7. Example of Residence Time Evaluation Using Excel Spreadsheets.....	45
4.3-8. Concept of Uncertainty in Load and Resistance.....	47
4.3-9. Point Estimate Load Approximation Used in PCSA.....	49
6.1-1. Comparison of the Horizontal Seismic Hazard Curves – Surface Facilities Area.....	78
6.1-2. Comparison of the Vertical Seismic Hazard Curves – Surface Facilities Area.....	79
6.1-3. Comparison of the Horizontal Seismic Hazard Curves – Subsurface Repository Block.....	80
6.1-4. Comparison of the Vertical Seismic Hazard Curves – Subsurface Repository Block.....	81
6.2-1. Example Seismic Fragility Curve (Canister Transfer Machine Hoist in a CRCF).....	84
6.2-2. Illustration of Horizontal Cask Tractor and Trailer.....	92
6.2-3. Example Jib Crane.....	95
6.2-4. Cask Transfer Trolley.....	96
6.2-5. IHF Cask Transfer Trolley.....	98
6.2-6. Canister Transfer Machine Elevation.....	101
6.2-7. Canister Transfer Machine Cross Section.....	102
6.2-8. CRCF Canister Staging Rack.....	104
6.2-9. Spent Fuel Transfer Machine.....	105
6.2-10. Waste Package Transfer Trolley.....	107
6.2-11. Transport and Emplacement Vehicle.....	109
6.2-12. Conceptual Design of TEV Seismic Restraint.....	111
6.2-13. Site Transporter.....	112
6.2-14. Vertical DPC Aging Overpack Isometric View.....	114
6.4-1. IHF Naval Canister Initiator Event Tree.....	125
6.4-2. Seismic Transfer Event Tree IHF-S-R-TC1.....	126
6.4-3. IHF HLW Canister Initiator Event Tree.....	131
6.5-1. RF TAD Canister Initiator Event Tree.....	138
6.5-2. Seismic Transfer Event Tree RF-S-R-TC1.....	139

FIGURES (Continued)

	Page
6.5-3. RF DPC Vertical Initiator Event Tree	144
6.5-4. RF DPC Horizontal Initiator Event Tree (HTC process).....	148
6.5-5. RF DPC Tilting Frame Initiator Event Tree	151
6.6-1. CRCF TAD to AO Initiator Event Tree.....	158
6.6-2. Seismic Transfer Event Tree CRCF-S-R-TC1	159
6.6-3. CRCF DPC to AO Initiator Event Tree	165
6.6-4. CRCF TAD to WP Initiator Event Tree (TWP)	169
6.6-5. CRCF DOE SNF to WP Initiator Event Tree	173
6.6-6. CRCF HLW to WP Initiator Event Tree.....	177
6.6-7. CRCF MCO to WP Initiator Event Tree.....	181
6.7-1. WHF DPC Initiator Event Tree	189
6.7-2. Seismic Transfer Event Tree WHF-S-R-TC1	192
6.7-3. WHF Truck Cask with Bare SNF Initiator Event Tree.....	198
6.7-4. WHF SNF Transfer Initiator Event Tree	203
6.7-5. WHF SNF Transfer in Pool SRET.....	204
6.7-6. WHF TAD Initiator Event Tree.....	208
6.8-1. Intra-Site Operations Initiator Event Tree	216
6.9-1. SSO Initiator Event Tree.....	224
6.9-2. Seismic Hazard Curve – Repository Block	231
6.9-3. Representation of Level 80% Burial for 2E-06 APE Rockfall (6.25 m ³ /m).....	233
6.9-4. Possible Profile for 2E-06 APE Rockfall (6.25 m ³ /m)	233

TABLES

	Page
4.1-1. Use of Non-Q References	27
6.1-1. Accelerations for Representative Mean Annual Probability of Exceedances – Surface Facilities Area (2007 Data).....	79
6.1-2. Accelerations for Representative Mean Annual Probability of Exceedances – Subsurface Repository Block (2007 Data)	81
6.1-3. Acceleration Interval Midpoints and Interval Frequency – Surface Facilities Area (2007 data)	82
6.1-4. Acceleration Interval Midpoints and Interval Frequency – Subsurface Repository Block (2007 data).....	82
6.1-5. MAPE For Earthquakes Not Included in Quantification (2007 data).....	83
6.2-1. Fragilities for Structures	85
6.2-2. Equipment Fragilities and Basis	87
6.3-1. Number of Waste Containers Processed in Each Facility	117
6.3-2. Standard PEFAs Used For the Seismic Analysis.....	121
6.4-1. Exposure Time Factors for Waste Handling Operations in the IHF.....	127
6.4-2. IHF Naval Canister Seismic Event Sequences	129
6.4-3. IHF HLW Canister Seismic Event Sequences.....	133
6.4-4. IHF Seismic Event Sequence Categorization	135
6.5-1. Exposure Time Factors for Waste Handling Operations in the RF	140
6.5-2. RF TAD Canister Seismic Event Sequences	142
6.5-3. RF DPC Vertical Seismic Event Sequences	146
6.5-4. RF DPC Horizontal Seismic Event Sequence	149
6.5-5. RF DPC Tilting Frame Seismic Event Sequences.....	153
6.5-6. RF Seismic Event Sequence Categorization.....	155
6.6-1. Exposure Time Factors for Waste Handling Operations in the CRCF	161
6.6-2. CRCF TAD to AO Seismic Event Sequences	164
6.6-3. CRCF DPC to AO Seismic Event Sequences.....	167
6.6-4. CRCF TAD to WP Seismic Event Sequences.....	171
6.6-5. CRCF DOE SNF to WP Seismic Event Sequences.....	175
6.6-6. CRCF HLW to WP Seismic Event Sequences	179
6.6-7. CRCF MCO to WP Seismic Event Sequences	183
6.6-8. CRCF Seismic Event Sequence Categorization	184
6.7-1. Exposure Time Factors for Waste Handling Operations in the WHF	193
6.7-2. WHF DPC Seismic Event Sequences	196

TABLES (Continued)

	Page
6.7-3. WHF Bare SNF Seismic Event Sequences.....	200
6.7-4. WHF SNF Transfer and Continuous Exposure Seismic Event Sequences.....	206
6.7-5. WHF TAD Seismic Event Sequences.....	210
6.7-6. WHF Seismic Event Sequence Categorization.....	212
6.8-1. Exposure Factors for ISO Waste Handling Activities.....	217
6.8-2. ISO Waste Handling Activities Event Sequences.....	219
6.8-3. ISO Seismic Event Sequence Categorization.....	221
6.9-1. Exposure Time Factors for Waste Handling Operations in the SSO.....	225
6.9-2. SSO Seismic Event Sequences.....	226
6.9-3. Summary of Temperature Results for Waste Package Burial.....	235
6.9-4. SSO Seismic Event Sequence Categorization.....	239
6.10-1. Preclosure Nuclear Safety Design Bases for Seismic Event Sequences for the Initial Handling Facility.....	242
6.10-2. Preclosure Nuclear Safety Design Bases for Seismic Event Sequences for the Receipt Facility.....	244
6.10-3. Preclosure Nuclear Safety Design Bases for Seismic Event Sequences for the Canister Receipt and Closure Facility.....	246
6.10-4. Preclosure Nuclear Safety Design Bases for Seismic Event Sequences for the Wet Handling Facility.....	249
6.10-5. Preclosure Nuclear Safety Design Bases for Seismic Event Sequences for Intra- Site and Balance of Plant Operations.....	252
6.10-6. Preclosure Nuclear Safety Design Bases for Seismic Event Sequences for Subsurface Operations.....	253
6.10-7. Summary of Procedural Safety Controls for Seismic Event Sequences.....	254
7-1. Key to Results.....	259

ACRONYMS AND ABBREVIATIONS

Acronyms

AHU	air handling unit
APC	auxiliary pool crane
APE	annual probability of exceedance
ASME	American Society of Mechanical Engineers
BWR	boiling water reactor
CDF	cumulative distribution function
CDFM	conservative deterministic failure margins
CHC	cask handling crane
CIP	cast-in-place
COV	coefficient of variation
CPP	cask preparation platform
CRCF	Canister Receipt and Closure Facility
CTM	canister transfer machine
CTM MC	canister transfer machine maintenance crane
CTT	cask transfer trolley
DBGM	design basis ground motion
DOE	U.S. Department of Energy
DPC	dual-purpose canister
DSNF	DOE spent nuclear fuel
EPRI	Electric Power Research Institute
EPS	equivalent (effective) plastic strain
ESD	event sequence diagram
ETF	exposure time factor
FEA	finite element analysis
GROA	geologic repository operations area
HAM	horizontal aging module
HCLPF	high confidence of low probability of failure
HEPA	high efficiency particulate air filter
HLW	high-level radioactive waste
HTC	horizontal transportation cask
HVAC	heating, ventilation, and air conditioning
IET	initiator event tree
IHF	Initial Handling Facility
INL	Idaho National Laboratory
ITC	important to criticality
ITS	important to safety

ACRONYMS AND ABBREVIATIONS (Continued)

LLNL	Lawrence Livermore National Laboratory
LLW	low-level radioactive waste
LOOP	loss of offsite power
MAP	mobile access platform
MAPE	mean annual probability of exceedance
MCO	multicanister overpack
MLD	master logic diagram
MPC	multipurpose canister
NRC	U.S. Nuclear Regulatory Commission
OCB	outer corrosion barrier
PCSA	preclosure safety analysis
PDF	probability density function
PEFA	passive equipment failure analysis
PGA	peak ground acceleration
PGV	peak ground velocity
PRA	probabilistic risk assessment
PSC	procedural safety control
PSHA	probabilistic seismic hazard assessment
PWR	pressurized water reactor
RF	Receipt Facility
RHS	remote handling system
SFTM	spent fuel transfer machine
SNF	spent nuclear fuel
SRET	system response event tree
SSC	structure, system, or component
SSCs	structures, systems, and components
STC	shielded transfer cask
TAD	transportation, aging, and disposal
TEV	transport and emplacement vehicle
TTC	transportation cask tilted on tilting frame
VTC	vertical transportation cask
WBS	work breakdown system
WHF	Wet Handling Facility
WPHC	waste package handling crane
WPTT	waste package transfer trolley
YMP	Yucca Mountain Project

ACRONYMS AND ABBREVIATIONS (Continued)**Abbreviations**

ft	foot, feet
ft/s	feet per second
hr, hrs	hour, hours
J	joule
m	meter
min	minute, minutes
MPa	Megapascals, 10^6 Pascals
mph	miles per hour
Pa	Pascal
s	second
yr, yrs	year, years

1. PURPOSE

An event sequence is defined in 10 CFR 63.2: Energy: Disposal of High-Level Radioactive Waste in Geologic Repository at Yucca Mountain, Nevada (Ref. 2.3.1) as:

“...a series of actions and/or occurrences within the natural and engineered components of a geologic repository operations area that could potentially lead to exposure of individuals to radiation. An event sequence includes one or more initiating events and associated combinations of repository system component failures, including those produced by the action or inaction of operating personnel. Those event sequences that are expected to occur one or more times before permanent closure of the geologic repository operations area are referred to as Category 1 event sequences. Other event sequences that have at least one chance in 10,000 of occurring before permanent closure are referred to as Category 2 event sequences.”

As an extrapolation of the definition of Category 2 event sequences, sequences that have less than one chance in 10,000 of occurring before permanent closure are identified as *beyond Category 2*.

The scope of this analysis is focused on seismic events that impact structures and/or equipment within the geologic repository operations area (GROA), including the Canister Receipt and Closure Facility (CRCF), Receipt Facility (RF), Initial Handling Facility (IHF), Wet Handling Facility (WHF), Intra-Site Operations (ISO), and Subsurface Operations (SSO). This analysis is one of several that comprise the preclosure safety analysis (PCSA) for the GROA. The other analyses evaluate internal initiating events, and the screening of other external events, while this specific analysis provides a comprehensive identification of the impacts that can be induced by ground motions at the repository. The internal initiating event analyses were used as a basis for the development of the seismic event sequence models. Those analyses provide detail on:

- Facility location, layout, and equipment
- Facility operations and processes
- Identification of potential internal initiating events (using master logic diagrams (MLDs) and hazard and operability (HAZOP) evaluations)
- Development of internal event sequence diagrams (ESDs) and corresponding event trees
- Fault trees for system/pivotal event analysis
- Analysis of active and passive equipment failures, and human reliability
- Quantification of internal event sequences.

This detailed information is documented in the event sequence development analysis for each facility (e.g., Ref. 2.2.27), and the reliability and event sequence categorization analysis for each facility (e.g., Ref. 2.2.59), and is not repeated in this seismic analysis document.

In a similar manner to the internal initiating event analyses, this seismic analysis uses event trees to delineate the potential event sequences, and fault trees are used to analyze the failure modes for the event tree pivotal events. The event sequences are developed for each facility, and for each waste container processed in the facility. The seismic event trees are then quantified to obtain the mean frequency of each event sequence for the purpose of categorization. Since the likelihood of a seismic induced failure is dependent on the magnitude of the ground motion, and multiple failures can be induced by a seismic event, a special SAPHIRE algorithm is used for the seismic event sequence quantification (Ref. 2.2.104).

Once quantified, each seismic event sequence is categorized as Category 1, Category 2, or beyond Category 2, based on its mean probability of occurrence over the preclosure period. The analysis also includes:

- Material at risk for each Category 1 and 2 seismic event sequence for purposes of dose calculations
- Important to safety (ITS) structures, systems, and components (SSCs)
- Procedural safety controls (PSCs) required for operations
- Compliance with the nuclear safety design bases.

Other PCSA documents cover categorization of internal events, screening of other external events, summarization of procedural safety controls, and summarization of nuclear safety design bases.

2. REFERENCES

2.1 PROJECT PROCEDURES/DIRECTIVES

- 2.1.1 EG-PRO-3DP-G04B-00037, REV 10. *Calculations and Analyses*. Las Vegas, Nevada: Bechtel SAIC Company. ACC: ENG.20071018.0001.
- 2.1.2 EG-PRO-3DP-G04B-00046, REV 10. *Engineering Drawings*. Las Vegas, Nevada. Bechtel SAIC Company. ACC: ENG.20080115.0014.
- 2.1.3 LS-PRO-0201, REV 5. *Preclosure Safety Analysis Process*. Las Vegas, Nevada: Bechtel SAIC Company. ACC: ENG.20071010.0021.
- 2.1.4 IT-PRO-0011, REV 7. *Software Management*. Las Vegas, Nevada: Bechtel SAIC Company. ACC: DOC.20070905.0007.

2.2 DESIGN INPUTS

The PCSA is a safety analysis based on a snapshot of the design. The reference design documents are appropriately documented as design input in this section. Since the safety analysis is based on a snapshot of the design, referencing subsequent revisions to the design documents (as described in EG-PRO-3DP-G04B-00037, *Calculations and Analyses* (Ref. 2.1.1, Section 3.2.2.F)) that implement PCSA requirements flowing from the safety analysis would not be appropriate for the purpose of the PCSA.

Some of the design inputs to this analysis are from output designated QA: N/A. Documentation that these sources are suitable for their intended uses is provided in Section 4.1. Also note that some of the tables and figures in this analysis use the term “Source: Original.” This indicates that the data and information has been generated directly in this analysis, and is not from another source, such as the references below. This is particularly true for the fault trees and event trees that were developed as part of this analysis, and are displayed in the analysis and attachments.

- 2.2.1 ANSI/ANS-58.21-2007. 2007. *American National Standard, External-Events PRA Methodology*. La Grange Park, Illinois: American Nuclear Society. TIC: 259266.
- 2.2.2 ASCE 7-98. 2000. *Minimum Design Loads for Buildings and Other Structures*. Revision of ANSI/ASCE 7-95. Reston, Virginia: American Society of Civil Engineers. TIC: 247427. ISBN: 0784404453.
- 2.2.3 ASCE/SEI 43-05. 2005. *Seismic Design Criteria for Structures, Systems, and Components in Nuclear Facilities*. Reston, Virginia: American Society of Civil Engineers. TIC: 257275. ISBN: 0784407622.
- 2.2.4 ASCE/SEI 7-05. 2006. *Minimum Design Loads for Buildings and Other Structures*. Including Supplement No. 1. Reston, Virginia: American Society of Civil Engineers. TIC: 258057. ISBN: 0-7844-0809-2.

- 2.2.5 ASM 1976. *Source Book on Stainless Steels*. Metals Park, Ohio: American Society for Metals. TIC: 259927.
- 2.2.6 ASME (American Society of Mechanical Engineers) 2004. *2004 ASME Boiler and Pressure Vessel Code*. 2004 Edition. New York, New York: American Society of Mechanical Engineers. TIC: 256479. ISBN: 0-7918-2899-9.
- 2.2.7 ASME 2005. "General Requirements for Division 1 and Division 2." Section III, Subsection NCA of *2004 ASME Boiler and Pressure Vessel Code (includes 2005 Addenda)*. New York, New York: American Society of Mechanical Engineers. TIC: 256479. ISBN: 0-7918-2899-9.
- 2.2.8 ASME NOG-1-2004. 2005. Rules for Construction of Overhead and Gantry Cranes (Top Running Bridge, Multiple Girders). New York, New York: American Society of Mechanical Engineers. TIC: 257672. ISBN: 0-7918-2939-1.
- 2.2.9 ASME RA-Sb-2005. *Addenda to ASME RA-S-2002, Standard for Probabilistic Risk Assessment for Nuclear Power Plant Applications*. New York, New York: American Society of Mechanical Engineers. TIC: 258909.
- 2.2.10 BSC (Bechtel SAIC Company) 2004. *5 DHLW/DOE SNF - Short Waste Package Drop with Emplacement Pallet*. 000-00C-DS00-00300-000-00A. Las Vegas, Nevada: Bechtel SAIC Company. ACC: ENG.20040217.0001.
- 2.2.11 BSC 2004. Development of Earthquake Ground Motion Input for Preclosure Seismic Design and Postclosure Performance Assessment of a Geologic Repository at Yucca Mountain. NV. MDL-MGR-GS-000003 REV 01. Las Vegas, Nevada: Bechtel SAIC Company. ACC: DOC.20041111.0006; DOC.20051130.0003. (DIRS 170027)
- 2.2.12 BSC 2004. *Drift Degradation Analysis*. ANL-EBS-MD-000027 REV 03. Las Vegas, Nevada: Bechtel SAIC Company. ACC: DOC.20040915.0010; DOC.20050419.0001; DOC.20051130.0002; DOC.20060731.0005. (DIRS 166107)
- 2.2.13 BSC 2004. *Waste Form, Heat Output, and Waste Package Spacing for an Idealized Drift Segment*. 000-00C-WIS0-00500-000-00A. Las Vegas, Nevada: Bechtel SAIC Company. ACC: ENG.20040121.0007; ENG.20050817.0031; ENG.20051019.0002.
- 2.2.14 BSC 2005. *Peak Ground Velocities for Seismic Events at Yucca Mountain, Nevada*. ANL-MGR-GS-000004 REV 00. Las Vegas, Nevada: Bechtel SAIC Company. ACC: DOC.20050223.0002; DOC.20050725.0002; DOC.20061002.0010 PCN 002. (DIRS: 170137)
- 2.2.15 BSC 2007. *5-DHLW/DOE SNF - Short Co-Disposal Waste Package Configuration*. 000-MW0-DS00-00103-000 REV 00C. Las Vegas, Nevada: Bechtel SAIC Company. ACC: ENG.20070719.0004.

- 2.2.16 BSC 2007. *Wet Handling Facility Spent Fuel Transfer Machine Mechanical Equipment Envelope*. 050-M90-HT00-00101-000 REV 00A. Las Vegas, Nevada: Bechtel SAIC Company. ACC: ENG.20061120.0016; ENG.20070207.0001; ENG.20070823.0003.
- 2.2.17 BSC 2007. *Aging Facility (AP) Foundation Design*. 170-DBC-AP00-00100-000-00A. Las Vegas, Nevada: Bechtel SAIC Company. ACC: ENG.20071031.0008.
- 2.2.18 BSC 2007. *Aging Facility Cask Transfer Trailers Mechanical Equipment Envelope*. 170-MJ0-HAT0-00201-000 REV 00A. Las Vegas, Nevada: Bechtel SAIC Company. ACC: ENG.20070518.0002.
- 2.2.19 BSC 2007. *Aging Facility General Arrangement Aging Pad 17R Plan*. 170-P10-AP00-00103-000 REVS 00C. Las Vegas, Nevada: Bechtel SAIC Company. ACC: ENG.20071126.0020.
- 2.2.20 BSC 2007. *Aging Facility General Arrangement Aging Pad Area Plan*. 170-P10-AP00-00101-000 REV 00C. Las Vegas, Nevada: Bechtel SAIC Company. ACC: ENG.20071126.0018.
- 2.2.21 BSC 2007. *Aging Facility General Arrangement Aging Pad Sections*. 170-P10-AP00-00104-000 REV 00B. Las Vegas, Nevada: Bechtel SAIC Company. ACC: ENG.20071126.0021.
- 2.2.22 BSC 2007. *Aging Facility Mechanical Handling System Block Flow Diagram-Level 3 Sheet 4*. 170-MH0-H000-00204-000 REV 00B. Las Vegas, Nevada: Bechtel SAIC Company. ACC: ENG.20071126.0024.
- 2.2.23 BSC 2007. *Aging Facility Vertical DPC Aging Overpack Mechanical Equipment Envelope Sheet 1 of 2*. 170-MJ0-HAC0-00201-000 REV 00B. Las Vegas, Nevada: Bechtel SAIC Company. ACC: ENG.20070928.0032.
- 2.2.24 BSC 2008. *Basis of Design for the TAD Canister-Based Repository Design Concept*. 000-3DR-MGR0-00300-000-002. Las Vegas, Nevada: Bechtel SAIC Company. ACC: ENG.20080229.0007.
- 2.2.25 BSC 2008. *Bounding Rockfall in Subsurface Turnout*. 800-00A-SS00-00100-000-00A. Las Vegas, Nevada: Bechtel SAIC Company. ACC: ENG.20080212.0001.
- 2.2.26 BSC 2007. *Canister Receipt and Closure Facility (CRCF) Seismic Fragility Evaluation*. 060-SYC-CR00-01100-000-00A. Las Vegas, Nevada: Bechtel SAIC Company. ACC: ENG.20071114.0001.
- 2.2.27 BSC 2008. *Canister Receipt and Closure Facility Event Sequence Development Analysis*. 060-PSA-CR00-00100-000-00A. Las Vegas, Nevada: Bechtel SAIC Company. ACC: ENG.20080221.0008.

- 2.2.28 BSC 2007. *CRCF-1 and IHF WP Transfer Trolley Mechanical Equipment Envelope Plan & Elevations–Sh 1 of 2*. 000-MJ0-HL00-00101-000 REV 00B. Las Vegas, Nevada: Bechtel SAIC Company. ACC: ENG.20061108.0002; ENG.20070517.0011; ENG.20071027.0015.
- 2.2.29 BSC 2007. *Drift Collapse Weight and Thermal Loading of TAD and 5-DHLW/DOE SNF Short Co-Disposal Waste Packages*. 000-00C-MGR0-04400-000-00A. Las Vegas, Nevada: Bechtel SAIC Company. ACC: ENG.20071030.0041.
- 2.2.30 BSC 2007. *Emplacement and Retrieval Drip Shield Emplacement Gantry Mechanical Equipment Envelope*. 800-MJ0-HE00-00201-000 REV 00B. Las Vegas, Nevada: Bechtel SAIC Company. ACC: ENG.20071026.0031.
- 2.2.31 BSC 2007. *Ground Control for Non-Emplacement Drifts for LA*. 800-K0C-SSD0-00400-000-00A. Las Vegas, Nevada: Bechtel SAIC Company. ACC: ENG.20071001.0042.
- 2.2.32 BSC 2007. *IHF BDBGM - Fragility Analysis for the Concrete Structures*. 51A-SYC-IH00-01000-000-00A. Las Vegas, Nevada: Bechtel SAIC Company. ACC: ENG.20071211.0001.
- 2.2.33 BSC 2007. *Initial Handling Facility (IHF): Seismic Steel Fragility Evaluation*. 51A-SYC-IH00-00800-000-00A. Las Vegas, Nevada: Bechtel SAIC Company. ACC: ENG.20071201.0009.
- 2.2.34 BSC 2007. *Leak Path Factors for Radionuclide Releases from Breached Confinement Barriers and Confinement Areas*. 000-00C-MGR0-01500-000-00A. Las Vegas, Nevada: Bechtel SAIC Company. ACC: ENG.20071018.0002.
- 2.2.35 BSC 2007. *Mechanical Handling Design Report - Site Transporter*. 170-30R-HAT0-00100-000-000. Las Vegas, Nevada: Bechtel SAIC Company. ACC: ENG.20071217.0015.
- 2.2.36 BSC 2007. *Mechanical Handling Design Report: Waste Package Transport and Emplacement Vehicle*. 000-30R-HE00-00200-000 REV 001. Las Vegas, Nevada: Bechtel SAIC Company. ACC: ENG.20071205.0002.
- 2.2.37 BSC 2007. *Naval Long Oblique Impact Inside TEV*. 000-00C-DNF0-01200-000-00A. Las Vegas, Nevada: Bechtel SAIC Company. ACC: ENG.20070806.0016; ENG.20071024.0004.
- 2.2.38 BSC 2007. *Naval Long Waste Package Vertical Impact on Emplacement Pallet and Invert*. 000-00C-DNF0-00100-000-00C. Las Vegas, Nevada: Bechtel SAIC Company. ACC: ENG.20071017.0001; ENG.20071116.0011.
- 2.2.39 BSC 2007. *Portals Design Layout and General Arrangement*. 800-KMR-SS00-00200-000 REV 00A. Las Vegas, Nevada: Bechtel SAIC Company. ACC: ENG.20070731.0041.

- 2.2.40 BSC 2007. *Prediction of Rockfalls in Nonemplacement Drifts Due to Preclosure Seismic Ground Motions*. 800-K0C-SSD0-00200-000-00B. Las Vegas, Nevada: Bechtel SAIC Company. ACC: ENG.20070625.0043.
- 2.2.41 BSC 2007. *Preliminary Throughput Study for the Canister Receipt and Closure Facility*. 060-30R-CR00-00100-000-001. Las Vegas, Nevada: Bechtel SAIC Company. ACC: ENG.20071101.0001.
- 2.2.42 BSC 2007. *Preliminary Throughput Study for the Initial Handling Facility*. 51A-30R-IH00-00100-000-001. Las Vegas, Nevada: Bechtel SAIC Company. ACC: ENG.20071102.0021.
- 2.2.43 BSC 2007. *Preliminary Throughput Study for the Receipt Facility*. 200-30R-RF00-00300-000-002. Las Vegas, Nevada: Bechtel SAIC Company. ACC: ENG.20071227.0021.
- 2.2.44 BSC 2007. *Preliminary Wet Handling Facility Throughput Study*. 050-30R-MGR0-00300-000-003. Las Vegas, Nevada: Bechtel SAIC Company. ACC: ENG.20071102.0019.
- 2.2.45 BSC 2007. *Probabilistic Characterization of Preclosure Rockfalls in Emplacement Drifts*. 800-00C-MGR0-00300-000-00A. Las Vegas, Nevada: Bechtel SAIC Company. ACC: ENG.20070329.0009.
- 2.2.46 BSC 2007. *Repository Subsurface Transport and Emplacement Vehicle (TEV) Routes Details*. 800-KM0-SS00-00402-000 REV 00A. Las Vegas, Nevada: Bechtel SAIC Company. ACC: ENG.20070830.0042.
- 2.2.47 BSC 2007. *Seismic Analysis and Design Approach Document*. 000-30R-MGR0-02000-000-001. Las Vegas, Nevada: Bechtel SAIC Company. ACC: ENG.20071220.0029.
- 2.2.48 BSC 2006. *Stability of Aging Casks and Cask Anchorage Design*. 170-SYC-HAP0-00200-000-00A. Las Vegas, Nevada: Bechtel SAIC Company. ACC: ENG.20061115.0004.
- 2.2.49 BSC 2007. *Subsurface - Underground Layout Configuration for LA General Arrangement*. 800-KM0-SS00-00301-000 REV 00B. Las Vegas, Nevada: Bechtel SAIC Company. ACC: ENG.20070830.0036.
- 2.2.50 BSC 2007. *Utilities Facility Deionized Water System Supply Piping & Instrument Diagram* 25A-M60-PSD0-00201-000-00C. ACC: ENG.20071015.0010.
- 2.2.51 BSC 2007. *Waste Form Throughputs for Preclosure Safety Analysis*. 000-PSA-MGR0-01800-000-00A. Las Vegas, Nevada: Bechtel SAIC Company. ACC: ENG.20071106.0001.

- 2.2.52 BSC 2007. *Waste Package Capability Analysis for Nonlithophysal Rock Impacts*. 000-00C-MGR0-04500-000-00A. Las Vegas, Nevada: Bechtel SAIC Company. ACC: ENG.20071113.0017.
- 2.2.53 BSC 2007. *Waste Package Retrieval Mechanical Handling System Block Flow Diagram Level 3*. 800-MH0-HER0-00201-000 REV 00C. Las Vegas, Nevada: Bechtel SAIC Company. ACC: ENG.20070830.0035.
- 2.2.54 BSC 2007. *Wet Handling Facility (WHF) Seismic Fragility Evaluation*. 050-SYC-WH00-01100-000-00A. Las Vegas, Nevada: Bechtel SAIC Company. ACC: ENG.20071201.0007.
- 2.2.55 BSC 2007. *Wet Handling Facility Fire Protection Double-Interlock Preaction Piping & Instrumentation Diagram*. 050-M60-FPS0-00301-000-00A. ACC: ENG.20070829.0001.
- 2.2.56 BSC 2007. *Wet Handling Facility Jib Cranes Mechanical Equipment Envelope*. 050-MJ0-H000-00801-000-00B. Las Vegas, Nevada: Bechtel SAIC Company. ACC: ENG.20070921.0005.
- 2.2.57 BSC 2007. *Yucca Mountain Repository Concept of Operations*. 000-30R-MGR0-03000-000 REV 001. Las Vegas, Nevada: Bechtel SAIC Company. ACC: ENG.20071130.0016.
- 2.2.58 BSC 2008. *CRCF 1 DOE Canister Staging Rack Mechanical Equipment Envelope*. 060-MJ0-HTC0-00601-000-00B. Las Vegas, Nevada: Bechtel SAIC Company. ACC: ENG.20080128.0003.
- 2.2.59 BSC 2008. *CRCF Facility Reliability and Event Sequence Categorization Analysis*. 060-PSA-CR00-00200-000-00A. Las Vegas, Nevada: Bechtel SAIC Company. ACC: ENG.20080311.0031.
- 2.2.60 BSC 2008. *Development of Equipment Seismic Fragilities at Yucca Mountain Surface Facilities*. 000-PSA-MGR0-02200-000-00A. Las Vegas, Nevada: Bechtel SAIC Company. ACC: ENG.20080310.0001.
- 2.2.61 BSC 2008. *Evaluation of an Event Sequence for Waste Package Burial*. 800-K0C-WIS0-00600-000-00A. Las Vegas, Nevada: Bechtel SAIC Company. ACC: ENG.20080221.0021.
- 2.2.62 BSC 2008. *External Events Hazards Screening Analysis*. 000-00C-MGR0-00500-000-00C. Las Vegas, Nevada: Bechtel SAIC Company. ACC: ENG.20080219.0001.
- 2.2.63 BSC 2008. *Geologic Repository Operations Area North Portal Site Plan*. 100-C00-MGR0-00501-000 REV 00F. Las Vegas, Nevada: Bechtel SAIC Company. ACC: ENG.20080125.0007.

- 2.2.64 BSC 2008. *Geologic Repository Operations Area Aging Pad Site Plan*. 170-C00-AP00-00101-000 REV 00C. Las Vegas, Nevada: Bechtel SAIC Company. ACC: ENG.20080129.0005.
- 2.2.65 BSC 2008. *Industrial/Military Activity-Initiated Accident Screening Analysis*. 000-PSA-MGR0-01500-000-00A. Las Vegas, Nevada: Bechtel SAIC Company. ACC: ENG.20080204.0006.
- 2.2.66 BSC 2008. *IED Seismic and Seismic Consequence Data*. 800-IED-MGR0-00701-000 REV 00B. Las Vegas, Nevada: Bechtel SAIC Company. ACC: ENG.20080215.0004.
- 2.2.67 BSC 2008. *Mechanical Handling Design Report - Canister Transfer Machine*. 000-30R-WHS0-01900-000 REV 002. Las Vegas, Nevada: Bechtel SAIC Company. ACC: ENG.20080109.0022.
- 2.2.68 BSC 2008. *Pool Water Treatment and Cooling System*. 050-M0C-PW00-00100-000-00C. ACC: ENG.20080212.0002.
- 2.2.69 BSC 2008. *Preclosure Consequence Analyses*. 000-00C-MGR0-00900-000-00D. Las Vegas, Nevada: Bechtel SAIC Company. ACC: ENG.20080129.0006.
- 2.2.70 BSC 2008. *Preclosure Criticality Safety Analysis*. TDR-MGR-NU-000002 REV 00. Las Vegas, Nevada: Bechtel SAIC Company. ACC: ENG.20080128.0006.
- 2.2.71 BSC 2008. *Seismic and Structural Container Analyses for the PCSA*. 000-PSA-MGR0-02100-000-00A. Rev. 00A. Las Vegas, NV: Bechtel SAIC Company. ACC: ENG.20080220.0003.
- 2.2.72 BSC 2008. *Seismic Fragility Evaluation of the Receipt Facility*. 200-SYC-RF00-01300-000-00B. Las Vegas, Nevada: Bechtel SAIC Company. ACC: ENG.20080205.0008.
- 2.2.73 BSC 2008. 2008. *Supplemental Earthquake Ground Motion Input for a Geologic Repository at Yucca Mountain, NV*. MDL-MGR-GS-000007 REV 00. Las Vegas, Nevada: Bechtel SAIC Company. ACC: DOC.20080221.0001. (DIRS 183776)
- 2.2.74 BSC 2008. *Supplemental Soils Report*. 100-S0C-CY00-00100-000-00D. Las Vegas, Nevada: Bechtel SAIC Company. ACC: ENG.20070222.0001; ENG.20071205.0004; ENG.20080102.0045.
- 2.2.75 BSC 2008. *Seismic Fragility Evaluation of the Aging Facility*. 170-SYC-AP00-00100-000. Las Vegas, NV: Bechtel SAIC Company (BSC). ACC: ENG.20080122.0011.

- 2.2.76 Chen, J.T.; Chokshi, N.C.; Kenneally, R.M.; Kelly, G.B.; Beckner, W.D.; McCracken, C.; Murphy, A.J.; Reiter, L.; and Jeng, D. 1991. *Procedural and Submittal Guidance for the Individual Plant Examination of External Events (IPEEE) for Severe Accident Vulnerabilities, Final Report*. NUREG-1407. Washington, D.C.: U.S. Nuclear Regulatory Commission. TIC: 237269.
- 2.2.77 Chopra, U.B. 2003. "Final Safety Analysis Report (FSAR) for the Standard Advanced NUHOMS® Horizontal Modular Storage for Irradiated Nuclear Fuel, Revision 0." Letter from U.B. Chopra (Transnuclear) to M.J. Ross-Lee (NRC), March 19, 2003, with enclosures. TIC: 255975. (DIRS 168870]
- 2.2.78 Not Used.
- 2.2.79 DOE (U.S. Department of Energy) 1996. *Final Environmental Impact Statement for the Nevada Test Site and Off-Site Locations in the State of Nevada*. DOE/EIS-0243. Las Vegas, Nevada: U.S. Department of Energy, Nevada Operations Office. ACC: MOL.20010727.0190; MOL.20010727.0191. (DIRS 101811)
- 2.2.80 DOE 2007. *Preclosure Seismic Design and Performance Demonstration Methodology for a Geologic Repository at Yucca Mountain Topical Report*. YMP/TR-003-NP, Rev. 5. Las Vegas, Nevada: U.S. Department of Energy, Office of Repository Development. ACC: DOC.20070625.0013. (DIRS 181572)
- 2.2.81 DOE 2007. *Quality Assurance Requirements and Description*. DOE/RW-0333P, Rev. 19. Washington, D. C.: U.S. Department of Energy, Office of Civilian Radioactive Waste Management. ACC: DOC.20070717.0006 (DIRS 182051)
- 2.2.82 DOE 2007. *Software Independent Verification and Validation Report, SAPHIRE Version 7.27*. Document ID: 10325-IVVR-7.27-00. Las Vegas, Nevada: U.S. Department of Energy, Office of Repository Development. ACC: MOL.20070813.0172. (DIRS 182592)
- 2.2.83 DOE 2007. *Transportation, Aging and Disposal Canister System Performance Specification*. WMO-TADCS-000001, Rev. 0. Washington, D.C.: U.S. Department of Energy, Office of Civilian Radioactive Waste Management. ACC: DOC.20070614.0007. (DIRS 181403)
- 2.2.84 DOE-STD-1020-2002. 2002. *Natural Phenomena Hazards Design and Evaluation Criteria for Department of Energy Facilities*. Washington, D.C.: U.S. Department of Energy. TIC: 253058.
- 2.2.85 Ellingwood, B.; Galambos, T.V.; MacGregor, J.G.; and Cornell, C.A. 1980. *Development of a Probability Based Load Criterion for American National Standard A58, Building Code Requirements for Minimum Design Loads in Buildings and Other Structures*. SP 577. Washington, D.C.: National Bureau of Standards, Department of Commerce. ACC: MOL.20061115.0081. (DIRS 177339)

- 2.2.86 Frank, M. 2008. "FW: Water Sources in WHF Room 1016." Email from M. Frank to D. Moore (Forwarded from R. Slovic), February 22, 2008. ACC: MOL.20080225.0026.
- 2.2.87 EPRI (Electric Power Research Institute) 1994. *Methodology for Developing Seismic Fragilities*. EPRI TR-103959. Palo Alto, California: Electric Power Research Institute. TIC: 253770.
- 2.2.88 Friedrich, T. and Schellhaas, H. 1998. *Computation of the percentage points and the power for the two-sided Kolmogorov-Smirnov one sample test*. Statistical Papers 39:361-75. TIC: 260013.
- 2.2.89 Hastings, P.S. 2002. Docket Number 070-03098, Duke Cogema Stone & Webster, Mixed Oxide Fuel Fabrication Facility, Construction Authorization Request, Clarification of Responses to NRC Request for Additional Information Letter from P.S. Hastings (DCS) to Document Control Desk, U.S. Nuclear Regulatory Commission, March 8, 2002, DCS-NRC-00085, with enclosures. Charlotte, North Carolina: Duke Cogema Stone & Webster. ACC: MOL.20080227.0019.
- 2.2.90 ICC (International Code Council) 2006. *2006 International Building Code*. Falls Church, Virginia: International Code Council. TIC: 258069. ISBN: 1-58001-251-5.
- 2.2.91 LL0703PA029SPC.014. *Rupture Probability for the LS-DYNA Kinematic Analyses for the 5-DHLW/DOE SNF-Long Co-Disposal Waste Package and the TAD-Bearing Waste Package*. Submittal date: 03/13/2007. (DIRS 179775)
- 2.2.92 MO0801HCUHSREB.001. *Hazard Curves and Mean Uniform Hazard Spectra for the Repository Block*. Submittal date: 01/14/2008. (DIRS 184803)
- 2.2.93 MO0801HCUHSSFA.001. *Mean Hazard Curves and Mean Uniform Hazard Spectra for the Surface Facilities Area*. Submittal date: 01/11/2008. (DIRS 184802)
- 2.2.94 Morris Material Handling 2007. *P&ID – Cask Transfer Trolley [Sheet 1 of 2]*. V0-CY05-QHC4-00459-00029-001 Rev. 005. Oak Creek, Wisconsin: Morris Material Handling. ACC: ENG.20071019.0003.
- 2.2.95 Morris Material Handling 2007. *Site Transporter Mechanical Equipment Envelope [Sheet 1 of 1]*. Drawing Number SW-ST-00100, Rev. 01. V0-CY05-QHC4-00459-00032-001 Rev. 004. Oak Creek, Wisconsin: Morris Material Handling. ACC: ENG.20071022.0010.
- 2.2.96 Morris Material Handling 2007. *Yucca Mountain Seismic Analysis of 265 Ton Cask Transfer Trolley*. Calculation Number N263903-17. V0-CY05-QHC4-00459-00070-001 Rev. 001. Oak Creek, Wisconsin: Morris Material Handling. ACC: ENG.20071018.0021.

- 2.2.97 NAC (Nuclear Assurance Corporation) 2004. "NAC-STC NAC Storage Transport Cask, Revision 15." Volume 1 of *Safety Analysis Report*. Docket No. 71-9235. Norcross, Georgia: NAC International. TIC: 257644.
- 2.2.98 NRC (U.S. Nuclear Regulatory Commission) 1997. *Standard Review Plan for Dry Cask Storage Systems*. NUREG-1536. Washington, D.C.: U.S. Nuclear Regulatory Commission. ACC: MOL.20010724.0307.
- 2.2.99 NRC 2003. *Interim Staff Guidance - 11, Revision 3. Cladding Considerations for the Transportation and Storage of Spent Fuel*. ISG-11, Rev. 3. Washington, D.C.: U.S. Nuclear Regulatory Commission. ACC: MOL.20040721.0065.
- 2.2.100 NRC 2003. *Interim Staff Guidance - 18. The Design/Qualification of Final Closure Welds on Austenitic Stainless Steel Canisters as Confinement Boundary for Spent Fuel Storage and Containment Boundary for Spent Fuel Transportation*. ISG-18. Washington, D.C.: U.S. Nuclear Regulatory Commission. TIC: 254660.
- 2.2.101 NRC 2006. *Interim Staff Guidance HLWRS-ISG-01. Review Methodology for Seismically Initiated Event Sequences*. HLWRS-ISG-01. Washington, D.C.: U.S. Nuclear Regulatory Commission. ACC: MOL.20061128.0036.
- 2.2.102 NRC 2007. *Staff Guidance HLWRS-ISG-02, Preclosure Safety Analysis – Level of Information and Reliability Estimation*. HLWRS-ISG-02. Washington, D.C.: U.S. Nuclear Regulatory Commission. ACC: MOL.20071018.0240.
- 2.2.103 Regulatory Guide 1.198. 2003. *Procedures and Criteria for Assessing Seismic Soil Liquefaction at Nuclear Power Plant Sites*. Washington, D.C.: U.S. Nuclear Regulatory Commission. ACC: MOL.20060105.0197.
- 2.2.104 SAPHIRE V. 7.27. 2007. WINDOWS 2000 & WINDOWS XP. STN: 10325-7.27-00. (DIRS 183171).
- 2.2.105 Shapiro, S. S. and Wilk, M. B. 1965. "An analysis of variance test for normality (complete samples)", *Biometrika*, 52 (3 - 4), pages 591-611. TIC: 259992.
- 2.2.106 SNL (Sandia National Laboratories) 2007. *Mechanical Assessment of Degraded Waste Packages and Drip Shields Subject to Vibratory Ground Motion*. MDL-WIS-AC-000001 REV 00. Las Vegas, Nevada: Sandia National Laboratories. ACC: DOC.20070917.0006.
- 2.2.107 Snow, S.D. 2007. *Structural Analysis Results of the DOE SNF Canisters Subjected to the 23-Foot Vertical Repository Drop Event to Support Probabilistic Risk Evaluations*. EDF-NSNF-085, Rev. 0. [Idaho Falls, Idaho: Idaho National Laboratory]. ACC: MOL.20080206.0062.
- 2.2.108 Stout, R.B. and Leider, H.R., eds. 1991. *Preliminary Waste Form Characteristics Report*. Version 1.0. Livermore, California: Lawrence Livermore National Laboratory. ACC: MOL.19940726.0118. (DIRS 102813)

- 2.2.109 Vesely, W.E.; Goldberg, F.F.; Roberts, N.H.; and Haasl, D.F. 1981. *Fault Tree Handbook*. NUREG-0492. Washington, D.C.: U.S. Nuclear Regulatory Commission. TIC: 208328.
- 2.2.110 YMP (Yucca Mountain Site Characterization Project) 1997. *Methodology to Assess Fault Displacement and Vibratory Ground Motion Hazards at Yucca Mountain*. Topical Report YMP/TR-002-NP, Rev. 1. Las Vegas, Nevada: Yucca Mountain Site Characterization Office. ACC: MOL.19971016.0777. (DIRS 100522)
- 2.2.111 Zirker, L. 2006. *Remote Handling System Usage Report*. 005128Q-0163-001-001. Engineering Design File, EDF-7384. Revision 1. Idaho Falls, Idaho: Idaho National Laboratory. ACC: ENG.20061006.0018.

2.3 DESIGN CONSTRAINTS

- 2.3.1 10 CFR (Code of Federal Regulations) 63. 2007. *Energy: Disposal of High-Level Radioactive Wastes in a Geologic Repository at Yucca Mountain, Nevada*.
- 2.3.2 10 CFR 71. 2007. *Energy: Packaging and Transportation of Radioactive Material*. ACC: MOL.20070829.0114. Internet Accessible.

2.4 DESIGN OUTPUTS

This calculation is used as input to the preclosure Nuclear Safety Design Basis and the preclosure procedural safety controls.

3. ASSUMPTIONS

3.1 ASSUMPTIONS REQUIRING VERIFICATION

None used.

3.2 ASSUMPTIONS NOT REQUIRING VERIFICATION

None used.

4. METHODOLOGY

4.1 QUALITY ASSURANCE

This calculation was prepared in accordance with EG-PRO-3DP-G04B-00037, *Calculations and Analyses* (Ref. 2.1.1) and LS-PRO-0201, *Preclosure Safety Analyses Process* (Ref. 2.1.3). Therefore, the approved record version is designated as QA: QA.

Information used in the development of this analysis is obtained from many sources, such as mechanical handling system block flow diagrams and engineering drawings. In general, input designated QA: QA was used. However, some engineering documents are designated QA: N/A. The suitability of these documents for the intended use in this calculation is discussed in the following section.

Documentation of suitability for intended use of other inputs designated QA: N/A. For a limited number of instances, QA: N/A references have been used to provide input in Attachments E, F and G and in Section 6.9. These QA: N/A references are listed in Table 4.1-1 together with where the references are used and the reason for their use.

Site plan drawings were used to compute approximate distances in Attachments E and F. Note that according to procedure, engineering drawings are treated the same whether they are designated QA: N/A or QA: QA. They are prepared using the QA procedure (Ref. 2.1.2). This means that they are checked by an independent checker and reviewed for constructability and coordination before review and approval by the Engineering Group Supervisor and the Discipline Engineering Manager (Ref. 2.1.2). The check, review, and approval process provides assurance that these drawings accurately document the design and operational philosophy of the facility. Also note that only approximate distances are used, so the level of accuracy of these drawings is considered to be adequate for this use.

References used in the estimation of residence times for various operations in Attachment G are based on informal engineering studies designated QA: N/A. These preliminary throughput studies are considered to be the best available data, and are a reasonable basis for this use. They are consistent with calculations designated QA: QA, were checked, reviewed and approved by the relevant engineering group on this topic, have been reviewed by operations experts, and were recently updated to reflect design revisions. The detailed spreadsheets are incorporated into this document in Attachment G, so their validity and traceability can be assessed in the context of this calculation.

Five additional references are used to illustrate aspects of the repository. One reference was used to discuss the potential for the drop of a drip shield during transport (Ref. 2.2.30). Another illustrates the rock support at the North Portal face (Ref. 2.2.39). The third provides a rough estimate of the WHF pool volume (Ref. 2.2.68), while the fourth provides the approximate volume of the deionized water tank (Ref. 2.2.50). For each of these references, the values used from the references need only be approximate for the purposes of this calculation. The fifth reference (Ref. 2.2.86) is an email that identifies those water sources that are located in the WHF pool room.

All these references listed in this section are considered to have a reasonable basis for this use in this analysis as they are consistent with QA: QA reports, drawings, and calculations, are provided by the relevant design groups on these topics, and alternative sources are not available at this time.

Table 4.1-1. Use of Non-Q References

Reference Number	Where Cited	Reason for Use
2.2.39	Section 6.9.2.1.1.3 and F3.1.1.3	Used as an example of rock support at face of North Portal
2.2.41	Sections 4.3.3.4, 6.3.2 and Attachment G	Used for evaluation of exposure/residence times of CRCF operations
2.2.42	Sections 4.3.3.4, 6.3.2 and Attachment G	Used for evaluation of exposure/residence times of IHF operations
2.2.43	Sections 4.3.3.4, 6.3.2 and Attachment G	Used for evaluation of exposure/residence times of RF operations
2.2.44	Sections 4.3.3.4, 6.3.2 and Attachment G	Used for evaluation of exposure/residence times of WHF operations
2.2.50	Section 6.7.1.1	Used to obtain estimate for the deionized water tank volume
2.2.63	Table E1.5-2	Used to identify the number of crossings and switches for the travel of the site transporter in facilities area
	Table F2-2	Used to obtain approximate distance for TEV travel on surface and identify the number of crossings and switches
2.2.64	Section 6.8.1.3	Used to obtain approximate distance from rail access interchange to CRCF-2
	Tables E1.4-4	Used to obtain approximate distance for site transporter travel on surface from the facilities area to Aging Pad 17P
2.2.68	Section 6.7.1.1	Used to obtain estimate for the WHF pool volume
2.2.86	Section 6.7.1.1	Identifies potential flooding sources for WHF pool room
2.2.111	Attachment G	Used as basis to modify exposure/residence times for remote handling system descriptions

NOTE: CRCF = Canister Receipt and Closure Facility; IHF = Initial Handling Facility; RF = Receipt Facility; TEV = transport and emplacement vehicle; WHF = Wet Handling Facility.

Source: Original

4.2 USE OF SOFTWARE

4.2.1 Level 1 Software

This section addresses software used in this analysis as Level 1 software, as defined in *Software Management* (Ref. 2.1.4, Attachment 12) (Level 1 software is to be used in the Nuclear Safety functional area and must be qualified). The computer code, SAPHIRE, Version 7.27 (STN: 10325-7.27-00) (Ref. 2.2.104) is used in this analysis for probabilistic risk assessment (PRA) simulation and analyses. The SAPHIRE software was used on a PC running Windows XP Professional within a virtual machine configuration (VMware Player 1.0.4) and is listed in the

current *Qualified and Controlled Software Report*, and was obtained from *Software Configuration Management*. The SAPHIRE software is specifically designed for PRA simulation and analyses, and has been verified to show that this software produces precise solutions for encoded mathematical models within the defined limits, for each parameter, employed (Ref. 2.2.82). Therefore, SAPHIRE version 7.27 is suitable for use in this analysis.

The SAPHIRE project files for this analysis are listed in Attachment J. They are contained on a compact disc, which is included as part of Attachment J. SAPHIRE project files contain all of the inputs that SAPHIRE requires to produce the outputs that are documented in this analysis.

4.2.2 Level 2 Software

This section addresses software used in this analysis that are classified as Level 2 software, as defined in *Software Management* (Ref. 2.1.4, Attachment 12). It is used on a PC running either Windows XP Professional or Windows 2000.

- The commercially available Visio Professional 2003 and Word 2003, which are components of the Microsoft Office 2003 suite of programs, are used in this analysis for the generation of graphics and text and are listed in the current Level 2 Usage Controlled Software Report. The accuracy of the resulting graphics and text is verified by visual inspection.
- The commercially available Excel 2003 (a component of Microsoft Office 2003), is listed in the current Level 2 Usage Controlled Software Report and is used in this analysis to calculate simple computations in a spread sheet format. All user defined formulas, inputs, results, and graphical representations have been verified by duplication of the calculations, or by visual inspection. The equations are also documented in sufficient detail to allow an independent repetition of the computations. Output from the Excel analyses is attached to this document as part of Attachment G; the input source is provided by input cited in Attachment G.

4.3 APPROACH AND ANALYSIS METHODS

The overall approach to the probabilistic seismic analysis and event sequence categorization is summarized in Figure 4.3-1 and follows standard practice as documented in seismic risk assessment references, (e.g., Ref. 2.2.1). This method conforms to guidance provided in HLWRS-ISG-01, *Review Methodology for Seismically Initiated Event Sequences* (Ref. 2.2.101).

A seismic event sequence analysis is conducted in four steps:

- **Development of the site seismic hazard curve.** A seismic hazard curve presents the annual probability of exceedance (APE) associated with a ground motion parameter at the site. The ground motion parameter selected for the YMP seismic hazard curve is the horizontal peak ground acceleration (PGA), a metric appropriate for representing the severity of a seismic event on a structure, system or component (SSC). A mean seismic hazard curve specific to the GROA is used for the surface facilities, consistent with Nuclear Regulatory Commission (NRC) interim staff guidance on seismically initiated

event sequences (Ref. 2.2.101). A second mean seismic hazard curve is used for the subsurface repository block. These curves are developed based on a probabilistic seismic hazard assessment, discussed in Section 4.3.1.

- **Development of seismic fragilities.** Seismic fragility evaluations are performed for SSCs that prevent or mitigate radionuclide releases, or prevent criticality. A fragility curve provides the mean probability of unacceptable performance (sometimes called seismic failure) of an SSC as a function of a ground motion parameter. The ground motion parameter selected is the same as that chosen for the seismic hazard curve (e.g., the horizontal PGA). The methodology used for the development of fragility curves is discussed in Section 4.3.2.
- **Modeling of seismic event sequences and SSC fault trees.** The method used is similar to the event tree and fault tree modeling for internal initiating events, and capitalizes on the fact that the event sequences resulting from a seismic event would have similar pivotal events and end states. However, there are unique seismic event sequences, such as those involving the collapse of a facility, that are also included as needed. The modeling method is discussed in Section 4.3.3.
- **Quantification of seismic event sequences.** Quantification of seismic event sequences must be performed in a different manner than for internal initiating events. The quantification must incorporate the dependency between the magnitude of seismic ground motion and the probability of seismic failure, the latter of which increases with the former as expressed with the SSC fragility curves. The algorithm also incorporates the decreasing frequency of a seismic event as the magnitude of seismic ground motion increases, expressed with the seismic hazard curve. This quantification process, often termed a convolution, is discussed in Section 4.3.5.

Referring to Figure 4.3-1, after the seismic event sequences are quantified, they are categorized in accordance with 10 CFR Part 63 (Ref. 2.3.1). The event sequences that are estimated to occur one or more times before permanent closure of the GROA are Category 1 event sequences. Other event sequences that have at least one chance in 10,000 of occurring before permanent closure are Category 2 event sequences. Event sequences that have less than one chance in 10,000 of occurring during the preclosure period are designated as beyond Category 2 event sequences.

Depending on the category and the consequences associated with the event sequence, the compliance of the event sequence with 10 CFR 63.111 (Ref. 2.3.1) criteria is determined. As Figure 4.3-1 depicts, if an event sequence does not comply, then the design requirements (or procedural safety requirements) can be revised such that compliance can be demonstrated. The design requirements and procedural safety requirements are documented in Section 6.10.

Each of the steps outlined above are discussed in more detail in the following sections.

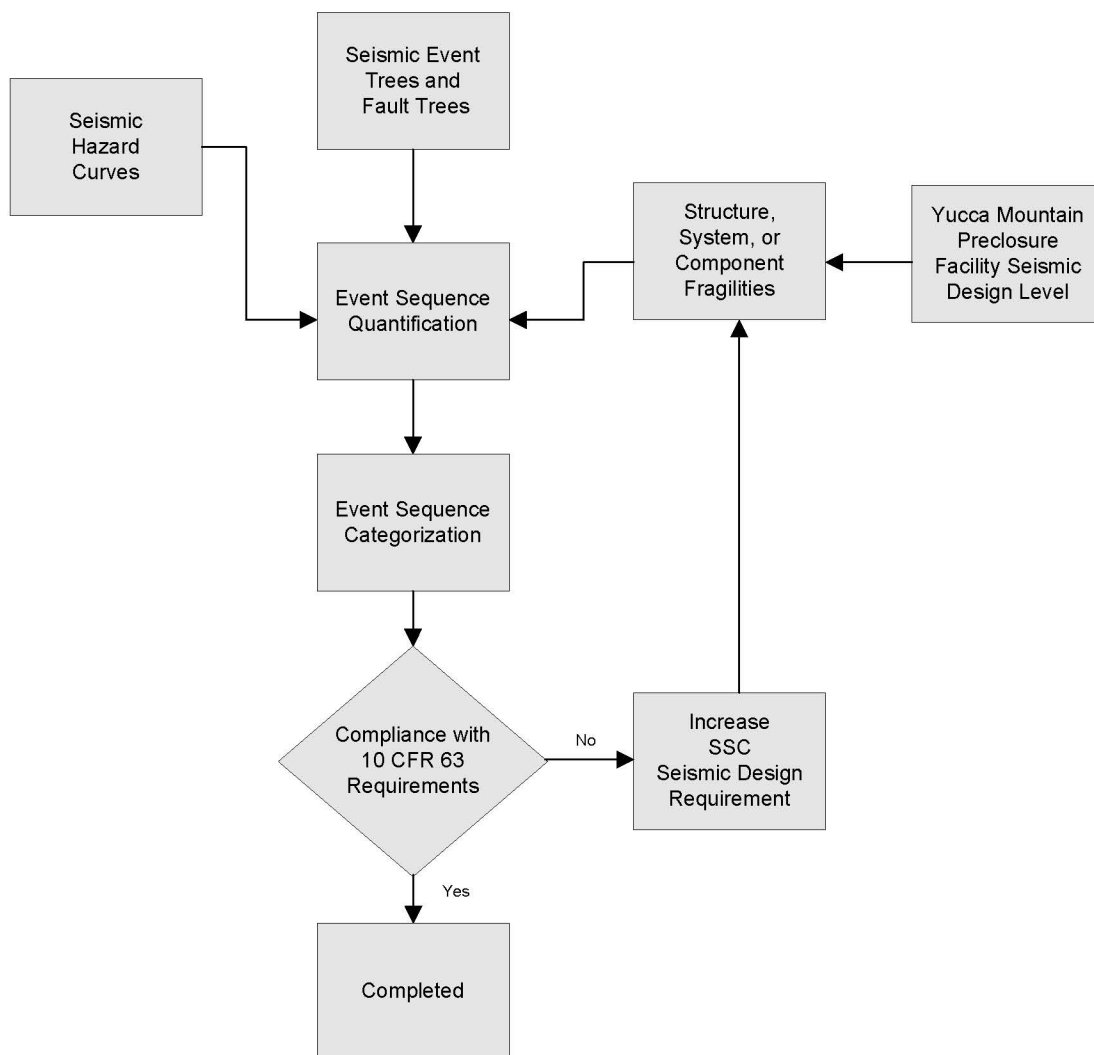

Source: Original

Figure 4.3-1. Probabilistic Seismic Analysis and Event Sequence Categorization

4.3.1 Development of the Site Seismic Hazard Curve

Site-specific seismic hazard curves are required to represent the annual probability of various amplitudes of ground motion at the location of the surface facilities, and the subsurface repository block. To assess the seismic hazards of vibratory ground motion at Yucca Mountain, a Probabilistic Seismic Hazard Assessment (PSHA) was performed consistent with that documented in *Methodology to Assess Fault Displacement and Vibratory Ground Motion Hazards at Yucca Mountain* (Ref. 2.2.110). The PSHA assesses the earthquake history, seismology, and geology of the region and produces a seismic hazard curve presenting the APE of experiencing different magnitude ground motions at the plant site. Both aleatory (parametric) and epistemic (modeling) uncertainties are considered in the hazard analysis and propagated through to the results in the form of a family of hazard curves.

The key elements of a PSHA are:

1. Identification of earthquake sources capable of producing significant ground motion at the site
2. Estimation of the recurrence frequencies of the identified sources
3. Ground motion attenuation modeling (predictive modeling of motions experienced at the site given the distance and geology between the site and the identified sources)
4. Integration of the above information to produce seismic hazard curves.

The mean ground motions at particular APEs, expressed as uniform hazard spectra (UHS), were calculated using the site response model (Ref. 2.2.11) and mean-centered representations of the uncertainty and variability in the inputs to the site response model. This site response model ensures that the soil motions are hazard consistent (e.g., the annual exceedance probability of the soil UHS should be the same as the rock UHS).

The results of the PSHA are documented in *Supplemental Earthquake Ground Motion Input for a Geologic Repository at Yucca Mountain, NV* (Ref. 2.2.73). More detail on the methodology can be found in these references.

4.3.2 Seismic Fragility Method

A seismic fragility curve provides the probability of unacceptable performance (sometimes called seismic failure) of an SSC as a function of a ground motion parameter. For the PCSA, the selected ground motion parameter is the horizontal peak ground acceleration. Fragility curves are developed for those SSCs with seismic failures that require detailed quantification in the PCSA.

A lognormal distribution is used to represent the mean fragility curve of an SSC and is characterized using two parameters: median fragility and composite uncertainty. Two different but compatible methods are used to develop the fragility curve parameters: one applies to structures, the other to equipment and components. For either method, the resulting median fragility (A_m) and composite uncertainty (β_c) are used as the parameters that characterize the mean fragility curves, which serve as inputs to the seismic event sequence quantification. An example of a mean fragility curve is shown on Figure 4.3-2. This curve gives the conditional probability of failure for the hoist for a canister transfer machine (CTM) in a CRCF, as a function of the horizontal peak ground acceleration. The failure mode for this SSC is the failure of the drum on the hoist, resulting in a dropped load. For this example, the median fragility A_m is equal to 2.28 g and the composite uncertainty β_c is equal to 0.50.

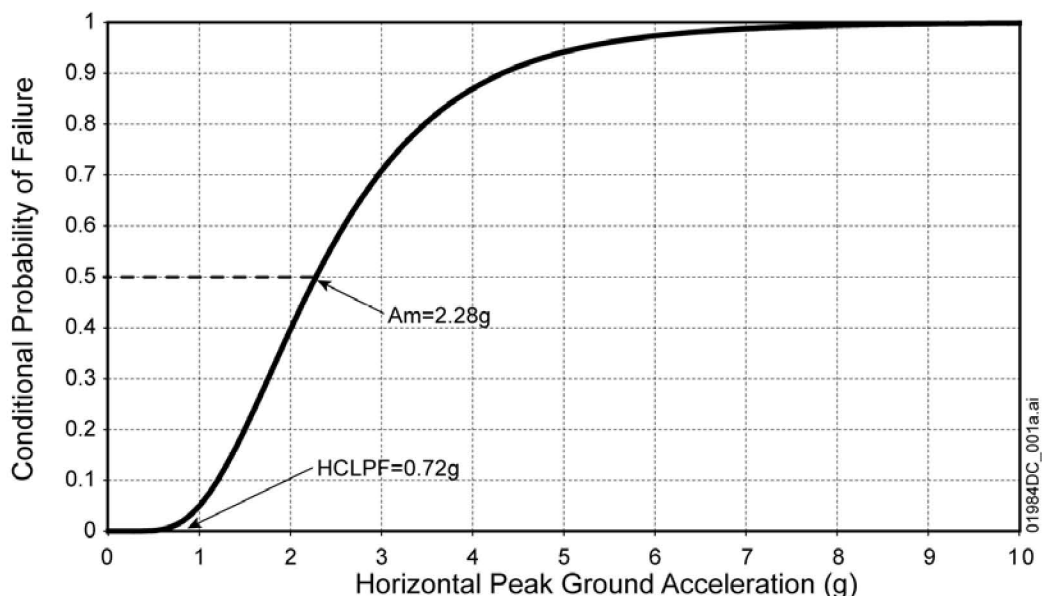

Source: (Ref. 2.2.60) Table 5

Figure 4.3-2. Example Seismic Fragility Curve (Canister Transfer Machine Hoist in a CRCF)

Also shown on Figure 4.3-2 is the high confidence of low probability of failure (HCLPF) value of 0.72 g. The HCLPF is defined as the acceleration at which there is 95% confidence of a 5% probability of failure. Since this seismic event sequence analysis uses mean values for the fragility curves, the HCLPF is closely approximated as the acceleration at which there is a mean probability of failure of 1%.

The determination of the seismic fragility of SSCs is carried out in a manner consistent with the guidance contained in the NRC document HLWRS-ISG-01 (Ref. 2.2.101).

4.3.2.1 Structure Fragilities

The seismic fragilities for the main structures (buildings) are determined using the conservative deterministic failure margins (CDFM) method. This method was developed by the Electric Power Research Institute (Ref. 2.2.87), and accepted by the NRC in NUREG-1407 (Ref. 2.2.76), to assess the capacity of a structure with respect to a beyond design basis ground motion. In the CDFM method, a series of calculations are made to determine the PGA that approximates but is lower than the HCLPF acceleration. The HCLPF represents the PGA at which there is a 1% probability of failure. Its calculation involves determining both a computed strength margin factor, and an inelastic energy dissipation factor, with respect to the beyond design basis ground motion. In effect, conservatism in the design codes and design process are quantified to determine when the limit states of the structure may be exceeded as the PGA is increased. As determined with the CDFM calculations, the calculated PGA is designated the HCLPF acceleration, and is used to represent the acceleration when there is a 1% probability that the seismic demand is greater than the building structural capacity. The uncertainty in the calculation of both the structural capacity and the seismic response is expressed mathematically as β_c , termed the composite uncertainty since it includes aleatory randomness as well as

epistemic modeling uncertainty. The median fragility (A_m) for the structure, used for the seismic event sequence quantification, can then be calculated from the HCLPF and β_c .

$$A_m = \text{HCLPF } e^{2.326 \beta_c} \quad \text{Eq. 4.3-1 (adapted from Ref. 2.2.47, Eq. B-30)}$$

Performance of the HCLPF calculations was guided by the methods given in the *Seismic Analysis and Design Approach* document (Ref. 2.2.47), and considered all failure modes in order to determine the “weakest link” of the structure. Based on experience with seismic probabilistic risk assessments of nuclear power plants, the structure HCLPF capacities are based on in-plane shear for shear walls and out-of-plane bending for slabs. However, in order to demonstrate the adequacy of the entire structure, additional evaluations were carried out:

- Out-of-plane bending of shear wall
- In-plane bending and in-plane shear of floor diaphragms
- Axial force in combination with in-plane bending of walls.

This detailed method was used for each of the four major structures: CRCF, RF, IHF, and WHF.

4.3.2.2 Equipment Fragilities

For the equipment, the seismic fragilities are calculated based on the separation of variables method, which is a method that has been used for numerous nuclear power plants and accepted by the NRC. The method is documented in detail in several EPRI technical reports (e.g., Ref. 2.2.87), and in the equipment fragility evaluation calculation (Ref. 2.2.60).

The factor of safety of a component is defined as the resistance capacity for failure modes of interest divided by the response associated with the reference earthquake. The development of seismic safety factors associated with the reference earthquake is based on consideration of several parameters. The two basic considerations for the evaluation of seismic fragilities are the evaluation of dynamic response to the input ground motion and the strength or capacity of the equipment. Several parameters are involved in determining the structural response, equipment response and the capacity, and each such parameter, in turn, has a median factor of safety and variability associated with it. The overall factor of safety is the product of the factors of safety for each parameter. The variability of the individual safety factors also combine to determine the variability of the overall safety factor.

Parameters influencing the factor of safety for equipment capacity to withstand earthquake shaking include the strength of the equipment compared to the evaluation or design stress or deformation level, and the inelastic energy absorption capacity (ductility) of the equipment, defined as its ability to withstand seismic inertial loads beyond elastic limits. Many parameters affect the computed structural response to free field earthquake input ground motion. The more significant parameters, each of which has variability, are (1) ground motion and the associated ground response spectra for a given median spectral acceleration, (2) energy dissipation (damping), (3) structural modeling, (4) method of analysis, (5) combination of modes, (6) combination of earthquake components, and (7) soil-structure interaction including the earthquake ground motion incoherence or spatial variation.

The overall factor of safety is combined with the PGA of the reference evaluation spectrum to determine the median fragility (A_m), and the variability estimates are combined to determine the composite uncertainty (β_c).

Because much of the equipment design is in a preliminary stage, the fragility calculations are based on a design that exactly meets the allowable stress levels, and does not provide any extra design margin. This provides a conservative calculation of the equipment seismic capacity, resulting in the minimum amount of seismic margin. It would be expected that the final equipment design would provide some conservative margin between the calculated design stress level and the allowable stress level.

4.3.3 Modeling of Seismic Event Sequences and SSC Fault Trees

In general, an event sequence is a series of actions and/or occurrences within the natural and engineered components of the GROA that could potentially lead to exposure of individuals to radiation (10 CFR 63.2 (Ref. 2.3.1)). For seismic event sequences, the event sequence begins with a seismic event and unfolds as a combination of failures and successes of pivotal events. An event sequence terminates with an end state that identifies the radiation exposure type or potential criticality, if any, resulting from the event sequence (Ref. 2.2.27, Section 4.3).

Seismic event sequences are developed and modeled with event trees and fault trees in a manner similar to the internal initiating events. However, there are several differences, such as the use of residence time factors that are required to model realistically the seismic initiating event and induced seismic failures. The seismic event sequence modeling is comprised of the following steps:

- Initiator event tree (IET) and system response event tree (SRET) models
- Fault tree models
- Waste container throughput analysis
- Residence time factors
- Passive equipment failure analysis.

Each of these steps is discussed below.

4.3.3.1 Event Tree Models

In general, event sequences are developed with the following objectives (Ref. 2.2.27, Section 4.3.2):

- Provide a comprehensive and accurate description of scenarios that could occur at the GROA before permanent closure
- Identify the end state associated with each event sequence to enable, as needed, the subsequent evaluation of radiological consequences

- Identify the design bases (safety functions and controlling parameters) of SSCs as well as the PSCs that are relied on to control the probability of occurrence of event sequences or mitigate their consequences.

To meet these objectives, the seismic event sequence development followed the process below:

- Use the event trees developed for the internal initiators to identify:
 - Equipment and failure modes that could initiate event sequences
 - Subsequent pivotal events that could lead to potential radiological consequences
 - End states for the event sequences.
- Determine which equipment and failure modes from the internal event trees can be induced by seismic events
- Identify additional seismic-induced failure modes for the identified equipment (such as crane collapse)
- Identify other equipment or structures that could fail due to a seismic event
- Develop seismic IETs that include the above seismic failures
- Modify the internal SRETs and pivotal events to reflect seismic events.

Use of the internal event trees to guide the seismic analysis: Since the process used for internal initiators was designed to be very comprehensive, and was documented in detail, it provided an excellent starting basis for the seismic event sequence development. The event tree process is described in detail in the event sequence development and reliability and event sequence categorization documents (e.g., Ref. 2.2.27, Section 4.3), and will only be discussed briefly here. Event sequences were developed using ESDs, which are designed to exhaustively and logically depict the progression of event sequences from their initiating event (or group of initiating events) up to and including their end state. ESDs identify the key safety functions necessary to reach an end state after the initiating event (or group of initiating events) as well as the associated SSC responses and personnel actions. The ESDs were then mapped into event tree logic diagrams. The use of event trees is consistent with standard industry practice, as indicated in ASME RA-Sb-2005 (Ref. 2.2.9, Table 4.5.2-2(a)), for nuclear power plants.

In the seismic PCSA, a seismically-induced event sequence starts with seismic failure of an individual SSC, and includes the dominant seismic failure modes for that SSC. The internal ESDs separated SSC-related failure modes into small circle events to enable use of correct conditional probabilities for the later pivotal events. The resulting small circle event sequences were later aggregated by the large circle events (or SSC) for categorization. In the seismic event trees, the correct conditional probabilities could be directly incorporated into the seismic fault trees, and separation into small circle events was not required. Therefore, the seismic IETs are based on seismic failure of SSCs, and the seismic fault trees contain the different seismic failure modes. Aggregation of sequences for categorization is thus not required for seismic event sequences.

Determination of seismic-induced failure modes: Although the internal event analysis identified a comprehensive list of potential SSCs and associated types of failure events, the seismic event sequence analysis determined which of these failure events could be caused by a seismic event. As one example, the internal events analysis included the spurious movement of the cask transfer trolley (CTT) as a failure event. For a seismic event, the equivalent failure mode is sliding of the CTT due to the seismic ground motion. In other cases, there was no equivalent seismic counterpart for the internal event, or the seismic counterpart was not a credible failure mode. For example, the analysis of the site transporter included random failure of the lift system resulting in drop of the aging overpack. For the seismic analysis, the potential seismic failures included sliding of the site transporter and tipover of the site transporter. However, the lift system was determined to have very high seismic capacity, such that it could be screened out as a potential seismic failure mode. Many of the internal event failure modes were screened out by the fragility analysis as not being credible, or being dominated by other seismic failure modes.

On the other hand, there are a number of failure modes that were not included in the internal event analysis, since their random failure probability was extremely small. Typical examples are the collapse of structures, which are simply not credible random failures, but are included as seismic failures. The rocking of the waste package transfer trolley (WPTT) after seismic restraint failure is another seismic example.

In addition to the facility layout and operational summaries in the internal event documents, a variety of information sources were used to identify all of the equipment and potential seismic failure modes that could lead to a seismic event sequence. The specific documents are referenced in Section 6 for each of the facilities. They include the facility block flow diagrams, the facility general arrangement drawings, the mechanical equipment envelope drawings, the equipment process and instrumentation diagrams, and the mechanical handling design reports. The typical process was to use the block flow diagrams and general arrangement drawings to essentially walk through the processing of a specific waste container, identifying the potential seismic failure modes of equipment that either handles the waste container, or is near the waste container and could impact it upon failure. These latter failures are often termed seismic interactions, or two-over-one issues. This process was repeated for each waste container at that facility, since the processing steps vary.

Therefore, while the internal event trees provided the starting point for the seismic event tree development, there is a significant difference in the SSCs and associated failure modes that are identified for the seismic event sequences.

Development of seismic initiator event trees: After using the internal event trees to identify potential SSCs and failure modes, and identifying unique seismic-induced failure modes, the seismic IETs are developed. Figure 4.3-3 provides a typical seismic IET, in this case for the CRCF process where a transportation, aging and disposal (TAD) canister is received in an aging overpack on the site transporter, and is processed into a waste package, placed in the transport and emplacement vehicle (TEV), and exported to the emplacement drifts. Note that the seismic IET is slightly different than an internal event IET, since it has an additional initial top event heading, "Seismic Event," that is used to represent the earthquake initiator for the quantification.

Seismic Event	Number of TADs from AO to WP	Identify initiating seismic failure		
SEIS-EVENT	CRCF-TAO-CAN	SEIS-FAIL	#	END-STATE
			1	OK
			2	OK
		CRCF building collapse	3	RR-UNF
		Entry door seismic collapse	4	T => 5
		Cask prep platform collapse	5	T => 5
		ST seismic failures	6	T => 5
		Shield door seismic failure	7	T => 3
		CTM seismic failures	8	T => 4
		RHS-robotic arm seismic failures	9	T => 7
		WPTT tipover	10	T => 7
		WPHC seismic failures	11	T => 7
		TEV seismic failures	12	T => 8

CRCF-S-IE-TWP - CRCF Seismic Event Tree - TAD in AO to WP 2007/12/11 Page 10

NOTE: Event tree branch captions are associated with the branch line below the caption.

Source: Attachment C, Figure C1.1-7

Figure 4.3-3. Typical Seismic Initiator Event Tree

The second event heading, in this case “CRCF-TAO-CAN,” is used to provide the total number of containers of the specific waste form under consideration that will be processed in this facility over the preclosure period. For this example, this would be the number of aging overpacks containing a TAD canister that are processed in all of the CRCF facilities over the preclosure period. The “up” branch is a “dummy” success state (OK end state), used for convenience in the quantification, and is not evaluated. The “down” branch provides the number of containers processed to the event sequence quantification. Section 4.3.3.3 provides a discussion of the derivation of number of containers for each facility and waste form process.

The seismic IETs also use the multiple branching features of event trees. As can be seen on Figure 4.3-3, the pivotal event “Identify initiating seismic failure (SEIS-FAIL)” has 11 branches corresponding to sequences 2 through 12. Sequence 2 is the success path (OK end state) representing no seismic failures due to the seismic event, and is not evaluated further. Each of the other 10 branches corresponds to SSCs that have potential seismic failure modes that could lead to radionuclide releases. Note that an SSC can have multiple seismic failure modes, which are modeled using the seismic fault trees. Also note that the event sequences treat each of these SSCs individually. The issues of seismic failure of multiple SSC seismic initiators, and of treatment of seismic “successes,” are described in Section 4.5, Quantification of Seismic Event Sequences.

Some seismic sequences can lead directly to a radionuclide release, while others are transferred to a SRET. In this example, sequence 3 represents a seismic event that causes collapse of the CRCF structure. An earthquake sufficiently severe to cause the collapse of a facility is considered to cause the breach of all waste containers inside, and loss of confinement and heating, ventilation and air conditioning (HVAC) for filtering. Thus the event sequence leads directly to an unfiltered radionuclide release end state (RR-UNF). See the discussion below on end states.

The other event sequences are transferred to corresponding SRETs, as denoted by the “T => #” sequence designator, and the SRET name is given in the “END-STATE” column. For example, sequence 7 will transfer to the CRCF-S-R-SD1 seismic SRET. Note that the same SRET can be used for multiple seismic sequence transfers. This is because the general pivotal events on the SRET are the same for those seismic sequences. However, the quantification will generally be different. That is, different fault trees will be used for the pivotal events on the SRET. This is discussed in Section 4.5, Quantification of Seismic Event Sequences.

Development of seismic system response event trees: The seismic SRETs are very similar to the internal event SRETs, although the associated fault trees for the pivotal events are significantly different. In general, the first heading is the incoming transfer, the next pivotal event(s) question whether the waste container is breached by the seismic event, followed by the shielding, confinement/HVAC, and moderator pivotal events. The end states are the same as for internal events. Figure 4.3-4 provides a typical example of a seismic SRET.

As with the internal event sequences, if the “TC-WP” pivotal event fails (breach of the waste container), then the “CANISTER” pivotal event is always set to fail as well. Thus, sequence 3 on this SRET will always have zero frequency, increasing the frequency of the remaining sequences. (There are differences in the pivotal events and branching among the SRETs, so the sequence numbers can change depending on the SRET.)

Note that it was decided to conservatively model the confinement/HVAC pivotal event as always failed if the seismic event caused a breach of a waste container. While this is conservative, it simplified the fault tree modeling since offsite power and recovery, onsite emergency power and recovery, and the HVAC system did not require models. Thus, for the seismic analysis, sequences 4 and 5 on this SRET will always have zero frequency, increasing the frequency of the remaining sequences.

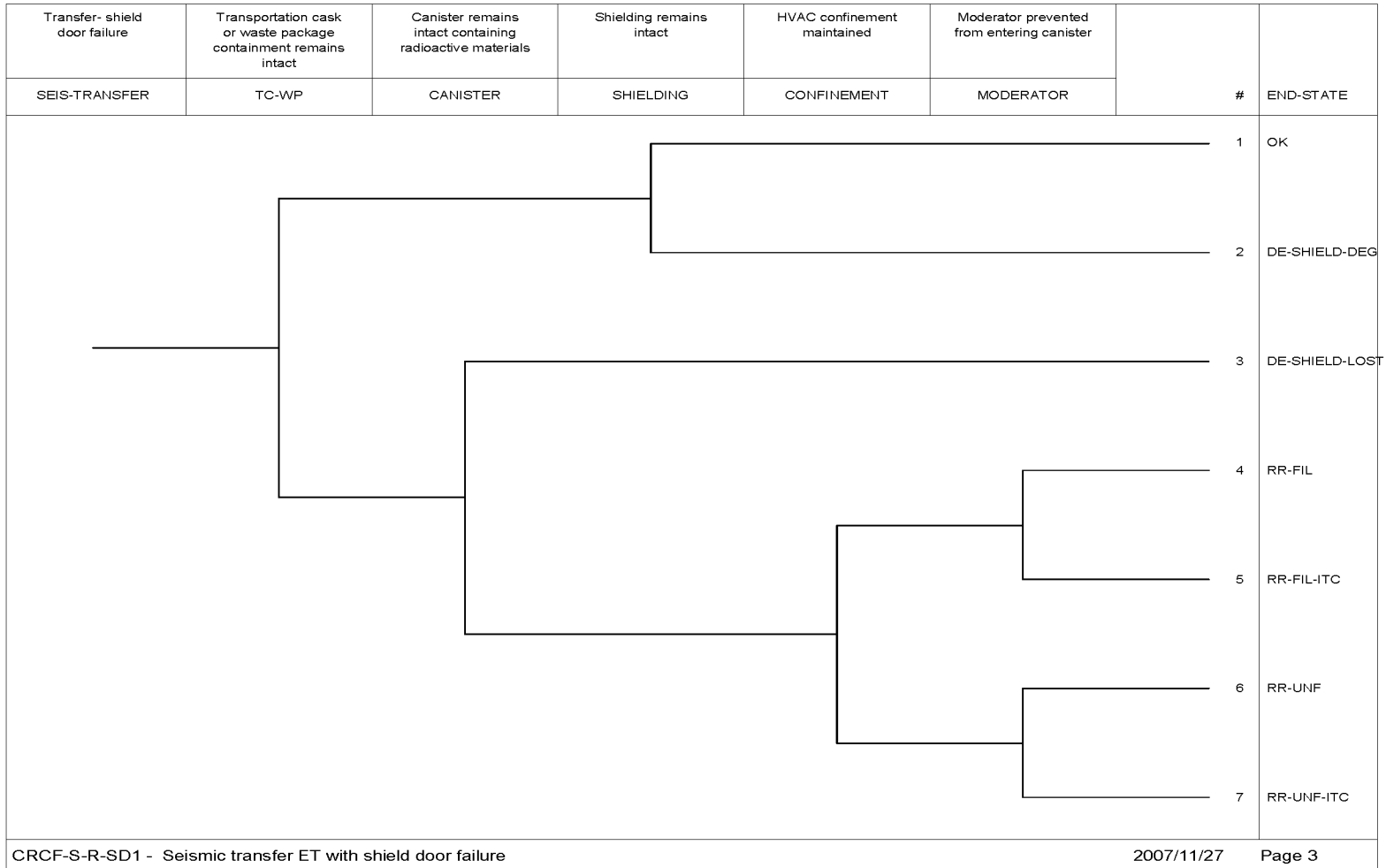

Source: Attachment C, Figure C1.1-3

Figure 4.3-4. Typical Seismic System Response Event Tree

Eight possible end states are considered in the internal events analysis, and are identical for the seismic analysis. These end states differentiate the consequences of the various states of radiation exposure. The first end state addresses absence of radiation exposure; the other end states classify the type of radiation exposure that could occur, as follows (Ref. 2.2.27, Section 4.3.2.1):

1. “OK”–Indicates the absence of the other end states.
2. Direct Exposure, Degraded Shielding–Applies to event sequences where an SSC providing shielding is not breached, but its shielding function is jeopardized. An example is a lead-shielded transportation cask that is dropped from a height great enough for the lead to slump toward the bottom of the cask at impact, leaving a partially shielded path for radiation to stream. This excludes radionuclide release from containment and an indication of a reactivity increase.
3. Direct Exposure, Loss of Shielding–Applies to event sequences where an SSC providing shielding fails, leaving a direct path for radiation to stream. For example, this end state applies to a breached transportation cask, with the DPC or TAD canister inside maintaining its containment function. In another example, this end state applies to shield doors inadvertently opened. This excludes radionuclide release from containment and an indication of a reactivity increase.
4. Radionuclide Release, Filtered–Indicates a release of radioactive material from its containment, through a filtered path, to the environment. The release is filtered when it is confined and filtered through the successful operation of the HVAC system over its mission time. This excludes nuclear reactivity increases.
5. Radionuclide Release, Unfiltered–Indicates a release of radioactive material from its confinement, through the pool of the WHF or through an unfiltered path, to the environment. This excludes nuclear reactivity increases. Pool water provides particulate removal so that a particulate release to the WHF air does not occur. However, the pool water does not filter non-soluble gases such as noble gases. HVAC is also ineffective at filtering noble gases. Radionuclide release to the WHF pool will be referred to as a gaseous unfiltered release.
6. Radionuclide Release, Filtered, Also Important to Criticality–For dry operations with canistered spent nuclear fuel (SNF), this end state refers to a situation in which a breach of a canister has occurred (resulting in a radionuclide release), and a moderator, such as unborated water, has entered the canister. For dry operations with uncanistered SNF, this end state refers to a situation in which a breach of a transportation cask has occurred (resulting in a radionuclide release), and a moderator, such as unborated water, has entered the cask. The release of the radioactive material to the environment is through a filtered path.
7. Radionuclide Release, Unfiltered, Also Important to Criticality–This end state refers to a situation in which an unfiltered radionuclide release occurs and (unless the associated event sequence is beyond Category 2 a criticality investigation is indicated.

8. Important to Criticality—This end state refers to a situation in which there has been no radionuclide release and (unless the associated event sequence is beyond Category 2) a criticality investigation is indicated. The WHF contains a borated pool for handling of spent fuel assemblies. This end state applies to event sequences in the pool that might result in reactivity increases associated with reduction of boron concentration.

The end states “radionuclide release, also important to criticality” and “important to criticality,” therefore, segregate event sequences for which some of the conditions necessary to lead to a criticality event have been met. This does not imply, however, that a criticality event is inevitable (Ref. 2.2.27, Section 4.3.2.1).

4.3.3.2 Fault Tree Models

In the seismic event trees, the initiating seismic failure events and pivotal events are modeled with seismic fault trees. A fault tree is a logic diagram that analyzes the combinations of individual SSC failures and human failure events that cause an undesired event, such as an initiating event or the undesired outcome of a pivotal event in an event sequence. Fault tree analysis is an accepted methodology for assessing the reliability of SSCs, and its use is common within the nuclear, aerospace, and chemical process industries. Fault trees are developed, as applicable, using the methodology detailed in NUREG-0492 (Ref. 2.2.109). The internal event reliability and event sequence categorization documents (e.g., Ref. 2.2.59, Sections 4.3.2 and 4.3.2.1) provide more detail on fault tree construction.

The seismic fault trees are generally less complex than those for internal events. Figure 4.3-5 provides a simple example of a seismic fault tree, in this case for the initiating seismic failure of the waste package handling crane (WPHC), corresponding to the “WPHC seismic failures” branch in sequence 11 of Figure 4.3-3 above. In this case, the top event represents the combination of potential seismic failures of the WPHC that could impact a waste package, potentially breaching the waste package and TAD inside. There are two seismic failures, the collapse of the WPHC onto the waste package below, and the drop of a heavy object by the WPHC hoist system onto the waste package below. Since the WPHC does not lift the waste package when the TAD is inside, a drop by the WPHC of the waste package with TAD is not a possible failure mode.

The seismic collapse of the WPHC is represented by the basic event S-060-WPHC-COLLAPSE. However, while a seismic event could cause this collapse, there may or may not be a waste package under the WPHC when the earthquake occurs. In order for a radiological consequence to be possible, the waste package must be under the WPHC. The basic event 060-TWP-WPHC-COL-ETF represents the fraction of time that a waste package would be under the WPHC (discussed in Section 4.3.3.4). Since both basic events, crane collapse and waste package under crane, must occur for an event sequence to initiate, the two basic events are “ANDed” together by the fault tree gate S-TWP-WPHC-COLLAP. The other WPHC failure mode, drop of heavy object on waste package, is modeled similarly under gate S-TWP-WPHC-OBJ-DROP. Since either of these seismic failure modes could occur during an earthquake, their gates are “ORed” together by the top gate, S-060-TWP-WPHC-FAIL, representing all of the potential initiating seismic failure modes of the WPHC. Quantification of the fault tree is discussed in Section 4.5, Quantification of Seismic Event Sequences. Note, however, that the seismic failure probabilities

listed by the basic event circles represent the conditional probability of failure at the design basis ground motion (DBGM)-2 ground motion, and do not represent the seismic failure probability for the event sequence.

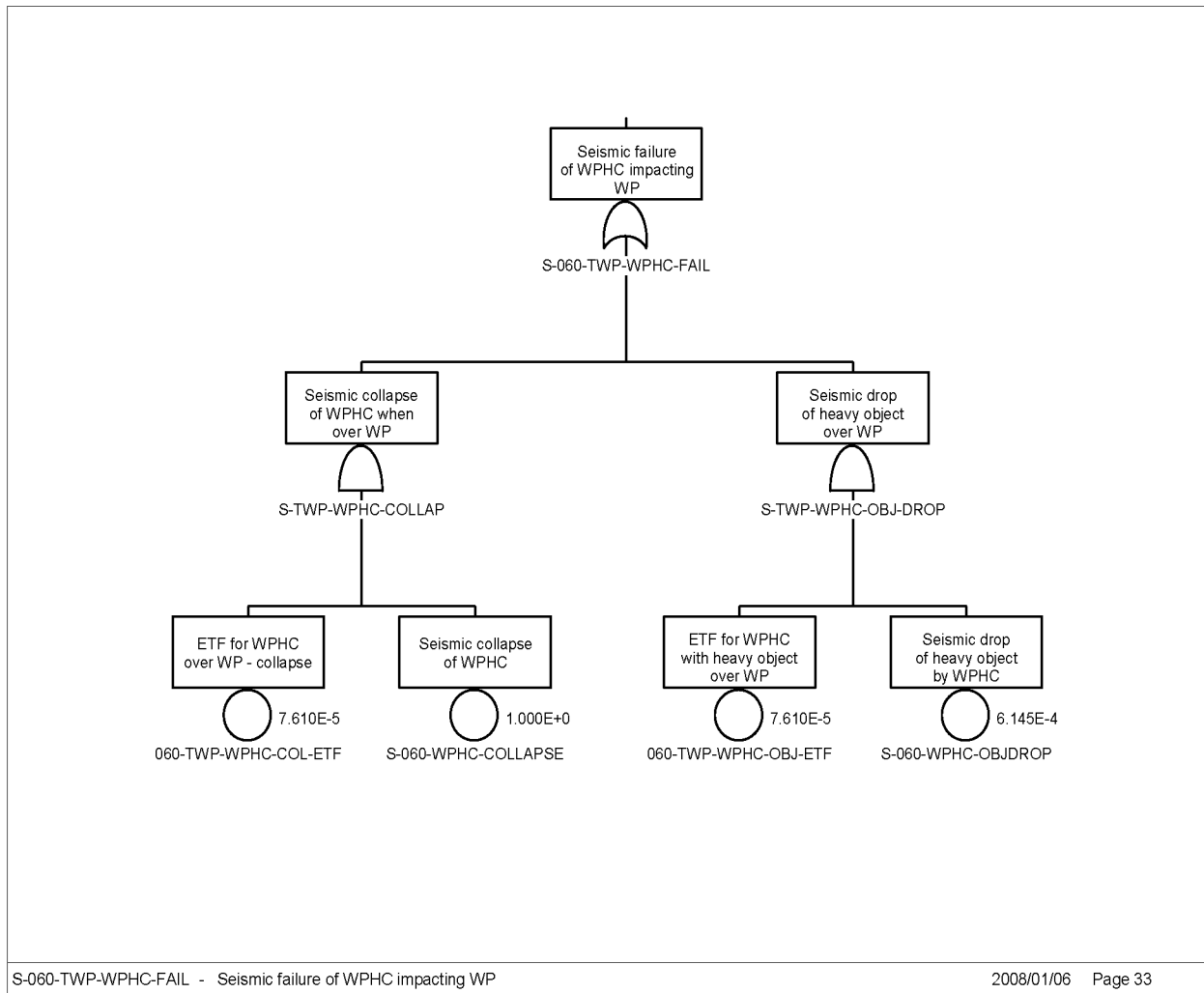

Source: Original

Figure 4.3-5. Example WPHC Initiating Seismic Failure Fault Tree

A second set of fault trees are used to model the potential breach of the waste container, given the initiating seismic failure. These fault trees are used to model and quantify the breach pivotal events on the SRETs. Figure 4.3-6 provides the fault tree that corresponds with the WPHC in Figure 4.3-5 discussed above. Note that one additional basic event has been added to each of the AND gates, representing the probability of breach of the waste package and TAD due to the WPHC seismic failure mode. For the WPHC collapse failure mode, the breach probability was conservatively set to guaranteed failure with the ASSUMED-BREACH basic event. (Note that the basic event "Assumed-Breach" is not an assumption, but is common terminology used to denote a scenario where the waste container is conservatively considered to be breached.) For the WPHC heavy object drop failure mode, the breach probability is represented by the basic

event 060-TWP-WPHC-OBJ-PFA. These passive equipment failure probabilities are discussed in Section 4.3.3.5.

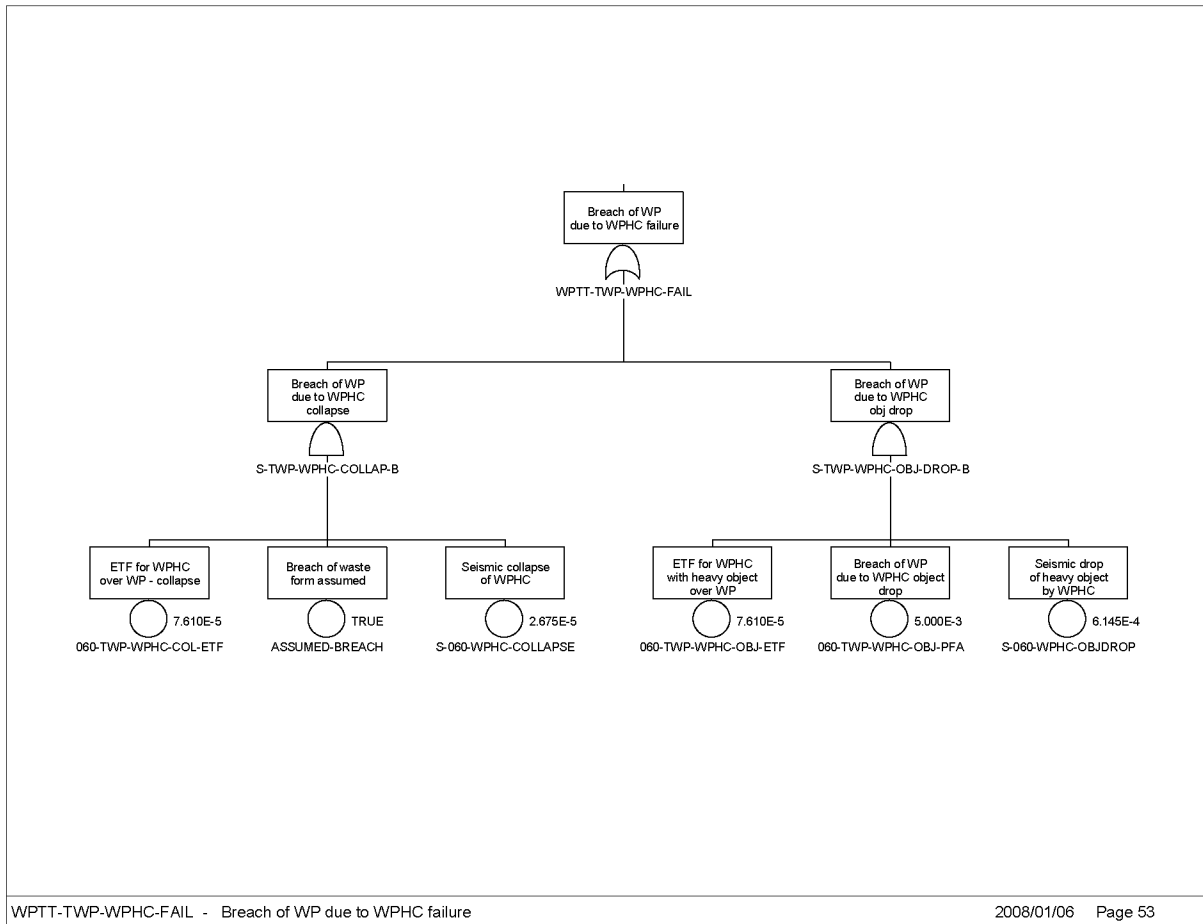

Source: Original

Figure 4.3-6. Example WPHC Breach Seismic Fault Tree

While these two fault tree types are the most typical, there are other seismic fault trees for other pivotal events, such as MODERATION on the SRETs.

After the seismic event trees and fault trees are constructed, the values for the basic events must be determined. The calculation of the seismic fragilities to determine the seismic failure mode probabilities was discussed in Section 4.3.2. The next sections discuss:

- Determination of number of waste containers processed in each facility
- Exposure/residence time fractions
- Breach probabilities.

4.3.3.3 Waste Container Throughput Analysis

As discussed more in Section 4.5, the seismic event sequence quantification is performed for the preclosure period as a whole in order to directly compare with the 10 CFR Part 63 (Ref. 2.3.1) compliance criteria. Therefore, the total number of waste containers handled in each facility and process is needed. This seismic event sequence analysis uses the same source for these numbers as the internal events analysis, *Waste Form Throughputs for Preclosure Safety Analysis* (Ref. 2.2.51). Tables 3 and 4 from that reference are used in the seismic analysis. The actual numbers used are provided later in Section 6 for each facility and waste container process.

4.3.3.4 Exposure/Residence Time Factors

An earthquake can occur at any time during the preclosure period and cause seismic failures of SSCs. However, most of the SSCs are not involved in waste handling operations 24 hours a day for 50 years. An SSC must be handling a waste container, or in close proximity, to potentially impact the waste container. Even for structures, there must be a waste container in the building in order for building collapse to damage the waste container. In risk analysis, this critical time when undesired outcomes could occur can be termed the exposure time. For example, for the event sequence involving the drop of a waste container by the cask handling crane (CHC) due to a seismic event, the time period when the container is being lifted or moved by the CHC is identified as the exposure time that will permit the potential event sequence. As a conditional requirement, the drop of the waste container by the CHC can only be caused by the earthquake when the waste container is actively being lifted by the CHC.

To determine the amount of time the waste container is exposed to a specific hazard, the expected times of each waste handling process in each facility were evaluated. Preliminary throughput estimates for waste handling in the CRCF (Ref. 2.2.41), IHF (Ref. 2.2.42), RF (Ref. 2.2.43) and the WHF (Ref. 2.2.44) were analyzed to identify when a waste container is in an exposed configuration.

As illustrated in Figure 4.3-7, for the evaluation of exposure times, a row-column format (spreadsheet) approach was adopted with the waste processing activities and times identified vertically along the left side of the spreadsheet (on a row by row basis), and the potential SSC seismic failure modes identified horizontally across the top of the form. When a specific activity exposes the waste container to an SSC seismic failure mode, the activity time (in minutes) is entered in the appropriate SSC seismic failure mode column (such as drop of the waste container by the CHC). Upon completion, the sum of the entire column at the base of the spreadsheet identifies the expected total exposure time (in minutes) for the SSC seismic failure mode for a single waste container during the identified process.

Since the seismic hazard is represented in terms of frequency per year, the exposure time factor is given in terms of “years per single waste container.” The exposure time factor varies for each SSC seismic failure mode, for each processing activity, and for each facility. The result is the exposure time by SSC seismic failure mode per waste container processed.

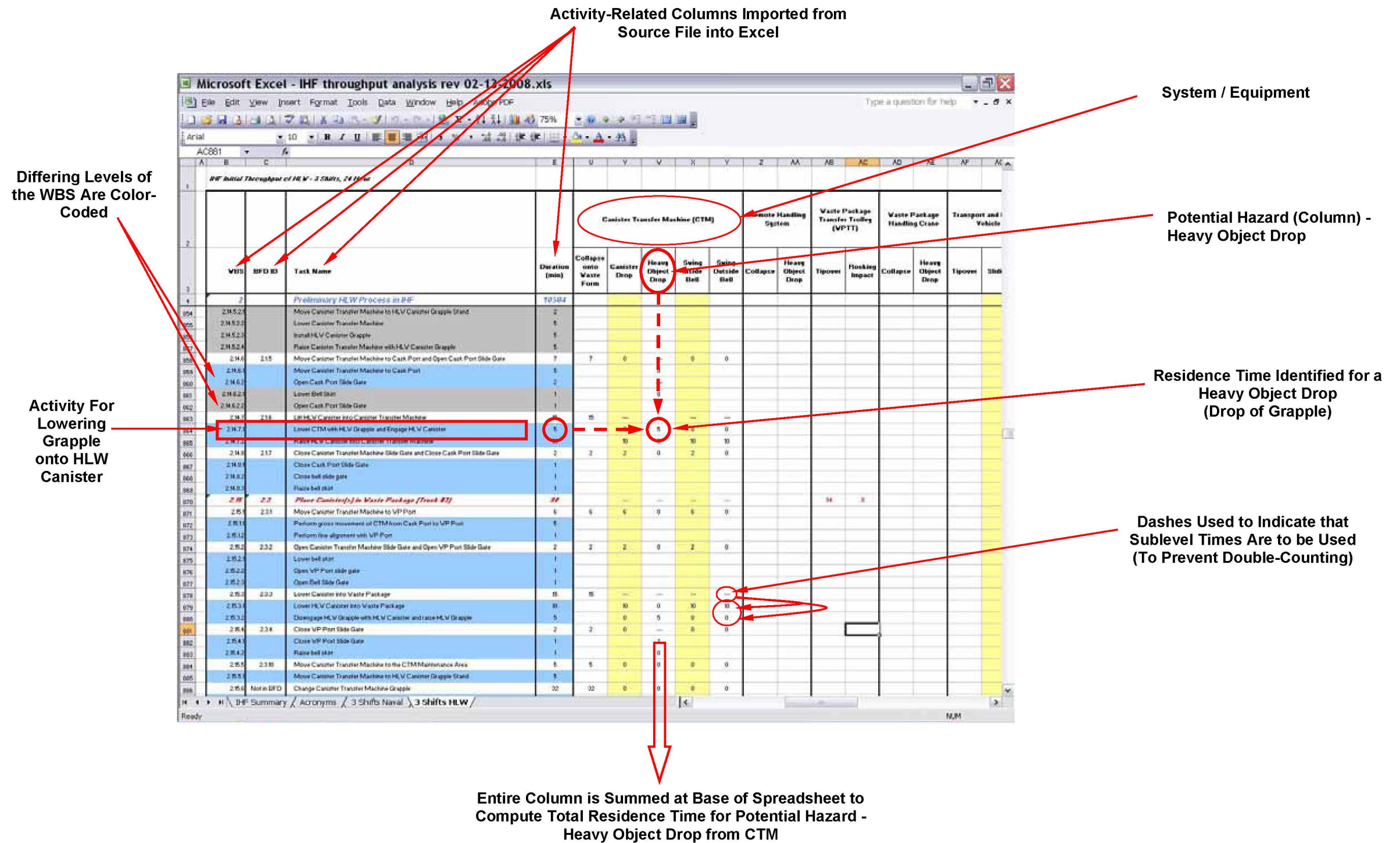

Source: Original

Figure 4.3-7. Example of Residence Time Evaluation Using Excel Spreadsheets

4.3.3.5 Passive Equipment Failure Analysis

The probability of waste container (e.g., transportation cask, waste package, or TAD canister) breach due to seismic failure of an SSC is dependent on a number of factors, including the type of container, the mode of seismic failure, and the load imparted by the SSC failure onto the container, which can vary by earthquake magnitude and seismic failure scenario. In general, the seismic failures involve:

- Drop of a container
- Drop of a heavy object onto a container
- Collapse of an SSC onto a container
- Lateral impact of a container.

The conditional probability of container breach, given one of these seismic failures, has been calculated for a large number of scenarios, which are collectively termed the passive equipment failure analysis. While some of the calculations are based on experiments (i.e., test drops of containers), most of the passive equipment failure analysis is based on simulations or finite element analysis. Attachment H contains a summary of the primary documents that have examined passive failures relevant to YMP.

Waste containers may fail from manufacturing defects, and normal and abnormal use. Industry codes, such as *ASCE 7* (Ref. 2.2.4) and *ASME Boiler and Pressure Vessel* (Ref. 2.2.6) establish design load combinations for passive structures (such as building supports) and components (such as canisters). These codes specify design basis load combinations and provide the method to establish allowable stresses. Typical load combinations for buildings involve snow load, dead (mass) load, live occupancy load, wind load, and earthquake load. Typical load combinations for canisters and casks are found in the *ASME Boiler and Pressure Vessel Code, Section III*, and would include, for example, preloads or pre-stresses, internal pressurization and drop loads, which are specified in terms of acceleration. Design basis load combinations are purposefully specified to conservatively encompass anticipated normal operational conditions as well as uncertainties in material properties and analysis. Therefore, passive components, when designed to codes and standards and in the absence of significant aging, generally fail because of load combinations or individual loads that are much more severe than those anticipated by the codes. Fortunately, the conservative nature of establishing the design basis coupled with the low probability of multiple design basis loads occurring concurrently, often means a significant margin or factor of safety exists between the design point and actual failure. The approach used in the PCSA takes advantage of the design margins (or factor of safety).

The development of code requirements for minimum design loads in buildings and other structures in the late 1970's considered multiple loads. A probabilistic basis for structural reliability was developed as part of the development of *Development of a Probability Based Load Criterion for American National Standard A58, Building Code Requirements for Minimum Design Loads in Buildings and Other Structures* (Ref. 2.2.85). This document refers to classic structural reliability theory. In this theory, each structure has a limit state (e.g. yield or ultimate), such that, loads and resistances are characterized by Equation 4.3-2:

$$g(x_1, x_2, \dots, x_i, \dots, x_n) = 0 \quad (\text{Eq. 4.3-2})$$

In Equation 4.3-2, g is termed the limit-state variable where failure is defined as $g < 0$ and the x_i are resistance (sometimes called capacity or fragility) variables or load (sometimes called stress or demand) variables. The probability of failure of a structure is given, in general, by Equation 4.3-3:

$$P_f = \int \dots \int f_x(x_1, x_2, \dots, x_i, \dots, x_n) dx_1 dx_2 \dots dx_n \quad (\text{Eq. 4.3-3})$$

Where f_x is the joint probability density function (PDF) of x_i and the integral is over the region in which $g < 0$. The fact that these variables are represented by probability distributions implies that absolutely precise values are not known. In other words, the variable values are uncertain. This concept is illustrated in Figure 4.3-8. Codes and standards, such as *ASCE 7-98* (Ref. 2.2.2), guide the process of designing structures such that there is a margin, often called a factor of safety, between the load and resistance. The factor of safety is established in recognition that quantities, methods used to evaluate them, and tests used to ascertain material strength give rise to uncertainty. A heuristic measure of the factor of safety is the distance between the mean values of the two curves.

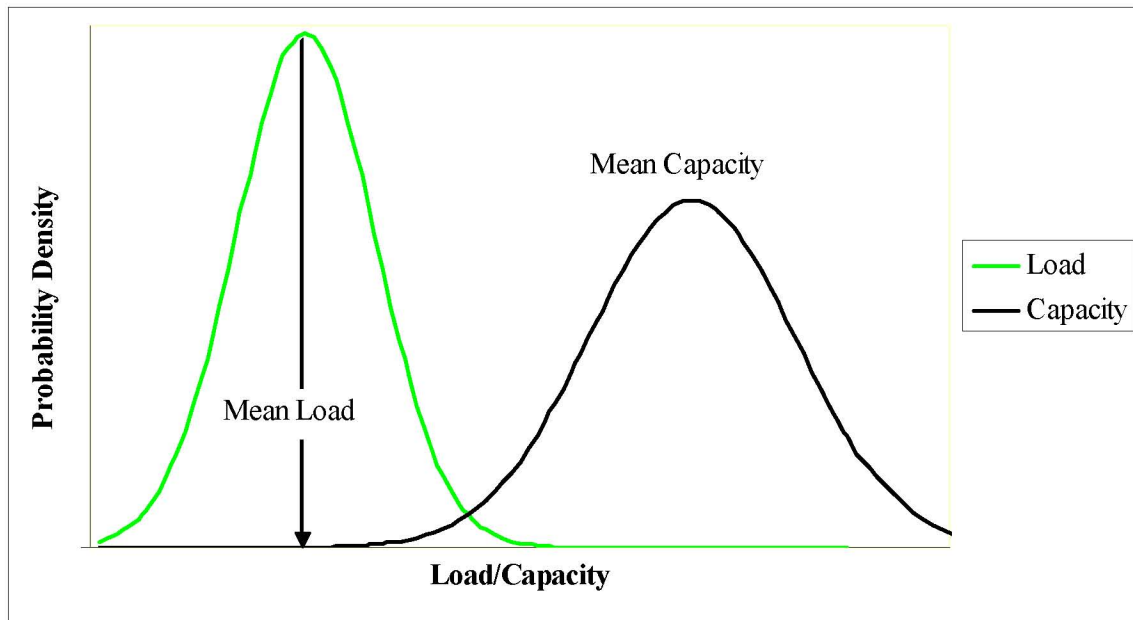

Source: Original

Figure 4.3-8. Concept of Uncertainty in Load and Resistance

In the case in which Equations 4.3-2 and 4.3-3 are approximated by one variable representing resistance and the other representing load, each of which is a function of the same independent variable y , the more familiar load-capacity interference integral results as shown in Equation 4.3-4.

$$P_f = \int F(y)h(y)dy \quad (\text{Eq. 4.3-4})$$

P_f is the mean probability of failure and is appropriate for use when comparing to a probability criterion such as one in a million. In Equation 4.3-4, $F(y)$ represents the cumulative density function (CDF) of passive equipment structural capacity and $h(y)$ represents the PDF of the load. The former is sometimes called the fragility function and the latter is sometimes called the hazard function.

To analyze the probability of breach of a dropped canister, y is typically in units of strain, F is typically a fragility function, which provides the conditional probability of breach given a strain; and h is the probability density function of the strain that would emerge from the drop. (Note that this same formulation is used in the seismic risk quantification, where h represents the seismic motion input, y is in units of PGA, and F is the seismic fragility. This is discussed in Section 4.5.) Degradation of shielding owing to impact loads uses a strain to failure criterion within the simplified approach of Equation 4.3-5, described below.

If load and capacity are known, then Equations 4.3-3 and 4.3-4 provide a single valued result, which is the mean probability of failure. Each function in Figure 4.3-7 is characterized by a mean value, \bar{L} and \bar{C} , and a measure of the uncertainty, generally the standard deviation, usually denoted by σ_L and σ_C for L and C , respectively. The spread of the functions may be expressed, alternatively, by the corresponding coefficient of variation (V) given by the ratio of standard deviation to mean, or $V_L = \sigma_L/\bar{L}$ and $V_C = \sigma_C/\bar{C}$ for load and capacity, respectively. The coefficient of variation may be thought of as a measure of dispersion expressed in terms of the number of means.

In the passive equipment failure analysis, the capacity curve for developing the fragility of casks and canisters against drops was constructed by a statistical fit to tensile elongation to failure tests (Ref. 2.2.71). The load curve may be constructed by varying drop height. A cumulative distribution function may be fit to a locus of points each of which is the product of drop height frequency and strain given drop height.

Impact Events Associated with Container Breach

A simplification of Equation 4.3-4, consistent with HLWRS-ISG-02 (Ref. 2.2.102), and shown in Equation 4.3-5 is used in the PCSA for container breach. It is illustrated in Figure 4.3-9.

$$P_f = \int_0^h F(y)dy \quad (\text{Eq. 4.3-5})$$

In Equation 4.3-5, h is a single value conservative load.

The load is a single value estimated by performing a calculation for a condition more severe than the mean. For example, the normal lift height of the bottom of a canister in the CRCF is 23 feet. However, canisters were analyzed for a drop height 32.5 feet and applied to all drop heights equal to or below this height. The conditional probability of breach is an increasing function of drop height. Strain resulting from drops is calculated by dynamic finite element analysis using LS-DYNA for canisters and transportation cask drops (Ref. 2.2.71). Therefore, use of a higher than mean drop height for the load for all drop heights, results in a conservative estimate of

breach probability. As an additional conservatism, a lower limit of breach probability of $1E-05$ was placed on drops of casks, canisters, and waste packages. To perform the analyses, representative canisters and casks were selected from the variety of available designs in current use which were relatively thin walled on the sides and bottom. This added another conservative element.

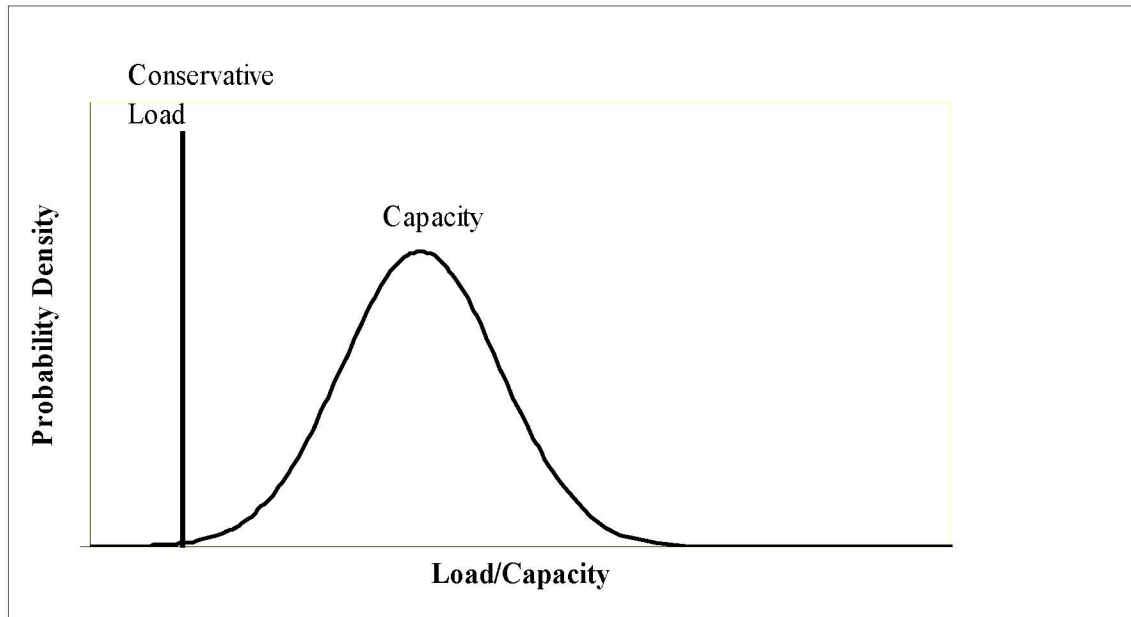

Source: Original

Figure 4.3-9. Point Estimate Load Approximation Used in PCSA

The PCSA applies passive equipment failure analyses (PEFAs) to a wide variety of event sequences including those associated with:

- Canister drops
- Canister collisions with other objects and structures
- Other objects dropped on canisters
- Transportation cask drops and subsequent slap-downs (analyzed without impact limiters)
- Conveyance derailments, lateral impacts and tipovers when carrying transportation casks and canisters (conveyances would be trucks, railcars, CTTs, and site transporters)
- Other objects dropped on transportation casks
- Waste package drops and lateral impacts
- Waste package impact with other waste packages

- TEV derailment or tipover when carrying a waste package
- Objects dropped on waste packages
- Objects dropped on TEV.

Many of these, such as lateral impacts, derailments, and objects dropped onto casks/canisters, involve far lower energy loads than drop events. For impact loads that are far less energetic than drops, the drop probability can be ratioed by impact energy to estimate the less energetic situation.

In addition to the potential seismic failures of SSCs that could impact the waste container, the seismic event itself will cause vibratory motion that can potentially cause the canister to move inside the cask, waste package, shield bell, or aging overpack. General vibratory motion is not a controlling failure mechanism for the seismic event sequences and represents an insignificant challenge to casks and canisters. Canisters are within a CTT, WPTT, aging overpack, or TEV except when in the shield bell, or being transferred between the cask, aging overpack, or waste package and the shield bell. Any relative vertical motion of the canister inside the container would be very limited, and certainly bounded by the evaluation of drops discussed in Attachment H. In a similar manner, the potential lateral motion of a canister inside a container would have a very low impact velocity. Shield bell interactions have been analyzed, as have swinging motions while lifting. Interactions of the canister with the cask or waste package within the CTT and WPTT are not controlling when compared to the interactions of the canister/cask/CTT system acting together or the WPTT/waste package/canister system acting together, which are analyzed. The interaction of the canister with the waste package is also bounded by the interaction of the canister/waste package within the TEV, which is explicitly analyzed.

In particular, the canisters in transportation casks and waste packages are designed to have a relatively snug fit to reduce the forces of such lateral impacts. In the aging overpacks, spacers are used to minimize lateral forces. As discussed in Attachment H, the canisters have very low PEFAs even at relatively high impact velocities. For example, the failure probability for the canister in a 20 ft/s lateral impact (based on a 6-ft horizontal drop with a 3 degree off-horizontal orientation) in a transportation cask is $<1E-08$ (Attachment H, Table H1.2-4, condition T.IC 3). Such high velocities when constrained by the cask, waste package, or aging overpack, are not credible for even the $1E-06$ APE seismic event accelerations. Therefore, based on this discussion and the analyses described in Attachment H, the potential failure of canisters inside casks, waste packages, or aging overpacks subject only to general seismic vibratory motion is not included further in the seismic event sequence assessment. The potential impacts for canisters inside the shield bell are included in the event sequences for the CTM, and discussed in Section 6.2.2.12.

The passive equipment failure probabilities are listed for each seismic failure mode in Section 6.

Shielding Degradation Events

Impact loads (such as drops) may not be severe enough to breach a transportation cask, but might lead to degradation of shielding such that onsite nearby personnel are exposed. However,

degradation of shielding events would not cause any significant offsite dose, and would therefore not be significant to seismic risk (see discussion in Section 4.4.12). The shielding degradation analysis for the seismic event analysis used the internal events analysis as a basis. Since shielding degradation is not significant for seismic events, the discussion of shielding passive failure analysis is not repeated in this document. For more information on shielding degradation, see, for example, Section 4.3.2.2, Passive Equipment Failure Analysis, and Attachment D.3, Shielding Degradation Events in *CRCF Reliability and Event Sequence Categorization Analysis* (Ref. 2.2.59).

There is, however, one seismic induced failure that results in shielding failure. If the seismic event causes the waste package to be ejected from the TEV, then the TEV shielding is no longer functioning, and shielding is lost. This loss of shielding is directly modeled in the appropriate seismic event sequences.

4.4 SPECIAL ISSUES

This section describes the methods used to incorporate or resolve the following special issues:

- Human failure events (HFEs) in seismic event sequences
- Non-seismic equipment failures in seismic event sequences
- Seismic failures after internal initiating events
- Seismic-induced relay chatter
- Seismic-induced fires and floods
- Seismic spatial system interactions (two-over-one issue)
- Unique seismic interactions
- Liquefaction of soils
- Loss of ventilation to the emplacement drifts
- Seismic-induced fault displacement hazards
- Ground motion due to underground nuclear explosions
- Category 1 seismic event sequences.

4.4.1 Human Failure Events in Seismic Event Sequences

The ANSI/ANS 58.21-2007 standard on external-events PRA (Ref. 2.2.1) states that non-seismic failures and human errors should be addressed in seismic PRAs. This recommendation was based on reviews of nuclear power plant seismic PRAs, as well as general concerns that the seismic PRA should be comprehensive, and should address these potential failures.

Large magnitude earthquakes can increase the probability of human error, particularly for actions that must be performed immediately after a seismic event. A seismic event can increase the stress on personnel, with potential further complications of blocked access, misleading or missing instrumentation, and communication degradation. At nuclear power plants, there can be a number of critical actions that must be performed during the first few minutes to 1 hour. In particular, relay chatter in circuits of critical safety equipment can cause spurious operation of equipment, such as closure of valves, or opening of circuit breakers removing power from critical pumps. If not rapidly corrected, the nuclear power plant could be damaged. However, the YMP facilities and systems do not face the same challenges.

Waste-handling operations at the GROA after a significant earthquake, however, would be halted by both a potential loss of offsite power, and by seismic shutoff switches on the major equipment. Interruption of electrical power to the nuclear facilities occurs from undervoltage relays. On loss of offsite power, the emergency diesel generators would auto-start, and power the ITS switchgear that feeds the ITS HVAC system. Although power may be restored, either from offsite or the standby diesel generators, power would not be routed to the non-critical loads without manual intervention. In addition, electrical power would be removed from the motors of a waste handling crane in a facility, through seismic shutoff switches, and operator controls would not be functional. The brakes on the hoist and crane trolleys would automatically actuate upon loss of power. For the CTT, the electrical shutoff switch closes the main air supply valve, which results in the trolley settling to the floor, and the air-powered driving motors will stop, leaving the CTT in a safe, stopped position. There are no required actions by equipment operators to secure SSCs or respond to the impacts of a seismic event on a facility. Power can not be restored until restoration of electrical interlocks, and the equipment startup sequence is completed with no faults. Procedures would prevent restoration of these interlocks until stabilization of the facility and further inspections.

The waste-handling operations were reviewed for all major operations, particularly for immediate operator actions. No HFEs, either of commission or omission, were identified that could lead to a significant seismic event sequence. In addition, the human reliability analyses for each of the facilities (e.g., Ref. 2.2.59, Attachment E) did not identify any HFEs that were response-to-initiator related. Only HFEs that could cause an initiator, or were pre-initiator errors such as miscalibration of instruments were identified for the facilities. The occurrence of a seismic event, therefore, does not require modeling of specific HFEs in the PCSA.

4.4.2 Non-seismic Equipment Failures in Seismic Event Sequences

Equipment could also fail after a seismic event due to purely random failures, such as fail to start or fail to run of a fan. While the random failure rate of most equipment is low compared to the seismic fragility of the equipment during an earthquake, the concern is that some equipment does have relatively higher failure rates. At nuclear power plants the failures to start and run modes of diesel generators and turbine driven pumps have generic failure rates that are higher than other active equipment. Since the diesel generators are critical to power the cooling and decay heat removal systems after a seismic event, and the turbine driven pumps are their usual backup, their random unavailability can impact the seismic risk at a nuclear power plant.

Waste-handling operations at the GROA, however, are halted after a seismic event. In fact, as stated above the power is removed from major equipment after a significant seismic event by the loss of offsite power and the seismic shutoff switches. In addition, the HVAC system was not included as a mitigation system in the seismic event sequence analysis, as discussed in Section 4.3.3 above. Therefore, it was not necessary to model the power system, including the diesel generators, in the seismic analysis. While it is expected that the diesel generators would start and run, they are not required to fulfill any safety function in the seismic analysis. There are no turbine driven pumps involved with waste-handling operations at the GROA. No other random failures of equipment were identified in the waste-handling operations that could impact seismic risk in a significant manner.

The occurrence of a seismic event, therefore, does not require modeling of random equipment failures in the PCSA.

4.4.3 Seismic Failures After Internal Initiating Events

There are two types of event sequences in which one or more seismic failures can intervene: those where the seismic event itself is the initiating event, and those where the seismic event randomly occurs while an event sequence initiated by an internal initiating event is already unfolding. As with seismic PRAs at nuclear power plants, this analysis focuses on the seismic event being the initiating event.

However, a seismic event could randomly occur after an event sequence initiated by an internal event and influence its unfolding. For example, mechanical failures of a CTM could cause a TAD canister to be dropped and breached during its handling inside a CRCF; in response, a 720-hr (30-day) confinement and filtering mission is assigned to the HVAC system. Should a seismic event occur over this period of time, the PCSA considers that the HVAC system could become inoperable. As a consequence, the seismic event could be a contributor to the probability of failure of the HVAC over its mission time. Similarly, the seismic event could cause the rupture of piping, potentially leading to moderator entry inside the breached canister.

To address this issue, the following review of the contribution of seismically induced failures to the conditional failure probability of the pivotal events that intervene in event sequences initiated by internal events was performed. In the Reliability and Event Sequence Categorization Analysis reports for the facilities (e.g., Ref. 2.2.59), the quantification of internal event sequence probabilities includes the following types of pivotal events:

1. Number of waste containers to be processed during the preclosure period
2. Accident initiating event probability per waste container processed
3. Conditional probabilities of breaches, given the accident initiating event
4. Conditional probability of shielding failure, given the accident initiating event
5. Conditional probability of HVAC/confinement failure, given the accident initiating event and breach
6. Conditional probability of moderator entering the canister, given the accident initiating event and breach.

The potential seismic impacts on each of these pivotal events are evaluated below.

Pivotal events 1, 3, and 4, above, do not have seismic dependencies. Therefore seismic failures are not appropriate for their analysis or quantification.

Pivotal event 2, the accident initiating event probability, has two potential seismic dependencies. First, the seismic event can directly cause an accident initiating event, such as a crane failure. These seismic initiating events are the main focus of this calculation, and are treated in detail in

this document. Therefore, the seismic initiating events should not be considered or double-counted in the internal events analysis.

Accidents can also be initiated by human failures or errors, although it is most likely that the operator would stop any ongoing activity when the earthquake is felt. As discussed above in Section 4.4.1, power is removed from the major equipment by the seismic shutoff switches if an earthquake occurs, and the equipment is stopped in a safe state. The operator controls would not be functional. Power can not be restored until restoration of electrical interlocks. PSCs would prevent restoration of these interlocks until stabilization of the facility and further inspections. Therefore, although stress on the operators would increase during a seismic event, it would not impact the accident initiating event probability.

Pivotal event 5, the conditional probability of HVAC/confinement failure, can be impacted by a seismic event subsequent to an unfolding internal initiating event. For failure of the HVAC/confinement system in conjunction with an internal accident initiating event, the seismic event would need to occur during the 30-day mission time of the HVAC. (Note that HVAC is ITS only for the CRCF, WHF, and RF.) The seismic event could impact the HVAC system, the supporting electrical power system, the doors maintaining confinement, or the building itself. A simplified, very conservative sensitivity study was performed to evaluate the probability of a seismic event within 30 days following an internal accident initiator and breach, and compare that probability with the non-seismic failure probability of the HVAC/confinement during the 30 day mission time. The non-seismic failure probability, based on CRCF quantification of the HVAC pivotal event, is about $2.3E-02$ per demand (30-day mission time) (Ref. 2.2.59, Figure B-3).

To develop the simplified, conservative model of the HVAC/confinement system, representative fragilities for the critical equipment and structures, including HVAC, power system, doors, and building were reviewed to determine the lowest capacity components. In this case, the offsite power system has a much lower seismic capacity than any of the other systems or structures. For example, the median capacity of the offsite power system is 0.3g (Ref. 2.2.60, Table 5, Item M), while the next lowest capacity for the HVAC system was 1.4g (Ref. 2.2.60, Table 5, welded anchorage). The yearly probability of a seismic event that fails offsite power, calculated with SAPHIRE, is about $1.5E-03$ /yr. For the 30-day mission time, the probability is $1.3E-04$ per demand ($1.5E-03$ per year \times 30 days / 365 days per year). This is over 2 orders of magnitude lower than the non-seismic failure probability of $2.3E-02$ given above for the HVAC system. Since the other HVAC equipment and structures have higher seismic capacities than offsite power, the probabilities of their failures would be even less. Thus, for internal accident sequences, the seismic failure of the HVAC/confinement system is not a significant contributor to the overall failure of the system.

Pivotal event 6, the conditional probability of moderator entering the canister, may also have seismic dependencies, since the contributors to this event are cracked or ruptured piping, and gear box leaks. The piping systems (chilled water, potable water, hot water, demineralized water, and fire protection water) are generally designed to seismic requirements in the *International Building Code* (IBC) (Ref. 2.2.90). Also, note that the fire protection water piping in rooms that can contain waste containers is pre-action dry pipe with sprinkler heads. The deluge valves are located outside the waste container rooms, and have double interlocks to

prevent inadvertent actuation. Using SAPHIRE, the probability of a seismic failure of IBC piping during the 30-day mission time is about $3E-05$ per accident demand. Based on the CRCF moderator fault tree analysis (Ref. 2.2.59, Figure B9.2-1), the non-seismic moderator failure is $1.1E-04$. Thus, the seismic contribution to piping failures would be at least a factor of 3 less than the internal moderator failure probability. These moderator failure estimates only include the initial failures providing a source of moderator. The moderator must still surround the breached waste container, and gain entry through the breach. Other factors reducing potential moderator failure, such as floor drains and doors, are conservatively not included in the internal events analysis. Since internal event sequences with moderator failures are not significant contributors to facility risk, the potential impacts of seismic moderator failures do not need to be added to the internal event moderator fault trees.

Based on consideration of the six types of pivotal events in the internal event sequence quantification, a coincidental seismic failure in conjunction with unfolding random internal event sequences would not be a significant contributor to the event sequence. Also, such event sequences have no more severe consequences than the more frequent event sequences where the seismic event occurs first (e.g., where the seismic event is the initiating event). Therefore, the seismic event sequence quantification can focus on accident sequences initiated by a seismic event, and not further quantify the impact of seismic failures on internal event sequences.

4.4.4 Impacts of Seismic-induced Relay Chatter

At nuclear power plants, relay chatter caused by a seismic event can induce spurious operation of components and equipment. Typical concerns are:

- Mis-positioning of equipment
- Inadvertent starting or stopping of equipment
- Misleading indications in control rooms.

While relay chatter can lead to undesired states in nuclear power plants, it does not pose a significant hazard for waste-handling operations at the GROA, for the following reasons.

- Active waste-handling operations at the facilities (such as crane lifts, remote welding operations, CTT air pallet transfers, TEV transfers) require power to continue. After an earthquake, the loss of offsite power and the seismic shutoff switches will remove power to these major components, such that the operations are ceased. (The circuit design of the seismic shutoff switches is not detailed, but it would be fail-safe for seismic events, since that is its design purpose.) Relay chatter, if there are relays in the equipment controls, would not impact the equipment once power is removed. For example, the cranes would stop and the brakes would automatically engage (fail-safe), the welding operations would be halted, the CTT air supply would be isolated such that movement would stop, and the TEV would stop with brakes automatically engaged. If the site transporter is inside a building, its electric power would be isolated. Manual reset is required to restore power. Thus, the removal of power would stop any relay chatter impacts for the major active operations.

- There are some relay-based safety systems that prevent accident initiators. Examples include switches that prevent hoists from travelling too high, switches that prevent crane trolleys from impacting the end stops, and interlocks that prevent CTT movement until the restraint pins are inserted. All of these systems are designed to be fail-safe, such that chatter would lock in the safety function, and manual reset would be necessary before further operation. In addition, the loss of offsite power and the seismic shutoff switch would remove power from the major waste-handling equipment, stopping the operation.
- There are some systems that may also have relays that isolate power. For example, the large transformers may have sudden pressure switches that isolate power from the transformer. If these switches actuate during the seismic event, power would be lost from that transformer until manual circuit reset. As discussed previously, the seismic event sequences do not take credit for any systems powered by offsite power, or the diesel generators, so transformer isolation would not impact the event sequences. Another example is over-current and under-voltage relays on switchgear. If relays are used for these circuits, they are usually lock-out relays that isolate power from the equipment, and must be manually reset. While systems such as the HVAC would be impacted until power is restored, the seismic PCSA does not take credit for the HVAC. Therefore, relay chatter in these types of circuits would not impact seismic risk.
- Misleading indication or spurious operation of equipment from the Control Center could occur during a seismic event if relays are used in the circuits, or switches used to gather equipment status (such as level switches in tanks or pools, or pressure/temperature switches in process systems). However, the digital control and management information system is designed such that it cannot affect motion of any ITS equipment, except for TEV permissives. In addition, most of the control systems and sensors are expected to be solid-state based systems, including the programmable logic controller systems. Solid-state control systems have very high seismic capacities, and are not considered to be impacted by seismic events. Also, hand switches on control boards used by the operators have very high seismic capacities, and would not chatter. While there could still be relays and switches in portions of the control and information systems, the circuits are designed such that the displays are easily reset to provide information to the operators.

There is one potential seismic relay chatter issue that is included in the seismic model. The fire protection system has preaction valves to prevent spurious actuation of the water sprays. While the design is not detailed enough to determine if relay chatter would be a potential issue, the potential was included in the model for relay chatter that could spuriously open the preaction valve, and allow water to flow into the spray headers. This is modeled for the moderator fault tree, since the fire protection water piping could fail during a seismic event.

Based on all of the above considerations, relay chatter is not a significant issue for the seismic event sequences. However, it is modeled for spurious operation of the fire protection pre-action valves.

4.4.5 Seismic-induced Fires and Floods

Concerns have been raised at nuclear power plants about the potential for seismic-induced fires or floods. Generally this issue is resolved through a walkdown process in the facility. The liquid and gaseous combustibles piping and tanks are reviewed to identify seismic failures that could release the flammables, identify potential ignition sources if released, and determine the impact of a fire on important systems. Tanks and piping systems are reviewed for seismic failure, and the impact of flooding on systems is evaluated. This walkdown process cannot be performed yet since the facility is only in the design process.

Therefore, a review of potential fire and flood sources, and impacts was performed. The internal events fire analysis reviewed the location and amounts of combustibles in each of the waste-handling facilities. There are no large sources of liquid or gaseous combustibles inside the facilities. Flammable gases are limited to bottled gases, for purposes such as welding. General industrial practice requires restraints be used for storage of bottled gases, which would prevent their movement during a seismic event. Flammable liquids inside vehicles (such as the prime mover, trucks, or site transporter) are limited in volume, and there is no significant seismic failure mode which would cause release. The prime mover and truck cabs are removed from the facility when not actually in use. The site transporter uses electrical power inside the facility, and has a high seismic capacity against tipover. While there may be other flammable liquids in the waste-handling facilities, such as cleaning fluids, paint, or solvents, these are generally in small quantities, and their storage is in areas (and fire-rated storage lockers) away from the rooms handling the waste containers. Therefore, the frequency and size of any seismic-induced fire in the facilities would not be significant to seismic risk. Also note that the frequency of any seismic-induced fire would be much less than the non-seismic fire ignition frequency for the facilities, which ranges from 0.02 to 0.1 per year (e.g., Ref. 2.2.59, Attachment F).

Seismic-induced flooding at nuclear power plants is an issue since it could short-out the electrical power to active safety system equipment, or flood active equipment such as pumps and fans. However, for the GROA facilities, as discussed previously, the seismic event sequence analysis does not credit electrical power, or any active safety systems depending on power. Seismic-induced flooding is considered in the seismic analysis for moderator intrusion, where water is available to enter a breached waste container. No credible flooding impacts, other than this moderator intrusion (which is already included in the analysis), have been identified that can be induced by a seismic flooding event.

4.4.6 Seismic Spatial System Interactions (Two-over-One Issue)

One of the seismic interaction concerns in the nuclear power industry is the issue of physical proximity of equipment and structures that can cause seismic failures of one item to physically impact another. This concern has been referred to as the two-over-one issue, and has been evaluated at all nuclear power plants, generally through walkdowns and calculations. For the waste-handling operations at the GROA facilities, the major spatial interactions are included directly in the seismic event sequence analysis. There are many examples, such as the entry doors falling on the transport casks, shield doors falling on the CTT or WPTT, and cranes falling on casks, canisters, or waste packages.

Further, the assignment of DBGGM levels will be extended as necessary to portions, parts, subparts or subsystems of an SSC when the response of such items could adversely affect the safety function performance of an ITS SSC in a seismically-induced event sequence. The potential seismic interaction of a non-ITS SSC (source) with an ITS SSC (target) shall require the assignment of the DBGGM level of the target to the source, unless one of the following conditions can be demonstrated:

1. The interaction does not strike or significantly damage the ITS component, and therefore does not impair the performance of the safety function of the ITS SSC
2. The event sequence involving the interaction has a probability of less than 1 chance in 10,000 over the preclosure period (without reliance on the non-ITS SSC to mitigate or prevent the sequence)
3. The consequence of the event sequence involving the interaction does not result in a dose in excess of the 10 CFR 63.111 (Ref. 2.3.1) performance standards.

If none of the above conditions are met, a preclosure safety requirement shall be applied, and the relevant portions, parts, subparts or subsystems of the source SSC(s) shall be required to be designed to the same seismic DBGGM level as the target SSC. However, the source SSC may or may not be designated as ITS, as considered appropriate (Ref. 2.2.80, Section 3.1.2).

Thus, the major seismic spatial system interactions are directly included in the seismic event sequence analysis. If other spatial interactions are identified as the design and construction is advanced, there is proper guidance for classifying and evaluating these potential interactions.

4.4.7 Unique Seismic Interactions

Another concern for seismic events is the potential for site-unique features to fail due the seismic event, and lead to a potential radiological consequence. These site-unique features are items such as hazardous chemical storage tanks (such as chlorine or ammonia), upstream dams that could flood a facility if breached, cooling water pond dams whose failure could degrade heat removal systems at a power plant, tall stacks or chimneys that could fail and damage SSCs nearby, or landslide areas that could damage SSCs due to a seismic event. The *External Events Hazards Screening Analysis* (Ref. 2.2.62) reviewed and screened many offsite hazards. There are no dams which are “upstream” of the waste handling facilities, and there are dike and ditch systems around the GROA to protect against flooding. The only significant buried pipelines are those associated with the underground diesel fuel oil storage for the emergency diesel generators. Since the diesel generator facility is physically separated from the waste handling facilities, seismic-induced pipeline failures would not impact the waste containers. Therefore, no site-unique features were identified whose seismic failure would impact the SSCs and lead to a potential radionuclide release.

4.4.8 Liquefaction of Soils

Although liquefaction of soils has been caused by earthquakes, it is not a potential problem at the GROA.

Liquefaction is a phenomenon in which the strength and stiffness of a saturated low-density soil is reduced significantly by earthquake shaking or other vibratory loading of sufficient magnitude. In effect, the soil becomes a suspension due to an increase in pore-water pressure, typically caused by the compaction of soils during intense shaking. Liquefaction can induce flow failure, ground oscillation, lateral spread of surface soils, and loss of bearing strength as well as induce slope failure.

The potential for liquefaction is based on several factors, including the potential for the local soil deposit to be saturated during the time period under consideration, the magnitude and nature of ground motions, the period of vibratory loading, the extent and depth of the soil deposit, the length of drainage paths, as well as the relative density and characteristics of the soil (e.g., grain size and cohesion).

In Midway Valley, where the repository surface facilities are to be constructed, the surface soils have a low in situ water content of 5 to 7% (Ref. 2.2.74, Section 6.4.1.1.2) and the groundwater table (e.g., the upper surface of the zone of saturation in an unconfined aquifer) lies approximately 1,270 ft (390 m) below the ground surface (Ref. 2.2.74, Section 7.1.12). In addition, there is no evidence that the soils have been saturated previously in recent times (i.e., they are above the historic high water table) or reasonable expectation that will become saturated, and therefore, no potential for liquefaction has been identified (e.g., Ref. 2.2.74, Section 7.1.12). Consistent with Regulatory Guide 1.198 (Ref. 2.2.103, pp. 1.198-5), such soils can be considered to pose no potential liquefaction hazard, and therefore liquefaction is not included in this analysis.

4.4.9 Loss of Ventilation to the Emplacement Drifts

Long term loss of ventilation to the emplacement drifts could result in high temperatures in the drifts, and in the waste packages. Specific analyses have been performed that demonstrate that the waste package response (stress intensity and temperature) to loads due to drift collapse and thermal loading is well within the waste package capabilities, and much lower than ultimate stresses (Ref. 2.2.29, Table 7-1, and Ref. 2.2.61). Since the waste packages are partially covered with the rock, this event is more severe than just a loss of drift ventilation. Therefore, the impacts of loss of ventilation are bounded by these analyses. Thus, loss of ventilation to the emplacement drifts would not cause breach of the waste packages, or a radionuclide release. Loss of ventilation for the emplacement drifts is discussed further in Section 6.9.2.2.

4.4.10 Seismic-induced Fault Displacement Hazards

Seismic events may also cause damage to SSCs if the earthquake causes fault displacements. Unlike vibratory ground motion hazard, fault displacement hazard is concentrated at the location of faults. Consequently, the exposure of SSCs to fault displacement hazard can be limited by avoiding the locations of faults that have a significant potential for fault displacement. Fault avoidance is the U.S. Department of Energy (DOE)-preferred approach to mitigating fault hazards (Ref. 2.2.80, Section 5).

Whether the potential for fault displacement is significant depends on the SSC in question. Reference 2.2.80 states that the hazard is judged significant when an explicit fault displacement

design might be necessary to accommodate the hazard. Conversely, the hazard is judged negligible—and fault displacement hazard avoidance is achieved—when the amplitude of displacement is so low that there clearly is no need for the SSC in question to have an explicit fault displacement design.

The ITS surface waste handling facilities, including the aging pads, have been specifically located to avoid potential faults. Fault displacement hazard avoidance may or may not be feasible for all subsurface SSCs that are spatially extended. A PSC requires that the emplacement of a waste package maintains a standoff distance from faults, or that an analysis is performed to specifically determine that conditions cannot credibly lead to a breach of the waste package (Table 6.10-7). In any case, if fault displacement hazard avoidance is not feasible for any SSC that is ITS, then it will be designed to accommodate the applicable design basis fault displacement without loss of safety function.

The justification and criteria for fault displacement hazard evaluation and design are described in more detail in *Preclosure Seismic Design and Performance Demonstration Methodology for a Geologic Repository at Yucca Mountain Topical Report*, (Ref. 2.2.80, Section 5). Fault displacement hazards are not considered further in this seismic event sequence evaluation.

4.4.11 Vibratory Ground Motion Due to Underground Nuclear Explosions

In addition to earthquakes, underground nuclear explosions (and other explosive detonations) can produce vibratory ground motions. Although such explosions can range to several hundred kilotons, evaluations have concluded that naturally-occurring motions from earthquakes control (e.g., bound) the seismic design criteria for both surface and subsurface facilities at Yucca Mountain (Ref. 2.2.65, Section 6.3.1.1.1). The significant distance from the testing areas of the Nevada Test Site to the repository site, and the natural attenuation of ground motions from such explosions support this conclusion.

Nuclear explosions can also induce secondary seismic effects. Secondary effects are associated with co-seismic strain release attributed to the release of tectonic strain, aftershocks due to tectonic strain release, and events due to the collapse of cavities created by the explosion (Ref. 2.2.79, pp. 5-24). From prior testing, beyond 3 to 6 miles of even the largest underground nuclear explosion (greater than 1 megaton), there was no evidence of significant secondary seismic effect associated with the test (Ref. 2.2.79, pp. 5-24). As the closest point of the underground testing areas to the repository is approximately 15 miles (to Area 6), no impact from secondary effects would be expected at the GROA from nuclear testing, in the event that additional nuclear testing were conducted.

Underground nuclear explosion testing has not been conducted at the Nevada Test Site since October 1992, and there are no current plans to resume such testing. In the unlikely event that underground nuclear explosion testing is resumed, the potential vibratory motions caused by underground nuclear explosion testing will be evaluated and, if necessary, included in seismic analyses, when the distribution in space, time, and magnitude (or yield) can be specified for such new tests (Ref. 2.2.110, Section A5). In the absence of planned testing, however, ground motions due to underground nuclear testing are not considered further in the present analyses

4.4.12 Category 1 Seismic Event Sequences

The seismic event sequence analysis is focused on potential radionuclide releases that can lead to offsite dose consequences. Potential seismic failures that could only lead to personnel exposure, with no significant offsite dose consequences, were not quantitatively assessed. For example, seismic failure of the concrete shield walls resulting in collapse and potential breach of a waste container is included in the assessment, while seismic cracking of the shield walls resulting in potential loss of shielding capability is not evaluated. Similarly, seismic collapse of the large shield doors dropping on waste containers is evaluated, but spurious opening of a shield door causing worker exposure is not evaluated. (Note that spurious opening of a shield door is evaluated as an internal event.)

The event sequences that are expected to occur one or more times before permanent closure of the GROA are designated as Category 1 event sequences (10 CFR 63.2), and the consequence criteria for this category are based on worker exposure and offsite dose consequences. If the event sequence frequency is less than Category 1, then the consequence criteria are based on higher offsite dose consequences.

Seismic event sequences that result in worker exposure are less than the Category 1 criterion, both because of the relatively low frequency of earthquakes, and the DBGGM used for design of SSCs that could impact worker exposure. Table 5-1 of the *Seismic Analysis and Design Approach Document* (Ref. 2.2.47) provides the requirement that SSCs that are designed to meet Category 1 event sequence criteria will be designed to the 1,000 year return period earthquake, which is equivalent to the $1\text{E-}03$ /yr annual exceedance frequency earthquake (which is about 0.3 g peak horizontal ground acceleration at the surface facilities area). Since the preclosure period is nominally 100 years, the probability of an earthquake that would exceed the design basis for Category 1 is 0.1 ($100 \text{ yr} \times 1\text{E-}03 \text{ /yr}$), which is less than the Category 1 criterion of one or more times before permanent closure, stated above. Therefore, the SSCs that could impact worker exposure are designed to a ground motion earthquake level that precludes failure of the SSC in Category 1 event sequences.

Potential seismic failures that could only lead to personnel exposure, or would not violate the Category 1 offsite dose consequences, are not further assessed.

4.5 QUANTIFICATION OF SEISMIC EVENT SEQUENCES

After the requisite inputs are developed (that is, the seismic hazard curve, the SSC fragilities, and the event tree / fault tree models), the seismic event sequences are quantitatively evaluated. The following quantification topics are discussed in this section:

- Facilities and operations to be quantified
- Quantification inputs and method
- Correlation of seismic failures
- Multiple seismic failures
- Seismic successes.

4.5.1 Facilities and Operations to be Quantified

The seismic event sequence quantification covers the following facilities and processes:

- IHF
 - Processing of naval canisters (from railcars with transportation casks entering the IHF, and transferred to waste package in the TEV leaving the IHF)
 - Processing of high level waste (HLW) canisters (from trucks with a transportation cask entering the IHF, and transferred to waste packages in the TEV leaving the IHF) (note that this truck delivery scenario bounds the case with railcars delivering HLW).
- RF
 - Processing of TAD canisters (from railcars with transportation casks entering the RF, and transferred to aging overpacks in the site transporter leaving the RF)
 - Processing of dual-purpose canisters (DPCs) (from railcars with transportation casks entering the RF, tilted on the railcar, and transferred to aging overpacks in the site transporter leaving the RF)
 - Processing of DPCs (from railcars with transportation casks entering the RF, tilted using the tilting frame, and transferred to aging overpacks in the site transporter leaving the RF)
 - Processing of DPCs (from railcars with horizontal transportation casks entering the RF, and transferred to the horizontal cask transport trailer leaving the RF).
- CRCF
 - Processing of TAD canisters (from railcars with transportation casks entering the CRCF, and transferred to aging overpacks in the site transporter leaving the CRCF)
 - Processing of DPCs (from railcars with transportation casks entering the CRCF, and transferred to aging overpacks in the site transporter leaving the CRCF)
 - Processing of TAD canisters (from aging overpacks in the site transporter entering the CRCF, and transferred to waste packages in the TEV leaving the CRCF)
 - Processing of HLW canisters (from railcars with transportation casks entering the CRCF, and transferred to waste packages in the TEV leaving the CRCF)
 - Processing of DOE standardized nuclear fuel (DSNF) canisters (from railcars with transportation casks entering the CRCF, and transferred to waste packages in the TEV leaving the CRCF)

- Processing of multicanister overpack (MCO) canisters (from railcars with transportation casks entering the CRCF, and transferred to waste packages in the TEV leaving the CRCF).
- WHF
 - Processing of DPCs (from railcars with transportation casks entering the WHF, transferred to STCs, and placed into the WHF pool for SNF assembly transfer)
 - Processing of transportation casks with bare SNF (from trucks with transportation casks entering the WHF, and placed into the WHF pool for SNF assembly transfer)
 - Transfer of the SNF assemblies (from the incoming DPC or bare SNF cask to the WHF SNF staging rack, then transferred to an empty TAD)
 - Processing of TAD canisters (from the pool station to an aging overpack leaving the WHF on the site transporter)
 - Loss of WHF HVAC system integrity resulting in radionuclide release.
- Intra-Site Operations
 - Movement of aging overpacks (with TAD or DPC) on the site transporter to and from the Aging Facility
 - Storage of aging overpacks at the Aging Facility
 - Movement of horizontal transportation casks (with DPC) on the horizontal cask transfer trailer to and from the Aging Facility
 - Storage of DPCs in the horizontal aging module (HAM) at the Aging Facility
 - Storage of low-level radioactive waste (LLW) at the LLW Facility
 - Temporary storage of transportation casks on railcars and trucks in buffer yard (before processing)
 - Movement of incoming railcars and truck trailers with transportation casks to the processing facilities.
- Subsurface Operations
 - Movement of waste packages in the TEV from the CRCF or IHF to the subsurface emplacement drifts
 - Storage of waste packages in subsurface emplacement drifts (preclosure phase)
 - Emplacement of drip shields over waste packages in subsurface emplacement drifts.

4.5.2 Quantification Inputs and Method

The major inputs required for quantification of the seismic event sequences are:

- Seismic hazard curve
- Seismic SSC fragilities
- Event tree and fault tree system models
- Waste container throughput numbers
- Exposure / residence time factors
- Passive equipment failure probabilities (generally used for probability of breach of a waste container).

The approaches for development of these inputs were discussed in Section 4.3.

The general method for quantification of seismic event sequences is similar to the internal initiator events. The event sequences are represented by the event trees, and the resulting event sequence path is quantified. The result of quantification of an event sequence is expressed in terms of the number of occurrences over the preclosure period. This number is the product (quantified in the manner discussed below) of the following factors:

1. The frequency (per year) of a seismic event that could initiate a radiological consequence. This is embodied in the seismic hazard curve (Section 4.3.1).
2. The total number of demands (or, in some activities, the time exposure interval) of the operation or activity over the preclosure period that gives rise to the event sequence. For example, this could be the total number of HLW canisters processed in a facility over the preclosure period. These demands are represented by the waste container throughput numbers (Section 4.3.3.3).
3. The frequency of occurrence of the initiating seismic failure per demand (or per time interval). Initiating seismic failure frequencies are developed using fault trees (Section 4.3.3.2), and include both the seismic SSC fragilities (Section 4.3.2) and the exposure / residence time factors (Section 4.3.3.4).
4. The conditional probability of each of the pivotal events of the event sequence, which appear in the associated SRET (Section 4.3.3.1). These probabilities are the results of a passive equipment failure analyses, fault tree analyses (e.g. moderator), and direct probability input (e.g. shielding). For example, the conditional probability of cask failure given a drop from 12 feet or less is less than 1E-05.

Factors one, two, and three above are represented in the seismic IETs (Section 4.3.3.1). The pivotal events in factor four are represented in the SRETs (Section 4.3.3.1).

Quantification of seismic event sequences must be performed in a different manner than for internal initiating events. The quantification must incorporate the dependency between the magnitude of seismic ground motion and the probability of seismic failure, the latter of which increases with the former as expressed with the SSC fragility curves. The algorithm also incorporates the decreasing frequency of a seismic event as the magnitude of seismic ground motion increases, expressed with the seismic hazard curve. This quantification process, often termed a convolution, was briefly described in Section 4.3.3.5 with reference to passive equipment failures (where it is termed the load-capacity interference integral). The general equation for this calculation was shown in Equation 4.3-4.

$$P_f = \int F(y)h(y)dy \quad (\text{Eq. 4.3-4})$$

For the seismic event sequence quantification, P_f is the mean probability of failure and is appropriate for use when comparing to a probability criterion such as one in 10,000. In Equation 4.3-4, $F(y)$ represents the CDF of equipment or structural capacity (the fragility of the SSC with respect to PGA) and $h(y)$ represents the PDF of the load (the seismic hazard expressed in terms of PGA).

The above equation is valid when calculating the probability of failure for one SSC seismic failure mode, using the fragility curve for that SSC failure mode, and the seismic hazard curve. However, the seismic event sequences include multiple SSCs, with multiple seismic failure modes. They also include the exposure time factors and container breach factors. Thus, $F(y)$ is redefined to represent a Boolean expression containing the cut sets generated for each seismic event sequence. Each cut set is of the general form:

$$\text{SEF} * \text{NWFC} * \text{SSC-FM-FRAG} * \text{ETF} * \text{CBF}$$

where

SEF = seismic event frequency (per year)

NWFC = number of waste containers (handled over the preclosure period in a facility)

SSC-FM-FRAG = conditional probability of failure (fragility) for one SSC failure mode given an earthquake

ETF = exposure time factor (years exposed to the SSC failure mode per waste container)

CBF = waste container breach factor (conditional probability of breach given the SSC failure mode).

The seismic event sequence Boolean equation will contain a cut set of the form above for each seismic failure mode of the SSC. There are variations of this cut set form that can include shielding failures rather than breach failures. Also, moderator failures (introduction of liquid moderator into a breached waste container) can be added to the cut set events.

The seismic event sequences differ from internal events in that the seismic event frequency and SSC-FM-FRAG events are both dependent on the level of PGA. Therefore, the quantification is an integration over the range of earthquake accelerations rather than a simple multiplication of

basic event point estimates. This quantification is usually termed the convolution of the seismic hazard curve with the fragility curves. In some software packages, this convolution is performed by dividing the hazard curve into acceleration intervals, and then quantifying the sequence Boolean equation at each acceleration interval (the fragility and hazard frequency vary at each interval), giving the probability of failure for that acceleration interval. The total event sequence probability is then the sum of the failure probabilities for all of the acceleration intervals.

Also note that the exposure time factor and waste container breach factor factors depend on the SSC and the seismic failure mode.

The seismic event sequences are generated and quantified using the NRC-developed SAPHIRE software (Ref. 2.2.104). Version 7.27 is used as the integrating software for the Boolean reduction and quantification of seismic event sequences and cut sets. Since SAPHIRE quantifies the event sequences using a summation over acceleration intervals as discussed above, the seismic hazard curve is entered into SAPHIRE as a table of acceleration interval midpoints and corresponding interval frequencies. The SSC fragilities are entered into the basic event database as median capacities (A_m) with composite uncertainties (β_c). All fault trees and event trees are entered into or produced directly in SAPHIRE. All waste container throughput numbers, exposure time factors, container breach factors, and other reliability information relevant to quantification is input into the SAPHIRE basic event database.

Following analyst input instructions or rules, SAPHIRE performs the following functions for this analysis:

- Following analyst instructions, links the IET with the appropriate SRET
- Following analyst instructions, called rules, links the fault trees and direct pivotal events that are involved in an event sequence
- Performs the Boolean manipulations to obtain a minimal cut set Boolean equation for the event sequence
- Convolves the event sequence Boolean equation over the range of acceleration intervals to obtain the end state probability of the event sequence.

The end state probability of the event sequence is the expected (mean) number of occurrences of the event sequence over the preclosure period.

This quantification process is used for each facility and waste container handling process listed in Section 4.5.1.

Only those event sequences that terminate in an undesired end state (i.e., exposure of individuals to radiation) are quantified. The event sequences that lead to a successful end state (i.e., no exposure of individuals to radiation) are not considered further.

At the end of the quantification process, the expected number of occurrences over the preclosure period has been quantified for each seismic event sequence.

4.5.3 Correlation, Multiple Failures, and Seismic Success Issues

There are several quantification issues in seismic PRAs for nuclear power plants that could theoretically impact the event sequences at YMP:

- Correlation of seismic failure events
- Multiple seismic failures
- Treatment of seismic successes.

4.5.3.1 Correlation of Seismic Failure Events

In seismic PRAs, the fragility curves show the dependency of the SSC seismic failure with respect to the magnitude of the earthquake ground motion, in this case the peak horizontal ground acceleration. As the acceleration increases, the fragility (or failure probability) of the SSC will increase. For different SSCs, for example a crane and a shield door, the probability of failure of the first SSC is not dependent on the probability of failure of the second component, except for this dependence on the acceleration level. However, there may be physical reasons why SSC failures should be correlated.

Correlation, in the seismic PRA context, is the failure relationship between two SSCs related to their dependent response to the earthquake. In general, seismic PRAs consider that the SSCs are correlated only if they are the same or similar equipment size, type, manufacturer, and floor level. For example, two identical HVAC air handling units (AHUs) located in the same room would be considered to both be failed if one is failed by an earthquake. That is, if one fails, then the other would be considered to fail as well. The same correlation presumption would be made for two (or more) diesel generators, or two or more motor control centers. Correlation of two or more identical SSCs would therefore defeat redundancy in a system, similar to a common cause failure for non-seismic basic events. For example, the correlated failure of the HVAC AHUs would fail the HVAC system, given the earthquake. If there is a cut set that includes failures of both HVAC AHUs, then the failure of one AHU would also be considered to result in failure of the other, which would increase the cut set probability. Essentially the system redundancy is defeated by the earthquake.

In nuclear power plants, where redundancy is used to increase the safety level of the system against internal event initiators such as pipe ruptures, correlation of equipment failures is a major contributor to loss of a system, and must be included in the seismic PRA. However, for the YMP seismic event sequence assessment, the SSCs that are included in the event and fault trees are generally single passive failures. For example, crane collapse is a single failure, and appears only with non-seismic failures in most crane failure cut sets. The only exceptions are cut sets for the event sequences when moderator intrusion into a breached container occurs. For these sequences, the cut sets will contain both the crane seismic failure, and a piping rupture seismic failure. Since these two seismic failures are not correlated (crane collapse failure and piping rupture failure are different equipment types, with different fundamental frequencies, responses, and failure modes), the seismic failure probability of their joint occurrence is dependent only on the acceleration level, and not on any correlation between the two components.

Therefore, since the seismic failures in a cut set were generally single failures, or failure with moderator intrusion due to a pipe failure, correlation of seismic failures was usually not a significant issue.

However, this gives rise to a second issue, which is the potential for multiple seismic failures during a seismic event. As discussed above, the cut sets from the seismic event sequences generally have one major seismic failure (and perhaps the moderator intrusion failure). The earthquake could induce multiple failures, of two types:

- Correlated multiple failures
- Non-correlated multiple failures.

4.5.3.2 Correlated Multiple Seismic Failures

An example of correlated multiple failures would be the failure of the hoist systems for the two CTMs in each of the three CRCFs. Since the six CTM hoists are the same manufacturer and equipment, located at the same building level, their failure could potentially be correlated. It is only “potential” because in reality the correlation would not be perfect. It is unlikely that all six CTMs are lifting a design maximum load, and it is unlikely that the trolleys are all at the crane midpoints, so that they would all see the same maximum acceleration and response. Since the three CRCFs are founded on soils of different depths, with shear wave velocities dependent on the actual soil under each structure, the base mat spectral accelerations that the buildings would see would be different, and the in-structure response spectra would be different. However, for seismic PRA purposes, the analysis would be simplified by assuming that the hoist failures are fully correlated. From a quantification view, the six hoist failures would be represented by one seismic basic failure event, but the processing of six canisters at once is already reflected in the total number of canisters processed over the preclosure period. Thus, the overall probability of the event sequence would remain the same, but the consequences for a sequence could potentially be higher.

If the event sequence had a Category 2 probability, then the consequence would be stated as six canisters breached, not one, giving a higher offsite consequence. However, as will be shown, all of the seismic event sequences with significant offsite consequences are categorized as beyond Category 2. The few event sequences that are Category 2 were reviewed to ensure that there were no potential seismic correlations that could increase the consequences, and there were no correlations or revisions needed.

A similar analysis was performed for the aging pad, where correlation in response of the aging overpacks could lead to multiple aging overpack impacts. To incorporate this correlation, it was considered that if one aging overpack tipped over, they all tipped over, with similar correlations for the other failure modes. Again, however, since the event sequences were beyond Category 2, the sequences could be screened out.

Therefore, correlated multiple failures have been reviewed, and some of the correlated failures are included in the event sequences. However, correlated multiple failures are not significant for the waste-handling facilities.

4.5.3.3 Non-correlated Multiple Seismic Failures

There is also the potential for multiple seismic failures for non-similar components that would not be correlated. If the components are in a single cut set (such as the seismic failure of a crane and piping for moderator intrusion), then that multiple seismic failure is directly included in the quantification process. However, there are many multiple seismic failures whose combinations were not developed in the seismic event trees. For example, there is not an event sequence with failure of a crane hoist and sliding of the site transporter, although both failures could occur in an earthquake. The reasons that two non-correlated failures do not need to be combined are:

1. Either of the seismic failures could lead to a waste container breach, so each is in a separate minimal cut set. A cut set with both seismic failures would not be minimal. No chain of seismic failures was identified where two (or more) separate seismic failures were required to cause a container breach. The only impact of two combined seismic failures would be a potential increase in the consequences due to a double breach. Therefore, multiple seismic failures would only be important if the sequence was in Category 2.
2. The joint probability of their combined seismic failure cannot be higher than the lower failure probability of the two failure probabilities, and would generally be lower. For example, if the crane hoist has a probability of failure of $1E-04$ over the hazard curve, and the site transporter has a probability of $1E-05$, then their joint probability must be $1E-05$ or lower. Therefore, if either of the individual event sequences is screened because it is beyond Category 2, their joint event sequence would also be beyond Category 2.

Thus, only two sequences both of which are Category 2 would possibly have a joint probability that remained in Category 2. After the Category 2 sequences are identified, the potential for multiple Category 2 failure sequences will be evaluated.

4.5.3.4 Treatment of Seismic Successes

For nuclear power plant seismic PRAs, the concept of seismic success is needed to reduce the conservatism that may be introduced when standard methods of event tree quantification are employed. For an internal events analysis, the “success” up branch is generally close to a value of 1, since the “failure” down branch is often $1E-02$ or less. Therefore, the standard methods often use the value 1, or something similar, for the up branch. However, in seismic analysis, as the acceleration level increases, the seismic failure can approach a value of 1, so the up branch should be close to zero. Most software, including SAPHIRE, does not automatically quantify seismic sequences with success probabilities included, so the event sequence probabilities are over-conservative.

In the same way, at the end of a nuclear power plant seismic PRA, when the sequences are combined to determine the total seismic core damage frequency, the overestimation becomes even more severe. If the individual frequencies of the sequences are just added together, the total will be unrealistically high.

An example may clarify the issue for the waste processing facilities. If the CRCF building collapses, any waste container inside is considered to be breached. It does not matter if there were crane failures, or trolley failures in addition to the building collapse, because the waste container is already breached. The event sequence for the building collapse is followed through any remaining pivotal events, and the probability quantified. However, when the crane failure event sequence is quantified, it does not remove the probability that the building collapse may have jointly occurred. Stated another way, for the crane failure sequence to be relevant, the building must not have collapsed (e.g., building seismic success). Therefore, in the quantification of the crane failure sequence, there is some portion that is double-counted, and should only be included in the building collapse sequence. This double counting is continued for all of the seismic failure initiators.

Since it is conservative to not include these seismic successes, and since the 10 CFR Part 63 Category 2 compliance criterion is based on the probability of an individual event sequence, and not the total for all sequences, seismic successes were not included in the seismic event sequence quantification. This does introduce conservatism in the individual event sequence probabilities.

This concludes the discussion of the methods and approach used for seismic event sequence development and quantification. Section 6 presents the analysis of the seismic event sequences using this approach.

4.6 EVENT SEQUENCE CATEGORIZATION, IDENTIFICATION OF ITS SSCS, DEVELOPMENT OF NUCLEAR SAFETY DESIGN BASIS, AND DEVELOPMENT OF PROCEDURAL SAFETY CONTROLS

This section includes the approach to event sequence categorization, identification of ITS SSCs, the development of the Nuclear Safety Design Basis requirements, and the development of PSCs. The approach for these tasks is identical to that for the internal events sequence analysis.

4.6.1 Categorization of Event Sequences

The expected number of occurrences of an event sequence over the preclosure period is compared to the screening criteria in 10 CFR 63.2 (Ref. 2.3.1) to determine its categorization. The event sequences that are expected to occur one or more times before permanent closure of the GROA are Category 1 event sequences. Other event sequences that have at least one chance in 10,000 of occurring before permanent closure are Category 2 event sequences. Event sequences that have less than one chance in 10,000 of occurring during the preclosure period are designated as beyond Category 2 event sequences. Restated, if the expected number of occurrences of the event sequence is greater than or equal to 1 over the preclosure period, it is a Category 1 event sequence; if the expected number of occurrences of the event sequence is greater than or equal to $1E-04$ but less than 1 over the preclosure period, it is a Category 2 event sequence; and, if the expected number of occurrences of the event sequence is less than $1E-04$ over the preclosure period, the event sequence is beyond Category 2 (Ref. 2.2.59, Section 6.8.2).

A consequence analysis is performed for Category 1 and Category 2 event sequences. Event sequences that are not beyond Category 2, and whose end state is “radionuclide release, important to criticality” or “important to criticality,” would also be addressed. Beyond Category 2, event sequences are not further considered.

4.6.2 Identification of ITS SSCs

ITS SSCs are subject to the Nuclear Safety Design Basis that is established to ensure that safety functions and failure frequencies applied in the seismic event sequence analysis are explicitly defined in a manner that assures proper categorization of event sequences.

Important to safety is defined in 10 CFR 63.2 (Ref. 2.3.1) as:

“Important to safety, with reference to with reference to structures, systems, and components, means those engineered features of the geologic repository operations area whose function is:

- (1) To provide reasonable assurance that high-level waste can be received, handled, packaged, stored, emplaced, and retrieved without exceeding the requirements of § 63.111(b)(1) for Category 1 event sequences; or
- (2) To prevent or mitigate Category 2 event sequences that could result in radiological exposures exceeding the values specified at § 63.111(b)(2) to any individual located on or beyond any point on the boundary of the site.”

Structures are defined as elements that provide support or enclosure such as buildings, free standing tanks, basins, dikes, and stacks. Systems are collections of components assembled to perform a function, such as HVAC, cranes, trolleys, and transporters. Components are items of equipment that taken in groups become systems such as pumps, valves, relays, piping, or elements of a larger array, such as digital controllers.

Implementation of the regulatory definition of ITS has produced the following specific criteria in the PCSA to classify SSCs:

An SSC is classified as ITS if it appears in an event sequence and at least one of the following criteria apply:

- The SSC is relied upon to reduce the frequency of an event sequence from Category 1 to Category 2
- The SSC is relied upon to reduce the frequency of an event sequence from Category 2 to beyond Category 2
- The SSC is relied upon to reduce the aggregated dose of Category 1 event sequences by reducing the event sequence mean frequency
- The SSC is relied upon to perform a dose mitigation or criticality control function.

An SSC is classified as ITS in order to assure safety function availability over the operating lifetime of the repository. The classification process involves the selection of the SSCs in the identified event sequences (including event sequences that involve nuclear criticality) that are relied upon to perform the identified safety functions such that the preclosure performance objectives of 10 CFR Part 63 (Ref. 2.3.1) are not exceeded. The ITS classification extends only to the attributes of the SSC involved in providing the ITS function. If one or more components of a system are determined to be ITS, the system is identified as ITS, even though only a portion of the system may actually be relied upon to perform a nuclear safety function. However, the specific safety functions that cause the ITS classification are delineated.

Seismic failures during an earthquake may initiate Category 1 or Category 2 seismic event sequences. The SSCs supporting normal operations (and not relied upon as described previously for event sequences) are identified as non-ITS. In addition, if an SSC (such as permanent shielding) is used solely to reduce normal operating radiation exposure, it is classified as non-ITS.

4.6.3 Development of Nuclear Safety Design Bases

Design bases are established for the ITS SSCs as described in 10 CFR 63.2 (Ref. 2.3.1):

“Design bases means that information that identifies the specific functions to be performed by a structure, system, or component of a facility and the specific values or ranges of values chosen for controlling parameters as reference bounds for design. These values may be constraints derived from generally accepted “state-of-the-art” practices for achieving functional goals or requirements derived from analysis (based on calculation or experiments) of the effects of a postulated event under which a structure, system, or component must meet its functional goals...”

The safety functions are developed from the applicable Category 1 and Category 2 event sequences for the SSCs that have been classified as ITS. For seismic safety functions, the controlling parameters and values are generally expressed in terms of the mean frequency of seismic event-induced failure. For example:

The mean frequency of collapse of the XXX structure due to a seismic event shall be less than or equal to $4E-07$ /yr.

These controlling parameters and values ensure that the ITS SSCs perform their identified safety functions such that the 10 CFR Part 63 (Ref. 2.3.1) performance objectives are met. The controlling parameters and values include frequencies or probabilities in order to provide a direct link from the design to the 10 CFR Part 63 (Ref. 2.3.1) requirement for categorization of event sequences. The PCSA will demonstrate that design of the respective ITS SSCs to meet these controlling parameters and values will satisfy the 10 CFR Part 63 (Ref. 2.3.1) performance objectives.

Section 6.10 presents lists of ITS SSCs for each facility, the Nuclear Safety Design Basis of the ITS SSCs, the actual value of the controlling parameter developed in this analysis, and a reference to that portion of the analysis (e.g. event sequence), which demonstrates that the criterion is met.

4.6.4 Identification of Procedural Safety Controls

10 CFR 63.112(e) (Ref. 2.3.1) requires that the PCSA include an analysis that “identifies and describes the controls that are relied upon to limit or prevent potential event sequences or mitigate their consequences” and “identifies measures taken to ensure the availability of safety systems.” The seismic event sequence assessment depends on certain operational measures to limit or prevent seismic risk. An example is a general administrative procedure to move overhead cranes to safe locations when not in use.

These operational measures are generally identified as the seismic event sequences are developed, but may also be imposed to reduce the likelihood of a quantified event sequence. After quantification those operational measures that are required to support the seismic event sequence analysis and categorization are collected into PSCs. The identified PSCs become candidates for licensing specifications.

5. LIST OF ATTACHMENTS

	Number of Pages
Attachment A. Initial Handling Facility Analyses	113
Attachment B. Receipt Facility Analyses	193
Attachment C. Canister Receipt and Closure Facility Analyses	255
Attachment D. Wet Handling Facility Analyses	182
Attachment E. Intra-Site Operations and Balance of Plant Analyses	15
Attachment F. Subsurface Operations Analyses	29
Attachment G. Throughput Analyses	18 + CD
Attachment H. Passive Equipment Failure Analysis	25
Attachment I. Seismic Hazard Curve Analysis	5
Attachment J. SAPHIRE files	1 + CD

Note: Both Attachment G and Attachment J files are on the same CD.

6. BODY OF ANALYSIS

The scope of this analysis is focused on seismic events that impact structures and/or equipment within the GROA, including the IHF, RF, CRCF, WHF, Intra-Site Operations, and Subsurface Operations.

The method of analysis was described in Section 4, and is performed for each facility, and for each waste container processed in the facility. The seismic event sequence analysis is conducted in four steps:

- **Development of the site seismic hazard curve.** The seismic hazard curve presents the mean annual probability of exceedance (MAPE) associated with a ground motion parameter at the site. The ground motion parameter selected for the YMP seismic hazard curve is the horizontal PGA, a metric appropriate for representing the severity of a seismic event on an SSC. A mean seismic hazard curve specific to the GROA is used for the surface facilities, and a second mean seismic hazard curve is used for the subsurface repository block.
- **Development of seismic fragilities.** Seismic fragility evaluations are performed for SSCs that prevent or mitigate radionuclide releases. A fragility curve provides the mean probability of unacceptable performance (or seismic failure) of an SSC as a function of a ground motion parameter. The ground motion parameter selected is the same as that chosen for the seismic hazard curve (e.g., the horizontal PGA).
- **Modeling of seismic event sequences and SSC fault trees.** The method used is similar to the event tree and fault tree modeling for internal initiating events, and capitalizes on the fact that the event sequences resulting from a seismic event would have similar pivotal events and end states. However, there are unique seismic event sequences, such as those involving the collapse of a facility, that are also included as needed.
- **Quantification of seismic event sequences.** Quantification of seismic event sequences must be performed in a different manner than for internal initiating events. The quantification must incorporate the dependency between the magnitude of seismic ground motion and the probability of seismic failure, the latter of which increases with the former as expressed with the SSC fragility curves. The algorithm also incorporates the decreasing frequency of a seismic event as the magnitude of seismic ground motion increases, expressed with the seismic hazard curve. This quantification process is often termed a convolution.

Uncertainties are considered in both the seismic hazard curve and the seismic fragilities, although the “convolution” quantification process results in a mean value only. This mean value is the best single value representation of the underlying uncertainties.

Once quantified, each seismic event sequence is categorized as Category 1, Category 2, or beyond Category 2 based on its mean probability of occurrence over the preclosure period. The analysis also includes:

- Material at risk for each Category 1 and 2 seismic event sequence for purposes of consequence calculations
- ITS SSCs
- PSCs required for operations
- Compliance with the Nuclear Safety Design Bases.

This section describes the analysis of seismic event sequences, and is organized in the following subsections:

- 6.1 Seismic Hazard Analysis Results
- 6.2 Seismic Fragility Analysis Results
- 6.3 Exposure Time and Passive Equipment Failure Factors
- 6.4 IHF Seismic Event Sequence Analysis
- 6.5 RF Seismic Event Sequence Analysis
- 6.6 CRCF Seismic Event Sequence Analysis
- 6.7 WHF Seismic Event Sequence Analysis
- 6.8 Intra-Site Operations Seismic Event Sequence Analysis
- 6.9 Subsurface Operations Seismic Event Sequence Analysis
- 6.10 ITS SSCs, Nuclear Safety Design Basis, and PSCs.

6.1 SEISMIC HAZARD ANALYSIS RESULTS

Site-specific seismic hazard curves were developed to represent the annual probability of various amplitudes of ground motion at the location of the surface facilities, and the subsurface repository block. The PSHA assessed the earthquake history, seismology, and geology of the region and produced seismic hazard curves presenting the MAPE of experiencing different magnitude ground motions at the plant site. Both aleatory (parametric) and epistemic (modeling) uncertainties were considered in the hazard analysis and propagated through to the results in the form of a family of hazard curves.

The seismic event sequence quantification used 2007 data for the seismic hazard:

- Mean Hazard Curves and Mean Uniform Hazard Spectra for the Surface Facilities Area, 11/01/2006 to 06/08/2007, TDIF 319830, DTN: MO0706HCUHSSFA.000
- Hazard Curves and Mean Uniform Hazard Spectra for the Repository Block, 11/01/2006 to 07/20/2007, TDIF 319899, DTN: MO0707HCUHSREB.000.

Updated results of the PSHA became available after the seismic event sequence quantification. These 2008 seismic hazard curves are provided in *Supplemental Earthquake Ground Motion Input for a Geologic Repository at Yucca Mountain, NV* (Ref. 2.2.73), with the data in *Mean Hazard Curves and Mean Uniform Hazard Spectra for the Surface Facilities Area* (Ref. 2.2.93), *IED Seismic and Seismic Consequence Data* (Ref. 2.2.66), and *Hazard Curves and Mean Uniform Hazard Spectra for the Repository Block* (Ref. 2.2.92). The 2007 and 2008 data was compared, and the 2007 data envelops the 2008 data for the surface facilities, and is essentially the same for the subsurface repository block:

- Figure 6.1-1: Comparison of the Horizontal Seismic Hazard Curves – Surface Facilities Area
- Figure 6.1-2: Comparison of the Vertical Seismic Hazard Curves – Surface Facilities Area
- Figure 6.1-3: Comparison of the Horizontal Seismic Hazard Curves – Subsurface Repository Block
- Figure 6.1-4: Comparison of the Vertical Seismic Hazard Curves – Subsurface Repository Block

Therefore, use of the 2007 hazard curve data is conservative for the surface facilities, such that the resulting seismic event sequence probabilities are conservatively high by a few percent. For the subsurface, use of the 2007 hazard curve data is equivalent to the 2008 data. Tables 6.1-1 and 6.1-2 present the acceleration levels for representative MAPEs, based on the 2007 data used in the seismic event sequence quantification.

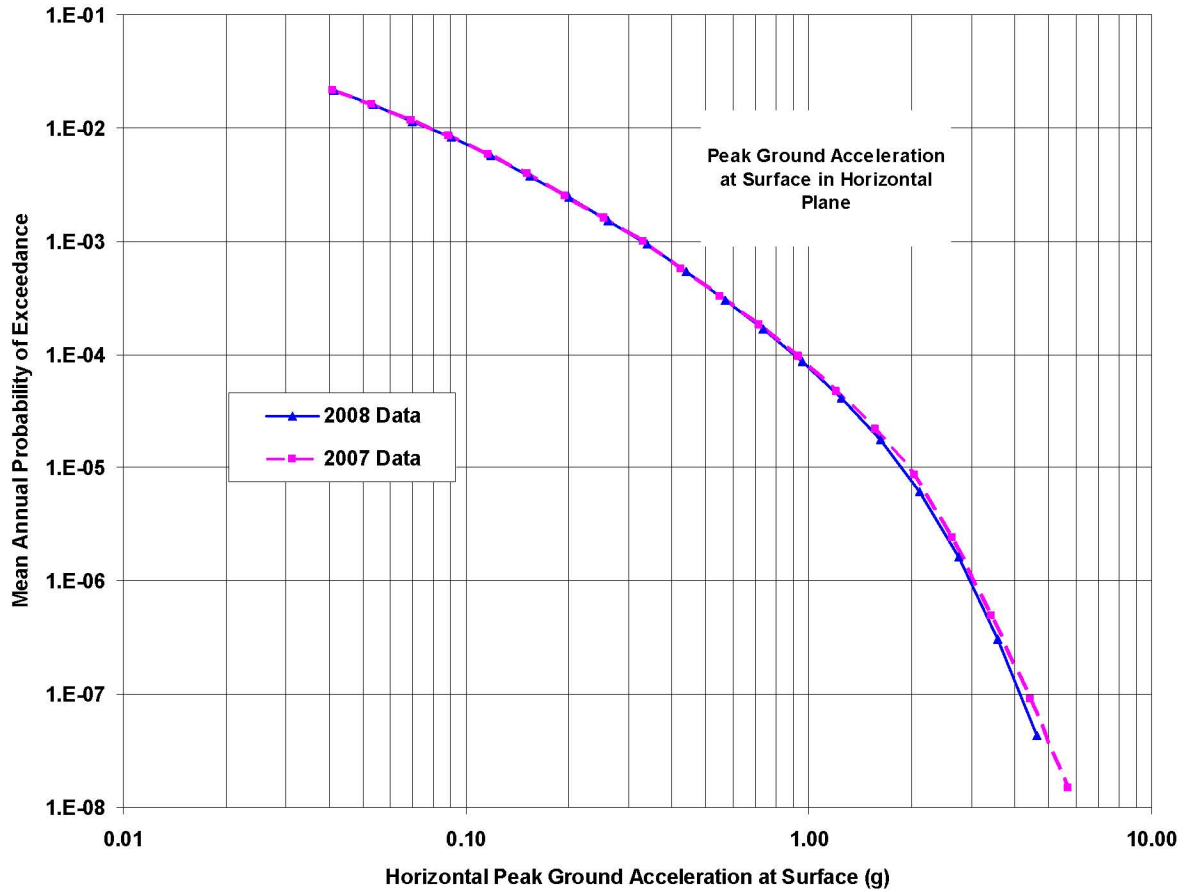

Source: 2007 data, DTN: MO0706HCUHSSFA.000; 2008 data, *Mean Hazard Curves and Mean Uniform Hazard Spectra for the Surface Facilities Area* (Ref. 2.2.93)

Figure 6.1-1. Comparison of the Horizontal Seismic Hazard Curves – Surface Facilities Area

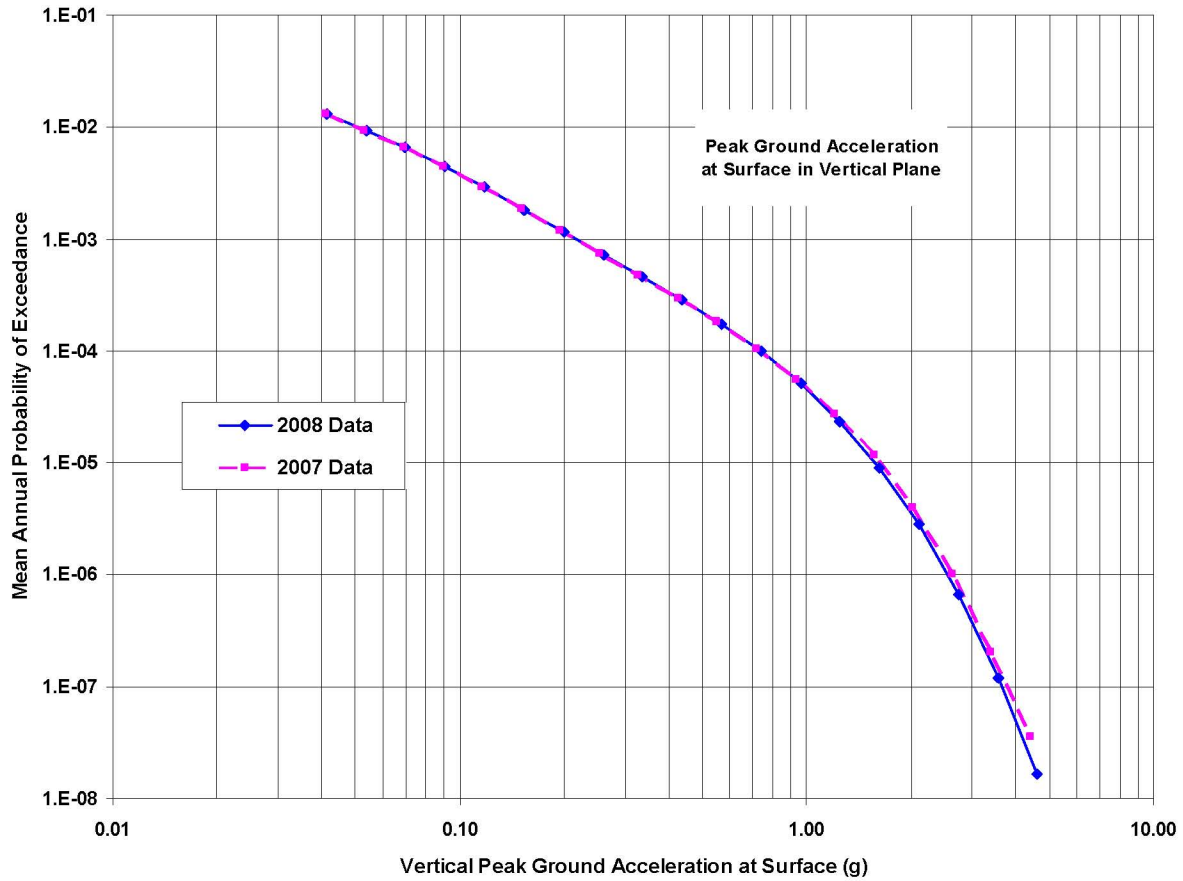

Source: 2007 data, DTN: MO0706HCUHSSFA.000; 2008 data, *Mean Hazard Curves and Mean Uniform Hazard Spectra for the Surface Facilities Area* (Ref. 2.2.93)

Figure 6.1-2. Comparison of the Vertical Seismic Hazard Curves – Surface Facilities Area

Table 6.1-1. Accelerations for Representative Mean Annual Probability of Exceedances – Surface Facilities Area (2007 Data)

Mean Annual Probability of Exceedance (MAPE) (yr)	Horizontal Peak Ground Acceleration (g)	Vertical Peak Ground Acceleration (g)
1.0E-03	3.25E-01	2.14E-01
5.0E-04	4.53E-01	3.19E-01
1.0E-04	9.10E-01	7.33E-01
1.0E-05	1.94E+00	1.62E+00
2.0E-06	2.71E+00	2.30E+00
1.0E-06	3.04E+00	2.63E+00
1.0E-07	4.34E+00	3.79E+00

Source: 2007 data, DTN: MO0706HCUHSSFA.000; 2008 data, *Mean Hazard Curves and Mean Uniform Hazard Spectra for the Surface Facilities Area* (Ref. 2.2.93)

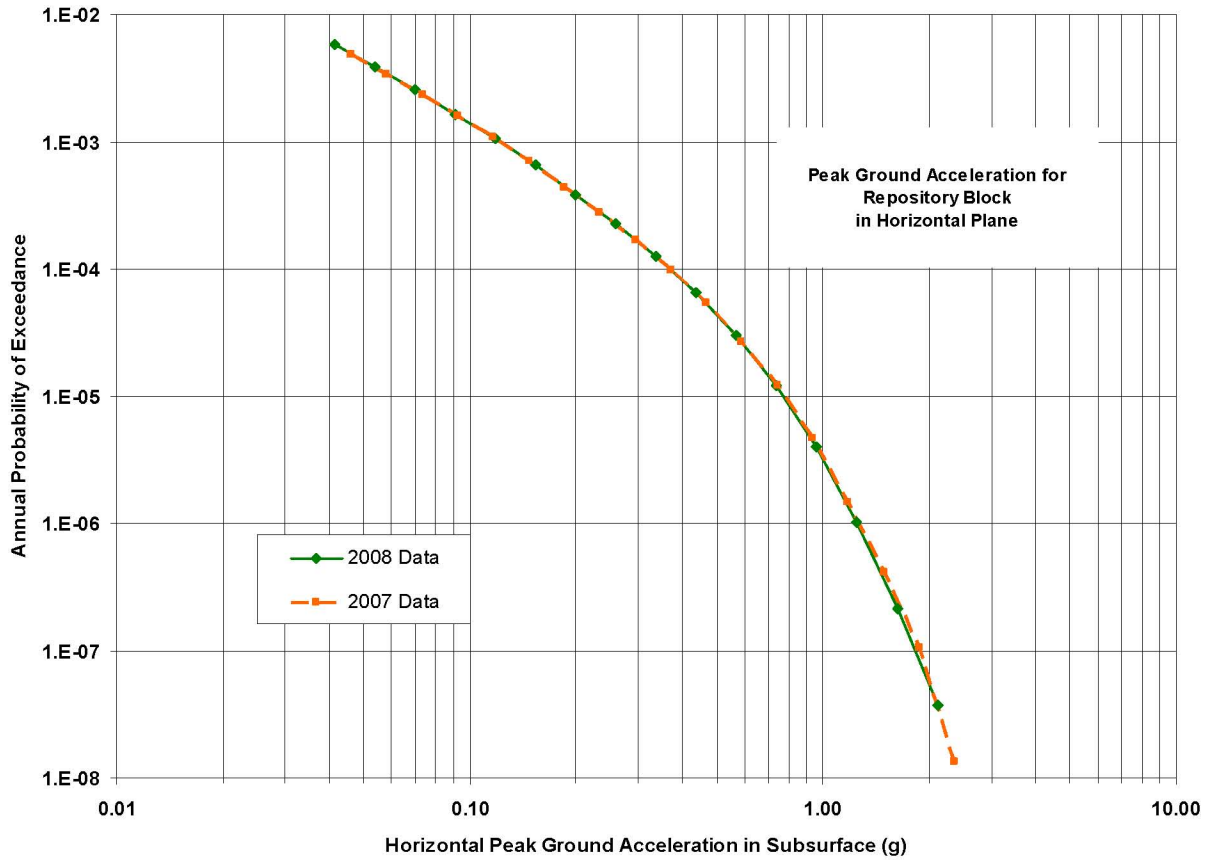

Source: 2007 data, DTN: MO0707HCUHSREB.000; 2008 data, *Hazard Curves and Mean Uniform Hazard Spectra for the Repository Block* (Ref. 2.2.92)

Figure 6.1-3. Comparison of the Horizontal Seismic Hazard Curves – Subsurface Repository Block

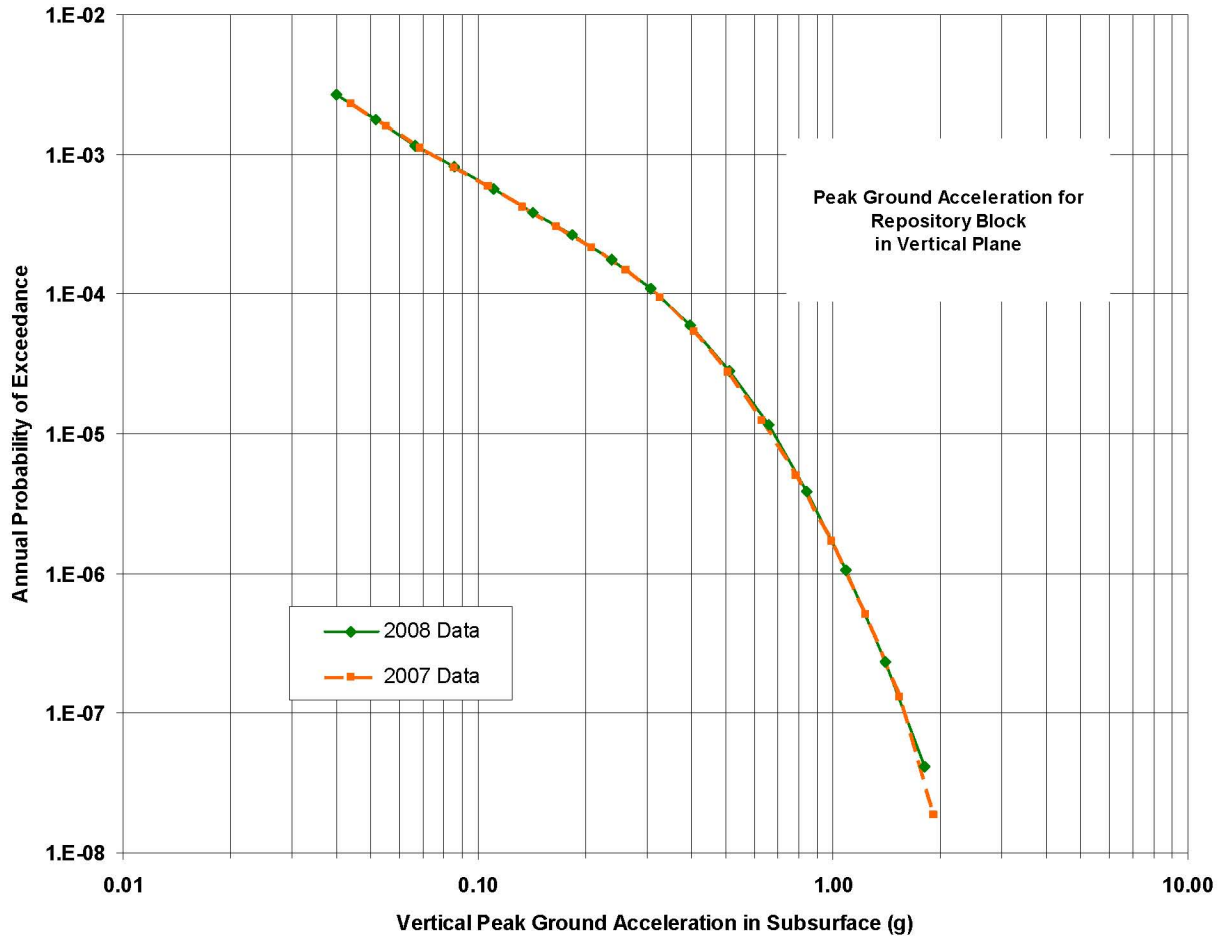

Source: 2007 data, DTN: MO0707HCUHSREB.000; 2008 data, *Hazard Curves and Mean Uniform Hazard Spectra for the Repository Block* (Ref. 2.2.92)

Figure 6.1-4. Comparison of the Vertical Seismic Hazard Curves – Subsurface Repository Block

Table 6.1-2. Accelerations for Representative Mean Annual Probability of Exceedances – Subsurface Repository Block (2007 Data)

Mean Annual Probability of Exceedance (MAPE) (/yr)	Horizontal Peak Ground Acceleration (g)	Vertical Peak Ground Acceleration (g)
1.0E-03	1.21E-01	7.38E-02
5.0E-04	1.74E-01	1.19E-01
1.0E-04	3.68E-01	3.18E-01
1.0E-05	7.78E-01	6.69E-01
1.0E-06	1.27E+00	1.09E+00
1.0E-07	1.88E+00	1.59E+00

Source: 2007 data, DTN: MO0707HCUHSREB.000; 2008 data, *Hazard Curves and Mean Uniform Hazard Spectra for the Repository Block* (Ref. 2.2.92)

While the seismic hazard curves are presented in frequency of exceedance format, the SAPHIRE seismic hazard convolution algorithm requires the frequency of the discrete acceleration intervals. An EXCEL spreadsheet was used to convert the frequency of exceedance format into 19 (18 for subsurface) discrete horizontal PGA intervals and associated interval frequencies. These spreadsheets are given in Attachment I. A standard log-log interpolation formula was used to calculate the acceleration midpoint for each interval. Tables 6.1-3 and 6.1-4 present the discrete acceleration interval midpoints and associated interval frequencies for surface and subsurface areas.

Table 6.1-3. Acceleration Interval Midpoints and Interval Frequency – Surface Facilities Area (2007 data)

Acceleration Interval Midpoint (g)	Interval Frequency (/yr)
0.047	5.53E-03
0.061	4.41E-03
0.079	3.31E-03
0.102	2.57E-03
0.132	1.96E-03
0.171	1.37E-03
0.222	9.31E-04
0.288	6.15E-04
0.373	4.09E-04
0.483	2.49E-04
0.626	1.44E-04
0.811	8.53E-05
1.050	4.79E-05
1.360	2.54E-05
1.758	1.31E-05
2.264	6.17E-06
2.916	1.95E-06
3.775	4.00E-07
4.888	7.45E-08

Source: Attachment I

Table 6.1-4. Acceleration Interval Midpoints and Interval Frequency – Subsurface Repository Block (2007 data)

Acceleration Interval Midpoint (g)	Interval Frequency (/yr)
0.041	1.96E-03
0.052	1.46E-03
0.065	1.05E-03
0.082	7.49E-04
0.104	5.16E-04

Table 6.1-4. Acceleration Interval Midpoints and Interval Frequency – Subsurface Repository Block (2007 data) (Continued)

Acceleration Interval Midpoint (g)	Interval Frequency (/yr)
0.130	3.70E-04
0.164	2.65E-04
0.207	1.65E-04
0.261	1.05E-04
0.329	7.14E-05
0.414	4.48E-05
0.521	2.67E-05
0.655	1.49E-05
0.823	7.48E-06
1.034	3.23E-06
1.300	1.07E-06
1.636	3.06E-07
2.038	9.15E-08

Source: Attachment I

The acceleration intervals above started at about 0.04 g. Below this acceleration, no significant impacts would be expected for the facilities or subsurface area. For example, the loss of offsite power has a HCLPF of 0.09 g, indicating that there is about a 1 % probability of offsite power failure at 0.09 g. At 0.04 g, the probability of failure of offsite power would be about 0.01 %, which is insignificant. Other SSCs have higher seismic capacities, and would not be impacted by acceleration levels below 0.04 g.

For quantification, the highest acceleration point on the hazard curve was selected such that the last interval had a frequency of about 1E-07 /yr. This ensures that all earthquakes with significant frequency contribution are included in the event sequence quantification. Table 6.1-5 provides the acceleration level, and MAPE for the earthquake hazard beyond the hazard curves included in the quantification. As shown in the table, the frequencies of exceedance excluded from the quantification are insignificant.

Table 6.1-5. MAPE For Earthquakes Not Included in Quantification (2007 data)

Hazard Curve	Acceleration (g)	MAPE (/yr)
Surface Facilities Area	5.73	1.50E-08
Subsurface Repository Block	2.36	1.35E-08

Source: *Mean Hazard Curves and Mean Uniform Hazard Spectra for the Surface Facilities Area*, Ref. 2.2.93 and *Hazard Curves and Mean Uniform Hazard Spectra for the Repository Block*, Ref. 2.2.92

The seismic hazard curves used for the event sequence quantification thus include all earthquake accelerations that are significant to preclosure seismic risk.

6.2 SEISMIC FRAGILITY ANALYSIS RESULTS

Seismic fragility evaluations were performed for SSCs that prevent or mitigate radionuclide releases. A fragility curve provides the mean probability of unacceptable performance of an SSC as a function of a ground motion parameter. The ground motion parameter selected is the same as that chosen for the seismic hazard curve (e.g., the horizontal peak ground acceleration). The methodology used for the development of fragility curves was discussed in Section 4.3.2.

A lognormal distribution is used to represent the mean fragility curve of an SSC and is characterized using two parameters: median fragility and composite uncertainty. An example of a mean fragility curve is shown on Figure 6.2-1. This curve gives the conditional probability of failure for the hoist for a CTM in a CRCF, as a function of the horizontal PGA. The failure mode for this SSC is the failure of the drum on the hoist, resulting in a dropped load. The median fragility A_m is equal to 2.28 g and the composite uncertainty β_c is equal to 0.50. This results in a HCLPF value of 0.72 g.

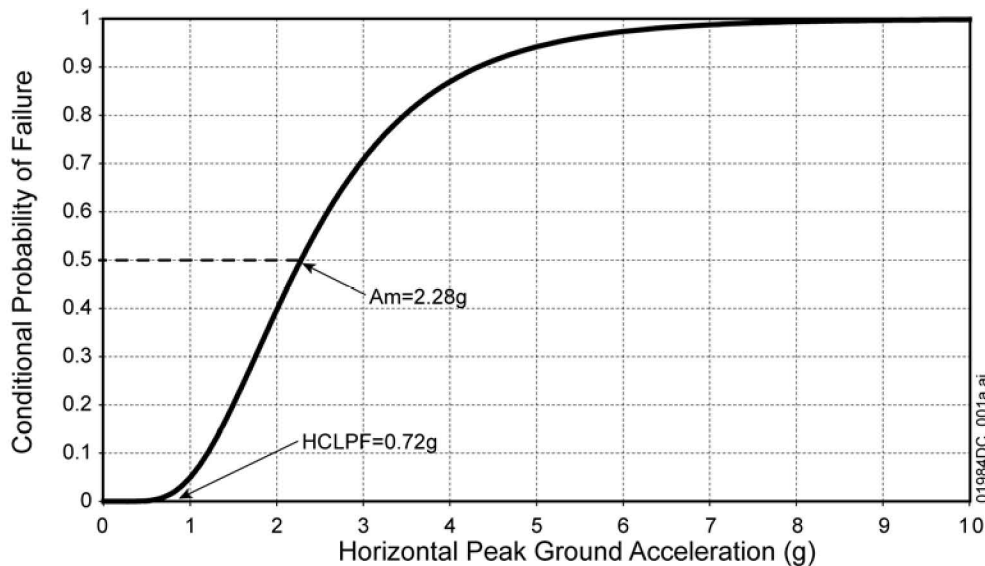

Source: *Development of Equipment Seismic Fragilities at Yucca Mountain Surface Facilities* (Ref. 2.2.60, Table 5)

Figure 6.2-1. Example Seismic Fragility Curve (Canister Transfer Machine Hoist in a CRCF)

From this curve, the quantification algorithm can calculate the conditional probability of failure given a specific acceleration level. For instance, for this component, the conditional probability of failure at 1 g is about 0.05. At 2 g the probability is about 0.4, and at 3 g the probability is about 0.7. While this example is based on the graphic figure, the actual calculation uses the curve parameters (median acceleration and composite uncertainty) and the mathematical representation to calculate the conditional probability of failure.

The fragility analysis results for structures are given in the next section, followed by the equipment.

6.2.1 Fragility Analysis Results for Structures

The seismic fragilities for the main structures (buildings) were determined using the CDFM method, as discussed in Section 4.3.2.1. Fragilities for other structures, including the aging pad, HAMs, and LLW Facility, were also determined. Table 6.2-1 provides the fragilities for the structures used in the seismic event sequence quantification. The fragilities for the four major structures were calculated for Limit State A (imminent collapse) given in ASCE/SEI 43-05 (Ref. 2.2.3). More detail for the fragility calculations is given in the references in the table, and the discussion below.

Table 6.2-1. Fragilities for Structures

Structure	A_m	β_c	HCLPF	Frequency of Failure (yr)	Basis / Reference
IHF	5.35	0.4	2.11	3.8E-07	Ref. 2.2.33 and Ref. 2.2.32
RF	5.25	0.4	2.07	4.1E-07	Ref. 2.2.72
CRCF	4.61	0.4	1.82	7.8E-07	Ref. 2.2.26
WHF	4.51	0.4	1.78	8.7E-07	Ref. 2.2.54
WHF pool	4.51	0.4	1.78	8.7E-07	Same as WHF building
Aging pad (shear and bending)	2.46	0.4	0.97	9.8E-06	Ref. 2.2.75
Horizontal aging module	4.5	0.4	1.77	8.8E-07	Based on other ITS structures above
LLW Facility	0.89	0.4	0.35	1.6E-04	IBC, SUG III design (Ref. 2.2.47)

NOTE: CRCF = Canister Receipt and Closure Facility; HCLPF = high confidence of low probability of failure; IHF = Initial Handling Facility; ITS = important to safety; LLW = Low-Level (radioactive) Waste; RF = Receipt Facility; WHF = Wet Handling Facility.

Source: Provided above in last column, and this section

The β_c used for this event sequence quantification was 0.4, while the references listed above used the more conservative value of 0.3 for the evaluation associated with the design criteria. Guidance in ASCE/SEI 43-05 (Ref. 2.2.3) states that the typical range for β_c for structures is from 0.3 to 0.5. The midpoint was selected as being more representative of the mean value for the seismic event sequence quantification. The frequency of failure given in the table above represents the yearly frequency of failure of the structure, generally for the imminent collapse mode of failure. This frequency of failure was calculated with SAPHIRE by the convolution of the seismic hazard curve with the building fragility curve, represented by the fragility parameters A_m and β_c .

The evaluation of the fragility of structures was performed conservatively. Conservatism include:

- The fragility analysis uses a minimum screening level such that when a structural component of the building under consideration is demonstrated to have a structural strength that exceeds the screening level, it is assigned the screening level fragility. This results in a minimum estimate of building seismic capacity rather than the actual capacity, which would be higher.

- The building capacity is estimated using conservative methods for effective shear wall area, load redistribution, and ductility.

The HCLPFs in Table 6.2-1 are for the concrete structure for the buildings. HCLPFs for the steel vestibules for the CRCF (2.48 g) and WHF (2.79 g for the Transportation Cask Vestibule, 3.56 g for the Site Transporter Vestibule) were greater than for the concrete structures. The HCLPF for the RF steel vestibule (2.0 g) was slightly lower than the concrete structure, but is still quite high. Because the time that the waste container is in the RF steel vestibule is only a few minutes per waste container, the fragility of the overall RF concrete structure would be more risk significant, and is used for the RF structure fragility. The HCLPF for the IHF steel structure (2.22 g) is larger than for the concrete structure in the table above, so the concrete structure fragility is used to represent the IHF.

The HAMs are reinforced concrete modular structures placed on the aging pads to hold horizontal DPCs. Their standard seismic design is for 1.5 g horizontal acceleration in both horizontal directions, and 1.0g in the vertical direction, acting simultaneously (Ref. 2.2.77). The modules are connected to each other on the aging pad, with the connections analyzed for 2.25 g. This standard design would meet or exceed the seismic fragility used in Table 6.2-1 above.

The aging pads at the Aging Facility are designed to DBGM-2. The margin in design (demand/capacity ratios for bending and shear (Ref. 2.2.17)) for the foundation pad would provide a HCLPF estimate slightly higher than the Beyond Design Basis Ground Motion (BDBGM), which is based on the 1E-04 MAPE earthquake (Ref. 2.2.75). A composite uncertainty of 0.4 was selected as representative for the aging pads.

The LLW Storage Facility is designed (Ref. 2.2.47) to the International Building Code (IBC), SUG III (Ref. 2.2.90). The IBC, SUG III design against collapse would use the 2500 MAPE earthquake, which has a frequency of 4E-04 /yr. From the surface facility hazard curve, Figure 6.1-1, this gives a horizontal PGA of 0.5 g. A detailed fragility was not estimated, since it was known that the offsite radiological consequences would not be significant. It was judged that using the PGA to represent the median capacity (50% chance of collapse) would be extremely conservative, but using the PGA to be the HCLPF (resulting in a median capacity of 1.27 g) would be non-conservative. A rough estimate of the LLW Facility fragility was made by assuming that the median fragility would be midpoint between 0.5 g and 1.27 g. The median fragility used for the LLW storage facility was thus calculated to be 0.89 g. A composite uncertainty of 0.4 was selected as representative for this type of structure.

6.2.2 Fragility Analysis for Equipment

For the equipment, the seismic fragilities are calculated based on the separation of variables method, which is a method that has been used for numerous nuclear power plants and accepted by the NRC. The method is described in Section 4.3.2.2, and in the equipment fragilities report (Ref. 2.2.60). Table 6.2-2 provides the list of equipment and associated fragility parameters, with the basis from Ref. 2.2.60, Table 6, unless otherwise noted. In *Development of Equipment Seismic Fragilities at Yucca Mountain Surface Facilities* (Ref. 2.2.60) Table 6 lists the equipment by Item "X," where "X" is a letter identifier. This convention is used in the "Basis" column of Table 6.2-2 below, to correspond to Ref. 2.2.60.

Table 6.2-2. Equipment Fragilities and Basis

Equipment and Seismic Failure Mode	A_m (g)	β_c	HCLPF (g)	Freq of Failure (/yr)	Basis	Section Reference
Rollup entry door, confinement door, or emplacement access door collapse	0.37	0.4	0.15	1.0E-03	IBC (Ref. 2.2.90)	6.2.2.1
Railcar, horizontal cask transfer trailer, or truck trailer tipover	0.45	0.4	0.18	6.9E-04	Engineering judgment based on earthquake exp. data	6.2.2.2
Mobile platform collapse	0.37	0.4	0.15	1.0E-03	IBC (Ref. 2.2.90)	6.2.2.3
Horizontal cask stand (tipover)	0.37	0.4	0.15	1.0E-03	IBC (Ref. 2.2.90)	6.2.2.4
Cask handling crane (CHC):						
Collapse	2.79	0.45	0.98	7.9E-06	Item A: CRCF CHC, bridge girders (trolley seismic restraints must not control fragility)	6.2.2.5
Load or object drop	2.28	0.5	0.72	1.8E-05	Item B: CRCF CTM hoist, drum	6.2.2.5
Swinging impact	1.14	0.4	0.45	8.8E-05	Ref. 2.2.60, Attachment : Impact velocity below DBGM-2 level is insignificant for transportation cask	6.2.2.5
Cask preparation crane (IHF), auxiliary pool crane (WHF), jib cranes (WHF):						
Collapse	2.79	0.45	0.98	7.9E-06	Item A: CRCF CHC, bridge girders (trolley seismic restraints must not control fragility)	6.2.2.6
Heavy object drop	2.28	0.5	0.72	1.8E-05	Item B: CRCF CTM hoist, drum	6.2.2.6
CTM maintenance crane (RF), waste package handling crane (CRCF and IHF), Entrance vestibule crane (WHF), Lid Bolting Room crane (RF)						
Collapse	2.79	0.45	0.98	7.9E-06	Item A: CRCF CHC, bridge girders (trolley seismic restraints must not control fragility)	6.2.2.6
Heavy object drop	1.14	0.4	0.45	8.8E-05	DBGM-2 used for HCLPF (conservative)	6.2.2.6

Table 6.2-2. Equipment Fragilities and Basis (Continued)

Equipment and Seismic Failure Mode	A _m (g)	β _c	HCLPF (g)	Freq of Failure (/yr)	Basis	Section Reference
Cask transfer trolley (CRCF, WHF, RF):						
Sliding (into wall or column)	3.08	0.58	0.79	1.0E-05	Item C: CRCF CTT, sliding	6.2.2.7
Rocking (into wall or column)	2.25	0.41	0.87	1.2E-05	Item C: CRCF CTT, rocking	6.2.2.7
Bumping (into energy absorbing feature)	2.25	0.41	0.87	1.2E-05	Item C: CRCF CTT, rocking	6.2.2.7
Cask transfer trolley (IHF):						
Sliding (into wall or column)	1.7	0.44	0.61	3.4E-05	Item E: IHF CTT, sliding	6.2.2.8
Rocking (into wall or column)	1.7	0.41	0.65	3.2E-05	Item E: IHF CTT, rocking	6.2.2.8
Bumping (into cask preparation platform)	1.7	0.44	0.61	3.4E-05	Item E: IHF CTT, sliding	6.2.2.8
Collapse of cask preparation platforms (CRCF, RF), preparation stations (WHF), DPC cutting station (WHF), TAD closure station (WHF), aging overpack access station (WHF), Lid Bolting Room platform (RF)	3.5	0.4	1.38	2.6E-06	Requirement: Increased margin for compliance	6.2.2.9
Cask support frame	3.03	0.6	0.75	1.2E-05	Item K: Post installed anchors (DBGM-2)	6.2.2.9
Collapse of cask preparation platform (IHF)	1.14	0.4	0.45	8.8E-05	DBGM-2 used for HCLPF (conservative est.)	6.2.2.10
Equipment shield door collapse	2.92	0.44	1.05	6.4E-06	Item L: CRCF shield door, weld (CIP bolts to wall embeds must not control fragility)	6.2.2.11
Canister transfer machine:						
Collapse	2.39	0.45	0.83	1.3E-05	Item D: CRCF CTM, bridge girders (trolley seismic restraints must not control fragility)	6.2.2.12
Load or heavy object drop	2.28	0.5	0.72	1.8E-05	Item B: CRCF CTM hoist, drum	6.2.2.12
Swinging impact inside bell	1.14	0.4	0.45	8.8E-05	Ref. 2.2.60, Attachment B: Impact velocity below DBGM-2 level is insignificant for canister inside bell	6.2.2.12
Swinging impact outside bell	0.91	0.4	0.36	1.5E-04	Ref. 2.2.60, Attachment B and Attachment C: Impact velocity and CTT displacement below BDBGM level is limited so damage would not be significant	6.2.2.12

Table 6.2-2. Equipment Fragilities and Basis (Continued)

Equipment and Seismic Failure Mode	A _m (g)	β _c	HCLPF (g)	Freq of Failure (/yr)	Basis	Section Reference
CRCF stage rack collapse	4.5	0.45	1.58	1.3E-06	Requirement: Increased margin for compliance	6.2.2.13
Spent fuel transfer machine (WHF):						
Collapse	2.19	0.47	0.72	1.8E-05	Item I: WHF SFTM, bridge girders	6.2.2.14
Assembly or heavy object drop	2.28	0.5	0.72	1.8E-05	Item B: CRCF CTM hoist, drum	6.2.2.14
WHF spent fuel staging rack collapse	4.5	0.4	1.77	8.8E-07	Requirement: Increased margin for compliance	6.2.2.15
WHF pool transfer stations collapse	1.41	0.46	0.48	6.0E-05	Item K: Fillet weld (DBGM-2)	6.2.2.16
Waste package transfer trolley:						
Tipover	3.41	0.4	1.34	2.9E-06	Item F: CRCF WPTT, tipover	6.2.2.17
Rocking impact	1.85	0.37	0.78	2.2E-05	Item F: CRCF WPTT, rail clamp (DBGM-2)	6.2.2.17
Remote handling system:						
Collapse	2.79	0.45	0.98	7.9E-06	Item A: CRCF CHC, bridge girders (trolley restraints must not control fragility)	6.2.2.18
Heavy object drop	1.14	0.4	0.45	8.8E-05	DBGM-2 used for HCLPF (conservative)	6.2.2.18
TEV:						
Sliding and derailling	1.12	0.43	0.41	1.0E-04	Item H: TEV, seismic restraints	6.2.2.19
Tipover	5.00	0.4	1.97	5.3E-07	Item H: TEV, tipover (estimate)	6.2.2.19
Ejection of WP	0.76	0.4	0.3	2.3E-04	DBGM-1 used for HCLPF (conservative estimate) (door bolt)	6.2.2.19
Site transporter:						
Tipover	5.00	0.4	1.97	5.3E-07	Ref. 2.2.60, Attachment G: tipover (estimate)	6.2.2.20
Sliding	1.89	0.42	0.71	2.4E-05	Item G: ST, sliding into wall	6.2.2.20
Bumping (into energy absorbing feature)	1.89	0.42	0.71	2.4E-05	Item G: ST, sliding into wall	6.2.2.20

Table 6.2-2. Equipment Fragilities and Basis (Continued)

Equipment and Seismic Failure Mode	A_m (g)	β_c	HCLPF (g)	Freq of Failure (/yr)	Basis	Section Reference
Aging overpack:						
Tipover	7.62	0.4	3.0	5.1E-08	HCLPF equal to 3g (Ref. 2.2.83)	6.2.2.21
Sliding impact	3.05	0.4	1.2	4.5E-06	Ref. 2.2.48	6.2.2.21
Drip shield collapse					Not quantified – screened out	6.2.2.22
Drip shield gantry derailment impact					Not quantified – screened out	6.2.2.22
Piping system integrity failure (fire protection, potable water, hot water, chilled water)	0.76	0.4	0.30	2.3E-04	DBGM-1 used for HCLPF (conservative estimate)	6.2.2.23
Electrical cabinets (relay chatter)	3.0	0.4	1.18	4.82E-06	Relay with stated capacity	6.2.2.24
HVAC system integrity failure (WHF)	2.69	0.66	0.57	2.2E-05	Item K: Equipment qualified by analysis, HVAC supports (DBGM-2)	6.2.2.25
Loss of offsite power	0.3	0.54	0.09	1.8E-03	Item M: Offsite Power	6.2.2.26

NOTE: CHC = cask handling crane; CRCF = Canister Receipt and Closure Facility; CTM = canister transfer machine; CTT = cask transfer trolley; DBGM = design basis ground motion; HVAC = heating, ventilation and air conditioning; HCLPF = high confidence of low probability of failure; IBC = International Building Code; IHF = Initial Handling Facility; RF = Receipt Facility; TAD = transportation, aging and disposal; TEV = transport and emplacement vehicle; WHF = Wet Handling Facility; WPTT = waste package transfer trolley.

Source: Development of Equipment Seismic Fragilities at Yucca Mountain Surface Facilities (Ref. 2.2.60) and Original

Note that there may be several failure modes for the equipment, with different fragilities. The column “Section Reference” corresponds to the following sections that describe the equipment and fragilities. The equipment is listed in approximate order from the start of waste processing operations to emplacement.

For some equipment, the lowest capacity in *Development of Equipment Seismic Fragilities at Yucca Mountain Surface Facilities* (Ref. 2.2.60) Table 5 was not used because a relatively inexpensive upgrade could increase the equipment seismic capacity. These are noted in Table 6.2-2 above, and discussed with the equipment in the sections below. Other failure modes and fragilities are based on *Development of Equipment Seismic Fragilities at Yucca Mountain Surface Facilities* (Ref. 2.2.60) attachments. They are briefly noted in Table 6.2-2 above, and discussed with the equipment below. Finally, for a few items, the equipment must be designed to have significant margin over the DBGM-2 minimum design. These are noted as requirements above, and discussed with the equipment below.

Because much of the equipment design is in a preliminary stage, the fragility calculations are based on a design that exactly meets the allowable stress levels, and does not provide any extra design margin. This provides a conservative calculation of the equipment seismic capacity, resulting in the minimum amount of seismic margin. It would be expected that the final equipment design would provide some conservative margin between the calculated design stress level and the allowable stress level.

6.2.2.1 Rollup Entry Door Collapse

The rollup entry doors are relatively lightweight doors over the major vehicle entrances and exits. During an earthquake, their anchorage could fail, leading to drop of the door onto a truck, railcar, TEV, or site transporter carrying a waste container. Since the waste container would be in a transportation cask, aging overpack, or waste package inside the TEV, the waste canister itself is also protected by the outer container. The anchorage of the entry door to the wall could be a spatial interaction issue, and would thus be designed to DBGM-2 level standards, with a resulting high seismic capacity. However, to be conservative, the anchorage was selected to be designed only to IBC standards (Ref. 2.2.90), which results in lower seismic capacity than the DBGM-2 requirements. Thus, based on *Natural Phenomena Hazards Design and Evaluation Criteria for Department of Energy Facilities*, DOE-STD-1020-2002 (Ref. 2.2.84), Table B-1, the design would have a failure probability of about 1E-03 per year, giving the median fragility in the table above.

6.2.2.2 Railcar, Horizontal Cask Transfer Trailer, Truck Trailer Tipover

Depending on the facility and waste container, the transportation cask is carried into or out of the facility on a railcar, truck trailer, or horizontal cask transfer trailer. During an earthquake, the conveyance for the transportation could rock, and potentially tip over, resulting in an impact of the transportation cask with the floor. Since the transportation casks are designed for such events, the tipover of the conveyance was not expected to be a major contributor to risk. Therefore, a detailed fragility analysis was not performed for the conveyances. Based on general earthquake experience with railcars and truck trailers, the median fragility was selected to be the DBGM-2 earthquake, or $A_m = 0.45$ g, with a β_c of 0.4. The basis is conservative engineering

judgment, supported by the earthquake experience. Figure 6.2-2 provides an illustration of the horizontal cask transfer trailer.

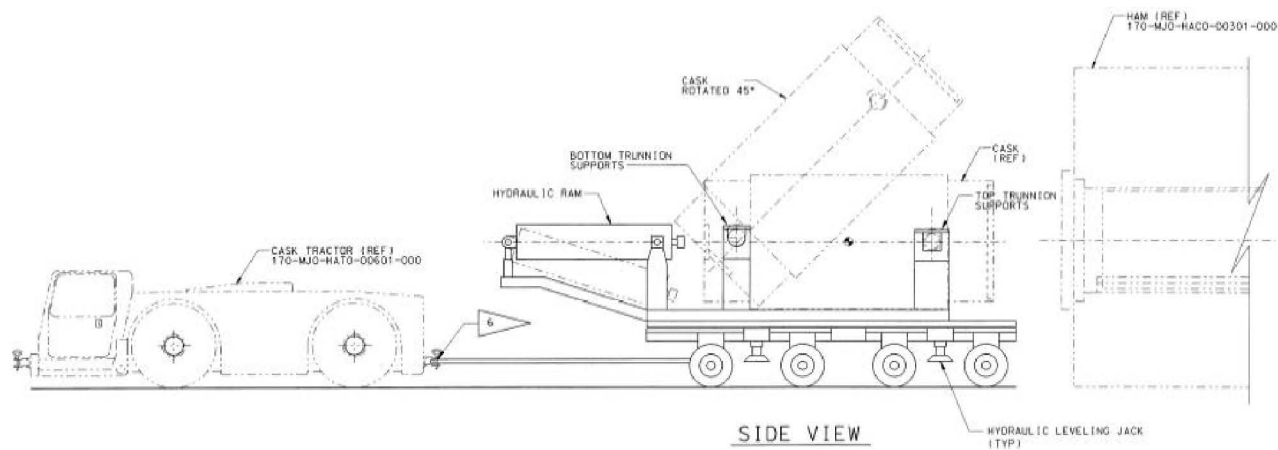

Source: *Aging Facility Cask Transfer Trailers Mechanical Equipment Envelope* (Ref. 2.2.18)

Figure 6.2-2. Illustration of Horizontal Cask Tractor and Trailer

6.2.2.3 Mobile Platform Collapse

The mobile platform is used to prepare the transportation cask for upending or lift off of the conveyance. As a potential spatial interaction with the transportation cask, it could be designed to DBGM-2 level standards to prevent impact/collapse, with a resulting high seismic capacity. However, to be conservative, the mobile platform design was selected to be designed only to IBC standards (Ref. 2.2.90), which results in lower seismic capacity than the DBGM-2 requirements. Thus, based on DOE-STD-1020-2002 (Ref. 2.2.84) Table B-1, the design would have a failure probability of about $1E-03$ per year, giving the median fragility in the table above.

6.2.2.4 Horizontal Cask Stand

For transportation casks that are lifted off of the conveyance in the horizontal orientation, a horizontal cask stand is used for intermediate support before further processing. The horizontal cask stand is non-ITS, and could potentially fail or tip over if the anchorage fails. Since the transportation casks are designed for such events, the tipover of the cask stand was not expected to be a major contributor to risk. However, to be conservative, the anchorage was selected to be designed only to IBC standards (Ref. 2.2.90), resulting in a relatively low seismic capacity. Thus, based on DOE-STD-1020-2002 (Ref. 2.2.84) Table B-1, the design would have a failure probability of about $1E-03$ per year, giving the median fragility in the table above.

6.2.2.5 Cask Handling Crane

The CHC is primarily used to tilt/lift the transportation cask from the railcar or truck, and place the transportation cask into the CTT. In the WHF, the CHC is also used to place the shielded transfer cask (STC) into the preparation stations and into the pool, and lift the STC out of the pool. Depending on the facility, there may be other uses as well. The CHC is a large

(200-300 ton lift) gantry crane, designed to ASME NOG-1, Type I single failure proof standards (Ref. 2.2.8). Four failure modes were identified for the crane:

- Collapse
- Drop of load (waste container)
- Drop of heavy object onto waste container
- Swing of waste container causing impact of with another object.

The CRCF CHC was used as the representative crane for fragility analysis for all of the facilities. *Development of Equipment Seismic Fragilities at Yucca Mountain Surface Facilities* (Ref. 2.2.60), Attachment A provides a detailed fragility analysis. For the collapse failure mode, the failure of the crane trolley seismic restraints was the initial failure mode ($A_m = 2.11 g$), potentially causing the trolley to collapse onto any waste container below. Since this seismic restraint failure could be easily strengthened, the second failure mode, failure of the bridge girders ($A_m = 2.79 g$) was selected as the controlling failure mode for collapse. In the detailed design of the CHC, the seismic restraints must not control the crane fragility. This could be accomplished by increasing the load factor by two for the seismic design loads for the restraints, or by demonstrating that the crane design is such that the bridge would remain on the rail or be supported on the associated concrete corbel system during a seismic event.

Crane hoist failure, including the drop of load and drop of heavy object failure modes, are based on the CTM hoist failure analysis discussed below.

If the CHC has a waste container suspended when the earthquake occurs, the load could swing in a several foot radius, depending on the load, rope length, and the earthquake acceleration. However, the waste form would still be in a protective container such as a transportation cask or STC, so waste container breach would be very unlikely. The potential for swinging that might result in damage to the waste container was selected to start at the DBGM-2 level, as the impact velocities at this level could be about 2 ft/s (Ref. 2.2.60, Attachment B, B7). Thus the median fragility is based on a HCLPF equivalent to the DBGM-2 level. Note that damage at this impact velocity would be extremely unlikely.

Since the CHC places various waste containers into other equipment, such as the cask transfer trolley or cask support frames, it is important that the crane hook remains attached to the waste container until the seismic restraints or gates of the other equipment are engaged. Thus the crane will provide stability in the event of an earthquake until the other equipment provides proper seismic stability. Operational procedures would direct the operators to ensure these actions (Table 6.10-7).

6.2.2.6 Other Cranes

Many other cranes are used in the processing of the waste containers. The following cranes are not used to lift waste containers, but may be over waste containers during processing operations. Therefore, they could collapse onto the waste container, or could drop a heavy object onto the waste container. The cranes are:

- Cask preparation crane (IHF)

- CTM maintenance crane (RF) – Note that there are CTM maintenance cranes (CTMMC) in the IHF, CRCF and WHF, but in these facilities the CTMMC can be parked in an area where its collapse would not impact waste handling operations below. Operational procedures would direct the operators to safely park the CTMMC (and other cranes) when not in use (Table 6.10-7).
- WPHC (IHF and CRCF)
- Auxiliary pool crane (APC) (WHF)
- Entrance Vestibule crane (WHF)
- Lid Bolting Room crane (RF)
- Jib cranes (WHF).

Except for the jib cranes, the above cranes are gantry cranes similar in design but smaller than the CHC discussed in Section 6.2.2.6. These cranes are designed to the same ASME NOG-1 requirements (Ref. 2.2.8) for structural design as the CHC. Therefore, the fragility for collapse was selected to be the same as for the CHC, based on the same structural design requirements. The cask preparation crane and APC also have the same hoist requirements as the CHC (ASME NOG-1, Type I (Ref. 2.2.8)), and thus use the same fragility for hoist failure and heavy object drop as for the CHC. However, the hoist requirements for the CTM MC, WPHC, Entrance Vestibule crane, and Lid Bolting Room crane do not require protection from single failures (that is, they are ASME NOG-1, Type II cranes (Ref. 2.2.8)). While these Type II cranes would still have a very high seismic margin in their hoist design, the fragility for hoist failure and heavy object drop was conservatively based on a HCLPF equivalent to DBGM-2 level.

While the WHF jib cranes are a different type of crane than the gantry cranes, they are designed to very similar requirements, including the single failure proof requirements for the hoist system. The jib cranes are much smaller capacity than the CHC, with a design load of 10 tons, and a maximum boom length of 25 ft (Ref. 2.2.56). Their design is also much less complex than the gantry cranes (Figure 6.2-3). Therefore, the CHC fragilities for collapse and heavy object drop can be used as representative for these jib cranes.

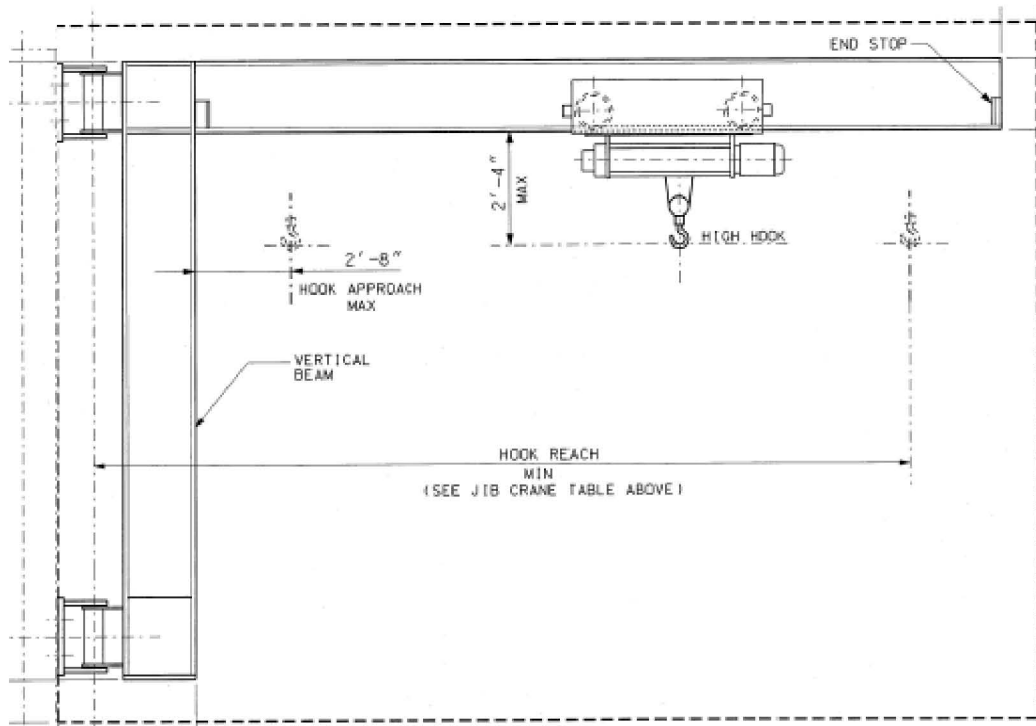

Source: *Wet Handling Facility Jib Cranes Mechanical Equipment Envelope* (Ref. 2.2.56)

Figure 6.2-3 Example Jib Crane

6.2.2.7 Cask Transfer Trolley (RF, CRCF, WHF)

Since the CTT is rather unique, it is described in some detail here. The CTT is an air powered machine that will be used to transport various vertically oriented transportation casks from the Cask Preparation Room to the Canister Transfer Room. The trolley consists of a platform, a cask support assembly, a pedestal assembly, a seismic restraint system, and an air system as illustrated in Figure 6.2-4.

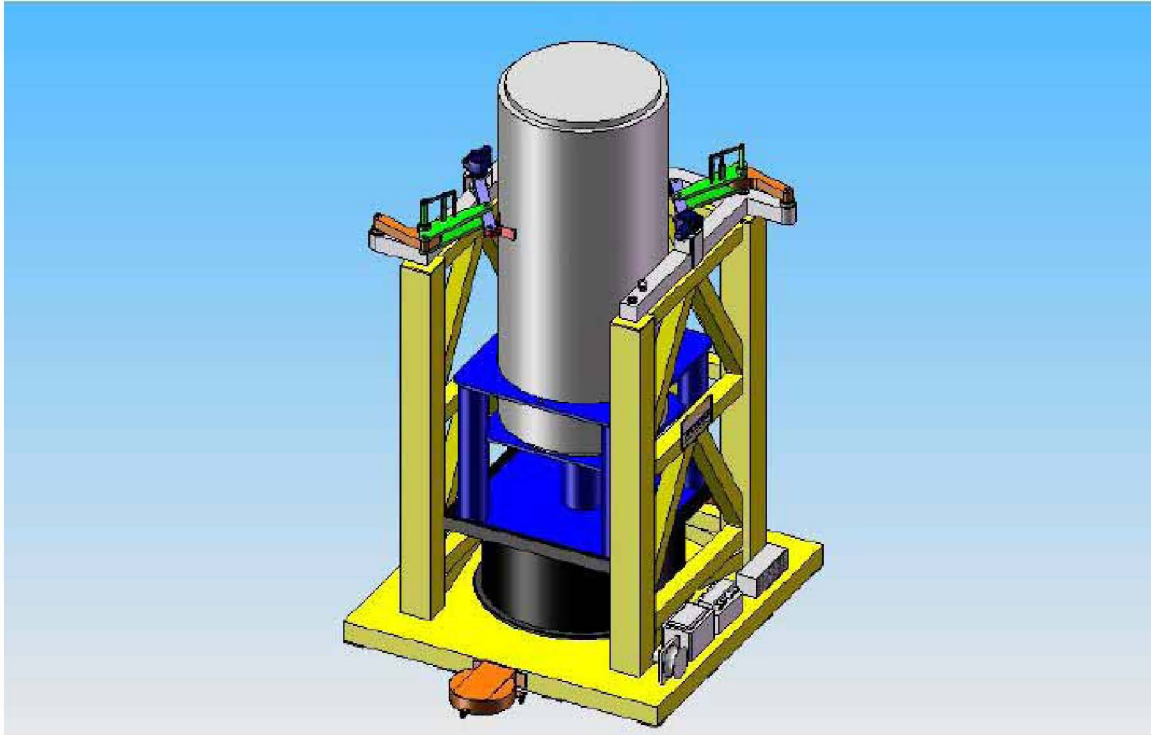

Source: Modified from *P&ID – Cask Transfer Trolley* (Ref. 2.2.94)

Figure 6.2-4 Cask Transfer Trolley

The platform, or main deck, is the main support structure for the trolley, and is 16 ft by 16 ft. The structure is designed to hold the air bearings under the deck and simultaneously support the cask support assembly and cask. The cask support assembly is the truss work that is welded to the platform and cradles three sides of the cask. The cask support assembly provides the structural support for the seismic restraint system and pedestal assembly to hold the cask during an earthquake or collision event.

The CTT must handle a number of different types of casks; consequently several different pedestals are used to properly position the cask height at 27 ft-3 in. from the floor. Each pedestal sub-component is designed for its respective cask to sit down in a “cavity.” The depth of the cavity is a minimum of 6 in., which prevents the cask from exiting from the pedestal due to uplift during a seismic event. In addition, the cask is restrained in the longitudinal and transverse directions by the cavity walls and restrained in the vertical down direction by the pedestal itself.

In addition to the cask being restrained at the bottom by the pedestal assembly, the upper section of the cask is restrained to prevent side motions during a seismic event. The system is made up of two linkage systems that are mounted on opposite corners of the cask support assembly. An electric motor extends and retracts the restraint brackets to predetermined positions. Different cask diameters are handled by bolting unique interface clamps onto the seismic restraints.

When the restraint system is properly positioned next to the cask, a locking pin is air actuated to secure the system. This solid, high strength, alloy, locking pin can take the shear stresses that would be seen during a seismic event. Both locking pins are monitored by proximity switches

(or limit switches) that are hard wired to the control system to verify the pins are in place. If the locking pins are not secured properly, the CTT will not be able to power up and move/levitate.

The facility compressed air supply inflates nine 54-inch diameter air casters beneath the trolley platform. Each air caster consists of a urethane, torus-shaped bag with a chamber inside the torus. The air film is produced when air is distributed to each air caster causing the air bags to inflate. The inflated bags create a seal against the floor surface and confine the air within the chambers of the bags until the air pressure is sufficient to offset the weight of the loaded trolley. The air bearings allow the CTT to rise above the floor approximately $\frac{1}{2}$ in. to $\frac{7}{8}$ in. The air supply is equipped with a valve shut-off on loss of facility power. End mounted turtle-style drive units that are 360-degree steerable, are used to steer the CTT. Traction is produced by down-pressure on the wheels provided by a small air bag on each drive unit. Air to the drives is shut off on loss of facility power.

The trolley is positioned within a set tolerance under the cask transfer port in the Canister Transfer Room using bumpers and stops that are bolted to the floor with bolts that will shear to allow the CTT to slide during a significant seismic event.

The CRCF CTT was selected as representative for the CRCF, RF, and WHF facilities. Of the seismic failure modes considered, the following were controlling:

- Sliding of CTT into wall or column causing damage to structure or waste container
- Rocking of CTT with impact resulting in damage to waste container
- Bumping of CTT into the energy absorbing feature on the cask preparation platform (CPP).

Trolley structural failure and seismic restraint failure were reviewed, and found not to be significant to the risk (Ref. 2.2.60, Attachment C). For the sliding failure mode, the minimum distance between the CTT and the CRCF wall in the Canister Transfer Room (4 ft) was found to be the critical seismic failure consideration. Although there are some steel columns and the door frame along the route, the columns are not important to the structural strength, and transit time is relatively short (10 min).

Rocking of the CTT could also result in potential impacts to the waste container. However, the rocking, and thus the impact forces, would be limited inside the canister transfer room, since the top of the cask is close to the ceiling.

When the CTT is being processed at the cask preparation platform, there is the potential for sliding and rocking as well. However, the CPP is designed with an energy absorbing feature that restrains the CTT, limiting the impact on the waste container and the CPP. This potential failure mode is labeled “bumping” to differentiate it from the more serious sliding and rocking failure modes, and was assigned the same median fragility as for rocking.

6.2.2.8 Cask Transfer Trolley (IHF)

The IHF CTT is similar to the CRCF trolley, but is 18 ft by 18 ft at the base (Figure 6.2-5). A separate detailed fragility analysis was performed since the controlling sliding distance in the IHF is 1.5 ft to the wall of the Canister Transfer Room. On the route from the CPP to the transfer room, it is about 2.5 ft to the nearest structural column. However, impact of the CTT on one column is very unlikely to cause structural collapse, and the transit time is short (10 min). Therefore, the risk is controlled by the 1.5 ft distance to the wall while in the transfer room.

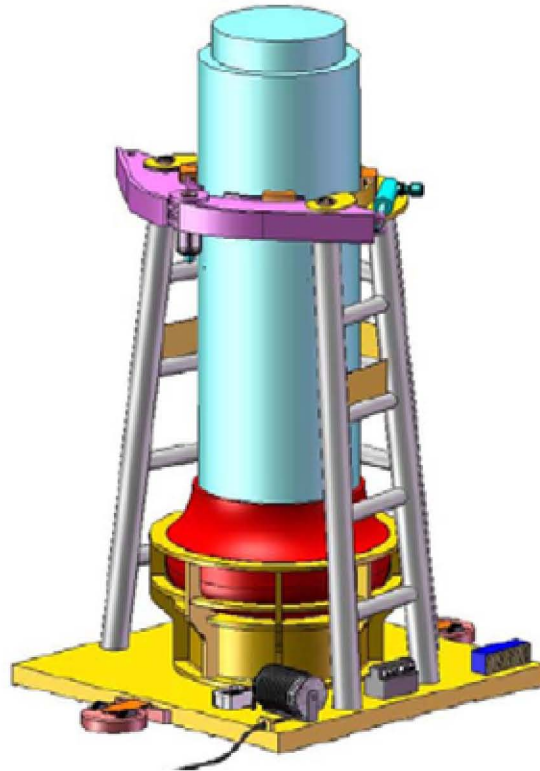

Source: *Yucca Mountain Seismic Analysis of 265 Ton Cask Transfer Trolley* (Ref. 2.2.96)

Figure 6.2-5. IHF Cask Transfer Trolley.

Since the critical sliding distance for the IHF is less than for the CRCF, it is more likely that the CTT could slide and impact the structure. Therefore, the seismic capacity (expressed as the median fragility) of the IHF CTT in the sliding failure mode is lower than for the other facilities. The seismic capacity of the rocking failure mode was also calculated to be lower. The median fragility for bumping was selected to be the same as for sliding.

6.2.2.9 Platforms

Each of the facilities has platforms to allow operators to process the waste containers. The following platforms are included in the seismic event sequence analysis:

- CPPs (CRCF, RF)
- Preparation stations (WHF)

- DPC cutting station (WHF)
- TAD closure station (WHF)
- Aging overpack access platform (WHF)
- Lid Bolting Room platform (RF).

For some platforms, there are relatively heavy (shielded) platforms above the waste container (e.g., CPP in CRCF and prep station #1 in WHF). The collapse of the platform could result in a large impact force on the waste container, resulting in breach. In other cases, the potential collapse of a platform could tip over the waste container and conveyance (e.g., CTT or site transporter), and cause breach of waste container. A detailed analysis of these potential impacts was not performed, and breach was selected as the conservative outcome.

Since the waste containers spend significant processing time in the platforms, the design must assure that the seismic capacity is relatively high. Because the platform design is in a preliminary stage, detailed fragility calculations were not performed. Instead, the seismic fragility of the platforms is set by requirement. The platforms will be designed to DBGM-2, but must have sufficient design margin to meet the established probabilistic requirements listed in Section 6.10. This results in the fragility parameters listed in Table 6.2-2 above, and used in the event sequence quantification.

In the WHF, the DPC cutting station, TAD closure station, and preparation station #2 also have cask support frames that are used to hold and stabilize the cask during processing. The cask support frames are similar to the cask transfer trolley discussed in Section 6.2.2.7, but are not on air pallets. The cask support frames are removable, but are anchored to the floor for seismic restraint purposes. They include adjustable seismic restraints similar to those for the CTT. Based on the analysis of the potential seismic failure modes for the CTT, it was determined that the floor anchorage would represent the seismic failure mode for the cask support frames. The median fragility is 3.03g, based on post-installed anchors designed for the DBGM-2 requirements.

6.2.2.10 Cask Preparation Platform (IHF)

The IHF processes naval canisters and HLW canisters. The expected number of canisters to be processed is relatively small compared to other facilities. Based on this relatively low throughput, the CPP may be designed to the DBGM-2 requirements, with no increased margin requirements. Its median fragility would then be lower than for the platforms just discussed above. The seismic failure of the fillet welds, leading to collapse of the platform, was selected to be the determining failure. Note that the IHF cask preparation platform does not have energy absorbing features, but it does have platforms that fold down around the cask providing restraint to limit sliding of the CTT when at the CPP.

6.2.2.11 Shield Door Collapse

The CRCF sliding shield doors to the Canister Transfer Room were selected to be representative for the all shield doors, as these were some of the largest. A detailed fragility analysis was performed (Ref. 2.2.60, Attachment L), and the controlling failure modes were:

- Anchorage failure of the embedded plates used for door support (cast-in-place (CIP) bolts) ($A_m = 1.25g$)
- Weld failure of door supports to the embedded plates ($A_m = 2.92g$)
- Failure of the structural steel door supports ($A_m = 3.16$).

The thick doors themselves would be lightly stressed, and would not be controlling.

As discussed in *Development of Equipment Seismic Fragilities at Yucca Mountain Surface Facilities* (Ref. 2.2.60), Attachment L and Attachment K, the allowable design stress ratio for CIP bolts is fairly high. If the design exactly meets the allowable (that is, has only the minimum strength), then the CIP bolt failure mode would be controlling. Since the bolting capacity could be easily increased to the level of the weld failure mode capacity, the fragility used for the shield doors is for the weld failure mode. As stated in Table 6.2-2 above, the shield doors must be designed such that the CIP bolt capacity must not be the controlling failure mode.

6.2.2.12 Canister Transfer Machine

The CTM transfers waste canisters from a cask on a CTT or from an aging overpack on a site transporter to another cask or overpack, or to a waste package supported by the WPTT. The CTM also has the capability to transfer canisters to staging areas for temporary staging for a later transfer to a waste package. The CTM is an overhead bridge crane with two trolleys as shown in Figure 6.2-6. The first is a canister hoist trolley with a grapple attachment and hoisting capacity of 70 tons. The second is a shield bell trolley that supports the shield bell. The shield bell is approximately 25 feet tall with an inside diameter of about 6 ft. The bottom end of the shield bell is attached to a larger chamber to accommodate cask lids with a diameter of up to 84 in. The CTM bottom plate assembly supports a 12-inch thick motorized slide gate. The slide gate, when closed, provides bottom shielding of the canister once the canister is inside the shield bell.

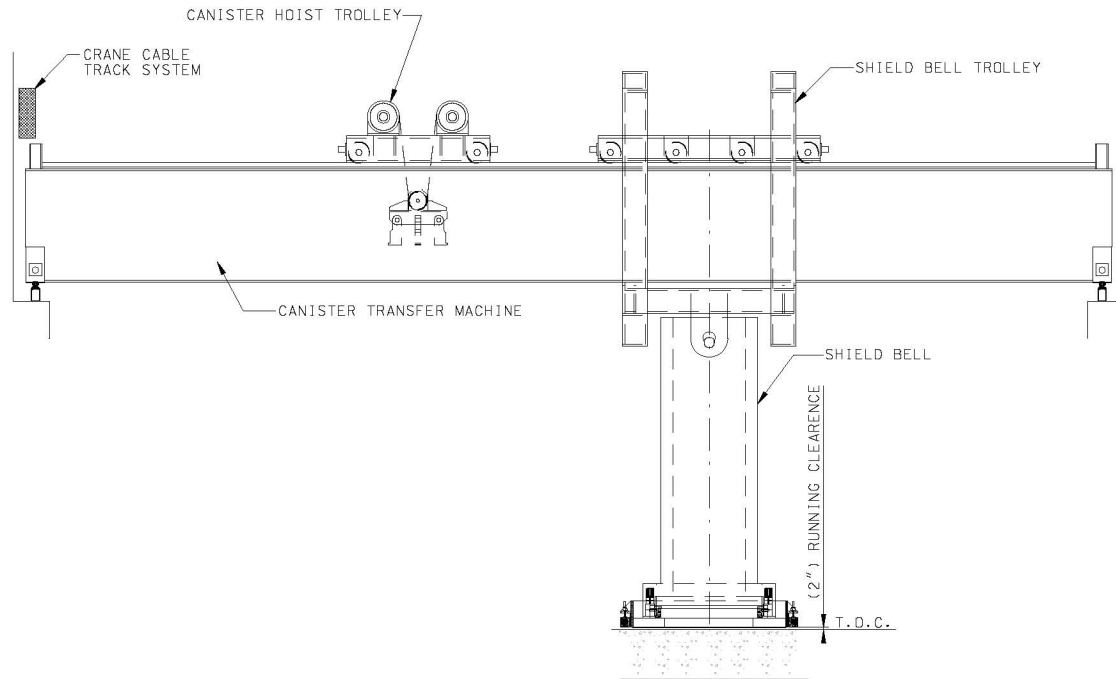

Source: *Mechanical Handling Design Report - Canister Transfer Machine* (Ref. 2.2.67)

Figure 6.2-6. Canister Transfer Machine Elevation

The CTM bridge is very similar to a typical crane bridge, with end trucks riding rails supported by wall corbels. Each bridge girder supports two sets of trolley rails; the two inner rails are for the canister hoist trolley and the two outer rails are for the shield bell trolley.

The CTM design allows for the two trolleys to move independently when required for maintenance but they are normally mechanically locked together and operate as a unit when performing a canister transfer operation. The hoist trolley with grapple is positioned over the shield bell and grapple center is aligned with the shield bell center as depicted in Figure 6.2-7.

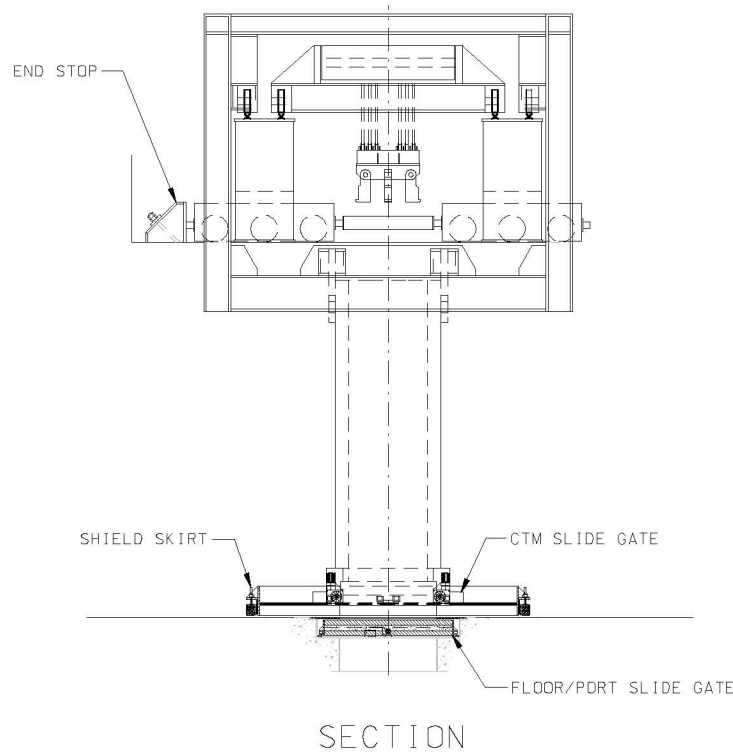

Source: *Mechanical Handling Design Report - Canister Transfer Machine* (Ref. 2.2.67)

Figure 6.2-7. Canister Transfer Machine Cross Section

A detailed fragility analysis was performed for the CTM, and for the CTM hoist system (Ref. 2.2.60, Attachment D and Attachment B, respectively), using the CRCF CTM as representative. The following seismic failure modes were evaluated:

- Collapse (bridge girder or trolley platform, or seismic restraint failure)
- Hoist failure (load drop or heavy object drop)
- Swinging of canister inside the shield bell.

In addition, there is a short period of time during the lifting/lowering of the canister when the canister may be outside or partly inside the bell.

For collapse, the seismic restraint failure had a lower seismic capacity ($A_m = 1.59\text{ g}$) than the bridge girder or trolley platform ($A_m = 2.39\text{ g}$). Since the seismic restraint capacity could be increased relatively easily, the bridge girder capacity was selected as the controlling fragility. In the detailed design of the CHC, the seismic restraints must not control the crane fragility, as noted in Table 6.2-2 above. This could be accomplished by increasing the load factor by two for the seismic design loads for the restraints.

The CTM hoist fragility was documented in *Development of Equipment Seismic Fragilities at Yucca Mountain Surface Facilities* (Ref. 2.2.60) Attachment B. The analysis examined failure of the following hoist components:

- Rope
- Hook
- Upper blocks and load blocks
- Lifting yokes
- Drum
- Drum shafts
- Gear box shafts
- Gears
- Motor shafts
- Mechanical fasteners.

Excessive deformation of the drum could potentially cause the gears on the drum shaft to misalign and possibly fail, resulting in release of the load. This was the controlling failure mode for hoist drop. Note that the fragility calculation includes the potential for a slack rope condition to occur, which can subsequently increase the load on the hoist when the rope becomes taut again.

The potential for damage to the canister from swinging inside the shield bell was examined by determining the expected impact velocity for different accelerations, and gap distances. Over the range of accelerations and gaps up to 1 ft (the gap between a TAD and the bell is about 3 in.), the impact velocity was less than 2 ft/s (Ref. 2.2.60, Attachment B, Section B7). Due to the low impact velocities, a simplified fragility model is used to indicate the onset of swinging impacts that would start to have some impact. Since the impact velocity at the DBGM-2 acceleration level is 0.6 ft/s, this acceleration level (0.45 g) was selected as the onset level, and used as the HCLPF for the fragility model. However, the breach probability would be low for any of the possible impact velocities, and a PEFA value for breach probability is applied in the fault tree model.

There is a short period of time during the lifting/lowering of the canister when the canister may be outside or partly inside the shield bell. Potential damage to the canister is dependent on a number of factors, including the extent that the canister is inside the bell, or inside the CTT below, the displacement due to sliding or rocking movement of the CTT, the radius of canister swinging, and the velocity of impact of the canister on the bell or slide gate. A detailed model of this scenario was not developed. Instead, the BDBGM acceleration level was selected for the median fragility based on the swinging analysis in Attachment B, and breach of the canister was selected as the conservative outcome.

6.2.2.13 CRCF Staging Rack Collapse

Some transportation casks contain multiple canisters, such as DSNF and HLW. For some processing operations in the CRCF, these multiple canisters must be staged before loading into a waste package for emplacement into the drifts. The CRCF has special shielded rooms with

staging racks where these canisters can be stored until a waste package is available to take the canister. Figure 6.2-8 provides an illustration of the CRCF staging rack.

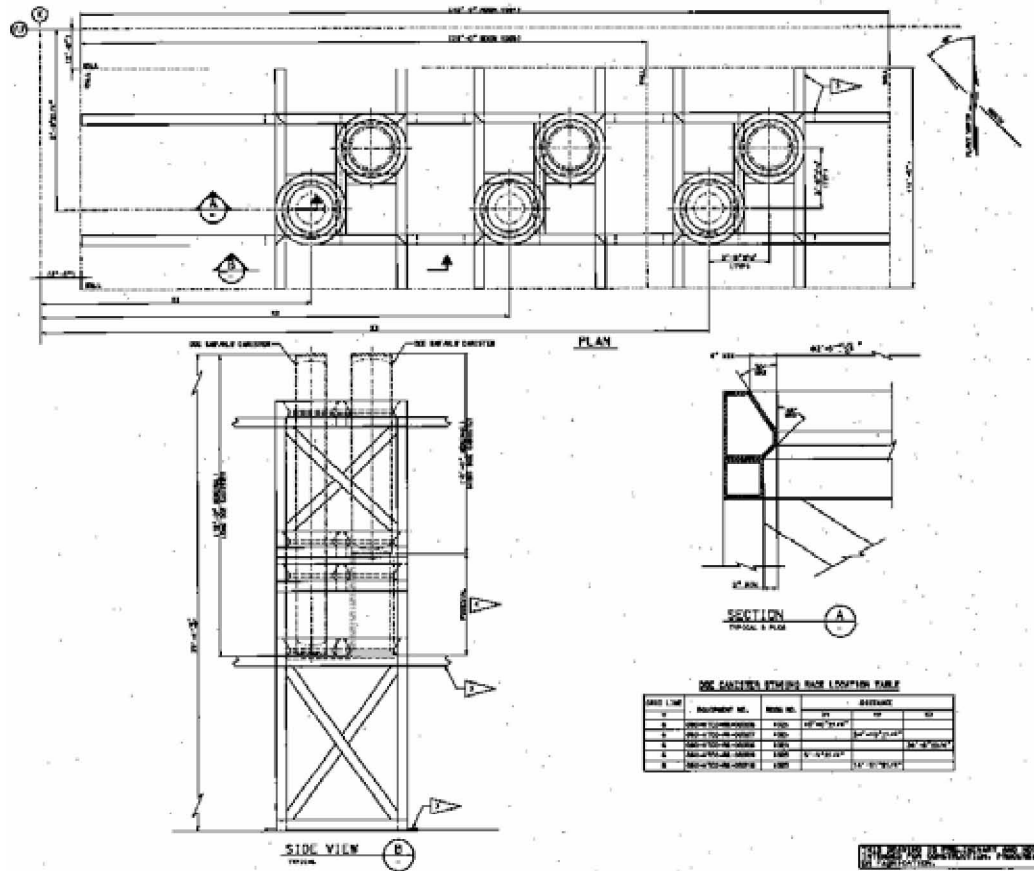

Source: CRCF 1 DOE Canister Staging Rack Mechanical Equipment Envelope (Ref. 2.2.58)

Figure 6.2-8. CRCF Canister Staging Rack

Because the staging racks can contain one or more canisters during much of the preclosure period, the staging racks must have high seismic capacity. A fragility analysis for the CRCF staging racks (Ref. 2.2.60, Attachment N) determined that the governing failure mode is buckling of the horizontal support steel members that extend out to the building walls. The analysis concluded that the median capacity ($A_m = 1.2$ g) was relatively low if the design were limited to just meet the code requirements (Ref. 2.2.60, Attachment N, Section N7). However, in Section N7 the analysis also states:

Canister staging racks are very stiff steel structures whose stiffness is derived from axial behavior of horizontal supporting members and of diagonal bracing members in vertical planes. With both braced frame behavior and horizontal supports at two elevations to all four walls, this structure has a great deal of redundancy and is likely to have very high seismic capacity. However, detailed designs are not currently available such that it must be assumed that all members are designed to their full capacity. Because of the many load paths in this design it is very likely that there will be substantial margin in the structural members.

Furthermore, sizes of HSS (hollow structural section) members indicated in the design concepts may be governed by allowable depth to thickness ratios rather than member stresses.

The canister staging racks ... are a very robust design that is not very susceptible to earthquake shaking such that when the seismic fragility of the final rack design is computed the median capacity and HCLPF values will be much greater than those shown in the above table.

Therefore, a design requirement is made for the CRCF canister staging racks to ensure that the final design is adequate. The associated fragility ($A_m = 4.5$ g) for this requirement is used in the seismic event sequence quantification for the staging racks. The β_c from the detailed analysis (0.45) was used for the composite uncertainty.

6.2.2.14 Spent Fuel Transfer Machine

The spent fuel transfer machine (SFTM) is located above the pool in the WHF, and is used for transferring SNF elements arriving in transportation casks and DPCs into the spent fuel racks and into TAD canisters. Figure 6.2-9 provides an illustration of the SFTM. The bridge spans the pool and runs on rails on the edge of the pool. The trolley runs on a set of rails on the bridge.

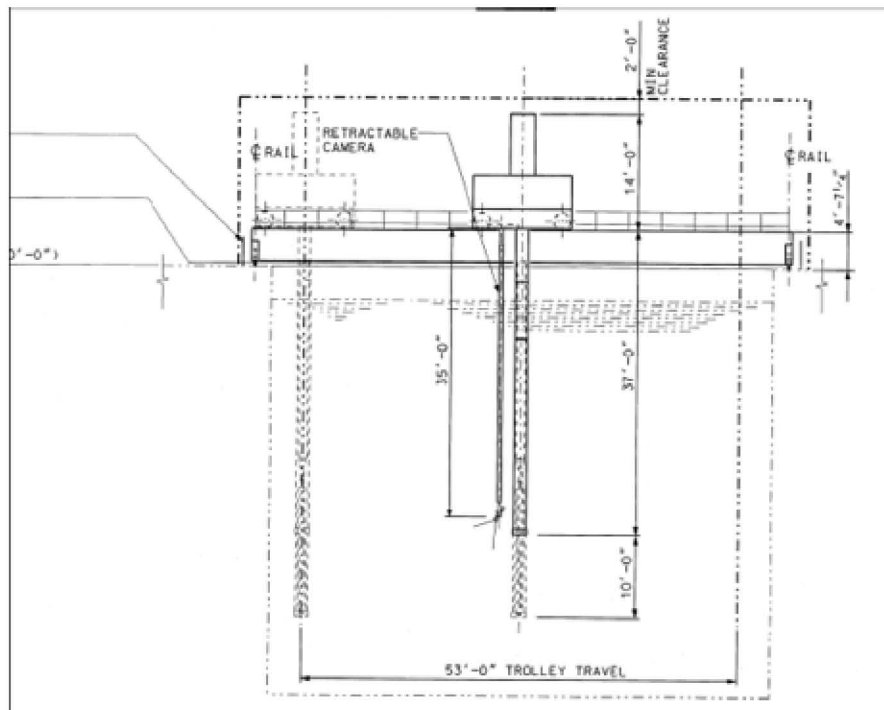

Source: *Wet Handling Facility Spent Fuel Transfer Machine Mechanical Equipment Envelope* (Ref. 2.2.16)

Figure 6.2-9. Spent Fuel Transfer Machine

There are two major failure modes for the SFTM:

- Collapse of the SFTM (or trolley) into the pool
- Drop of an assembly or heavy object.

A detailed fragility analysis for the SFTM was performed for the collapse of the SFTM, with two controlling failures resulting (Ref. 2.2.60, Attachment I):

- Failure of the bridge girders or trolley frame ($A_m = 2.19$ g)
- Failure of the bridge or trolley seismic restraints ($A_m = 2.17$ g).

Since these fragilities were very similar, and the seismic restraint capacity could be increased relatively easily, the bridge girder capacity was selected as the controlling fragility.

The fragility analysis of the CTM hoist discussed previously was used to represent the potential drop of an assembly or heavy object by the SFTM.

6.2.2.15 WHF Spent Fuel Staging Rack

The SNF staging rack provides interim storage for SNF assemblies during the transfer process from a DPC or bare fuel cask into an empty TAD. All transfer operations are carried out under water in the WHF pool. The staging rack may be used extensively, and therefore must have high seismic capacity. A detailed fragility analysis was not performed for the staging rack, although the comments made for the CRCF canister staging racks also apply to the WHF staging racks.

Therefore, a design requirement is made for the WHF spent fuel staging racks to ensure that the final design is adequate. The associated fragility ($A_m = 4.5$ g) for this requirement is used in the seismic event sequence quantification for the staging racks. The standard β_c for structural elements (0.4) was used for the composite uncertainty.

6.2.2.16 WHF Pool Transfer Stations

The WHF pool transfer stations are steel box-like structures in the pool that hold the STC with either a DPC or TAD inside, or a truck or rail cask with bare SNF assemblies inside. Their purpose is to guide the STC or cask to the proper location, and to hold the STC or cask to prevent movement or tipover. A detailed fragility analysis was not performed for the transfer stations, although the comments made for the CRCF canister staging racks also apply to the WHF pool transfer stations.

Even if the transfer stations tip over, and the contents of the STC or cask spill onto the pool floor, there is no significant radionuclide release. The potential for criticality was also reviewed. Based on the boration of the pool, the criticality analysis determined that a criticality event could not occur (Ref. 2.2.70). The fragility associated with welds ($A_m = 1.41$ g, (Ref. 2.2.60, Table 5, Item K, fillet weld) is used in the seismic event sequence quantification for the pool transfer stations.

6.2.2.17 Waste Package Transfer Trolley

The WPTT is used in the CRCF and IHF to transport an empty waste package to the Waste Package Positioning Room, where the waste package is loaded with a sealed TAD or other waste containers. The WPTT then transports the full waste package to the waste package sealing location below the Waste Package Closure Room, where the waste package is sealed and welds are inspected. Once the waste package has been sealed, the WPTT transports the waste package to the Waste Package Loadout Room where the waste package is rotated to the horizontal position, and then loaded into a TEV via the waste package transfer carriage docking station. Figure 6.2-10 provides an illustration of the WPTT. The WPTT moves on a rail system.

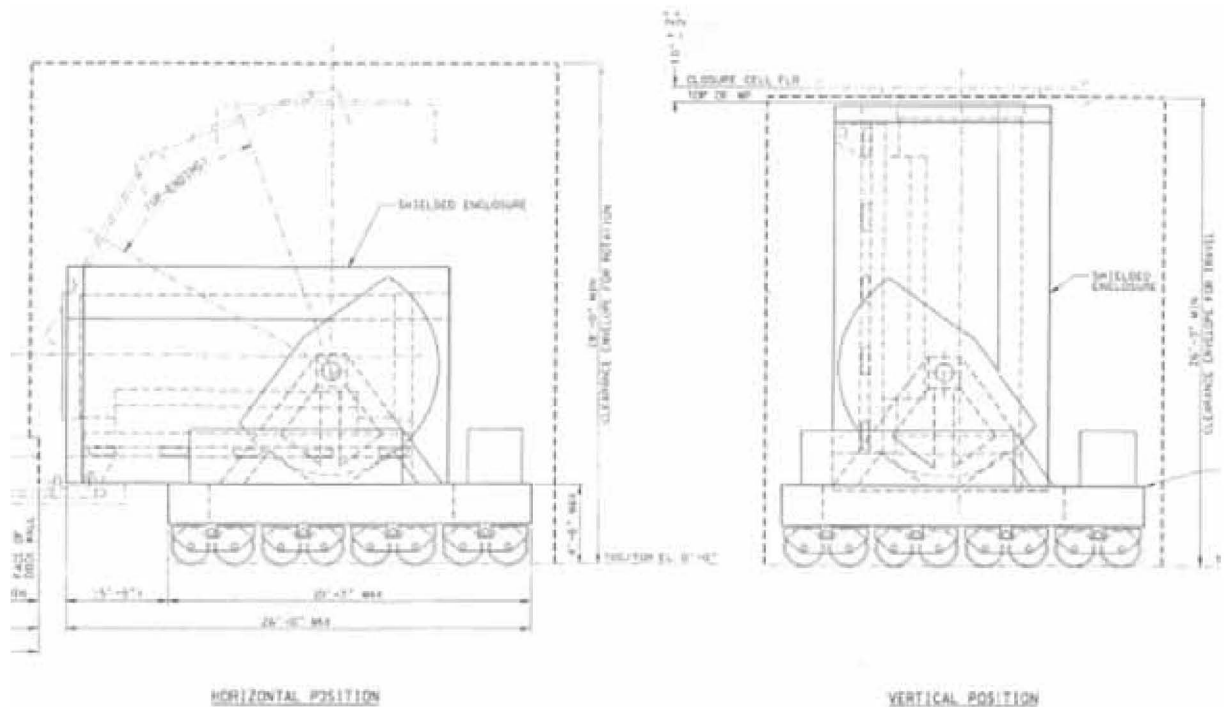

Source: *CRCF-1 and IHF WP Transfer Trolley Mechanical Equipment Envelope* (Ref. 2.2.28)

Figure 6.2-10 Waste Package Transfer Trolley

A detailed fragility analysis was performed for the WPTT (Ref. 2.2.60, Attachment F). A number of failure modes were evaluated, with the following modes potentially controlling:

- Failure of the seismic restraints between the trolley and rails that resist overturning
- Rocking of the WPTT and impact with the overhead floor structure after failure of the clamps
- Tipover of the WPTT after failure of the seismic restraints
- Failure of the trolley rotating mechanism when the WPTT is in the vertical position.

The last failure mode was determined to have very high safety factors such that the fragility was not required to be calculated.

The seismic rail restraints were determined to have the lowest seismic capacity ($A_m = 1.47$ g). However, the WPTT has a relatively low center of gravity, such that failure of the seismic rail restraints does not lead to an immediate impact or tipover. If the WPTT is in the waste package closure position, then the floor above extends down on both sides of the upper portion of the WPTT, preventing total tipover. However, the rocking of the WPTT could impact these floor slabs. The impacts would just start (WPTT just touch the floor slab) with $A_m = 1.85$ g. This fragility was therefore used to represent rocking with floor slab impacts.

If the WPTT is not in the closure position, then it could potentially tip over farther before impacting a wall or floor, resulting in a more severe impact to the waste package and canister inside. However, the fragility analysis demonstrated that tipover would take large accelerations. The fragility for tipover was calculated to be $A_m = 3.41$ g, and breach of the waste package and canister was selected as the end state for this scenario.

6.2.2.18 Remote Handling System

The remote handling system (RHS) is used to support the welding and closure process for the waste package containing one or more canisters. The RHS is essentially a gantry crane with the trolley supporting the telescoping vertical mast which, in turn, picks, moves, and places tools and components to support the waste package closure operation. The RHS bridge girder system is designed to the same requirements as the other gantry cranes described previously. The trolley seismic restraints also meet the same design requirements. Two seismic failure modes are modeled for the RHS:

- Collapse of the RHS bridge and girder structure onto the waste package or canister inside
- Drop of a heavy object onto the waste package or canister inside.

The seismic design requirements for the RHS gantry crane bridge girder and seismic restraints are the same as for the cask handling crane. Thus, the fragilities for the RHS collapse failure mode is based on the representative CHC collapse failure mode described in the section above. For heavy object drop, the RHS system is designed to the ASME NOG-1 Type II requirements (Ref. 2.2.8). Therefore, as for the other Type II cranes discussed in Section 6.2.2.6, the fragility for heavy object drop is based on the DBGM-2 level for the HCLPF.

6.2.2.19 Transport and Emplacement Vehicle

The TEV transports waste packages from the CRCF or IHF to the emplacement drifts. Figure 6.2-11 illustrates the design of the TEV. When the TEV reaches the docking station in the loadout area, several mechanical movements of components must take place in order to receive the waste package and emplacement pallet. The front and rear shield doors must be opened and the base plate must be extended. Then, the shielded enclosure is lowered from its transport position via the shielded enclosure jack screw lifting system. The waste package and pallet are then placed into the shielded enclosure so that the TEV integral shielded enclosure

lifting features are positioned under the emplacement pallet lifting points. The waste package is then lifted into place and the TEV shielded enclosure is raised by jack screws to the transportation height where shot bolts are placed to carry the load during transportation. The lifting jacks are then raised so that they are no longer supporting the shielded enclosure. The base plate extension, which is a shield, is then retracted. The shield doors are then closed and bolted, and the TEV is ready to transport a waste package to the drifts.

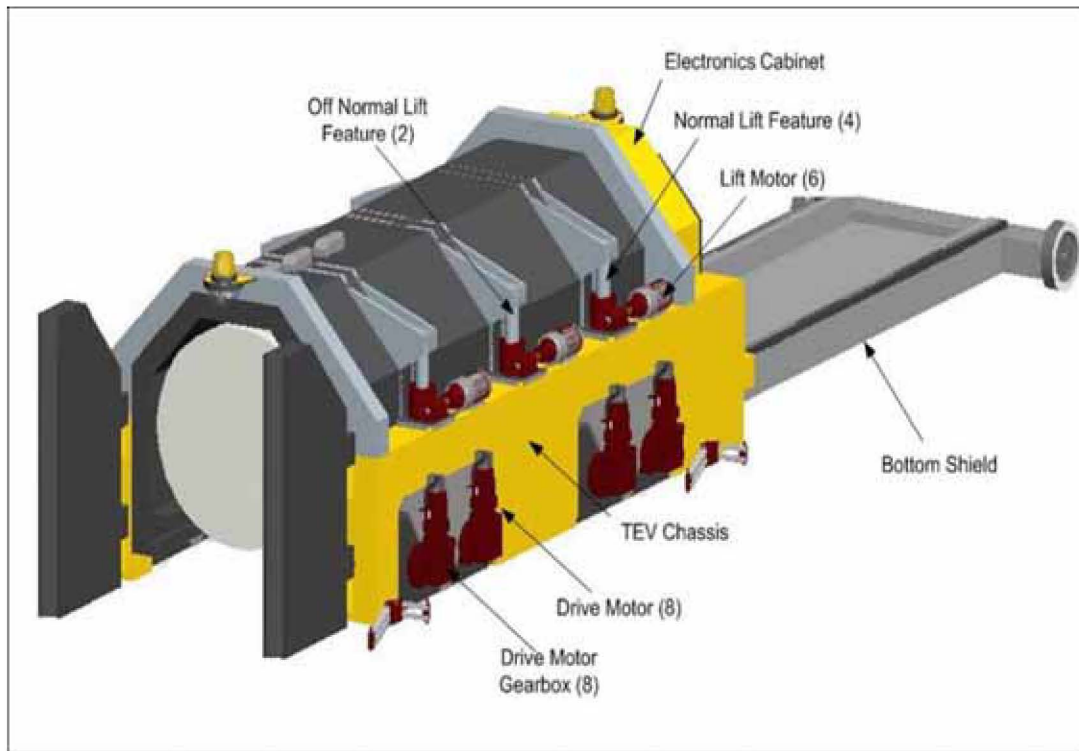

Source: *Mechanical Handling Design Report: Waste Package Transport and Emplacement Vehicle* (Ref. 2.2.36)

Figure 6.2-11 Transport and Emplacement Vehicle

A detailed fragility analysis was performed for the TEV (Ref. 2.2.60) Attachment H. The following TEV design features (based on the TEV MHDR, *Mechanical Handling Design Report: Waste Package Transport and Emplacement Vehicle* (Ref. 2.2.36)) were reviewed for the analysis:

1. The front and rear wheels are double flanged on one side of the TEV and the remaining wheels on both sides are flangeless.
2. On loss of power, rail brakes are activated to prevent runaway.
3. The gear drive motors on the wheels are a high ratio such that the wheels cannot back drive the motors.

4. The screw jack shielded enclosure lifting devices are self locking to prevent a drop during a shielded enclosure lifting operation and there are redundant lifting devices.
5. The screw jack shielded enclosure lifting devices are protected from lateral loading with a roller assembly between the TEV frame and the shielding enclosure.
6. ASME NOG-1 (Ref. 2.2.8) is specified for design of mechanical components so that all drive systems and lifting devices have no single failure features and are individually sized for the design loads, thus the safety factor to failure of all drive systems and lifting devices are higher than for the structural components, or any rail clamps that may be present.
7. The maximum lift height for a waste package, when in a horizontal orientation, is 6.5 ft. The TEV design limits the maximum lift height of the emplacement pallet base to 20 in. so a drop during a lift does not fail the waste package.
8. The shielded enclosure straddles the waste package and pallet. The bottom edges of the shielded enclosure are within 2 in. of any surface and the distance between the shielded enclosure internal top faces and a maximum diameter waste package is 4 in. so a failure of the shielded enclosure support will not impact the waste package.
9. The shielded enclosure, including the door bolts, is designed for DBGM-1.
10. The TEV, when fully loaded with a waste package, has a center of gravity of less than 65 in. from the top of the rails, the fully loaded maximum weight is 600,000 pounds and the distance between rails is 132 in. Depending on the fundamental frequency of the TEV in the horizontal and vertical directions, the TEV could tip when subjected to a DBGM-2 earthquake. One possible failure mode is tipping and/or jumping the rails although this does not necessarily result in failure of a waste package.

From the above discussions on design features and redundancy, the controlling failure modes of the TEV are:

- Failure of the seismic restraints (or rail system) with subsequent derailment and sliding of the TEV
- Tipover of the TEV
- Failure of the door bolts and ejection of a waste package from the TEV.

The conceptual design for the seismic restraint is shown in Figure 6.2-12.

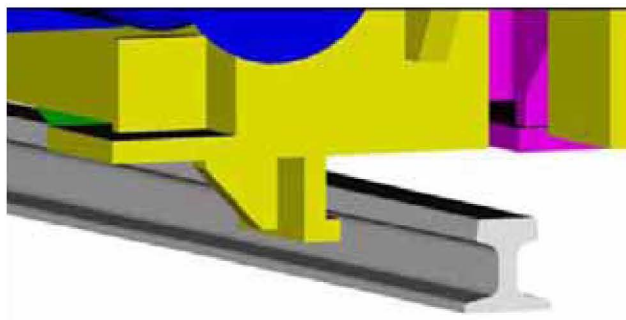

Source: *Mechanical Handling Design Report: Waste Package Transport and Emplacement Vehicle* (Ref. 2.2.36)

Figure 6.2-12 Conceptual Design of TEV Seismic Restraint

When the TEV is outside the facilities, failure of the seismic restraint and subsequent derailment would not be likely to cause breach of the waste package. However, when the waste package is being transferred from the WPTT to the TEV, there is a short interval (5 min) when derailment of the TEV and sliding could put lateral forces on the sides of the waste package. Breach of the waste package was selected to be the end state if the seismic event occurred during this time interval, and the TEV seismic restraints or rail system failed ($A_m = 1.12$ g).

Once the waste package is emplaced in the drift, there is some potential that a seismic event could occur during the 2 to 5 minutes that the TEV is backing away from the emplaced waste package. Unlike the loading process in the CRCF and IHF, this scenario is not considered to have the potential to bend the waste package. This is because, for a partially disgorged waste package, there is nothing to restrain the “free” end of the waste package. In addition, the accelerations in the drift are less than half of those for the surface facilities (compare Figures 6.1-1 and 6.1-2), so derailment of the TEV with significant lateral movement is less likely. Therefore, due to the lower accelerations, the short time periods at hazard, and the reduced potential for bending loads, this drift scenario was determined not to be a dominant failure mode.

Tipover of the TEV was evaluated, even though the TEV has a low center of gravity, and the rails are wide. At about 4 g horizontal PGA, the TEV only rotated 23 degrees, and the instability point is about 45 degrees (Ref. 2.2.48, Attachment H, Section H6.2.4). The fragility analysis concluded that “the TEV cannot tip over at any credible ground motion.” However, this seismic event sequence analysis used a conservative $A_m = 5$ g for the quantification.

The final TEV failure mode is ejection of the waste package due to impact of the waste package with the TEV shield door, and failure of the door bolt. Since the door bolt is designed to DBGM-1 (1E-3/yr MAPE corresponding to about 0.3g horizontal PGA), the HCLPF for the door bolt was set equal to 0.3g, giving a median fragility of $A_m = 0.76$ g.

6.2.2.20 Site Transporter

The site transporter is a diesel/electric self-propelled tracked vehicle that is designed to transport the aging overpack among the CRCF, WHF, RF and aging facilities. Figure 6.2-13 provides an illustration of the site transporter. When loaded, the aging overpack is in the vertical position with its lid fastened on the top. The interface between the site transporter and the aging overpack is via two lifting forks that pass through the aging overpack at its lower end. In addition, the aging overpack is held in the transporter by front support arms and by a three-point cask restraint system applied near the top end of the aging overpack. The site transporter operates on diesel power when outdoors between handling facilities and the aging facility. It is operated through an electrical umbilical when it is located inside the CRCF or other facilities. The mechanical handling design report (MHDR) provides additional descriptive information (Ref. 2.2.35).

While in the CRCF, the site transporter sits on the concrete ground floor. Minimum clearance is 19 in. from the edge of the transporter to the back wall of the canister transfer room, and 51 in. to the side wall.

While on the road outdoors, the site transporter may be on a slope of as much as 5 % grade in the direction of travel and as much as 2 % grade transversely.

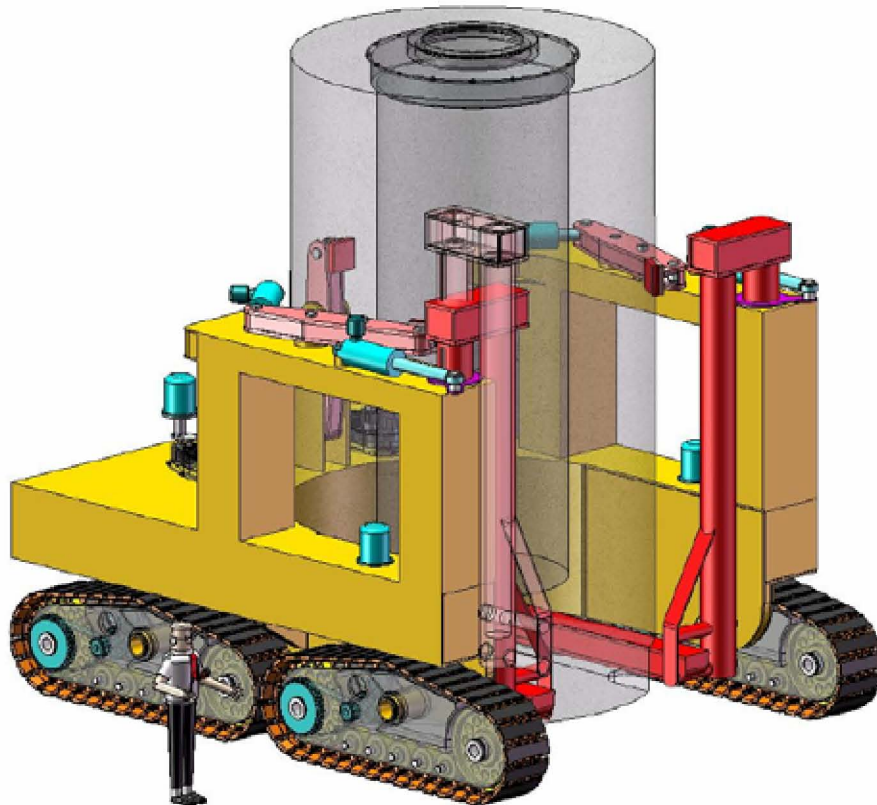

Source: *Site Transporter Mechanical Equipment Envelope* (Ref. 2.2.95)

Figure 6.2-13. Site Transporter

The detailed fragility analysis (Ref. 2.2.60, Attachment G) reviewed potential seismic failure modes. The structural and mechanical features of the site transporter were found to have very high seismic capacity. Fragilities for the following failure modes were calculated:

- Sliding of site transporter into structural wall
- Tipover of site transporter.

As mentioned above, the minimum distance from the site transporter to a structural wall in the Canister Transfer Room is about 19 in. The median fragility for this sliding distance was determined to be $A_m = 1.89$ g. For the tipover failure mode, the fragility analysis compared the ratio of b/h of the site transporter to the TEV, where b is the horizontal distance from the center of gravity to the edge of the site transporter body, and h is the height of the center of gravity. The b/h ratio for the site transporter is slightly lower than for the TEV, leading to the conclusion that the site transporter will not tip over at any credible acceleration level (Ref. 2.2.35, Attachment G, Section G6.3.3). The tipover fragility for the TEV was also used for the site transporter ($A_m = 5$ g).

When the site transporter is parked in the aging overpack access platform (in the WHF), Lid Bolting Room platform (in the RF), or CPP (in the CRCF), there is some potential for sliding of the site transporter into the platform, potentially causing platform collapse. However, these platforms have energy absorbing features that will prevent significant impact of the site transporter on the platforms. This failure mode is called “bumping” in the event sequence analysis, and uses the sliding fragility value for the quantification.

6.2.2.21 Aging Overpack

The aging overpack is a concrete and steel cylindrical container that can hold a DPC or TAD for either transport among the RF, CRCF, and WHF, or for storage at the Aging Facility on the aging pad. The base of the aging overpack is a maximum of 12 ft in diameter, and the height is a maximum of 22 ft, with a maximum weight (loaded) of 250 tons (Ref. 2.2.83). Figure 6.2-14 provides an isometric view of the vertical DPC aging overpack (Ref. 2.2.23).

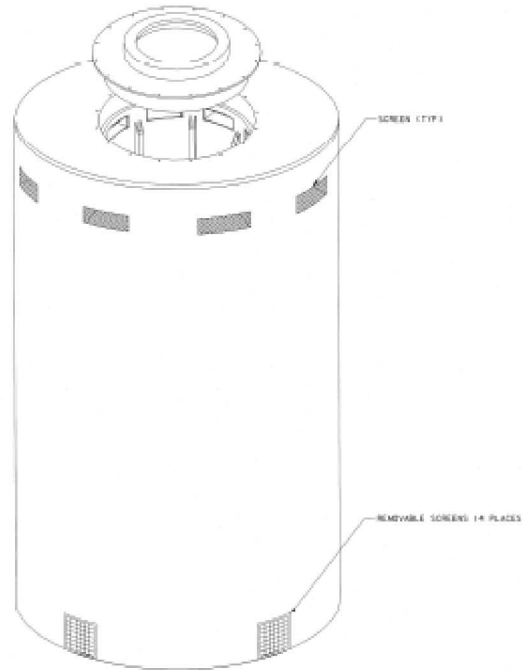

Source: *Aging Facility Vertical DPC Aging Overpack Mechanical Equipment Envelope Sheet 1 of 2* (Ref. 2.2.23)

Figure 6.2-14. Vertical DPC Aging Overpack Isometric View

Two seismic failure modes were used in the event sequence quantification. For potential tipover, the design requirement for the aging overpack is that the aging overpack shall remain upright and free standing during and after a seismic event characterized by the horizontal and vertical peak ground accelerations of 96.52 ft/s^2 (3 g) (Ref. 2.2.83). Therefore, 3 g was used for the HCLPF estimate, giving a median fragility of $A_m = 7.62 \text{ g}$ for tipover of the aging overpack.

The aging overpacks are spaced on 18 ft centers on the aging pads such that they are about 6 ft apart (Ref. 2.2.21). A sliding analysis was performed (Ref. 2.2.48, B1.1.2.2) which determined that a 1.2 g PGA earthquake could cause about 3 ft of sliding. Instead of sliding into each other, it would be more likely that all of the aging overpacks would slide approximately the same direction and distance. However, to be conservative, this earthquake level was taken as the HCLPF of the sliding fragility, giving a median fragility of $A_m = 3.0\text{g}$ for sliding causing impact. The closest edge of an aging overpack is 14 ft from the edge of the aging pad (Ref. 2.2.19), so the aging overpack would not slide off of the pad onto the compacted aggregate surrounding the concrete aging overpack pad.

6.2.2.22 Drip Shield and Drip Shield Gantry

Fragilities were not estimated for these subsurface components. Qualitative and semi-quantitative discussions of potential seismic failures of these components are given in Section 6.9.2.

6.2.2.23 Piping System Integrity Failure

Most of the seismic event sequences include the potential for moderator intrusion into a breached canister causing a potential criticality. (Sequences involving HLW and the WHF pool do not have these moderator questions.) The most credible sources of moderator in a seismic event are the water piping systems. These include fire protection water, potable water, hot water, and chilled water, as well as some pool-related water systems in the WHF.

Experience in earthquakes has demonstrated that welded piping systems perform very well during earthquakes. However, there have been failures of fire protection water piping systems, and threaded piping systems during earthquakes. The detailed fragility analysis determined that the piping designed to the DBGM-2 level would have a median fragility of about 2.2 g (Ref. 2.2.60, Attachment K). However, the Balance of Plant piping systems listed above could be designed to lesser criteria such as IBC, NFPA-13 or DBGM-1 level, depending on final requirements. Although it would be expected that the piping would still have significant seismic capacity, the fragility was estimated by selecting the HCLPF to be approximately the DBGM-1 level. This gives a HCLPF of 0.3 g, with a median fragility $A_m = 0.76$ g.

However, the potential availability of moderator due to a piping system failure does not immediately lead to a moderator intrusion event, much less a criticality event. The piping system break must be in the same room as the breached canister, or the curbing and drain systems would route the water away from the canister. System piping breaks in other rooms, or outside the facility, could divert the system water away from the break in the room containing the canister. Since it is unlikely that offsite power would be available (offsite power failure has an A_m of 0.3 g, compared to the much stronger piping system A_m of 0.76 g), it is unlikely that the piping system pumps would be operable, so only gravity feed would be possible, limiting the water volume. The breach in the canister may not be located where the water would build up to enter the canister, or the breach may be just a crack, preventing any substantial amounts of water from entering the canister. For all of these reasons, it would be very unlikely that a criticality event would occur. Therefore, the value for spray or flood intrusion of moderator into a breached canister was selected to be 1E-02 per event. This engineering judgment, based on the above factors, is conservative.

6.2.2.24 Electrical Cabinets and Relay Chatter

The fire protection system will use dry pipe, pre-action design in the rooms where waste containers are handled. The pre-action valves are only opened when a double interlock circuit is satisfied. Relay chatter in the circuit could cause spurious opening of the pre-action valves, allowing water to flow into the dry pipe system. The design of the electrical circuits and identification of relays to be used in the circuits has not been performed, and it may be that solid state circuits would be used rather than relays subject to chatter during earthquakes. Solid state circuits have high seismic capacities, and would not have seismic chatter issues. To be conservative, relays were considered to be used in this application, with the potential for relay chatter to occur.

The detailed fragility analysis examined equipment qualified by test, such as electrical cabinets with relays, for the “function during” mode, which is the relay chatter failure mode (Ref. 2.2.60, Attachment J). However, since the fire protection preaction valve and control systems are designed to ITS criteria, it is expected that the final design will have high seismic capacity. Relays for these low voltage circuits often have very high capacity (15 g or greater). The fragility was conservatively estimated to be approximately 3 g median fragility.

6.2.2.25 Heating, Ventilation, and Air Conditioning (HVAC) System Integrity

As noted in Section 4.3.3.1, the HVAC system was not credited for radionuclide release filtering in the seismic event sequences. However, failure of HVAC system integrity could cause a release of any radioactive material inside the system. For most of the facilities, there would be minimal contamination in the HVAC ducts and filters. However, there could be radioactive material in the WHF HVAC system.

The detailed fragility calculation included the evaluation of HVAC ducting and supports for the DBGM-2 design level, resulting in a median seismic capacity of 2.7 g (Ref. 2.2.60, Attachment K).

6.2.2.26 Loss of Offsite Power

Although the loss of offsite power, and the onsite emergency power system was not modeled for the seismic event sequence analysis, the seismic capacity of the offsite power system is used for qualitative discussions in several sections of this report. The median fragility is 0.3g, while the HCLPF, which represents the acceleration at which there is about 1% chance of failure, is 0.09g.

The seismic fragilities for the structures and equipment described above are summarized in Tables 6.2-1 and 6.2-2.

6.3 THROUGHPUT, EXPOSURE TIME, AND PASSIVE EQUIPMENT FAILURE ANALYSIS FACTORS

The next subsections discuss:

- Determination of number of waste containers processed in each facility
- Exposure/residence time fractions
- Breach probabilities (PEFA).

6.3.1 Waste Form Throughput Analysis

The seismic event sequence quantification is performed for the preclosure period as a whole in order to directly compare the results with the 10 CFR Part 63 (Ref. 2.3.1) compliance criteria. Therefore, the total number of waste containers handled in each facility and process was determined. The seismic event sequence analysis uses the same source for these numbers as the internal events analysis, *Waste Form Throughputs for Preclosure Safety Analysis* (Ref. 2.2.51) Tables 3 and 4. Table 6.3-1 provides the throughput numbers for each facility and waste form process used in the seismic analysis.

Table 6.3-1. Number of Waste Containers Processed in Each Facility

Facility	Process	Number of Waste Containers
IHF	Transfer naval canisters from railcar TC to WP	400 naval canisters
	Transfer HLW from truck TC to WP	1000 HLW canisters
RF	Transfer TAD from railcar TC to AO	6,978 TAD canisters
	Transfer DPC from vertical TC to AO	346 DPCs
	Transfer DPC from tilting frame TC to AO	346 DPCs
	Transfer DPC from horizontal TC to horizontal cask transfer trailer	346 DPCs
CRCF	Transfer TAD from railcar TC to AO	6,978 TAD canisters
	Transfer DPC from railcar TC to AO	346 DPCs
	Transfer TAD AOs to WPs	8,143 TAD canisters
	Transfer DOE SNF from TC to WP	3,300 DOE SNF canisters
	Transfer MCO from railcar TC to WP	451 MCO canisters
	Transfer HLW from railcar TC to WP	9,801 HLW canisters ¹
WHF	Transfer DPC from tilting frame TC to STC in pool	346 DPCs
	Transfer bare SNF assemblies from TC to pool	3,775 bare SNF casks
	Transfer SNF assemblies from TC to rack, then from rack to TAD	33, 104 assemblies (2 transfers each assembly)
	Transfer TAD from pool to AO	1,165 TAD canisters
Intra-Site Operations	Transfer AO to and from Aging Facility	17,000 one-way trips with TAD or vertical DPC
	Transfer horizontal DPC to and from Aging Facility	692 one-way trips with horizontal DPC
	Average number of AOs on aging pad	1,920 AOs
	Maximum number of railcars and truck trailers with loaded TC in buffer yard area	30 conveyances
	Number of railcar and truck trailer deliveries	14,357 conveyances
Subsurface Operations	TEV trips with WP	12,068 WPs

NOTE: 1. Each HLW canister is considered to be transferred twice: once from the TC to the staging rack, and once from the staging rack to the WP.

AO = aging overpack; DOE = U.S. Department of Energy; DPC = dual-purpose canister; HLW = high-level (radioactive) waste; MCO = multi-canister overpack; SNF = spent nuclear fuel; STC = shielded transfer cask; TAD = transportation, aging and disposal; TC = transportation cask; TEV = transport and emplacement vehicle; WP = waste package.

Source: *Waste Form Throughputs for Preclosure Safety Analysis* (Ref. 2.2.51) Table 3 and Table 4, and original

Intermediate calculations were required for the following waste containers in Table 6.3-1:

- Transfer aging overpack to and from Aging Facility: this includes 8,143 TAD canisters in aging overpacks, and 346 vertical DPCs in aging overpacks. Each aging overpack makes two one-way trips as it goes to the aging pad and returns. $(8,143 + 346) * 2 \sim 17,000$ total one-way trips of an aging overpack.
- Average number of aging overpacks on aging pad: An approximate estimate of the average number of aging overpacks on the aging pad was made based on a maximum number of 2,400 aging overpacks (Ref. 2.2.20). It would take about 10 years to fill the aging pads, and another 10 years to deplete the aging pad at the end of processing, with about 30 years at full capacity. Thus the average over the 50 years would be $[(10 * 2400 * 0.5) + (30 * 2400) + (10 * 2400 * 0.5)] * 0.02 = 1920$.
- Railcars and truck trailers with loaded transportation cask in yard: The buffer yard has a capacity of 25 railcars loaded with transportation casks (Ref. 2.2.24, Section 9.9.2.2.1). While there is no documented reference, it is expected that there will be buffer storage for five truck trailers loaded with a transportation cask. This sums to 30 conveyances in buffer yard areas.
- Number of railcar and truck trailer deliveries: From Ref. 2.2.51, Tables 3 and 4, the number of railcar and truck trailer deliveries to the site is 14,357, composed of:

Naval casks: 400	MCO casks: 113	DOE SNF casks: 385
HLW casks-rail: 1860	HLW casks-truck: 500	Bare SNF casks: 3775
DPC casks: 346	TAD casks: 6978	

From Table 6.3-1, it can be seen that there are a number of conservatisms in the analysis, since several processes consider the same waste containers. For example, the number of TADs transferred from railcar transportation cask to aging overpacks in the RF (6,978) is the same as the number of TADs transferred from railcar transportation casks to aging overpacks in the CRCF (6,978). This double-counts the number of TADs processed to aging overpacks. The numbers also double count the DPC processes. This over-estimation for individual processes provides flexibility to operation of the facilities, and is discussed in more detail in the source report referenced above.

6.3.2 Exposure/Residence Time Factors

An earthquake can occur at any time during the preclosure period, and cause seismic failures of SSCs. However, most of the SSCs are not involved in waste handling operations 24 hours a day for 50 years. An SSC must be handling a waste container, or in close proximity, to potentially impact the waste container. Even for structures, there must be a waste container in the building in order for collapse to damage the waste container. In risk analysis, this critical time when undesired outcomes could occur can be termed the exposure time. For example, for the event sequence involving the drop of a waste container by the cask handling crane due to a seismic event, the time period when the container is being lifted or moved by the CHC is identified as the

exposure time that will permit the potential event sequence. As a conditional requirement, the drop of the waste container by the CHC can only be caused by the earthquake when the waste container is actively being lifted by the CHC.

To determine the amount of time the waste container is exposed to a specific hazard, the expected times of each waste handling process in each facility were evaluated. Preliminary throughput estimates for waste handling in the CRCF (Ref. 2.2.41), IHF (Ref. 2.2.42), RF (Ref. 2.2.43) and the WHF (Ref. 2.2.44) were analyzed to identify when a waste container is in an exposed configuration. The approach was discussed in Section 4.3.3.4, and is documented in detail in Attachment G. The result is the exposure time by SSC seismic failure mode per waste container processed.

Since the seismic hazard is represented in terms of frequency per year, the ETF is given in terms of “years per single waste container.” The exposure time factor varies for each SSC seismic failure mode, for each processing activity, and for each facility. A summary table of exposure time factors is provided for each facility in the respective facility sections. Note that the ETFs provided in these tables have been rounded to two significant figures for presentation. However, the source files in Attachment G remain at three significant figures, and three significant figures were input into the SAPHIRE calculations for event sequence quantification, and are displayed in the detailed quantification attachments, Attachments A through F.

6.3.3 Passive Equipment Failure Analysis Factors

The probability of waste container (e.g., transportation cask, waste package, or TAD canister) breach due to seismic failure of an SSC is dependent on a number of factors, including the type of container, the mode of seismic failure, and the load imparted by the SSC failure onto the container, which can vary by earthquake magnitude and seismic failure scenario. In general, the seismic failures involve:

- Drop of a container
- Drop of a heavy object onto a container
- Collapse of an SSC onto a container
- Lateral impact of a container.

The conditional probability of container breach, given one of these seismic failures, has been calculated for a large number of scenarios, which are collectively termed the passive equipment failure analysis. While some of the calculations are based on experiments (e.g., test drops of containers), most of the passive equipment failure analysis is based on simulations or finite element analysis. Section 4.3.3.5 describes the approach to the passive equipment failure analysis. Attachment H contains a summary of the primary documents that have examined passive failures relevant to YMP, and provides the passive equipment failure probabilities.

The conditional probability that the waste container is breached, given the accident scenario, is termed the PEFA (from passive equipment failure analysis). As would be expected, the PEFA can vary depending on the accident scenario and waste container involved. For example, the PEFA for a waste container inside a building that collapses due to a seismic event is 1. That is, if the structure fails, any waste container inside the structure would be breached. Conversely, if a heavy object (defined as 10 tons or less) is dropped on a sealed transportation cask, the PEFA is $1E-05$. That is, there is a very small chance that the transportation cask would be breached. As discussed in Attachment H, the PEFA calculated in the finite element models for this failure is less than $1E-08$. As an additional conservatism, a lower limit of breach probability of $1E-05$ was placed on drops of most casks, canisters, and waste packages. To perform the analyses, representative canisters and casks were selected from the variety of available designs in current use which were relatively thin walled on the sides and bottom. This added another conservative element.

The standard PEFAs used in the seismic event sequence analysis are given in Table 6.3-2, and are based on the information referenced in Attachment H.

Many of these, such as lateral impacts, derailments, and objects dropped onto casks, involve far lower energy loads than drop events. Although the PEFA can be ratioed by impact energy to estimate the less energetic situation, this was not done for the seismic event sequence analysis.

Also note that the seismic event sequence analysis conservatively identified some PEFAs to be equal to 1 (that is, considered to be breached). For example, the discussion in Attachment H, Section H1.3 states that the transportation cask and co-disposal waste package are designed to preclude contact with the HLW or DSNF canister inside by a dropped lid or other heavy object. However, for the seismic analysis, the PEFA for heavy object drops on HLW, DSNF, and MCOs did not take advantage of this design feature. For the cask preparation crane, CTM, or RHS, the heavy object drop PEFAs were conservatively set equal to 1 (considered to be breached).

Shielding Degradation Events

Impact loads (such as drops) may not be severe enough to breach a transportation cask, but might lead to degradation of shielding such that onsite nearby personnel are exposed. However, degradation of shielding events would not cause any significant offsite dose. Since the shielding degradation events are not significant for seismic risk, a very simple model was used. Based on the internal events analysis, shielding degradation has a conditional probability of $1E-05$ (Ref. 2.2.59, Attachment D.3). This is very conservative, but does not impact the seismic event sequence results.

There is, however, one seismic induced failure that results in shielding failure. If the seismic event causes the waste package to be ejected from the TEV, then the TEV shielding is no longer functioning, and shielding is lost. This loss of shielding is directly modeled in the appropriate TEV seismic event sequences.

Table 6.3-2. Standard PEFA's Used For the Seismic Analysis

Seismic Failure Mode	Target	PEFA
Collapse of building	Any waste container	1 (breach for containers, or damage for SNF assemblies) ¹
Collapse of mobile platform, collapse of rollup entry or confinement door, tipover of railcar, truck trailer, or horizontal cask transfer trailer	Transportation cask, horizontal shielded transfer cask	1E-05
Collapse of crane (CHC, CPC, CTM, CTMMC, WPHC, EVC, SFTM, APC, LBRC, Jib cranes)	Any waste container (note: Each crane is evaluated only for the waste containers that may be impacted)	1 (breach for containers, or damage for SNF assemblies) ¹
Drop of transportation cask or heavy object by CHC	Transportation cask	1E-05
Impact due to lateral swinging of TC by CHC	Transportation cask	1E-05
Tipover of horizontal cask stand	Transportation cask	1E-05
Drop of heavy object by CPC or EVC	Transportation cask (except HLW in opened cask)	1E-05
	HLW in opened cask (IHF only)	1 (breach) ¹
Drop of heavy object by SFTM, APC	DPC, bare SNF cask, or TAD	1 (damage to SNF) ¹
Drop of heavy object by jib cranes	DPC or TAD	1 (damage to SNF) ¹
	Bare SNF cask	1E-5 (transportation cask lid on)
Collapse of platform (cask preparation platform, preparation station #1 and #2, DPC cutting station, TAD closure station, AO access platform, Lid Bolting Room platform)	Transportation cask, shielded transfer cask, aging overpack	1 (breach) ¹
Impact of cask transfer trolley with wall or structural column	Transportation cask, shielded transfer cask	1 (breach) ¹
Impact of cask transfer trolley with cask preparation platform (IHF), energy absorbing feature (EAF) of cask preparation platform (RF, CRCF), or EAF of preparation station #1 (WHF)	Transportation cask, or shielded transfer cask	1E-05
Collapse of equipment shield doors or emplacement access doors	Any waste container	1 (breach) ¹
Canister drop by CTM	TAD, naval canister, DPC, DOE SNF	1E-05
	HLW	3E-02
	MCO	0.1
Drop of heavy object by CTM	TAD, naval canister, DPC	1E-05
	HLW, DOE SNF, MCO	1 (breach) ¹
Canister impact swinging inside CTM shield bell	Any canister	1E-5
Canister impact swinging outside CTM shield bell	Any canister	1 (breach) ¹
Collapse of canister staging racks (CRCF)	Any canister	1 (breach) ¹
Collapse of spent fuel staging racks (WHF)	SNF assemblies	1 (damage to SNF) ¹
Collapse of RHS	WP with TAD or naval canister	1E-05
	WP with HLW	1 (breach) ¹
	WP with DOE SNF or MCO – lid unfastened	1 (breach) ¹
	WP with DOE SNF or MCO – lid fastened	1E-05
Drop of heavy object by RHS	WP with TAD or naval canister	1E-05
	WP with HLW, DOE SNF, or MCO	1 (breach) ¹
Tipover of WPTT holding WP	Any WP	1 (breach) ¹
Rocking impact of WPTT holding WP	Any WP	1E-05
Drop of heavy object by WPHC on WP	Any WP	1E-05
TEV tipover	Any WP	1E-05

Table 6.3-2. Standard PEFA's Used For the Seismic Analysis (Continued)

Seismic Failure Mode	Target	PEFA
TEV derailment and lateral sliding during WP loading	Any WP	1 (breach due to bending) ¹
TEV derailment and lateral sliding in transit to drift	Any WP	1E-05
TEV – ejection of WP	Any WP	5E-03 (ejected at angle)
Sliding impact of site transporter with wall or structural column	Aging overpack	1 (breach) ¹
Sliding impact of site transporter with AO, or energy absorbing feature (EAF) of cask preparation platform (CRCF), aging overpack access platform (WHF), or Lid Bolting Room platform (RF)	Aging overpack	1E-05
Tipover of site transporter	Aging overpack	1E-05
Tipover of AO on aging pad	Aging overpack	1E-05
Sliding impact of AO on aging pad	Aging overpack	1E-05

NOTE 1: The use of a PEFA equal to one (1) denotes a scenario where the waste container has been conservatively considered to be breached, or the SNF assembly considered to be damaged.

AO = aging overpack; APC = auxiliary pool crane; CHC = cask handling crane; CRCF = Canister Receipt and Closure Facility; CPC = cask preparation crane; CTM = canister transfer machine; CTMMC = canister transfer machine maintenance crane; DOE = U.S. Department of Energy; DPC = dual-purpose canister; EAF = energy absorbing feature; EVC = Entrance Vestibule crane; HLW = high-level (radioactive) waste; IHF = Initial Handling Facility; LBRC = Lid Bolting Room crane; MCO = multicanister overpack; RF = Receipt Facility; RHS = remote handling system; SFTM = spent fuel transfer machine; SNF = spent nuclear fuel; TAD = transportation aging and disposal; TEV = transport and emplacement vehicle; WHF = Wet Handling Facility; WP = waste package; WPHC = waste package handling crane; WPTT = waste package transfer trolley.

Source: Original (Attachment H)

6.4 INITIAL HANDLING FACILITY SEISMIC EVENT SEQUENCE ANALYSIS

This section provides a description of the seismic event sequences and quantification process for the IHF, including:

- Development of the seismic event trees
- Development of the seismic fault trees
- Summary of the input data
- Results for the event sequence quantification
- Categorization of seismic event sequences.

Detailed information for the IHF quantification is provided in Attachment A, and referenced as appropriate below.

The IHF seismic event sequence quantification covers the following processes:

- Processing of naval canisters (from railcars with transportation casks entering the IHF to waste packages in the TEV leaving the IHF)
- Processing of HLW canisters (from trucks with transportation casks entering the IHF to waste packages in the TEV leaving the IHF).

HLW canisters can also be received in transportation casks on railcars. This processing scenario is bounded by the HLW on trucks scenario.

6.4.1 Processing of Naval Canisters

Naval canisters inside a transportation cask are received on railcars, and are transferred into a waste package, sealed, and then transported in a TEV out of the IHF. Transport to the emplacement drifts is not included in this section.

6.4.1.1 IHF Naval Canister Event Trees

Using the approach described in Section 4.3.3.1, the IET and SRETs were developed to delineate the potential seismic event sequences that could occur during processing of naval canisters in the IHF. Figure 6.4-1 provides the IET for processing naval canisters in the IHF. The pivotal events are described below:

- SEIS-EVENT: This initial heading is the initiating seismic event, representing the seismic hazard curve discussed in Section 6.1.
- IHF-NVL-CAN: This event is the number of naval canisters processed over the preclosure period (Table 6.3-1). (Note: the “up” branch is not used.)

- **SEIS-FAIL:** These branches indicate the potential SSCs that can fail and potentially damage the naval canister. Note that the event tree branch captions are associated with the branch line below the caption. These failures and their seismic fragilities are listed in Table 6.2-1 (structures) and Table 6.2-2 (equipment). They are described in Section 6.2.

The end states for most of the sequences on the IHF naval canister IET are transferred to seismic SRETs, as listed in the last column of Figure 6.4-1. An example of the SRET is provided in Figure 6.4-2, IHF-S-R-TC1, Seismic transfer (Event Tree) with canister in transportation cask. These SRETs have pivotal events that determine whether the waste container (cask, canister, waste package) is breached, whether shielding is degraded or lost, whether HVAC/confinement is available to filter the release, and whether there is moderator intrusion in a breached canister to potentially cause criticality. Note that HVAC/confinement was not credited for the seismic event sequence analysis, as previously discussed. Attachment A1 provides all of the SRETs.

6.4.1.2 IHF Naval Canister Fault Trees

Fault trees were used to identify the potential failures for each of the pivotal events above (see Section 4.3.3.2 for the approach). These fault trees are provided in Attachment A1.2. Table A1.1-1 identifies the fault trees that are assigned to each pivotal event on the IET, while Table A1.1-2 identifies the fault trees that are assigned to each pivotal event on the SRETs.

6.4.1.3 Exposure Times and Passive Equipment Failure Analysis

To determine the amount of time the waste container is exposed to a specific hazard, the expected times of each waste handling process in each facility were evaluated. The approach was discussed in Section 4.3.3.4, and is documented in detail in Attachment G. The result is the exposure time by SSC seismic failure mode per waste container processed.

Since the seismic hazard is represented in terms of frequency per year, the exposure time factor is given in terms of “years per single waste container.” Table 6.4-1 provides the exposure time factors for the processing of the naval canisters.

Seismic Event	Number of Naval canisters processed in IHF	Identify initiating seismic failure			
SEIS-EVENT	IHF-NVL-CAN	SEIS-FAIL		#	END-STATE
				1	OK
		IHF building collapse		2	OK
		Entry door seismic collapse		3	RR-UNF
		Railcar accident	T => 2	4	IHF-S-R-TC1
		Mobile platform seismic collapse	T => 2	5	IHF-S-R-TC1
		CHC seismic failures	T => 2	6	IHF-S-R-TC1
		CPC seismic failures	T => 2	7	IHF-S-R-TC1
		Cask prep platform collapse	T => 2	8	IHF-S-R-TC1
		CTT seismic failures	T => 2	9	IHF-S-R-TC1
		Shield door seismic failure	T => 2	10	IHF-S-R-TC1
		CTM seismic failures	T => 3	11	IHF-S-R-SD1
		RHS-robotic arm seismic failures	T => 4	12	IHF-S-R-CTM
		WPTT tipover	T => 5	13	IHF-S-R-WP1
		WPHC seismic failures	T => 5	14	IHF-S-R-WP1
		TEV seismic failures	T => 5	15	IHF-S-R-WP1
			T => 6	16	IHF-S-R-TEV

IHF-S-IE-NVL - IHF Seismic Event Tree - Initiating seismic failures

2007/12/13 Page 1

NOTE: Event tree branch captions are associated with the branch line below the caption.

CAN = canister; CHC = cask handling crane; CPC = cask preparation crane; CTM = canister transfer machine; CTT = cask transfer trolley; IHF = Initial Handling Facility; NVL = naval; RC = railcar; RHS = remote handling system; RR = radioactive release; SEIS = seismic; T = transfer; TC = transportation cask; TEV = transport and emplacement vehicle; TT = truck trailer; WP = waste package; WPHC = waste package handling crane; WPTT = waste package transfer trolley.

Source: Original

Figure 6.4-1. IHF Naval Canister Initiator Event Tree

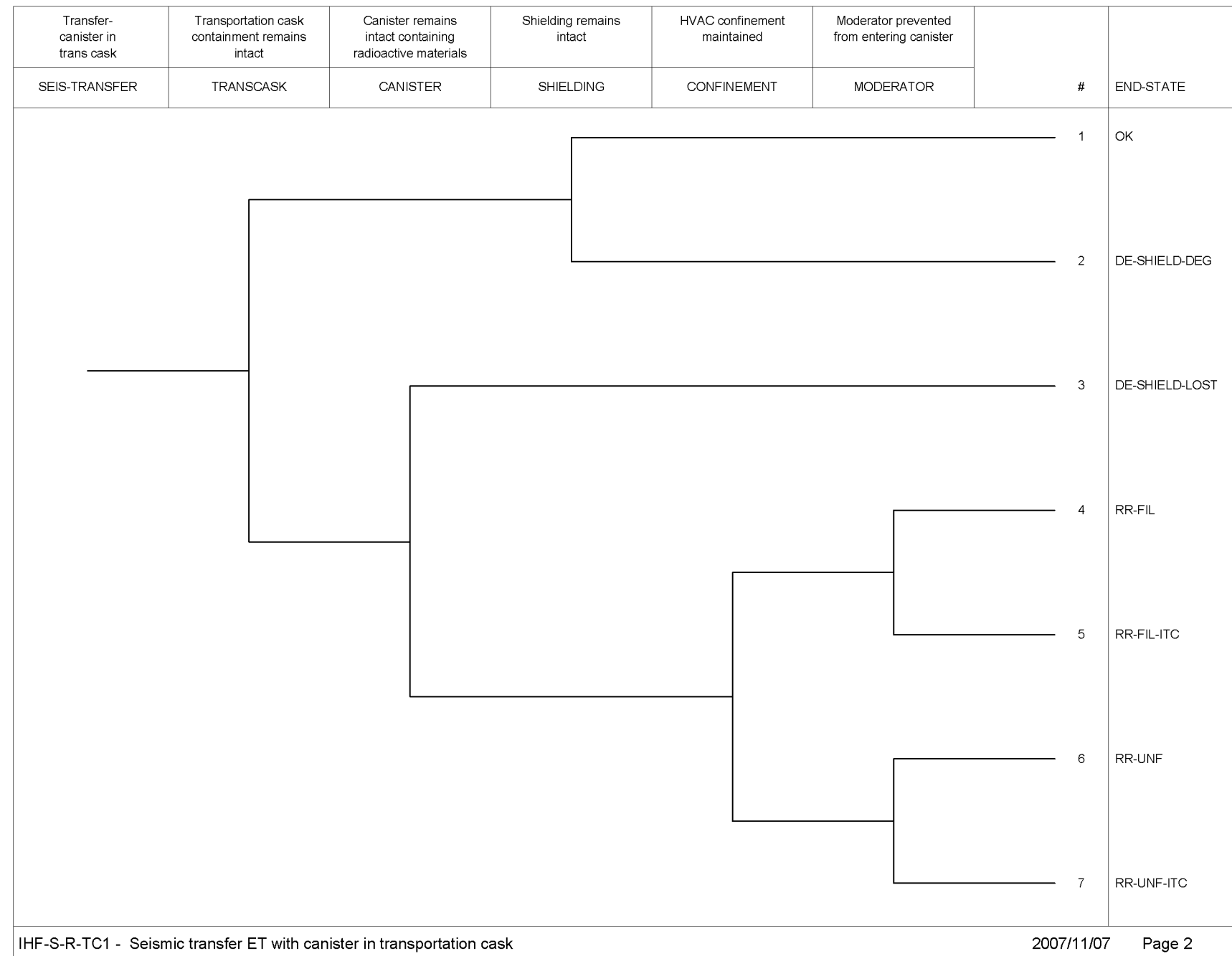

NOTE: DE = direct exposure; DEG = degradation; ET = event tree; FIL = filtered; HVAC = heating, ventilation and air conditioning; ITC = important to criticality; RR = radioactive release; SEIS = seismic; UNF = unfiltered.

Source: Original

Figure 6.4-2. Seismic Transfer Event Tree IHF-S-R-TC1

Table 6.4-1. Exposure Time Factors for Waste Handling Operations in the IHF

SSC	Seismic Failure Mode	Naval Canister Import from Railcar (yr)	HLW Canister Transfer from Truck (5 Canisters) (yr)
IHF structure	Collapse onto waste container	7.7E-03	3.3E-03
Entry door	Collapse onto waste container	1.9E-05	1.9E-05
Truck / railcar	Tipover	1.0E-03	5.1E-04
Mobile platform	Collapse onto waste container	7.9E-04	4.5E-04
Cask handling crane	Collapse	1.5E-03	3.5E-04
	Cask drop	7.0E-05	7.6E-05
	Heavy object drop	6.5E-04	4.8E-05
Cask preparation crane	Collapse	1.3E-03	7.2E-04
	Heavy object drop	7.4E-04	4.4E-04
Cask preparation platform	Collapse onto waste container	1.3E-03	2.9E-04
Cask transfer trolley	Slide	2.1E-04	4.5E-04
	Bump impact	1.1E-03	2.5E-04
	Rocking restraint failure w. drop	8.9E-05	1.6E-04
Equipment shield doors	Mount failure	5.5E-04	2.1E-03
Canister transfer machine (CTM)	Collapse onto waste container	3.9E-04	4.6E-04
	Canister drop	6.7E-05	5.7E-05
	Heavy object drop	1.9E-04	6.6E-05
	Swing inside bell	6.7E-05	5.7E-05
	Swing outside bell	4.8E-05	3.8E-05
Remote handling system	Collapse	2.8E-04	5.6E-05
	Heavy object drop	5.7E-05	1.1E-05
Waste package transfer trolley (WPTT)	Tipover	5.1E-04	2.1E-03
	Rocking impact	1.7E-03	3.4E-04
Waste package handling crane	Collapse	4.8E-05	9.5E-06
	Heavy object drop	1.9E-05	9.5E-06
Transport and emplacement vehicle (TEV)	Tipover	8.0E-05	1.6E-05
	Sliding	9.5E-06	1.9E-06
	Waste package ejection	7.0E-05	1.4E-05

NOTE: IHF = Initial Handling Facility; SSC = system, structure or component.

Source: Attachment G (rounded to two significant figures)

The conditional probability of breach of the waste container is also used in the fault trees. These “PEFA” values are discussed in Section 6.3.3, and given in Table 6.3-2.

6.4.1.4 Quantification of the IHF Naval Canister Waste Handling Process

The quantification approach, using the SAPHIRE software (Ref. 2.2.104), was discussed in detail in Section 4.5. Each of the following inputs is described in previous sections:

- Seismic hazard curve (Section 6.1)
- Seismic fragilities for SSCs (Section 6.2)
- Throughput, exposure time factors, and PEFAs (Section 6.3)
- Event trees (Section 6.4.1.1)
- Fault trees (Section 6.4.1.2).

Quantification of seismic event sequences must be performed in a different manner than for internal initiating events. The quantification must incorporate the dependency between the magnitude of seismic ground motion and the probability of seismic failure, the latter of which increases with the former as expressed with the SSC fragility curves. The algorithm also incorporates the decreasing frequency of a seismic event as the magnitude of seismic ground motion increases, expressed with the seismic hazard curve. This quantification process is often termed a convolution.

The results of the quantification are the probabilities of the event sequences, and the detailed cut sets for each event sequence. These detailed results for the IHF naval canister waste handling are given in Table A1.4-1 for the event sequences, and Table A1.4-2 for the cut sets. The dominant event sequences (greater than 1E-06 probability over the preclosure period) are listed in Table 6.4-2.

Table 6.4-2. IHF Naval Canister Seismic Event Sequences

Event Sequence ID	Description	Mean Probability (over the preclosure period)	End State
IHF-S-IE-NVL 09-06	Seismic collapse of cask preparation platform breaching naval canister	4E-05	RR-UNFILTERED
IHF-S-IE-NVL 16-02	Seismic failure of TEV shielding with naval canister in WP (no breach)	6E-06	DE-SHIELD-LOSS
IHF-S-IE-NVL 07-06	Seismic failure of cask handling crane breaching naval TC and canister	5E-06	RR-UNFILTERED
IHF-S-IE-NVL 12-05	Seismic failure of canister transfer machine breaching naval canister	5E-06	RR-UNFILTERED
IHF-S-IE-NVL 08-06	Seismic failure of cask preparation crane breaching naval canister	4E-06	RR-UNFILTERED
IHF-S-IE-NVL 10-06	Seismic failure of cask transfer trolley breaching naval canister	4E-06	RR-UNFILTERED
IHF-S-IE-NVL 05-02	Seismic tipover of railcar with naval transport cask, damaging shielding of cask (no breach)	2E-06	DE-SHIELD-DEGRADE
IHF-S-IE-NVL 11-06	Seismic failure of shield door breaching naval canister	1E-06	RR-UNFILTERED
IHF-S-IE-NVL 03	Seismic collapse of IHF structure breaching naval canister	1E-06	RR-UNFILTERED

NOTE: IHF = Initial Handling Facility; TC = transportation cask; TEV = transport and emplacement vehicle; WP = waste package.

Source: Original

All of the event sequences are below the 10 CFR Part 63 (Ref. 2.3.1) compliance criteria for Category 2.

Seismic event sequence IHF-S-IE-NVL 09-6 has the highest probability over the preclosure period. The sequence represents a scenario where the naval canister is in the transportation cask, which is held by the CTT at the CPP. Due to the seismic event, the cask preparation platform collapses around the CTT, damaging the naval canister. The end state was conservatively assigned to be a breached cask and canister, with an unfiltered radionuclide release.

The next highest sequence, IHF-S-IE-NVL 16-02, represents a scenario where the naval canister has been sealed inside a waste package and moved into the TEV. The earthquake causes the closure bolt on the shield door to fail, and the waste package slides out through the open shield door. On impact with the floor, the waste package and canister are not breached, but since they are outside the TEV shielding, the shielding has been lost. Therefore the sequence is not a radionuclide release, but a loss of shielding of the waste package.

The next three sequences represent failures of the large cranes, CHC, CTM, and cask preparation crane, breaching the naval canister. These sequences all have a probability less than 1E-05 over the preclosure period, and result in an unfiltered radionuclide release.

6.4.2 Processing of HLW Canisters in the IHF

HLW canisters inside a transportation cask are received on trucks or railcars, and are transferred into a waste package, sealed, and then transported in a TEV out of the IHF. Each waste package contains up to five HLW canisters. Transport to the emplacement drifts is not included in this section. The truck casks contain one HLW canister each, while a railcar cask contains five HLW canisters. The truck processing scenario was used for the quantification since it takes more time to process, and thus bounds the railcar scenario.

6.4.2.1 IHF HLW Canister Event Trees

Figure 6.4-3 provides the IET for processing HLW canisters in the IHF. The pivotal events are very similar to those for the naval canister IET, and are described below:

- SEIS-EVENT: This initial heading is the initiating seismic event, representing the seismic hazard curve discussed in Section 6.1.
- IHF-HLW-CAN: This event is the number of HLW canisters processed over the preclosure period (Table 6.3-1). (Note: the “up” branch is not used.)
- SEIS-FAIL: These branches indicate the potential SSCs that can fail and potentially damage the HLW canisters. Note that the event tree branch captions are associated with the branch line below the caption. These failures and their seismic fragilities are listed in Table 6.2-1 (structures) and Table 6.2-2 (equipment). They are described in Section 6.2.

The end states for most of the sequences on the IHF HLW canister IET are transferred to seismic SRETs, as listed in the last column of Figure 6.4-3. These SRETs are the same as for the naval canister. The SRETs have pivotal events that determine whether the waste container (cask, canister, waste package) is breached, whether shielding is degraded or lost, whether HVAC/confinement is available to filter the release, and whether there is moderator intrusion in a breached canister to potentially cause criticality. (Note that HVAC/confinement was not credited for the seismic event sequence analysis, as previously discussed. Also note that the moderator pivotal event is not applicable to HLW canisters since criticality cannot occur with the vitrified HLW waste form.) Attachment A2 provides all of the SRETs.

Seismic Event	Number of HLW canisters processed in IHF	Identify initiating seismic failure			
SEIS-EVENT	IHF-HLW-CAN	SEIS-FAIL		#	END-STATE
				1	OK
		IHF building collapse		2	OK
		Entry door seismic collapse		3	RR-UNF
		Truck accident	T => 2	4	IHF-S-R-TC1
		Mobile platform seismic collapse	T => 2	5	IHF-S-R-TC1
		CHC seismic failures	T => 2	6	IHF-S-R-TC1
		CPC seismic failures	T => 2	7	IHF-S-R-TC1
		Cask prep platform collapse	T => 2	8	IHF-S-R-TC1
		CTT seismic failures	T => 2	9	IHF-S-R-TC1
		Shield door seismic failure	T => 2	10	IHF-S-R-TC1
		CTM seismic failures	T => 3	11	IHF-S-R-SD1
		RHS-robotic arm seismic failures	T => 4	12	IHF-S-R-CTM
		WPTT tipover	T => 5	13	IHF-S-R-WP1
		WPHC seismic failures	T => 5	14	IHF-S-R-WP1
		TEV seismic failures	T => 5	15	IHF-S-R-WP1
			T => 6	16	IHF-S-R-TEV

IHF-S-IE-HLW - IHF Seismic Event Tree - Initiating seismic failures 2008/01/07 Page 1

NOTE: Event tree branch captions are associated with the branch line below the caption.

CAN = canister; CHC = cask handling crane; CPC = cask preparation crane; CTM = canister transfer machine; CTT = cask transfer trolley; HLW = high-level waste; IHF = Initial Handling Facility; INIT = initiating; NVL = naval; NUM = number; RC = railcar; RESP = response; RHS = remote handling system; SEIS = seismic; T = transfer; TC = transportation cask; TEV = transport and emplacement vehicle; WPHC = waste package handling crane; WPTT = waste package transfer trolley.

Source: Original

Figure 6.4-3. IHF HLW Canister Initiator Event Tree

6.4.2.2 IHF HLW Canister Fault Trees

Fault trees were used to identify the potential failures for each of the pivotal events above (see Section 4.3.3.2 for the approach). These fault trees are provided in Attachment A2.2. Table A2.1-1 identifies the fault trees that are assigned to each pivotal event on the IET, while Table A2.1-2 identifies the fault trees that are assigned to each pivotal event on the SRETs.

6.4.2.3 Exposure Times and Passive Equipment Failure Analysis

To determine the amount of time the waste container is exposed to a specific hazard, the expected times of each waste handling process in each facility were evaluated. The approach was discussed in Section 4.3.3.4, and is documented in detail in Attachment G. The result is the exposure time by SSC seismic failure mode per waste container processed.

Since the seismic hazard is represented in terms of frequency per year, the exposure time factor is given in terms of “years per single waste container.” Table 6.4-1 provides the exposure time factors for the processing of the HLW canisters.

The conditional probability of breach of the waste container is also used in the fault trees. These PEFA values are discussed in Section 6.3.3, and given in Table 6.3-2.

6.4.2.4 Quantification of the IHF HLW Canister Waste Handling Process

The quantification approach was the same as for naval canisters discussed above.

The results of the quantification are the probabilities of the event sequences, and the detailed cut sets for each event sequence. These detailed results for the IHF HLW canister waste handling are given in Table A2.4-1 for the event sequences, and Table A2.4-2 for the cut sets. The dominant event sequences (greater than 1E-06 probability over the preclosure period) are listed in Table 6.4-3.

All of the event sequences are below the 10 CFR Part 63 (Ref. 2.3.1) compliance criteria for Category 2.

Seismic event sequence IHF-S-IE-HLW 09-6 has the highest probability over the preclosure period. The sequence represents a scenario where the HLW canister is in the transportation cask, which is held by the CTT at the cask preparation platform. Due to the seismic event, the cask preparation platform collapses around the CTT, damaging the HLW canister. The end state was conservatively assigned to be a breached cask and canister, with an unfiltered radionuclide release.

Table 6.4-3. IHF HLW Canister Seismic Event Sequences

Event Sequence ID	Description	Mean Probability (over the preclosure period)	End State
IHF-S-IE-HLW 09-06	Seismic collapse of cask preparation platform breaching HLW canister	3E-05	RR-UNFILTERED
IHF-S-IE-HLW 10-06	Seismic failure of cask transfer trolley breaching HLW canister	2E-05	RR-UNFILTERED
IHF-S-IE-HLW 08-06	Seismic failure of cask preparation crane breaching HLW canister	1E-05	RR-UNFILTERED
IHF-S-IE-HLW 11-06	Seismic failure of shield door breaching HLW canisters	1E-05	RR-UNFILTERED
IHF-S-IE-HLW 12-05	Seismic failure of canister transfer machine breaching HLW canister	1E-05	RR-UNFILTERED
IHF-S-IE-HLW 07-06	Seismic failure of cask handling crane breaching HLW TC and canister	3E-06	RR-UNFILTERED
IHF-S-IE-HLW 16-02	Seismic failure of TEV shielding with HLW canisters in WP (no breach)	3E-06	DE-SHIELD-LOSS
IHF-S-IE-HLW 06-02	Seismic collapse of mobile platform with HLW transport cask, damaging shielding of cask (no breach)	3E-06	DE-SHIELD-DEGRADE
IHF-S-IE-HLW 05-02	Seismic tipover of truck trailer with HLW transport cask, damaging shielding of cask (no breach)	2E-06	DE-SHIELD-DEGRADE
IHF-S-IE-HLW 13-06	Seismic failure of remote handling system breaching HLW canisters	1E-06	RR-UNFILTERED
IHF-S-IE-HLW 03	Seismic collapse of IHF structure breaching HLW canisters	1E-06	RR-UNFILTERED

NOTE: HLW = high-level radioactive waste; IHF = Initial Handling Facility; TC = transportation cask; TEV = transport and emplacement vehicle; WP = waste package.

Source: Original

The next highest sequence, IHF-S-IE-HLW 08-06, represents failure of the cask preparation crane, either by collapse onto the HLW canister, or drop of a heavy object onto the HLW canister. This sequence results in an unfiltered radionuclide release. Sequence 10-06 represents sliding of the CTT into the Canister Transfer Room wall while holding HLW in the transportation cask. The extent of damage to the wall, or to the HLW canister is not known, so the end state is conservatively assigned to an unfiltered radionuclide release. Other sequences include collapse of a shield door onto the HLW container, and failure of the CTM breaching the HLW canister.

6.4.3 IHF Event Sequence Categorization

The expected number of occurrences of an event sequence over the preclosure period is compared to the screening criteria in 10 CFR 63.2 (Ref. 2.3.1) to determine its categorization. If the expected number of occurrences of the event sequence is greater than or equal to 1 over the preclosure period, it is a Category 1 event sequence; if the expected number of occurrences of the event sequence is greater than or equal to $1E-04$ but less than 1 over the preclosure period, it is a Category 2 event sequence; and, if the expected number of occurrences of the event sequence is less than $1E-04$ over the preclosure period, the event sequence is beyond Category 2 (Ref. 2.2.59) Section 6.8.2.

The IHF seismic event sequences in Table 6.4-2 for naval canister processing, and Table 6.4-3 for HLW canister processing are combined in Table 6.4-4. The sequences are then categorized as Category 1 (C1), Category 2 (C2), or beyond Category 2 (BC2) based on the criteria above. The material at risk for each scenario is also presented in the table, and the need for any consequence analysis is listed.

As demonstrated by the table, none of the IHF seismic event sequences is Category 1 or Category 2. Based on this finding, it is concluded that none of the event sequences in this table requires a consequence analysis.

Table 6.4-4. IHF Seismic Event Sequence Categorization

Event Sequence ID	End State	Description	Material-At-Risk	Mean Probability	Event Sequence Categorization	Consequence Analysis
IHF-S-IE-NVL 09-06	RR-UNFILTERED	Seismic collapse of cask preparation platform breaching naval canister	1 naval canister	4E-05	BC2	No consequence analysis necessary
IHF-S-IE-HLW 09-06	RR-UNFILTERED	Seismic collapse of cask preparation platform breaching HLW canister	1 HLW canister	3E-05	BC2	No consequence analysis necessary
IHF-S-IE-HLW 10-06	RR-UNFILTERED	Seismic failure of cask transfer trolley breaching HLW canister	1 HLW canister	2E-05	BC2	No consequence analysis necessary
IHF-S-IE-HLW 08-06	RR-UNFILTERED	Seismic failure of cask preparation crane breaching HLW canister	1 HLW canister	1E-05	BC2	No consequence analysis necessary
IHF-S-IE-HLW 11-06	RR-UNFILTERED	Seismic failure of shield door breaching HLW canisters	5 HLW canisters	1E-05	BC2	No consequence analysis necessary
IHF-S-IE-HLW 12-05	RR-UNFILTERED	Seismic failure of canister transfer machine breaching HLW canister	1 HLW canister	1E-05	BC2	No consequence analysis necessary
IHF-S-IE-NVL 16-02	DE-SHIELD-LOSS	Seismic failure of TEV shielding with naval canister in WP (no breach)	1 naval canister	6E-06	BC2	No consequence analysis necessary
IHF-S-IE-NVL 07-06	RR-UNFILTERED	Seismic failure of cask handling crane breaching naval TC and canister	1 naval canister	5E-06	BC2	No consequence analysis necessary
IHF-S-IE-NVL 12-05	RR-UNFILTERED	Seismic failure of canister transfer machine breaching naval canister	1 naval canister	5E-06	BC2	No consequence analysis necessary
IHF-S-IE-NVL 08-06	RR-UNFILTERED	Seismic failure of cask preparation crane breaching naval canister	1 naval canister	4E-06	BC2	No consequence analysis necessary
IHF-S-IE-NVL 10-06	RR-UNFILTERED	Seismic failure of cask transfer trolley breaching naval canister	1 naval canister	4E-06	BC2	No consequence analysis necessary
IHF-S-IE-HLW 07-06	RR-UNFILTERED	Seismic failure of cask handling crane breaching HLW TC and canister	1 HLW canister	3E-06	BC2	No consequence analysis necessary
IHF-S-IE-HLW 16-02	DE-SHIELD-LOSS	Seismic failure of TEV shielding with HLW canisters in WP (no breach)	5 HLW canisters	3E-06	BC2	No consequence analysis necessary
IHF-S-IE-HLW 06-02	DE-SHIELD-DEGRADE	Seismic collapse of mobile platform with HLW transport cask, damaging shielding of cask (no breach)	5 HLW canisters	3E-06	BC2	No consequence analysis necessary
IHF-S-IE-NVL 05-02	DE-SHIELD-DEGRADE	Seismic tipover of railcar with naval transport cask, damaging shielding of cask (no breach)	1 naval canister	2E-06	BC2	No consequence analysis necessary
IHF-S-IE-HLW 05-02	DE-SHIELD-DEGRADE	Seismic tipover of truck trailer with HLW transport cask, damaging shielding of cask (no breach)	1 HLW canister	2E-06	BC2	No consequence analysis necessary
IHF-S-IE-HLW 13-06	RR-UNFILTERED	Seismic failure of remote handling system breaching HLW canisters	5 HLW canisters	1E-06	BC2	No consequence analysis necessary
IHF-S-IE-NVL 11-06	RR-UNFILTERED	Seismic failure of shield door breaching naval canister	1 naval canister	1E-06	BC2	No consequence analysis necessary
IHF-S-IE-NVL 03	RR-UNFILTERED	Seismic collapse of IHF structure breaching naval canister	1 naval canister	1E-06	BC2	No consequence analysis necessary
IHF-S-IE-HLW 03	RR-UNFILTERED	Seismic collapse of IHF structure breaching HLW canisters	5 HLW canisters	1E-06	BC2	No consequence analysis necessary

NOTE: HLW = high-level radioactive waste; IHF = Initial Handling Facility; TC = transportation cask; TEV = transport and emplacement vehicle; WP = waste package.

Source: Original

6.5 SEISMIC EVENT SEQUENCE ANALYSIS FOR RECEIPT FACILITY

This section provides a description of the seismic event sequences and quantification process for the RF, including:

- Development of the seismic event trees
- Development of the seismic fault trees
- Summary of the input data
- Results for the event sequence quantification
- Categorization of seismic event sequences.

Detailed information for the RF quantification is provided in Attachment B, and referenced as appropriate below.

The RF seismic event sequence quantification covers the following processes:

- Processing of TADs (from railcars with transportation casks entering the RF and transferred to aging overpacks in the site transporter leaving the RF)
- Processing of DPCs (from railcars with transportation casks entering the RF, tilted on the railcar, then transferred to aging overpacks in the site transporter leaving the RF)
- Processing of DPCs (from railcars with horizontal transportation casks entering the RF, and transferred to the horizontal cask transfer trailer leaving the RF)
- Processing of DPCs (from railcars with transportation casks entering the RF, tilted using the tilting frame, and transferred to aging overpacks in the site transporter leaving the RF).

The three methods of processing DPCs each use the same throughput number of canisters, and are separately quantified. The first process, tilting the transportation on the railcar before further processing is designated VTC for vertical transportation cask, although it arrives on the railcar in the horizontal position. The second process, transferring the horizontal transportation cask with slings to the horizontal cask transfer trailer, is designated HTC for horizontal transportation cask. The third process involves lifting the horizontal transportation cask off of the railcar with slings, and tilting it up on the tilting frame. It is then processed vertically. It is designated TTC for tilting frame transportation cask.

6.5.1 Processing of TAD Canisters

TAD canisters inside a transportation cask are received on railcars, and are transferred into an aging overpack, and then transported in a site transporter out of the RF. From the RF the TADs can be sent to the aging facility, or to the CRCF for processing into waste packages.

6.5.1.1 RF TAD Canister Event Trees

Using the approach described in Section 4.3.3.1, the IET and SRETs were developed to delineate the potential seismic event sequences that could occur during processing of TAD canisters in the RF. Figure 6.5-1 provides the IET for processing TAD canisters in the RF. The pivotal events are described below:

- SEIS-EVENT: This initial heading is the initiating seismic event, representing the seismic hazard curve discussed in Section 6.1.
- RF-TAD-AO: This event is the number of TAD canisters processed over the preclosure period (Table 6.3-1). (Note: the “up” branch is not used.)
- SEIS-FAIL: These branches indicate the potential SSCs that can fail and potentially damage the TAD canister. Note that the event tree branch captions are associated with the branch line below the caption. These failures and their seismic fragilities are listed in Table 6.2-1 (structures) and Table 6.2-2 (equipment). They are described in Section 6.2.

The end states for most of the sequences on the RF TAD canister IET are transferred to seismic SRETs, as listed in the last column of Figure 6.5-1. An example of the SRET is provided in Figure 6.5-2, RF-S-R-TC1, Seismic transfer (Event Tree) with canister in transportation cask. These SRETs have pivotal events that determine whether the waste container (cask, canister, aging overpack) is breached, whether shielding is degraded or lost, whether HVAC/confinement is available to filter the release, and whether there is moderator intrusion in a breached canister to potentially cause criticality. (Note that HVAC/confinement was not credited for the seismic event sequence analysis, as previously discussed.) Attachment B1 provides all of the SRETs.

6.5.1.2 RF TAD Canister Fault Trees

Fault trees were used to identify the potential failures for each of the pivotal events above (see Section 4.3.3.2 for the approach). These fault trees are provided in Attachment B1.2. Table B1.1-1 identifies the fault trees that are assigned to each pivotal event on the IET, while Table B1.1-2 identifies the fault trees that are assigned to each pivotal event on the SRETs.

Seismic Event	Number of TAD canisters transferred to AO	Identify initiating seismic failure		
SEIS-EVENT	RF-TAD-AO	SEIS-FAIL	#	END-STATE
			1	OK
			2	OK
		RF building collapse	3	RR-UNF
		Entry door seismic collapse	4	T => 2 RF-S-R-TC1
		Railcar accident	5	T => 2 RF-S-R-TC1
		Mobile platform seismic collapse	6	T => 2 RF-S-R-TC1
		CHC seismic failures	7	T => 2 RF-S-R-TC1
		Cask prep platform collapse	8	T => 2 RF-S-R-TC1
		CTT seismic failures	9	T => 2 RF-S-R-TC1
		Shield door seismic failure	10	T => 3 RF-S-R-SD1
		CTM seismic failures	11	T => 4 RF-S-R-CTM
		CRM MC seismic collapse	12	T => 4 RF-S-R-CTM
		ST seismic failures	13	T => 5 RF-S-R-AO
		LBR platform collapse	14	T => 5 RF-S-R-AO
		LBR crane collapse	15	T => 5 RF-S-R-AO

RF-S-IE-TAD-AO - RF Seismic Event Tree - Initiating Seismic Failures - TAD to AO

NOTE: Event tree branch captions are associated with the branch line below the caption.

AO = aging overpack; CHC = cask handling crane; CTM = canister transfer machine; CTM MC = canister transfer machine maintenance crane; CTT = cask transfer trolley; INIT = initiating; LBR = Lid Bolting Room; NUM = number; RESP = response; RF = Receipt Facility; SD = shield door; SEIS = seismic; ST = site transporter; TAD = transportation, aging and disposal; TC = transportation cask; T = transfer; TC = transportation cask; UNF = unfiltered.

Source: Original

Figure 6.5-1. RF TAD Canister Initiator Event Tree

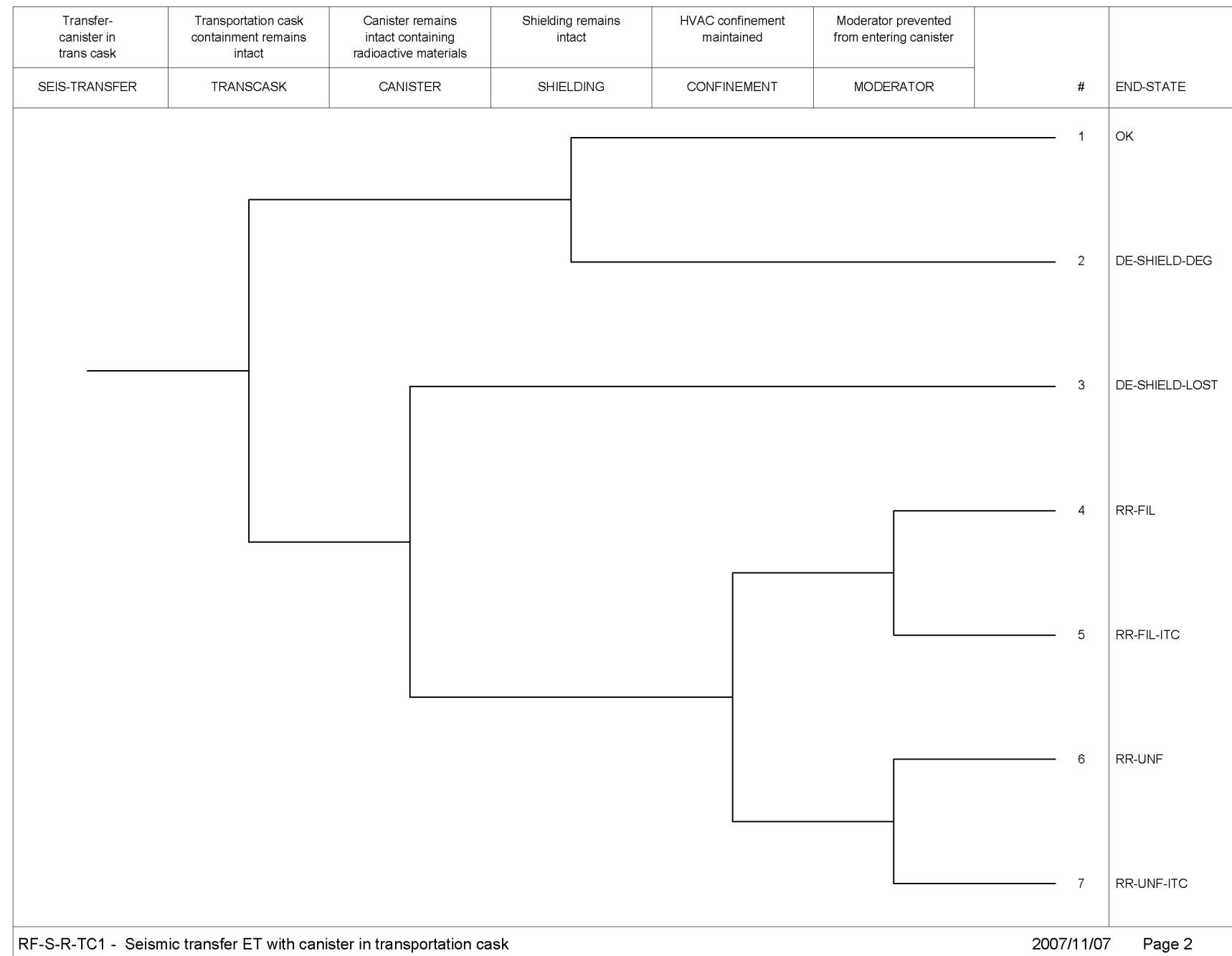

NOTE: DE = direct exposure; DEG = degradation; FIL = filtered; HVAC = heating, ventilation and air conditioning; INIT = initiating; ITC = important to criticality; RF = Receipt Facility; RR = radioactive release; SEIS = seismic; TC = transportation cask; UNF = unfiltered.

Source: Original

Figure 6.5-2. Seismic Transfer Event Tree RF-S-R-TC1

6.5.1.3 Exposure Times and Passive Equipment Failure Analysis

To determine the amount of time the waste container is exposed to a specific hazard, the expected times of each waste handling process in each facility were evaluated. The approach was discussed in Section 4.3.3.4, and is documented in detail in Attachment G. The result is the exposure time by SSC seismic failure mode per waste container processed.

Since the seismic hazard is represented in terms of frequency per year, the exposure time factor is given in terms of “years per single waste container.” Table 6.5-1 provides the exposure time factors for the processing of the TAD canisters (and the other waste containers).

Table 6.5-1. Exposure Time Factors for Waste Handling Operations in the RF

SSC	Seismic Failure Mode	TAD Transfer	DPC (VTC) Transfer	DPC (HTC) Transfer	DPC (TTC) Transfer
RF structure	Collapse onto waste container	2.2E-03	2.4E-03	1.5E-03	2.9E-03
Entry/ confinement door	Collapse onto waste container	4.6E-05	7.2E-05	8.0E-05	1.3E-04
Railcar	Tipover	9.0E-04	7.2E-04	6.6E-04	3.8E-04
Mobile platform	Collapse onto waste container	5.5E-04	3.7E-04	5.4E-04	2.9E-04
Cask handling crane (CHC)	Collapse	9.2E-04	1.1E-03	1.3E-03	1.5E-03
	Cask drop	9.5E-05	1.1E-04	1.1E-04	3.2E-04
	Heavy object drop	1.5E-04	3.4E-04	2.7E-04	3.7E-04
Cask preparation platform	Collapse	2.4E-04	6.3E-04	N/A	6.3E-04
Cask transfer trolley (CTT)	Slide	2.9E-04	2.3E-04	N/A	2.3E-04
	Bump impact	2.2E-04	6.1E-04	N/A	6.1E-04
	Rocking impact	7.6E-05	9.5E-05	N/A	7.6E-05
Equipment shield doors	Mount failure	8.2E-04	1.2E-03	N/A	1.2E-03
Canister transfer machine (CTM)	Collapse onto waste container	2.5E-04	1.7E-04	N/A	1.7E-04
	Canister drop	6.1E-05	6.1E-05	N/A	6.1E-05
	Heavy object drop	6.9E-05	4.6E-05	N/A	4.4E-05
	Swing inside bell	6.1E-05	6.1E-05	N/A	6.1E-05
	Swing outside bell	3.8E-05	3.8E-05	N/A	3.8E-05
Lid Bolting Room platform	Collapse	5.7E-04	5.7E-04	N/A	5.7E-04

Table 6.5-1. Exposure Time Factors for Waste Handling Operations in the RF (Continued)

SSC	Seismic Failure Mode	TAD Transfer	DPC (VTC) Transfer	DPC (HTC) Transfer	DPC (TTC) Transfer
Lid Bolting Room crane (LBRC)	Collapse	5.7E-04	5.7E-04	N/A	5.7E-04
Site transporter	Sliding impact	2.3E-04	1.9E-04	N/A	2.2E-04
	Bump impact	5.6E-04	5.6E-04	N/A	5.6E-04
Cask stand	Tipover	N/A	N/A	6.7E-04	N/A
Cask transfer trailer	Tipover	N/A	N/A	3.4E-04	N/A
CTM maintenance crane	Collapse	1.2E-04	8.5E-05	N/A	8.3E-05

NOTE: DPC = dual-purpose canister; CTM = canister transfer machine; HTC = horizontal transportation cask; RF = Receipt Facility; SSC = structure, system or component; TAD = transportation, aging and disposal; TTC = transportation cask tilted on tilting frame; VTC = vertical transportation cask.

Source: Attachment G (rounded to two significant figures)

The conditional probability of breach of the waste container is also used in the fault trees. These PEFA values are discussed in Section 6.3.3, and given in Table 6.3-2.

6.5.1.4 Quantification of the RF TAD Canister Waste Handling Process

The quantification approach, using the SAPHIRE software (Ref. 2.2.104), was discussed in detail in Section 4.5. Each of the following inputs has been described in previous sections:

- Seismic hazard curve (Section 6.1)
- Seismic fragilities for SSCs (Section 6.2)
- Throughput, exposure time factors, and PEFA (Section 6.3)
- Event trees (Section 6.5.1.1)
- Fault trees (Section 6.5.1.2).

The results of the quantification are the probabilities of the event sequences, and the detailed cut sets for each event sequence. These detailed results for the RF TAD canister waste handling are given in Table B1.4-1 for the event sequences, and Table B1.4-2 for the cut sets. The dominant event sequences (greater than 1E-06 probability over the preclosure period) are listed in Table 6.5-2.

Table 6.5-2. RF TAD Canister Seismic Event Sequences

Event Sequence ID	Description	Mean Probability (over the preclosure period)	End State
RF-S-IE-TAD-AO 11-05	Seismic failure of canister transfer machine breaching TAD during processing to aging overpack	6E-05	RR-UNFILTERED
RF-S-IE-TAD-AO 07-06	Seismic failure of cask handling crane breaching TAD during processing to aging overpack	5E-05	RR-UNFILTERED
RF-S-IE-TAD-AO 10-06	Seismic collapse of shield door breaching TAD during processing to aging overpack	4E-05	RR-UNFILTERED
RF-S-IE-TAD-AO 13-05	Seismic sliding impact of site transporter breaching TAD during processing to aging overpack	4E-05	RR-UNFILTERED
RF-S-IE-TAD-AO 15-05	Seismic collapse of lid bolting room crane breaching TAD during processing to aging overpack	3E-05	RR-UNFILTERED
RF-S-IE-TAD-AO 09-06	Seismic sliding impact of cask transfer trolley breaching TAD during processing to aging overpack	3E-05	RR-UNFILTERED
RF-S-IE-TAD-AO 14-05	Seismic collapse of lid bolting room platform breaching TAD during processing to aging overpack	1E-05	RR-UNFILTERED
RF-S-IE-TAD-AO 12-05	Seismic collapse of CTM maintenance crane breaching TAD during processing to aging overpack	7E-06	RR-UNFILTERED
RF-S-IE-TAD-AO 03	Seismic failure of RF structure breaching TAD during processing to aging overpack	6E-06	RR-UNFILTERED
RF-S-IE-TAD-AO 08-06	Seismic collapse of cask preparation platform breaching TAD during processing to aging overpack	4E-06	RR-UNFILTERED

NOTE: CTM = canister transfer machine; RF = Receipt Facility; TAD = transportation, aging and disposal.

Source: Original

All of the event sequences are below the 10 CFR Part 63 (Ref. 2.3.1) compliance criteria for Category 2.

Seismic event sequence RF-S-IE-TAD-AO 11-05 has the highest probability over the preclosure period. The sequence represents a scenario where the TAD canister is breached due to a failure of the CTM. Either the CTM collapses onto the TAD canister, or the TAD canister is sheared during the canister lifting or lowering process. The end state is assigned to be a breached TAD canister, with an unfiltered radionuclide release.

The next highest sequences, RF-S-IE-TAD-AO 07-06 and 10-06, represent scenarios where the TAD canister is breached due to collapse of the CHC, or collapse of a shield door onto a TAD canister, either in the CTT or the aging overpack. These sequences result in an unfiltered radionuclide release.

Sequence RF-S-IE-TAD-AO 13-05 represents a scenario when the TAD has been placed into the aging overpack in the site transporter. The earthquake causes the site transporter to slide into the concrete wall. The extent of damage to the wall, or to the TAD canister is not known, so the end state is conservatively assigned to an unfiltered radionuclide release.

6.5.2 Processing of DPCs Tilted on the Railcar in the RF (VTC process)

The term “VTC process” is used to differentiate among the three modes of transportation casks used to transport DPCs. VTC is used for “vertical transportation cask,” where the DPCs inside a transportation cask are received on railcars (in the horizontal position), tilted to vertical orientation on the railcar, and then transferred into an aging overpack and transported in a site transporter out of the RF. Although not included in this part of the quantification, the aging overpack is either sent to the Aging Facility, or to the WHF for further processing.

6.5.2.1 RF DPC Vertical Event Trees (VTC process)

Figure 6.5-3 provides the IET for processing DPCs in the RF. The pivotal events are very similar to those for the TAD canister IET, and are described below:

- **SEIS-EVENT:** This initial heading is the initiating seismic event, representing the seismic hazard curve discussed in Section 6.1.
- **RF-DP-VERT:** This event is the number of DPCs processed over the preclosure period (Table 6.3-1). (Note: the “up” branch is not used.)
- **SEIS-FAIL:** These branches indicate the potential SSCs that can fail and potentially damage the DPCs. Note that the event tree branch captions are associated with the branch line below the caption. These failures and their seismic fragilities are listed in Table 6.2-1 (structures) and Table 6.2-2 (equipment). They are described in Section 6.2.

Seismic Event	Number of DPCs transferred to AO	Identify initiating seismic failure		
SEIS-EVENT	RF-DP-VERT	SEIS-FAIL	#	END-STATE
			1	OK
			2	OK
		RF building collapse	3	RR-UNF
		Entry door seismic collapse	4	T => 2 RF-S-R-TC1
		Railcar accident	5	T => 2 RF-S-R-TC1
		Mobile platform seismic collapse	6	T => 2 RF-S-R-TC1
		CHC seismic failures	7	T => 2 RF-S-R-TC1
		Cask prep platform collapse	8	T => 2 RF-S-R-TC1
		CTT seismic failures	9	T => 2 RF-S-R-TC1
		Shield door seismic failure	10	T => 3 RF-S-R-SD1
		CTM seismic failures	11	T => 4 RF-S-R-CTM
		CTM MC seismic collapse	12	T => 4 RF-S-R-CTM
		ST seismic failures	13	T => 5 RF-S-R-AO
		LBR platform collapse	14	T => 5 RF-S-R-AO
		LBR crane collapse	15	T => 5 RF-S-R-AO

RF-S-IE-DP-VERT - RF Seismic Event Tree - Initiating Seismic Failures - DPC-Vertical 2008/02/24 Page 1

NOTE: Event tree branch captions are associated with the branch line below the caption.

AO = aging overpack; CHC = cask handling crane; CTM = canister transfer machine; CTM MC = canister transfer machine maintenance crane; CTT = cask transfer trolley; DPC = dual-purpose canister; IE = initiating event; LBR = Lid Bolting Room; RF = Receipt Facility; SD = shield door; SEIS = seismic; ST = site transporter; T = transfer; TAD = transportation, aging and disposal; TC = transportation cask; UNF = unfiltered.

Source: Original

Figure 6.5-3. RF DPC Vertical Initiator Event Tree

The end states for most of the sequences on the RF DPC IET are transferred to seismic SRETs, as listed in the last column of Figure 6.5-3. These SRETs are the same as for the TAD canister. The SRETs have pivotal events that determine whether the waste container (cask, canister, aging overpack) is breached, whether shielding is degraded or lost, whether HVAC/confinement is available to filter the release, and whether there is moderator intrusion in a breached canister to potentially cause criticality. (Note that HVAC/confinement was not credited for the seismic event sequence analysis, as previously discussed.) Attachment B2 provides all of the SRETs.

6.5.2.2 RF DPC Vertical Fault Trees

Fault trees were used to identify the potential failures for each of the pivotal events above (see Section 4.3.3.2 for the approach). These fault trees are provided in Attachment B2.2. Table B2.1-1 identifies the fault trees that are assigned to each pivotal event on the IET, while Table B2.1-2 identifies the fault trees that are assigned to each pivotal event on the SRETs.

6.5.2.3 Exposure Times and Passive Equipment Failure Analysis

To determine the amount of time the waste container is exposed to a specific hazard, the expected times of each waste handling process in each facility were evaluated. The approach was discussed in Section 4.3.3.4, and is documented in detail in Attachment G. The result is the exposure time by SSC seismic failure mode per waste container processed.

Since the seismic hazard is represented in terms of frequency per year, the exposure time factor is given in terms of “years per single waste container.” Table 6.5-1 provides the exposure time factors for the processing of the DPCs.

The conditional probability of breach of the waste container is also used in the fault trees. These PEFA values are discussed in Section 6.3.3, and given in Table 6.3-2.

6.5.2.4 Quantification of the RF DPC Vertical Waste Handling Process

The quantification approach was the same as for TAD canisters discussed above.

The results of the quantification are the probabilities of the event sequences, and the detailed cut sets for each event sequence. These detailed results for the RF DPC vertical waste handling are given in Table B2.4-1 for the event sequences, and Table B2.4-2 for the cut sets. The dominant event sequences (greater than 1E-06 probability over the preclosure period) are listed in Table 6.5-3.

Table 6.5-3. RF DPC Vertical Seismic Event Sequences

Event Sequence ID	Description	Mean Probability (over the preclosure period)	End State
RF-S-IE-VTC 07-06	Seismic failure of cask handling crane breaching DPC during processing to aging overpack	3E-06	RR-UNFILTERED
RF-S-IE-VTC 10-06	Seismic collapse of shield door breaching DPC during processing to aging overpack	3E-06	RR-UNFILTERED
RF-S-IE-VTC 11-05	Seismic failure of canister transfer machine breaching DPC during processing to aging overpack	3E-06	RR-UNFILTERED
RF-S-IE-VTC 13-05	Seismic sliding impact of site transporter breaching DPC during processing to aging overpack	2E-06	RR-UNFILTERED
RF-S-IE-VTC 15-05	Seismic collapse of Lid Bolting Room crane breaching DPC during processing to aging overpack	2E-06	RR-UNFILTERED

NOTE: DPC = dual-purpose canister; RF = Receipt Facility.

Source: Original

All of the event sequences are well below the 10 CFR Part 63 (Ref. 2.3.1) compliance criteria for Category 2.

Seismic event sequence RF-S-IE-VTC 07-6 has the highest probability over the preclosure period. The sequence represents a scenario where the DPC is in the transportation cask, and is breached when the cask handling crane collapses onto it. The end state was assigned to be a breached cask and canister, with an unfiltered radionuclide release.

The next highest sequence, RF-S-IE-VTC 10-06, represents collapse of one of the shield doors onto the DPC, either in the transportation cask or the aging overpack. This sequence results in an unfiltered radionuclide release. Sequence 11-05 represents failure of the CTM breaching the DPC, and is assigned to an unfiltered radionuclide release.

6.5.3 Processing of DPCs Lifted Horizontally from the Railcar to the Horizontal Cask Transfer Trailer (HTC process)

The term “HTC process” is used to differentiate among the three modes of transportation casks used to transport DPCs. HTC is used for “horizontal transportation cask,” where DPCs inside a transportation cask are received on railcars, lifted horizontally using slings, and transported on a horizontal cask transfer trailer out of the RF. Although not included in this part of the quantification, the trailer is then sent to the Aging Facility, and placed into the HAMs.

6.5.3.1 RF DPC Horizontal Event Trees (HTC process)

Figure 6.5-4 provides the IET for processing horizontal DPCs in the RF. The pivotal events are described below:

- SEIS-EVENT: This initial heading is the initiating seismic event, representing the seismic hazard curve discussed in Section 6.1.
- RF-DP-HOR: This event is the number of DPCs processed over the preclosure period (Table 6.3-1). (Note: the “up” branch is not used.)
- SEIS-FAIL: These branches indicate the potential SSCs that can fail and potentially damage the DPCs. Note that the event tree branch captions are associated with the branch line below the caption. These failures and their seismic fragilities are listed in Table 6.2-1 (structures) and Table 6.2-2 (equipment). They are described in Section 6.2.

The end states for most of the sequences on the RF DPC horizontal IET are transferred to seismic SRETs, as listed in the last column of Figure 6.5-4. The SRET is the same as for the TAD canister in Figure 6.5-2 above. The SRET has pivotal events that determine whether the waste container (cask, canister) is breached, whether shielding is degraded or lost, whether HVAC/confinement is available to filter the release, and whether there is moderator intrusion in a breached canister to potentially cause criticality. (Note that HVAC/confinement was not credited for the seismic event sequence analysis, as previously discussed.) Attachment B3 provides the SRET.

Seismic Event	Number of Horizontal DP canisters	Identify initiating seismic failure				
SEIS-EVENT	RF-DP-HOR	SEIS-FAIL	#		END-STATE	
			1		OK	
			2		OK	
			RF building collapse	3		RR-UNF
			Entry door seismic collapse	4	T => 2	RF-S-R-TC1
			Railcar accident	5	T => 2	RF-S-R-TC1
			Mobile platform seismic collapse	6	T => 2	RF-S-R-TC1
			CHC seismic failures	7	T => 2	RF-S-R-TC1
			Horizontal cask stand tipover	8	T => 2	RF-S-R-TC1
			Cask Transfer Trailer Tipover	9	T => 2	RF-S-R-TC1

RF-S-IE-DP-HOR - RF Seismic Event Tree - Initiating Seismic Failures - Horizontal DP 2008/01/07 Page 1

NOTE: Event tree branch captions are associated with the branch line below the caption.

AO = aging overpack; CHC = cask handling crane; CTM = canister transfer machine; DP = dual-purpose; HOR = horizontal; INIT = initiating; NUM = number; RESP = response; RF = Receipt Facility; SEIS = seismic; TC = transportation cask; T = transfer; TC = transportation cask; UNF = unfiltered.

Source: Original

Figure 6.5-4. RF DPC Horizontal Initiator Event Tree (HTC process)

6.5.3.2 RF DPC Horizontal Fault Trees

Fault trees were used to identify the potential failures for each of the pivotal events above (see Section 4.3.3.2 for the approach). These fault trees are provided in Attachment B3.2. Table B3.1-1 identifies the fault trees that are assigned to each pivotal event on the IET, while Table B3.1-2 identifies the fault trees that are assigned to each pivotal event on the SRET.

6.5.3.3 Exposure Times and Passive Equipment Failure Analysis

To determine the amount of time the waste container is exposed to a specific hazard, the expected times of each waste handling process in each facility were evaluated. The approach was discussed in Section 4.3.3.4, and is documented in detail in Attachment G. The result is the exposure time by SSC seismic failure mode per waste container processed.

Since the seismic hazard is represented in terms of frequency per year, the exposure time factor is given in terms of “years per single waste container.” Table 6.5-1 provides the exposure time factors for the processing of the DPCs.

The conditional probability of breach of the waste container is also used in the fault trees. These PEFA values are discussed in Section 6.3.3, and given in Table 6.3-2.

6.5.3.4 Quantification of the RF DPC Horizontal Waste Handling Process

The quantification approach was the same as for TAD canisters discussed above.

The results of the quantification are the probabilities of the event sequences, and the detailed cut sets for each event sequence. These detailed results for the RF DPC horizontal waste handling are given in Table B3.4-1 for the event sequences, and Table B3.4-2 for the cut sets. The only dominant event sequence (greater than 1E-06 probability over the preclosure period) is listed in Table 6.5-4.

Table 6.5-4. RF DPC Horizontal Seismic Event Sequence

Event Sequence ID	Description	Mean Probability (over the preclosure period)	End State
RF-S-IE-DP-HOR 07-06	Seismic failure of cask handling crane breaching horizontal DPC during processing to horizontal cask transfer trailer	4E-06	RR-UNFILTERED

NOTE: DPC = dual-purpose canister; RF = Receipt Facility.

Source: Original

The event sequence is well below the 10 CFR Part 63 (Ref. 2.3.1) compliance criteria for Category 2.

Seismic event sequence RF-S-IE-DP-HOR 07-6 represents a scenario where the DPC is in the transportation cask, and is breached when the cask handling crane collapses onto it. The end state was assigned to be a breached cask and canister, with an unfiltered radionuclide release.

6.5.4 Processing of DPCs Tilted on the Tilting Frame in the RF (TTC process)

The term “TTC process” is used to differentiate among the three modes of transportation casks used to transport DPCs. TTC is used for “tilting frame transportation cask,” where DPCs inside a transportation cask are received on railcars, tilted to vertical orientation on the tilting frame, and then transferred into an aging overpack and transported in a site transporter out of the RF. Although not included in this part of the quantification, the aging overpack is either sent to the Aging Facility, or to the WHF for further processing.

6.5.4.1 RF DPC Tilting Frame Event Trees (TTC process)

Figure 6.5-5 provides the IET for processing DPCs in the RF using the tilting frame. The pivotal events are very similar to those for the TAD canister IET, and are described below:

- **SEIS-EVENT:** This initial heading is the initiating seismic event, representing the seismic hazard curve discussed in Section 6.1.
- **RF-HISTAR:** This event is the number of DPCs processed over the preclosure period (Table 6.3-1). (Note: the “up” branch is not used.)
- **SEIS-FAIL:** These branches indicate the potential SSCs that can fail and potentially damage the DPCs. Note that the event tree branch captions are associated with the branch line below the caption. These failures and their seismic fragilities are listed in Table 6.2-1 (structures) and Table 6.2-2 (equipment). They are described in Section 6.2.

Seismic Event	Number of DPCs transferred to AO	Identify initiating seismic failure		
SEIS-EVENT	RF-DPC-TILT	SEIS-FAIL	#	END-STATE
			1	OK
		RF building collapse	2	OK
		Entry door seismic collapse	3	RR-UNF
		Railcar accident	4	T => 2 RF-S-R-TC1
		Mobile platform seismic collapse	5	T => 2 RF-S-R-TC1
		CHC seismic failures	6	T => 2 RF-S-R-TC1
		Cask prep platform collapse	7	T => 2 RF-S-R-TC1
		CTT seismic failures	8	T => 2 RF-S-R-TC1
		Shield door seismic failure	9	T => 2 RF-S-R-TC1
		CTM seismic failures	10	T => 3 RF-S-R-SD1
		CTM MC seismic collapse	11	T => 4 RF-S-R-CTM
		ST seismic failures	12	T => 4 RF-S-R-CTM
		LBR platform collapse	13	T => 5 RF-S-R-AO
		LBR crane collapse	14	T => 5 RF-S-R-AO
			15	T => 5 RF-S-R-AO

RF-S-IE-TILT - RF Seismic Event Tree - Initiating Seismic Failures - DPC-Tilting Frame 2008/02/24 Page 1

NOTE: Event tree branch captions are associated with the branch line below the caption.

AO = aging overpack; CHC = cask handling crane; CTM = canister transfer machine; CTM MC = canister transfer machine maintenance crane; CTT = cask transfer trolley; DPC = dual-purpose canister; INIT = initiating; LBR = Lid Bolting Room; NUM = number; RESP = response; RF = Receipt Facility; SD = shield door; SEIS = seismic; ST = site transporter; T = transfer; TC = transportation cask; UNF = unfiltered.

Source: Original

Figure 6.5-5. RF DPC Tilting Frame Initiator Event Tree

The end states for most of the sequences on the RF DPC tilting frame IET are transferred to seismic SRETs, as listed in the last column of Figure 6.5-5. These SRETs are the same as for the TAD canister. The SRETs have pivotal events that determine whether the waste container (cask, canister, aging overpack) is breached, whether shielding is degraded or lost, whether HVAC/confinement is available to filter the release, and whether there is moderator intrusion in a breached canister to potentially cause criticality. (Note that HVAC/confinement was not credited for the seismic event sequence analysis, as previously discussed.) Attachment B4 provides all of the SRETs.

6.5.4.2 RF DPC Tilting Frame Fault Trees

Fault trees were used to identify the potential failures for each of the pivotal events above (see Section 4.3.3.2 for the approach). These fault trees are provided in Attachment B4.2. Table B4.1-1 identifies the fault trees that are assigned to each pivotal event on the IET, while Table B4.1-2 identifies the fault trees that are assigned to each pivotal event on the SRETs.

6.5.4.3 Exposure Times and Passive Equipment Failure Analysis

To determine the amount of time the waste container is exposed to a specific hazard, the expected times of each waste handling process in each facility were evaluated. The approach was discussed in Section 4.3.3.4, and is documented in detail in Attachment G. The result is the exposure time by SSC seismic failure mode per waste container processed.

Since the seismic hazard is represented in terms of frequency per year, the exposure time factor is given in terms of “years per single waste container.” Table 6.5-1 provides the exposure time factors for the processing of the DPCs.

The conditional probability of breach of the waste container is also used in the fault trees. These PEFA values are discussed in Section 6.3.3, and given in Table 6.3-2.

6.5.4.4 Quantification of the RF DPC Tilting Frame Waste Handling Process

The quantification approach was the same as for TAD canisters discussed above.

The results of the quantification are the probabilities of the event sequences, and the detailed cut sets for each event sequence. These detailed results for the RF DPC tilting frame waste handling are given in Table B4.4-1 for the event sequences, and Table B4.4-2 for the cut sets. The dominant event sequences (greater than 1E-06 probability over the preclosure period) are listed in Table 6.5-5.

Table 6.5-5. RF DPC Tilting Frame Seismic Event Sequences

Event Sequence ID	Description	Mean Probability (over the preclosure period)	End State
RF-S-IE-TTC 07-06	Seismic failure of cask handling crane breaching DPC during processing to aging overpack	4E-06	RR-UNFILTERED
RF-S-IE-TTC 10-06	Seismic collapse of shield door breaching DPC during processing to aging overpack	3E-06	RR-UNFILTERED
RF-S-IE-TTC 11-05	Seismic failure of canister transfer machine breaching DPC during processing to aging overpack	3E-06	RR-UNFILTERED
RF-S-IE-TTC 13-05	Seismic sliding impact of site transporter breaching DPC during processing to aging overpack	2E-06	RR-UNFILTERED
RF-S-IE-TTC 15-05	Seismic collapse of lid bolting room crane breaching DPC during processing to aging overpack	2E-06	RR-UNFILTERED

NOTE: DPC = dual-purpose canister; RF = Receipt Facility.

Source: Original

All of the event sequences are well below the 10 CFR Part 63 (Ref. 2.3.1) compliance criteria for Category 2.

Seismic event sequence RF-S-IE-TTC 07-6 has the highest probability over the preclosure period. The sequence represents a scenario where the DPC is in the transportation cask, and is breached when the cask handling crane collapses onto it. The end state was assigned to be a breached cask and canister, with an unfiltered radionuclide release.

The next highest sequence, RF-S-IE-TTC 10-06, represents collapse of one of the shield doors onto the DPC, either in the transportation cask or the aging overpack. This sequence results in an unfiltered radionuclide release. Sequence 11-05 represents failure of the CTM breaching the DPC, and is assigned to an unfiltered radionuclide release.

6.5.5 RF Event Sequence Categorization

The expected number of occurrences of an event sequence over the preclosure period is compared to the screening criteria in 10 CFR 63.2 (Ref. 2.3.1) to determine its categorization. If the expected number of occurrences of the event sequence is greater than or equal to 1 over the preclosure period, it is a Category 1 event sequence; if the expected number of occurrences of the event sequence is greater than or equal to $1E-04$ but less than 1 over the preclosure period, it is a Category 2 event sequence; and, if the expected number of occurrences of the event sequence is less than $1E-04$ over the preclosure period, the event sequence is beyond Category 2 (Ref. 2.2.59) Section 6.8.2.

The RF seismic event sequences in Table 6.5-2 for TAD canister processing, Table 6.5-4 for horizontal DPC processing, and Table 6.5-5 for the tilting frame DPC processing are combined in Table 6.5-6. Note that Table 6.5-3 for the vertical DPC process is not included. The reason is that a DPC will be processed in only one of the three processes, depending on the type of DPC and transportation cask. Since the total number of expected DPCs over the preclosure period was used to quantify each of the three DPC IETs, the results are essentially triple-counted. This was done to allow flexibility in processing whichever DPCs are received. The event sequences for vertical DPCs and tilting frame DPCs are similar, but the probability of the tilting frame DPCs sequences are equal to or higher than for the vertical DPCs. Therefore, the tilting frame DPC event sequences bound the vertical DPC sequences, and are used in Table 6.5-6 below.

The sequences are categorized as Category 1 (C1), Category 2 (C2), or beyond Category 2 (BC2) based on the criteria above. The material at risk for each scenario is also presented in the table, and the need for any consequence is listed.

Table 6.5-6. RF Seismic Event Sequence Categorization

Event Sequence ID	End State	Description	Material-At-Risk	Mean Probability	Event Sequence Categorization	Consequence Analysis
RF-S-IE-TAD-AO 11-05	RR-UNFILTERED	Seismic failure of canister transfer machine breaching TAD during processing to aging overpack	1 TAD	6E-05	BC2	No consequence analysis necessary
RF-S-IE-TAD-AO 07-06	RR-UNFILTERED	Seismic failure of cask handling crane breaching TAD during processing to aging overpack	1 TAD	5E-05	BC2	No consequence analysis necessary
RF-S-IE-TAD-AO 10-06	RR-UNFILTERED	Seismic collapse of shield door breaching TAD during processing to aging overpack	1 TAD	4E-05	BC2	No consequence analysis necessary
RF-S-IE-TAD-AO 13-05	RR-UNFILTERED	Seismic sliding impact of site transporter breaching TAD during processing to aging overpack	1 TAD	4E-05	BC2	No consequence analysis necessary
RF-S-IE-TAD-AO 15-05	RR-UNFILTERED	Seismic collapse of lid bolting room crane breaching TAD during processing to aging overpack	1 TAD	3E-05	BC2	No consequence analysis necessary
RF-S-IE-TAD-AO 09-06	RR-UNFILTERED	Seismic sliding impact of cask transfer trolley breaching TAD during processing to aging overpack	1 TAD	3E-05	BC2	No consequence analysis necessary
RF-S-IE-TAD-AO 14-05	RR-UNFILTERED	Seismic collapse of lid bolting room platform breaching TAD during processing to aging overpack	1 TAD	1E-05	BC2	No consequence analysis necessary
RF-S-IE-TAD-AO 12-05	RR-UNFILTERED	Seismic collapse of CTM maintenance crane breaching TAD during processing to aging overpack	1 TAD	7E-06	BC2	No consequence analysis necessary
RF-S-IE-TAD-AO 03	RR-UNFILTERED	Seismic failure of RF structure breaching TAD during processing to aging overpack	1 TAD	6E-06	BC2	No consequence analysis necessary
RF-S-IE-TAD-AO 08-06	RR-UNFILTERED	Seismic collapse of cask preparation platform breaching TAD during processing to aging overpack	1 TAD	4E-06	BC2	No consequence analysis necessary
RF-S-IE-TTC 07-06	RR-UNFILTERED	Seismic failure of cask handling crane breaching DPC during processing to aging overpack	1 DPC	4E-06	BC2	No consequence analysis necessary
RF-S-IE-DP-HOR 07-06	RR-UNFILTERED	Seismic failure of cask handling crane breaching horizontal DPC during processing to horizontal cask transfer trailer	1 DPC (HOR)	4E-06	BC2	No consequence analysis necessary
RF-S-IE-TTC 10-06	RR-UNFILTERED	Seismic collapse of shield door breaching DPC during processing to aging overpack	1 DPC	3E-06	BC2	No consequence analysis necessary
RF-S-IE-TTC 11-05	RR-UNFILTERED	Seismic failure of canister transfer machine breaching DPC during processing to aging overpack	1 DPC	3E-06	BC2	No consequence analysis necessary
RF-S-IE-TTC 13-05	RR-UNFILTERED	Seismic sliding impact of site transporter breaching DPC during processing to aging overpack	1 DPC	2E-06	BC2	No consequence analysis necessary
RF-S-IE-TTC 15-05	RR-UNFILTERED	Seismic collapse of lid bolting room crane breaching DPC during processing to aging overpack	1 DPC	2E-06	BC2	No consequence analysis necessary

NOTE: CTM = canister transfer machine; DPC = dual-purpose canister; RF = Receipt Facility; TAD = transportation, aging and disposal.

Source: Original

As demonstrated by the table, none of the RF seismic event sequences is Category 1 or Category 2. Based on this finding, it is concluded that none of the event sequences in this table requires a consequence analysis.

6.6 SEISMIC EVENT SEQUENCE ANALYSIS FOR CANISTER RECEIPT AND CLOSURE FACILITY

This section provides a description of the seismic event sequences and quantification process for the CRCF, including:

- Development of the seismic event trees
- Development of the seismic fault trees
- Summary of the input data
- Results for the event sequence quantification
- Categorization of seismic event sequences.

Detailed information for the CRCF quantification is provided in Attachment C, and referenced as appropriate below.

The CRCF seismic event sequence quantification covers the following processes:

- Processing of TADs from arriving railcar with transportation cask entering the CRCF, and transferred to aging overpack in the site transporter leaving the CRCF
- Processing of DPCs from arriving railcar with transportation cask entering the CRCF, and transferred to aging overpack in the site transporter leaving the CRCF
- Processing of TADs from aging overpack in site transporter entering the CRCF, and transferred to waste package in the TEV leaving the CRCF
- Processing of DOE SNF canisters from railcar with transportation cask entering the CRCF, and transferred to waste package in TEV leaving the CRCF
- Processing of HLW canisters from railcar with TC entering the CRCF, and transferred to waste package in the TEV leaving the CRCF
- Processing of MCO canisters from railcar with transportation cask entering the CRCF, transferred to waste package in the TEV leaving the CRCF.

6.6.1 Processing of TADs from Railcar Transportation Casks to Aging Overpacks

TADs inside a transportation cask are received on railcars, and are transferred into an aging overpack, and then transported in the site transporter out of the CRCF. The aging overpack is sent to the Aging Facility, but this segment is not included in this section.

6.6.1.1 CRCF TAD to Aging Overpack Event Trees

Using the approach described in Section 4.3.3.1, the IET and SRETs were developed to delineate the potential seismic event sequences that could occur during processing of TADs in the CRCF. Figure 6.6-1 provides the IET for processing TADs into aging overpacks in the CRCF. The pivotal events are described below:

- **SEIS-EVENT:** This initial heading is the initiating seismic event, representing the seismic hazard curve discussed in Section 6.1.
- **CRCF-TAD-AO:** This event is the number of TADs processed into aging overpacks over the preclosure period (Table 6.3-1). To maintain flexibility of operations, all arriving TADs in transportation casks were transferred to aging overpacks and sent to the Aging Facility, maximizing the number of TAD handling operations. This is very conservative, since it would be expected that most TADs would be directly processed to waste packages, rather than “double-processed” by being sent to the Aging Facility first, then brought back to the CRCF for processing to a waste package. (Note: the “up” branch is not used.)
- **SEIS-FAIL:** These branches indicate the potential SSCs that can fail and potentially damage the TAD. Note that the event tree branch captions are associated with the branch line below the caption. These failures and their seismic fragilities are listed in Table 6.2-1 (structures) and Table 6.2-2 (equipment). They are described in Section 6.2.

The end states for most of the sequences on the CRCF TAD to aging overpack IET are transferred to seismic SRETs, as listed in the last column of Figure 6.6-1. An example of the SRET is provided in Figure 6.6-2, CRCF-S-R-TC1, Seismic transfer (Event Tree) with canister in transportation cask. These SRETs have pivotal events that determine whether the waste container (cask, canister, aging overpack) is breached, whether shielding is degraded or lost, whether HVAC/confinement is available to filter the release, and whether there is moderator intrusion in a breached canister to potentially cause criticality. (Note that HVAC/confinement was not credited for the seismic event sequence analysis, as previously discussed.) Attachment C1 provides all of the SRETs.

Seismic Event	Number of TAD canisters transferred to AO	Identify initiating seismic failure		
SEIS-EVENT	CRCF-TAD-AO	SEIS-FAIL	#	END-STATE
			1	OK
			2	OK
		CRCF building collapse	3	RR-UNF
		Entry door seismic collapse	4	T => 2 CRCF-S-R-TC1
		Railcar accident	5	T => 2 CRCF-S-R-TC1
		Mobile platform seismic collapse	6	T => 2 CRCF-S-R-TC1
		CHC seismic failures	7	T => 2 CRCF-S-R-TC1
		Cask prep platform collapse	8	T => 2 CRCF-S-R-TC1
		CTT seismic failures	9	T => 2 CRCF-S-R-TC1
		Shield door seismic failure	10	T => 3 CRCF-S-R-SD1
		CTM seismic failures	11	T => 4 CRCF-S-R-CTM
		ST seismic failures	12	T => 5 CRCF-S-R-AO

CRCF-S-IE-TAD-AO - CRCF Seismic Event Tree - Initiating Seismic Failures - TAD to AO

2008/01/07 Page 6

NOTE: Event tree branch captions are associated with the branch line below the caption.
 AO= aging overpack; CHC = cask handling crane; CRCF = Canister Receipt and Closure Facility; CTM = canister transfer machine; CTT = cask transfer trolley; DE = direct exposure; ET = event tree; FIL = filtered; ITC = important to criticality; RR = radioactive release; SD = shield door; SEIS = seismic; ST = site transporter; TAD = transportation, aging and disposal; TC = transportation cask; UNF = unfiltered.

Source: Original

Figure 6.6-1. CRCF TAD to AO Initiator Event Tree

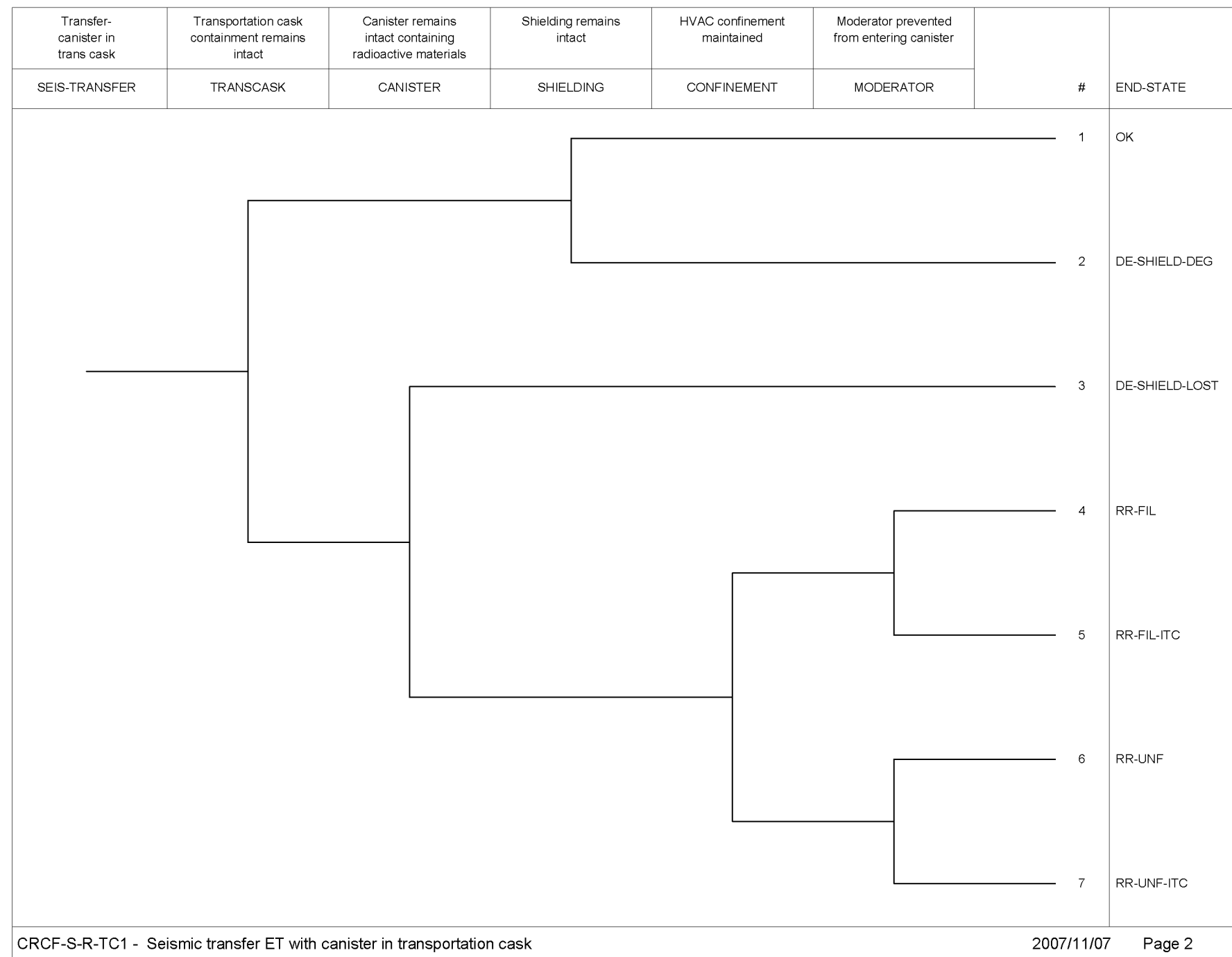

NOTE: CRCF = Canister Receipt and Closure Facility; DE = direct exposure; DEG = degradation; FIL = filtered; HVAC = heating, ventilation and air conditioning; INIT = initiating; ITC = important to criticality; RR = radioactive release; SEIS = seismic; UNF = unfiltered.

Source: Original

Figure 6.6-2. Seismic Transfer Event Tree CRCF-S-R-TC1

6.6.1.2 CRCF TAD to Aging Overpack Fault Trees

Fault trees were used to identify the potential failures for each of the pivotal events above (see Section 4.3.3.2 for the approach). These fault trees are provided in Attachment C1.2. Table C1.1-1 identifies the fault trees that are assigned to each pivotal event on the IET, while Table C1.1-2 identifies the fault trees that are assigned to each pivotal event on the SRETs.

6.6.1.3 Exposure Times and Passive Equipment Failure Analysis

To determine the amount of time the waste container is exposed to a specific hazard, the expected times of each waste handling process in each facility were evaluated. The approach was discussed in Section 4.3.3.4, and is documented in detail in Attachment G. The result is the exposure time by SSC seismic failure mode per waste container processed.

Since the seismic hazard is represented in terms of frequency per year, the exposure time factor is given in terms of “years per single waste container.” Table 6.6-1 provides the exposure time factors for the processing of the TADs. Other waste handling operations in the CRCF are also included in the table.

The conditional probability of breach of the waste container is also used in the fault trees. These PEFA values are discussed in Section 6.3.3, and given in Table 6.3-2.

6.6.1.4 Quantification of the CRCF TAD Waste Handling Process

The quantification approach, using the SAPHIRE software (Ref. 2.2.104), was discussed in detail in Section 4.5. Each of the following inputs is described in previous sections:

- Seismic hazard curve (Section 6.1)
- Seismic fragilities for SSCs (Section 6.2)
- Throughput, exposure time factors, and PEFA (Section 6.3)
- Event trees (Section 6.6.1.1)
- Fault trees (Section 6.6.1.2).

Table 6.6-1. Exposure Time Factors for Waste Handling Operations in the CRCF

SSC	Seismic Failure Mode	TAD on Railcar - Transfer to AO	DPC on Railcar - Transfer to AO	TAD on Site Transporter to WP	SNF-HLW Import to a Waste Package		MCO-HLW Process into a Waste Package - Short Campaign	
		TAD	DPC	TAD	HLW	SNF	HLW	MCO
CRCF structure	Collapse onto waste container	2.4E-03	2.4E-03	5.9E-03	5.2E-04	8.4E-03	2.0E-03	1.8E-03
Entry / confinement door	Collapse onto waste container	6.5E-05	6.5E-05	4.8E-05	5.3E-06	1.3E-05	5.3E-06	9.0E-06
Railcar	Collision /tipover	8.0E-04	8.0E-04	N/A	1.8E-04	8.9E-05	1.8E-04	2.0E-04
Mobile platform	Collapse onto waste container	4.5E-04	4.5E-04	N/A	9.1E-05	1.2E-04	9.8E-05	1.1E-04
Cask handling crane (CHC)	Collapse	9.6E-04	9.6E-04	N/A	1.9E-04	1.1E-04	1.9E-04	2.4E-04
	Cask drop / swing	1.1E-04	1.1E-04	N/A	2.3E-05	1.3E-05	2.1E-05	2.6E-05
	Heavy object drop	1.4E-04	1.4E-04	N/A	3.4E-05	1.7E-05	2.9E-05	3.8E-05
Cask preparation platform	Collapse	9.5E-04	9.5E-04	3.2E-04	1.1E-04	6.9E-05	1.1E-04	1.6E-04
Cask transfer trolley (CTT)	Slide	1.9E-04	1.9E-04	N/A	1.4E-04	1.2E-04	1.6E-04	1.3E-04
	Bump impact	5.9E-04	5.9E-04	N/A	1.1E-04	6.7E-05	1.0E-04	1.5E-04
	Rocking impact	4.8E-05	4.8E-05	N/A	9.5E-06	5.3E-06	2.9E-05	1.2E-05
Equipment shield doors	Mount failure	1.0E-03	1.0E-03	6.2E-04	1.2E-04	1.3E-04	1.2E-04	1.8E-04
Canister transfer machine (CTM)	Collapse onto waste container	3.0E-04	3.0E-04	2.3E-04	1.5E-04	3.5E-04	3.1E-04	1.3E-04
	Canister drop	5.5E-05	5.5E-05	5.5E-05	6.5E-05	1.1E-04	1.2E-04	5.5E-05
	Heavy object drop	6.9E-05	6.9E-05	5.5E-05	3.7E-05	9.0E-05	5.4E-05	3.3E-05
	Swing inside bell	5.5E-05	5.5E-05	5.5E-05	6.5E-05	1.1E-04	1.2E-04	5.5E-05
	Swing outside bell	3.8E-05	3.8E-05	3.8E-05	2.9E-05	7.6E-05	6.7E-05	3.8E-05
Canister staging racks	Collapse	N/A	N/A	N/A	N/A	7.7E-03	3.0E-03	0.0E+00
Remote handling system	Collapse - lid unfastened	N/A	N/A	3.2E-04	See Note 1	5.1E-05	See Note 1	1.3E-05
	Collapse - lid fastened	N/A	N/A		See Note 1	2.3E-04	See Note 1	5.7E-05
	Heavy object drop	N/A	N/A	8.6E-05	See Note 1	5.7E-05	See Note 1	1.4E-05

Table 6.6-1. Exposure Time Factors for Waste Handling Operations in the CRCF (Continued)

SSC	Seismic Failure Mode	TAD on Railcar - Transfer to AO	DPC on Railcar - Transfer to AO	TAD on Site Transporter to WP	SNF-HLW Import to a Waste Package		MCO-HLW Process into a Waste Package - Short Campaign	
		TAD	DPC	TAD	HLW	SNF	HLW	MCO
Site transporter	Sliding impact	2.6E-04	2.6E-04	2.4E-04	N/A	N/A	N/A	N/A
	Piping failure	0.0E+00	0.0E+00	3.3E-04	N/A	N/A	N/A	N/A
	Valve spurious Open	0.0E+00	0.0E+00	3.2E-04	N/A	N/A	N/A	N/A
	Bump	3.4E-04	3.4E-04	3.3E-04	N/A	N/A	N/A	N/A
WP transfer trolley (WPTT)	Tipover	N/A	N/A	3.0E-04	1.1E-04	2.5E-04	8.9E-05	5.7E-05
	Rocking impact	N/A	N/A	5.1E-03	See Note 1	5.0E-03	See Note 1	1.3E-03
WP handling crane	Collapse	N/A	N/A	7.6E-05	See Note 1	7.6E-05	See Note 1	1.9E-05
	Heavy object drop	N/A	N/A	7.6E-05	See Note 1	7.6E-05	See Note 1	1.9E-05
Transport and emplacement vehicle	Tipover	N/A	N/A	9.7E-05	See Note 1	9.7E-05	See Note 1	2.4E-05
	Sliding	N/A	N/A	9.5E-06	See Note 1	9.5E-06	See Note 1	2.4E-06
	WP ejection	N/A	N/A	8.8E-05	See Note 1	8.8E-05	See Note 1	2.2E-05

NOTE ¹: This portion of the HLW processing is included with the DOE SNF or MCO scenarios, since the HLW is in the waste package with the DOE SNF or MCO; AO = aging overpack; CRCF = Canister Receipt and Closure Facility; DPC = dual-purpose canister; HLW = high-level radioactive waste; MCO = multicanister overpack; SNF = spent nuclear fuel; SSC = system, structure or component; TAD = transportation, aging and disposal; WP = waste package.

Source: Attachment G (rounded to two significant figures)

Quantification of seismic event sequences must be performed in a different manner than for internal initiating events. The quantification must incorporate the dependency between the magnitude of seismic ground motion and the probability of seismic failure, the latter of which increases with the former as expressed with the SSC fragility curves. The algorithm also incorporates the decreasing frequency of a seismic event as the magnitude of seismic ground motion increases, expressed with the seismic hazard curve. This quantification process is often termed a convolution.

The results of the quantification are the probabilities of the event sequences, and the detailed cut sets for each event sequence. These detailed results for the CRCF TAD to aging overpack waste handling are given in Table C1.4-1 for the event sequences, and Table C1.4-2 for the cut sets. The dominant event sequences (greater than 1E-06 probability over the preclosure period) are listed in Table 6.6-2.

All of the event sequences are below the 10 CFR Part 63 (Ref. 2.3.1) compliance criteria for Category 2.

Seismic event sequence CRCF-S-IE-TAD-AO 11-05 has the highest probability over the preclosure period. The sequence represents a scenario where the TAD is being transferred from the transportation cask to the aging overpack by the CTM. Seismic failure of the CTM causes breach of the TAD, resulting in an unfiltered radionuclide release.

The next highest sequence, CRCF-S-IE-TAD-AO 07-06, represents a scenario where the cask handling crane is damaged by the seismic event, breaching the TAD in the transportation cask. The third sequence, CRCF-S-IE-TAD-AO 10-06, represents the scenario where one of the shield doors collapses due to the earthquake, breaching the TAD in a transportation cask or an aging overpack. Both of these sequences result in an unfiltered radionuclide release.

Other sequences represent sliding of the site transporter into the CRCF closure room wall, collapse of the cask preparation platform, and collapse of the CRCF structure itself. All of these sequences breach the TAD, and result in an unfiltered radionuclide release.

Table 6.6-2. CRCF TAD to AO Seismic Event Sequences

Event Sequence ID	Description	Mean Probability (over the preclosure period)	End State
CRCF-S-IE-TAD-AO 11-05	Seismic failure of canister transfer machine breaching TAD during processing to aging overpack	6E-05	RR-UNFILTERED
CRCF-S-IE-TAD-AO 07-06	Seismic failure of cask handling crane breaching TAD during processing to aging overpack	5E-05	RR-UNFILTERED
CRCF-S-IE-TAD-AO 10-06	Seismic collapse of shield door breaching TAD during processing to aging overpack	5E-05	RR-UNFILTERED
CRCF-S-IE-TAD-AO 12-05	Seismic failure of site transporter breaching TAD during processing to aging overpack	4E-05	RR-UNFILTERED
CRCF-S-IE-TAD-AO 09-06	Seismic failure of cask transfer trolley breaching TAD during processing to aging overpack	2E-05	RR-UNFILTERED
CRCF-S-IE-TAD-AO 08-06	Seismic collapse of cask preparation platform breaching TAD during processing to aging overpack	2E-05	RR-UNFILTERED
CRCF-S-IE-TAD-AO 03	Seismic failure of CRCF structure breaching TAD during processing to aging overpack	1E-05	RR-UNFILTERED

NOTE: AO = aging overpack; CRCF = Canister Receipt and Closure Facility; TAD = transportation, aging and disposal.

Source: Original

6.6.2 Processing of DPCs to Aging Overpacks in the CRCF

DPCs inside a transportation cask are received on trucks or railcars, and are transferred into an aging overpack, and then transported in the site transporter out of the CRCF. The aging overpack is sent to the Aging Facility or the WHF for processing, but this segment is not included in this section.

6.6.2.1 CRCF DPC to Aging Overpack Event Trees

Figure 6.6-3 provides the IET for processing DPCs in the CRCF. The pivotal events are very similar to those for the TAD to aging overpack IET, and are described below:

- **SEIS-EVENT:** This initial heading is the initiating seismic event, representing the seismic hazard curve discussed in Section 6.1.
- **CRCF-DP-CAN:** This event is the number of DPCs processed over the preclosure period (Table 6.3-1). (Note: the “up” branch is not used.)
- **SEIS-FAIL:** These branches indicate the potential SSCs that can fail and potentially damage the DPCs. Note that the event tree branch captions are associated with the branch line below the caption. These failures and their seismic fragilities are listed in Table 6.2-1 (structures) and Table 6.2-2 (equipment). They are described in Section 6.2.

Seismic Event	Number of DP canisters transferred to AO	Identify initiating seismic failure		
SEIS-EVENT	CRCF-DP-CAN	SEIS-FAIL	#	END-STATE
			1	OK
			2	OK
		CRCF building collapse	3	RR-UNF
		Entry door seismic collapse	4	T => 2 CRCF-S-R-TC1
		Railcar accident	5	T => 2 CRCF-S-R-TC1
		Mobile platform seismic collapse	6	T => 2 CRCF-S-R-TC1
		CHC seismic failures	7	T => 2 CRCF-S-R-TC1
		Cask prep platform collapse	8	T => 2 CRCF-S-R-TC1
		CTT seismic failures	9	T => 2 CRCF-S-R-TC1
		Shield door seismic failure	10	T => 3 CRCF-S-R-SD1
		CTM seismic failures	11	T => 4 CRCF-S-R-CTM
		ST seismic failures	12	T => 5 CRCF-S-R-AO

CRCF-S-IE-DPAO - CRCF Seismic Event Tree - Initiating Seismic Failures - DPs to AO

2008/01/07 Page 1

NOTE: Event tree branch captions are associated with the branch line below the caption.

AO = aging overpack; CAN = canister; CHC = cask handling crane; CRCF = Canister Receipt and Closure Facility; CTM = canister transfer machine; CTT = cask transfer trolley; DP = dual-purpose; INIT = initiating; NUM = number; RESP = response; RR = radioactive release; SEIS = seismic; ST = site transporter; UNF = unfiltered.

Source: Original

Figure 6.6-3. CRCF DPC to AO Initiator Event Tree

The end states for most of the sequences on the CRCF DPC IET are transferred to seismic SRETs, as listed in the last column of Figure 6.6-3. These SRETs are the same as for the TAD to aging overpack. The SRETs have pivotal events that determine whether the waste container (cask, canister, aging overpack) is breached, whether shielding is degraded or lost, whether HVAC/confinement is available to filter the release, and whether there is moderator intrusion in a breached canister to potentially cause criticality. (Note that HVAC/confinement was not credited for the seismic event sequence analysis, as previously discussed.) Attachment C1 provides all of the SRETs.

6.6.2.2 CRCF DPC to Aging Overpack Fault Trees

Fault trees were used to identify the potential failures for each of the pivotal events above (see Section 4.3.3.2 for the approach). These fault trees are provided in Attachment C1.2. Table C1.1-1 identifies the fault trees that are assigned to each pivotal event on the IET, while Table C1.1-4 identifies the fault trees that are assigned to each pivotal event on the SRETs.

6.6.2.3 Exposure Times and Passive Equipment Failure Analysis

To determine the amount of time the waste container is exposed to a specific hazard, the expected times of each waste handling process in each facility were evaluated. The approach was discussed in Section 4.3.3.4, and is documented in detail in Attachment G. The result is the exposure time by SSC seismic failure mode per waste container processed.

Since the seismic hazard is represented in terms of frequency per year, the exposure time factor is given in terms of “years per single waste container.” Table 6.6-1 provides the exposure time factors for the processing of the DPCs.

The conditional probability of breach of the waste container is also used in the fault trees. These PEFA values are discussed in Section 6.3.3, and given in Table 6.3-2.

6.6.2.4 Quantification of the CRCF DPC to Aging Overpack Waste Handling Process

The quantification approach was the same as for TADs discussed above.

The results of the quantification are the probabilities of the event sequences, and the detailed cut sets for each event sequence. These detailed results for the CRCF DPC waste handling are given in Table C1.4-1 for the event sequences, and Table C1.4-2 for the cut sets. The dominant event sequences (greater than 1E-06 probability over the preclosure period) are listed in Table 6.6-3.

Table 6.6-3. CRCF DPC to AO Seismic Event Sequences

Event Sequence ID	Description	Mean Probability (over the preclosure period)	End State
CRCF-S-IE-DPAO 07-06	Seismic failure of cask handling crane breaching DPC during processing to aging overpack	3E-06	RR-UNFILTERED
CRCF-S-IE-DPAO 11-05	Seismic failure of canister transfer machine breaching DPC during processing to aging overpack	3E-06	RR-UNFILTERED
CRCF-S-IE-DPAO 10-06	Seismic collapse of shield door breaching DPC during processing to aging overpack	2E-06	RR-UNFILTERED
CRCF-S-IE-DPAO 12-05	Seismic failure of site transporter breaching DPC during processing to aging overpack	2E-06	RR-UNFILTERED

NOTE: AO = aging overpack; CRCF = Canister Receipt and Closure Facility; DPC = dual-purpose canister.

Source: Original

All of the event sequences are well below the 10 CFR Part 63 (Ref. 2.3.1) compliance criteria for Category 2.

The highest sequence, CRCF-S-IE-DPAO 07-06, represents a scenario where the cask handling crane is damaged by the seismic event, breaching the DPC in the transportation cask. Seismic event sequence CRCF-S-IE-DPAO 11-05 has the next highest probability over the preclosure period. The sequence represents a scenario where the DPC is being transferred from the transportation cask to the aging overpack by the CTM. Seismic failure of the CTM causes breach of the DPC, resulting in an unfiltered radionuclide release.

The third sequence, CRCF-S-IE-DPAO 10-06, represents the scenario where one of the shield doors collapses due to the earthquake, breaching the DPC in a transportation cask or an aging overpack. This sequence results in an unfiltered radionuclide release.

6.6.3 Processing of TADs to Waste Packages in the CRCF

TADs inside an aging overpack are received on the site transporter, transferred into a waste package, sealed, and then loaded into the TEV and transported out of the CRCF. The waste package is sent to the emplacement drifts, but this segment is not included in this section.

6.6.3.1 CRCF TAD to Waste Package Event Trees

Figure 6.6-4 provides the IET for processing TADs to waste packages in the CRCF. The pivotal events are described below:

- **SEIS-EVENT:** This initial heading is the initiating seismic event, representing the seismic hazard curve discussed in Section 6.1.
- **CRCF-TAO-CAN:** This event is the number of TADs processed into waste packages over the preclosure period (Table 6.3-1). (Note: the “up” branch is not used).
- **SEIS-FAIL:** These branches indicate the potential SSCs that can fail and potentially damage the TADs. Note that the event tree branch captions are associated with the branch line below the caption. These failures and their seismic fragilities are listed in Table 6.2-1 (structures) and Table 6.2-2 (equipment). They are described in Section 6.2.

The end states for most of the sequences on the CRCF TWP IET are transferred to seismic SRETs, as listed in the last column of Figure 6.6-4. These SRETs are similar to the TAD to aging overpack, but have some changes to represent the waste package processing and the TEV. The SRETs have pivotal events that determine whether the waste container (aging overpack, canister, waste package) is breached, whether shielding is degraded or lost, whether HVAC/confinement is available to filter the release, and whether there is moderator intrusion in a breached canister to potentially cause criticality. (Note that HVAC/confinement was not credited for the seismic event sequence analysis, as previously discussed.) Attachment C1.1 provides all of the SRETs

Seismic Event	Number of TADs from AO to WP	Identify initiating seismic failure		
SEIS-EVENT	CRCF-TAO-CAN	SEIS-FAIL	#	END-STATE
			1	OK
			2	OK
		CRCF building collapse	3	RR-UNF
		Entry door seismic collapse	4	T => 5
		Cask prep platform collapse	5	T => 5
		ST seismic failures	6	T => 5
		Shield door seismic failure	7	T => 3
		CTM seismic failures	8	T => 4
		RHS-robotic arm seismic failures	9	T => 8
		WPTT tipover	10	T => 8
		WPHC seismic failures	11	T => 8
		TEV seismic failures	12	T => 9

CRCF-S-IE-TWP - CRCF Seismic Event Tree - TAD in AO to WP

2008/01/05 Page 7

NOTE: Event tree branch captions are associated with the branch line below the caption

AO= aging overpack; CRCF = Canister Receipt and Closure Facility; CTM = canister transfer machine; DE = direct exposure; ET = event tree; FIL = filtered; IHF = Initial Handling Facility; ITC = important to criticality; RR = radioactive release; SEIS = seismic; TAD = transportation, aging and disposal; TEV = transport and emplacement vehicle; UNF = unfiltered; WP = waste package; WPTT = waste package transfer trolley.

Source: Original

Figure 6.6-4. CRCF TAD to WP Initiator Event Tree (TWP)

6.6.3.2 CRCF TAD to Waste Package Fault Trees

Fault trees were used to identify the potential failures for each of the pivotal events above (see Section 4.3.3.2 for the approach). These fault trees are provided in Attachment C1.2. Table C1.1-1 identifies the fault trees that are assigned to each pivotal event on the IET, while Table C1.1-3 identifies the fault trees that are assigned to each pivotal event on the SRETs.

6.6.3.3 Exposure Times and Passive Equipment Failure Analysis

To determine the amount of time the waste container is exposed to a specific hazard, the expected times of each waste handling process in each facility were evaluated. The approach was discussed in Section 4.3.3.4, and is documented in detail in Attachment G. The result is the exposure time by SSC seismic failure mode per waste container processed.

Since the seismic hazard is represented in terms of frequency per year, the exposure time factor is given in terms of “years per single waste container.” Table 6.6-1 provides the exposure time factors for the processing of the TADs.

The conditional probability of breach of the waste container is also used in the fault trees. These PEFA values are discussed in Section 6.3.3, and given in Table 6.3-2.

6.6.3.4 Quantification of the CRCF TAD to Waste Package Waste Handling Process

The quantification approach was the same as for TADs to aging overpacks discussed above.

The results of the quantification are the probabilities of the event sequences, and the detailed cut sets for each event sequence. These detailed results for the CRCF TAD to waste package waste handling are given in Table C1.4-1 for the event sequences, and Table C1.4-2 for the cut sets. The dominant event sequences (greater than 1E-06 probability over the preclosure period) are listed in Table 6.6-4.

Table 6.6-4. CRCF TAD to WP Seismic Event Sequences

Event Sequence ID	Description	Mean Probability (over the preclosure period)	End State
CRCF-S-IE-TWP 12-02	Seismic failure of TEV shielding while holding waste package with TAD in CRCF (no breach)	2E-04	DE-SHIELD-LOSS
CRCF-S-IE-TWP 8-05	Seismic failure of canister transfer machine breaching TAD during processing to waste package	6E-05	RR-UNFILTERED
CRCF-S-IE-TWP 6-05	Seismic failure of site transporter breaching TAD during processing to waste package	5E-05	RR-UNFILTERED
CRCF-S-IE-TWP 03	Seismic failure of CRCF structure breaching TAD during processing to waste package	4E-05	RR-UNFILTERED
CRCF-S-IE-TWP 7-06	Seismic collapse of shield door breaching TAD during processing to waste package	3E-05	RR-UNFILTERED
CRCF-S-IE-TWP 12-07	Seismic failure of TEV breaching TAD in CRCF	8E-06	RR-UNFILTERED
CRCF-S-IE-TWP 05-05	Seismic failure of cask preparation platform breaching TAD during processing to waste package	7E-06	RR-UNFILTERED
CRCF-S-IE-TWP 11-06	Seismic failure of waste package handling crane breaching TAD during processing to waste package	5E-06	RR-UNFILTERED

NOTE: CRCF = Canister Receipt and Closure Facility; TAD = transportation, aging and disposal; TEV = transport and emplacement vehicle.

Source: Original

All of the radionuclide release event sequences are below the 10 CFR Part 63 (Ref. 2.3.1) compliance criteria for Category 2. However, there is one Category 2 sequence that is a loss of shielding sequence. Sequence CRCF-S-IE-TWP 12-02 represents the ejection of the TAD in a waste package from the TEV. The waste package and TAD do not breach, but the TEV shielding is no longer effective for the ejected waste package. Since this loss of shielding sequence does not cause offsite dose consequences, and is not in Category 1, it meets the compliance criteria.

Seismic event sequence CRCF-S-IE-TWP 8-05 has the highest probability for a radionuclide release sequence. The sequence represents a scenario where the TAD is being transferred from the aging overpack to the waste package by the CTM. Seismic failure of the CTM causes breach of the TAD, resulting in an unfiltered radionuclide release.

Other sequences represent sliding of the site transporter into the CRCF closure room wall, collapse of the CRCF structure itself, and collapse of one of the shield doors on the TAD in the aging overpack or waste package. All of these sequences breach the TAD, and result in an unfiltered radionuclide release.

6.6.4 Processing of DSNF to Waste Packages in the CRCF

DSNF canisters inside a transportation cask are received on railcar or truck, transferred into a waste package with HLW canisters, sealed, and then loaded into the TEV and transported out of the CRCF. The waste package is sent to the emplacement drifts, but this segment is not included in this section. Each DSNF transportation cask contains five to nine SNF canisters, and each waste package contains one DSNF canister, and up to five HLW canisters. Since the transportation casks contain more DSNF canisters than the waste package, the CRCF SNF staging rack is used for temporary storage during processing.

6.6.4.1 CRCF DOE SNF to Waste Package Event Trees

Figure 6.6-5 provides the IET for processing DSNF canisters to waste packages in the CRCF. The pivotal events are described below:

- **SEIS-EVENT:** This initial heading is the initiating seismic event, representing the seismic hazard curve discussed in Section 6.1.
- **CRCF-DOE-SNF:** This event is the number of DSNF canisters processed into waste packages over the preclosure period (Table 6.3-1). (Note: the “up” branch is not used.)
- **SEIS-FAIL:** These branches indicate the potential SSCs that can fail and potentially damage the DSNF canisters. Note that the event tree branch captions are associated with the branch line below the caption. These failures and their seismic fragilities are listed in Table 6.2-1 (structures) and Table 6.2-2 (equipment). They are described in Section 6.2.

Seismic Event	Number of DOE SNF canisters	Identify initiating seismic failure		
SEIS-EVENT	CRCF-DOE-SNF	SEIS-FAIL	#	END-STATE
			1	OK
		CRCF building collapse	2	OK
		Entry door seismic collapse	3	RR-UNF
		Railcar accident	4	T => 2 CRCF-S-R-TC1
		Mobile platform seismic collapse	5	T => 2 CRCF-S-R-TC1
		CHC seismic failures	6	T => 2 CRCF-S-R-TC1
		Cask prep platform collapse	7	T => 2 CRCF-S-R-TC1
		CTT seismic failures	8	T => 2 CRCF-S-R-TC1
		Shield door seismic failure	9	T => 2 CRCF-S-R-TC1
		CTM seismic failure	10	T => 3 CRCF-S-R-SD1
		Staging rack failure	11	T => 4 CRCF-S-R-CTM
		RHS-robotic arm seismic failure	12	T => 5 CRCF-S-R-CAN
		WPTT tipover	13	T => 6 CRCF-S-R-WP1
		WPHC seismic failure	14	T => 6 CRCF-S-R-WP1
		TEV seismic failure	15	T => 6 CRCF-S-R-WP1
			16	T => 7 CRCF-S-R-TEV

NOTE: Event tree branch captions are associated with the branch line below the caption.

CAN = canister; CHC = cask handling crane; CRCF = Canister Receipt and Closure Facility; CTM = canister transfer machine; CTT = cask transfer trolley; DOE = U.S. Department of Energy; RESP = response; RHS = remote handling system; SEIS = seismic; TC = transportation cask; T = transfer; TEV = transport and emplacement vehicle; UNF = unfiltered; WP = waste package; WPTT = waste package transfer trolley.

Source: Original

Figure 6.6-5. CRCF DOE SNF to WP Initiator Event Tree

The end states for most of the sequences on the CRCF DOE SNF IET are transferred to seismic SRETs, as listed in the last column of Figure 6.6-5. These SRETs are the similar to those for the TAD to aging overpack and TAD to waste package processes. The SRETs have pivotal events that determine whether the waste container (transportation cask, canister, waste package) is breached, whether shielding is degraded or lost, whether HVAC/confinement is available to filter the release, and whether there is moderator intrusion in a breached canister to potentially cause criticality. (Note that HVAC/confinement was not credited for the seismic event sequence analysis, as previously discussed.) Attachment C2.1 provides all of the SRETs.

6.6.4.2 CRCF DOE SNF to Waste Package Fault Trees

Fault trees were used to identify the potential failures for each of the pivotal events above (see Section 4.3.3.2 for the approach). These fault trees are provided in Attachment C2.2. Table C2.1-1 identifies the fault trees that are assigned to each pivotal event on the IET, while Table C2.1-2 identifies the fault trees that are assigned to each pivotal event on the SRETs.

6.6.4.3 Exposure Times and Passive Equipment Failure Analysis

To determine the amount of time the waste container is exposed to a specific hazard, the expected times of each waste handling process in each facility were evaluated. The approach was discussed in Section 4.3.3.4, and is documented in detail in Attachment G. The result is the exposure time by SSC seismic failure mode per waste container processed.

Since the seismic hazard is represented in terms of frequency per year, the exposure time factor is given in terms of “years per single waste container.” Table 6.6-1 provides the exposure time factors for the processing of the DSNF canisters.

The conditional probability of breach of the waste container is also used in the fault trees. These PEFA values are discussed in Section 6.3.3, and given in Table 6.3-2.

6.6.4.4 Quantification of the CRCF DOE SNF to Waste Package Waste Handling Process

The quantification approach was the same as for TADs to aging overpacks discussed above.

The results of the quantification are the probabilities of the event sequences, and the detailed cut sets for each event sequence. These detailed results for the CRCF DSNF to waste package waste handling are given in Table C2.4-1 for the event sequences, and Table C2.4-2 for the cut sets. The dominant event sequences (greater than 1E-06 probability over the preclosure period) are listed in Table 6.6-5.

Table 6.6-5. CRCF DOE SNF to WP Seismic Event Sequences

Event Sequence ID	Description	Mean Probability (over the preclosure period)	End State
CRCF-S-IE-DOE-SNF 16-02	Seismic failure of TEV shielding while holding waste package with DSNF in CRCF (no breach)	7E-05	DE-SHIELD-LOSS
CRCF-S-IE-DOE-SNF 11-05	Seismic failure of canister transfer machine breaching DSNF during processing to waste package	5E-05	RR-UNFILTERED
CRCF-S-IE-DOE-SNF 12-05	Seismic collapse of staging rack breaching DSNF during processing to waste package	3E-05	RR-UNFILTERED
CRCF-S-IE-DOE-SNF 13-06	Seismic failure of remote handling system breaching DSNF during processing to waste package	2E-05	RR-UNFILTERED
CRCF-S-IE-DOE-SNF 03	Seismic failure of CRCF structure breaching DSNF during processing to waste package	2E-05	RR-UNFILTERED
CRCF-S-IE-DOE-SNF 09-06	Seismic failure of cask transfer trolley breaching DSNF during processing to waste package	4E-06	RR-UNFILTERED
CRCF-S-IE-DOE-SNF 7-06	Seismic collapse of cask handling crane breaching DSNF during processing to waste package	3E-06	RR-UNFILTERED
CRCF-S-IE-DOE-SNF 10-06	Seismic collapse of shield door breaching DSNF during processing to waste package	3E-06	RR-UNFILTERED
CRCF-S-IE-DOE-SNF 16-07	Seismic failure of TEV breaching DSNF in CRCF	3E-06	RR-UNFILTERED
CRCF-S-IE-DOE-SNF 15-06	Seismic failure of waste package handling crane breaching DSNF during processing to waste package	2E-06	RR-UNFILTERED

NOTE: CRCF = Canister Receipt and Closure Facility; DSNF = U.S. Department of Energy standardized spent nuclear fuel; TEV = transport and emplacement vehicle.

Source: Original

All of the event sequences are below the 10 CFR 63 (Ref. 2.3.1) compliance criteria for Category 2. The highest sequence is a loss of shielding sequence. Sequence CRCF-S-IE-DOE-SNF 16-02 represents the ejection of the waste package from the TEV. The waste package and canisters inside do not breach, but the TEV shielding is no longer effective for the ejected waste package. Since this loss of shielding sequence does not cause offsite dose consequences, and is not in Category 1, it meets the compliance criteria.

Seismic event sequence CRCF-S-IE-DOE-SNF 11-05 has the highest probability for a radionuclide release sequence. The sequence represents a scenario where the SNF is being transferred from the transportation cask to the waste package by the CTM. Seismic failure of the CTM causes breach of the SNF canister, resulting in an unfiltered radionuclide release.

Other sequences represent collapse of the CRCF SNF staging racks, collapse or heavy object drop of the RHS, and collapse of the CRCF structure itself on the DSNF canister or waste package. All of these sequences breach the DSNF canisters, and result in an unfiltered radionuclide release.

6.6.5 Processing of HLW to Waste Packages in the CRCF

DOE HLW canisters inside a transportation cask are received on railcar or truck, transferred into a waste package with DSNF or MCO canisters, sealed, and then loaded into the TEV and transported out of the CRCF. The waste package is sent to the emplacement drifts, but this segment is not included in this section. Each HLW railcar transportation cask contains five HLW canisters. Each waste package contains one DSNF canister, and up to five HLW canisters, or two MCOs and two HLW canisters. Since the transportation casks contain more HLW canisters than the MCO waste packages, the CRCF SNF staging rack is used for temporary storage of HLW during processing. Both HLW processes, mixing with DSNF or with MCOs, were reviewed, and the MCO process selected for quantification since it generally bounded the exposure times.

6.6.5.1 CRCF HLW to Waste Package Event Trees

Figure 6.6-6 provides the IET for processing HLW canisters to waste packages in the CRCF. The pivotal events are described below:

- **SEIS-EVENT:** This initial heading is the initiating seismic event, representing the seismic hazard curve discussed in Section 6.1.
- **CRCF-HLW-CAN:** This event is the number of HLW canisters processed into waste packages over the preclosure period (Table 6.3-1). (Note: the “up” branch is not used.)
- **SEIS-FAIL:** These branches indicate the potential SSCs that can fail and potentially damage the HLW canisters. (Note that the event tree branch captions are associated with the branch line below the caption.) These failures and their seismic fragilities are listed in Table 6.2-1 (structures) and Table 6.2-2 (equipment). They are described in Section 6.2.

Seismic Event	Number of HLW canisters	Identify initiating seismic failure				
SEIS-EVENT	CRCF-HLW-CAN	SEIS-FAIL	#	END-STATE		
			1	OK		
			2	OK		
			CRCF building collapse	3	RR-UNF	
			Entry door seismic collapse	4	T => 2	CRCF-S-R-TC1
			Railcar accident	5	T => 2	CRCF-S-R-TC1
			Mobile platform seismic collapse	6	T => 2	CRCF-S-R-TC1
			CHC seismic failures	7	T => 2	CRCF-S-R-TC1
			Cask prep platform collapse	8	T => 2	CRCF-S-R-TC1
			CTT seismic failures	9	T => 2	CRCF-S-R-TC1
			Shield door seismic failure	10	T => 3	CRCF-S-R-SD1
			CTM seismic failure	11	T => 4	CRCF-S-R-CTM
			Staging rack failure	12	T => 5	CRCF-S-R-CAN
			WPTT tipover	13	T => 6	CRCF-S-R-WP1

CRCF-S-IE-HLW - CRCF Seismic Event Tree - Initiating Seismic Failures - HLW

NOTE: The event tree branch captions are associated with the branch line below the caption.

CAN = canister; CHC = cask handling crane; CRCF = Canister Receipt and Closure Facility; CTM = canister transfer machine; CTT = cask transfer trolley; HLW= high-level radioactive waste; IE = initiating event; SD = shield door; SEIS = seismic; T = transfer; TC = transportation cask; UNF = unfiltered; WP = waste package; WPTT = waste package transfer trolley.

Source: Original

Figure 6.6-6. CRCF HLW to WP Initiator Event Tree

Note that the CRCF HLW IET does not evaluate potential seismic failures of the RHS during the waste package sealing process, or seismic failures during transfer of the waste package to the TEV. Since the HLW canisters are combined with either DSNF or MCO canisters in the waste package during these processes, the potential seismic failure are covered by the DSNF and MCO evaluations in Sections 6.6.4 and 6.6.6. If the seismic failure for the RHS and TEV processes were also included for HLW, the event sequences would be double counted.

The end states for most of the sequences on the CRCF HLW IET are transferred to seismic SRETs, as listed in the last column of Figure 6.6-6. These SRETs are similar to those for the TAD to aging overpack and TAD to waste package processes. The SRETs have pivotal events that determine whether the waste container (transportation cask, canister, waste package) is breached, whether shielding is degraded or lost, whether HVAC/confinement is available to filter the release, and whether there is moderator intrusion in a breached canister to potentially cause criticality. (Note that HVAC/confinement was not credited for the seismic event sequence analysis, as previously discussed. Also note that the moderator pivotal event is not applicable to HLW canisters since criticality cannot occur with the vitrified HLW waste form.) Attachment C3.1 provides all of the SRETs.

6.6.5.2 CRCF HLW to Waste Package Fault Trees

Fault trees were used to identify the potential failures for each of the pivotal events above (see Section 4.3.3.2 for the approach). These fault trees are provided in Attachment C3.2. Table C3.1-1 identifies the fault trees that are assigned to each pivotal event on the IET, while Table C3.1-2 identifies the fault trees that are assigned to each pivotal event on the SRETs.

6.6.5.3 Exposure Times and Passive Equipment Failure Analysis

To determine the amount of time the waste container is exposed to a specific hazard, the expected times of each waste handling process in each facility were evaluated. The approach was discussed in Section 4.3.3.4, and is documented in detail in Attachment G. The result is the exposure time by SSC seismic failure mode per waste container processed.

Since the seismic hazard is represented in terms of frequency per year, the exposure time factor is given in terms of “years per single waste container.” Table 6.6-1 provides the exposure time factors for the processing of the HLW canisters.

The conditional probability of breach of the waste container is also used in the fault trees. These PEFA values are discussed in Section 6.3.3, and given in Table 6.3-2.

6.6.5.4 Quantification of the CRCF HLW to Waste Package Waste Handling Process

The quantification approach was the same as for TADs to aging overpacks discussed above.

The results of the quantification are the probabilities of the event sequences, and the detailed cut sets for each event sequence. These detailed results for the CRCF HLW to waste package waste handling are given in Table C3.4-1 for the event sequences, and Table C3.4-2 for the cut sets. The dominant event sequences (greater than 1E-06 probability over the preclosure period) are listed in Table 6.6-6. However, only those sequences that do not involve waste packages with

DOE SNF or MCOs are included in this table. If SNF or MCOs are involved in the event sequence, the event sequence probability is already included with the SNF or MCO sequences, and is not double-counted in this table. There is some double-counting of sequence CRCF-S-IE-HLW 03, since this is the CRCF structure collapse sequence, and is included for all CRCF waste handling processes.

Table 6.6-6. CRCF HLW to WP Seismic Event Sequences

Event Sequence ID	Description	Mean Probability (over the preclosure period)	End State
CRCF-S-IE-HLW 11-05	Seismic failure of canister transfer machine breaching HLW during processing to waste package	1E-04	RR-UNFILTERED
CRCF-S-IE-HLW 12-05	Seismic collapse of staging rack breaching HLW during processing to waste package	4E-05	RR-UNFILTERED
CRCF-S-IE-HLW 03	Seismic failure of CRCF structure breaching HLW during processing to waste package	2E-05	RR-UNFILTERED
CRCF-S-IE-HLW 09-06	Seismic failure of cask transfer trolley breaching HLW during processing to waste package	2E-05	RR-UNFILTERED
CRCF-S-IE-HLW 7-06	Seismic collapse of cask handling crane breaching HLW during processing to waste package	1E-05	RR-UNFILTERED
CRCF-S-IE-HLW 10-06	Seismic collapse of shield door breaching HLW during processing to waste package	7E-06	RR-UNFILTERED
CRCF-S-IE-HLW 8-06	Seismic collapse of cask preparation platform breaching HLW during processing to waste package	3E-06	RR-UNFILTERED

NOTE: CRCF = Canister Receipt and Closure Facility; HLW = high-level radioactive waste; WP = waste package.

Source: Original

Most of the event sequences are below the 10 CFR Part 63 (Ref. 2.3.1) compliance criteria for Category 2. The highest sequence, CRCF-S-IE-HLW 11-05, is a Category 2 sequence, and represents the scenario where the HLW is being transferred from the transportation cask to the waste package by the CTM. Seismic failure of the CTM causes breach of the HLW canister, resulting in an unfiltered radionuclide release. However, the consequence analysis (Ref. 2.2.69) demonstrates that the offsite dose easily meets compliance criteria.

Other sequences represent collapse of the CRCF SNF staging racks, collapse of the CRCF structure itself on the HLW canisters, or sliding of the CTT into the canister transfer room wall. All of these sequences breach the HLW canisters, and result in an unfiltered radionuclide release, and are beyond Category 2.

6.6.6 Processing of MCOs to Waste Packages in the CRCF

MCOs inside a transportation cask are received on railcar, transferred into a waste package with HLW canisters, sealed, and then loaded into the TEV and transported out of the CRCF. The waste package is sent to the emplacement drifts, but this segment is not included in this section. Each MCO transportation cask contains four MCOs, and each waste package contains two MCOs, and two HLW canisters. Since the transportation casks contain more MCOs than the waste package, both CTM processing lines are used during processing. The CRCF staging rack is not used for MCOs in this process, but is used for HLW canisters as described in the previous sections.

6.6.6.1 CRCF MCO to Waste Package Event Trees

Figure 6.6-7 provides the IET for processing MCOs to waste packages in the CRCF. The pivotal events are described below:

- **SEIS-EVENT:** This initial heading is the initiating seismic event, representing the seismic hazard curve discussed in Section 6.1.
- **CRCF-MCO-CAN:** This event is the number of MCOs processed into waste packages over the preclosure period (Table 6.3-1). (Note: the “up” branch is not used.)
- **SEIS-FAIL:** These branches indicate the potential SSCs that can fail and potentially damage the MCOs. Note that the event tree branch captions are associated with the branch line below the caption. These failures and their seismic fragilities are listed in Table 6.2-1 (structures) and Table 6.2-2 (equipment). They are described in Section 6.2.

Seismic Event	Number of MCO canisters	Identify initiating seismic failure		
SEIS-EVENT	CRCF-MCO-CAN	SEIS-FAIL	#	END-STATE
			1	OK
			2	OK
		CRCF building collapse	3	RR-UNF
		Entry door seismic collapse	4	T => 2
		Railcar accident	5	T => 2
		Mobile platform seismic collapse	6	T => 2
		CHC seismic failures	7	T => 2
		Cask prep platform collapse	8	T => 2
		CTT seismic failures	9	T => 2
		Shield door seismic failure	10	T => 3
		CTM seismic failure	11	T => 4
		RHS-robotic arm seismic failure	12	T => 5
		WPTT tipover	13	T => 5
		WPHC seismic failure	14	T => 5
		TEV seismic failure	15	T => 6

CRCF-S-IE-MCO - CRCF Seismic Event Tree - Initiating Seismic Failures - MCO

2007/12/07 Page 1

NOTE: The event tree branch captions are associated with the branch line below the caption.

CHC = cask handling crane; CRCF = Canister Receipt and Closure Facility; CTM = canister transfer machine; INIT = initiating; MCO = multicatcher overpack; RHS = remote handling system; SEIS = seismic; TC = transportation cask; TEV = transport and emplacement vehicle; T = transfer; UNF = unfiltered; WP = waste package; WPHC = waste package handling crane; WPTT = waste package transfer trolley.

Source: Original

Figure 6.6-7. CRCF MCO to WP Initiator Event Tree

The end states for most of the sequences on the CRCF MCO IET are transferred to seismic SRETs, as listed in the last column of Figure 6.6-7. These SRETs are similar to those for the DSNF process. The SRETs have pivotal events that determine whether the waste container (transportation cask, canister, waste package) is breached, whether shielding is degraded or lost, whether HVAC/confinement is available to filter the release, and whether there is moderator intrusion in a breached canister to potentially cause criticality. (Note that HVAC/confinement was not credited for the seismic event sequence analysis, as previously discussed.) Attachment C4.1 provides all of the SRETs.

6.6.6.2 CRCF MCO to Waste Package Fault Trees

Fault trees were used to identify the potential failures for each of the pivotal events above (see Section 4.3.3.2 for the approach). These fault trees are provided in Attachment C4.2. Table C4.1-1 identifies the fault trees that are assigned to each pivotal event on the IET, while Table C4.1-2 identifies the fault trees that are assigned to each pivotal event on the SRETs.

6.6.6.3 Exposure Times and Passive Equipment Failure Analysis

To determine the amount of time the waste container is exposed to a specific hazard, the expected times of each waste handling process in each facility were evaluated. The approach was discussed in Section 4.3.3.4, and is documented in detail in Attachment G. The result is the exposure time by SSC seismic failure mode per waste container processed.

Since the seismic hazard is represented in terms of frequency per year, the exposure time factor is given in terms of “years per single waste container.” Table 6.6-1 provides the exposure time factors for the processing of the MCO canisters.

The conditional probability of breach of the waste container is also used in the fault trees. These PEFA values are discussed in Section 6.3.3, and given in Table 6.3-2.

6.6.6.4 Quantification of the CRCF MCO to WP Waste Handling Process

The quantification approach was the same as for TAD to aging overpacks discussed above.

The results of the quantification are the probabilities of the event sequences, and the detailed cut sets for each event sequence. These detailed results for the CRCF MCO to waste package waste handling are given in Table C4.4-1 for the event sequences, and Table C4.4-2 for the cut sets. The dominant event sequences (greater than 1E-06 probability over the preclosure period) are listed in Table 6.6-7.

Table 6.6-7. CRCF MCO to WP Seismic Event Sequences

Event Sequence ID	Description	Mean Probability (over the preclosure period)	End State
CRCF-S-IE-MCO 11-05	Seismic failure of canister transfer machine breaching MCO during processing to waste package	4E-06	RR-UNFILTERED
CRCF-S-IE-MCO 15-02	Seismic failure of TEV shielding while holding waste package with MCO in CRCF (no breach)	2E-06	DE-SHIELD-LOSS

NOTE: CRCF = Canister Receipt and Closure Facility; MCO = multicanister overpack; TEV = transport and emplacement vehicle; WP = waste package.

Source: Original

These event sequences are well below the 10 CFR Part 63 (Ref. 2.3.1) compliance criteria for Category 2. Seismic event sequence CRCF-S-IE-MCO 11-05 has the highest probability for a radionuclide release sequence. The sequence represents a scenario where the MCO is being transferred from the transportation cask to the waste package by the CTM. Seismic failure of the CTM causes breach of the MCO, resulting in an unfiltered radionuclide release. The second sequence represents ejection of the waste package from the TEV, which is a loss of shielding sequence.

6.6.7 CRCF Event Sequence Categorization

The expected number of occurrences of an event sequence over the preclosure period is compared to the screening criteria in 10 CFR 63.2 (Ref. 2.3.1) to determine its categorization. If the expected number of occurrences of the event sequence is greater than or equal to 1 over the preclosure period, it is a Category 1 event sequence; if the expected number of occurrences of the event sequence is greater than or equal to 1E-04 but less than 1 over the preclosure period, it is a Category 2 event sequence; and, if the expected number of occurrences of the event sequence is less than 1E-04 over the preclosure period, the event sequence is beyond Category 2 (Ref. 2.2.59) Section 6.8.2.

The CRCF seismic event sequences in Tables 6.6-2, 6.6-3, 6.6-4, 6.6-5, 6.6-6, and 6.6-7 are combined in Table 6.6-8. The sequences are then categorized as Category 1 (C1), Category 2 (C2), or beyond Category 2 (BC2) based on the criteria above. The material at risk for each scenario is also presented in the table, and the need for any consequence analysis is listed.

Table 6.6-8. CRCF Seismic Event Sequence Categorization

Event Sequence ID	End State	Description	Material-At-Risk	Mean Probability	Event Sequence Categorization	Consequence Analysis ¹
CRCF-S-IE-TWP 12-02	DE-SHIELD-LOSS	Seismic failure of TEV shielding while holding waste package with TAD in CRCF (no breach)	1 TAD	2E-04	C2	No consequence analysis necessary
CRCF-S-IE-HLW 11-05	RR-UNFILTERED	Seismic failure of canister transfer machine breaching HLW during processing to waste package	5 HLW	1E-04	C2	2-03
CRCF-S-IE-DOE-SNF 16-02	DE-SHIELD-LOSS	Seismic failure of TEV shielding while holding waste package with DOE SNF in CRCF (no breach)	1 DOE SNF and 5 HLW	7E-05	BC2	No consequence analysis necessary
CRCF-S-IE-TAD-AO 11-05	RR-UNFILTERED	Seismic failure of canister transfer machine breaching TAD during processing to aging overpack	1 TAD	6E-05	BC2	No consequence analysis necessary
CRCF-S-IE-TWP 8-05	RR-UNFILTERED	Seismic failure of canister transfer machine breaching TAD during processing to waste package	1 TAD	6E-05	BC2	No consequence analysis necessary
CRCF-S-IE-TAD-AO 07-06	RR-UNFILTERED	Seismic failure of cask handling crane breaching TAD during processing to aging overpack	1 TAD	5E-05	BC2	No consequence analysis necessary
CRCF-S-IE-TAD-AO 10-06	RR-UNFILTERED	Seismic collapse of shield door breaching TAD during processing to aging overpack	1 TAD	5E-05	BC2	No consequence analysis necessary
CRCF-S-IE-TWP 6-05	RR-UNFILTERED	Seismic failure of site transporter breaching TAD during processing to waste package	1 TAD	5E-05	BC2	No consequence analysis necessary
CRCF-S-IE-DOE-SNF 11-05	RR-UNFILTERED	Seismic failure of canister transfer machine breaching DOE SNF during processing to waste package	9 DOE SNF	5E-05	BC2	No consequence analysis necessary
CRCF-S-IE-TWP 03	RR-UNFILTERED	Seismic failure of CRCF structure breaching TAD during processing to waste package	1 TAD (note 2)	4E-05	BC2	No consequence analysis necessary
CRCF-S-IE-TAD-AO 12-05	RR-UNFILTERED	Seismic failure of site transporter breaching TAD during processing to aging overpack	1 TAD	4E-05	BC2	No consequence analysis necessary
CRCF-S-IE-HLW 12-05	RR-UNFILTERED	Seismic collapse of staging rack breaching HLW during processing to waste package	5 HLW	4E-05	BC2	No consequence analysis necessary
CRCF-S-IE-TWP 7-06	RR-UNFILTERED	Seismic collapse of shield door breaching TAD during processing to waste package	1 TAD	3E-05	BC2	No consequence analysis necessary
CRCF-S-IE-DOE-SNF 12-05	RR-UNFILTERED	Seismic collapse of staging rack breaching DOE SNF during processing to waste package	9 DOE SNF	3E-05	BC2	No consequence analysis necessary
CRCF-S-IE-DOE-SNF 13-06	RR-UNFILTERED	Seismic failure of remote handling system breaching DOE SNF during processing to waste package	1 DOE SNF and 5 HLW	3E-05	BC2	No consequence analysis necessary
CRCF-S-IE-TAD-AO 08-06	RR-UNFILTERED	Seismic collapse of cask preparation platform breaching TAD during processing to aging overpack	1 TAD	2E-05	BC2	No consequence analysis necessary

Table 6.6-8. CRCF Seismic Event Sequence Categorization (Continued)

Event Sequence ID	End State	Description	Material-At-Risk	Mean Probability	Event Sequence Categorization	Consequence Analysis ¹
CRCF-S-IE-DOE-SNF 03	RR-UNFILTERED	Seismic failure of CRCF structure breaching DOE SNF during processing to waste package	9 DOE SNF and 5 HLW	2E-05	BC2	No consequence analysis necessary
CRCF-S-IE-HLW 03	RR-UNFILTERED	Seismic failure of CRCF structure breaching HLW during processing to waste package	5 HLW	2E-05	BC2	No consequence analysis necessary
CRCF-S-IE-HLW 09-06	RR-UNFILTERED	Seismic failure of cask transfer trolley breaching HLW during processing to waste package	5 HLW	2E-05	BC2	No consequence analysis necessary
CRCF-S-IE-TAD-AO 09-06	RR-UNFILTERED	Seismic failure of cask transfer trolley breaching TAD during processing to aging overpack	1 TAD	2E-05	BC2	No consequence analysis necessary
CRCF-S-IE-TAD-AO 03	RR-UNFILTERED	Seismic failure of CRCF structure breaching TAD during processing to aging overpack	1 TAD (note 2)	1E-05	BC2	No consequence analysis necessary
CRCF-S-IE-HLW 7-06	RR-UNFILTERED	Seismic collapse of cask handling crane breaching HLW during processing to waste package	5 HLW	1E-05	BC2	No consequence analysis necessary
CRCF-S-IE-TWP 12-07	RR-UNFILTERED	Seismic failure of TEV breaching TAD in CRCF	1 TAD	8E-06	BC2	No consequence analysis necessary
CRCF-S-IE-HLW 10-06	RR-UNFILTERED	Seismic collapse of shield door breaching HLW during processing to waste package	5 HLW	7E-06	BC2	No consequence analysis necessary
CRCF-S-IE-TWP 05-05	RR-UNFILTERED	Seismic failure of cask preparation platform breaching TAD during processing to waste package	1 TAD	7E-06	BC2	No consequence analysis necessary
CRCF-S-IE-TWP 11-06	RR-UNFILTERED	Seismic failure of waste package handling crane breaching TAD during processing to waste package	1 TAD	5E-06	BC2	No consequence analysis necessary
CRCF-S-IE-MCO 11-05	RR-UNFILTERED	Seismic failure of canister transfer machine breaching MCO during processing to waste package	2 MCO and 2 HLW	4E-06	BC2	No consequence analysis necessary
CRCF-S-IE-DOE-SNF 09-06	RR-UNFILTERED	Seismic failure of cask transfer trolley breaching DOE SNF during processing to waste package	9 DOE SNF	4E-06	BC2	No consequence analysis necessary
CRCF-S-IE-DPAO 07-06	RR-UNFILTERED	Seismic failure of cask handling crane breaching DPC during processing to aging overpack	1 DPC	3E-06	BC2	No consequence analysis necessary
CRCF-S-IE-DPAO 11-05	RR-UNFILTERED	Seismic failure of canister transfer machine breaching DPC during processing to aging overpack	1 DPC	3E-06	BC2	No consequence analysis necessary
CRCF-S-IE-DOE-SNF 7-06	RR-UNFILTERED	Seismic collapse of cask handling crane breaching DOE SNF during processing to waste package	9 DOE SNF	3E-06	BC2	No consequence analysis necessary
CRCF-S-IE-DOE-SNF 10-06	RR-UNFILTERED	Seismic collapse of shield door breaching DOE SNF during processing to waste package	9 DOE SNF or 1 DOE SNF and 5 HLW	3E-06	BC2	No consequence analysis necessary

Table 6.6-8. CRCF Seismic Event Sequence Categorization (Continued)

Event Sequence ID	End State	Description	Material-At-Risk	Mean Probability	Event Sequence Categorization	Consequence Analysis ¹
CRCF-S-IE-DOE-SNF 16-07	RR-UNFILTERED	Seismic failure of TEV breaching DOE SNF in CRCF	1 DOE SNF and 5 HLW	3E-06	BC2	No consequence analysis necessary
CRCF-S-IE-HLW 8-06	RR-UNFILTERED	Seismic collapse of cask preparation platform breaching HLW during processing to waste package	5 HLW	3E-06	BC2	No consequence analysis necessary
CRCF-S-IE-DPAO 10-06	RR-UNFILTERED	Seismic collapse of shield door breaching DPC during processing to aging overpack	1 DPC	2E-06	BC2	No consequence analysis necessary
CRCF-S-IE-DPAO 12-05	RR-UNFILTERED	Seismic failure of site transporter breaching DPC during processing to aging overpack	1 DPC	2E-06	BC2	No consequence analysis necessary
CRCF-S-IE-MCO 15-02	DE-SHIELD-LOSS	Seismic failure of TEV shielding while holding waste package with MCO in CRCF (no breach)	2 MCO and 2 HLW	2E-06	BC2	No consequence analysis necessary
CRCF-S-IE-DOE-SNF 15-06	RR-UNFILTERED	Seismic failure of waste package handling crane breaching DOE SNF during processing to waste package	1 DOE SNF and 5 HLW	2E-06	BC2	No consequence analysis necessary

NOTE: 1. The bounding event number provided in this column identifies the bounding Category 2 event sequence identified in the *Preclosure Consequence Analyses* (Ref. 2.2.69, Table 2) that results in dose consequences that bound the event sequence under consideration.

2. Potentially other waste containers could be in residence, and damaged by the structural collapse.

CRCF = Canister Receipt and Closure Facility; DOE = U.S. Department of Energy; DPC = dual-purpose canister; HLW = high-level radioactive waste; MCO = multiccanister overpack; SNF = spent nuclear fuel; TAD = transportation, aging and disposal; TEV = transport and emplacement vehicle.

Source: Original

None of the CRCF seismic event sequences are Category 1. There are two Category 2 sequences. The first is a loss of shielding sequence, but no consequence analysis is necessary since this is not a Category 1 sequence. The second is a breach involving five HLW canisters. This consequence analysis has been evaluated, and easily meets the 10 CFR Part 63 (Ref. 2.3.1) offsite dose criteria.

6.7 SEISMIC EVENT SEQUENCE ANALYSIS FOR WET HANDLING FACILITY (WHF)

This section provides a description of the seismic event sequences and quantification process for the WHF, including:

- Development of the seismic event trees
- Development of the seismic fault trees
- Summary of the input data
- Results for the event sequence quantification
- Categorization of seismic event sequences.

Detailed information for the WHF quantification is provided in Attachment D, and referenced as appropriate below.

The WHF seismic event sequence quantification covers the following processes:

- Processing of DPCs (from railcars with transportation casks entering the WHF, transferred to STCs, and placed into the WHF pool for SNF assembly transfer)
- Processing of transportation casks with bare SNF (from trucks with transportation casks entering the WHF, and placed into the WHF pool for SNF assembly transfer)
- Transfer of the SNF assemblies (from the incoming cask to the WHF SNF staging rack, then transferred to an empty TAD)
- Processing of the TAD (from the pool station to an aging overpack leaving the WHF on the site transporter).

There are other process variations, but these cover all of the equipment and waste containers used in the various processes.

6.7.1 Processing of DPCs

DPCs inside a transportation cask are received on railcars, and are transferred by the CTM into a STC, cut open in the DPC cutting station, and then transferred to the WHF pool. DPCs can also be received from aging overpacks, or from the horizontal cask transfer trailer. While the WHF could also transfer DPCs to aging overpacks, this process is very similar to the process evaluated for the RF.

6.7.1.1 WHF DPC Event Trees

Using the approach described in Section 4.3.3.1, the IET and SRETs were developed to delineate the potential seismic event sequences that could occur during processing of DPCs in the WHF. Figure 6.7-1 provides the IET for processing DPCs in the WHF. The pivotal events are described below:

- **SEIS-EVENT:** This initial heading is the initiating seismic event, representing the seismic hazard curve discussed in Section 6.1.
- **WHF-DPC-CAN:** This event is the number of DPCs processed over the preclosure period (Table 6.3-1). (Note: the “up” branch is not used.) This includes DPCs in all configurations.
- **SEIS-FAIL:** These branches indicate the potential SSCs that can fail and potentially damage the DPC. Note that the event tree branch captions are associated with the branch line below the caption. These failures and their seismic fragilities are listed in Table 6.2-1 (structures) and Table 6.2-2 (equipment). They are described in Section 6.2.

Seismic Event	Number of DP canisters processed in WHF	Identify initiating seismic failure			
SEIS-EVENT	WHF-DPC-CAN	SEIS-FAIL	#		END-STATE
			1		OK
			2		OK
		WHF building collapse	3		RR-UNF
		Entry door seismic collapse	4	T => 2	WHF-S-R-TC1
		Railcar accident	5	T => 2	WHF-S-R-TC1
		Mobile platform seismic collapse	6	T => 2	WHF-S-R-TC1
		Entrance Vestibule Crane	7	T => 2	WHF-S-R-TC1
		CHC seismic failures	8	T => 2	WHF-S-R-TC1
		Horizontal cask stand tipover	9	T => 2	WHF-S-R-TC1
		CTT seismic failures	10	T => 2	WHF-S-R-TC1
		Preparation station #1 collapse	11	T => 2	WHF-S-R-TC1
		Jib cranes seismic failures	12		RR-UNF
		Shield door seismic failure	13	T => 3	WHF-S-R-SD1
		CTM seismic failures	14	T => 4	WHF-S-R-CTM
		Cutting station collapse	15		RR-UNF
		DPC transfer station collapse	16	T => 6	WHF-S-R-POOL
		Auxiliary pool crane	17	T => 6	WHF-S-R-POOL
		Spent fuel transfer machine	18	T => 6	WHF-S-R-POOL

WHF-S-IE-DPC - WHF Seismic Event Tree - Initiating seismic failures - DPC

2007/12/19 WHF p. 1

NOTE: Event tree branch captions are associated with the branch line below the caption.

CAN = canister; CHC = cask handling crane; CTM = canister transfer machine; DPC = dual-purpose canister; INIT = initiating; NUM = number; RR = radioactive release; SD = shield door; SEIS = seismic; UNF = unfiltered; WHF = Wet Handling Facility.

Source: Original

Figure 6.7-1. WHF DPC Initiator Event Tree

The end states for most of the sequences on the WHF DPC IET are transferred to seismic SRETs, as listed in the last column of Figure 6.7-1. An example of the SRET is provided in Figure 6.7-2, WHF-S-R-TC1, Seismic transfer (Event Tree) with canister in transportation cask. These SRETs have pivotal events that determine whether the waste container (cask, canister, waste package) is breached, whether shielding is degraded or lost, whether HVAC/confinement is available to filter the release, and whether there is moderator intrusion in a breached canister to potentially cause criticality. (Note that HVAC/confinement was not credited for the seismic event sequence analysis, as previously discussed.) For those processing activities that take place while the STC is in the pool, the question of moderator intrusion becomes one of pool failure and loss of boration. Attachment D1.1 provides all of the SRETs.

Pool Boron Dilution Evaluation: The potential for pool boron dilution due to flooding sources was assessed by reviewing the piping systems that go through the pool room, and the potential volume of water that could be released. Initially, there were six water containing systems in the room:

- Pool water cooling
- Deionized water
- Potable water
- Chilled water
- Hot water
- Fire protection water.

After review, it was determined that the potable water, chilled water, and hot water systems are not used in this room, and the piping was removed from the pool room to reduce the flooding sources (Ref. 2.2.86).

The pool water cooling system is borated water, so leakage from this system that entered the pool would not dilute the boration.

The source for the deionized water system is a tank in the Utility Facility, and the base of the tank is below the top of the pool wall (Ref. 2.2.50). Therefore, gravity flow from the tank would not be possible. Since the offsite power system, which powers the deionized water pumps, has a lower seismic capacity ($A_m = 0.3 g$, Table 6.2-2) than the piping system ($A_m = 0.76g$), it is not likely that the pumps would be available after the piping is failed. However, even if the power were available, and the piping breaks in the pool room, the total volume of water would be limited to the tank capacity (19,600 gallons, Ref. 2.2.50), since the pump would be starved when the tank emptied.

The fire protection water piping in the pool room is dry pipe, with a double-interlocked preaction valve outside the room (Ref. 2.2.55). As discussed in Section 6.2.2.24, these ITS valves would be expected to have solid state actuation circuitry, and would not be subject to relay chatter during a seismic event. Therefore, even if the fire protection water piping fails in the pool room, the preaction valve will not spuriously open due to the seismic event, and fire protection water will not enter the pool room. As a backup measure, standard nuclear plant practice for fire protection system actuation is to send an operator to the room immediately, to determine the fire threat level. If there is no fire, then the operator would be instructed to isolate the spuriously actuated valve using the upstream manual valve. However, no credit was taken for this operator action.

Thus, the potential flooding sources have been examined for the pool room, and it is unlikely that any boron dilution would occur. However, there is some potential for the 19,600 gallons of deionized water to be pumped from the utility facility tank up to the WHF pool room. This volume of water would result in less than 2% dilution of the pool boration, since the pool has over one million gallons of borated water (Ref. 2.2.68, Section 6.1.1).

Maximum acceptable dilution percentages have been calculated for a number of different cask and assembly scenarios (Ref. 2.2.70, Table 5). In particular, for truck casks with four pressurized water reactor (PWR) or nine boiling water reactor (BWR) fuel assemblies, the maximum acceptable dilution is 55%. Thus, for truck cask tipover scenarios, the potential flooding from water sources in the room is far lower than the maximum acceptable dilution percentage. This information is also used for the WHF pool event sequences in Section 6.7.2 and 6.7.3.

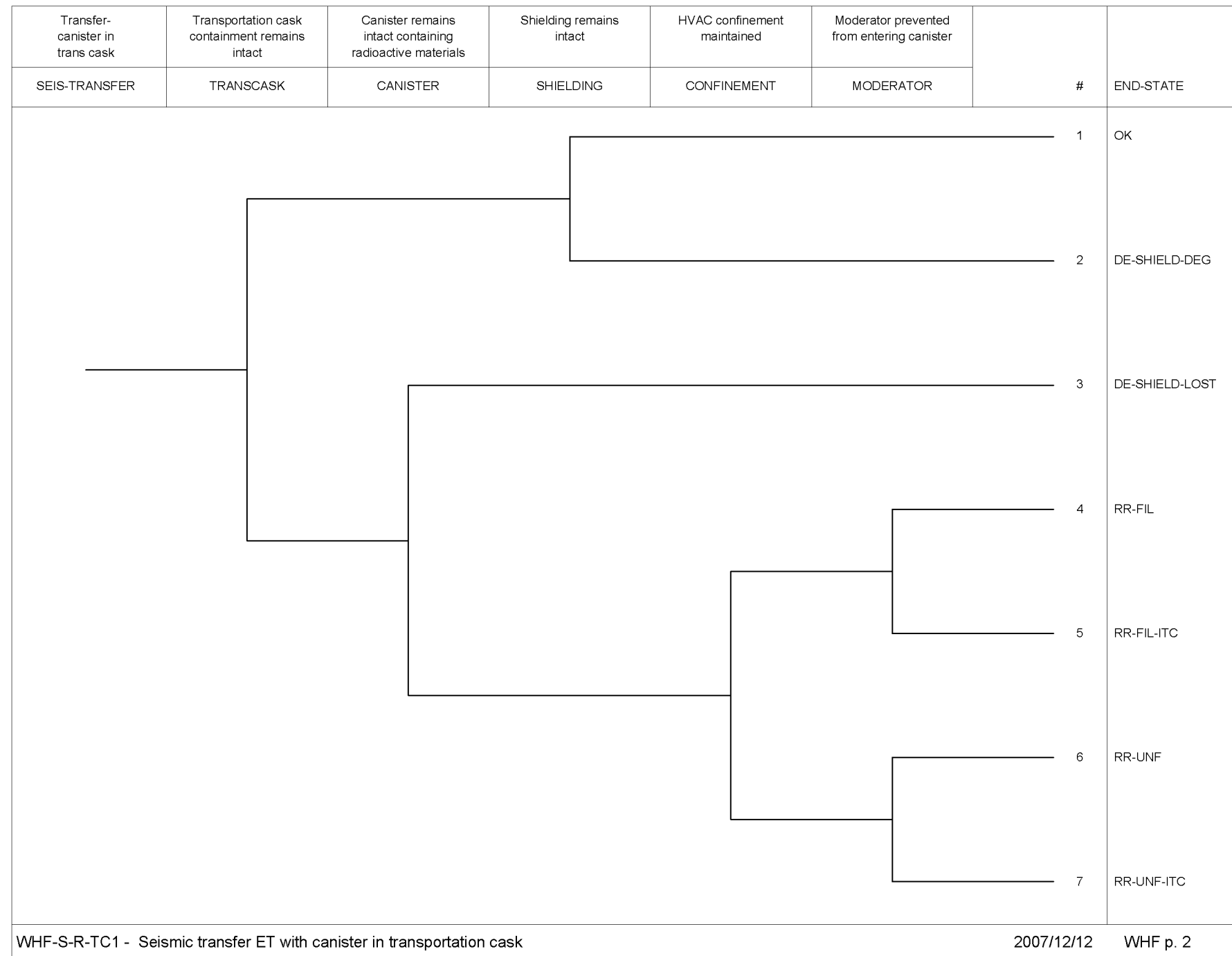

NOTE: DE = direct exposure; DEG = degradation; ET = event tree; FIL = filtered; HVAC = heating, ventilation and air conditioning; INIT = initiating; ITC = important to criticality; RR = radioactive release; SEIS = seismic; UNF = unfiltered; WHF = Wet Handling Facility.

Source: Original

Figure 6.7-2. Seismic Transfer Event Tree WHF-S-R-TC1

6.7.1.2 WHF DPC Fault Trees

Fault trees were used to identify the potential failures for each of the pivotal events above (see Section 4.3.3.2 for the approach). These fault trees are provided in Attachment D1.2. Table D1.1-1 identifies the fault trees that are assigned to each pivotal event on the IET, while Table D1.1-2 identifies the fault trees that are assigned to each pivotal event on the SRETs.

6.7.1.3 Exposure Times and Passive Equipment Failure Analysis

To determine the amount of time the waste container is exposed to a specific hazard, the expected times of each waste handling process in each facility were evaluated. The approach was discussed in Section 4.3.3.4, and is documented in detail in Attachment G. The result is the exposure time by SSC seismic failure mode per waste container processed.

Since the seismic hazard is represented in terms of frequency per year, the exposure time factor is given in terms of “years per single waste container.” Table 6.7-1 provides the exposure time factors for the processing of the DPCs.

Table 6.7-1. Exposure Time Factors for Waste Handling Operations in the WHF

SSC	Seismic Failure Mode	Import DPC in STC into Pool	Import TC with Bare Fuel into Pool	Transfer Assembly from Cask to Staging	Transfer Assembly from Staging into a TAD	Export TAD from Pool to AO
WHF structure	Collapse onto waste container	1.2E-02	1.9E-03	3.8E-05	5.7E-05	6.6E-03
Entry door	Collapse onto waste container	1.1E-05	1.1E-05	N/A	N/A	1.9E-05
Entrance Vestibule crane (EVC)	Collapse	3.3E-04	3.0E-04	N/A	N/A	N/A
Rail / truck	Collision / tipover	6.1E-04	4.7E-04	N/A	N/A	N/A
Mobile access platform	Collapse	6.8E-04	5.0E-04	N/A	N/A	N/A
Cask stand	Collapse	5.7E-04	0.0E+00	N/A	N/A	N/A
Transfer station - In pool	Collapse	7.3E-04	8.0E-04	3.8E-05	5.7E-05	7.7E-04
Cask handling crane	Collapse	1.7E-03	6.7E-04	N/A	N/A	5.2E-04
	Cask drop	3.7E-04	2.1E-04	N/A	N/A	2.2E-04
	Heavy object drop	1.6E-04	1.8E-04	N/A	N/A	6.7E-05
Auxiliary pool crane	Collapse	2.1E-03	1.9E-04	N/A	N/A	1.8E-04
	Heavy object drop	2.3E-04	7.6E-05	N/A	N/A	7.6E-05
Prep. sta. #1	Collapse	1.5E-03	4.4E-04	N/A	N/A	9.3E-05

Table 6.7-1. Exposure Time Factors for Waste Handling Operations in the WHF (Continued)

SSC	Seismic Failure Mode	Import DPC in STC into Pool	Import TC with Bare Fuel into Pool	Transfer Assembly from Cask to Staging	Transfer Assembly from Staging into a TAD	Export TAD from Pool to AO
TAD closure and prep. sta. #2	Collapse	0.0E+00	0.0E+00	N/A	N/A	4.7E-03
Cask support frame	Fail	5.71E-05	N/A	N/A	N/A	5.71E-05
Jib cranes	Collapse	5.1E-04	8.6E-05	N/A	N/A	2.2E-03
	Heavy object drop	1.7E-04	9.5E-06	N/A	N/A	3.6E-04
DPC cutting station	Collapse	4.0E-03	N/A	N/A	N/A	N/A
Spent fuel transfer machine (SFTM)	Collapse	4.8E-05	1.0E-04	3.8E-05	5.7E-05	1.1E-04
	Heavy object drop	9.5E-06	9.5E-06	0.0E+00	0.0E+00	0.0E+00
	SNF assembly drop	N/A	N/A	3.8E-05	5.7E-05	N/A
Staging rack	Collapse	N/A	N/A	3.8E-05	5.7E-05	N/A
Cask transfer trolley	Slide	3.3E-04	4.8E-05	N/A	N/A	1.5E-04
	Bump impact	1.3E-03	3.9E-04	N/A	N/A	1.1E-04
	Tipover	1.1E-04	4.8E-05	N/A	N/A	2.9E-05
Shield doors	Mount failure	1.5E-03	4.4E-04	N/A	N/A	1.3E-04
Canister transfer machine (CTM)	Collapse onto waste container	2.5E-03	N/A	N/A	N/A	2.9E-04
	Canister drop	2.3E-03	N/A	N/A	N/A	4.6E-05
	Heavy object drop	6.1E-05	N/A	N/A	N/A	6.7E-05
	Swing inside bell	2.3E-03	N/A	N/A	N/A	4.6E-05
	Swing outside bell	2.9E-05	N/A	N/A	N/A	2.9E-05
Aging overpack (AO) access platform	Collapse	N/A	N/A	N/A	N/A	4.6E-04

Table 6.7-1. Exposure Time Factors for Waste Handling Operations in the WHF (Continued)

SSC	Seismic Failure Mode	Import DPC in STC into Pool	Import TC with Bare Fuel into Pool	Transfer Assembly from Cask to Staging	Transfer Assembly from Staging into a TAD	Export TAD from Pool to AO
Site transporter	Sliding impact	N/A	N/A	N/A	N/A	2.1E-04
	Bump impact	N/A	N/A	N/A	N/A	4.6E-04

NOTE: AO = aging overpack; DPC = dual-purpose canister; SSC = structure, system or component; STC = shielded transfer cask; TAD = transportation, aging and disposal; TC = transportation cask; WHF = Wet Handling Facility.

Source: Original, Attachment G (rounded to two significant figures)

The conditional probability of breach of the waste container is also used in the fault trees. These PEFA values are discussed in Section 6.3.3, and given in Table 6.3-2.

6.7.1.4 Quantification of the WHF DPC Waste Handling Process

The quantification approach, using the SAPHIRE software (Ref. 2.2.104), was discussed in detail in Section 4.5. Each of the following inputs is described in previous sections:

- Seismic hazard curve (Section 6.1)
- Seismic fragilities for SSCs (Section 6.2)
- Throughput, exposure time factors, and PEFA (Section 6.3)
- Event trees (Section 6.7.1.1)
- Fault trees (Section 6.7.1.2).

Quantification of seismic event sequences must be performed in a different manner than for internal initiating events. The quantification must incorporate the dependency between the magnitude of seismic ground motion and the probability of seismic failure, the latter of which increases with the former as expressed with the SSC fragility curves. The algorithm also incorporates the decreasing frequency of a seismic event as the magnitude of seismic ground motion increases, expressed with the seismic hazard curve. This quantification process is often termed a convolution.

The results of the quantification are the probabilities of the event sequences, and the detailed cut sets for each event sequence. These detailed results for the WHF DPC waste handling are given in Table D1.4-1 for the event sequences, and Table D1.4-2 for the cut sets. The dominant event sequences (greater than 1E-06 probability over the preclosure period) are listed in Table 6.7-2.

Table 6.7-2. WHF DPC Seismic Event Sequences

Event Sequence ID	Description	Mean Probability (over the preclosure period)	End State
WHF-S-IE-DPC 16-5	Seismic tipover of DPC in pool transfer station spilling DPC assemblies in pool	2E-05	RR-UNFILTERED
WHF-S-IE-DPC 14-05	Seismic failure of canister transfer machine damaging SNF in DPC	1E-05	RR-UNFILTERED
WHF-S-IE-DPC 17-05	Seismic failure of auxiliary pool crane damaging SNF in DPC	7E-06	RR-UNFILTERED
WHF-S-IE-DPC 08-06	Seismic failure of cask handling crane damaging SNF in DPC	5E-06	RR-UNFILTERED
WHF-S-IE-DPC 15	Seismic failure of cutting station platform damaging SNF in DPC	4E-06	RR-UNFILTERED
WHF-S-IE-DPC 13-06	Seismic failure of shield door damaging SNF in DPC	3E-06	RR-UNFILTERED
WHF-S-IE-DPC 03	Seismic failure of WHF structure damaging SNF in DPC	3E-06	RR-UNFILTERED
WHF-S-IE-DPC 12	Seismic failure of jib crane damaging SNF in DPC	2E-06	RR-UNFILTERED
WHF-S-IE-DPC 11-06	Seismic failure of preparation station #1 damaging SNF in DPC	1E-06	RR-UNFILTERED

NOTE: DPC = dual-purpose canister; SNF = spent nuclear fuel; WHF = Wet Handling Facility.

Source: Original

All of the event sequences are below the 10 CFR Part 63 (Ref. 2.3.1) compliance criteria for Category 2.

Seismic event sequence WHF-S-IE-DPC 16-5 has the highest probability over the preclosure period. The sequence represents a scenario where the DPC is in the STC, which is held by the transfer station support on the bottom of the pool. Due to the seismic event, the STC tips over, spilling the SNF assemblies from the DPC. Although this event sequence is beyond Category 2, it has been evaluated for criticality concerns. It was determined that the boron in the pool was sufficient to preclude criticality for the spilled SNF assemblies (Ref. 2.2.70, Section 2.3.2.2.4). Since the release is in the pool, it is significantly reduced. Therefore, the end state is assigned to a gaseous unfiltered radionuclide release (no HVAC available).

The next three sequences represent failures of the large cranes, CTM, APC, and CHC, breaching the DPC. These sequences all have a probability of 1E-05 or less over the preclosure period, and result in an unfiltered radionuclide release.

6.7.2 Processing of Truck Casks with Bare SNF in the WHF

Transportation casks containing bare SNF are received on trucks, placed into cask support frames, and then transferred into the WHF pool where the casks are opened for transfer of the assemblies to the staging rack or empty TAD.

6.7.2.1 WHF HLW Canister Event Trees

Figure 6.7-3 provides the IET for processing bare SNF in the WHF. The pivotal events are similar to those for the DPC IET, and are described below:

- **SEIS-EVENT:** This initial heading is the initiating seismic event, representing the seismic hazard curve discussed in Section 6.1.
- **WHF-BARE-CASK:** This event is the number of truck casks with bare SNF processed over the preclosure period (Table 6.3-1). (Note: the “up” branch is not used.)
- **SEIS-FAIL:** These branches indicate the potential SSCs that can fail and potentially damage the truck casks and bare SNF. Note that the event tree branch captions are associated with the branch line below the caption. These failures and their seismic fragilities are listed in Table 6.2-1 (structures) and Table 6.2-2 (equipment). They are described in Section 6.2.

Seismic Event	Number of TCs with bare SNF processed in WHF	Identify initiating seismic failure		
SEIS-EVENT	WHF-BARE-CASK	SEIS-FAIL	#	END-STATE
			1	OK
		WHF building collapse	2	OK
		Entry door seismic collapse	3	RR-UNF
		Truck tipover	4	T => 2 WHF-S-R-TC1
		Mobile platform seismic collapse	5	T => 2 WHF-S-R-TC1
		Entrance Vestibule Crane	6	T => 2 WHF-S-R-TC1
		CHC seismic failures	7	T => 2 WHF-S-R-TC1
		CTT seismic failures	8	T => 2 WHF-S-R-TC1
		Preparation station #1 collapse	9	T => 2 WHF-S-R-TC1
		Jib cranes seismic failures	10	T => 2 WHF-S-R-TC1
		Shield door seismic failure	11	T => 2 WHF-S-R-TC1
		TC transfer stations	12	T => 2 WHF-S-R-TC1
		Auxiliary pool crane	13	T => 3 WHF-S-R-POOL
		Spent fuel transfer machine	14	T => 3 WHF-S-R-POOL
			15	T => 3 WHF-S-R-POOL

WHF-S-IE-BARE - WHF Seismic Event Tree - Initiating seismic failures - Bare SNF 2007/12/19 WHF-Bare 1

NOTE: Event tree branch captions are associated with the branch line below the caption.

CHC = cask handling crane; CTM = canister transfer machine; CTT = cask transfer trolley; RR = radioactive release; SEIS = seismic; SNF = spent nuclear fuel; TC = transportation cask; UNF = unfiltered; WHF = Wet Handling Facility.

Source: Original

Figure 6.7-3. WHF Truck Cask with Bare SNF Initiator Event Tree

The end states for most of the sequences on the WHF bare SNF IET are transferred to seismic SRETs, as listed in the last column of Figure 6.7-3. These SRETs are the same as for the DPC. The SRETs have pivotal events that determine whether the waste cask is breached, whether shielding is degraded or lost, whether HVAC/confinement is available to filter the release, and whether there is moderator intrusion in a breached cask to potentially cause criticality. (Note that HVAC/confinement was not credited for the seismic event sequence analysis, as previously discussed.) For those processing activities that take place while the transportation cask is in the pool, the question of moderator intrusion becomes one of pool failure and loss of boration. See the discussion of boron dilution in Section 6.7.1.1. Attachment D2 provides all of the SRETs.

6.7.2.2 WHF Bare SNF Fault Trees

Fault trees were used to identify the potential failures for each of the pivotal events above (see Section 4.3.3.2 for the approach). These fault trees are provided in Attachment D2.2. Table D2.1-1 identifies the fault trees that are assigned to each pivotal event on the IET, while Table D2.1-2 identifies the fault trees that are assigned to each pivotal event on the SRETs.

6.7.2.3 Exposure Times and Passive Equipment Failure Analysis

To determine the amount of time the waste container is exposed to a specific hazard, the expected times of each waste handling process in each facility were evaluated. The approach was discussed in Section 4.3.3.4, and is documented in detail in Attachment G. The result is the exposure time by SSC seismic failure mode per waste container processed.

Since the seismic hazard is represented in terms of frequency per year, the exposure time factor is given in terms of “years per single waste container.” Table 6.7-1 provides the exposure time factors for the processing of the bare SNF truck casks.

The conditional probability of breach of the waste container is also used in the fault trees. These PEFA values are discussed in Section 6.3.3, and given in Table 6.3-2.

6.7.2.4 Quantification of the WHF Bare SNF Waste Handling Process

The quantification approach was the same as for DPCs discussed above.

The results of the quantification are the probabilities of the event sequences, and the detailed cut sets for each event sequence. These detailed results for the WHF bare SNF waste handling are given in Table D2.4-1 for the event sequences, and Table D2.4-2 for the cut sets. The dominant event sequences (greater than 1E-06 probability over the preclosure period) are listed in Table 6.7-3.

Table 6.7-3. WHF Bare SNF Seismic Event Sequences

Event Sequence ID	Description	Mean Probability (over the preclosure period)	End State
WHF-S-IE-BARE 13-5	Seismic tipover of truck cask in pool transfer station spilling SNF in pool	2E-04	RR-UNFILTERED
WHF-S-IE-BARE 08-06	Seismic failure of cask handling crane breaching truck cask with bare SNF	2E-05	RR-UNFILTERED
WHF-S-IE-BARE 12-06	Seismic failure of shield door breaching truck cask with bare SNF	1E-05	RR-UNFILTERED
WHF-S-IE-BARE 14-05	Seismic failure of auxiliary pool crane breaching truck cask with bare SNF	1E-05	RR-UNFILTERED
WHF-S-IE-BARE 07-06	Seismic failure of entrance vestibule crane breaching truck cask with bare SNF	9E-06	RR-UNFILTERED
WHF-S-IE-BARE 15-05	Seismic failure of spent fuel transfer machine damaging SNF in truck cask in pool	8E-06	RR-UNFILTERED
WHF-S-IE-BARE 03	Seismic failure of WHF structure damaging SNF in truck cask in pool	6E-06	RR-UNFILTERED
WHF-S-IE-BARE 10-06	Seismic failure of preparation station #1 breaching SNF truck cask	4E-06	RR-UNFILTERED
WHF-S-IE-BARE 09-06	Seismic failure of cask transfer trolley breaching SNF truck cask	4E-06	RR-UNFILTERED
WHF-S-IE-BARE 11-06	Seismic failure of jib crane breaching SNF truck cask	3E-06	RR-UNFILTERED
WHF-S-IE-BARE 13-6	Seismic tipover of truck cask with bare assemblies in pool transfer station spilling assemblies in pool	2E-06	RR-UNFILTERED

NOTE: SNF = spent nuclear fuel; WHF = Wet Handling Facility.

Source: Original

All but one of the event sequences are below the 10 CFR Part 63 (Ref. 2.3.1) compliance criteria for Category 2.

Seismic event sequence WHF-S-IE-BARE 13-5 has the highest probability over the preclosure period. The sequence represents a scenario where the bare SNF is in the truck cask, which is held by the truck cask transfer station at the bottom of the pool. Due to the seismic event, the cask tips over and spills the bare SNF assemblies on the pool floor. This event sequence has been evaluated for criticality concerns. It was determined that the normal boration in the pool was sufficient to preclude criticality for the spilled SNF assemblies (Ref. 2.2.70, Section 2.3.2.2.4). The potential for boron dilution due to piping system failures in the pool area was also considered, and discussed in Section 6.7.1.1. Even the maximum possible dilution would not result in a criticality concern. Since the release is in the pool, it is significantly reduced. Therefore, the end state is assigned to a gaseous unfiltered radionuclide release (no HVAC available). The consequence analysis (Ref. 2.2.69) demonstrates that this event sequence release is very limited, and easily meets the 10 CFR Part 63 (Ref. 2.3.1) offsite dose criteria.

Other sequences include failures of the large cranes, CHC, APC, and Entrance Vestibule crane, and collapse of the shield door breaching the truck cask. These sequences all have a probability of $2E-05$ or less over the preclosure period, and result in an unfiltered radionuclide release.

6.7.3 Transfer of SNF Assemblies in the WHF Pool

Once the DPC (in an STC) or bare SNF (in a truck transportation cask) is in the pool, the SNF assemblies are transferred to the WHF SNF staging rack or empty TAD using the SFTM. This processing operation covers the transfer of SNF assemblies from the incoming cask to the staging rack, and then transfer of the assemblies back to an empty TAD. (Note that it is conservatively modeled that all of the SNF assemblies are transferred to the staging rack, and then back to the empty TAD. It is likely that some SNF assemblies will be directly transferred from the DPC or truck cask to the empty TAD, thus saving processing time, minimizing handling of the assemblies, and reducing the total number of transfers required.)

In addition, this event tree includes the general failures of the WHF structure, WHF pool, SNF staging rack, and HVAC system integrity, as discussed below.

6.7.3.1 WHF Transfer of SNF Assemblies Event Trees

Figure 6.7-4 provides the IET for transferring SNF in the WHF pool. The pivotal events are described below:

- **SEIS-EVENT:** This initial heading is the initiating seismic event, representing the seismic hazard curve discussed in Section 6.1.
- **WHF-POOL-OPS:** This event has two values. The first (assembly transfer operations) is the number of SNF assemblies to be transferred to the staging rack and then to the TAD over the preclosure period (Table 6.3-1). The second is the value for continuously exposed hazards (50 years), and is used for general risks that occur during the facility operations.

- SEIS-FAIL: These upper set of branches indicate the potential SSCs that can fail and potentially damage the SNF. Note that the event tree branch captions are associated with the branch line below the caption. The lower set of branches represents the general risks, such as pool failure. Their seismic fragilities are listed in Table 6.2-1 (structures) and Table 6.2-2 (equipment). They are described in Section 6.2.

The end states for the upper set of sequences on the WHF SNF transfer IET are transferred to the WHF-S-R-POOL SRET, as listed in the last column of Figure 6.7-4. This SRET is shown in Figure 6.7-5, and has pivotal events that determine whether the waste cask tips over, whether the assemblies are damaged if tipover does not occur, and whether the pool is available for shielding, scrubbing of radioactive releases, and boration. (Note that HVAC/confinement was not credited for the seismic event sequence analysis, as previously discussed.)

Seismic Event	Time waste forms potentially at risk in WHF	Identify initiating seismic failure			
SEIS-EVENT	WHF-POOL-OPS	SEIS-FAIL	#	END-STATE	
			1	OK	
			2	OK	
			3	T => 2	WHF-S-R-POOL
			4	T => 2	WHF-S-R-POOL
			5	T => 2	WHF-S-R-POOL
			6		OK
			7		RR-UNF
			8		RR-UNF
			9		RR-UNF-ITC
			10		RR-UNF
WHF-S-IE-SNF-XFER - WHF Seismic Event Tree - Initiating Seismic Failures - SNF transfer			2007/12/20	WHF-TAD 1	

NOTE: Event tree branch captions are associated with the branch line below the caption.

HVAC = heating, ventilation and air conditioning; ITC = important to criticality; OPS = operations; RR = radioactive release; SEIS = seismic; SNF = spent nuclear fuel; TAD = transportation, aging and disposal; UNF = unfiltered; WHF = Wet Handling Facility.

Source: Original

Figure 6.7-4. WHF SNF Transfer Initiator Event Tree

Transfer-Pool Operations	No tipover of STC in pool	SNF assemblies are not damaged	Pool available (shielding, scrubbing, boration)		
SEIS-TRANSFER	TIPOVER	ASSEMBLY	POOL	#	END-STATE
				1	OK
				2	DE-SHIELD-DEG
				3	RR-UNF
				4	RR-UNF
				5	RR-UNF
				6	RR-UNF-ITC
WHF-S-R-POOL - Seismic transfer ET for Pool operations				2007/12/19	WHF-TAD 2

NOTE: DE = direct exposure; DEG = degradation; ET = event tree; FIL = filtered; INIT = initiating; ITC = important to criticality; RR = radioactive release; SEIS = seismic; SNF = spent nuclear fuel; STC = shielded transfer cask;

UNF = unfiltered; WHF = Wet Handling Facility.

Source: Original

Figure 6.7-5. WHF SNF Transfer in Pool SRET

The end states for the lower set of sequences on the WHF SNF transfer IET are unfiltered radioactive releases (no HVAC available for filtering). Collapse of the staging rack is designated as a potential ITC end state as well.

6.7.3.2 WHF SNF Transfer Fault Trees

Fault trees were used to identify the potential failures for each of the pivotal events above (see Section 4.3.3.2 for the approach). These fault trees are provided in Attachment D3.2. Table D3.1-1 identifies the fault trees that are assigned to each pivotal event on the IET, while Table D3.1-2 identifies the fault trees that are assigned to each pivotal event on the SRET.

6.7.3.3 Exposure Times and Passive Equipment Failure Analysis

To determine the amount of time the waste container is exposed to a specific hazard, the expected times of each waste handling process in each facility were evaluated. The approach was discussed in Section 4.3.3.4, and is documented in detail in Attachment G. The result is the exposure time by SSC seismic failure mode per waste container processed.

Since the seismic hazard is represented in terms of frequency per year, the exposure time factor is given in terms of “years per single waste container.” Table 6.7-1 provides the exposure time factors for the transferring of SNF assemblies. The exposure time factor for the continuous exposure event sequences is 50 years.

The conditional probability of breach of the waste container is also used in the fault trees. These PEFA values are discussed in Section 6.3.3, and given in Table 6.3-2.

6.7.3.4 Quantification of the WHF SNF Transfer Process

The quantification approach was the same as for DPCs discussed above.

The results of the quantification are the probabilities of the event sequences, and the detailed cut sets for each event sequence. These detailed results for the WHF SNF transfer waste handling are given in Table D3.4-1 for the event sequences, and Table D3.4-2 for the cut sets. The dominant event sequences (greater than 1E-06 probability over the preclosure period) are listed in Table 6.7-4.

Table 6.7-4. WHF SNF Transfer and Continuous Exposure Seismic Event Sequences

Event Sequence ID	Description	Mean Probability (over the preclosure period)	End State
WHF-S-IE-SNF-XFER 10	Seismic failure of WHF HVAC system integrity releasing radioactive accumulation	1E-03	RR-UNFILTERED
WHF-S-IE-SNF-XFER 03-05	Seismic tipover of SNF truck cask or DPC in transfer station spilling SNF in truck cask or DPC in pool	2E-04	RR-UNFILTERED
WHF-S-IE-SNF-XFER 05-05	Seismic tipover of TAD in transfer station spilling SNF in TAD in pool	2E-04	RR-UNFILTERED
WHF-S-IE-SNF-XFER 04-05	Seismic failure of spent fuel transfer machine damaging SNF in pool	7E-05	RR-UNFILTERED
WHF-S-IE-SNF-XFER 07	Seismic collapse of WHF structure damaging SNF in pool	4E-05	RR-UNFILTERED
WHF-S-IE-SNF-XFER 08	Seismic failure of WHF pool damaging SNF in pool	4E-05	RR-UNFILTERED
WHF-S-IE-SNF-XFER 09	Seismic collapse of WHF pool staging rack damaging SNF in pool	4E-05	RR-UNFILTERED-ITC

NOTE: DPC = dual-purpose canister; HVAC = heating, ventilation and air conditioning; SNF = spent nuclear fuel; WHF = Wet Handling Facility.

Source: Original

All but one of the event sequences are below the 10 CFR Part 63 (Ref. 2.3.1) compliance criteria for Category 2.

Seismic event sequence WHF-S-IE-SNF-XFER 10 has the highest probability over the preclosure period. The sequence represents a scenario where the earthquake causes a breach of the system integrity of the ITS HVAC ducting and filtration system. The end state is assigned to an unfiltered radionuclide release. While this is a Category 2 sequence, the offsite dose is very limited such that the 10 CFR Part 63 (Ref. 2.3.1) compliance criteria are easily met (Ref. 2.2.69).

The beyond Category 2 sequences include the failure of the SFTM, collapse of the WHF building, failure of the pool, and collapse of the SNF staging rack. These sequences could all damage the SNF assemblies in the pool, and result in an unfiltered radionuclide release (no HVAC filtering available). However, since they are beyond Category 2, a consequence assessment is not required.

6.7.4 Processing of TADs in the WHF

Empty TADs are placed in STCs, placed on the pool floor, filled with SNF assemblies, lifted from the pool, drained and sealed, transferred with the CTM into an aging overpack, and transferred with the site transporter out of the WHF to the aging facility or the CRCF for further processing.

6.7.4.1 WHF TAD Event Trees

Figure 6.7-6 provides the IET for processing the TAD in the WHF. The pivotal events are described below:

- **SEIS-EVENT:** This initial heading is the initiating seismic event, representing the seismic hazard curve discussed in Section 6.1.
- **WHF-TAD-AO:** This event is the number of TADs processed in the WHF over the preclosure period (Table 6.3-1). (Note: the “up” branch is not used.)
- **SEIS-FAIL:** These branches indicate the potential SSCs that can fail and potentially damage the TADs. Note that the event tree branch captions are associated with the branch line below the caption. These failures and their seismic fragilities are listed in Table 6.2-1 (structures) and Table 6.2-2 (equipment). They are described in Section 6.2.

Seismic Event	Number of TAD canisters transferred to AO	Identify initiating seismic failure		
SEIS-EVENT	WHF-TAD-AO	SEIS-FAIL	#	END-STATE
			1	OK
		WHF building collapse	2	OK
		TAD transfer station (pool)	3	RR-UNF
		Auxiliary pool crane	4	T => 2 WHF-S-R-POOL
		Spent fuel transfer machine	5	T => 2 WHF-S-R-POOL
		Cask handling crane	6	T => 2 WHF-S-R-POOL
		TAD closure or prep station #2	7	T => 3 WHF-S-R-STC
		Jib cranes	8	RR-UNF
		Cask transfer trolley	9	RR-UNF
		Preparation station #1	10	T => 4 WHF-S-R-CTM
		Shield door seismic failure	11	T => 4 WHF-S-R-CTM
		Canister transfer machine	12	T => 4 WHF-S-R-CTM
		Site transporter	13	T => 4 WHF-S-R-CTM
		Aging overpack access platform	14	T => 5 WHF-S-R-AO
		Entry door seismic collapse	15	T => 5 WHF-S-R-AO
			16	T => 5 WHF-S-R-AO

WHF-S-IE-TAD-AO - WHF Seismic Event Tree - Initiating Seismic Failures - TAD to AO 2007/12/18 WHF-TAD 1

NOTE: Event tree branch captions are associated with the branch line below the caption.

AO = aging overpack; CTM = canister transfer machine; RR = radioactive release; SEIS = seismic; TAD = transportation, aging and disposal; STC = shielded transfer cask; UNF = unfiltered; WHF = Wet Handling Facility.

Source: Original

Figure 6.7-6. WHF TAD Initiator Event Tree

The end states for most of the sequences on the WHF TAD IET are transferred to seismic SRETs, as listed in the last column of Figure 6.7-6. These SRETs are similar to those for the DPC, but also include additional SRETs for aging overpack activities. The SRETs have pivotal events that determine whether the waste cask is breached, whether shielding is degraded or lost, whether HVAC/confinement is available to filter the release, and whether there is moderator intrusion in a breached TAD to potentially cause criticality. (Note that HVAC/confinement was not credited for the seismic event sequence analysis, as previously discussed.) For those processing activities that take place while the TAD is in the pool, the question of moderator intrusion becomes one of pool failure and loss of boration. Attachment D4 provides all of the SRETs.

One SSC is expected to be used only on an infrequent basis, and is therefore not included in the WHF TAD IET. The decontamination pit is designed to be used to decontaminate TAD STCs if the regular washdown is not adequate. However, this additional operation is not expected to be required for the majority of TADs processed in the WHF. The decontamination pit, and the seismic supports and restraints are therefore not included in the WHF TAD IET, but are included in terms of their Nuclear Safety Design Basis in Section 6.10.

6.7.4.2 WHF TAD Fault Trees

Fault trees were used to identify the potential failures for each of the pivotal events above (see Section 4.3.3.2 for the approach). These fault trees are provided in Attachment D4.2. Table D4.1-1 identifies the fault trees that are assigned to each pivotal event on the IET, while Table D4.1-2 identifies the fault trees that are assigned to each pivotal event on the SRETs.

6.7.4.3 Exposure Times and Passive Equipment Failure Analysis

To determine the amount of time the waste container is exposed to a specific hazard, the expected times of each waste handling process in each facility were evaluated. The approach was discussed in Section 4.3.3.4, and is documented in detail in Attachment G. The result is the exposure time by SSC seismic failure mode per waste container processed.

Since the seismic hazard is represented in terms of frequency per year, the exposure time factor is given in terms of “years per single waste container.” Table 6.7-1 provides the exposure time factors for the processing of the TADs.

The conditional probability of breach of the waste container is also used in the fault trees. These PEFA values are discussed in Section 6.3.3, and given in Table 6.3-2.

6.7.4.4 Quantification of the WHF TAD Waste Handling Process

The quantification approach was the same as for DPCs discussed above.

The results of the quantification are the probabilities of the event sequences, and the detailed cut sets for each event sequence. These detailed results for the WHF TAD waste handling are given in Table D4.4-1 for the event sequences, and Table D4.4-2 for the cut sets. The dominant event sequences (greater than 1E-06 probability over the preclosure period) are listed in Table 6.7-5.

Table 6.7-5. WHF TAD Seismic Event Sequences

Event Sequence ID	Description	Mean Probability (over the preclosure period)	End State
WHF-S-IE-TAD-AO 04-05	Seismic tipover of TAD in pool transfer station spilling TAD assemblies in pool	5E-05	RR-UNFILTERED
WHF-S-IE-TAD-AO 09	Seismic failure of jib crane damaging TAD	2E-05	RR-UNFILTERED
WHF-S-IE-TAD-AO 08	Seismic failure of TAD closure or preparation station #2 damaging TAD	1E-05	RR-UNFILTERED
WHF-S-IE-TAD-AO 13-05	Seismic failure of canister transfer machine damaging TAD	9E-06	RR-UNFILTERED
WHF-S-IE-TAD-AO 03	Seismic failure of WHF structure damaging TAD	7E-06	RR-UNFILTERED
WHF-S-IE-TAD-AO 14-05	Seismic failure of site transporter breaching TAD	6E-06	RR-UNFILTERED
WHF-S-IE-TAD-AO 07-06	Seismic failure of cask handling crane damaging TAD	5E-06	RR-UNFILTERED
WHF-S-IE-TAD-AO 05-05	Seismic failure of auxiliary pool crane damaging TAD in pool	3E-06	RR-UNFILTERED
WHF-S-IE-TAD-AO 06-05	Seismic failure of spent fuel transfer machine damaging TAD in pool	2E-06	RR-UNFILTERED
WHF-S-IE-TAD-AO 10-05	Seismic failure of cask transfer trolley breaching TAD	2E-06	RR-UNFILTERED
WHF-S-IE-TAD-AO 15-05	Seismic failure of aging overpack access platform breaching TAD	1E-06	RR-UNFILTERED

NOTE: TAD = transportation, aging and disposal; WHF = Wet Handling Facility.

Source: Original

All of the event sequences are below the 10 CFR Part 63 (Ref. 2.3.1) compliance criteria for Category 2.

Seismic event sequence WHF-S-IE-TAD-AO 04-05 has the highest probability over the preclosure period. The sequence represents a scenario where the TAD is open and in an STC, which is held by the TAD transfer station at the bottom of the pool. Due to the seismic event, the STC tips over and spills the TAD assemblies on the pool floor. This event sequence has been evaluated for criticality concerns. It was determined that the boration in the pool was sufficient to preclude criticality for the spilled SNF assemblies (Ref. 2.2.70, Section 2.3.2.2.4). Since the release is in the pool, it is significantly reduced. Therefore, the end state is assigned to a gaseous unfiltered radionuclide release (no HVAC available).

Other sequences include failures of the jib cranes, and collapse of the preparation or TAD closure station breaching the TAD. These sequences have a probability of $2E-05$ or less over the preclosure period, and result in an unfiltered radionuclide release.

6.7.5 WHF Event Sequence Categorization

The expected number of occurrences of an event sequence over the preclosure period is compared to the screening criteria in 10 CFR 63.2 (Ref. 2.3.1) to determine its categorization. If the expected number of occurrences of the event sequence is greater than or equal to 1 over the preclosure period, it is a Category 1 event sequence; if the expected number of occurrences of the event sequence is greater than or equal to $1E-04$ but less than 1 over the preclosure period, it is a Category 2 event sequence; and, if the expected number of occurrences of the event sequence is less than $1E-04$ over the preclosure period, the event sequence is beyond Category 2 (Ref. 2.2.59) Section 6.8.2.

The WHF seismic event sequences in Table 6.7-2 for DPC processing, Table 6.7-3 for bare SNF processing, Table 6.7-4 for SNF transfer operations and continuous activities, and Table 6.7-5 for TAD processing are combined in Table 6.7-6. The sequences are then categorized as Category 1 (C1), Category 2 (C2), or beyond Category 2 (BC2) based on the criteria above. The material at risk for each scenario is also presented in the table, and the need for any consequence analysis is listed.

Table 6.7-6. WHF Seismic Event Sequence Categorization

Event Sequence ID	End State	Description	Material-At-Risk	Mean Probability	Event Sequence Categorization	Consequence Analysis ¹
WHF-S-IE-SNF-XFER 10	RR-UNFILTERED	Seismic failure of WHF HVAC system integrity releasing radioactive accumulation	Radioactive material in HVAC system	1E-03	C2	2-01
WHF-S-IE-BARE 13-5	RR-UNFILTERED	Seismic tipover of truck cask in pool transfer station spilling SNF in pool	1 truck cask with bare SNF in pool	2E-04	C2	2-06
WHF-S-IE-SNF-XFER 03-05	RR-UNFILTERED	Seismic tipover of SNF truck cask or DPC in transfer station spilling SNF in truck cask or DPC in pool	1 DPC or truck cask in pool	2E-04	C2	2-08
WHF-S-IE-SNF-XFER 05-05	RR-UNFILTERED	Seismic tipover of TAD in transfer station spilling SNF in TAD in pool	1 TAD in pool	2E-04	C2	2-10
WHF-S-IE-SNF-XFER 04-05	RR-UNFILTERED	Seismic failure of spent fuel transfer machine damaging SNF in pool	SNF assemblies in staging rack	7E-05	BC2	No consequence analysis necessary
WHF-S-IE-TAD-AO 04-05	RR-UNFILTERED	Seismic tipover of TAD in pool transfer station spilling TAD assemblies in pool	1 TAD in pool	5E-05	BC2	No consequence analysis necessary
WHF-S-IE-SNF-XFER 07	RR-UNFILTERED	Seismic collapse of WHF structure damaging SNF in pool	SNF assemblies in staging rack, plus other SNF in building	4E-05	BC2	No consequence analysis necessary
WHF-S-IE-SNF-XFER 08	RR-UNFILTERED	Seismic failure of WHF pool damaging SNF in pool	SNF assemblies in staging rack	4E-05	BC2	No consequence analysis necessary
WHF-S-IE-SNF-XFER 09	RR-UNFILTERED-ITC	Seismic collapse of WHF pool staging rack damaging SNF in pool	SNF assemblies in staging rack	4E-05	BC2	No consequence analysis necessary
WHF-S-IE-BARE 08-06	RR-UNFILTERED	Seismic failure of cask handling crane breaching truck cask with bare SNF	1 truck cask with bare SNF	2E-05	BC2	No consequence analysis necessary
WHF-S-IE-DPC 16-5	RR-UNFILTERED	Seismic tipover of DPC in pool transfer station spilling DPC assemblies in pool	1 DPC in pool	2E-05	BC2	No consequence analysis necessary
WHF-S-IE-TAD-AO 09	RR-UNFILTERED	Seismic failure of jib crane damaging TAD	1 TAD	2E-05	BC2	No consequence analysis necessary
WHF-S-IE-BARE 12-06	RR-UNFILTERED	Seismic failure of shield door breaching truck cask with bare SNF	1 truck cask with bare SNF	1E-05	BC2	No consequence analysis necessary
WHF-S-IE-BARE 14-05	RR-UNFILTERED	Seismic failure of auxiliary pool crane breaching truck cask with bare SNF	1 truck cask with bare SNF	1E-05	BC2	No consequence analysis necessary
WHF-S-IE-DPC 14-05	RR-UNFILTERED	Seismic failure of canister transfer machine damaging SNF in DPC	1 DPC	1E-05	BC2	No consequence analysis necessary
WHF-S-IE-TAD-AO 08	RR-UNFILTERED	Seismic failure of TAD closure or preparation station #2 damaging TAD	1 TAD	1E-05	BC2	No consequence analysis necessary
WHF-S-IE-BARE 07-06	RR-UNFILTERED	Seismic failure of entrance vestibule crane breaching truck cask with bare SNF	1 truck cask with bare SNF	9E-06	BC2	No consequence analysis necessary
WHF-S-IE-TAD-AO 13-05	RR-UNFILTERED	Seismic failure of canister transfer machine damaging TAD	1 TAD	9E-06	BC2	No consequence analysis necessary
WHF-S-IE-BARE 15-05	RR-UNFILTERED	Seismic failure of spent fuel transfer machine damaging SNF in truck cask in pool	1 truck cask with bare SNF in pool	8E-06	BC2	No consequence analysis necessary
WHF-S-IE-DPC 17-05	RR-UNFILTERED	Seismic failure of auxiliary pool crane damaging SNF in DPC	1 DPC	7E-06	BC2	No consequence analysis necessary
WHF-S-IE-TAD-AO 03	RR-UNFILTERED	Seismic failure of WHF structure damaging TAD	1 TAD	7E-06	BC2	No consequence analysis necessary
WHF-S-IE-TAD-AO 14-05	RR-UNFILTERED	Seismic failure of site transporter breaching TAD	1 TAD	6E-06	BC2	No consequence analysis necessary

Table 6.7-6. WHF Seismic Event Sequence Categorization (Continued)

Event Sequence ID	End State	Description	Material-At-Risk	Mean Probability	Event Sequence Categorization	Consequence Analysis ¹
WHF-S-IE-BARE 03	RR-UNFILTERED	Seismic failure of WHF structure damaging SNF in truck cask in pool	1 truck cask with bare SNF in pool	6E-06	BC2	No consequence analysis necessary
WHF-S-IE-DPC 08-06	RR-UNFILTERED	Seismic failure of cask handling crane damaging SNF in DPC	1 DPC	5E-06	BC2	No consequence analysis necessary
WHF-S-IE-TAD-AO 07-06	RR-UNFILTERED	Seismic failure of cask handling crane damaging TAD	1 TAD	5E-06	BC2	No consequence analysis necessary
WHF-S-IE-BARE 10-06	RR-UNFILTERED	Seismic failure of preparation station #1 breaching SNF truck cask	1 truck cask with bare SNF	4E-06	BC2	No consequence analysis necessary
WHF-S-IE-DPC 03	RR-UNFILTERED	Seismic failure of WHF structure damaging SNF in DPC	1 DPC	3E-06	BC2	No consequence analysis necessary
WHF-S-IE-DPC 15	RR-UNFILTERED	Seismic failure of cutting station platform damaging SNF in DPC	1 DPC	4E-06	BC2	No consequence analysis necessary
WHF-S-IE-BARE 11-06	RR-UNFILTERED	Seismic failure of jib crane breaching SNF truck cask	1 truck cask with bare SNF	3E-06	BC2	No consequence analysis necessary
WHF-S-IE-DPC 13-06	RR-UNFILTERED	Seismic failure of shield door damaging SNF in DPC	1 DPC	3E-06	BC2	No consequence analysis necessary
WHF-S-IE-TAD-AO 05-05	RR-UNFILTERED	Seismic failure of auxiliary pool crane damaging TAD in pool	1 TAD in pool	3E-06	BC2	No consequence analysis necessary
WHF-S-IE-BARE 09-06	RR-UNFILTERED	Seismic failure of cask transfer trolley breaching SNF truck cask	1 truck cask with bare SNF	4E-06	BC2	No consequence analysis necessary
WHF-S-IE-BARE 13-6	RR-UNFILTERED	Seismic tipover of truck cask with bare assemblies in pool transfer station spilling assemblies in pool	1 truck cask with bare SNF in pool	2E-06	BC2	No consequence analysis necessary
WHF-S-IE-DPC 12	RR-UNFILTERED	Seismic failure of jib crane damaging SNF in DPC	1 DPC	2E-06	BC2	No consequence analysis necessary
WHF-S-IE-TAD-AO 06-05	RR-UNFILTERED	Seismic failure of spent fuel transfer machine damaging TAD in pool	1 TAD in pool	2E-06	BC2	No consequence analysis necessary
WHF-S-IE-DPC 11-06	RR-UNFILTERED	Seismic failure of preparation station #1 damaging SNF in DPC	1 DPC	1E-06	BC2	No consequence analysis necessary
WHF-S-IE-TAD-AO 10-05	RR-UNFILTERED	Seismic failure of cask transfer trolley breaching TAD	1 TAD	2E-06	BC2	No consequence analysis necessary
WHF-S-IE-TAD-AO 15-05	RR-UNFILTERED	Seismic failure of aging overpack access platform breaching TAD	1 TAD	1E-06	BC2	No consequence analysis necessary

NOTE 1. The bounding event number provided in this column identifies the bounding Category 2 event sequence identified in the *Preclosure Consequence Analyses* (Ref. 2.2.69, Table 2) that results in dose consequences that bound the event sequence under consideration.
DPC = dual-purpose canister; HVAC = heating, ventilation and air conditioning; SNF = spent nuclear fuel; TAD = transportation, aging and disposal; WHF = Wet Handling Facility.

Source: Original

As demonstrated by the table, most of the WHF seismic event sequences are beyond Category 2. There are four Category 2 sequences. The first Category 2 sequence is the failure of the HVAC system ducting and filter integrity, causing a breach of the system and potential release of accumulated radioactive materials in the system. The second is the tipover of a truck cask with bare SNF in the WHF pool, spilling the SNF assemblies onto the pool floor. The third Category 2 sequence is the tipover of SNF truck cask or DPC residing in transfer station spilling SNF in pool. The fourth involves the tipover of TAD in transfer station spilling SNF in pool.

All of these sequences have been analyzed for consequences (Ref. 2.2.69), and the offsite dose easily complies with 10 CFR Part 63 (Ref. 2.3.1) criteria.

6.8 SEISMIC EVENT SEQUENCE ANALYSIS FOR INTRA-SITE OPERATIONS

This section provides a description of the seismic event sequences and quantification process for the Intra-Site operations, including:

- Development of the seismic event tree
- Development of the seismic fault trees
- Summary of the input data
- Results for the event sequence quantification
- Categorization of seismic event sequences.

Detailed information for the Intra-Site quantification is provided in Attachment E, and referenced as appropriate below.

The Intra-Site seismic event sequence quantification covers the following processes:

- Movement of aging overpacks (with TAD or DPC) on site transporter to and from Aging Facility
- Storage of aging overpacks at Aging Facility
- Movement of horizontal transportation casks (with DPC) on horizontal cask transport trailer to and from Aging Facility
- Storage of DPCs in HAM at Aging Facility
- Storage of LLW at LLW Facility
- Temporary storage of transportation casks on railcars and trucks in buffer yard (before processing)
- Movement of incoming railcars and truck trailers with transportation casks to the processing facilities.

6.8.1 Transportation of Aging Overpacks to and from the Aging Facility

TADs or DPCs are placed into aging overpacks, and transported to and from the Aging Facility using the site transporter.

6.8.1.1 Intra-Site Operations Event Tree

Using the approach described in Section 4.3.3.1, the IET was developed to delineate the potential seismic event sequences that could occur during Intra-Site Operations waste handling activities. Figure 6.8-1 provides the IET for Intra-Site Operations waste handling activities. The pivotal events are described below:

- **SEIS-EVENT:** This initial heading is the initiating seismic event, representing the seismic hazard curve discussed in Section 6.1.
- **ISO-IE:** While this pivotal event is the number of waste containers over the preclosure period (or similar preclosure measure) for other IETs, for the Intra-Site Operations this event is a dummy event. The Intra-Site Operations sequences have a variety of “measures” used to represent the number of activities for that event sequence. For example, the measure for LLW building collapse is 50 years, while the measure for aging overpack tipover is the average number of aging overpacks on the aging pad. These measures are incorporated into the fault trees of the event sequences, and are discussed in Section 6.8.1.3 below. (Note: the “up” branch is not used.)
- **SEIS-FAIL:** These branches indicate the potential SSCs that can fail and potentially damage the waste container. Note that the event tree branch captions are associated with the branch line below the caption. These failures and their seismic fragilities are listed in Table 6.2-1 (structures) and Table 6.2-2 (equipment). They are described in Section 6.2.

The seismic failure of the aging overpack (sequence 6 on the IET) includes the potential for the aging overpack to tip over due to the seismic event ground motion, to slide into other aging overpacks, or for the aging pad itself to bend or shear, and cause the aging overpack to tip over.

Seismic Event	Time waste forms potentially at risk	Identify initiating seismic failure			
SEIS-EVENT	ISO-IE	SEIS-FAIL	#	END-STATE	
			1	OK	
			2	OK	
			LLW building collapse	3	RR-UNF
			Site transporter en route	4	RR-UNF
			Horizontal trailer failure	5	RR-UNF
			AO failure	6	RR-UNF
			HAM structure failure	7	RR-UNF
			Railcar and truck yard failures	8	RR-UNF
			Moving railcar and trailer failure	9	RR-UNF

ISO-IE-S-MAIN - ISO Seismic Event Tree - Initiating Seismic Failures - Intrasite 2008/02/24 Page 1

NOTE: Event tree branch captions are associated with the branch line below the caption.
 AO = aging overpack; HAM = horizontal aging module; IE = initiating event; ISO = Intra-Site Operations; LLW = low-level radioactive waste; RR = radioactive release; SEIS = seismic; UNF = unfiltered.

Source: Original

Figure 6.8-1. Intra-Site Operations Initiator Event Tree

The end state for all of the sequences on the Intra-Site Operations IET is unfiltered radionuclide release. SRETs are not needed.

6.8.1.2 Intra-Site Operations Fault Trees

Fault trees were used to identify the potential failures for each of the pivotal events above (see Section 4.3.3.2 for the approach). These fault trees are provided in Attachment E1.2. Table E1.1-1 identifies the fault trees that are assigned to each pivotal event on the IET.

6.8.1.3 Exposure Factors and Passive Equipment Failure Analysis

For the Intra-Site Operations, several different measures were used to express the amount of time or number of activities when the waste container is exposed to a specific hazard. Table 6.8-1 provides the exposure factors for the Intra-Site Operations activities.

Table 6.8-1. Exposure Factors for ISO Waste Handling Activities

SSC	Seismic Failure Mode	Exposure Factor	Number Waste containers
LLW building	Collapse onto waste container	50 yr	N/A
Site transporter	Sliding or tipover	1.1E-04 (60 min)	17,000 loaded trips
Horizontal cask transfer trailer	Tipover	2.3E-04 yr (120 min)	692 loaded trips
Aging overpack	Tipover	50 yr	1920 AOs (average on aging pad)
	Sliding		
	Aging pad displacement		
HAM structure	Collapse	50 yr	N/A
Railcar and truck buffer area yard	Tipover	50 yr	30 railcars and trucks
Railcar and truck trailers with transportation casks	Tipover	6.2E-05 yr (33 min)	14,357 railcars and truck trailers

NOTE: HAM = horizontal aging module; LLW = low-level radioactive waste; SSC = system, structure or component.

Source: Original, Attachment E1.5

If an activity is performed over the 50-year active preclosure period, then it has an exposure time of 50 years, as shown above. For the structures, the LLW building and the HAMs, no other measure is needed since collapse affects all waste containers in the structure. For the aging overpacks and railcar/truck buffer areas, the number of containers at risk is needed, since they will all be impacted by the seismic event.

For the site transporter and horizontal cask transfer trailer, the number of loaded trips and the time of exposure for each trip provide the overall exposure for the preclosure period. The 60- and 120-minute exposure times above are based on 80% of the maximum speed of the site transporter and tractor to the farthest aging pad (43 min), then rounded up substantially for conservatism. For the horizontal cask transfer trailer, an additional 60 minutes was included to represent the time needed to transfer the canister into the HAM. More detail is provided in Attachment E.

For the railcars and truck trailers that are delivering transportation casks to the waste handling facilities, the total number of deliveries was developed in Table 6.3-1. In addition, the time that the conveyance is moving through the GROA has been calculated. The distance from the rail access interchange to the CRCF 2 was approximately 1.4 miles (scaled from *Geologic Repository Operations Area North Portal Site Plan* (Ref. 2.2.63)). While the conveyances may travel at speeds of 9 mph, the lower speed of 2.5 mph was used, resulting in 0.545 hr (33 min, or 6.2E-05 yr).

The conditional probability of breach of the waste container is also used in the fault trees. These PEFA values are discussed in Section 6.3.3, and given in Table 6.3-2.

6.8.1.4 Quantification of the Intra-Site Operations Waste Handling Activities

The quantification approach, using the SAPHIRE software (Ref. 2.2.104), was discussed in detail in Section 4.5. Each of the following inputs is described in previous sections:

- Seismic hazard curve (Section 6.1)
- Seismic fragilities for SSCs (Section 6.2)
- Throughput, exposure time factors, and PEFA (Section 6.3)
- Event tree (Section 6.8.1.1)
- Fault trees (Section 6.8.1.2).

Quantification of seismic event sequences must be performed in a different manner than for internal initiating events. The quantification must incorporate the dependency between the magnitude of seismic ground motion and the probability of seismic failure, the latter of which increases with the former as expressed with the SSC fragility curves. The algorithm also incorporates the decreasing frequency of a seismic event as the magnitude of seismic ground motion increases, expressed with the seismic hazard curve. This quantification process is often termed a convolution.

The results of the quantification are the probabilities of the event sequences, and the detailed cut sets for each event sequence. These detailed results for the Intra-Site Operations waste handling activities are given in Table E1.4-1 for the event sequences, and Table E1.4-2 for the cut sets. The dominant event sequences (greater than 1E-06 probability over the preclosure period) are listed in Table 6.8-2.

Table 6.8-2 ISO Waste Handling Activities Event Sequences

Event Sequence ID	Description	Mean Probability (over the preclosure period)	End State
ISO-IE-S-MAIN 03	Seismic collapse of LLW building breaching low level waste containers	8E-03	RR-UNFILTERED
ISO-IE-S-MAIN 07	Seismic collapse of horizontal aging modules breaching horizontal DPCs	4E-05	RR-UNFILTERED
ISO-IE-S-MAIN 08	Seismic tipover of railcars and trucks in buffer area breaching canisters in transportation casks	1E-05	RR-UNFILTERED
ISO-IE-S-MAIN 06	Seismic failure of AO on aging pad resulting in breaching of canister	1E-05	RR-UNFILTERED

NOTE: AO = aging overpack; DPC = dual-purpose canister; LLW = low-level radioactive waste.

Source: Original

Seismic event sequence ISO-S-IE-MAIN 03 has the highest probability over the preclosure period. The sequence represents a scenario where the LLW building collapses due to the earthquake, damaging the LLW stored at the facility. The end state is an unfiltered radionuclide release. Because of the small release and the large distances to the site boundary, offsite dose due to this Category 2 event sequence would be very low (Ref. 2.2.69), and easily meet the 10 CFR Part 63 (Ref. 2.3.1) dose criteria..

The next highest sequence, ISO-S-IE-MAIN 07, represents collapse of the HAMs, breaching any horizontal DPCs stored in the HAMs. The end state is an unfiltered radionuclide release. However this sequence is beyond Category 2.

The next sequence represents tipover of railcars or trucks with transportation casks, with subsequent breach of the waste container. The last sequence represents either tipover or sliding impact of the aging overpacks, including the potential for tipover caused by vertical displacement of the aging pad foundation, resulting in canister breach. These sequences have a probability of about 1E-05 over the preclosure period, and result in an unfiltered radionuclide release.

6.8.2 Intra-Site Operations Event Sequence Categorization

The expected number of occurrences of an event sequence over the preclosure period is compared to the screening criteria in 10 CFR 63.2 (Ref. 2.3.1) to determine its categorization. If the expected number of occurrences of the event sequence is greater than or equal to 1 over the preclosure period, it is a Category 1 event sequence; if the expected number of occurrences of the event sequence is greater than or equal to $1E-04$ but less than 1 over the preclosure period, it is a Category 2 event sequence; and, if the expected number of occurrences of the event sequence is less than $1E-04$ over the preclosure period, the event sequence is beyond Category 2 (Ref. 2.2.59) Section 6.8.2.

The Intra-Site Operations seismic event sequences in Table 6.8-2 are categorized as Category 1 (C1), Category 2 (C2), or beyond Category 2 (BC2) based on the criteria above. The material at risk for each scenario and the need for any consequence analysis is presented in Table 6.8-3.

One sequence, ISO-IE-S-MAIN 03, represents the collapse of the LLW building, breaching low level waste containers inside. This sequence is Category 2, but because of the small release and the large distances to the site boundary, offsite dose due to this Category 2 event sequence would be very low (Ref. 2.2.69), and easily meet the 10 CFR Part 63 (Ref. 2.3.1) dose criteria.

Table 6.8-3 ISO Seismic Event Sequence Categorization

Event Sequence ID	End State	Description	Material-At-Risk	Mean Probability	Event Sequence Categorization	Consequence Analysis ¹
ISO-IE-S-MAIN 03	RR-UNFILTERED	Seismic collapse of LLW building breaching low level waste containers	Multiple LLW containers	8E-03	C2	2-01
ISO-IE-S-MAIN 07	RR-UNFILTERED	Seismic collapse of Horizontal Aging Modules breaching horizontal DPCs	Multiple DPCs	4E-05	BC2	No consequence analysis necessary
ISO-IE-S-MAIN 08	RR-UNFILTERED	Seismic tipover of railcars and trucks in buffer area breaching canisters in transportation casks	1 transport cask (e.g., 1 TAD)	1E-05	BC2	No consequence analysis necessary
ISO-IE-S-MAIN 06	RR-UNFILTERED	Seismic failure of AO on aging pad resulting in breaching of canister	1 canister	1E-05	BC2	No consequence analysis necessary

NOTE: ¹ The bounding event number provided in this column identifies the bounding Category 2 event sequence identified in the Preclosure Consequence Analyses (Ref. 2.2.69, Table 2) that results in dose consequences that bound the event sequence under consideration.

AO = aging overpack; DPC = dual-purpose canister; LLW = low-level radioactive waste.

Source: Original

6.9 SEISMIC EVENT SEQUENCE ANALYSIS FOR SUBSURFACE OPERATIONS

This section provides a description of the seismic event sequences and quantification process for the Subsurface Operations, including:

- Development of the seismic event tree
- Development of the seismic fault trees
- Summary of the input data
- Results for the event sequence quantification
- Discussion of unique Subsurface Operations event sequences
- Categorization of seismic event sequences.

Detailed information for the Subsurface Operations quantification is provided in Attachment F, and referenced as appropriate below.

The Subsurface Operations seismic event sequence evaluation covers the following processes:

- Movement of the TEV with waste package from the CRCF or IHF to the subsurface emplacement drifts
- Storage of the waste packages in the emplacement drifts (preclosure phase)
 - Waste package stability during seismic events
 - Rockfall impacts (physical and thermal)
- Installation of drip shields over the waste packages in the emplacement drifts.

The first process, TEV transfer of waste packages from the facilities to the subsurface drifts, is quantified in Section 6.9.1. The other event sequences have been evaluated in detail by other calculations. The evaluation of Subsurface Operations includes quantitative screening of potential rockfall events and waste package impacts in the subsurface drifts (Section 6.9.2).

6.9.1 TEV Event Sequences

This section evaluates the seismic event sequences associated with TEV transfer of waste packages to the subsurface drifts.

6.9.1.1 Subsurface Operations Event Tree

Using the approach described in Section 4.3.3.1, the IET and SRETs were developed to delineate the potential seismic event sequences that could occur during Subsurface Operations. Figure 6.9-1 provides the IET for Subsurface Operations. The pivotal events are described below:

- SEIS-EVENT: This initial heading is the initiating seismic event, representing the seismic hazard curve discussed in Section 6.1.

- SSO-IE: In the same manner as for the intra-site operations, this event is a dummy event. The Subsurface Operations sequences have the “initiator” number included in the fault trees, as discussed for each sequence.
- SEIS-FAIL: These branches indicate the potential SSCs that can fail and potentially damage the waste package and canisters. Note that the event tree branch captions are associated with the branch line below the caption. These failures and their seismic fragilities are listed in Table 6.2-1 (structures) and Table 6.2-2 (equipment). They are described in Section 6.2.

Seismic Event	Time waste forms potentially at risk	Identify initiating seismic failure	WP containment remains intact	Shielding is maintained	#	END-STATE
SEIS-EVENT	SSO-IE	SEIS-FAIL	WP-CONTAIN	SHIELDING		
<p>The diagram is a tree structure starting from a single point on the left. It branches into 10 paths, each ending in a horizontal line. The paths are labeled with failure events: 1 (no label), 2 (no label), 3 (no label), 4 (TEV failures), 5 (no label), 6 (Rockfall), 7 (Drip shield failure), 8 (Emplacement access door), 9 (WP stability in drifts), and 10 (Ventilation system failure). The end states are listed in the right column of the table.</p>					1	OK
					2	OK
					3	OK
					4	DE-SHIELD-LOSS
					5	RR-UNF
					6	RR-UNF
					7	RR-UNF
					8	RR-UNF
					9	RR-UNF
					10	LONG-TERM
SSO-IE-S-MAIN - SSO Seismic Event Tree - Initiating Seismic Failures - Subsurface					2008/02/25	Page 1

NOTE: Event tree branch captions are associated with the branch line below the caption.

DE = direct exposure; IE = initiating event; RR = radionuclide release; SEIS = seismic; SSO = Subsurface Operations; TEV = transport and emplacement vehicle; UNF = unfiltered; WP = waste package.

Source: Original

Figure 6.9-1 SSO Initiator Event Tree

The end states for the sequences on the Subsurface Operations IET are either degraded shielding or radionuclide release. SRETs are not needed.

6.9.1.2 Subsurface Operations Fault Trees

Fault trees were used to identify the potential failures for two of the pivotal events above (see Section 4.3.3.2 for the approach). These fault trees are for the TEV seismic failures, and the emplacement access doors, and are provided in Attachment F1.2. Table F1.1-1 identifies the fault trees that are assigned to these pivotal events on the IET.

6.9.1.3 Exposure Times and Passive Equipment Failure Analysis

To determine the amount of time the waste container is exposed to a specific hazard, the expected times of the waste handling process in the Subsurface Operations were evaluated. The approach was discussed in Section 4.3.3.4, and is documented in detail in Attachment F. The result is the exposure time by SSC seismic failure mode per waste package processed.

Since the seismic hazard is represented in terms of frequency per year, the exposure time factor is given in terms of “years per waste package.” Table 6.9-1 provides the exposure time factors for the processing of the waste packages.

Table 6.9-1 Exposure Time Factors for Waste Handling Operations in the SSO

SSC	Seismic Failure Mode	Exposure Time (yr)	Number of WPs
TEV	Tipover, derailment, WP ejection	3.3E-04 (171 min)	12,068
Entry door	Collapse onto TEV	3.8E-06 (2 min)	12,068

NOTE: SSO = Subsurface Operations; TEV = transport and emplacement vehicle; WP = waste package.

Source: Attachment F3, Table 6.3-1

The conditional probability of breach of the waste container is also used in the fault trees. These PEFA values are discussed in Section 6.3.3, and given in Table 6.3-2.

6.9.1.4 Quantification of the SSO Waste Handling Process

The quantification approach, using the SAPHIRE software (Ref. 2.2.104), was discussed in detail in Section 4.5. Each of the following inputs is described in previous sections:

- Seismic hazard curve (Section 6.1)
- Seismic fragilities for SSCs (Section 6.2)
- Throughput, exposure time factors, and PEFA (Section 6.3)
- Event tree (Section 6.9.1.1)
- Fault trees (Section 6.9.1.2).

Quantification of seismic event sequences must be performed in a different manner than for internal initiating events. The quantification must incorporate the dependency between the magnitude of seismic ground motion and the probability of seismic failure, the latter of which increases with the former as expressed with the SSC fragility curves. The algorithm also incorporates the decreasing frequency of a seismic event as the magnitude of seismic ground motion increases, expressed with the seismic hazard curve. This quantification process is often termed a convolution.

The results of the quantification are the probabilities of the event sequences, and the detailed cut sets for each event sequence. These detailed results for the Subsurface Operations activities are given in Table F1.4-1 for the event sequences, and Table F1.4-2 for the cut sets. The dominant event sequence (greater than 1E-06 probability over the preclosure period) is listed in Table 6.9-2.

Table 6.9-2 SSO Seismic Event Sequences

Event Sequence ID	Description	Mean Probability (over the preclosure period)	End State
SSO-S-IE-MAIN 03	Seismic failure of TEV shielding while holding TAD en route to emplacement (no breach)	6E-04	DE-SHIELD-LOSS

NOTE: SSO = Subsurface Operations; TAD = transportation, aging and disposal; TEV = transport and emplacement vehicle.

Source: Original

Seismic event sequence SSO-S-IE-MAIN 03 represents a scenario where the waste package is inside the TEV, which is en route to the emplacement drifts. The earthquake causes the closure bolt on the shield door to fail, and the waste package slides out through the open shield door. On impact with the ground, the waste package and canister are not breached, but since they are outside the TEV shielding, the shielding has been lost. Therefore the sequence is not a radionuclide release, but a loss of shielding of the waste package.

Since the only event sequence that is greater than 1E-6 over the preclosure period is a loss of shielding sequence, there are no significant radionuclide release event sequences from Subsurface Operations.

6.9.2 Screening of Subsurface Operations Event Sequences

This section provides an evaluation of the following Subsurface Operations activities:

- Rockfall impacts on the waste package
- Rockfall impacts on ventilation and thermal impacts on the waste package
- Impacts of seismic-induced movement of the waste package in the drifts
- Impacts of the drip shield and drip shield gantry on the waste package.

Not all seismically-induced event sequences are evaluated in terms of their expected number of occurrences over the preclosure period. There are situations where, consistent with the risk-informed intention of 10 CFR Part 63 (Ref. 2.3.1), a qualitative or semi-quantitative evaluation is used to categorize an event sequence. This approach is used for evaluating the event sequences associated with a seismically-induced rock fall onto waste packages in the emplacement drifts, including both physical impacts and thermal impacts. Evaluations show that a wide range of rock sizes could be produced as a result of a seismic event, depending on several parameters, including, for example, the severity of the earthquake, the nature of the rock (lithophysal or nonlithophysal), and the fracture geometry in a given emplacement drift. This multitude of parameters makes the use of the stress-strength interference integral rather complex to evaluate the probability that one or more waste packages would breach as a result of a rock fall impact.

Since detailed studies, both deterministic and probabilistic in nature, have been performed on rockfall impacts, there exists sufficient information to evaluate and screen the rockfall event sequences as beyond Category 2.

Detailed analyses also have examined seismic-induced movement of the waste package in the drifts, including both waste package-to-waste package impacts, and waste package-to-pallet impacts. The following sections describe the existing information, and provide the risk-informed justification for categorizing these Subsurface Operations sequences as beyond Category 2.

6.9.2.1 Screening Evaluation of Rockfall Impacts in Emplacement Drifts

For rockfall impacts, the basis of the compliance demonstration is focused on defining a bounding rockfall event together with the design strength of the waste package and the residence time that the waste package is present such that the entire event sequence will have a mean probability of less than $1E-06/\text{yr}$, or less than 1 chance in 10,000 over the preclosure period of 100 years.

The ground support systems, such as the rock bolts and stainless steel sheeting, in emplacement and access drifts are designed to protect against rockfall during the service life and against the effects of design basis earthquakes for both vibratory ground motion and fault displacements. These designs reduce the occurrence of events such as massive rockfall due to an earthquake or collapse of ground support systems that could impact one or more waste packages. In addition, the design basis of the waste package includes the consideration of rockfall, including for the postclosure phase when the ground support systems may have deteriorated. Therefore, the likelihood of having a radionuclide release event initiated by rockfall during the preclosure phase is expected (qualitatively) to be very small.

However, for compliance to 10 CFR Part 63 (Ref. 2.3.1), it is necessary to demonstrate that the frequency of such an event sequence as initiated by a rockfall is below the 1 chance in 10,000 threshold for Category 2 event sequences (e.g., that the sequence is beyond Category 2), and can be screened from further consideration.

6.9.2.1.1 Determination of Bounding Rockfall Loadings

In the preclosure period, rock fall can occur:

- Upon entry into the subsurface at the North Portal
- During transit in the subsurface prior to emplacement
- Within the emplacement drifts.

The various possible rockfall scenarios are examined in Attachment F, Section F3.1.1, to determine the bounding rockfall induced by credible seismic events for evaluating impact loads upon the waste package over the preclosure period. It was determined that the bounding rockfall would be within the emplacement drifts.

As noted in *Probabilistic Characterization of Preclosure Rockfalls in Emplacement Drifts* (Ref. 2.2.45, Section 6.1.1), and explained further in *Drift Degradation Analysis* (Ref. 2.2.12, p. vii and Section 6.1.2), the repository horizon essentially consists of two main types of rock: nonlithophysal tuff rock units and lithophysal tuff rock units. The nonlithophysal rock units comprise roughly 15% of the emplacement area, and are hard, strong, jointed rock. In contrast, the lithophysal rock units comprise approximately 85% of the emplacement area, and are relatively a more deformable material with lower compressive strength. These units also contain various small cavities (lithophysae), connected by intense fracturing (Ref. 2.2.12, Sections 6.1.2 and 6.4.1.1).

This difference in rock fabric results in differing impact loadings from the various rock types. The fracture surfaces in the stronger nonlithophysal rock units control rock movement, and the failure mode consists of distinct rock blocks (ranging from large to small) which can impact the waste package. In contrast, the intense small-scale fracturing in the lithophysal rock combined with the presence of lithophysae in a relatively weaker material, results in a relatively smaller block size from a rockfall (essentially a rubble) (Ref. 2.2.12, Section 6.4.1.1), which in turn significantly reduces the impact loads to the waste package.

Analysis of seismic response and rockfall in emplacement drifts were conducted with representative geometries for both types of rock units, employing computer models that could simulate the discontinuous fabric of the rock mass (Ref. 2.2.45, Sections 6.3.1 and 6.4.2). In the nonlithophysal rock units, the impact loading by falling rocks was higher than for the lithophysal rock. Again, numerical simulations indicated the resulting impacts increased with increasing magnitude of the seismic event (and decreasing annual probability of the event). For the ground motions associated with a seismic event of $1E-06$ APE, the mean rockfall on the drip shield was a rock block of 0.43 metric tons with a standard deviation of 1.3. Further, a statistical and probabilistic evaluation of these data was conducted to evaluate the bounding rockfall on the waste package (Ref. 2.2.45). In these analyses, uncertainty in key parameters was considered by accounting for their variability, and by introducing conservatisms as needed in the calculation. It was found that the most severe credible rockfall would have a mean kinetic energy on the order of $1.1E05$ J to $5.6E05$ J, depending on the severity of the specific event (Ref. 2.2.45, Section 7). Representing a kinetic energy of $1E06$ J, a rockfall with a mass of 20 metric tons and a velocity at impact on a waste package of 10 m/s was selected as an acceptable realization of an extreme bounding rockfall. This kinetic energy was found to be about the 98 to 99th percentile of the

bounding credible rockfall kinetic energy distributions resulting from ground motions associated with a seismic event of 1E-06 APE (Ref. 2.2.45, Section 6.4.5).

Recent changes in the seismic hazard increase the conservatism in these conclusions. The rockfall simulations described were conducted using these ground motions based on the site seismic hazard as defined in 2004 (Ref. 2.2.11). These older ground motions are based on the probabilistic seismic hazard assessment, with extrapolations to very low probabilities without consideration of upper constraints on physical ground motion processes, and therefore these ground motions are termed “unconstrained.” Upon re-evaluation, the extrapolations of ground motions were deemed not representative or credible for the site, and constrained ground motions were established based on geologic evidence of past seismic events, including rock testing data, geologic data, and ground-motion site response data (Ref. 2.2.14). This re-evaluation has significantly reduced the peak ground motions at the emplacement level for a specific level of annual probability, especially at very low probabilities (e.g., at 1E-05 APE and below), thereby significantly reducing the related expected rockfall effects at a specific annual probability from those presented in the simulations.

Summary - Bounding Rockfall: From the discussions provided above, the bounding rockfall impact that the waste package must withstand without breach is identified as that occurring in an emplacement drift within a nonlithophysal rock unit. The bounding value of 1E06 J is identified as a conservative bound, representing approximately the 98 to 99th percentile of the bounding credible rockfall kinetic energy distribution resulting from ground motions associated with a seismic event of 1E-06 APE. This energy value is equivalent to a rockfall of 20 metric tons and a velocity at impact of 10 m/s.

6.9.2.1.2 Probability of Waste Package Failure Due to a Rockfall

This section describes the analyses that have demonstrated that the waste package design can sustain impact loads of 1E06 J, and, therefore, that the probability of radionuclide release is beyond Category 2.

Finite element analyses of the structural response of 5 DHLW/DOE Co-Disposal Short and the TAD waste package configurations were conducted over a range of rock fall impacts (Ref. 2.2.52) Rock impact energies ranging up to 8.6E06 J were analyzed for both waste package configurations for impacts at the waste package lower end (directly above the lower sleeve in the region of the support ring); and at mid-length of the waste package. The expended toughness fraction is used as the measure of the damage to the waste package, and is defined as the ratio of the Demand Toughness Index to the Available Toughness Index. Expended toughness fraction values less than 1.0 do not indicate failure, while expended toughness fraction values equal to or above 1.0 indicate failure.

The results indicated that the maximum element wall-averaged effective stresses (von Mises stress) generated by a rock impact event do not exceed the total toughness allowed by the worst case triaxiality adjusted mean strength toughness of Alloy 22, when impacted by a rock of mean compressive strength for the range of impacts considered. Specifically, for a rock impact of 1E06 J (as represented by a 20 metric ton rock impacting with a velocity of 10 m/s), the measure of waste package strength, the expended toughness fraction, was equal or less than 0.1107 for

both waste package configurations at either impact location (Ref. 2.2.52, Tables 4 and 5). This indicates a very substantial margin to failure, which would be represented by an expended toughness fraction value of 1.0.

The probability of failure for this expended toughness fraction can be estimated using a Gaussian distribution (Attachment F3.1.2). Because the expended toughness fraction for the rockfall impact is so low compared with the failure expended toughness fraction of 1, the probability of waste package breach is less than 1E-08, or considerably beyond Category 2.

Conclusion - Rockfall Impact on Waste Package: This probabilistic analysis determined, for the range of credible seismic events that could occur over the preclosure period, the bounding characteristics of the credible rocks that could impact a waste package. A conservative analysis established that the bounding kinetic energy at impact on a waste package (e.g., for the rocks that would impact a waste package over the preclosure period, the kinetic energy that has a probability less than 1/10,000 of being exceeded) is one million joule, realized by a rock of 20 metric tons impacting a waste package at 10 m/s. A subsequent analysis established that a waste package subjected to such an impact would have a probability less than 1E-08 of losing its containment function. These two pieces of information were then combined to conclude, without actually calculating the stress-strength interference integral, that the seismically-induced event sequences leading to a breach of a waste package from impacts by rockfalls over the preclosure period can be categorized as beyond Category 2.

6.9.2.2 Screening Evaluation of Loss of Ventilation in an Emplacement Drift

In addition to rockfall physical impacts to a waste package, seismically-induced rockfall can also accumulate around a waste package, potentially restricting air flow in the emplacement drift. In severe scenarios, the combined loss of air flow and the blanketing insulation could cause the temperature of the waste packages to increase, perhaps leading to a breach of the waste package due to rockfall imposed stresses, overpressurization, or creep.

The following sections will examine the following aspects of this event sequence and demonstrate that it is beyond Category 2:

- 6.9.2.2.1 Definition of Scenarios and Seismic Events
- 6.9.2.2.2 Rockfall Burial
- 6.9.2.2.3 Thermal Response and Thermal Limit
- 6.9.2.2.4 Conclusion for Loss of Ventilation in Emplacement Drift.

6.9.2.2.1 Definition of Scenarios and Seismic Events

The preclosure period for waste packages in the emplacement drifts is nominally 100 years. The actual receipt and emplacement operations are estimated to take about 25 years. The hottest waste packages have a thermal loading of 18 kW when placed in the drifts, but these packages will cool to less than 14 kW in 10 years, and 7 kW in 55 years (Ref. 2.2.61, Figure 5). Therefore, there is a period of about 35 years when a waste package could have a thermal loading greater than 14 kW, and a period of 80 years when a waste package could have a thermal loading greater than 7 kW. (Note that 14 kW and 7 kW are used since these levels of thermal loading can withstand higher burial levels without waste package failure or breach.)

Therefore, three scenarios and time periods are defined for evaluation:

- 18 kW: The first 50 years of the 100 year preclosure period, when 18 kW waste packages may be in the drifts
- 14 kW: The next 30 years of the preclosure period, when all waste packages will be 14 kW or less
- 7 kW: The final 20 years of the preclosure period, when all waste packages will be 7 kW or less.

For the first 50 years, the seismic event to be considered is the 2E-06 APE seismic event in order to result in an event with a probability of 1 in 10,000 (e.g., $50 \text{ yr} \times 2\text{E-}06 \text{ /yr} = 1\text{E-}04 = 1/10,000$), such that the 10 CFR Part 63 criterion for beyond Category 2 would be met. Figure 6.9-3 provides the seismic hazard curve for the repository block, in this case using peak ground velocity (PGV) as the ground motion parameter. From this figure, the 2E-06 APE seismic event would have a horizontal PGV of 1.35 m/s.

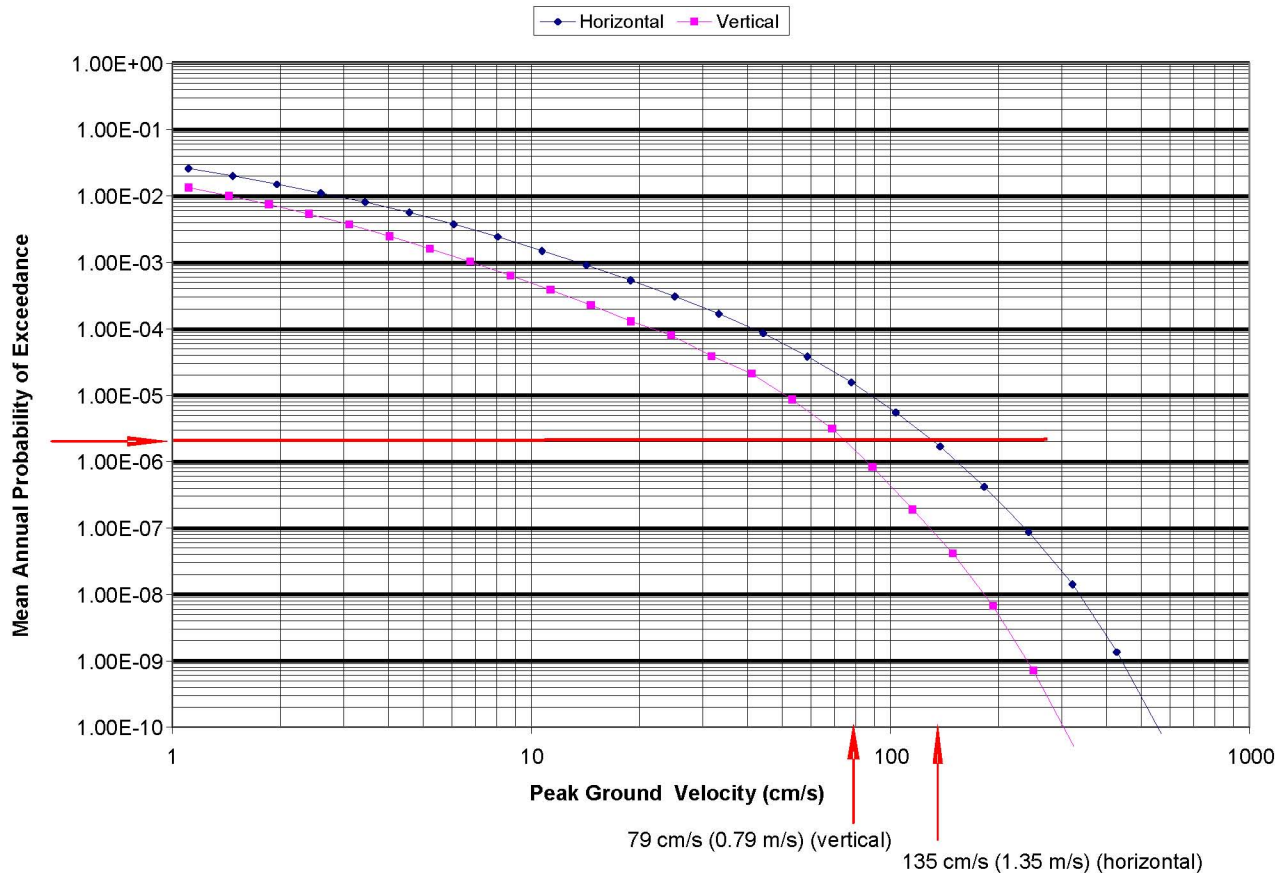

Source: Modified from Ref. 2.2.61

Figure 6.9-2. Seismic Hazard Curve – Repository Block

For the second scenario, the next 30 years, the 1.25E-06 APE seismic event is used, to cover the 80 years since repository emplacement began (e.g., $80 \times 1.25E-6 = 1E-04 = 1/10,000$). From Figure 6.9-2, the horizontal PGV for the 1.25E-06 APE is about 1.55 m/s. The third scenario, the last 20 years, considers the 1E-06 APE seismic event.

6.9.2.2.2 Rockfall Burial

This section provides a description of the potential rockfall analyses and burial percentage. The burial percentage is a linear measure of the percent of the vertical diameter of the waste package that is covered by the fallen rubble, with a flat rubble horizon. Burial of 50% would mean that the rubble level is mid-way up the waste package, while 100% just covers the waste package.

As mentioned in the rockfall impact analysis, the difference in rock fabric between nonlithophysal and lithophysal rock units results in differing rockfall configurations. Of most concern to a loss of ventilation is a rockfall in the weaker lithophysal rock; rockfall in this unit has a relatively smaller block size which can potentially fill the excavation opening and blanket the waste package, reducing ventilation flow around the waste package. Even for large ground motions, burial in nonlithophysal rock units would not be significant (Ref. 2.2.61, Section 6.1.2).

Note that the following analyses did not include the effect of the ground support in the emplacement drifts (i.e., rock bolts and stainless steel sheeting). Ground support will significantly retard rockfall due to a seismic event and in most cases, prevent small rockfalls from detaching from the rock wall or crown. Also note that forced ventilation from the drift ventilation system was not credited for these analyses.

2E-06 APE Seismic Event Rockfall: *Evaluation of an Event Sequence for Waste Package Burial* (Ref. 2.2.61), specifically evaluates large peak ground velocities and the resultant rockfall. This analysis demonstrates that for representative horizontal peak ground velocities of 1.5 m/s, rockfall should be less than 5 m³/m of tunnel and occur primarily in weaker rock units (Category 1, which only accounts for 5% of the drift lithophysal rock) (Ref. 2.2.61, Section 6.1.1). Since the 2E-06 APE peak ground velocity is only 1.35 m/s, the 5 m³/m rockfall would bound the expected rockfall. This 5m³/m rockfall is then expanded by 25% to 6.25m³/m to account for the bulking of the rubble. Rockfall of this amount will only partially bury the waste package, at about 80%, (Ref. 2.2.61, Figure 3) and leave the top of the waste package exposed to convective heat transport. The 80% coverage presumes a level horizon of rockfall in a perfectly round tunnel. Figure 6.9-3 provides a representation of the 80% coverage case, as used in the thermal analyses.

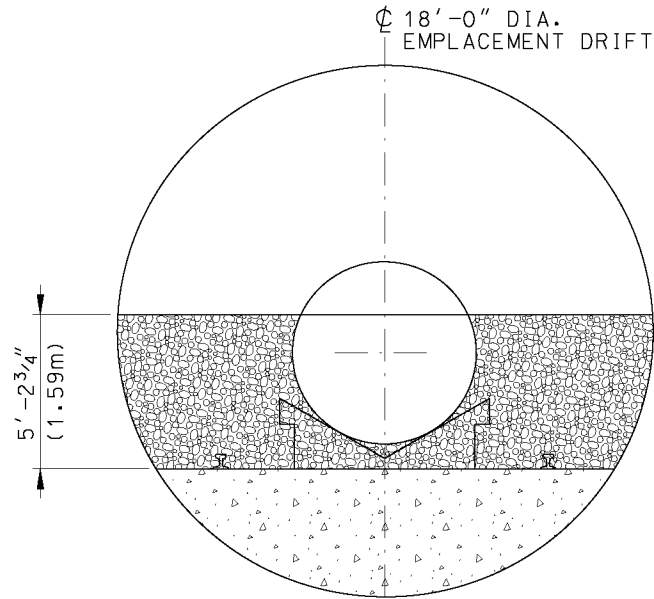

Source: Ref. 2.2.61 Figure 3

Figure 6.9-3. Representation of Level 80% Burial for 2E-06 APE Rockfall (6.25 m³/m)

However, when the failure pattern generated by the loose rock is considered, the expected final configuration is more elliptical in shape, exposing more of the waste package. Figure 6.9-4 provides a more likely failure pattern for the rockfall. Although the exact geometry of the rockfall cannot be predicted, the level representation used for the thermal analysis is considered conservative.

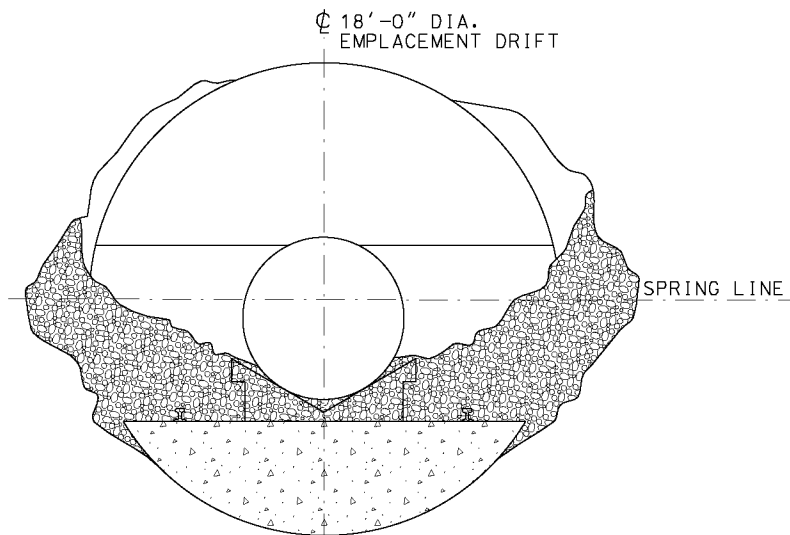

Source: Ref. 2.2.61 Figure 4

Figure 6.9-4. Possible Profile for 2E-06 APE Rockfall (6.25 m³/m)

1.25E-06 APE Seismic Event Rockfall: For the 1.25E-06 APE earthquake (over the first 80 years of preclosure), the peak ground velocities (1.55 m/s) are only 3% higher than the 1.5 m/s velocity that results in a bounding rockfall of 5 m³/m, as discussed above. A 125% rockfall height would represent a bulked rubble volume of approximately 11 m³/m, which equates to an in situ rockfall of 8.8 m³/m when the 25% bulking is removed ($11/1.25 = 8.8$). The 8.8 m³/m rockfall is approximately 75% higher than the 5 m³/m rockfall level that could occur at 1.5 m/s PGV. It is not reasonable to expect that a 3% increase in PGV would result in a 75% increase in rockfall volume. Therefore, the rockfall burial level over the first 80 years of the preclosure period would be expected to be less than 125% burial. Conservatively, the 125% burial level was selected to represent the maximum burial level during the 30 year period between 50 to 80 years.

1E-06 Seismic Event Rockfall: Rather than determine bounding rockfalls for the last 20 years of the 100 year preclosure period, the rockfall was conservatively selected to fill the entire drift (MAX rockfall).

6.9.2.2.3 Thermal Analyses of the Waste Package

With restricted airflow and with the increased insulation of the rockfall around the waste package, the waste package temperature will increase with time. The waste package containment will potentially be challenged by the imposed stresses from the rockfall together with the time-dependent movement (creep) of the waste package materials. Containment may also be challenged by the increased internal pressurization of the canister induced by the higher temperatures. Both of these conditions were examined to identify a critical temperature at which loss of containment of the waste package (breach) could occur. Based on these evaluations, waste package survivability was defined as the peak outer corrosion barrier (Alloy 22) temperatures not exceeding 541°C (Ref. 2.2.61, Section 6.2).

As to the potential range of possible waste package temperatures, parametric thermal analyses have been conducted to evaluate the range of temperatures that can be induced by waste package burial. These analyses examined five levels of burial of the waste package, a temperature dependent effective thermal conductivity of the rockfall material, and five levels of initial waste package heat loading for a TAD. Burial levels for the waste package included 40%, 80%, 100%, 125%, and MAX (which is rubble filling the entire area of the drift), and the heat loads included 6, 7, 8, 12, 14, 16 and 18 kW (Ref. 2.2.61, Section 6.2). The waste form itself would not be critical under these conditions (Attachment F3.2.3).

The thermal calculations for an emplaced waste package buried under rubble are summarized in Table 6.9-3 (Ref. 2.2.61, Table 4). Note that there are no MAX runs for the 100°C initial drift temperature, since the MAX burial scenario (complete drift collapse) is modeled with no convective heat transfer off of the waste package. Therefore, the drift air temperature is not relevant for the MAX scenarios, and the MAX scenarios are valid for both 50°C and 100°C drift air temperatures.

Table 6.9-3 Summary of Temperature Results for Waste Package Burial

Drift Temperature (°C)	WP Heat (kW)	Burial Depth (%)	Peak OCB Surface Temperature (°C)	Peak Fuel Temperature (°C)
50	18	MAX	955	1055
		125	595	675
		100	504	576
		80	428	492
		40	338	400
	16	MAX	869	956
		125	544	618
		100	462	527
	14	MAX	785	860
		125	493	560
		100	418	477
	12	125	442	501
	8	MAX	544	585
	7	MAX	507	542
	6	MAX	471	500
	100	18	125	611
100			523	594
80			451	515
40			366	429
16		125	560	633
		100	481	545
14		125	509	575
12		125	458	516

NOTE: OCB = outer corrosion barrier.

Source: Ref. 2.2.61, Table 4

18 KW Waste Package Scenario: From Table 6.9-3 above, for a heat loading of 18 kW, the peak temperature value at the outer corrosion barrier (OCB) is computed as 428°C and 451°C for the 80% burial case, and initial drift temperatures of 50°C and 100°C (respectively). As both these temperature values are well below the critical limit temperature, it is concluded that a waste package with nominal heat load of 18 kW can sustain without breach a rockfall resulting in a partial burial of the waste package (80%) which could be induced by a bounding seismic event of 2E-06 APE. Note that even at 100% burial, the peak 18 kW waste package temperature is 523°C, which is below the acceptable temperature limit of 541°C.

14 KW Waste Package Scenario: From Table 6.9-3 above, for a heat loading of 14 kW, the peak temperature value at the OCB is computed as 493°C and 509°C for the 125% burial case, and initial drift temperatures of 50°C and 100°C (respectively). As both these temperature values are below the critical limit temperature, it is concluded that a waste package with nominal heat load of 14 kW can sustain without breach a 1.25E-06 APE rockfall resulting in a 125% burial of the waste package.

7 KW Waste Package Scenario: From Table 6.9-3 above, for a heat loading of 7 kW, the peak temperature value at the OCB is computed as 507°C for the MAX burial case. As this temperature value is below the critical limit temperature, it is concluded that a waste package with nominal heat load of 7 kW can sustain without breach a complete drift collapse without failure due to overheating effects.

The analyses do not consider any post-rockfall actions to increase cooling of the repository excavations. Waste packages will take a period of months after a rockfall to reach peak temperatures or exceed the critical limit temperature, depending on the extent of burial and the initial thermal load of the waste package (Ref. 2.2.61, Attachment II, Table 7). Thus there is significant time for measures to be taken to establish cooling in the drifts. Conservatively, credit for such actions was not taken for this analysis.

It is also noted that the thermal output of the 18 kW package would decrease to approximately 14 kW over a period of 10 years, and to approximately 7 kW in 55 years (Ref. 2.2.61, Figure 5) so that the severity of the hazard decreases over the preclosure period.

6.9.2.2.4 Conclusion for Loss of Ventilation in an Emplacement Drift

The potential for waste package temperature increases due to rockfall burial has been evaluated. For seismic events at 2E-06 APE, the level of burial of the waste package would be about 80% of the waste package. Based on a range of initial thermal loading conditions, the waste package peak temperatures would be well below the critical thermal limit of 541°C for breach of the waste package.

There are a number of conservatisms in this assessment (Attachment F3.2.4), including:

- Burial levels in nonlithophysal rock units would not be significant
- Even in lithophysal rock units, the weakest rock (Category 1) represents only about 5% of the total emplacement drifts. Burial levels in stronger lithophysal rock categories would generally be less than evaluated here.
- The thermal analysis selected a level burial horizon in the drift, while it is more likely that an elliptical horizon would occur, resulting in less burial of the waste package.
- The thermal analyses did not give credit for forced ventilation, or for long-term recovery actions.

Based on these conservative analyses, it is concluded that loss of ventilation due to rockfall burial of a waste package in the drifts would not cause breach of the waste package, and that this seismic event scenario can be screened out as beyond Category 2.

6.9.2.3 Impacts of Seismic-induced Movement of the Waste Package in the Drifts

In addition to the rockfall evaluations above, a number of evaluations have been performed examining the potential damage that could occur to waste package movement in the subsurface drifts due to a seismic event. These studies examined impacts of waste packages on other waste packages, and waste package impacts on pallets and inverters. The conclusions are that the rupture of the waste packages and/or the containers inside is not predicted to occur during the preclosure period. *Seismic and Structural Container Analyses for the PCSA* (Ref. 2.2.71), describes several of the analyses and concludes:

1. Postclosure seismic analyses were performed at four PGV levels for horizontal ground motion in *Mechanical Assessment of Degraded Waste Packages and Drip Shields Subject to Vibratory Ground Motion* (Ref. 2.2.106). The four PGV levels are 0.40 m/s, 1.05 m/s, 2.44 m/s, and 4.07 m/s. These PGV levels correspond to mean annual exceedance frequencies of about 1E-04, 5E-06, 1E-07, and 2E-09, respectively, from Figure 6.9-2 above. As previously noted, only ground motions with an annual exceedance frequency of 1E-06 or greater need to be considered for the 100 year preclosure period. The 2.44 m/s PGV level provides bounding ground motions, and the 4.07 m/s PGV level does not require consideration.
2. The postclosure analyses were performed for the TAD-bearing waste package and the codisposal waste package. These analyses were performed with 2.4 mm removed from the OCB thickness (to bound the general corrosion that could occur during the preclosure period) and with the inner vessel and its contents intact.
3. The probability of rupture caused by a seismic event during the 100-year preclosure period is determined separately from damage. An effective strain threshold of 0.285 was determined as a value below which rupture of the Alloy 22 outer corrosion barrier could be screened out. The value of 0.285 includes an 11% reduction for strain rate effects and a reduction factor of 2 for a worst case biaxial state of stress (Ref. 2.2.106).
4. Two types of impacts were considered in the postclosure seismic analyses: waste package-to-waste package and waste package-to-pallet (Ref. 2.2.106). For ground motion with PGV up to 2.44 m/s, the maximum impact velocity for waste package-to-waste package impacts is 4.711 m/s for TAD-bearing waste packages and 4.165 m/s for codisposal waste packages. Detailed waste-package-to-waste-package impact analyses for the TAD-bearing and codisposal waste packages compute maximum effective strains of 0.166 and 0.188, respectively, for waste-package-to-waste-package impacts up to 6 m/s. The maximum effective strains computed for all waste package-to-pallet

- impacts are 0.064 and 0.076 for the TAD-bearing and codisposal waste packages, respectively. These maximum effective strains are well below the threshold value of 0.285.
5. A second approach for assessing rupture was utilized in the postclosure analyses, and involves estimating the probability of rupture based on multiple impacts causing large deformations (Ref. 2.2.91 and Ref. 2.2.106). However, since the inner vessel and its contents remain intact during the preclosure period, the deformations will be small and no probability of rupture would be estimated.
 6. Based on the above discussion, rupture of the OCB of the waste packages is not predicted by the analyses for seismic events occurring in the 100-year preclosure period (Ref. 2.2.106).

Therefore, the potential for waste package-to-waste package impacts or waste package-to-pallet impacts are screened as beyond Category 2 event sequences.

6.9.2.4 Impacts of the Drip Shield and Drip Shield Gantry on the Waste Package

Toward the end of the preclosure period, drip shields are planned to be installed over the waste packages in the drifts. A drip shield emplacement gantry is used to place the drip shields. The drip shields themselves weigh less than 6 tons. Because of their light weight, they would not breach the waste package if they were to move laterally, or tip during an earthquake and contact the waste package.

If the drip shield gantry was over the waste package when the earthquake occurred, it could potentially tip to one side, or perhaps drop a drip shield prematurely. The gantry has only 1 ft of clearance in the drift, so it could not contact the waste package before the tipping was stopped by the walls of the circular drift (Ref. 2.2.30). Premature release of the drip shield could potentially cause the drip shield to contact the waste package, but there would not be any “spearing” action because the bottom of the drip shield is carried below the centerline of the waste package (Ref. 2.2.30, end view). Therefore, the drip shield impact on the waste package would be much less than the rockfall impacts discussed earlier.

Based on these qualitative evaluations, the drip shield and drip shield emplacement gantry seismic event sequences are screened as beyond Category 2 event sequences.

6.9.3 Subsurface Operations Event Sequence Categorization

The expected number of occurrences of an event sequence over the preclosure period is compared to the screening criteria in 10 CFR 63.2 (Ref. 2.3.1) to determine its categorization. If the expected number of occurrences of the event sequence is greater than or equal to 1 over the preclosure period, it is a Category 1 event sequence; if the expected number of occurrences of the event sequence is greater than or equal to $1E-04$ but less than 1 over the preclosure period, it is a Category 2 event sequence; and, if the expected number of occurrences of the event sequence is less than $1E-04$ over the preclosure period, the event sequence is beyond Category 2 (Ref. 2.2.59) Section 6.8.2.

The Subsurface Operations seismic event sequence in Table 6.9-2 is thus categorized as Category 2 (C2) based on the criteria above. The material at risk is also presented in Table 6.9-4, and the need for any consequence is listed.

Table 6.9-4. SSO Seismic Event Sequence Categorization

Event Sequence ID	End State	Description	Material-At-Risk	Mean Probability	Event Sequence Categorization	Consequence Analysis
SSO-S-IE-MAIN 03	DE-SHIELD-LOSS	Seismic failure of TEV shielding while holding TAD en route to emplacement (no breach)	1 TAD	6E-04	C2	No consequence analysis necessary

NOTE: SSO = Subsurface Operations; TAD = transportation, aging and disposal; TEV = transport and emplacement vehicle.

Source: Original

In addition to the seismic event sequences that were evaluated by convolution with the seismic hazard curve, the following event sequences were evaluated using extensive deterministic and probabilistic analyses:

- Rockfall impacts on waste packages
- Degradation of subsurface drift ventilation
- Impacts to waste packages due to seismic ground motion
- Impacts to waste packages due to drip shield and gantry failures.

Rockfall Impacts on Waste Packages: Rockfall impacts were screened out in Section 6.9.2.1 as beyond Category 2 based on the determination that a waste package subjected to the bounding rockfall impact would have a probability much less than 1E-8 of losing containment function. The bounding rockfall was selected at the upper end of the distribution of credible rocks from the 1E-06 APE seismic event and is equivalent to the 98% confidence level. The kinetic energy at impact on a waste package, based on the bounding rockfall, would be one million joule, or equivalent to a 20 metric ton rock impacting the waste package at 10 m/s.

Degradation of Subsurface Drift Ventilation: The rockfall analysis was also used to screen out potential degradation of subsurface drift ventilation as beyond Category 2 (Section 6.9.2.2). Three scenarios were evaluated, with multiple variations of waste package heat loading, and rockfall coverage of the waste package. Forced ventilation from the drift ventilation system was not credited for these evaluations. During the first 50 years of the preclosure period, some waste packages could have relatively high heat loading (18 kW). It was demonstrated in Section 6.9.2.2 that, for the credible rockfalls during the first 50 years, coverage of the waste package would be 80% or less from rockfalls. Based on a range of thermal evaluations of heat-up of the waste package, there would not be a failure of the waste package containment at the calculated temperatures. For the next 30 years, all of the waste packages would have heat loads less than 14 kW. At this lower heat load level, the waste packages could be 125% covered with rockfall, and the waste package would still maintain containment. For the last 20 years of the

preclosure period, the waste packages would have heat loads less than 7 kW. At this heat load level, even total drift collapse would not cause over temperature failures of the waste packages. Therefore, drift ventilation degradation, either due to rockfalls or loss of the forced ventilation system, would not cause breach of the waste package containment.

Impacts to Waste Packages Due to Seismic Ground Motion: Extensive analyses and simulations of impacts to waste packages due to seismic ground motion in the subsurface drifts have been conducted. Both waste package-to-waste package impacts, and waste package-to-pallet impacts were considered (Section 6.9.2.3). Based on multiple types of analyses, over a range of parameters, it was concluded that waste package strains and deformations would remain well below the threshold where the waste package could fail. Thus, these potential seismic failures were screened out as beyond Category 2.

Impacts to Waste Packages Due to Drip Shield and Gantry Failures: Toward the end of the preclosure period, the drip shields are installed over the waste packages using the drip shield gantry. The potential for drip shield or gantry failures to damage the waste packages, and cause a breach, was examined in Section 6.9.2.4. Based on the mass of the drip shields, the geometry of the shields, gantry, and drift, and the strength of the waste package, it was concluded that the potential failure of the drip shield and gantry could be screened from the seismic analysis as beyond Category 2.

This concludes the evaluation of seismic event sequences for Subsurface Operations.

6.10 IMPORTANT TO SAFETY STRUCTURES, SYSTEMS, AND COMPONENTS AND PROCEDURAL SAFETY CONTROL REQUIREMENTS

The results of the PCSA are used to define design bases for repository SSCs to prevent to the extent practical event sequences that could lead to the release of radioactive material and/or result in radiological exposure of workers or the public. Potential releases of radioactive material are minimized to ensure resulting worker and public exposures to radiation are below the limits established by 10 CFR 63.111 (Ref. 2.3.1). This strategy requires using prevention features in the repository design wherever reasonable. This strategy is implemented by performing the PCSA as an integral part of the design process in a manner consistent with a performance-based, risk-informed philosophy. This integral design approach ensures the ITS design features and operational controls are selected in a manner that ensures safety while minimizing design and operational complexity through the use of proven technology. Using this strategy, design rules are developed to provide guidance on the safety classification of SSCs.

The following information is developed in order to implement this strategy:

- Essential safety functions needed to ensure worker and public safety
- SSCs relied upon to ensure essential safety functions
- Design criteria that will ensure that the essential safety functions will be performed with a high degree of reliability and margin of safety

- Administrative and PSCs that, in conjunction with the repository design ensure operations are conducted within the limits of the PCSAs.

Section 6.10.1 identifies ITS SSCs and Section 6.10.2 identifies the PSCs.

6.10.1 Important to Safety Structures, Systems, and Components

Tables 6.10-1 through 6.10-6 contain the Nuclear Safety Design Bases for the ITS SSCs identified by this analysis for the various facilities and operations areas.

6.10.2 Procedural Safety Controls

PSCs are the controls that are relied upon to limit or prevent potential event sequences or mitigate their consequences. For this analysis, all PSCs were derived to reduce the initiating event sequence to an acceptable level. Table 6.10-7 lists the PSCs that are required to support the event sequence analysis and categorization of seismic events.

In many cases, PSCs are defined as procedures or administrative controls that prevent or minimize the chance of event sequences to occur or to mitigate potential consequences of event sequences. A PSC is identified as a specific action, or series of actions, that are taken by the operating staff in preparation for, or during the execution of a particular waste processing operation. On one hand, a PSC may be a localized action that ensures the intended occurrence, or prevented occurrence of an event, often a potential human failure event. On the other hand, a PSC may be a general requirement that ensures that the baseline operating environment used for PCSA screening and detailed analyses are maintained.

Table 6.10-1. Preclosure Nuclear Safety Design Bases for Seismic Event Sequences for the Initial Handling Facility

System or Facility (System Code)	Subsystem (Subsystem Code) (As Applicable)	Component (Component Code) (As Applicable)	Nuclear Safety Design Bases		Bounding Affiliated Event Sequence (Sequence Number)	Source
			Safety Function	Controlling Parameters and Values ^a		
Initial Handling Facility (IH)	Facility	Structure	Protect against building collapse onto waste containers	<i>IHF.01</i> The mean frequency of collapse of the IHF structure due to the spectrum of seismic events shall be less than or equal to 2×10^{-06} /yr.	IHF-S-IE-HLW (Seq. 03)	S-51A-NVL-STR-COLLAP
		Equipment Shield Doors (including anchorages)	Protect against equipment shield door collapse onto a waste container	<i>IHF.02</i> The mean frequency of collapse of the equipment shield doors (including attachment of door to wall and frame anchorages) due to the spectrum of seismic events shall be less than or equal to 6×10^{-06} /yr.	IHF-S-IE-HLW (Seq. 11-6)	S-51A-NVL-SHIELDOOR
		Rail System for the TEV inside the IHF	Protect against derailment of the TEV during loading of a waste package	<i>IHF.03</i> The mean frequency of TEV derailment due to failure of the TEV rail system (at the loadout station) due to the spectrum of seismic events shall be less than or equal to 1×10^{-04} /yr.	IHF-S-IE-NVL (Seq. 16-2)	S-51A-NVL-TEV-FAIL
Mechanical Handling System (H)	Cask Handling (HM)	Cask Handling Crane, 300 ton (51A-HM00-CRN-00001)	Protect against crane collapse onto a waste container	<i>H.IHF.HM.01</i> The mean frequency of collapse of the cask handling crane due to the spectrum of seismic events shall be less than or equal to 8×10^{-06} /yr.	IHF-S-IE-NVL (Seq. 07-6)	S-51A-NVL-CHC-FAIL
			Protect against cask or heavy object drop from the crane	<i>H.IHF.HM.02</i> The mean frequency of a hoist system failure of the cask handling crane due to the spectrum of seismic events shall be less than or equal to 2×10^{-05} /yr.	IHF-S-IE-NVL (Seq. 07-6)	S-51A-NVL-CHC-FAIL
	Cask Transfer Trolley (including seismic restraints) (51A-HM00-TRLY-00001)	Protect against impact and inducing stresses on the waste container or on the facility structure	<i>H.IHF.HM.03</i> The mean frequency of the sliding impact of the CTT into a wall or structural column and inducing stresses that can breach the waste container due to the spectrum of seismic events shall be less than or equal to 1×10^{-06} /yr.	IHF-S-IE-HLW (Seq. 10-6)	S-51A-NVL-CTT-FAIL	
			<i>H.IHF.HM.04</i> The mean frequency of a rocking impact of the CTT into a wall or structural column and inducing stresses that can breach the waste container due to the spectrum of seismic events shall be less than or equal to 1×10^{-06} /yr.	IHF-S-IE-HLW (Seq. 10-6)	S-51A-NVL-CTT-FAIL	
	Cask Preparation Crane, 30 ton (51A-HM00-CRN-00002)	Protect against collapse of the cask preparation crane	<i>H.IHF.HM.05</i> The mean frequency of collapse of the cask preparation crane due to the spectrum of seismic events shall be less than or equal to 8×10^{-06} /yr.	IHF-S-IE-HLW (Seq. 08-6)	S-51A-NVL-CPC-FAIL	
	Cask Handling/ Cask Preparation (HMH)	Cask Preparation Platform (51A-HMH0-PLAT-00001)	Protect against platform collapse	<i>H.IHF.HMH.01</i> The mean frequency of collapse of the cask preparation platform due to the spectrum of seismic events shall be less than or equal to 9×10^{-04} /yr.	IHF-S-IE-NVL (Seq. 09-6)	S-51A-NVL-CPREP-PLAT
	Cask Handling/ Waste Package Preparation (HMP)	Waste Package Handling Crane (51A-HMP0-CRN-00001)	Protect against collapse of the WP handling crane	<i>H.IHF.HMP.01</i> The mean frequency of collapse of the WP handling crane due to the spectrum of seismic events shall be less than or equal to 8×10^{-06} /yr.	IHF-S-IE-NVL (Seq. 15-6)	S-51A-NVL-WPHC-FAIL
	Waste Transfer/ Canister Transfer (HTC)	Canister Transfer Machine (51A-HTC0-FHM-00001)	Protect against collapse of the canister transfer machine	<i>H.IHF.HTC.01</i> The mean frequency of collapse of the canister transfer machine due to the spectrum of seismic events shall be less than or equal to 1×10^{-05} /yr.	IHF-S-IE-HLW (Seq. 12-5)	S-51A-NVL-CTM-FAIL
			Protect against canister or heavy object drop from the canister transfer machine	<i>H.IHF.HTC.02</i> The mean frequency of a hoist system failure of the canister transfer machine due to the spectrum of seismic events shall be less than or equal to 2×10^{-05} /yr.	IHF-S-IE-HLW (Seq. 12-5)	S-51A-NVL-CTM-FAIL
	Waste Package Closure/ Material Handling (HWH)	Remote Handling System Bridge (51A-HWH0-HEQ-00003)	Protect against collapse of the remote handling system bridge	<i>H.IHF.HWH.01</i> The mean frequency of collapse of the remote handling system bridge due to the spectrum of seismic events shall be less than or equal to 8×10^{-06} /yr.	IHF-S-IE-HLW (Seq. 13-6)	S-51A-NVL-RHS-FAIL

Table 6.10-1. Preclosure Nuclear Safety Design Bases for Seismic Event Sequences for the Initial Handling Facility (Continued)

System or Facility (System Code)	Subsystem (Subsystem Code) (As Applicable)	Component (Component Code) (As Applicable)	Nuclear Safety Design Bases		Bounding Affiliated Event Sequence (Sequence Number)	Source
			Safety Function	Controlling Parameters and Values ^a		
Mechanical Handling System (H) (Continued)	Waste Package Loadout (HL)	WP Transfer Trolley (and Rail System) (51A-HL00-TRLY-00001)	Protect against tipover of the WPTT holding a loaded waste package	<i>H.IHF.HL.01</i> The mean frequency of tipover of the WPTT due to the spectrum of seismic events shall be less than or equal to 2×10^{-06} /yr.	IHF-S-IE-HLW (Seq. 14-6)	S-51A-NVL-WPTT-FAIL
			Protect against rocking (which induces an impact into a wall) of a WPTT transfer trolley holding a loaded waste package	<i>H.IHF.HL.02</i> The mean frequency of the rocking impact of the WPTT into a wall or column due to the spectrum of seismic events shall be less than or equal to 2×10^{-05} /yr.	IHF-S-IE-HLW (Seq. 14-6)	S-51A-NVL-WPTT-FAIL
		WP Shield Rings (51A-HL00-HEQ-00001 and -00002)	Provide lateral and vertical stability to the WP in the WPTT	<i>H.IHF.HL.03</i> The mean frequency of the shield ring becoming displaced from the WPTT due to the spectrum of seismic events shall be less than or equal to 2×10^{-05} /yr	IHF-S-IE-HLW (Seq. 14-6)	S-51A-NVL-WPTT-FAIL
	Grapples, Yokes, Bails, Plates, and Adapters	Cask, Canister, and Waste Package Grapples, Yokes, and Adapters Including: Cask Handling Yoke (51A-HM00-BEAM-00001), Naval Cask Lift Bail (51A-HMC0-BEAM-00001) and Naval Cask Lift Plate (51A-HMC0-HEQ-00005)	Protect against a waste container or heavy object drop from a crane	<i>H.IHF.01</i> The mean frequency of a hoist system failure (induced by a seismic event) due to the failure of grapples, yokes, and adapters used in the load-bearing path shall have the same (or less) frequency of failure as specified for the crane or machine on which the component is used.	See the corresponding hoist system failure information for appropriate crane.	See the corresponding hoist system failure information for appropriate crane.
Emplacement and Retrieval and Drip Shield Installation (HE)		Transport and Emplacement Vehicle	Protect against derailment of a transport and emplacement vehicle during loading of a waste package	<i>H.IHF.HE.01</i> The mean frequency of derailment of the transport and emplacement vehicle at the loadout station due to the spectrum of seismic events shall be less than or equal to 1×10^{-04} /yr.	IHF-S-IE-NVL (Seq. 16-2)	S-51A-NVL-TEV-FAIL
			Protect against tipover of the transport and emplacement vehicle	<i>H.IHF.HE.02</i> The mean frequency of tipover of the transport and emplacement vehicle due to the spectrum of seismic events shall be less than or equal to 2×10^{-06} /yr.	IHF-S-IE-NVL (Seq. 16-2)	S-51A-NVL-TEV-FAIL
			Protect against ejection of the waste package from the shielded enclosure of the transport and emplacement vehicle	<i>H.IHF.HE.03</i> The mean frequency of ejection of a waste package from the transport and emplacement vehicle due to the spectrum of seismic events shall be less than or equal to 2×10^{-04} /yr.	IHF-S-IE-NVL (Seq. 16-2)	S-51A-NVL-TEV-FAIL

NOTE: ^a Control values shown represent the integration of the probability distribution of SSC failure (i.e., the loss of safety function) with the site seismic hazard curve (see Figure 6.1-1).

CTT = cask transfer trolley; IHF = Initial Handling Facility; TEV = transport and emplacement vehicle; WP = waste package; WPTT = waste package transfer trolley.

Source: Original

Table 6.10-2. Preclosure Nuclear Safety Design Bases for Seismic Event Sequences for the Receipt Facility

System or Facility (System Code)	Subsystem (Subsystem Code) (As Applicable)	Component (Component Code) (As Applicable)	Nuclear Safety Design Bases		Bounding Affiliated Event Sequence (Sequence Number)	Source
			Safety Function	Controlling Parameters and Values ^a		
Receipt Facility (RF)	Facility	Structure	Protect against building collapse onto waste containers	<i>RF.01</i> The mean frequency of collapse of the RF structure due to the spectrum of seismic events shall be less than or equal to 2×10^{-06} /yr.	RF-S-IE-TAD-AO (Seq. 03)	S-200-TAO-STR-COLLAP
		Equipment Shield Doors (including anchorages) (200-RF00-DR-00001 to -00002)	Protect against equipment shield door collapse onto a waste container	<i>RF.02</i> The mean frequency of collapse of the equipment shield doors (including attachment of door to wall and frame anchorages) due to the spectrum of seismic events shall be less than or equal to 6×10^{-06} /yr.	RF-S-IE-TAD-AO (Seq. 10-6)	S-200-TAO-SHIELDOOR
Mechanical Handling System (H)	Cask Handling/ Cask Preparation (HM)	Cask Handling Crane, 200 ton (200-HM00-CRN-00001)	Protect against crane collapse onto a waste container	<i>H.RF.HM.01</i> The mean frequency of collapse of the cask handling crane due to the spectrum of seismic events shall be less than or equal to 8×10^{-06} /yr.	RF-S-IE-TAD-AO (Seq. 07-6)	S-200-TAO-CHC-FAIL
			Protect against a cask or heavy object drop from the crane	<i>H.RF.HM.02</i> The mean frequency of a hoist system failure of the cask handling crane due to the spectrum of seismic events shall be less than or equal to 2×10^{-05} /yr.	RF-S-IE-TAD-AO (Seq. 07-6)	S-200-TAO-CHC-FAIL
		Cask Transfer Trolley (Including Seismic Restraints) (200-HM00-TRLY-00001)	Protect against impact and inducing stresses on the waste container	<i>H.RF.HM.03</i> The mean frequency of the sliding of the CTT into a wall and inducing stresses that can breach the waste container due to the spectrum of seismic events shall be less than or equal to 1×10^{-06} /yr.	RF-S-IE-TAD-AO (Seq. 09-6)	S-200-TAO-CTT-FAIL
				<i>H.RF.HM.04</i> The mean frequency of a rocking impact of the CTT into a wall and inducing stresses that can breach the waste container due to the spectrum of seismic events shall be less than or equal to 1×10^{-06} /yr.	RF-S-IE-TAD-AO (Seq. 09-6)	S-200-TAO-CTT-FAIL
	Cask Handling/ Cask Receipt (HMC)	Lid Bolting Room Crane (200-HMC0-CRN-00001)	Protect against collapse of the lid bolting room crane	<i>H.RF.HMC.01</i> The mean frequency of collapse of the lid bolting room crane due to the spectrum of seismic events shall be less than or equal to 8×10^{-06} /yr.	RF-S-IE-TAD-AO (Seq. 15-5)	S-200-TAO-LBRC-COL
			Lid Bolting Room Platform (200-HMC0-PLAT-00003)	Protect against platform collapse	<i>H.RF.HMC.02</i> The mean frequency of collapse of the Lid Bolting Room platform due to the spectrum of seismic events shall be less than or equal to 3×10^{-06} /yr.	RF-S-IE-TAD-AO (Seq. 14-5)
Protect against platform collapse or waste container breach due to an impact from the site transporter				<i>H.RF.HMC.03</i> The mean frequency of platform collapse or waste container breach from the impact of the site transporter onto the platform due to the spectrum of seismic events shall be less than or equal to 2×10^{-05} /yr.	RF-S-IE-TAD-AO (Seq. 13-5)	S-200-TAO-ST-SLIDE
Cask Handling/ Cask Preparation (HMH)	Cask Preparation Platform (200-HMH0-PLAT-00001)	Protect against platform collapse	<i>H.RF.HMH.1</i> The mean frequency of collapse of the cask preparation platform due to the spectrum of seismic events shall be less than or equal to 3×10^{-06} /yr.	RF-S-IE-TAD-AO (Seq. 08-6)	S-200-TAO-CPREP-PLAT	
		Protect against platform collapse or waste container breach due to an impact from the cask transfer trolley	<i>H.RF.HMH.2</i> The mean frequency of platform collapse or waste container breach from the impact of the cask transfer trolley onto the platform due to the spectrum of seismic events shall be less than or equal to 2×10^{-05} /yr.	RF-S-IE-TAD-AO (Seq. 09-6)	S-200-TAO-CTT-PLAT	

Table 6.10-2. Preclosure Nuclear Safety Design Bases for Seismic Event Sequences for the Receipt Facility (Continued)

System or Facility (System Code)	Subsystem (Subsystem Code) (As Applicable)	Component (Component Code) (As Applicable)	Nuclear Safety Design Bases		Bounding Affiliated Event Sequence (Sequence Number)	Source
			Safety Function	Controlling Parameters and Values ^a		
Mechanical Handling System (H) (Continued)	Waste Transfer/ Canister Transfer (HTC)	Canister Transfer Machine (200-HTC0-FHM-00001)	Protect against collapse of the canister transfer machine	<i>H.RF.HTC.01</i> The mean frequency of collapse of the canister transfer machine due to the spectrum of seismic events shall be less than or equal to 1×10^{-05} /yr.	RF-S-IE-TAD-AO (Seq. 11-5)	S-200-TAO-CTM-FAIL
			Protect against canister or heavy object drop from the canister transfer machine	<i>H.RF.HTC.02</i> The mean frequency of a hoist system failure of the canister transfer machine due to the spectrum of seismic events shall be less than or equal to 2×10^{-05} /yr.	RF-S-IE-TAD-AO (Seq. 11-5)	S-200-TAO-CTM-FAIL
		CTM Maintenance Crane (200-HTC0-CRN-00001)	Protect against collapse of the CTM maintenance crane	<i>H.RF.HTC.03</i> The mean frequency of collapse of the canister transfer machine maintenance crane due to the spectrum of seismic events shall be less than or equal to 8×10^{-06} /yr.	RF-S-IE-TAD-AO (Seq. 12-5)	S-200-TAO-CTMMC
	Aging Handling/ Cask Transfer (HAT)	Site Transporter (170-HAT0-MEQ-00001)	Protect against tipover of the site transporter	<i>H.RF.HAT.01</i> The mean frequency of tipover of the site transporter due to the spectrum of seismic events shall be less than or equal to 2×10^{-06} /yr.	RF-S-IE-TAD-AO (Seq. 13-5)	S-200-TAO-ST-SLIDE
			Protect against sliding impact and inducing stresses on the waste container	<i>H.RF.HAT.02</i> The mean frequency of sliding impact of the site transporter into a wall and inducing stresses that can breach a waste container due to the spectrum of seismic events shall be less than or equal to 2×10^{-05} /yr.	RF-S-IE-TAD-AO (Seq. 13-5)	S-200-TAO-ST-SLIDE
		Cask Transfer Trailer (170-HAT0-TRLY-00001-2)	Preclude puncture of a cask	<i>H.RF.HAT.03</i> The cask transfer trailer shall be designed to preclude puncture of a cask due to the spectrum of seismic events.	Screened from consideration	Section 6.2.2.2
	All	Cask, Canister, and Aging Overpack Grapples, Yokes, and Adapters	Protect against waste container drop from a crane	<i>H.RF.01</i> The mean frequency of hoist system failure (as induced by a seismic event) due to the failure of grapples, yokes, and adapters used in the load-bearing path shall have the same (or less) frequency as specified for the crane or machine on which the component is used.	See the corresponding hoist system failure information for appropriate crane.	See the corresponding hoist system failure information for appropriate crane.

NOTE: ^a Control values shown represent the integration of the probability distribution of SSC failure (i.e., the loss of safety function) with the site seismic hazard curve (see Figure 6.1-1).
CTM = canister transfer machine; CTT = cask transfer trolley; RF = Receipt Facility.

Source: Original

Table 6.10-3. Preclosure Nuclear Safety Design Bases for Seismic Event Sequences for the Canister Receipt and Closure Facility

System or Facility (System Code)	Subsystem (Subsystem Code) (As Applicable)	Component (Component Code) (As Applicable)	Nuclear Safety Design Bases		Bounding Affiliated Event Sequence (Sequence Number)	Source
			Safety Function	Controlling Parameters and Values ^a		
Canister Receipt and Closure Facility (CR)	Facility	Structure	Protect against building collapse onto waste containers	<i>CR.01</i> The mean frequency of collapse of the CRCF structure due to the spectrum of seismic events shall be less than or equal to $2 \times 10^{-06}/\text{yr}$.	CRCF-S-IE-TWP (Seq. 03)	S-060-TWP-STR-COLLAP
		Equipment Shield Doors (including Anchorages) (060-CR00-DR-00005 and -00006)	Protect against equipment shield door collapse onto a waste container	<i>CR.02</i> The mean frequency of collapse of equipment shield doors (including attachment of door to wall and frame anchorages) due to the spectrum of seismic events shall be less than or equal to $6 \times 10^{-06}/\text{yr}$.	CRCF-S-IE-TAD-AO (Seq. 10-6)	S-060-TAO-SHIELDOOR
		Rail System for the Transport and Emplacement Vehicle (TEV) inside the CRCF	Protect against derailment of the TEV during loading of a waste package	<i>CR.03</i> The mean frequency of transport and emplacement vehicle derailment due to failure of the TEV rail system (at the loadout station) due to the spectrum of seismic events shall be less than or equal to $1 \times 10^{-04}/\text{yr}$.	CRCF-S-IE-TWP (12-7)	S-060-TWP-TEV-FAIL
Mechanical Handling System (H)	Cask Handling/ Cask Preparation (HM)	Cask Handling Crane; 200-ton (060-HM00-CRN-00001)	Protect against crane collapse onto a waste container	<i>H.CR.HM.01</i> The mean frequency of collapse of the cask handling crane due to the spectrum of seismic events shall be less than or equal to $8 \times 10^{-06}/\text{yr}$.	CRCF-S-IE-TAD-AO (Seq. 07-6)	S-060-TAO-CHC-FAIL
			Protect against cask or heavy object drop from the crane	<i>H.CR.HM.02</i> The mean frequency of a hoist system failure of the cask handling crane due to the spectrum of seismic events shall be less than or equal to $2 \times 10^{-05}/\text{yr}$.	CRCF-S-IE-TAD-AO (Seq. 07-6)	S-060-TAO-CHC-FAIL
		Cask Transfer Trolley (including seismic restraints) (060-HM00-TRLY-00001 and -00002)	Protect against impact and inducing stresses on the waste container	<i>H.CR.HM.03</i> The mean frequency of the sliding of the CTT into a wall and inducing stresses that can breach the waste container due to the spectrum of seismic events shall be less than or equal to $1 \times 10^{-06}/\text{yr}$.	CRCF-S-IE-HLW (Seq. 09-6)	S-060-HLW-CTT-FAIL
			<i>H.CR.HM.04</i> The mean frequency of a rocking impact of the CTT into a wall and inducing stresses that can breach the waste container due to the spectrum of seismic events shall be less than or equal to $1 \times 10^{-06}/\text{yr}$.	CRCF-S-IE-HLW (Seq. 09-6)	S-060-HLW-CTT-FAIL	
	Cask Handling/ Cask Preparation (HMH)	Cask Preparation Platform (060-HMH0-PLAT-00001)	Protect against platform collapse	<i>H.CR.HMH.01</i> The mean frequency of collapse of the cask preparation platform due to the spectrum of seismic events shall be less than or equal to $3 \times 10^{-06}/\text{yr}$.	CRCF-S-IE-TAD-AO (Seq. 08-6)	S-060-TAO-CRPREP-PLAT
			Protect against platform collapse or waste container breach due to an impact from the CTT or site transporter	<i>H.CR.HMH.02</i> The mean frequency of platform collapse or waste container breach from the impact of the cask transfer trolley or site transporter onto the platform due to the spectrum of seismic events shall be less than or equal to $2 \times 10^{-05}/\text{yr}$.	CRCF-S-IE-TAD-AO (Seq. 012-5)	S-060-TAO-ST-SLIDE
Cask Handling/ Waste Package Preparation (HMP)	WP Handling Crane (060-HMP0-CRN-00001)	Protect against collapse of the WP handling crane	<i>H.CR.HMP.01</i> The mean frequency of collapse of the WP handling crane due to the spectrum of seismic events shall be less than or equal to $8 \times 10^{-06}/\text{yr}$.	CRCF-S-IE-TWP (Seq. 11-6)	S-060-TWP-WPHC-FAIL	
Waste Transfer/ Canister Transfer (HTC)	Canister Transfer Machine (060-HTC0-FHM-00001-2)	Protect against collapse of the canister transfer machine	<i>H.CR.HTC.01</i> The mean frequency of collapse of the canister transfer machine due to the spectrum of seismic events shall be less than or equal to $1 \times 10^{-05}/\text{yr}$.	CRCF-S-IE-TWP (Seq. 08-5)	S-060-TWP-CTM-FAIL	
		Protect against canister or heavy object drop from the canister transfer machine	<i>H.CR.HTC.02</i> The mean frequency of a hoist system failure of the canister transfer machine due to the spectrum of seismic events shall be less than or equal to $2 \times 10^{-05}/\text{yr}$.	CRCF-S-IE-TWP (Seq. 08-5)	S-060-TWP-CTM-FAIL	

Table 6.10-3. Preclosure Nuclear Safety Design Bases for Seismic Event Sequences for the Canister Receipt and Closure Facility (Continued)

System or Facility (System Code)	Subsystem (Subsystem Code) (As Applicable)	Component (Component Code) (As Applicable)	Nuclear Safety Design Bases		Bounding Affiliated Event Sequence (Sequence Number)	Source
			Safety Function	Controlling Parameters and Values ^a		
Mechanical Handling System (H) (Continued)	Waste Transfer/ Canister Transfer (HTC) (Continued)	DOE Canister Staging Racks (060-HTC0-RK-00006-10)	Protect against tipover/impact of a canister in the staging rack.	<i>H.CR.HTC.03</i> The mean frequency of collapse of the DOE canister staging racks due to the spectrum of seismic events shall be less than or equal to 2×10^{-06} /yr.	CRCF-S-IE-DOE-SNF (Seq. 12-5)	S-060-DSNF-SRACK-FAIL
		TAD Canister Staging Racks (060-HTC0-RK-00011-12)	Protect against tipover/impact of a canister in the staging rack.	<i>H.CR.HTC.04</i> The mean frequency of collapse of the TAD canister staging racks due to the spectrum of seismic events shall be less than or equal to 2×10^{-06} /yr.	CRCF-S-IE-DOE-SNF (Seq. 12-5)	S-060-DSNF-SRACK-FAIL
	Waste Package Closure/ Material Handling (HWH)	Remote Handling System Bridge (060-HWH0-HEQ-00003)	Protect against collapse of the remote handling system bridge	<i>H.CR.HWH.01</i> The mean frequency of collapse of the remote handling system bridge due to the spectrum of seismic events shall be less than or equal to 8×10^{-06} /yr.	CRCF-S-IE-DOE-SNF (Seq. 13-6)	S-060-DSNF-RHS-FAIL
	Waste Package Loadout (HL)	WP Transfer Trolley (Including Rail System) (060-HL00-TRLY-00001 and -00002)	Protect against tipover of the WPTT holding a loaded waste package	<i>H.CR.HL.01</i> The mean frequency of tipover of the WPTT due to the spectrum of seismic events shall be less than or equal to 2×10^{-06} /yr.	CRCF-S-IE-TWP (Seq. 10-6)	S-060-TWP-WPTT-FAIL
		WP Transfer Trolley (Including Rail System) (060-HL00-TRLY-00001 and -00002)	Protect against rocking (which induces an impact into a wall) of a WP transfer trolley holding a loaded waste package	<i>H.CR.HL.02</i> The mean frequency of rocking impact of the WPTT into a wall or column due to the spectrum of seismic events shall be less than or equal to 2×10^{-05} /yr.	CRCF-S-IE-TWP (Seq. 10-6)	S-060-TWP-WPTT-FAIL
		WP Shield Rings (060-HL00-HEQ-00001 to -00006)	Provide lateral and vertical stability to the WP in the WP transfer trolley	<i>H.IHF.HL.03</i> The mean frequency of the shield ring becoming displaced from the WP transfer trolley due to the spectrum of seismic events shall be less than or equal to 2×10^{-05} /yr.	CRCF-S-IE-TWP (Seq. 10-6)	S-060-TWP-WPTT-FAIL
	Aging Handling/ Cask Transfer (HAT)	Site Transporter (170-HAT0-MEQ-00001)	Protect against tipover of the site transporter	<i>H.CR.HAT.01</i> The mean frequency of tipover of the site transporter due to the spectrum of seismic events shall be less than or equal to 2×10^{-06} /yr.	CRCF-S-IE-TWP (Seq. 06-5)	S-060-TWP-ST-SLIDE
			Protect against sliding impact and inducing stresses on the waste container	<i>H.CR.HAT.02</i> The mean frequency of sliding impact of the site transporter into a wall and inducing stresses that can breach a waste container due to the spectrum of seismic events shall be less than or equal to 2×10^{-05} /yr.	CRCF-S-IE-TWP (Seq. 06-5)	S-060-TWP-ST-SLIDE
	All	Cask, Canister, and Waste Package Grapples, Yokes, and Adapters Including: Rail Cask Lid Adapters (060-HMH0-HEQ-00003-4), Canister Grapples (060-HTC0-HEQ-00003-7), Canister Transfer Machine Grapples (060-HTC0-HEQ-00001-2)	Protect against waste container or heavy object drop from a crane	<i>H.CR.01</i> The mean frequency of a hoist system failure (induced by a seismic event) due to the failure of grapples, yokes, and adapters used in the load-bearing path shall have the same (or less) frequency as specified for the crane or machine on which the component is used.	See the corresponding hoist system failure information for appropriate crane.	See the corresponding hoist system failure information for appropriate crane.

Table 6.10-3. Preclosure Nuclear Safety Design Bases for Seismic Event Sequences for the Canister Receipt and Closure Facility (Continued)

System or Facility (System Code)	Subsystem (Subsystem Code) (As Applicable)	Component (Component Code) (As Applicable)	Nuclear Safety Design Bases		Bounding Affiliated Event Sequence (Sequence Number)	Source
			Safety Function	Controlling Parameters and Values ^a		
Emplacement and Retrieval and Drip Shield Installation (HE)		Transport and Emplacement Vehicle	Protect against derailment of a transport and emplacement vehicle during loading of a waste package	<i>HE.CR.01</i> The mean frequency of derailment of the TEV at the loadout station due to the spectrum of seismic events shall be less than or equal to 1×10^{-04} /yr.	CRCF-S-IE-TWP (Seq. 12-7)	S-060-TWP-TEV-FAIL
			Protect against tipover of the transport and emplacement vehicle	<i>HE.CR.02</i> The mean frequency of tipover of the transport and emplacement vehicle due to the spectrum of seismic events shall be less than or equal to 2×10^{-06} /yr.	CRCF-S-IE-TWP (Seq. 12-7)	S-060-TWP-TEV-FAIL
			Protect against ejection of the waste package from the shielded enclosure of the TEV	<i>HE.CR.03</i> The mean frequency of ejection of a waste package from the TEV due to the spectrum of seismic events shall be less than or equal to 2×10^{-04} /yr.	CRCF-S-IE-TWP (Seq. 12-2)	S-060-TWP-TEV-FAIL

NOTE: ^a. Control values shown represent the integration of the probability distribution of SSC failure (i.e., the loss of safety function) with the site seismic hazard curve (see Figure 6.1-1).

CRCF= Canister Receipt and Closure Facility; CTT = cask transfer trolley; DOE = U.S. Department of Energy; TAD = transportation, aging and disposal; TEV = transport and emplacement vehicle; WP = waste package; WPTT = waste package transfer trolley.

Source: Original

Table 6.10-4. Preclosure Nuclear Safety Design Bases for Seismic Event Sequences for the Wet Handling Facility

System or Facility (System Code)	Subsystem (Subsystem Code) (As Applicable)	Component (Component Code) (As Applicable)	Nuclear Safety Design Bases		Bounding Affiliated Event Sequence (Sequence Number)	Source
			Safety Function	Controlling Parameters and Values ^a		
Wet Handling Facility (WH)	Facility	Structure	Protect against building collapse onto waste containers	<i>WH.01</i> The mean frequency of collapse of the WHF structure due to the spectrum of seismic events shall be less than or equal to 2×10^{-06} /yr.	WHF-S-IE-SNF-XFER (Seq. 07)	S-050-XFER-STR-COLLAP
		Pool Structure	Maintain pool integrity to protect against collapse onto waste containers and to maintain pool water retention capability	<i>WH.02</i> The mean frequency of collapse of or water loss from the WHF pool due to the spectrum of seismic events shall be less than or equal to 2×10^{-06} /yr.	WHF-S-IE-SNF-XFER (Seq. 08)	S-050-XFER-POOL-FAIL
		Equipment Shield Doors (including anchorages) (050-WH00-DR-00003 and -00004)	Protect against equipment shield door collapse onto a waste container	<i>WH.04</i> The mean frequency of collapse of the equipment shield doors (including attachment of door to wall and frame anchorages) due to the spectrum of seismic events shall be less than or equal to 6×10^{-06} /yr.	WHF-S-IE-BARE (Seq. 12-6)	S-050-BARE-SHIELDDOOR
Mechanical Handling System (H)	Cask Handling (HM)	Cask Handling Crane (050-HM00-CRN-00001)	Protect against crane collapse onto a waste container	<i>H.WH.HM.01</i> The mean frequency of collapse of the cask handling crane due to the spectrum of seismic events shall be less than or equal to 8×10^{-06} /yr.	WHF-S-IE-BARE (Seq. 05-6)	S-050-BARE-CHC-FAIL
			Protect against cask or heavy object drop from the crane	<i>H.WH.HM.02</i> The mean frequency of a hoist system failure of the cask handling crane due to the spectrum of seismic events shall be less than or equal to 2×10^{-05} /yr.	WHF-S-IE-BARE (Seq. 05-6)	S-050-BARE-CHC-FAIL
		Cask Transfer Trolley (Including Seismic Restraints) (050-HM00-TRLY-00001)	Protect against impact and inducing stresses on the waste container	<i>H.WH.HM.03</i> The mean frequency of the sliding of the CTT into a wall and inducing stresses that can breach the waste container due to the spectrum of seismic events shall be less than or equal to 1×10^{-06} /yr.	WHF-S-IE-BARE (Seq. 09-6)	S-050-BARE-CTT-FAIL
				<i>H.WH.HM.04</i> The mean frequency of a rocking impact of the CTT into a wall and inducing stresses that can breach the waste container due to the spectrum of seismic events shall be less than or equal to 1×10^{-06} /yr.	WHF-S-IE-BARE (Seq. 09-6)	S-050-BARE-CTT-FAIL
		Decontamination Pit, Decontamination Pit Seismic Restraints (050-HM00-BRAC-00001)	Provide lateral stability to the cask in the decontamination pit	<i>H.WH.HM.05</i> The mean frequency of the failure of the seismic restraints in the decontamination pit due to the spectrum of seismic events shall be less than or equal to 2×10^{-05} /yr .	Screening assessment	See Section 6.7.3
	Cask Handling/ Cask Receipt (HMC)	Entrance Vestibule Crane (050-HMC0-CRN-00001)	Protect against collapse	<i>H.WH.HMC.01</i> The mean frequency of collapse of the entrance vestibule crane due to the spectrum of seismic events shall be less than or equal to 8×10^{-06} /yr.	WHF-S-IE-BARE (Seq. 07-6)	S-050-BARE-EVC-FAIL
	Cask Handling/ Cask Preparation (HMH)	Auxiliary Pool Crane (050-HMH0-CRN-00001)	Protect against collapse of the auxiliary pool crane	<i>H.WH.HMH.01</i> The mean frequency of collapse of the auxiliary pool crane due to the spectrum of seismic events shall be less than or equal to 8×10^{-06} /yr.	WHF-S-IE-BARE (Seq. 14-5)	S-050-BARE-APC-FAIL
			Protect against heavy object drop from the auxiliary pool crane	<i>H.WH.HMH.02</i> The mean frequency of a hoist system failure of the auxiliary pool crane due to the spectrum of seismic events shall be less than or equal to 2×10^{-05} /yr.	WHF-S-IE-BARE (Seq. 14-5)	S-050-BARE-APC-FAIL

Table 6.10-4. Preclosure Nuclear Safety Design Bases for Seismic Event Sequences for the Wet Handling Facility (Continued)

System or Facility (System Code)	Subsystem (Subsystem Code) (As Applicable)	Component (Component Code) (As Applicable)	Nuclear Safety Design Bases		Bounding Affiliated Event Sequence (Sequence Number)	Source
			Safety Function	Controlling Parameters and Values ^a		
Mechanical Handling System (H) (Continued)	Cask Handling/ Cask Preparation (HMH) (Continued)	Preparation Station #1 Jib Crane and Preparation Station #2 Jib Crane (050-HMH0-CRN-00002 to -00003)	Protect against collapse of the jib crane	<i>H.WH.HMH.03</i> The mean frequency of collapse of the jib crane due to the spectrum of seismic events shall be less than or equal to 8×10^{-06} /yr.	WHF-S-IE-TAD-AO (Seq. 09)	S-050-WHFJIBC-FAIL
			Protect against heavy object drop from the jib crane	<i>H.WH.HMH.04</i> The mean frequency of a hoist system failure of the jib crane due to the spectrum of seismic events shall be less than or equal to 2×10^{-05} /yr.	WHF-S-IE-TAD-AO (Seq. 09)	S-050-WHFJIBC-FAIL
		Preparation Station #1 Platform (050-HMH0-PLAT-00001)	Protect against platform collapse	<i>H.WH.HMH.05</i> The mean frequency of collapse of the preparation station platform due to the spectrum of seismic events shall be less than or equal to 3×10^{-06} /yr.	WHF-S-IE-BARE (Seq. 10-6)	S-050-BARE-PS1-COL
		Preparation Station #1 Platform (050-HMH0-PLAT-00001)	Protect against platform collapse or waste container breach due to an impact of the cask transfer trolley	<i>H.WH.HMH.</i> The mean frequency of platform collapse or waste container breach from the impact of the cask transfer trolley onto the platform due to the spectrum of seismic events shall be less than or equal to 2×10^{-05} /yr.	WHF-S-IE-BARE (Seq. 9-6)	S-050-BARE-CTT-FAIL
		Preparation Station #2 Platform (050-HMH0-PLAT-00002)	Protect against platform collapse	<i>H.WH.HMH.07</i> The mean frequency of collapse of the preparation station platform due to the spectrum of seismic events shall be less than or equal to 3×10^{-06} /yr.	WHF-S-IE-TAD-AO (Seq. 08)	S-050-WHF-TC-PS2-COL
	Waste Transfer/ Fuel Assembly Transfer (HTF)	Spent Fuel Transfer Machine (050-HTF0-FHM-00001)	Protect against collapse of the SFTM	<i>H.WH.HTF.01</i> The mean frequency of collapse of the SFTM due to the spectrum of seismic events shall be less than or equal to 2×10^{-05} /yr.	WHF-S-IE-BARE (Seq. 15-5)	S-050-BARE-SFTM-FAIL
			Protect against an SNF assembly or heavy object drop from the SFTM	<i>H.WH.HTF.02</i> The mean frequency of a hoist system failure of the SFTM due to the spectrum of seismic events shall be less than or equal to 2×10^{-05} /yr.	WHF-S-IE-BARE (Seq. 15-5)	S-050-BARE-SFTM-FAIL
		SNF Staging Racks (050-HTF0-RK-00001)	Protect against tipover of SNF in staging racks	<i>H.WH.HTF.03</i> The mean frequency of collapse of the SNF staging racks due to the spectrum of seismic events shall be less than or equal to 2×10^{-06} /yr.	WHF-S-IE-SNF-XFER (Seq. 09)	S-050-XFER-SRACK-FAIL
		Truck Cask Handling Frame (050-HTF0-RK-00006)	Protect against cask drop from a crane	<i>H.WH.HM.02</i> The mean frequency of a cask drop due to failure of the truck cask handling frame due to the spectrum of seismic events shall be less than or equal to 2×10^{-05} /yr.	WHF-S-IE-BARE (Seq. 05-6)	S-050-BARE-CHC-FAIL
	Waste Transfer/ Canister Transfer (HTC)	Canister Transfer Machine (050-HTC0-FHM-00001)	Protect against collapse of the canister transfer machine	<i>H.WH.HTC.01</i> The mean frequency of collapse of the canister transfer machine due to the spectrum of seismic events shall be less than or equal to 1×10^{-05} /yr.	WHF-S-IE-DPC (Seq. 14-5)	S-050-DPC-CTM-FAIL
			Protect against a canister or heavy object drop from the canister transfer machine	<i>H.WH.HTC.02</i> The mean frequency of a hoist system failure of the canister transfer machine due to the spectrum of seismic events shall be less than or equal to 2×10^{-05} /yr.	WHF-S-IE-DPC (Seq. 14-5)	S-050-DPC-CTM-FAIL
	Tad Closure (HC)	TAD Closure Jib Crane (050-HC00-CRN-00001)	Protect against collapse of the TAD closure jib crane	<i>H.WH.HC.01</i> The mean frequency of collapse of the TAD closure jib crane due to the spectrum of seismic events shall be less than or equal to 8×10^{-06} /yr.	WHF-S-IE-TAD-AO (Seq. 09)	S-050-WHF-JIBC-FAIL
			Protect against heavy object drop from the TAD closure jib crane	<i>H.WH.HC.02</i> The mean frequency of a hoist system failure of the TAD closure jib crane due to the spectrum of seismic events shall be less than or equal to 2×10^{-05} /yr.	WHF-S-IE-TAD-AO (Seq. 09)	S-050-WHF-JIBC-FAIL
		TAD Closure Station Platform (050-HC00-PLAT-00001)	Protect against platform collapse	<i>H.WH.HC.03</i> The mean frequency of collapse of the TAD closure station platform due to the spectrum of seismic events shall be less than or equal to 3×10^{-06} /yr.	WHF-S-IE-TAD-AO (Seq. 08)	S-050-WHF-TC-PS2-COL

Table 6.10-4. Preclosure Nuclear Safety Design Bases for Seismic Event Sequences for the Wet Handling Facility (Continued)

System or Facility (System Code)	Subsystem (Subsystem Code) (As Applicable)	Component (Component Code) (As Applicable)	Nuclear Safety Design Bases		Bounding Affiliated Event Sequence (Sequence Number)	Source
			Safety Function	Controlling Parameters and Values ^a		
Mechanical Handling System (H) (Continued)	Dual Purpose Canister Cutting (HD)	DPC Cutting Jib Crane (050-HD00-CRN-00001)	Protect against collapse of the DPC cutting jib crane	<i>H.WH.HD.01</i> The mean frequency of collapse of the DPC cutting jib crane due to the spectrum of seismic events shall be less than or equal to 8×10^{-06} /yr.	WHF-S-IE-TAD-AO (Seq. 09)	S-050-WHF-JIBC-FAIL
			Protect against heavy object drop from the DPC cutting jib crane	<i>H.WH.HD.02</i> The mean frequency of a hoist system failure of the DPC cutting jib crane due to the spectrum of seismic events shall be less than or equal to 2×10^{-05} /yr.	WHF-S-IE-TAD-AO (Seq. 09)	S-050-WHF-JIBC-FAIL
	Dual Purpose Canister Cutting (HD) (Continued)	DPC Cutting Station Platform (050-HD00-PLAT-00001)	Protect against platform collapse	<i>H.WH.HD.03</i> The mean frequency of collapse of the DPC cutting station platform due to the spectrum of seismic events shall be less than or equal to 3×10^{-06} /yr.	WHF-S-IE-DPC (Seq. 15)	S-050-DPC-CUTS-COL
Aging Handling/ Cask Transfer (HAT)	Site Transporter (170-HAT0-MEQ-00001)		Protect against tipover of the site transporter	<i>H.WH.HAT.01</i> The mean frequency of tipover of the site transporter due to the spectrum of seismic events shall be less than or equal to 2×10^{-06} /yr.	WHF-S-IE-TAD-AO (Seq. 14-5)	S-050-WHF-ST-SLIDE
			Protect against sliding impact and inducing stresses on the waste container	<i>H.WH.HAT.02</i> The mean frequency of sliding impact of the site transporter into a wall and inducing stresses that can breach a waste container due to the spectrum of seismic events shall be less than or equal to 2×10^{-05} /yr.	WHF-S-IE-TAD-AO (Seq. 14-5)	S-050-WHF-ST-SLIDE
Aging Handling/ Aging Overpack (HAC)	Aging Overpack Access Platform (050-HAC0-PLAT-00001)		Protect against platform collapse	<i>H.WH.HAC.01</i> The mean frequency of collapse of the aging overpack access platform due to the spectrum of seismic events shall be less than or equal to 3×10^{-06} /yr.	WHF-S-IE-TAD-AO (Seq. 15-5)	S-050-WHF-AOAP-COL
			Protect against platform collapse or waste container breach due to an impact from the site transporter	<i>H.WH.HAC.</i> The mean frequency of platform collapse or waste container breach from the impact of the site transporter onto the platform due to the spectrum of seismic events shall be less than or equal to 2×10^{-05} /yr.	WHF-S-IE-TAD-AO (Seq. 14-5)	S-050-WHF-ST SLIDE
All	Cask Support Frame (TAD closure station: 050-HC00-FRM-00001, DPC cutting station: 050-HD00-FRM-00001, Preparation station #2: 050-HMH0-FRM-00001)		Protect against tipover of a cask	<i>H.WH.01</i> The mean frequency of failure of the cask support frame and anchorage due to the spectrum of seismic events shall be less than or equal to 6×10^{-05} /yr.	WHF-S-IE-TAD-AO (Seq. 08)	S-050-WHF-TC-PS2-COL
All	Cask, Canister, and Aging Overpack Grapples, Yokes, and Adapters		Protect against waste container or heavy object drop from a crane	<i>H.WH.02</i> The mean frequency of a hoist system failure (induced by a seismic event) due to the failure of grapples, yokes, and adapters used in the load-bearing path shall have the same (or less) frequency as specified for the crane or machine on which the component is used.	See the corresponding hoist system failure information for appropriate crane.	See the corresponding hoist system failure information for appropriate crane.

NOTE: ^a. Control values shown represent the integration of the probability distribution of SSC failure (i.e., the loss of safety function) with the site seismic hazard curve (see Fig. 6.1-1).

CTT = cask transfer trolley; DPC = dual-purpose canister; SFTM = spent fuel transfer machine; SNF = spent nuclear fuel; TAD = transportation, aging and disposal; WHF= Wet Handling Facility.

Source: Original

Table 6.10-5. Preclosure Nuclear Safety Design Bases for Seismic Event Sequences for Intra-Site and Balance of Plant Operations

System or Facility (System Code)	Subsystem (Subsystem Code) (As Applicable)	Component (Component Code) (As Applicable)	Nuclear Safety Design Bases		Bounding Affiliated Event Sequence (Sequence Number)	Source
			Safety Function	Controlling Parameters and Values ^a		
Aging Facility (AP)	Facility	Aging Pad	Protect against aging overpack tipover	<i>AP.01</i> The mean frequency of aging pad structure failure causing aging overpack tipover due to the spectrum of seismic events shall be less than or equal to 1×10^{-05} /yr.	ISO-IE-S-MAIN (Seq. 03)	S-ISO-AO-FAIL-FT
Mechanical Handling System (H)	Aging Handling / Cask Transfer (HAT)	Site Transporter (170-HAT0-MEQ-00001)	Protect against tipover of the site transporter	<i>H.AP.HAT.01</i> The mean frequency of tipover of the site transporter due to the spectrum of seismic events shall be less than or equal to 2×10^{-06} /yr.	ISO-IE-S-MAIN (Seq. 04)	S-ISO-ST-FAIL-FT
		Cask Transfer Trailer (170-HAT0-TRLY-00001 to -00002)	Preclude puncture of a cask	<i>H.AP.HAT.02</i> The cask transfer trailer shall be designed to preclude puncture of a cask due to the spectrum of seismic events.	Screened from consideration	Section 6.2.2.2
	Aging Handling/ Aging Overpack (HAC)	Horizontal Aging Module (170-HAC0-ENCL-00001)	Protect against structural collapse onto a waste container	<i>H.AP.HAC.01</i> The mean frequency of collapse of the horizontal aging module structure due to the spectrum of seismic events shall be less than or equal to 2×10^{-06} /yr.	ISO-IE-S-MAIN (Seq. 07)	S-ISO-HAM-COL-FT
		Aging Overpack (170-HAC0-ENCL-00002 to -00003)	Protect against sliding of an aging overpack	<i>H.AP.HAC.02</i> The mean frequency of sliding of an aging overpack (with waste container) into another aging overpack on the aging pad due to the spectrum of seismic events shall be less than or equal to 5×10^{-06} /yr.	ISO-IE-S-MAIN (Seq. 06)	S-ISO-AO-FAIL-FT
			Protect against tipover of an aging overpack	<i>H.AP.HAC.03</i> The mean frequency of tipover of the aging overpack on the aging pad due to the spectrum of seismic events shall be less than or equal to 5×10^{-06} /yr.	ISO-IE-S-MAIN (Seq. 06)	S-ISO-AO-FAIL-FT

NOTE: ^a Control values shown represent the integration of the probability distribution of SSC failure (i.e., the loss of safety function) with the site seismic hazard curve (see Fig. 6.1-1).

Source: Original

Table 6.10-6. Preclosure Nuclear Safety Design Bases for Seismic Event Sequences for Subsurface Operations

System or Facility (System Code)	Subsystem (Subsystem Code) (As Applicable)	Component (Component Code) (As Applicable)	Nuclear Safety Design Bases		Bounding Affiliated Event Sequence (Sequence Number)	Source
			Safety Function	Controlling Parameters and Values ^a		
Emplacement and Retrieval and Drip Shield Installation (HE)		Transport and Emplacement Vehicle	Protect against tipover of the transport and emplacement vehicle	<i>H.SS.HE.01</i> The mean frequency of tipover of the transport and emplacement vehicle due to the spectrum of seismic events shall be less than or equal to 2×10^{-06} /yr.	SSO-IE-S-MAIN (Seq. 03)	S-SSO-FT-TEV-FAIL
			Protect against ejection of the waste package from the shielded enclosure of the transport and emplacement vehicle	<i>H.SS.HE.02</i> The mean frequency of ejection of a waste package from the transport and emplacement vehicle due to the spectrum of seismic events shall be less than or equal to 2×10^{-04} /yr.	SSO-IE-S-MAIN (Seq. 03)	S-SSO-FT-TEV-FAIL
DOE and Commercial Waste Package System (DS)	DOE and Commercial Waste Package	Entire	Provide containment (Protect against rockfall breaching a waste package)	<i>DS.SS. 1</i> The mean frequency of breach of the waste package from a rockfall due to the spectrum of seismic events shall be less than or equal to 1×10^{-06} /yr.	Based on screening analyses of physical and thermal impacts from rockfalls	See Section 6.9.2
			Protect against waste package breach due to seismic vibratory motion in an emplacement drift	<i>DS.SS. 2</i> The mean frequency of breach of the waste package from vibratory motion impacts in an emplacement drift due to the spectrum of seismic events shall be less than or equal to 1×10^{-06} /yr.	Based on screening analysis of waste package impacts in the emplacement drift	See Section 6.9.2
Naval SNF Waste Package System (DN)	Naval SNF Waste Package	Entire	Protect against rockfall breaching a waste package	<i>DN.SS.01</i> The mean frequency of breach of the waste package from a rockfall due to the spectrum of seismic events shall be less than or equal to 1×10^{-06} /yr	Based on screening analyses of physical and thermal impacts from rockfalls	See Section 6.9.2
			Protect against waste package breach due to seismic vibratory motion in an emplacement drift	<i>DN.SS.02</i> The mean frequency of breach of the waste package from vibratory motion impacts in an emplacement drift due to the spectrum of seismic events shall be less than or equal to 1×10^{-06} /yr.	Based on screening analysis of waste package impacts in the emplacement drift	See Section 6.9.2

NOTE: ^a Control values shown represent the integration of the probability distribution of SSC failure (i.e., the loss of safety function) with the site seismic hazard curve (see Fig. 6.1-1).

DOE = U.S. Department of Energy; SNF = spent nuclear fuel.

Source: Original

Table 6.10-7. Summary of Procedural Safety Controls for Seismic Event Sequences

Procedural Safety Controls	Basis for Selection	Event Sequence References
Rock condition is to be observed as emplacement drift boring is accomplished. Observed faults are to be specifically evaluated to ensure that conditions cannot credibly lead to a breach of the waste package during the preclosure period, or a standoff distance from the fault is to be established.	This control is to limit the potential for fault displacement (or related rockfall hazard) from a seismic event to induce a breach of the waste package at rest in an emplacement drift during the preclosure period.	Required to screen out fault displacement event sequences (see Section 4.4.10). Based on Ref. 2.2.80, Section 5.1.
When not in use, cranes, mobile platforms, and handling equipment are maintained in a location such that they cannot fall on a waste form container.	To limit the exposure time of components over waste form containers such that a seismic event will not cause the component to fall on the waste form container.	Required to reduce the probability of 2-over-1 seismic interaction event sequences from further consideration (see Section 6.2.2.6).
The amount of time that a waste form container spends in each process area or in a given process operation, including total residence time in a facility, is periodically compared against the average exposure times used in the PCSA. Significant deviations will be analyzed for risk significance.	The seismic PCSA uses exposure and residence times to calculate the probability of seismic induced failures leading to an event sequence. This control ensures that the average exposure times are maintained consistent with those used in the PCSA.	Required as basis for exposure/residence times presented in Attachment G, particularly for the processing times of a naval canister in the IHF.
When transferring waste form containers, the crane will remain connected to the waste form container until the proper seismic restraints are established.	Certain equipment, such as the CTT and cask support frames, have built-in seismic restraints that stabilize the cask and prevent cask tipover. During cask transfer, however, the crane must provide seismic stability until the equipment seismic restraints are engaged.	Required to screen out potential cask tipover event sequences due to seismic events before restraints are engaged (see Section 6.2.2.5).

NOTE: CTT = cask transfer trolley; IHF = Initial Handling Facility; PCSA = preclosure safety analysis.

Source: References as noted.

7. RESULTS AND CONCLUSIONS

This seismic event sequence analysis is part of the PCSA of the GROA that supports the license application. It provides categorization of seismic event sequences for the IHF, RF, CRCF, WHF, Intra-Site Operations, and Subsurface Operations, and other results as described in Table 7-1. The results of this analysis are intended for use as inputs to the technical products listed in Section 2.4.

For the facilities, the analysis identifies no Category 1 seismic event sequences. The number of Category 2 seismic event sequences which involves facility worker exposure to radiation or radioactive materials is:

- IHF: No Category 2 seismic event sequences
- RF: No Category 2 seismic event sequences
- CRCF: Two Category 2 seismic event sequences
- WHF: Two Category 2 seismic event sequences
- ISO: One Category 2 seismic event sequence
- SSO: One Category 2 seismic event sequence.

For both the CRCF and the Subsurface Operations, one of the Category 2 seismic event sequences represents a scenario where the waste package is inside the TEV, and the earthquake causes the closure bolt on the shield door to fail. The waste package slides out through the open shield door and impacts the CRCF floor, or the ground at an angle. The waste package and canister are not breached, but since they are outside the TEV shielding, the shielding has been lost. Therefore this sequence is not a radionuclide release, but a loss of shielding of the waste package. Since this is not a Category 1 event sequence, and there is no radionuclide release, no consequence analysis is necessary, and the event sequence is acceptable under the 10 CFR Part 63 criteria.

The second CRCF Category 2 seismic event sequence represents a failure of the CTM while handling or over a HLW canister. Although the HLW canister could be breached in this scenario, the potential radionuclide release from the vitrified waste is very limited, and the offsite dose has been determined to be extremely small (Ref. 2.2.69, Bounding Consequence 2-03), thus easily meeting the 10 CFR Part 63 offsite dose criteria.

The first WHF Category 2 event sequence represents a failure of the HVAC system integrity, potentially resulting in a release of any radioactive material that is in the HVAC ducts and filters. A bounding consequence analysis has been performed for this limited release, and the offsite dose has been determined to be extremely small (Ref. 2.2.69, Bounding Consequence 2-01), thus easily meeting the 10 CFR Part 63 offsite dose criteria.

The second WHF Category 2 seismic event sequence represents the tipover of a truck cask containing bare SNF assemblies while in the WHF pool. If the assemblies were to fail, any potential release would be scrubbed by the pool water, limiting the release primarily to a gaseous release. A bounding consequence analysis has been performed for this limited release, and the offsite dose has been determined to be extremely small (Ref. 2.2.69, Bounding Consequence 2-06), thus easily meeting the 10 CFR Part 63 offsite dose criteria.

The final Category 2 seismic event sequence, from Intra-Site Operations, represents the collapse of the LLW Facility due to the earthquake, damaging the LLW containers stored at the facility. Because of the small release and the large distances to the site boundary, offsite dose due to this Category 2 event sequence would be very low (Ref. 2.2.69, Bounding Consequence 2-01), and easily meet the 10 CFR Part 63 dose criteria.

It should also be noted that the event sequence identification and categorization were conducted with many conservatisms built into the analysis inputs. Since the purpose of the analysis was to demonstrate compliance with 10 CFR Part 63, the assessment was generally only detailed sufficiently to demonstrate that the seismic event sequences could be screened out as beyond Category 2, or demonstrate that the offsite dose consequences would be relatively insignificant. Therefore, once an event sequence became beyond Category 2, and was screened out, further analysis was ended, leaving conservatisms in the assessment. Some of the more important conservatisms included the following:

- The throughput analysis (Ref. 2.2.51), in some cases, is based on doubling or tripling the probable available quantity of waste containers to account for the uncertainty in the partitioning of these waste containers (e.g., of about 346 DPCs available for transfer in the RF, the throughput analysis considers 346 DPCs are transferred from vertical transportation casks to aging overpacks, another 346 DPCs are transferred from horizontal transportation casks to aging overpacks, and another 346 DPCs are transferred from the horizontal transportation casks to the horizontal cask transfer trailer). By including this conservatism in the analysis, the event sequence quantification results would be higher than they should be.
- In many of the breach sequences, the structural PEFA used a conservative failure probability of 1E-5, whereas the actual PEFA assessment indicates values of less than 1E-8 failure probabilities (Attachment H). This conservatism, again, provides event sequence quantification results that are orders of magnitude higher than what they would be if the actual PEFA assessment values had been used.
- Many of the waste container breach failure probabilities (PEFAs) were conservatively considered to be one (1), indicating that the container would always be breached for that sequence. However, there are many seismic event sequences where this is a very conservative selection. For example, structural failure of a platform, such as the cask preparation platform, was considered to collapse the platform, tip over the CTT or site transporter, damage the transportation cask or aging overpack, and then breach the canister contained inside the cask or overpack. This cascading set of worst case scenarios, and other similarly unlikely sets of events, was conservatively selected as the outcome for many of the seismic event sequences.

- The ETFs, indicating the time that the waste container was subject to a particular risk scenario, were conservatively calculated. For example, one failure mode of the cranes considered the collapse of the crane onto a waste container. When calculating the time that the crane was over the waste container, the time approaching the container, and again when leaving the container was conservatively included in the ETF. This easily tripled the time that the crane would actually be over the waste container. The same was true for heavy object drops and other ETF calculations. When the facilities are being operated, the actual times when the waste containers are at risk can be better determined, and this conservatism can be reduced.
- Another conservatism with the cranes is the use of the seismic fragility calculated when the crane is at maximum load. In fact, the seismic median fragility that could be used for heavy object drops would be considerably higher (that is, stronger) than for the crane at maximum load. For example, the CRCF cask handling crane is rated at 200 tons, while the heavy object drop considered loads of 10 tons. At this reduced load of 10 tons, the median fragility would be much higher, such that a crane failure would be much less likely. The use of maximum stresses due to the maximum loads is very conservative, both for crane collapse, and for heavy object drops.
- As discussed in Section 4.5.3.4, seismic successes were not included in the seismic event sequence quantification. This introduces conservatism in the individual event sequence probabilities.
- As discussed in Section 4.3.3.1, it was decided to conservatively model the confinement/HVAC as always failed if the seismic event caused a breach of a waste container. While this is conservative, it simplified the fault tree modeling since offsite power and recovery, onsite emergency power and recovery, and the HVAC system did not require models for the seismic assessment.
- Event sequences involving loss or degraded shielding attributed to lead transportation cask are overly conservative since the analysis considered that all transportation casks involved in any event sequences are fabricated as leaded casks, but in reality, not all transportation casks received at the GROA will be leaded casks. Since non-lead casks are not affected by this degraded shielding condition, and only lead casks are, the introduction of this conservatism would result in an increase in the affected event sequence quantification value.
- No credit was taken for any operator actions to intervene in potential accident sequences, and prevent waste container breach.

Uncertainties were extensively considered in both the seismic hazard curve and the equipment seismic fragilities, although the “convolution” quantification process results in a mean value only. This mean value is the best single value representation of the underlying uncertainties. A full uncertainty analysis was not performed (or required) for the seismic event sequence assessment. However, as discussed above, there were many conservatisms in the two other main portions of the seismic analysis, the development of the breach probabilities (PEFAs), and the ETFs. Based on the uncertainties and conservatisms included in the supporting assessments, the seismic event sequence results are considered to be a very conservative representation of the seismic risk.

Table 7-1. Key to Results

Result	Description	IHF	RF	CRCF	WHF	ISO	SSO
Quantification and categorization of seismic event sequences	Calculation of the numbers of occurrences of seismic event sequences over the preclosure period, and assignment of event sequences to Category 1, Category 2, or beyond Category 2	Table 6.4-4	Table 6.5-6	Table 6.6-8	Table 6.7-6	Table 6.8-3	Table 6.9-3
Designation of SSCs as ITS	Identification of SSCs that are relied on in the quantification of internal event sequences for prevention or mitigation	Table 6.10-1	Table 6.10-2	Table 6.10-3	Table 6.10-4	Table 6.10-5	Table 6.10-6
Statement of Nuclear Safety Design Bases	Determination of nuclear safety design bases for SSCs that are relied on in the quantification of internal event sequences for prevention or mitigation	Table 6.10-1	Table 6.10-2	Table 6.10-3	Table 6.10-4	Table 6.10-5	Table 6.10-6
Statement of procedural safety controls	Determination of procedural safety controls that are relied on in the quantification of internal event sequences for prevention or mitigation	Table 6.10-7					

NOTE: CRCF = Canister Receipt and Closure Facility; IHF = Initial Handling Facility; ISO = Intra-Site Operations; ITS = important to safety; RF = Receipt Facility; SSCs = structures, systems, and components; SSO = Subsurface Operations; WHF = Wet Handling Facility

Source: Original

ATTACHMENT A INITIAL HANDLING FACILITY ANALYSES

This attachment contains detailed information for the IHF seismic event sequence analysis:

- IET and SRETs
- Event tree to fault tree assignment tables
- Fault trees
- Non-seismic basic event tables
- Seismic basic event tables
- Event sequence probability tables
- Event sequence cut set tables.

The IHF analysis covers processing of naval canisters and HLW canisters, to include the following:

- 1 Processing of naval canisters from railcars with transportation casks entering the IHF to waste packages in TEVs leaving the IHF
- 2 Processing of HLW canisters from trucks with transportation casks entering the IHF to waste packages in TEVs leaving the IHF. (Note that this scenario bounds the case with railcars with HLW, since a railcar transportation cask has five HLW canisters, compared to a truck cask, which has only one HLW canister. Thus, the railcar cask is only handled by cranes and trolleys once per five HLW canisters, while five truck casks must be handled to process the same number of HLW canisters.)

A1 NAVAL CANISTERS

This section provides the detailed information used to develop the event sequences for the analysis of processing of the naval canisters inside the IHF. Naval canisters inside a transportation cask are received on railcars, and are transferred into a waste package, sealed, and then transported in a TEV out of the IHF. Transport to the emplacement drifts is not included in this section.

A1.1 EVENT TREES

The IET and SRETs are presented in this section. Tables A1.1-1 and A1.1-2 provide the assignments between the event tree branches and the fault trees given in the next section.

Seismic Event	Number of Naval canisters processed in IHF	Identify initiating seismic failure			
SEIS-EVENT	IHF-NVL-CAN	SEIS-FAIL		#	END-STATE
				1	OK
		IHF building collapse		2	OK
		Entry door seismic collapse		3	RR-UNF
		Railcar accident	T => 2	4	IHF-S-R-TC1
		Mobile platform seismic collapse	T => 2	5	IHF-S-R-TC1
		CHC seismic failures	T => 2	6	IHF-S-R-TC1
		CPC seismic failures	T => 2	7	IHF-S-R-TC1
		Cask prep platform collapse	T => 2	8	IHF-S-R-TC1
		CTT seismic failures	T => 2	9	IHF-S-R-TC1
		Shield door seismic failure	T => 2	10	IHF-S-R-TC1
		CTM seismic failures	T => 3	11	IHF-S-R-SD1
		RHS-robotic arm seismic failures	T => 4	12	IHF-S-R-CTM
		WPTT tipover	T => 5	13	IHF-S-R-WP1
		WPHC seismic failures	T => 5	14	IHF-S-R-WP1
		TEV seismic failures	T => 5	15	IHF-S-R-WP1
			T => 6	16	IHF-S-R-TEV

IHF-S-IE-NVL - IHF Seismic Event Tree - Initiating seismic failures

2007/12/13 Page 1

NOTE: Event tree branch captions are associated with the branch line below the caption.

CAN = canister; CHC = cask handling crane; CPC = cask preparation crane; CTM = canister transfer machine; CTT = cask transfer trolley; IHF = Initial Handling Facility; NVL = naval; RHS = remote handling system; RR = radioactive release; SD = shield door; SEIS = seismic; T = transfer; TC = transportation cask; TEV = transport and emplacement vehicle; UNF = unfiltered; WP = waste package; WPHC = waste package handling crane; WPTT = waste package transfer trolley.

Source: Original

Figure A1.1-1. IHF Seismic Event Tree IHF-S-IE-NVL – Initiating Seismic Failures

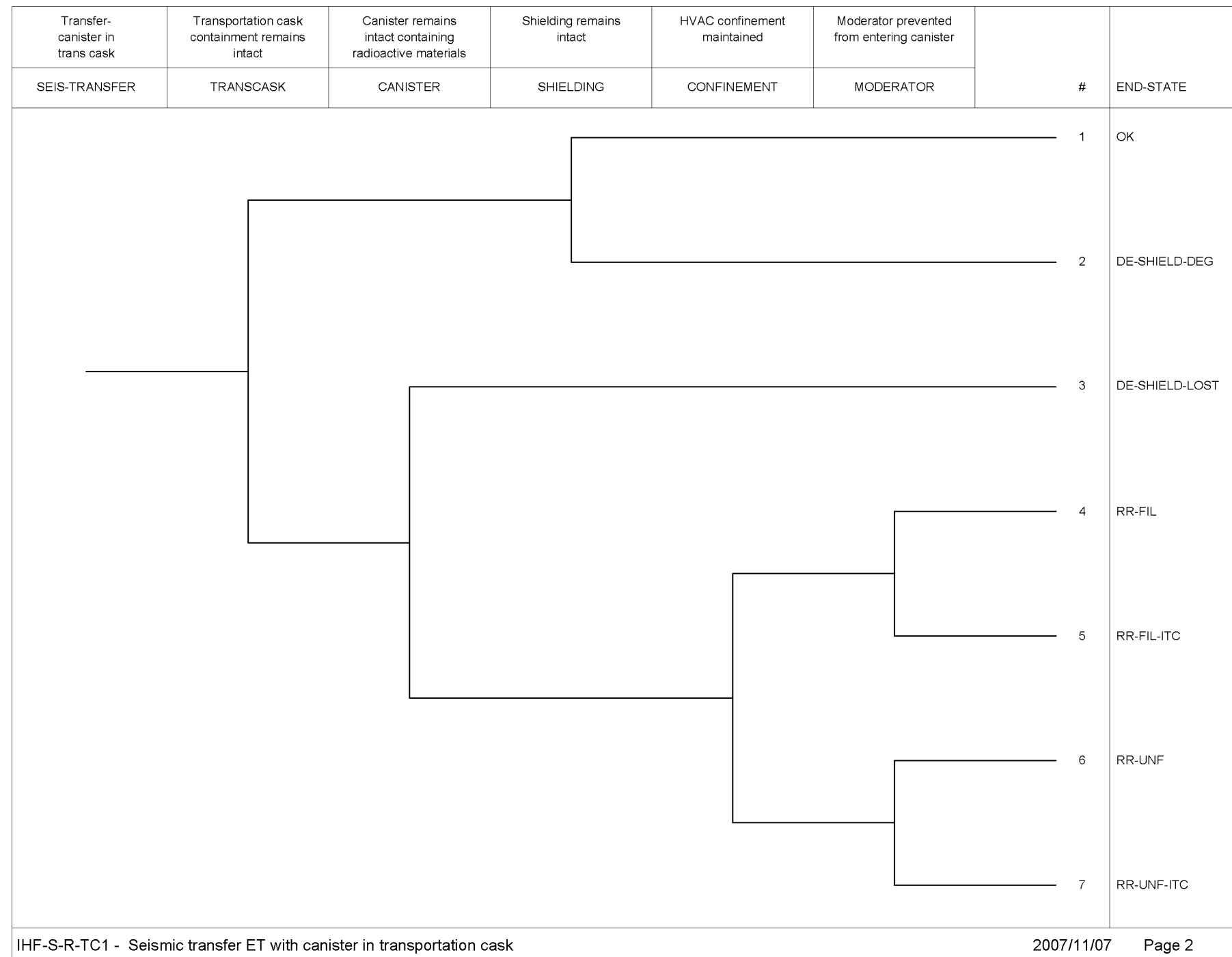

NOTE: DE = direct exposure; DEG = degradation; ET = event tree; FIL = filtered; HVAC = heating, ventilation and air conditioning; IHF = Initial Handling Facility; ITC = important to criticality; RR = radioactive release; SEIS = seismic; TC = transportation cask; UNF = unfiltered.

Source: Original

Figure A1.1-2. IHF Seismic Event Tree IHF-S-R-TC1 – Seismic Transfer ET with Canister in Transportation Cask

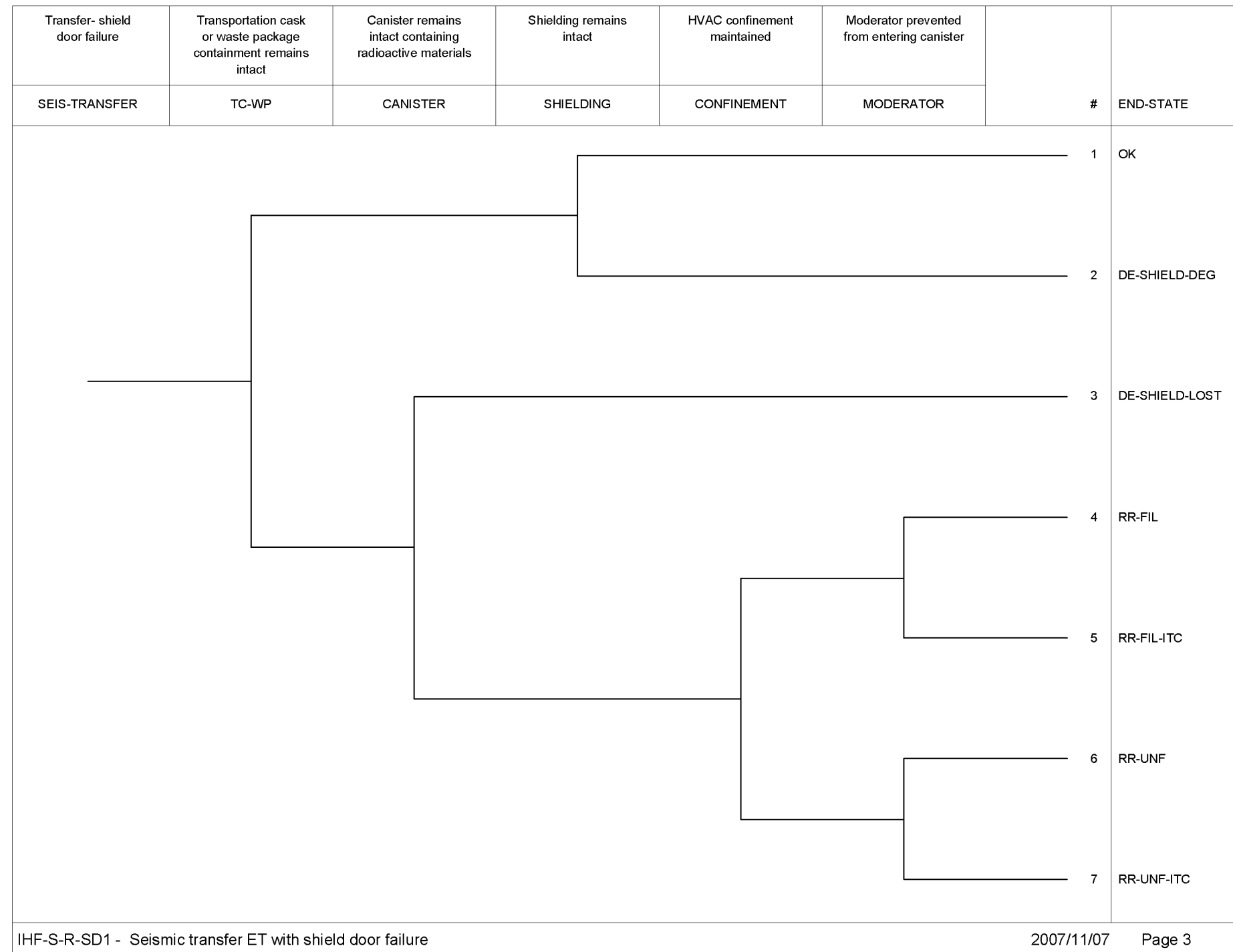

NOTE: DE = direct exposure; DEG = degradation; ET = event tree; FIL = filtered; HVAC = heating, ventilation and air conditioning; IHF = Initial Handling Facility; ITC = important to criticality; RR = radioactive release; SD = shield door; SEIS = seismic; TC = transportation cask; UNF = unfiltered; WP = waste package.

Source: Original

Figure A1.1-3. IHF Seismic Event Tree IHF-S-R-SD1 – Seismic Transfer ET with Shield Door Failure

Transfer- CTM failures	Canister remains intact containing radioactive materials	Shielding remains intact	HVAC confinement maintained	Moderator prevented from entering canister		
SEIS-TRANSFER	CANISTER	SHIELDING	CONFINEMENT	MODERATOR	#	END-STATE
					1	OK
					2	DE-SHIELD-LOST
					3	RR-FIL
					4	RR-FIL-ITC
					5	RR-UNF
					6	RR-UNF-ITC
IHF-S-R-CTM - Seismic transfer ET with CTM operations					2007/11/07	Page 4

NOTE: CTM = canister transfer machine; DE = direct exposure; ET = event tree; FIL = filtered; HVAC = heating, ventilation and air conditioning; IHF = Initial Handling Facility; ITC = important to criticality; RR = radioactive release; SEIS = seismic; UNF = unfiltered.

Source: Original

Figure A1.1-4. IHF Seismic Event Tree IHF-S-R-CTM – Seismic Transfer ET with CTM Operations

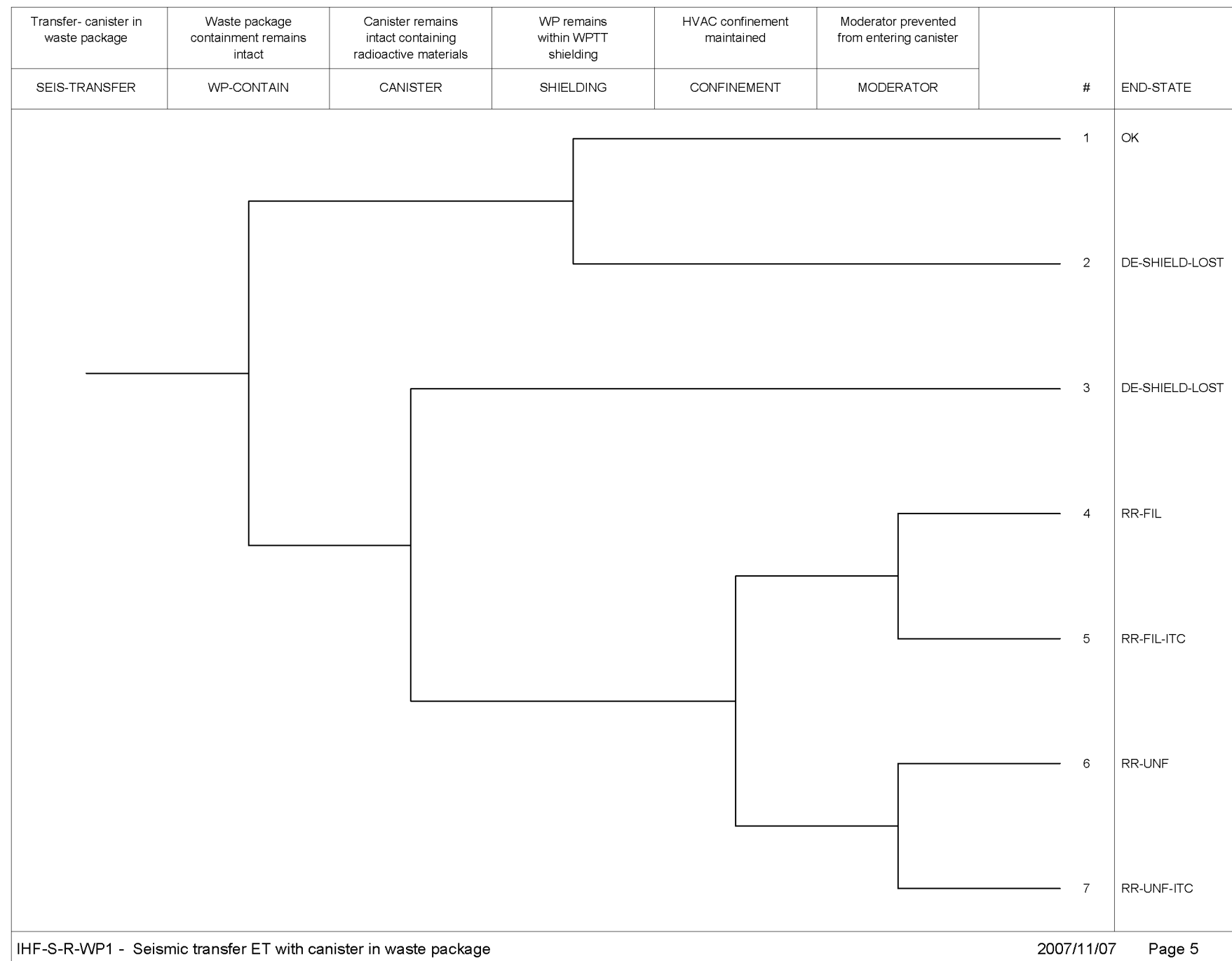

NOTE: CTM = canister transfer machine; DE = direct exposure; ET = event tree; FIL = filtered; HVAC = heating, ventilation and air conditioning; IHF = Initial Handling Facility; ITC = important to criticality; RR = radioactive release; SEIS = seismic; UNF = unfiltered; WP = waste package; WPTT = waste package transfer trolley.

Source: Original

Figure A1.1-5. IHF Seismic Event Tree IHF-S-R-WP1 – Seismic Transfer ET with Canister in Waste Package

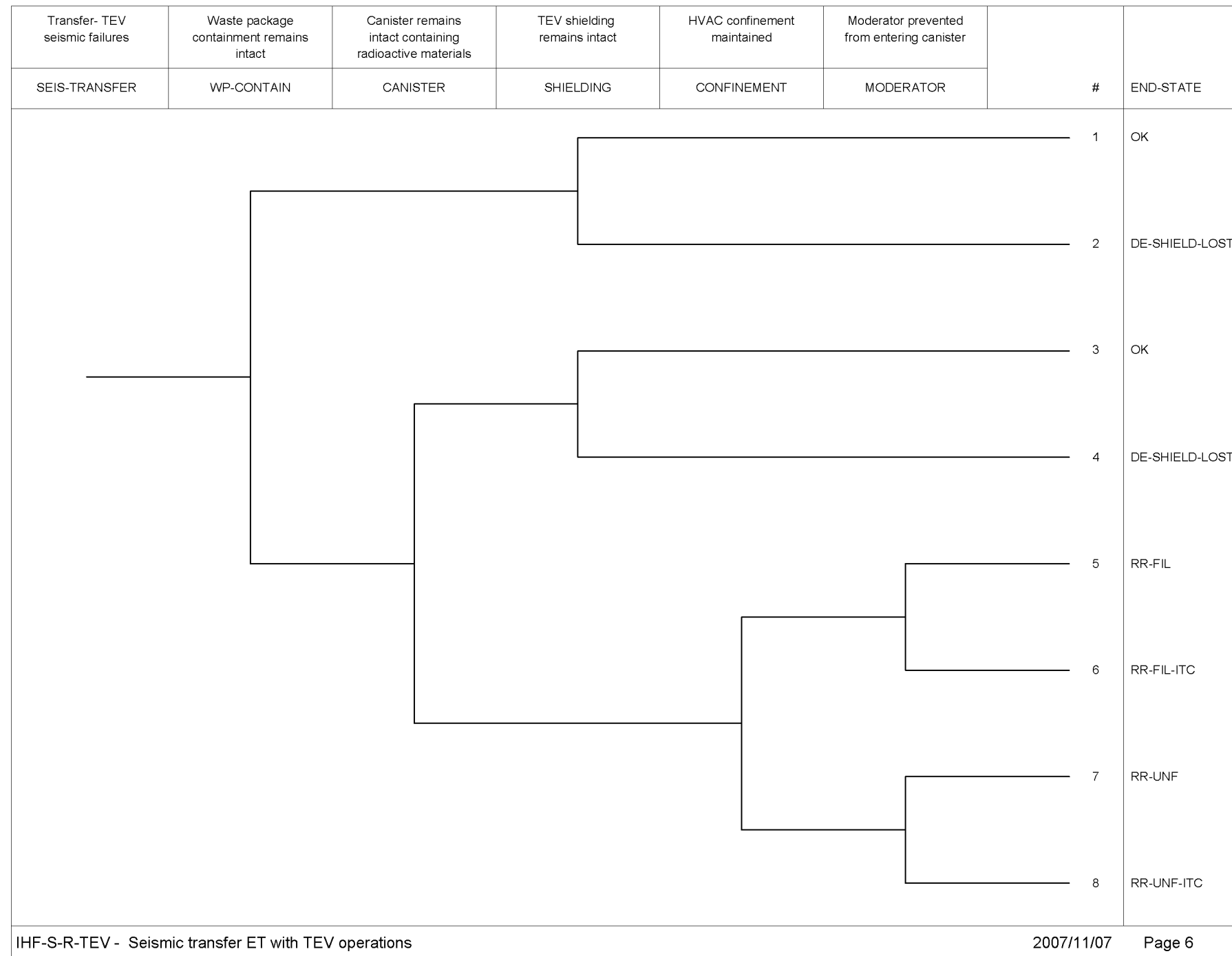

NOTE: DE = direct exposure; ET = event tree; FIL = filtered; HVAC = heating, ventilation and air conditioning; IHF = Initial Handling Facility; ITC = important to criticality; RR = radioactive release; SEIS = seismic; TEV = transport and emplacement vehicle; UNF = unfiltered; WP = waste package.

Source: Original

Figure A1.1-6. IHF Seismic Event Tree IHF-S-R-TEV – Seismic Transfer ET with TEV Operations

Table A1.1-1. Fault Trees Assigned for Initiating Seismic Failures for the IHF

Process	Initiator Event Tree	Initiating Seismic Failure	Associated Fault Tree
Naval Canister	IHF-S-IE-NVL	IHF building collapse	S-51A-NVL-STR-COLLAP
		Entry door seismic collapse	S-51A-NVL-ENTDOORCOL
		Railcar accident	S-51A-NVL-RAILCARACC
		Mobile platform seismic collapse	S-51A-NVL-MOBPLATCOL
		CHC seismic failures	S-51A-NVL-CHC-FAIL
		CPC seismic failures	S-51A-NVL-CPC-FAIL
		Cask prep platform collapse	S-51A-NVL-CPREP-PLAT
		CTT seismic failures	S-51A-NVL-CTT-FAIL
		Shield door seismic failures	S-51A-NVL-SHIELDDOOR
		CTM seismic failures	S-51A-NVL-CTM-FAIL
		RHS - robotic arm seismic failures	S-51A-NVL-RHS-FAIL
		WPTT tipover	S-51A-NVL-WPTT-FAIL
		WPHC seismic failures	S-51A-NVL-WPHC-FAIL
		TEV seismic failures	S-51A-NVL-TEV-FAIL

NOTE: CHC = cask handling crane; CPC = cask preparation crane; CTM = canister transfer machine; IE = initiating event; NVL = naval; RHS = remote handling system; TEV = transport and emplacement vehicle; WPHC = waste package handling crane; WPTT = waste package transfer trolley.

Source: Original

Table A1.1-2. Fault Trees Assigned for Pivotal Events for IHF-S-IE-NVL Initiating Event Tree

Initiating Seismic Failure	TRANSCASK	MODERATOR
IHF building collapse	N/A	N/A
Entry door seismic collapse	RC-NVL-DOORDROP-CASK	IHF-MOD-MULT-SYS
Railcar accident	RC-NVL-RC-ACC-CASK	IHF-MOD-MULT-SYS
Mobile platform seismic collapse	RC-NVL-MOB-PLAT-CASK	IHF-MOD-MULT-SYS
CHC seismic failures	TC-NVL-CHC-CASK	IHF-MOD-MULT-SYS
CPC seismic failures	TC-NVL-CPC-CASK	IHF-MOD-MULT-SYS
Cask prep platform collapse	TC-NVL-CPP-CASK	IHF-MOD-MULT-SYS
CTT seismic failures	CTT-NVL-CTT-CASK	IHF-MOD-FPW-ONLY
TC-WP		
Shield door seismic failures	TCWP-NVL-SHIELDDOOR-CASK	IHF-MOD-MULT-SYS
CANISTER		
CTM seismic failures	CTM-NVL-CTM-CAN	IHF-MOD-FPW-ONLY
WP-CONTAIN		
RHS - robotic arm seismic failures	WPTT-NVL-RHS-FAIL	IHF-MOD-FPW-ONLY
WPTT tipover	WPTT-NVL-WPTT-FAIL	IHF-MOD-FPW-ONLY
WPHC seismic failures	WPTT-NVL-WPHC-FAIL	IHF-MOD-MULT-SYS
TEV seismic failures	TEV-NVL-TEV-FAIL	IHF-MOD-MULT-SYS

NOTE: CHC = cask handling crane; CPC = cask preparation crane; CPP = cask preparation platform; CTM = canister transfer machine; CTT = cask transfer trolley; IE = initiating event; IHF = Initial Handling Facility; NVL = naval; RHS = remote handling system; TC = transportation cask; TEV = transport and emplacement vehicle; WP = waste package; WPHC = waste package handling crane; WPTT = waste package transfer trolley.

Source: Original

A1.2 FAULT TREES

Seismic fault trees for the processing of naval canisters in the IHF are presented in alphanumeric order in this section.

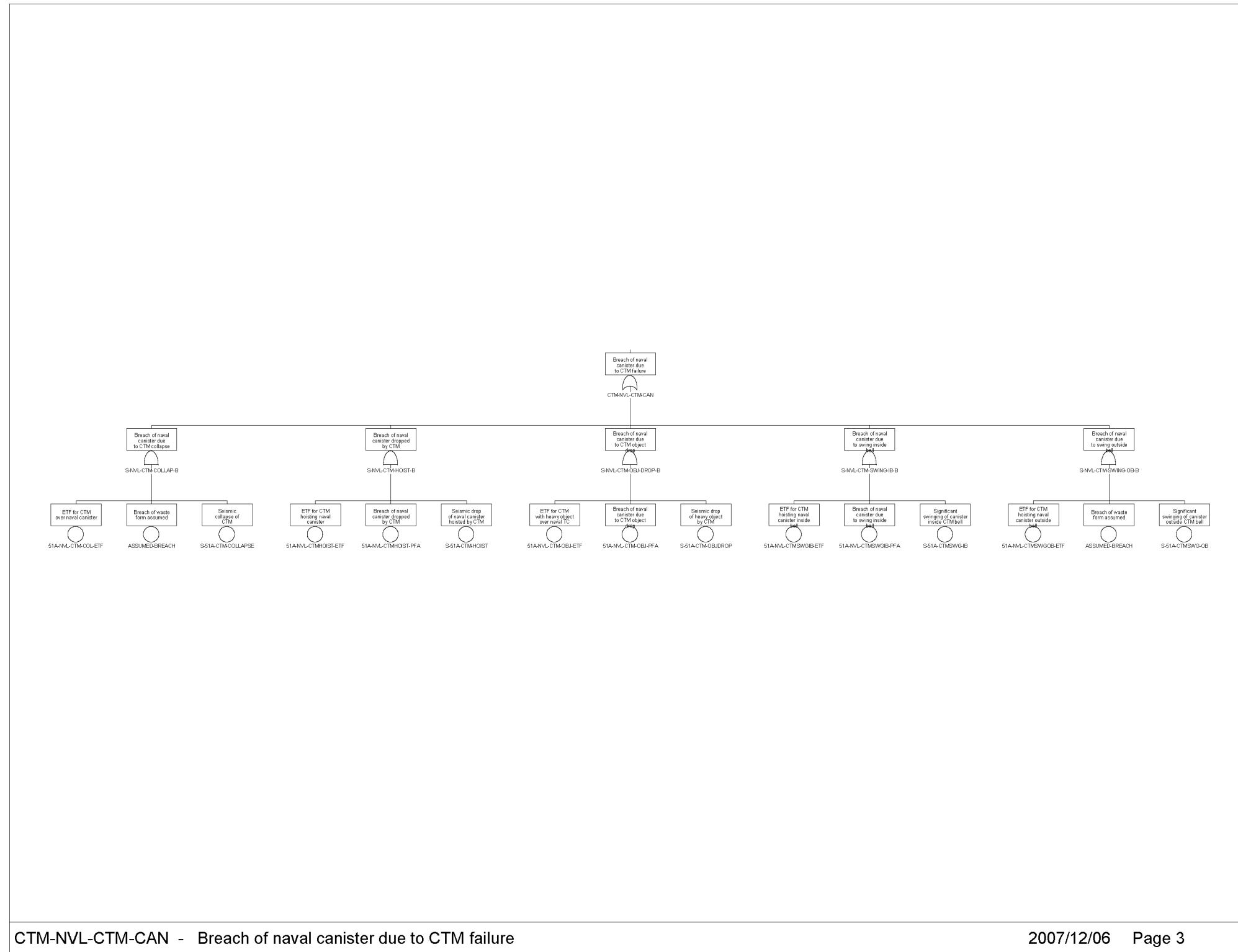

Source: Original

Figure A1.2-1. Fault Tree CTM-NVL-CTM-CAN – Breach of Naval Canister due to CTM Failure

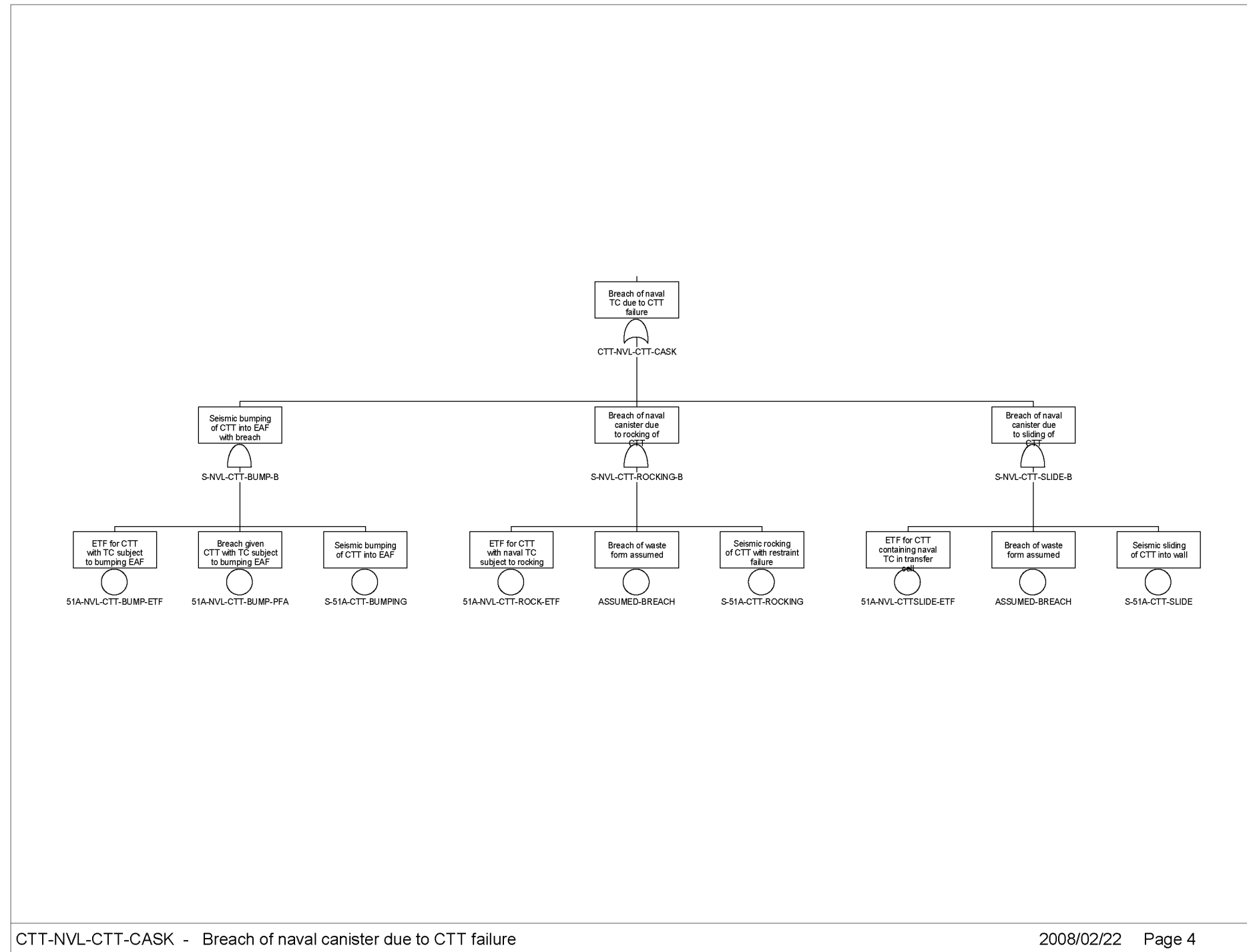

Source: Original

Figure A1.2-2. CTT-NVL-CTT-CASK – Breach of Naval Canister due to CTT Failure

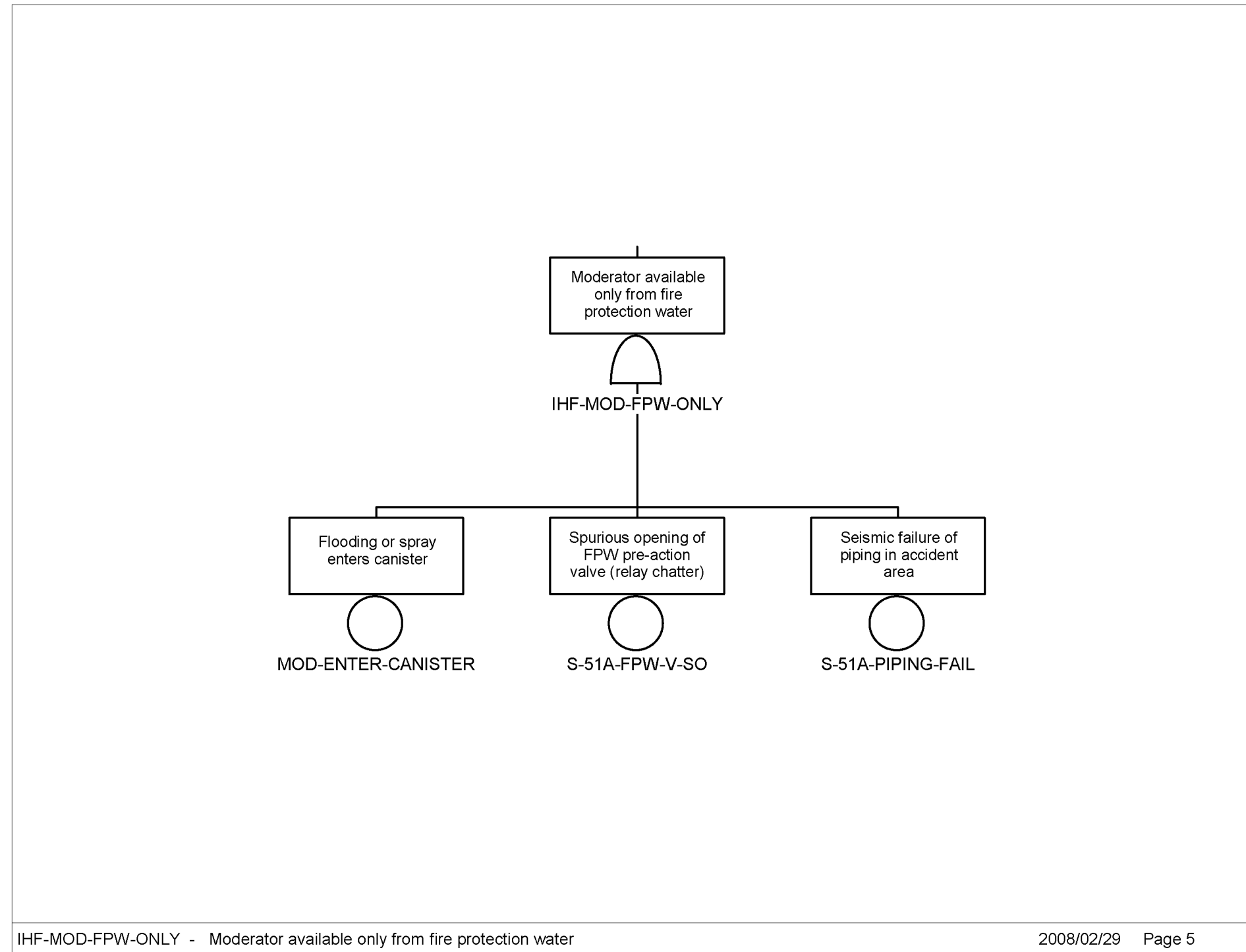

Source: Original

Figure A1.2-3 IHF-MOD-FPW-ONLY – Moderator Available Only from Fire Protection Water

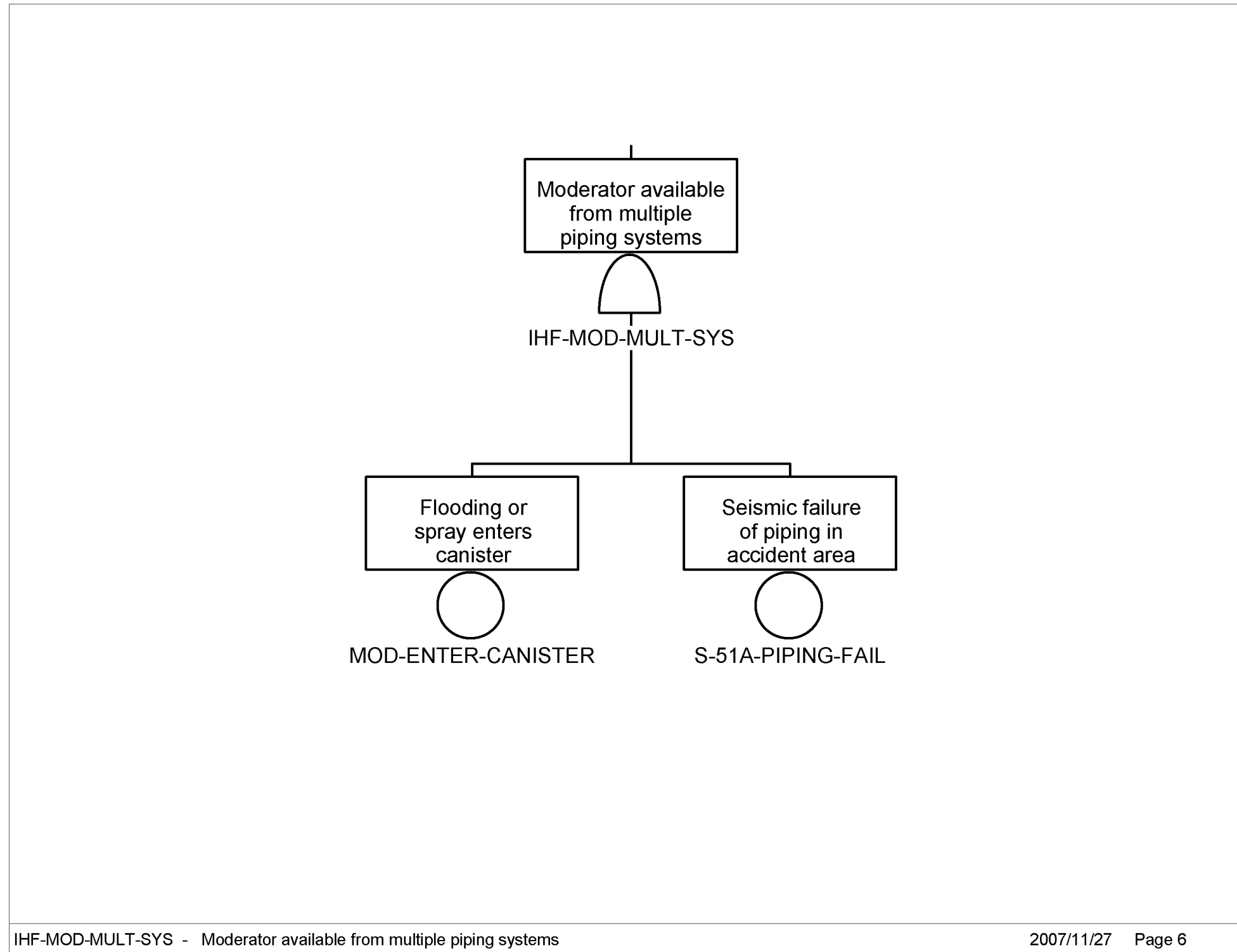

Source: Original

Figure A1.2-4. IHF MOD-MULT-SYS – Moderator Available from Multiple Piping Systems

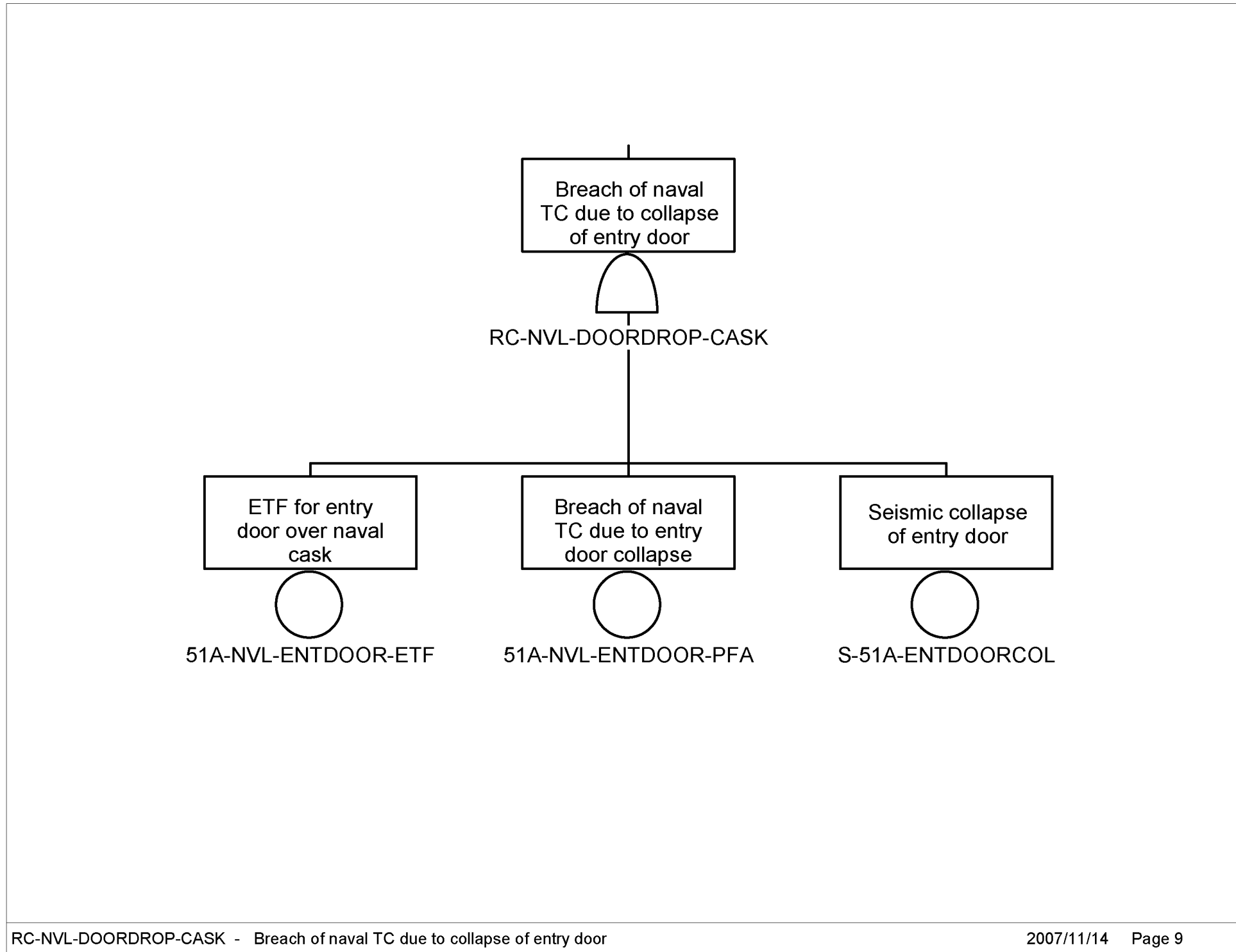

Source: Original

Figure A1.2-5. RC-NVL-DOORDROP-CASK – Breach of Naval TC due to Collapse of Entry Door

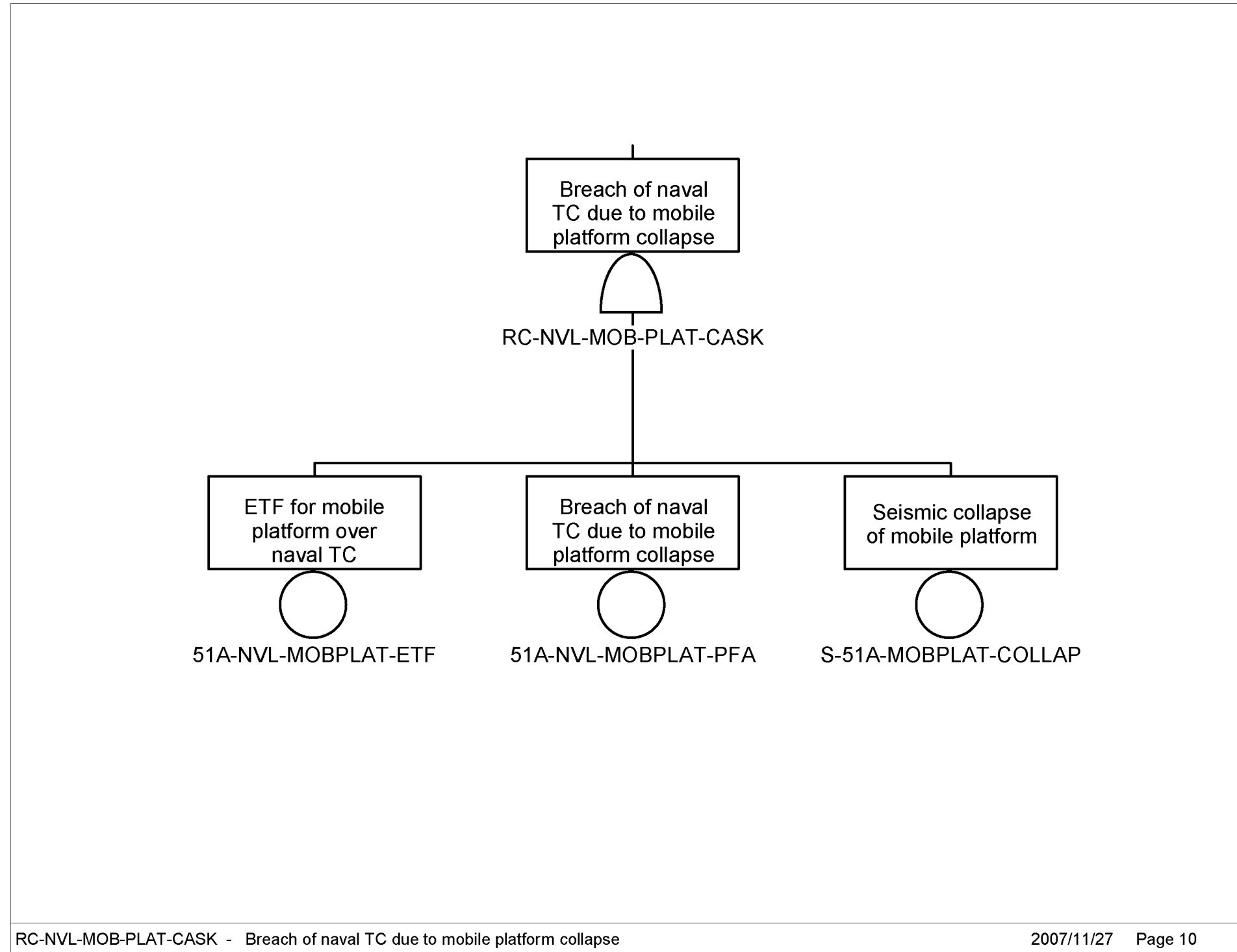

RC-NVL-MOB-PLAT-CASK - Breach of naval TC due to mobile platform collapse

2007/11/27 Page 10

Source: Original

Figure A1.2-6. RC-NVL-MOB-PLAT-CASK – Breach of Naval TC due to Mobile Platform Collapse

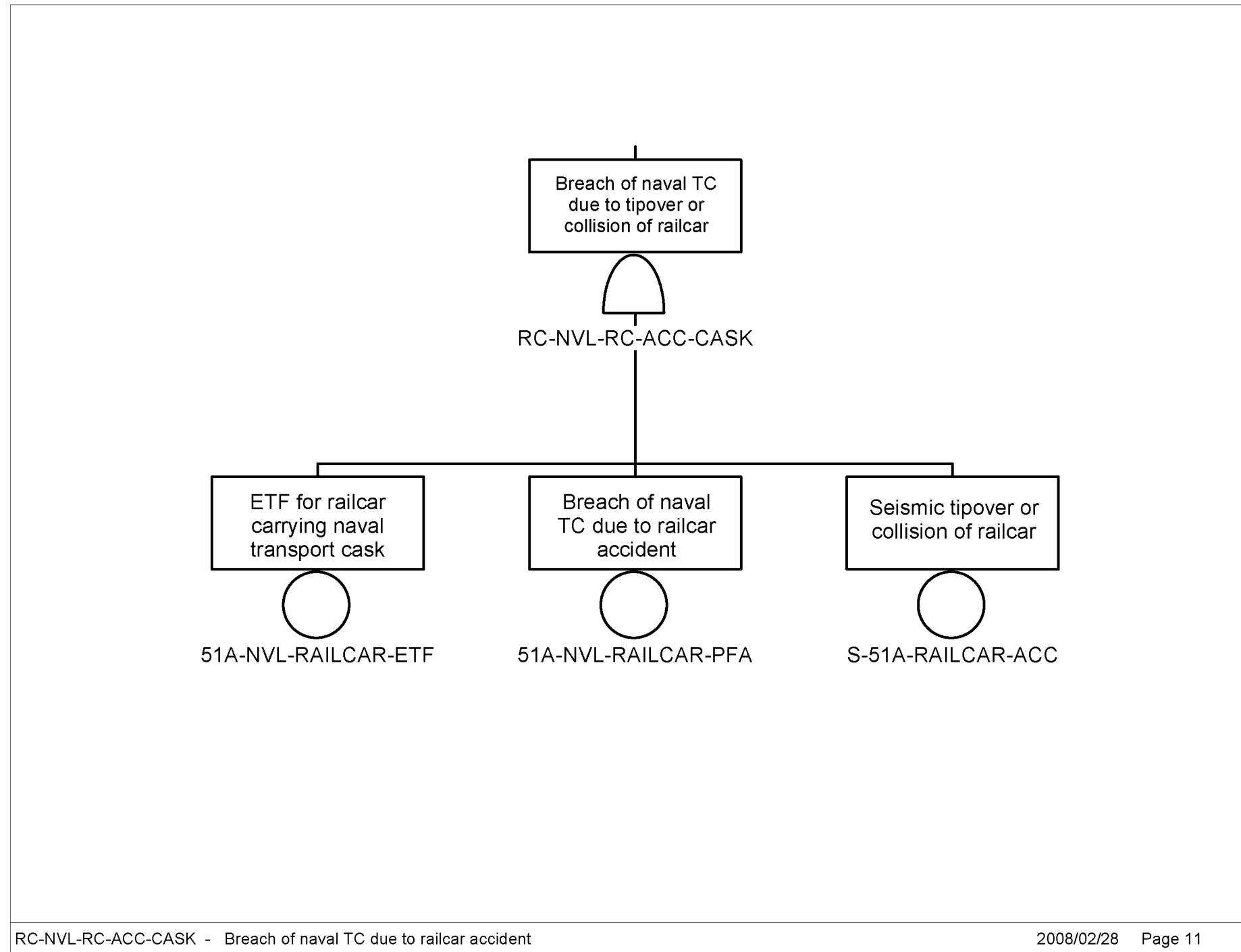

Source: Original

Figure A1.2-7. RC-NVL-RC-ACC-CASK – Breach of Naval TC due to Railcar Accident

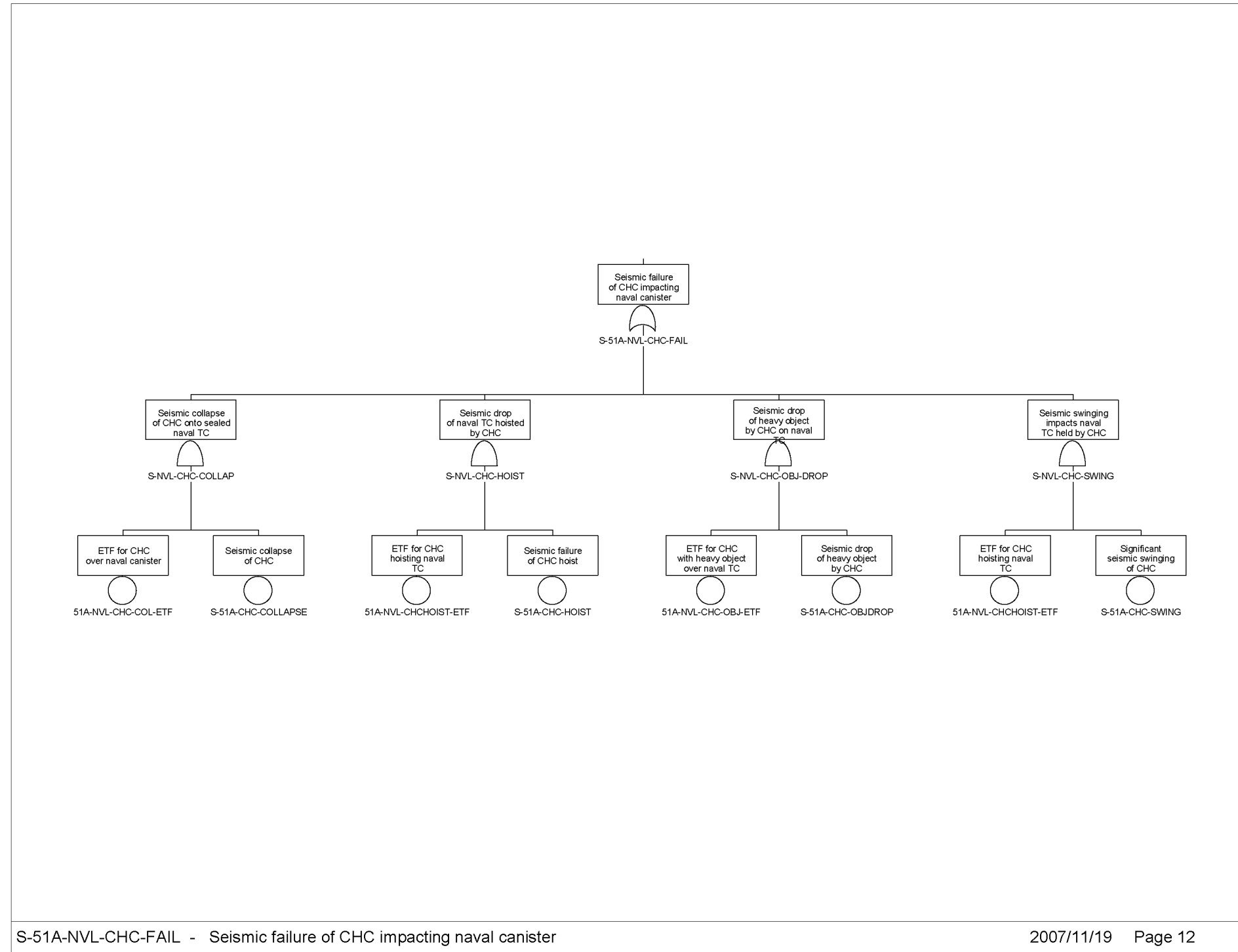

Source: Original

Figure A1.2-8. S-51A-NVL-CHC-FAIL – Seismic Failure of CHC Impacting Naval Canister

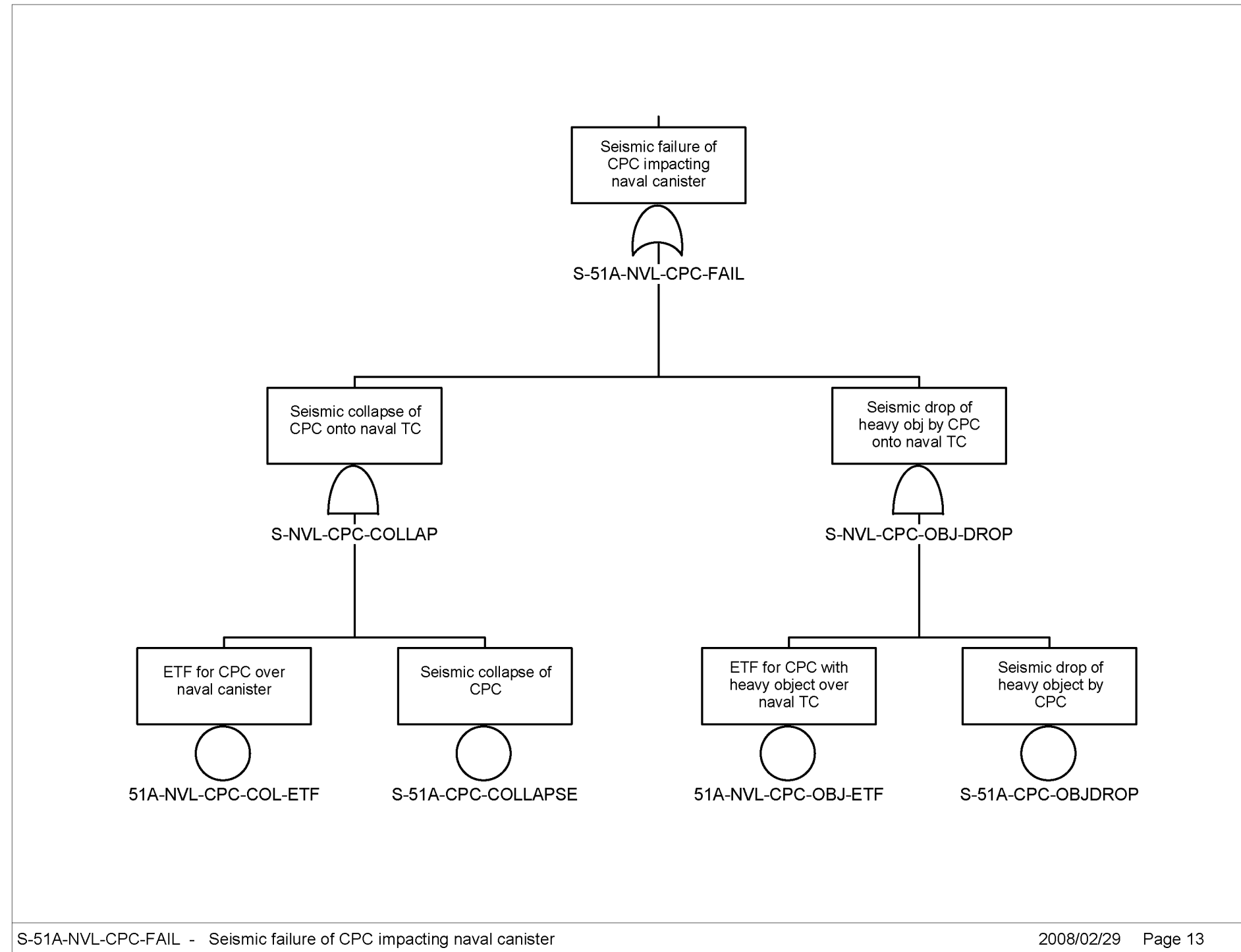

Source: Original

Figure A1.2-9. S-51A-NVL-CPC-FAIL – Seismic Failure of CPC Impacting Naval Canister

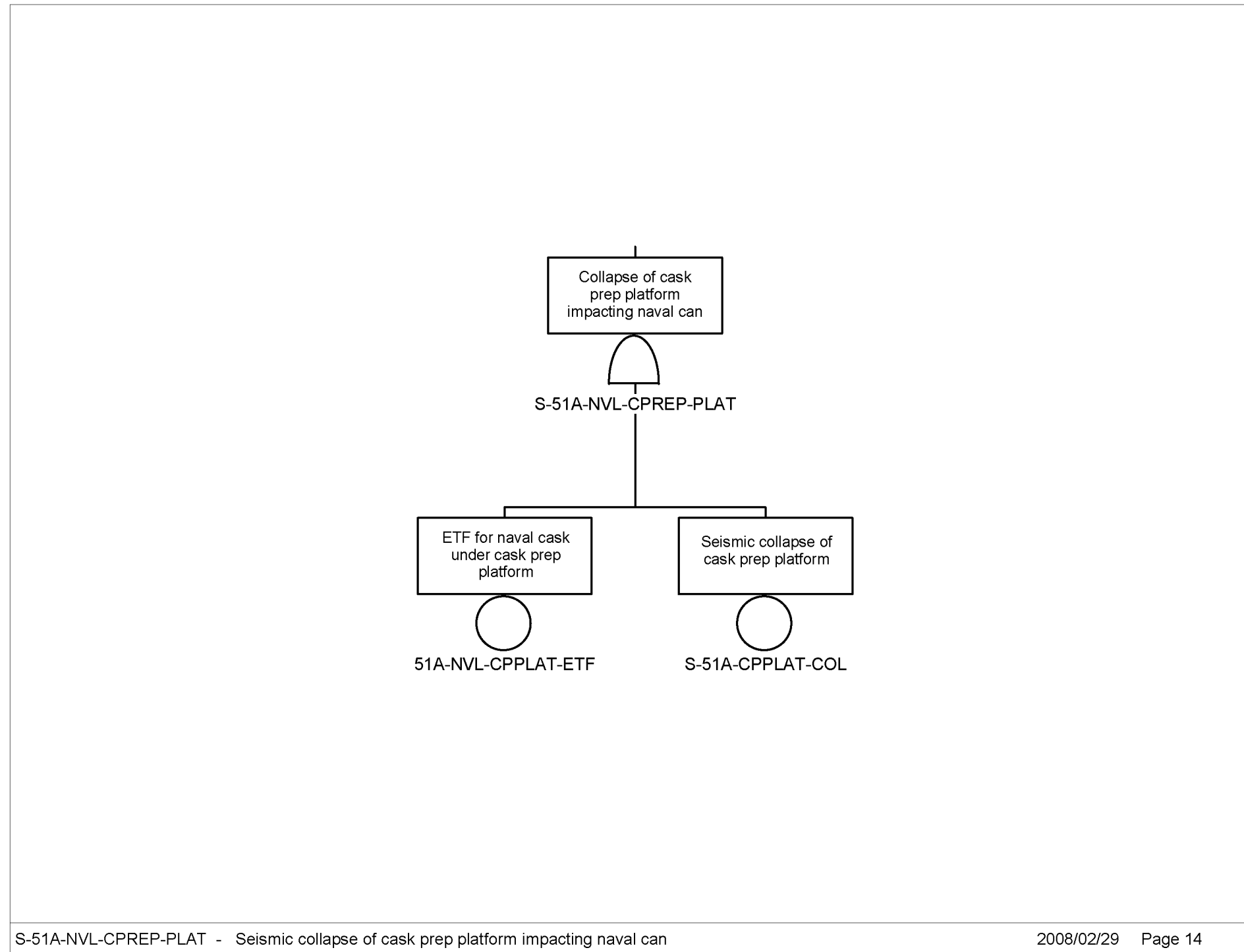

Source: Original

Figure A1.2-10. S-51A-NVL-CPREP-PLAT – Seismic Collapse of Cask Prep Platform Impacting Naval Can

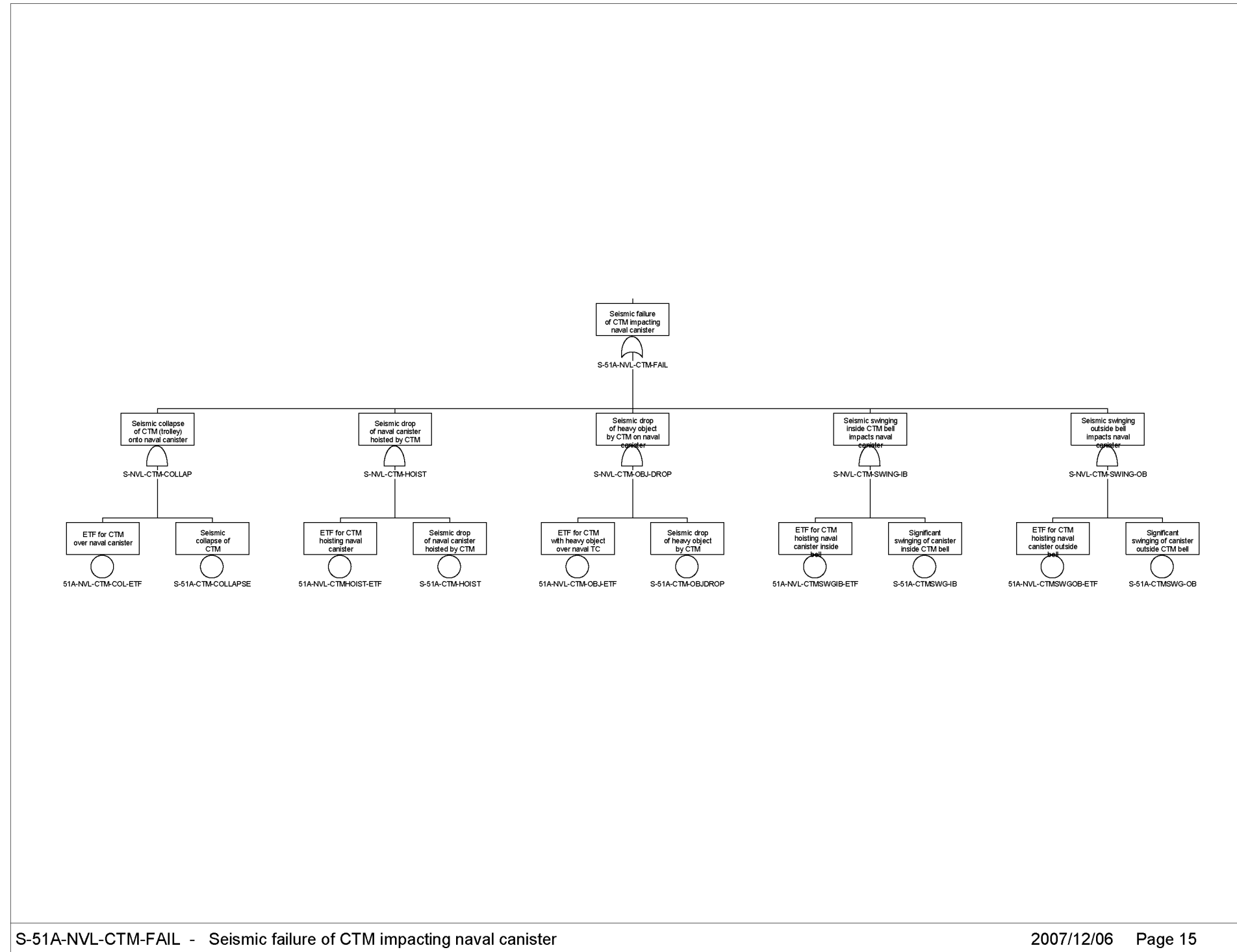

Source: Original

Figure A1.2-11. S-51A-NVL-CTM-FAIL – Seismic Failure of CTM Impacting Naval Canister

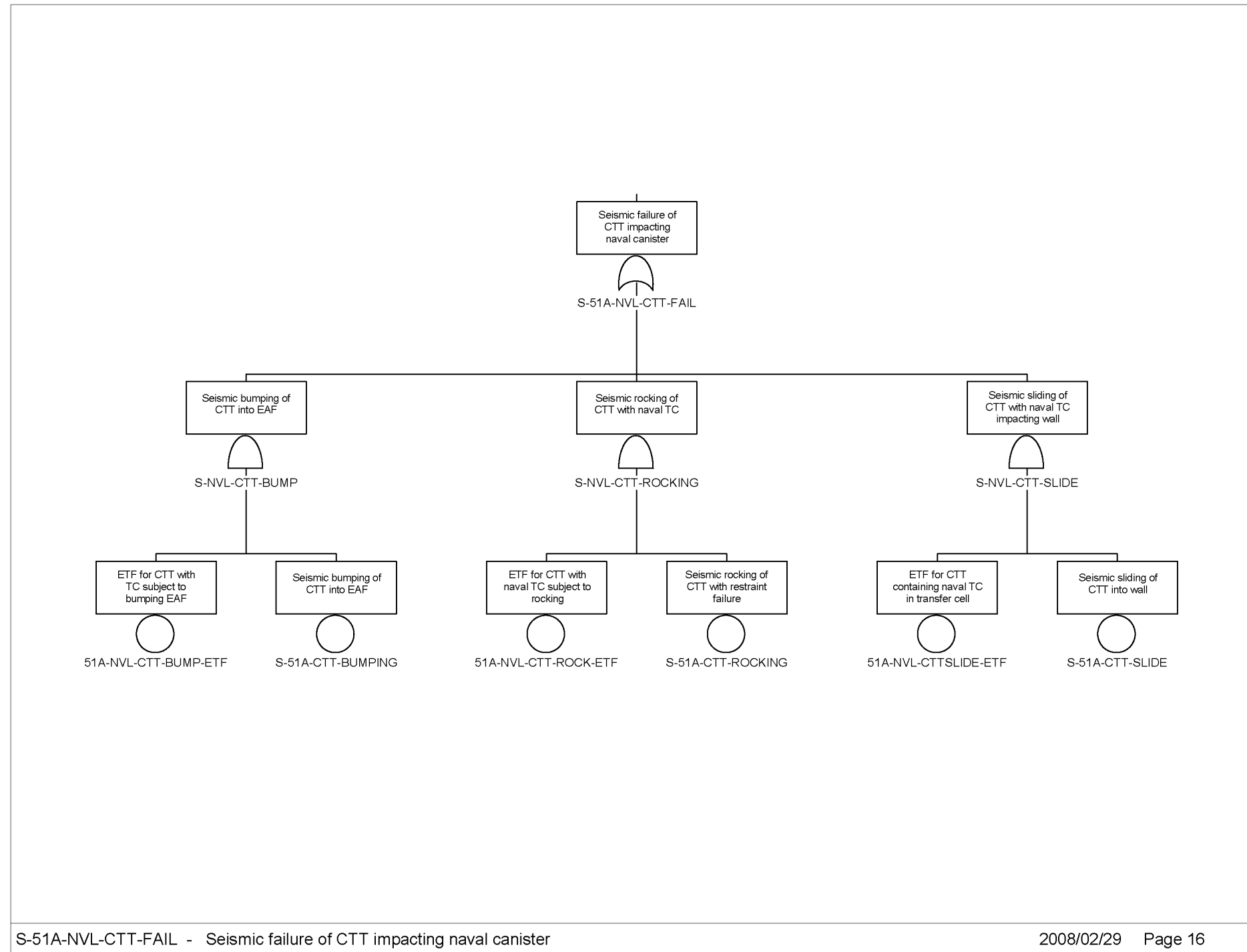

Source: Original

Figure A1.2-12. S-51A-NVL-CTT-FAIL – Seismic Failure of CTT Impacting Naval Canister

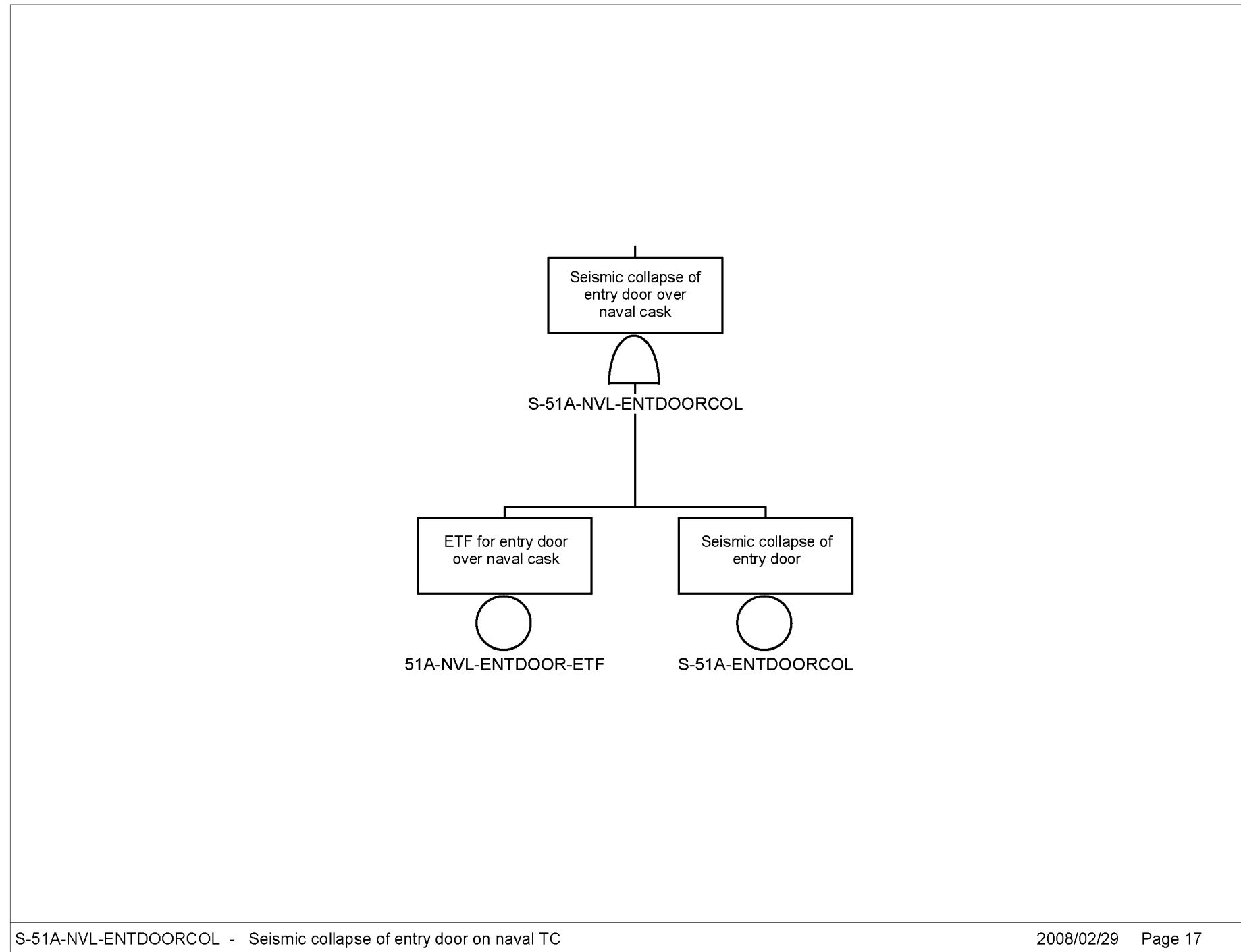

S-51A-NVL-ENTDOORCOL - Seismic collapse of entry door on naval TC

2008/02/29 Page 17

Source: Original

Figure A1.2-13. S-51A-NVL-ENTDOORCOL – Seismic Collapse of Entry Door on Naval TC

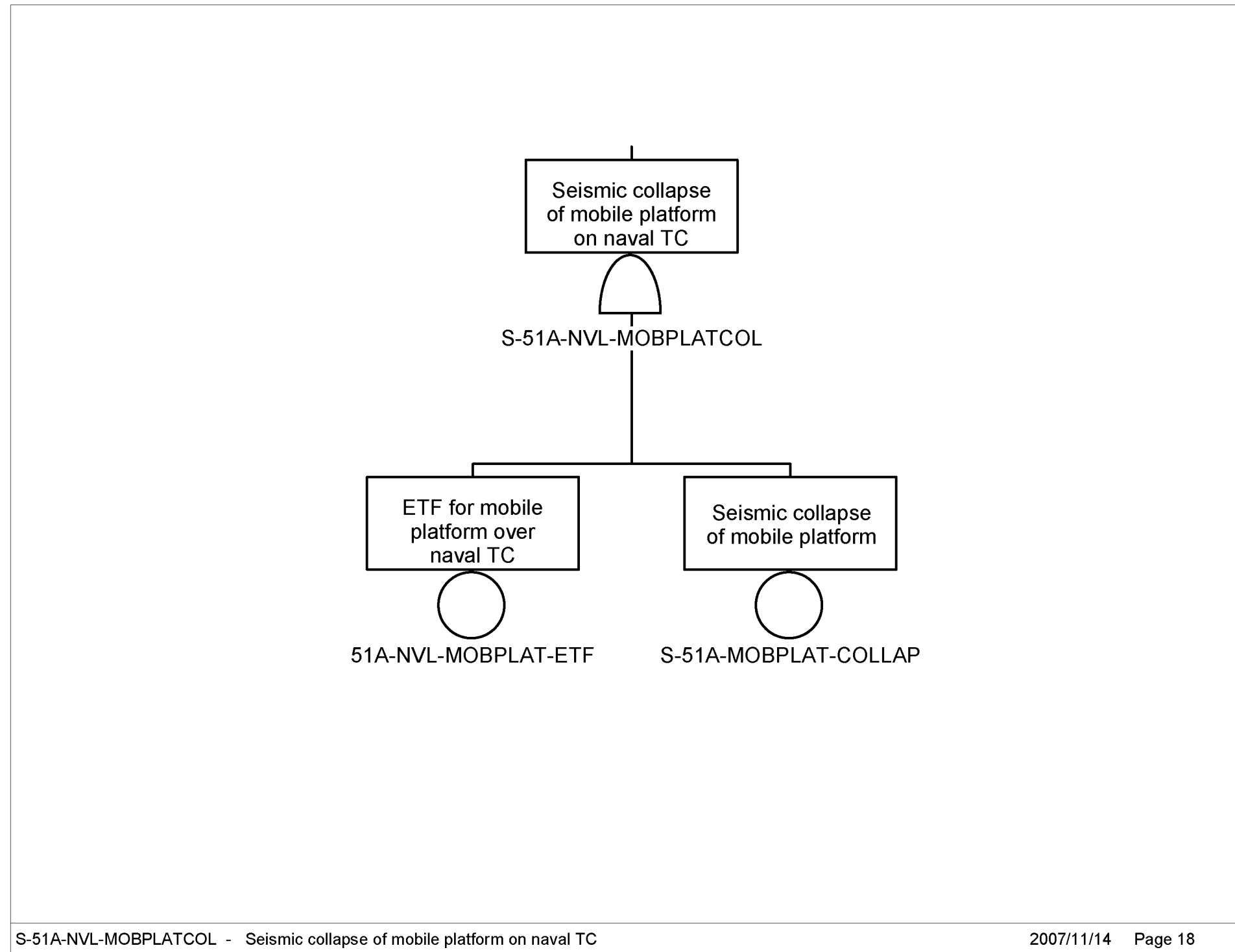

Source: Original

Figure A1.2-14. S-51A-NVL-MOBPLATCOL – Seismic Collapse of Mobile Platform on Naval TC

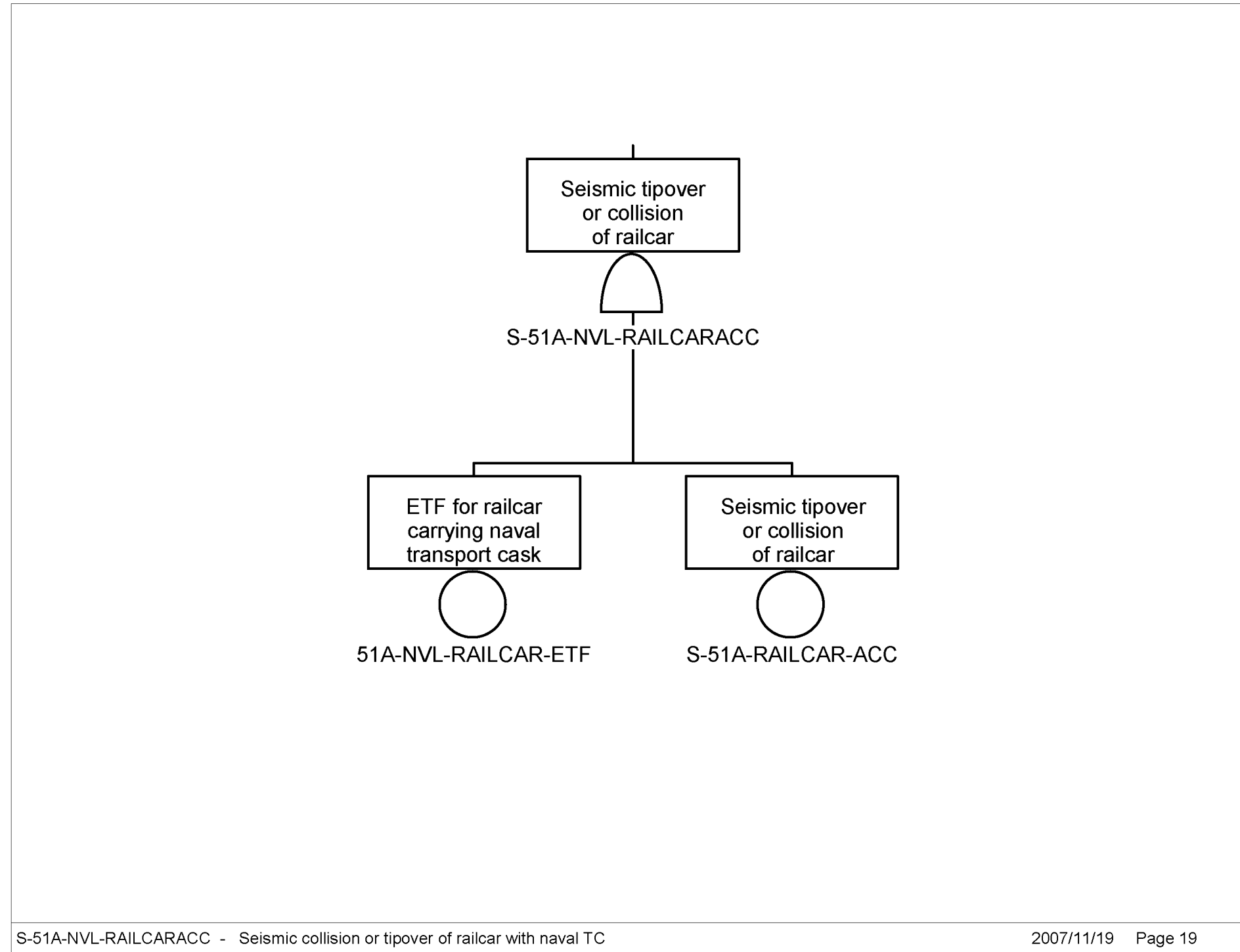

S-51A-NVL-RAILCARACC - Seismic collision or tipover of railcar with naval TC

2007/11/19 Page 19

Source: Original

Figure A1.2-15. S-51A-NVL-RAILCARACC – Seismic Collapse or Tipover of Railcar with Naval TC

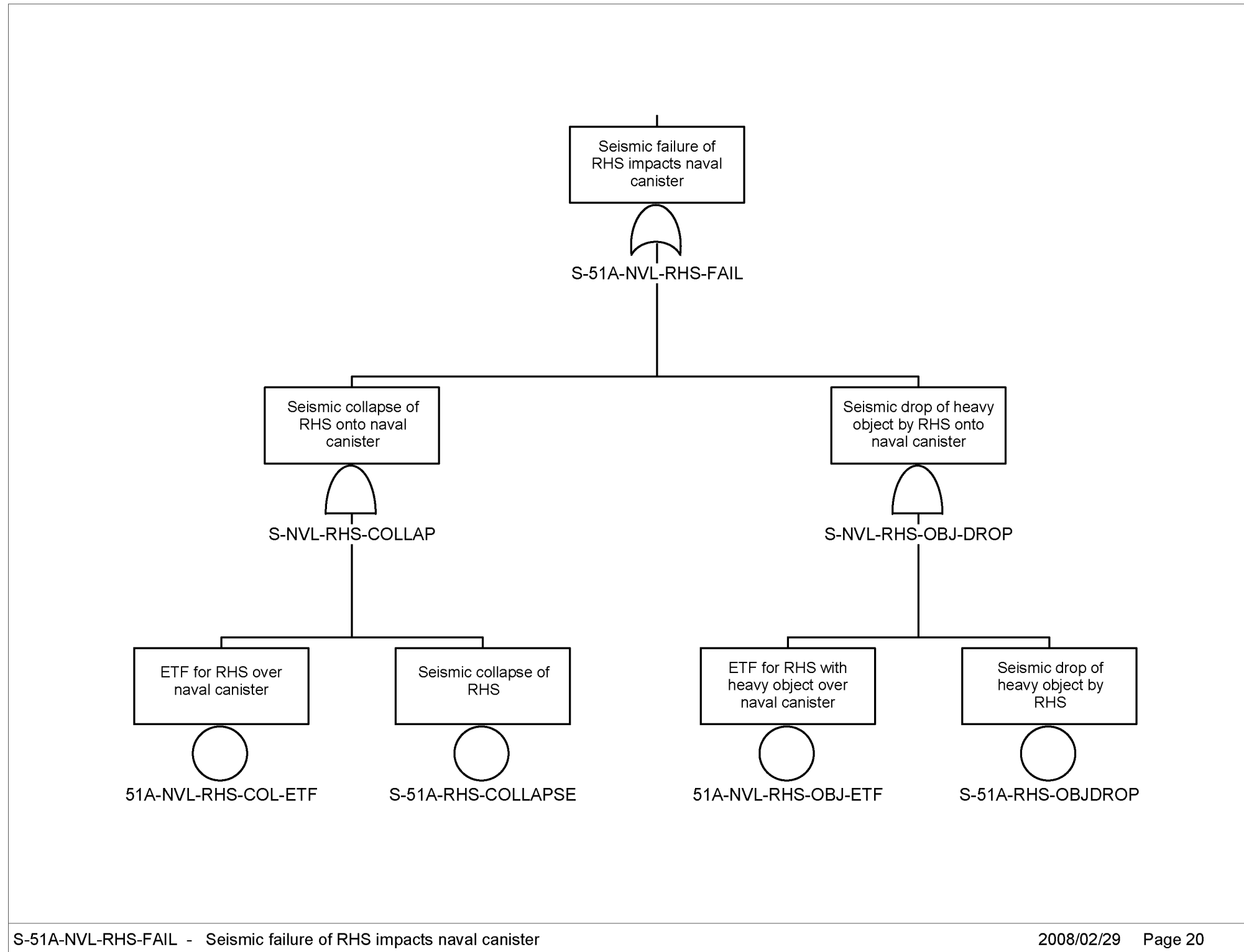

Source: Original

Figure A1.2-16. S-51A-NVL-RHS-FAIL– Seismic Failure of RHS Impacts Naval Canister

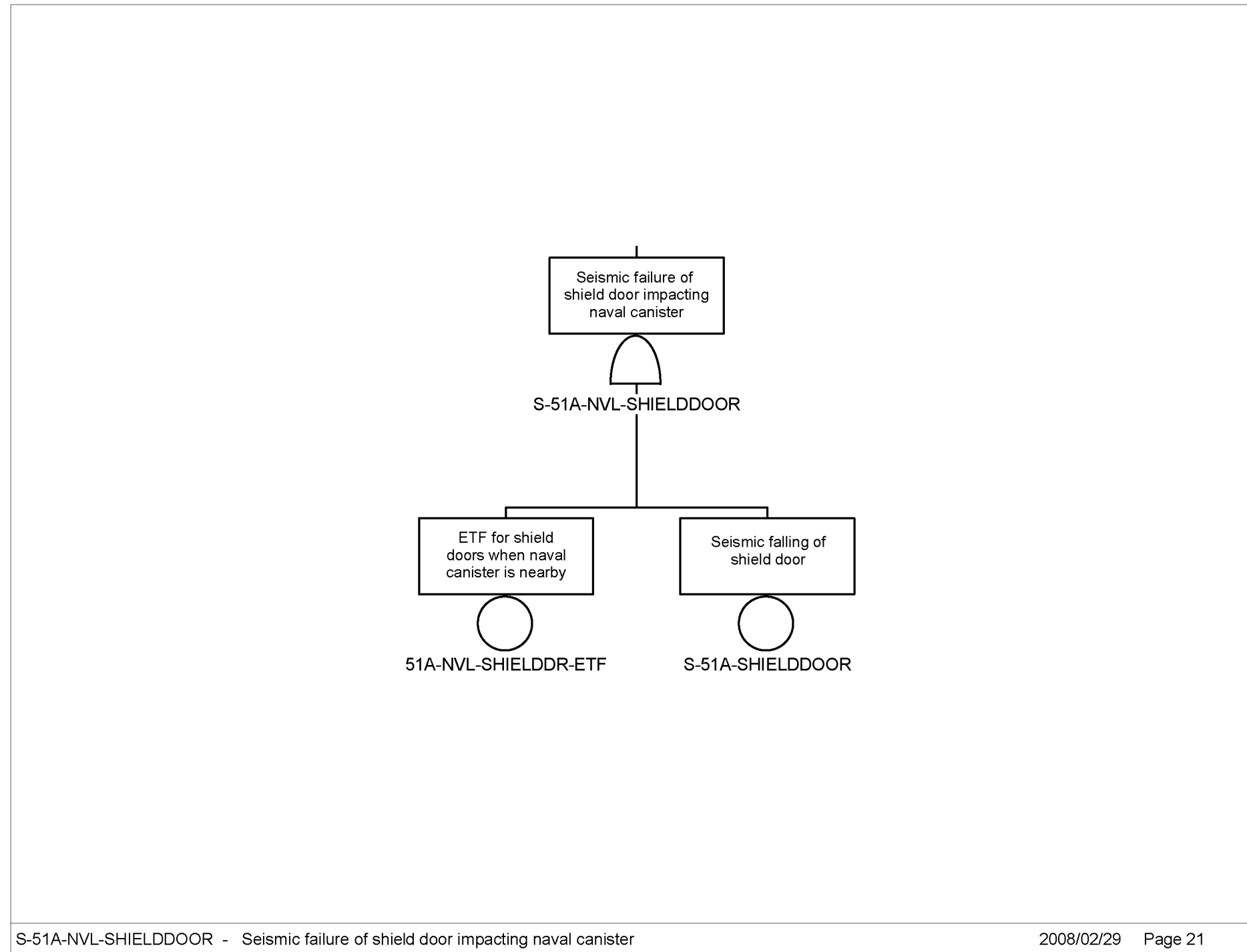

Source: Original

Figure A1.2-17. S-51A-NVL-SHIELDDOOR – Seismic Failure of Shield Door Impacting Naval Canister

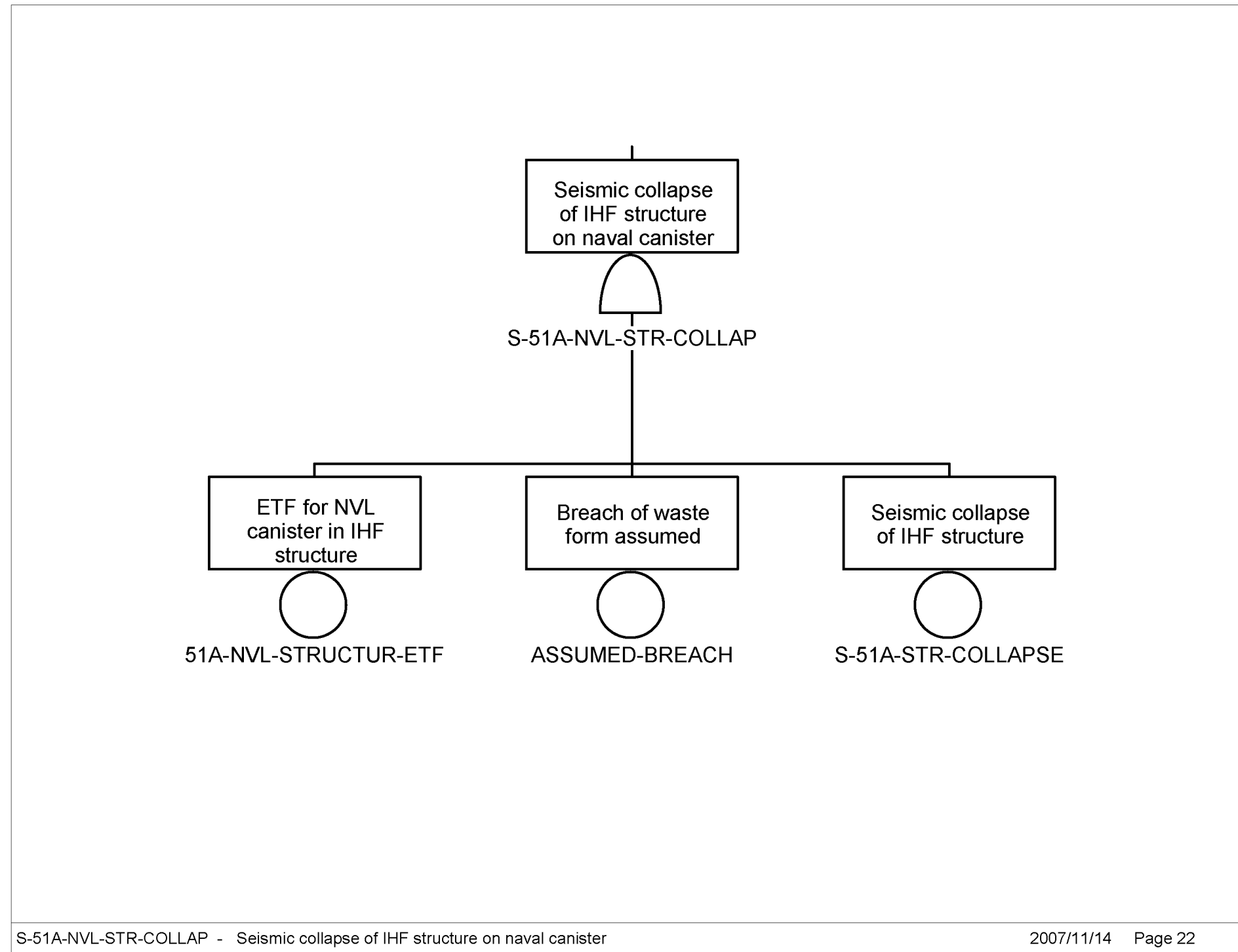

Source: Original

Figure A1.2-18. S-51A-NVL-STR-COLLAP – Seismic Collapse of IHF Structure on Naval Canister

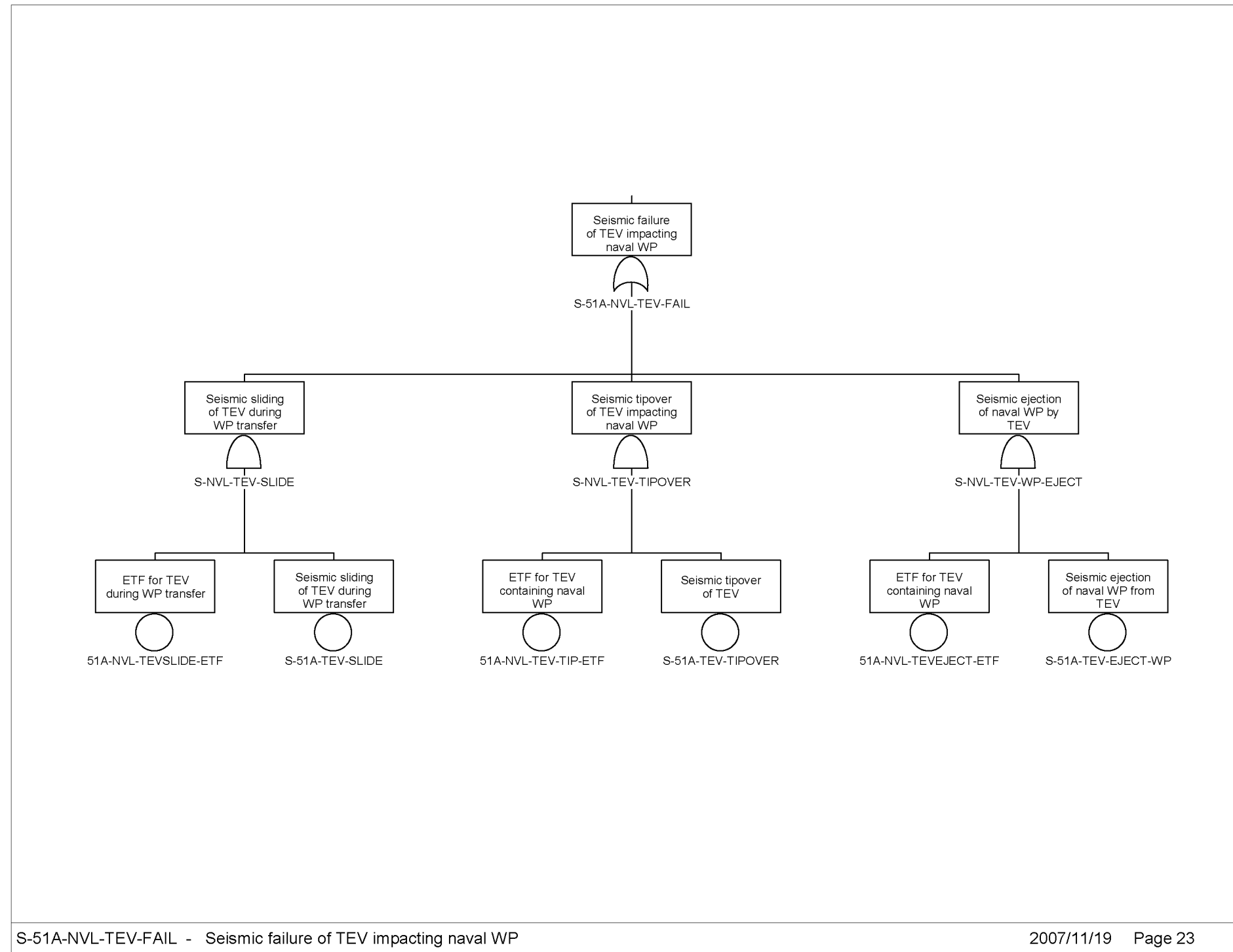

Source: Original

Figure A1.2-19. S-51A-NVL-TEV-FAIL – Seismic Failure of TEV Impacting Naval WP

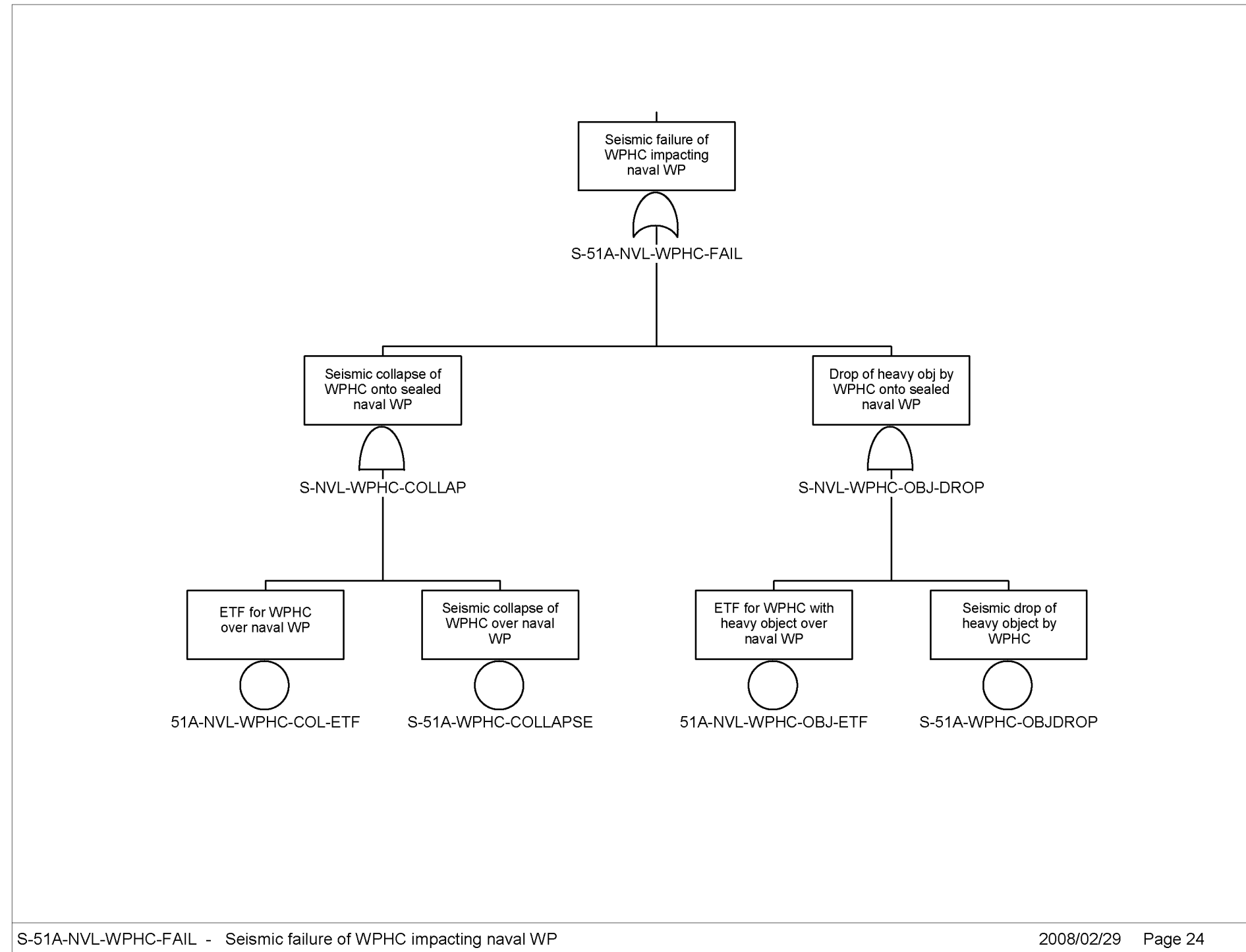

Source: Original

Figure A1.2-20. S-51A-NVL-WPHC-FAIL – Seismic Failure of WPHC Impacting Naval WP

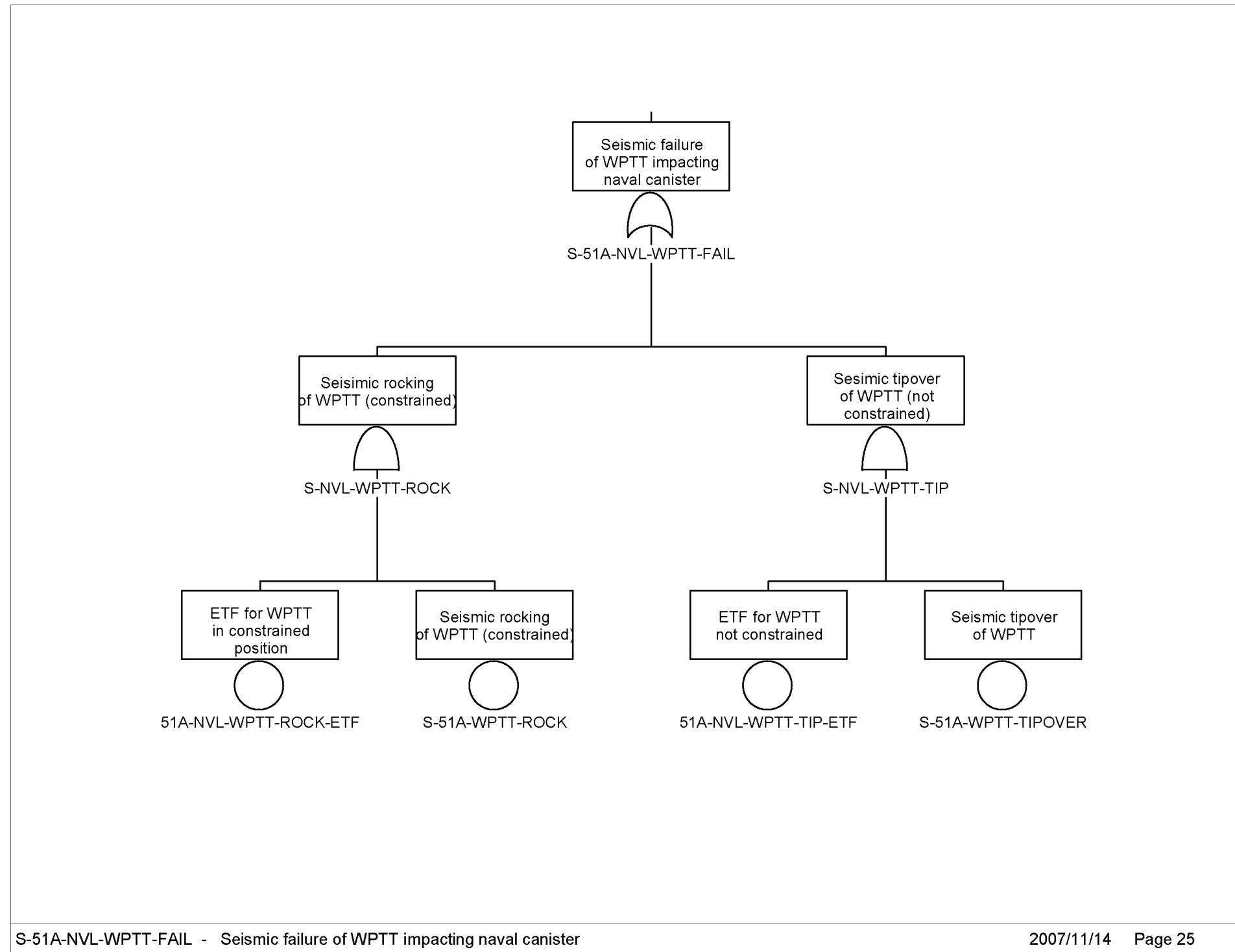

Source: Original

Figure A1.2-21. S-51A-NVL-WPTT-FAIL – Seismic Failure of WPTT Impacting Naval Canister

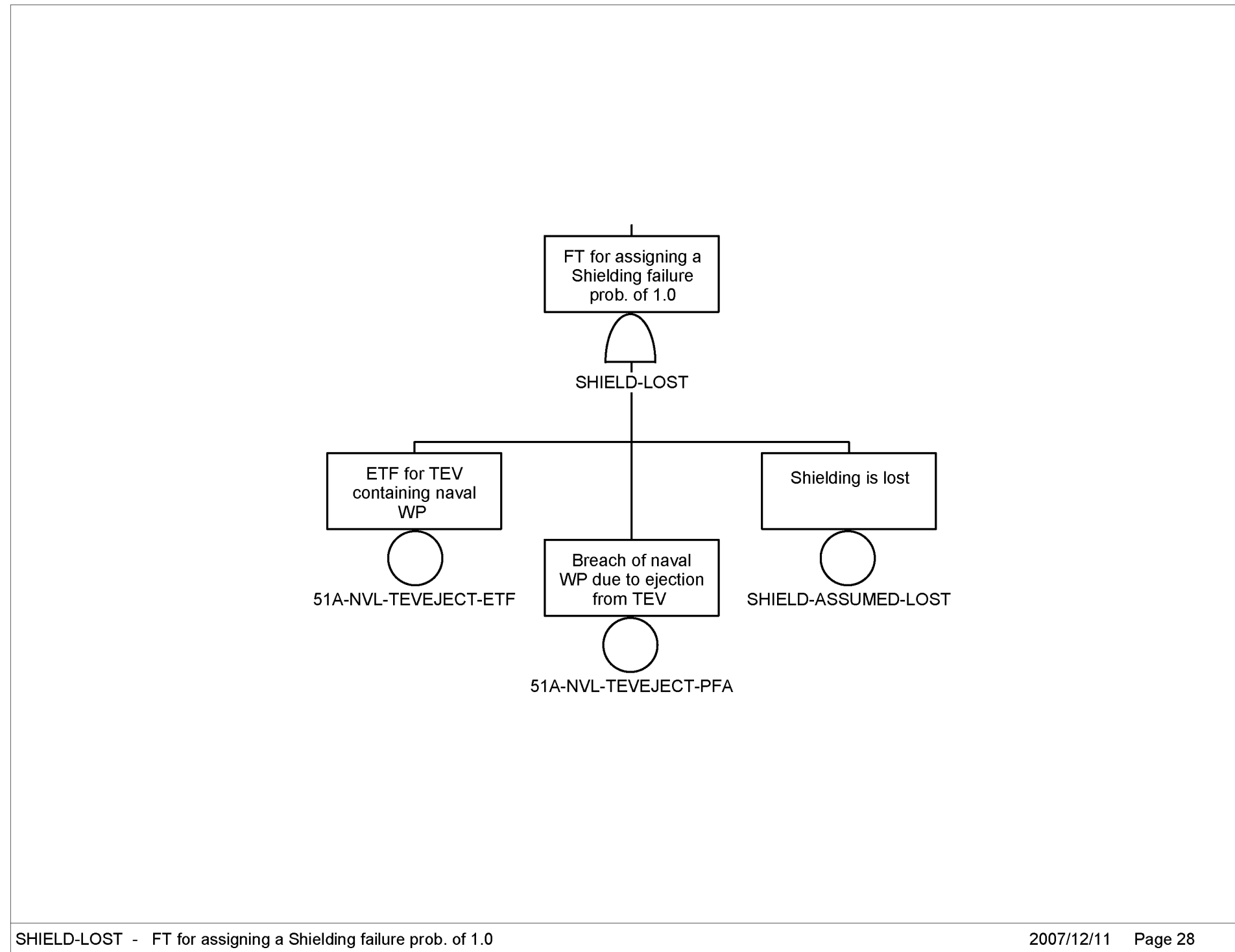

Source: Original

Figure A1.2-22 SHIELD-LOST – FT for Assigning a Shielding Failure Prob. of 1.0

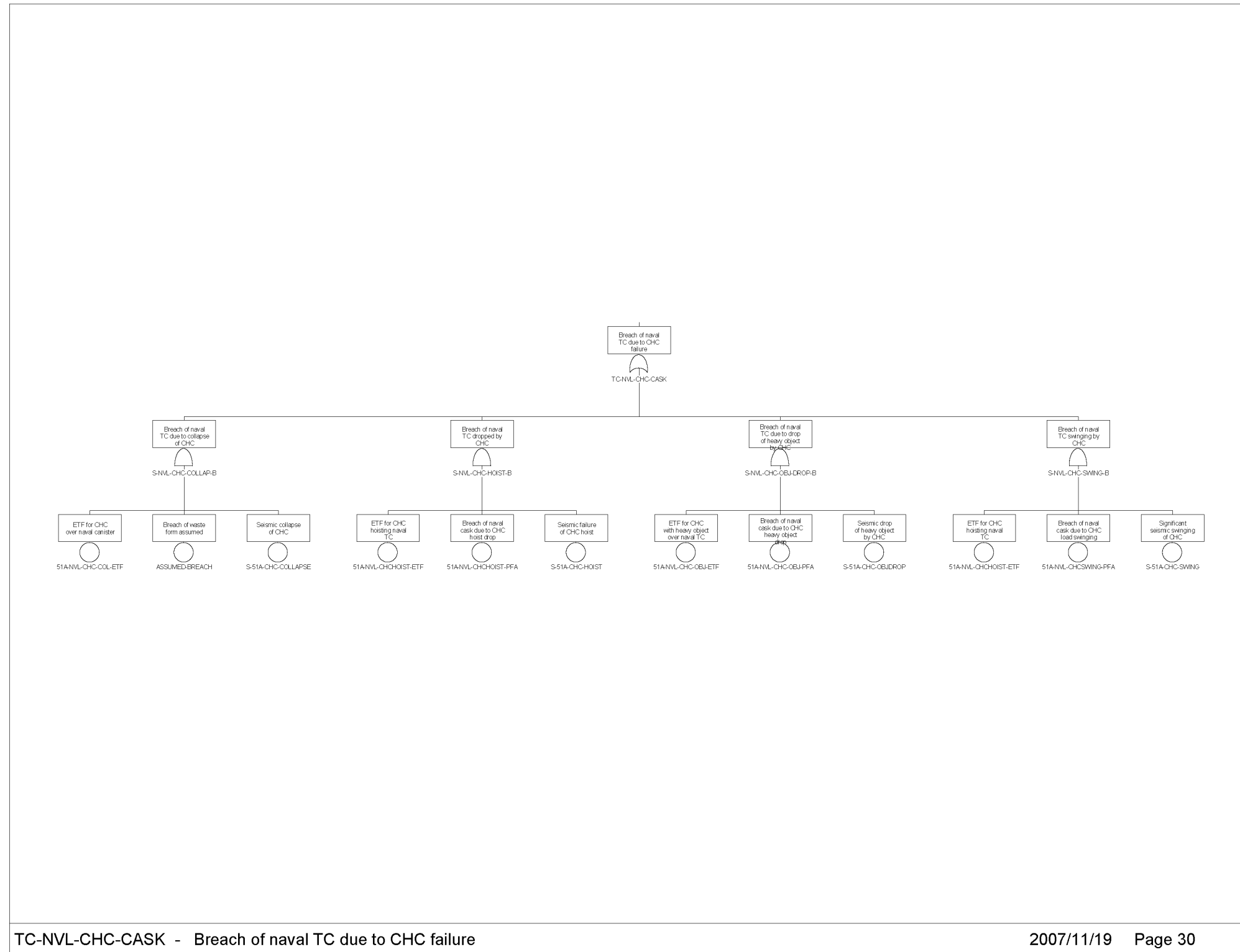

Source: Original

Figure A1.2-23. TC-NVL-CHC-CASK – Breach of Naval TC due to CHC Failure

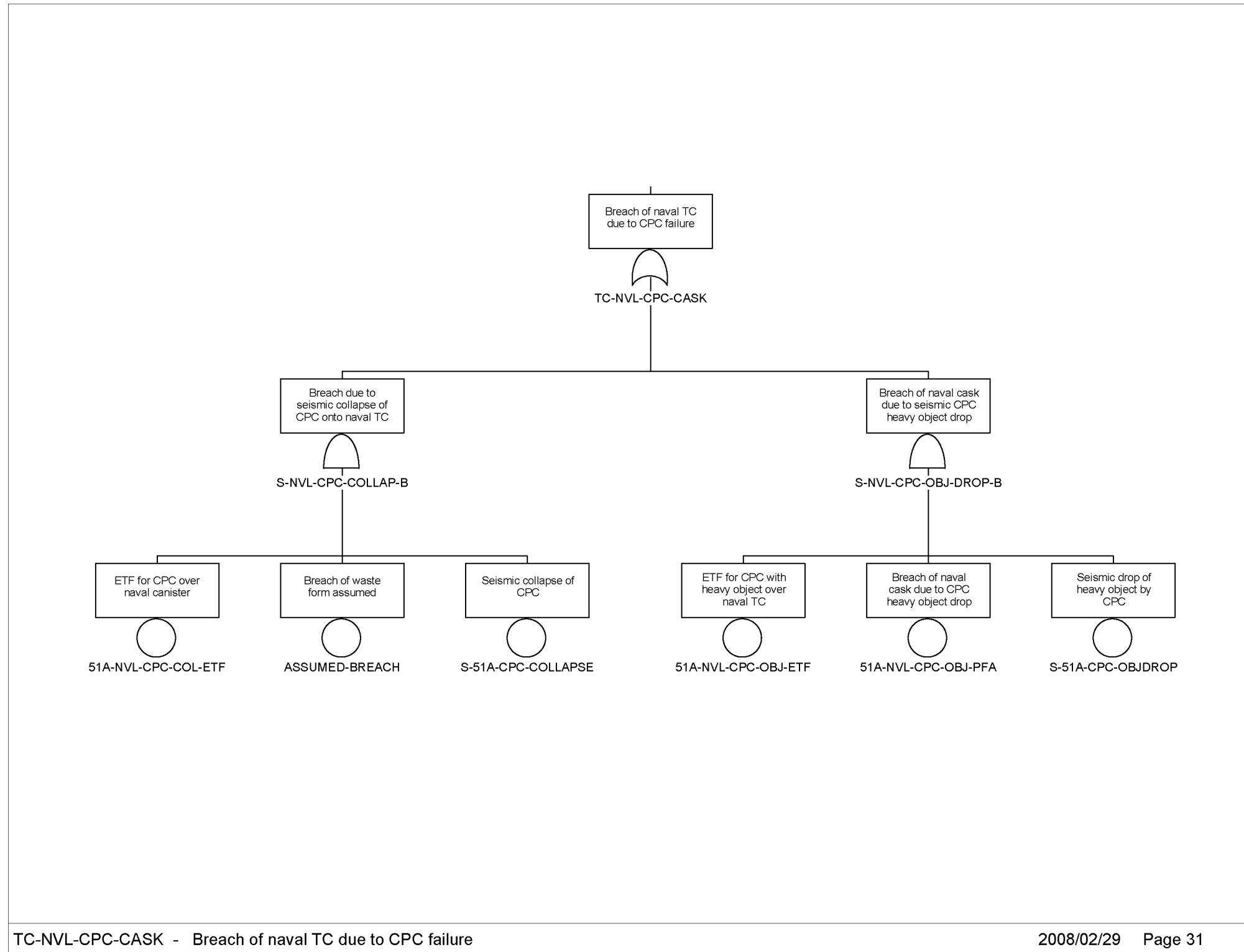

Source: Original

Figure A1.2-24. TC-NVL-CPC-CASK – Breach of Naval TC due to CPC Failure

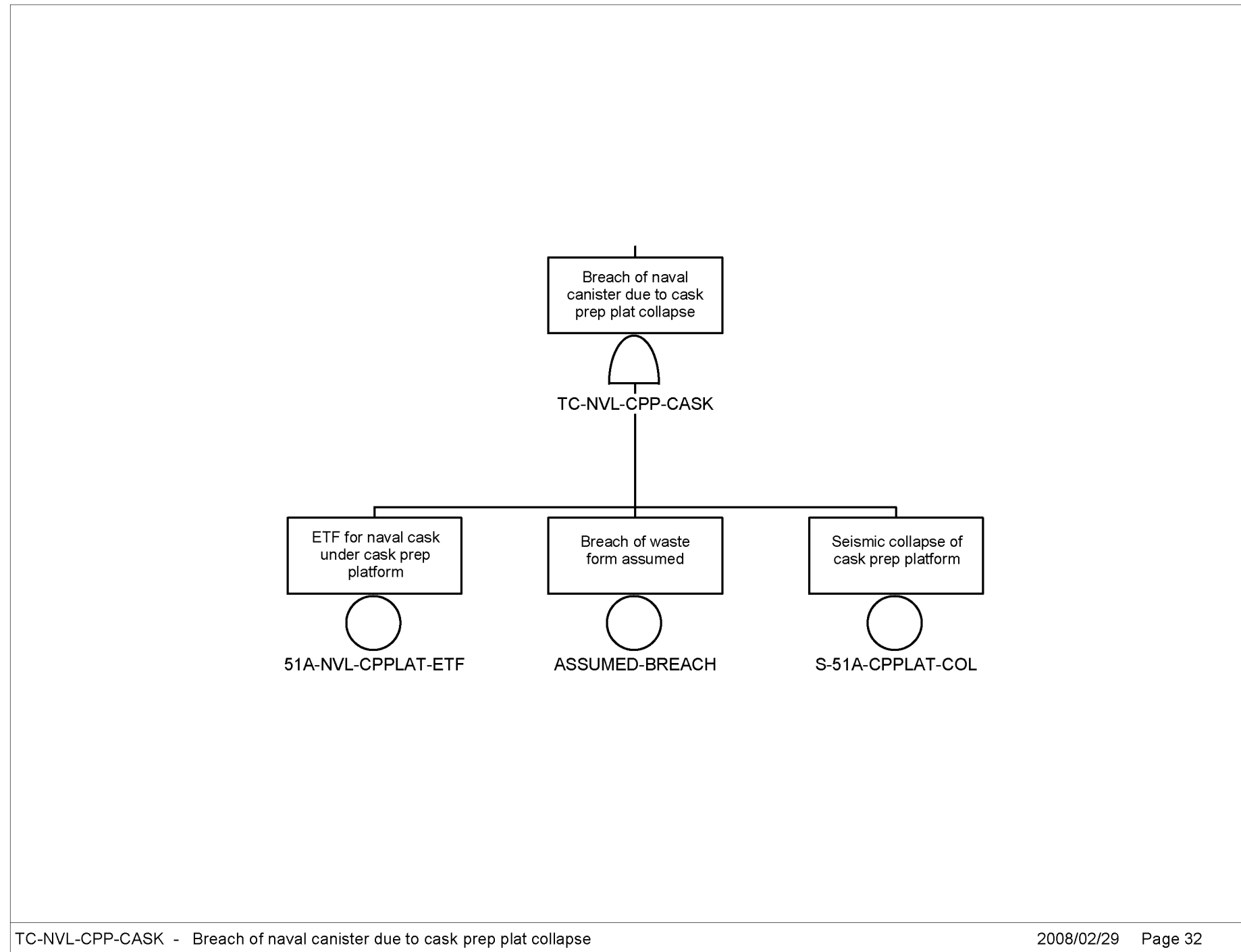

Source: Original

Figure A1.2-25. TC-NVL-CPP-CASK – Breach of Naval Canister due to Cask Prep Plat Collapse

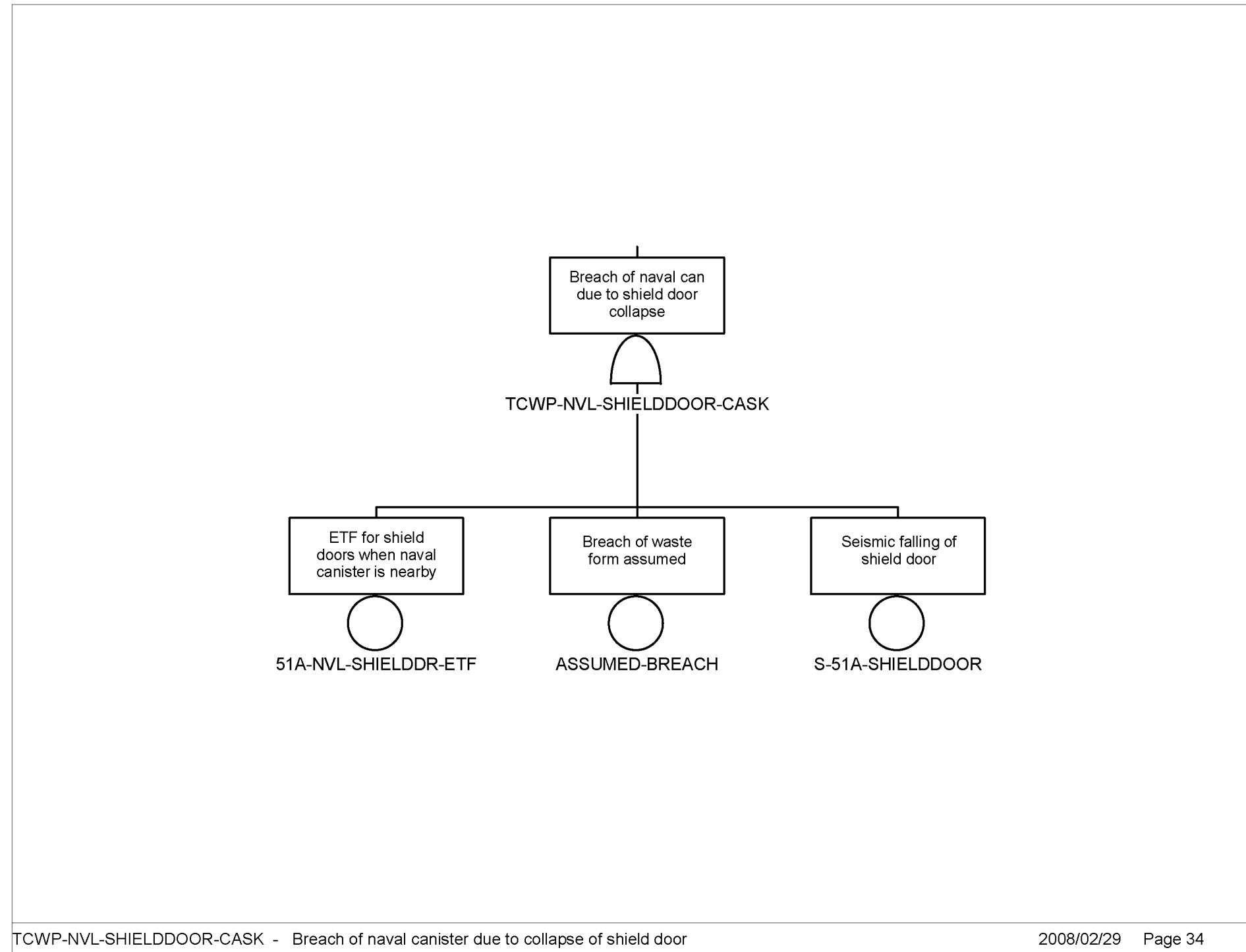

Source: Original

Figure A1.2-26. TCWP-NVL-SHIELDDOOR-CASK – Breach of Naval Canister due to Collapse of Shield Door

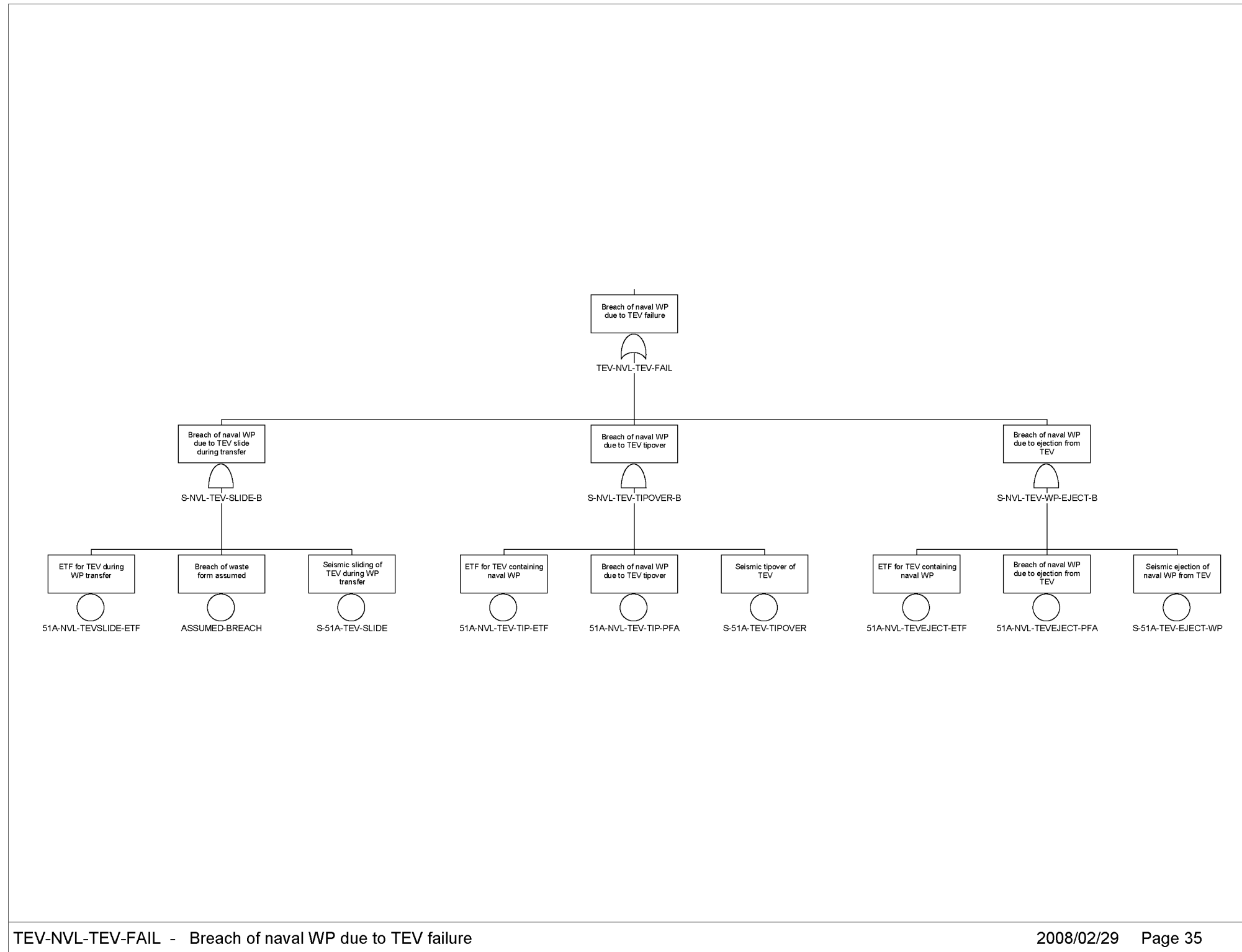

Source: Original

Figure A1.2-27. TEV-NVL-TEV-FAIL – Breach of Naval WP due to TEV Failure

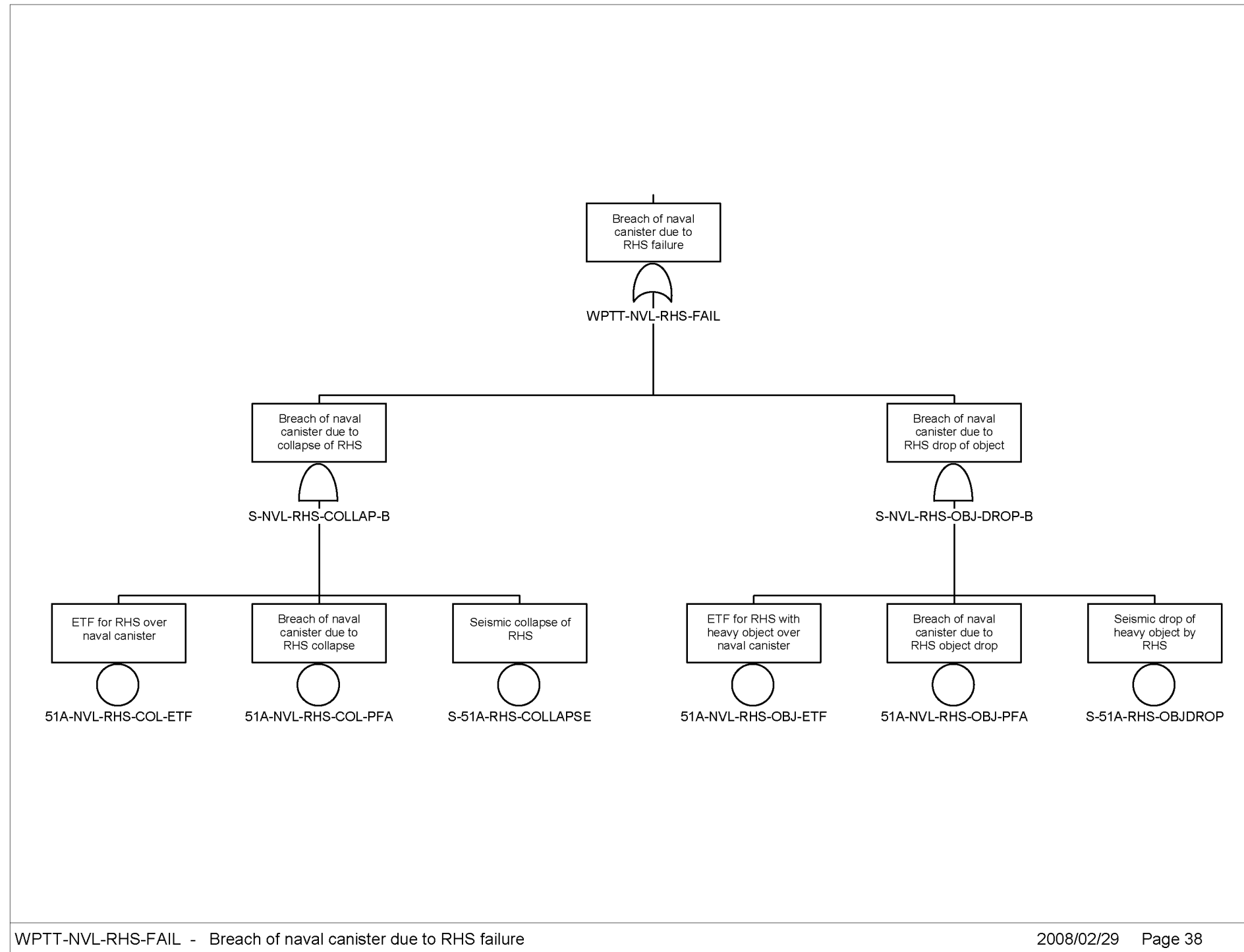

Source: Original

Figure A1.2-28. WPTT-NVL-RHS-FAIL – Breach of Naval Canister due to RHS Failure

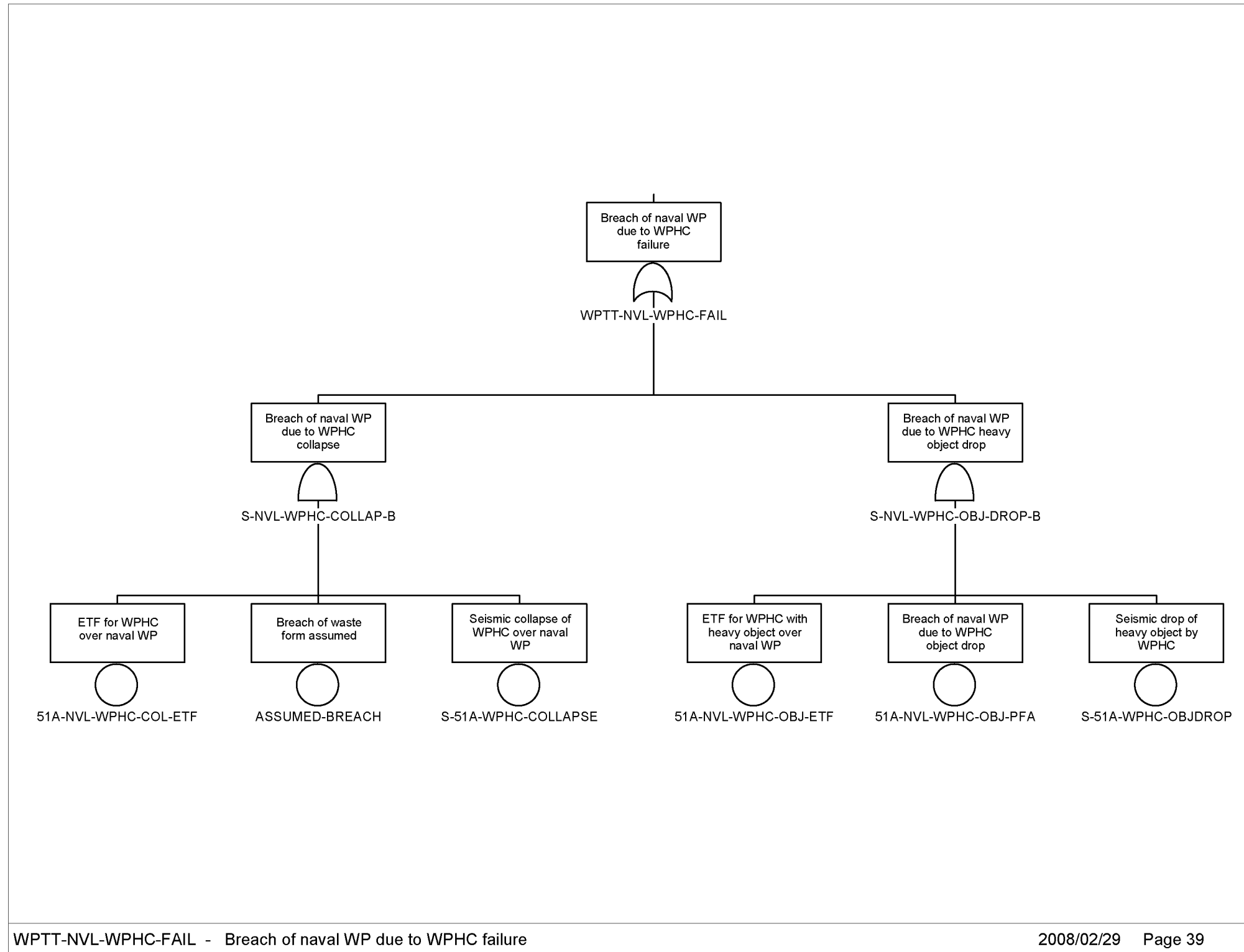

Source: Original

Figure A1.2-29. WPTT-NVL-WPHC-FAIL – Breach of Naval WP due to WPHC Failure

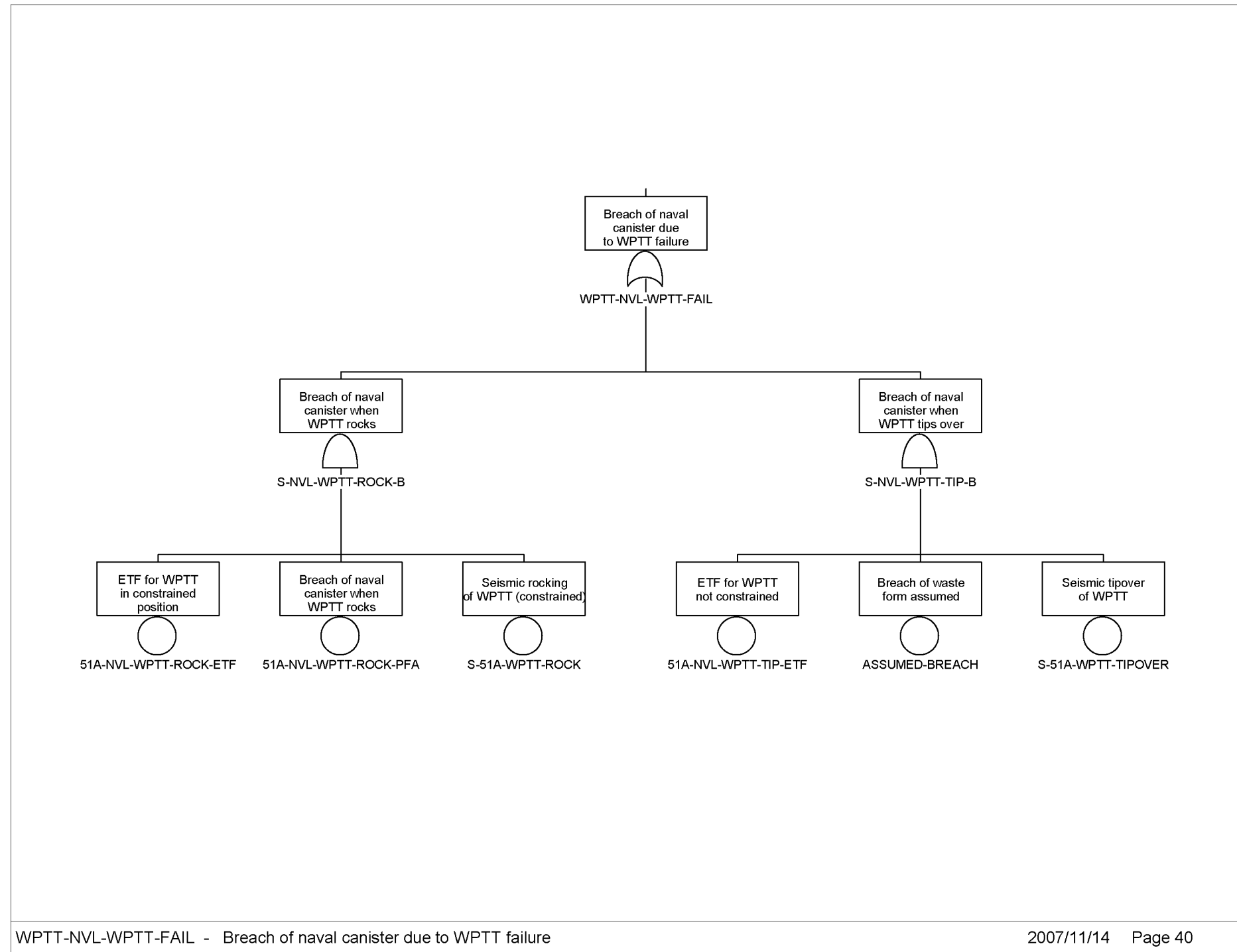

Source: Original

Figure A1.2-30. WPTT-NVL-WPTT-FAIL – Breach of Naval Canister due to WPTT Failure

A1.3 BASIC EVENT DATA

A1.3.1 Non-seismic Basic Event Data

The following table presents the basic event identifiers used in the fault trees, the description of the basic events and the failure probability (or other numeric data) of the basic events. For exposure time factors (denoted with “ETF” at the end of the basic event identifier), the value given is the time, in years, that one waste form container is exposed to the seismic failure mode.

Table A1.3-1. Non-seismic Basic Event Data

Name	Description	Calc. Probability
51A-NVL-CHC-COL-ETF	ETF for CHC over naval canister	1.480E-003
51A-NVL-CHC-OBJ-ETF	ETF for CHC with heavy object over naval TC	6.450E-004
51A-NVL-CHC-OBJ-PFA	Breach of naval cask due to CHC heavy object drop	1.000E-005
51A-NVL-CHCHOIST-ETF	ETF for CHC hoisting naval TC	7.040E-005
51A-NVL-CHCHOIST-PFA	Breach of naval cask due to CHC hoist drop	1.000E-005
51A-NVL-CHCSWING-PFA	Breach of naval cask due to CHC load swinging	1.000E-005
51A-NVL-CPC-COL-ETF	ETF for CPC over naval canister	1.310E-003
51A-NVL-CPC-OBJ-ETF	ETF for CPC with heavy object over naval TC	7.360E-004
51A-NVL-CPC-OBJ-PFA	Breach of naval cask due to CPC heavy object drop	1.000E-005
51A-NVL-CPPLAT-ETF	ETF for naval cask under cask prep platform	1.270E-003
51A-NVL-CTM-COL-ETF	ETF for CTM over naval canister	3.880E-004
51A-NVL-CTM-OBJ-ETF	ETF for CTM with heavy object over naval TC	1.940E-004
51A-NVL-CTM-OBJ-PFA	Breach of naval canister due to CTM object drop	1.000E-005
51A-NVL-CTMHOIST-ETF	ETF for CTM hoisting naval canister	6.660E-005
51A-NVL-CTMHOIST-PFA	Breach of naval canister dropped by CTM	1.000E-005
51A-NVL-CTMSWGIB-ETF	ETF for CTM hoisting naval canister inside bell	6.660E-005
51A-NVL-CTMSWGIB-PFA	Breach of naval canister due to swing inside bell	1.000E-005
51A-NVL-CTMSWGOB-ETF	ETF for CTM hoisting naval canister outside bell	4.760E-005
51A-NVL-CTT-BUMP-ETF	ETF for CTT with TC subject to bumping EAF	1.060E-003
51A-NVL-CTT-BUMP-PFA	Breach given CTT with TC subject to bumping EAF	1.000E-005
51A-NVL-CTT-ROCK-ETF	ETF for CTT with naval TC subject to rocking	8.940E-005
51A-NVL-CTTSLIDE-ETF	ETF for CTT containing naval TC in transfer cell	2.070E-004
51A-NVL-ENTDOOR-ETF	ETF for entry door over naval cask	1.900E-005
51A-NVL-ENTDOOR-PFA	Breach of naval TC due to entry door collapse	1.000E-005
51A-NVL-MOBPLAT-ETF	ETF for mobile platform over naval TC	7.880E-004
51A-NVL-MOBPLAT-PFA	Breach of naval TC due to mobile platform collapse	1.000E-005
51A-NVL-RAILCAR-ETF	ETF for railcar carrying naval transport cask	1.030E-003
51A-NVL-RAILCAR-PFA	Breach of naval TC due to railcar accident	1.000E-005
51A-NVL-RHS-COL-ETF	ETF for RHS over naval canister	2.780E-004
51A-NVL-RHS-COL-PFA	Breach of naval canister due to RHS collapse	1.000E-005
51A-NVL-RHS-OBJ-ETF	ETF for RHS with heavy object over naval canister	5.710E-005
51A-NVL-RHS-OBJ-PFA	Breach of naval canister due to RHS object drop	1.000E-005

Table A1.3-1. Non-seismic Basic Event Data (Continued)

Name	Description	Calc. Probability
51A-NVL-SHIELDDR-ETF	ETF for shield doors when naval canister is nearby	5.500E-004
51A-NVL-STRUCTUR-ETF	ETF for NVL canister in IHF structure	7.690E-003
51A-NVL-TEV-TIP-ETF	ETF for TEV containing naval WP	7.990E-005
51A-NVL-TEV-TIP-PFA	Breach of naval WP due to TEV tipover	1.000E-005
51A-NVL-TEVEJECT-ETF	ETF for TEV containing naval WP	7.040E-005
51A-NVL-TEVEJECT-PFA	Breach of naval WP due to ejection from TEV	5.000E-003
51A-NVL-TEVSLIDE-ETF	ETF for TEV during WP transfer	9.510E-006
51A-NVL-WPHC-COL-ETF	ETF for WPHC over naval WP	4.760E-005
51A-NVL-WPHC-OBJ-ETF	ETF for WPHC with heavy object over naval WP	1.900E-005
51A-NVL-WPHC-OBJ-PFA	Breach of naval WP due to WPHC object drop	1.000E-005
51A-NVL-WPTT-ROCK-ETF	ETF for WPTT in constrained position	1.710E-003
51A-NVL-WPTT-ROCK-PFA	Breach of naval canister when WPTT rocks	1.000E-005
51A-NVL-WPTT-TIP-ETF	ETF for WPTT not constrained	5.120E-004
ASSUMED-BREACH	Breach of waste form assumed	1.000E+000
IHF-NVL-CAN	Number of naval canisters processed in IHF	4.000E+002
MOD-ENTER-CANISTER	Flooding or spray enters canister	1.000E-002
SHIELDING	Shielding remains intact	1.000E-005
51A-NVL-CHC-COL-ETF	ETF for CHC over naval canister	1.480E-003

NOTE: The basic event "ASSUMED-BREACH" is not an assumption, but is common terminology used to denote a scenario where the waste container is conservatively considered to be breached; CHC = cask handling crane; CPC = cask preparation crane; CTM = canister transfer machine; CTT = cask transfer trolley; EAF = energy absorbing feature; ETF = exposure time factor; FPW = fire protection water; IHF = Initial Handling Facility; NVL = naval; RHS = remote handling system; TC = transportation cask; TEV = transport and emplacement vehicle; WP = waste package; WPHC = waste package handling crane; WPTT = waste package transfer trolley.

Source: Sections 6.2.2.23 and 6.3.3, Table 6.3-1, Table 6.3-2, Table 6.4-1

A1.3.2 Seismic Basic Event Fragility Data

The following table provides the seismic failure basic event identifier, description, median fragility, and composite uncertainty.

Table A1.3-2 Seismic Basic Event Fragility Data

Event Name	Description	Med. Fragility (g)	Beta C
S-51A-CHC-COLLAPSE	Seismic collapse of CHC	2.790E+000	4.500E-001
S-51A-CHC-HOIST	Seismic failure of CHC hoist	2.280E+000	5.000E-001
S-51A-CHC-OBJDROP	Seismic drop of heavy object by CHC	2.280E+000	5.000E-001
S-51A-CHC-SWING	Significant seismic swinging of CHC	1.140E+000	4.000E-001
S-51A-CPC-COLLAPSE	Seismic collapse of CPC	2.790E+000	4.500E-001
S-51A-CPC-OBJDROP	Seismic drop of heavy object by CPC	2.280E+000	5.000E-001

Table A1.3-2. Seismic Basic Event Fragility Data (Continued)

Event Name	Description	Med. Fragility (g)	Beta C
S-51A-CPPLAT-COL	Seismic collapse of cask prep platform	1.140E+000	4.000E-001
S-51A-CTM-COLLAPSE	Seismic collapse of CTM	2.390E+000	4.500E-001
S-51A-CTM-HOIST	Seismic drop of naval canister hoisted by CTM	2.280E+000	5.000E-001
S-51A-CTM-OBJDROP	Seismic drop of heavy object by CTM	2.280E+000	5.000E-001
S-51A-CTMSWG-IB	Significant swinging of canister inside CTM bell	1.140E+000	4.000E-001
S-51A-CTMSWG-OB	Significant swinging of canister outside CTM bell	9.100E-001	4.000E-001
S-51A-CTT-BUMPING	Seismic bumping of CTT into EAF	1.700E+000	4.400E-001
S-51A-CTT-ROCKING	Seismic rocking of CTT with restraint failure	1.700E+000	4.100E-001
S-51A-CTT-SLIDE	Seismic sliding of CTT into wall	1.700E+000	4.400E-001
S-51A-ENTDOORCOL	Seismic collapse of entry door	3.700E-001	4.000E-001
S-51A-FPW-V-SO	Spurious opening of FPW pre-action valve (relay chatter)	3.000E+000	4.000E-001
S-51A-MOBPLAT-COLLAP	Seismic collapse of mobile platform	3.700E-001	4.000E-001
S-51A-PIPING-FAIL	Seismic failure of piping in accident area	7.600E-001	4.000E-001
S-51A-RAILCAR-ACC	Seismic tipover or collision of railcar	4.500E-001	4.000E-001
S-51A-RHS-COLLAPSE	Seismic collapse of RHS	2.790E+000	4.500E-001
S-51A-RHS-OBJDROP	Seismic drop of heavy object by RHS	1.140E+000	4.000E-001
S-51A-SHIELDDOOR	Seismic falling of shield door	2.920E+000	4.400E-001
S-51A-STR-COLLAPSE	Seismic collapse of IHF structure	5.350E+000	4.000E-001
S-51A-TEV-EJECT-WP	Seismic ejection of naval WP from TEV	7.600E-001	4.000E-001
S-51A-TEV-SLIDE	Seismic sliding of TEV during WP transfer	1.120E+000	4.300E-001
S-51A-TEV-TIPOVER	Seismic tipover of TEV	5.000E+000	4.000E-001
S-51A-WPHC-COLLAPSE	Seismic collapse of WPHC over naval WP	2.790E+000	4.500E-001
S-51A-WPHC-OBJDROP	Seismic drop of heavy object by WPHC	1.140E+000	4.000E-001
S-51A-WPTT-ROCK	Seismic rocking of WPTT (constrained)	1.850E+000	3.700E-001
S-51A-WPTT-TIPOVER	Seismic tipover of WPTT	3.410E+000	4.000E-001

NOTE: CHC = cask handling crane; CPC = cask preparation crane; CTM = canister transfer machine; CTT = cask transfer trolley; EAF = energy absorbing feature; FPW = fire protection water; IHF = Initial Handling Facility; RHS = remote handling system; TC = transportation cask; TEV = transport and emplacement vehicle; WP = waste package; WPHC = waste package handling crane; WPTT = waste package transfer trolley.

Source: Table 6.2-1 and Table 6.2-2

A1.4 EVENT SEQUENCE QUANTIFICATION

This section provides the quantification results by sequence. The event sequence probabilities are provided first, and the cut sets are provided afterwards.

A1.4.1 Sequence Level Results

Table A1.4-1. Sequence Level Results

Event Tree	Sequence	Base Min. Cut	Base Cut Sets
IHF-S-IE-NVL	03	1.154E-006	1
IHF-S-IE-NVL	04-2	7.659E-011	1
IHF-S-IE-NVL	04-3	+0.000E+000	1
IHF-S-IE-NVL	04-4	+0.000E+000	1
IHF-S-IE-NVL	04-5	+0.000E+000	1
IHF-S-IE-NVL	04-6	7.659E-011	1
IHF-S-IE-NVL	04-7	1.548E-013	1
IHF-S-IE-NVL	05-2	2.847E-009	1
IHF-S-IE-NVL	05-3	+0.000E+000	1
IHF-S-IE-NVL	05-4	+0.000E+000	1
IHF-S-IE-NVL	05-5	+0.000E+000	1
IHF-S-IE-NVL	05-6	2.847E-009	1
IHF-S-IE-NVL	05-7	7.691E-012	1
IHF-S-IE-NVL	06-2	3.177E-009	1
IHF-S-IE-NVL	06-3	+0.000E+000	1
IHF-S-IE-NVL	06-4	+0.000E+000	1
IHF-S-IE-NVL	06-5	+0.000E+000	1
IHF-S-IE-NVL	06-6	3.177E-009	1
IHF-S-IE-NVL	06-7	6.419E-012	1
IHF-S-IE-NVL	07-2	7.679E-011	3
IHF-S-IE-NVL	07-3	+0.000E+000	1
IHF-S-IE-NVL	07-4	+0.000E+000	1
IHF-S-IE-NVL	07-5	+0.000E+000	1
IHF-S-IE-NVL	07-6	4.646E-006	4
IHF-S-IE-NVL	07-7	4.372E-008	4
IHF-S-IE-NVL	08-2	5.340E-011	1
IHF-S-IE-NVL	08-3	+0.000E+000	1
IHF-S-IE-NVL	08-4	+0.000E+000	1
IHF-S-IE-NVL	08-5	+0.000E+000	1
IHF-S-IE-NVL	08-6	4.112E-006	2
IHF-S-IE-NVL	08-7	3.870E-008	2

Table A1.4-1. Sequence Level Results (Continued)

Event Tree	Sequence	Base Min. Cut	Base Cut Sets
IHF-S-IE-NVL	09-2		0
IHF-S-IE-NVL	09-3	+0.000E+000	1
IHF-S-IE-NVL	09-4	+0.000E+000	1
IHF-S-IE-NVL	09-5	+0.000E+000	1
IHF-S-IE-NVL	09-6	4.489E-005	1
IHF-S-IE-NVL	09-7	3.255E-007	1
IHF-S-IE-NVL	10-2	1.455E-010	1
IHF-S-IE-NVL	10-3	+0.000E+000	1
IHF-S-IE-NVL	10-4	+0.000E+000	1
IHF-S-IE-NVL	10-5	+0.000E+000	1
IHF-S-IE-NVL	10-6	3.932E-006	3
IHF-S-IE-NVL	10-7	3.659E-009	3
IHF-S-IE-NVL	11-2		0
IHF-S-IE-NVL	11-3	+0.000E+000	1
IHF-S-IE-NVL	11-4	+0.000E+000	1
IHF-S-IE-NVL	11-5	+0.000E+000	1
IHF-S-IE-NVL	11-6	1.411E-006	1
IHF-S-IE-NVL	11-7	1.344E-008	1
IHF-S-IE-NVL	12-2	4.245E-011	3
IHF-S-IE-NVL	12-3	+0.000E+000	1
IHF-S-IE-NVL	12-4	+0.000E+000	1
IHF-S-IE-NVL	12-5	4.878E-006	5
IHF-S-IE-NVL	12-6	3.864E-009	5
IHF-S-IE-NVL	13-2	2.891E-011	2
IHF-S-IE-NVL	13-3	+0.000E+000	1
IHF-S-IE-NVL	13-4	+0.000E+000	1
IHF-S-IE-NVL	13-5	+0.000E+000	1
IHF-S-IE-NVL	13-6	2.891E-011	2
IHF-S-IE-NVL	13-7	2.565E-014	2
IHF-S-IE-NVL	14-2	1.501E-010	1
IHF-S-IE-NVL	14-3	+0.000E+000	1
IHF-S-IE-NVL	14-4	+0.000E+000	1
IHF-S-IE-NVL	14-5	+0.000E+000	1
IHF-S-IE-NVL	14-6	6.001E-007	2
IHF-S-IE-NVL	14-7	1.712E-009	2
IHF-S-IE-NVL	15-2	6.716E-012	1

Table A1.4-1. Sequence Level Results (Continued)

Event Tree	Sequence	Base Min. Cut	Base Cut Sets
IHF-S-IE-NVL	15-3	+0.000E+000	1
IHF-S-IE-NVL	15-4	+0.000E+000	1
IHF-S-IE-NVL	15-5	+0.000E+000	1
IHF-S-IE-NVL	15-6	1.494E-007	2
IHF-S-IE-NVL	15-7	1.406E-009	2
IHF-S-IE-NVL	16-2	6.476E-006	2
IHF-S-IE-NVL	16-4	+0.000E+000	1
IHF-S-IE-NVL	16-5	+0.000E+000	1
IHF-S-IE-NVL	16-6	+0.000E+000	1
IHF-S-IE-NVL	16-7	4.075E-007	3
IHF-S-IE-NVL	16-8	2.736E-009	3

Source: Original

A1.4.2 Cut Set Level Results by Sequence

Note that the SAPHIRE software does not provide special tables for seismic cut sets. Therefore, the “Cut Set %” given in the third column of this table is not correct for seismic events, although it does provide the approximate rank order for the cut sets.

Table A1.4-2. Cut Set Level Results by Sequence

Event Tree	Sequence	Cut Set %	Basic Event	Description
IHF-S-IE-NVL	03	100.00	51A-NVL-STRUCTUR-ETF	ETF for NVL canister in IHF structure
			IHF-NVL-CAN	Number of naval canisters processed in IHF
			S-51A-STR-COLLAPSE	Seismic collapse of IHF structure
			= Total	
	04-2	100.00	51A-NVL-ENTDOOR-ETF	ETF for entry door over naval cask
			IHF-NVL-CAN	Number of naval canisters processed in IHF
			S-51A-ENTDOORCOL	Seismic collapse of entry door
			SHIELDING	Shielding remains intact
			= Total	
	04-3	0.00	<FALSE>	System Generated Success Event
			= Total	
	04-4	0.00	<FALSE>	System Generated Success Event
			= Total	
	04-5	0.00	<FALSE>	System Generated Success Event
			= Total	
	04-6	100.00	51A-NVL-ENTDOOR-ETF	ETF for entry door over naval cask
			51A-NVL-ENTDOOR-PFA	Breach of naval TC due to entry door collapse
			IHF-NVL-CAN	Number of naval canisters processed in IHF
			S-51A-ENTDOORCOL	Seismic collapse of entry door
			= Total	
	04-7	100.00	51A-NVL-ENTDOOR-ETF	ETF for entry door over naval cask
			51A-NVL-ENTDOOR-PFA	Breach of naval TC due to entry door collapse
			IHF-NVL-CAN	Number of naval canisters processed in IHF
			MOD-ENTER-CANISTER	Flooding or spray enters canister
			S-51A-ENTDOORCOL	Seismic collapse of entry door
			S-51A-PIPING-FAIL	Seismic failure of piping in accident area
			= Total	
	05-2	100.00	51A-NVL-RAILCAR-ETF	ETF for railcar carrying naval transport cask
			IHF-NVL-CAN	Number of naval canisters processed in IHF

Table A1.4-2. Cut Set Level Results by Sequence (Continued)

Event Tree	Sequence	Cut Set %	Basic Event	Description
			S-51A-RAILCAR-ACC	Seismic tipover or collision of railcar
			SHIELDING	Shielding remains intact
			= Total	
	05-3	0.00	<FALSE>	System Generated Success Event
			= Total	
	05-4	0.00	<FALSE>	System Generated Success Event
			= Total	
	05-5	0.00	<FALSE>	System Generated Success Event
			= Total	
	05-6	100.00	51A-NVL-RAILCAR-ETF	ETF for railcar carrying naval transport cask
			51A-NVL-RAILCAR-PFA	Breach of naval TC due to railcar accident
			IHF-NVL-CAN	Number of naval canisters processed in IHF
			S-51A-RAILCAR-ACC	Seismic tipover or collision of railcar
			= Total	
	05-7	100.00	51A-NVL-RAILCAR-ETF	ETF for railcar carrying naval transport cask
			51A-NVL-RAILCAR-PFA	Breach of naval TC due to railcar accident
			IHF-NVL-CAN	Number of naval canisters processed in IHF
			MOD-ENTER-CANISTER	Flooding or spray enters canister
			S-51A-PIPING-FAIL	Seismic failure of piping in accident area
			S-51A-RAILCAR-ACC	Seismic tipover or collision of railcar
			= Total	
	06-2	100.00	51A-NVL-MOBPLAT-ETF	ETF for mobile platform over naval TC
			IHF-NVL-CAN	Number of naval canisters processed in IHF
			S-51A-MOBPLAT-COLLAP	Seismic collapse of mobile platform
			SHIELDING	Shielding remains intact
			= Total	
	06-3	0.00	<FALSE>	System Generated Success Event
			= Total	
	06-4	0.00	<FALSE>	System Generated Success Event
			= Total	
	06-5	0.00	<FALSE>	System Generated Success Event
			= Total	

Table A1.4-2. Cut Set Level Results by Sequence (Continued)

Event Tree	Sequence	Cut Set %	Basic Event	Description
	06-6	100.00	51A-NVL-MOBPLAT-ETF	ETF for mobile platform over naval TC
			51A-NVL-MOBPLAT-PFA	Breach of naval TC due to mobile platform collapse
			IHF-NVL-CAN	Number of naval canisters processed in IHF
			S-51A-MOBPLAT-COLLAP	Seismic collapse of mobile platform
			= Total	
	06-7	100.00	51A-NVL-MOBPLAT-ETF	ETF for mobile platform over naval TC
			51A-NVL-MOBPLAT-PFA	Breach of naval TC due to mobile platform collapse
			IHF-NVL-CAN	Number of naval canisters processed in IHF
			MOD-ENTER-CANISTER	Flooding or spray enters canister
			S-51A-MOBPLAT-COLLAP	Seismic collapse of mobile platform
			S-51A-PIPING-FAIL	Seismic failure of piping in accident area
			= Total	
	07-2	62.76	51A-NVL-CHCHOIST-ETF	ETF for CHC hoisting naval TC
			IHF-NVL-CAN	Number of naval canisters processed in IHF
			S-51A-CHC-SWING	Significant seismic swinging of CHC
			SHIELDING	Shielding remains intact
		33.58	51A-NVL-CHC-OBJ-ETF	ETF for CHC with heavy object over naval TC
			IHF-NVL-CAN	Number of naval canisters processed in IHF
			S-51A-CHC-OBJDROP	Seismic drop of heavy object by CHC
			SHIELDING	Shielding remains intact
		3.67	51A-NVL-CHCHOIST-ETF	ETF for CHC hoisting naval TC
			IHF-NVL-CAN	Number of naval canisters processed in IHF
			S-51A-CHC-HOIST	Seismic failure of CHC hoist
			SHIELDING	Shielding remains intact
			= Total	
	07-3	0.00	<FALSE>	System Generated Success Event
			= Total	
	07-4	0.00	<FALSE>	System Generated Success Event
			= Total	
	07-5	0.00	<FALSE>	System Generated Success Event
			= Total	

Table A1.4-2. Cut Set Level Results by Sequence (Continued)

Event Tree	Sequence	Cut Set %	Basic Event	Description
	07-6	99.97	51A-NVL-CHC-COL-ETF	ETF for CHC over naval canister
			IHF-NVL-CAN	Number of naval canisters processed in IHF
			S-51A-CHC-COLLAPSE	Seismic collapse of CHC
		0.02	51A-NVL-CHCHOIST-ETF	ETF for CHC hoisting naval TC
			51A-NVL-CHCSWING-PFA	Breach of naval cask due to CHC load swinging
			IHF-NVL-CAN	Number of naval canisters processed in IHF
			S-51A-CHC-SWING	Significant seismic swinging of CHC
		0.01	51A-NVL-CHC-OBJ-ETF	ETF for CHC with heavy object over naval TC
			51A-NVL-CHC-OBJ-PFA	Breach of naval cask due to CHC heavy object drop
			IHF-NVL-CAN	Number of naval canisters processed in IHF
			S-51A-CHC-OBJDROP	Seismic drop of heavy object by CHC
		0.00	51A-NVL-CHCHOIST-ETF	ETF for CHC hoisting naval TC
			51A-NVL-CHCHOIST-PFA	Breach of naval cask due to CHC hoist drop
			IHF-NVL-CAN	Number of naval canisters processed in IHF
			S-51A-CHC-HOIST	Seismic failure of CHC hoist
			= Total	
	07-7	99.97	51A-NVL-CHC-COL-ETF	ETF for CHC over naval canister
			IHF-NVL-CAN	Number of naval canisters processed in IHF
			MOD-ENTER-CANISTER	Flooding or spray enters canister
			S-51A-CHC-COLLAPSE	Seismic collapse of CHC
			S-51A-PIPING-FAIL	Seismic failure of piping in accident area
		0.02	51A-NVL-CHCHOIST-ETF	ETF for CHC hoisting naval TC
			51A-NVL-CHCSWING-PFA	Breach of naval cask due to CHC load swinging
			IHF-NVL-CAN	Number of naval canisters processed in IHF
			MOD-ENTER-CANISTER	Flooding or spray enters canister
			S-51A-CHC-SWING	Significant seismic swinging of CHC
			S-51A-PIPING-FAIL	Seismic failure of piping in accident area
		0.01	51A-NVL-CHC-OBJ-ETF	ETF for CHC with heavy object over naval TC
			51A-NVL-CHC-OBJ-PFA	Breach of naval cask due to CHC heavy object drop

Table A1.4-2. Cut Set Level Results by Sequence (Continued)

Event Tree	Sequence	Cut Set %	Basic Event	Description
			IHF-NVL-CAN	Number of naval canisters processed in IHF
			MOD-ENTER-CANISTER	Flooding or spray enters canister
			S-51A-CHC-OBJDROP	Seismic drop of heavy object by CHC
			S-51A-PIPING-FAIL	Seismic failure of piping in accident area
		0.00	51A-NVL-CHCHOIST-ETF	ETF for CHC hoisting naval TC
			51A-NVL-CHCHOIST-PFA	Breach of naval cask due to CHC hoist drop
			IHF-NVL-CAN	Number of naval canisters processed in IHF
			MOD-ENTER-CANISTER	Flooding or spray enters canister
			S-51A-CHC-HOIST	Seismic failure of CHC hoist
			S-51A-PIPING-FAIL	Seismic failure of piping in accident area
			= Total	
	08-2	100.00	51A-NVL-CPC-OBJ-ETF	ETF for CPC with heavy object over naval TC
			IHF-NVL-CAN	Number of naval canisters processed in IHF
			S-51A-CPC-OBJDROP	Seismic drop of heavy object by CPC
			SHIELDING	Shielding remains intact
			= Total	
	08-3	0.00	<FALSE>	System Generated Success Event
			= Total	
	08-4	0.00	<FALSE>	System Generated Success Event
			= Total	
	08-5	0.00	<FALSE>	System Generated Success Event
			= Total	
	08-6	99.99	51A-NVL-CPC-COL-ETF	ETF for CPC over naval canister
			IHF-NVL-CAN	Number of naval canisters processed in IHF
			S-51A-CPC-COLLAPSE	Seismic collapse of CPC
		0.01	51A-NVL-CPC-OBJ-ETF	ETF for CPC with heavy object over naval TC
			51A-NVL-CPC-OBJ-PFA	Breach of naval cask due to CPC heavy object drop
			IHF-NVL-CAN	Number of naval canisters processed in IHF
			S-51A-CPC-OBJDROP	Seismic drop of heavy object by CPC
			= Total	
	08-7	99.99	51A-NVL-CPC-COL-ETF	ETF for CPC over naval canister

Table A1.4-2. Cut Set Level Results by Sequence (Continued)

Event Tree	Sequence	Cut Set %	Basic Event	Description
			IHF-NVL-CAN	Number of naval canisters processed in IHF
			MOD-ENTER-CANISTER	Flooding or spray enters canister
			S-51A-CPC-COLLAPSE	Seismic collapse of CPC
			S-51A-PIPING-FAIL	Seismic failure of piping in accident area
		0.01	51A-NVL-CPC-OBJ-ETF	ETF for CPC with heavy object over naval TC
			51A-NVL-CPC-OBJ-PFA	Breach of naval cask due to CPC heavy object drop
			IHF-NVL-CAN	Number of naval canisters processed in IHF
			MOD-ENTER-CANISTER	Flooding or spray enters canister
			S-51A-CPC-OBJDROP	Seismic drop of heavy object by CPC
			S-51A-PIPING-FAIL	Seismic failure of piping in accident area
			= Total	
	09-2			
	09-3	0.00	<FALSE>	System Generated Success Event
			= Total	
	09-4	0.00	<FALSE>	System Generated Success Event
			= Total	
	09-5	0.00	<FALSE>	System Generated Success Event
			= Total	
	09-6	100.00	51A-NVL-CPPLAT-ETF	ETF for naval cask under cask prep platform
			IHF-NVL-CAN	Number of naval canisters processed in IHF
			S-51A-CPPLAT-COL	Seismic collapse of cask prep platform
			= Total	
	09-7	100.00	51A-NVL-CPPLAT-ETF	ETF for naval cask under cask prep platform
			IHF-NVL-CAN	Number of naval canisters processed in IHF
			MOD-ENTER-CANISTER	Flooding or spray enters canister
			S-51A-CPPLAT-COL	Seismic collapse of cask prep platform
			S-51A-PIPING-FAIL	Seismic failure of piping in accident area
			= Total	
	10-2	100.00	51A-NVL-CTT-BUMP-ETF	ETF for CTT with TC subject to bumping EAF
			IHF-NVL-CAN	Number of naval canisters processed in IHF
			S-51A-CTT-BUMPING	Seismic bumping of CTT into EAF

Table A1.4-2. Cut Set Level Results by Sequence (Continued)

Event Tree	Sequence	Cut Set %	Basic Event	Description
			SHIELDING	Shielding remains intact
			= Total	
	10-3	0.00	<FALSE>	System Generated Success Event
			= Total	
	10-4	0.00	<FALSE>	System Generated Success Event
			= Total	
	10-5	0.00	<FALSE>	System Generated Success Event
			= Total	
	10-6	82.99	51A-NVL-CTTSLIDE-ETF	ETF for CTT containing naval TC in transfer cell
			IHF-NVL-CAN	Number of naval canisters processed in IHF
			S-51A-CTT-SLIDE	Seismic sliding of CTT into wall
		17.00	51A-NVL-CTT-ROCK-ETF	ETF for CTT with naval TC subject to rocking
			IHF-NVL-CAN	Number of naval canisters processed in IHF
			S-51A-CTT-ROCKING	Seismic rocking of CTT with restraint failure
		0.00	51A-NVL-CTT-BUMP-ETF	ETF for CTT with TC subject to bumping EAF
			51A-NVL-CTT-BUMP-PFA	Breach given CTT with TC subject to bumping EAF
			IHF-NVL-CAN	Number of naval canisters processed in IHF
			S-51A-CTT-BUMPING	Seismic bumping of CTT into EAF
			= Total	
	10-7	82.96	51A-NVL-CTTSLIDE-ETF	ETF for CTT containing naval TC in transfer cell
			IHF-NVL-CAN	Number of naval canisters processed in IHF
			MOD-ENTER-CANISTER	Flooding or spray enters canister
			S-51A-CTT-SLIDE	Seismic sliding of CTT into wall
			S-51A-FPW-V-SO	Spurious opening of FPW pre-action valve (relay chatter)
			S-51A-PIPING-FAIL	Seismic failure of piping in accident area
		17.00	51A-NVL-CTT-ROCK-ETF	ETF for CTT with naval TC subject to rocking
			IHF-NVL-CAN	Number of naval canisters processed in IHF
			MOD-ENTER-CANISTER	Flooding or spray enters canister
			S-51A-CTT-ROCKING	Seismic rocking of CTT with restraint failure
			S-51A-FPW-V-SO	Spurious opening of FPW pre-action valve (relay chatter)

Table A1.4-2. Cut Set Level Results by Sequence (Continued)

Event Tree	Sequence	Cut Set %	Basic Event	Description
			S-51A-PIPING-FAIL	Seismic failure of piping in accident area
		0.00	51A-NVL-CTT-BUMP-ETF	ETF for CTT with TC subject to bumping EAF
			51A-NVL-CTT-BUMP-PFA	Breach given CTT with TC subject to bumping EAF
			IHF-NVL-CAN	Number of naval canisters processed in IHF
			MOD-ENTER-CANISTER	Flooding or spray enters canister
			S-51A-CTT-BUMPING	Seismic bumping of CTT into EAF
			S-51A-FPW-V-SO	Spurious opening of FPW pre-action valve (relay chatter)
			S-51A-PIPING-FAIL	Seismic failure of piping in accident area
			= Total	
	11-2			
	11-3	0.00	<FALSE>	System Generated Success Event
			= Total	
	11-4	0.00	<FALSE>	System Generated Success Event
			= Total	
	11-5	0.00	<FALSE>	System Generated Success Event
			= Total	
	11-6	100.00	51A-NVL-SHIELDDDR-ETF	ETF for shield doors when naval canister is nearby
			IHF-NVL-CAN	Number of naval canisters processed in IHF
			S-51A-SHIELDDOOR	Seismic falling of shield door
			= Total	
	11-7	100.00	51A-NVL-SHIELDDDR-ETF	ETF for shield doors when naval canister is nearby
			IHF-NVL-CAN	Number of naval canisters processed in IHF
			MOD-ENTER-CANISTER	Flooding or spray enters canister
			S-51A-PIPING-FAIL	Seismic failure of piping in accident area
			S-51A-SHIELDDOOR	Seismic falling of shield door
			= Total	
	12-2	81.40	51A-NVL-CTMSWGIB-ETF	ETF for CTM hoisting naval canister inside bell
			IHF-NVL-CAN	Number of naval canisters processed in IHF
			S-51A-CTMSWG-IB	Significant swinging of canister inside CTM bell
			SHIELDING	Shielding remains intact
		13.85	51A-NVL-CTM-OBJ-ETF	ETF for CTM with heavy object over naval TC

Table A1.4-2. Cut Set Level Results by Sequence (Continued)

Event Tree	Sequence	Cut Set %	Basic Event	Description
			IHF-NVL-CAN	Number of naval canisters processed in IHF
			S-51A-CTM-OBJDROP	Seismic drop of heavy object by CTM
			SHIELDING	Shielding remains intact
		4.75	51A-NVL-CTMHOIST-ETF	ETF for CTM hoisting naval canister
			IHF-NVL-CAN	Number of naval canisters processed in IHF
			S-51A-CTM-HOIST	Seismic drop of naval canister hoisted by CTM
			SHIELDING	Shielding remains intact
			= Total	
	12-3	0.00	<FALSE>	System Generated Success Event
			= Total	
	12-4	0.00	<FALSE>	System Generated Success Event
			= Total	
	12-5	97.85	51A-NVL-CTMSWGOB-ETF	ETF for CTM hoisting naval canister outside bell
			IHF-NVL-CAN	Number of naval canisters processed in IHF
			S-51A-CTMSWG-OB	Significant swinging of canister outside CTM bell
		2.15	51A-NVL-CTM-COL-ETF	ETF for CTM over naval canister
			IHF-NVL-CAN	Number of naval canisters processed in IHF
			S-51A-CTM-COLLAPSE	Seismic collapse of CTM
		0.00	51A-NVL-CTMSWGIB-ETF	ETF for CTM hoisting naval canister inside bell
			51A-NVL-CTMSWGIB-PFA	Breach of naval canister due to swing inside bell
			IHF-NVL-CAN	Number of naval canisters processed in IHF
			S-51A-CTMSWG-IB	Significant swinging of canister inside CTM bell
		0.00	51A-NVL-CTM-OBJ-ETF	ETF for CTM with heavy object over naval TC
			51A-NVL-CTM-OBJ-PFA	Breach of naval canister due to CTM object drop
			IHF-NVL-CAN	Number of naval canisters processed in IHF
			S-51A-CTM-OBJDROP	Seismic drop of heavy object by CTM
		0.00	51A-NVL-CTMHOIST-ETF	ETF for CTM hoisting naval canister
			51A-NVL-CTMHOIST-PFA	Breach of naval canister dropped by CTM

Table A1.4-2. Cut Set Level Results by Sequence (Continued)

Event Tree	Sequence	Cut Set %	Basic Event	Description
			IHF-NVL-CAN	Number of naval canisters processed in IHF
			S-51A-CTM-HOIST	Seismic drop of naval canister hoisted by CTM
			= Total	
	12-6	97.84	51A-NVL-CTMSWGOB-ETF	ETF for CTM hoisting naval canister outside bell
			IHF-NVL-CAN	Number of naval canisters processed in IHF
			MOD-ENTER-CANISTER	Flooding or spray enters canister
			S-51A-CTMSWG-OB	Significant swinging of canister outside CTM bell
			S-51A-FPW-V-SO	Spurious opening of FPW pre-action valve (relay chatter)
			S-51A-PIPING-FAIL	Seismic failure of piping in accident area
		2.15	51A-NVL-CTM-COL-ETF	ETF for CTM over naval canister
			IHF-NVL-CAN	Number of naval canisters processed in IHF
			MOD-ENTER-CANISTER	Flooding or spray enters canister
			S-51A-CTM-COLLAPSE	Seismic collapse of CTM
			S-51A-FPW-V-SO	Spurious opening of FPW pre-action valve (relay chatter)
			S-51A-PIPING-FAIL	Seismic failure of piping in accident area
		0.00	51A-NVL-CTMSWGIB-ETF	ETF for CTM hoisting naval canister inside bell
			51A-NVL-CTMSWGIB-PFA	Breach of naval canister due to swing inside bell
			IHF-NVL-CAN	Number of naval canisters processed in IHF
			MOD-ENTER-CANISTER	Flooding or spray enters canister
			S-51A-CTMSWG-IB	Significant swinging of canister inside CTM bell
			S-51A-FPW-V-SO	Spurious opening of FPW pre-action valve (relay chatter)
			S-51A-PIPING-FAIL	Seismic failure of piping in accident area
		0.00	51A-NVL-CTM-OBJ-ETF	ETF for CTM with heavy object over naval TC
			51A-NVL-CTM-OBJ-PFA	Breach of naval canister due to CTM object drop
			IHF-NVL-CAN	Number of naval canisters processed in IHF
			MOD-ENTER-CANISTER	Flooding or spray enters canister
			S-51A-CTM-OBJDROP	Seismic drop of heavy object by CTM

Table A1.4-2. Cut Set Level Results by Sequence (Continued)

Event Tree	Sequence	Cut Set %	Basic Event	Description
			S-51A-FPW-V-SO	Spurious opening of FPW pre-action valve (relay chatter)
			S-51A-PIPING-FAIL	Seismic failure of piping in accident area
		0.00	51A-NVL-CTMHOIST-ETF	ETF for CTM hoisting naval canister
			51A-NVL-CTMHOIST-PFA	Breach of naval canister dropped by CTM
			IHF-NVL-CAN	Number of naval canisters processed in IHF
			MOD-ENTER-CANISTER	Flooding or spray enters canister
			S-51A-CTM-HOIST	Seismic drop of naval canister hoisted by CTM
			S-51A-FPW-V-SO	Spurious opening of FPW pre-action valve (relay chatter)
			S-51A-PIPING-FAIL	Seismic failure of piping in accident area
			= Total	
	13-2	98.78	51A-NVL-RHS-OBJ-ETF	ETF for RHS with heavy object over naval canister
			IHF-NVL-CAN	Number of naval canisters processed in IHF
			S-51A-RHS-OBJDROP	Seismic drop of heavy object by RHS
			SHIELDING	Shielding remains intact
		1.22	51A-NVL-RHS-COL-ETF	ETF for RHS over naval canister
			IHF-NVL-CAN	Number of naval canisters processed in IHF
			S-51A-RHS-COLLAPSE	Seismic collapse of RHS
			SHIELDING	Shielding remains intact
			= Total	
	13-3	0.00	<FALSE>	System Generated Success Event
			= Total	
	13-4	0.00	<FALSE>	System Generated Success Event
			= Total	
	13-5	0.00	<FALSE>	System Generated Success Event
			= Total	
	13-6	98.78	51A-NVL-RHS-OBJ-ETF	ETF for RHS with heavy object over naval canister
			51A-NVL-RHS-OBJ-PFA	Breach of naval canister due to RHS object drop
			IHF-NVL-CAN	Number of naval canisters processed in IHF
			S-51A-RHS-OBJDROP	Seismic drop of heavy object by RHS
		1.22	51A-NVL-RHS-COL-ETF	ETF for RHS over naval canister

Table A1.4-2. Cut Set Level Results by Sequence (Continued)

Event Tree	Sequence	Cut Set %	Basic Event	Description
			51A-NVL-RHS-COL-PFA	Breach of naval canister due to RHS collapse
			IHF-NVL-CAN	Number of naval canisters processed in IHF
			S-51A-RHS-COLLAPSE	Seismic collapse of RHS
			= Total	
	13-7	0.00	51A-NVL-RHS-OBJ-ETF	ETF for RHS with heavy object over naval canister
			51A-NVL-RHS-OBJ-PFA	Breach of naval canister due to RHS object drop
			IHF-NVL-CAN	Number of naval canisters processed in IHF
			MOD-ENTER-CANISTER	Flooding or spray enters canister
			S-51A-FPW-V-SO	Spurious opening of FPW pre-action valve (relay chatter)
			S-51A-PIPING-FAIL	Seismic failure of piping in accident area
			S-51A-RHS-OBJDROP	Seismic drop of heavy object by RHS
		0.00	51A-NVL-RHS-COL-ETF	ETF for RHS over naval canister
			51A-NVL-RHS-COL-PFA	Breach of naval canister due to RHS collapse
			IHF-NVL-CAN	Number of naval canisters processed in IHF
			MOD-ENTER-CANISTER	Flooding or spray enters canister
			S-51A-FPW-V-SO	Spurious opening of FPW pre-action valve (relay chatter)
			S-51A-PIPING-FAIL	Seismic failure of piping in accident area
			S-51A-RHS-COLLAPSE	Seismic collapse of RHS
			= Total	
	14-2	100.00	51A-NVL-WPTT-ROCK-ETF	ETF for WPTT in constrained position
			IHF-NVL-CAN	Number of naval canisters processed in IHF
			S-51A-WPTT-ROCK	Seismic rocking of WPTT (constrained)
			SHIELDING	Shielding remains intact
			= Total	
	14-3	0.00	<FALSE>	System Generated Success Event
			= Total	
	14-4	0.00	<FALSE>	System Generated Success Event
			= Total	
	14-5	0.00	<FALSE>	System Generated Success Event
			= Total	
	14-6	98.95	51A-NVL-WPTT-TIP-ETF	ETF for WPTT not constrained

Table A1.4-2. Cut Set Level Results by Sequence (Continued)

Event Tree	Sequence	Cut Set %	Basic Event	Description
			IHF-NVL-CAN	Number of naval canisters processed in IHF
			S-51A-WPTT-TIPOVER	Seismic tipover of WPTT
		1.05	51A-NVL-WPTT-ROCK-ETF	ETF for WPTT in constrained position
			51A-NVL-WPTT-ROCK-PFA	Breach of naval canister when WPTT rocks
			IHF-NVL-CAN	Number of naval canisters processed in IHF
			S-51A-WPTT-ROCK	Seismic rocking of WPTT (constrained)
			= Total	
	14-7	0.00	51A-NVL-WPTT-TIP-ETF	ETF for WPTT not constrained
			IHF-NVL-CAN	Number of naval canisters processed in IHF
			MOD-ENTER-CANISTER	Flooding or spray enters canister
			S-51A-FPW-V-SO	Spurious opening of FPW pre-action valve (relay chatter)
			S-51A-PIPING-FAIL	Seismic failure of piping in accident area
			S-51A-WPTT-TIPOVER	Seismic tipover of WPTT
		0.00	51A-NVL-WPTT-ROCK-ETF	ETF for WPTT in constrained position
			51A-NVL-WPTT-ROCK-PFA	Breach of naval canister when WPTT rocks
			IHF-NVL-CAN	Number of naval canisters processed in IHF
			MOD-ENTER-CANISTER	Flooding or spray enters canister
			S-51A-FPW-V-SO	Spurious opening of FPW pre-action valve (relay chatter)
			S-51A-PIPING-FAIL	Seismic failure of piping in accident area
			S-51A-WPTT-ROCK	Seismic rocking of WPTT (constrained)
			= Total	
	15-2	100.00	51A-NVL-WPHC-OBJ-ETF	ETF for WPHC with heavy object over naval WP
			IHF-NVL-CAN	Number of naval canisters processed in IHF
			S-51A-WPHC-OBJDROP	Seismic drop of heavy object by WPHC
			SHIELDING	Shielding remains intact
			= Total	
	15-3	0.00	<FALSE>	System Generated Success Event
			= Total	
	15-4	0.00	<FALSE>	System Generated Success Event
			= Total	

Table A1.4-2. Cut Set Level Results by Sequence (Continued)

Event Tree	Sequence	Cut Set %	Basic Event	Description
	15-5	0.00	<FALSE>	System Generated Success Event
			= Total	
	15-6	99.84	51A-NVL-WPHC-COL-ETF	ETF for WPHC over naval WP
			IHF-NVL-CAN	Number of naval canisters processed in IHF
			S-51A-WPHC-COLLAPSE	Seismic collapse of WPHC over naval WP
		0.16	51A-NVL-WPHC-OBJ-ETF	ETF for WPHC with heavy object over naval WP
			51A-NVL-WPHC-OBJ-PFA	Breach of naval WP due to WPHC object drop
			IHF-NVL-CAN	Number of naval canisters processed in IHF
			S-51A-WPHC-OBJDROP	Seismic drop of heavy object by WPHC
			= Total	
	15-7	99.84	51A-NVL-WPHC-COL-ETF	ETF for WPHC over naval WP
			IHF-NVL-CAN	Number of naval canisters processed in IHF
			MOD-ENTER-CANISTER	Flooding or spray enters canister
			S-51A-PIPING-FAIL	Seismic failure of piping in accident area
			S-51A-WPHC-COLLAPSE	Seismic collapse of WPHC over naval WP
		0.16	51A-NVL-WPHC-OBJ-ETF	ETF for WPHC with heavy object over naval WP
			51A-NVL-WPHC-OBJ-PFA	Breach of naval WP due to WPHC object drop
			IHF-NVL-CAN	Number of naval canisters processed in IHF
			MOD-ENTER-CANISTER	Flooding or spray enters canister
			S-51A-PIPING-FAIL	Seismic failure of piping in accident area
			S-51A-WPHC-OBJDROP	Seismic drop of heavy object by WPHC
			= Total	
	16-2	100.00	51A-NVL-TEVEJECT-ETF	ETF for TEV containing naval WP
			IHF-NVL-CAN	Number of naval canisters processed in IHF
			S-51A-TEV-EJECT-WP	Seismic ejection of naval WP from TEV
		0.00	51A-NVL-TEV-TIP-ETF	ETF for TEV containing naval WP
			IHF-NVL-CAN	Number of naval canisters processed in IHF
			S-51A-TEV-TIPOVER	Seismic tipover of TEV
			= Total	
	16-4	0.00	<FALSE>	System Generated Success Event

Table A1.4-2. Cut Set Level Results by Sequence (Continued)

Event Tree	Sequence	Cut Set %	Basic Event	Description
			= Total	
	16-5	0.00	<FALSE>	System Generated Success Event
			= Total	
	16-6	0.00	<FALSE>	System Generated Success Event
			= Total	
	16-7	82.96	51A-NVL-TEVSLIDE-ETF	ETF for TEV during WP transfer
			IHF-NVL-CAN	Number of naval canisters processed in IHF
			S-51A-TEV-SLIDE	Seismic sliding of TEV during WP transfer
		17.04	51A-NVL-TEVEJECT-ETF	ETF for TEV containing naval WP
			51A-NVL-TEVEJECT-PFA	Breach of naval WP due to ejection from TEV
			IHF-NVL-CAN	Number of naval canisters processed in IHF
			S-51A-TEV-EJECT-WP	Seismic ejection of naval WP from TEV
		0.00	51A-NVL-TEV-TIP-ETF	ETF for TEV containing naval WP
			51A-NVL-TEV-TIP-PFA	Breach of naval WP due to TEV tipover
			IHF-NVL-CAN	Number of naval canisters processed in IHF
			S-51A-TEV-TIPOVER	Seismic tipover of TEV
			= Total	
	16-8	82.96	51A-NVL-TEVSLIDE-ETF	ETF for TEV during WP transfer
			IHF-NVL-CAN	Number of naval canisters processed in IHF
			MOD-ENTER-CANISTER	Flooding or spray enters canister
			S-51A-PIPING-FAIL	Seismic failure of piping in accident area
			S-51A-TEV-SLIDE	Seismic sliding of TEV during WP transfer
		17.04	51A-NVL-TEVEJECT-ETF	ETF for TEV containing naval WP
			51A-NVL-TEVEJECT-PFA	Breach of naval WP due to ejection from TEV
			IHF-NVL-CAN	Number of naval canisters processed in IHF
			MOD-ENTER-CANISTER	Flooding or spray enters canister
			S-51A-PIPING-FAIL	Seismic failure of piping in accident area
			S-51A-TEV-EJECT-WP	Seismic ejection of naval WP from TEV
		0.00	51A-NVL-TEV-TIP-ETF	ETF for TEV containing naval WP
			51A-NVL-TEV-TIP-PFA	Breach of naval WP due to TEV tipover
			IHF-NVL-CAN	Number of naval canisters processed in IHF

Table A1.4-2. Cut Set Level Results by Sequence (Continued)

Event Tree	Sequence	Cut Set %	Basic Event	Description
			MOD-ENTER-CANISTER	Flooding or spray enters canister
			S-51A-PIPING-FAIL	Seismic failure of piping in accident area
			S-51A-TEV-TIPOVER	Seismic tipover of TEV
			= Total	
IHF-S-IE-NVL	03	100.00	51A-NVL-STRUCTUR-ETF	ETF for NVL canister in IHF structure
			IHF-NVL-CAN	Number of naval canisters processed in IHF
			S-51A-STR-COLLAPSE	Seismic collapse of IHF structure
			= Total	

NOTE: CHC = cask handling crane; CPC = cask preparation crane; CTM = canister transfer machine; CTT = cask transfer trolley; EAF = energy absorbing feature; ETF = exposure time factor; FPW = fire protection water; IHF = Initial Handling Facility; NVL = naval; RHS = remote handling system; TC = transportation cask; TEV = transport and emplacement vehicle; WP = waste package; WPHC = waste package handling crane; WPTT = waste package transfer trolley.

Source: Original

A2 HIGH-LEVEL RADIOACTIVE WASTE

This section provides the detailed information used to develop the event sequences for the analysis of processing of the HLW canisters inside the IHF. HLW canisters inside a transportation cask are received on a railcar or truck, and are transferred into a waste package, sealed, and then transported in a TEV out of the IHF. Transport to the emplacement drifts is not included in this section.

A2.1 EVENT TREES

The IET and SRETs are presented in this section. The tables provide the assignments between the event tree branches and the fault trees given in the next section.

Seismic Event	Number of HLW canisters processed in IHF	Identify initiating seismic failure			
SEIS-EVENT	IHF-HLW-CAN	SEIS-FAIL		#	END-STATE
				1	OK
		IHF building collapse		2	OK
		Entry door seismic collapse		3	RR-UNF
		Truck accident	T => 2	4	IHF-S-R-TC1
		Mobile platform seismic collapse	T => 2	5	IHF-S-R-TC1
		CHC seismic failures	T => 2	6	IHF-S-R-TC1
		CPC seismic failures	T => 2	7	IHF-S-R-TC1
		Cask prep platform collapse	T => 2	8	IHF-S-R-TC1
		CTT seismic failures	T => 2	9	IHF-S-R-TC1
		Shield door seismic failure	T => 2	10	IHF-S-R-TC1
		CTM seismic failures	T => 3	11	IHF-S-R-SD1
		RHS-robotic arm seismic failures	T => 4	12	IHF-S-R-CTM
		WPTT tipover	T => 5	13	IHF-S-R-WP1
		WPHC seismic failures	T => 5	14	IHF-S-R-WP1
		TEV seismic failures	T => 5	15	IHF-S-R-WP1
			T => 6	16	IHF-S-R-TEV

IHF-S-IE-HLW - IHF Seismic Event Tree - Initiating seismic failures

2008/01/07 Page 1

NOTE: Event tree branch captions are associated with the branch line below the caption.

CAN = canister; CHC = cask handling crane; CPC = cask preparation crane; CTM = canister transfer machine; CTT = cask transfer trolley; HLW = high-level radioactive waste; IHF = Initial Handling Facility; NVL = naval; RHS = remote handling system; SD = shield door; SEIS = seismic; T = transfer; TC = transportation cask; TEV = transport and emplacement vehicle; UNF = unfiltered; WPHC = waste package handling crane; WPTT = waste package transfer trolley.

Source: Original

Figure A2.1-1. IHF Seismic Event Tree IHF-S-IE-HLW – Initiating Seismic Failures

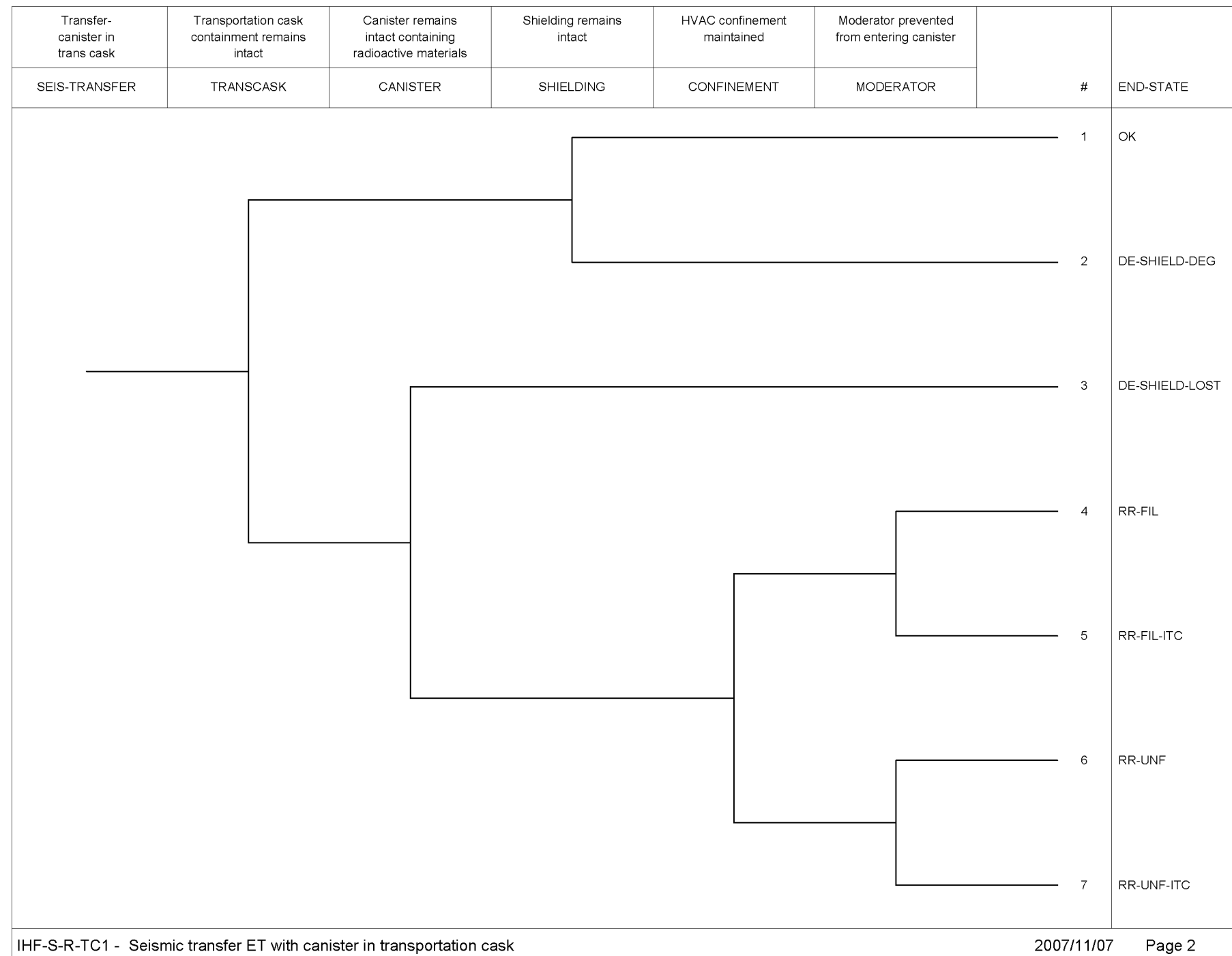

NOTE: DE = direct exposure; DEG = degradation; ET = event tree; FIL = filtered; HVAC = heating, ventilation and air conditioning; ITC = important to criticality; RR = radioactive release; SEIS = seismic; TC = transportation cask; UNF = unfiltered.
 Source: Original

Figure A2.1-2. IHF Seismic Event Tree IHF-S-R-TC1 – Seismic Transfer ET with Canister in Transportation Cask

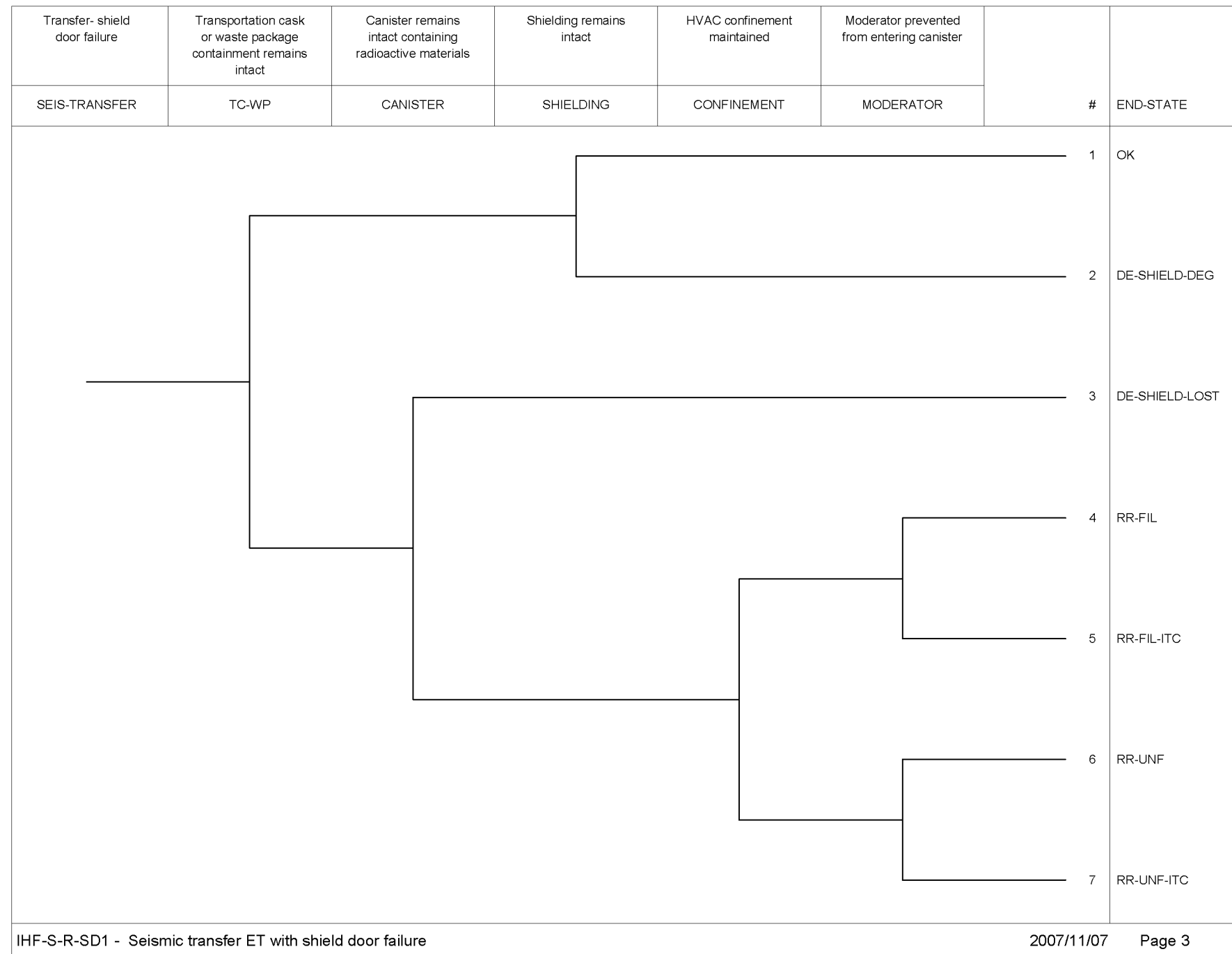

NOTE: DE = direct exposure; DEG = degradation; ET = event tree; FIL = filtered; HVAC = heating, ventilation and air conditioning; IHF = Initial Handling Facility; ITC = important to criticality; NVL = naval; RR = radioactive release; SD = shield door; SEIS = seismic; TC = transportation cask; UNF = unfiltered; WP = waste package.

Source: Original

Figure A2.1-3. IHF Seismic Event Tree IHF-S-R-SD1 – Seismic Transfer ET with Shield Door Failure

Transfer- CTM failures	Canister remains intact containing radioactive materials	Shielding remains intact	HVAC confinement maintained	Moderator prevented from entering canister		
SEIS-TRANSFER	CANISTER	SHIELDING	CONFINEMENT	MODERATOR	#	END-STATE
					1	OK
					2	DE-SHIELD-LOST
					3	RR-FIL
					4	RR-FIL-ITC
					5	RR-UNF
					6	RR-UNF-ITC
IHF-S-R-CTM - Seismic transfer ET with CTM operations					2007/11/07	Page 4

NOTE: CTM = canister transfer machine; DE = direct exposure; ET = event tree; FIL = filtered; HVAC = heating, ventilation and air conditioning; IHF = Initial Handling Facility; ITC = important to criticality; RR = radioactive release; SEIS = seismic; UNF = unfiltered.

Source: Original

Figure A2.1-4. IHF Seismic Event Tree IHF-S-R-CTM – Seismic Transfer ET with CTM Operations

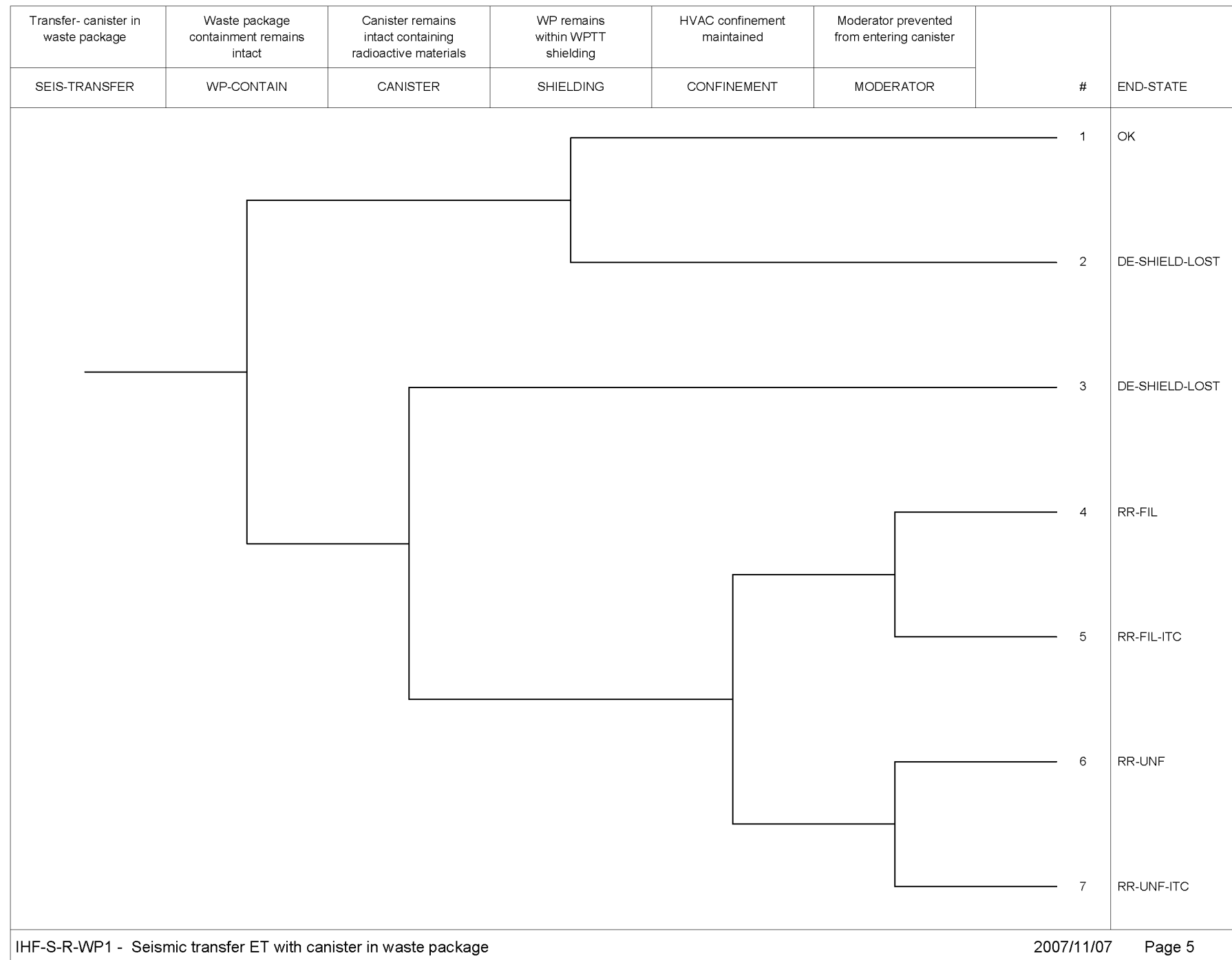

NOTE: CTM = canister transfer machine; DE = direct exposure; ET = event tree; FIL = filtered; HVAC = heating, ventilation and air conditioning; IHF = Initial Handling Facility; ITC = important to criticality; RR = radioactive release; SEIS = seismic; UNF = unfiltered; WP = waste package; WPTT = waste package transfer trolley.

Source: Original

Figure A2.1-5. IHF Seismic Event Tree IHF-S-R-WP1 – Seismic Transfer ET with Canister in Waste Package

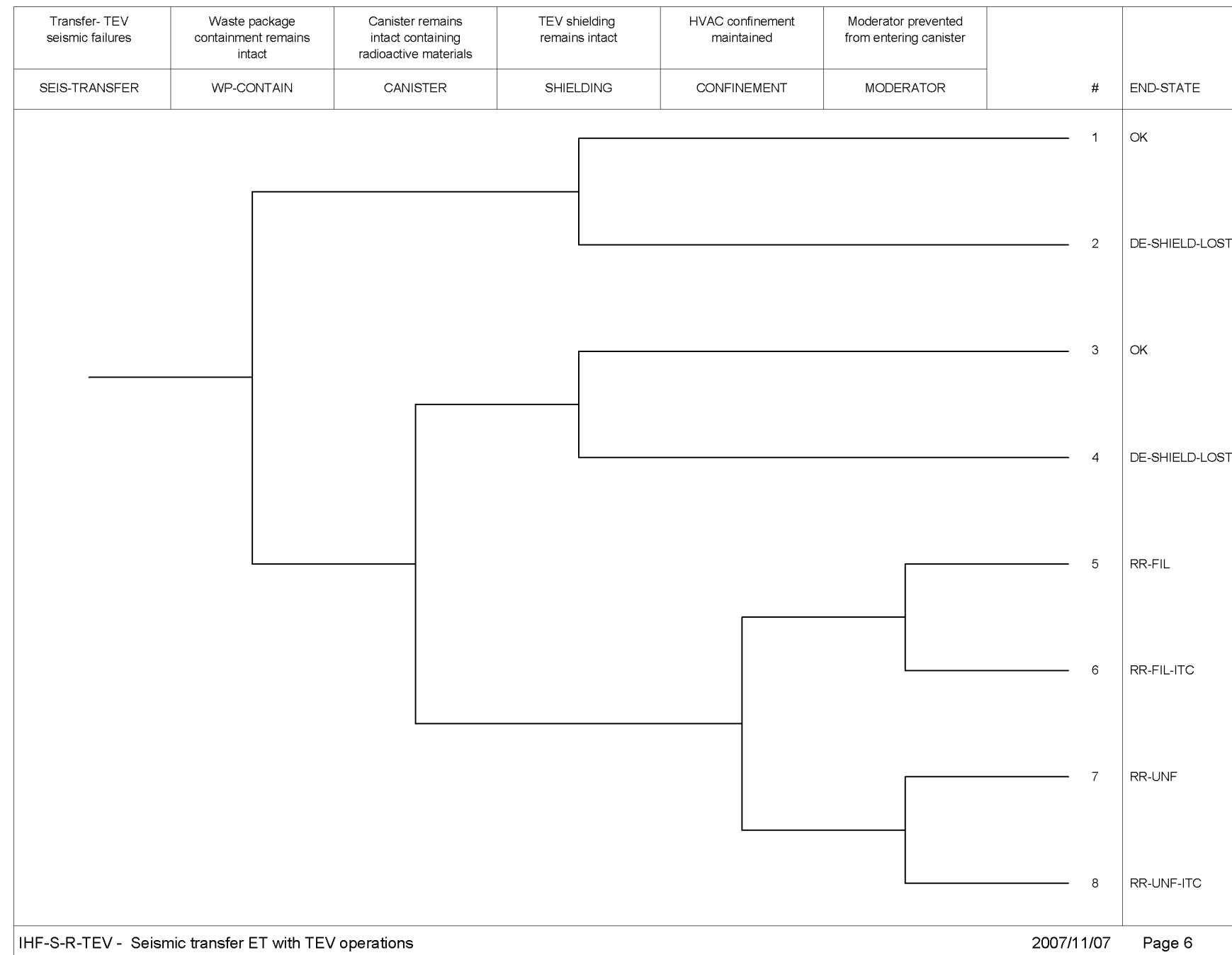

NOTE: CTM = canister transfer machine; DE = direct exposure; ET = event tree; FIL = filtered; HVAC = heating, ventilation and air conditioning; IHF = Initial Handling Facility; ITC = important to criticality; RR = radioactive release; SEIS = seismic; TEV = transport and emplacement vehicle; UNF = unfiltered; WP = waste package.

Source: Original

Figure A2.1-6. IHF Seismic Event Tree IHF-S-R-TEV – Seismic Transfer ET with TEV Operations

Table A2.1-1. Fault Trees Assigned for Initiating Seismic Failures for the IHF

Process	Initiator Event Tree	Initiating Seismic Failure	Associated Fault Tree
HLW Canister	IHF-S-IE-HLW	IHF building collapse	S-51A-NVL-STR-COLLAP
		Entry door seismic collapse	S-51A-NVL-ENTDOORCOL
		Truck accident	S-51A-NVL-RAILCARACC
		Mobile platform seismic collapse	S-51A-NVL-MOBPLATCOL
		CHC seismic failures	S-51A-NVL-CHC-FAIL
		CPC seismic failures	S-51A-NVL-CPC-FAIL
		Cask prep platform collapse	S-51A-NVL-CPREP-PLAT
		CTT seismic failures	S-51A-NVL-CTT-FAIL
		Shield door seismic failures	S-51A-NVL-SHIELDDOOR
		CTM seismic failures	S-51A-NVL-CTM-FAIL
		RHS - robotic arm seismic failures	S-51A-NVL-RHS-FAIL
		WPTT tipover	S-51A-NVL-WPTT-FAIL
		WPHC seismic failures	S-51A-NVL-WPHC-FAIL
		TEV seismic failures	S-51A-NVL-TEV-FAIL

NOTE: The fault trees used for the HLW seismic event sequences are identical in form to the fault trees used for the naval canister waste form, although the basic event values are different. Therefore, the same fault trees are used for NVL and for HLW, and the naming scheme includes the NVL abbreviation rather than HLW. However, the quantification correctly used the HLW basic event values, as given in Section A2.3 tables.

CHC = cask handling crane; CPC = cask preparation crane; CTM = canister transfer machine; CTT = cask transfer trolley; HLW = high-level radioactive waste; IHF = Initial Handling Facility; RHS = remote handling system; TEV = transport and emplacement vehicle; WPHC = waste package handling crane; WPTT = waste package transfer trolley.

Source: Original

Table A2.1-2. Fault Trees Assigned for Pivotal Events for IHF-S-IE-HLW Initiating Event Tree

Initiating Seismic Failure	TRANSCASK	MODERATOR
IHF building collapse	N/A	N/A
Entry door seismic collapse	RC-NVL-DOORDROP-CASK	N/A
Railcar accident	RC-NVL-RC-ACC-CASK	N/A
Mobile platform seismic collapse	RC-NVL-MOB-PLAT-CASK	N/A
CHC seismic failures	TC-NVL-CHC-CASK	N/A
CPC seismic failures	TC-NVL-CPC-CASK	N/A
Cask prep platform collapse	TC-NVL-CPP-CASK	N/A
CTT seismic failures	CTT-NVL-CTT-CASK	N/A
	TC-WP	
Shield door seismic failures	TCWP-NVL-SHIELDDOOR-CASK	N/A
	CANISTER	
CTM seismic failures	CTM-NVL-CTM-CAN	N/A
	WP-CONTAIN	
RHS - robotic arm seismic failures	WPTT-NVL-RHS-FAIL	N/A
WPTT tipover	WPTT-NVL-WPTT-FAIL	N/A
WPHC seismic failures	WPTT-NVL-WPHC-FAIL	N/A
TEV seismic failures	TEV-NVL-TEV-FAIL	N/A

NOTE: The fault trees used for the HLW seismic event sequences are identical in form to the fault trees used for the naval canister waste form, although the basic event values are different. Therefore, the same fault trees are used for NVL and for HLW, and the naming scheme includes the NVL abbreviation rather than HLW. However, the quantification correctly used the HLW basic event values, as given in Section A2.3 tables.

CHC = cask handling crane; CPC = cask preparation crane; CTM = canister transfer machine;
 CTT = cask transfer trolley; IHF = Initial Handling Facility; RHS = remote handling system;
 TEV = transport and emplacement vehicle; WPHC = waste package handling crane;
 WPTT = waste package transfer trolley.

Source: Original

A2.2 Fault Trees

Seismic fault trees for the processing of HLW canisters in the IHF are presented in alpha-numeric order in this section. Note that the fault trees used for the HLW seismic event sequences are identical in form to the fault trees used for the naval canister waste form, although the basic event values are different. Therefore, the same fault trees are used for NVL and for HLW, and the naming scheme includes the NVL abbreviation rather than HLW. However, the quantification correctly used the HLW basic event values, as given in Section A2.3 tables.

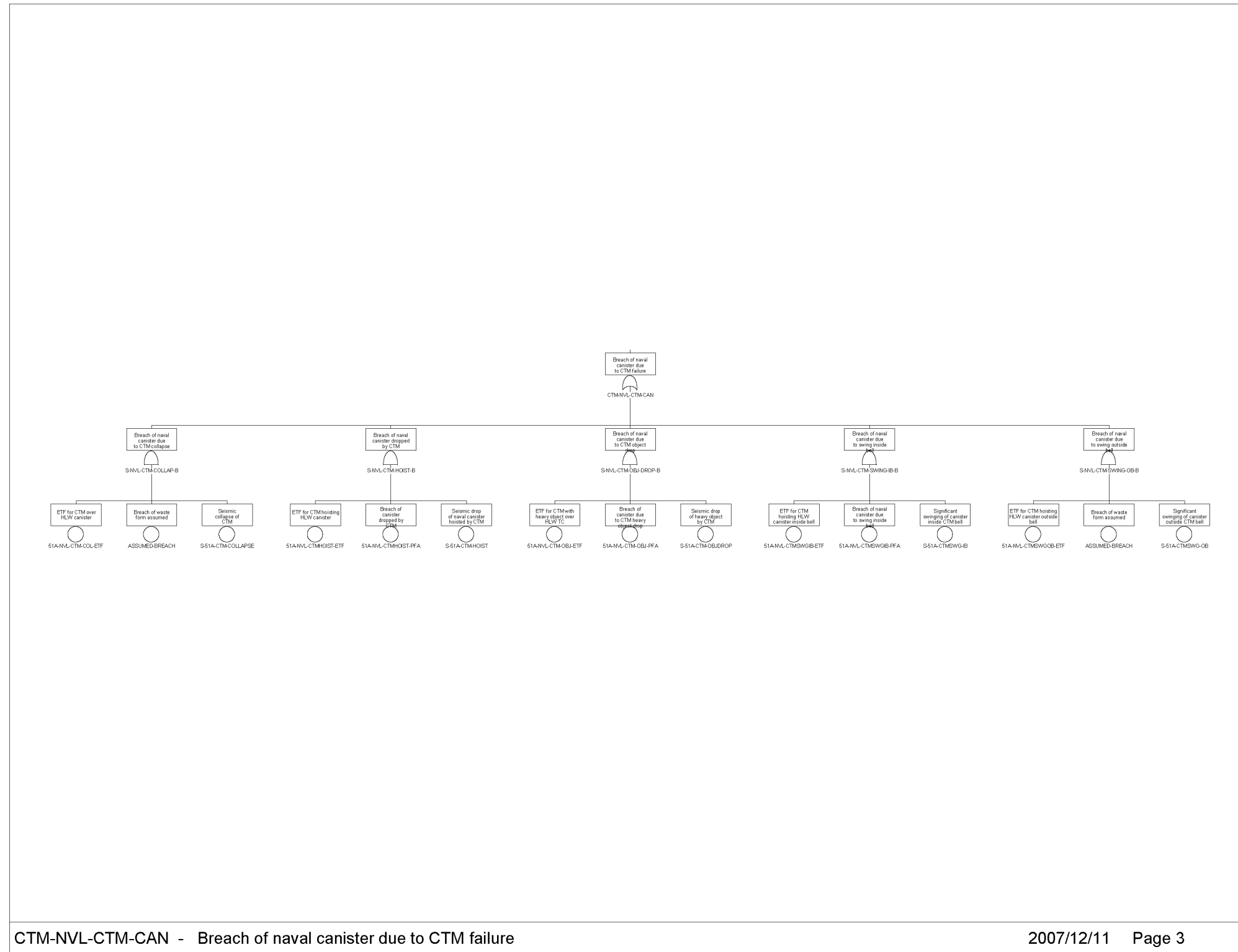

Source: Original

Figure A2.2-1. Fault Tree CTM-NVL-CTM-CAN – Breach of HLW Canister Due to CTM Failure

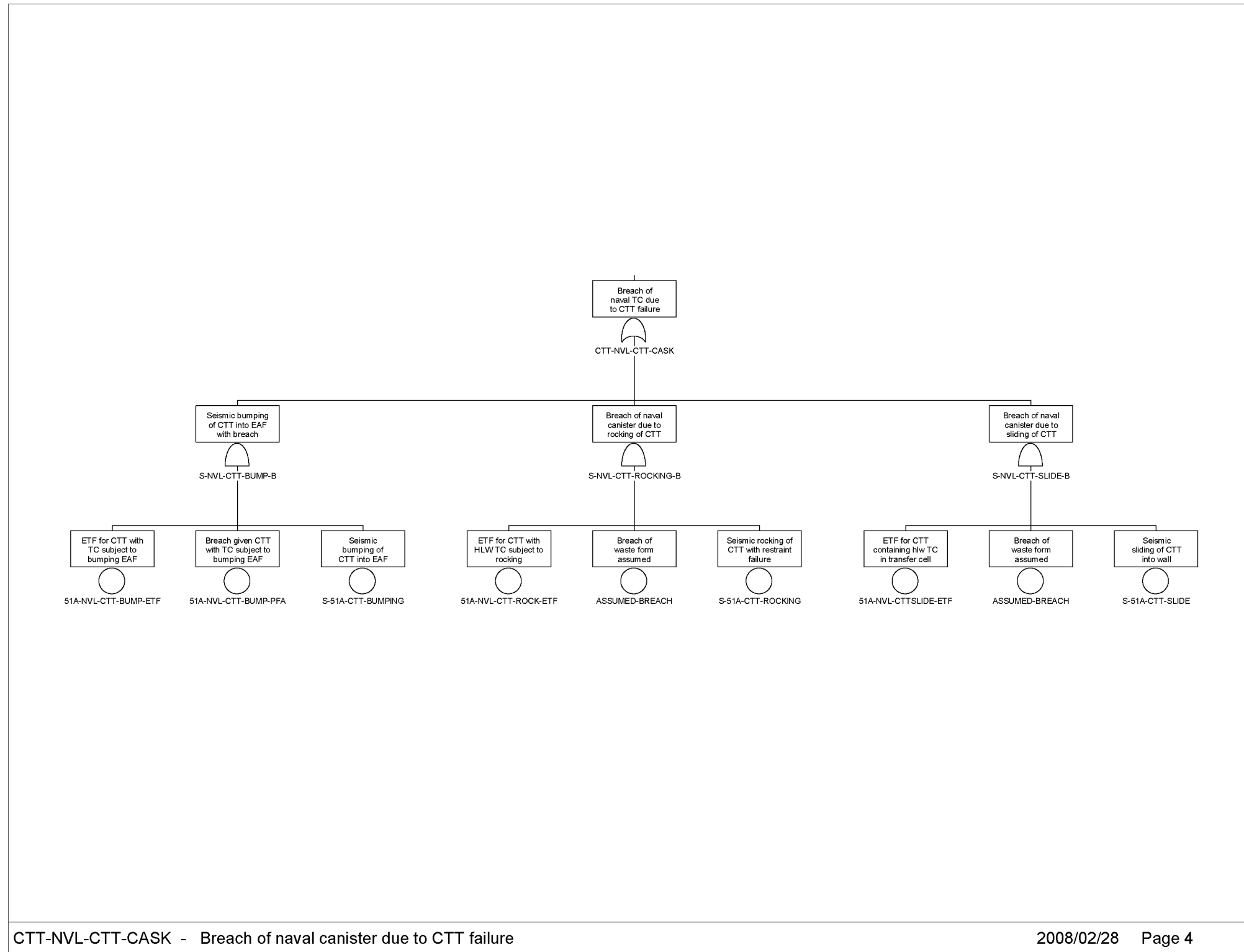

Source: Original

Figure A2.2-2. CTT-NVL-CTT-CASK – Breach of HLW Canister due to CTT Failure

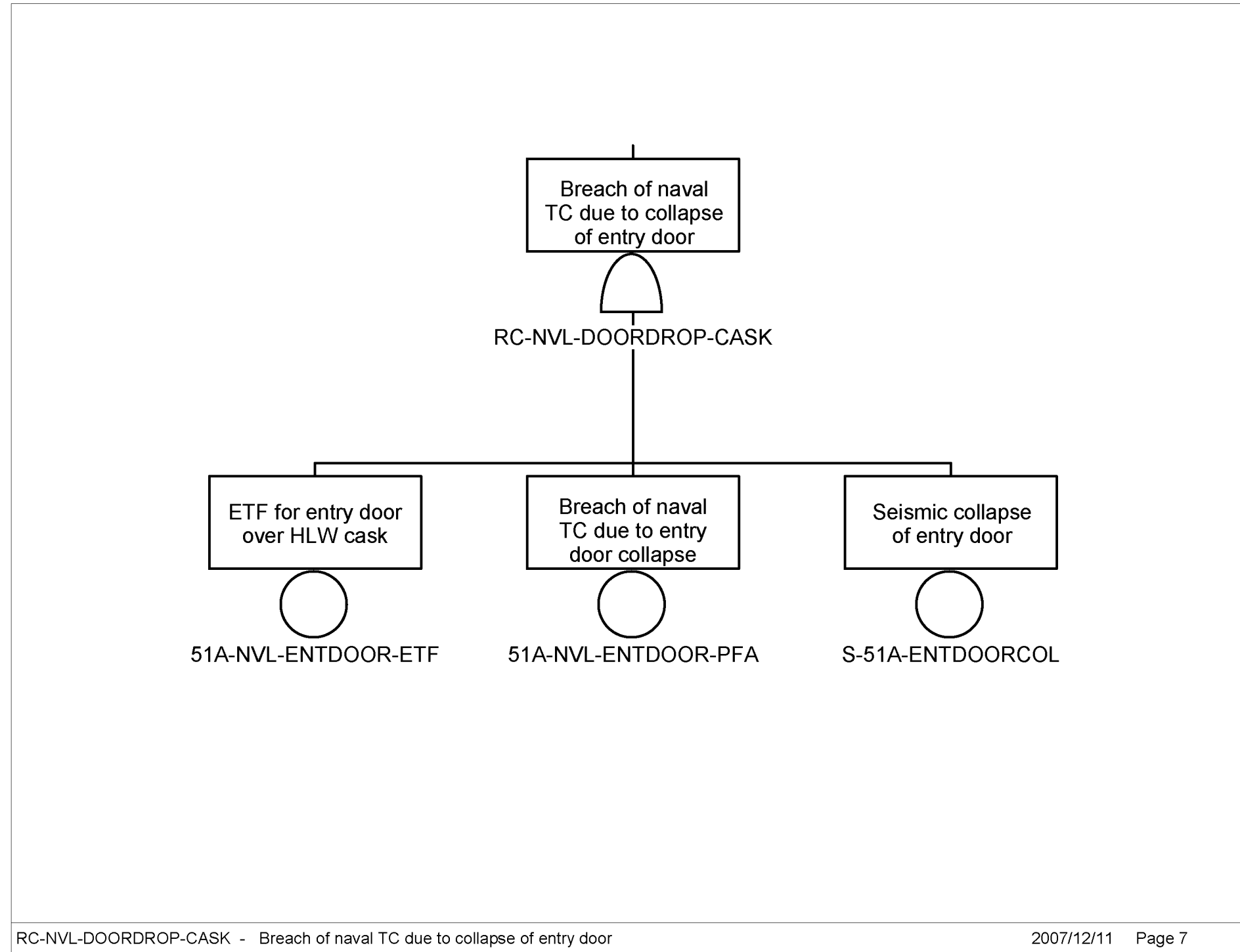

Source: Original

Figure A2.2-3. RC-NVL-DOORDROP-CASK – Breach of HLW TC due to Collapse of Entry Door

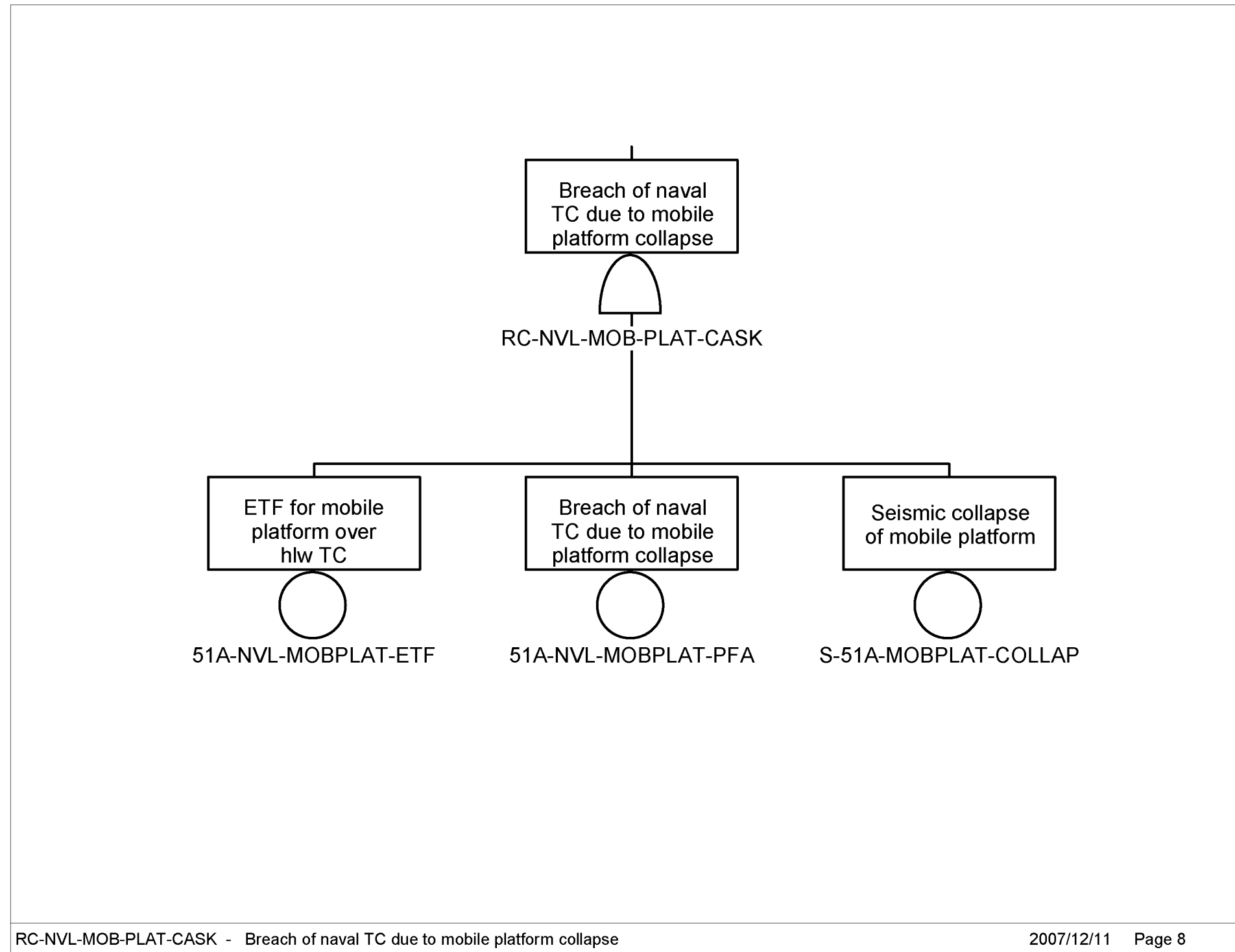

Source: Original

Figure A2.2-4. RC-NVL-MOB-PLAT-CASK – Breach of HLW TC due to Mobile Platform Collapse

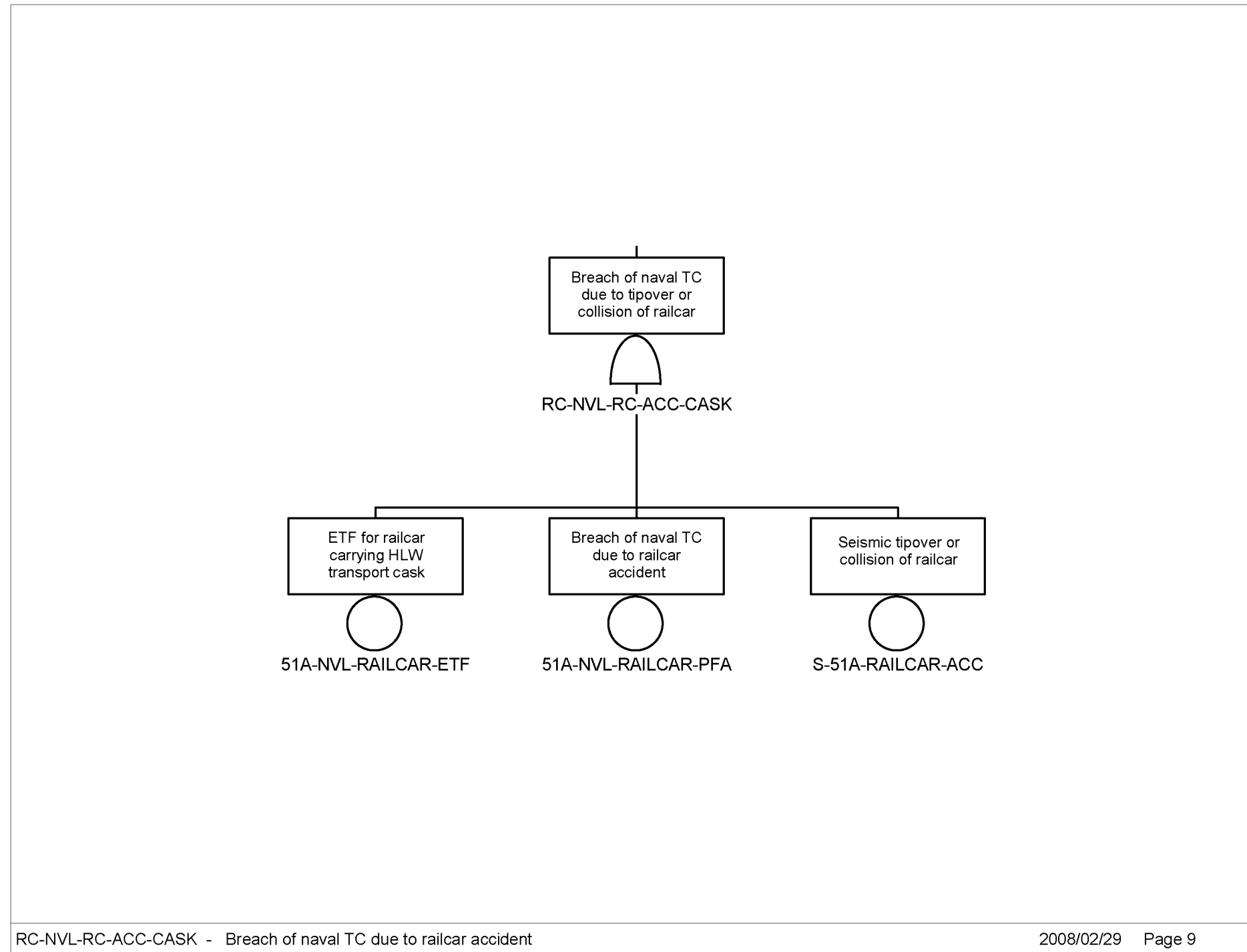

Source: Original

Figure A2.2-5. RC-NVL-RC-ACC-CASK – Breach of HLW TC due to Railcar Accident

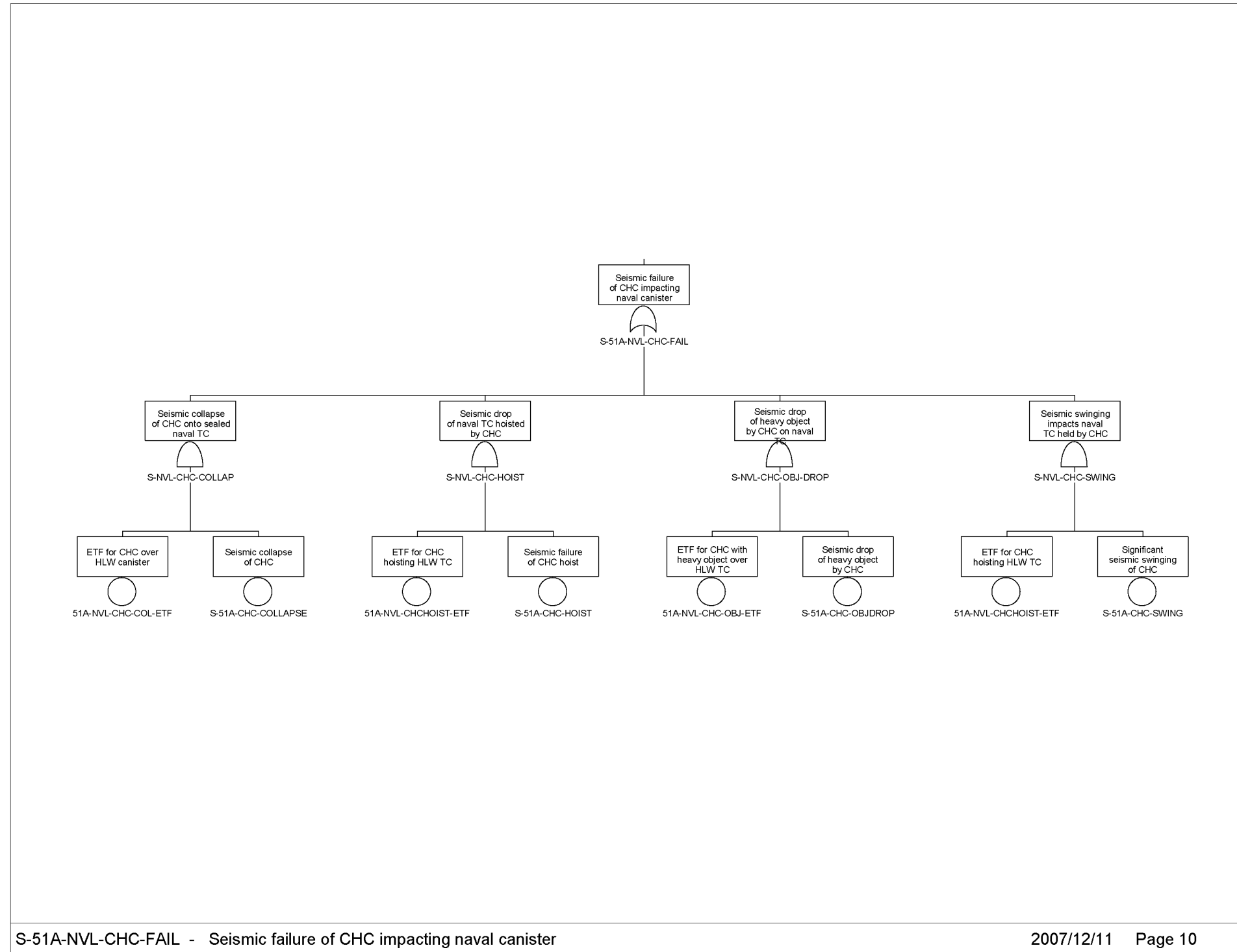

Source: Original

Figure A2.2-6. S-51A-NVL-CHC-FAIL – Seismic Failure of CHC Impacting HLW Canister

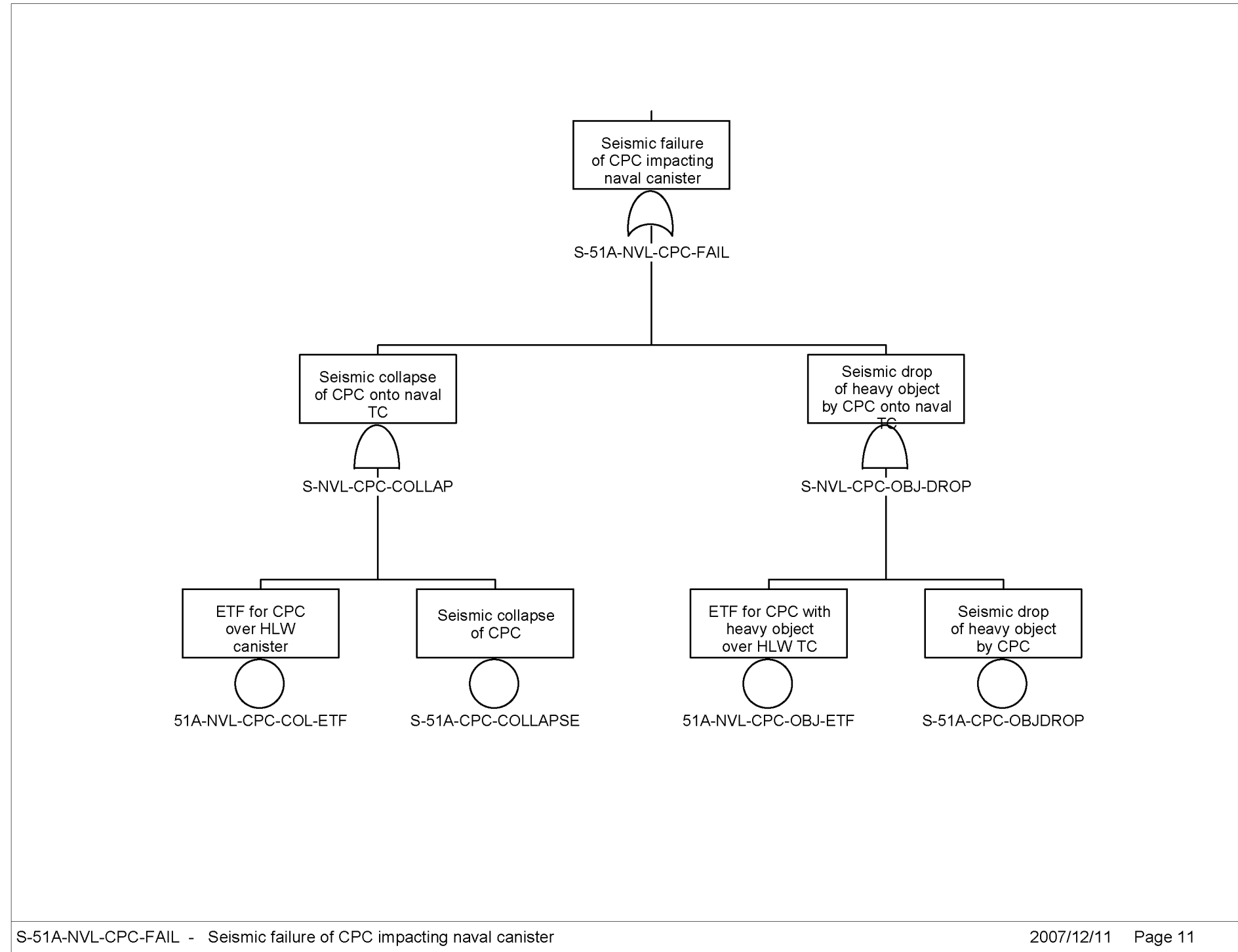

Source: Original

Figure A2.2-7. S-51A-NVL-CPC-FAIL – Seismic Failure of CPC Impacting HLW Canister

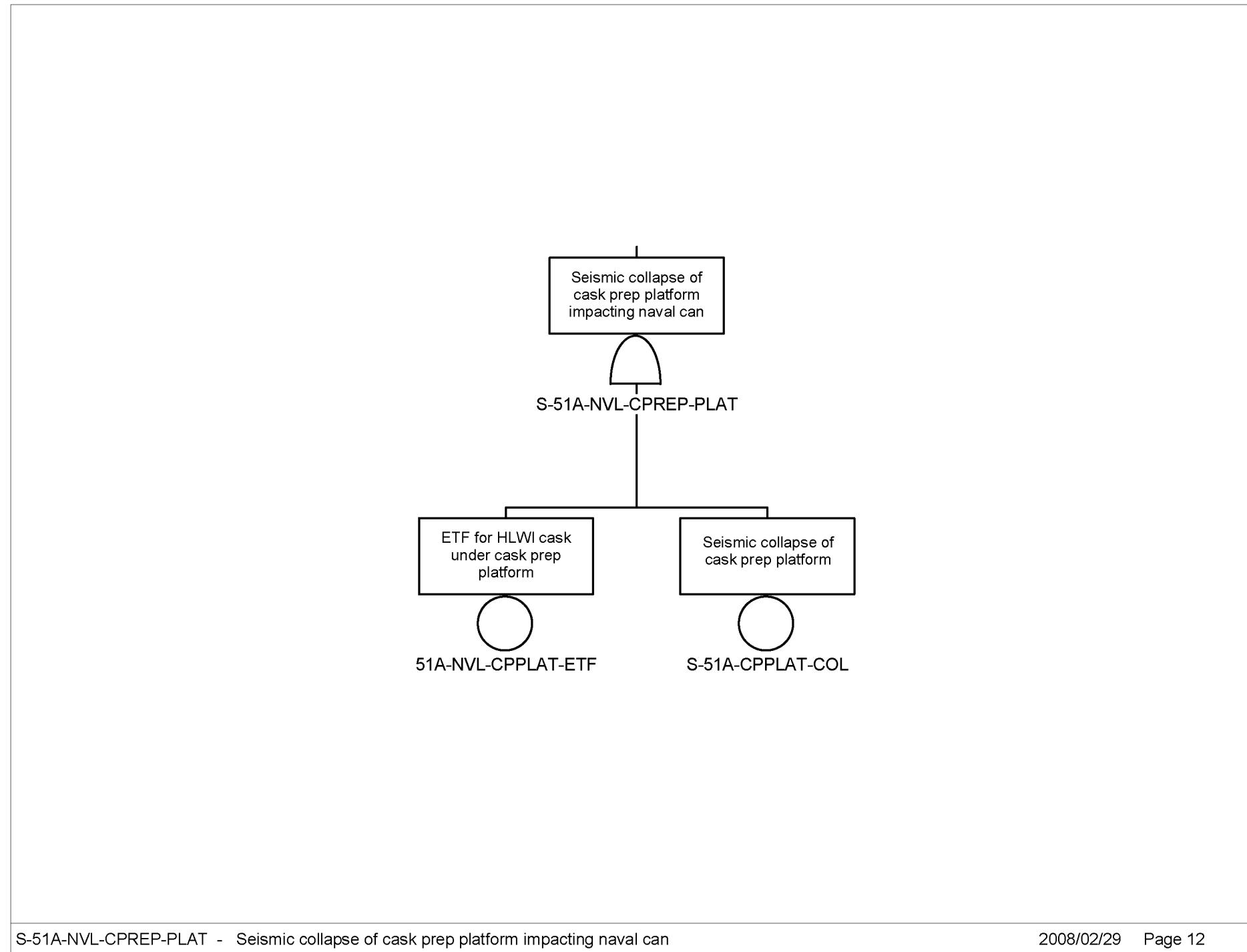

S-51A-NVL-CPREP-PLAT - Seismic collapse of cask prep platform impacting naval can

2008/02/29 Page 12

Source: Original

Figure A2.2-8. S-51A-NVL-CPREP-PLAT – Seismic Collapse of Cask Prep Platform Impacting HLW Can

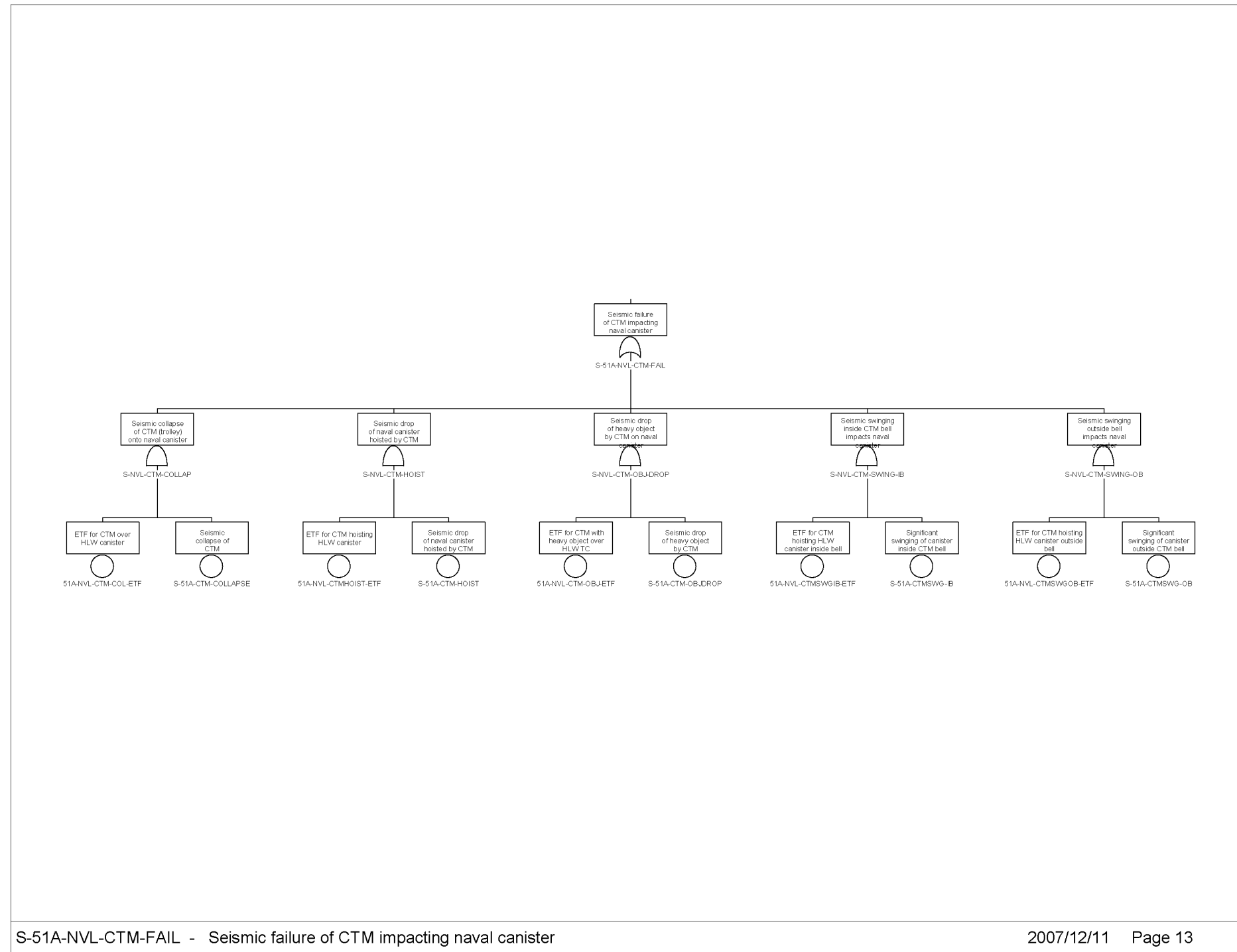

Source: Original

Figure A2.2-9. S-51A-NVL-CTM-FAIL – Seismic Failure of CTM Impacting HLW Canister

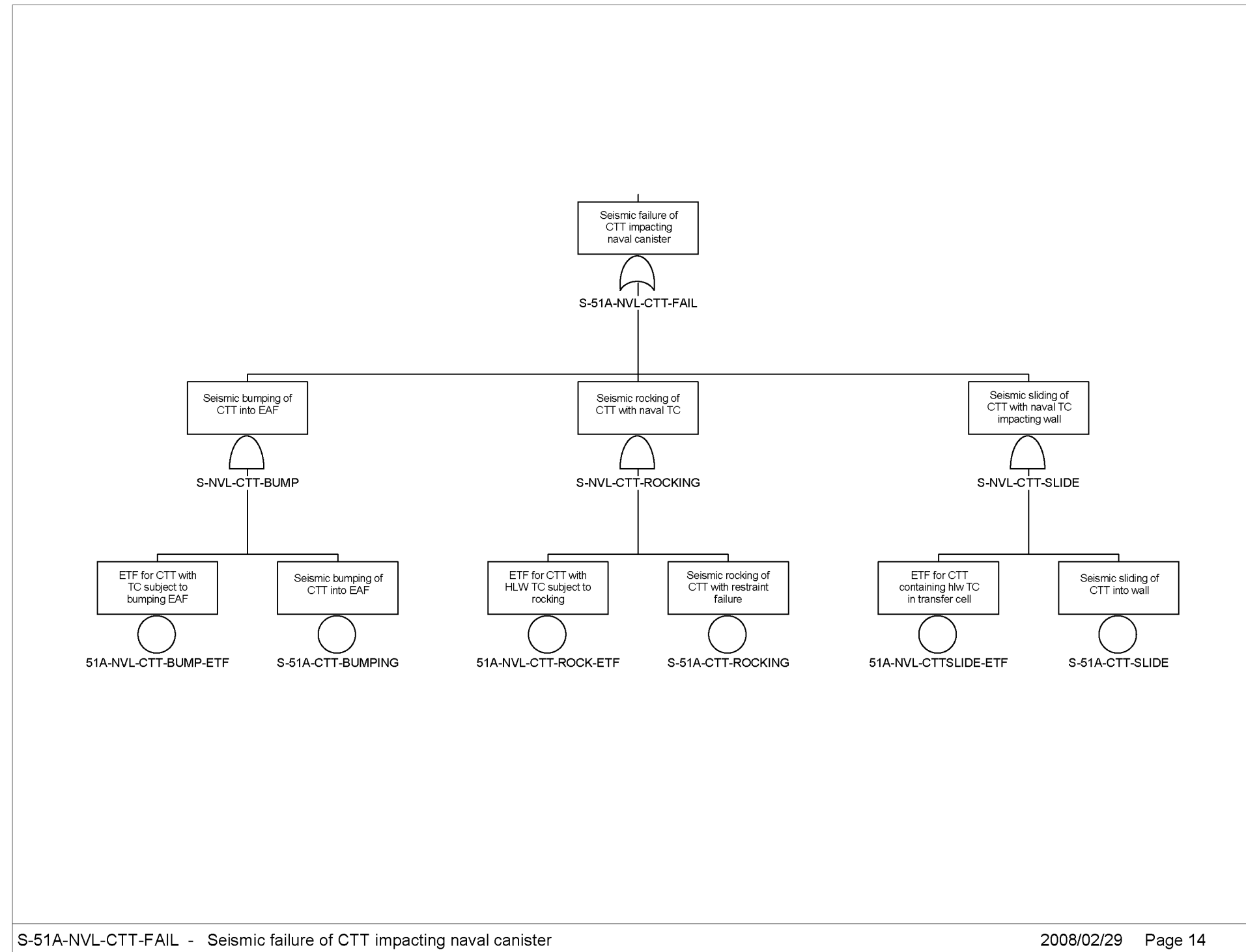

Source: Original

Figure A2.2-10. S-51A-NVL-CTT-FAIL – Seismic Failure of CTT Impacting HLW Canister

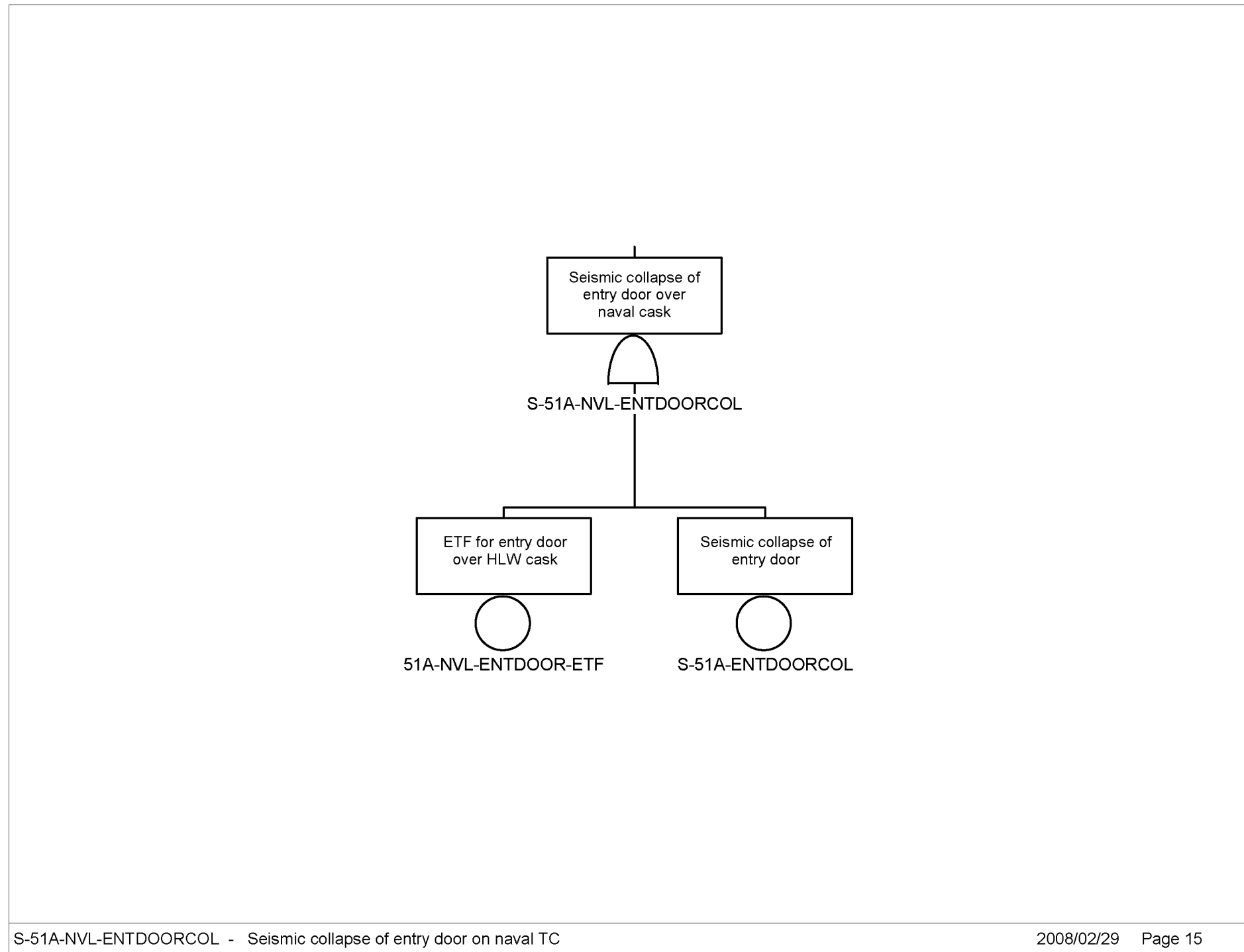

Source: Original

Figure A2.2-11. S-51A-NVL-ENTDOORCOL – Seismic Collapse of Entry Door on HLW TC

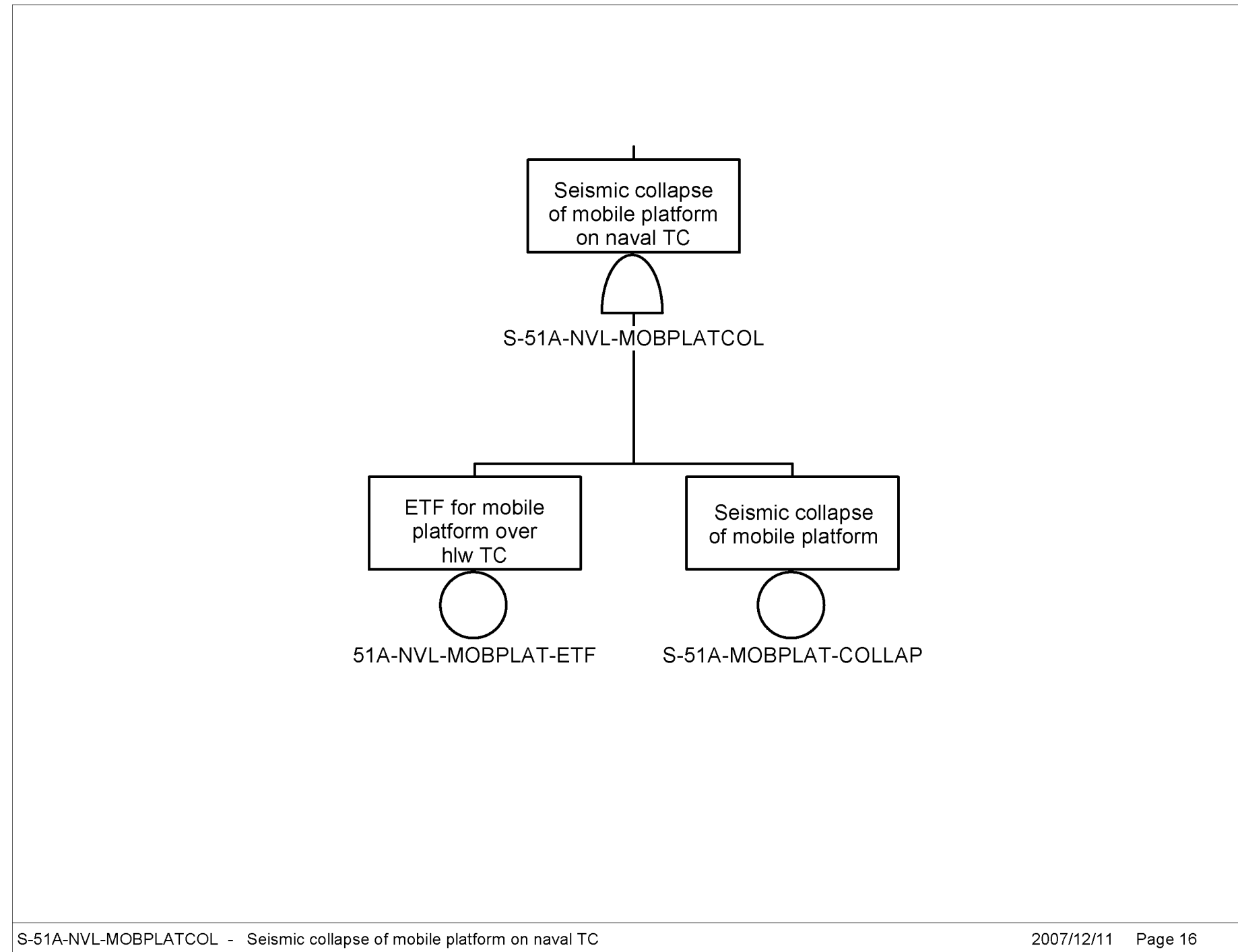

Source: Original

Figure A2.2-12. S-51A-NVL-MOBPLATCOL – Seismic Collapse of Mobile Platform on HLW TC

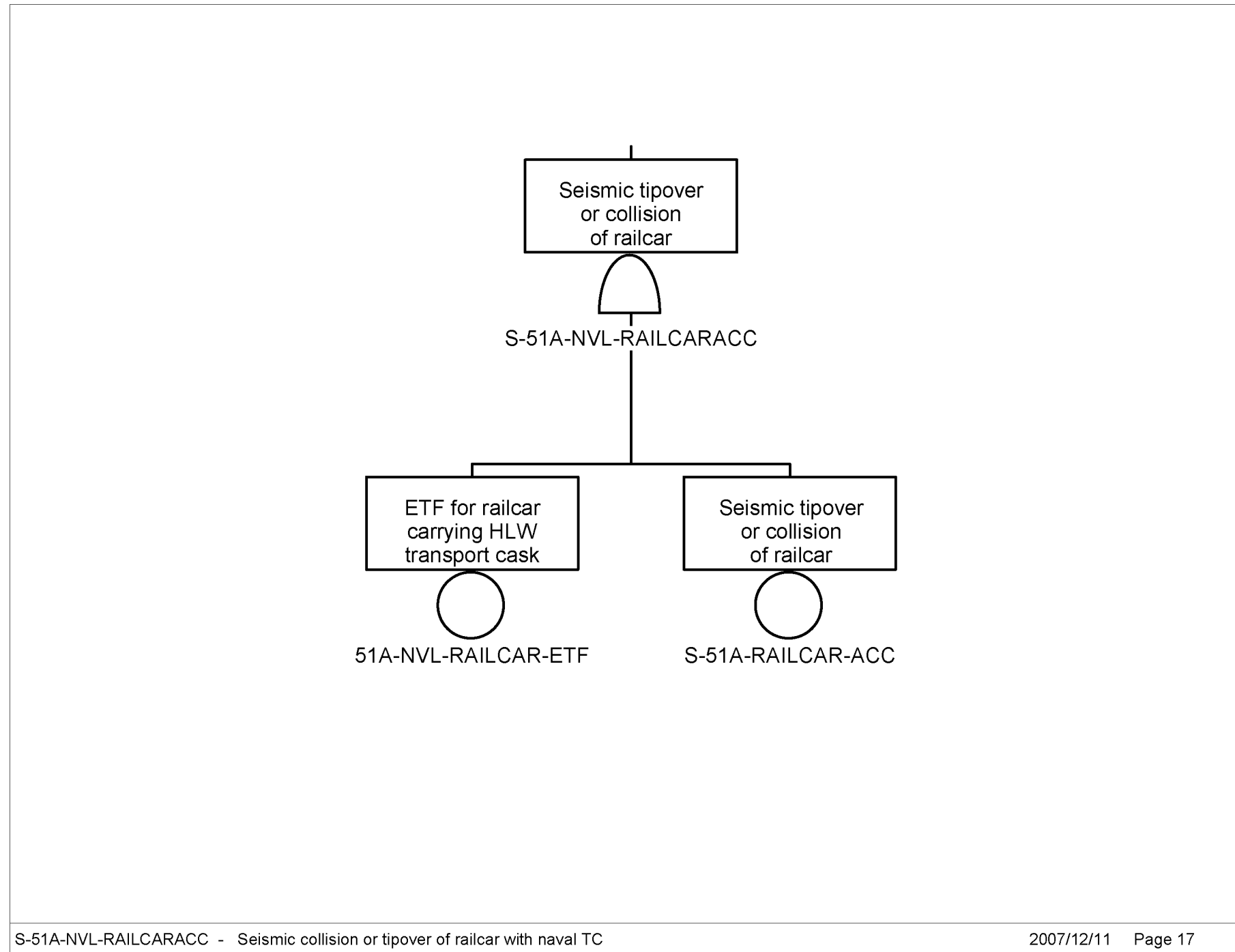

S-51A-NVL-RAILCARACC - Seismic collision or tipover of railcar with naval TC

2007/12/11 Page 17

Source: Original

Figure A2.2-13. S-51A-NVL-RAILCARACC – Seismic Collision or Tipover of Railcar with HLW TC

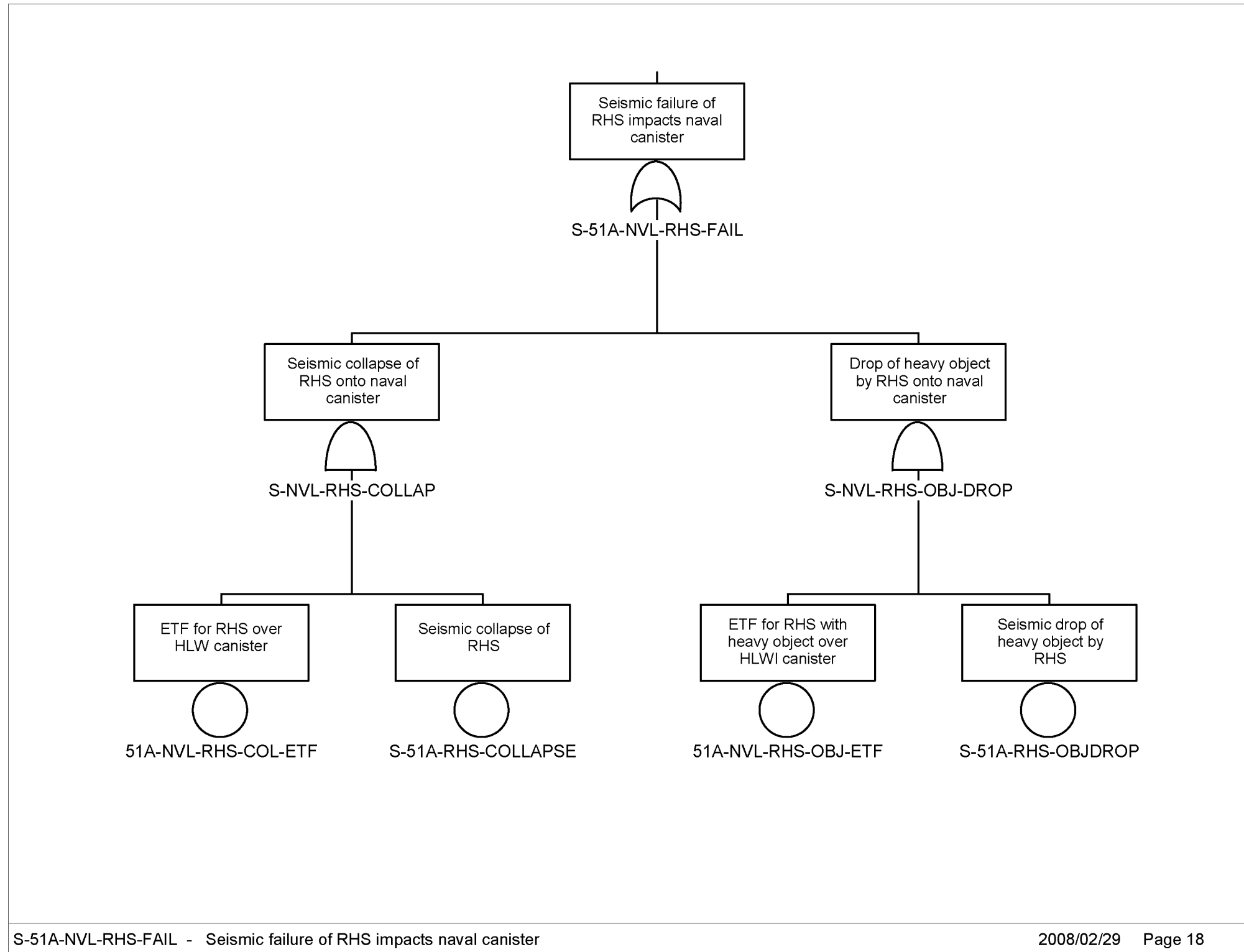

Source: Original

Figure A2.2-14. S-51A-NVL-RHS-FAIL– Seismic Failure of RHS Impacts HLW Canister

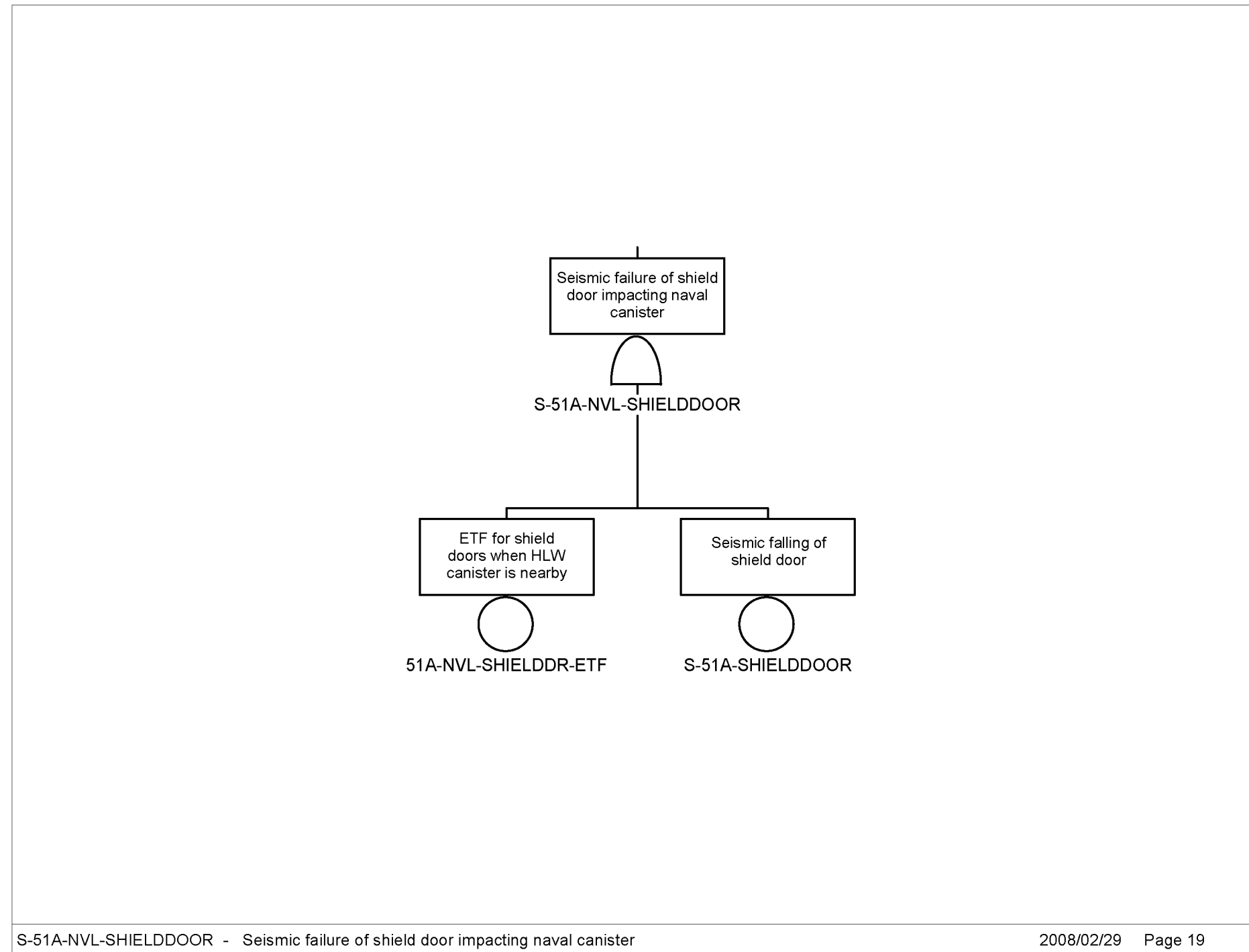

Source: Original

Figure A2.2-15. S-51A-NVL-SHIELDDOOR – Seismic Failure of Shield Door Impacting HLW Canister

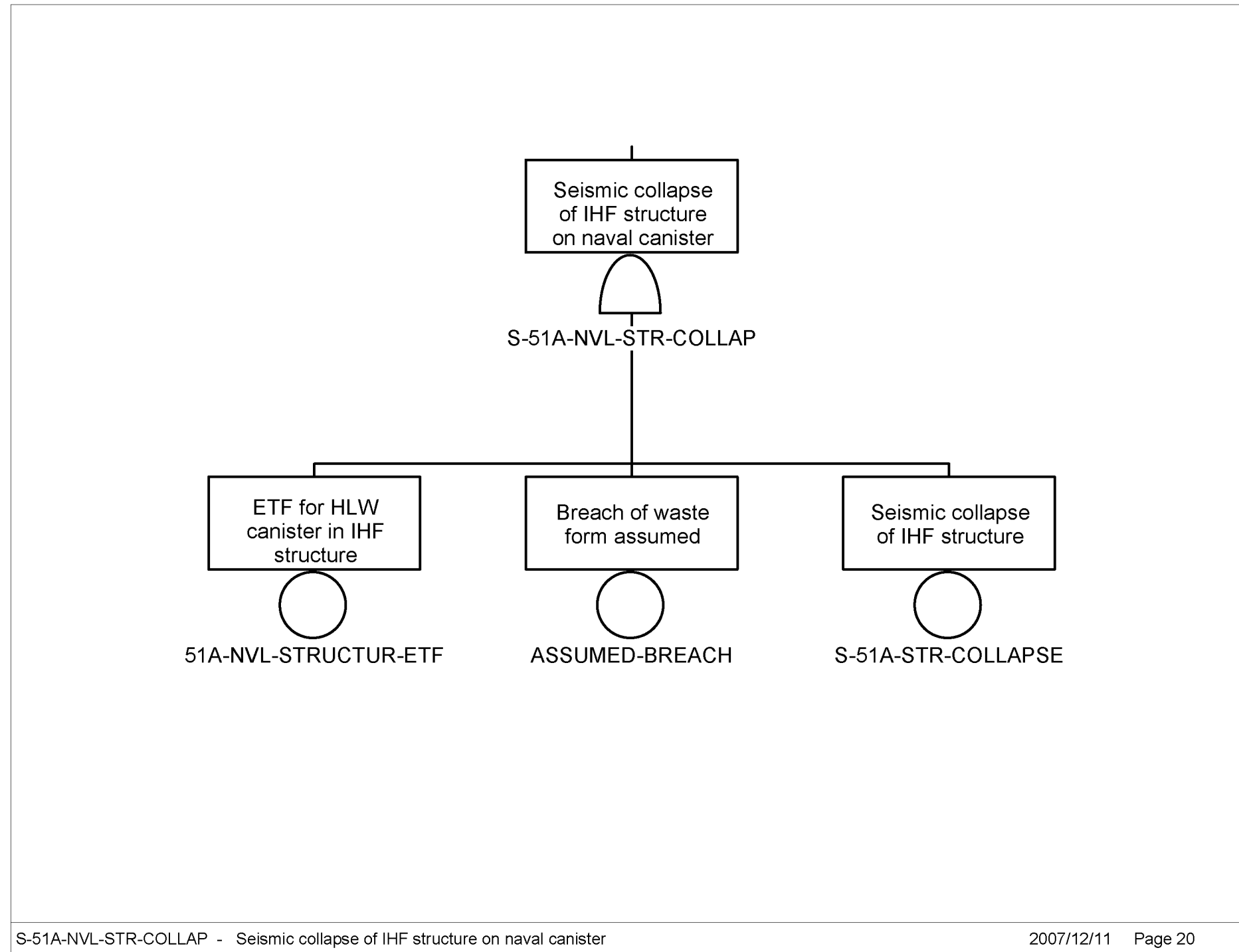

Source: Original

Figure A2.2-16. S-51A-NLV-STR-COLLAP – Seismic Collapse of IHF Structure on HLW Canister

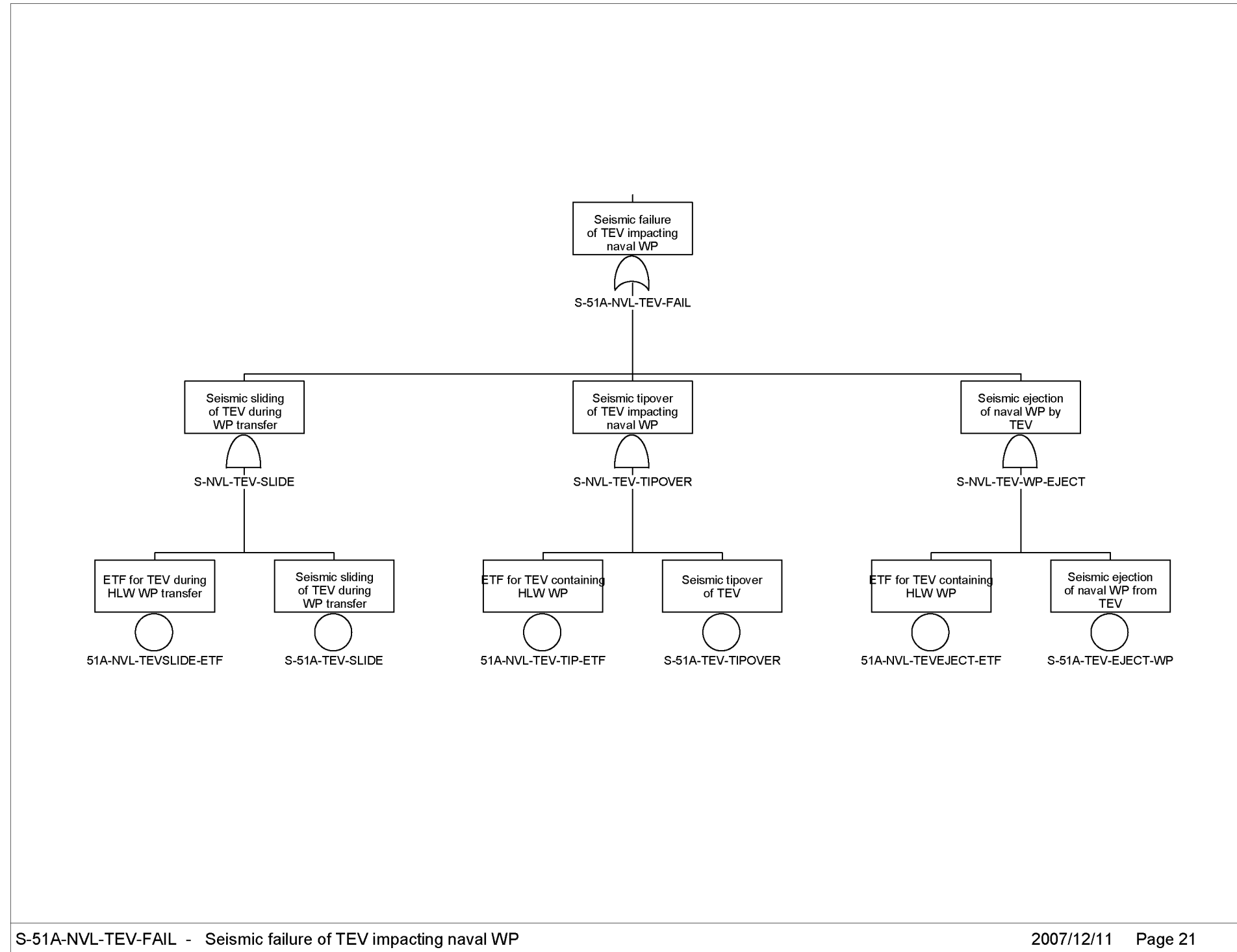

Source: Original

Figure A2.2-17. S-51A-NVL-TEV-FAIL – Seismic Failure of TEV Impacting HLW WP

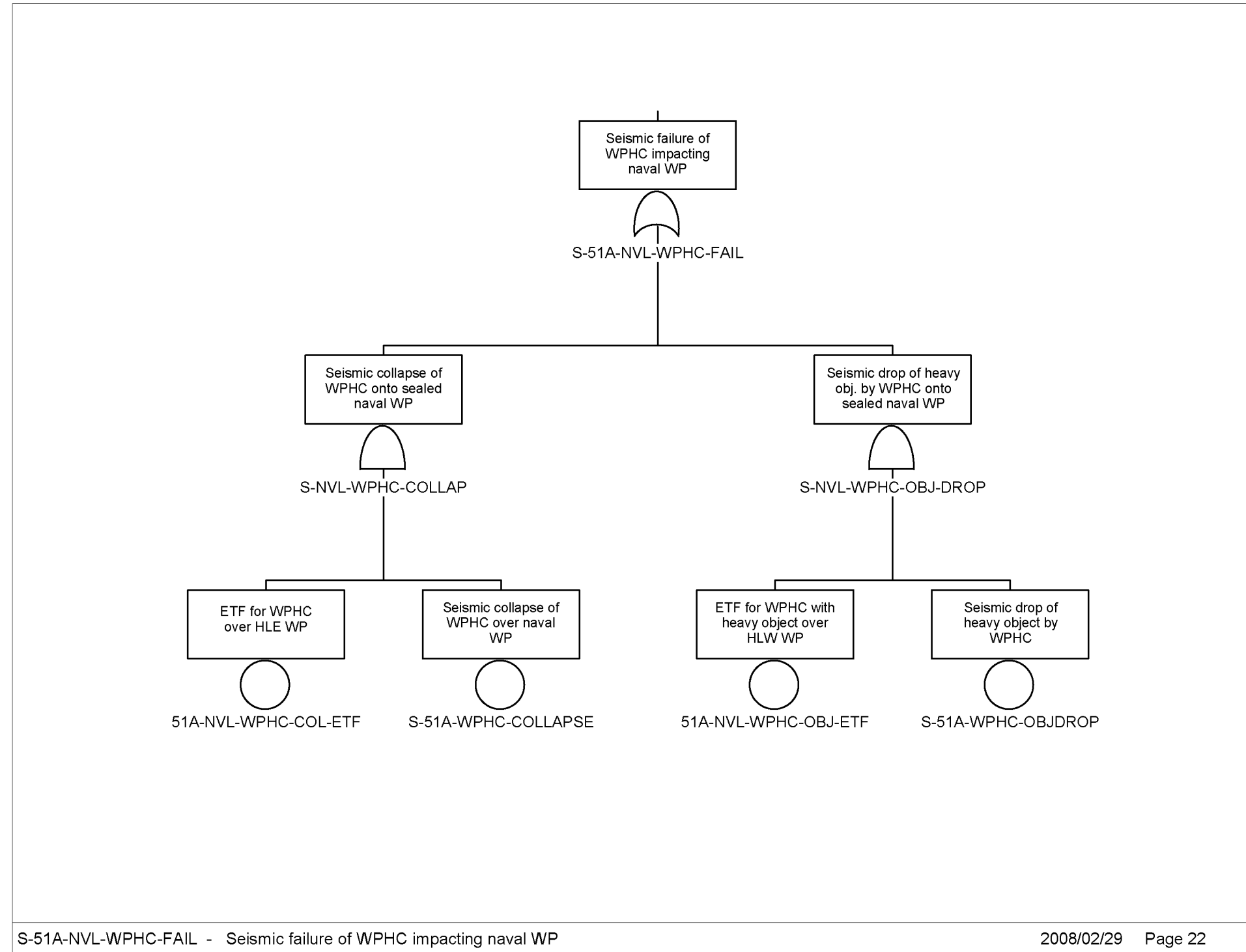

Source: Original

Figure A2.2-18. S-51A-NVL-WPHC-FAIL – Seismic Failure of WPHC Impacting HLW WP

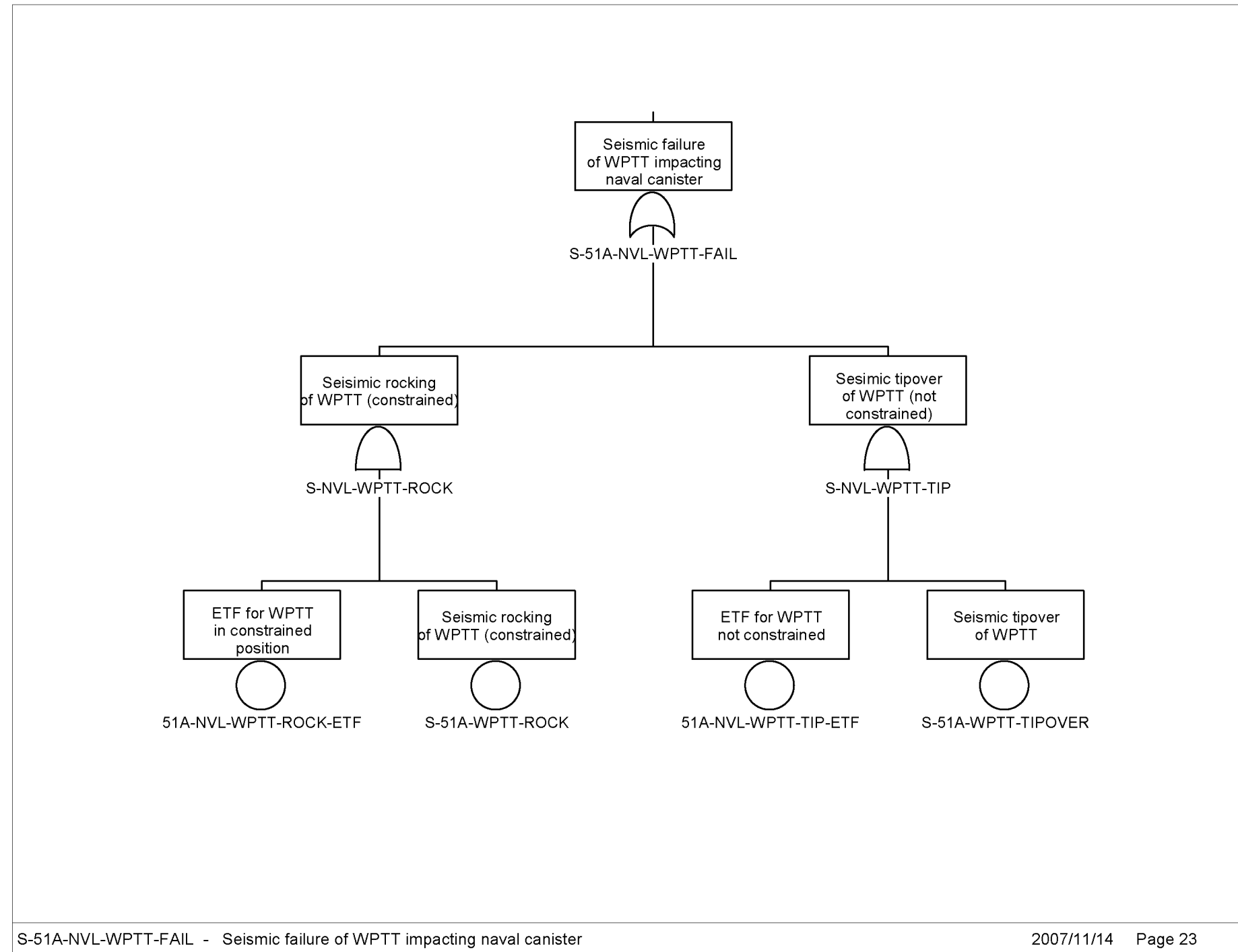

Source: Original

Figure A2.2-19. S-51A-NVL-WPTT-FAIL – Seismic Failure of WPTT Impacting HLW Canister

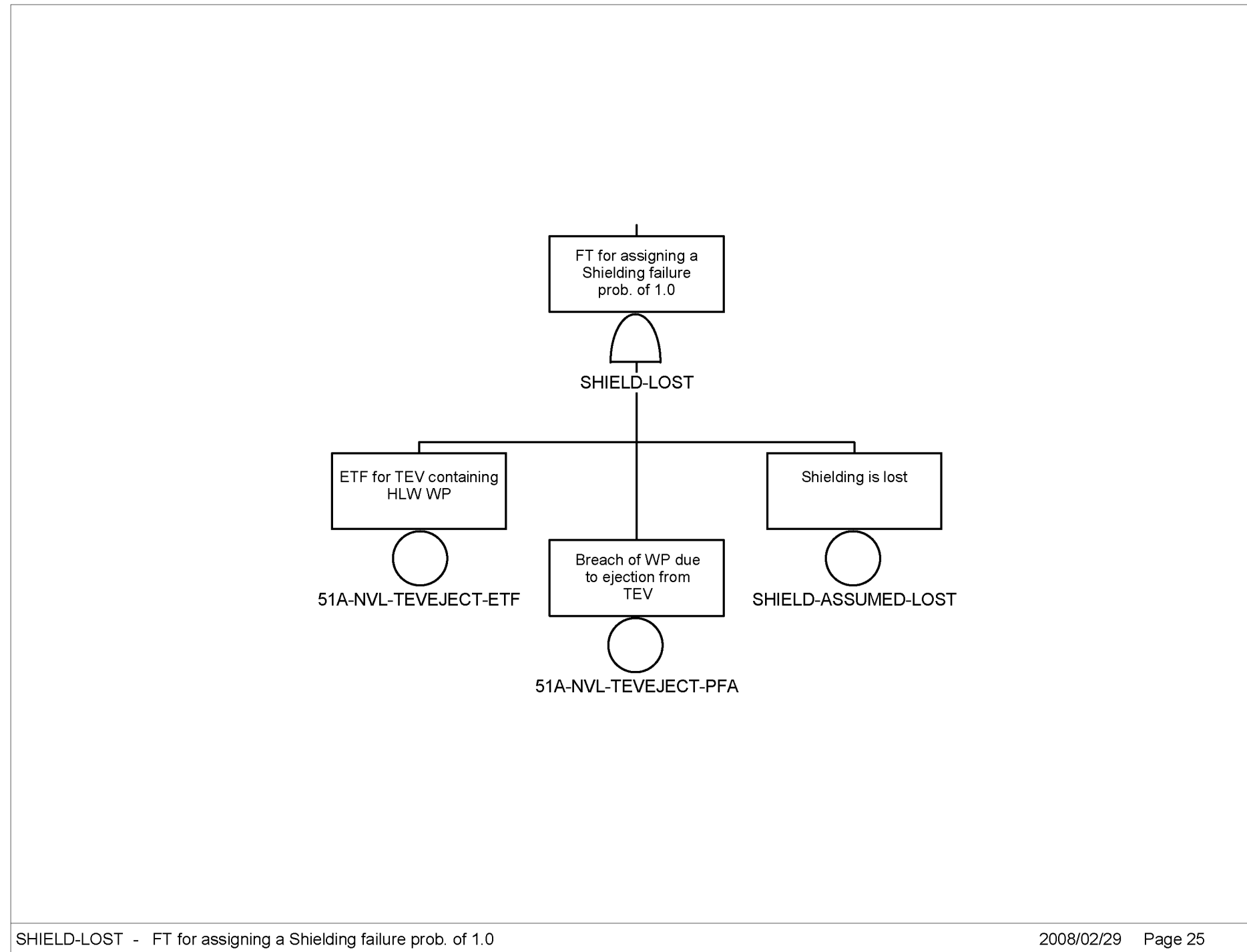

SHIELD-LOST - FT for assigning a Shielding failure prob. of 1.0

2008/02/29 Page 25

Source: Original

Figure A2.2-20 SHIELD-LOST – FT for Assigning a Shielding Failure Prob. of 1.0

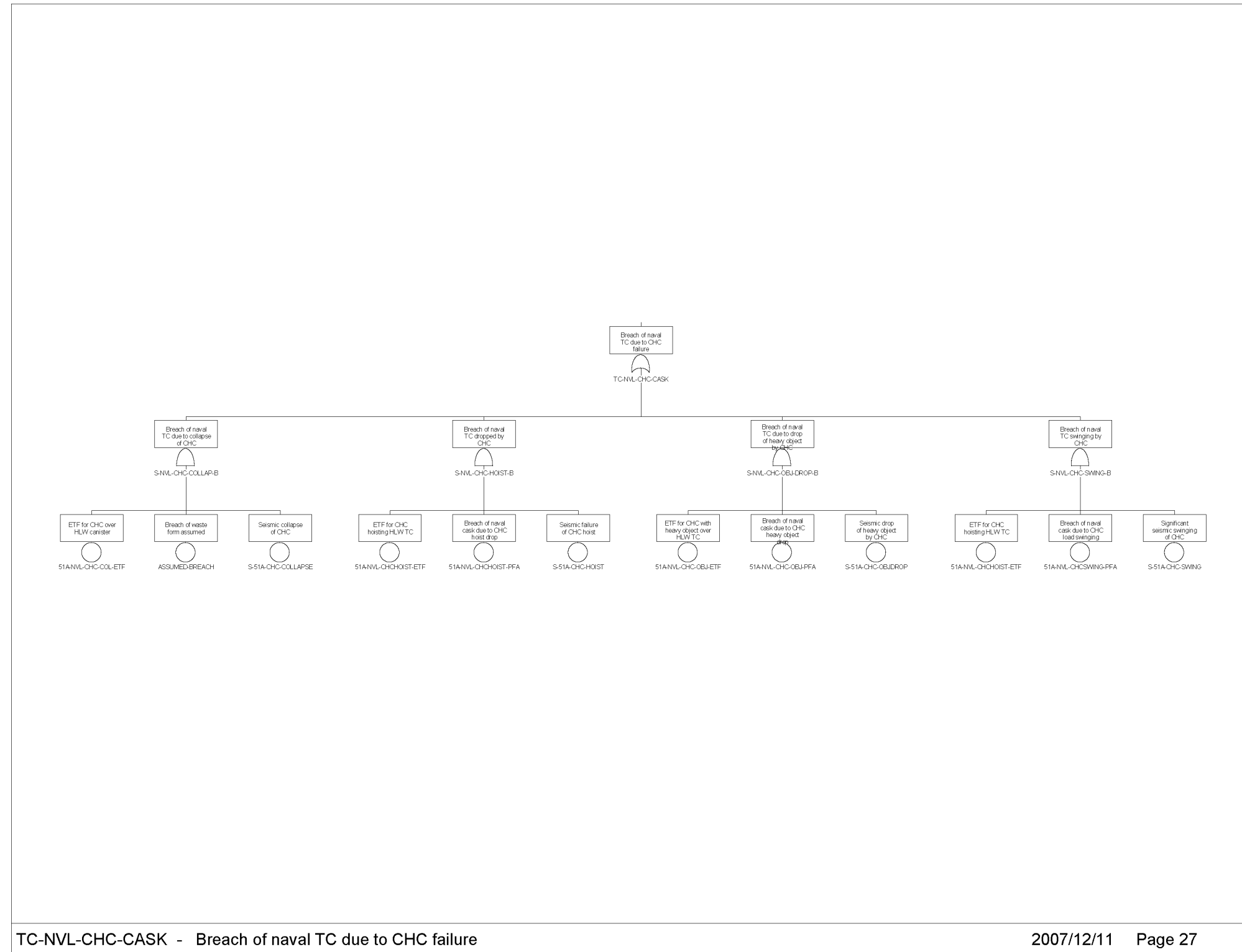

Source: Original

Figure A2.2-21. TC-NVL-CHC-CASK – Breach of HLW TC due to CHC Failure

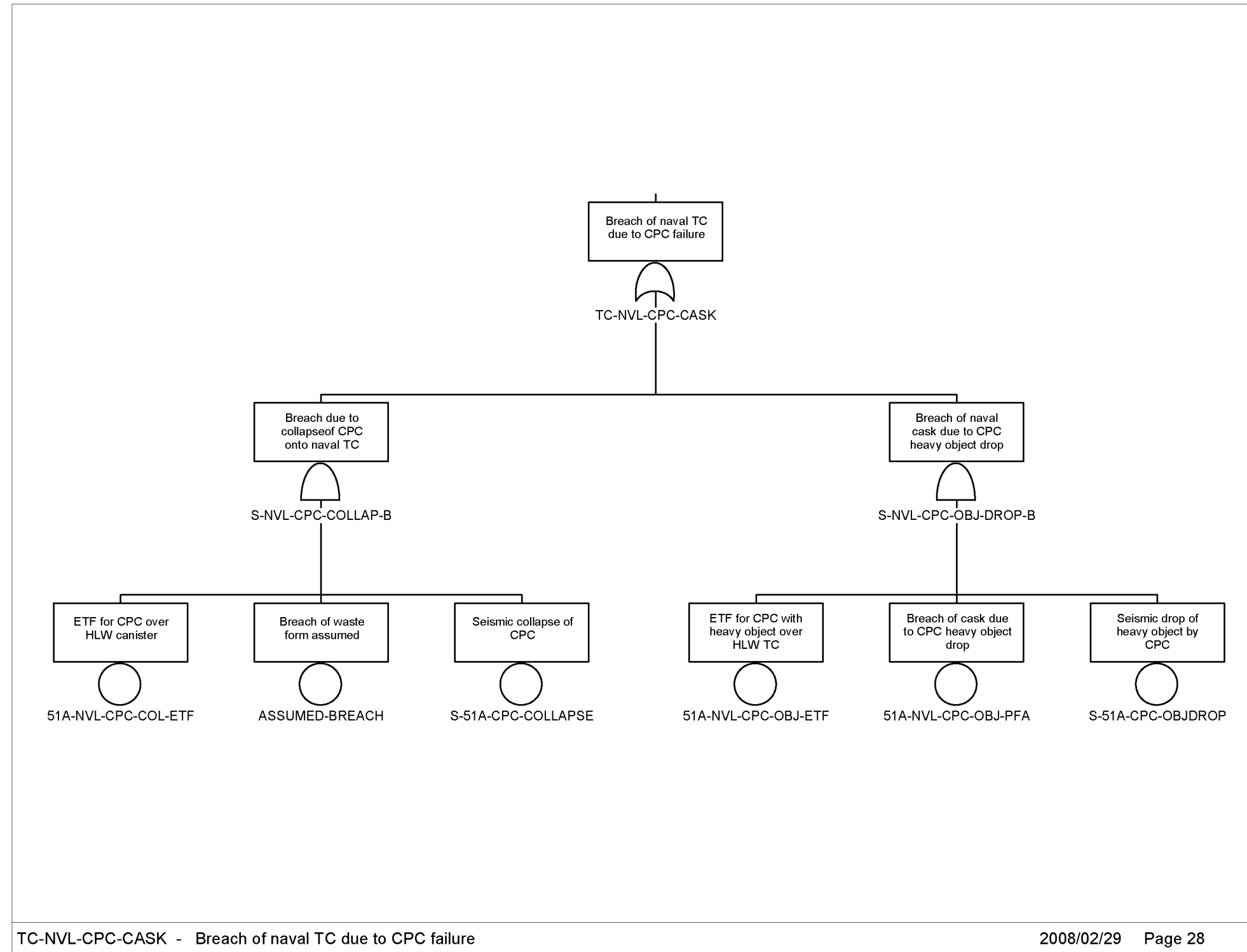

Source: Original

Figure A2.2-22. TC-NVL-CPC-CASK – Breach of HLW TC due to CPC Failure

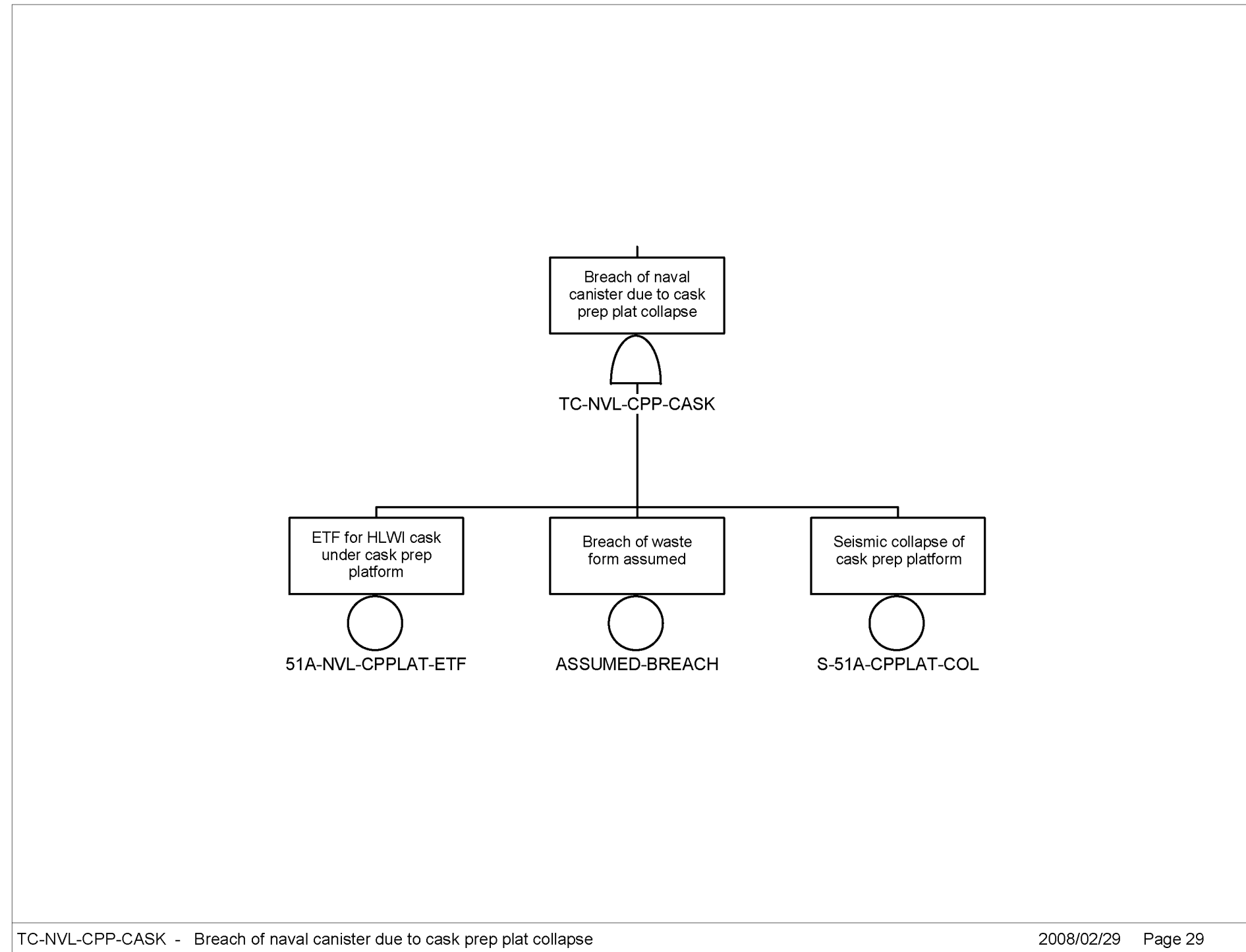

Source: Original

Figure A2.2-23. TC-NVL-CPP-CASK – Breach of HLW Canister due to Cask Prep Plat Collapse

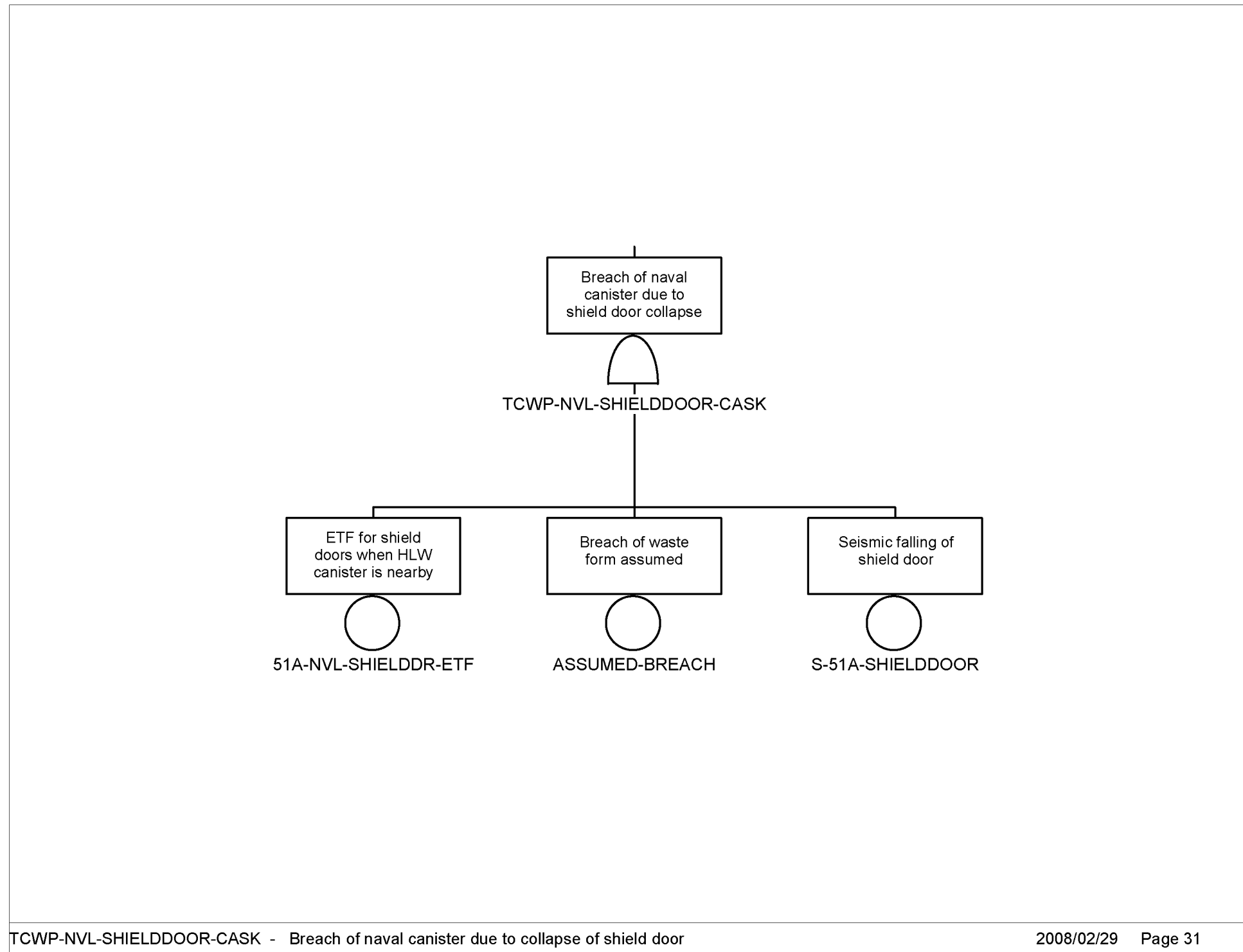

Source: Original

Figure A2.2-24. TCWP-NVL-SHIELDDOOR-CASK – Breach of HLW Canister due to Collapse of Shield Door

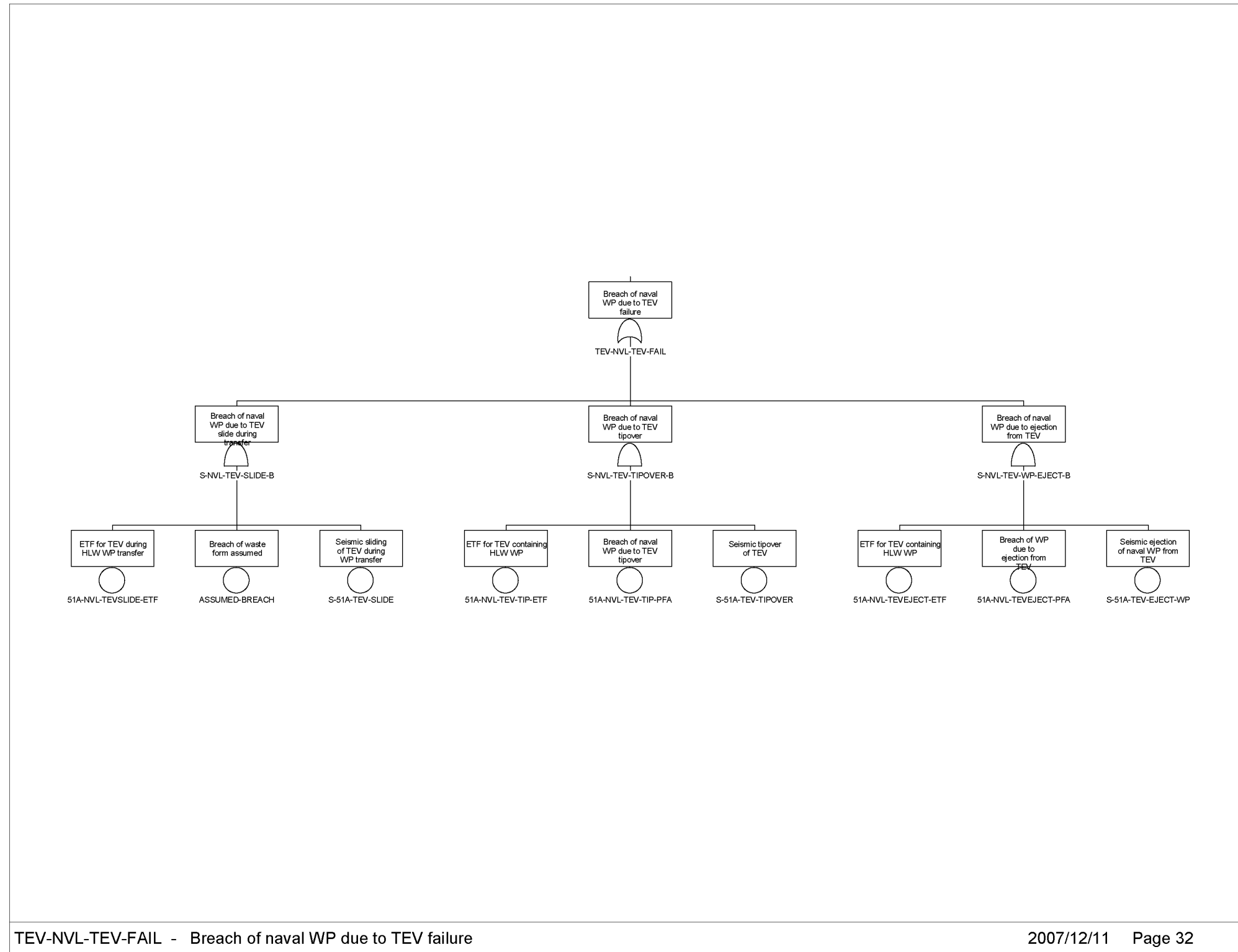

Source: Original

Figure A2.2-25. TEV-NVL-TEV-FAIL – Breach of HLW WP due to TEV Failure

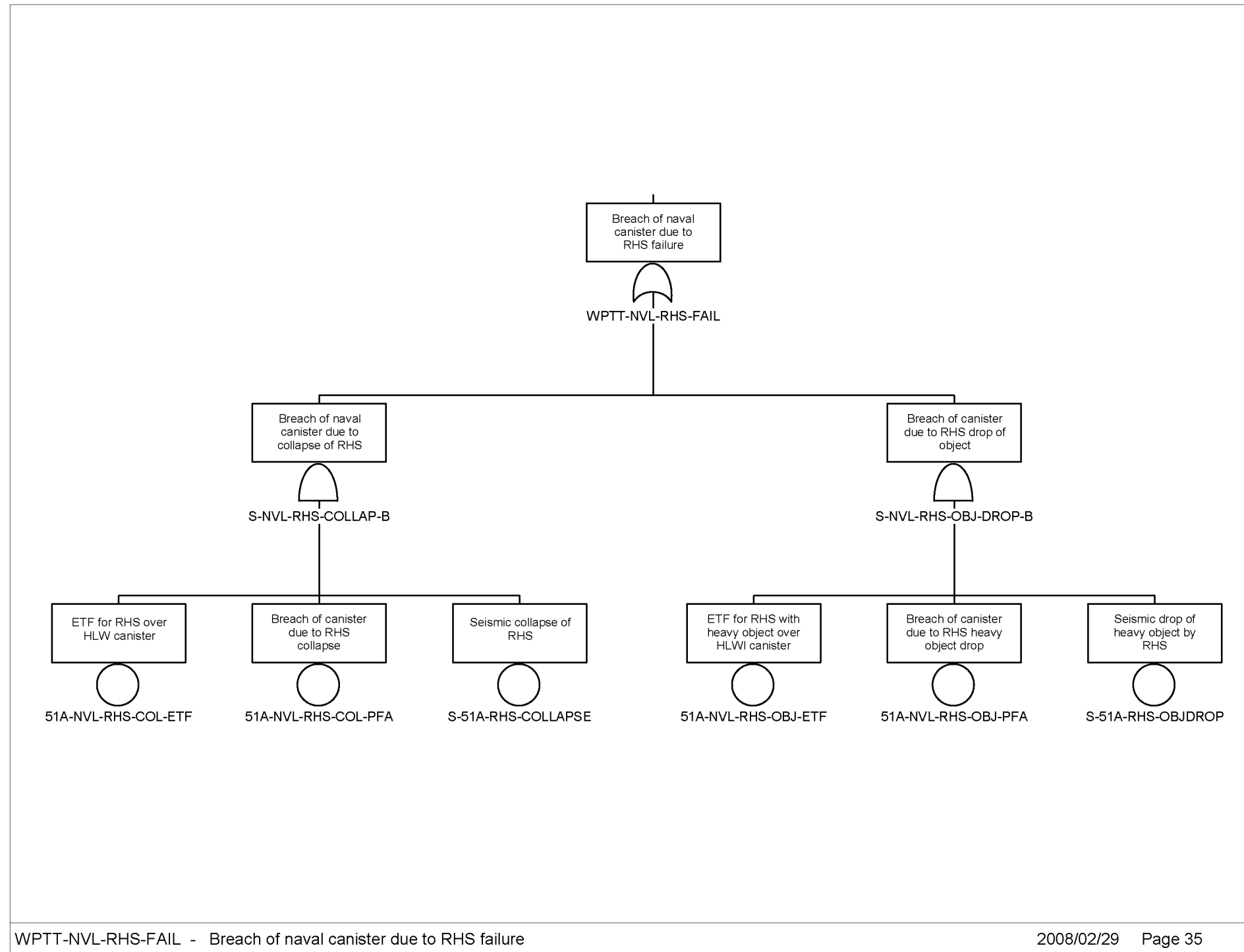

Source: Original

Figure A2.2-26. WPTT-NVL-RHS-FAIL – Breach of HLW Canister due to RHS Failure

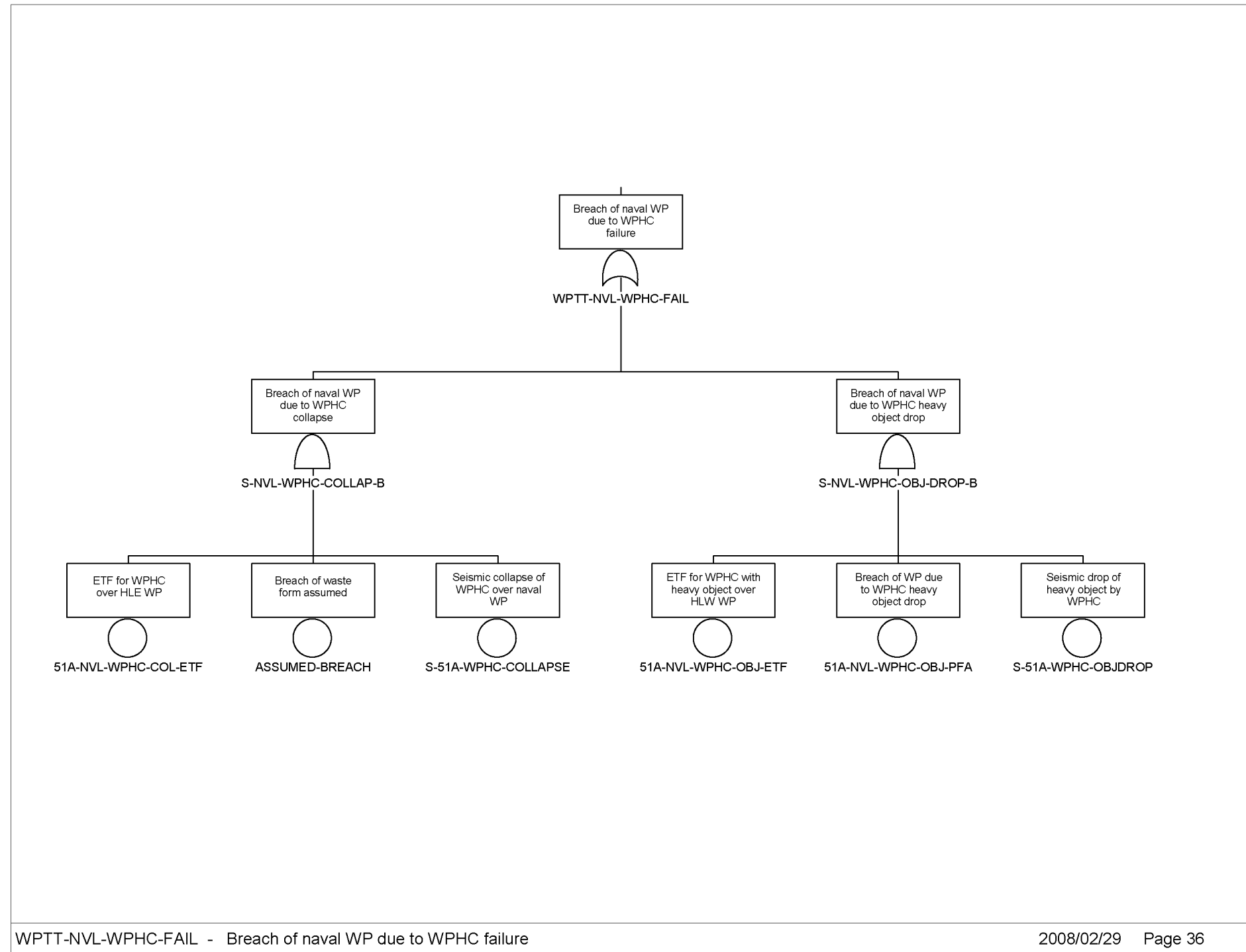

Source: Original

Figure A2.2-27. WPTT-NVL-WPHC-FAIL – Breach of HLW WP due to WPHC Failure

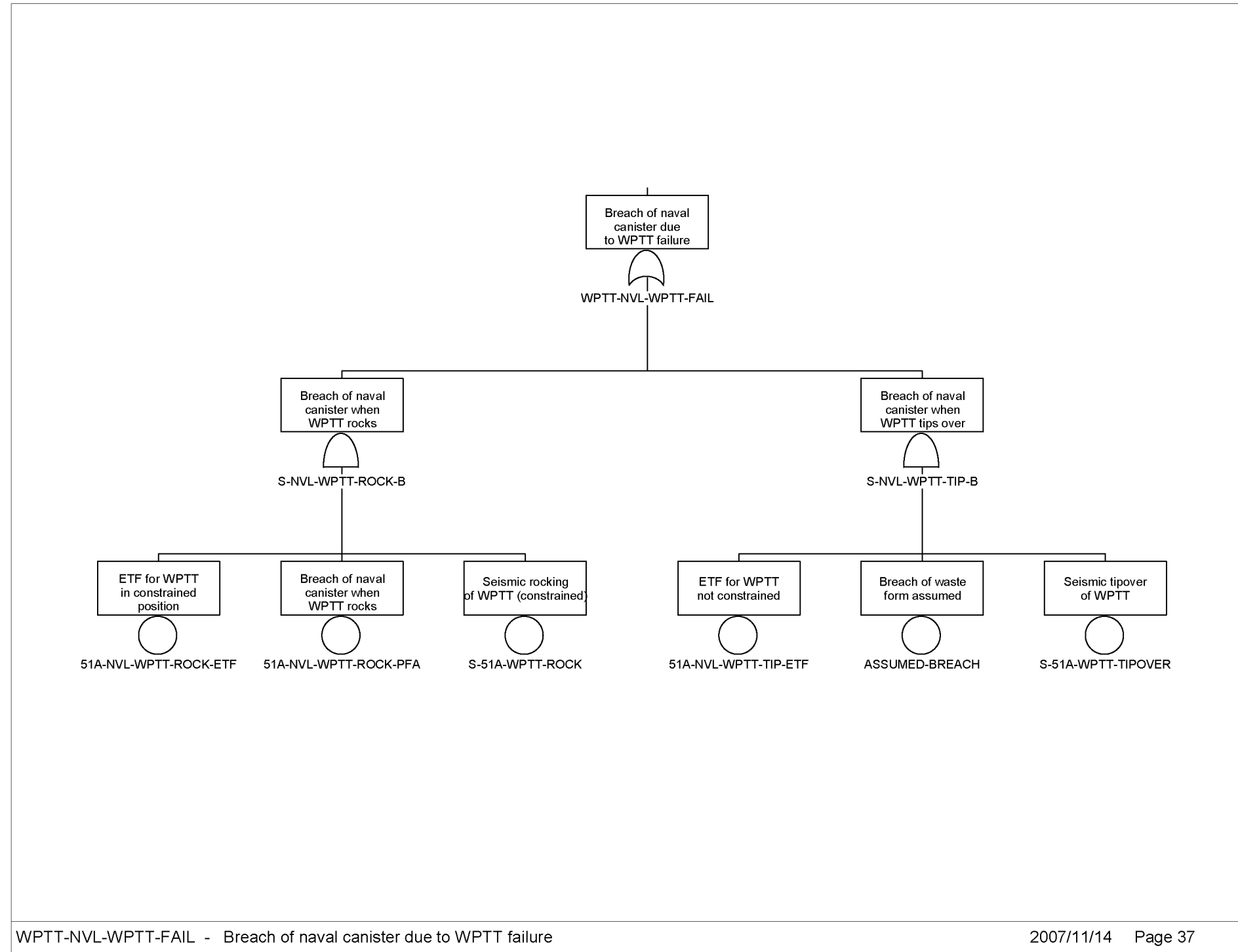

Source: Original

Figure A2.2-28. WPTT-NVL-WPTT-FAIL – Breach of HLW Canister due to WPTT Failure

A2.3 BASIC EVENT DATA

A2.3.1 Non-seismic Basic Event Data

The following table presents the basic event identifier used in the fault trees, the description of the basic event, and the failure probability (or other numeric data) of the basic event. For exposure time factors (denoted with “ETF” at the end of the basic event identifier), the value given is the time, in years, that one waste form container is exposed to the seismic failure mode. The fault trees and basic event names used for the HLW seismic event sequences are identical in form to the fault trees and basic event names used for the naval canister waste form, although the basic event values are different. Therefore, the same fault trees and basic event names are used for NVL and for HLW, and the naming scheme includes the NVL abbreviation rather than HLW. However, the quantification correctly used the HLW basic event values, as given in Section A2.3 tables below.

Table A2.3-1. Non-seismic Basic Event Data

Name	Description	Calc. Probability
51A-NVL-CHC-COL-ETF	ETF for CHC over HLW canister	3.480E-004
51A-NVL-CHC-OBJ-ETF	ETF for CHC with heavy object over HLW TC	4.760E-005
51A-NVL-CHC-OBJ-PFA	Breach of HLW cask due to CHC heavy object drop	1.000E-005
51A-NVL-CHCHOIST-ETF	ETF for CHC hoisting HLW TC	7.610E-005
51A-NVL-CHCHOIST-PFA	Breach of HLW cask due to CHC hoist drop	1.000E-005
51A-NVL-CHCSWING-PFA	Breach of HLW cask due to CHC load swinging	1.000E-005
51A-NVL-CPC-COL-ETF	ETF for CPC over HLW canister	7.230E-004
51A-NVL-CPC-OBJ-ETF	ETF for CPC with heavy object over HLW TC	4.390E-004
51A-NVL-CPC-OBJ-PFA	Breach of cask due to CPC heavy object drop	1.000E+000
51A-NVL-CPPLAT-ETF	ETF for HLW cask under cask prep platform	2.870E-004
51A-NVL-CTM-COL-ETF	ETF for CTM over HLW canister	4.560E-004
51A-NVL-CTM-OBJ-ETF	ETF for CTM with heavy object over HLW TC	6.580E-005
51A-NVL-CTM-OBJ-PFA	Breach of canister due to CTM heavy object drop	1.000E+000
51A-NVL-CTMHOIST-ETF	ETF for CTM hoisting HLW canister	5.710E-005
51A-NVL-CTMHOIST-PFA	Breach of canister dropped by CTM	3.000E-002
51A-NVL-CTMSWGIB-ETF	ETF for CTM hoisting HLW canister inside bell	5.710E-005
51A-NVL-CTMSWGIB-PFA	Breach of HLW canister due to swing inside bell	1.000E-005
51A-NVL-CTMSWGOB-ETF	ETF for CTM hoisting HLW canister outside bell	3.810E-005
51A-NVL-CTT-BUMP-ETF	ETF for CTT with TC subject to bumping EAF	2.490E-004
51A-NVL-CTT-BUMP-PFA	Breach given CTT with TC subject to bumping EAF	1.000E-005
51A-NVL-CTT-ROCK-ETF	ETF for CTT with HLW TC subject to rocking	1.640E-004
51A-NVL-CTTSLIDE-ETF	ETF for CTT containing HLW TC in transfer cell	4.510E-004
51A-NVL-ENTDOOR-ETF	ETF for entry door over HLW cask	1.900E-005
51A-NVL-ENTDOOR-PFA	Breach of HLW TC due to entry door collapse	1.000E-005
51A-NVL-MOBPLAT-ETF	ETF for mobile platform over HLW TC	4.200E-004
51A-NVL-MOBPLAT-PFA	Breach of HLW TC due to mobile platform collapse	1.000E-005
51A-NVL-RAILCAR-ETF	ETF for railcar carrying HLW transport cask	5.080E-004
51A-NVL-RAILCAR-PFA	Breach of HLW TC due to railcar accident	1.000E-005

Table A2.3-1. Non-seismic Basic Event Data (Continued)

Name	Description	Calc. Probability
51A-NVL-RHS-COL-ETF	ETF for RHS over HLW canister	5.560E-005
51A-NVL-RHS-COL-PFA	Breach of canister due to RHS collapse	1.000E+000
51A-NVL-RHS-OBJ-ETF	ETF for RHS with heavy object over HLW canister	1.140E-005
51A-NVL-RHS-OBJ-PFA	Breach of canister due to RHS heavy object drop	1.000E+000
51A-NVL-SHIELDDR-ETF	ETF for shield doors when HLW canister is nearby	2.080E-003
51A-NVL-STRUCTUR-ETF	ETF for HLW canister in IHF structure	3.320E-003
51A-NVL-TEV-TIP-ETF	ETF for TEV containing HLW WP	1.600E-005
51A-NVL-TEV-TIP-PFA	Breach of HLW WP due to TEV tipover	1.000E-005
51A-NVL-TEVEJECT-ETF	ETF for TEV containing HLW WP	1.410E-005
51A-NVL-TEVEJECT-PFA	Breach of WP due to ejection from TEV	5.000E-003
51A-NVL-TEVSLIDE-ETF	ETF for TEV during HLW WP transfer	1.900E-006
51A-NVL-WPHC-COL-ETF	ETF for WPHC over HLW WP	9.510E-006
51A-NVL-WPHC-OBJ-ETF	ETF for WPHC with heavy object over HLW WP	9.510E-006
51A-NVL-WPHC-OBJ-PFA	Breach of WP due to WPHC heavy object drop	1.000E-005
51A-NVL-WPTT-ROCK-ETF	ETF for WPTT in constrained position	3.420E-004
51A-NVL-WPTT-ROCK-PFA	Breach of HLW canister when WPTT rocks	1.000E-005
51A-NVL-WPTT-TIP-ETF	ETF for WPTT not constrained	2.110E-003
ASSUMED-BREACH	Breach of waste form assumed	1.000E+000
IHF-HLW-CAN	Number of HLW canisters processed in IHF	1.000E+003
SHIELDING	WP remains within WPTT shielding	1.000E-005
51A-NVL-CHC-COL-ETF	ETF for CHC over HLW canister	3.480E-004
51A-NVL-CHC-OBJ-ETF	ETF for CHC with heavy object over HLW TC	4.760E-005

NOTE: The basic event "ASSUMED-BREACH" is not an assumption, but is common terminology used to denote a scenario where the waste container is conservatively considered to be breached; CHC = cask handling crane; CPC = cask preparation crane; CTM = canister transfer machine; CTT = cask transfer trolley; EAF = energy absorbing feature; ETF = exposure time factor; HLW = high-level radioactive waste; IHF = Initial Handling Facility; RHS = remote handling system; TC = transportation cask; TEV = transport and emplacement vehicle; WP = waste package; WPHC = waste package handling crane; WPTT = waste package transfer trolley.

Source: Sections 6.2.2.23 and 6.3.3, Table 6.3-1, Table 6.3-2, Table 6.4-1

A2.3.2 Seismic Basic Event Fragility Data

The following table provides the seismic failure basic event identifier, description, median fragility, and composite uncertainty.

Table A2.3-2. Seismic Basic Event Fragility Data

Event Name	Description	Med. Fragility (g)	Beta C
S-51A-CHC-COLLAPSE	Seismic collapse of CHC	2.790E+000	4.500E-001
S-51A-CHC-HOIST	Seismic failure of CHC hoist	2.280E+000	5.000E-001
S-51A-CHC-OBJDROP	Seismic drop of heavy object by CHC	2.280E+000	5.000E-001
S-51A-CHC-SWING	Significant seismic swinging of CHC	1.140E+000	4.000E-001
S-51A-CPC-COLLAPSE	Seismic collapse of CPC	2.790E+000	4.500E-001

Table A2.3-2. Seismic Basic Event Fragility Data (Continued)

Event Name	Description	Med. Fragility (g)	Beta C
S-51A-CPC-OBJDROP	Seismic drop of heavy object by CPC	2.280E+000	5.000E-001
S-51A-CPPLAT-COL	Seismic collapse of cask prep platform	1.140E+000	4.000E-001
S-51A-CTM-COLLAPSE	Seismic collapse of CTM	2.390E+000	4.500E-001
S-51A-CTM-HOIST	Seismic drop of HLW canister hoisted by CTM	2.280E+000	5.000E-001
S-51A-CTM-OBJDROP	Seismic drop of heavy object by CTM	2.280E+000	5.000E-001
S-51A-CTMSWG-IB	Significant swinging of canister inside CTM bell	1.140E+000	4.000E-001
S-51A-CTMSWG-OB	Significant swinging of canister outside CTM bell	9.100E-001	4.000E-001
S-51A-CTT-BUMPING	Seismic bumping of CTT into EAF	1.700E+000	4.400E-001
S-51A-CTT-ROCKING	Seismic rocking of CTT with restraint failure	1.700E+000	4.100E-001
S-51A-CTT-SLIDE	Seismic sliding of CTT into wall	1.700E+000	4.400E-001
S-51A-ENTDOORCOL	Seismic collapse of entry door	3.700E-001	4.000E-001
S-51A-MOBPLAT-COLLAP	Seismic collapse of mobile platform	3.700E-001	4.000E-001
S-51A-RAILCAR-ACC	Seismic tipover or collision of railcar	4.500E-001	4.000E-001
S-51A-RHS-COLLAPSE	Seismic collapse of RHS	2.790E+000	4.500E-001
S-51A-RHS-OBJDROP	Seismic drop of heavy object by RHS	1.140E+000	4.000E-001
S-51A-SHIELDDOOR	Seismic falling of shield door	2.920E+000	4.400E-001
S-51A-STR-COLLAPSE	Seismic collapse of IHF structure	5.350E+000	4.000E-001
S-51A-TEV-EJECT-WP	Seismic ejection of naval WP from TEV	7.600E-001	4.000E-001
S-51A-TEV-SLIDE	Seismic sliding of TEV during WP transfer	1.120E+000	4.300E-001
S-51A-TEV-TIPOVER	Seismic tipover of TEV	5.000E+000	4.000E-001
S-51A-WPHC-COLLAPSE	Seismic collapse of WPHC over naval WP	2.790E+000	4.500E-001
S-51A-WPHC-OBJDROP	Seismic drop of heavy object by WPHC	1.140E+000	4.000E-001
S-51A-WPTT-ROCK	Seismic rocking of WPTT (constrained)	1.850E+000	3.700E-001
S-51A-WPTT-TIPOVER	Seismic tipover of WPTT	3.410E+000	4.000E-001

NOTE: CHC = cask handling crane; CPC = cask preparation crane; CTM = canister transfer machine; CTT = cask transfer trolley; EAF = energy absorbing feature; ETF = exposure time factor; HLW = high-level radioactive waste; IHF = Initial Handling Facility; NVL = naval; RHS = remote handling system; TC = transportation cask; TEV = transport and emplacement vehicle; WP = waste package; WPHC = waste package handling crane; WPTT = waste package transfer trolley.

Source: Table 6.2-1 and Table 6.2-2

A2.4 EVENT SEQUENCE QUANTIFICATION

This section provides the quantification results by sequence. The event sequence probabilities are provided first, and the cut sets are provided afterwards.

A2.4.1 Sequence Level Results

Table A.2.4-1. Sequence Level Results

Event Tree	Sequence	Base Min. Cut	Base Cut Sets
IHF-S-IE-HLW	03	1.245E-006	1
IHF-S-IE-HLW	04-2	1.149E-007	1
IHF-S-IE-HLW	04-3	+0.000E+000	1
IHF-S-IE-HLW	04-4	+0.000E+000	1
IHF-S-IE-HLW	04-5	+0.000E+000	1
IHF-S-IE-HLW	04-6	1.915E-010	1
IHF-S-IE-HLW	04-7	+0.000E+000	1
IHF-S-IE-HLW	05-2	2.106E-006	1
IHF-S-IE-HLW	05-3	+0.000E+000	1
IHF-S-IE-HLW	05-4	+0.000E+000	1
IHF-S-IE-HLW	05-5	+0.000E+000	1
IHF-S-IE-HLW	05-6	3.510E-009	1
IHF-S-IE-HLW	05-7	+0.000E+000	1
IHF-S-IE-HLW	06-2	2.540E-006	1
IHF-S-IE-HLW	06-3	+0.000E+000	1
IHF-S-IE-HLW	06-4	+0.000E+000	1
IHF-S-IE-HLW	06-5	+0.000E+000	1
IHF-S-IE-HLW	06-6	4.233E-009	1
IHF-S-IE-HLW	06-7	+0.000E+000	1
IHF-S-IE-HLW	07-2	5.380E-008	3
IHF-S-IE-HLW	07-3	+0.000E+000	1
IHF-S-IE-HLW	07-4	+0.000E+000	1
IHF-S-IE-HLW	07-5	+0.000E+000	1
IHF-S-IE-HLW	07-6	2.731E-006	4
IHF-S-IE-HLW	07-7	+0.000E+000	1
IHF-S-IE-HLW	08-2		0
IHF-S-IE-HLW	08-3	+0.000E+000	1
IHF-S-IE-HLW	08-4	+0.000E+000	1
IHF-S-IE-HLW	08-5	+0.000E+000	1
IHF-S-IE-HLW	08-6	1.272E-005	2
IHF-S-IE-HLW	08-7	+0.000E+000	1
IHF-S-IE-HLW	09-2		0
IHF-S-IE-HLW	09-3	+0.000E+000	1
IHF-S-IE-HLW	09-4	+0.000E+000	1
IHF-S-IE-HLW	09-5	+0.000E+000	1
IHF-S-IE-HLW	09-6	2.536E-005	1
IHF-S-IE-HLW	09-7	+0.000E+000	1
IHF-S-IE-HLW	10-2	5.128E-008	1
IHF-S-IE-HLW	10-3	+0.000E+000	1

Table A2.4-1. Seismic Basic Event Fragility Data (Continued)

Event Tree	Sequence	Base Min. Cut	Base Cut Sets
IHF-S-IE-HLW	10-4	+0.000E+000	1
IHF-S-IE-HLW	10-5	+0.000E+000	1
IHF-S-IE-HLW	10-6	1.973E-005	3
IHF-S-IE-HLW	10-7	+0.000E+000	1
IHF-S-IE-HLW	11-2		0
IHF-S-IE-HLW	11-3	+0.000E+000	1
IHF-S-IE-HLW	11-4	+0.000E+000	1
IHF-S-IE-HLW	11-5	+0.000E+000	1
IHF-S-IE-HLW	11-6	1.334E-005	1
IHF-S-IE-HLW	11-7	+0.000E+000	1
IHF-S-IE-HLW	12-2	3.649E-008	2
IHF-S-IE-HLW	12-3	+0.000E+000	1
IHF-S-IE-HLW	12-4	+0.000E+000	1
IHF-S-IE-HLW	12-5	1.259E-005	5
IHF-S-IE-HLW	12-6	+0.000E+000	1
IHF-S-IE-HLW	13-2		0
IHF-S-IE-HLW	13-3	+0.000E+000	1
IHF-S-IE-HLW	13-4	+0.000E+000	1
IHF-S-IE-HLW	13-5	+0.000E+000	1
IHF-S-IE-HLW	13-6	1.440E-006	2
IHF-S-IE-HLW	13-7	+0.000E+000	1
IHF-S-IE-HLW	14-2	4.503E-008	1
IHF-S-IE-HLW	14-3	+0.000E+000	1
IHF-S-IE-HLW	14-4	+0.000E+000	1
IHF-S-IE-HLW	14-5	+0.000E+000	1
IHF-S-IE-HLW	14-6	6.181E-006	2
IHF-S-IE-HLW	14-7	+0.000E+000	1
IHF-S-IE-HLW	15-2	5.042E-009	1
IHF-S-IE-HLW	15-3	+0.000E+000	1
IHF-S-IE-HLW	15-4	+0.000E+000	1
IHF-S-IE-HLW	15-5	+0.000E+000	1
IHF-S-IE-HLW	15-6	7.464E-008	2
IHF-S-IE-HLW	15-7	+0.000E+000	1
IHF-S-IE-HLW	16-2	3.243E-006	2
IHF-S-IE-HLW	16-4	+0.000E+000	1
IHF-S-IE-HLW	16-5	+0.000E+000	1
IHF-S-IE-HLW	16-6	+0.000E+000	1
IHF-S-IE-HLW	16-7	2.036E-007	3
IHF-S-IE-HLW	16-8	+0.000E+000	1

Source: Original

A2.4.2 Cut Set Level Results by Sequence

Note that the SAPHIRE software does not provide special tables for seismic cut sets. Therefore, the “Cut Set %” given in the third column of this table is not correct for seismic events, although it does provide the approximate rank order for the cut sets. Also note that the basic events used the basic event names from the naval canister fault trees, since the fault trees are identical. However, the basic event values used in the quantification correctly reflect the HLW basic event values given in Section A2.3.

Table A2.4-2. Cut Set Level Results by Sequence

Event Tree	Sequence	Cut Set %	Basic Event	Description
IHF-S-IE-HLW	03	100.00	51A-NVL-STRUCTUR-ETF	ETF for HLW canister in IHF structure
			IHF-HLW-CAN	Number of HLW canisters processed in IHF
			S-51A-STR-COLLAPSE	Seismic collapse of IHF structure
			= Total	
	04-2	100.00	51A-NVL-ENTDOOR-ETF	ETF for entry door over HLW cask
			IHF-HLW-CAN	Number of HLW canisters processed in IHF
			S-51A-ENTDOORCOL	Seismic collapse of entry door
			SHIELDING	WP remains within WPTT shielding
			= Total	
	04-3	0.00	<FALSE>	System Generated Success Event
			= Total	
	04-4	0.00	<FALSE>	System Generated Success Event
			= Total	
	04-5	0.00	<FALSE>	System Generated Success Event
			= Total	
	04-6	100.00	51A-NVL-ENTDOOR-ETF	ETF for entry door over HLW cask
			51A-NVL-ENTDOOR-PFA	Breach of HLW TC due to entry door collapse
			IHF-HLW-CAN	Number of HLW canisters processed in IHF
			S-51A-ENTDOORCOL	Seismic collapse of entry door
			= Total	
	04-7	0.00	<FALSE>	System Generated Success Event
			= Total	
	05-2	100.00	51A-NVL-RAILCAR-ETF	ETF for railcar carrying HLW transport cask
			IHF-HLW-CAN	Number of HLW canisters processed in IHF
			S-51A-RAILCAR-ACC	Seismic tipover or collision of railcar
			SHIELDING	WP remains within WPTT shielding
			= Total	
	05-3	0.00	<FALSE>	System Generated Success Event

Table A2.4-2. Cut Set Level Results by Sequence (Continued)

Event Tree	Sequence	Cut Set %	Basic Event	Description
			= Total	
	05-4	0.00	<FALSE>	System Generated Success Event
			= Total	
	05-5	0.00	<FALSE>	System Generated Success Event
			= Total	
	05-6	100.00	51A-NVL-RAILCAR-ETF	ETF for railcar carrying HLW transport cask
			51A-NVL-RAILCAR-PFA	Breach of HLW TC due to railcar accident
			IHF-HLW-CAN	Number of HLW canisters processed in IHF
			S-51A-RAILCAR-ACC	Seismic tipover or collision of railcar
			= Total	
	05-7	0.00	<FALSE>	System Generated Success Event
			= Total	
	06-2	100.00	51A-NVL-MOBPLAT-ETF	ETF for mobile platform over HLW TC
			IHF-HLW-CAN	Number of HLW canisters processed in IHF
			S-51A-MOBPLAT-COLLAP	Seismic collapse of mobile platform
			SHIELDING	WP remains within WPTT shielding
			= Total	
	06-3	0.00	<FALSE>	System Generated Success Event
			= Total	
	06-4	0.00	<FALSE>	System Generated Success Event
			= Total	
	06-5	0.00	<FALSE>	System Generated Success Event
			= Total	
	06-6	100.00	51A-NVL-MOBPLAT-ETF	ETF for mobile platform over HLW TC
			51A-NVL-MOBPLAT-PFA	Breach of HLW TC due to mobile platform collapse
			IHF-HLW-CAN	Number of HLW canisters processed in IHF
			S-51A-MOBPLAT-COLLAP	Seismic collapse of mobile platform
			= Total	
	06-7	0.00	<FALSE>	System Generated Success Event
			= Total	
	07-2	91.33	51A-NVL-CHCHOIST-ETF	ETF for CHC hoisting HLW TC
			IHF-HLW-CAN	Number of HLW canisters processed in IHF
			S-51A-CHC-SWING	Significant seismic swinging of CHC
			SHIELDING	WP remains within WPTT shielding
		5.33	51A-NVL-CHCHOIST-ETF	ETF for CHC hoisting HLW TC
			IHF-HLW-CAN	Number of HLW canisters processed in IHF

Table A2.4-2. Cut Set Level Results by Sequence (Continued)

Event Tree	Sequence	Cut Set %	Basic Event	Description
			S-51A-CHC-HOIST	Seismic failure of CHC hoist
			SHIELDING	WP remains within WPTT shielding
		3.34	51A-NVL-CHC-OBJ-ETF	ETF for CHC with heavy object over HLW TC
			IHF-HLW-CAN	Number of HLW canisters processed in IHF
			S-51A-CHC-OBJDROP	Seismic drop of heavy object by CHC
			SHIELDING	WP remains within WPTT shielding
			= Total	
	07-3	0.00	<FALSE>	System Generated Success Event
			= Total	
	07-4	0.00	<FALSE>	System Generated Success Event
			= Total	
	07-5	0.00	<FALSE>	System Generated Success Event
			= Total	
	07-6	99.91	51A-NVL-CHC-COL-ETF	ETF for CHC over HLW canister
			IHF-HLW-CAN	Number of HLW canisters processed in IHF
			S-51A-CHC-COLLAPSE	Seismic collapse of CHC
		0.09	51A-NVL-CHCHOIST-ETF	ETF for CHC hoisting HLW TC
			51A-NVL-CHCSWING-PFA	Breach of HLW cask due to CHC load swinging
			IHF-HLW-CAN	Number of HLW canisters processed in IHF
			S-51A-CHC-SWING	Significant seismic swinging of CHC
		0.01	51A-NVL-CHCHOIST-ETF	ETF for CHC hoisting HLW TC
			51A-NVL-CHCHOIST-PFA	Breach of HLW cask due to CHC hoist drop
			IHF-HLW-CAN	Number of HLW canisters processed in IHF
			S-51A-CHC-HOIST	Seismic failure of CHC hoist
		0.00	51A-NVL-CHC-OBJ-ETF	ETF for CHC with heavy object over HLW TC
			51A-NVL-CHC-OBJ-PFA	Breach of HLW cask due to CHC heavy object drop
			IHF-HLW-CAN	Number of HLW canisters processed in IHF
			S-51A-CHC-OBJDROP	Seismic drop of heavy object by CHC
			= Total	
	07-7	0.00	<FALSE>	System Generated Success Event
			= Total	
	08-2			
	08-3	0.00	<FALSE>	System Generated Success Event
			= Total	

Table A2.4-2. Cut Set Level Results by Sequence (Continued)

Event Tree	Sequence	Cut Set %	Basic Event	Description
	08-4	0.00	<FALSE>	System Generated Success Event
			= Total	
	08-5	0.00	<FALSE>	System Generated Success Event
			= Total	
	08-6	93.31	51A-NVL-CPC-OBJ-ETF	ETF for CPC with heavy object over HLW TC
			IHF-HLW-CAN	Number of HLW canisters processed in IHF
			S-51A-CPC-OBJDROP	Seismic drop of heavy object by CPC
		6.69	51A-NVL-CPC-COL-ETF	ETF for CPC over HLW canister
			IHF-HLW-CAN	Number of HLW canisters processed in IHF
			S-51A-CPC-COLLAPSE	Seismic collapse of CPC
			= Total	
	08-7	0.00	<FALSE>	System Generated Success Event
			= Total	
	09-2			
	09-3	0.00	<FALSE>	System Generated Success Event
			= Total	
	09-4	0.00	<FALSE>	System Generated Success Event
			= Total	
	09-5	0.00	<FALSE>	System Generated Success Event
			= Total	
	09-6	100.00	51A-NVL-CPPLAT-ETF	ETF for HLW cask under cask prep platform
			IHF-HLW-CAN	Number of HLW canisters processed in IHF
			S-51A-CPPLAT-COL	Seismic collapse of cask prep platform
			= Total	
	09-7	0.00	<FALSE>	System Generated Success Event
			= Total	
	10-2	100.00	51A-NVL-CTT-BUMP-ETF	ETF for CTT with TC subject to bumping EAF
			IHF-HLW-CAN	Number of HLW canisters processed in IHF
			S-51A-CTT-BUMPING	Seismic bumping of CTT into EAF
			SHIELDING	WP remains within WPTT shielding
			= Total	
	10-3	0.00	<FALSE>	System Generated Success Event
			= Total	
	10-4	0.00	<FALSE>	System Generated Success Event
			= Total	
	10-5	0.00	<FALSE>	System Generated Success Event

Table A2.4-2. Cut Set Level Results by Sequence (Continued)

Event Tree	Sequence	Cut Set %	Basic Event	Description
			= Total	
	10-6	85.29	51A-NVL-CTTSLIDE-ETF	ETF for CTT containing HLW TC in transfer cell
			IHF-HLW-CAN	Number of HLW canisters processed in IHF
			S-51A-CTT-SLIDE	Seismic sliding of CTT into wall
		14.71	51A-NVL-CTT-ROCK-ETF	ETF for CTT with HLW TC subject to rocking
			IHF-HLW-CAN	Number of HLW canisters processed in IHF
			S-51A-CTT-ROCKING	Seismic rocking of CTT with restraint failure
		0.00	51A-NVL-CTT-BUMP-ETF	ETF for CTT with TC subject to bumping EAF
			51A-NVL-CTT-BUMP-PFA	Breach given CTT with TC subject to bumping EAF
			IHF-HLW-CAN	Number of HLW canisters processed in IHF
			S-51A-CTT-BUMPING	Seismic bumping of CTT into EAF
			= Total	
	10-7	0.00	<FALSE>	System Generated Success Event
			= Total	
	11-2			
	11-3	0.00	<FALSE>	System Generated Success Event
			= Total	
	11-4	0.00	<FALSE>	System Generated Success Event
			= Total	
	11-5	0.00	<FALSE>	System Generated Success Event
			= Total	
	11-6	100.00	51A-NVL-SHIELDDDR-ETF	ETF for shield doors when HLW canister is nearby
			IHF-HLW-CAN	Number of HLW canisters processed in IHF
			S-51A-SHIELDDOOR	Seismic falling of shield door
			= Total	
	11-7	0.00	<FALSE>	System Generated Success Event
			= Total	
	12-2	94.48	51A-NVL-CTMSWGIB-ETF	ETF for CTM hoisting HLW canister inside bell
			IHF-HLW-CAN	Number of HLW canisters processed in IHF
			S-51A-CTMSWG-IB	Significant swinging of canister inside CTM bell
			SHIELDING	WP remains within WPTT shielding
		5.52	51A-NVL-CTMHOIST-ETF	ETF for CTM hoisting HLW canister

Table A2.4-2. Cut Set Level Results by Sequence (Continued)

Event Tree	Sequence	Cut Set %	Basic Event	Description
			IHF-HLW-CAN	Number of HLW canisters processed in IHF
			S-51A-CTM-HOIST	Seismic drop of naval canister hoisted by CTM
			SHIELDING	WP remains within WPTT shielding
			= Total	
	12-3	0.00	<FALSE>	System Generated Success Event
			= Total	
	12-4	0.00	<FALSE>	System Generated Success Event
			= Total	
	12-5	94.43	51A-NVL-CTMSWGOB-ETF	ETF for CTM hoisting HLW canister outside bell
			IHF-HLW-CAN	Number of HLW canisters processed in IHF
			S-51A-CTMSWG-OB	Significant swinging of canister outside CTM bell
		3.05	51A-NVL-CTM-COL-ETF	ETF for CTM over HLW canister
			IHF-HLW-CAN	Number of HLW canisters processed in IHF
			S-51A-CTM-COLLAPSE	Seismic collapse of CTM
		2.47	51A-NVL-CTM-OBJ-ETF	ETF for CTM with heavy object over HLW TC
			IHF-HLW-CAN	Number of HLW canisters processed in IHF
			S-51A-CTM-OBJDROP	Seismic drop of heavy object by CTM
		0.06	51A-NVL-CTMHOIST-ETF	ETF for CTM hoisting HLW canister
			51A-NVL-CTMHOIST-PFA	Breach of canister dropped by CTM
			IHF-HLW-CAN	Number of HLW canisters processed in IHF
			S-51A-CTM-HOIST	Seismic drop of HLW canister hoisted by CTM
		0.00	51A-NVL-CTMSWGIB-ETF	ETF for CTM hoisting HLW canister inside bell
			51A-NVL-CTMSWGIB-PFA	Breach of HLW canister due to swing inside bell
			IHF-HLW-CAN	Number of HLW canisters processed in IHF
			S-51A-CTMSWG-IB	Significant swinging of canister inside CTM bell
			= Total	
	12-6	0.00	<FALSE>	System Generated Success Event
			= Total	
	13-2			
	13-3	0.00	<FALSE>	System Generated Success Event
			= Total	

Table A2.4-2. Cut Set Level Results by Sequence (Continued)

Event Tree	Sequence	Cut Set %	Basic Event	Description
	13-4	0.00	<FALSE>	System Generated Success Event
			= Total	
	13-5	0.00	<FALSE>	System Generated Success Event
			= Total	
	13-6	98.78	51A-NVL-RHS-OBJ-ETF	ETF for RHS with heavy object over HLW canister
			IHF-HLW-CAN	Number of HLW canisters processed in IHF
			S-51A-RHS-OBJDROP	Seismic drop of heavy object by RHS
		1.22	51A-NVL-RHS-COL-ETF	ETF for RHS over HLW canister
			IHF-HLW-CAN	Number of HLW canisters processed in IHF
			S-51A-RHS-COLLAPSE	Seismic collapse of RHS
			= Total	
	13-7	0.00	<FALSE>	System Generated Success Event
			= Total	
	14-2	100.00	51A-NVL-WPTT-ROCK-ETF	ETF for WPTT in constrained position
			IHF-HLW-CAN	Number of HLW canisters processed in IHF
			S-51A-WPTT-ROCK	Seismic rocking of WPTT (constrained)
			SHIELDING	WP remains within WPTT shielding
			= Total	
	14-3	0.00	<FALSE>	System Generated Success Event
			= Total	
	14-4	0.00	<FALSE>	System Generated Success Event
			= Total	
	14-5	0.00	<FALSE>	System Generated Success Event
			= Total	
	14-6	99.95	51A-NVL-WPTT-TIP-ETF	ETF for WPTT not constrained
			IHF-HLW-CAN	Number of HLW canisters processed in IHF
			S-51A-WPTT-TIPOVER	Seismic tipover of WPTT
		0.05	51A-NVL-WPTT-ROCK-ETF	ETF for WPTT in constrained position
			51A-NVL-WPTT-ROCK-PFA	Breach of HLW canister when WPTT rocks
			IHF-HLW-CAN	Number of HLW canisters processed in IHF
			S-51A-WPTT-ROCK	Seismic rocking of WPTT (constrained)
			= Total	
	14-7	0.00	<FALSE>	System Generated Success Event
			= Total	

Table A2.4-2. Cut Set Level Results by Sequence (Continued)

Event Tree	Sequence	Cut Set %	Basic Event	Description
	15-2	100.00	51A-NVL-WPHC-OBJ-ETF	ETF for WPHC with heavy object over HLW WP
			IHF-HLW-CAN	Number of HLW canisters processed in IHF
			S-51A-WPHC-OBJDROP	Seismic drop of heavy object by WPHC
			SHIELDING	WP remains within WPTT shielding
			= Total	
	15-3	0.00	<FALSE>	System Generated Success Event
			= Total	
	15-4	0.00	<FALSE>	System Generated Success Event
			= Total	
	15-5	0.00	<FALSE>	System Generated Success Event
			= Total	
	15-6	99.61	51A-NVL-WPHC-COL-ETF	ETF for WPHC over HLE WP
			IHF-HLW-CAN	Number of HLW canisters processed in IHF
			S-51A-WPHC-COLLAPSE	Seismic collapse of WPHC over HLW WP
		0.39	51A-NVL-WPHC-OBJ-ETF	ETF for WPHC with heavy object over HLW WP
			51A-NVL-WPHC-OBJ-PFA	Breach of WP due to WPHC heavy object drop
			IHF-HLW-CAN	Number of HLW canisters processed in IHF
			S-51A-WPHC-OBJDROP	Seismic drop of heavy object by WPHC
			= Total	
	15-7	0.00	<FALSE>	System Generated Success Event
			= Total	
	16-2	100.00	51A-NVL-TEVEJECT-ETF	ETF for TEV containing HLW WP
			IHF-HLW-CAN	Number of HLW canisters processed in IHF
			S-51A-TEV-EJECT-WP	Seismic ejection of HLW WP from TEV
		0.00	51A-NVL-TEV-TIP-ETF	ETF for TEV containing HLW WP
			IHF-HLW-CAN	Number of HLW canisters processed in IHF
			S-51A-TEV-TIPOVER	Seismic tipover of TEV
			= Total	
	16-4	0.00	<FALSE>	System Generated Success Event
			= Total	
	16-5	0.00	<FALSE>	System Generated Success Event
			= Total	
	16-6	0.00	<FALSE>	System Generated Success Event
			= Total	
	16-7	82.92	51A-NVL-TEVSLIDE-ETF	ETF for TEV during HLW WP transfer

Table A2.4-2. Cut Set Level Results by Sequence (Continued)

Event Tree	Sequence	Cut Set %	Basic Event	Description
			IHF-HLW-CAN	Number of HLW canisters processed in IHF
			S-51A-TEV-SLIDE	Seismic sliding of TEV during WP transfer
		17.08	51A-NVL-TEVEJECT-ETF	ETF for TEV containing HLW WP
			51A-NVL-TEVEJECT-PFA	Breach of WP due to ejection from TEV
			IHF-HLW-CAN	Number of HLW canisters processed in IHF
			S-51A-TEV-EJECT-WP	Seismic ejection of HLW WP from TEV
		0.00	51A-NVL-TEV-TIP-ETF	ETF for TEV containing HLW WP
			51A-NVL-TEV-TIP-PFA	Breach of HLW WP due to TEV tipover
			IHF-HLW-CAN	Number of HLW canisters processed in IHF
			S-51A-TEV-TIPOVER	Seismic tipover of TEV
			= Total	
	16-8	0.00	<FALSE>	System Generated Success Event
			= Total	
IHF-S-IE-HLW	03	100.00	51A-NVL-STRUCTUR-ETF	ETF for HLW canister in IHF structure
			IHF-HLW-CAN	Number of HLW canisters processed in IHF

NOTE: CHC = cask handling crane; CPC = cask preparation crane; CTM = canister transfer machine; CTT = cask transfer trolley; EAF = energy absorbing feature; ETF = exposure time factor; HLW = high-level radioactive waste; IHF = Initial Handling Facility; RHS = remote handling system; TC = transportation cask; TEV = transport and emplacement vehicle; WP = waste package; WPHC = waste package handling crane; WPTT = waste package transfer trolley.

Source: Original

ATTACHMENT B RECEIPT FACILITY ANALYSES

This attachment contains detailed information for the RF seismic event sequence analysis:

- IET and SRETs
- Event tree to fault tree assignment tables
- Fault trees
- Non-seismic basic event tables
- Seismic basic event tables
- Event sequence probability tables
- Event sequence cut set tables.

The RF analysis covers processing of TAD canisters and DPCs, to include the following:

- 1 Processing of TAD canisters from railcars with transportation casks entering the RF to aging overpacks in site transporters leaving the RF
- 2 Processing of DPCs from railcars with transportation casks entering the RF to aging overpacks in site transporters leaving the RF
- 3 Processing of DPCs from railcars with horizontal transportation casks entering the RF to horizontal transportation casks on horizontal cask transfer trailers leaving the RF
- 4 Processing of DPCs from railcars with transportation casks entering the RF, using tilting frames to aging overpacks in site transporters leaving the RF.

B1 TRANSPORTATION, AGING AND DISPOSAL CANISTERS

This section provides the detailed information used to develop the event sequences for the analysis of processing of a TAD canister in the RF. TAD canisters inside a transportation cask are received on railcars, and are transferred into an aging overpack and then transported in a site transporter out of the RF.

B1.1 EVENT TREES

The IET and SRETs are presented in this section. The tables provide the assignments between the event tree branches and the fault trees given in the next section.

Seismic Event	Number of TAD canisters transferred to AO	Identify initiating seismic failure		
SEIS-EVENT	RF-TAD-AO	SEIS-FAIL	#	END-STATE
			1	OK
		RF building collapse	2	OK
		Entry door seismic collapse	3	RR-UNF
		Railcar accident	4	T => 2 RF-S-R-TC1
		Mobile platform seismic collapse	5	T => 2 RF-S-R-TC1
		CHC seismic failures	6	T => 2 RF-S-R-TC1
		Cask prep platform collapse	7	T => 2 RF-S-R-TC1
		CTT seismic failures	8	T => 2 RF-S-R-TC1
		Shield door seismic failure	9	T => 2 RF-S-R-TC1
		CTM seismic failures	10	T => 3 RF-S-R-SD1
		CRM MC seismic collapse	11	T => 4 RF-S-R-CTM
		ST seismic failures	12	T => 4 RF-S-R-CTM
		LBR platform collapse	13	T => 5 RF-S-R-AO
		LBR crane collapse	14	T => 5 RF-S-R-AO
			15	T => 5 RF-S-R-AO

RF-S-IE-TAD-AO - RF Seismic Event Tree - Initiating Seismic Failures - TAD to AO 2008/01/07 Page 1

NOTE: Event tree branch captions are associated with the branch line below the caption.

AO = aging overpack; CHC = cask handling crane; CTM = canister transfer machine; CTM MC = canister transfer machine maintenance crane; CTT = cask transfer trolley; IE = initiating event; LBR = Lid Bolting Room; RF = Receipt Facility; RR = radioactive release; SD = shield door; SEIS = seismic; ST = site transporter; TAD = transportation, aging and disposal; TC = transportation cask; T = transfer; TC = transportation cask; UNF = unfiltered.

Source: Original

Figure B1.1-1. RF Seismic Event Tree RF-S-IE-TAD-AO – Initiating Seismic Failures – TAD to AO

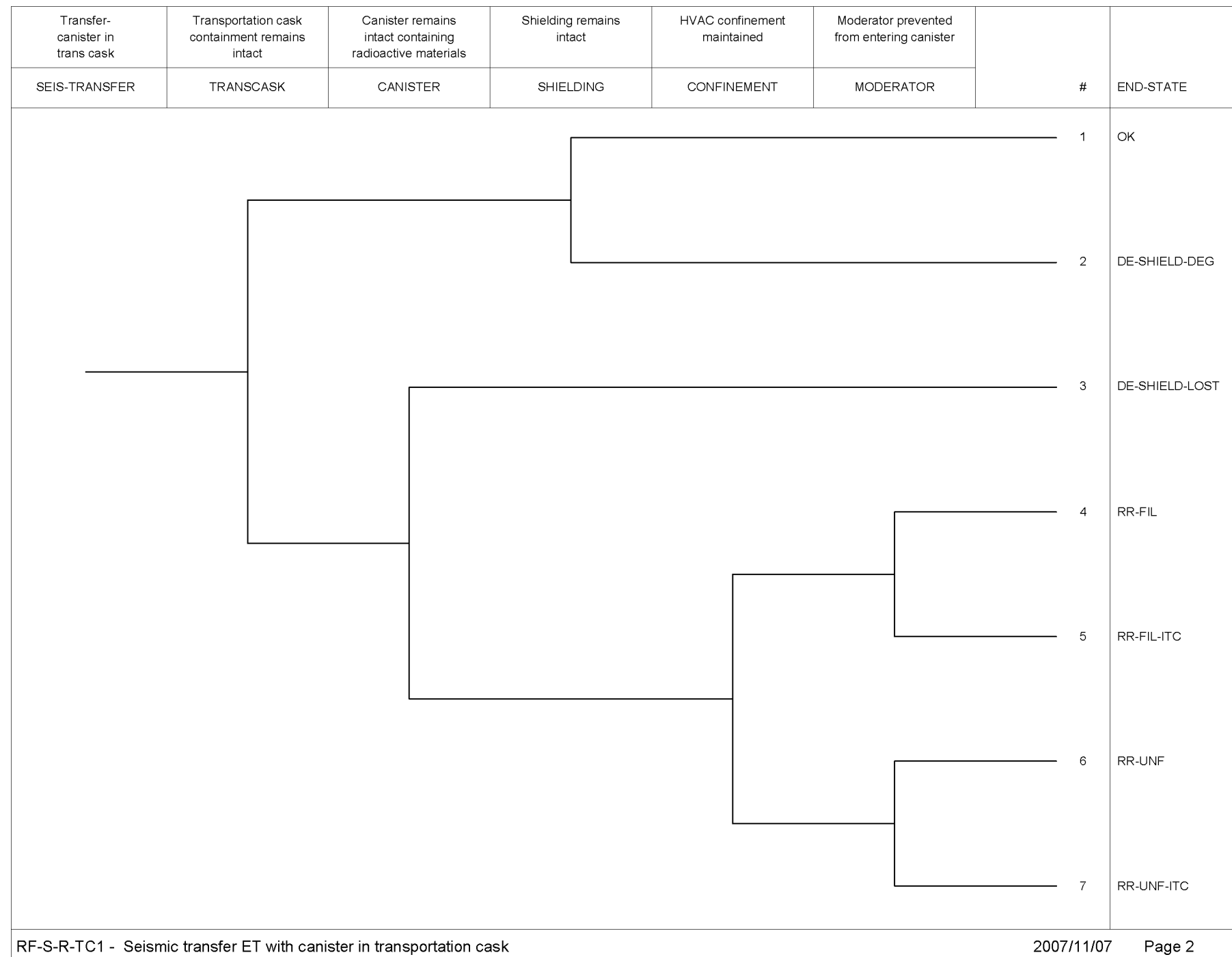

NOTE: DE = direct exposure; DEG = degradation; FIL = filtered; HVAC = heating, ventilation and air conditioning; ITC = important to criticality; RF = Receipt Facility; RR = radioactive release; SEIS = seismic; TC = transportation cask; UNF = unfiltered.

Source: Original

Figure B1.1-2. RF Seismic Event Tree RF-S-R-TC1 – Seismic Transfer ET with Canister in Transportation Cask

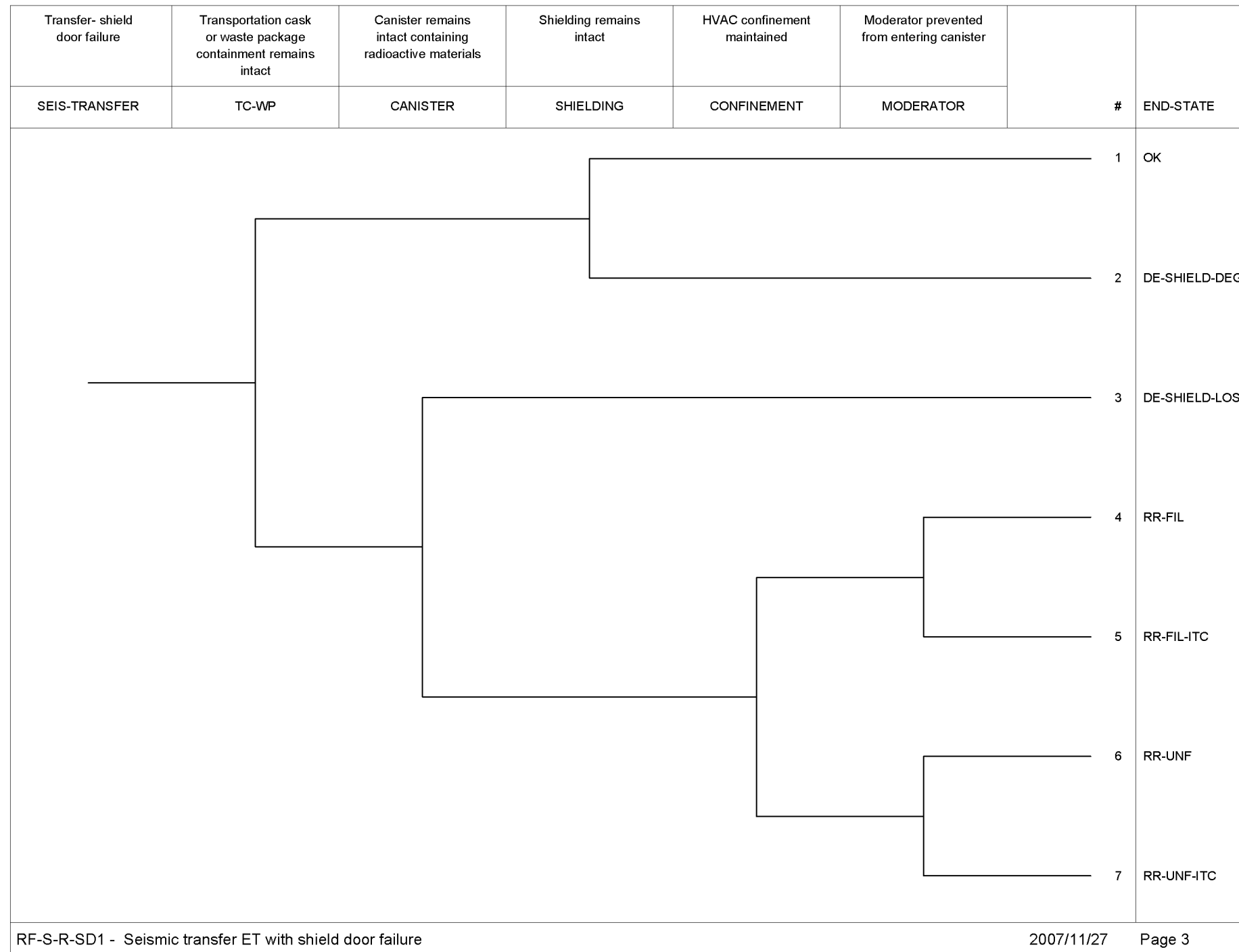

NOTE: DE = direct exposure; DEG = degradation; ET = event tree; FIL = filtered; HVAC = heating, ventilation and air conditioning; ITC = important to criticality; RF = Receipt Facility; RR = radioactive release; SD = shield door; SEIS = seismic; TC = transportation cask; UNF = unfiltered; WP = waste package.

Source: Original

Figure B1.1-3. RF Seismic Event Tree RF-S-R-SD1 – Seismic Transfer ET with Shield Door Failure

Transfer- CTM failures	Canister remains intact containing radioactive materials	Shielding remains intact	HVAC confinement maintained	Moderator prevented from entering canister		
SEIS-TRANSFER	CANISTER	SHIELDING	CONFINEMENT	MODERATOR	#	END-STATE
					1	OK
					2	DE-SHIELD-LOST
					3	RR-FIL
					4	RR-FIL-ITC
					5	RR-UNF
					6	RR-UNF-ITC
RF-S-R-CTM - Seismic transfer ET for CTM operations					2007/11/27	Page 4

NOTE: CTM = canister transfer machine; DE = direct exposure; ET = event tree; FIL = filtered; HVAC = heating, ventilation and air conditioning; ITC = important to criticality; RF = Receipt Facility; RR = radioactive release; SEIS = seismic; UNF = unfiltered.

Source: Original

Figure B1.1-4. RF Seismic Event Tree RF-S-R-CTM – Seismic Transfer ET for CTM Operations

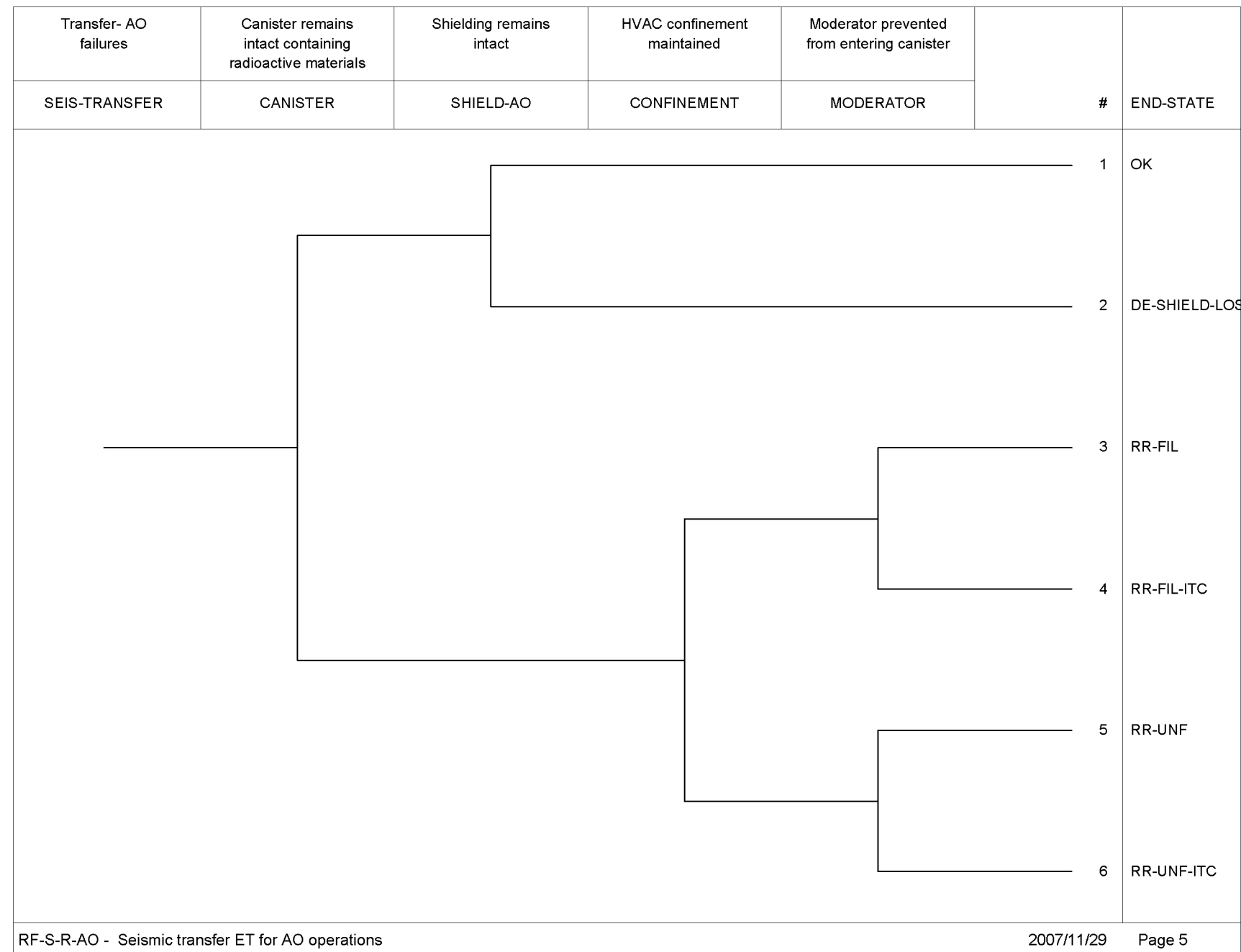

NOTE: AO = aging overpack; CTM = canister transfer machine; DE = direct exposure; ET = event tree; FIL = filtered; HVAC = heating, ventilation and air conditioning; ITC = important to criticality; RF = Receipt Facility; RR = radioactive release; SEIS = seismic; UNF = unfiltered.

Source: Original

Figure B1.1-5. RF Seismic Event Tree RF-S-R-AO – Seismic Transfer ET for AO Operations

Table B1.1-1. Fault Trees Assigned for Initiating Seismic Failures for the RF

Process	Initiator Event Tree	Initiating Seismic Failure	Associated Fault Tree
TAD to AO	RF-S-IE-TAD-AO	RF building collapse	S-200-TAO-STR-COLLAP
		Entry door seismic collapse	S-200-TAO-ENTDOORCOL
		Railcar accident	S-200-TAO-RAILCARACC
		Mobile platform seismic collapse	S-200-TAO-MOBPLATCOL
		CHC seismic failures	S-200-TAO-CHC-FAIL
		Cask prep platform collapse	S-200-TAO-CPREP-PLAT
		CTT seismic failures	S-200-TAO-CTT-FAIL
		Shield door seismic failures	S-200-TAO-SHIELDDOOR
		CTM seismic failures	S-200-TAO-CTM-FAIL
		CTM MC seismic collapse	S-200-TAO-CTMMC
		ST seismic failures	S-200-TAO-ST-SLIDE
		LBR platform collapse	S-200-TAO-LBRPLAT
		LBR crane collapse	S-200-TAO-LBRC-COL

NOTE: AO = aging overpack; CHC = cask handling crane; CTM = canister transfer machine; CTM MC = canister transfer machine maintenance crane; CTT = cask transfer trolley; IE = initiating event; LBR = Lid Bolting Room; RF = Receipt Facility; TAD = transportation, aging and disposal; ST = site transporter.

Source: Original

Table B1.1-2. Fault Trees Assigned for Pivotal Events for RF-S-IE-TAD-AO Initiating Event Tree

Initiating Seismic Failure	TRANSCASK	MODERATOR
RF building collapse	N/A	N/A
Entry door seismic collapse	RC-TAO-DOORDROP-CASK	RF-MOD-MULT-SYS
Railcar accident	RC-TAO-RC-ACC-CASK	RF-MOD-MULT-SYS
Mobile platform seismic collapse	RC-TAO-MOB-PLAT-CASK	RF-MOD-MULT-SYS
CHC seismic failures	TC-TAO-CHC-CASK	RF-MOD-MULT-SYS
Cask prep platform collapse	TC-TAO-CPP-CASK	RF-MOD-MULT-SYS
CTT seismic failures	CTT-TAO-CTT-CASK	RF-MOD-FPW-ONLY
TC-WP		
Shield door seismic failures	TCWP-TAO-SHIELDDOOR-CASK	RF-MOD-MULT-SYS
CANISTER		
CTM seismic failures	CTM-TAO-CTM-CAN	RF-MOD-FPW-ONLY
CTM MC seismic collapse	CTM-TAO-CTMMC	RF-MOD-FPW-ONLY
ST seismic failures	ST-TAO-AO-FAIL	RF-MOD-FPW-ONLY
LBR platform collapse	ST-TAO-LBRPLAT	RF-MOD-FPW-ONLY
LBR crane collapse	ST-TAO-LBRC-COL	RF-MOD-FPW-ONLY

NOTE: AO = aging overpack; CHC = cask handling crane; CTM = canister transfer machine; CTM MC = canister transfer machine maintenance crane; CTT = cask transfer trolley; IE = initiating event; LBR = Lid Bolting Room; RF = Receipt Facility; TAD = transportation, aging and disposal; TC = transportation cask; ST = site transporter; WP = waste package.

Source: Original

B1.2 FAULT TREES

Seismic fault trees for the processing of TAD canisters in the RF are presented in alpha-numeric order in this section.

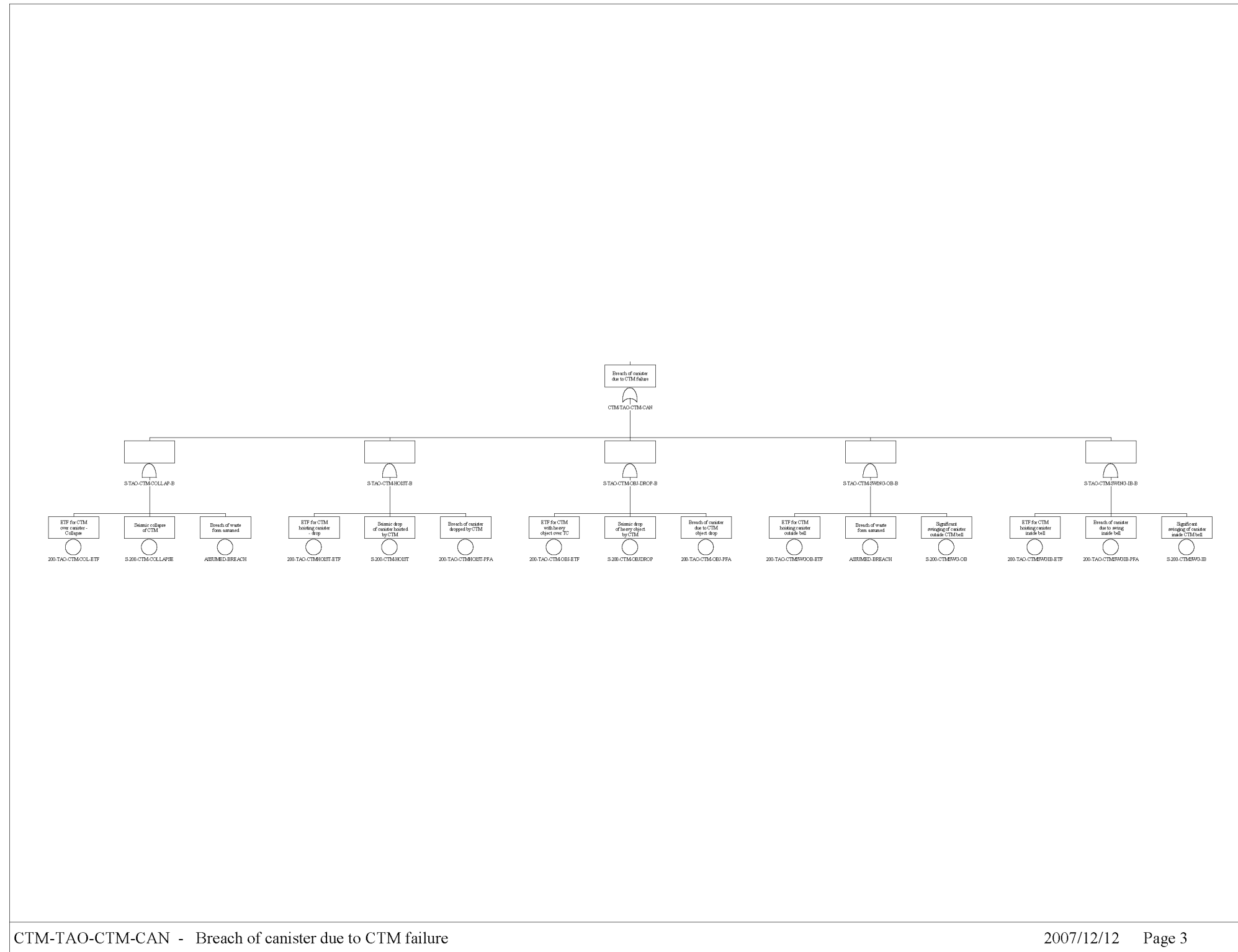

Source: Original

Figure B1.2-1. Fault Tree CTM-TAO-CTM-CAN – Breach of Canister due to CTM Failure

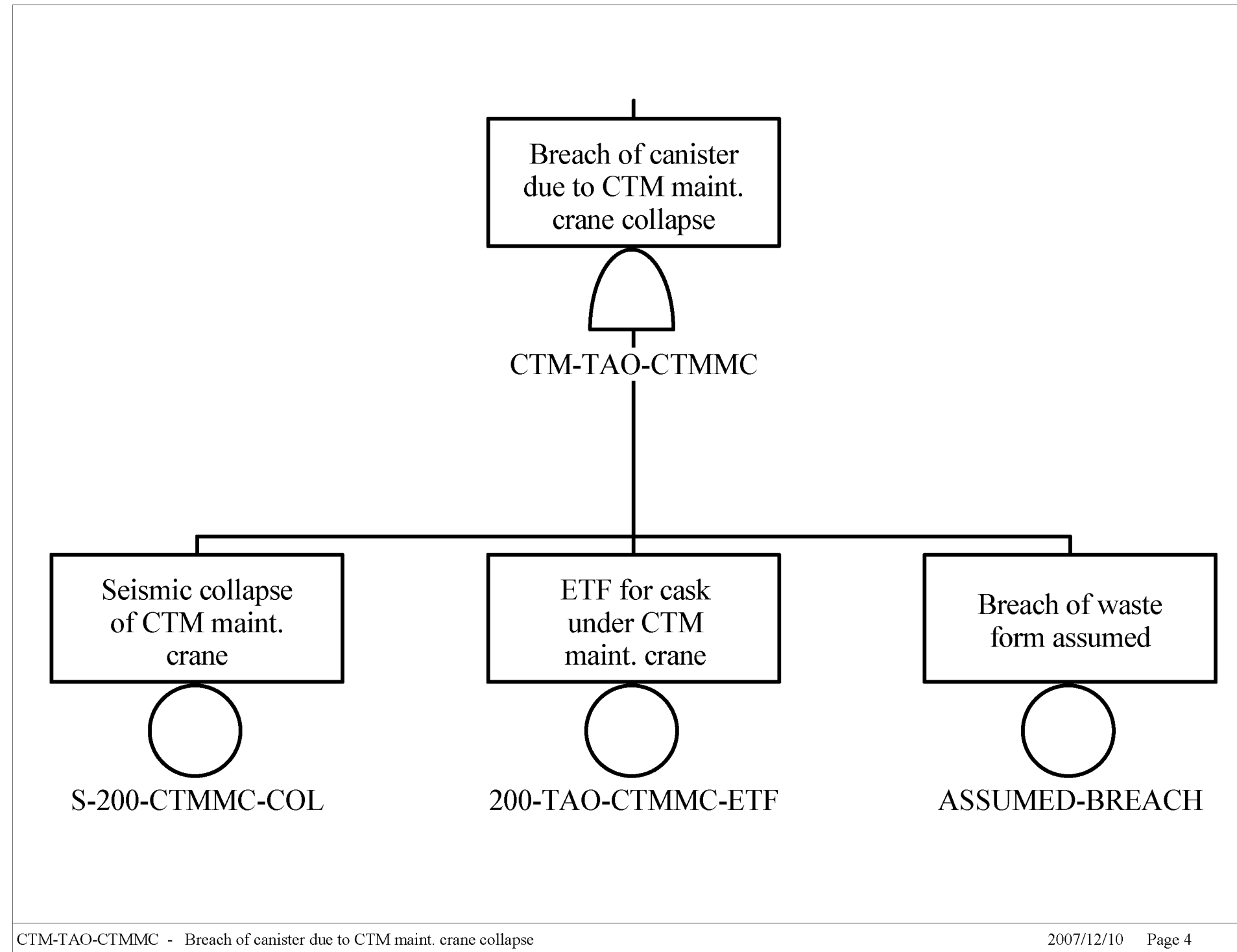

Source: Original

Figure B1.2-2. CTM-TAO-CTMMC – Breach of Canister due to CTM Maint. Crane Collapse

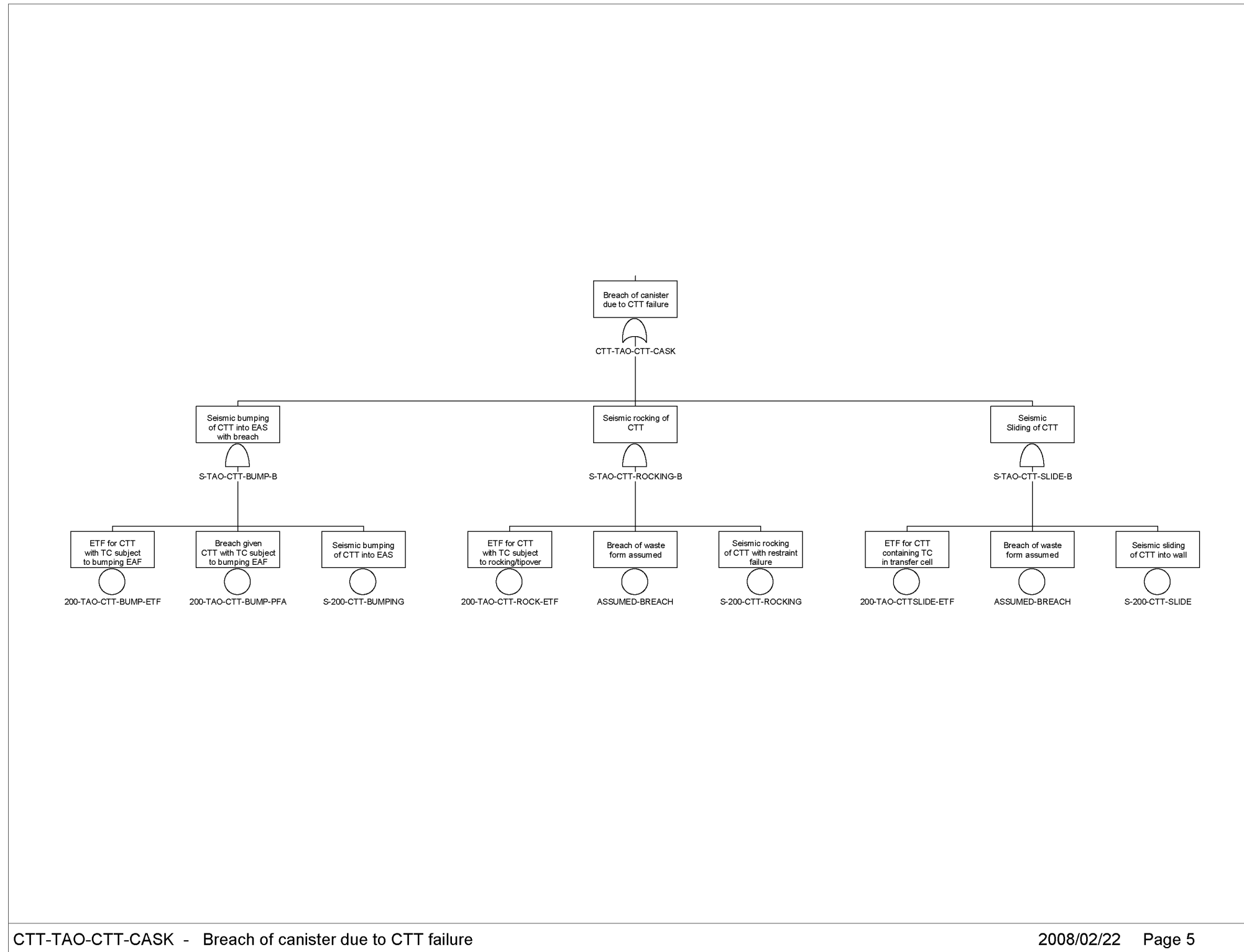

Source: Original

Figure B1.2-3 CTT-TAO-CTT-CASK – Breach of Canister due to CTT Failure

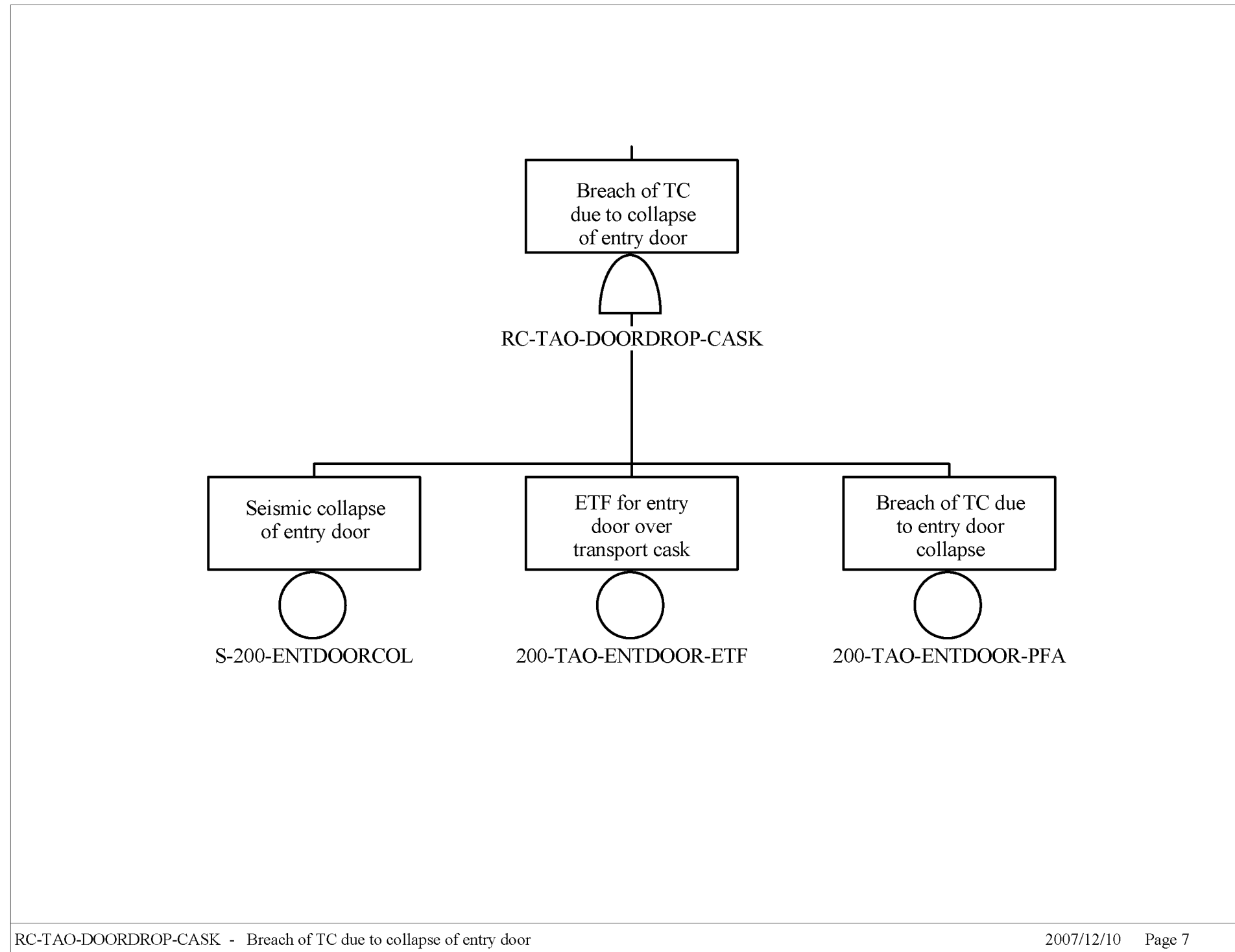

Source: Original

Figure B1.2-4. RC-TAO-DOORDROP-CASK – Breach of TC due to Collapse of Entry Door

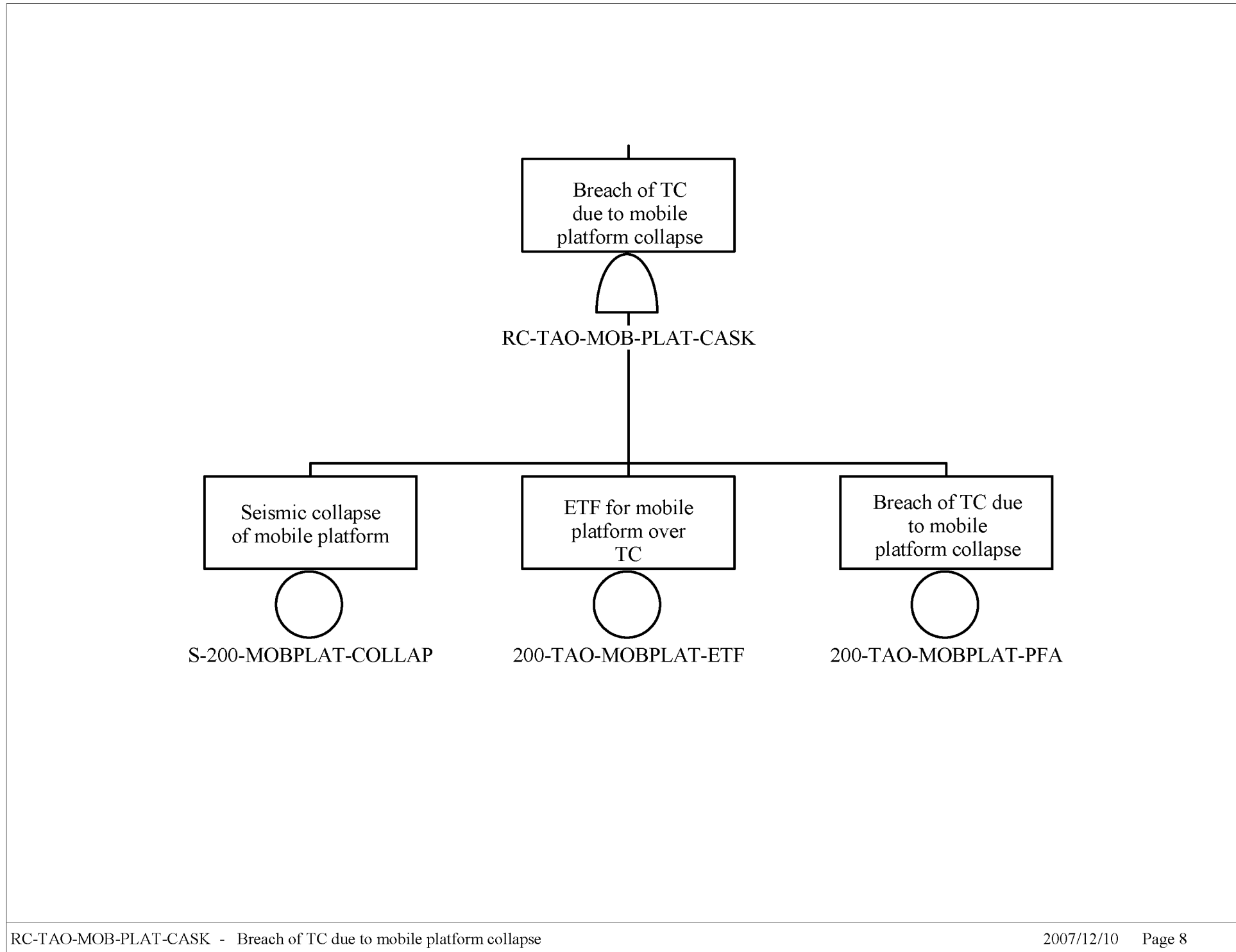

Source: Original

Figure B1.2-5. RC-TAO-MOB-PLAT-CASK – Breach of TC due to Mobile Platform Collapse

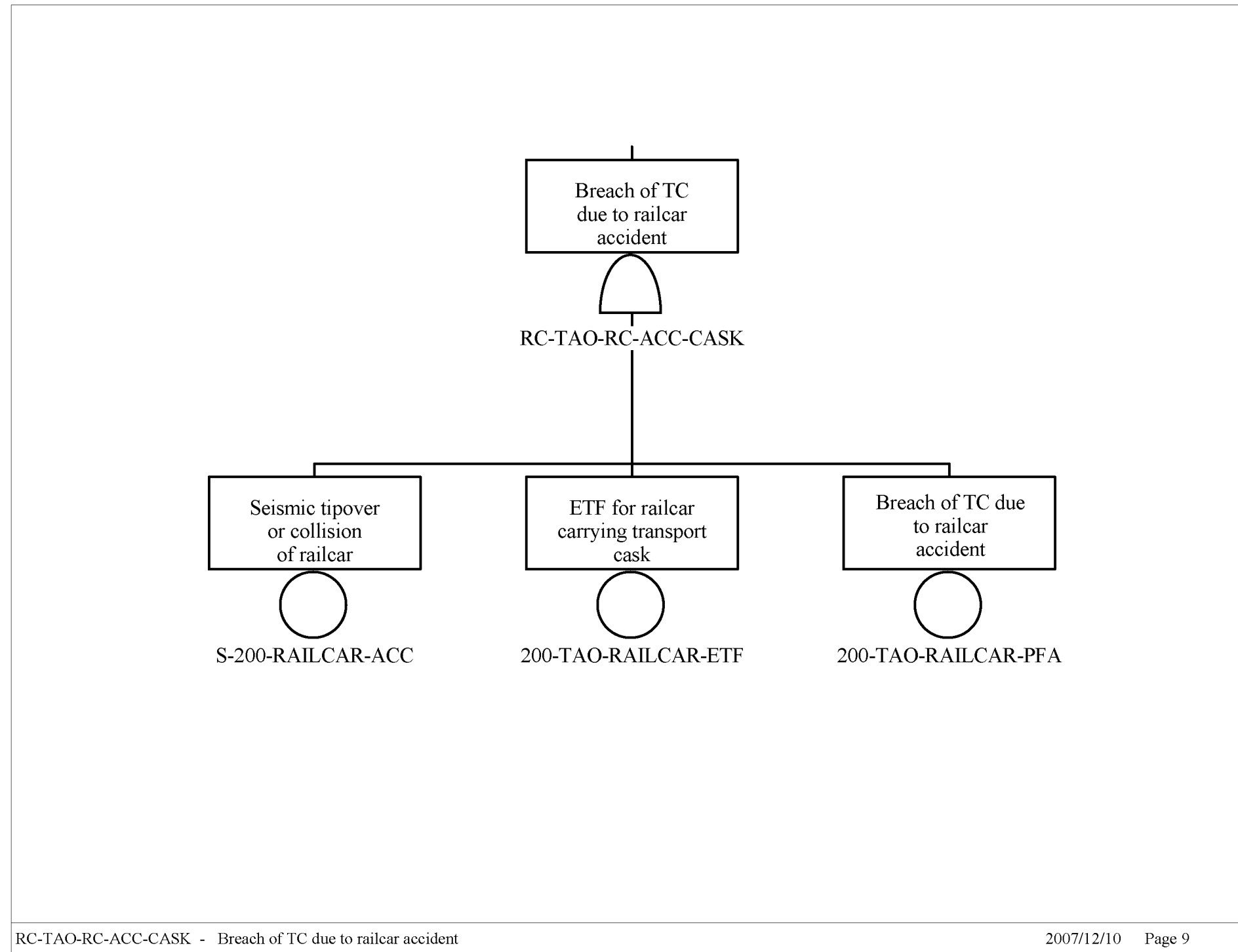

Source: Original

Figure B1.2-6. RC-TAO-RC-ACC-CASK – Breach of TC due to Railcar Accident

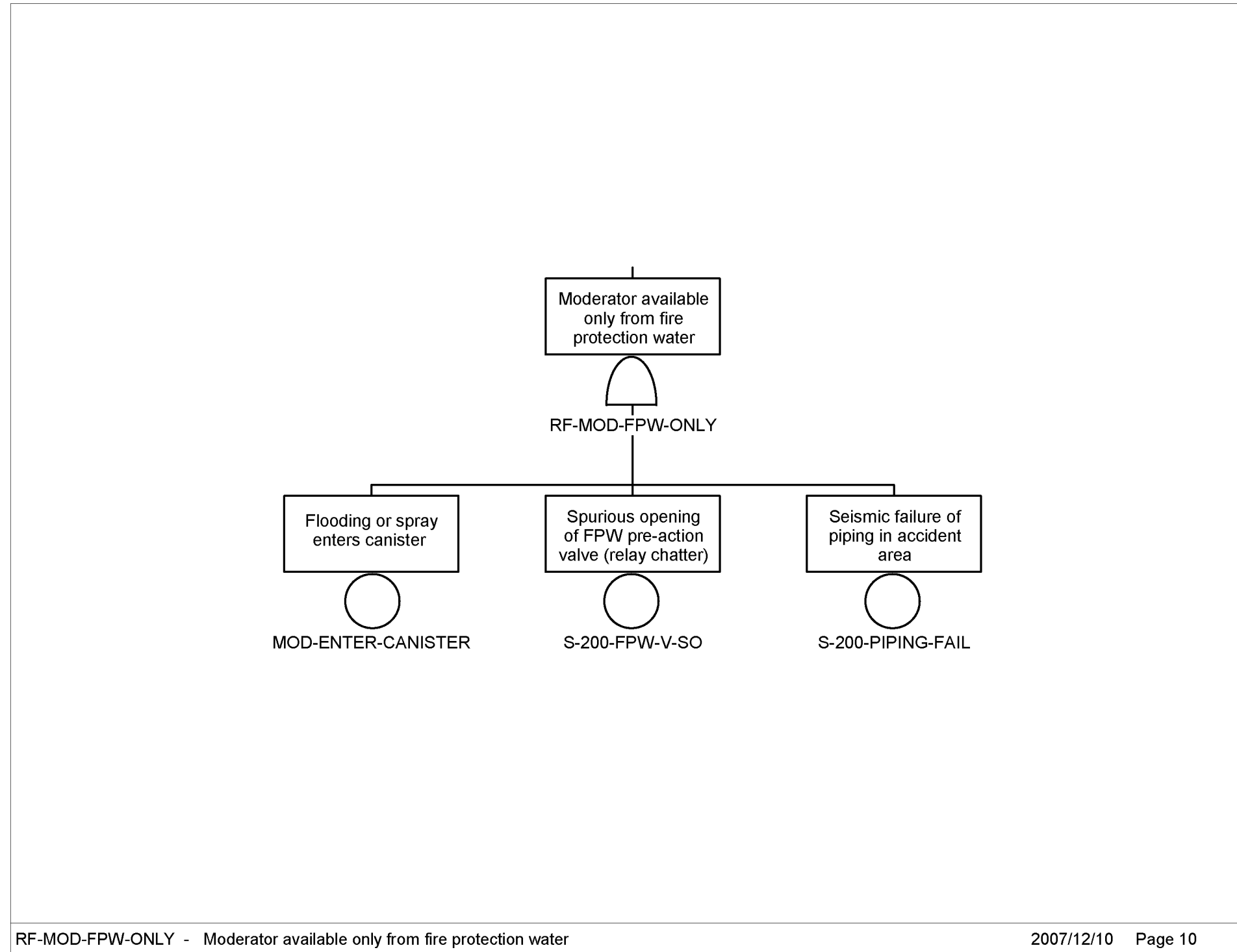

Source: Original

Figure B1.2-7. RF-MOD-FPW-ONLY – Moderator Available Only from Fire Protection Water

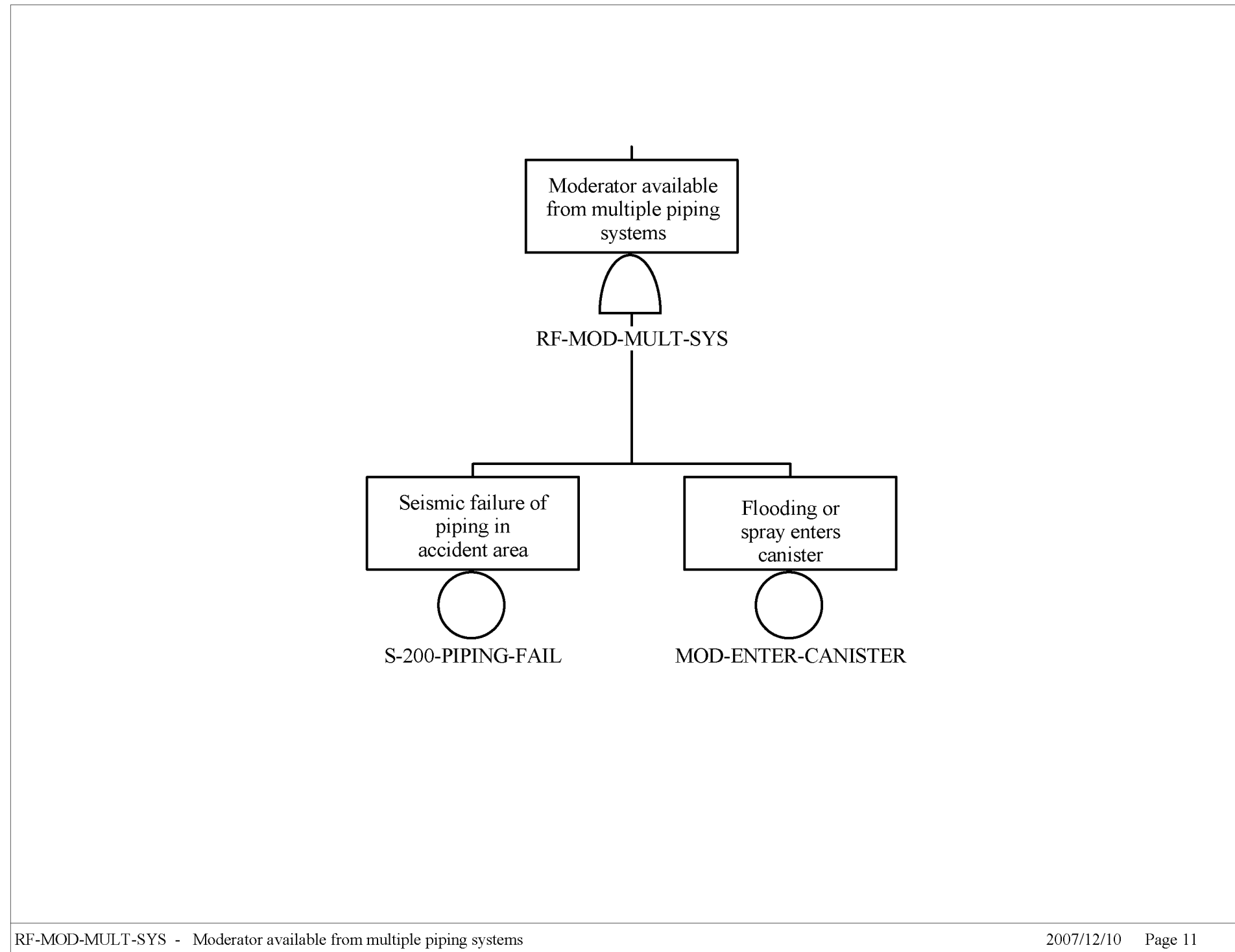

Source: Original

Figure B1.2-8. RF-MOD-MULT-SYS – Moderator Available from Multiple Piping Systems

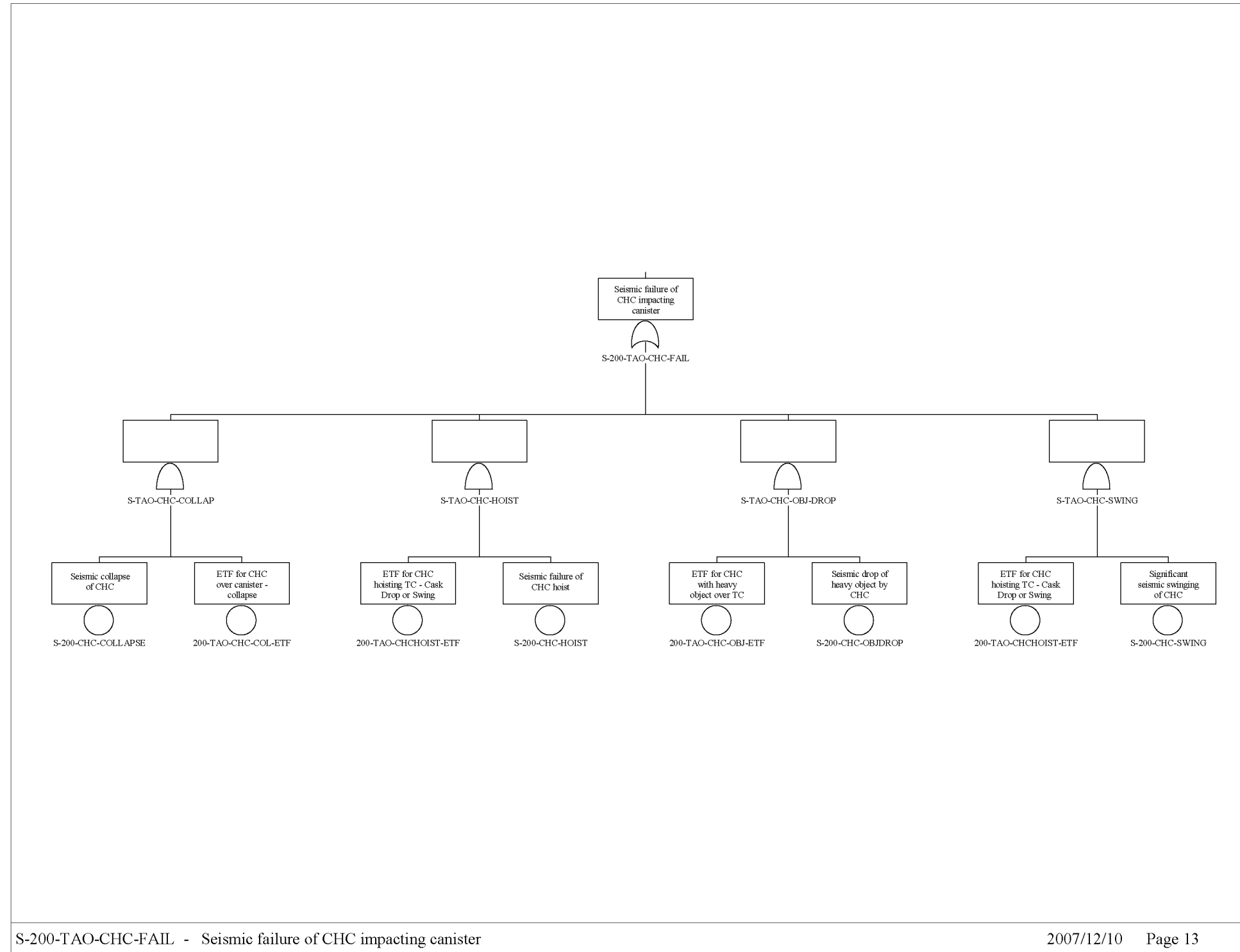

Source: Original

Figure B1.2-9. S-200-TAO-CHC-FAIL – Seismic Failure of CHC Impacting Canister

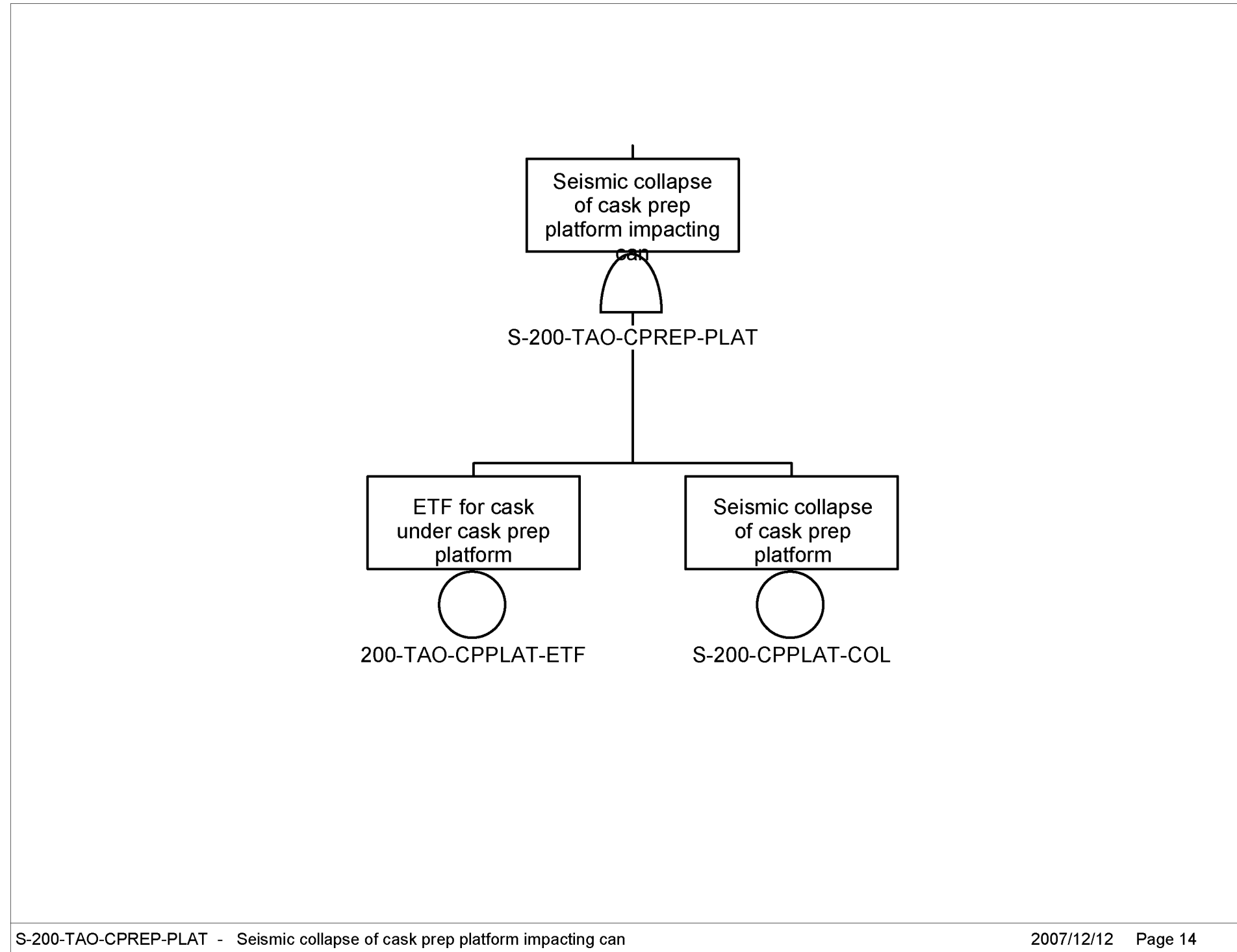

Source: Original

Figure B1.2-10. S-200-TAO-CPREP-PLAT – Seismic Collapse of Cask Prep Platform Impacting Can

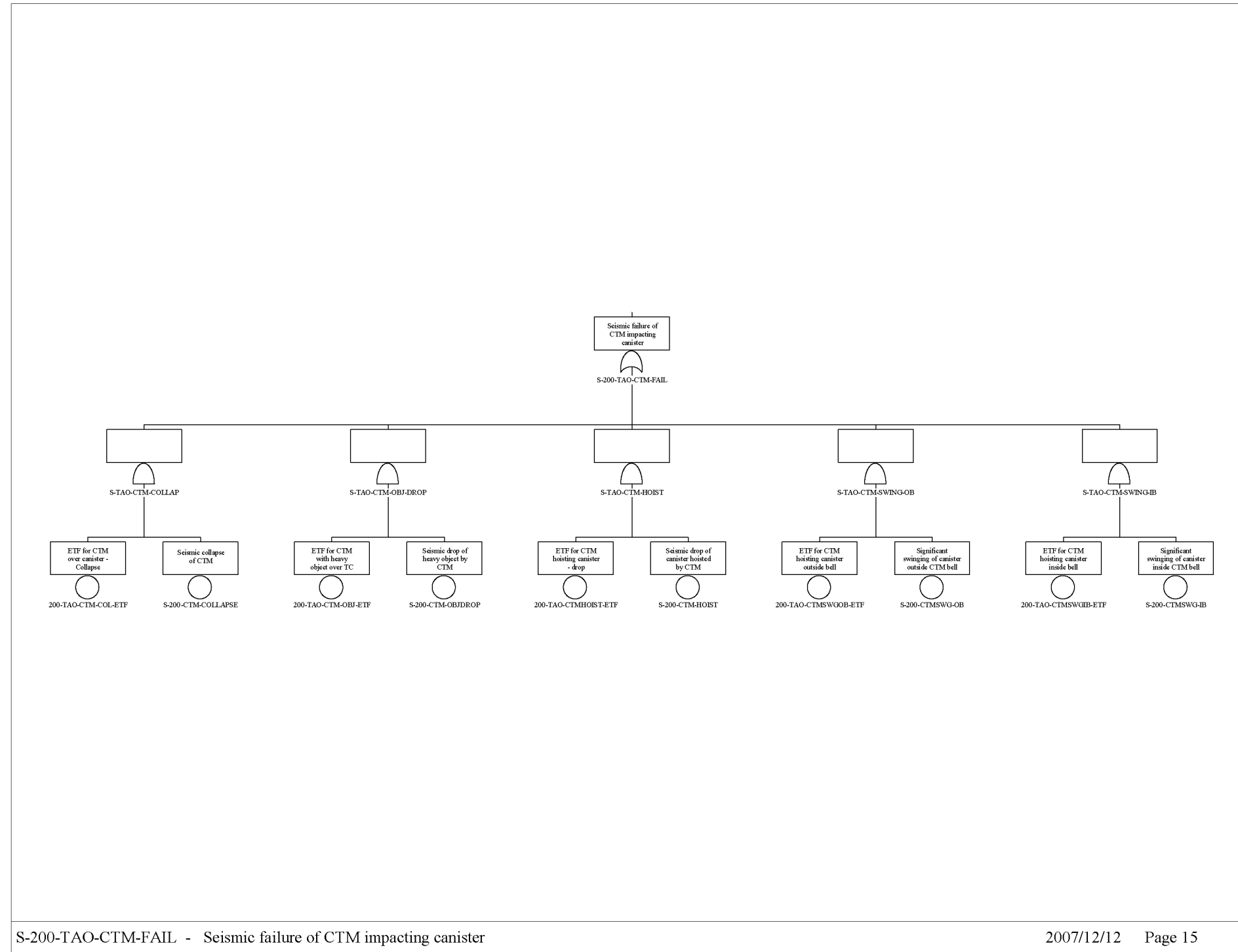

Source: Original

Figure B1.2-11. S-200-TAO-CTM-FAIL – Seismic Failure of CTM Impacting Canister

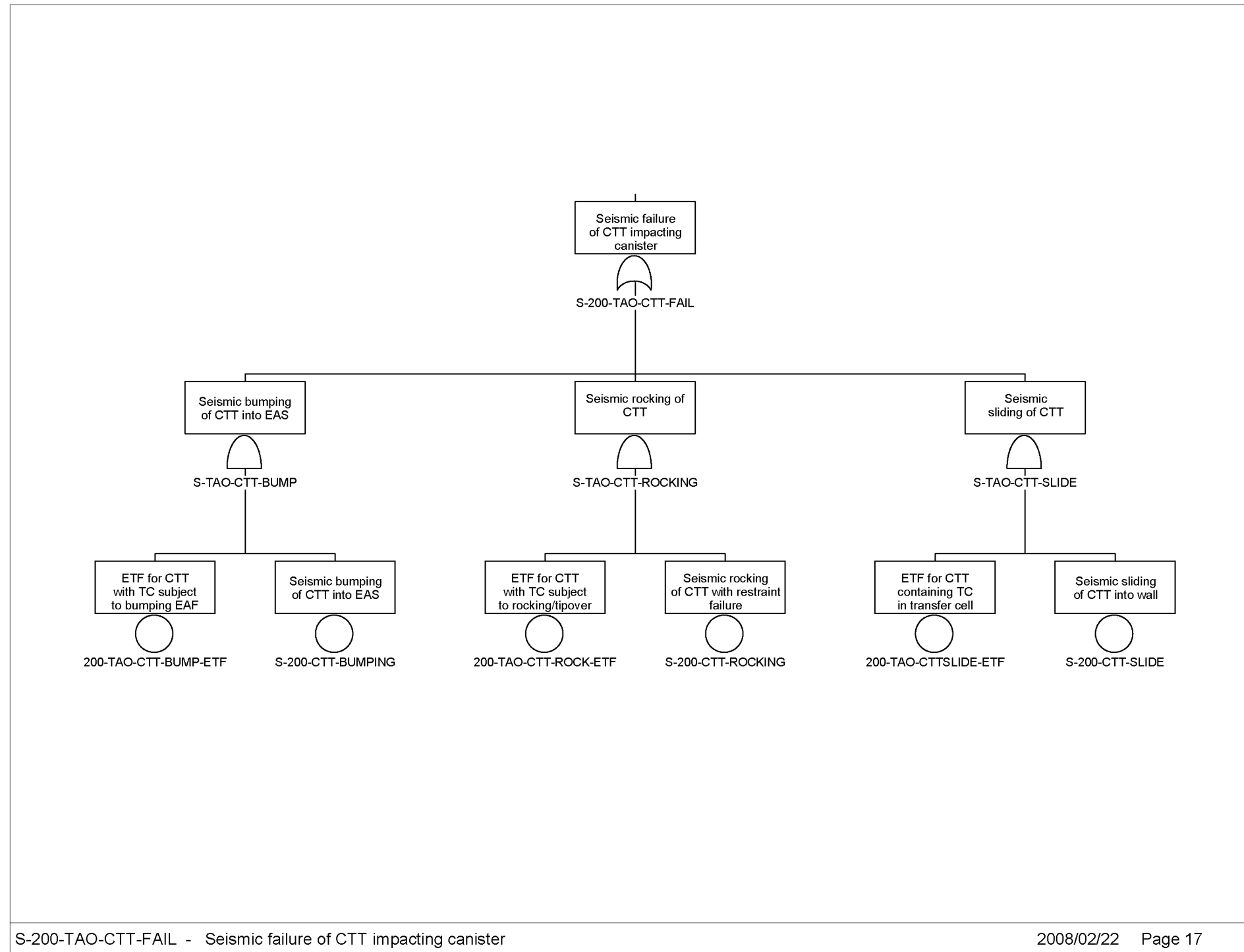

Source: Original

Figure B1.2-12. S-200-TAO-CTT-FAIL – Seismic Failure of CTT Impacting Canister

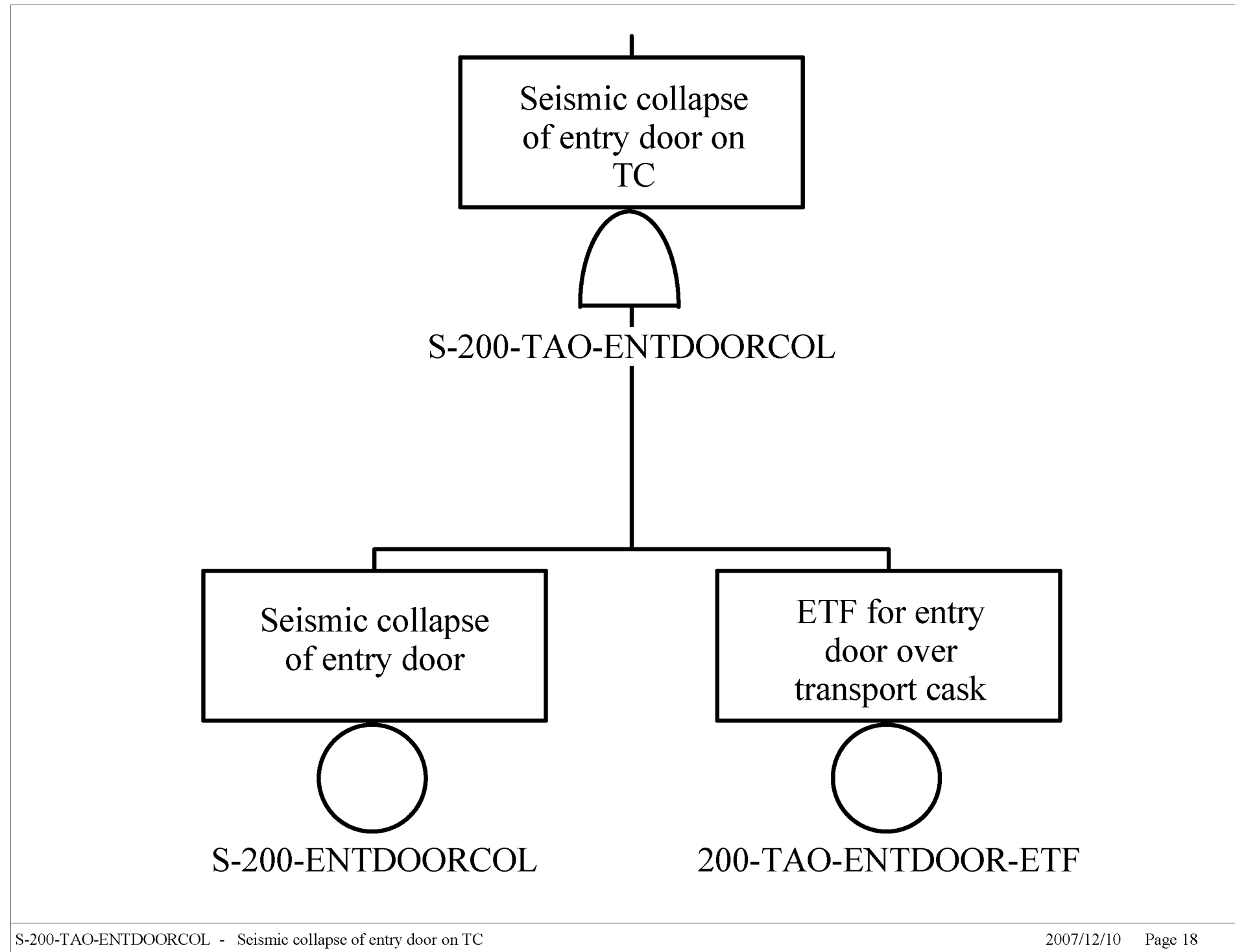

Source: Original

Figure B1.2-13. S-200-TAO-ENTDOORCOL – Seismic Collapse of Entry Door on TC

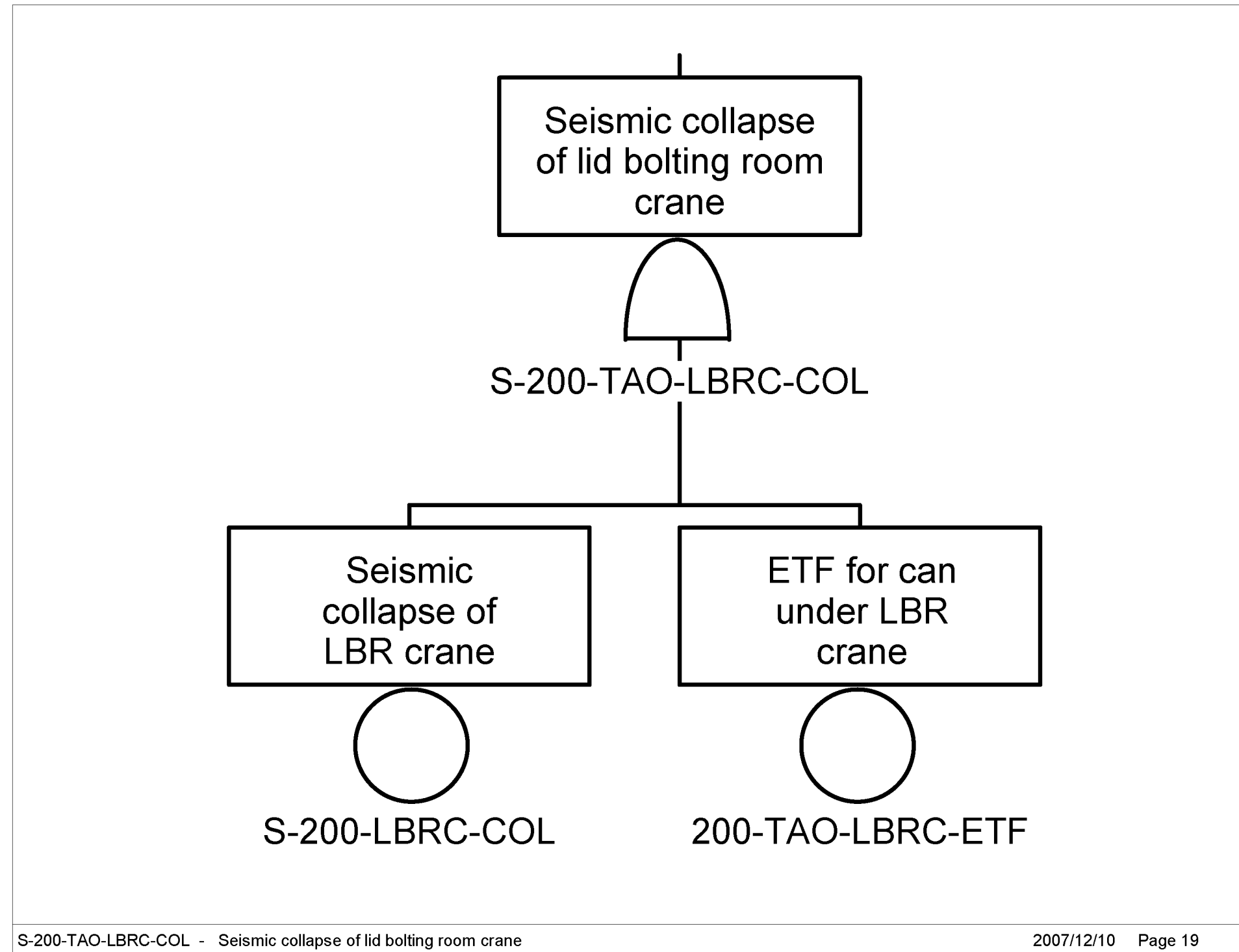

Source: Original

Figure B1.2-14. S-200-TAO-LBRC-COL – Seismic Collapse of Lid Bolting Room Crane

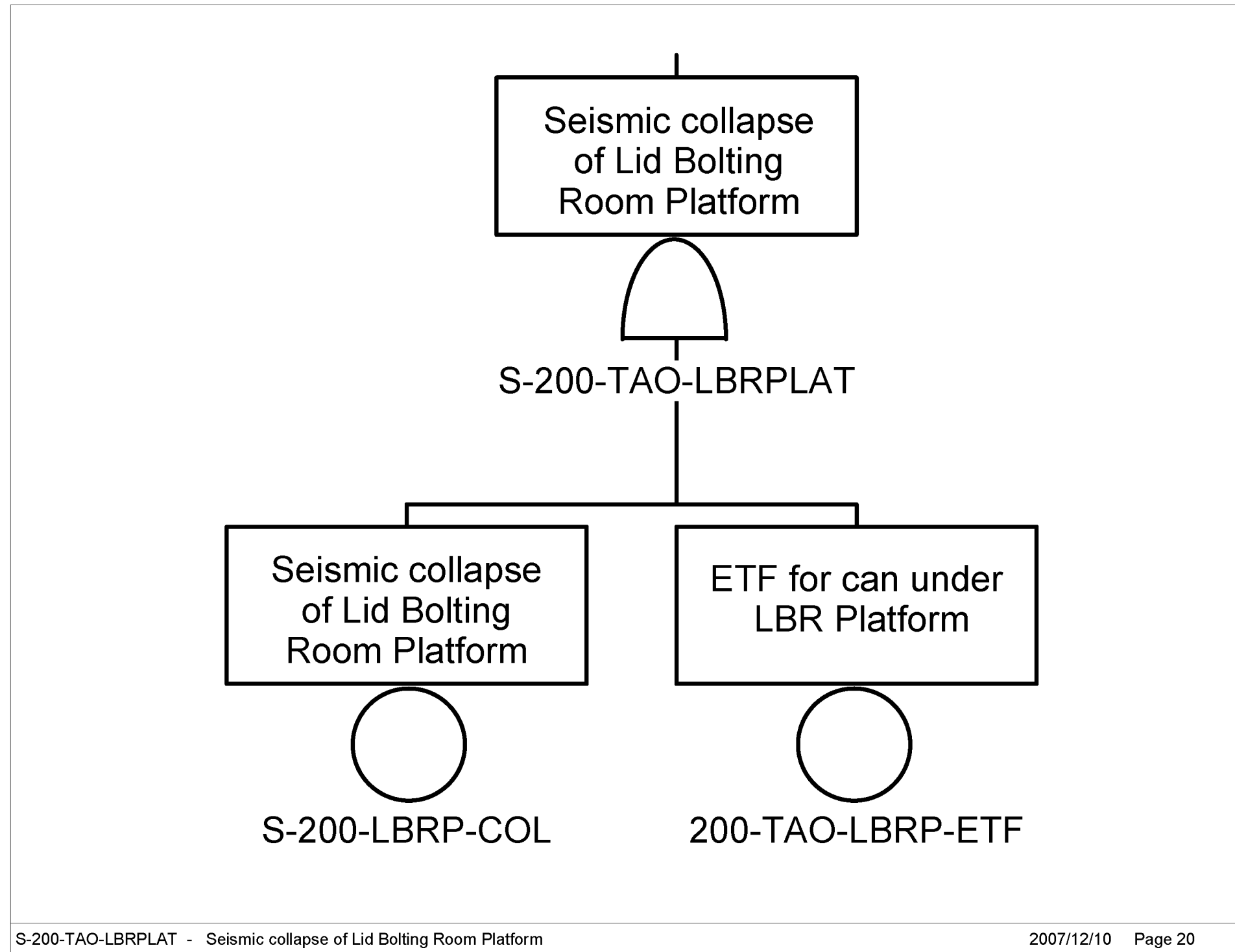

S-200-TAO-LBRPLAT - Seismic collapse of Lid Bolting Room Platform

2007/12/10 Page 20

Source: Original

Figure B1.2-15. S-200-TAO-LBRPLAT – Seismic Collapse of Lid Bolting Room Platform

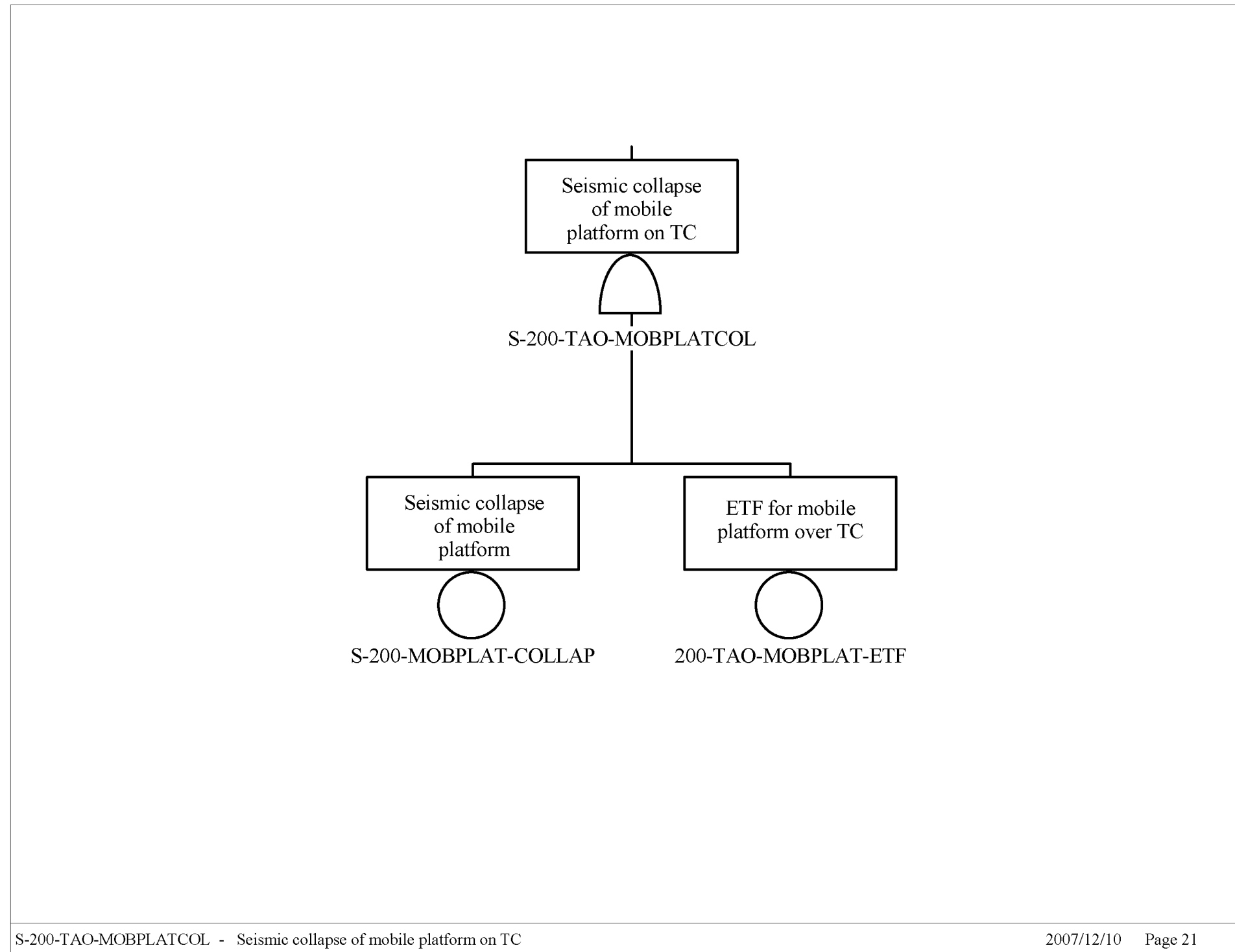

S-200-TAO-MOBPLATCOL - Seismic collapse of mobile platform on TC

2007/12/10 Page 21

Source: Original

Figure B1.2-16. S-200-TAO-MOBPLATCOL – Seismic Collapse of Mobile Platform on TC

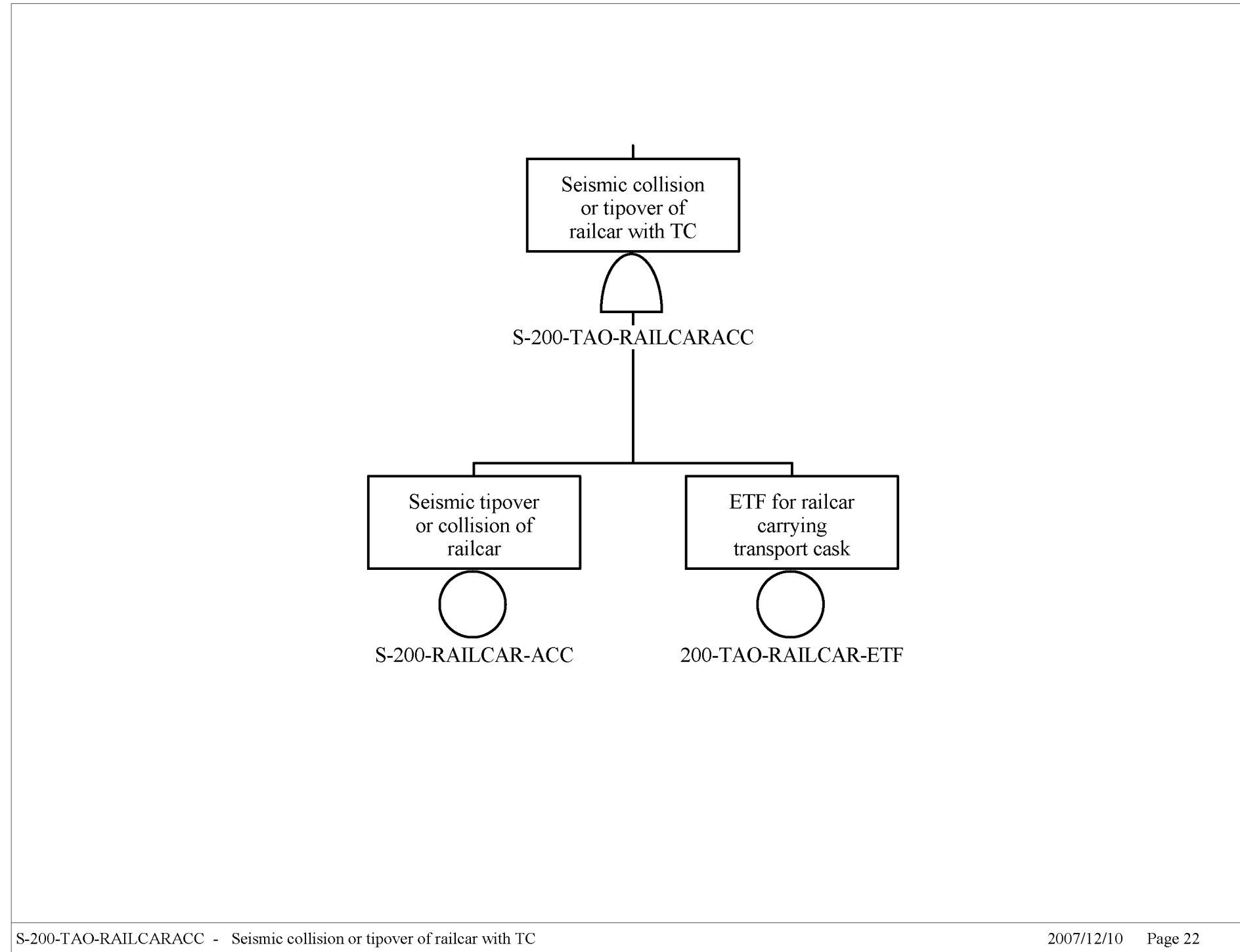

S-200-TAO-RAILCARACC - Seismic collision or tipover of railcar with TC

2007/12/10 Page 22

Source: Original

Figure B1.2-17. S-200-TAO-RAILCARACC – Seismic Collapse or Tipover of Railcar with TC

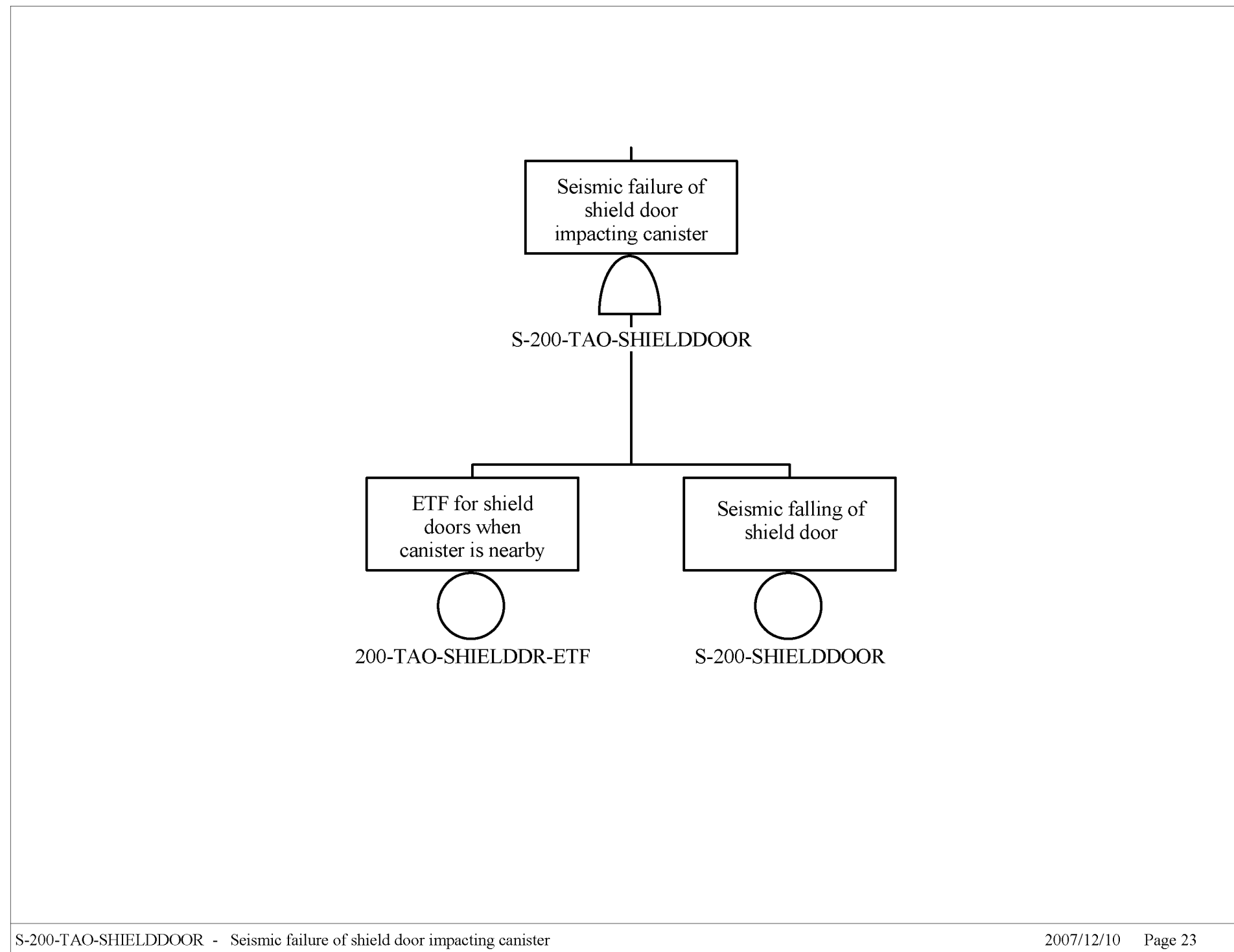

Source: Original

Figure B1.2-18. S-200-TAO-SHIELDDOOR– Seismic Failure of Shield Door Impacting Canister

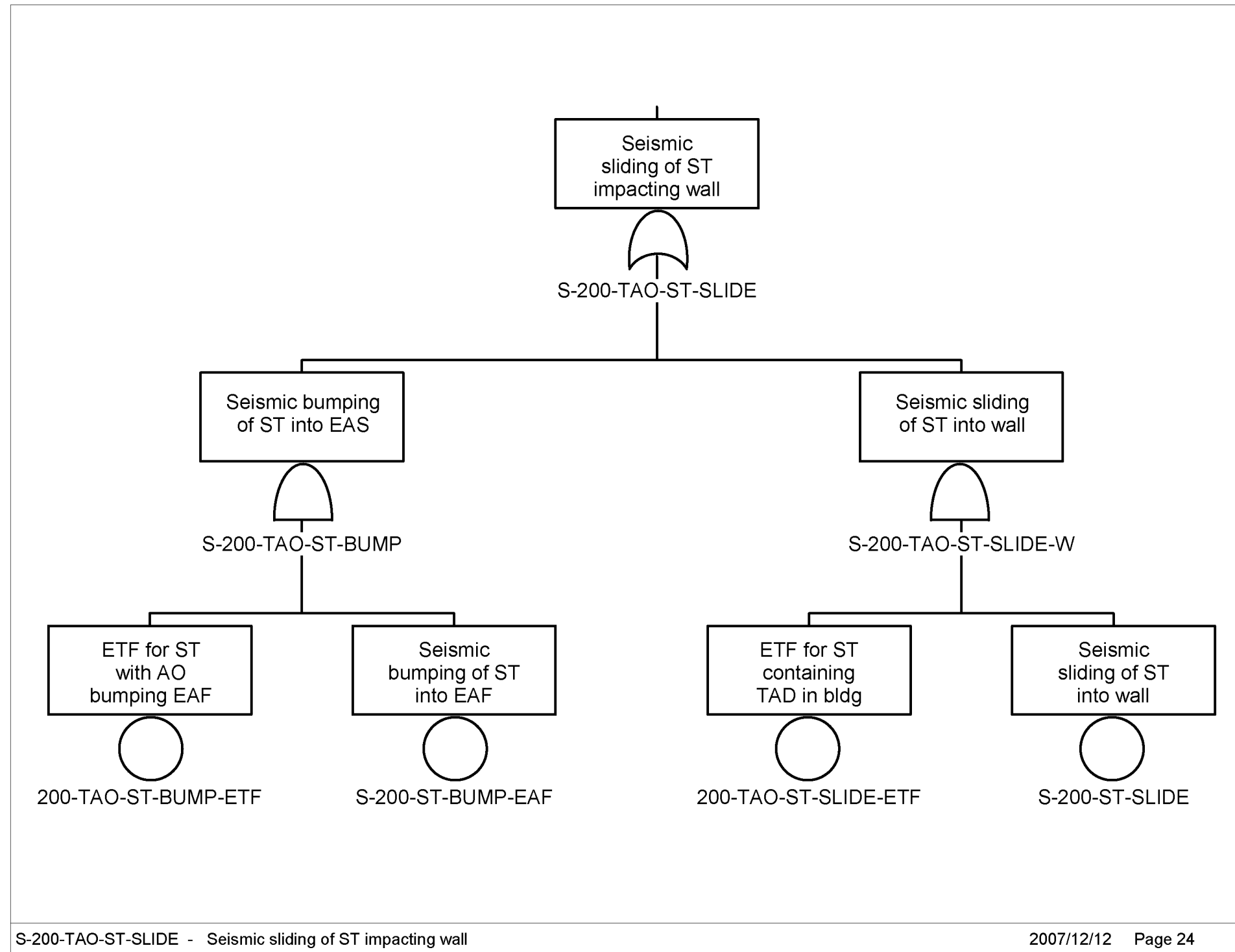

Source: Original

Figure B1.2-19. S-200-TAO-ST-SLIDE – Seismic Sliding of ST Impacting Wall

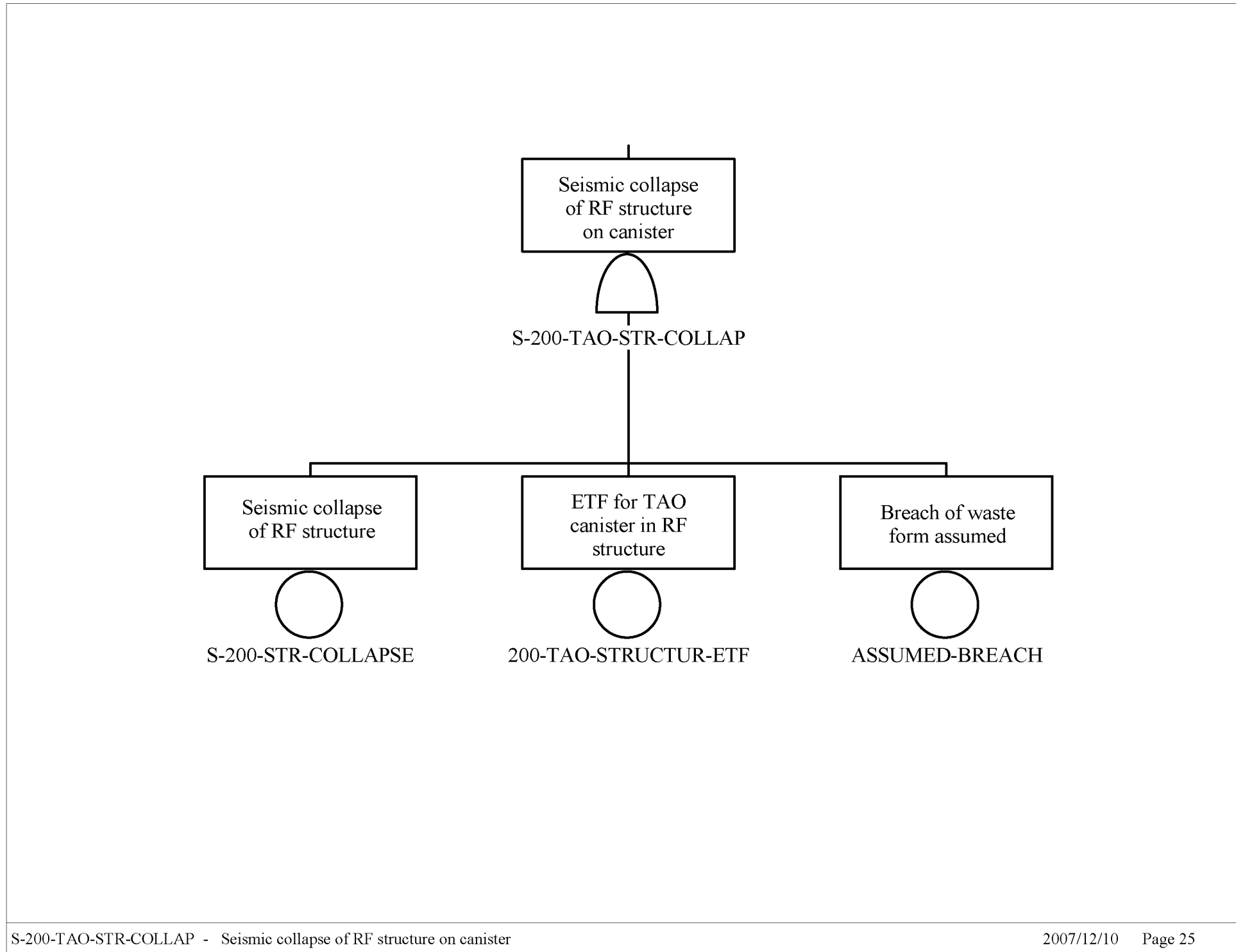

Source: Original

Figure B1.2-20. S-200-TAO-STR-COLLAP – Seismic Collapse of RF Structure on Canister

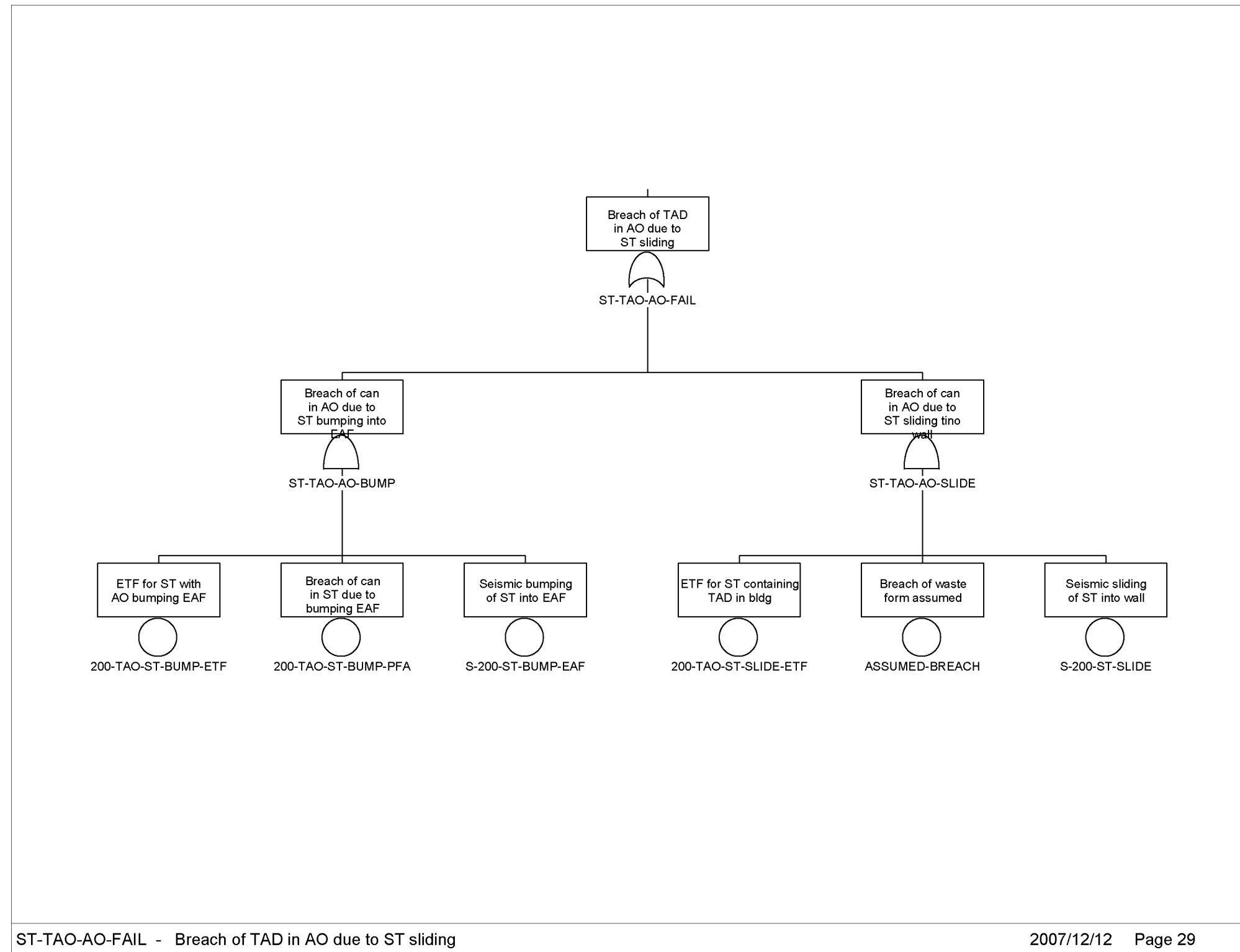

Source: Original

Figure B1.2-21. ST-TAO-AO-FAIL – Breach of TAD in AO due to ST Sliding

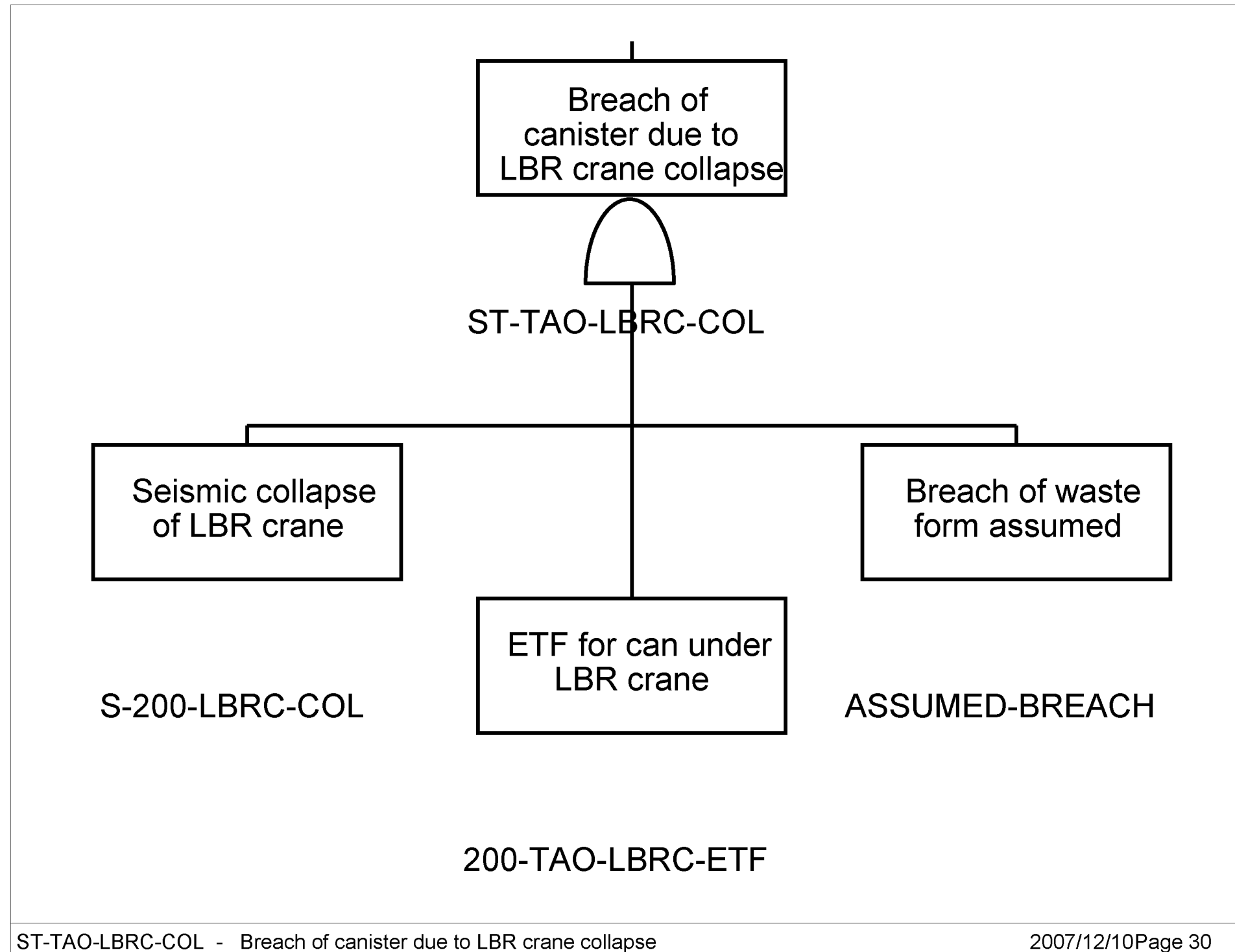

Source: Original

Figure B1.2-22. ST-TAO-LBRC-COL – Breach of Canister due to LBR Crane Collapse

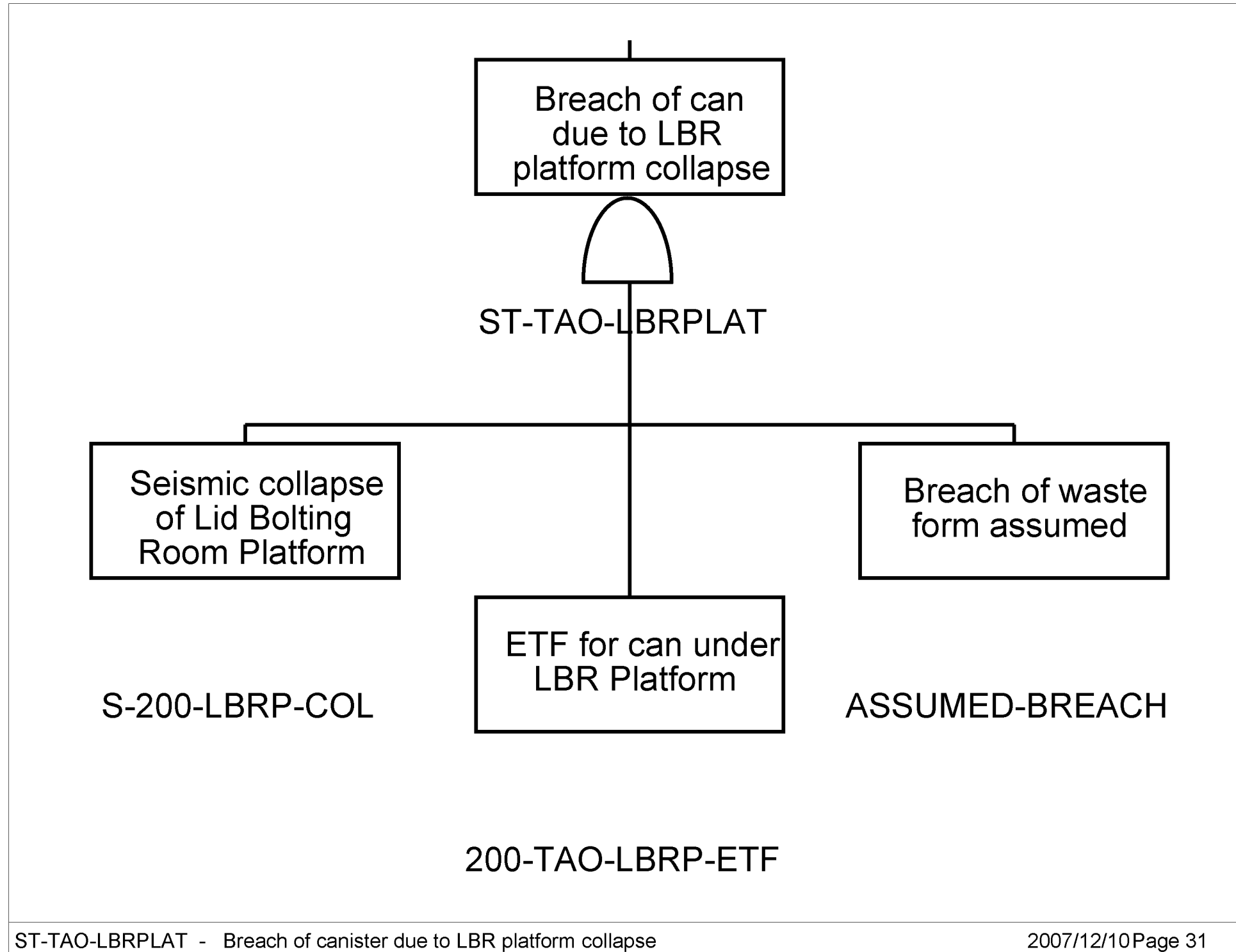

Source: Original

Figure B1.2-23. ST-TAO-LBRPLAT – Breach of Canister due to LBR Platform Collapse

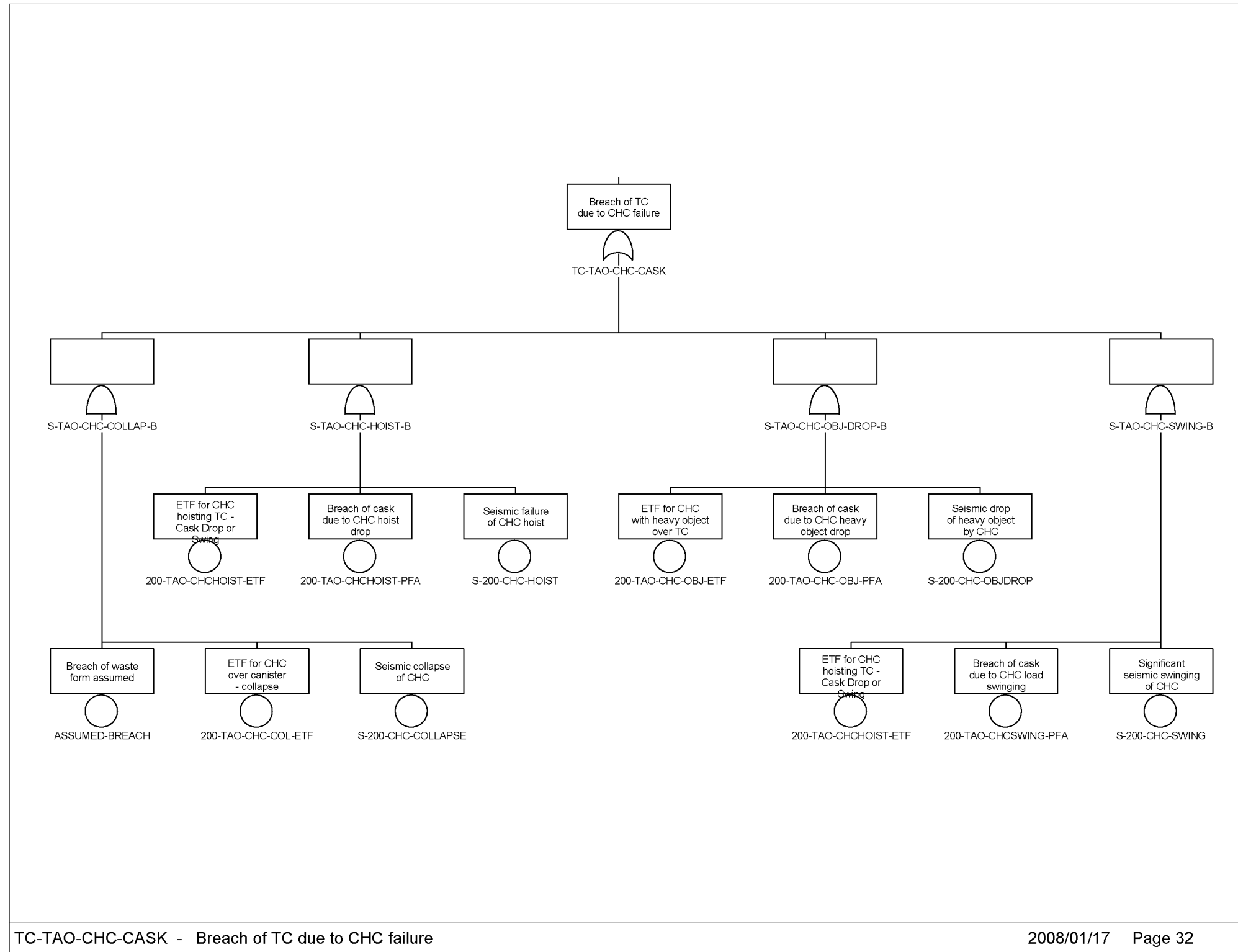

Source: Original

Figure B1.2-24 TC-TAO-CHC-CASK – Breach of TC due to CHC Failure

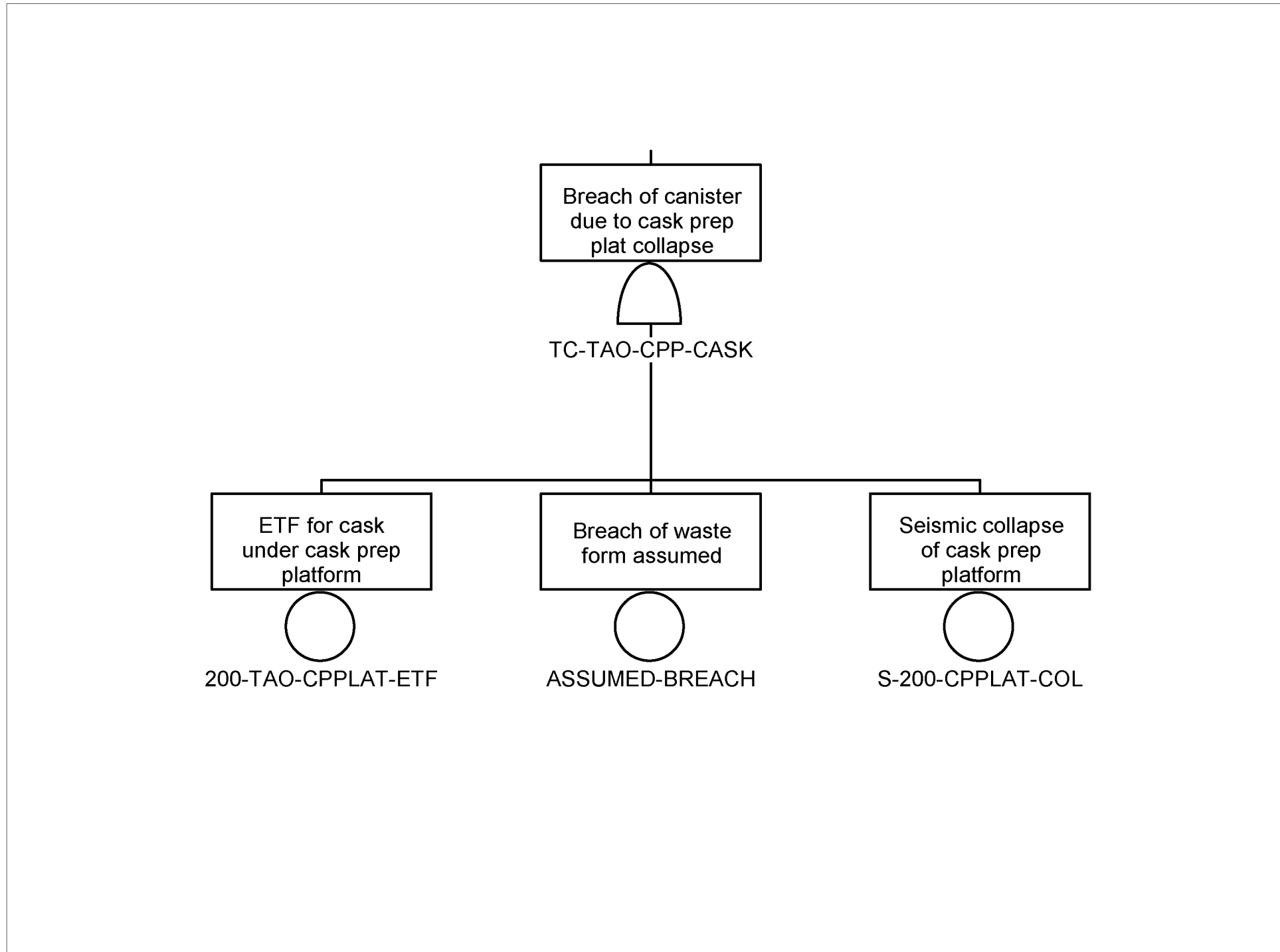

TC-TAO-CPP-CASK - Breach of canister due to cask prep plat collapse

2007/12/12 Page 33

Source: Original

Figure B1.2-25. TC-TAO-CPP-CASK – Breach of Canister due to Cask Prep Plat Collapse

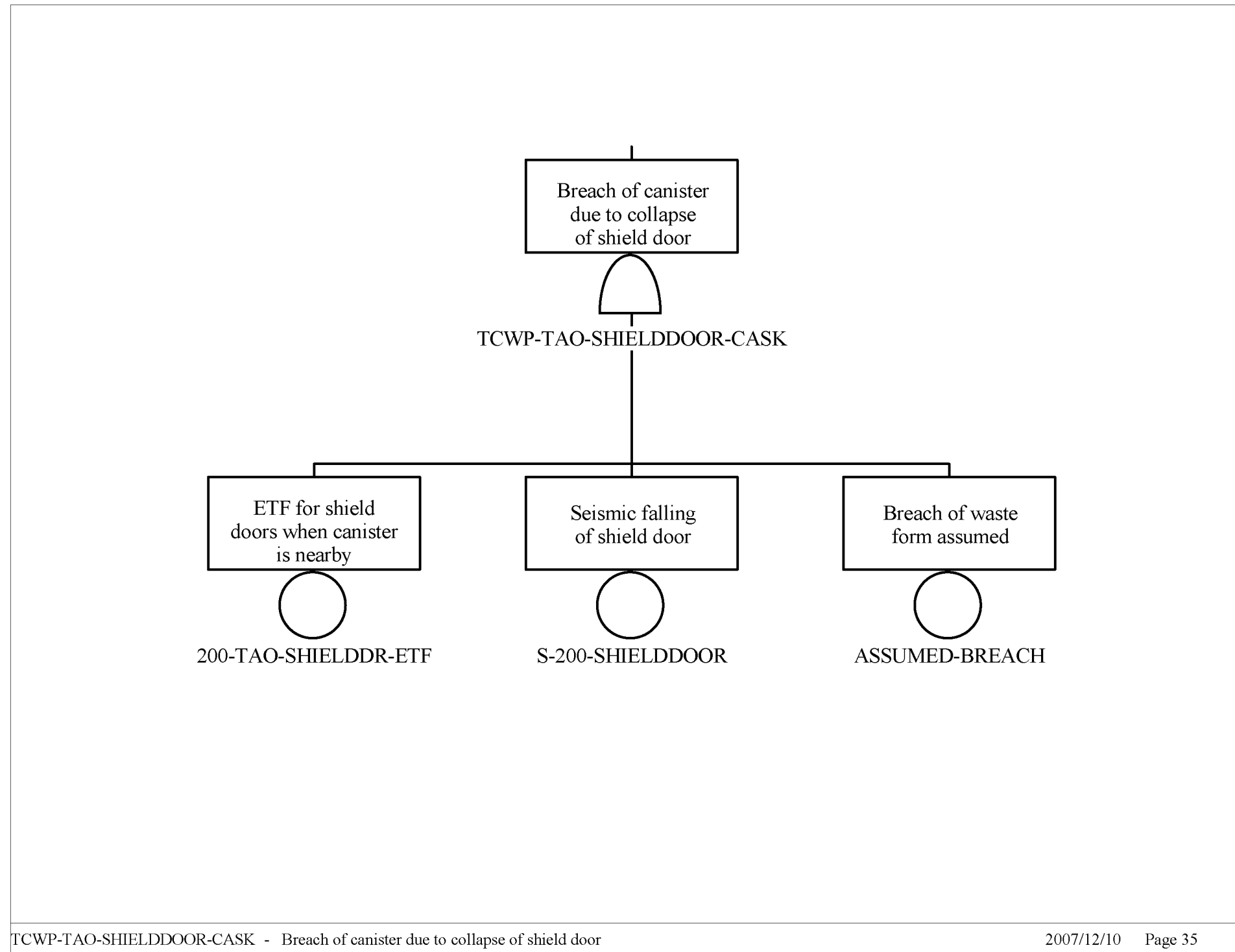

Source: Original

Figure B1.2-26. TCWP-TAO-SHIELDDOOR-CASK – Breach of Canister due to Collapse of Shield Door

B1.3 BASIC EVENTS DATA

B1.3.1 Non-seismic Basic Event Data

The following table presents the basic event identifier used in the fault trees, the description of the basic event, and the failure probability (or other numeric data) of the basic event. For exposure time factors (denoted with “ETF” at the end of the basic event identifier), the value given is the time, in years, that one waste form container is exposed to the seismic failure mode.

Table B1.3-1. Non-seismic Basic Event Data

Name	Description	Calc. Probability
200-TAO-CHC-COL-ETF	ETF for CHC over canister - collapse	9.230E-004
200-TAO-CHC-OBJ-ETF	ETF for CHC with heavy object over TC	1.520E-004
200-TAO-CHC-OBJ-PFA	Breach of cask due to CHC heavy object drop	1.000E-005
200-TAO-CHCHOIST-ETF	ETF for CHC hoisting TC - cask drop or swing	9.510E-005
200-TAO-CHCHOIST-PFA	Breach of cask due to CHC hoist drop	1.000E-005
200-TAO-CHCSWING-PFA	Breach of cask due to CHC load swinging	1.000E-005
200-TAO-CPPLAT-ETF	ETF for cask under cask prep platform	2.440E-004
200-TAO-CTM-COL-ETF	ETF for CTM over canister - collapse	2.470E-004
200-TAO-CTM-OBJ-ETF	ETF for CTM with heavy object over TC	6.850E-005
200-TAO-CTM-OBJ-PFA	Breach of canister due to CTM object drop	1.000E-005
200-TAO-CTMHOIST-ETF	ETF for CTM hoisting canister - drop	6.090E-005
200-TAO-CTMHOIST-PFA	Breach of canister dropped by CTM	1.000E-005
200-TAO-CTMMC-ETF	ETF for can under CTM maint. crane	1.240E-004
200-TAO-CTMSWGIB-ETF	ETF for CTM hoisting canister inside bell	6.090E-005
200-TAO-CTMSWGIB-PFA	Breach of canister due to swing inside bell	1.000E-005
200-TAO-CTMSWGOB-ETF	ETF for CTM hoisting canister outside bell	3.810E-005
200-TAO-CTT-BUMP-ETF	ETF for CTT with TC subject to bumping EAF	2.150E-004
200-TAO-CTT-BUMP-PFA	Breach given CTT with TC subject to bumping EAF	1.000E-005
200-TAO-CTT-ROCK-ETF	ETF for CTT with TC subject to rocking/tipover	7.610E-005
200-TAO-CTTSLIDE-ETF	ETF for CTT containing TC in transfer cell	2.930E-004
200-TAO-ENTDOOR-ETF	ETF for entry door over transport cask	4.570E-005
200-TAO-ENTDOOR-PFA	Breach of TC due to entry door collapse	1.000E-005
200-TAO-LBRC-ETF	ETF for can under LBR crane	5.690E-004
200-TAO-LBRP-ETF	ETF for can under LBR platform	5.690E-004
200-TAO-MOBPLAT-ETF	ETF for mobile platform over TC	5.480E-004
200-TAO-MOBPLAT-PFA	Breach of TC due to mobile platform collapse	1.000E-005
200-TAO-RAILCAR-ETF	ETF for railcar carrying transport cask	9.000E-004
200-TAO-RAILCAR-PFA	Breach of TC due to railcar accident	1.000E-005
200-TAO-SHIELD-ETF	ETF for shield doors when canister is nearby	8.220E-004
200-TAO-ST-BUMP-ETF	ETF for ST with AO bumping EAF	5.590E-004
200-TAO-ST-BUMP-PFA	Breach of can in ST due to bumping EAF	1.000E-005
200-TAO-ST-SLIDE-ETF	ETF for ST containing TAD in bldg	2.280E-004

Table B1.3-1. Non-seismic Basic Event Data (Continued)

Name	Description	Calc. Probability
200-TAO-ST-SLIDE-PFA	Breach of TAD in AO due to ST sliding	1.000E-005
200-TAO-STRUCTUR-ETF	ETF for TAO canister in RF structure	2.230E-003
ASSUMED-BREACH	Breach of waste form assumed	1.000E+000
MOD-ENTER-CANISTER	Flooding or spray enters canister	1.000E-002
RF-TAD-AO	Number of TAD canisters transferred to AO	6.978E+003
SHIELD-AO	Shielding remains intact	1.000E-005
SHIELDING	WP remains within WPTT shielding	1.000E-005
200-TAO-CHC-COL-ETF	ETF for CHC over canister - collapse	9.230E-004

NOTE: The basic event "ASSUMED-BREACH" is not an assumption, but is common terminology used to denote a scenario where the waste container is conservatively considered to be breached; AO = aging overpack; CHC = cask handling crane; CTM = canister transfer machine; CTT = cask transfer trolley; EAF = energy absorbing feature; ETF = exposure time factor; LBR = Lid Bolting Room; RF = Receipt Facility; ST = site transporter; TAD = transportation, aging, and disposal; TC = transportation cask; WP = waste package; WPTT = waste package transfer trolley.

Source: Sections 6.2.2.23 and 6.3.3, Table 6.3-1, Table 6.3-2, Table 6.5-1

B1.3.2 Seismic Basic Event Fragility Data

The following table provides the seismic failure basic event identifier, description, median fragility, and composite uncertainty.

Table B1.3-2. Seismic Basic Event Fragility Data

Event Name	Description	Med. Fragility (g)	Beta c
S-200-CHC-COLLAPSE	Seismic collapse of CHC	2.790E+000	4.500E-001
S-200-CHC-HOIST	Seismic failure of CHC hoist	2.280E+000	5.000E-001
S-200-CHC-OBJDROP	Seismic drop of heavy object by CHC	2.280E+000	5.000E-001
S-200-CHC-SWING	Significant seismic swinging of CHC	1.140E+000	4.000E-001
S-200-CTM-COLLAPSE	Seismic collapse of CTM	2.390E+000	4.500E-001
S-200-CTM-HOIST	Seismic drop of canister hoisted by CTM	2.280E+000	5.000E-001
S-200-CTM-OBJDROP	Seismic drop of heavy object by CTM	2.280E+000	5.000E-001
S-200-CTMMC-COL	Seismic collapse of CTM maint. crane	2.790E+000	4.500E-001
S-200-CTMSWG-IB	Significant swinging of canister inside CTM bell	1.140E+000	4.000E-001
S-200-CTMSWG-OB	Significant swinging of canister outside CTM bell	9.100E-001	4.000E-001
S-200-CTT-BUMPING	Seismic bumping of CTT into EAF	2.250E+000	4.100E-001
S-200-CTT-ROCKING	Seismic rocking of CTT with restraint failure	2.250E+000	4.100E-001
S-200-CTT-SLIDE	Seismic sliding of CTT into wall	3.080E+000	5.800E-001
S-200-ENTDOORCOL	Seismic collapse of entry door	3.700E-001	4.000E-001
S-200-FPW-V-SO	Spurious opening of FPW pre-action valve (relay chatter)	3.000E+000	4.000E-001

Table B1.3-2. Seismic Basic Event Fragility Data (Continued)

Event Name	Description	Med. Fragility (g)	Beta c
S-200-LBRC-COL	Seismic collapse of LBR crane	2.790E+000	4.500E-001
S-200-LBRP-COL	Seismic collapse of Lid Bolting Room platform	3.500E+000	4.000E-001
S-200-MOBPLAT-COLLAP	Seismic collapse of mobile platform	3.700E-001	4.000E-001
S-200-PIPING-FAIL	Seismic failure of piping in accident area	7.600E-001	4.000E-001
S-200-RAILCAR-ACC	Seismic tipover or collision of railcar	4.500E-001	4.000E-001
S-200-SHIELDDOOR	Seismic falling of shield door	2.920E+000	4.400E-001
S-200-ST-BUMP-EAF	Seismic bumping of ST into EAF	1.890E+000	4.200E-001
S-200-ST-SLIDE	Seismic sliding of ST into wall	1.890E+000	4.200E-001
S-200-STR-COLLAPSE	Seismic collapse of RF structure	5.250E+000	4.000E-001

NOTE: CHC = cask handling crane; CTM = canister transfer machine; CTT = cask transfer trolley; EAF = energy absorbing feature; FPW = fire protection water; LBR = Lid Bolting Room; RF = Receipt Facility; ST = site transporter.

Source: Table 6.2-1 and Table 6.2-2

B1.4 EVENT SEQUENCE QUANTIFICATION

This section provides the quantification results by sequence. The event sequence probabilities are provided first, and the cut sets are provided afterwards.

B1.4.1 Sequence Level

Table B1.4-1 Sequence Level Results

Event Tree	Sequence	Base Min. Cut	Base Cut Sets
RF-S-IE-TAD-AO	03	6.428E-006	1
RF-S-IE-TAD-AO	04-2	3.214E-009	1
RF-S-IE-TAD-AO	04-3	+0.000E+000	1
RF-S-IE-TAD-AO	04-4	+0.000E+000	1
RF-S-IE-TAD-AO	04-5	+0.000E+000	1
RF-S-IE-TAD-AO	04-6	3.214E-009	1
RF-S-IE-TAD-AO	04-7	6.494E-012	1
RF-S-IE-TAD-AO	05-2	4.340E-008	1
RF-S-IE-TAD-AO	05-3	+0.000E+000	1
RF-S-IE-TAD-AO	05-4	+0.000E+000	1
RF-S-IE-TAD-AO	05-5	+0.000E+000	1
RF-S-IE-TAD-AO	05-6	4.340E-008	1
RF-S-IE-TAD-AO	05-7	1.172E-010	1
RF-S-IE-TAD-AO	06-2	3.854E-008	1
RF-S-IE-TAD-AO	06-3	+0.000E+000	1
RF-S-IE-TAD-AO	06-4	+0.000E+000	1

Table B1.4-1. Sequence Level Results (Continued)

Event Tree	Sequence	Base Min. Cut	Base Cut Sets
RF-S-IE-TAD-AO	06-5	+0.000E+000	1
RF-S-IE-TAD-AO	06-6	3.854E-008	1
RF-S-IE-TAD-AO	06-7	7.787E-011	1
RF-S-IE-TAD-AO	07-2	8.991E-010	3
RF-S-IE-TAD-AO	07-3	+0.000E+000	1
RF-S-IE-TAD-AO	07-4	+0.000E+000	1
RF-S-IE-TAD-AO	07-5	+0.000E+000	1
RF-S-IE-TAD-AO	07-6	5.055E-005	4
RF-S-IE-TAD-AO	07-7	4.756E-007	4
RF-S-IE-TAD-AO	08-2		0
RF-S-IE-TAD-AO	08-3	+0.000E+000	1
RF-S-IE-TAD-AO	08-4	+0.000E+000	1
RF-S-IE-TAD-AO	08-5	+0.000E+000	1
RF-S-IE-TAD-AO	08-6	4.488E-006	1
RF-S-IE-TAD-AO	08-7	4.405E-008	1
RF-S-IE-TAD-AO	09-2	2.036E-010	1
RF-S-IE-TAD-AO	09-3	+0.000E+000	1
RF-S-IE-TAD-AO	09-4	+0.000E+000	1
RF-S-IE-TAD-AO	09-5	+0.000E+000	1
RF-S-IE-TAD-AO	09-6	2.542E-005	3
RF-S-IE-TAD-AO	09-7	3.882E-008	3
RF-S-IE-TAD-AO	10-2		0
RF-S-IE-TAD-AO	10-3	+0.000E+000	1
RF-S-IE-TAD-AO	10-4	+0.000E+000	1
RF-S-IE-TAD-AO	10-5	+0.000E+000	1
RF-S-IE-TAD-AO	10-6	3.679E-005	1
RF-S-IE-TAD-AO	10-7	3.503E-007	1
RF-S-IE-TAD-AO	11-2	5.393E-010	3
RF-S-IE-TAD-AO	11-3	+0.000E+000	1
RF-S-IE-TAD-AO	11-4	+0.000E+000	1
RF-S-IE-TAD-AO	11-5	5.771E-005	5
RF-S-IE-TAD-AO	11-6	4.529E-008	5
RF-S-IE-TAD-AO	12-2		0
RF-S-IE-TAD-AO	12-3	+0.000E+000	1
RF-S-IE-TAD-AO	12-4	+0.000E+000	1
RF-S-IE-TAD-AO	12-5	6.791E-006	1
RF-S-IE-TAD-AO	12-6	1.261E-008	1
RF-S-IE-TAD-AO	13-2	9.326E-010	1
RF-S-IE-TAD-AO	13-3	+0.000E+000	1
RF-S-IE-TAD-AO	13-4	+0.000E+000	1
RF-S-IE-TAD-AO	13-5	3.804E-005	2

Table B1.4-1. Sequence Level Results (Continued)

Event Tree	Sequence	Base Min. Cut	Base Cut Sets
RF-S-IE-TAD-AO	13-6	4.369E-008	2
RF-S-IE-TAD-AO	14-2		0
RF-S-IE-TAD-AO	14-3	+0.000E+000	1
RF-S-IE-TAD-AO	14-4	+0.000E+000	1
RF-S-IE-TAD-AO	14-5	1.047E-005	1
RF-S-IE-TAD-AO	14-6	3.078E-008	1
RF-S-IE-TAD-AO	15-2		0
RF-S-IE-TAD-AO	15-3	+0.000E+000	1
RF-S-IE-TAD-AO	15-4	+0.000E+000	1
RF-S-IE-TAD-AO	15-5	3.116E-005	1
RF-S-IE-TAD-AO	15-6	5.785E-008	1

Source: Original

B1.4.2 Cut Set Level Results by Sequence

Note that the SAPHIRE software does not provide special tables for seismic cut sets. Therefore, the “Cut Set %” given in the third column of this table is not correct for seismic events, although it does provide the approximate rank order for the cut sets.

Table B1.4-2. Cut Set Level Results by Sequence

Event Tree	Sequence	Cut Set %	Basic Event	Description
RF-S-IE-TAD-AO	03	100.00	200-TAO-STRUCTUR-ETF	ETF for TAO canister in RF structure
			RF-TAD-AO	Number of TAD canisters transferred to AO
			S-200-STR-COLLAPSE	Seismic collapse of RF structure
			= Total	
	04-2	100.00	200-TAO-ENTDOOR-ETF	ETF for entry door over transport cask
			RF-TAD-AO	Number of TAD canisters transferred to AO
			S-200-ENTDOORCOL	Seismic collapse of entry door
			SHIELDING	WP remains within WPTT shielding
			= Total	
	04-3	0.00	<FALSE>	System Generated Success Event
			= Total	
	04-4	0.00	<FALSE>	System Generated Success Event

Table B1.4-2. Cut Set Level Results by Sequence (Continued)

Event Tree	Sequence	Cut Set %	Basic Event	Description
			= Total	
	04-5	0.00	<FALSE>	System Generated Success Event
			= Total	
	04-6	100.00	200-TAO-ENTDOOR-ETF	ETF for entry door over transport cask
			200-TAO-ENTDOOR-PFA	Breach of TC due to entry door collapse
			RF-TAD-AO	Number of TAD canisters transferred to AO
			S-200-ENTDOORCOL	Seismic collapse of entry door
			= Total	
	04-7	100.00	200-TAO-ENTDOOR-ETF	ETF for entry door over transport cask
			200-TAO-ENTDOOR-PFA	Breach of TC due to entry door collapse
			MOD-ENTER-CANISTER	Flooding or spray enters canister
			RF-TAD-AO	Number of TAD canisters transferred to AO
			S-200-ENTDOORCOL	Seismic collapse of entry door
			S-200-PIPING-FAIL	Seismic failure of piping in accident area
			= Total	
	05-2	100.00	200-TAO-RAILCAR-ETF	ETF for railcar carrying transport cask
			RF-TAD-AO	Number of TAD canisters transferred to AO
			S-200-RAILCAR-ACC	Seismic tipover or collision of railcar
			SHIELDING	WP remains within WPTT shielding
			= Total	
	05-3	0.00	<FALSE>	System Generated Success Event
			= Total	
	05-4	0.00	<FALSE>	System Generated Success Event
			= Total	
	05-5	0.00	<FALSE>	System Generated Success Event
			= Total	

Table B1.4-2. Cut Set Level Results by Sequence (Continued)

Event Tree	Sequence	Cut Set %	Basic Event	Description
	05-6	100.00	200-TAO-RAILCAR-ETF	ETF for railcar carrying transport cask
			200-TAO-RAILCAR-PFA	Breach of TC due to railcar accident
			RF-TAD-AO	Number of TAD canisters transferred to AO
			S-200-RAILCAR-ACC	Seismic tipover or collision of railcar
			= Total	
	05-7	100.00	200-TAO-RAILCAR-ETF	ETF for railcar carrying transport cask
			200-TAO-RAILCAR-PFA	Breach of TC due to railcar accident
			MOD-ENTER-CANISTER	Flooding or spray enters canister
			RF-TAD-AO	Number of TAD canisters transferred to AO
			S-200-PIPING-FAIL	Seismic failure of piping in accident area
			S-200-RAILCAR-ACC	Seismic tipover or collision of railcar
			= Total	
	06-2	100.00	200-TAO-MOBPLAT-ETF	ETF for mobile platform over TC
			RF-TAD-AO	Number of TAD canisters transferred to AO
			S-200-MOBPLAT-COLLAP	Seismic collapse of mobile platform
			SHIELDING	WP remains within WPTT shielding
			= Total	
	06-3	0.00	<FALSE>	System Generated Success Event
			= Total	
	06-4	0.00	<FALSE>	System Generated Success Event
			= Total	
	06-5	0.00	<FALSE>	System Generated Success Event
			= Total	
	06-6	100.00	200-TAO-MOBPLAT-ETF	ETF for mobile platform over TC
			200-TAO-MOBPLAT-PFA	Breach of TC due to mobile platform collapse
			RF-TAD-AO	Number of TAD canisters transferred to AO

Table B1.4-2. Cut Set Level Results by Sequence (Continued)

Event Tree	Sequence	Cut Set %	Basic Event	Description
			S-200-MOBPLAT-COLLAP	Seismic collapse of mobile platform
			= Total	
	06-7	100.00	200-TAO-MOBPLAT-ETF	ETF for mobile platform over TC
			200-TAO-MOBPLAT-PFA	Breach of TC due to mobile platform collapse
			MOD-ENTER-CANISTER	Flooding or spray enters canister
			RF-TAD-AO	Number of TAD canisters transferred to AO
			S-200-MOBPLAT-COLLAP	Seismic collapse of mobile platform
			S-200-PIPING-FAIL	Seismic failure of piping in accident area
			= Total	
	07-2	86.82	200-TAO-CHCHOIST-ETF	ETF for CHC hoisting TC - cask drop or swing
			RF-TAD-AO	Number of TAD canisters transferred to AO
			S-200-CHC-SWING	Significant seismic swinging of CHC
			SHIELDING	WP remains within WPTT shielding
		8.10	200-TAO-CHC-OBJ-ETF	ETF for CHC with heavy object over TC
			RF-TAD-AO	Number of TAD canisters transferred to AO
			S-200-CHC-OBJDROP	Seismic drop of heavy object by CHC
			SHIELDING	WP remains within WPTT shielding
		5.07	200-TAO-CHCHOIST-ETF	ETF for CHC hoisting TC - cask drop or swing
			RF-TAD-AO	Number of TAD canisters transferred to AO
			S-200-CHC-HOIST	Seismic failure of CHC hoist
			SHIELDING	WP remains within WPTT shielding
			= Total	
	07-3	0.00	<FALSE>	System Generated Success Event
			= Total	
	07-4	0.00	<FALSE>	System Generated Success Event
			= Total	

Table B1.4-2. Cut Set Level Results by Sequence (Continued)

Event Tree	Sequence	Cut Set %	Basic Event	Description
	07-5	0.00	<FALSE>	System Generated Success Event
			= Total	
	07-6	99.95	200-TAO-CHC-COL-ETF	ETF for CHC over canister - collapse
			RF-TAD-AO	Number of TAD canisters transferred to AO
			S-200-CHC-COLLAPSE	Seismic collapse of CHC
		0.04	200-TAO-CHCHOIST-ETF	ETF for CHC hoisting TC - cask drop or swing
			200-TAO-CHCSWING-PFA	Breach of cask due to CHC load swinging
			RF-TAD-AO	Number of TAD canisters transferred to AO
			S-200-CHC-SWING	Significant seismic swinging of CHC
		0.00	200-TAO-CHC-OBJ-ETF	ETF for CHC with heavy object over TC
			200-TAO-CHC-OBJ-PFA	Breach of cask due to CHC heavy object drop
			RF-TAD-AO	Number of TAD canisters transferred to AO
			S-200-CHC-OBJDROP	Seismic drop of heavy object by CHC
		0.00	200-TAO-CHCHOIST-ETF	ETF for CHC hoisting TC - cask drop or swing
			200-TAO-CHCHOIST-PFA	Breach of cask due to CHC hoist drop
			RF-TAD-AO	Number of TAD canisters transferred to AO
			S-200-CHC-HOIST	Seismic failure of CHC hoist
			= Total	
	07-7	99.95	200-TAO-CHC-COL-ETF	ETF for CHC over canister - collapse
			MOD-ENTER-CANISTER	Flooding or spray enters canister
			RF-TAD-AO	Number of TAD canisters transferred to AO
			S-200-CHC-COLLAPSE	Seismic collapse of CHC
			S-200-PIPING-FAIL	Seismic failure of piping in accident area
		0.04	200-TAO-CHCHOIST-ETF	ETF for CHC hoisting TC - cask drop or swing
			200-TAO-CHCSWING-PFA	Breach of cask due to CHC load swinging

Table B1.4-2. Cut Set Level Results by Sequence (Continued)

Event Tree	Sequence	Cut Set %	Basic Event	Description
			MOD-ENTER-CANISTER	Flooding or spray enters canister
			RF-TAD-AO	Number of TAD canisters transferred to AO
			S-200-CHC-SWING	Significant seismic swinging of CHC
			S-200-PIPING-FAIL	Seismic failure of piping in accident area
		0.00	200-TAO-CHC-OBJ-ETF	ETF for CHC with heavy object over TC
			200-TAO-CHC-OBJ-PFA	Breach of cask due to CHC heavy object drop
			MOD-ENTER-CANISTER	Flooding or spray enters canister
			RF-TAD-AO	Number of TAD canisters transferred to AO
			S-200-CHC-OBJDROP	Seismic drop of heavy object by CHC
			S-200-PIPING-FAIL	Seismic failure of piping in accident area
		0.00	200-TAO-CHCHOIST-ETF	ETF for CHC hoisting TC - cask drop or swing
			200-TAO-CHCHOIST-PFA	Breach of cask due to CHC hoist drop
			MOD-ENTER-CANISTER	Flooding or spray enters canister
			RF-TAD-AO	Number of TAD canisters transferred to AO
			S-200-CHC-HOIST	Seismic failure of CHC hoist
			S-200-PIPING-FAIL	Seismic failure of piping in accident area
			= Total	
	08-2			
	08-3	0.00	<FALSE>	System Generated Success Event
			= Total	
	08-4	0.00	<FALSE>	System Generated Success Event
			= Total	
	08-5	0.00	<FALSE>	System Generated Success Event
			= Total	
	08-6	100.00	200-TAO-CPPLAT-ETF	ETF for cask under cask prep platform
			RF-TAD-AO	Number of TAD canisters transferred to AO

Table B1.4-2. Cut Set Level Results by Sequence (Continued)

Event Tree	Sequence	Cut Set %	Basic Event	Description
			S-200-CPPLAT-COL	Seismic collapse of cask prep platform
			= Total	
	08-7	100.00	200-TAO-CPPLAT-ETF	ETF for cask under cask prep platform
			MOD-ENTER-CANISTER	Flooding or spray enters canister
			RF-TAD-AO	Number of TAD canisters transferred to AO
			S-200-CPPLAT-COL	Seismic collapse of cask prep platform
			S-200-PIPING-FAIL	Seismic failure of piping in accident area
			= Total	
	09-2	100.00	200-TAO-CTT-BUMP-ETF	ETF for CTT with TC subject to bumping EAF
			RF-TAD-AO	Number of TAD canisters transferred to AO
			S-200-CTT-BUMPING	Seismic bumping of CTT into EAS
			SHIELDING	WP remains within WPTT shielding
			= Total	
	09-3	0.00	<FALSE>	System Generated Success Event
			= Total	
	09-4	0.00	<FALSE>	System Generated Success Event
			= Total	
	09-5	0.00	<FALSE>	System Generated Success Event
			= Total	
	09-6	97.53	200-TAO-CTTSLIDE-ETF	ETF for CTT containing TC in transfer cell
			RF-TAD-AO	Number of TAD canisters transferred to AO
			S-200-CTT-SLIDE	Seismic sliding of CTT into wall
		2.47	200-TAO-CTT-ROCK-ETF	ETF for CTT with TC subject to rocking/tipover
			RF-TAD-AO	Number of TAD canisters transferred to AO
			S-200-CTT-ROCKING	Seismic rocking of CTT with restraint failure
		0.00	200-TAO-CTT-BUMP-ETF	ETF for CTT with TC subject to bumping EAF

Table B1.4-2. Cut Set Level Results by Sequence (Continued)

Event Tree	Sequence	Cut Set %	Basic Event	Description
			200-TAO-CTT-BUMP-PFA	Breach given CTT with TC subject to bumping EAF
			RF-TAD-AO	Number of TAD canisters transferred to AO
			S-200-CTT-BUMPING	Seismic bumping of CTT into EAS
			= Total	
	09-7	97.53	200-TAO-CTTSLIDE-ETF	ETF for CTT containing TC in transfer cell
			MOD-ENTER-CANISTER	Flooding or spray enters canister
			RF-TAD-AO	Number of TAD canisters transferred to AO
			S-200-CTT-SLIDE	Seismic sliding of CTT into wall
			S-200-FPW-V-SO	Spurious opening of FPW pre-action valve (relay chatter)
			S-200-PIPING-FAIL	Seismic failure of piping in accident area
		2.47	200-TAO-CTT-ROCK-ETF	ETF for CTT with TC subject to rocking/tipover
			MOD-ENTER-CANISTER	Flooding or spray enters canister
			RF-TAD-AO	Number of TAD canisters transferred to AO
			S-200-CTT-ROCKING	Seismic rocking of CTT with restraint failure
			S-200-FPW-V-SO	Spurious opening of FPW pre-action valve (relay chatter)
			S-200-PIPING-FAIL	Seismic failure of piping in accident area
		0.00	200-TAO-CTT-BUMP-ETF	ETF for CTT with TC subject to bumping EAF
			200-TAO-CTT-BUMP-PFA	Breach given CTT with TC subject to bumping EAF
			MOD-ENTER-CANISTER	Flooding or spray enters canister
			RF-TAD-AO	Number of TAD canisters transferred to AO
			S-200-CTT-BUMPING	Seismic bumping of CTT into EAS
			S-200-FPW-V-SO	Spurious opening of FPW pre-action valve (relay chatter)
			S-200-PIPING-FAIL	Seismic failure of piping in accident area
			= Total	

Table B1.4-2. Cut Set Level Results by Sequence (Continued)

Event Tree	Sequence	Cut Set %	Basic Event	Description
	10-2			
	10-3	0.00	<FALSE>	System Generated Success Event
			= Total	
	10-4	0.00	<FALSE>	System Generated Success Event
			= Total	
	10-5	0.00	<FALSE>	System Generated Success Event
			= Total	
	10-6	100.00	200-TAO-SHIELDDR-ETF	ETF for shield doors when canister is nearby
			RF-TAD-AO	Number of TAD canisters transferred to AO
			S-200-SHIELDDOOR	Seismic falling of shield door
			= Total	
	10-7	100.00	200-TAO-SHIELDDR-ETF	ETF for shield doors when canister is nearby
			MOD-ENTER-CANISTER	Flooding or spray enters canister
			RF-TAD-AO	Number of TAD canisters transferred to AO
			S-200-PIPING-FAIL	Seismic failure of piping in accident area
			S-200-SHIELDDOOR	Seismic falling of shield door
			= Total	
	11-2	88.96	200-TAO-CTMSWGIB-ETF	ETF for CTM hoisting canister inside bell
			RF-TAD-AO	Number of TAD canisters transferred to AO
			S-200-CTMSWG-IB	Significant swinging of canister inside CTM bell
			SHIELDING	WP remains within WPTT shielding
		5.84	200-TAO-CTM-OBJ-ETF	ETF for CTM with heavy object over TC
			RF-TAD-AO	Number of TAD canisters transferred to AO
			S-200-CTM-OBJDROP	Seismic drop of heavy object by CTM
			SHIELDING	WP remains within WPTT shielding
		5.20	200-TAO-CTMHOIST-ETF	ETF for CTM hoisting canister - drop

Table B1.4-2. Cut Set Level Results by Sequence (Continued)

Event Tree	Sequence	Cut Set %	Basic Event	Description
			RF-TAD-AO	Number of TAD canisters transferred to AO
			S-200-CTM-HOIST	Seismic drop of canister hoisted by CTM
			SHIELDING	WP remains within WPTT shielding
			= Total	
	11-3	0.00	<FALSE>	System Generated Success Event
			= Total	
	11-4	0.00	<FALSE>	System Generated Success Event
			= Total	
	11-5	98.30	200-TAO-CTMSWGOB-ETF	ETF for CTM hoisting canister outside bell
			RF-TAD-AO	Number of TAD canisters transferred to AO
			S-200-CTMSWG-OB	Significant swinging of canister outside CTM bell
		1.72	200-TAO-CTM-COL-ETF	ETF for CTM over canister - collapse
			RF-TAD-AO	Number of TAD canisters transferred to AO
			S-200-CTM-COLLAPSE	Seismic collapse of CTM
		0.00	200-TAO-CTMSWGIB-ETF	ETF for CTM hoisting canister inside bell
			200-TAO-CTMSWGIB-PFA	Breach of canister due to swing inside bell
			RF-TAD-AO	Number of TAD canisters transferred to AO
			S-200-CTMSWG-IB	Significant swinging of canister inside CTM bell
		0.00	200-TAO-CTM-OBJ-ETF	ETF for CTM with heavy object over TC
			200-TAO-CTM-OBJ-PFA	Breach of canister due to CTM object drop
			RF-TAD-AO	Number of TAD canisters transferred to AO
			S-200-CTM-OBJDROP	Seismic drop of heavy object by CTM
		0.00	200-TAO-CTMHOIST-ETF	ETF for CTM hoisting canister - drop
			200-TAO-CTMHOIST-PFA	Breach of canister dropped by CTM
			RF-TAD-AO	Number of TAD canisters transferred to AO

Table B1.4-2. Cut Set Level Results by Sequence (Continued)

Event Tree	Sequence	Cut Set %	Basic Event	Description
			S-200-CTM-HOIST	Seismic drop of canister hoisted by CTM
			= Total	
	11-6	98.28	200-TAO-CTMSWGOB-ETF	ETF for CTM hoisting canister outside bell
			MOD-ENTER-CANISTER	Flooding or spray enters canister
			RF-TAD-AO	Number of TAD canisters transferred to AO
			S-200-CTMSWG-OB	Significant swinging of canister outside CTM bell
			S-200-FPW-V-SO	Spurious opening of FPW pre-action valve (relay chatter)
			S-200-PIPING-FAIL	Seismic failure of piping in accident area
		1.72	200-TAO-CTM-COL-ETF	ETF for CTM over canister - collapse
			MOD-ENTER-CANISTER	Flooding or spray enters canister
			RF-TAD-AO	Number of TAD canisters transferred to AO
			S-200-CTM-COLLAPSE	Seismic collapse of CTM
			S-200-FPW-V-SO	Spurious opening of FPW pre-action valve (relay chatter)
			S-200-PIPING-FAIL	Seismic failure of piping in accident area
		0.00	200-TAO-CTMSWGIB-ETF	ETF for CTM hoisting canister inside bell
			200-TAO-CTMSWGIB-PFA	Breach of canister due to swing inside bell
			MOD-ENTER-CANISTER	Flooding or spray enters canister
			RF-TAD-AO	Number of TAD canisters transferred to AO
			S-200-CTMSWG-IB	Significant swinging of canister inside CTM bell
			S-200-FPW-V-SO	Spurious opening of FPW pre-action valve (relay chatter)
			S-200-PIPING-FAIL	Seismic failure of piping in accident area
		0.00	200-TAO-CTM-OBJ-ETF	ETF for CTM with heavy object over TC
			200-TAO-CTM-OBJ-PFA	Breach of canister due to CTM object drop

Table B1.4-2. Cut Set Level Results by Sequence (Continued)

Event Tree	Sequence	Cut Set %	Basic Event	Description
			MOD-ENTER-CANISTER	Flooding or spray enters canister
			RF-TAD-AO	Number of TAD canisters transferred to AO
			S-200-CTM-OBJDROP	Seismic drop of heavy object by CTM
			S-200-FPW-V-SO	Spurious opening of FPW pre-action valve (relay chatter)
			S-200-PIPING-FAIL	Seismic failure of piping in accident area
		0.00	200-TAO-CTMHOIST-ETF	ETF for CTM hoisting canister - drop
			200-TAO-CTMHOIST-PFA	Breach of canister dropped by CTM
			MOD-ENTER-CANISTER	Flooding or spray enters canister
			RF-TAD-AO	Number of TAD canisters transferred to AO
			S-200-CTM-HOIST	Seismic drop of canister hoisted by CTM
			S-200-FPW-V-SO	Spurious opening of FPW pre-action valve (relay chatter)
			S-200-PIPING-FAIL	Seismic failure of piping in accident area
			= Total	
	12-2			
	12-3	0.00	<FALSE>	System Generated Success Event
			= Total	
	12-4	0.00	<FALSE>	System Generated Success Event
			= Total	
	12-5	100.00	200-TAO-CTMMC-ETF	ETF for can under CTM maint. crane
			RF-TAD-AO	Number of TAD canisters transferred to AO
			S-200-CTMMC-COL	Seismic collapse of CTM maint. crane
			= Total	
	12-6	100.21	200-TAO-CTMMC-ETF	ETF for can under CTM maint. crane
			MOD-ENTER-CANISTER	Flooding or spray enters canister
			RF-TAD-AO	Number of TAD canisters transferred to AO

Table B1.4-2. Cut Set Level Results by Sequence (Continued)

Event Tree	Sequence	Cut Set %	Basic Event	Description
			S-200-CTMMC-COL	Seismic collapse of CTM maint. crane
			S-200-FPW-V-SO	Spurious opening of FPW pre-action valve (relay chatter)
			S-200-PIPING-FAIL	Seismic failure of piping in accident area
			= Total	
	13-2	100.00	200-TAO-ST-BUMP-ETF	ETF for ST with AO bumping EAF
			RF-TAD-AO	Number of TAD canisters transferred to AO
			S-200-ST-BUMP-EAF	Seismic bumping of ST into EAF
			SHIELD-AO	Shielding remains intact
			= Total	
	13-3	0.00	<FALSE>	System Generated Success Event
			= Total	
	13-4	0.00	<FALSE>	System Generated Success Event
			= Total	
	13-5	100.00	200-TAO-ST-SLIDE-ETF	ETF for ST containing TAD in bldg
			RF-TAD-AO	Number of TAD canisters transferred to AO
			S-200-ST-SLIDE	Seismic sliding of ST into wall
		0.00	200-TAO-ST-BUMP-ETF	ETF for ST with AO bumping EAF
			200-TAO-ST-BUMP-PFA	Breach of can in ST due to bumping EAF
			RF-TAD-AO	Number of TAD canisters transferred to AO
			S-200-ST-BUMP-EAF	Seismic bumping of ST into EAF
			= Total	
	13-6	99.99	200-TAO-ST-SLIDE-ETF	ETF for ST containing TAD in bldg
			MOD-ENTER-CANISTER	Flooding or spray enters canister
			RF-TAD-AO	Number of TAD canisters transferred to AO
			S-200-FPW-V-SO	Spurious opening of FPW pre-action valve (relay chatter)
			S-200-PIPING-FAIL	Seismic failure of piping in accident area

Table B1.4-2. Cut Set Level Results by Sequence (Continued)

Event Tree	Sequence	Cut Set %	Basic Event	Description
			S-200-ST-SLIDE	Seismic sliding of ST into wall
		0.00	200-TAO-ST-BUMP-ETF	ETF for ST with AO bumping EAF
			200-TAO-ST-BUMP-PFA	Breach of can in ST due to bumping EAF
			MOD-ENTER-CANISTER	Flooding or spray enters canister
			RF-TAD-AO	Number of TAD canisters transferred to AO
			S-200-FPW-V-SO	Spurious opening of FPW pre-action valve (relay chatter)
			S-200-PIPING-FAIL	Seismic failure of piping in accident area
			S-200-ST-BUMP-EAF	Seismic bumping of ST into EAF
			= Total	
	14-2			
	14-3	0.00	<FALSE>	System Generated Success Event
			= Total	
	14-4	0.00	<FALSE>	System Generated Success Event
			= Total	
	14-5	100.00	200-TAO-LBRP-ETF	ETF for can under LBR platform
			RF-TAD-AO	Number of TAD canisters transferred to AO
			S-200-LBRP-COL	Seismic collapse of Lid Bolting Room platform
			= Total	
	14-6	106.64	200-TAO-LBRP-ETF	ETF for can under LBR platform
			MOD-ENTER-CANISTER	Flooding or spray enters canister
			RF-TAD-AO	Number of TAD canisters transferred to AO
			S-200-FPW-V-SO	Spurious opening of FPW pre-action valve (relay chatter)
			S-200-LBRP-COL	Seismic collapse of Lid Bolting Room platform
			S-200-PIPING-FAIL	Seismic failure of piping in accident area
			= Total	
	15-2			

Table B1.4-2. Cut Set Level Results by Sequence (Continued)

Event Tree	Sequence	Cut Set %	Basic Event	Description
	15-3	0.00	<FALSE>	System Generated Success Event
			= Total	
	15-4	0.00	<FALSE>	System Generated Success Event
			= Total	
	15-5	100.00	200-TAO-LBRC-ETF	ETF for can under LBR crane
			RF-TAD-AO	Number of TAD canisters transferred to AO
			S-200-LBRC-COL	Seismic collapse of LBR crane
			= Total	
	15-6	100.04	200-TAO-LBRC-ETF	ETF for can under LBR crane
			MOD-ENTER-CANISTER	Flooding or spray enters canister
			RF-TAD-AO	Number of TAD canisters transferred to AO
			S-200-FPW-V-SO	Spurious opening of FPW pre-action valve (relay chatter)
			S-200-LBRC-COL	Seismic collapse of LBR crane
			S-200-PIPING-FAIL	Seismic failure of piping in accident area
			= Total	
RF-S-IE-TAD-AO	03	100.00	200-TAO-STRUCTUR-ETF	ETF for TAO canister in RF structure
			RF-TAD-AO	Number of TAD canisters transferred to AO
			S-200-STR-COLLAPSE	Seismic collapse of RF structure
			= Total	

NOTE: AO = aging overpack; CHC = cask handling crane; CTM = canister transfer machine; CTT = cask transfer trolley; EAF = energy absorbing feature; ETF = exposure time factor; FPW = fire protection water; LBR = Lid Bolting Room; RF = Receipt Facility; ST = site transporter; TAD = transportation, aging, and disposal (canister); TAO = TAD to aging overpack; TC = transportation cask; WP = waste package; WPTT = waste package transfer trolley.

Source: Original

B2 VERTICAL DUAL-PURPOSE CANISTER

This section provides the detailed information used to develop the event sequences for the analysis of processing of the DPCs which arrive inside a vertical transportation cask in the RF. DPCs inside a vertical transportation cask are received on railcars and are transferred into an aging overpack, then transported in a site transporter out of the RF.

B2.1 EVENT TREES

The IET and SRETs are presented in this section. The tables provide the assignments between the event tree branches and the fault trees given in the next section.

Seismic Event	Number of DPCs transferred to AO	Identify initiating seismic failure		
SEIS-EVENT	RF-DP-VERT	SEIS-FAIL	#	END-STATE
			1	OK
			2	OK
		RF building collapse	3	RR-UNF
		Entry door seismic collapse	4	T => 2 RF-S-R-TC1
		Railcar accident	5	T => 2 RF-S-R-TC1
		Mobile platform seismic collapse	6	T => 2 RF-S-R-TC1
		CHC seismic failures	7	T => 2 RF-S-R-TC1
		Cask prep platform collapse	8	T => 2 RF-S-R-TC1
		CTT seismic failures	9	T => 2 RF-S-R-TC1
		Shield door seismic failure	10	T => 3 RF-S-R-SD1
		CTM seismic failures	11	T => 4 RF-S-R-CTM
		CTM MC seismic collapse	12	T => 4 RF-S-R-CTM
		ST seismic failures	13	T => 5 RF-S-R-AO
		LBR platform collapse	14	T => 5 RF-S-R-AO
		LBR crane collapse	15	T => 5 RF-S-R-AO

RF-S-IE-DP-VERT - RF Seismic Event Tree - Initiating Seismic Failures - DPC-Vertical

2008/02/24

Page 1

NOTE: Event tree branch captions are associated with the branch line below the caption.

AO = aging overpack; CHC = cask handling crane; CTM = canister transfer machine; CTM MC = canister transfer machine maintenance crane; CTT = cask transfer trolley; DPC = dual-purpose canister; IE = initiating event; LBR = Lid Bolting Room; RF = Receipt Facility; SD = shield door; SEIS = seismic; ST = site transporter; T = transfer; TAD = transportation, aging and disposal; TC = transportation cask; UNF = unfiltered.

Source: Original

Figure B2.1-1. RF Seismic Event Tree RF-S-IE-TAD-AO – Initiating Seismic Failures – DPC Vertical

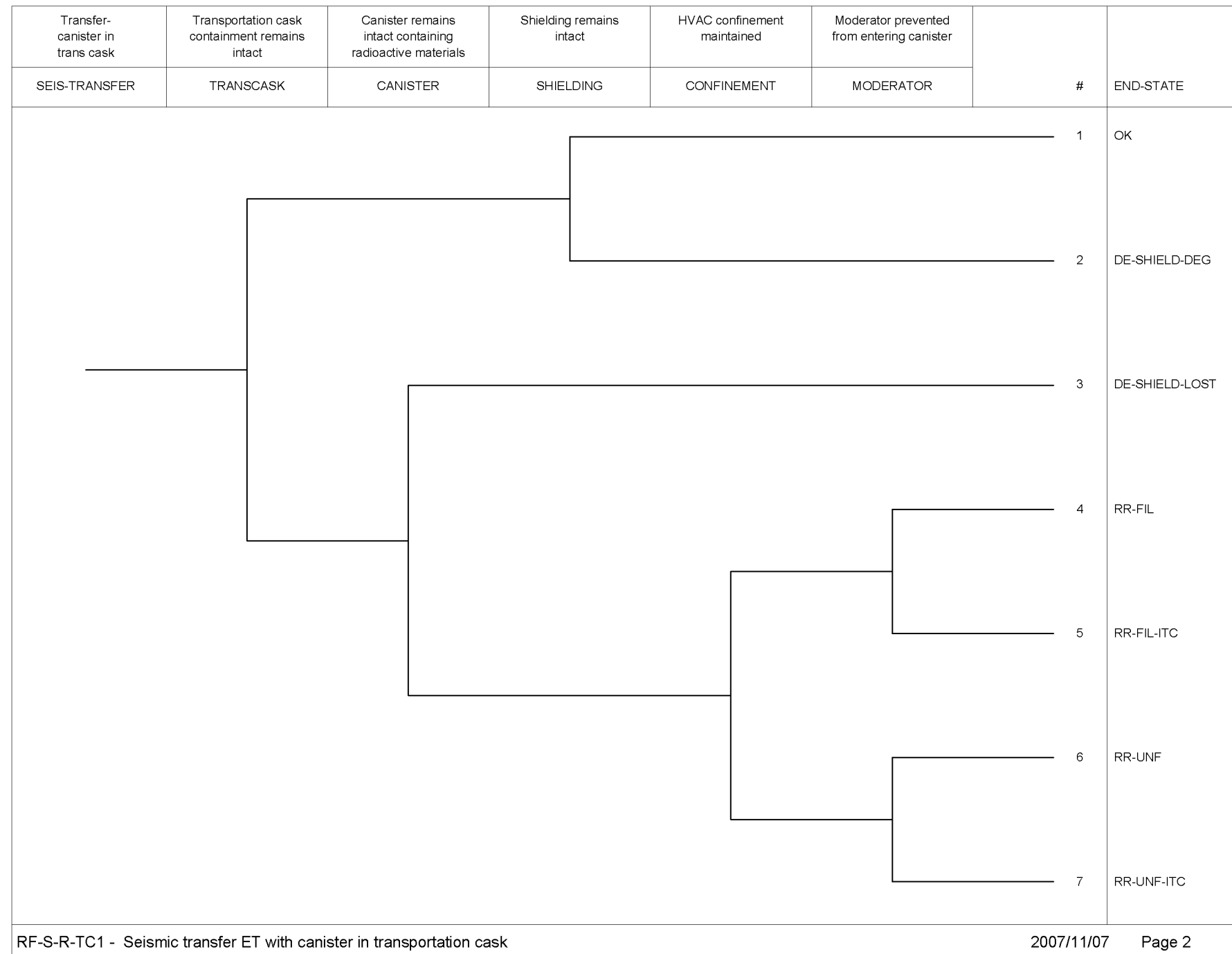

NOTE: DE = direct exposure; ET = event tree; FIL = filtered; HVAC = heating, ventilation and air conditioning; INIT = initiating; ITC = important to criticality; RF = Receipt Facility; RR = radioactive release; SEIS = seismic; TC = transportation cask; UNF = unfiltered.

Source: Original

Figure B2.1-2. RF Seismic Event Tree RF-S-R-TC1 – Seismic Transfer ET with Canister in Transportation Cask

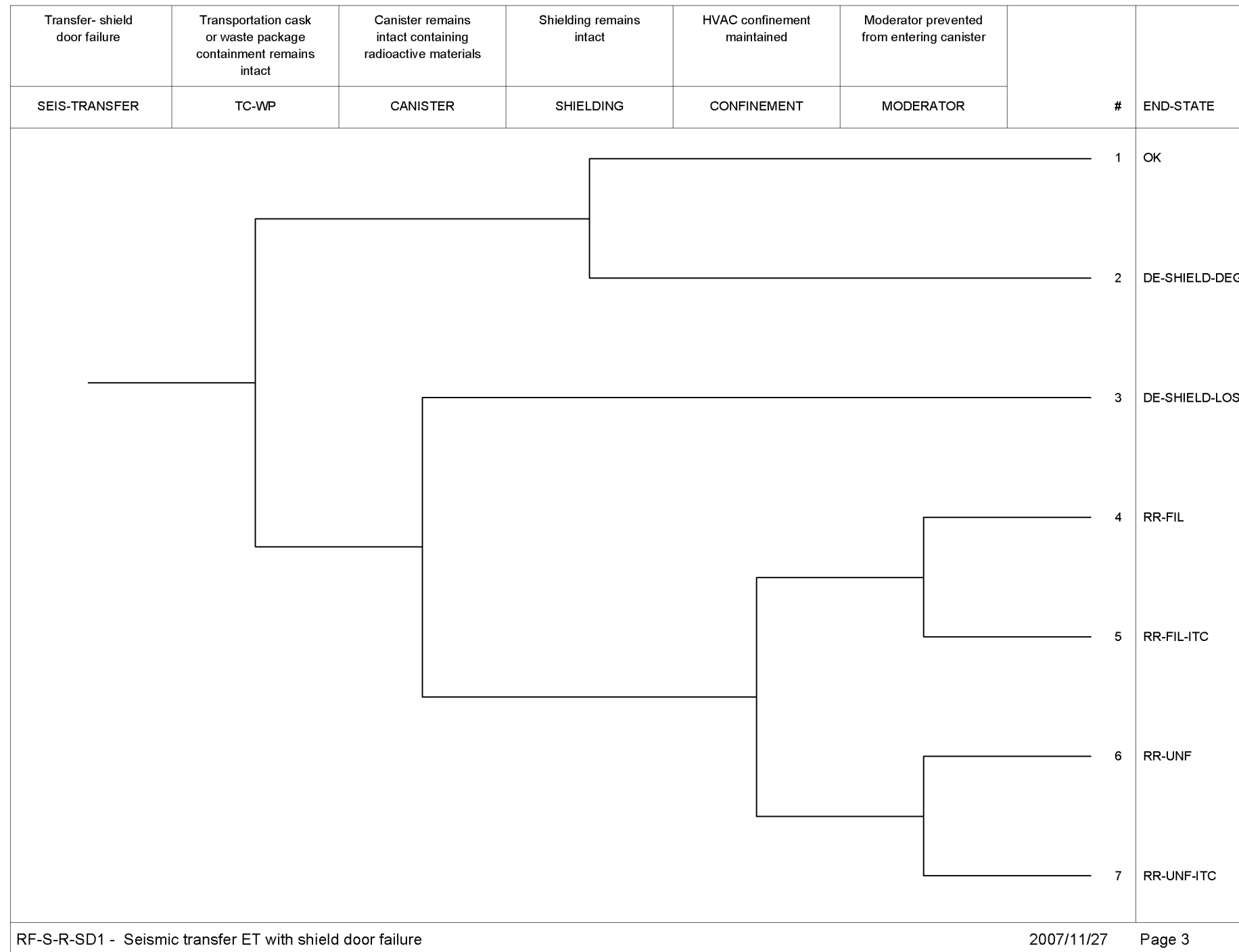

NOTE: DE = direct exposure; DEG = degradation; ET = event tree; INIT = initiating; ITC = important to criticality; RF = Receipt Facility RR = radioactive release; SD = shield door; SEIS = seismic; WP = waste package.

Source: Original

Figure B2.1-3. RF Seismic Event Tree RF-S-R-SD1 – Seismic Transfer ET with Shield Door Failure

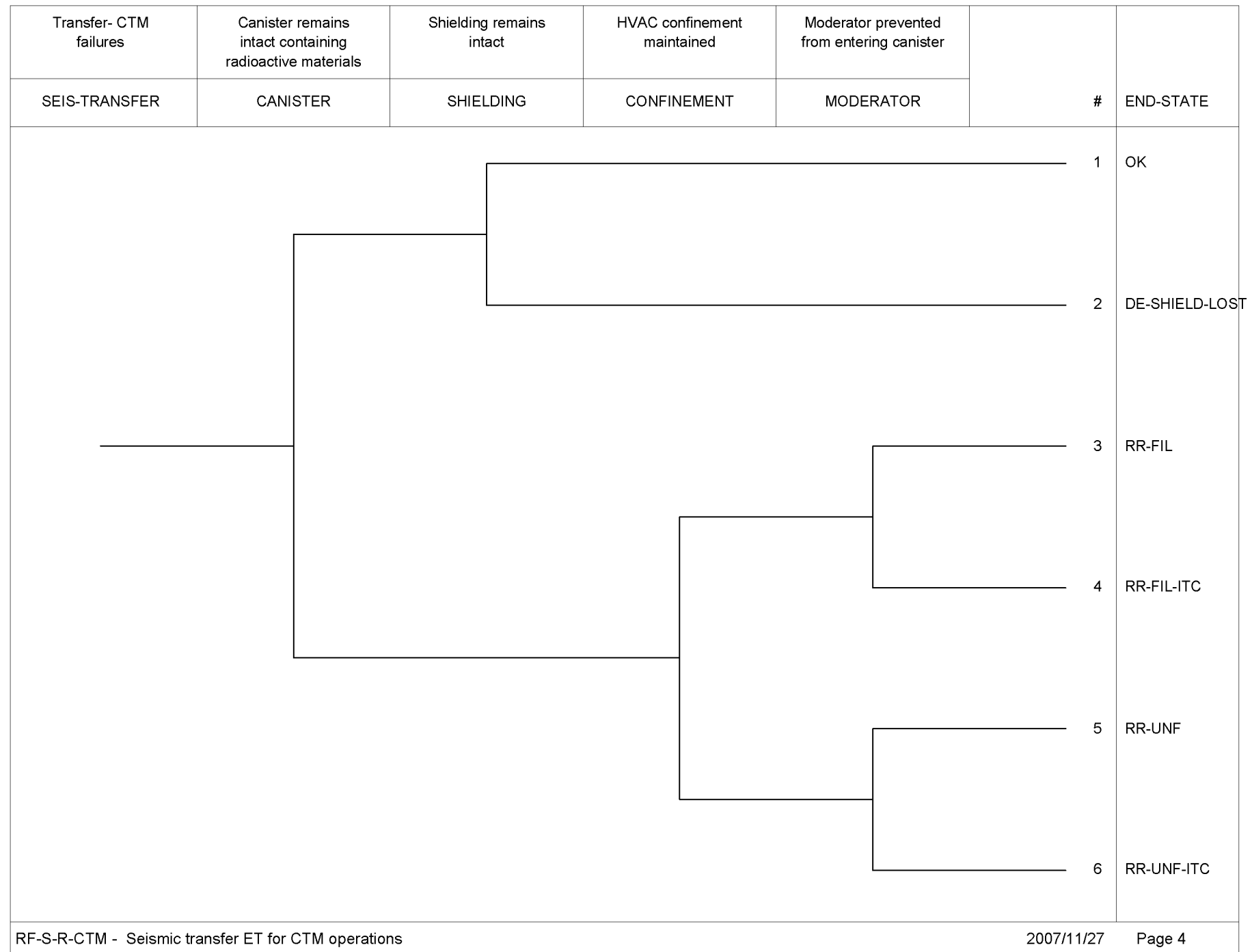

NOTE: CTM = canister transfer machine; DE = direct exposure; ET = event tree; FIL = filtered; HVAC = heating, ventilation and air conditioning; ITC = important to criticality; RF = Receipt Facility; RR = radioactive release; SEIS = seismic; UNF = unfiltered.

Source: Original

Figure B2.1-4. RF Seismic Event Tree RF-S-R-CTM – Seismic Transfer ET for CTM Operations

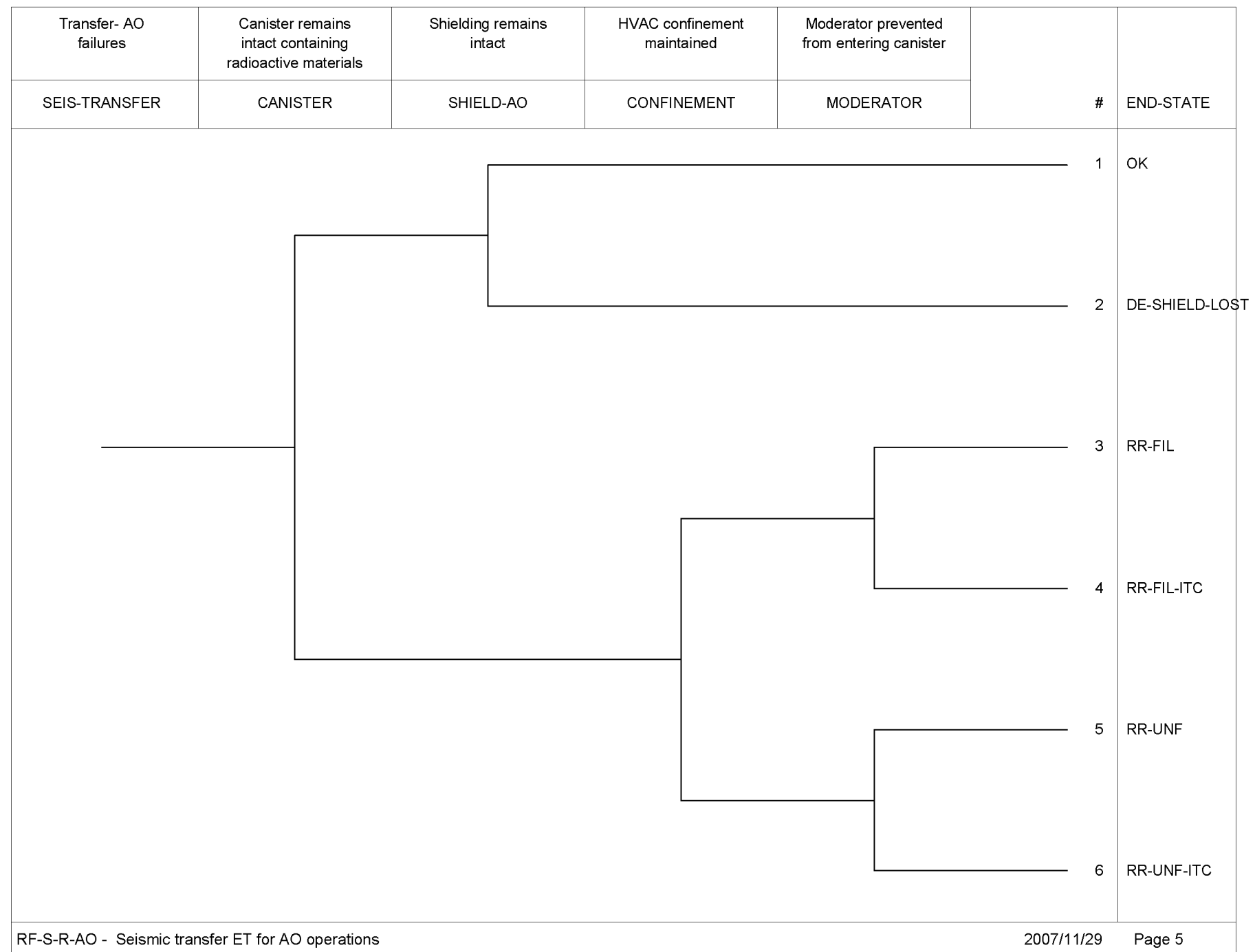

NOTE: AO = aging overpack; CTM = canister transfer machine; DE = direct exposure; ET = event tree; FIL = filtered; HVAC = heating, ventilation and air conditioning; ITC = important to criticality; RF = Receipt Facility; RR = radioactive release; SEIS = seismic; UNF = unfiltered.

Source: Original

Figure B2.1-5. RF Seismic Event Tree RF-S-R-AO – Seismic Transfer ET for AO Operations

Table B2.1-1. Fault Trees Assigned for Initiating Seismic Failures for the RF

Process	Initiator Event Tree	Initiating Seismic Failure	Associated Fault Tree
DPC-VTC	RF-S-IE-DP-VERT	RF building collapse	S-200-TAO-STR-COLLAP
		Entry door seismic collapse	S-200-TAO-ENTDOORCOL
		Railcar accident	S-200-TAO-RAILCARACC
		Mobile platform seismic collapse	S-200-TAO-MOBPLATCOL
		CHC seismic failures	S-200-TAO-CHC-FAIL
		Cask prep platform collapse	S-200-TAO-CPREP-PLAT
		CTT seismic failures	S-200-TAO-CTT-FAIL
		Shield door seismic failures	S-200-TAO-SHIELDDOOR
		CTM seismic failures	S-200-TAO-CTM-FAIL
		CTM MC seismic collapse	S-200-TAO-CTMMC
		ST seismic failures	S-200-TAO-ST-SLIDE
		LBR platform collapse	S-200-TAO-LBRPLAT
		LBR crane collapse	S-200-TAO-LBRC-COL

NOTE: CHC = cask handling crane; CTM = canister transfer machine; CTM MC = canister transfer machine maintenance crane; CTT = cask transfer trolley; LBR = Lid Bolting Room; RF = Receipt Facility; TAD = transportation, aging and disposal; ST = site transporter.

Source: Original

Table B2.1-2. Fault Trees Assigned for Pivotal Events for RF-S-IE-DP-VERT Initiating Event Tree

Initiating Seismic Failure	TRANSCASK	MODERATOR
RF building collapse	N/A	N/A
Entry door seismic collapse	RC-TAO-DOORDROP-CASK	RF-MOD-MULT-SYS
Railcar accident	RC-TAO-RC-ACC-CASK	RF-MOD-MULT-SYS
Mobile platform seismic collapse	RC-TAO-MOB-PLAT-CASK	RF-MOD-MULT-SYS
CHC seismic failures	TC-TAO-CHC-CASK	RF-MOD-MULT-SYS
Cask prep platform collapse	TC-TAO-CPP-CASK	RF-MOD-MULT-SYS
CTT seismic failures	CTT-TAO-CTT-CASK	RF-MOD-FPW-ONLY
	TC-WP	
Shield door seismic failures	TCWP-TAO-SHIELDDOOR-CASK	RF-MOD-MULT-SYS
	CANISTER	
CTM seismic failures	CTM-TAO-CTM-CAN	RF-MOD-FPW-ONLY
CTM MC seismic collapse	CTM-TAO-CTMMC	RF-MOD-FPW-ONLY
ST seismic failures	ST-TAO-AO-FAIL	RF-MOD-FPW-ONLY
LBR platform collapse	ST-TAO-LBRPLAT	RF-MOD-FPW-ONLY
LBR crane collapse	ST-TAO-LBRC-COL	RF-MOD-FPW-ONLY

NOTE: CHC = cask handling crane; CTM = canister transfer machine; CTM MC = canister transfer machine maintenance crane; CTT = cask transfer trolley; LBR = Lid Bolting Room; RF = Receipt Facility; TAD = transportation, aging and disposal; ST = site transporter.

Source: Original

B2.2 Fault Trees

Seismic fault trees for the processing of vertical DPCs in the RF are presented in alpha-numeric order in this section. Note that the TAD to aging overpack fault trees and basic events presented in B1 above were used as the templates for the DPC fault trees. Therefore, many of the fault tree names and basic event names are the same as for the TAD to aging overpack fault trees and basic events presented in B1 above, although the values for the basic events have been revised to reflect the DPC process. The revisions to the basic event values are given in Section B2.3.

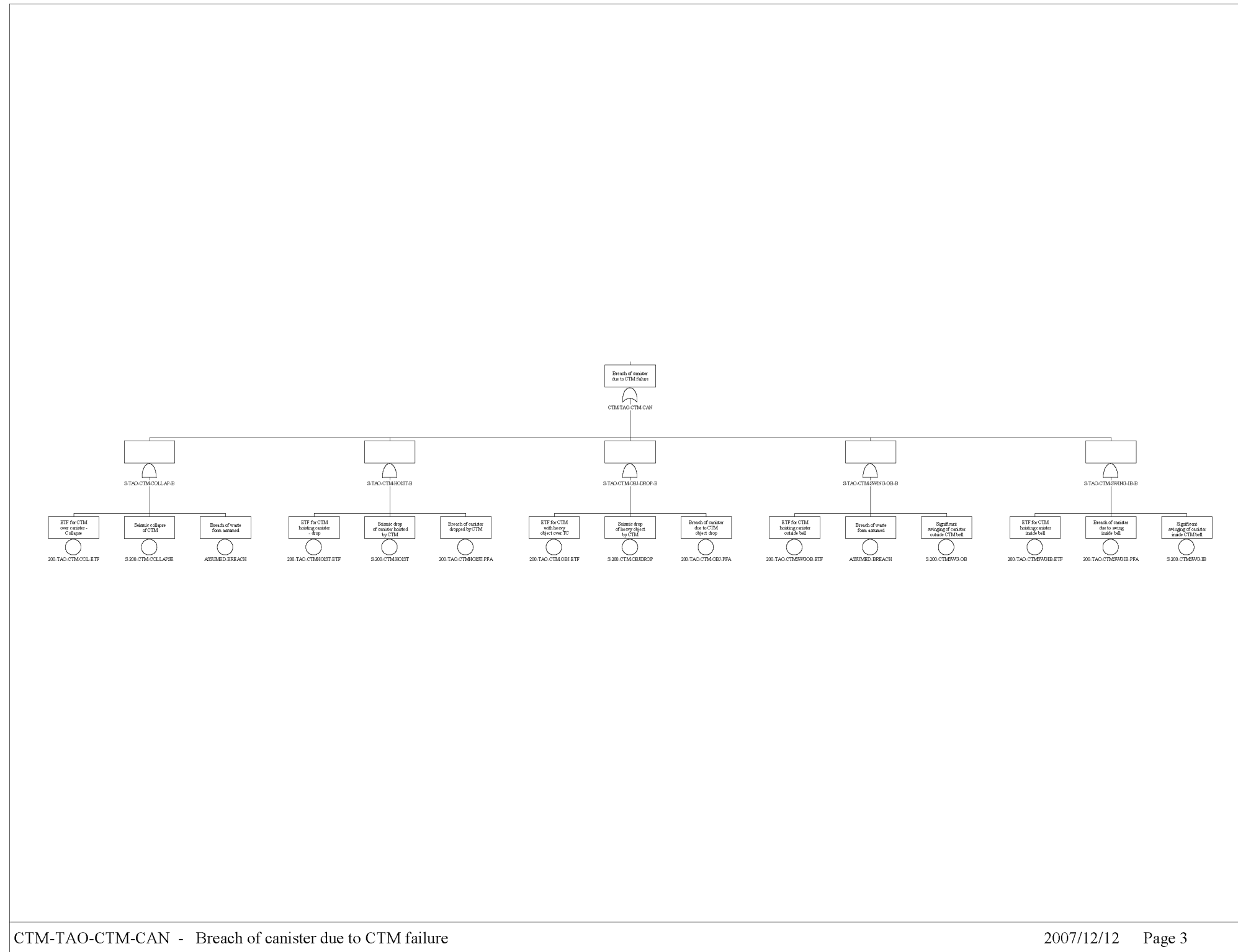

Source: Original

Figure B2.2-1. Fault Tree CTM-TAO-CTM-CAN – Breach of Canister due to CTM Failure

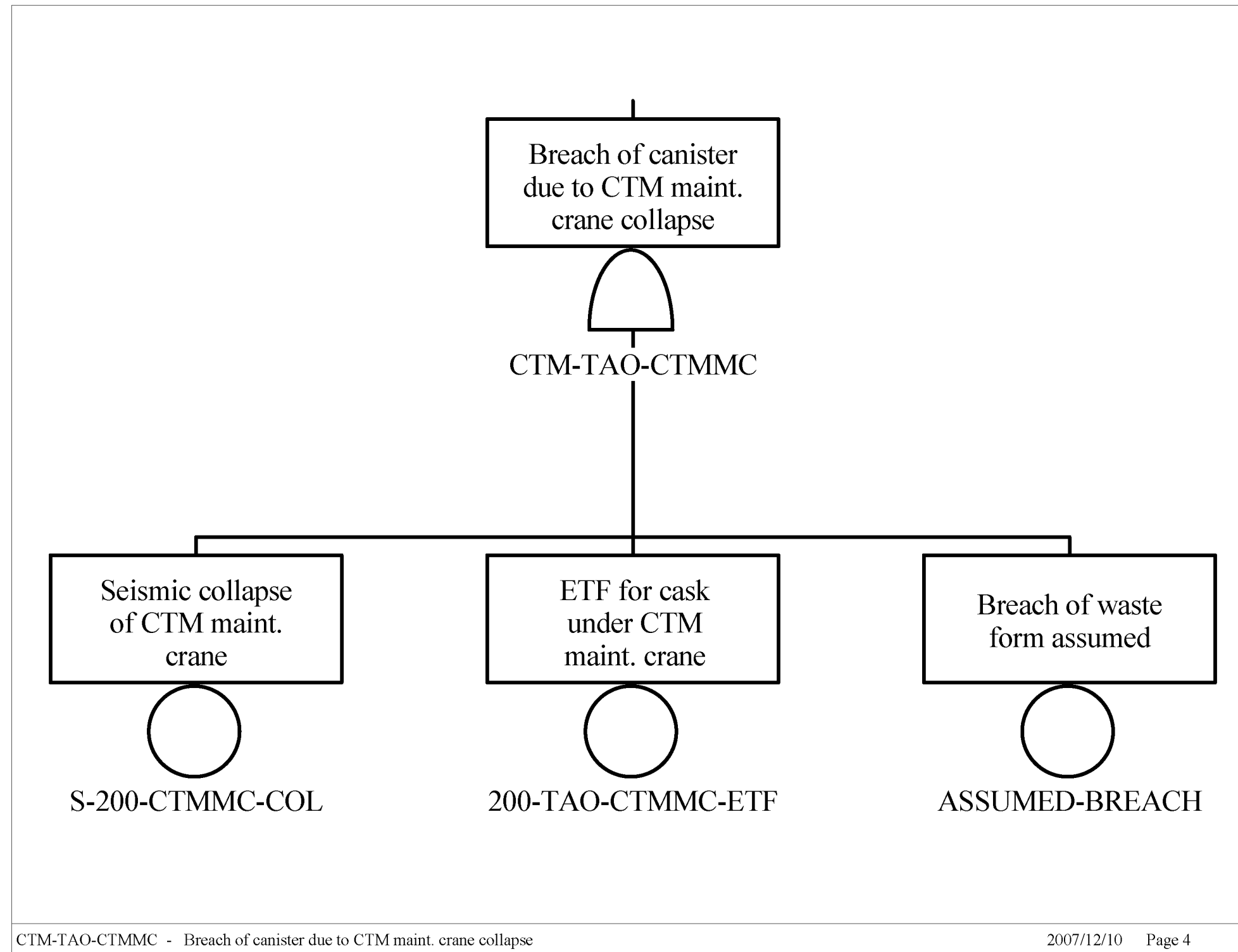

Source: Original

Figure B2.2-2. CTM-TAO-CTMMC – Breach of Canister due to CTM Maint. Crane Collapse

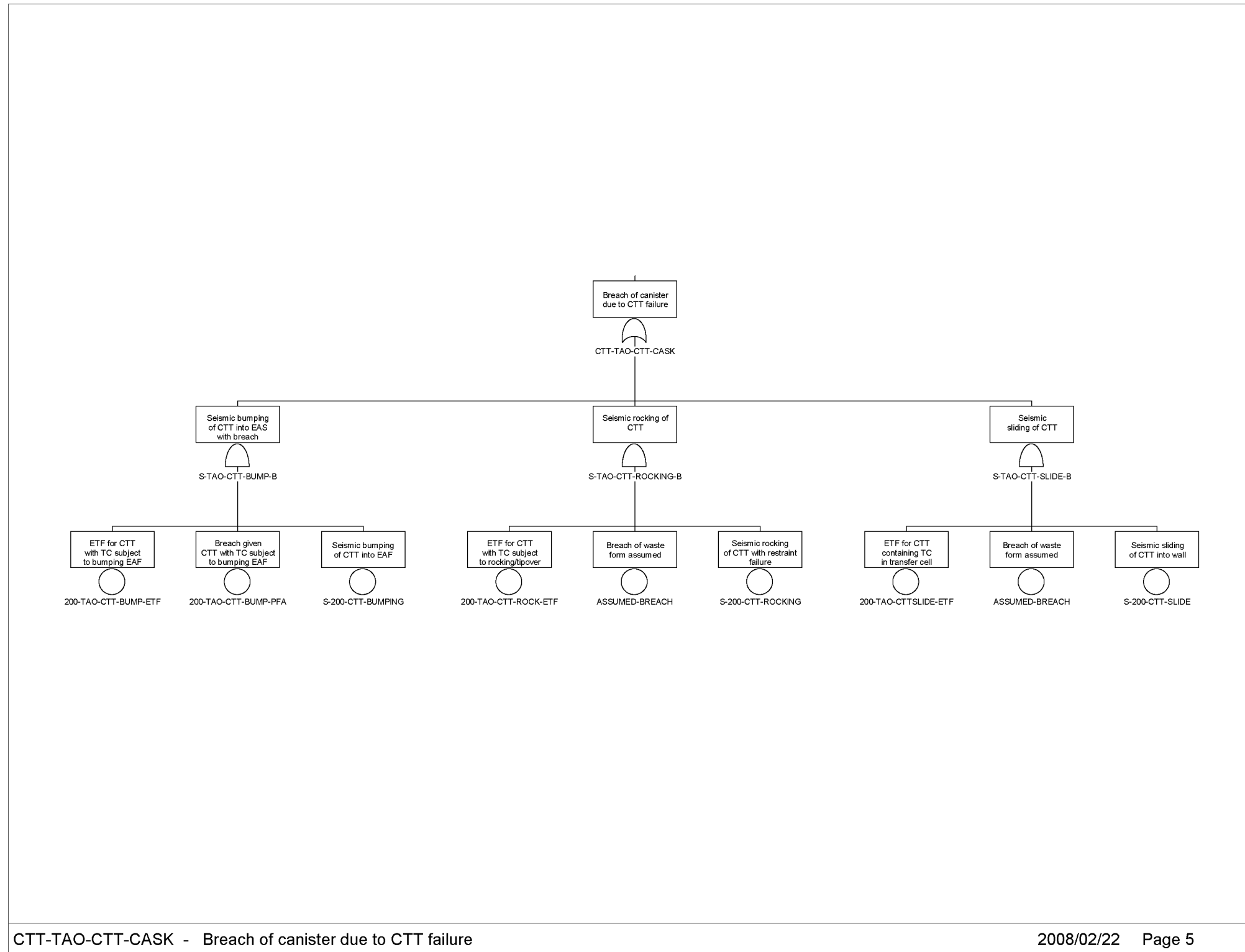

Source: Original

Figure B2.2-3 CTT-TAO-CTT-CASK – Breach of Canister due to CTT Failure

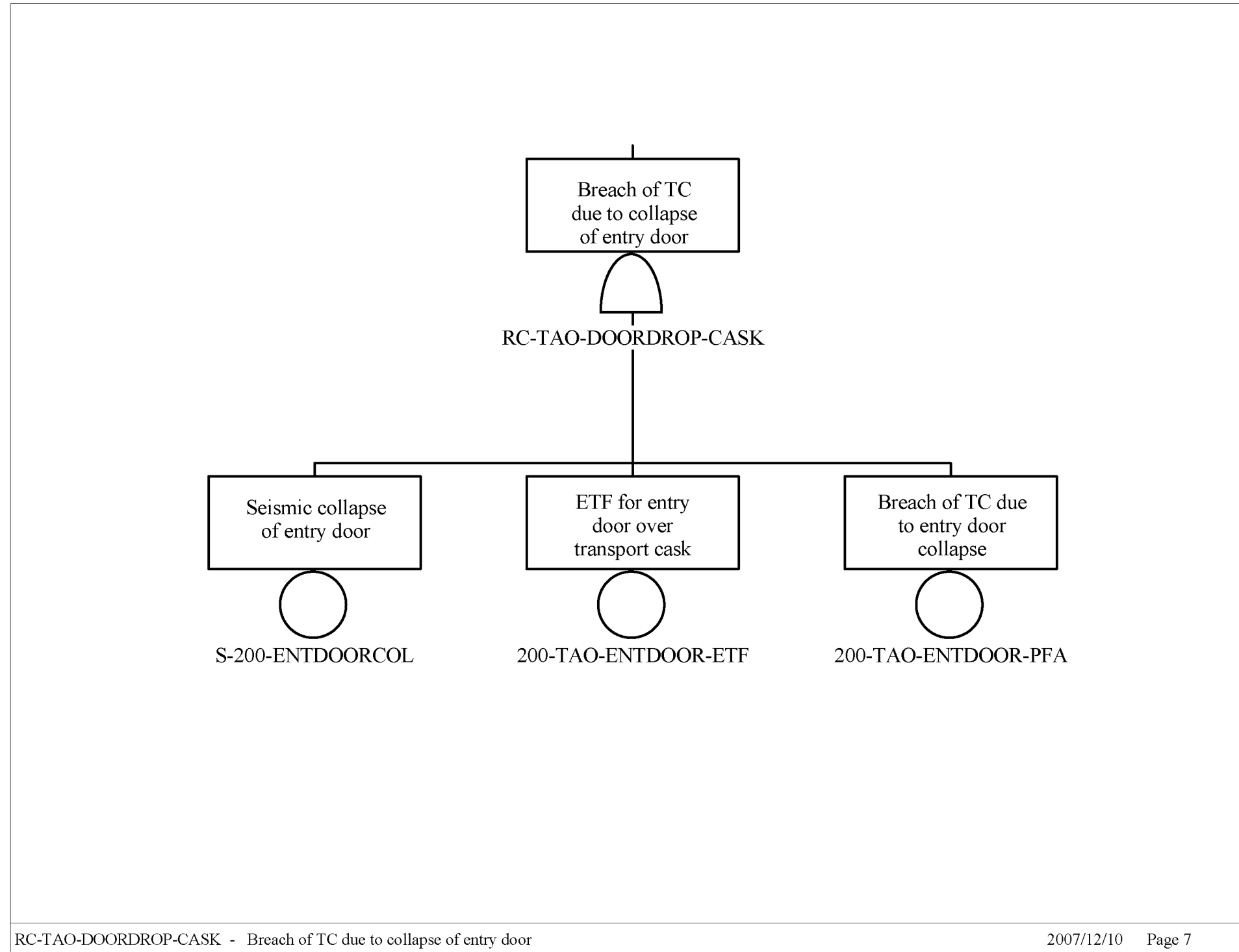

Source: Original

Figure B2.2-4. RC-TAO-DOORDROP-CASK – Breach of TC due to Collapse of Entry Door

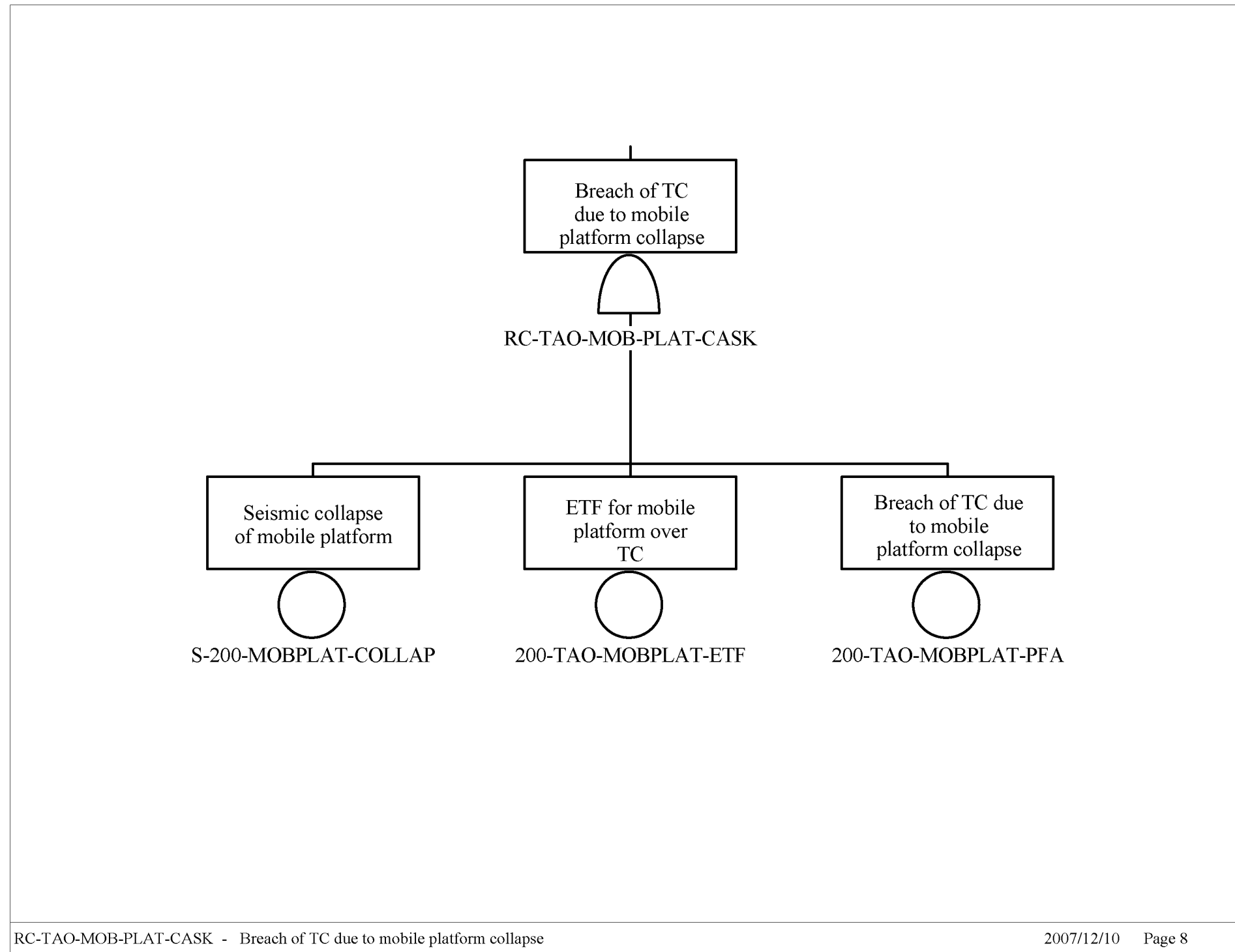

Source: Original

Figure B2.2-5. RC-TAO-MOB-PLAT-CASK – Breach of TC due to Mobile Platform Collapse

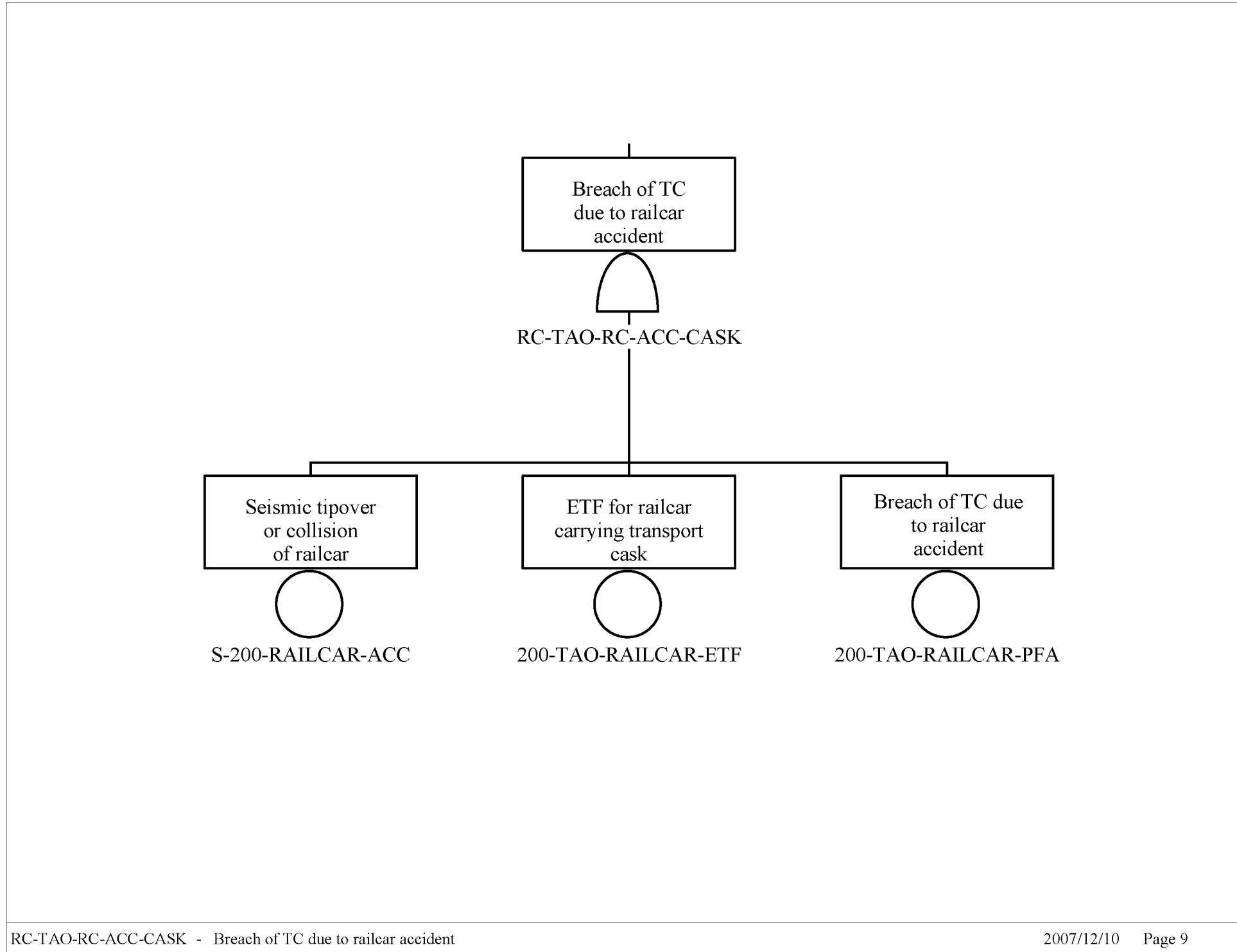

Source: Original

Figure B2.2-6. RC-TAO-RC-ACC-CASK – Breach of TC due to Railcar Accident

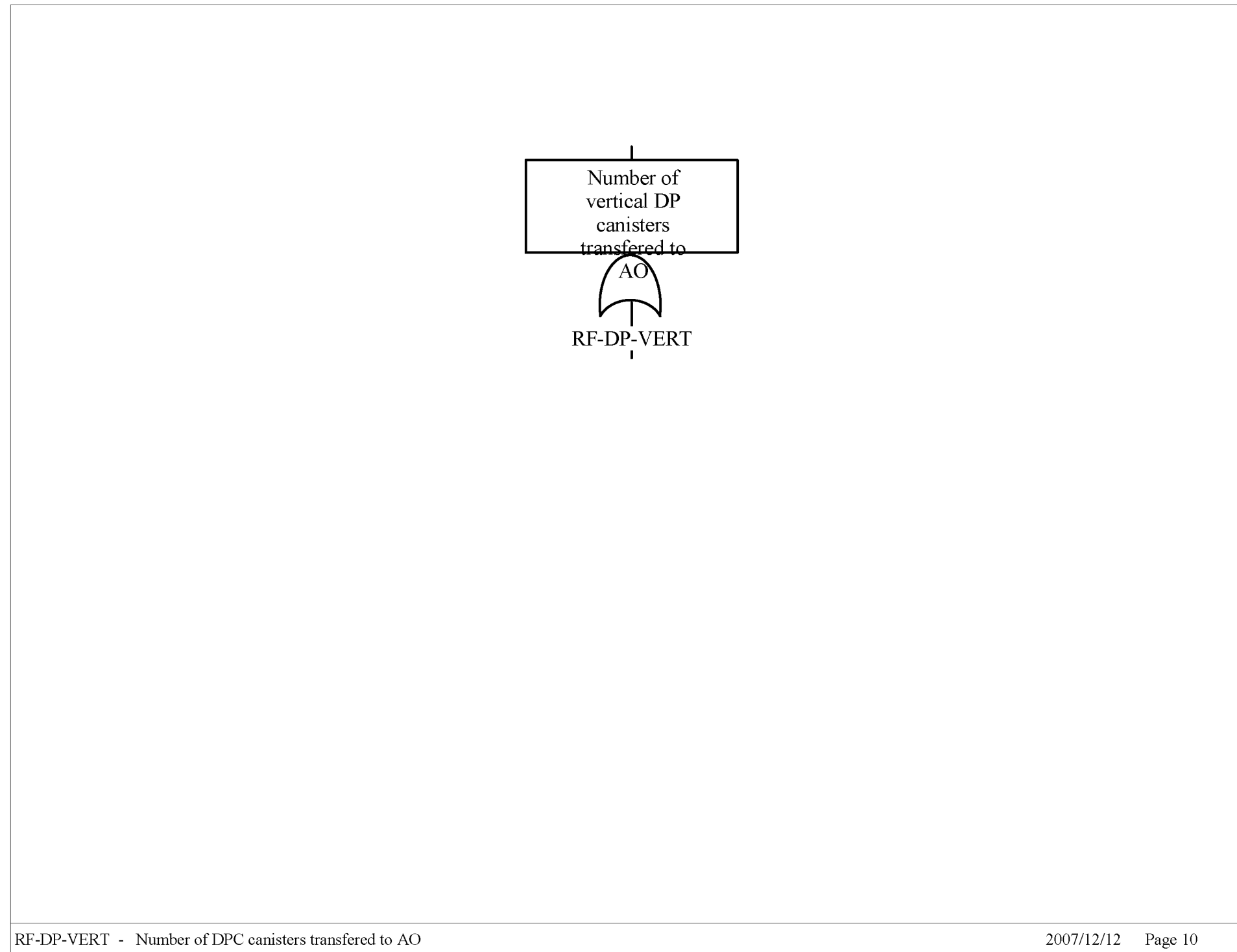

Source: Original

Figure B2.2-7. RF-DP-VERT – Number of DPC Canisters Transferred to AO

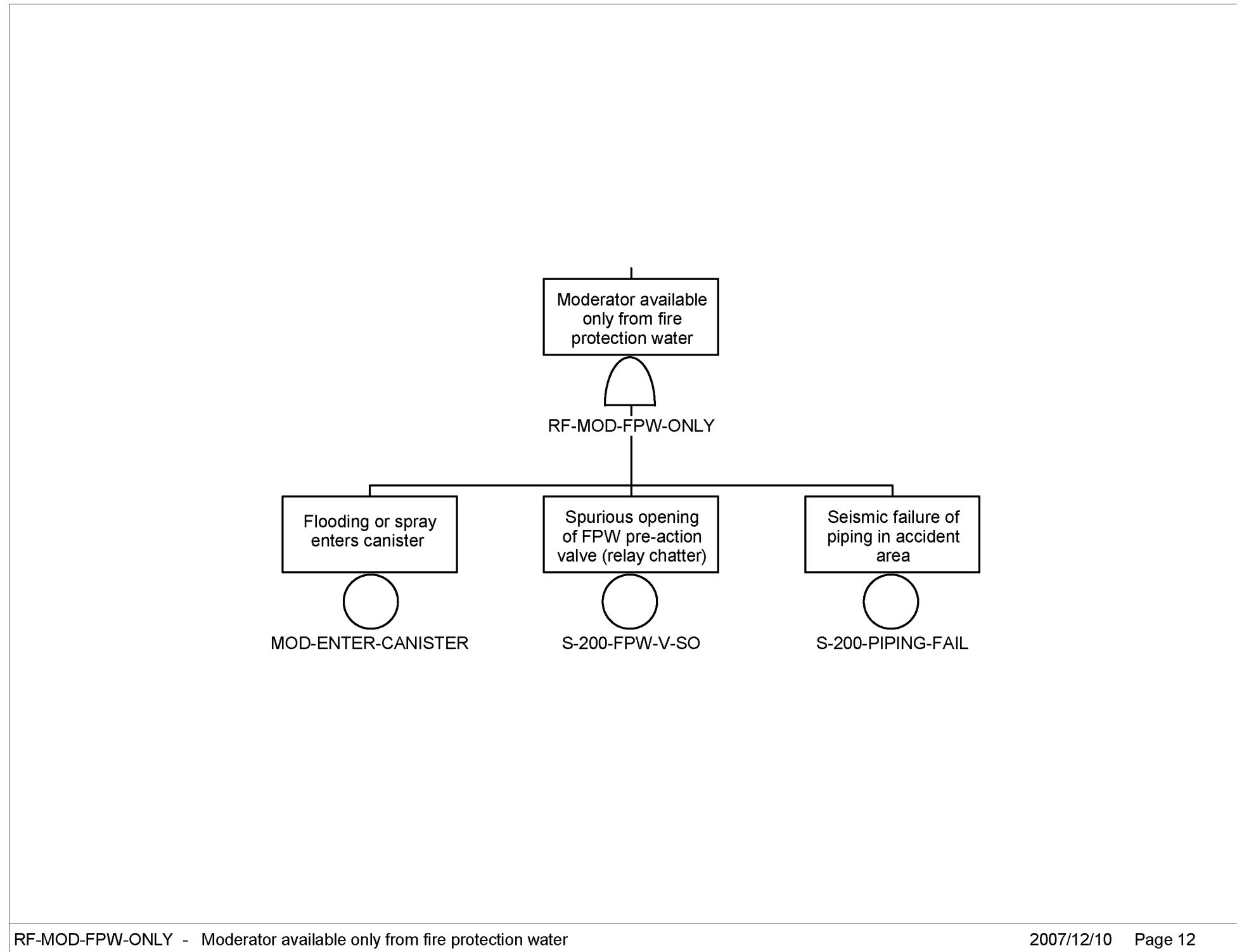

Source: Original

Figure B2.2-8. RF-MOD-FPW-ONLY – Moderator Available Only from Fire Protection Water

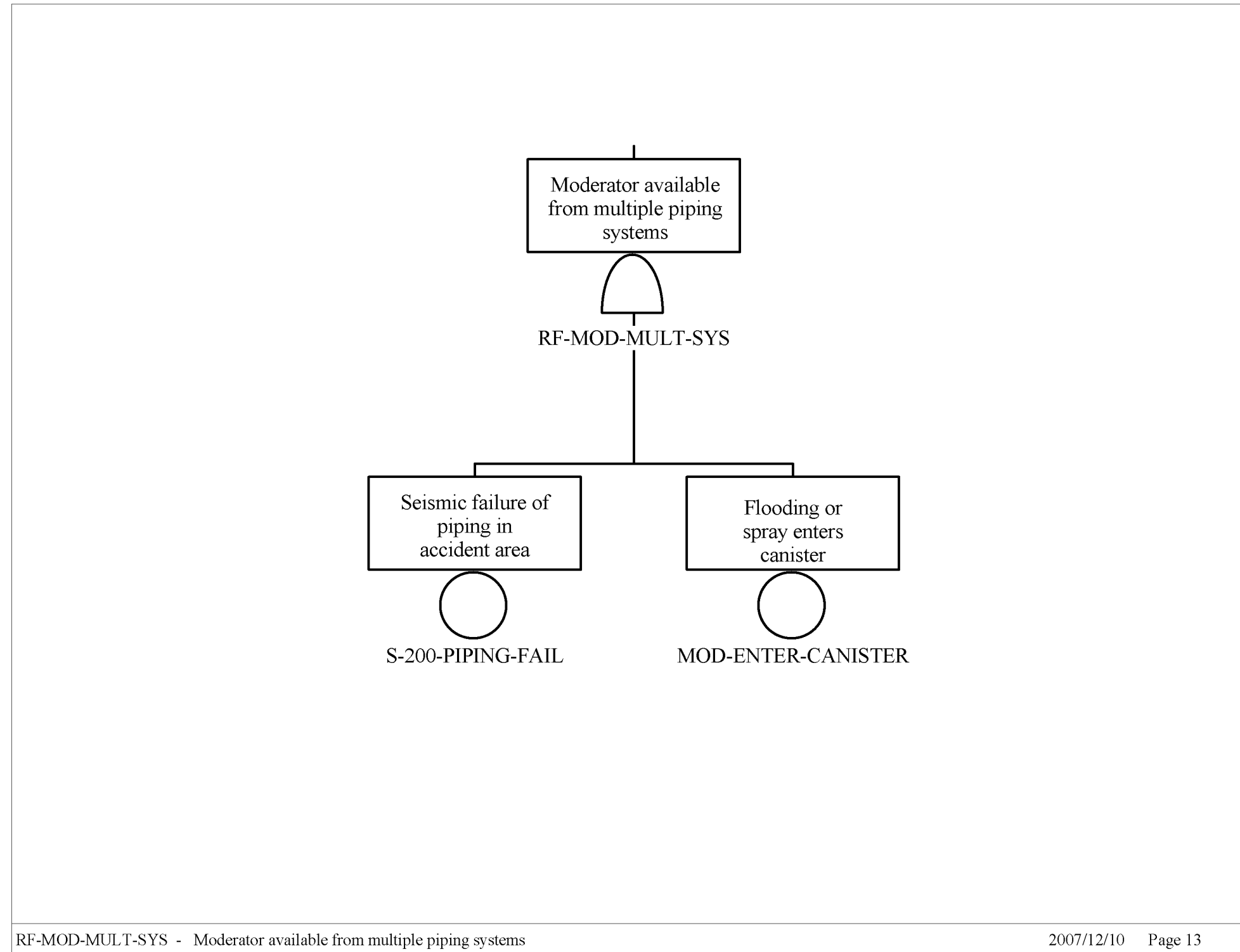

Source: Original

Figure B2.2-9. RF-MOD-MULT-SYS – Moderator Available from Multiple Piping Systems

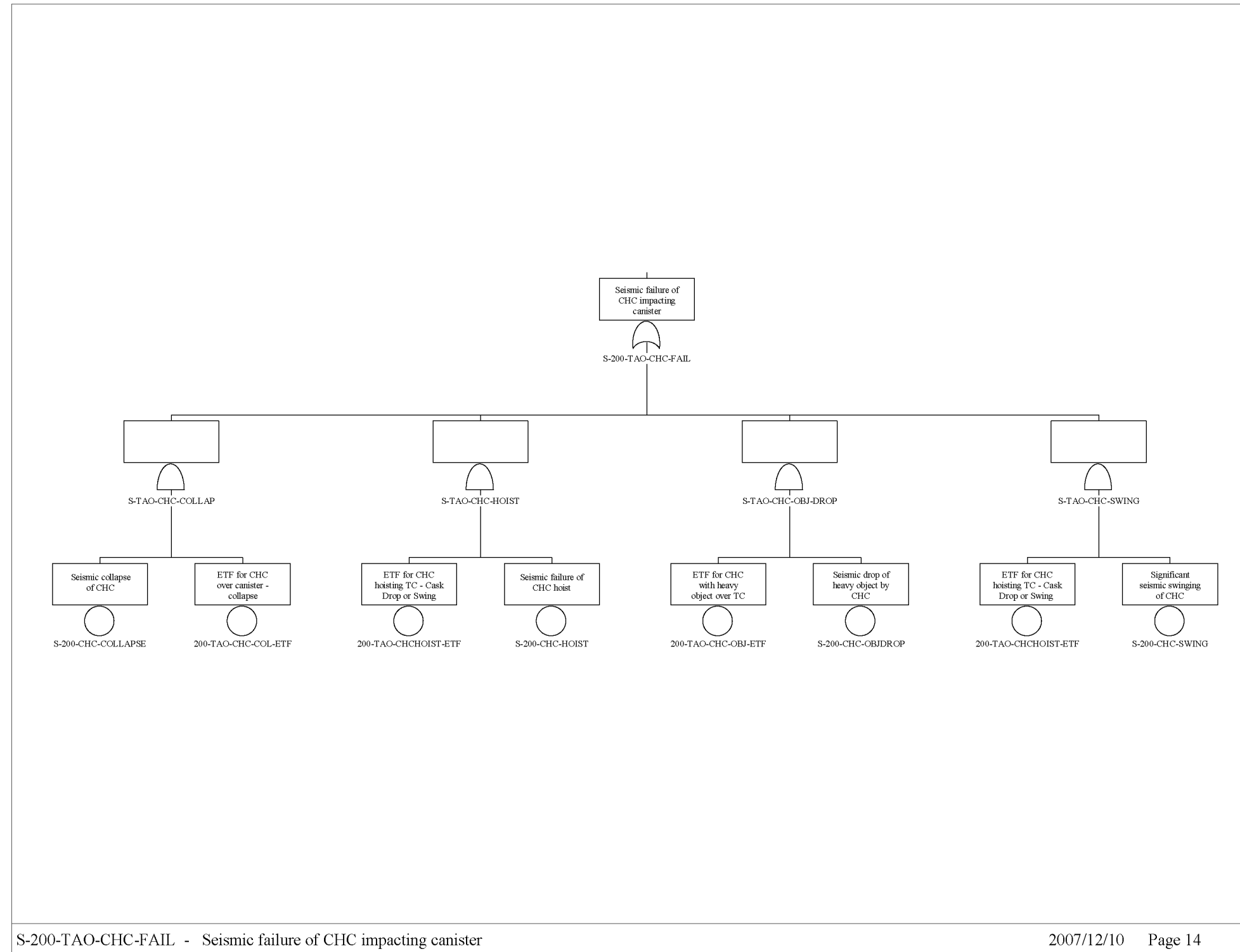

Source: Original

Figure B2.2-10. S-200-TAO-CHC-FAIL – Seismic Failure of CHC Impacting Canister

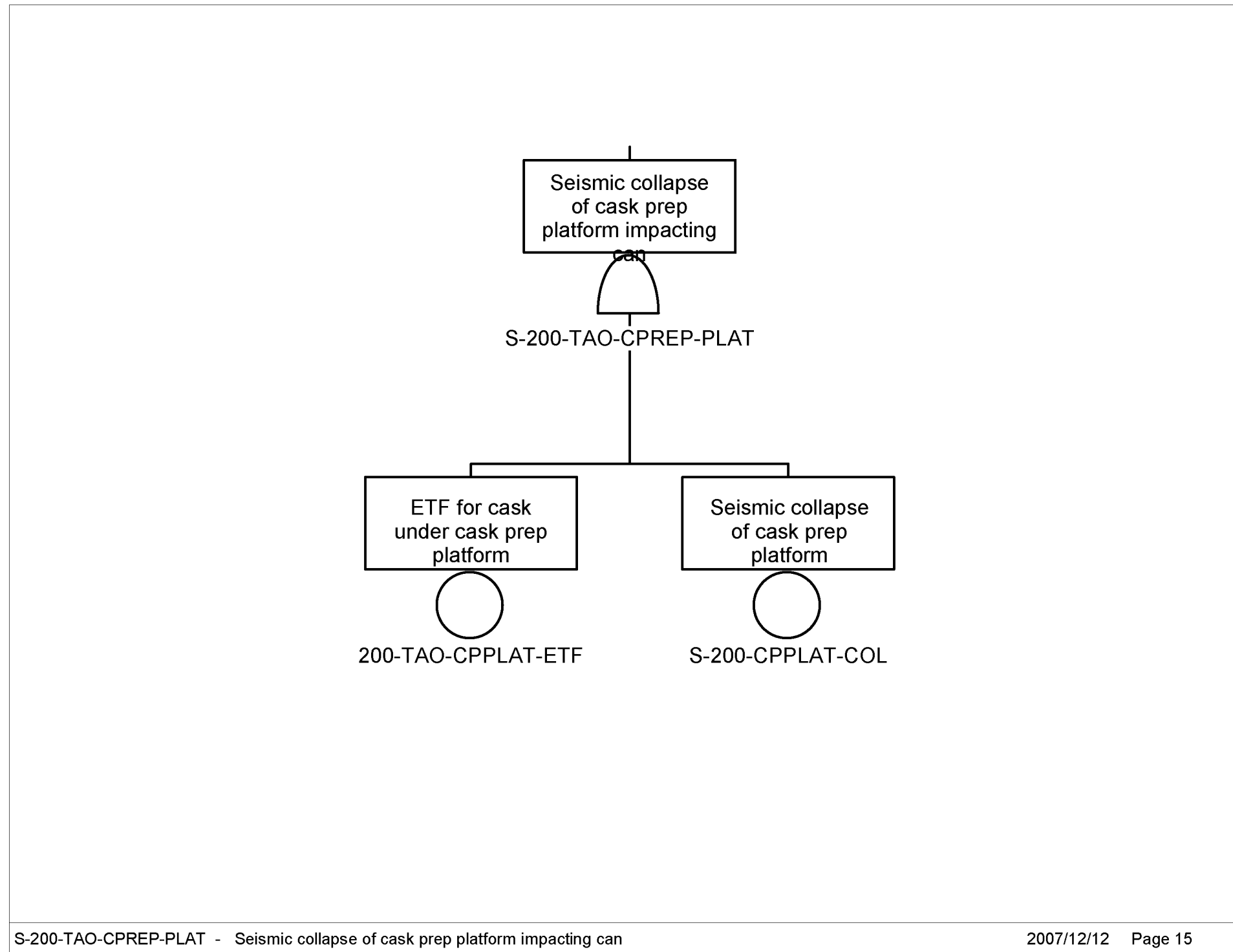

Source: Original

Figure B2.2-11. S-200-TAO-CPREP-PLAT – Seismic Collapse of Cask Prep Platform Impacting Can

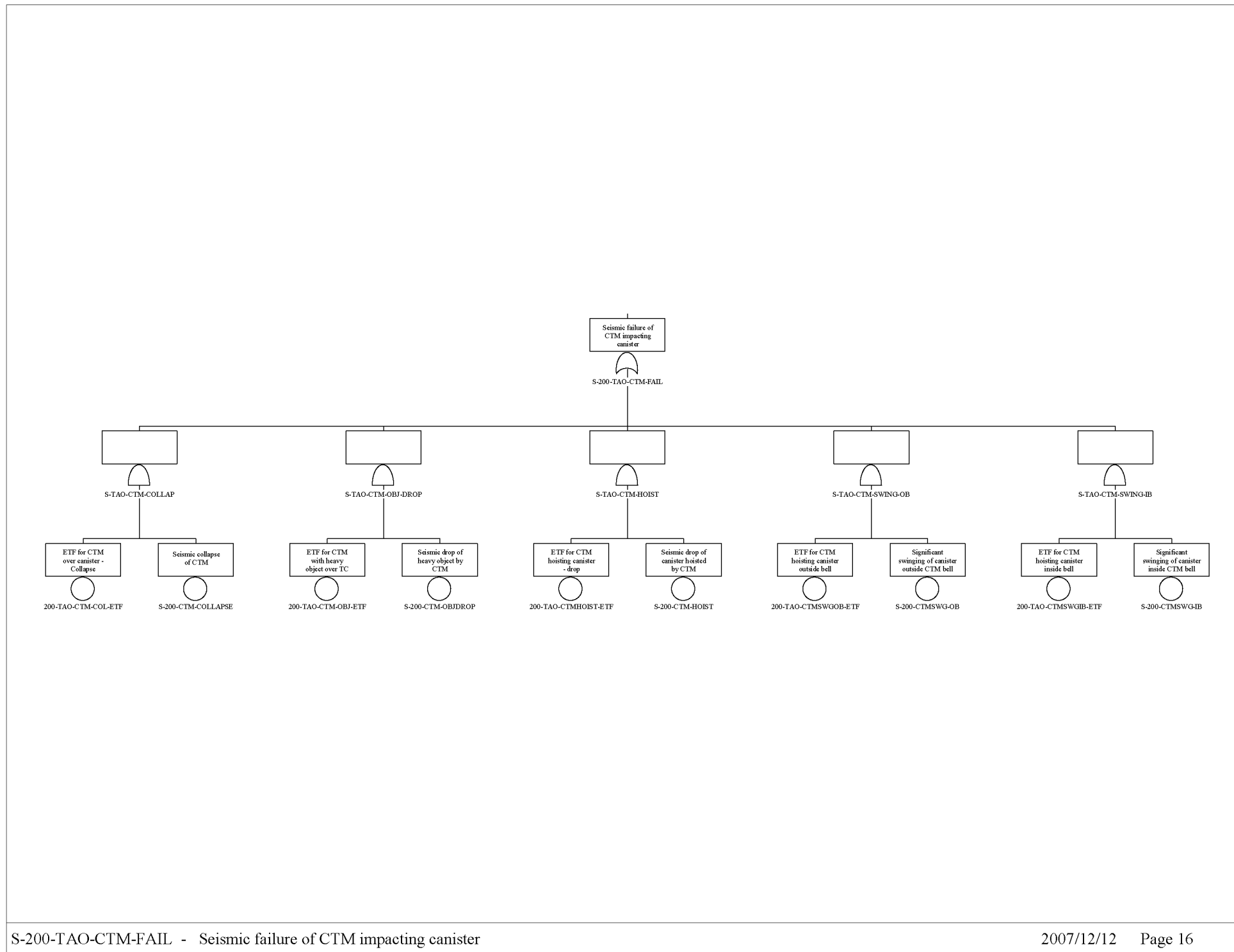

Source: Original

Figure B2.2-12. S-200-TAO-CTM-FAIL – Seismic Failure of CTM Impacting Canister

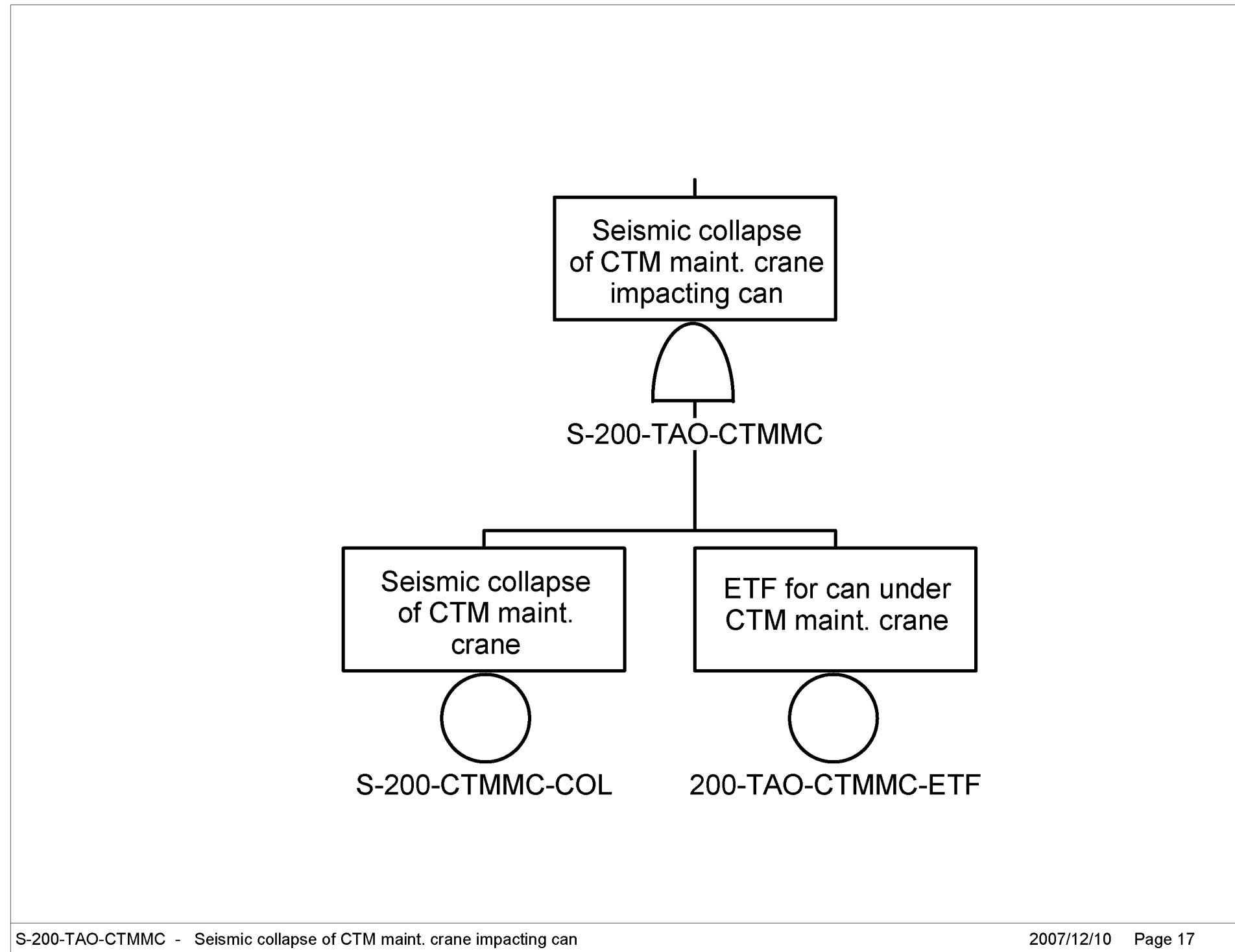

Source: Original

Figure B2.2-13. S-200-TAO-CTMMC – Seismic Collapse of CTM Maint. Crane Impacting Can

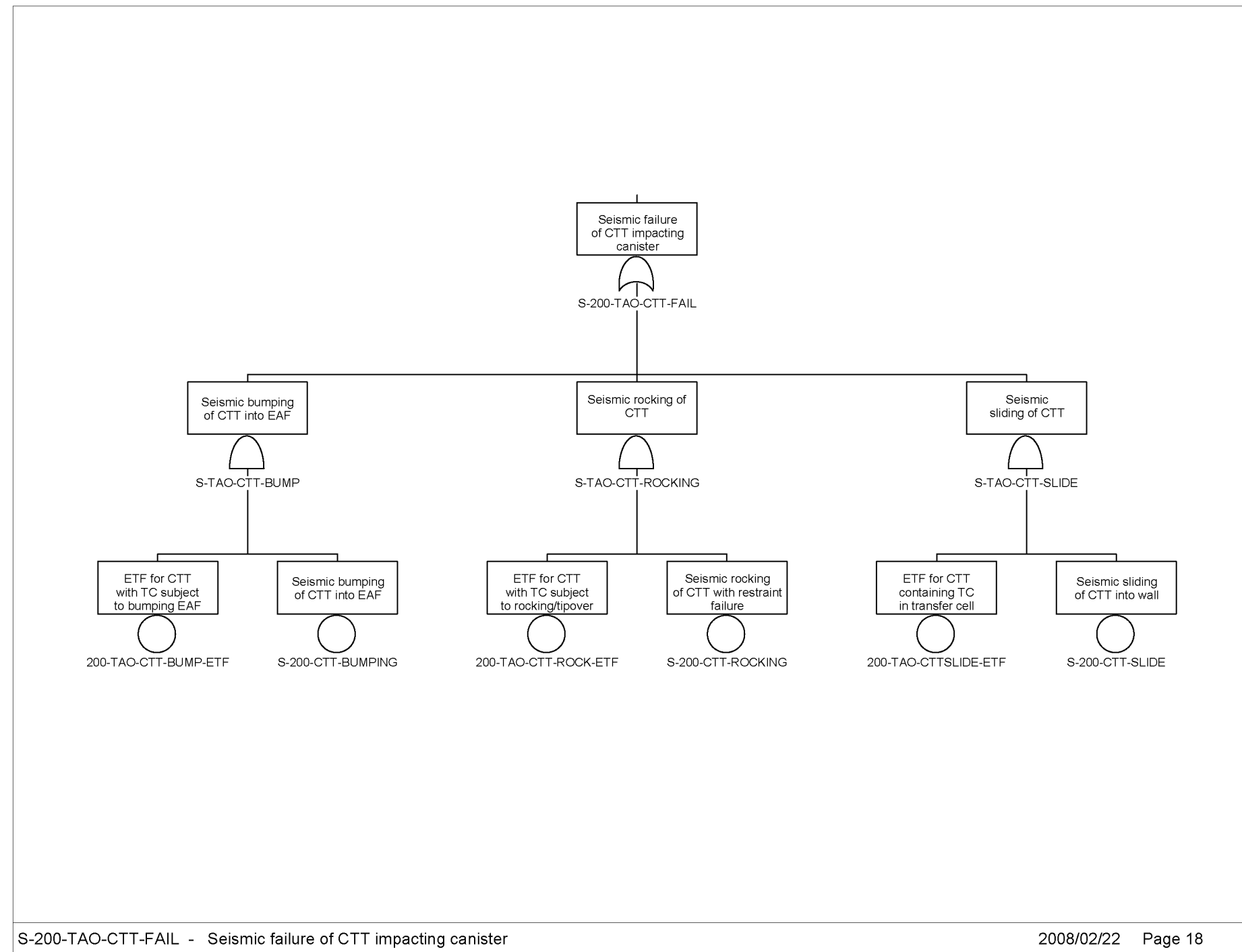

Source: Original

Figure B2.2-14. S-200-TAO-CTT-FAIL – Seismic Failure of CTT Impacting Canister

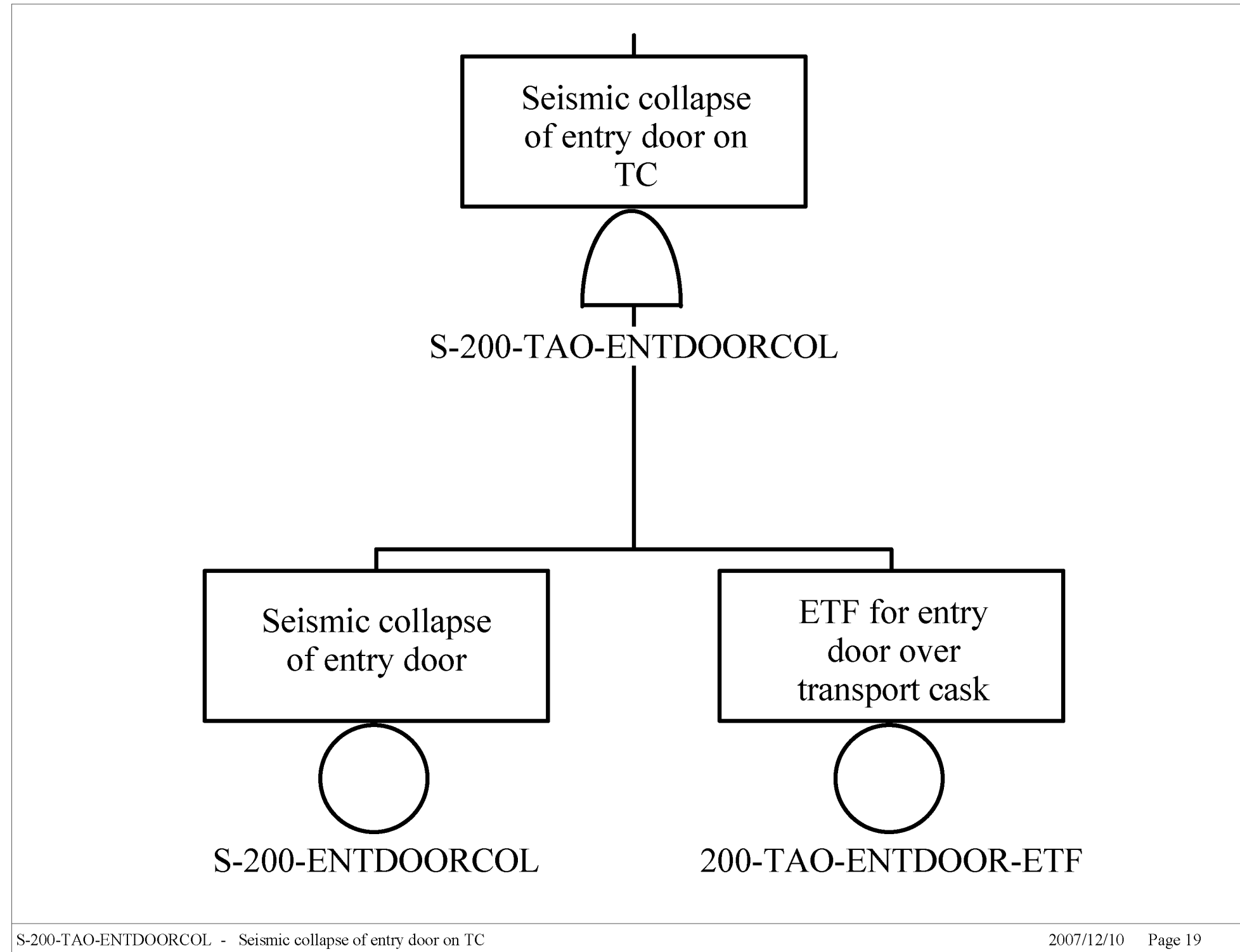

Source: Original

Figure B2.2-15. S-200-TAO-ENTDOORCOL – Seismic Collapse of Entry Door on TC

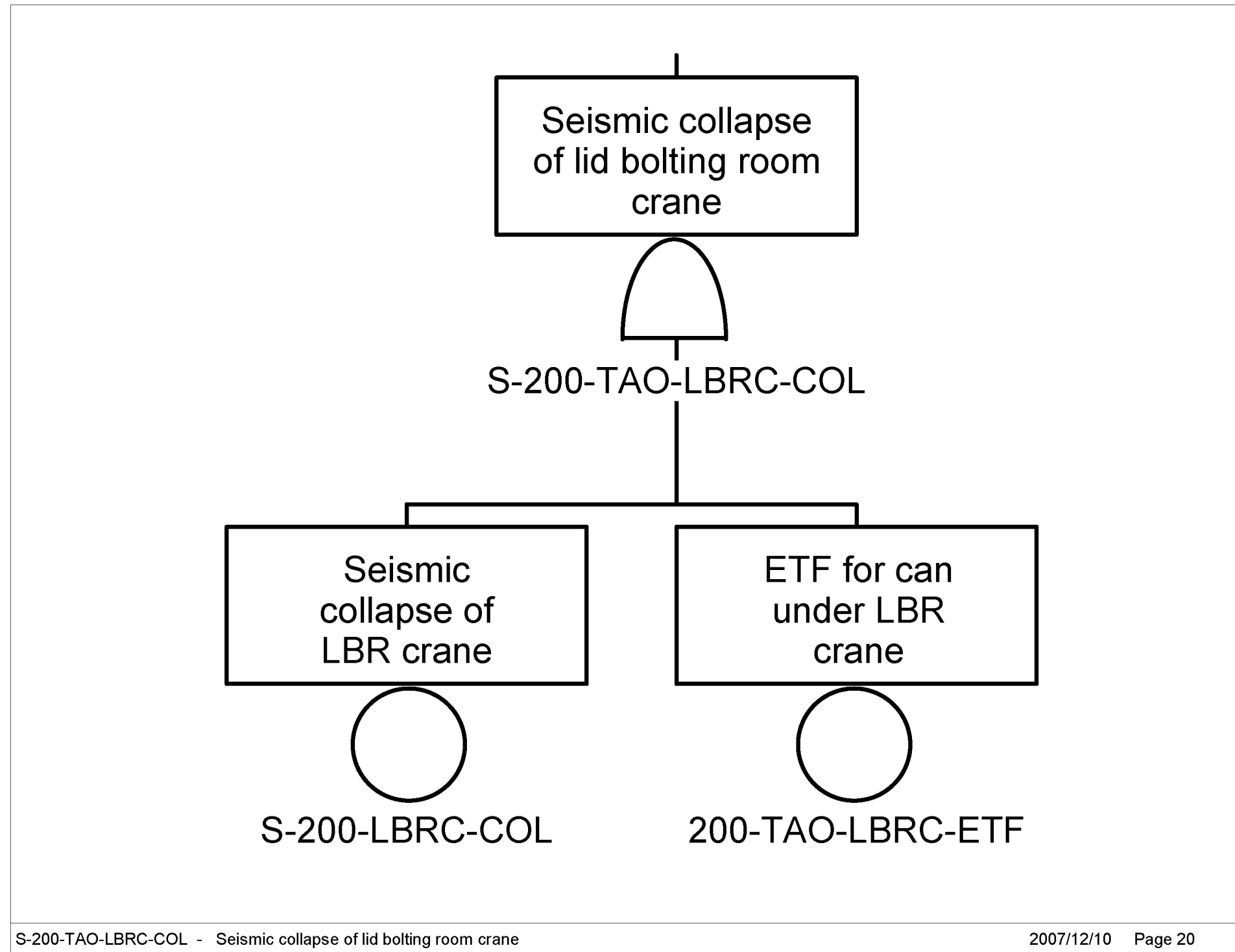

Source: Original

Figure B2.2-16. S-200-TAO-LBRC-COL – Seismic Collapse of Lid Bolting Room Crane

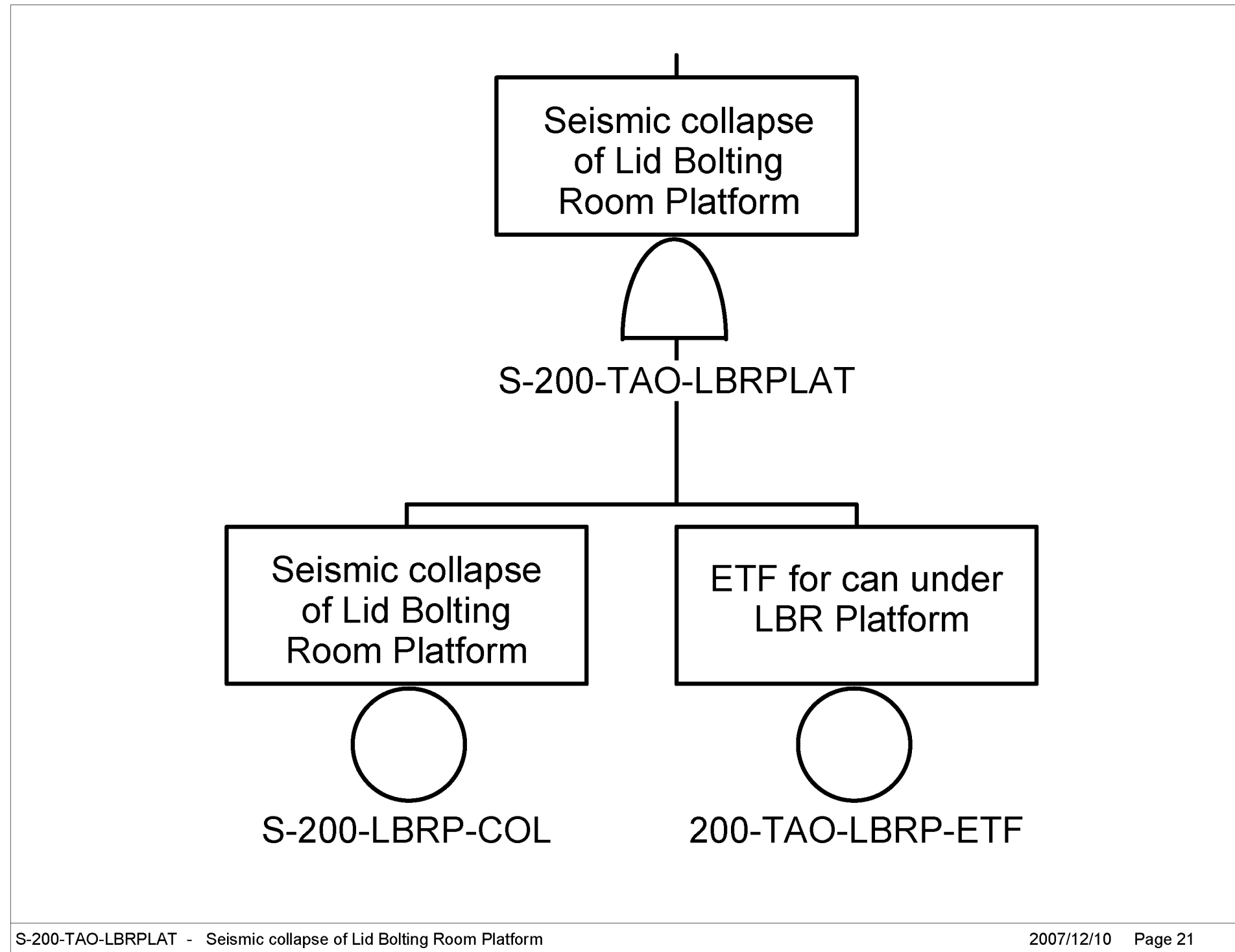

S-200-TAO-LBRPLAT - Seismic collapse of Lid Bolting Room Platform

2007/12/10 Page 21

Source: Original

Figure B2.2-17. S-200-TAO-LBRPLAT – Seismic Collapse of Lid Bolting Room Platform

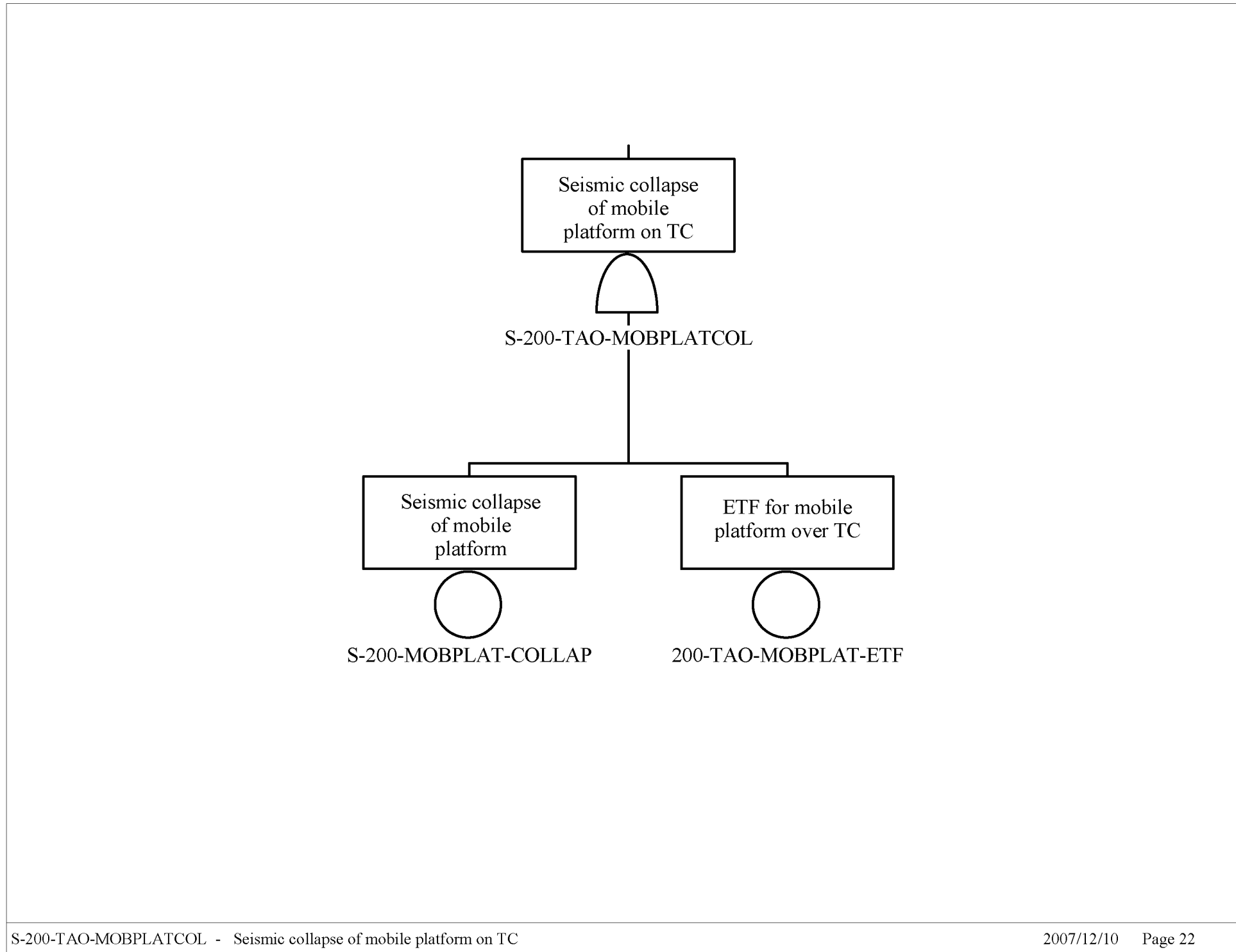

S-200-TAO-MOBPLATCOL - Seismic collapse of mobile platform on TC

2007/12/10 Page 22

Source: Original

Figure B2.2-18. S-200-TAO-MOBPLATCOL – Seismic Collapse of Mobile Platform on TC

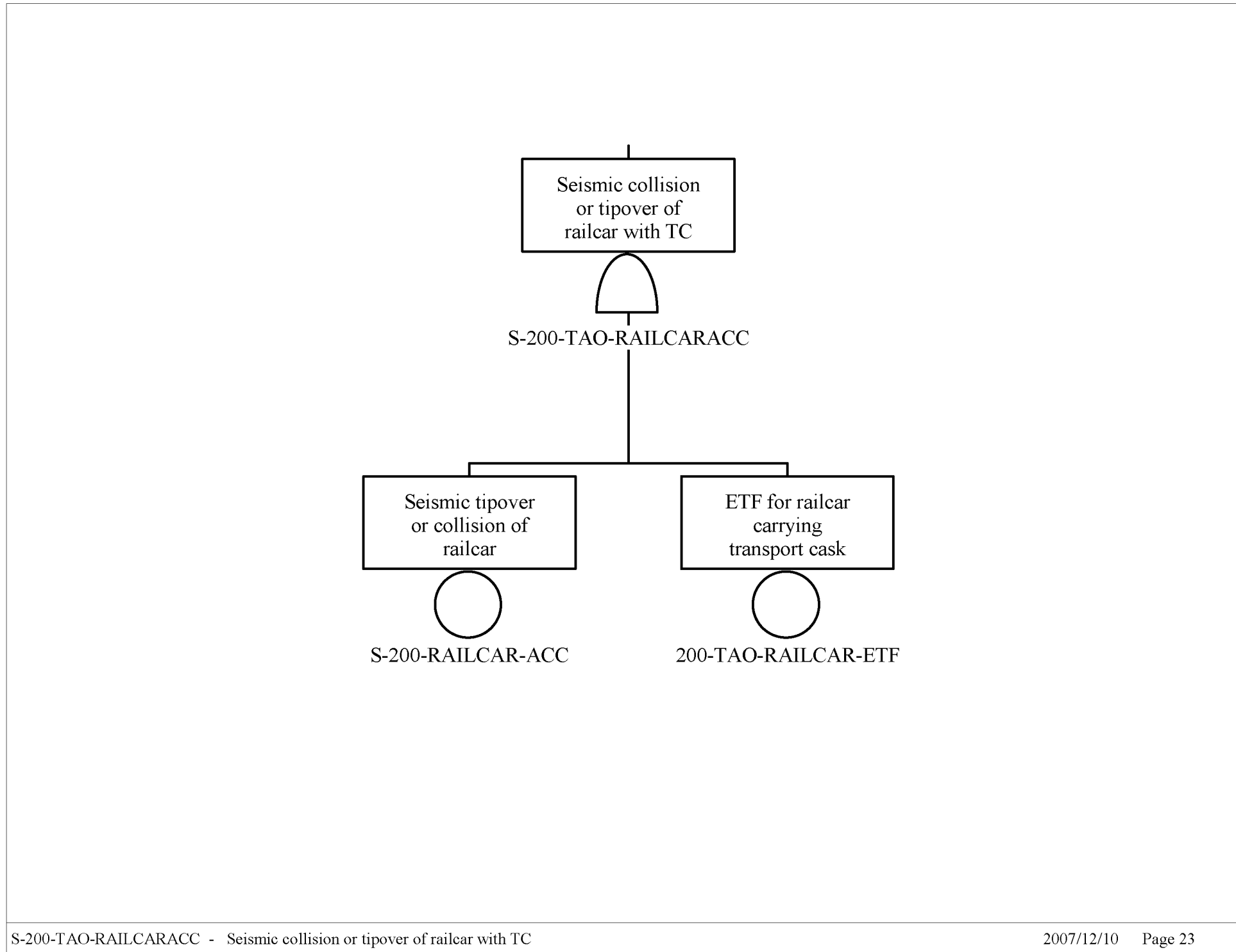

S-200-TAO-RAILCARACC - Seismic collision or tipover of railcar with TC

2007/12/10 Page 23

Source: Original

Figure B2.2-19. S-200-TAO-RAILCARACC – Seismic Collision or Tipover of Railcar with TC

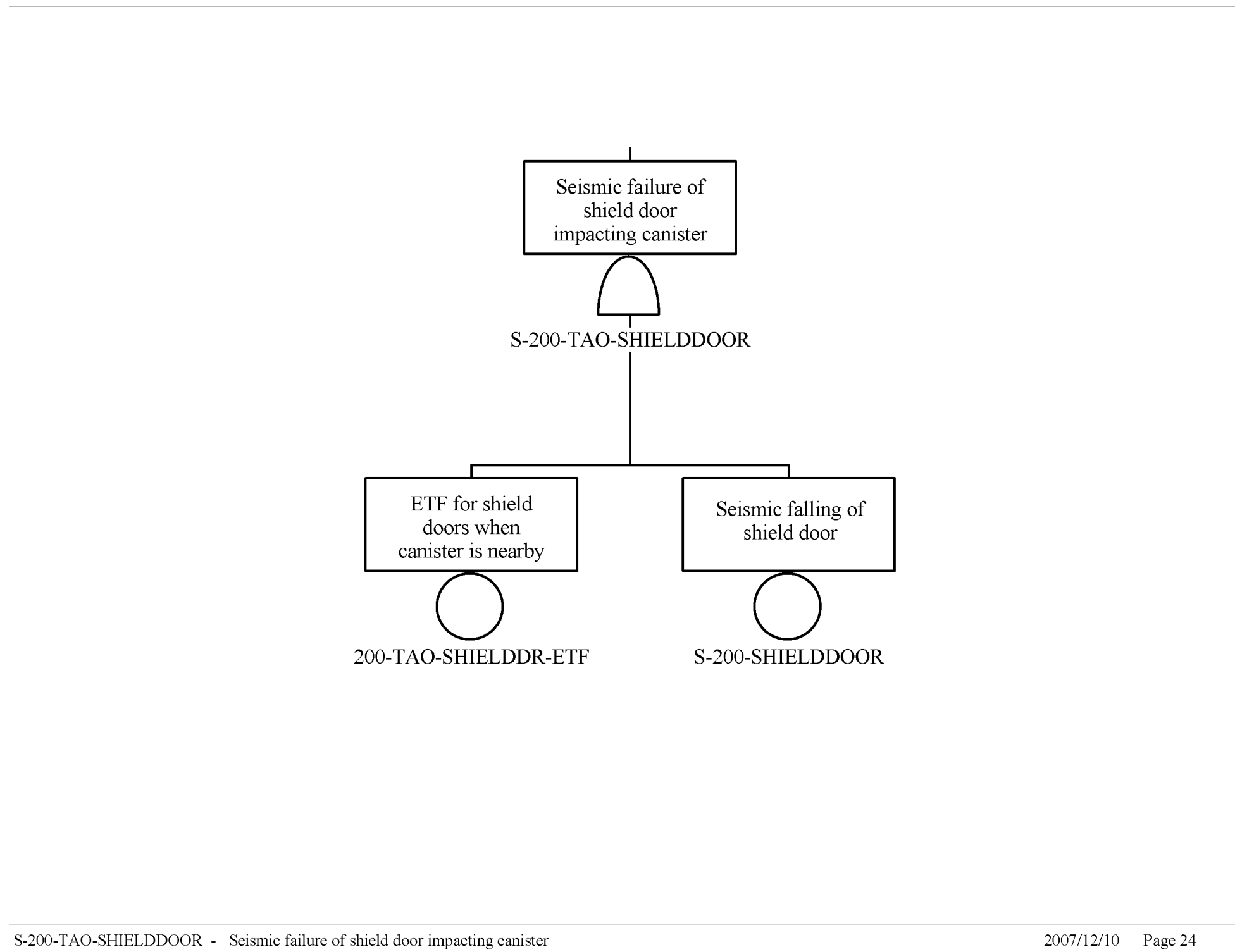

Source: Original

Figure B2.2-20. S-200-TAO-SHIELDDOOR–
Seismic Failure of Shield Door
Impacting Canister

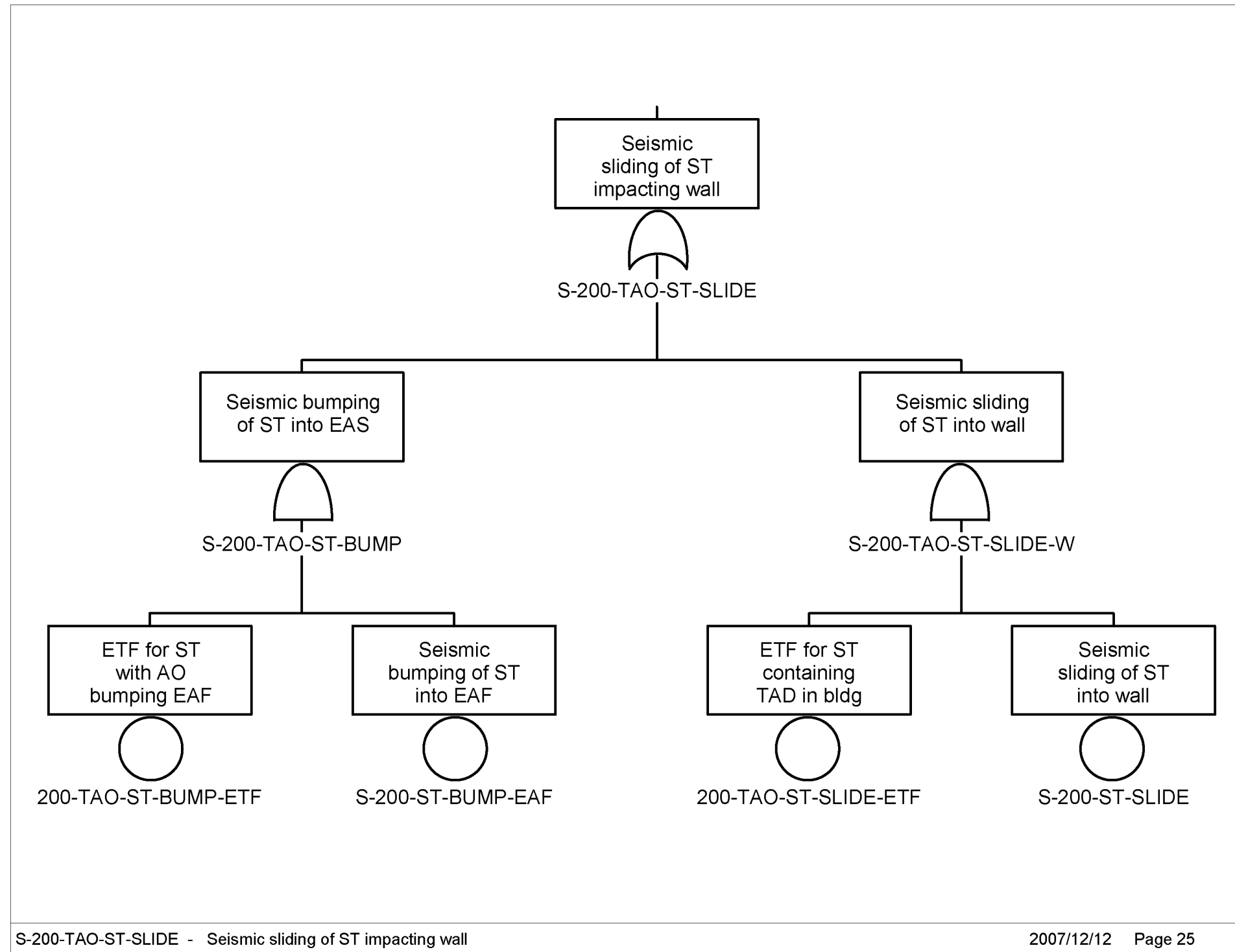

Source: Original

Figure B2.2-21. S-200-TAO-ST-SLIDE – Seismic Sliding of ST Impacting Wall

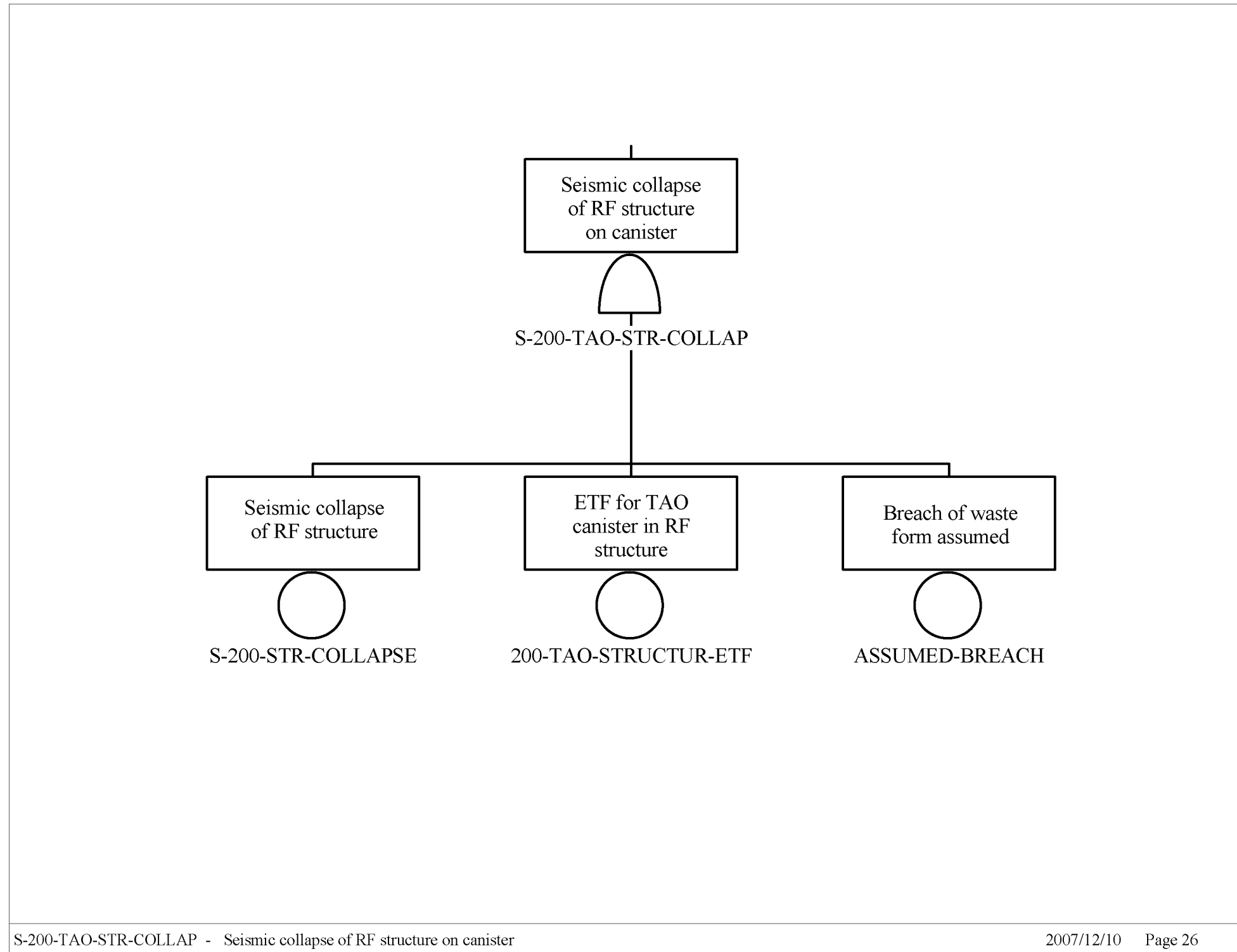

Source: Original

Figure B2.2-22. S-200-TAO-STR-COLLAP – Seismic Collapse of RF Structure on Canister

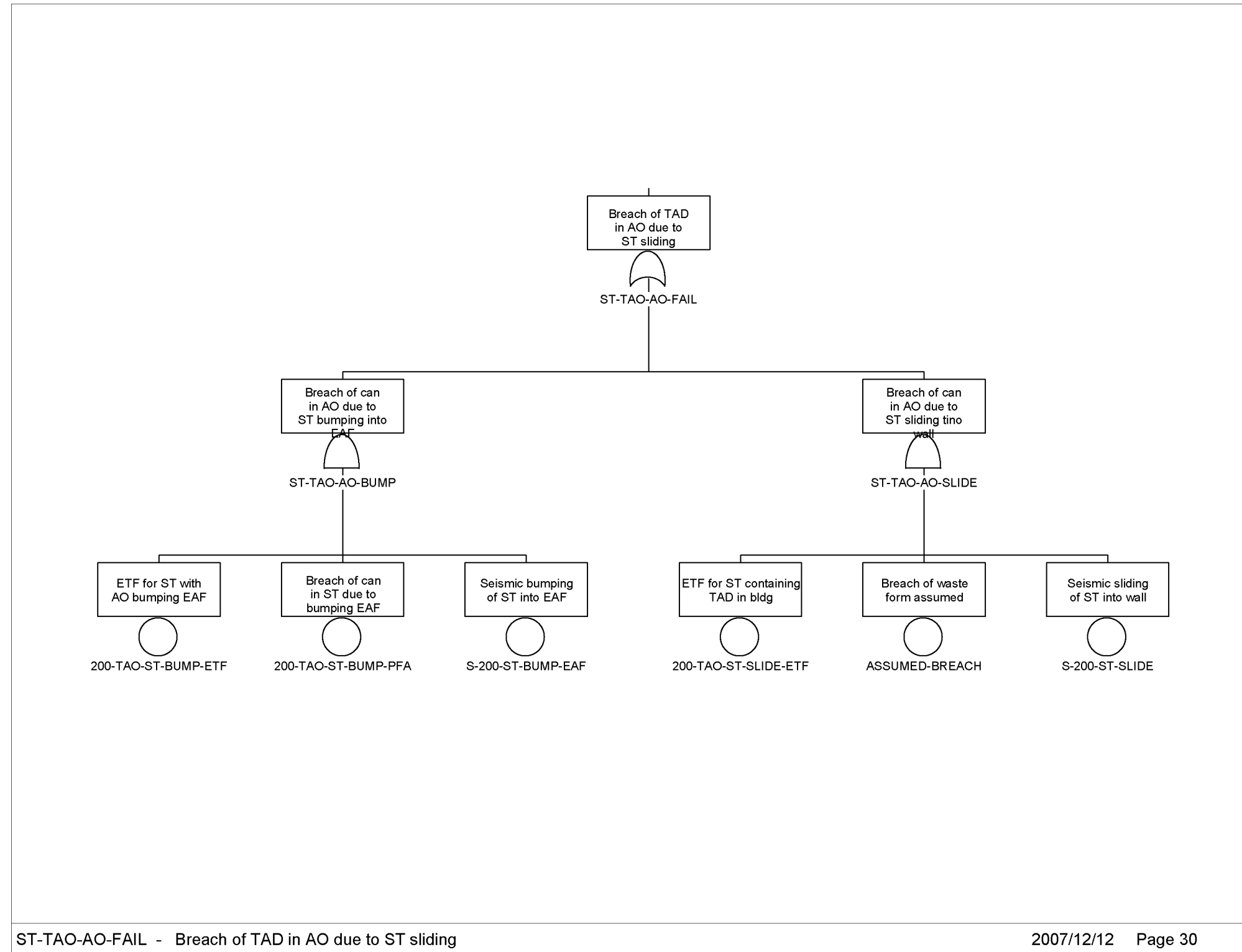

Source: Original

Figure B2.2-23. ST-TAO-AO-FAIL – Breach of TAD in AO due to ST Sliding

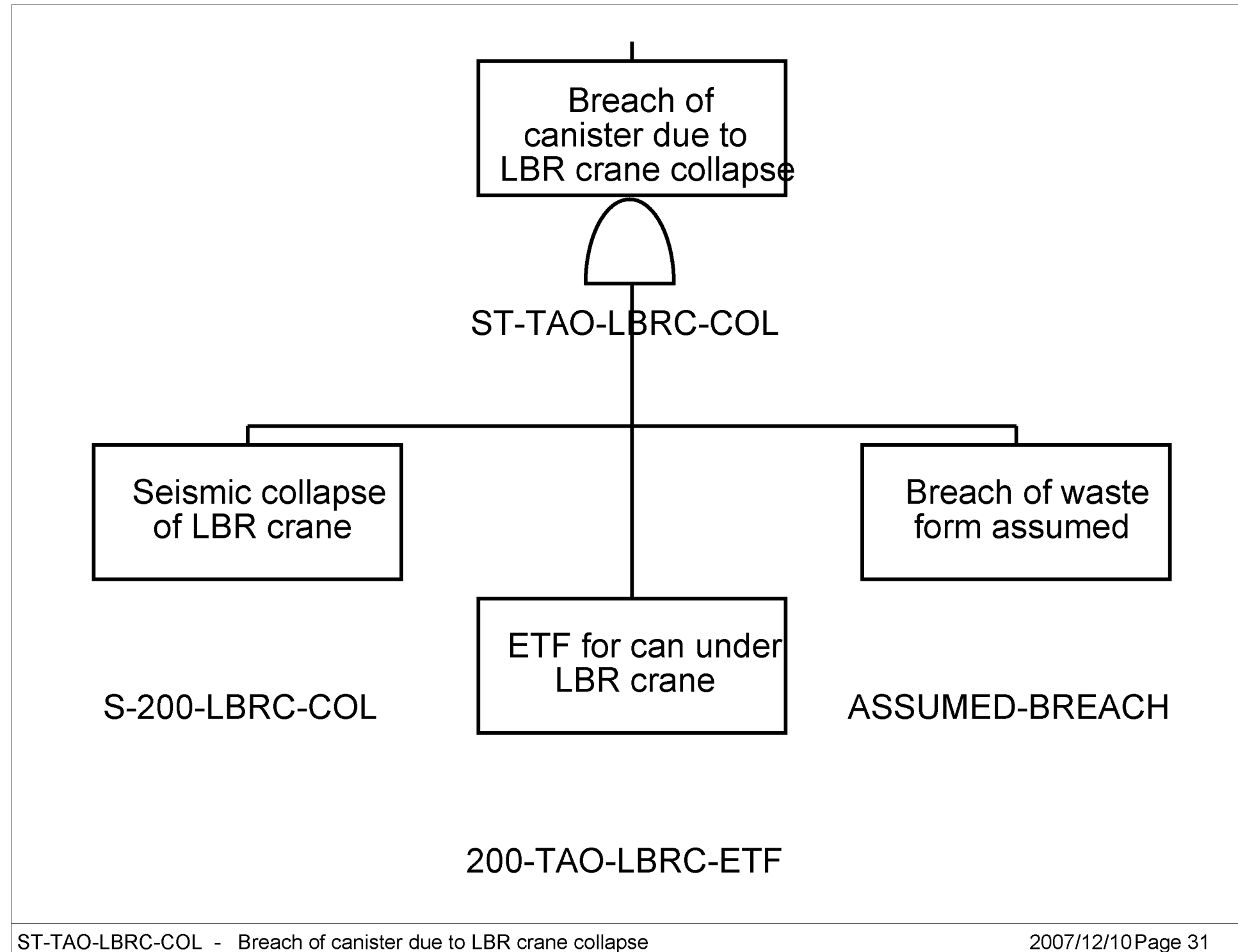

Source: Original

Figure B2.2-24. ST-TAO-LBRC-COL – Breach of Canister due to LBR Crane Collapse

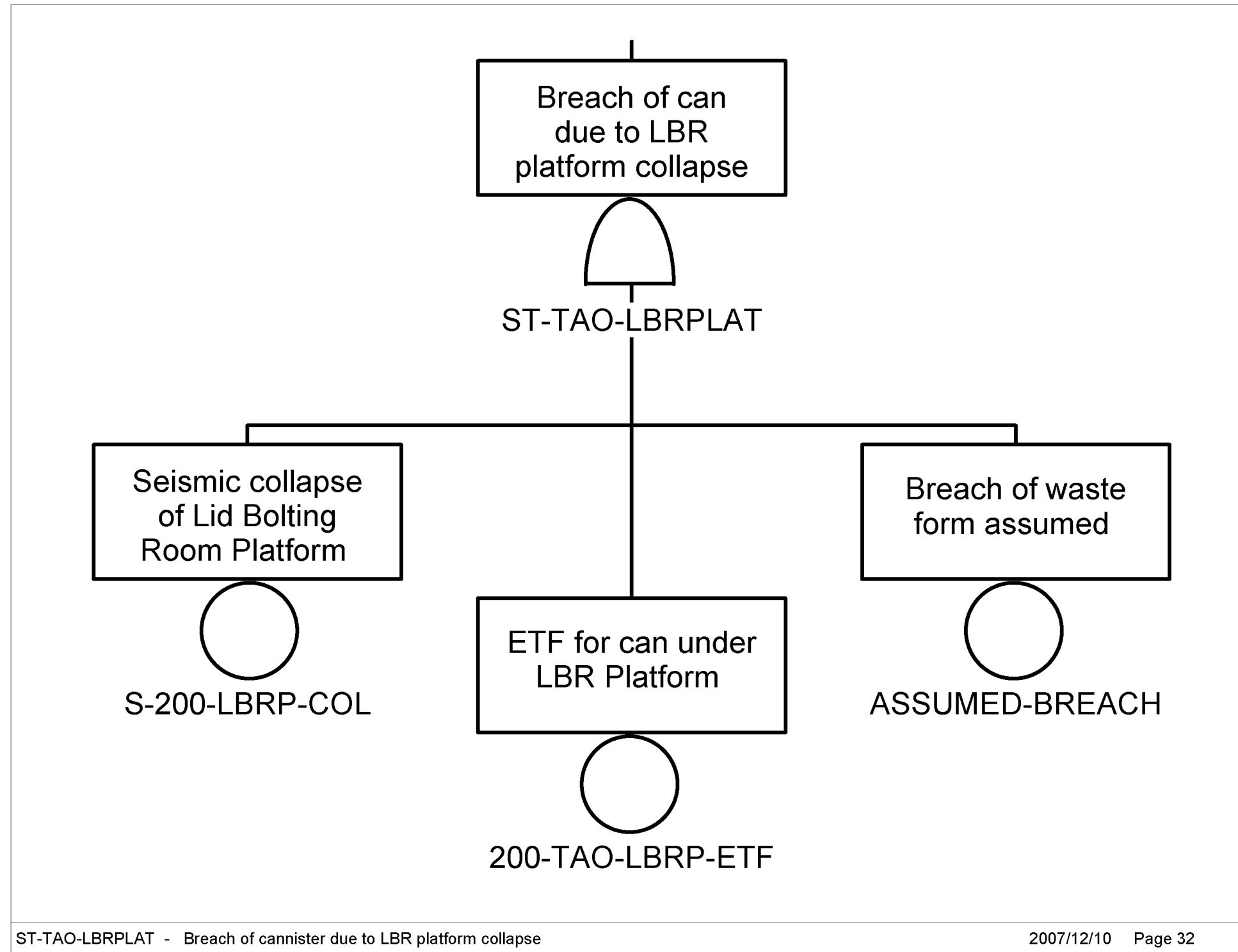

Source: Original

Figure B2.2-25. ST-TAO-LBRPLAT – Breach of Canister due to LBR Platform Collapse

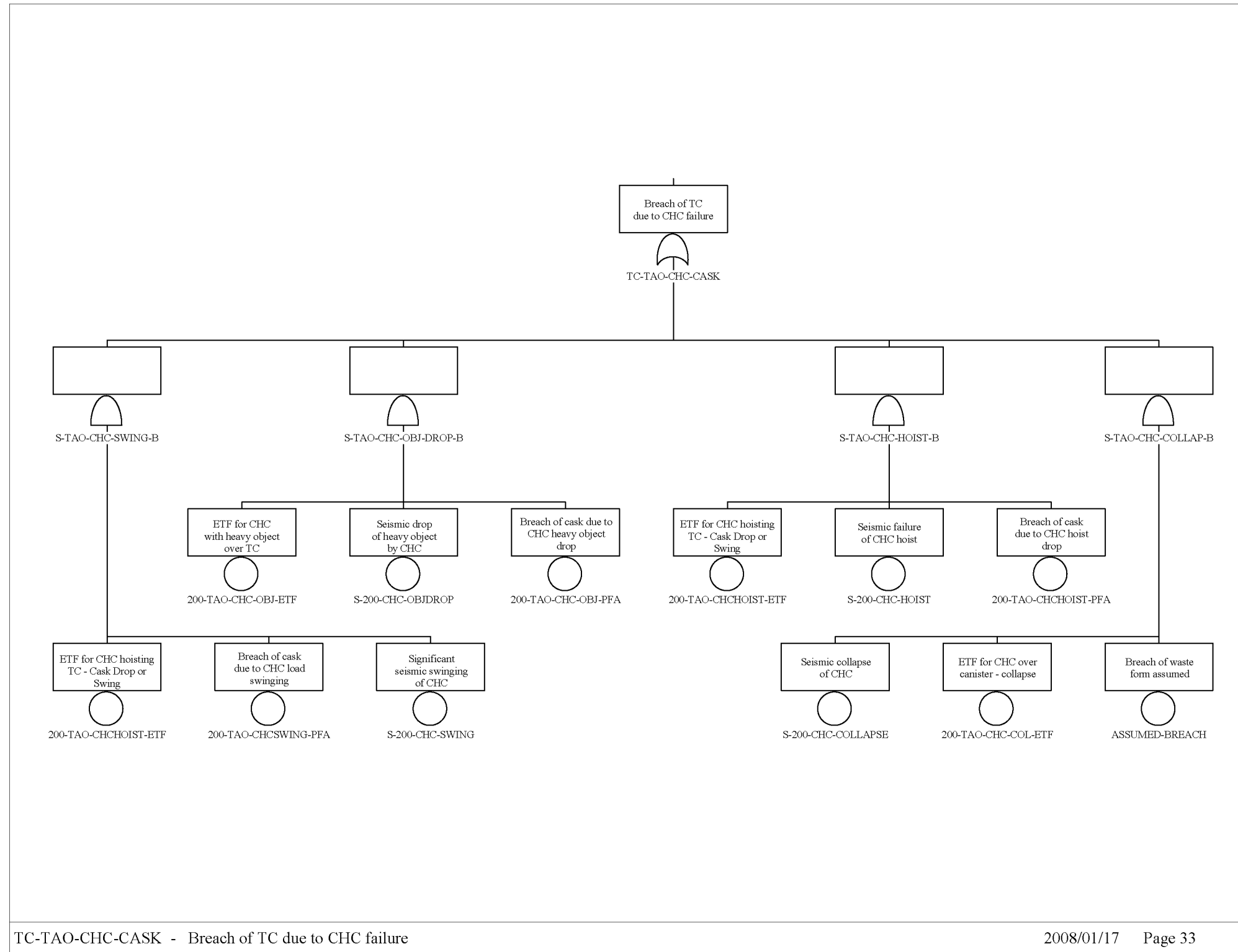

Source: Original

Figure B2.2-26 TC-TAO-CHC-CASK – Breach of TC due to CHC Failure

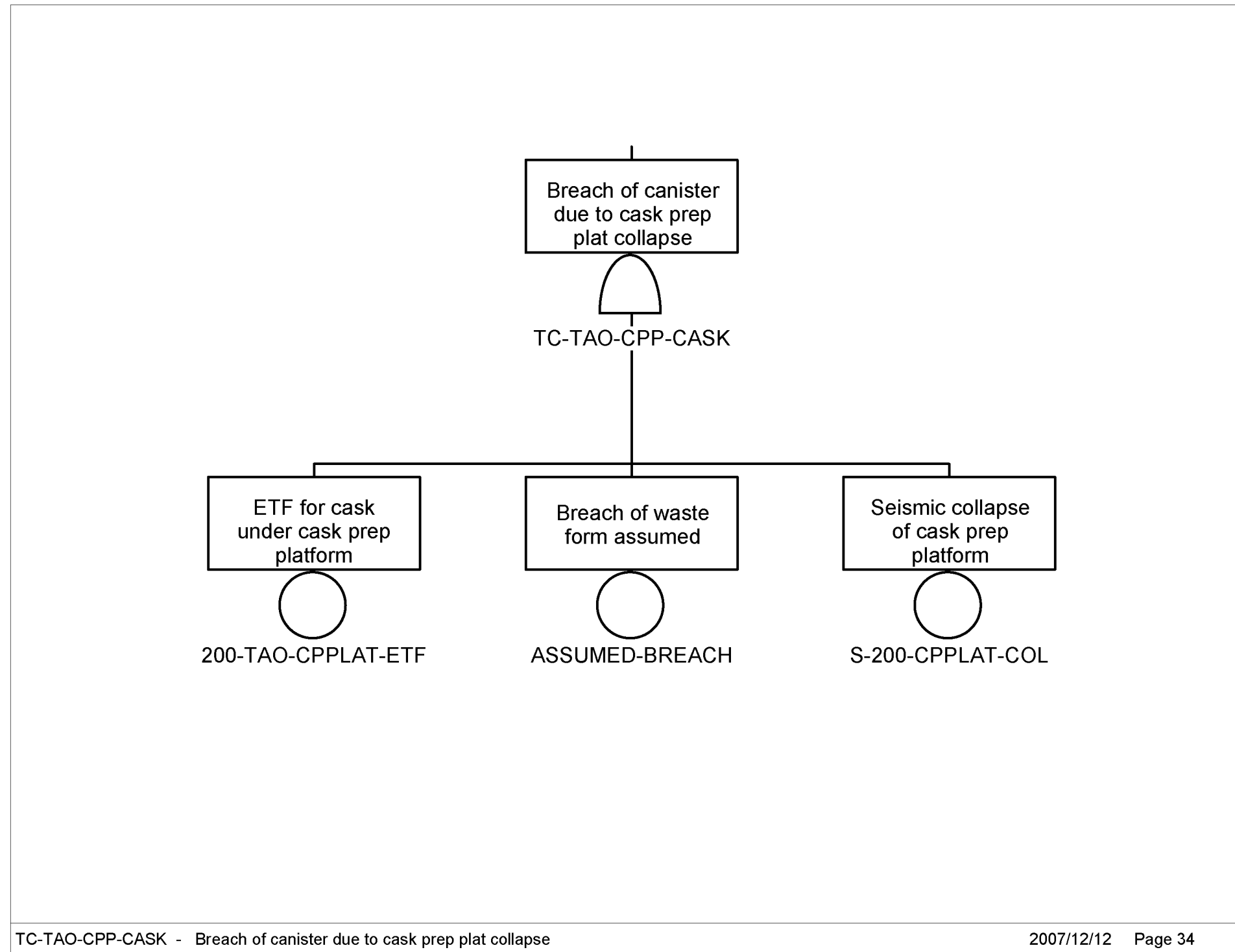

Source: Original

Figure B2.2-27. TC-TAO-CPP-CASK – Breach of Canister due to Cask Prep Plat Collapse

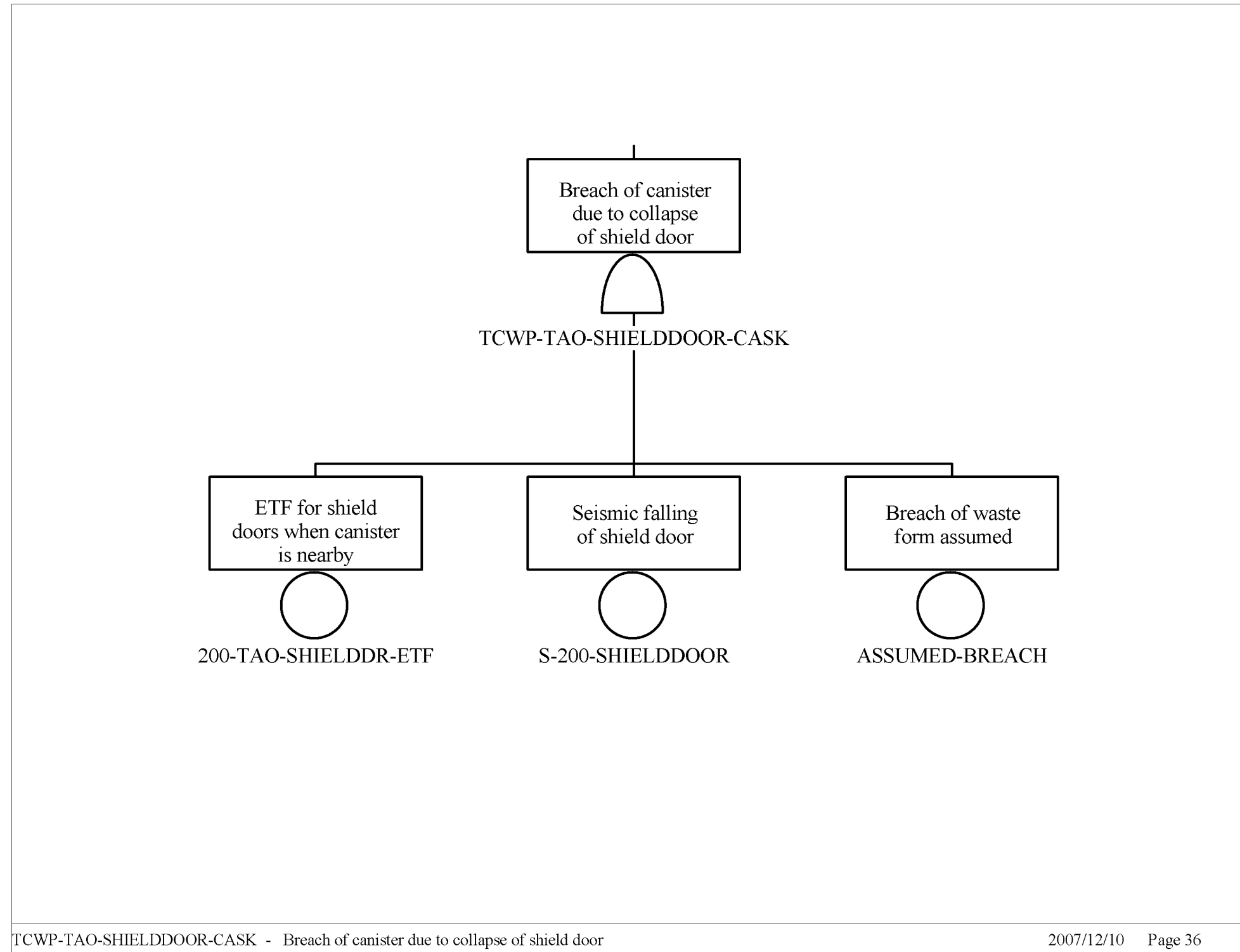

Source: Original

Figure B2.2-28. TCWP-TAO-SHIELDDOOR-CASK – Breach of Canister due to Collapse of Shield Door

B2.3 BASIC EVENT DATA

B2.3.1 Non-seismic Basic Event Data

The following table presents the basic event identifier used in the fault trees, the description of the basic event, and the failure probability (or other numeric data) of the basic event. For exposure time factors (denoted with “ETF” at the end of the basic event identifier), the value given is the time, in years, that one waste form container is exposed to the seismic failure mode.

Table B2.3-1. Non-seismic Basic Event Data

Name	Description	Calc. Probability
200-TAO-CHC-COL-ETF	ETF for CHC over canister - collapse	1.050E-003
200-TAO-CHC-OBJ-ETF	ETF for CHC with heavy object over TC	3.420E-004
200-TAO-CHC-OBJ-PFA	Breach of cask due to CHC heavy object drop	1.000E-005
200-TAO-CHCHOIST-ETF	ETF for CHC hoisting TC - cask drop or swing	1.140E-004
200-TAO-CHCHOIST-PFA	Breach of cask due to CHC hoist drop	1.000E-005
200-TAO-CHCSWING-PFA	Breach of cask due to CHC load swinging	1.000E-005
200-TAO-CPPLAT-ETF	ETF for cask under cask prep platform	6.340E-004
200-TAO-CTM-COL-ETF	ETF for CTM over canister - collapse	1.690E-004
200-TAO-CTM-OBJ-ETF	ETF for CTM with heavy object over TC	4.570E-005
200-TAO-CTM-OBJ-PFA	Breach of canister due to CTM object drop	1.000E-005
200-TAO-CTMHOIST-ETF	ETF for CTM hoisting canister - drop	6.090E-005
200-TAO-CTMHOIST-PFA	Breach of canister dropped by CTM	1.000E-005
200-TAO-CTMMC-ETF	ETF for can under CTM maint. crane	8.470E-005
200-TAO-CTMSWGIB-ETF	ETF for CTM hoisting canister inside bell	6.090E-005
200-TAO-CTMSWGIB-PFA	Breach of canister due to swing inside bell	1.000E-005
200-TAO-CTMSWGOB-ETF	ETF for CTM hoisting canister outside bell	3.810E-005
200-TAO-CTT-BUMP-ETF	ETF for CTT with TC subject to bumping EAF	6.050E-004
200-TAO-CTT-BUMP-PFA	Breach given CTT with TC subject to bumping EAF	1.000E-005
200-TAO-CTT-ROCK-ETF	ETF for CTT with TC subject to rocking/tipover	9.510E-005
200-TAO-CTTSLIDE-ETF	ETF for CTT containing TC in transfer cell	2.340E-004
200-TAO-ENTDOOR-ETF	ETF for entry door over transport cask	7.230E-005
200-TAO-ENTDOOR-PFA	Breach of TC due to entry door collapse	1.000E-005
200-TAO-LBRC-ETF	ETF for can under LBR crane	5.690E-004
200-TAO-LBRP-ETF	ETF for can under LBR platform	5.690E-004
200-TAO-MOBPLAT-ETF	ETF for mobile platform over TC	3.730E-004
200-TAO-MOBPLAT-PFA	Breach of TC due to mobile platform collapse	1.000E-005
200-TAO-RAILCAR-ETF	ETF for railcar carrying transport cask	7.170E-004
200-TAO-RAILCAR-PFA	Breach of TC due to railcar accident	1.000E-005
200-TAO-SHIELDOR-ETF	ETF for shield doors when canister is nearby	1.210E-003
200-TAO-ST-BUMP-ETF	ETF for ST with AO bumping EAF	5.590E-004
200-TAO-ST-BUMP-PFA	Breach of can in ST due to bumping EAF	1.000E-005

Table B2.3-1. Non-seismic Basic Event Data (Continued)

Name	Description	Calc. Probability
200-TAO-ST-SLIDE-ETF	ETF for ST containing TAD in bldg	1.860E-004
200-TAO-STRUCTUR-ETF	ETF for TAO canister in RF structure	2.400E-003
ASSUMED-BREACH	Breach of waste form assumed	1.000E+000
MOD-ENTER-CANISTER	Flooding or spray enters canister	1.000E-002
RF-DP-VERT	Number of DPCs transferred to AO	3.460E+002
SHIELD-AO	Shielding remains intact	1.000E-005
SHIELDING	WP remains within WPTT shielding	1.000E-005
200-TAO-CHC-COL-ETF	ETF for CHC over canister - collapse	1.050E-003
200-TAO-CHC-OBJ-ETF	ETF for CHC with heavy object over TC	3.420E-004

NOTE: The basic event "ASSUMED-BREACH" is not an assumption, but is common terminology used to denote a scenario where the waste container is conservatively considered to be breached; AO = aging overpack; CHC = cask handling crane; CTM = canister transfer machine; CTT = cask transfer trolley; DPC = dual-purpose canister; EAF = energy absorbing feature; ETF = exposure time factor; LBR = Lid Bolting Room; RF = Receipt Facility; ST = site transporter; TAD = transportation, aging, and disposal; TC = transportation cask; WP = waste package; WPTT = waste package transfer trolley.

Source: Sections 6.2.2.23 and 6.3.3, Table 6.3-1, Table 6.3-2, Table 6.5-1

B2.3.2 Seismic Basic Event Fragility Data

The following table provides the seismic failure basic event identifier, description, median fragility, and composite uncertainty.

Table B2.3-2. Seismic Basic Event Fragility Data

Event Name	Description	Med. Fragility (g)	Beta C
S-200-CHC-COLLAPSE	Seismic collapse of CHC	2.790E+000	4.500E-001
S-200-CHC-HOIST	Seismic failure of CHC hoist	2.280E+000	5.000E-001
S-200-CHC-OBJDROP	Seismic drop of heavy object by CHC	2.280E+000	5.000E-001
S-200-CHC-SWING	Significant seismic swinging of CHC	1.140E+000	4.000E-001
S-200-CTM-COLLAPSE	Seismic collapse of CTM	2.390E+000	4.500E-001
S-200-CTM-HOIST	Seismic drop of canister hoisted by CTM	2.280E+000	5.000E-001
S-200-CTM-OBJDROP	Seismic drop of heavy object by CTM	2.280E+000	5.000E-001
S-200-CTMMC-COL	Seismic collapse of CTM maint. crane	2.790E+000	4.500E-001
S-200-CTMSWG-IB	Significant swinging of canister inside CTM bell	1.140E+000	4.000E-001
S-200-CTMSWG-OB	Significant swinging of canister outside CTM bell	9.100E-001	4.000E-001
S-200-CTT-BUMPING	Seismic bumping of CTT into EAF	2.250E+000	4.100E-001
S-200-CTT-ROCKING	Seismic rocking of CTT with restraint failure	2.250E+000	4.100E-001
S-200-CTT-SLIDE	Seismic sliding of CTT into wall	3.080E+000	5.800E-001
S-200-ENTDOORCOL	Seismic collapse of entry door	3.700E-001	4.000E-001

Table B2.3-2. Seismic Basic Event Fragility Data (Continued)

Event Name	Description	Med. Fragility (g)	Beta C
S-200-FPW-V-SO	Spurious opening of FPW pre-action valve (relay chatter)	3.000E+000	4.000E-001
S-200-LBRC-COL	Seismic collapse of LBR crane	2.790E+000	4.500E-001
S-200-LBRP-COL	Seismic collapse of Lid Bolting Room platform	3.500E+000	4.000E-001
S-200-MOBPLAT-COLLAP	Seismic collapse of mobile platform	3.700E-001	4.000E-001
S-200-PIPING-FAIL	Seismic failure of piping in accident area	7.600E-001	4.000E-001
S-200-RAILCAR-ACC	Seismic tipover or collision of railcar	4.500E-001	4.000E-001
S-200-SHIELDDOOR	Seismic falling of shield door	2.920E+000	4.400E-001
S-200-ST-BUMP-EAF	Seismic bumping of ST into EAF	1.890E+000	4.200E-001
S-200-ST-SLIDE	Seismic sliding of ST into wall	1.890E+000	4.200E-001
S-200-STR-COLLAPSE	Seismic collapse of RF structure	5.250E+000	4.000E-001

NOTE: CHC = cask handling crane; CTM = canister transfer machine; CTT = cask transfer trolley; EAF = energy absorbing feature; FPW = fire protection water; LBR = Lid Bolting Room; RF = Receipt Facility; ST = site transporter.

Source: Table 6.2-1 and Table 6.2-2

B2.4 EVENT SEQUENCE QUANTIFICATION

This section provides the quantification results by sequence. The event sequence probabilities are provided first, and the cut sets are provided afterwards.

B2.4.1 Sequence Level Results

Table B2.4-1. Sequence Level Results

Event Tree	Sequence	Base Min. Cut	Base Cut Sets
RF-S-IE-DP-VERT	03	3.430E-007	1
RF-S-IE-DP-VERT	04-2	2.521E-010	1
RF-S-IE-DP-VERT	04-3	+0.000E+000	1
RF-S-IE-DP-VERT	04-4	+0.000E+000	1
RF-S-IE-DP-VERT	04-5	+0.000E+000	1
RF-S-IE-DP-VERT	04-6	2.521E-010	1
RF-S-IE-DP-VERT	04-7	5.094E-013	1
RF-S-IE-DP-VERT	05-2	1.714E-009	1
RF-S-IE-DP-VERT	05-3	+0.000E+000	1
RF-S-IE-DP-VERT	05-4	+0.000E+000	1
RF-S-IE-DP-VERT	05-5	+0.000E+000	1
RF-S-IE-DP-VERT	05-6	1.714E-009	1
RF-S-IE-DP-VERT	05-7	4.631E-012	1
RF-S-IE-DP-VERT	06-2	1.301E-009	1
RF-S-IE-DP-VERT	06-3	+0.000E+000	1

Table B2.4-1. Sequence Level Results (Continued)

Event Tree	Sequence	Base Min. Cut	Base Cut Sets
RF-S-IE-DP-VERT	06-4	+0.000E+000	1
RF-S-IE-DP-VERT	06-5	+0.000E+000	1
RF-S-IE-DP-VERT	06-6	1.301E-009	1
RF-S-IE-DP-VERT	06-7	2.628E-012	1
RF-S-IE-DP-VERT	07-2	6.347E-011	3
RF-S-IE-DP-VERT	07-3	+0.000E+000	1
RF-S-IE-DP-VERT	07-4	+0.000E+000	1
RF-S-IE-DP-VERT	07-5	+0.000E+000	1
RF-S-IE-DP-VERT	07-6	2.851E-006	4
RF-S-IE-DP-VERT	07-7	2.683E-008	4
RF-S-IE-DP-VERT	08-2		0
RF-S-IE-DP-VERT	08-3	+0.000E+000	1
RF-S-IE-DP-VERT	08-4	+0.000E+000	1
RF-S-IE-DP-VERT	08-5	+0.000E+000	1
RF-S-IE-DP-VERT	08-6	5.782E-007	1
RF-S-IE-DP-VERT	08-7	5.676E-009	1
RF-S-IE-DP-VERT	09-2	2.841E-011	1
RF-S-IE-DP-VERT	09-3	+0.000E+000	1
RF-S-IE-DP-VERT	09-4	+0.000E+000	1
RF-S-IE-DP-VERT	09-5	+0.000E+000	1
RF-S-IE-DP-VERT	09-6	1.279E-006	3
RF-S-IE-DP-VERT	09-7	1.792E-009	3
RF-S-IE-DP-VERT	10-2		0
RF-S-IE-DP-VERT	10-3	+0.000E+000	1
RF-S-IE-DP-VERT	10-4	+0.000E+000	1
RF-S-IE-DP-VERT	10-5	+0.000E+000	1
RF-S-IE-DP-VERT	10-6	2.686E-006	1
RF-S-IE-DP-VERT	10-7	2.557E-008	1
RF-S-IE-DP-VERT	11-2	2.531E-011	3
RF-S-IE-DP-VERT	11-3	+0.000E+000	1
RF-S-IE-DP-VERT	11-4	+0.000E+000	1
RF-S-IE-DP-VERT	11-5	2.755E-006	5
RF-S-IE-DP-VERT	11-6	1.722E-009	5
RF-S-IE-DP-VERT	12-2		0
RF-S-IE-DP-VERT	12-3	+0.000E+000	1
RF-S-IE-DP-VERT	12-4	+0.000E+000	1
RF-S-IE-DP-VERT	12-5	2.300E-007	1
RF-S-IE-DP-VERT	12-6	4.270E-010	1
RF-S-IE-DP-VERT	13-2	4.624E-011	1
RF-S-IE-DP-VERT	13-3	+0.000E+000	1
RF-S-IE-DP-VERT	13-4	+0.000E+000	1

Table B2.4-1. Sequence Level Results (Continued)

Event Tree	Sequence	Base Min. Cut	Base Cut Sets
RF-S-IE-DP-VERT	13-5	1.539E-006	2
RF-S-IE-DP-VERT	13-6	1.767E-009	2
RF-S-IE-DP-VERT	14-2		0
RF-S-IE-DP-VERT	14-3	+0.000E+000	1
RF-S-IE-DP-VERT	14-4	+0.000E+000	1
RF-S-IE-DP-VERT	14-5	5.190E-007	1
RF-S-IE-DP-VERT	14-6	1.526E-009	1
RF-S-IE-DP-VERT	15-2		0
RF-S-IE-DP-VERT	15-3	+0.000E+000	1
RF-S-IE-DP-VERT	15-4	+0.000E+000	1
RF-S-IE-DP-VERT	15-5	1.545E-006	1
RF-S-IE-DP-VERT	15-6	2.869E-009	1

Source: Original

B2.4.2 Cut Set Level Results by Sequence

Note that the SAPHIRE software does not provide special tables for seismic cut sets. Therefore, the “Cut Set %” given in the third column of this table is not correct for seismic events, although it does provide the approximate rank order for the cut sets.

Table B2.4-2. Cut Set Level Results by Sequence

Event Tree	Sequence	Cut Set %	Basic Event	Description
RF-S-IE-DP-VERT	03	100.00	200-TAO-STRUCTUR-ETF	ETF for TAO canister in RF structure
			RF-DP-VERT	Number of DPCs transferred to AO
			S-200-STR-COLLAPSE	Seismic collapse of RF structure
			= Total	
	04-2	100.00	200-TAO-ENTDOOR-ETF	ETF for entry door over transport cask
			RF-DP-VERT	Number of DPCs transferred to AO
			S-200-ENTDOORCOL	Seismic collapse of entry door
			SHIELDING	WP remains within WPTT shielding
			= Total	
	04-3	0.00	<FALSE>	System Generated Success Event
			= Total	
	04-4	0.00	<FALSE>	System Generated Success Event

Table B2.4-2. Cut Set Level Results by Sequence (Continued)

Event Tree	Sequence	Cut Set %	Basic Event	Description
			= Total	
	04-5	0.00	<FALSE>	System Generated Success Event
			= Total	
	04-6	100.00	200-TAO-ENTDOOR-ETF	ETF for entry door over transport cask
			200-TAO-ENTDOOR-PFA	Breach of TC due to entry door collapse
			RF-DP-VERT	Number of DPCs transferred to AO
			S-200-ENTDOORCOL	Seismic collapse of entry door
			= Total	
	04-7	100.00	200-TAO-ENTDOOR-ETF	ETF for entry door over transport cask
			200-TAO-ENTDOOR-PFA	Breach of TC due to entry door collapse
			MOD-ENTER-CANISTER	Flooding or spray enters canister
			RF-DP-VERT	Number of DPCs transferred to AO
			S-200-ENTDOORCOL	Seismic collapse of entry door
			S-200-PIPING-FAIL	Seismic failure of piping in accident area
			= Total	
	05-2	100.00	200-TAO-RAILCAR-ETF	ETF for railcar carrying transport cask
			RF-DP-VERT	Number of DPCs transferred to AO
			S-200-RAILCAR-ACC	Seismic tipover or collision of railcar
			SHIELDING	WP remains within WPTT shielding
			= Total	
	05-3	0.00	<FALSE>	System Generated Success Event
			= Total	
	05-4	0.00	<FALSE>	System Generated Success Event
			= Total	
	05-5	0.00	<FALSE>	System Generated Success Event
			= Total	

Table B2.4-2. Cut Set Level Results by Sequence (Continued)

Event Tree	Sequence	Cut Set %	Basic Event	Description
	05-6	100.00	200-TAO-RAILCAR-ETF	ETF for railcar carrying transport cask
			200-TAO-RAILCAR-PFA	Breach of TC due to railcar accident
			RF-DP-VERT	Number of DPCs transferred to AO
			S-200-RAILCAR-ACC	Seismic tipover or collision of railcar
			= Total	
	05-7	100.00	200-TAO-RAILCAR-ETF	ETF for railcar carrying transport cask
			200-TAO-RAILCAR-PFA	Breach of TC due to railcar accident
			MOD-ENTER-CANISTER	Flooding or spray enters canister
			RF-DP-VERT	Number of DPCs transferred to AO
			S-200-PIPING-FAIL	Seismic failure of piping in accident area
			S-200-RAILCAR-ACC	Seismic tipover or collision of railcar
			= Total	
	06-2	100.00	200-TAO-MOBPLAT-ETF	ETF for mobile platform over TC
			RF-DP-VERT	Number of DPCs transferred to AO
			S-200-MOBPLAT-COLLAP	Seismic collapse of mobile platform
			SHIELDING	WP remains within WPTT shielding
			= Total	
	06-3	0.00	<FALSE>	System Generated Success Event
			= Total	
	06-4	0.00	<FALSE>	System Generated Success Event
			= Total	
	06-5	0.00	<FALSE>	System Generated Success Event
			= Total	
	06-6	100.00	200-TAO-MOBPLAT-ETF	ETF for mobile platform over TC
			200-TAO-MOBPLAT-PFA	Breach of TC due to mobile platform collapse
			RF-DP-VERT	Number of DPCs transferred to AO

Table B2.4-2. Cut Set Level Results by Sequence (Continued)

Event Tree	Sequence	Cut Set %	Basic Event	Description
			S-200-MOBPLAT-COLLAP	Seismic collapse of mobile platform
			= Total	
	06-7	100.00	200-TAO-MOBPLAT-ETF	ETF for mobile platform over TC
			200-TAO-MOBPLAT-PFA	Breach of TC due to mobile platform collapse
			MOD-ENTER-CANISTER	Flooding or spray enters canister
			RF-DP-VERT	Number of DPCs transferred to AO
			S-200-MOBPLAT-COLLAP	Seismic collapse of mobile platform
			S-200-PIPING-FAIL	Seismic failure of piping in accident area
			= Total	
	07-2	81.06	200-TAO-CHCHOIST-ETF	ETF for CHC hoisting TC - cask drop or swing
			RF-DP-VERT	Number of DPCs transferred to AO
			S-200-CHC-SWING	Significant seismic swinging of CHC
			SHIELDING	WP remains within WPTT shielding
		14.20	200-TAO-CHC-OBJ-ETF	ETF for CHC with heavy object over TC
			RF-DP-VERT	Number of DPCs transferred to AO
			S-200-CHC-OBJDROP	Seismic drop of heavy object by CHC
			SHIELDING	WP remains within WPTT shielding
		4.73	200-TAO-CHCHOIST-ETF	ETF for CHC hoisting TC - cask drop or swing
			RF-DP-VERT	Number of DPCs transferred to AO
			S-200-CHC-HOIST	Seismic failure of CHC hoist
			SHIELDING	WP remains within WPTT shielding
			= Total	
	07-3	0.00	<FALSE>	System Generated Success Event
			= Total	
	07-4	0.00	<FALSE>	System Generated Success Event
			= Total	

Table B2.4-2. Cut Set Level Results by Sequence (Continued)

Event Tree	Sequence	Cut Set %	Basic Event	Description
	07-5	0.00	<FALSE>	System Generated Success Event
			= Total	
	07-6	99.95	200-TAO-CHC-COL-ETF	ETF for CHC over canister - collapse
			RF-DP-VERT	Number of DPCs transferred to AO
			S-200-CHC-COLLAPSE	Seismic collapse of CHC
		0.04	200-TAO-CHCHOIST-ETF	ETF for CHC hoisting TC - cask drop or swing
			200-TAO-CHCSWING-PFA	Breach of cask due to CHC load swinging
			RF-DP-VERT	Number of DPCs transferred to AO
			S-200-CHC-SWING	Significant seismic swinging of CHC
		0.01	200-TAO-CHC-OBJ-ETF	ETF for CHC with heavy object over TC
			200-TAO-CHC-OBJ-PFA	Breach of cask due to CHC heavy object drop
			RF-DP-VERT	Number of DPCs transferred to AO
			S-200-CHC-OBJDROP	Seismic drop of heavy object by CHC
		0.00	200-TAO-CHCHOIST-ETF	ETF for CHC hoisting TC - cask drop or swing
			200-TAO-CHCHOIST-PFA	Breach of cask due to CHC hoist drop
			RF-DP-VERT	Number of DPCs transferred to AO
			S-200-CHC-HOIST	Seismic failure of CHC hoist
			= Total	
	07-7	99.95	200-TAO-CHC-COL-ETF	ETF for CHC over canister - collapse
			MOD-ENTER-CANISTER	Flooding or spray enters canister
			RF-DP-VERT	Number of DPCs transferred to AO
			S-200-CHC-COLLAPSE	Seismic collapse of CHC
			S-200-PIPING-FAIL	Seismic failure of piping in accident area
		0.04	200-TAO-CHCHOIST-ETF	ETF for CHC hoisting TC - cask drop or swing
			200-TAO-CHCSWING-PFA	Breach of cask due to CHC load swinging

Table B2.4-2. Cut Set Level Results by Sequence (Continued)

Event Tree	Sequence	Cut Set %	Basic Event	Description
			MOD-ENTER-CANISTER	Flooding or spray enters canister
			RF-DP-VERT	Number of DPCs transferred to AO
			S-200-CHC-SWING	Significant seismic swinging of CHC
			S-200-PIPING-FAIL	Seismic failure of piping in accident area
		0.01	200-TAO-CHC-OBJ-ETF	ETF for CHC with heavy object over TC
			200-TAO-CHC-OBJ-PFA	Breach of cask due to CHC heavy object drop
			MOD-ENTER-CANISTER	Flooding or spray enters canister
			RF-DP-VERT	Number of DPCs transferred to AO
			S-200-CHC-OBJDROP	Seismic drop of heavy object by CHC
			S-200-PIPING-FAIL	Seismic failure of piping in accident area
		0.00	200-TAO-CHCHOIST-ETF	ETF for CHC hoisting TC - cask drop or swing
			200-TAO-CHCHOIST-PFA	Breach of cask due to CHC hoist drop
			MOD-ENTER-CANISTER	Flooding or spray enters canister
			RF-DP-VERT	Number of DPCs transferred to AO
			S-200-CHC-HOIST	Seismic failure of CHC hoist
			S-200-PIPING-FAIL	Seismic failure of piping in accident area
			= Total	
	08-2			
	08-3	0.00	<FALSE>	System Generated Success Event
			= Total	
	08-4	0.00	<FALSE>	System Generated Success Event
			= Total	
	08-5	0.00	<FALSE>	System Generated Success Event
			= Total	
	08-6	100.00	200-TAO-CPPLAT-ETF	ETF for cask under cask prep platform
			RF-DP-VERT	Number of DPCs transferred to AO

Table B2.4-2. Cut Set Level Results by Sequence (Continued)

Event Tree	Sequence	Cut Set %	Basic Event	Description
			S-200-CPPLAT-COL	Seismic collapse of cask prep platform
			= Total	
	08-7	100.00	200-TAO-CPPLAT-ETF	ETF for cask under cask prep platform
			MOD-ENTER-CANISTER	Flooding or spray enters canister
			RF-DP-VERT	Number of DPCs transferred to AO
			S-200-CPPLAT-COL	Seismic collapse of cask prep platform
			S-200-PIPING-FAIL	Seismic failure of piping in accident area
			= Total	
	09-2	100.00	200-TAO-CTT-BUMP-ETF	ETF for CTT with TC subject to bumping EAF
			RF-DP-VERT	Number of DPCs transferred to AO
			S-200-CTT-BUMPING	Seismic bumping of CTT into EAF
			SHIELDING	WP remains within WPTT shielding
			= Total	
	09-3	0.00	<FALSE>	System Generated Success Event
			= Total	
	09-4	0.00	<FALSE>	System Generated Success Event
			= Total	
	09-5	0.00	<FALSE>	System Generated Success Event
			= Total	
	09-6	96.19	200-TAO-CTTSLIDE-ETF	ETF for CTT containing TC in transfer cell
			RF-DP-VERT	Number of DPCs transferred to AO
			S-200-CTT-SLIDE	Seismic sliding of CTT into wall
		3.81	200-TAO-CTT-ROCK-ETF	ETF for CTT with TC subject to rocking/tipover
			RF-DP-VERT	Number of DPCs transferred to AO
			S-200-CTT-ROCKING	Seismic rocking of CTT with restraint failure
		0.00	200-TAO-CTT-BUMP-ETF	ETF for CTT with TC subject to bumping EAF

Table B2.4-2. Cut Set Level Results by Sequence (Continued)

Event Tree	Sequence	Cut Set %	Basic Event	Description
			200-TAO-CTT-BUMP-PFA	Breach given CTT with TC subject to bumping EAF
			RF-DP-VERT	Number of DPCs transferred to AO
			S-200-CTT-BUMPING	Seismic bumping of CTT into EAF
			= Total	
	09-7	96.30	200-TAO-CTTSLIDE-ETF	ETF for CTT containing TC in transfer cell
			MOD-ENTER-CANISTER	Flooding or spray enters canister
			RF-DP-VERT	Number of DPCs transferred to AO
			S-200-CTT-SLIDE	Seismic sliding of CTT into wall
			S-200-FPW-V-SO	Spurious opening of FPW pre-action valve (relay chatter)
			S-200-PIPING-FAIL	Seismic failure of piping in accident area
		3.81	200-TAO-CTT-ROCK-ETF	ETF for CTT with TC subject to rocking/tipover
			MOD-ENTER-CANISTER	Flooding or spray enters canister
			RF-DP-VERT	Number of DPCs transferred to AO
			S-200-CTT-ROCKING	Seismic rocking of CTT with restraint failure
			S-200-FPW-V-SO	Spurious opening of FPW pre-action valve (relay chatter)
			S-200-PIPING-FAIL	Seismic failure of piping in accident area
		0.00	200-TAO-CTT-BUMP-ETF	ETF for CTT with TC subject to bumping EAF
			200-TAO-CTT-BUMP-PFA	Breach given CTT with TC subject to bumping EAF
			MOD-ENTER-CANISTER	Flooding or spray enters canister
			RF-DP-VERT	Number of DPCs transferred to AO
			S-200-CTT-BUMPING	Seismic bumping of CTT into EAF
			S-200-FPW-V-SO	Spurious opening of FPW pre-action valve (relay chatter)
			S-200-PIPING-FAIL	Seismic failure of piping in accident area
			= Total	

Table B2.4-2. Cut Set Level Results by Sequence (Continued)

Event Tree	Sequence	Cut Set %	Basic Event	Description
	10-2			
	10-3	0.00	<FALSE>	System Generated Success Event
			= Total	
	10-4	0.00	<FALSE>	System Generated Success Event
			= Total	
	10-5	0.00	<FALSE>	System Generated Success Event
			= Total	
	10-6	100.00	200-TAO-SHIELDDR-ETF	ETF for shield doors when canister is nearby
			RF-DP-VERT	Number of DPCs transferred to AO
			S-200-SHIELDDOOR	Seismic falling of shield door
			= Total	
	10-7	100.00	200-TAO-SHIELDDR-ETF	ETF for shield doors when canister is nearby
			MOD-ENTER-CANISTER	Flooding or spray enters canister
			RF-DP-VERT	Number of DPCs transferred to AO
			S-200-PIPING-FAIL	Seismic failure of piping in accident area
			S-200-SHIELDDOOR	Seismic falling of shield door
			= Total	
	11-2	90.73	200-TAO-CTMSWGIB-ETF	ETF for CTM hoisting canister inside bell
			RF-DP-VERT	Number of DPCs transferred to AO
			S-200-CTMSWG-IB	Significant swinging of canister inside CTM bell
			SHIELDING	WP remains within WPTT shielding
		5.30	200-TAO-CTMHOIST-ETF	ETF for CTM hoisting canister - drop
			RF-DP-VERT	Number of DPCs transferred to AO
			S-200-CTM-HOIST	Seismic drop of canister hoisted by CTM
			SHIELDING	WP remains within WPTT shielding
		3.98	200-TAO-CTM-OBJ-ETF	ETF for CTM with heavy object over TC

Table B2.4-2. Cut Set Level Results by Sequence (Continued)

Event Tree	Sequence	Cut Set %	Basic Event	Description
			RF-DP-VERT	Number of DPCs transferred to AO
			S-200-CTM- OBJDROP	Seismic drop of heavy object by CTM
			SHIELDING	WP remains within WPTT shielding
			= Total	
	11-3	0.00	<FALSE>	System Generated Success Event
			= Total	
	11-4	0.00	<FALSE>	System Generated Success Event
			= Total	
	11-5	98.82	200-TAO- CTMSWGOB-ETF	ETF for CTM hoisting canister outside bell
			RF-DP-VERT	Number of DPCs transferred to AO
			S-200-CTMSWG- OB	Significant swinging of canister outside CTM bell
		1.18	200-TAO-CTM- COL-ETF	ETF for CTM over canister - collapse
			RF-DP-VERT	Number of DPCs transferred to AO
			S-200-CTM- COLLAPSE	Seismic collapse of CTM
		0.00	200-TAO- CTMSWGIB-ETF	ETF for CTM hoisting canister inside bell
			200-TAO- CTMSWGIB-PFA	Breach of canister due to swing inside bell
			RF-DP-VERT	Number of DPCs transferred to AO
			S-200-CTMSWG- IB	Significant swinging of canister inside CTM bell
		0.00	200-TAO- CTMHOIST-ETF	ETF for CTM hoisting canister - drop
			200-TAO- CTMHOIST-PFA	Breach of canister dropped by CTM
			RF-DP-VERT	Number of DPCs transferred to AO
			S-200-CTM- HOIST	Seismic drop of canister hoisted by CTM
		0.00	200-TAO-CTM- OBJ-ETF	ETF for CTM with heavy object over TC
			200-TAO-CTM- OBJ-PFA	Breach of canister due to CTM object drop
			RF-DP-VERT	Number of DPCs transferred to AO

Table B2.4-2. Cut Set Level Results by Sequence (Continued)

Event Tree	Sequence	Cut Set %	Basic Event	Description
			S-200-CTM- OBJDROP	Seismic drop of heavy object by CTM
			= Total	
	11-6	98.80	200-TAO- CTMSWGOB-ETF	ETF for CTM hoisting canister outside bell
			MOD-ENTER- CANISTER	Flooding or spray enters canister
			RF-DP-VERT	Number of DPCs transferred to AO
			S-200-CTMSWG- OB	Significant swinging of canister outside CTM bell
			S-200-FPW-V-SO	Spurious opening of FPW pre-action valve (relay chatter)
			S-200-PIPING- FAIL	Seismic failure of piping in accident area
		1.18	200-TAO-CTM- COL-ETF	ETF for CTM over canister – collapse
			MOD-ENTER- CANISTER	Flooding or spray enters canister
			RF-DP-VERT	Number of DPCs transferred to AO
			S-200-CTM- COLLAPSE	Seismic collapse of CTM
			S-200-FPW-V-SO	Spurious opening of FPW pre-action valve (relay chatter)
			S-200-PIPING- FAIL	Seismic failure of piping in accident area
		0.00	200-TAO- CTMSWGIB-ETF	ETF for CTM hoisting canister inside bell
			200-TAO- CTMSWGIB-PFA	Breach of canister due to swing inside bell
			MOD-ENTER- CANISTER	Flooding or spray enters canister
			RF-DP-VERT	Number of DPCs transferred to AO
			S-200-CTMSWG- IB	Significant swinging of canister inside CTM bell
			S-200-FPW-V-SO	Spurious opening of FPW pre-action valve (relay chatter)
			S-200-PIPING- FAIL	Seismic failure of piping in accident area
		0.00	200-TAO- CTMHOIST-ETF	ETF for CTM hoisting canister - drop
			200-TAO- CTMHOIST-PFA	Breach of canister dropped by CTM

Table B2.4-2. Cut Set Level Results by Sequence (Continued)

Event Tree	Sequence	Cut Set %	Basic Event	Description
			MOD-ENTER-CANISTER	Flooding or spray enters canister
			RF-DP-VERT	Number of DPCs transferred to AO
			S-200-CTM-HOIST	Seismic drop of canister hoisted by CTM
			S-200-FPW-V-SO	Spurious opening of FPW pre-action valve (relay chatter)
			S-200-PIPING-FAIL	Seismic failure of piping in accident area
		0.00	200-TAO-CTM-OBJ-ETF	ETF for CTM with heavy object over TC
			200-TAO-CTM-OBJ-PFA	Breach of canister due to CTM object drop
			MOD-ENTER-CANISTER	Flooding or spray enters canister
			RF-DP-VERT	Number of DPCs transferred to AO
			S-200-CTM-OBJDROP	Seismic drop of heavy object by CTM
			S-200-FPW-V-SO	Spurious opening of FPW pre-action valve (relay chatter)
			S-200-PIPING-FAIL	Seismic failure of piping in accident area
			= Total	
	12-2			
	12-3	0.00	<FALSE>	System Generated Success Event
			= Total	
	12-4	0.00	<FALSE>	System Generated Success Event
			= Total	
	12-5	100.00	200-TAO-CTMMC-ETF	ETF for can under CTM maint. crane
			RF-DP-VERT	Number of DPCs transferred to AO
			S-200-CTMMC-COL	Seismic collapse of CTM maint. crane
			= Total	
	12-6	98.85	200-TAO-CTMMC-ETF	ETF for can under CTM maint. crane
			MOD-ENTER-CANISTER	Flooding or spray enters canister
			RF-DP-VERT	Number of DPCs transferred to AO

Table B2.4-2. Cut Set Level Results by Sequence (Continued)

Event Tree	Sequence	Cut Set %	Basic Event	Description
			S-200-CTMMC-COL	Seismic collapse of CTM maint. crane
			S-200-FPW-V-SO	Spurious opening of FPW pre-action valve (relay chatter)
			S-200-PIPING-FAIL	Seismic failure of piping in accident area
			= Total	
	13-2	100.00	200-TAO-ST-BUMP-ETF	ETF for ST with AO bumping EAF
			RF-DP-VERT	Number of DPCs transferred to AO
			S-200-ST-BUMP-EAF	Seismic bumping of ST into EAF
			SHIELD-AO	Shielding remains intact
			= Total	
	13-3	0.00	<FALSE>	System Generated Success Event
			= Total	
	13-4	0.00	<FALSE>	System Generated Success Event
			= Total	
	13-5	100.00	200-TAO-ST-SLIDE-ETF	ETF for ST containing TAD in bldg
			RF-DP-VERT	Number of DPCs transferred to AO
			S-200-ST-SLIDE	Seismic sliding of ST into wall
		0.00	200-TAO-ST-BUMP-ETF	ETF for ST with AO bumping EAF
			200-TAO-ST-BUMP-PFA	Breach of can in ST due to bumping EAF
			RF-DP-VERT	Number of DPCs transferred to AO
			S-200-ST-BUMP-EAF	Seismic bumping of ST into EAF
			= Total	
	13-6	99.95	200-TAO-ST-SLIDE-ETF	ETF for ST containing TAD in bldg
			MOD-ENTER-CANISTER	Flooding or spray enters canister
			RF-DP-VERT	Number of DPCs transferred to AO
			S-200-FPW-V-SO	Spurious opening of FPW pre-action valve (relay chatter)
			S-200-PIPING-FAIL	Seismic failure of piping in accident area

Table B2.4-2. Cut Set Level Results by Sequence (Continued)

Event Tree	Sequence	Cut Set %	Basic Event	Description
			S-200-ST-SLIDE	Seismic sliding of ST into wall
		0.00	200-TAO-ST-BUMP-ETF	ETF for ST with AO bumping EAF
			200-TAO-ST-BUMP-PFA	Breach of can in ST due to bumping EAF
			MOD-ENTER-CANISTER	Flooding or spray enters canister
			RF-DP-VERT	Number of DPCs transferred to AO
			S-200-FPW-V-SO	Spurious opening of FPW pre-action valve (relay chatter)
			S-200-PIPING-FAIL	Seismic failure of piping in accident area
			S-200-ST-BUMP-EAF	Seismic bumping of ST into EAF
			= Total	
	14-2			
	14-3	0.00	<FALSE>	System Generated Success Event
			= Total	
	14-4	0.00	<FALSE>	System Generated Success Event
			= Total	
	14-5	100.00	200-TAO-LBRP-ETF	ETF for can under LBR platform
			RF-DP-VERT	Number of DPCs transferred to AO
			S-200-LBRP-COL	Seismic collapse of Lid Bolting Room platform
			= Total	
	14-6	0.00	200-TAO-LBRP-ETF	ETF for can under LBR platform
			MOD-ENTER-CANISTER	Flooding or spray enters canister
			RF-DP-VERT	Number of DPCs transferred to AO
			S-200-FPW-V-SO	Spurious opening of FPW pre-action valve (relay chatter)
			S-200-LBRP-COL	Seismic collapse of Lid Bolting Room platform
			S-200-PIPING-FAIL	Seismic failure of piping in accident area
			= Total	
	15-2			

Table B2.4-2. Cut Set Level Results by Sequence (Continued)

Event Tree	Sequence	Cut Set %	Basic Event	Description
	15-3	0.00	<FALSE>	System Generated Success Event
			= Total	
	15-4	0.00	<FALSE>	System Generated Success Event
			= Total	
	15-5	100.00	200-TAO-LBRC-ETF	ETF for can under LBR crane
			RF-DP-VERT	Number of DPCs transferred to AO
			S-200-LBRC-COL	Seismic collapse of LBR crane
			= Total	
	15-6	100.23	200-TAO-LBRC-ETF	ETF for can under LBR crane
			MOD-ENTER-CANISTER	Flooding or spray enters canister
			RF-DP-VERT	Number of DPCs transferred to AO
			S-200-FPW-V-SO	Spurious opening of FPW pre-action valve (relay chatter)
			S-200-LBRC-COL	Seismic collapse of LBR crane
			S-200-PIPING-FAIL	Seismic failure of piping in accident area
			= Total	
RF-S-IE-DP-VERT	03	100.00	200-TAO-STRUCTUR-ETF	ETF for TAO canister in RF structure
			RF-DP-VERT	Number of DPCs transferred to AO
			S-200-STR-COLLAPSE	Seismic collapse of RF structure
			= Total	

NOTE: AO = aging overpack; CHC = cask handling crane; CTM = canister transfer machine; CTT = cask transfer trolley; DPC = dual-purpose canister; EAF = energy absorbing feature; ETF = exposure time factor; FPW = fire protection water; LBR = Lid Bolting Room; RF = Receipt Facility; ST = site transporter; TAD = transportation, aging, and disposal; TC = transportation cask; WP = waste package; WPTT = waste package transfer trolley.

Source: Original

B3 HORIZONTAL DUAL-PURPOSE CANISTERS

This section provides the detailed information used to develop the event sequences for the analysis of processing of the DPCs which arrive inside a horizontal transportation cask in the RF. DPCs inside a horizontal transportation cask are received on railcars, transferred to a cask transfer trailer, and then transported in the cask transfer trailer out of the RF.

B3.1 EVENT TREES

The IET and SRETs are presented in this section. The tables provide the assignments between the event tree branches and the fault trees given in the next section.

Seismic Event	Number of Horizontal DP canisters	Identify initiating seismic failure		
SEIS-EVENT	RF-DP-HOR	SEIS-FAIL	#	END-STATE
			1	OK
			2	OK
		RF building collapse	3	RR-UNF
		Entry door seismic collapse	4	T => 2 RF-S-R-TC1
		Railcar accident	5	T => 2 RF-S-R-TC1
		Mobile platform seismic collapse	6	T => 2 RF-S-R-TC1
		CHC seismic failures	7	T => 2 RF-S-R-TC1
		Horizontal cask stand tipover	8	T => 2 RF-S-R-TC1
		Cask Transfer Trailer Tipover	9	T => 2 RF-S-R-TC1

RF-S-IE-DP-HOR - RF Seismic Event Tree - Initiating Seismic Failures - Horizontal DP

2008/01/07

Page 1

NOTE: Event tree branch captions are associated with the branch line below the caption.

CHC = cask handling crane; CTM = canister transfer machine; DP = dual-purpose; HOR = horizontal; IE = initiating event; NUM = number; RESP = response; RF = Receipt Facility; SEIS = seismic; TC = transportation cask; T = transfer; TC = transportation cask; UNF = unfiltered.

Source: Original

Figure B3.1-1. RF Seismic Event Tree RF-S-IE-DP-HOR – Initiating Seismic Failures – Horizontal DP

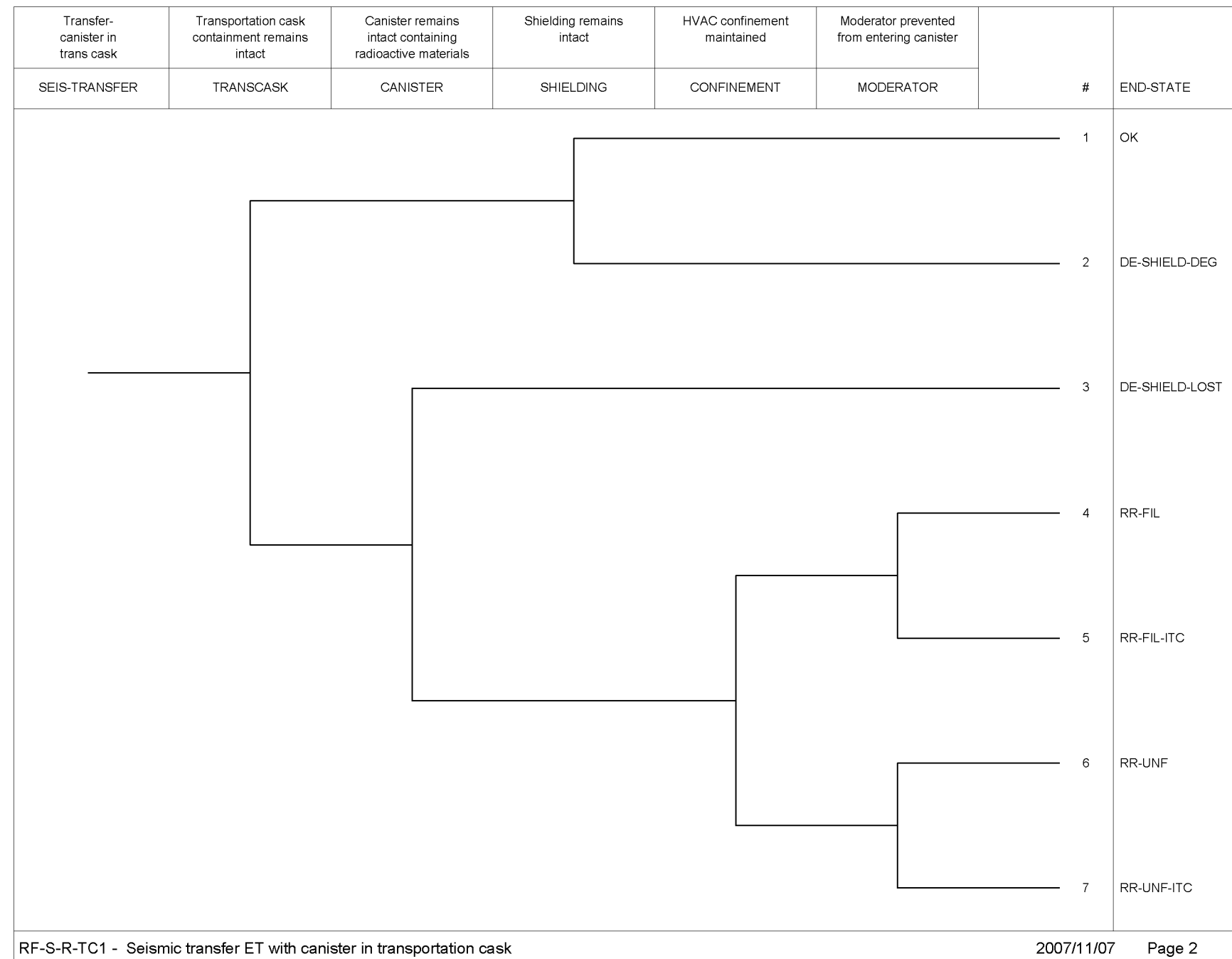

NOTE: DE = direct exposure; DEG = degradation; ET = event tree; FIL = filtered; HVAC = heating, ventilation and air conditioning; INIT = initiating; ITC = important to criticality; RF = Receipt Facility; RR = radioactive release; SEIS = seismic; TC = transportation cask; UNF = unfiltered.

Source: Original

Figure B3.1-2. RF Seismic Event Tree RF-S-R-TC1 – Seismic Transfer ET with Canister in Transportation Cask

Table B3.1-1. Fault Trees Assigned for Initiating Seismic Failures for the RF

Process	Initiator Event Tree	Initiating Seismic Failure	Associated Fault Tree
DPC-HTC	RF-S-IE-DP-HOR	RF building collapse	S-200-TAO-STR-COLLAP
		Entry door seismic collapse	S-200-TAO-ENTDOORCOL
		Railcar accident	S-200-TAO-RAILCARACC
		Mobile platform seismic collapse	S-200-TAO-MOBPLATCOL
		CHC seismic failures	S-200-TAO-CHC-FAIL
		Horizontal cask stand tipover	S-200-DPH-CSTAND
		Cask transfer trailer tipover	S-200-DPH-CTRLR

NOTE: CHC = cask handling crane; DPC = dual-purpose canister; HTC = horizontal transportation cask; IE = initiating event; RF = Receipt Facility.

Source: Original

Table B3.1-2. Fault Trees Assigned for Pivotal Events for RF-S-IE-DP-HOR Initiating Event Tree

Initiating Seismic Failure	TRANSCASK	MODERATOR
RF building collapse	N/A	N/A
Entry door seismic collapse	RC-TAO-DOORDROP-CASK	RF-MOD-MULT-SYS
Railcar accident	RC-TAO-RC-ACC-CASK	RF-MOD-MULT-SYS
Mobile platform seismic collapse	RC-TAO-MOB-PLAT-CASK	RF-MOD-MULT-SYS
CHC seismic failures	TC-TAO-CHC-CASK	RF-MOD-MULT-SYS
Horizontal cask stand tipover	TC-DPH-CSTAND	RF-MOD-MULT-SYS
Cask transfer trailer tipover	TC-DPH-CTRLR	RF-MOD-MULT-SYS

NOTE: CHC = cask handling crane; RF = Receipt Facility.

Source: Original

B3.2 FAULT TREES

Seismic fault trees for the processing of horizontal DPCs in the RF are presented in alphanumeric order in this section. Note that the TAD to aging overpack fault trees and basic events presented in B1 above were used as the templates for the DPC fault trees. Therefore, many of the fault tree names and basic event names are the same as for the TAD to aging overpack fault trees and basic events presented in B1 above, although the values for the basic events have been revised to reflect the DPC process. The revisions to the basic event values are given in Section B3.3.

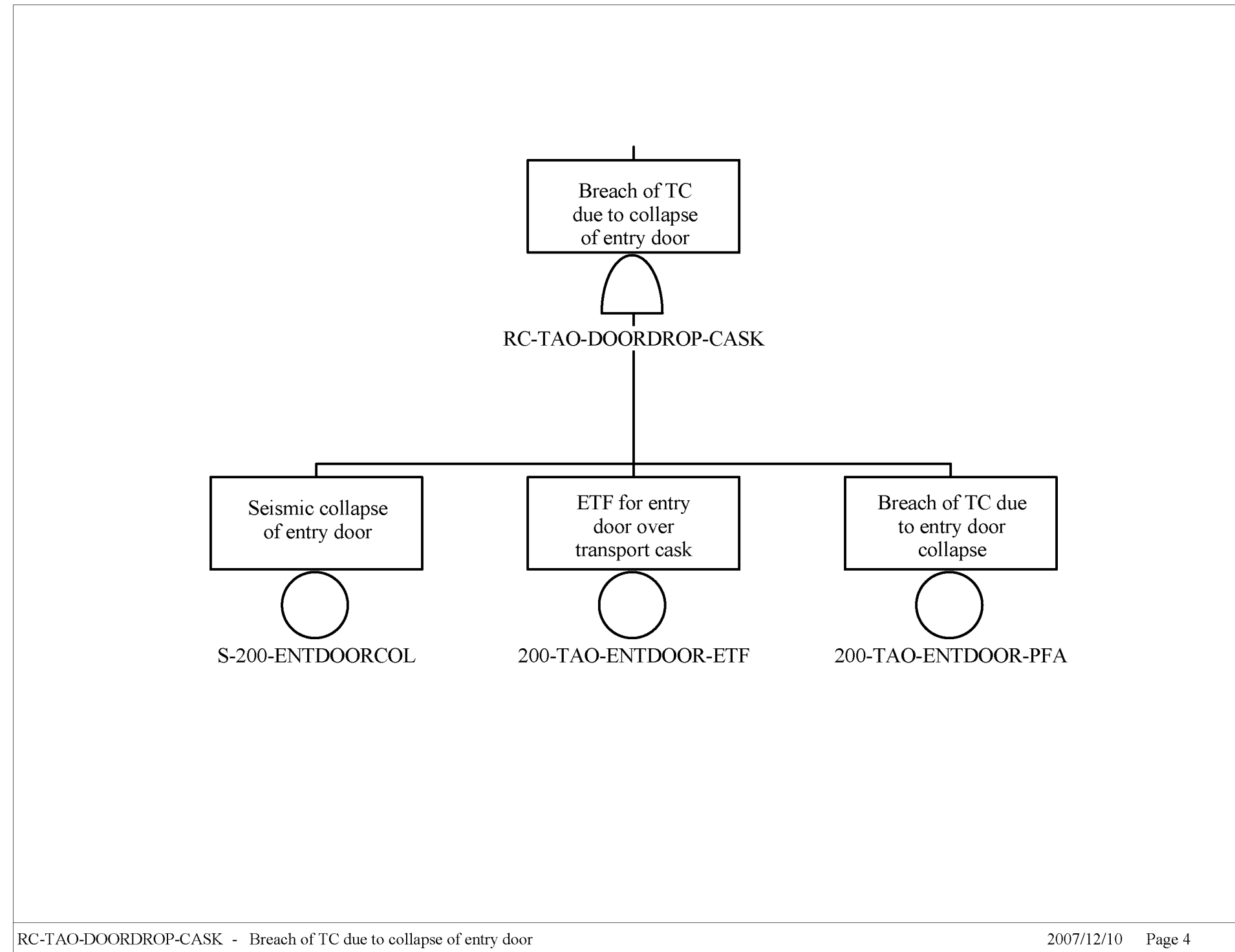

Source Original

Figure B3.2-1. Fault Tree RC-TAO-DOORDROP-CASK – Breach of TC due to Collapse of Entry Door

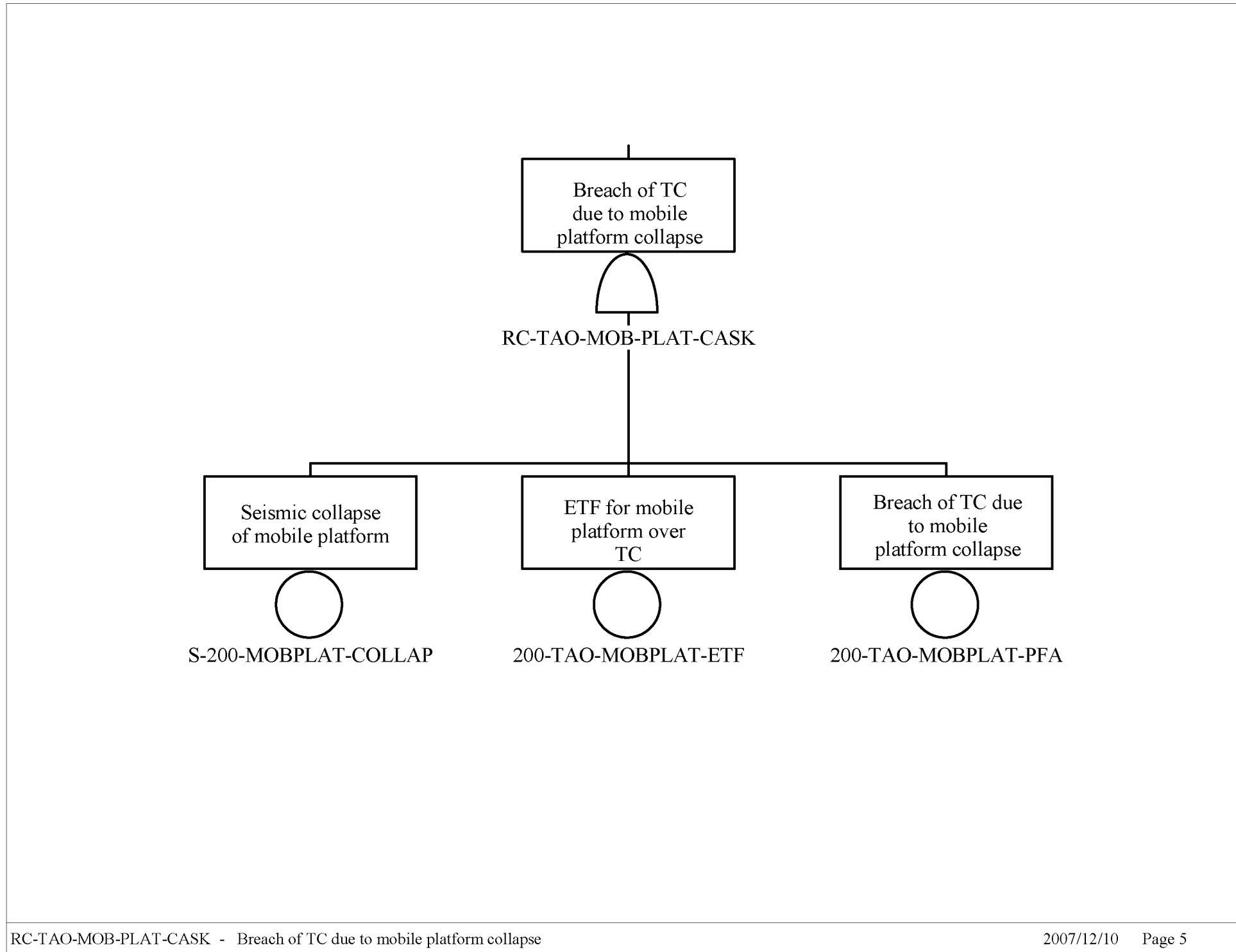

Source: Original

Figure B3.2-2. RC-TAO-MOB-PLAT-CASK – Breach of TC due to Mobile Platform Collapse

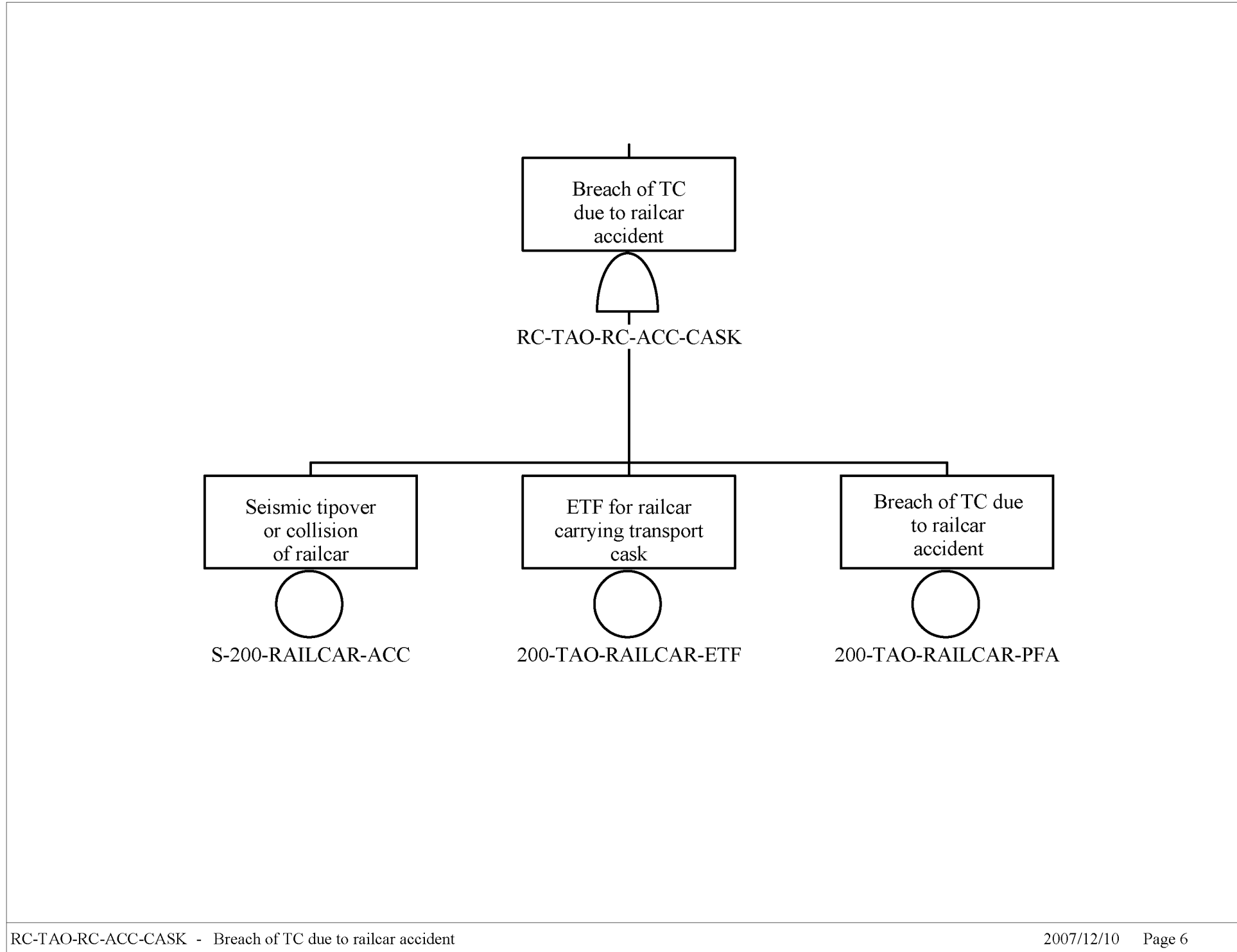

Source: Original

Figure B3.2-3 RC-TAO-RC-ACC-CASK – Breach of TC due to Railcar Accident

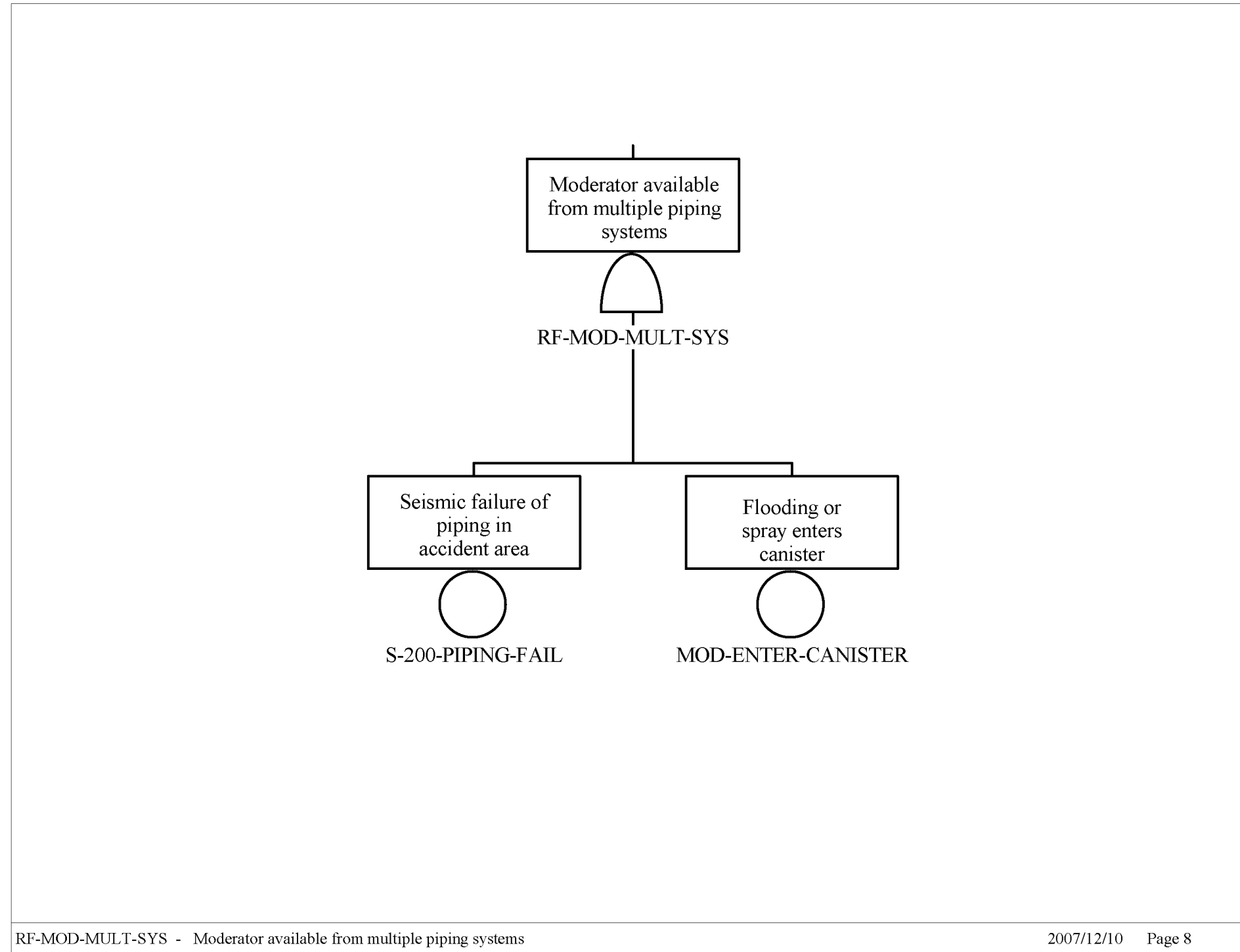

Source: Original

Figure B3.2-4. RF-MOD-MULT-SYS – Moderator Available from Multiple Piping Systems

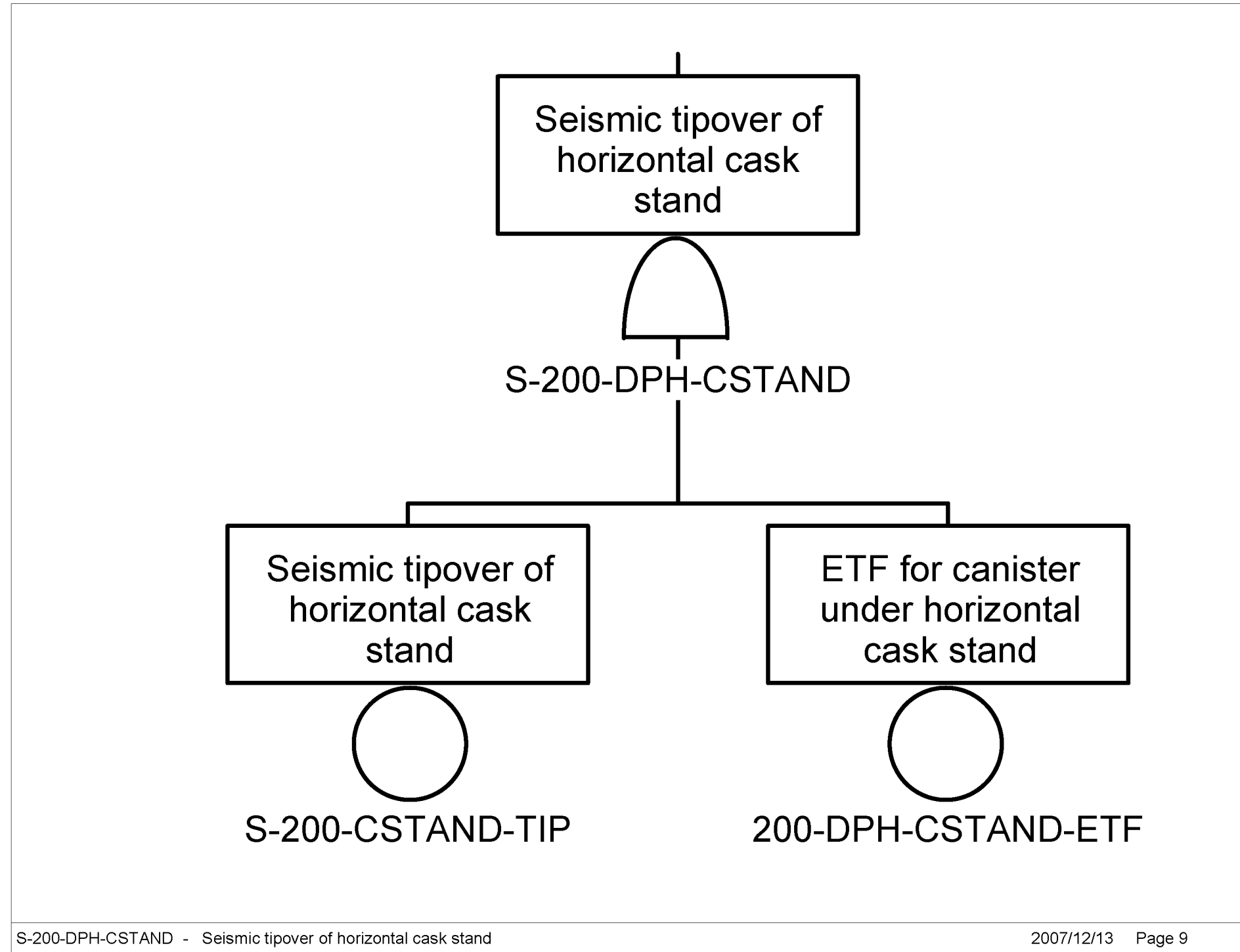

Source: Original

Figure B3.2-5. S200-DPH-CSTAND– Seismic Tipover of Horizontal Cask Stand

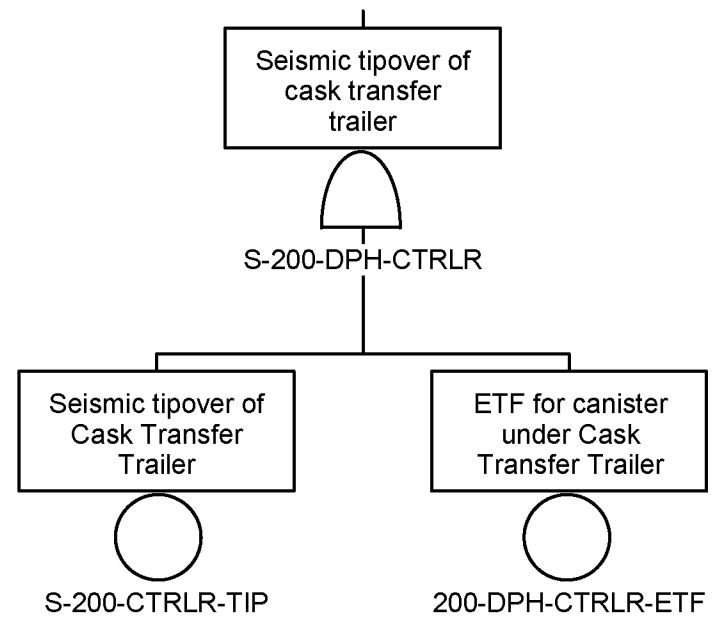

S-200-DPH-CTRLR - Seismic tipover of cask transfer trailer

2007/12/13 Page 10

Source: Original

Figure B3.2-6. S-200-DPH-CTRLR – Seismic Tipover of Cask Transfer Trailer

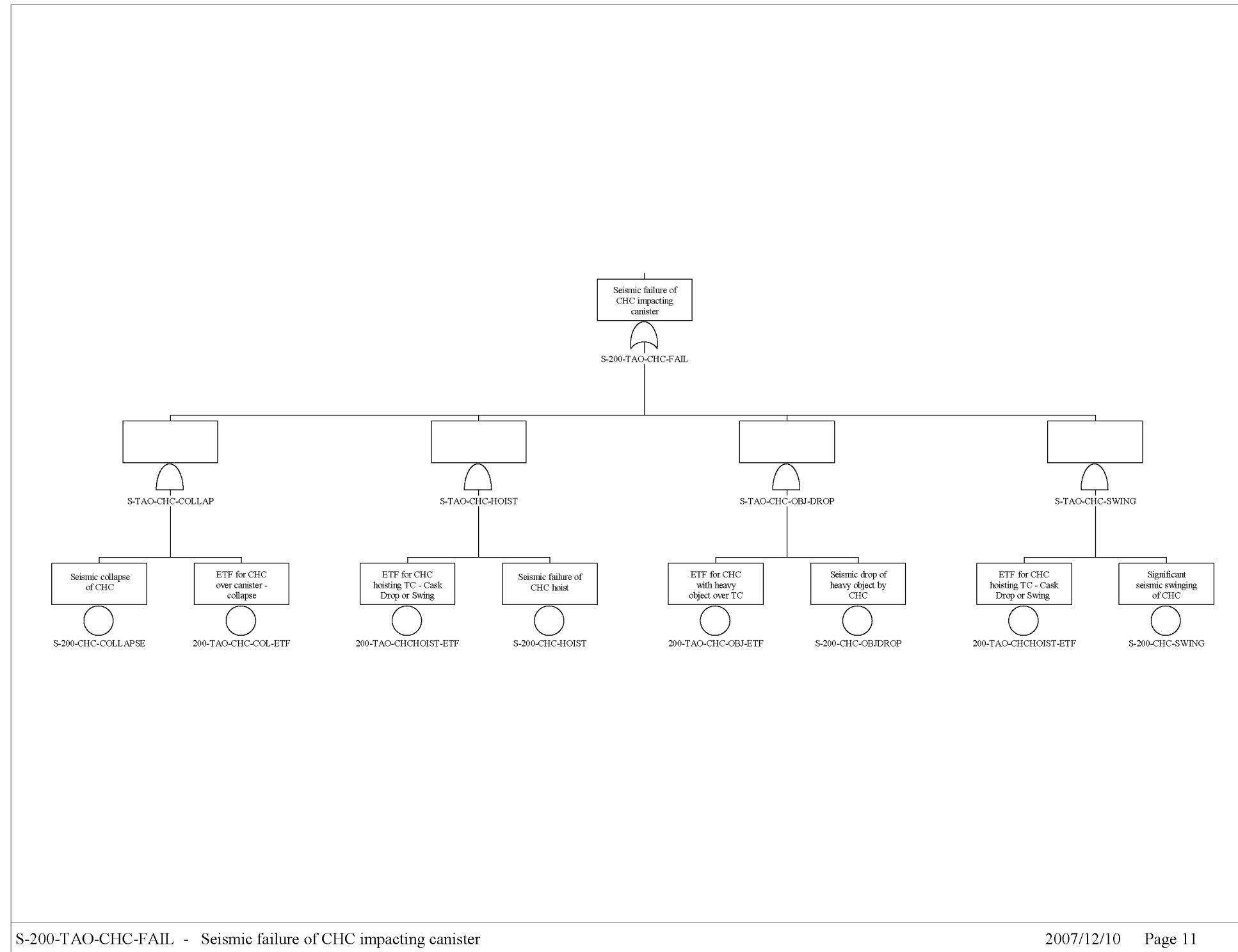

Source: Original

Figure B3.2-7. S-200-TAO-CHC-FAIL – Seismic Failure of CHC Impacting Canister

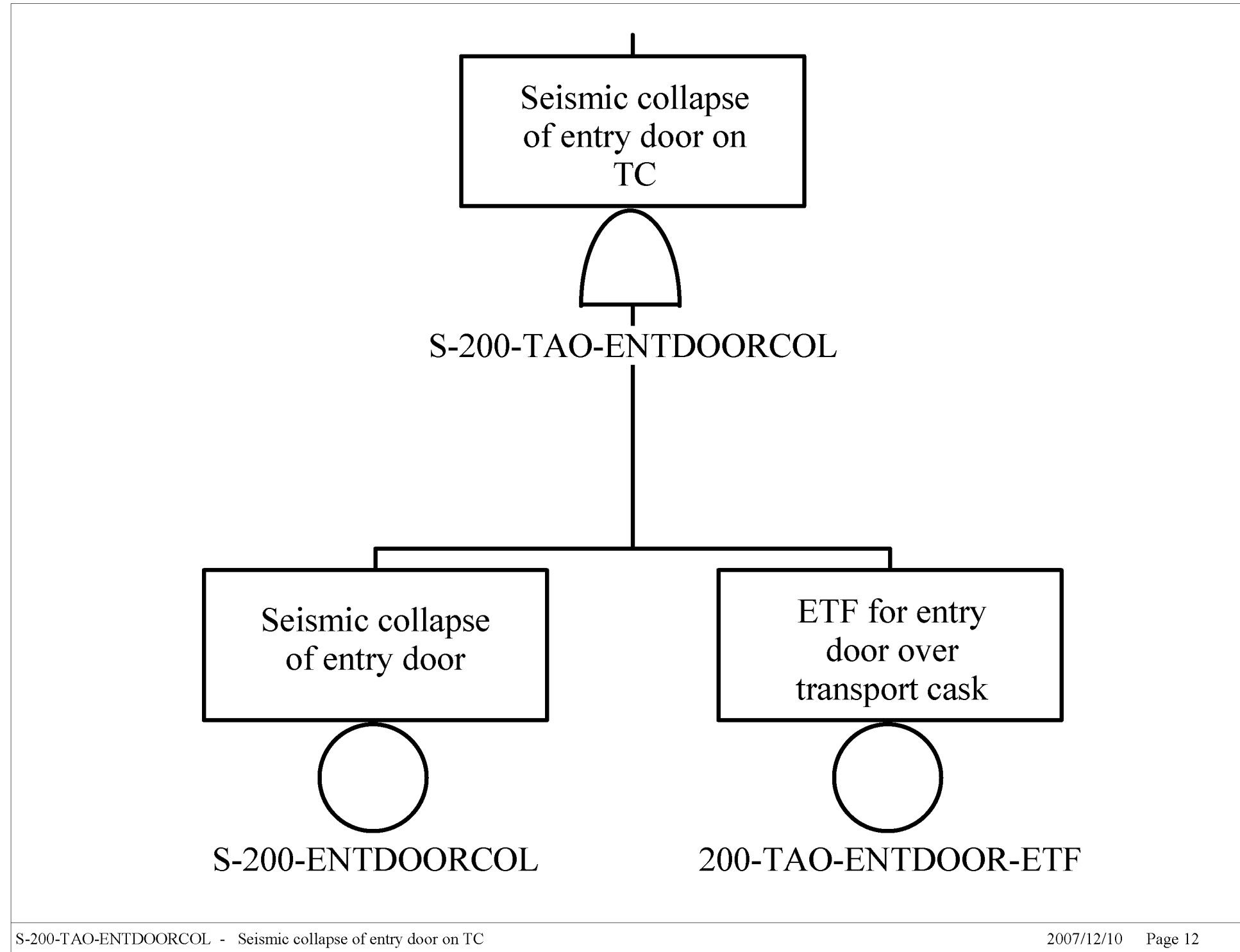

Source: Original

Figure B3.2-8. S-200-TAO-ENTDOORCOL – Seismic Collapse of Entry Door on TC

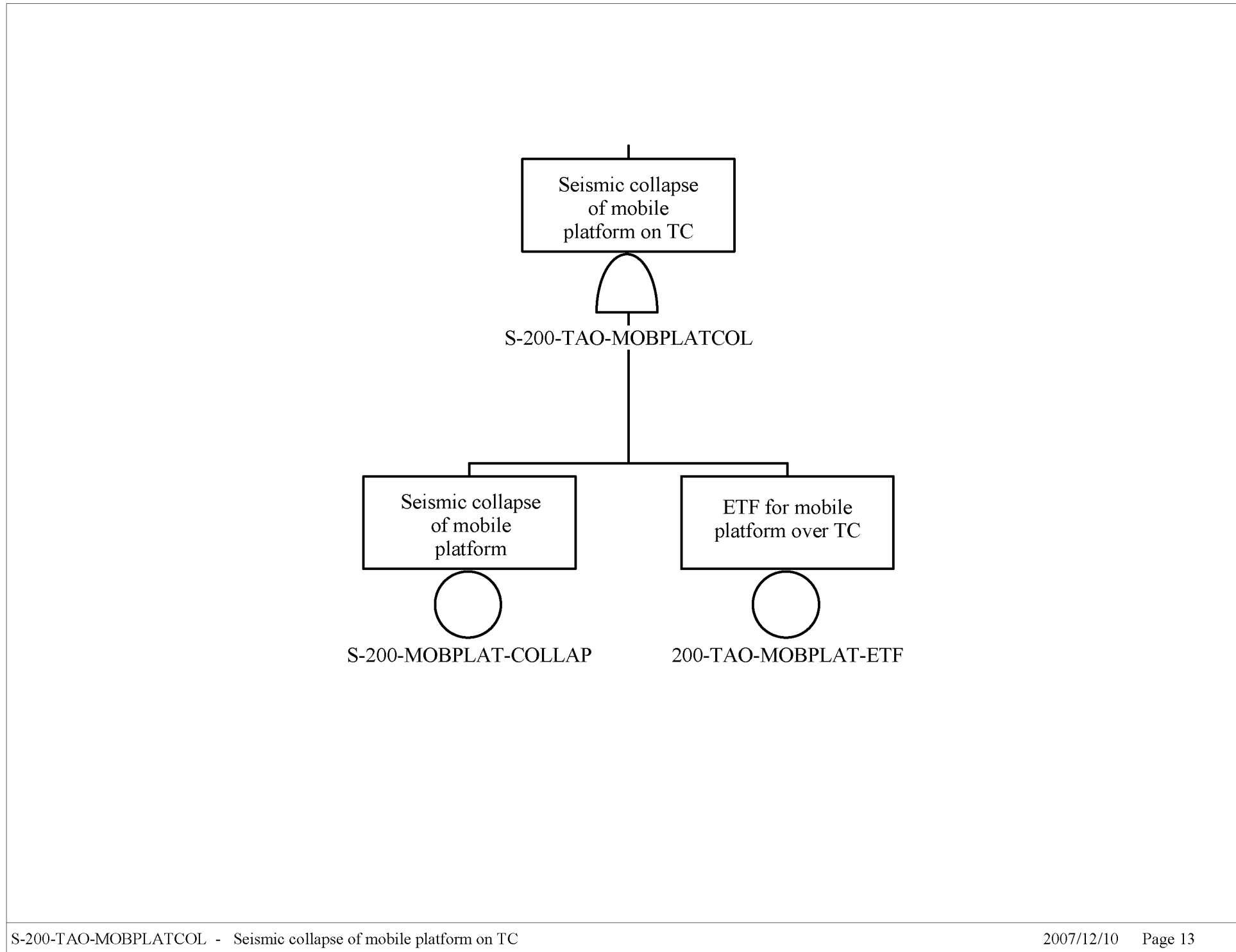

S-200-TAO-MOBPLATCOL - Seismic collapse of mobile platform on TC

2007/12/10 Page 13

Source: Original

Figure B3.2-9. S-200-TAO-MOBPLATCOL – Seismic Collapse of Mobile Platform on TC

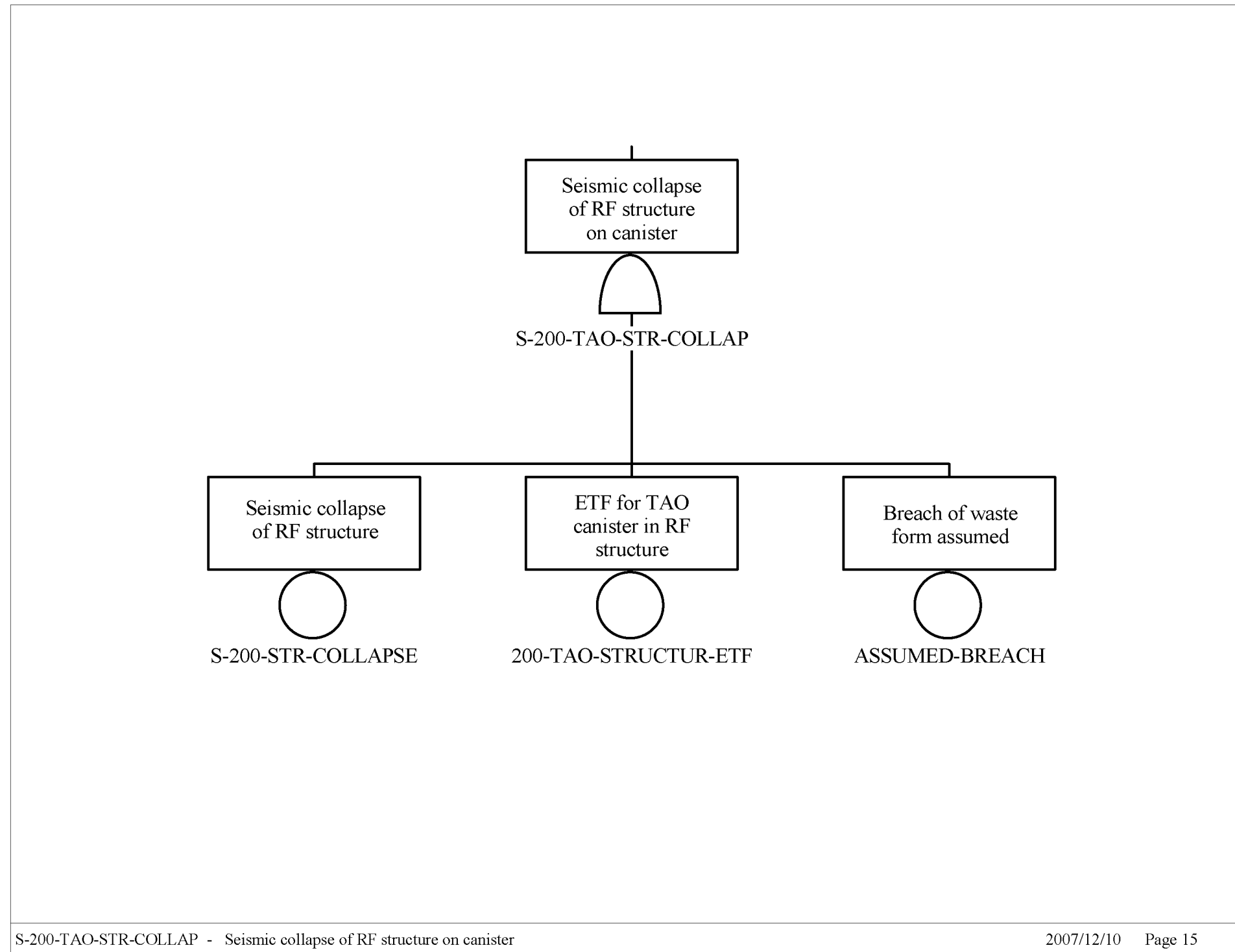

Source: Original

Figure B3.2-10. S-200-TAO-STR-COLLAP – Seismic Collapse of RF Structure on Canister

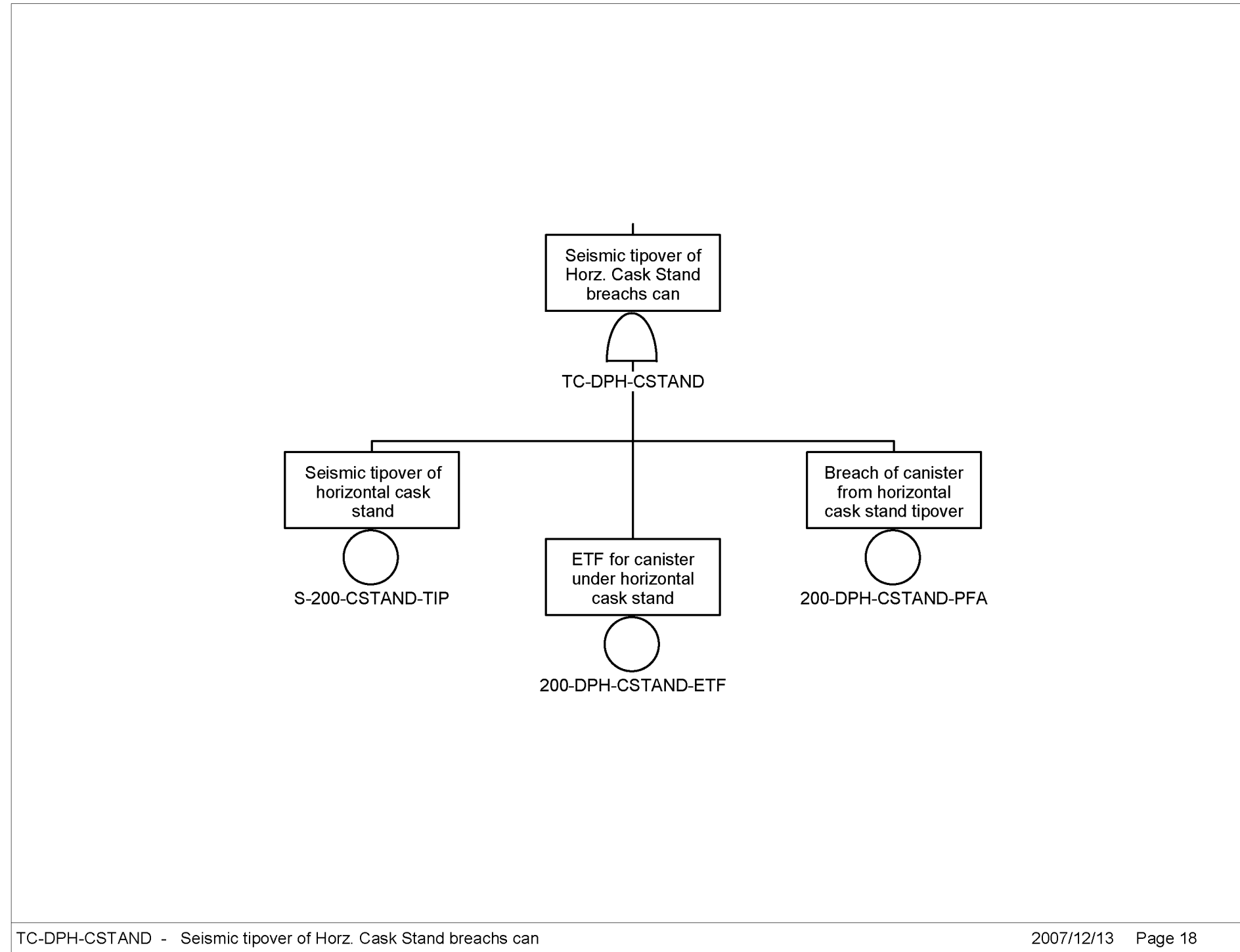

Source: Original

Figure B3.2-11. TC-DPH-CSTAND – Seismic Tipover of Horz. Cask Stand Breaches Can

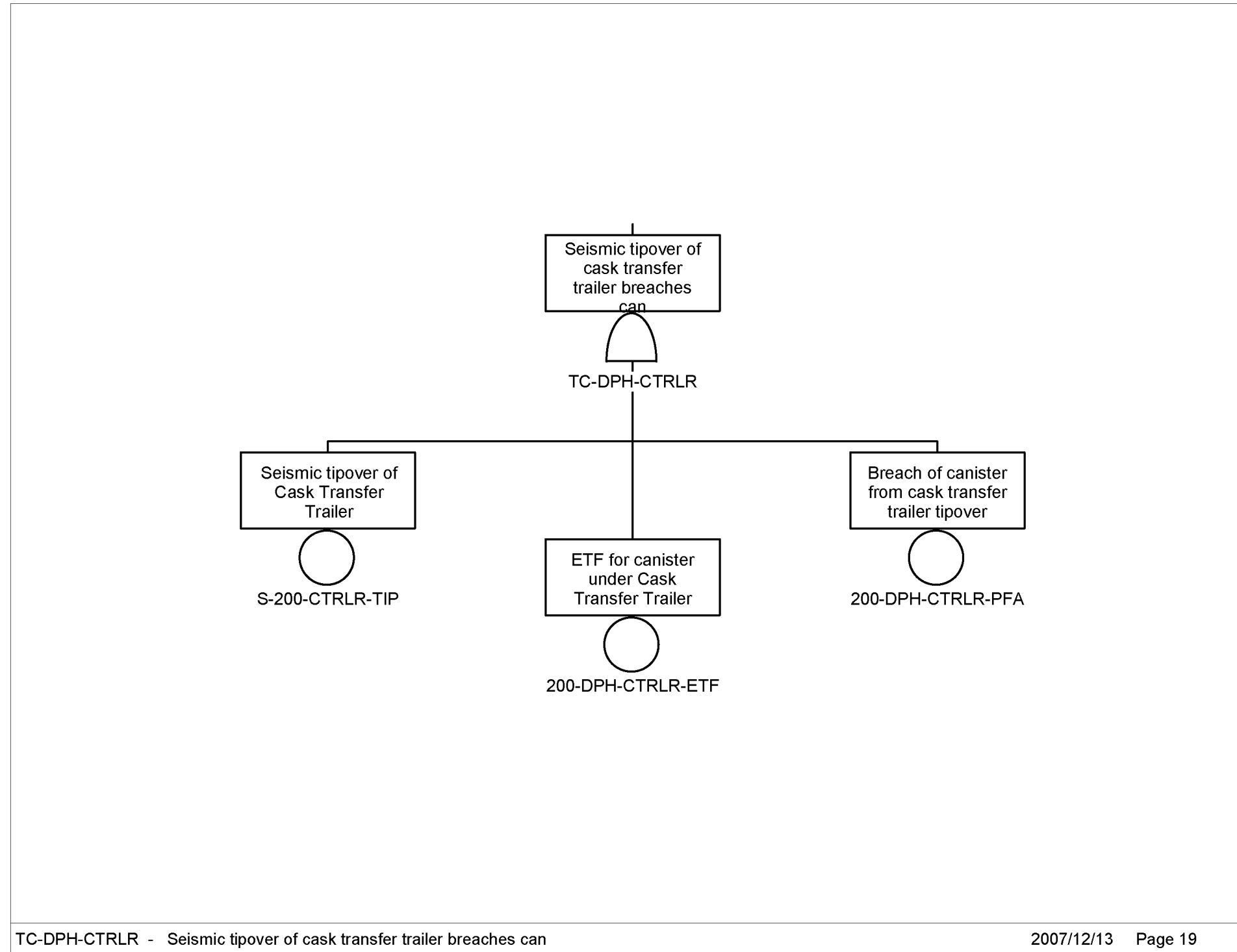

Source: Original

Figure B3.2-12.TC-DPH-CTRLR – Seismic Tipover of Cask Transfer Trailer Breaches Can

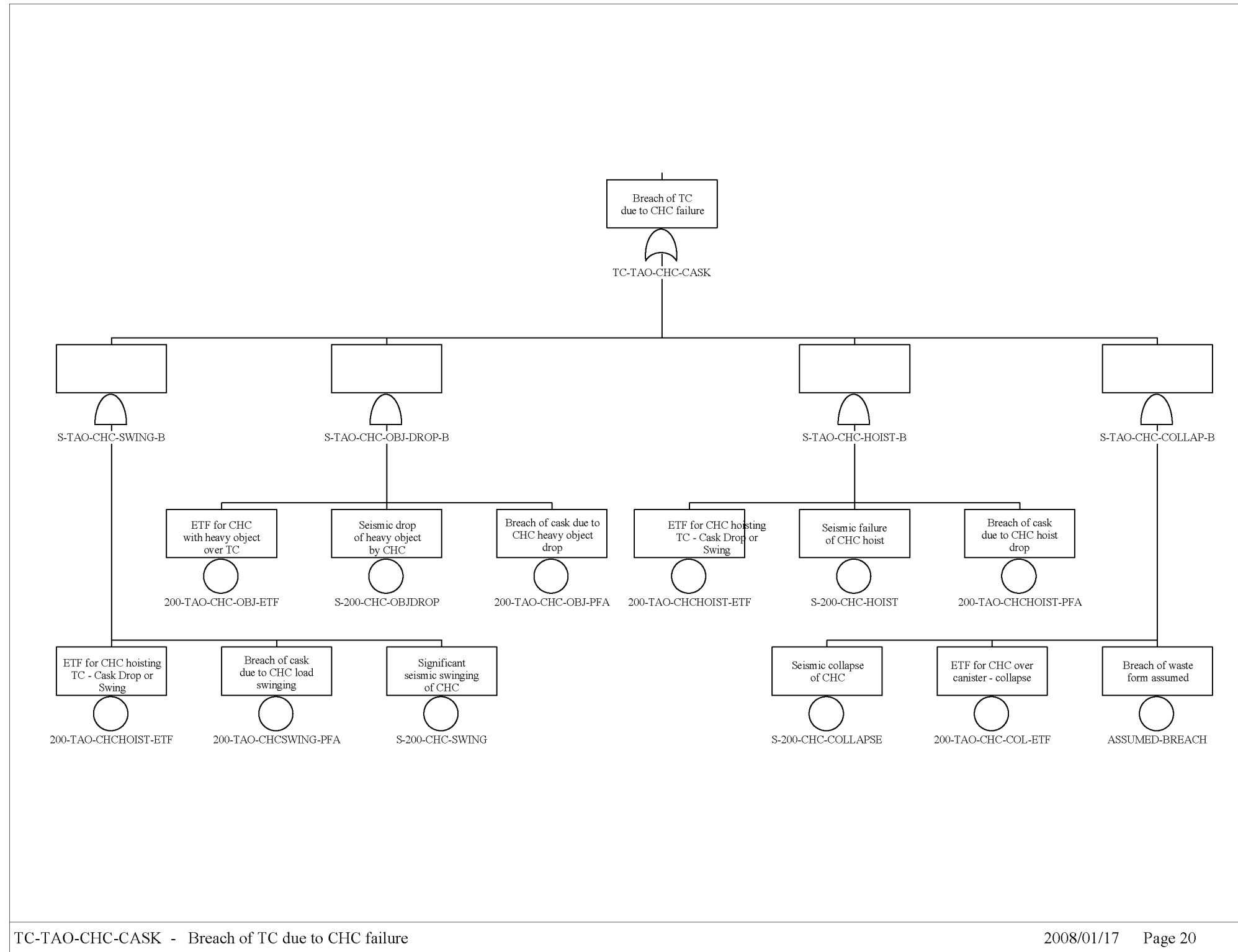

Source: Original

Figure B3.2-13.TC-TAO-CHC-CASK – Breach of TC due to CHC Failure

B3.3 BASIC EVENT DATA

B3.3.1 Non-seismic Basic Event Data

The following table presents the basic event identifier used in the fault trees, the description of the basic event, and the failure probability (or other numeric data) of the basic event. For exposure time factors (denoted with “ETF” at the end of the basic event identifier), the value given is the time, in years, that one waste form container is exposed to the seismic failure mode.

Table B3.3-1. Non-seismic Basic Event Data

Name	Description	Calc. Probability
200-DPH-CSTAND-ETF	ETF for canister under horizontal cask stand	6.720E-004
200-DPH-CSTAND-PFA	Breach of canister from horizontal cask stand tipover	1.000E-005
200-DPH-CTRLR-ETF	ETF for canister under cask transfer trailer	3.370E-004
200-DPH-CTRLR-PFA	Breach of canister from cask transfer trailer tipover	1.000E-005
200-TAO-CHC-COL-ETF	ETF for CHC over canister - collapse	1.340E-003
200-TAO-CHC-OBJ-ETF	ETF for CHC with heavy object over TC	2.700E-004
200-TAO-CHC-OBJ-PFA	Breach of cask due to CHC heavy object drop	1.000E-005
200-TAO-CHCHOIST-ETF	ETF for CHC hoisting TC - cask drop or swing	1.140E-004
200-TAO-CHCHOIST-PFA	Breach of cask due to CHC hoist drop	1.000E-005
200-TAO-CHCSWING-PFA	Breach of cask due to CHC load swinging	1.000E-005
200-TAO-ENTDOOR-ETF	ETF for entry door over transport cask	7.990E-005
200-TAO-ENTDOOR-PFA	Breach of TC due to entry door collapse	1.000E-005
200-TAO-MOBPLAT-ETF	ETF for mobile platform over TC	5.440E-004
200-TAO-MOBPLAT-PFA	Breach of TC due to mobile platform collapse	1.000E-005
200-TAO-RAILCAR-ETF	ETF for railcar carrying transport cask	6.600E-004
200-TAO-RAILCAR-PFA	Breach of TC due to railcar accident	1.000E-005
200-TAO-STRUCTUR-ETF	ETF for TAO canister in RF structure	1.450E-003
ASSUMED-BREACH	Breach of waste form assumed	1.000E+000
MOD-ENTER-CANISTER	Flooding or spray enters canister	1.000E-002
RF-DP-HOR	Number of horizontal DP canisters	3.460E+002
SHIELDING	WP remains within WPTT shielding	1.000E-005

NOTE: The basic event "ASSUMED-BREACH" is not an assumption, but is common terminology used to denote a scenario where the waste container is conservatively considered to be breached; CHC = cask handling crane; CTT = cask transfer trolley; DPC = dual-purpose canister; ETF = exposure time factor; RF = Receipt Facility; TAD = transportation, aging, and disposal; TC = transportation cask; WP = waste package; WPTT = waste package transfer trolley.

Source: Sections 6.2.2.23 and 6.3.3, Table 6.3-1, Table 6.3-2, Table 6.5-1

B3.3.2 Seismic Basic Event Fragility Data

The following table provides the seismic failure basic event identifier, description, median fragility, and composite uncertainty.

Table B3.3-2. Seismic Basic Event Fragility Data

Event Name	Description	Med. Fragility (g)	Beta c
S-200-CHC-COLLAPSE	Seismic collapse of CHC	2.790E+000	4.500E-001
S-200-CHC-HOIST	Seismic failure of CHC hoist	2.280E+000	5.000E-001
S-200-CHC-OBJDROP	Seismic drop of heavy object by CHC	2.280E+000	5.000E-001
S-200-CHC-SWING	Significant seismic swinging of CHC	1.140E+000	4.000E-001
S-200-CSTAND-TIP	Seismic tipover of horizontal cask stand	3.700E-001	4.000E-001
S-200-CTRLR-TIP	Seismic tipover of CTT	4.500E-001	4.000E-001
S-200-ENTDOORCOL	Seismic collapse of entry door	3.700E-001	4.000E-001
S-200-MOBPLAT-COLLAP	Seismic collapse of mobile platform	3.700E-001	4.000E-001
S-200-PIPING-FAIL	Seismic failure of piping in accident area	7.600E-001	4.000E-001
S-200-RAILCAR-ACC	Seismic tipover or collision of railcar	4.500E-001	4.000E-001
S-200-STR-COLLAPSE	Seismic collapse of RF structure	5.250E+000	4.000E-001

NOTE: CHC = cask handling crane; CTT = cask transfer trolley; RF = Receipt Facility.

Source: Table 6.2-1 and Table 6.2-2

B3.4 EVENT SEQUENCE QUANTIFICATION

This section provides the quantification results by sequence. The event sequence probabilities are provided first, and the cut sets are provided afterwards.

B3.4.1 Sequence Level Results

Table 3.4-1. Sequence Level Results

Event Tree	Sequence	Base Min. Cut	Base Cut Sets
RF-S-IE-DP-HOR	3	2.072E-007	1
RF-S-IE-DP-HOR	4-2	2.786E-010	1
RF-S-IE-DP-HOR	4-3	+0.000E+000	1
RF-S-IE-DP-HOR	4-4	+0.000E+000	1
RF-S-IE-DP-HOR	4-5	+0.000E+000	1
RF-S-IE-DP-HOR	4-6	2.786E-010	1
RF-S-IE-DP-HOR	4-7	5.630E-013	1
RF-S-IE-DP-HOR	5-2	1.578E-009	1
RF-S-IE-DP-HOR	5-3	+0.000E+000	1
RF-S-IE-DP-HOR	5-4	+0.000E+000	1
RF-S-IE-DP-HOR	5-5	+0.000E+000	1
RF-S-IE-DP-HOR	5-6	1.578E-009	1
RF-S-IE-DP-HOR	5-7	4.263E-012	1
RF-S-IE-DP-HOR	6-2	1.897E-009	1
RF-S-IE-DP-HOR	6-3	+0.000E+000	1

Table 3.4-1. Sequence Level Results (Continued)

Event Tree	Sequence	Base Min. Cut	Base Cut Sets
RF-S-IE-DP-HOR	6-4	+0.000E+000	1
RF-S-IE-DP-HOR	6-5	+0.000E+000	1
RF-S-IE-DP-HOR	6-6	1.897E-009	1
RF-S-IE-DP-HOR	6-7	3.833E-012	1
RF-S-IE-DP-HOR	7-2	5.895E-011	3
RF-S-IE-DP-HOR	7-3	+0.000E+000	1
RF-S-IE-DP-HOR	7-4	+0.000E+000	1
RF-S-IE-DP-HOR	7-5	+0.000E+000	1
RF-S-IE-DP-HOR	7-6	3.639E-006	4
RF-S-IE-DP-HOR	7-7	3.424E-008	4
RF-S-IE-DP-HOR	8-2	2.343E-009	1
RF-S-IE-DP-HOR	8-3	+0.000E+000	1
RF-S-IE-DP-HOR	8-4	+0.000E+000	1
RF-S-IE-DP-HOR	8-5	+0.000E+000	1
RF-S-IE-DP-HOR	8-6	2.343E-009	1
RF-S-IE-DP-HOR	8-7	4.735E-012	1
RF-S-IE-DP-HOR	9-2	8.057E-010	1
RF-S-IE-DP-HOR	9-3	+0.000E+000	1
RF-S-IE-DP-HOR	9-4	+0.000E+000	1
RF-S-IE-DP-HOR	9-5	+0.000E+000	1
RF-S-IE-DP-HOR	9-6	8.057E-010	1
RF-S-IE-DP-HOR	9-7	2.177E-012	1

Source: Original

B3.4.2 Cut Set Level Results by Sequence

Note that the SAPHIRE software does not provide special tables for seismic cut sets. Therefore, the “Cut Set %” given in the third column of this table is not correct for seismic events, although it does provide the approximate rank order for the cut sets.

Table B3.4-2. Cut Set Level Results by Sequence

Event Tree	Sequence	Cut Set %	Basic Event	Description
RF-S-IE-DP-HOR	3	100.00	200-TAO-STRUCTUR-ETF	ETF for TAO canister in RF structure
			RF-DP-HOR	Number of horizontal DP canisters
			S-200-STR-COLLAPSE	Seismic collapse of RF structure
			= Total	
	4-2	100.00	200-TAO-ENTDOOR-ETF	ETF for entry door over transport cask

Table 3.4-2. Cut Set Level Results by Sequence (Continued)

Event Tree	Sequence	Cut Set %	Basic Event	Description
			RF-DP-HOR	Number of horizontal DP canisters
			S-200-ENTDOORCOL	Seismic collapse of entry door
			SHIELDING	WP remains within WPTT shielding
			= Total	
	4-3	0.00	<FALSE>	System Generated Success Event
			= Total	
	4-4	0.00	<FALSE>	System Generated Success Event
			= Total	
	4-5	0.00	<FALSE>	System Generated Success Event
			= Total	
	4-6	100.00	200-TAO-ENTDOOR-ETF	ETF for entry door over transport cask
			200-TAO-ENTDOOR-PFA	Breach of TC due to entry door collapse
			RF-DP-HOR	Number of horizontal DP canisters
			S-200-ENTDOORCOL	Seismic collapse of entry door
			= Total	
	4-7	100.00	200-TAO-ENTDOOR-ETF	ETF for entry door over transport cask
			200-TAO-ENTDOOR-PFA	Breach of TC due to entry door collapse
			MOD-ENTER-CANISTER	Flooding or spray enters canister
			RF-DP-HOR	Number of horizontal DP canisters
			S-200-ENTDOORCOL	Seismic collapse of entry door
			S-200-PIPING-FAIL	Seismic failure of piping in accident area
			= Total	
	5-2	100.00	200-TAO-RAILCAR-ETF	ETF for railcar carrying transport cask
			RF-DP-HOR	Number of horizontal DP canisters
			S-200-RAILCAR-ACC	Seismic tipover or collision of railcar
			SHIELDING	WP remains within WPTT shielding
			= Total	

Table 3.4-2. Cut Set Level Results by Sequence (Continued)

Event Tree	Sequence	Cut Set %	Basic Event	Description
	5-3	0.00	<FALSE>	System Generated Success Event
			= Total	
	5-4	0.00	<FALSE>	System Generated Success Event
			= Total	
	5-5	0.00	<FALSE>	System Generated Success Event
			= Total	
	5-6	100.00	200-TAO-RAILCAR-ETF	ETF for railcar carrying transport cask
			200-TAO-RAILCAR-PFA	Breach of TC due to railcar accident
			RF-DP-HOR	Number of horizontal DP canisters
			S-200-RAILCAR-ACC	Seismic tipover or collision of railcar
			= Total	
	5-7	100.00	200-TAO-RAILCAR-ETF	ETF for railcar carrying transport cask
			200-TAO-RAILCAR-PFA	Breach of TC due to railcar accident
			MOD-ENTER-CANISTER	Flooding or spray enters canister
			RF-DP-HOR	Number of horizontal DP canisters
			S-200-PIPING-FAIL	Seismic failure of piping in accident area
			S-200-RAILCAR-ACC	Seismic tipover or collision of railcar
			= Total	
	6-2	100.00	200-TAO-MOBPLAT-ETF	ETF for mobile platform over TC
			RF-DP-HOR	Number of horizontal DP canisters
			S-200-MOBPLAT-COLLAP	Seismic collapse of mobile platform
			SHIELDING	WP remains within WPTT shielding
			= Total	
	6-3	0.00	<FALSE>	System Generated Success Event
			= Total	
	6-4	0.00	<FALSE>	System Generated Success Event
			= Total	

Table 3.4-2. Cut Set Level Results by Sequence (Continued)

Event Tree	Sequence	Cut Set %	Basic Event	Description
	6-5	0.00	<FALSE>	System Generated Success Event
			= Total	
	6-6	100.00	200-TAO-MOBPLAT-ETF	ETF for mobile platform over TC
			200-TAO-MOBPLAT-PFA	Breach of TC due to mobile platform collapse
			RF-DP-HOR	Number of horizontal DP canisters
			S-200-MOBPLAT-COLLAP	Seismic collapse of mobile platform
			= Total	
	6-7	100.00	200-TAO-MOBPLAT-ETF	ETF for mobile platform over TC
			200-TAO-MOBPLAT-PFA	Breach of TC due to mobile platform collapse
			MOD-ENTER-CANISTER	Flooding or spray enters canister
			RF-DP-HOR	Number of horizontal DP canisters
			S-200-MOBPLAT-COLLAP	Seismic collapse of mobile platform
			S-200-PIPING-FAIL	Seismic failure of piping in accident area
			= Total	
	7-2	83.56	200-TAO-CHCHOIST-ETF	ETF for CHC hoisting TC - cask drop or swing
			RF-DP-HOR	Number of horizontal DP canisters
			S-200-CHC-SWING	Significant seismic swinging of CHC
			SHIELDING	WP remains within WPTT shielding
		11.56	200-TAO-CHC-OBJ-ETF	ETF for CHC with heavy object over TC
			RF-DP-HOR	Number of horizontal DP canisters
			S-200-CHC-OBJDROP	Seismic drop of heavy object by CHC
			SHIELDING	WP remains within WPTT shielding
		4.88	200-TAO-CHCHOIST-ETF	ETF for CHC hoisting TC - cask drop or swing
			RF-DP-HOR	Number of horizontal DP canisters
			S-200-CHC-HOIST	Seismic failure of CHC hoist

Table 3.4-2. Cut Set Level Results by Sequence (Continued)

Event Tree	Sequence	Cut Set %	Basic Event	Description
			SHIELDING	WP remains within WPTT shielding
			= Total	
	7-3	0.00	<FALSE>	System Generated Success Event
			= Total	
	7-4	0.00	<FALSE>	System Generated Success Event
			= Total	
	7-5	0.00	<FALSE>	System Generated Success Event
			= Total	
	7-6	99.96	200-TAO-CHC-COL-ETF	ETF for CHC over canister - collapse
			RF-DP-HOR	Number of horizontal DP canisters
			S-200-CHC-COLLAPSE	Seismic collapse of CHC
		0.03	200-TAO-CHCHOIST-ETF	ETF for CHC hoisting TC - cask drop or swing
			200-TAO-CHCSWING-PFA	Breach of cask due to CHC load swinging
			RF-DP-HOR	Number of horizontal DP canisters
			S-200-CHC-SWING	Significant seismic swinging of CHC
		0.00	200-TAO-CHC-OBJ-ETF	ETF for CHC with heavy object over TC
			200-TAO-CHC-OBJ-PFA	Breach of cask due to CHC heavy object drop
			RF-DP-HOR	Number of horizontal DP canisters
			S-200-CHC-OBJDROP	Seismic drop of heavy object by CHC
		0.00	200-TAO-CHCHOIST-ETF	ETF for CHC hoisting TC - cask drop or swing
			200-TAO-CHCHOIST-PFA	Breach of cask due to CHC hoist drop
			RF-DP-HOR	Number of horizontal DP canisters
			S-200-CHC-HOIST	Seismic failure of CHC hoist
			= Total	
	7-7	99.96	200-TAO-CHC-COL-ETF	ETF for CHC over canister - collapse
			MOD-ENTER-CANISTER	Flooding or spray enters canister

Table 3.4-2. Cut Set Level Results by Sequence (Continued)

Event Tree	Sequence	Cut Set %	Basic Event	Description
			RF-DP-HOR	Number of horizontal DP canisters
			S-200-CHC-COLLAPSE	Seismic collapse of CHC
			S-200-PIPING-FAIL	Seismic failure of piping in accident area
		0.03	200-TAO-CHCHOIST-ETF	ETF for CHC hoisting TC - cask drop or swing
			200-TAO-CHCSWING-PFA	Breach of cask due to CHC load swinging
			MOD-ENTER-CANISTER	Flooding or spray enters canister
			RF-DP-HOR	Number of horizontal DP canisters
			S-200-CHC-SWING	Significant seismic swinging of CHC
			S-200-PIPING-FAIL	Seismic failure of piping in accident area
		0.00	200-TAO-CHC-OBJ-ETF	ETF for CHC with heavy object over TC
			200-TAO-CHC-OBJ-PFA	Breach of cask due to CHC heavy object drop
			MOD-ENTER-CANISTER	Flooding or spray enters canister
			RF-DP-HOR	Number of horizontal DP canisters
			S-200-CHC-OBJDROP	Seismic drop of heavy object by CHC
			S-200-PIPING-FAIL	Seismic failure of piping in accident area
		0.00	200-TAO-CHCHOIST-ETF	ETF for CHC hoisting TC - cask drop or swing
			200-TAO-CHCHOIST-PFA	Breach of cask due to CHC hoist drop
			MOD-ENTER-CANISTER	Flooding or spray enters canister
			RF-DP-HOR	Number of horizontal DP canisters
			S-200-CHC-HOIST	Seismic failure of CHC hoist
			S-200-PIPING-FAIL	Seismic failure of piping in accident area
			= Total	
	8-2	100.00	200-DPH-CSTAND-ETF	ETF for canister under horizontal cask stand
			RF-DP-HOR	Number of horizontal DP canisters

Table 3.4-2. Cut Set Level Results by Sequence (Continued)

Event Tree	Sequence	Cut Set %	Basic Event	Description
			S-200-CSTAND-TIP	Seismic tipover of horizontal cask stand
			SHIELDING	WP remains within WPTT shielding
			= Total	
	8-3	0.00	<FALSE>	System Generated Success Event
			= Total	
	8-4	0.00	<FALSE>	System Generated Success Event
			= Total	
	8-5	0.00	<FALSE>	System Generated Success Event
			= Total	
	8-6	100.00	200-DPH-CSTAND-ETF	ETF for canister under horizontal cask stand
			200-DPH-CSTAND-PFA	Breach of canister from horizontal cask stand tipover
			RF-DP-HOR	Number of horizontal DP canisters
			S-200-CSTAND-TIP	Seismic tipover of horizontal cask stand
			= Total	
	8-7	100.00	200-DPH-CSTAND-ETF	ETF for canister under horizontal cask stand
			200-DPH-CSTAND-PFA	Breach of canister from horizontal cask stand tipover
			MOD-ENTER-CANISTER	Flooding or spray enters canister
			RF-DP-HOR	Number of horizontal DP canisters
			S-200-CSTAND-TIP	Seismic tipover of horizontal cask stand
			S-200-PIPING-FAIL	Seismic failure of piping in accident area
			= Total	
	9-2	100.00	200-DPH-CTRLR-ETF	ETF for canister under cask transfer trailer
			RF-DP-HOR	Number of horizontal DP canisters
			S-200-CTRLR-TIP	Seismic tipover of cask transfer trailer
			SHIELDING	WP remains within WPTT shielding
			= Total	
	9-3	0.00	<FALSE>	System Generated Success Event

Table 3.4-2. Cut Set Level Results by Sequence (Continued)

Event Tree	Sequence	Cut Set %	Basic Event	Description
			= Total	
	9-4	0.00	<FALSE>	System Generated Success Event
			= Total	
	9-5	0.00	<FALSE>	System Generated Success Event
			= Total	
	9-6	100.00	200-DPH-CTRLR-ETF	ETF for canister under cask transfer trailer
			200-DPH-CTRLR-PFA	Breach of canister from cask transfer trailer tipover
			RF-DP-HOR	Number of horizontal DP canisters
			S-200-CTRLR-TIP	Seismic tipover of cask transfer trailer
			= Total	
	9-7	100.00	200-DPH-CTRLR-ETF	ETF for canister under cask transfer trailer
			200-DPH-CTRLR-PFA	Breach of canister from cask transfer trailer tipover
			MOD-ENTER-CANISTER	Flooding or spray enters canister
			RF-DP-HOR	Number of horizontal DP canisters
			S-200-CTRLR-TIP	Seismic tipover of cask transfer trailer
			S-200-PIPING-FAIL	Seismic failure of piping in accident area
			= Total	

NOTE: CHC = cask handling crane; CTT = cask transfer trolley; DPC = dual-purpose canister; ETF = exposure time factor; RF = Receipt Facility; TAD = transportation, aging, and disposal; TC = transportation cask; WP = waste package; WPTT = waste package transfer trolley.

Source: Original

B4 TILTING DUAL-PURPOSE CANISTER

This section provides the detailed information used to develop the event sequences for the analysis of processing of a DPC that arrives at the RF in a transportation cask requiring tilting on a cask tilting frame. DPCs inside the transportation cask are received on railcars, transferred into an aging overpack, and then transported in a site transporter out of the RF.

B4.1 EVENT TREES

The IET and SRETs are presented in this section. The tables provide the assignments between the event tree branches and the fault trees given in the next section.

Seismic Event	Number of DPCs transferred to AO	Identify initiating seismic failure		
SEIS-EVENT	RF-DPC-TILT	SEIS-FAIL	#	END-STATE
			1	OK
			2	OK
		RF building collapse	3	RR-UNF
		Entry door seismic collapse	4	T => 2 RF-S-R-TC1
		Railcar accident	5	T => 2 RF-S-R-TC1
		Mobile platform seismic collapse	6	T => 2 RF-S-R-TC1
		CHC seismic failures	7	T => 2 RF-S-R-TC1
		Cask prep platform collapse	8	T => 2 RF-S-R-TC1
		CTT seismic failures	9	T => 2 RF-S-R-TC1
		Shield door seismic failure	10	T => 3 RF-S-R-SD1
		CTM seismic failures	11	T => 4 RF-S-R-CTM
		CTM MC seismic collapse	12	T => 4 RF-S-R-CTM
		ST seismic failures	13	T => 5 RF-S-R-AO
		LBR platform collapse	14	T => 5 RF-S-R-AO
		LBR crane collapse	15	T => 5 RF-S-R-AO

RF-S-IE-TILT - RF Seismic Event Tree - Initiating Seismic Failures - DPC-Tilting Frame 2008/02/24 Page 1

NOTE: Event tree branch captions are associated with the branch line below the caption.

AO = aging overpack; CHC = cask handling crane; CTM = canister transfer machine; CTM MC = canister transfer machine maintenance crane; CTT = cask transfer trolley; DPC = dual-purpose canister; IE = initiating event; LBR = Lid Bolting Room; RF = Receipt Facility; SD = shield door; SEIS = seismic; ST = site transporter; T = transfer; TC = transportation cask; UNF = unfiltered.

Source: Original

Figure B4.1-1. RF Seismic Event Tree RF-S-IE-TILT – Initiating Seismic Failures – DPC-Tilting Frame

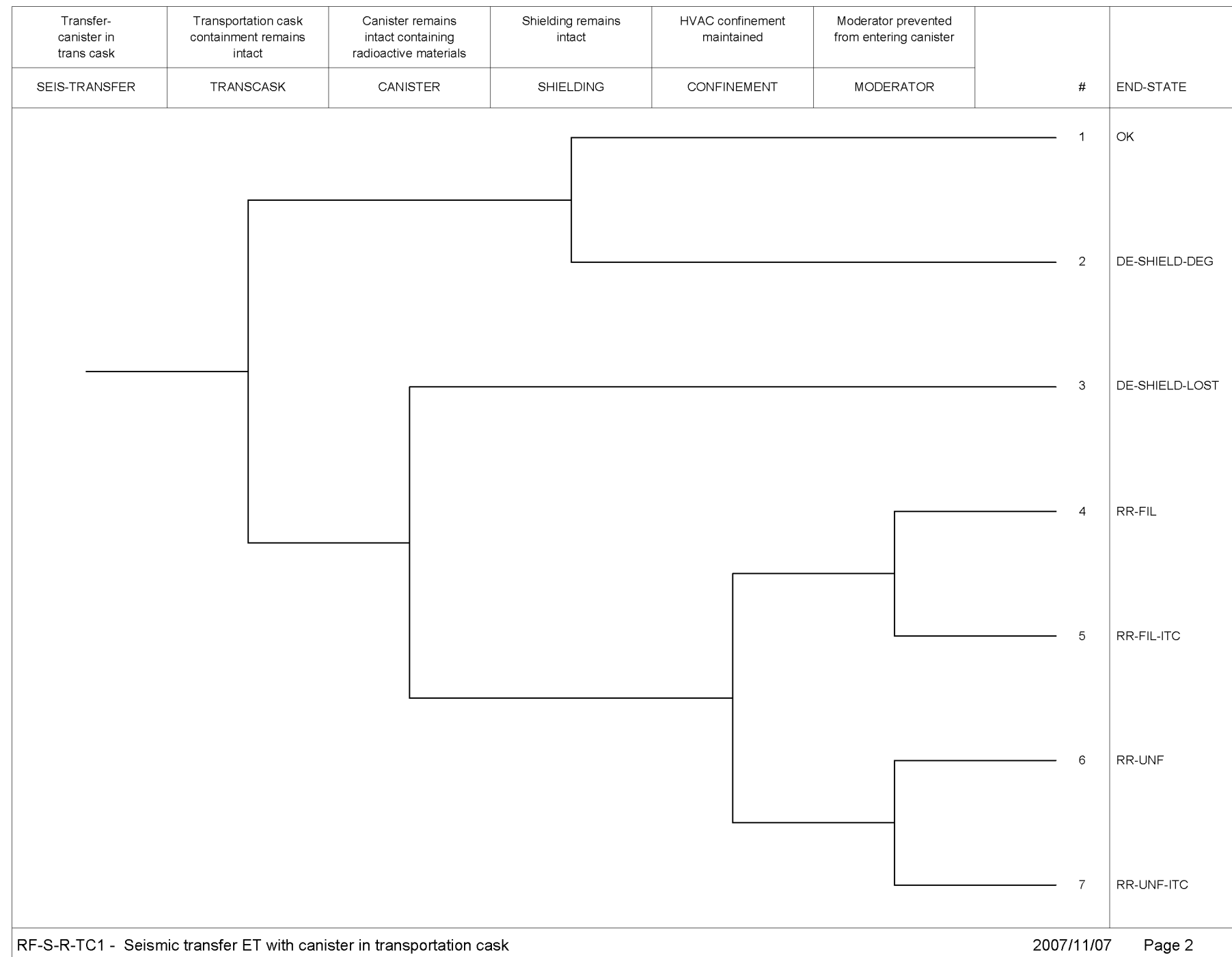

NOTE: DE = direct exposure; DEG = degradation; ET = event tree; FIL = filtered; HVAC = heating, ventilation and air conditioning; INIT = initiating; ITC = important to criticality; RF = Receipt Facility; RR = radioactive release; SEIS = seismic; TC = transportation cask; UNF = unfiltered.

Source: Original

Figure B4.1-2. RF Seismic Event Tree RF-S-R-TC1 – Seismic Transfer ET with Canister in Transportation Cask

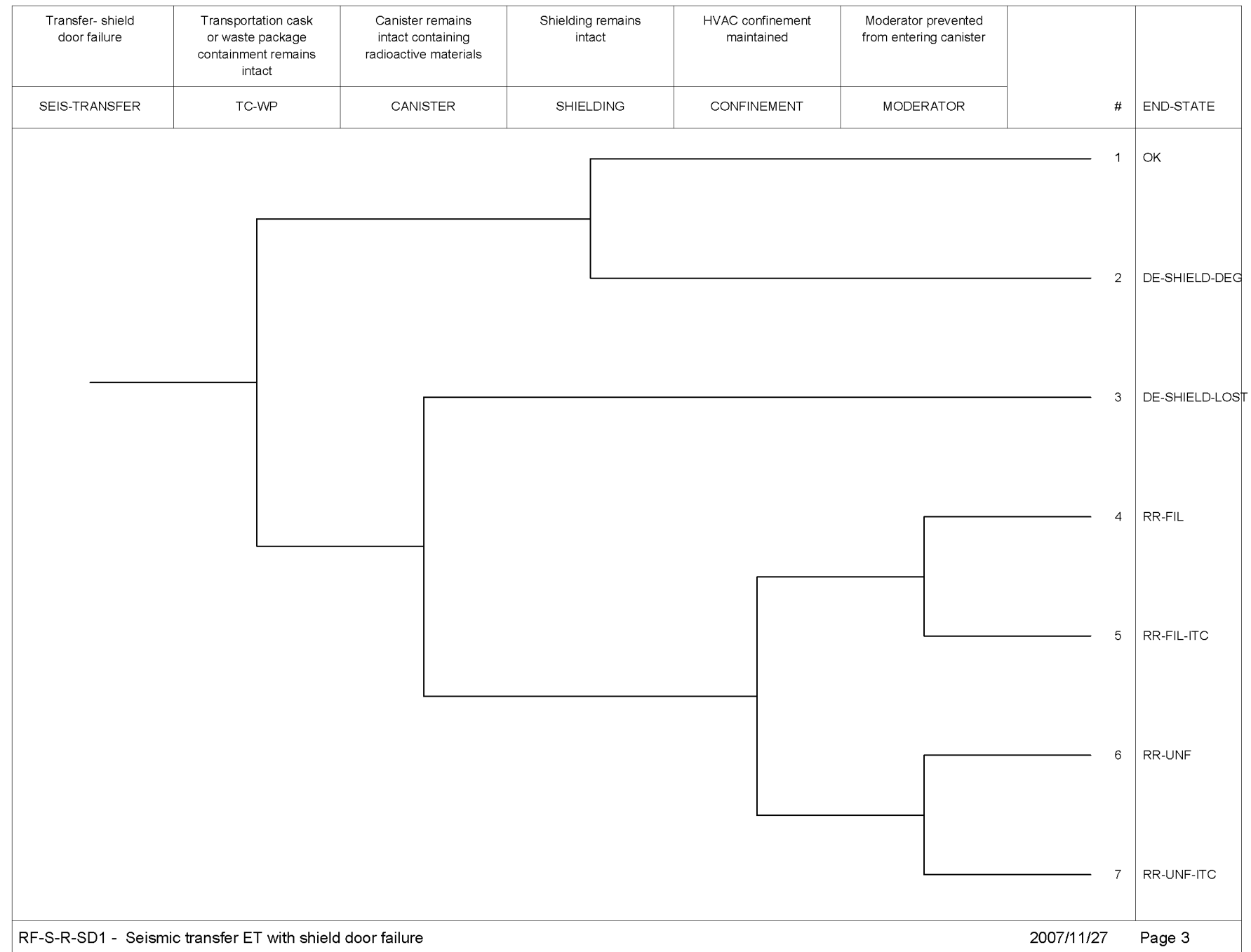

NOTE: DE = direct exposure; DEG = degradation; ET = event tree; HVAC = heating, ventilation and air conditioning; ITC = important to criticality; RF = Receipt Facility; RR = radioactive release; SD = shield door; SEIS = seismic; TC = transportation cask; WP = waste package.

Source: Original

Figure B4.1-3. RF Seismic Event Tree RF-S-R-SD1 – Seismic Transfer ET with Shield Door Failure

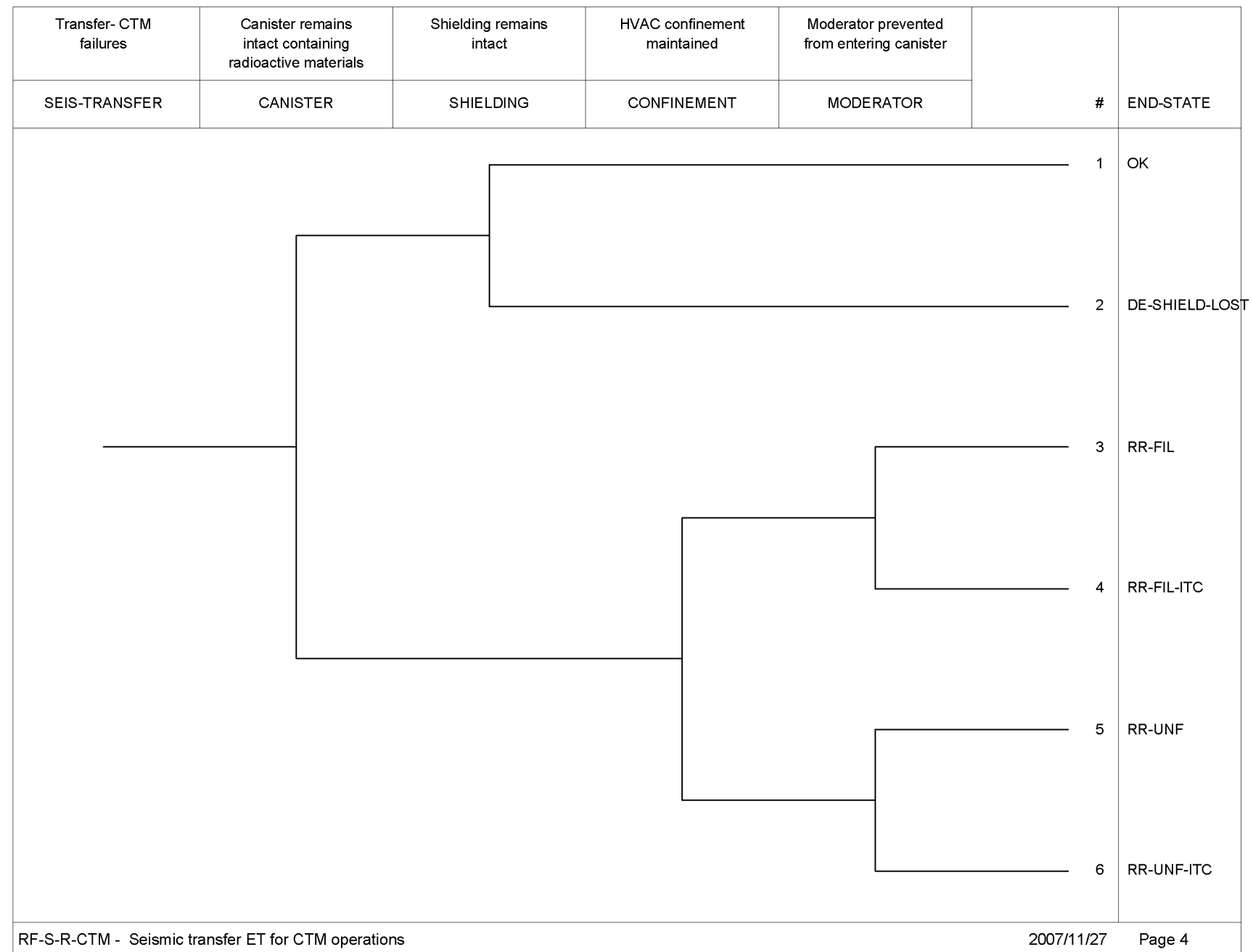

NOTE: CTM = canister transfer machine; DE = direct exposure; ET = event tree; FIL = filtered; HVAC = heating, ventilation and air-conditioning; ITC = important to criticality; RF = Receipt Facility; RR = radioactive release; SEIS = seismic; UNF = unfiltered.

Source: Original

Figure B4.1-4. RF Seismic Event Tree RF-S-R-CTM – Seismic Transfer ET for CTM Operations

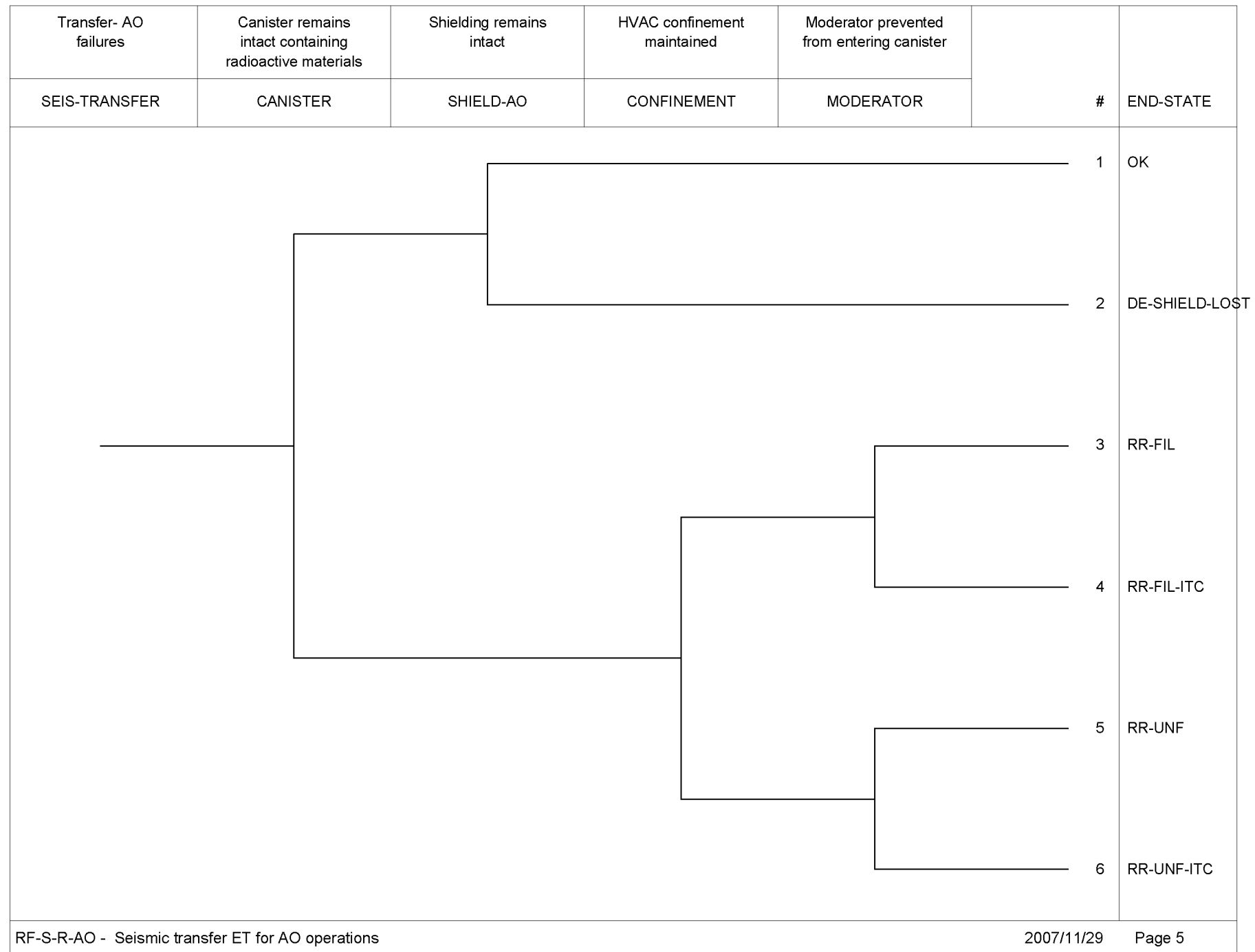

NOTE: AO= aging overpack; DE = direct exposure; ET = event tree; FIL = filtered; HVAC = heating, ventilation and air-conditioning; ITC = important to criticality; RF = Receipt Facility; RR = radioactive release; SEIS = seismic; UNF = unfiltered.

Source: Original

Figure B4.1-5. RF Seismic Event Tree RF-S-R-AO – Seismic Transfer ET for AO Operations

Table B4.1-1. Fault Trees Assigned for Initiating Seismic Failures for the RF

Process	Initiator Event Tree	Initiating Seismic Failure	Associated Fault Tree
DPC-TTC	RF-S-IE-HISTAR	RF building collapse	S-200-TAO-STR-COLLAP
		Entry door seismic collapse	S-200-TAO-ENTDOORCOL
		Railcar accident	S-200-TAO-RAILCARACC
		Mobile platform seismic collapse	S-200-TAO-MOBPLATCOL
		CHC seismic failures	S-200-TAO-CHC-FAIL
		Cask prep platform collapse	S-200-TAO-CPREP-PLAT
		CTT seismic failures	S-200-TAO-CTT-FAIL
		Shield door seismic failures	S-200-TAO-SHIELDDOOR
		CTM seismic failures	S-200-TAO-CTM-FAIL
		CTM MC seismic collapse	S-200-TAO-CTMMC
		ST seismic failures	S-200-TAO-ST-SLIDE
		LBR platform collapse	S-200-TAO-LBRPLAT
		LBR crane collapse	S-200-TAO-LBRC-COL

NOTE: CHC = cask handling crane; CTM = canister transfer machine; CTM MC = canister transfer machine maintenance crane; CTT = cask transfer trolley; IE = initiating event; LBR = Lid Bolting Room; RF = Receipt Facility; TAD = transportation, aging and disposal; ST = site transporter.

Source: Original

Table B4.1-2. Fault Trees Assigned for Pivotal Events for RF-S-IE-HISTAR Initiating Event Tree

Initiating Seismic Failure	TRANSCASK	MODERATOR
RF building collapse	N/A	N/A
Entry door seismic collapse	RC-TAO-DOORDROP-CASK	RF-MOD-MULT-SYS
Railcar accident	RC-TAO-RC-ACC-CASK	RF-MOD-MULT-SYS
Mobile platform seismic collapse	RC-TAO-MOB-PLAT-CASK	RF-MOD-MULT-SYS
CHC seismic failures	TC-TAO-CHC-CASK	RF-MOD-MULT-SYS
Cask prep platform collapse	TC-TAO-CPP-CASK	RF-MOD-MULT-SYS
CTT seismic failures	CTT-TAO-CTT-CASK	RF-MOD-FPW-ONLY
TC-WP		
Shield door seismic failures	TCWP-TAO-SHIELDDOOR-CASK	RF-MOD-MULT-SYS
CANISTER		
CTM seismic failures	CTM-TAO-CTM-CAN	RF-MOD-FPW-ONLY
CTM MC seismic collapse	CTM-TAO-CTMMC	RF-MOD-FPW-ONLY
ST seismic failures	ST-TAO-AO-FAIL	RF-MOD-FPW-ONLY
LBR platform collapse	ST-TAO-LBRPLAT	RF-MOD-FPW-ONLY
LBR crane collapse	ST-TAO-LBRC-COL	RF-MOD-FPW-ONLY

NOTE: AO = aging overpack; CHC = cask handling crane; CPP = cask preparation platform; CTM = canister transfer machine; CTM MC = canister transfer machine maintenance crane; CTT = cask transfer trolley; FPW = fire protection water; LBR = Lid Bolting Room; RF = Receipt Facility; TAD = transportation, aging and disposal; ST = site transporter; TC = transportation cask; WP = waste package.

Source: Original

B4.2 FAULT TREES

Seismic fault trees for the processing of tilting DPCs in the RF are presented in alpha-numeric order in this section. Note that the TAD to aging overpack fault trees and basic events presented in B1 above were used as the templates for the DPC fault trees. Therefore, many of the fault tree names and basic event names are the same as for the TAD to aging overpack fault trees and basic events presented in B1 above, although the values for the basic events have been revised to reflect the DPC process. The revisions to the basic event values are given in Section B4.3.

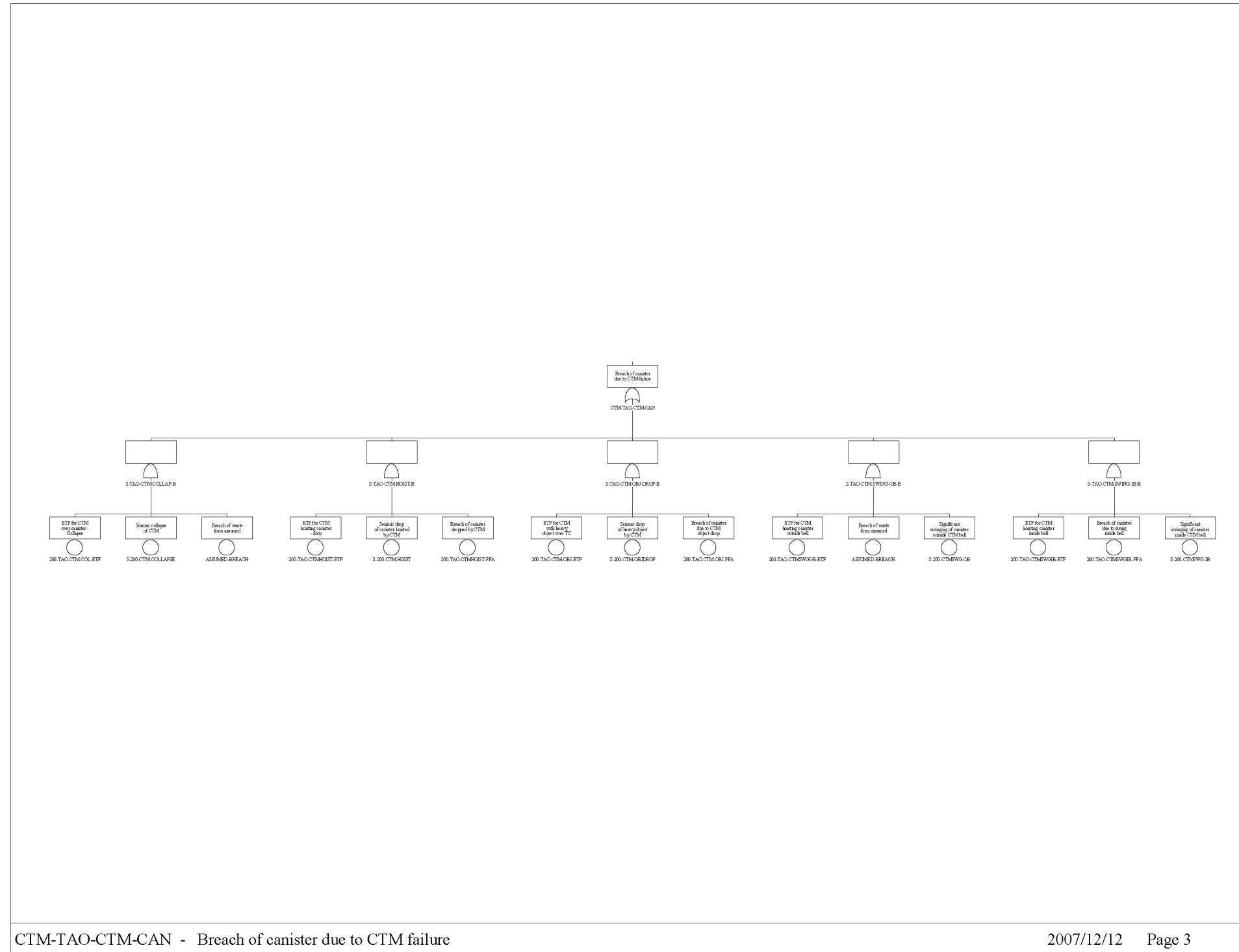

Source: Original

Figure B4.2-1. Fault Tree CTM-TAO-CTM-CAN – Breach of Canister Due to CTM Failure

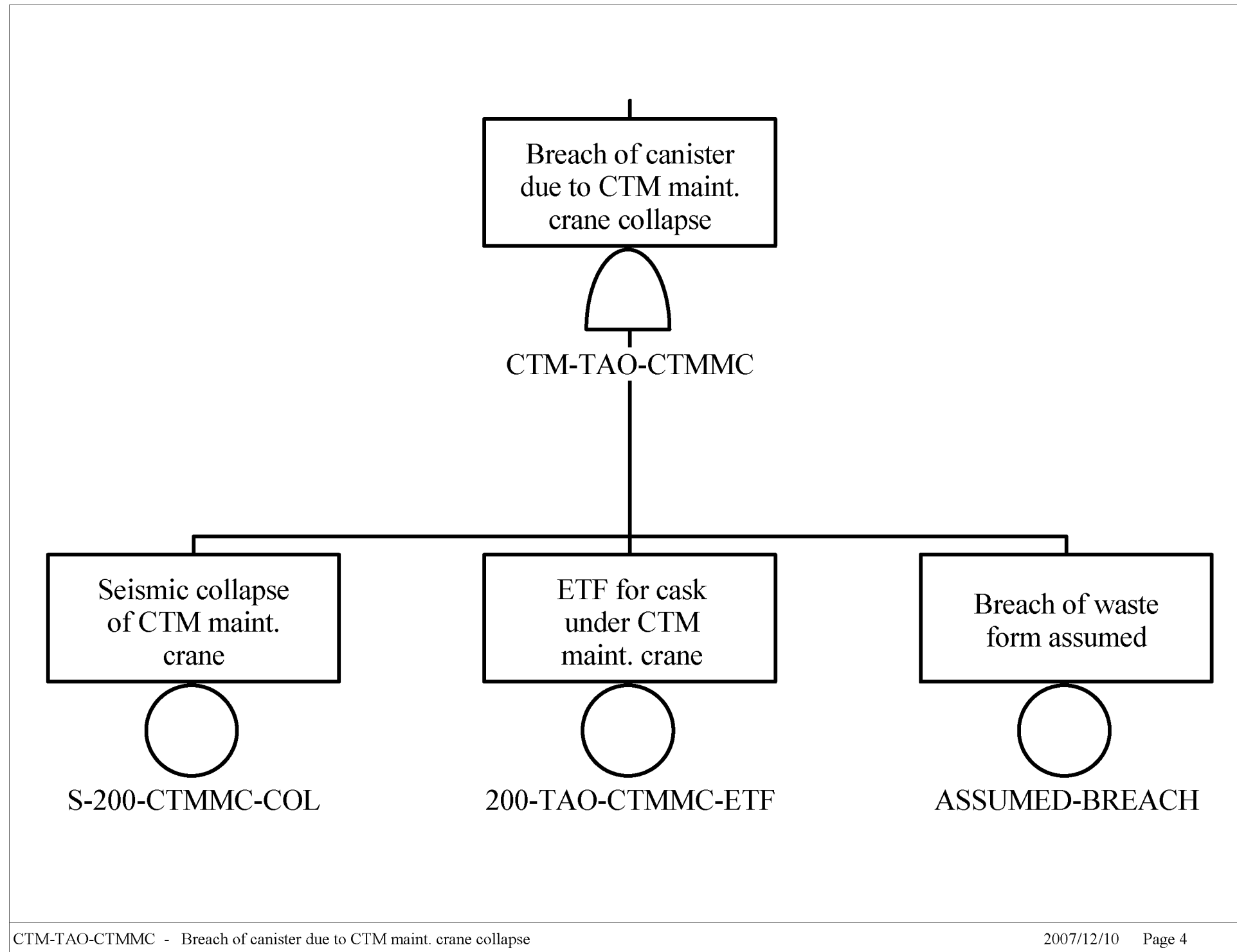

Source: Original

Figure B4.2-2. CTM-TAO-CTMMC – Breach of Canister due to CTM Maint. Crane Collapse

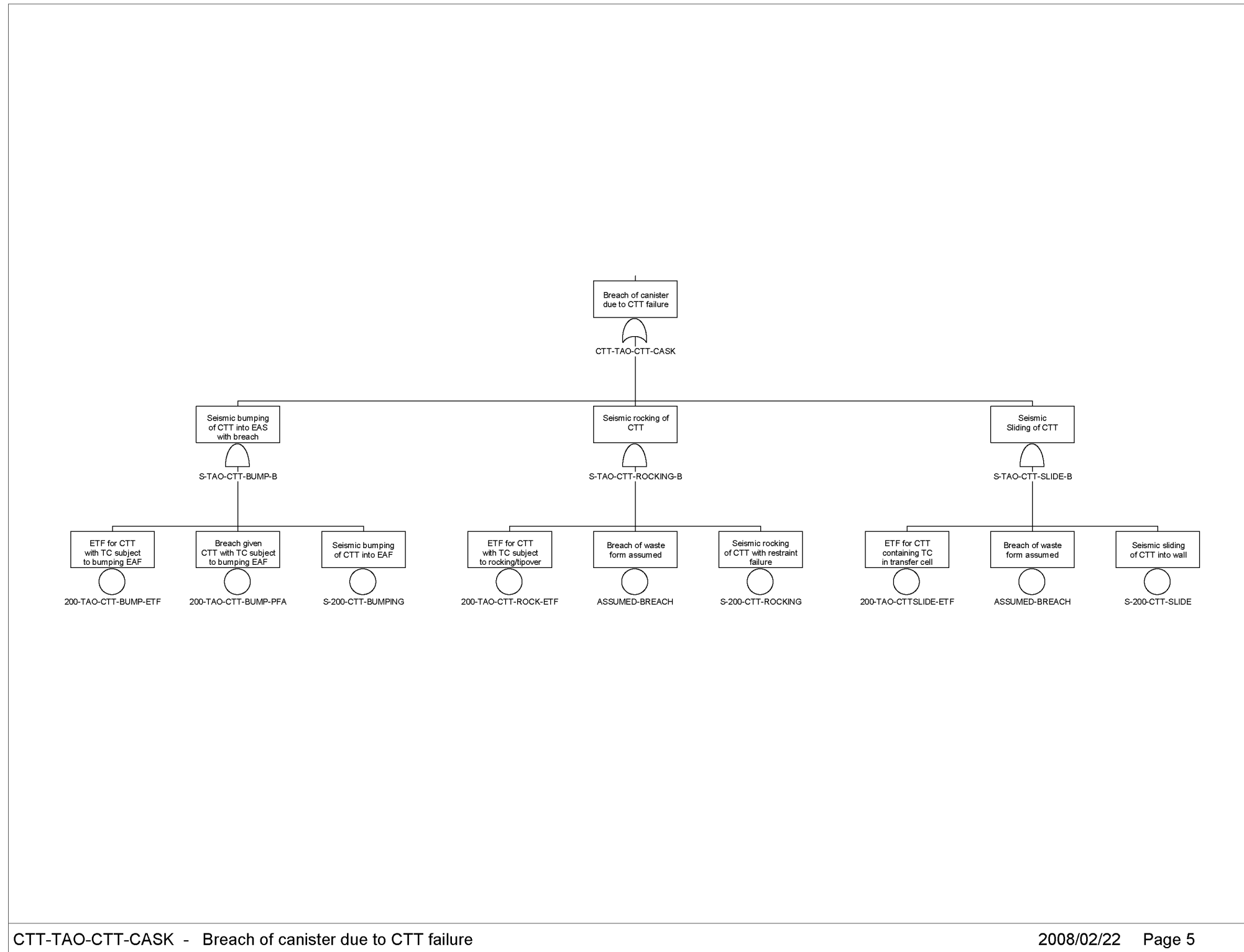

Source: Original

Figure B4.2-3 CTT-TAO-CTT-CASK – Breach of Canister due to CTT Failure

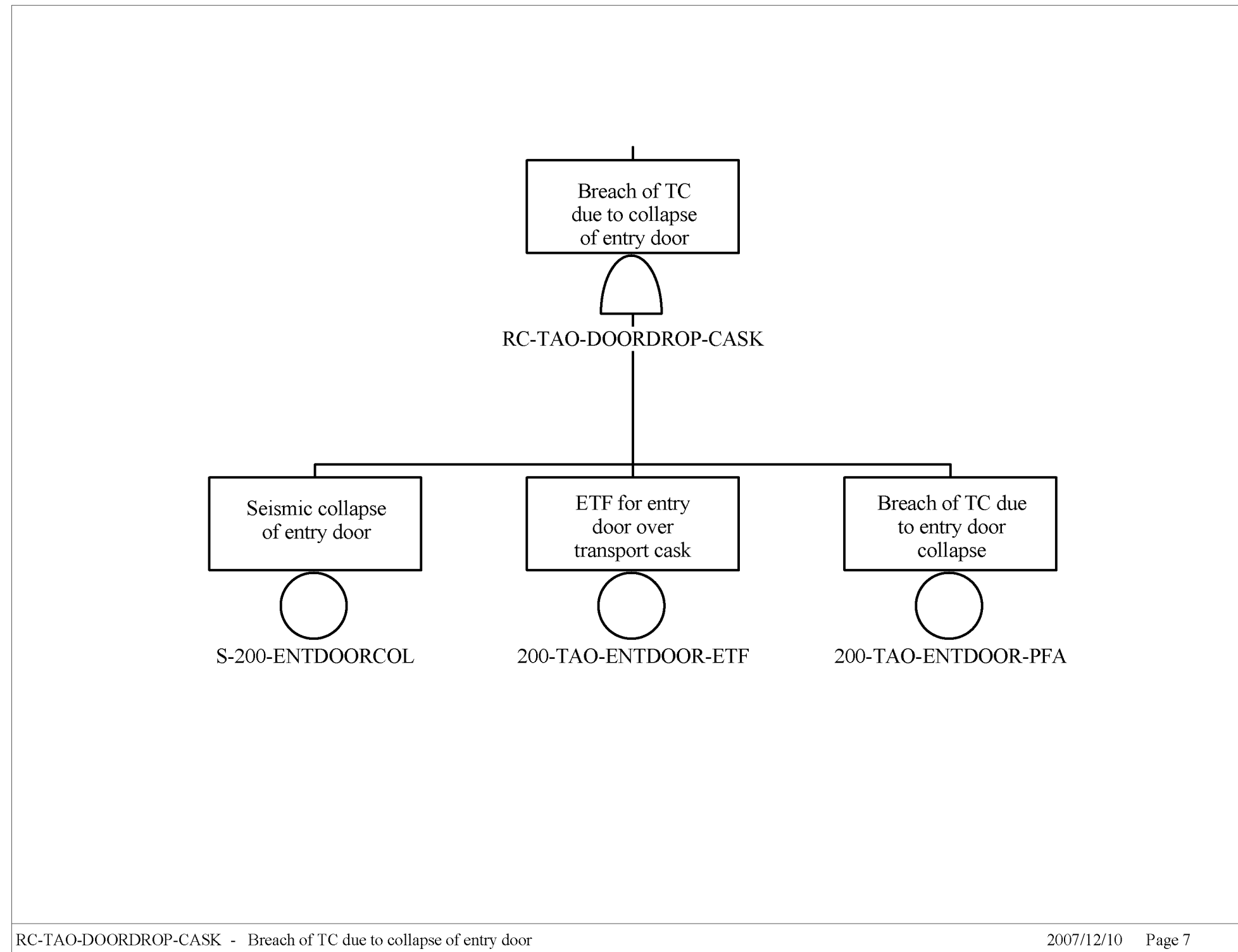

Source: Original

Figure B4.2-4. RC-TAO-DOORDROP-CASK – Breach of TC due to Collapse of Entry Door

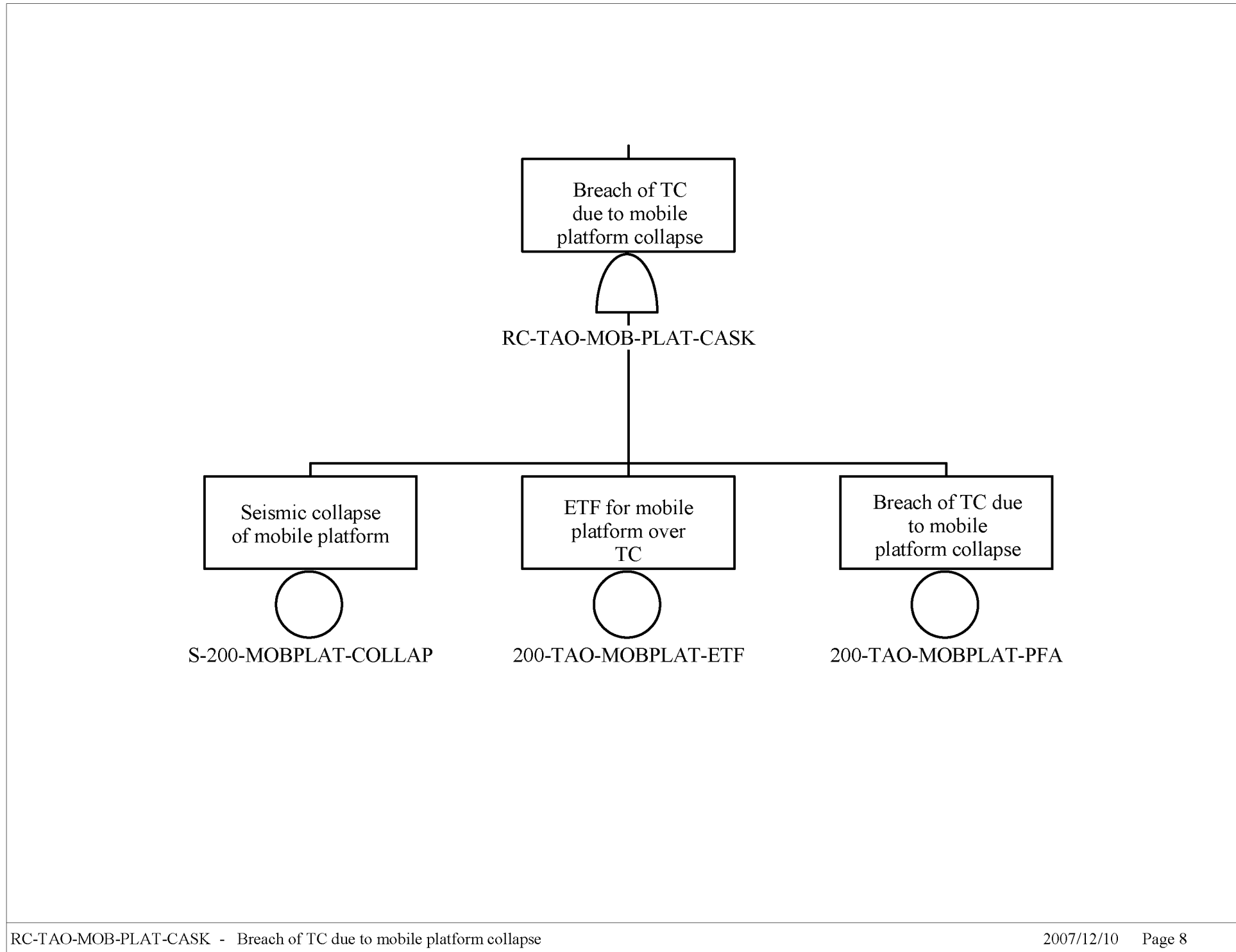

Source: Original

Figure B4.2-5. RC-TAO-MOB-PLAT-CASK – Breach of TC due to Mobile Platform Collapse

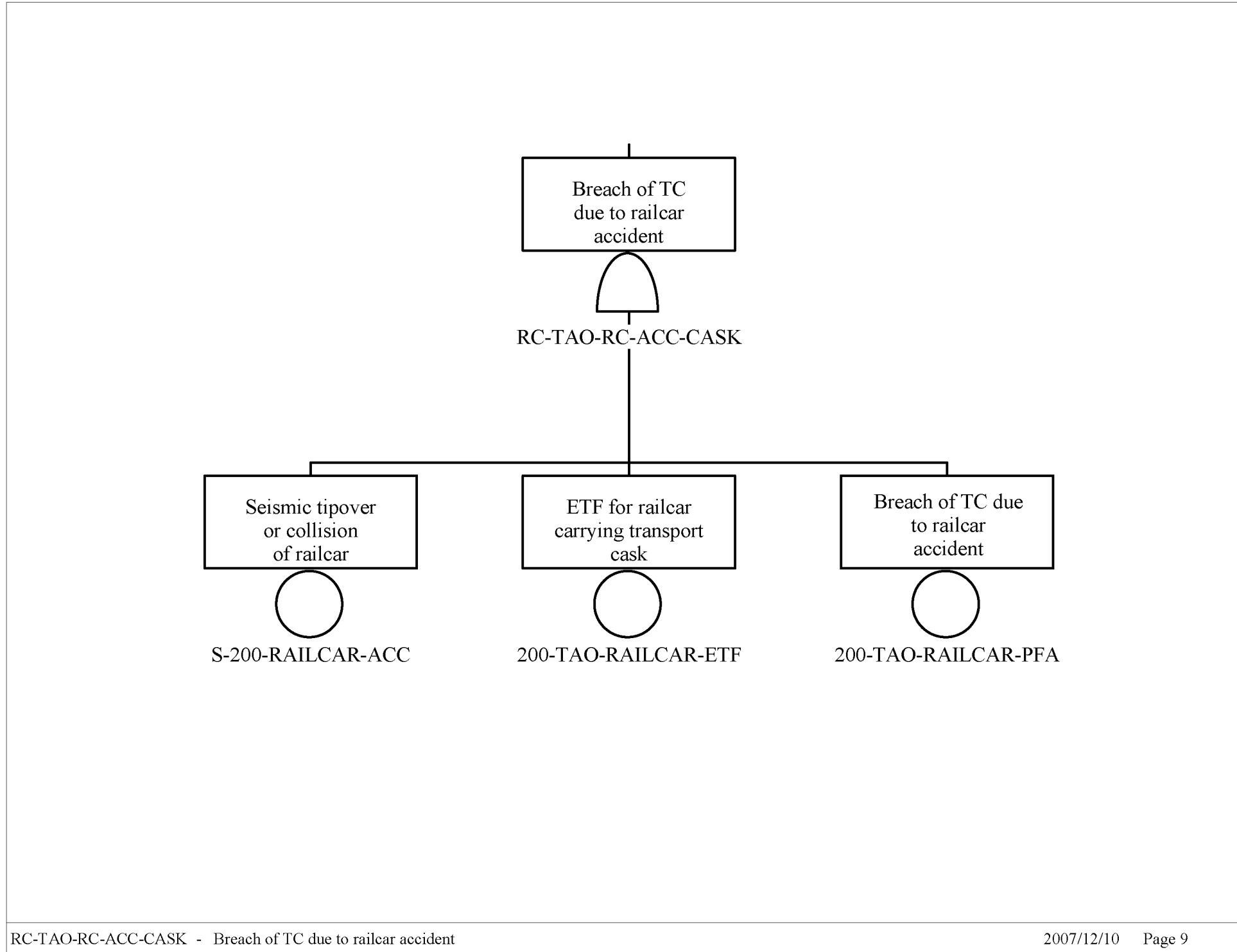

Source: Original

Figure B4.2-6. RC-TAO-RC-ACC-CASK – Breach of TC due to Railcar Accident

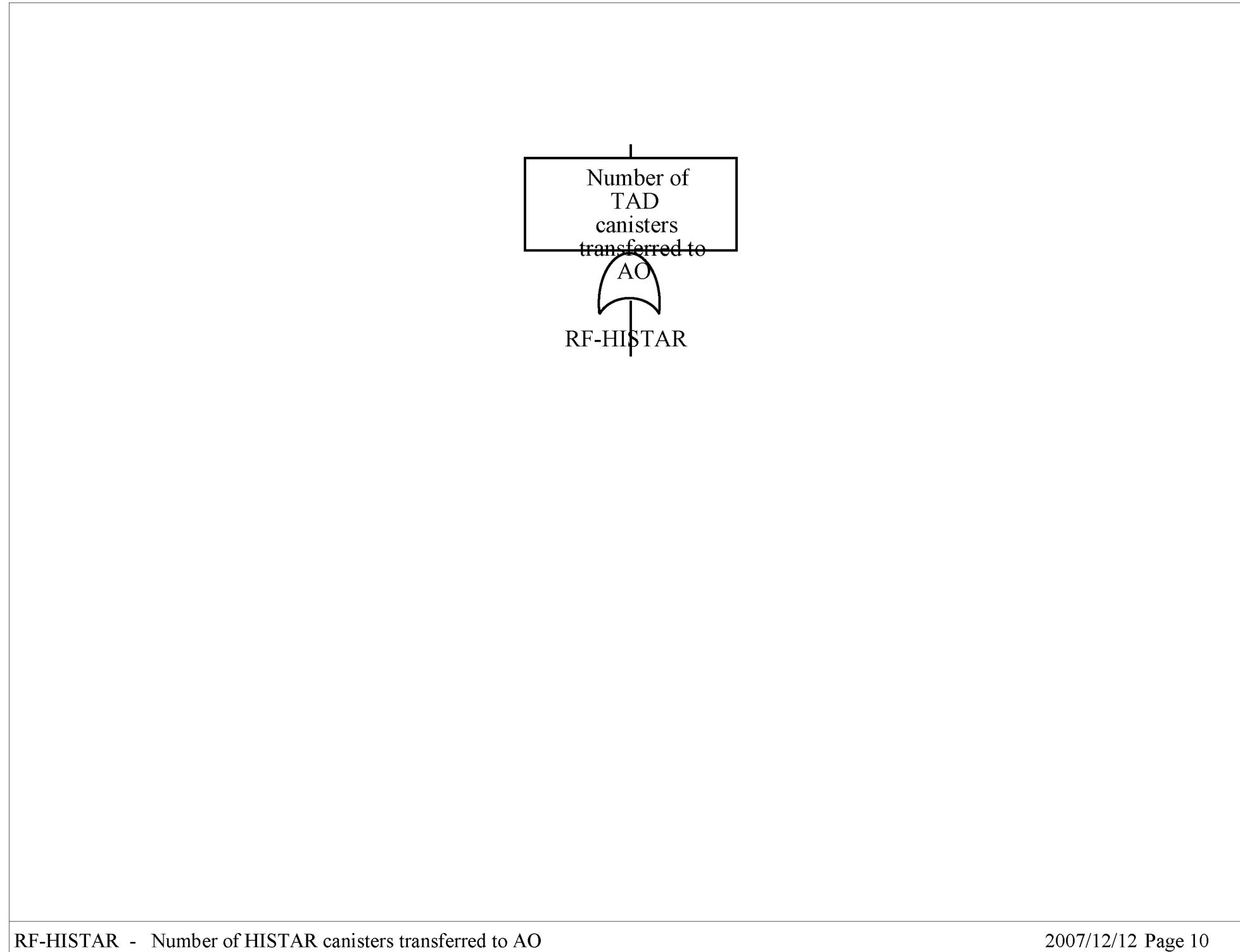

RF-HISTAR - Number of HISTAR canisters transferred to AO

2007/12/12 Page 10

Source: Original

Figure B4.2-7. RF-HISTAR – Number of HISTAR Canisters Transferred to AO

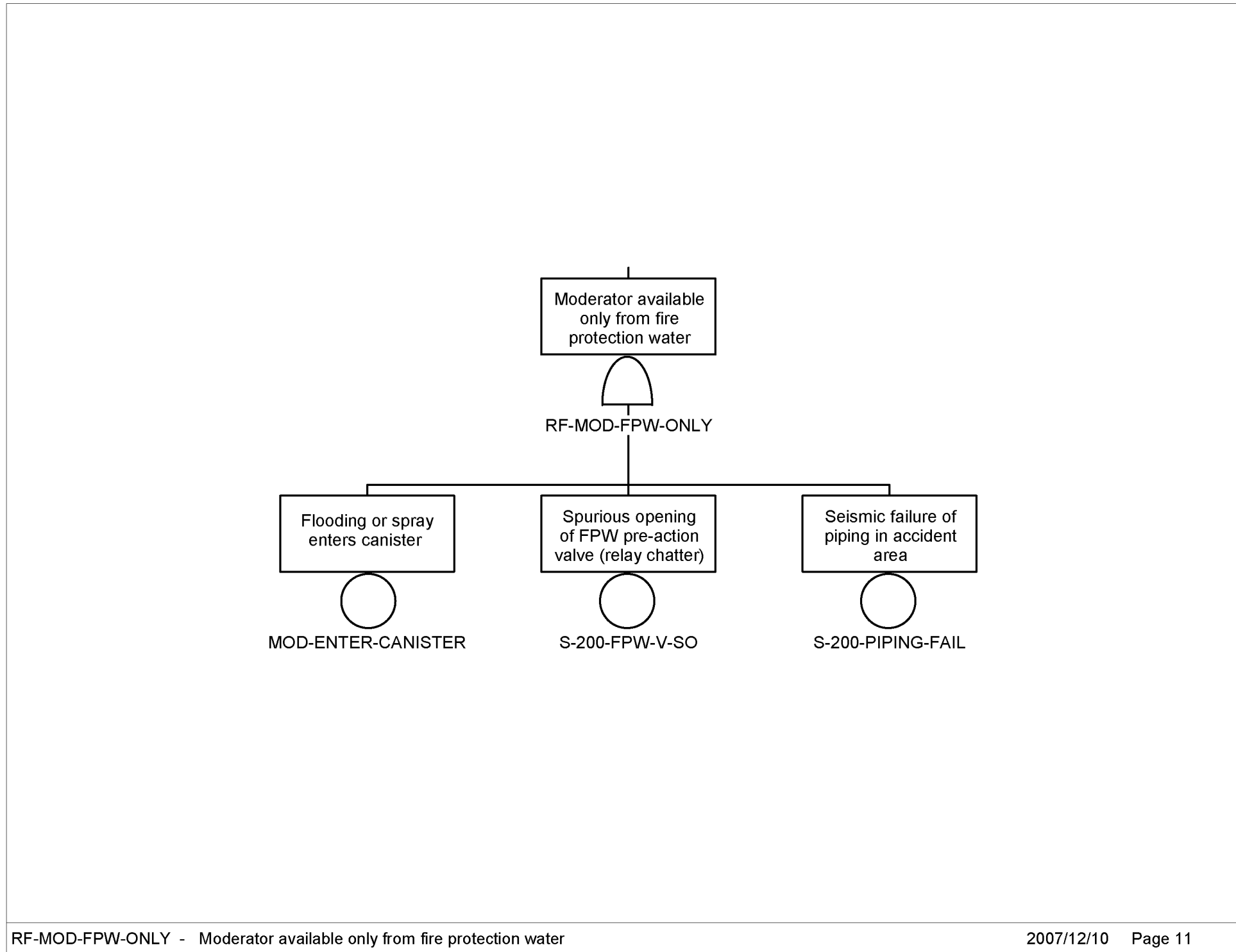

Source: Original

Figure B4.2-8. RF-MOD-FPW-ONLY – Moderator Available from Fire Protection Water

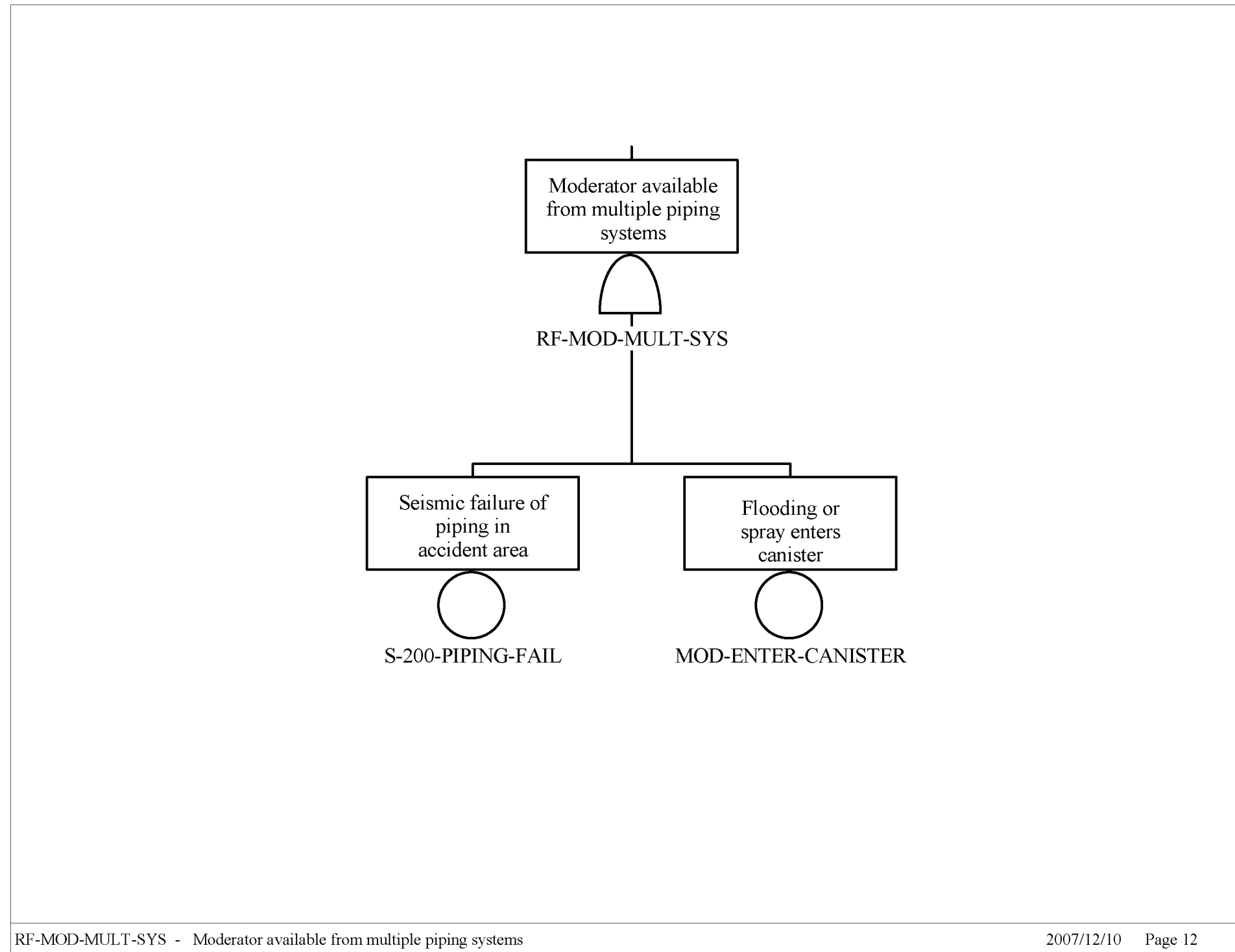

Source: Original

Figure B4.2-9. RF-MOD-MULT-SYS – Moderator Available from Multiple Piping Systems

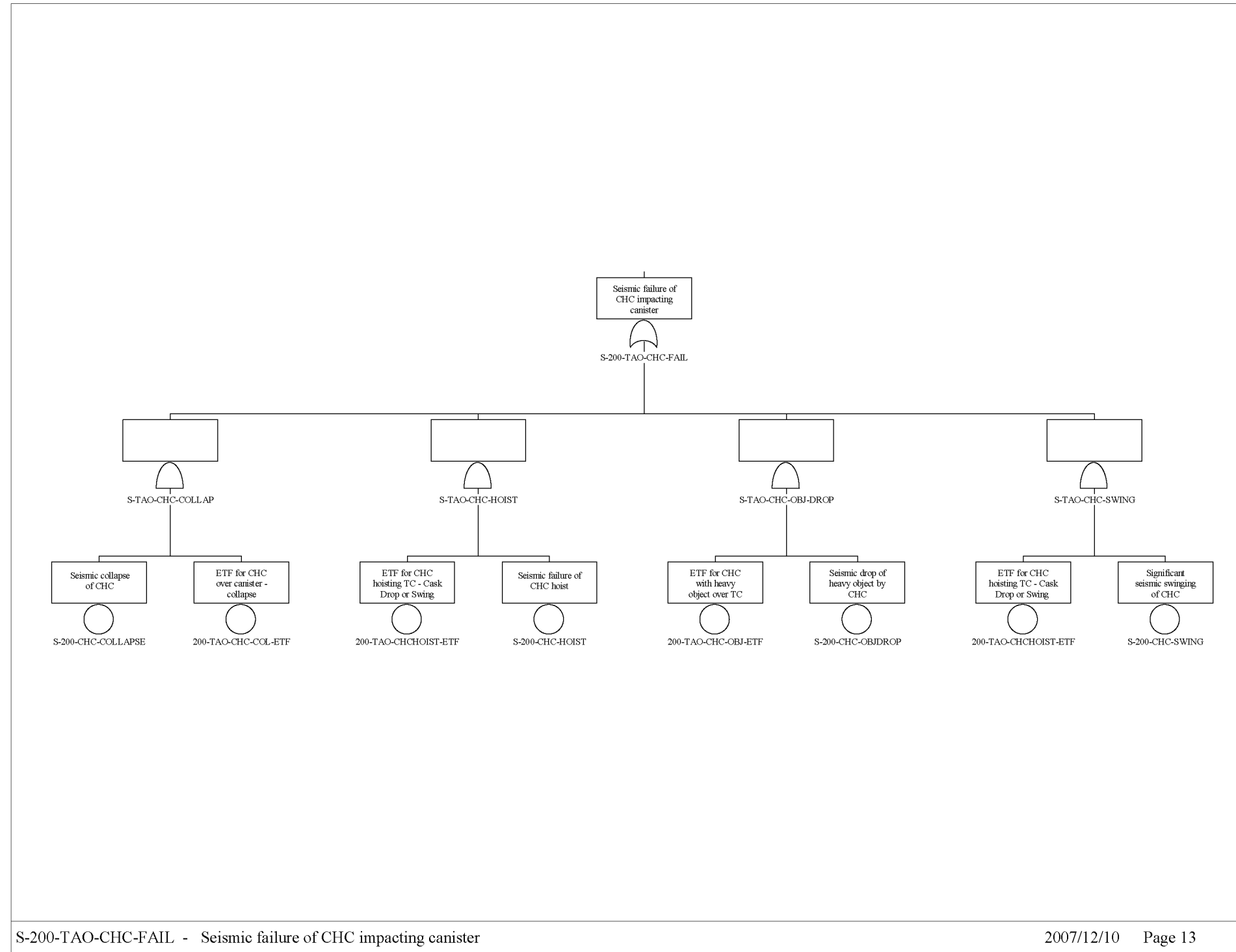

Source: Original

Figure B4.2-10. S-200-TAO-CHC-FAIL – Seismic Failure of CHC Impacting Canister

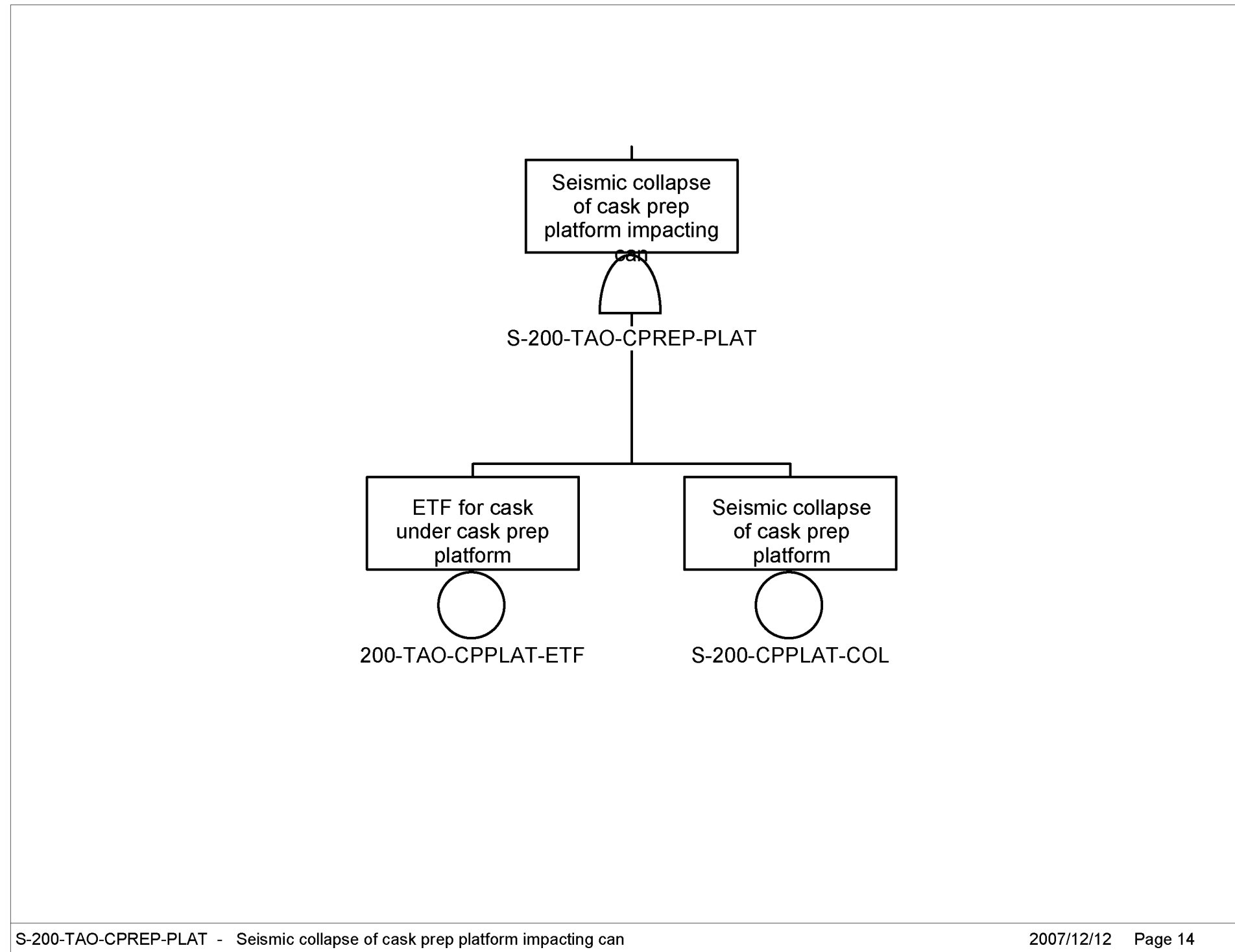

S-200-TAO-CPREP-PLAT - Seismic collapse of cask prep platform impacting can

2007/12/12 Page 14

Source: Original

Figure B4.2-11. S-200-TAO-CPREP-PLAT – Seismic Collapse of Cask Prep Platform Impacting Can

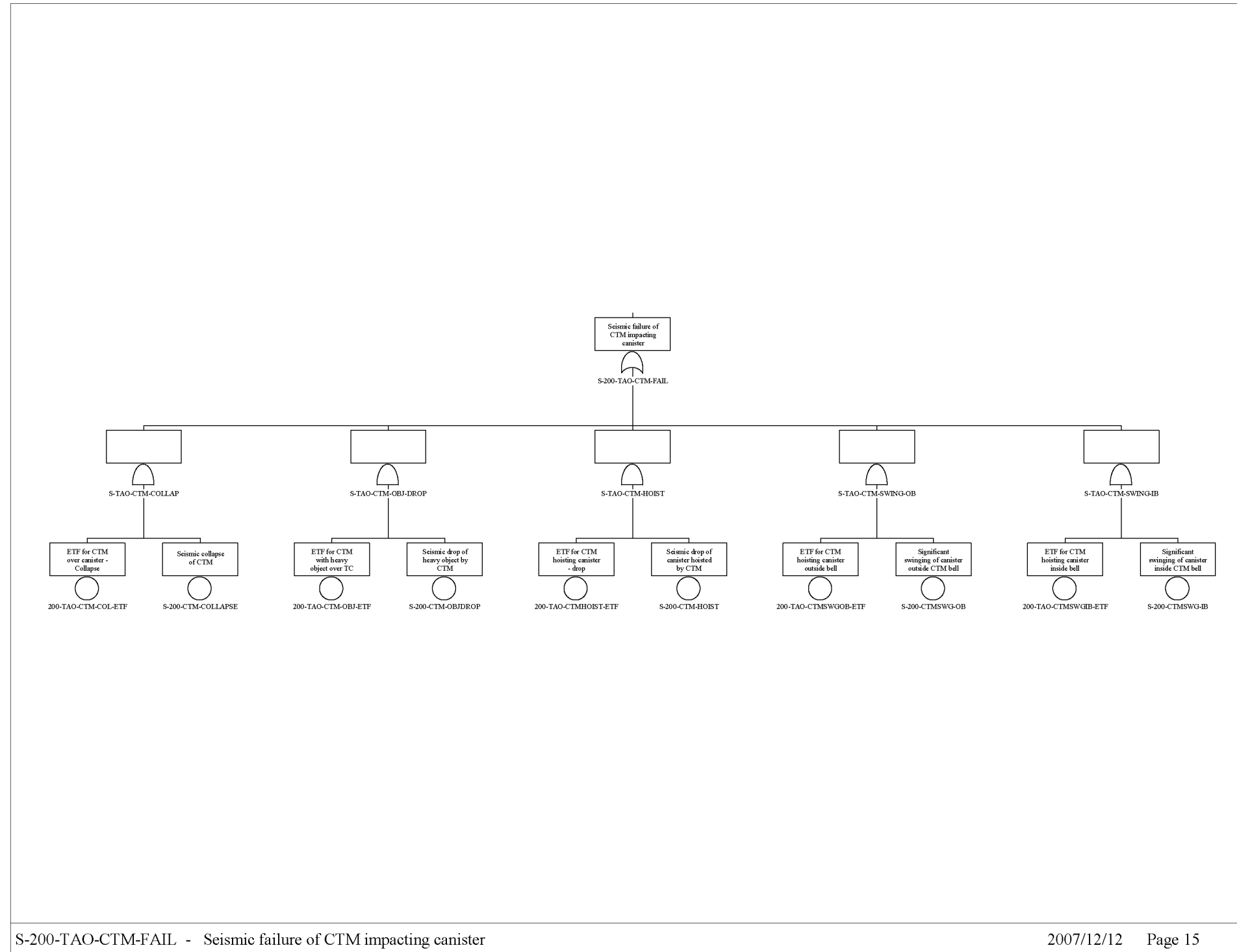

Source: Original

Figure B4.2-12. S-200-TAO-CTM-FAIL – Seismic Failure of CTM Impacting Canister

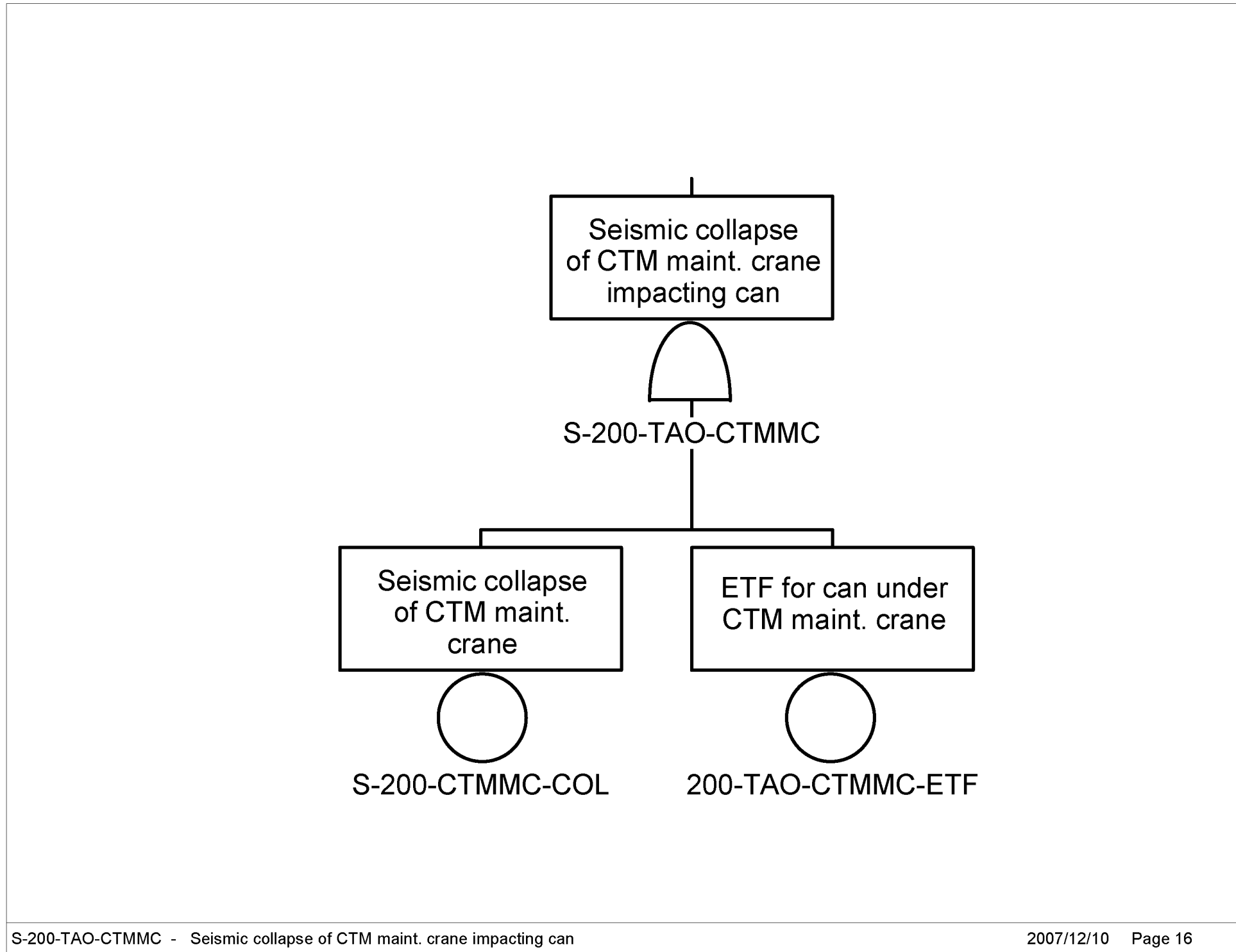

Source: Original

Figure B4.2-13. S-200-TAO-CTMMC – Seismic Collapse of CTM Maint. Crane Impacting Can

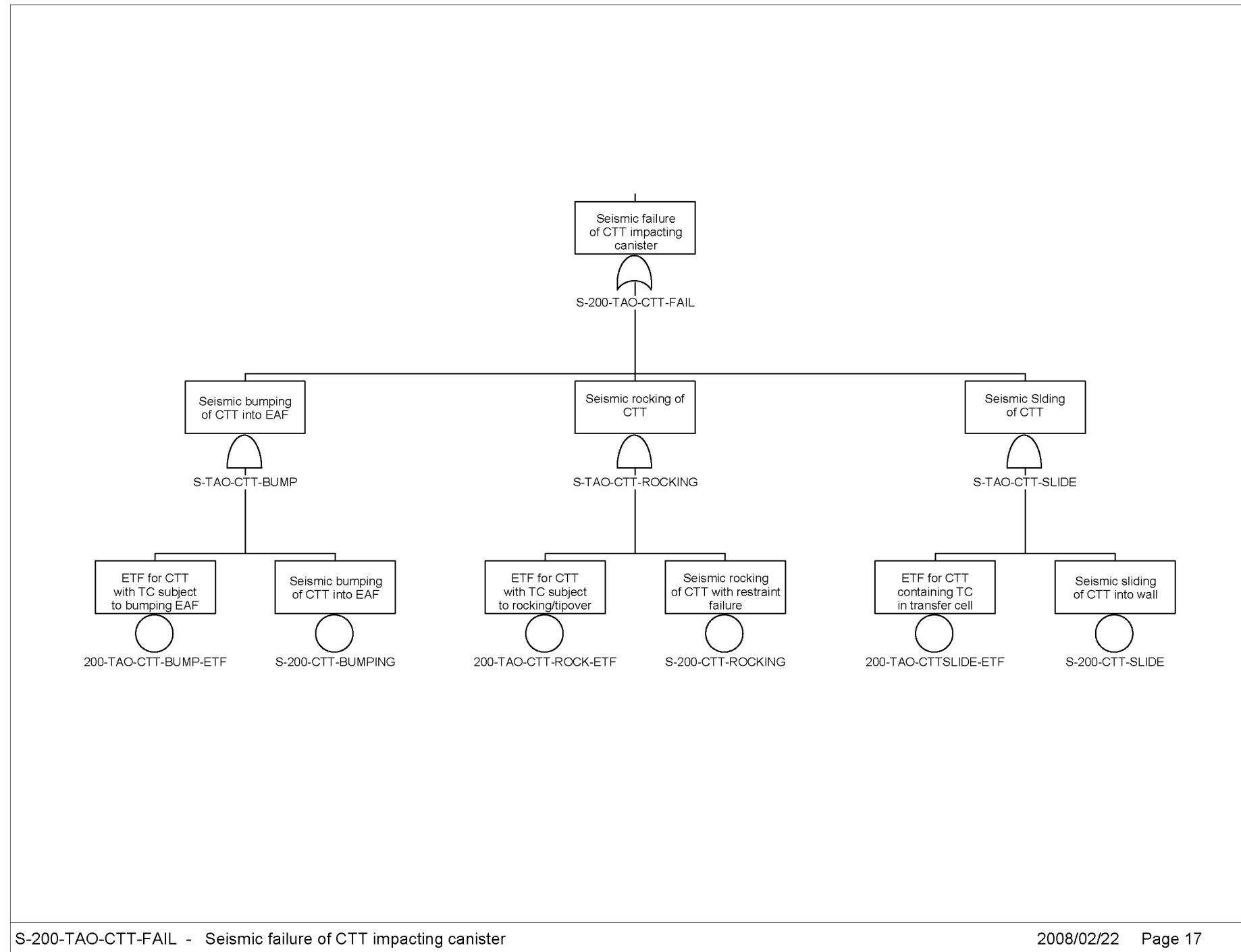

Source: Original

Figure B4.2-14. S-200-TAO-CTT-FAIL – Seismic Failure of CTT Impacting Canister

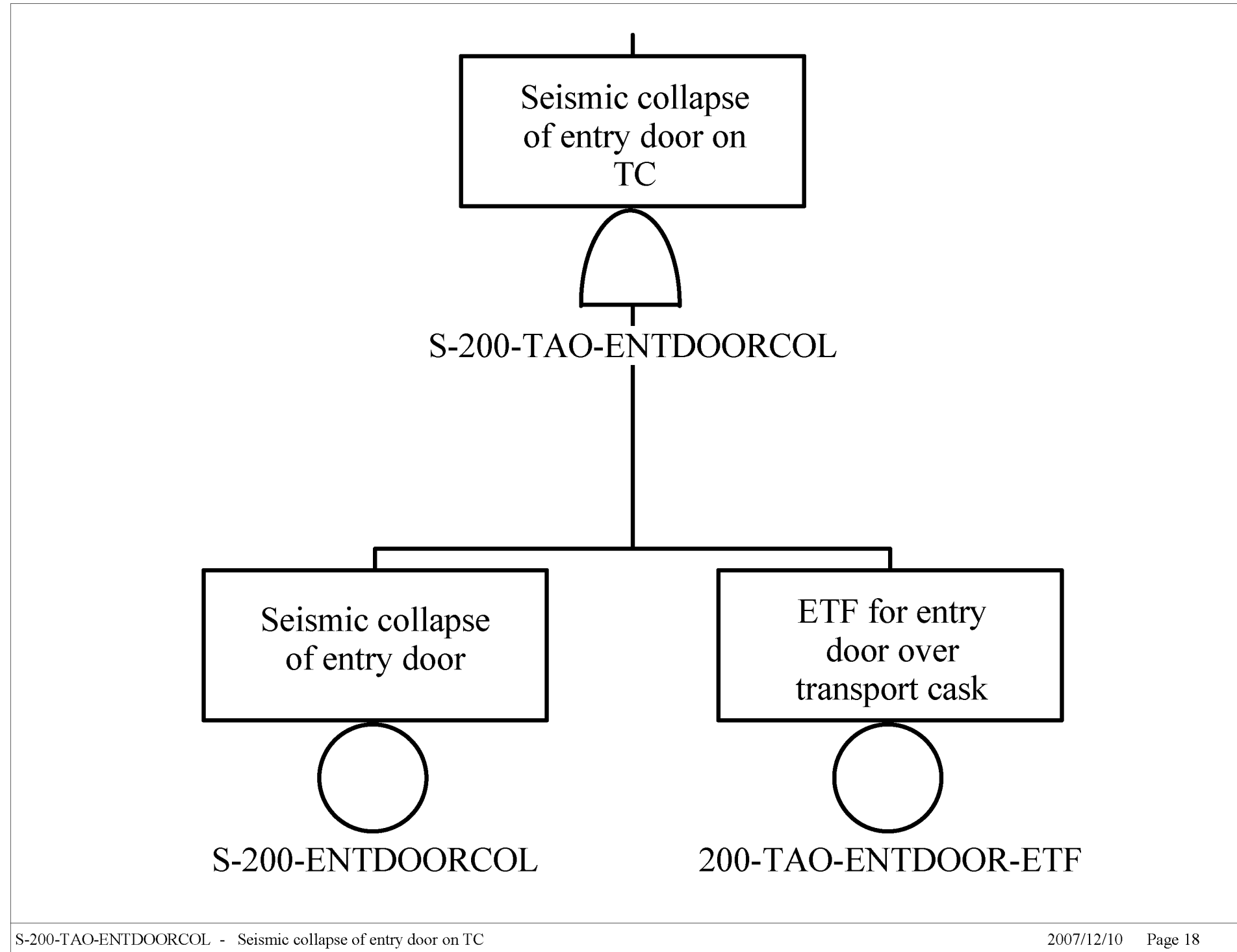

Source: Original

Figure B4.2-15. S-200-TAO-ENTDOORCOL – Seismic Collapse of Entry Door on TC

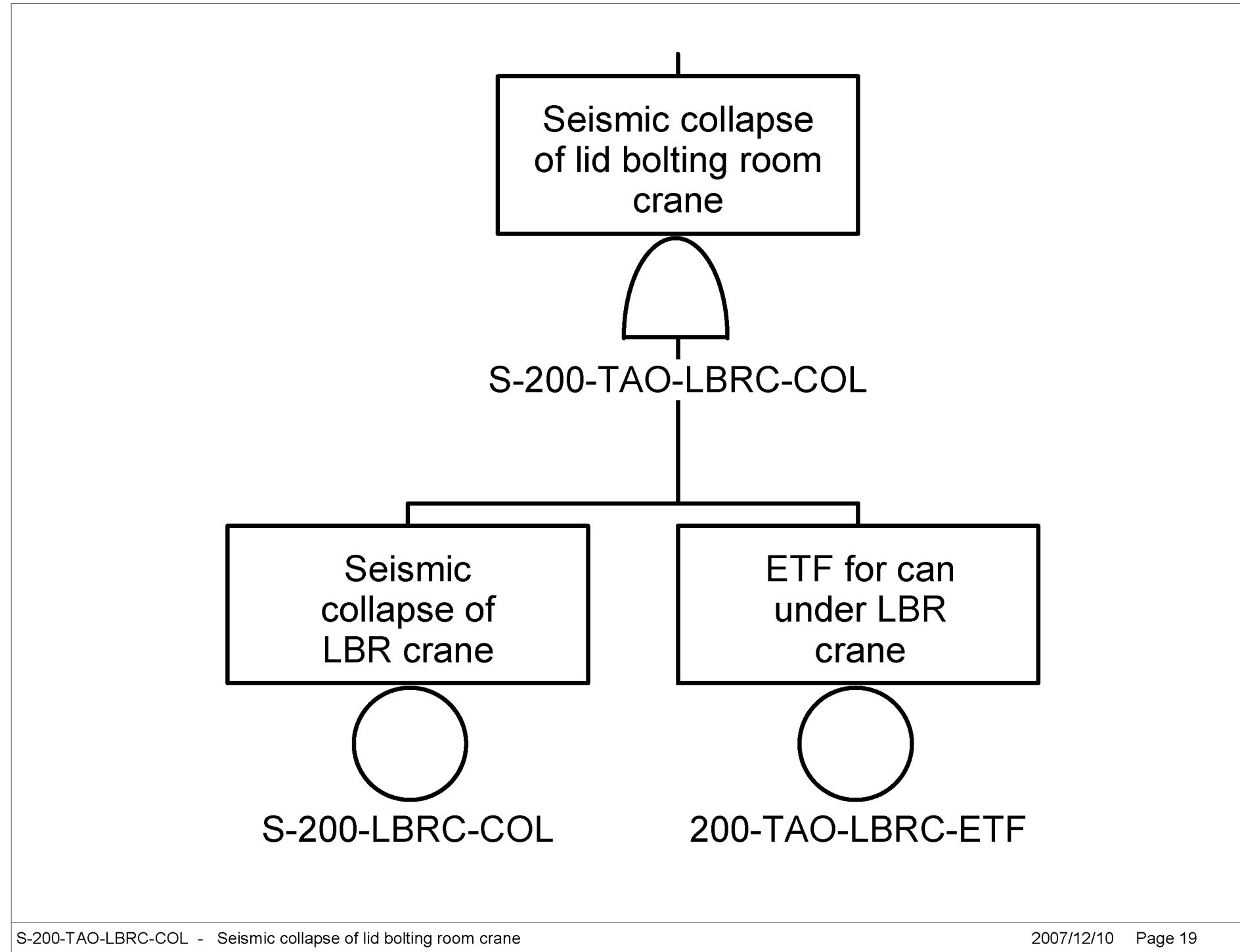

Source: Original

Figure B4.2-16. S-200-TAO-LBRC – Seismic Collapse of Lid Bolting Room Crane

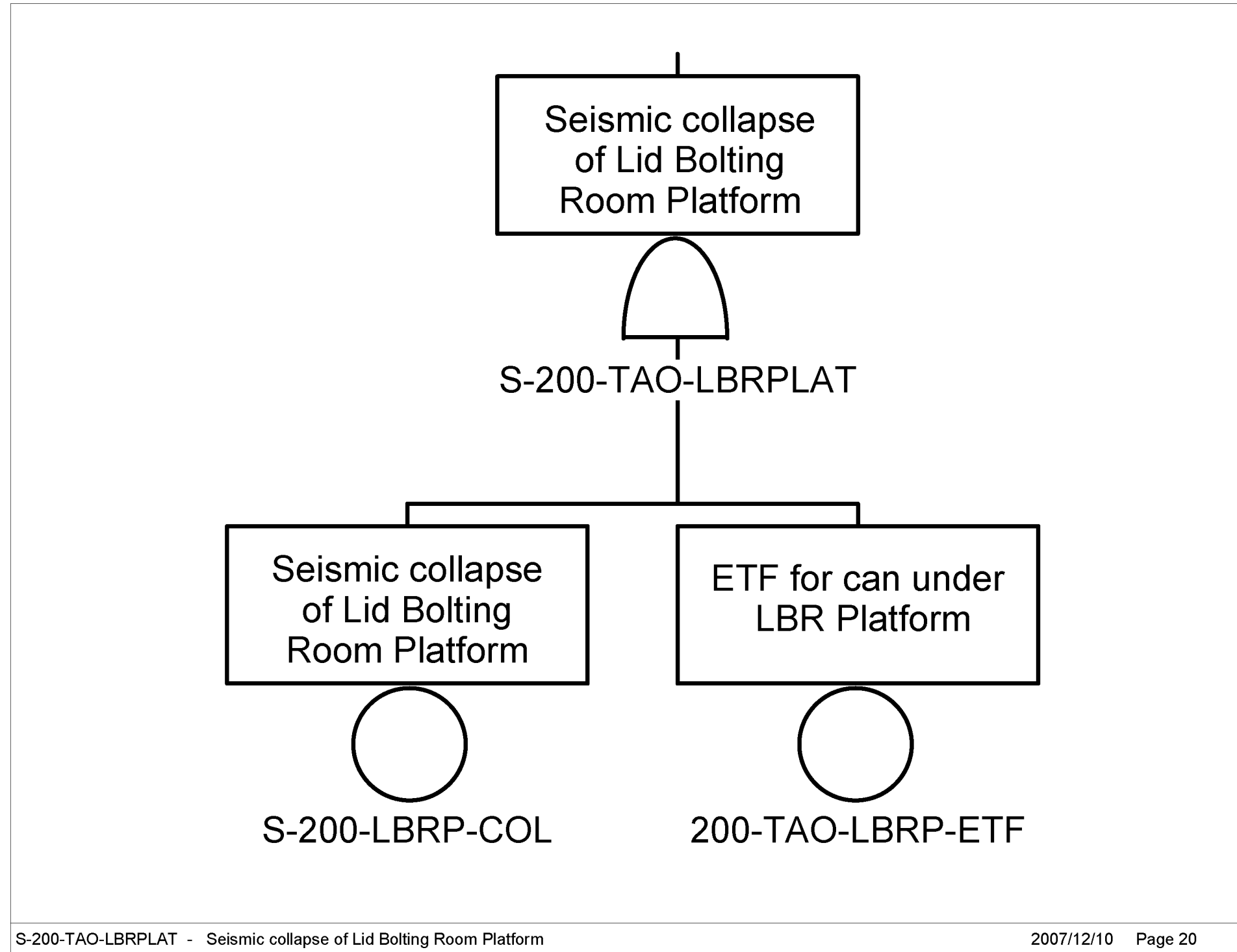

Source: Original

Figure B4.2-17. S-200-TAO-LBRPLAT – Seismic Collapse of Lid Bolting Room Platform

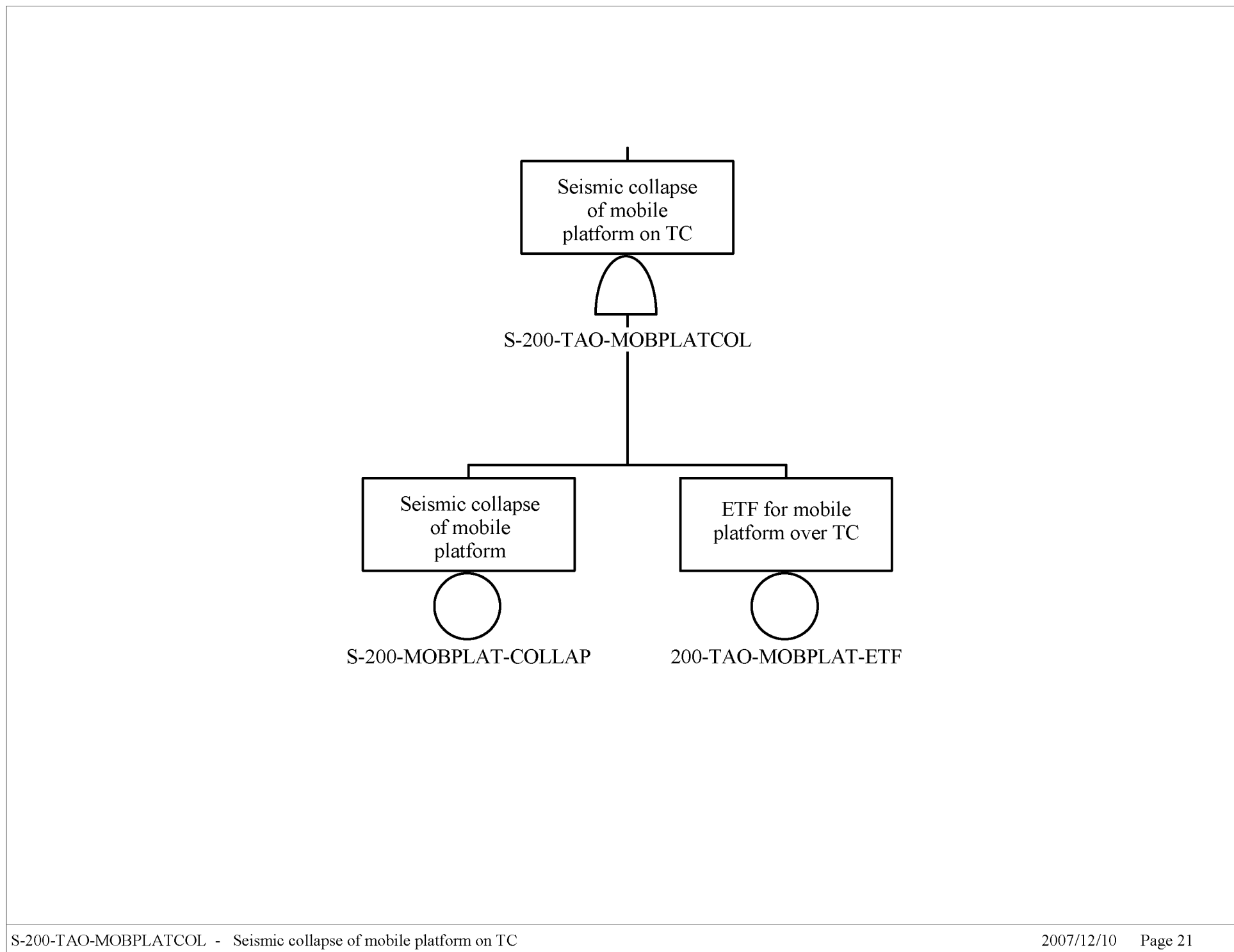

Source: Original

Figure B4.2-18. S-200-TAO-MOBPLATCOL– Seismic Collapse of Mobile Platform on TC

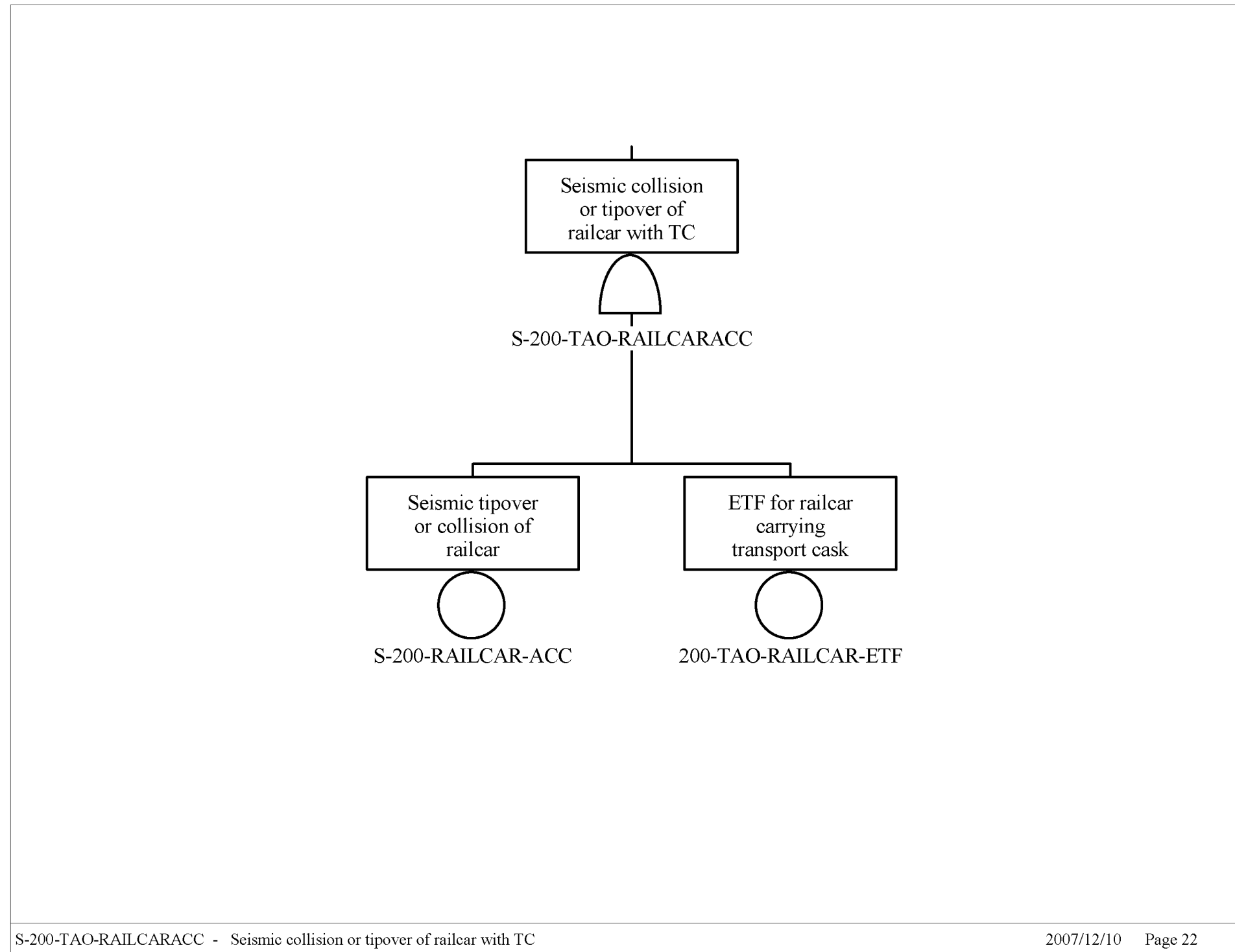

S-200-TAO-RAILCARACC - Seismic collision or tipover of railcar with TC

2007/12/10 Page 22

Source: Original

Figure B4.2-19. S-200-TAO-RAILCARACC – Seismic Collision or Tipover of Railcar with TC

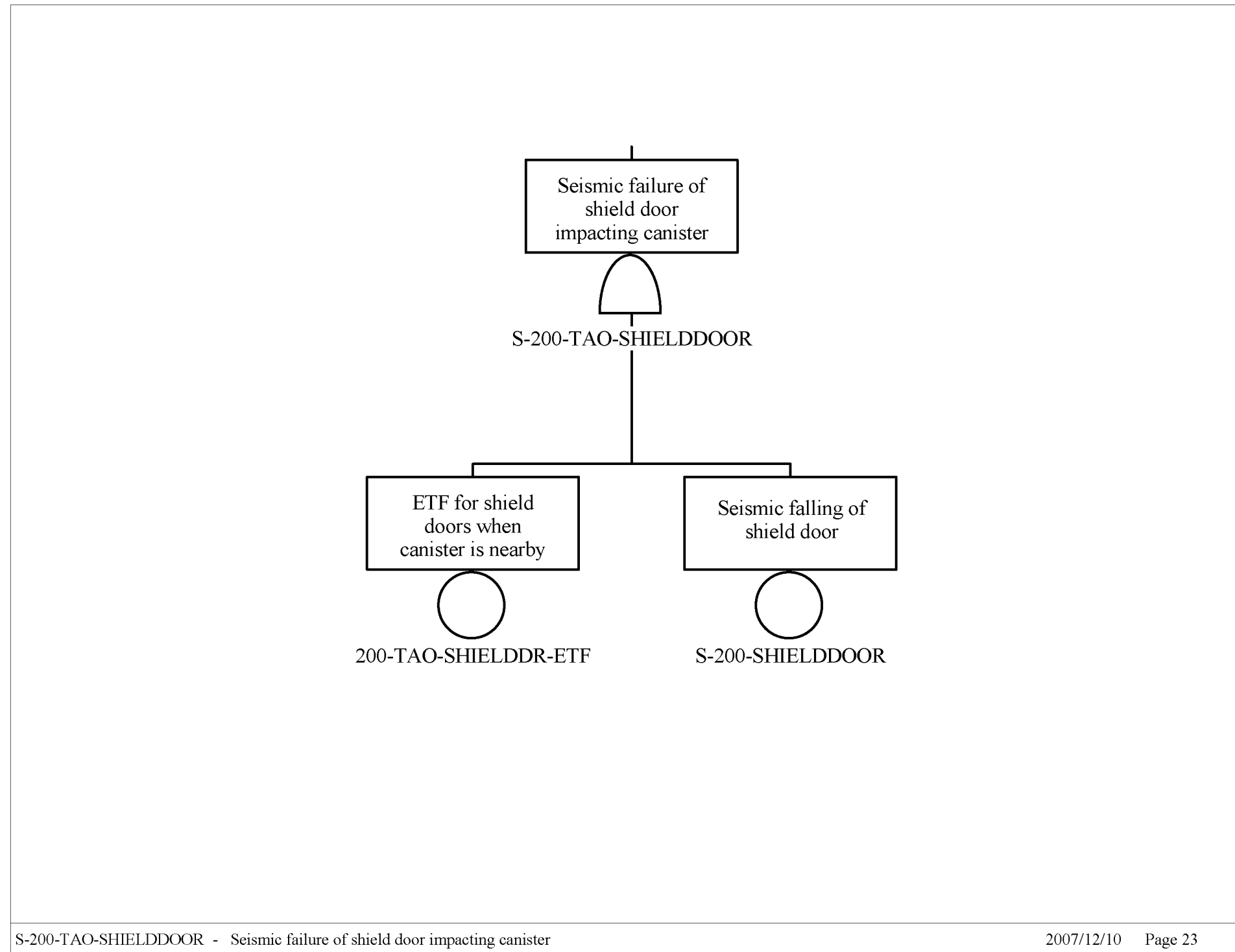

Source: Original

Figure B4.2-20. S-200-TAO-SHIELDDOOR – Seismic Failure of Shield Door Impacting Canister

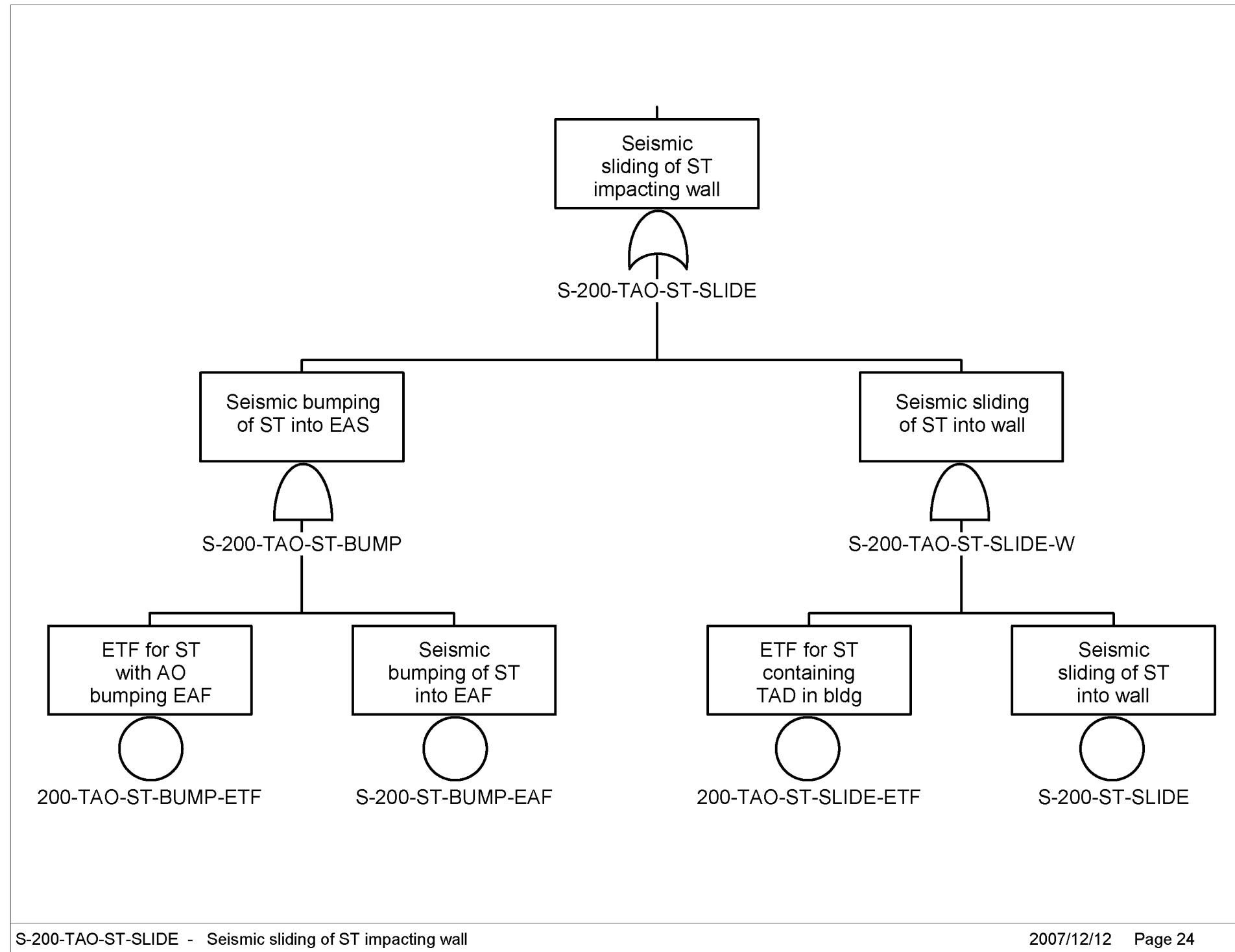

Source: Original

Figure B4.2-21. S-200-TAO-ST-SLIDE – Seismic Sliding of ST Impacting Wall

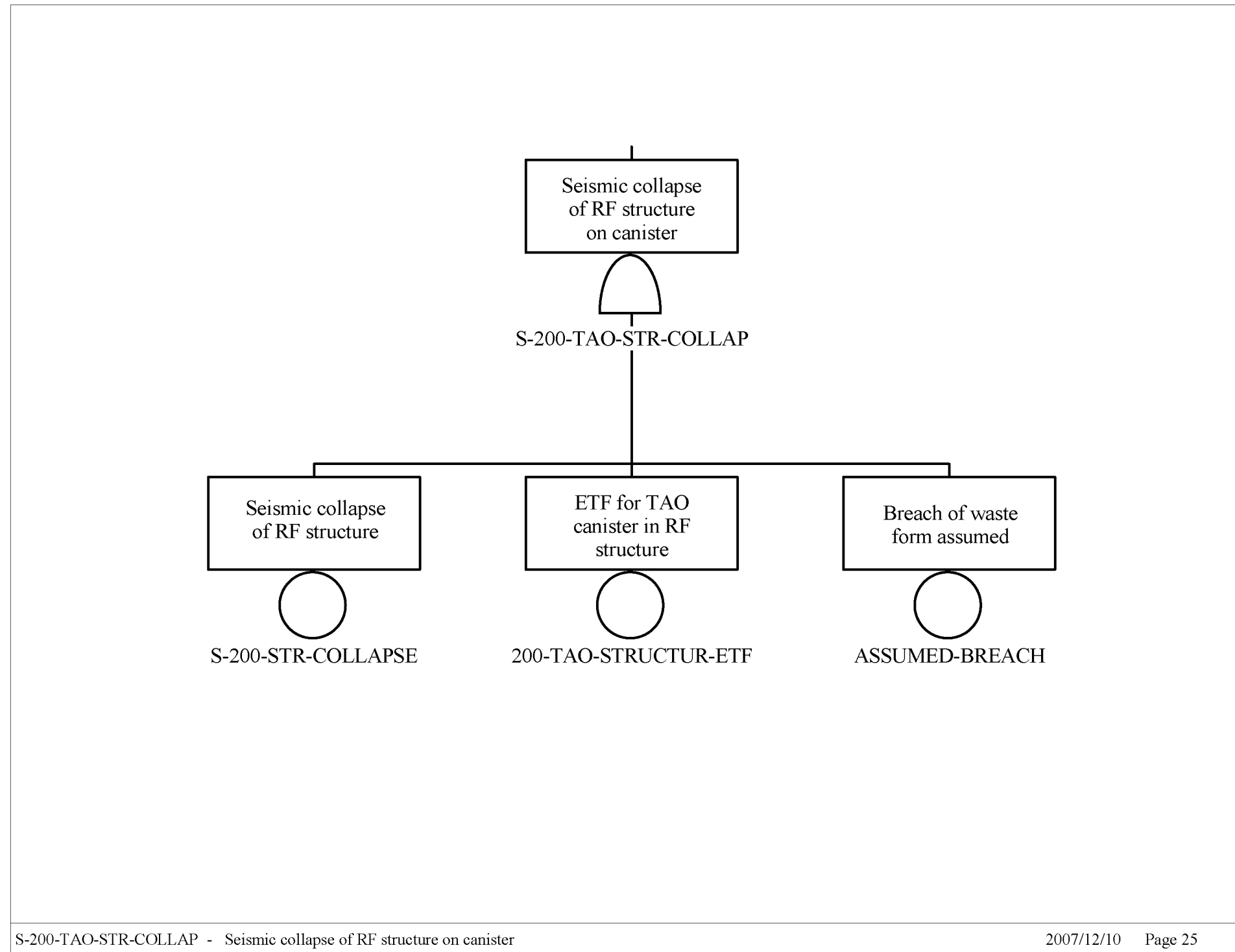

Source: Original

Figure B4.2-22. S-200-TAO-STR-COLLAP – Seismic Collapse of RF Structure on Canister

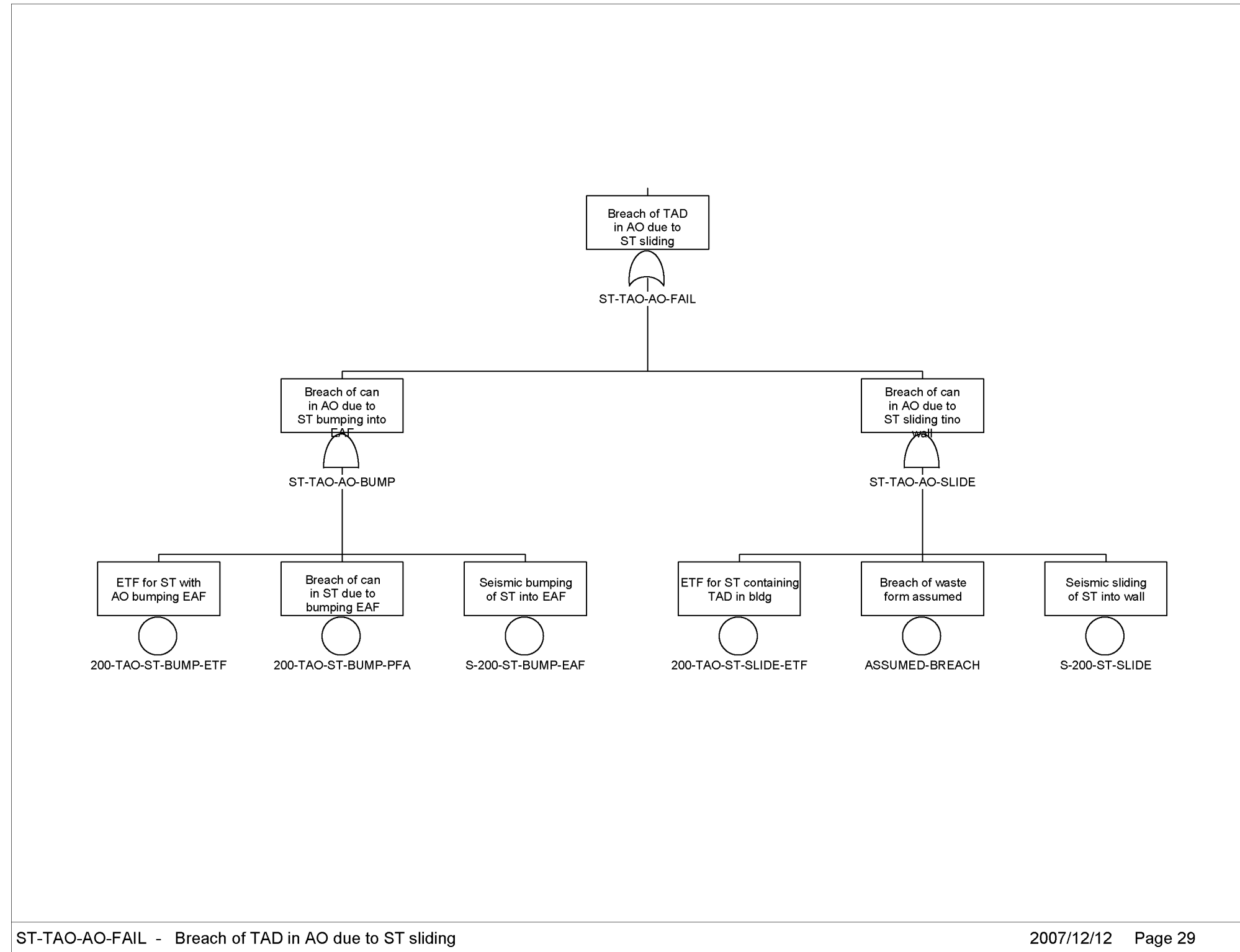

Source: Original

Figure B4.2-23. ST-TAO-AO-FAIL – Breach of TAD in AO due to ST Sliding

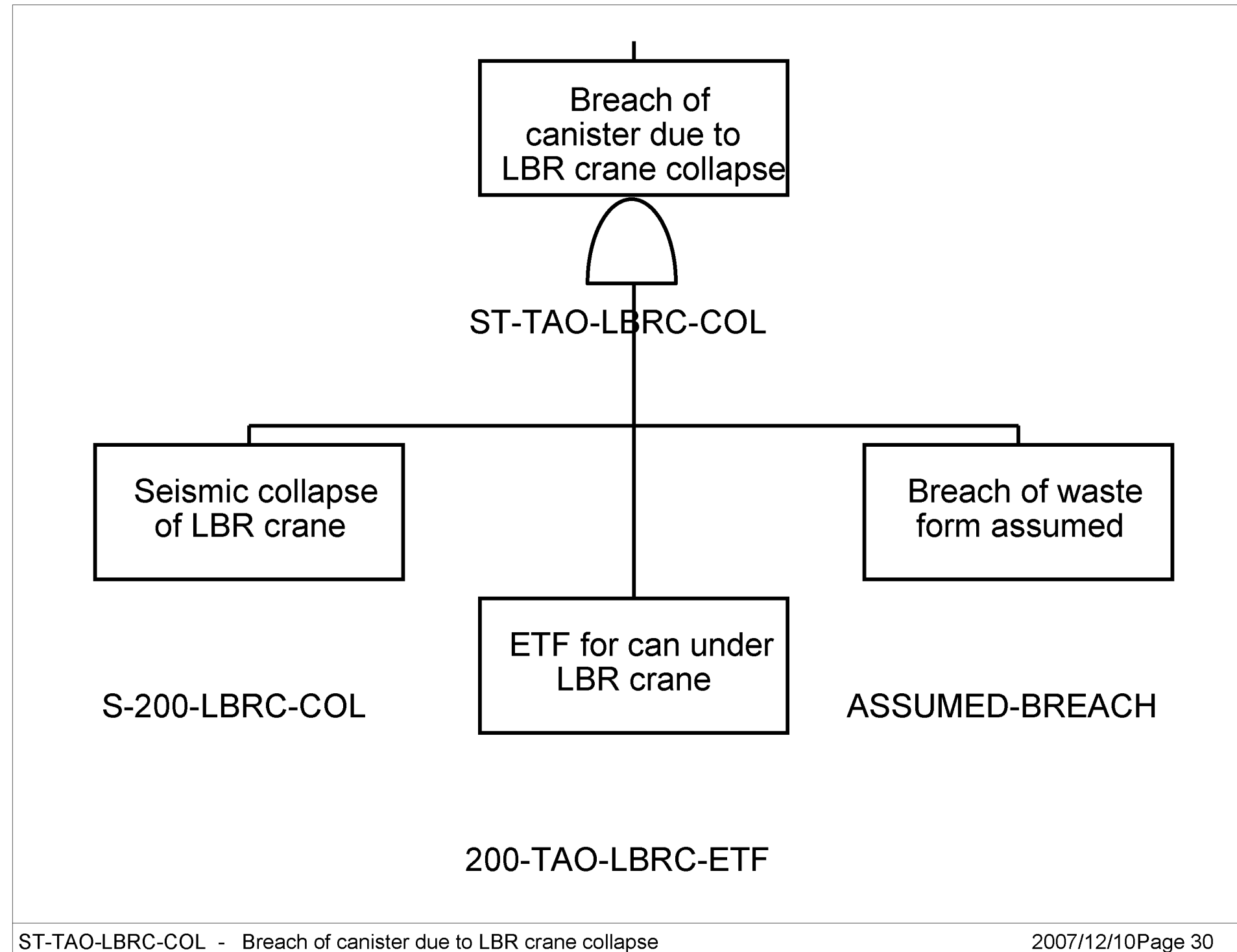

Source: Original

Figure B4.2-24 ST-TAO-LBRC-COL – Breach of Canister due to LBR Crane Collapse

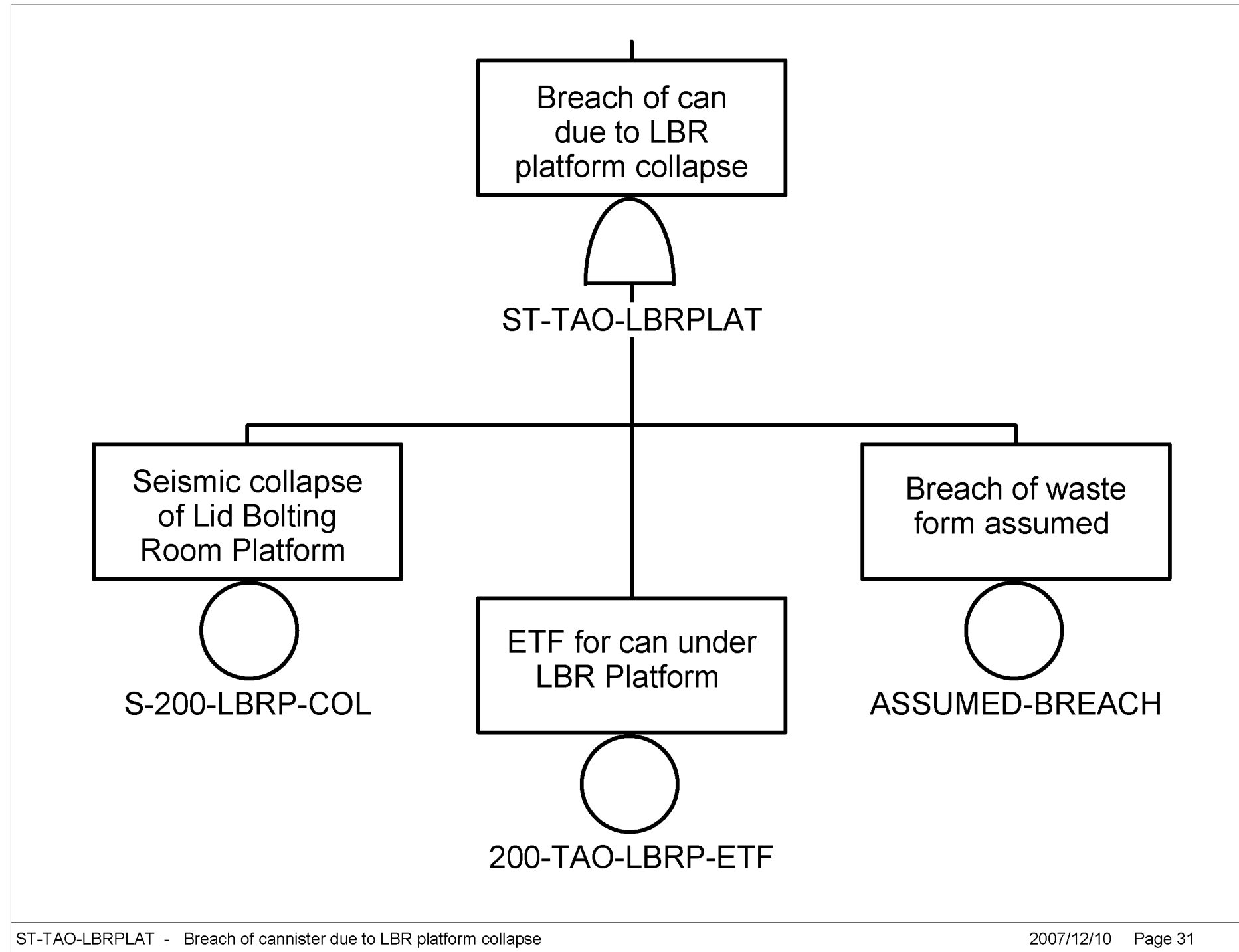

Source: Original

Figure B4.2-25. ST-TAO-LBRPLAT – Breach of Canister due to LBR Platform Collapse

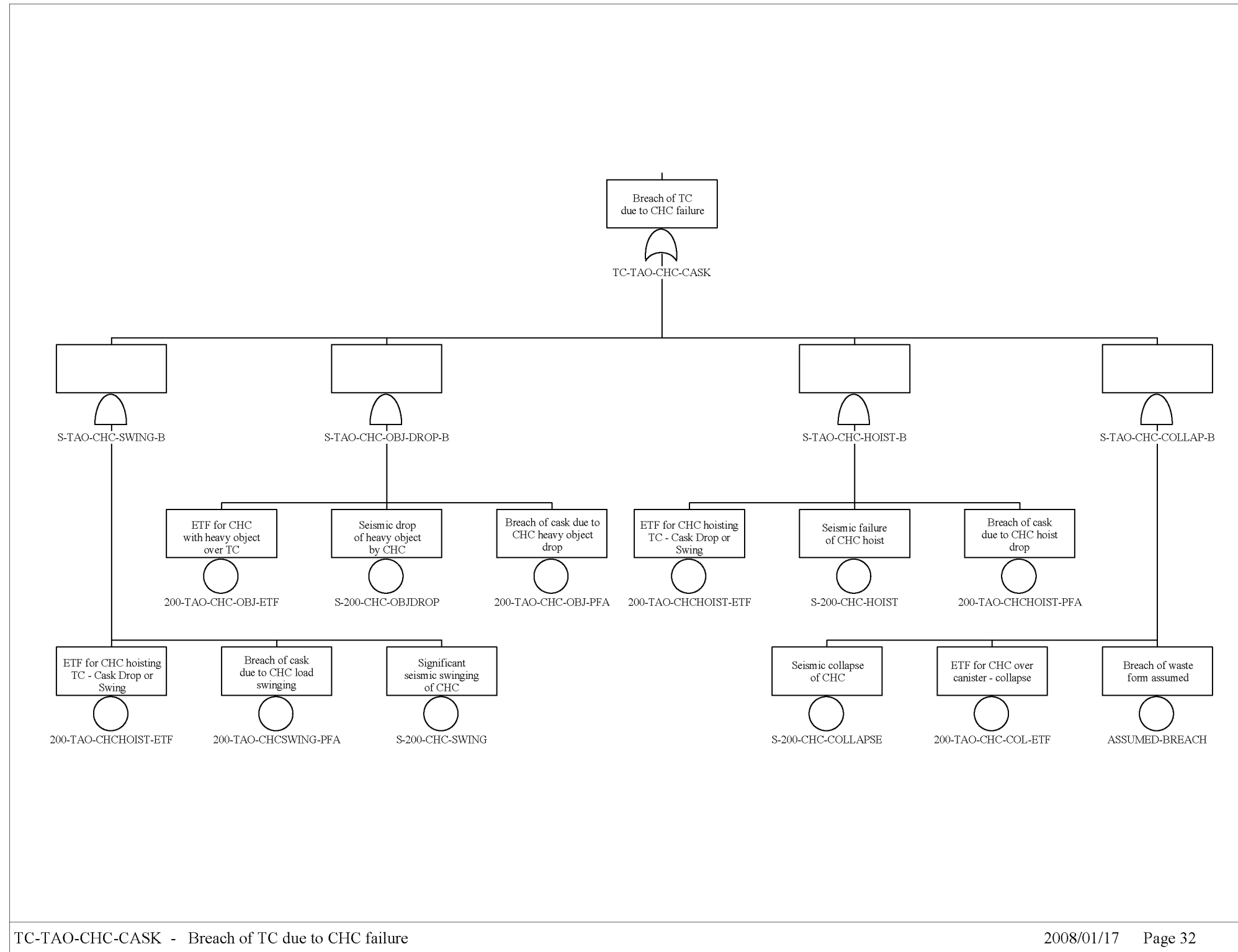

Source: Original

Figure B4.2-26. TC-TAO-CHC-CASK – Breach of TC due to CHC Failure

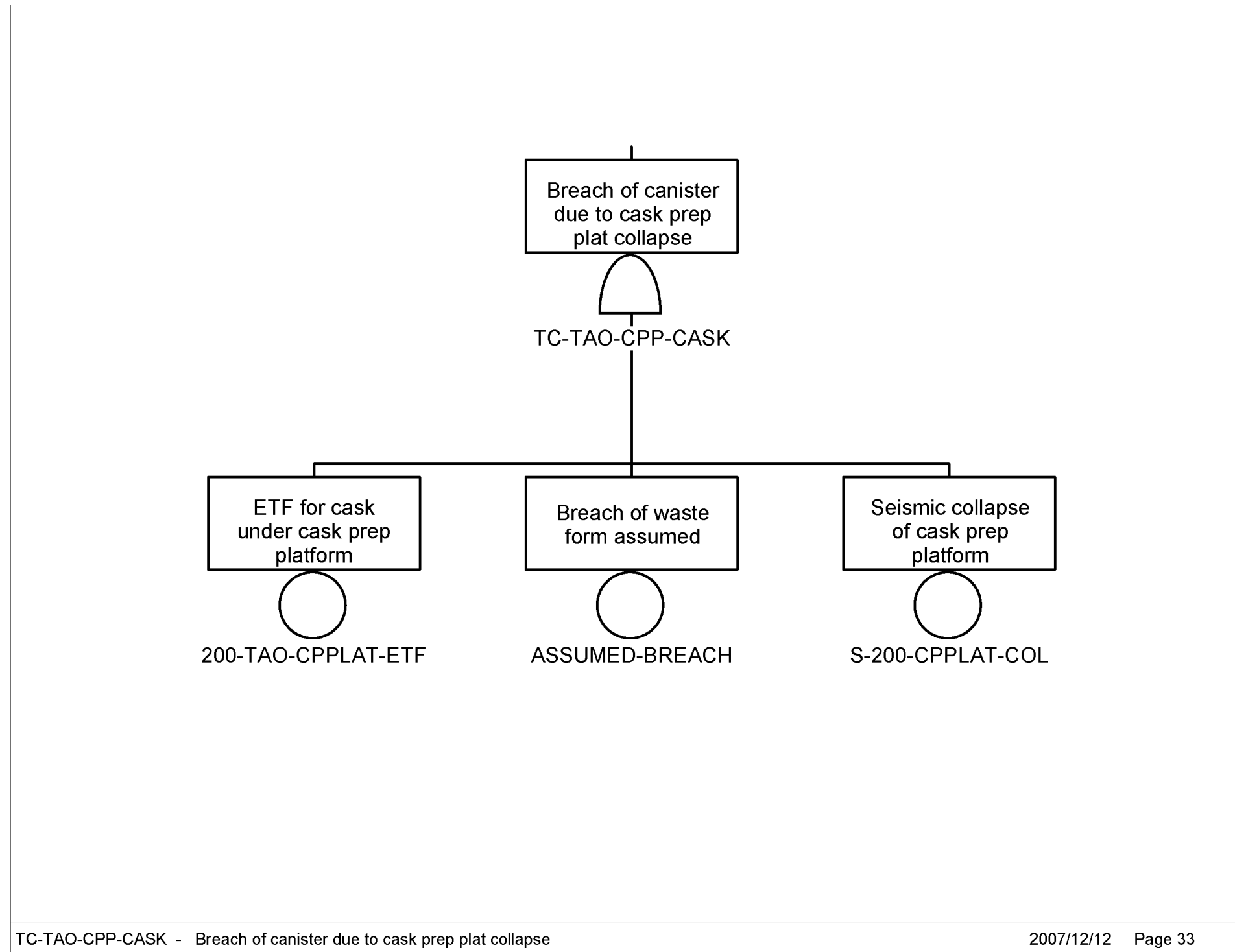

Source: Original

Figure B4.2-27. TC-TAO-CPP-CASK – Breach of Canister due to Cask Prep Plat Collapse

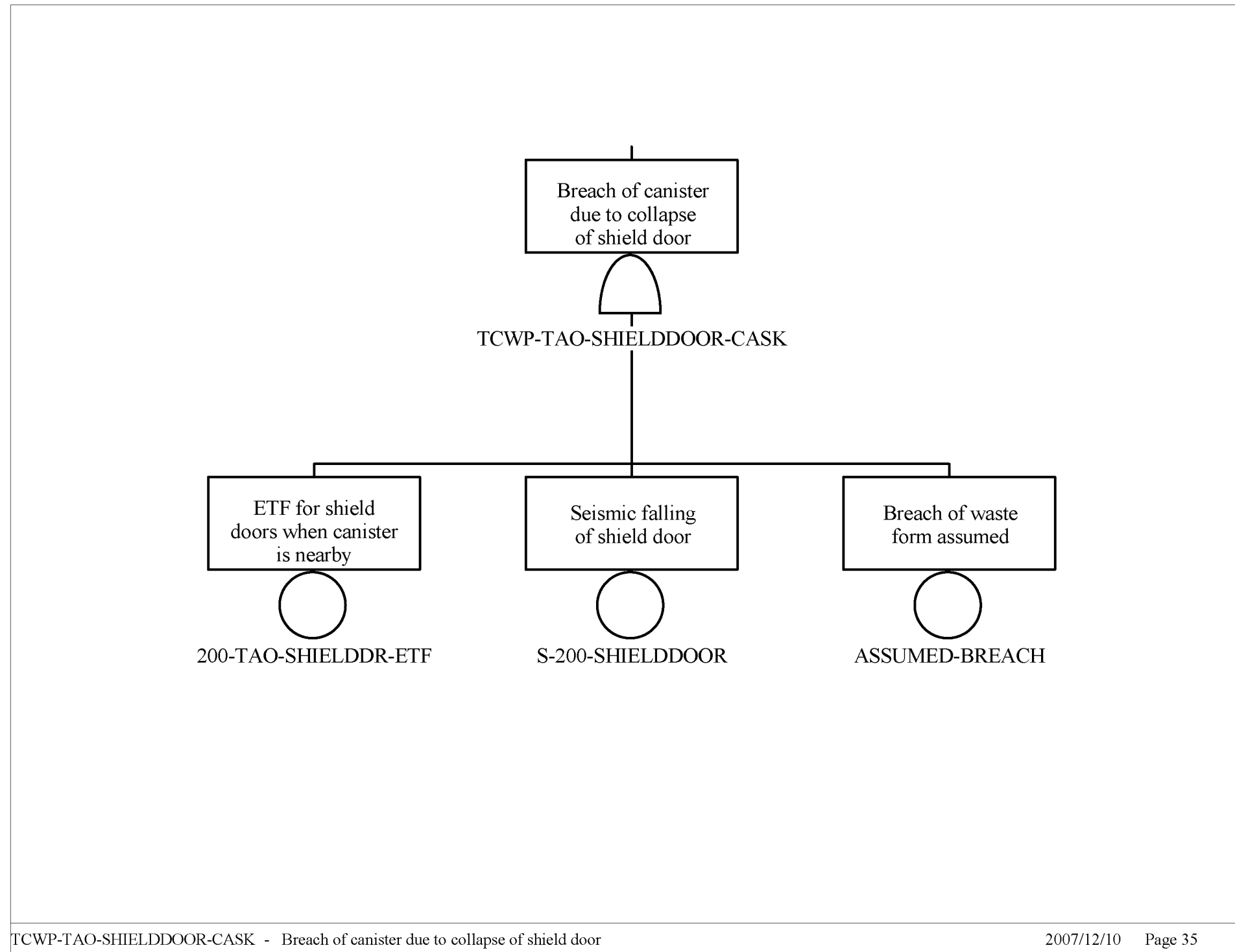

Source: Original

Figure B4.2-28. TCWP-TAO-SHIELDDOOR-CASK – Breach of Canister due to Collapse of Shield Door

B4.3 BASIC EVENTS DATA

B4.3.1 Non-seismic Basic Event Data

The following table presents the basic event identifier used in the fault trees, the description of the basic event, and the failure probability (or other numeric data) of the basic event. For exposure time factors (denoted with “ETF” at the end of the basic event identifier), the value given is the time, in years, that one waste form container is exposed to the seismic failure mode.

Table B4.3-1. Non-seismic Basic Event Data

Name	Description	Calc. Probability
200-TAO-CHC-COL-ETF	ETF for CHC over canister - collapse	1.540E-003
200-TAO-CHC-OBJ-ETF	ETF for CHC with heavy object over TC	3.650E-004
200-TAO-CHC-OBJ-PFA	Breach of cask due to CHC heavy object drop	1.000E-005
200-TAO-CHCHOIST-ETF	ETF for CHC hoisting TC - cask drop or swing	3.230E-004
200-TAO-CHCHOIST-PFA	Breach of cask due to CHC hoist drop	1.000E-005
200-TAO-CHCSWING-PFA	Breach of cask due to CHC load swinging	1.000E-005
200-TAO-CPPLAT-ETF	ETF for cask under cask prep platform	6.340E-004
200-TAO-CTM-COL-ETF	ETF for CTM over canister - collapse	1.660E-004
200-TAO-CTM-OBJ-ETF	ETF for CTM with heavy object over TC	4.380E-005
200-TAO-CTM-OBJ-PFA	Breach of canister due to CTM object drop	1.000E-005
200-TAO-CTMHOIST-ETF	ETF for CTM hoisting canister - drop	6.090E-005
200-TAO-CTMHOIST-PFA	Breach of canister dropped by CTM	1.000E-005
200-TAO-CTMMC-ETF	ETF for can under CTM maint. crane	8.280E-005
200-TAO-CTMSWGIB-ETF	ETF for CTM hoisting canister inside bell	6.090E-005
200-TAO-CTMSWGIB-PFA	Breach of canister due to swing inside bell	1.000E-005
200-TAO-CTMSWGOB-ETF	ETF for CTM hoisting canister outside bell	3.810E-005
200-TAO-CTT-BUMP-ETF	ETF for CTT with TC subject to bumping EAF	6.050E-004
200-TAO-CTT-BUMP-PFA	Breach given CTT with TC subject to bumping EAF	1.000E-005
200-TAO-CTT-ROCK-ETF	ETF for CTT with TC subject to rocking/tipover	7.610E-005
200-TAO-CTTSLIDE-ETF	ETF for CTT containing TC in transfer cell	2.250E-004
200-TAO-ENTDOOR-ETF	ETF for entry door over transport cask	1.260E-004
200-TAO-ENTDOOR-PFA	Breach of TC due to entry door collapse	1.000E-005
200-TAO-LBRC-ETF	ETF for can under LBR crane	5.690E-004
200-TAO-LBRP-ETF	ETF for can under LBR platform	5.690E-004
200-TAO-MOBPLAT-ETF	ETF for mobile platform over TC	2.910E-004
200-TAO-MOBPLAT-PFA	Breach of TC due to mobile platform collapse	1.000E-005
200-TAO-RAILCAR-ETF	ETF for railcar carrying transport cask	3.790E-004
200-TAO-RAILCAR-PFA	Breach of TC due to railcar accident	1.000E-005
200-TAO-SHIELD-ETF	ETF for shield doors when canister is nearby	1.200E-003
200-TAO-ST-BUMP-ETF	ETF for ST with AO bumping EAF	5.590E-004
200-TAO-ST-BUMP-PFA	Breach of can in ST due to bumping EAF	1.000E-005
200-TAO-ST-SLIDE-ETF	ETF for ST containing TAD in bldg	2.150E-004

Table B4.3-1. Non-seismic Basic Event Data (Continued)

Name	Description	Calc. Probability
200-TAO-STRUCTUR-ETF	ETF for TAO canister in RF structure	2.940E-003
ASSUMED-BREACH	Breach of waste form assumed	1.000E+000
MOD-ENTER-CANISTER	Flooding or spray enters canister	1.000E-002
RF-DPC-TILT	Number of DPCs transferred to AO	3.460E+002
SHIELD-AO	Shielding remains intact	1.000E-005
SHIELDING	WP remains within WPTT shielding	1.000E-005
200-TAO-CHC-COL-ETF	ETF for CHC over canister - collapse	1.540E-003

NOTE: The basic event "ASSUMED-BREACH" is not an assumption, but is common terminology used to denote a scenario where the waste container is conservatively considered to be breached; AO = aging overpack; CHC = cask handling crane; CTM = canister transfer machine; CTT = cask transfer trolley; DPC = dual-purpose canister; EAF = energy absorbing feature; ETF = exposure time factor; RF = Receipt Facility; ST = site transporter; TAD = transportation, aging, and disposal; TC = transportation cask; WP = waste package; WPTT = waste package transfer trolley.

Source: Sections 6.2.2.23 and 6.3.3, Table 6.3-1, Table 6.3-2, Table 6.5-1

B4.3.2 Seismic Basic Event Fragility Data

The following table provides the seismic failure basic event identifier, description, median fragility, and composite uncertainty.

Table B4.3-2. Seismic Basic Event Fragility Data

Event Name	Description	Med. Fragility (g)	Beta C
S-200-CHC-COLLAPSE	Seismic collapse of CHC	2.790E+000	4.500E-001
S-200-CHC-HOIST	Seismic failure of CHC hoist	2.280E+000	5.000E-001
S-200-CHC-OBJDROP	Seismic drop of heavy object by CHC	2.280E+000	5.000E-001
S-200-CHC-SWING	Significant seismic swinging of CHC	1.140E+000	4.000E-001
S-200-CTM-COLLAPSE	Seismic collapse of CTM	2.390E+000	4.500E-001
S-200-CTM-HOIST	Seismic drop of canister hoisted by CTM	2.280E+000	5.000E-001
S-200-CTM-OBJDROP	Seismic drop of heavy object by CTM	2.280E+000	5.000E-001
S-200-CTMMC-COL	Seismic collapse of CTM maint. crane	2.790E+000	4.500E-001
S-200-CTMSWG-IB	Significant swinging of canister inside CTM bell	1.140E+000	4.000E-001
S-200-CTMSWG-OB	Significant swinging of canister outside CTM bell	9.100E-001	4.000E-001
S-200-CTT-BUMPING	Seismic bumping of CTT into EAF	2.250E+000	4.100E-001
S-200-CTT-ROCKING	Seismic rocking of CTT with restraint failure	2.250E+000	4.100E-001
S-200-CTT-SLIDE	Seismic sliding of CTT into wall	3.080E+000	5.800E-001
S-200-ENTDOORCOL	Seismic collapse of entry door	3.700E-001	4.000E-001
S-200-FPW-V-SO	Spurious opening of FPW pre-action valve (relay chatter)	3.000E+000	4.000E-001
S-200-LBRC-COL	Seismic collapse of LBR crane	2.790E+000	4.500E-001

Table B4.3-2. Seismic Basic Event Fragility Data (Continued)

Event Name	Description	Med. Fragility (g)	Beta C
S-200-LBRP-COL	Seismic collapse of Lid Bolting Room platform	3.500E+000	4.000E-001
S-200-MOBPLAT-COLLAP	Seismic collapse of mobile platform	3.700E-001	4.000E-001
S-200-PIPING-FAIL	Seismic failure of piping in accident area	7.600E-001	4.000E-001
S-200-RAILCAR-ACC	Seismic tipover or collision of railcar	4.500E-001	4.000E-001
S-200-SHIELDDOOR	Seismic falling of shield door	2.920E+000	4.400E-001
S-200-ST-BUMP-EAF	Seismic bumping of ST into EAF	1.890E+000	4.200E-001
S-200-ST-SLIDE	Seismic sliding of ST into wall	1.890E+000	4.200E-001
S-200-STR-COLLAPSE	Seismic collapse of RF structure	5.250E+000	4.000E-001

NOTE: CHC = cask handling crane; CTM = canister transfer machine; CTT = cask transfer trolley; EAF = energy absorbing feature; FPW = fire protection water; LBR = Lid Bolting Room; RF = Receipt Facility; ST = site transporter.

Source: Table 6.2-1 and Table 6.2-2

B4.4 EVENT SEQUENCE QUANTIFICATION

This section provides the quantification results by sequence. The event sequence probabilities are provided first, and the cut sets are provided afterwards.

B4.4.1 Sequence Level Results

Table B4.4-1. Sequence Level Results

Event Tree	Sequence	Base Min. Cut	Base Cut Sets
RF-S-IE-TILT	03	4.202E-007	1
RF-S-IE-TILT	04-2	4.393E-010	1
RF-S-IE-TILT	04-3	+0.000E+000	1
RF-S-IE-TILT	04-4	+0.000E+000	1
RF-S-IE-TILT	04-5	+0.000E+000	1
RF-S-IE-TILT	04-6	4.393E-010	1
RF-S-IE-TILT	04-7	8.878E-013	1
RF-S-IE-TILT	05-2	9.061E-010	1
RF-S-IE-TILT	05-3	+0.000E+000	1
RF-S-IE-TILT	05-4	+0.000E+000	1
RF-S-IE-TILT	05-5	+0.000E+000	1
RF-S-IE-TILT	05-6	9.061E-010	1
RF-S-IE-TILT	05-7	2.448E-012	1
RF-S-IE-TILT	06-2	1.015E-009	1
RF-S-IE-TILT	06-3	+0.000E+000	1
RF-S-IE-TILT	06-4	+0.000E+000	1
RF-S-IE-TILT	06-5	+0.000E+000	1

Table B4.4-1. Sequence Level Results (Continued)

Event Tree	Sequence	Base Min. Cut	Base Cut Sets
RF-S-IE-TILT	06-6	1.015E-009	1
RF-S-IE-TILT	06-7	2.050E-012	1
RF-S-IE-TILT	07-2	1.419E-010	3
RF-S-IE-TILT	07-3	+0.000E+000	1
RF-S-IE-TILT	07-4	+0.000E+000	1
RF-S-IE-TILT	07-5	+0.000E+000	1
RF-S-IE-TILT	07-6	4.182E-006	4
RF-S-IE-TILT	07-7	3.935E-008	4
RF-S-IE-TILT	08-2		0
RF-S-IE-TILT	08-3	+0.000E+000	1
RF-S-IE-TILT	08-4	+0.000E+000	1
RF-S-IE-TILT	08-5	+0.000E+000	1
RF-S-IE-TILT	08-6	5.782E-007	1
RF-S-IE-TILT	08-7	5.676E-009	1
RF-S-IE-TILT	09-2	2.841E-011	1
RF-S-IE-TILT	09-3	+0.000E+000	1
RF-S-IE-TILT	09-4	+0.000E+000	1
RF-S-IE-TILT	09-5	+0.000E+000	1
RF-S-IE-TILT	09-6	1.159E-006	3
RF-S-IE-TILT	09-7	1.610E-009	3
RF-S-IE-TILT	10-2		0
RF-S-IE-TILT	10-3	+0.000E+000	1
RF-S-IE-TILT	10-4	+0.000E+000	1
RF-S-IE-TILT	10-5	+0.000E+000	1
RF-S-IE-TILT	10-6	2.663E-006	1
RF-S-IE-TILT	10-7	2.536E-008	1
RF-S-IE-TILT	11-2	2.519E-011	3
RF-S-IE-TILT	11-3	+0.000E+000	1
RF-S-IE-TILT	11-4	+0.000E+000	1
RF-S-IE-TILT	11-5	2.742E-006	5
RF-S-IE-TILT	11-6	1.702E-009	5
RF-S-IE-TILT	12-2		0
RF-S-IE-TILT	12-3	+0.000E+000	1
RF-S-IE-TILT	12-4	+0.000E+000	1
RF-S-IE-TILT	12-5	2.248E-007	1
RF-S-IE-TILT	12-6	4.174E-010	1
RF-S-IE-TILT	13-2	4.624E-011	1
RF-S-IE-TILT	13-3	+0.000E+000	1
RF-S-IE-TILT	13-4	+0.000E+000	1
RF-S-IE-TILT	13-5	1.779E-006	2
RF-S-IE-TILT	13-6	2.043E-009	2

Table B4.4-1. Sequence Level Results (Continued)

Event Tree	Sequence	Base Min. Cut	Base Cut Sets
RF-S-IE-TILT	14-2		0
RF-S-IE-TILT	14-3	+0.000E+000	1
RF-S-IE-TILT	14-4	+0.000E+000	1
RF-S-IE-TILT	14-5	5.190E-007	1
RF-S-IE-TILT	14-6	1.526E-009	1
RF-S-IE-TILT	15-2		0
RF-S-IE-TILT	15-3	+0.000E+000	1
RF-S-IE-TILT	15-4	+0.000E+000	1
RF-S-IE-TILT	15-5	1.545E-006	1
RF-S-IE-TILT	15-6	2.869E-009	1

Source: Original

B4.4.2 Cut Set Level Results by Sequence

Note that the SAPHIRE software does not provide special tables for seismic cut sets. Therefore, the “Cut Set %” given in the third column of this table is not correct for seismic events, although it does provide the approximate rank order for the cut sets.

Table B4.4-2. Cut Set Level Results by Sequence

Event Tree	Sequence	Cut Set %	Basic Event	Description
RF-S-IE-TILT	03	100.00	200-TAO-STRUCTUR-ETF	ETF for TAO canister in RF structure
			RF-DPC-TILT	Number of DPCs transferred to AO
			S-200-STR-COLLAPSE	Seismic collapse of RF structure
			= Total	
	04-2	100.00	200-TAO-ENTDOOR-ETF	ETF for entry door over transport cask
			RF-DPC-TILT	Number of DPCs transferred to AO
			S-200-ENTDOORCOL	Seismic collapse of entry door
			SHIELDING	WP remains within WPTT shielding
			= Total	
	04-3	0.00	<FALSE>	System Generated Success Event
			= Total	
	04-4	0.00	<FALSE>	System Generated Success Event
			= Total	

Table B4.4-2. Cut Set Level Results by Sequence (Continued)

Event Tree	Sequence	Cut Set %	Basic Event	Description
	04-5	0.00	<FALSE>	System Generated Success Event
			= Total	
	04-6	100.00	200-TAO-ENTDOOR-ETF	ETF for entry door over transport cask
			200-TAO-ENTDOOR-PFA	Breach of TC due to entry door collapse
			RF-DPC-TILT	Number of DPCs transferred to AO
			S-200-ENTDOORCOL	Seismic collapse of entry door
			= Total	
	04-7	100.00	200-TAO-ENTDOOR-ETF	ETF for entry door over transport cask
			200-TAO-ENTDOOR-PFA	Breach of TC due to entry door collapse
			MOD-ENTER-CANISTER	Flooding or spray enters canister
			RF-DPC-TILT	Number of DPCs transferred to AO
			S-200-ENTDOORCOL	Seismic collapse of entry door
			S-200-PIPING-FAIL	Seismic failure of piping in accident area
			= Total	
	05-2	100.00	200-TAO-RAILCAR-ETF	ETF for railcar carrying transport cask
			RF-DPC-TILT	Number of DPCs transferred to AO
			S-200-RAILCAR-ACC	Seismic tipover or collision of railcar
			SHIELDING	WP remains within WPTT shielding
			= Total	
	05-3	0.00	<FALSE>	System Generated Success Event
			= Total	
	05-4	0.00	<FALSE>	System Generated Success Event
			= Total	
	05-5	0.00	<FALSE>	System Generated Success Event
			= Total	
	05-6	100.00	200-TAO-RAILCAR-ETF	ETF for railcar carrying transport cask
			200-TAO-RAILCAR-PFA	Breach of TC due to railcar accident

Table B4.4-2. Cut Set Level Results by Sequence (Continued)

Event Tree	Sequence	Cut Set %	Basic Event	Description
			RF-DPC-TILT	Number of DPCs transferred to AO
			S-200-RAILCAR-ACC	Seismic tipover or collision of railcar
			= Total	
	05-7	100.00	200-TAO-RAILCAR-ETF	ETF for railcar carrying transport cask
			200-TAO-RAILCAR-PFA	Breach of TC due to railcar accident
			MOD-ENTER-CANISTER	Flooding or spray enters canister
			RF-DPC-TILT	Number of DPCs transferred to AO
			S-200-PIPING-FAIL	Seismic failure of piping in accident area
			S-200-RAILCAR-ACC	Seismic tipover or collision of railcar
			= Total	
	06-2	100.00	200-TAO-MOBPLAT-ETF	ETF for mobile platform over TC
			RF-DPC-TILT	Number of DPCs transferred to AO
			S-200-MOBPLAT-COLLAP	Seismic collapse of mobile platform
			SHIELDING	WP remains within WPTT shielding
			= Total	
	06-3	0.00	<FALSE>	System Generated Success Event
			= Total	
	06-4	0.00	<FALSE>	System Generated Success Event
			= Total	
	06-5	0.00	<FALSE>	System Generated Success Event
			= Total	
	06-6	100.00	200-TAO-MOBPLAT-ETF	ETF for mobile platform over TC
			200-TAO-MOBPLAT-PFA	Breach of TC due to mobile platform collapse
			RF-DPC-TILT	Number of DPCs transferred to AO
			S-200-MOBPLAT-COLLAP	Seismic collapse of mobile platform
			= Total	

Table B4.4-2. Cut Set Level Results by Sequence (Continued)

Event Tree	Sequence	Cut Set %	Basic Event	Description
	06-7	100.00	200-TAO-MOBPLAT-ETF	ETF for mobile platform over TC
			200-TAO-MOBPLAT-PFA	Breach of TC due to mobile platform collapse
			MOD-ENTER-CANISTER	Flooding or spray enters canister
			RF-DPC-TILT	Number of DPCs transferred to AO
			S-200-MOBPLAT-COLLAP	Seismic collapse of mobile platform
			S-200-PIPING-FAIL	Seismic failure of piping in accident area
			= Total	
	07-2	88.94	200-TAO-CHCHOIST-ETF	ETF for CHC hoisting TC - cask drop or swing
			RF-DPC-TILT	Number of DPCs transferred to AO
			S-200-CHC-SWING	Significant seismic swinging of CHC
			SHIELDING	WP remains within WPTT shielding
		5.87	200-TAO-CHC-OBJ-ETF	ETF for CHC with heavy object over TC
			RF-DPC-TILT	Number of DPCs transferred to AO
			S-200-CHC-OBJDROP	Seismic drop of heavy object by CHC
			SHIELDING	WP remains within WPTT shielding
		5.19	200-TAO-CHCHOIST-ETF	ETF for CHC hoisting TC - cask drop or swing
			RF-DPC-TILT	Number of DPCs transferred to AO
			S-200-CHC-HOIST	Seismic failure of CHC hoist
			SHIELDING	WP remains within WPTT shielding
			= Total	
	07-3	0.00	<FALSE>	System Generated Success Event
			= Total	
	07-4	0.00	<FALSE>	System Generated Success Event
			= Total	
	07-5	0.00	<FALSE>	System Generated Success Event
			= Total	

Table B4.4-2. Cut Set Level Results by Sequence (Continued)

Event Tree	Sequence	Cut Set %	Basic Event	Description
	07-6	99.91	200-TAO-CHC-COL-ETF	ETF for CHC over canister - collapse
			RF-DPC-TILT	Number of DPCs transferred to AO
			S-200-CHC-COLLAPSE	Seismic collapse of CHC
		0.08	200-TAO-CHCHOIST-ETF	ETF for CHC hoisting TC - cask drop or swing
			200-TAO-CHCSWING-PFA	Breach of cask due to CHC load swinging
			RF-DPC-TILT	Number of DPCs transferred to AO
			S-200-CHC-SWING	Significant seismic swinging of CHC
		0.01	200-TAO-CHC-OBJ-ETF	ETF for CHC with heavy object over TC
			200-TAO-CHC-OBJ-PFA	Breach of cask due to CHC heavy object drop
			RF-DPC-TILT	Number of DPCs transferred to AO
			S-200-CHC-OBJDROP	Seismic drop of heavy object by CHC
		0.00	200-TAO-CHCHOIST-ETF	ETF for CHC hoisting TC - cask drop or swing
			200-TAO-CHCHOIST-PFA	Breach of cask due to CHC hoist drop
			RF-DPC-TILT	Number of DPCs transferred to AO
			S-200-CHC-HOIST	Seismic failure of CHC hoist
			= Total	
	07-7	99.91	200-TAO-CHC-COL-ETF	ETF for CHC over canister - collapse
			MOD-ENTER-CANISTER	Flooding or spray enters canister
			RF-DPC-TILT	Number of DPCs transferred to AO
			S-200-CHC-COLLAPSE	Seismic collapse of CHC
			S-200-PIPING-FAIL	Seismic failure of piping in accident area
		0.08	200-TAO-CHCHOIST-ETF	ETF for CHC hoisting TC - cask drop or swing
			200-TAO-CHCSWING-PFA	Breach of cask due to CHC load swinging
			MOD-ENTER-CANISTER	Flooding or spray enters canister

Table B4.4-2. Cut Set Level Results by Sequence (Continued)

Event Tree	Sequence	Cut Set %	Basic Event	Description
			RF-DPC-TILT	Number of DPCs transferred to AO
			S-200-CHC-SWING	Significant seismic swinging of CHC
			S-200-PIPING-FAIL	Seismic failure of piping in accident area
		0.01	200-TAO-CHC-OBJ-ETF	ETF for CHC with heavy object over TC
			200-TAO-CHC-OBJ-PFA	Breach of cask due to CHC heavy object drop
			MOD-ENTER-CANISTER	Flooding or spray enters canister
			RF-DPC-TILT	Number of DPCs transferred to AO
			S-200-CHC-OBJDROP	Seismic drop of heavy object by CHC
			S-200-PIPING-FAIL	Seismic failure of piping in accident area
		0.00	200-TAO-CHCHOIST-ETF	ETF for CHC hoisting TC - cask drop or swing
			200-TAO-CHCHOIST-PFA	Breach of cask due to CHC hoist drop
			MOD-ENTER-CANISTER	Flooding or spray enters canister
			RF-DPC-TILT	Number of DPCs transferred to AO
			S-200-CHC-HOIST	Seismic failure of CHC hoist
			S-200-PIPING-FAIL	Seismic failure of piping in accident area
			= Total	
	08-2			
	08-3	0.00	<FALSE>	System Generated Success Event
			= Total	
	08-4	0.00	<FALSE>	System Generated Success Event
			= Total	
	08-5	0.00	<FALSE>	System Generated Success Event
			= Total	
	08-6	100.00	200-TAO-CPPLAT-ETF	ETF for cask under cask prep platform
			RF-DPC-TILT	Number of DPCs transferred to AO
			S-200-CPPLAT-COL	Seismic collapse of cask prep platform

Table B4.4-2. Cut Set Level Results by Sequence (Continued)

Event Tree	Sequence	Cut Set %	Basic Event	Description
			= Total	
	08-7	100.00	200-TAO-CPPLAT-ETF	ETF for cask under cask prep platform
			MOD-ENTER-CANISTER	Flooding or spray enters canister
			RF-DPC-TILT	Number of DPCs transferred to AO
			S-200-CPPLAT-COL	Seismic collapse of cask prep platform
			S-200-PIPING-FAIL	Seismic failure of piping in accident area
			= Total	
	09-2	100.00	200-TAO-CTT-BUMP-ETF	ETF for CTT with TC subject to bumping EAF
			RF-DPC-TILT	Number of DPCs transferred to AO
			S-200-CTT-BUMPING	Seismic bumping of CTT into EAF
			SHIELDING	WP remains within WPTT shielding
			= Total	
	09-3	0.00	<FALSE>	System Generated Success Event
			= Total	
	09-4	0.00	<FALSE>	System Generated Success Event
			= Total	
	09-5	0.00	<FALSE>	System Generated Success Event
			= Total	
	09-6	96.81	200-TAO-CTTSLIDE-ETF	ETF for CTT containing TC in transfer cell
			RF-DPC-TILT	Number of DPCs transferred to AO
			S-200-CTT-SLIDE	Seismic sliding of CTT into wall
		3.19	200-TAO-CTT-ROCK-ETF	ETF for CTT with TC subject to rocking/tipover
			RF-DPC-TILT	Number of DPCs transferred to AO
			S-200-CTT-ROCKING	Seismic rocking of CTT with restraint failure
		0.00	200-TAO-CTT-BUMP-ETF	ETF for CTT with TC subject to bumping EAF
			200-TAO-CTT-BUMP-PFA	Breach given CTT with TC subject to bumping EAF

Table B4.4-2. Cut Set Level Results by Sequence (Continued)

Event Tree	Sequence	Cut Set %	Basic Event	Description
			RF-DPC-TILT	Number of DPCs transferred to AO
			S-200-CTT-BUMPING	Seismic bumping of CTT into EAF
			= Total	
	09-7	96.93	200-TAO-CTTSLIDE-ETF	ETF for CTT containing TC in transfer cell
			MOD-ENTER-CANISTER	Flooding or spray enters canister
			RF-DPC-TILT	Number of DPCs transferred to AO
			S-200-CTT-SLIDE	Seismic sliding of CTT into wall
			S-200-FPW-V-SO	Spurious opening of FPW pre-action valve (relay chatter)
			S-200-PIPING-FAIL	Seismic failure of piping in accident area
		3.19	200-TAO-CTT-ROCK-ETF	ETF for CTT with TC subject to rocking/tipover
			MOD-ENTER-CANISTER	Flooding or spray enters canister
			RF-DPC-TILT	Number of DPCs transferred to AO
			S-200-CTT-ROCKING	Seismic rocking of CTT with restraint failure
			S-200-FPW-V-SO	Spurious opening of FPW pre-action valve (relay chatter)
			S-200-PIPING-FAIL	Seismic failure of piping in accident area
		0.00	200-TAO-CTT-BUMP-ETF	ETF for CTT with TC subject to bumping EAF
			200-TAO-CTT-BUMP-PFA	Breach given CTT with TC subject to bumping EAF
			MOD-ENTER-CANISTER	Flooding or spray enters canister
			RF-DPC-TILT	Number of DPCs transferred to AO
			S-200-CTT-BUMPING	Seismic bumping of CTT into EAF
			S-200-FPW-V-SO	Spurious opening of FPW pre-action valve (relay chatter)
			S-200-PIPING-FAIL	Seismic failure of piping in accident area
			= Total	
	10-2			

Table B4.4-2. Cut Set Level Results by Sequence (Continued)

Event Tree	Sequence	Cut Set %	Basic Event	Description
	10-3	0.00	<FALSE>	System Generated Success Event
			= Total	
	10-4	0.00	<FALSE>	System Generated Success Event
			= Total	
	10-5	0.00	<FALSE>	System Generated Success Event
			= Total	
	10-6	100.00	200-TAO-SHIELDDR-ETF	ETF for shield doors when canister is nearby
			RF-DPC-TILT	Number of DPCs transferred to AO
			S-200-SHIELDDOOR	Seismic falling of shield door
			= Total	
	10-7	100.00	200-TAO-SHIELDDR-ETF	ETF for shield doors when canister is nearby
			MOD-ENTER-CANISTER	Flooding or spray enters canister
			RF-DPC-TILT	Number of DPCs transferred to AO
			S-200-PIPING-FAIL	Seismic failure of piping in accident area
			S-200-SHIELDDOOR	Seismic falling of shield door
			= Total	
	11-2	90.88	200-TAO-CTMSWGIB-ETF	ETF for CTM hoisting canister inside bell
			RF-DPC-TILT	Number of DPCs transferred to AO
			S-200-CTMSWG-IB	Significant swinging of canister inside CTM bell
			SHIELDING	WP remains within WPTT shielding
		5.31	200-TAO-CTMHOIST-ETF	ETF for CTM hoisting canister - drop
			RF-DPC-TILT	Number of DPCs transferred to AO
			S-200-CTM-HOIST	Seismic drop of canister hoisted by CTM
			SHIELDING	WP remains within WPTT shielding
		3.82	200-TAO-CTM-OBJ-ETF	ETF for CTM with heavy object over TC
			RF-DPC-TILT	Number of DPCs transferred to AO

Table B4.4-2. Cut Set Level Results by Sequence (Continued)

Event Tree	Sequence	Cut Set %	Basic Event	Description
			S-200-CTM- OBJDROP	Seismic drop of heavy object by CTM
			SHIELDING	WP remains within WPTT shielding
			= Total	
	11-3	0.00	<FALSE>	System Generated Success Event
			= Total	
	11-4	0.00	<FALSE>	System Generated Success Event
			= Total	
	11-5	98.84	200-TAO- CTMSWGOB-ETF	ETF for CTM hoisting canister outside bell
			RF-DPC-TILT	Number of DPCs transferred to AO
			S-200-CTMSWG- OB	Significant swinging of canister outside CTM bell
		1.16	200-TAO-CTM- COL-ETF	ETF for CTM over canister – collapse
			RF-DPC-TILT	Number of DPCs transferred to AO
			S-200-CTM- COLLAPSE	Seismic collapse of CTM
		0.00	200-TAO- CTMSWGIB-ETF	ETF for CTM hoisting canister inside bell
			200-TAO- CTMSWGIB-PFA	Breach of canister due to swing inside bell
			RF-DPC-TILT	Number of DPCs transferred to AO
			S-200-CTMSWG- IB	Significant swinging of canister inside CTM bell
		0.00	200-TAO- CTMHOIST-ETF	ETF for CTM hoisting canister - drop
			200-TAO- CTMHOIST-PFA	Breach of canister dropped by CTM
			RF-DPC-TILT	Number of DPCs transferred to AO
			S-200-CTM- HOIST	Seismic drop of canister hoisted by CTM
		0.00	200-TAO-CTM- OBJ-ETF	ETF for CTM with heavy object over TC
			200-TAO-CTM- OBJ-PFA	Breach of canister due to CTM object drop
			RF-DPC-TILT	Number of DPCs transferred to AO
			S-200-CTM- OBJDROP	Seismic drop of heavy object by CTM
			= Total	

Table B4.4-2. Cut Set Level Results by Sequence (Continued)

Event Tree	Sequence	Cut Set %	Basic Event	Description
	11-6	98.84	200-TAO-CTMSWGOB-ETF	ETF for CTM hoisting canister outside bell
			MOD-ENTER-CANISTER	Flooding or spray enters canister
			RF-DPC-TILT	Number of DPCs transferred to AO
			S-200-CTMSWG-OB	Significant swinging of canister outside CTM bell
			S-200-FPW-V-SO	Spurious opening of FPW pre-action valve (relay chatter)
			S-200-PIPING-FAIL	Seismic failure of piping in accident area
		1.16	200-TAO-CTM-COL-ETF	ETF for CTM over canister - collapse
			MOD-ENTER-CANISTER	Flooding or spray enters canister
			RF-DPC-TILT	Number of DPCs transferred to AO
			S-200-CTM-COLLAPSE	Seismic collapse of CTM
			S-200-FPW-V-SO	Spurious opening of FPW pre-action valve (relay chatter)
			S-200-PIPING-FAIL	Seismic failure of piping in accident area
		0.00	200-TAO-CTMSWGIB-ETF	ETF for CTM hoisting canister inside bell
			200-TAO-CTMSWGIB-PFA	Breach of canister due to swing inside bell
			MOD-ENTER-CANISTER	Flooding or spray enters canister
			RF-DPC-TILT	Number of DPCs transferred to AO
			S-200-CTMSWG-IB	Significant swinging of canister inside CTM bell
			S-200-FPW-V-SO	Spurious opening of FPW pre-action valve (relay chatter)
			S-200-PIPING-FAIL	Seismic failure of piping in accident area
		0.00	200-TAO-CTMHOIST-ETF	ETF for CTM hoisting canister - drop
			200-TAO-CTMHOIST-PFA	Breach of canister dropped by CTM
			MOD-ENTER-CANISTER	Flooding or spray enters canister
			RF-DPC-TILT	Number of DPCs transferred to AO

Table B4.4-2. Cut Set Level Results by Sequence (Continued)

Event Tree	Sequence	Cut Set %	Basic Event	Description
			S-200-CTM-HOIST	Seismic drop of canister hoisted by CTM
			S-200-FPW-V-SO	Spurious opening of FPW pre-action valve (relay chatter)
			S-200-PIPING-FAIL	Seismic failure of piping in accident area
		0.00	200-TAO-CTM-OBJ-ETF	ETF for CTM with heavy object over TC
			200-TAO-CTM-OBJ-PFA	Breach of canister due to CTM object drop
			MOD-ENTER-CANISTER	Flooding or spray enters canister
			RF-DPC-TILT	Number of DPCs transferred to AO
			S-200-CTM-OBJDROP	Seismic drop of heavy object by CTM
			S-200-FPW-V-SO	Spurious opening of FPW pre-action valve (relay chatter)
			S-200-PIPING-FAIL	Seismic failure of piping in accident area
			= Total	
	12-2			
	12-3	0.00	<FALSE>	System Generated Success Event
			= Total	
	12-4	0.00	<FALSE>	System Generated Success Event
			= Total	
	12-5	100.00	200-TAO-CTMMC-ETF	ETF for can under CTM maint. crane
			RF-DPC-TILT	Number of DPCs transferred to AO
			S-200-CTMMC-COL	Seismic collapse of CTM maint. crane
			= Total	
	12-6	96.63	200-TAO-CTMMC-ETF	ETF for can under CTM maint. crane
			MOD-ENTER-CANISTER	Flooding or spray enters canister
			RF-DPC-TILT	Number of DPCs transferred to AO
			S-200-CTMMC-COL	Seismic collapse of CTM maint. crane
			S-200-FPW-V-SO	Spurious opening of FPW pre-action valve (relay chatter)

Table B4.4-2. Cut Set Level Results by Sequence (Continued)

Event Tree	Sequence	Cut Set %	Basic Event	Description
			S-200-PIPING-FAIL	Seismic failure of piping in accident area
			= Total	
	13-2	100.00	200-TAO-ST-BUMP-ETF	ETF for ST with AO bumping EAF
			RF-DPC-TILT	Number of DPCs transferred to AO
			S-200-ST-BUMP-EAF	Seismic bumping of ST into EAF
			SHIELD-AO	Shielding remains intact
			= Total	
	13-3	0.00	<FALSE>	System Generated Success Event
			= Total	
	13-4	0.00	<FALSE>	System Generated Success Event
			= Total	
	13-5	100.00	200-TAO-ST-SLIDE-ETF	ETF for ST containing TAD in bldg
			RF-DPC-TILT	Number of DPCs transferred to AO
			S-200-ST-SLIDE	Seismic sliding of ST into wall
		0.00	200-TAO-ST-BUMP-ETF	ETF for ST with AO bumping EAF
			200-TAO-ST-BUMP-PFA	Breach of can in ST due to bumping EAF
			RF-DPC-TILT	Number of DPCs transferred to AO
			S-200-ST-BUMP-EAF	Seismic bumping of ST into EAF
			= Total	
	13-6	99.95	200-TAO-ST-SLIDE-ETF	ETF for ST containing TAD in bldg
			MOD-ENTER-CANISTER	Flooding or spray enters canister
			RF-DPC-TILT	Number of DPCs transferred to AO
			S-200-FPW-V-SO	Spurious opening of FPW pre-action valve (relay chatter)
			S-200-PIPING-FAIL	Seismic failure of piping in accident area
			S-200-ST-SLIDE	Seismic sliding of ST into wall
		0.00	200-TAO-ST-BUMP-ETF	ETF for ST with AO bumping EAF

Table B4.4-2. Cut Set Level Results by Sequence (Continued)

Event Tree	Sequence	Cut Set %	Basic Event	Description
			200-TAO-ST-BUMP-PFA	Breach of can in ST due to bumping EAF
			MOD-ENTER-CANISTER	Flooding or spray enters canister
			RF-DPC-TILT	Number of DPCs transferred to AO
			S-200-FPW-V-SO	Spurious opening of FPW pre-action valve (relay chatter)
			S-200-PIPING-FAIL	Seismic failure of piping in accident area
			S-200-ST-BUMP-EAF	Seismic bumping of ST into EAF
			= Total	
	14-2			
	14-3	0.00	<FALSE>	System Generated Success Event
			= Total	
	14-4	0.00	<FALSE>	System Generated Success Event
			= Total	
	14-5	100.00	200-TAO-LBRP-ETF	ETF for can under LBR platform
			RF-DPC-TILT	Number of DPCs transferred to AO
			S-200-LBRP-COL	Seismic collapse of Lid Bolting Room platform
			= Total	
	14-6	0.00	200-TAO-LBRP-ETF	ETF for can under LBR platform
			MOD-ENTER-CANISTER	Flooding or spray enters canister
			RF-DPC-TILT	Number of DPCs transferred to AO
			S-200-FPW-V-SO	Spurious opening of FPW pre-action valve (relay chatter)
			S-200-LBRP-COL	Seismic collapse of Lid Bolting Room platform
			S-200-PIPING-FAIL	Seismic failure of piping in accident area
			= Total	
	15-2			
	15-3	0.00	<FALSE>	System Generated Success Event
			= Total	

Table B4.4-2. Cut Set Level Results by Sequence (Continued)

Event Tree	Sequence	Cut Set %	Basic Event	Description
	15-4	0.00	<FALSE>	System Generated Success Event
			= Total	
	15-5	100.00	200-TAO-LBRC-ETF	ETF for can under LBR crane
			RF-DPC-TILT	Number of DPCs transferred to AO
			S-200-LBRC-COL	Seismic collapse of LBR crane
			= Total	
	15-6	100.23	200-TAO-LBRC-ETF	ETF for can under LBR crane
			MOD-ENTER-CANISTER	Flooding or spray enters canister
			RF-DPC-TILT	Number of DPCs transferred to AO
			S-200-FPW-V-SO	Spurious opening of FPW pre-action valve (relay chatter)
			S-200-LBRC-COL	Seismic collapse of LBR crane
			S-200-PIPING-FAIL	Seismic failure of piping in accident area
			= Total	
RF-S-IE-TILT	03	100.00	200-TAO-STRUCTUR-ETF	ETF for TAO canister in RF structure
			RF-DPC-TILT	Number of DPCs transferred to AO
			S-200-STR-COLLAPSE	Seismic collapse of RF structure
			= Total	

NOTE: AO = aging overpack; CHC = cask handling crane; CTM = canister transfer machine; CTT = cask transfer trolley; EAF = energy absorbing feature; ETF = exposure time factor; FPW = fire protection water; LBR = Lid Bolting Room; RF = Receipt Facility; ST = site transporter; TAD = transportation, aging, and disposal; TAO = TAD to aging overpack; TC = transportation cask; WP = waste package; WPTT = waste package transfer trolley.

Source: Original

ATTACHMENT C

CANISTER RECEIPT AND CLOSURE FACILITY ANALYSES

This attachment contains detailed information for the CRCF seismic event sequence analysis:

- IET and SRETs
- Event tree to fault tree assignment tables
- Fault trees
- Non-seismic basic event tables
- Seismic basic event tables
- Event sequence probability tables
- Event sequence cut set tables.

The CRCF analysis covers processing of TAD canisters, DPCs, DOE standardized SNF, HLW and MCO canisters, to include the following:

- 1 Processing of:
 - i) TAD canisters from railcars with transportation casks entering the CRCF to aging overpacks in site transporters leaving the CRCF
 - ii) TAD canisters from aging overpacks in site transporters entering the CRCF to waste packages in TEVs leaving the CRCF
 - iii) DPCs from railcars with transportation casks entering the CRCF to aging overpacks in site transporters leaving the CRCF
- 2 Processing of DOE standardized SNF canisters from railcars with transportation casks entering the CRCF to waste packages in TEVs leaving the CRCF
- 3 Processing of HLW canisters from railcars with transportation casks entering the CRCF to waste packages in TEVs leaving the CRCF
- 4 Processing of MCO canisters from railcars with transportation casks entering the CRCF to waste packages in TEVs leaving the CRCF.

C1 TRANSPORTATION, AGING AND DISPOSAL AND DUAL-PURPOSE CANISTERS

This section provides the detailed information used to develop the event sequences for the analysis of processing of TAD canisters or DPCs inside the CRCF. TAD canisters and DPCs inside a transportation cask are received on railcars, are transferred into an aging overpack, and then transported in a site transporter out of the CRCF. Alternatively, TAD canisters inside an aging overpack are received on a site transporter, are transferred to a waste package, sealed and then transported in a TEV out of the CRCF. This section does not cover the emplacement of the waste package.

C1.1 EVENT TREES

The IET and SRETs are presented in this section. The tables provide the assignments between the event tree branches and the fault trees given in the next section.

Seismic Event	Number of DP canisters transferred to AO	Identify initiating seismic failure		
SEIS-EVENT	CRCF-DP-CAN	SEIS-FAIL	#	END-STATE
			1	OK
			2	OK
		CRCF building collapse	3	RR-UNF
		Entry door seismic collapse	4	T => 2 CRCF-S-R-TC1
		Railcar accident	5	T => 2 CRCF-S-R-TC1
		Mobile platform seismic collapse	6	T => 2 CRCF-S-R-TC1
		CHC seismic failures	7	T => 2 CRCF-S-R-TC1
		Cask prep platform collapse	8	T => 2 CRCF-S-R-TC1
		CTT seismic failures	9	T => 2 CRCF-S-R-TC1
		Shield door seismic failure	10	T => 3 CRCF-S-R-SD1
		CTM seismic failures	11	T => 4 CRCF-S-R-CTM
		ST seismic failures	12	T => 5 CRCF-S-R-AO

CRCF-S-IE-DPAO - CRCF Seismic Event Tree - Initiating Seismic Failures - DPs to AO

NOTE: Event tree branch captions are associated with the branch line below the caption.

AO = aging overpack; CAN = canister; CHC = cask handling crane; CRCF = Canister Receipt and Closure Facility; CTM = canister transfer machine; CTT = cask transfer trolley; DP = dual-purpose; IE = initiating event; RR = radioactive release; SD = shield door; SEIS = seismic; ST = site transporter; TC = transportation cask; UNF = unfiltered.

Source: Original

Figure C1.1-1. CRCF Seismic Event Tree
 CRCF-S-IE-DPAO – Initiating
 Seismic Failures – DPs to AO

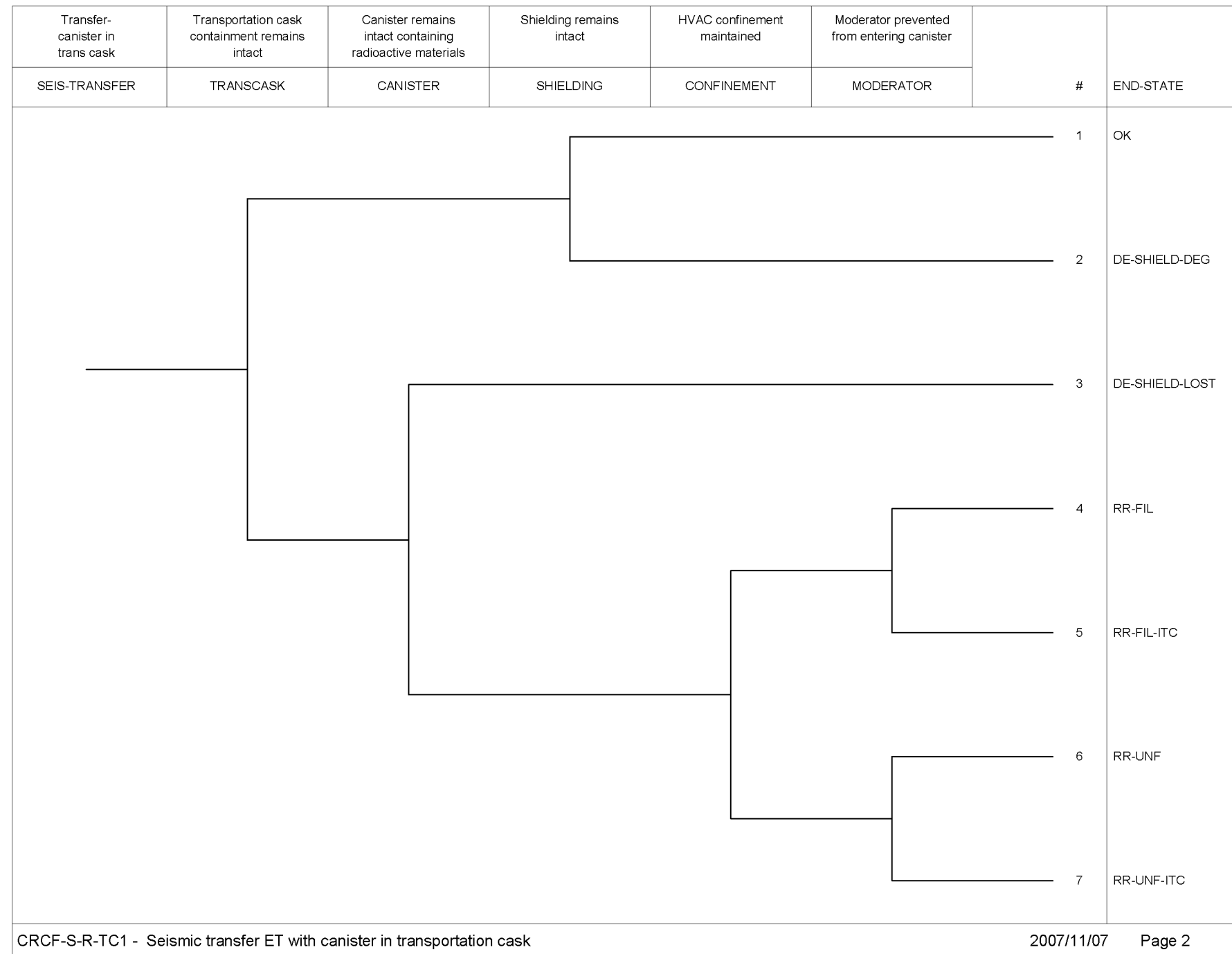

NOTE: CRCF = Canister Receipt and Closure Facility; DE = direct exposure; DEG = degradation; ET = event tree; FIL = filtered; HVAC = heating, ventilation and air conditioning; ITC = important to criticality; RR = radioactive release; SEIS = seismic; TC = transportation cask; UNF = unfiltered.

Source: Original

Figure C1.1-2. CRCF Seismic Event Tree CRCF-S-R-TC1 – Seismic Transfer ET with Canister in Transportation Cask

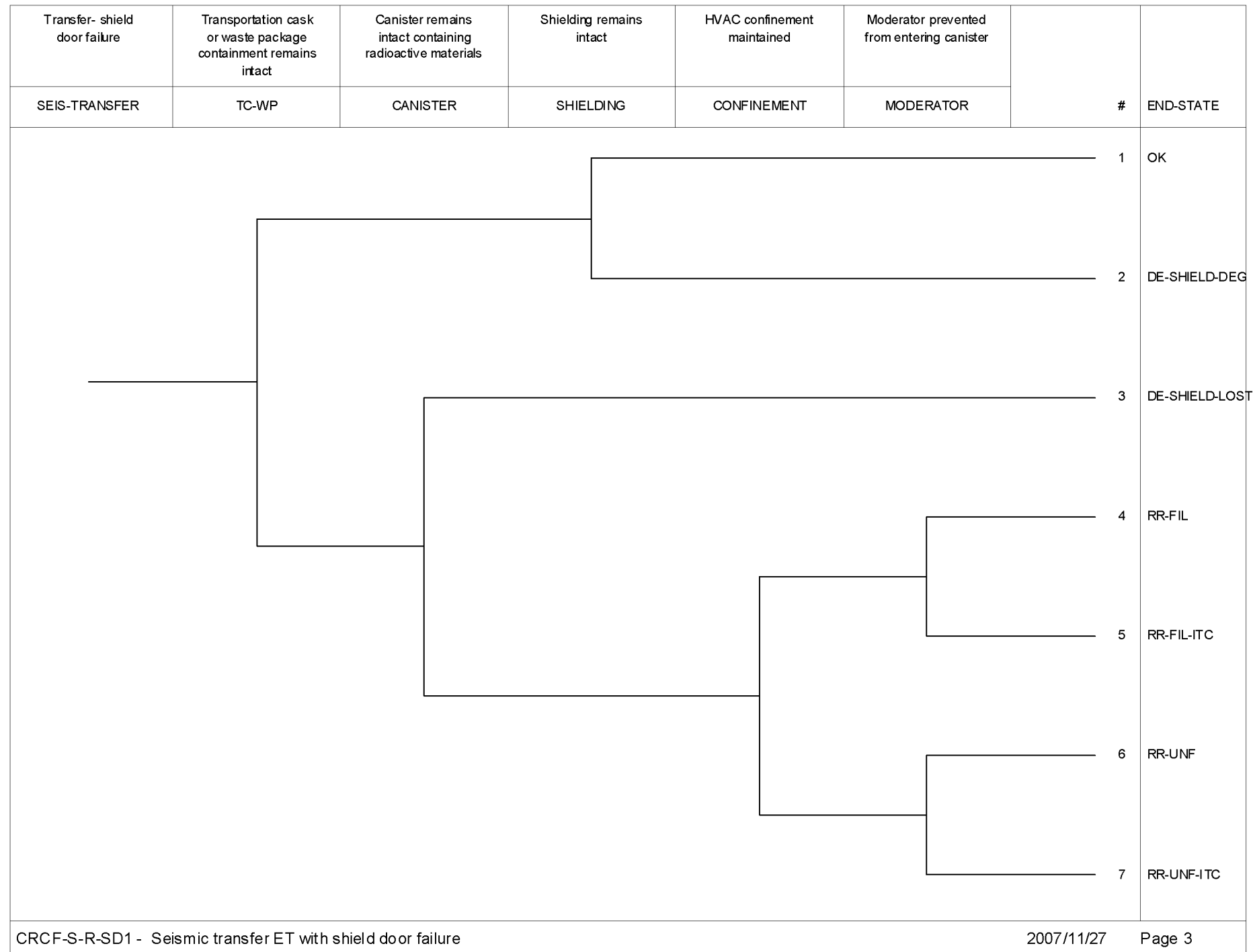

NOTE: CRCF = Canister Receipt and Closure Facility; DE = direct exposure; ET = event tree; FIL = filtered; INIT = initiating; HVAC = heating, ventilation and air conditioning; ITC = important to criticality; RR = radioactive release; SD = shield door; SEIS = seismic; TC = transportation cask; UNF = unfiltered; WP = waste package.

Source: Original

Figure C1.1-3. CRCF Seismic Event Tree
CRCF-S-R-SD1 – Seismic
Transfer ET with Shield Door
Failure

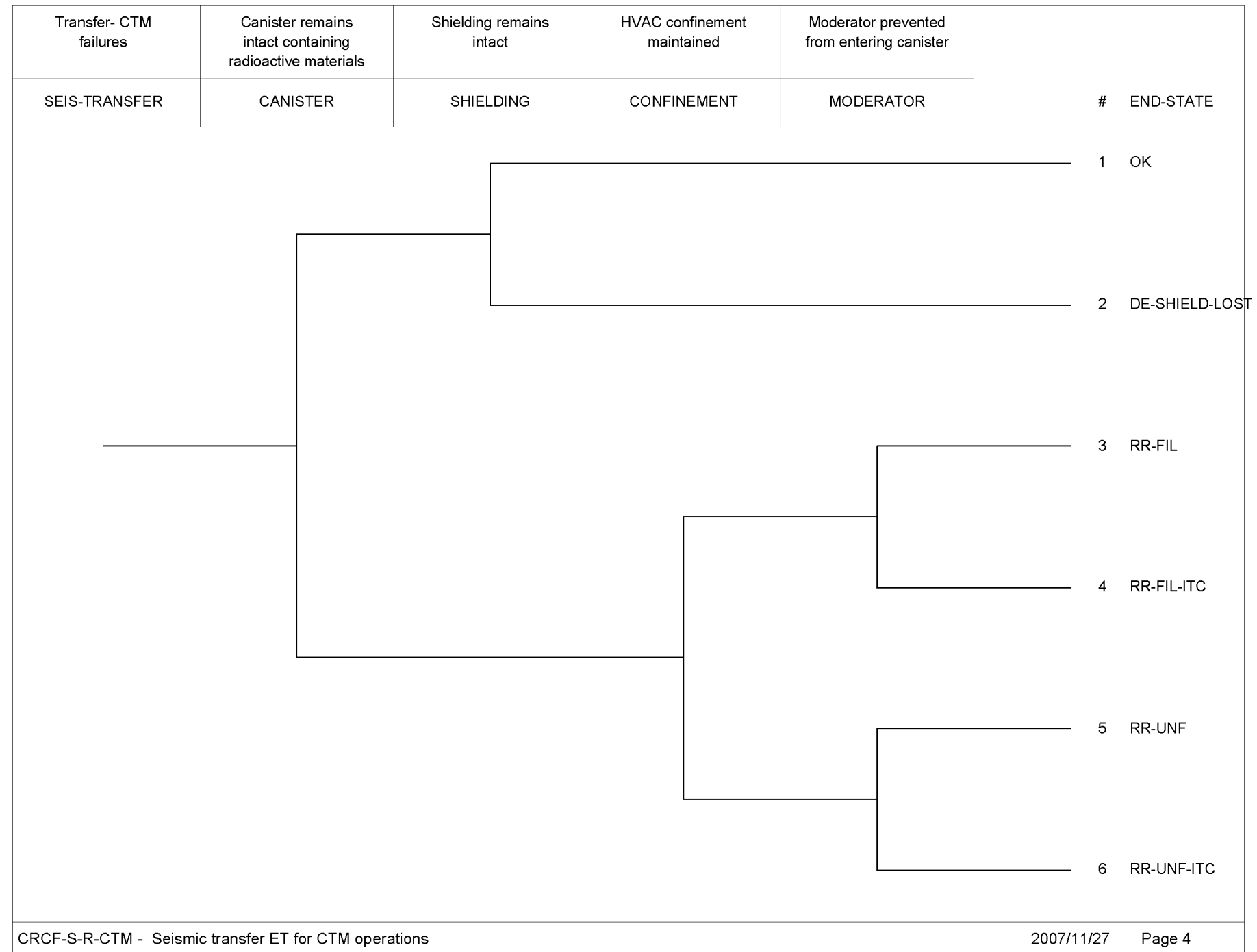

NOTE: CRCF = Canister Receipt and Closure Facility; CTM = canister transfer machine; DE = direct exposure; ET = event tree; FIL = filtered; HVAC = heating, ventilation and air conditioning; ITC = important to criticality; RR = radioactive release; SEIS = seismic; UNF = unfiltered.

Source: Original

Figure C1.1-4. CRCF Seismic Event Tree
 CRCF-S-R-CTM – Seismic
 Transfer ET for CTM Operations

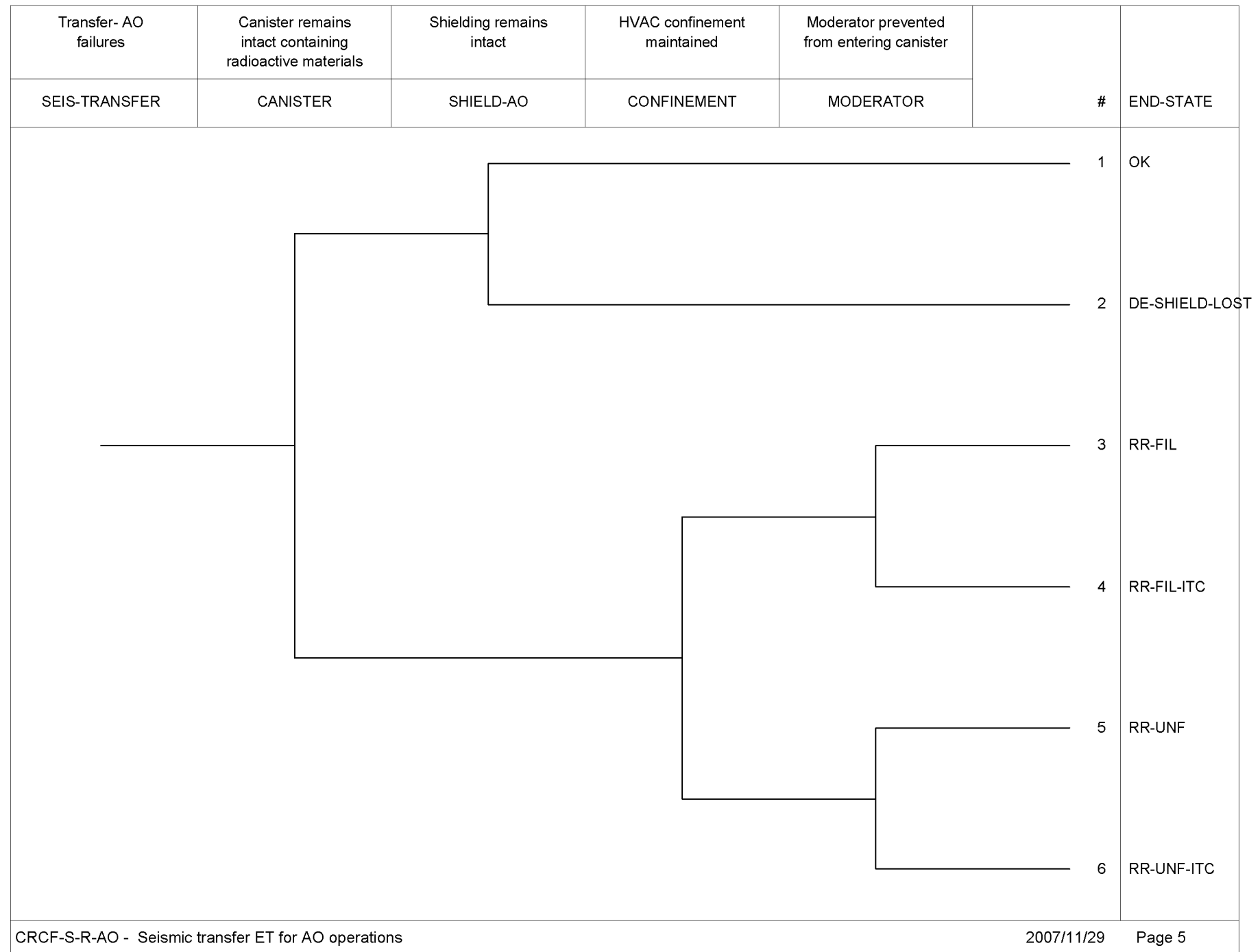

NOTE: AO= aging overpack; CRCF = Canister Receipt and Closure Facility; CTM = canister transfer machine; DE = direct exposure; ET = event tree; FIL = filtered; HVAC = heating, ventilation and air conditioning; ITC = important to criticality; RR = radioactive release; SEIS = seismic; UNF = unfiltered.

Source: Original

Figure C1.1-5. CRCF Seismic Event Tree
CRCF-S-R-AO – Seismic
Transfer ET for AO Operations

Seismic Event	Number of TAD canisters transferred to AO	Identify initiating seismic failure			
SEIS-EVENT	CRCF-TAD-AO	SEIS-FAIL		#	END-STATE
				1	OK
				2	OK
		CRCF building collapse		3	RR-UNF
		Entry door seismic collapse		4	T => 2 CRCF-S-R-TC1
		Railcar accident		5	T => 2 CRCF-S-R-TC1
		Mobile platform seismic collapse		6	T => 2 CRCF-S-R-TC1
		CHC seismic failures		7	T => 2 CRCF-S-R-TC1
		Cask prep platform collapse		8	T => 2 CRCF-S-R-TC1
		CTT seismic failures		9	T => 2 CRCF-S-R-TC1
		Shield door seismic failure		10	T => 3 CRCF-S-R-SD1
		CTM seismic failures		11	T => 4 CRCF-S-R-CTM
		ST seismic failures		12	T => 5 CRCF-S-R-AO

CRCF-S-IE-TAD-AO - CRCF Seismic Event Tree - Initiating Seismic Failures - TAD to AO

2008/01/07 Page 6

NOTE: AO= aging overpack; CHC = cask handling crane; CRCF = Canister Receipt and Closure Facility; CTM = canister transfer machine; CTT = cask transfer trolley; DE = direct exposure; ET = event tree; FIL = filtered; ITC = important to criticality; RR = radioactive release; SD = shield door; SEIS = seismic; ST = site transporter; TAD = transportation, aging and disposal; TC = transportation cask; UNF = unfiltered.

Source: Original

Figure C1.1-6. CRCF Seismic Event Tree
CRCF-S-IE-TAD-AO – Initiating
Seismic Failures - TAD to AO

Seismic Event	Number of TADs from AO to WP	Identify initiating seismic failure			
SEIS-EVENT	CRCF-TAO-CAN	SEIS-FAIL	#	END-STATE	
			1	OK	
			2	OK	
		CRCF building collapse	3	RR-UNF	
		Entry door seismic collapse	4	T => 5	CRCF-S-R-AO
		Cask prep platform collapse	5	T => 5	CRCF-S-R-AO
		ST seismic failures	6	T => 5	CRCF-S-R-AO
		Shield door seismic failure	7	T => 3	CRCF-S-R-SD1
		CTM seismic failures	8	T => 4	CRCF-S-R-CTM
		RHS-robotic arm seismic failures	9	T => 8	CRCF-S-R-WP1
		WPTT tipover	10	T => 8	CRCF-S-R-WP1
		WPHC seismic failures	11	T => 8	CRCF-S-R-WP1
		TEV seismic failures	12	T => 9	CRCF-S-R-TEV

CRCF-S-IE-TWP - CRCF Seismic Event Tree - TAD in AO to WP

NOTE: AO = aging overpack; CAN = canister; CRCF = Canister Receipt and Closure Facility; CTM = canister transfer machine; DE = direct exposure; ET = event tree; FIL = filtered; ITC = important to criticality; RHS = remote handling system; RR = radioactive release; SD = shield door; SEIS = seismic; ST = site transporter; TAD = transportation, aging and disposal; TEV = transport and emplacement vehicle; UNF = unfiltered; WP = waste package; WPTT = waste package transfer trolley.

Source: Original

Figure C1.1-7. CRCF Seismic Event Tree
CRCF-S-IE-TWP – TAD in AO to WP

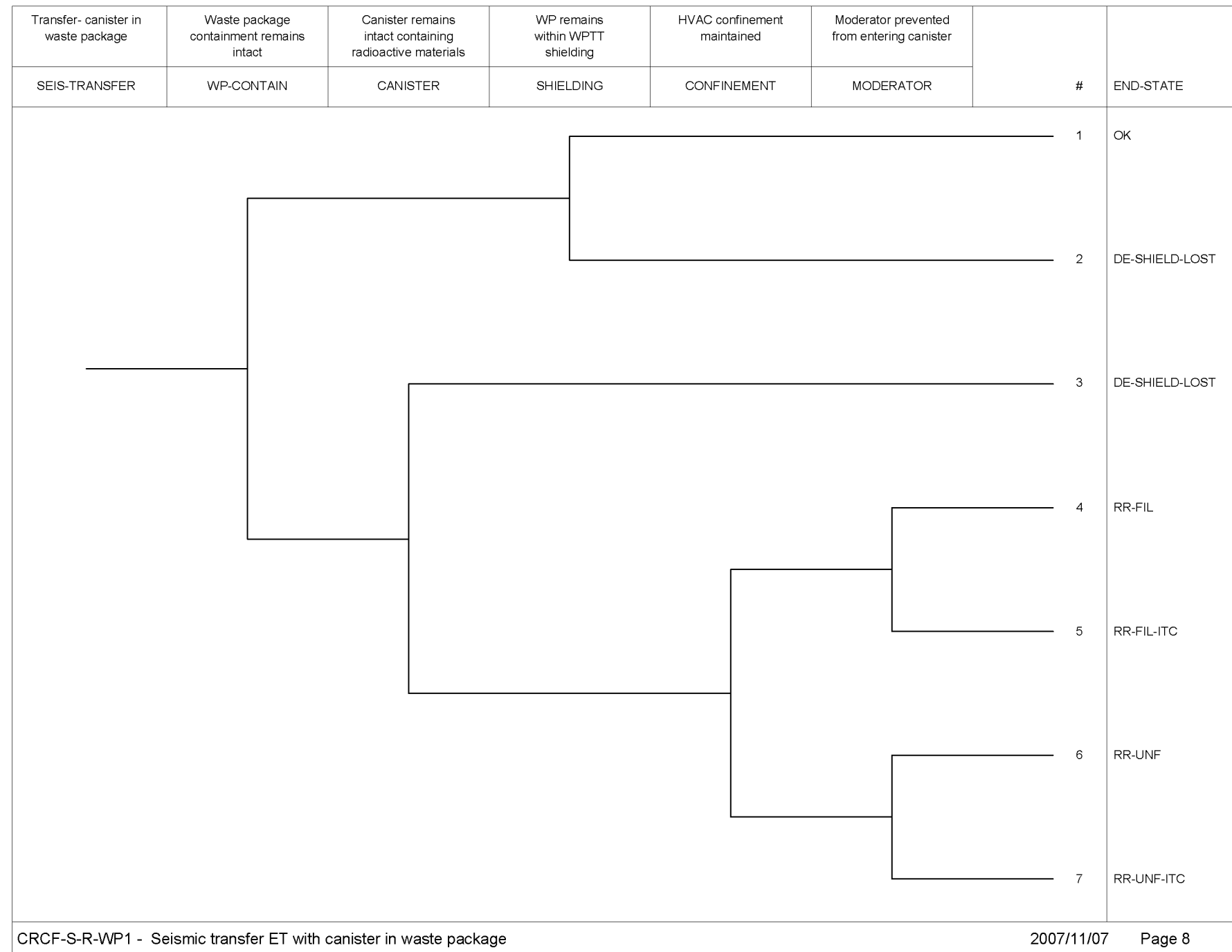

NOTE: AO = aging overpack; CRCF = Canister Receipt and Closure Facility; CTM = canister transfer machine; DE = direct exposure; ET = event tree; FIL = filtered; HVAC = heating, ventilation and air conditioning; ITC = important to criticality; RR = radioactive release; SEIS = seismic; UNF = unfiltered; WP = waste package; WPTT = waste package transfer trolley.

Source: Original

Figure C1.1-8. CRCF Seismic Event Tree
 CRCF-S-R-WP1 – Seismic
 Transfer ET with Canister in
 Waste Package

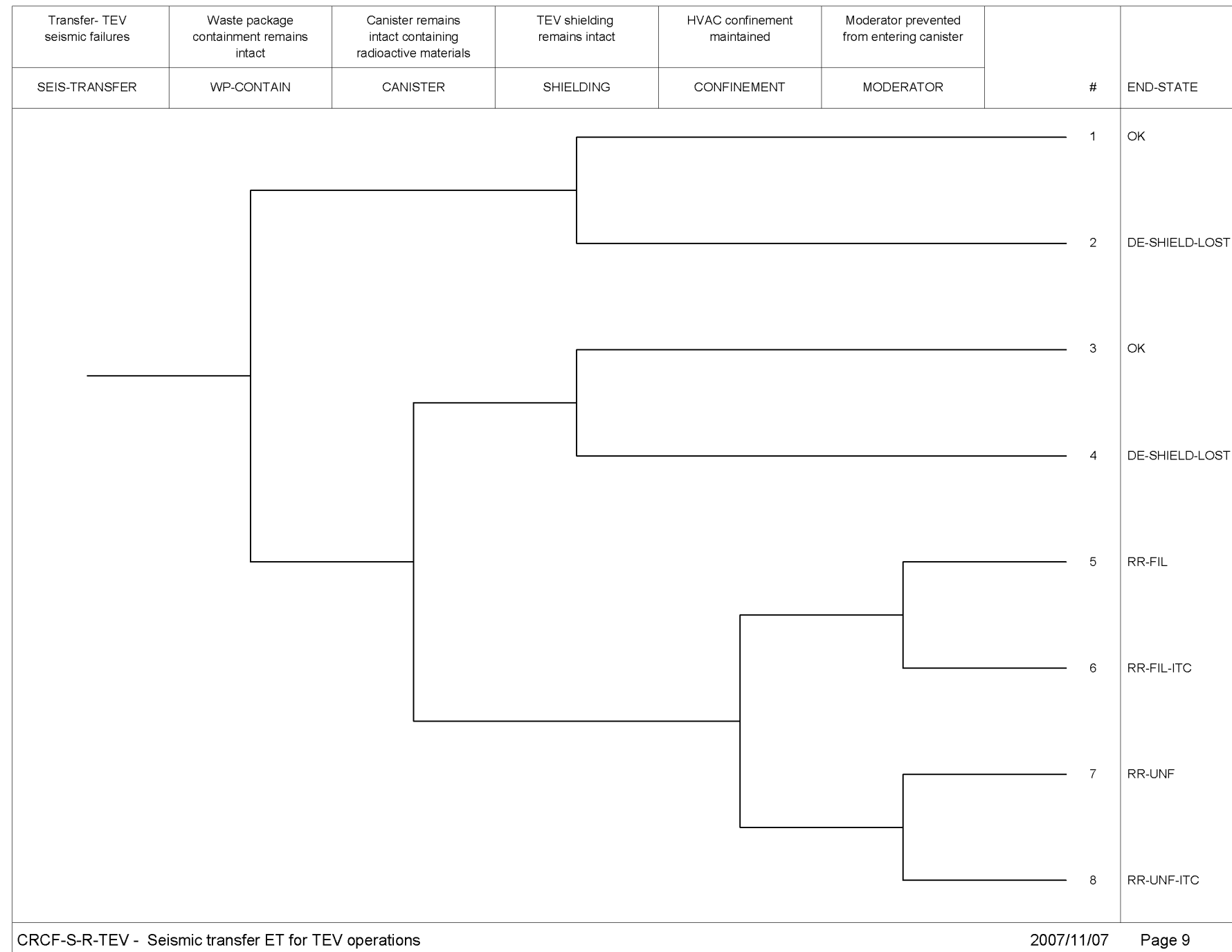

NOTE: CRCF = Canister Receipt and Closure Facility; DE = direct exposure; ET = event tree; FIL = filtered; HVAC = heating, ventilation and air conditioning; ITC = important to criticality; RR = radioactive release; SEIS = seismic; TEV = transport and emplacement vehicle; UNF = unfiltered; WP = waste package.

Source: Original

Figure C1.1-9. CRCF Seismic Event Tree
 CRCF-S-R-TEV – Seismic
 Transfer ET for TEV Operations

Table C1.1-1. Fault Trees Assigned for Initiating Seismic Failures for the CRCF

Process	Initiator Event Tree	Initiating Seismic Failure	Associated Fault Tree
TAD canister to AO	CRCF-S-IE-TAD-AO	CRCF building collapse	S-060-TAO-STR-COLLAP
		Entry door seismic collapse	S-060-TAO-ENTDOORCOL
		Railcar accident	S-060-TAO-RAILCARACC
		Mobile platform seismic collapse	S-060-TAO-MOBPLATCOL
		CHC seismic failures	S-060-TAO-CHC-FAIL
		Cask prep platform collapse	S-060-TAO-CPREP-PLAT
		CTT seismic failures	S-060-TAO-CTT-FAIL
		Shield door seismic failure	S-060-TAO-SHIELDDOOR
		CTM seismic failures	S-060-TAO-CTM-FAIL
		ST seismic failures	S-060-TAO-ST-SLIDE
TAD canister in AO to WP	CRCF-S-IE-TWP	CRCF building collapse	S-060-TWP-STR-COLLAP
		Entry door seismic collapse	S-060-TWP-ENTDOORCOL
		Cask prep platform collapse	S-060-TWP-CPREP-PLAT
		ST seismic failures	S-060-TWP-ST-SLIDE
		Shield door seismic failure	S-060-TWP-SHIELDDOOR
		CTM seismic failures	S-060-TWP-CTM-FAIL
		RHS-robotic arm seismic failures	S-060-TWP-RHS-FAIL
		WPTT tipover	S-060-TWP-WPTT-FAIL
		WPHC seismic failures	S-060-TWP-WPHC-FAIL
		TEV seismic failures	S-060-TWP-TEV-FAIL

Process	Initiator Event Tree	Initiating Seismic Failure	Associated Fault Tree
DPC to AO	CRCF-S-IE-DPAO	CRCF building collapse	S-060-TAO-STR-COLLAP
		Entry door seismic collapse	S-060-TAO-ENTDOORCOL
		Railcar accident	S-060-TAO-RAILCARACC
		Mobile platform seismic collapse	S-060-TAO-MOBPLATCOL
		CHC seismic failures	S-060-TAO-CHC-FAIL
		Cask prep platform collapse	S-060-TAO-CPREP-PLAT
		CTT seismic failures	S-060-TAO-CTT-FAIL
		Shield door seismic failure	S-060-TAO-SHIELDDOOR
		CTM seismic failures	S-060-TAO-CTM-FAIL
		ST seismic failures	S-060-TAO-ST-SLIDE

NOTE: AO = aging overpack; CAN = canister; CHC = cask handling crane; CRCF = Canister Receipt and Closure Facility; CTM = canister transfer machine; CTT = cask transfer trolley; DPC = dual-purpose canister; RHS = remote handling system; RR = radioactive release; SEIS = seismic; ST = site transporter; UNF = unfiltered; WP = waste package; WPHC = waste package handling crane; WPTT = waste package transfer trolley.

Source: Original

Table C1.1-2. Fault Trees Assigned for Pivotal Events for CRCF-S-IE-TAD-AO Initiating Event Tree

Initiating Seismic Failure	TRANSCASK	MODERATOR
CRCF building collapse	N/A	N/A
Entry door seismic collapse	RC-TAO-DOORDROP-CASK	CRCF-MOD-MULT-SYS
Railcar accident	RC-TAO-RC-ACC-CASK	CRCF-MOD-MULT-SYS
Mobile platform seismic collapse	RC-TAO-MOB-PLAT-CASK	CRCF-MOD-MULT-SYS
CHC seismic failures	TC-TAO-CHC-CASK	CRCF-MOD-MULT-SYS
Cask prep platform collapse	TC-TAO-CPP-CASK	CRCF-MOD-MULT-SYS
CTT seismic failures	CTT-TAO-CTT-CASK	CRCF-MOD-MULT-SYS
	TC-WP	
Shield door seismic failure	TCWP-TAO-SHIELDDOOR-CASK	CRCF-MOD-MULT-SYS
	CANISTER	
CTM seismic failures	CTM-TAO-CTM-CAN	CRCF-MOD-MULT-SYS
ST seismic failures	ST-TAO-AO-FAIL	CRCF-MOD-MULT-SYS

NOTE: AO = aging overpack; CHC = cask handling crane; CPP = cask preparation platform; CRCF = Canister Receipt and Closure Facility; CTM = canister transfer machine; CTT = cask transfer trolley; ST = site transporter; TC = transportation cask; WP = waste package.

Source: Original

Table C1.1-3. Fault Trees Assigned for Pivotal Events for CRCF-S-IE-TWP Initiating Event Tree

Initiating Seismic Failure	CANISTER	MODERATOR
CRCF building collapse	N/A	N/A
Entry door seismic collapse	ST-TWP-DOORDROP-AO	CRCF-MOD-MULT-SYS
Cask prep platform collapse	ST-TWP-CPP-AO	CRCF-MOD-MULT-SYS
ST seismic failures	ST-TWP-AO-FAIL	CRCF-MOD-MULT-SYS
CTM seismic failures	CTM-TWP-CTM-CAN	CRCF-MOD-MULT-SYS
	TC-WP	
Shield door seismic failure	TCWP-TWP-SHIELDDOOR-CASK	CRCF-MOD-MULT-SYS
	WP-CONTAIN	
RHS-robotic arm seismic failures	WPTT-TWP-RHS-FAIL	CRCF-MOD-MULT-SYS
WPTT tipover	WPTT-TWP-WPTT-FAIL	CRCF-MOD-MULT-SYS
WPHC seismic failures	WPTT-TWP-WPHC-FAIL	CRCF-MOD-MULT-SYS
TEV seismic failures	TEV-TWP-TEV-FAIL	CRCF-MOD-MULT-SYS

NOTE: AO = aging overpack; CAN = canister; CHC = cask handling crane; CRCF = Canister Receipt and Closure Facility; CTM = canister transfer machine; CTT = cask transfer trolley; RHS = remote handling system; ST = site transporter; TC = transportation cask; TEV = transport and emplacement vehicle; WP = waste package; WPHC = waste package handling crane; WPTT = waste package transfer trolley.

Source: Original

Table C1.1-4. Fault Trees Assigned for Pivotal Events for CRCF-S-IE-DPAO Initiating Event Tree

Initiating Seismic Failure	TRANSCASK	MODERATOR
CRCF building collapse	N/A	N/A
Entry door seismic collapse	RC-TAO-DOORDROP-CASK	CRCF-MOD-MULT-SYS
Railcar accident	RC-TAO-RC-ACC-CASK	CRCF-MOD-MULT-SYS
Mobile platform seismic collapse	RC-TAO-MOB-PLAT-CASK	CRCF-MOD-MULT-SYS
CHC seismic failures	TC-TAO-CHC-CASK	CRCF-MOD-MULT-SYS
Cask prep platform collapse	TC-TAO-CPP-CASK	CRCF-MOD-MULT-SYS
CTT seismic failures	CTT-TAO-CTT-CASK	CRCF-MOD-MULT-SYS
	TC-WP	
Shield door seismic failure	TCWP-TAO-SHIELDDOOR-CASK	CRCF-MOD-MULT-SYS
	CANISTER	
CTM seismic failures	CTM-TAO-CTM-CAN	CRCF-MOD-MULT-SYS
ST seismic failures	ST-TAO-AO-FAIL	CRCF-MOD-MULT-SYS

NOTE: AO = aging overpack; CAN = canister; CHC = cask handling crane; CPP = cask preparation platform; CRCF = Canister Receipt and Closure Facility; CTM = canister transfer machine; CTT = cask transfer trolley; RHS = remote handling system; ST = site transporter; TC = transportation cask; WP = waste package.

Source: Original

C1.2 FAULT TREES

Seismic fault trees for the processing of TAD canisters and DPCs in the CRCF are presented in alpha-numeric order in this section.

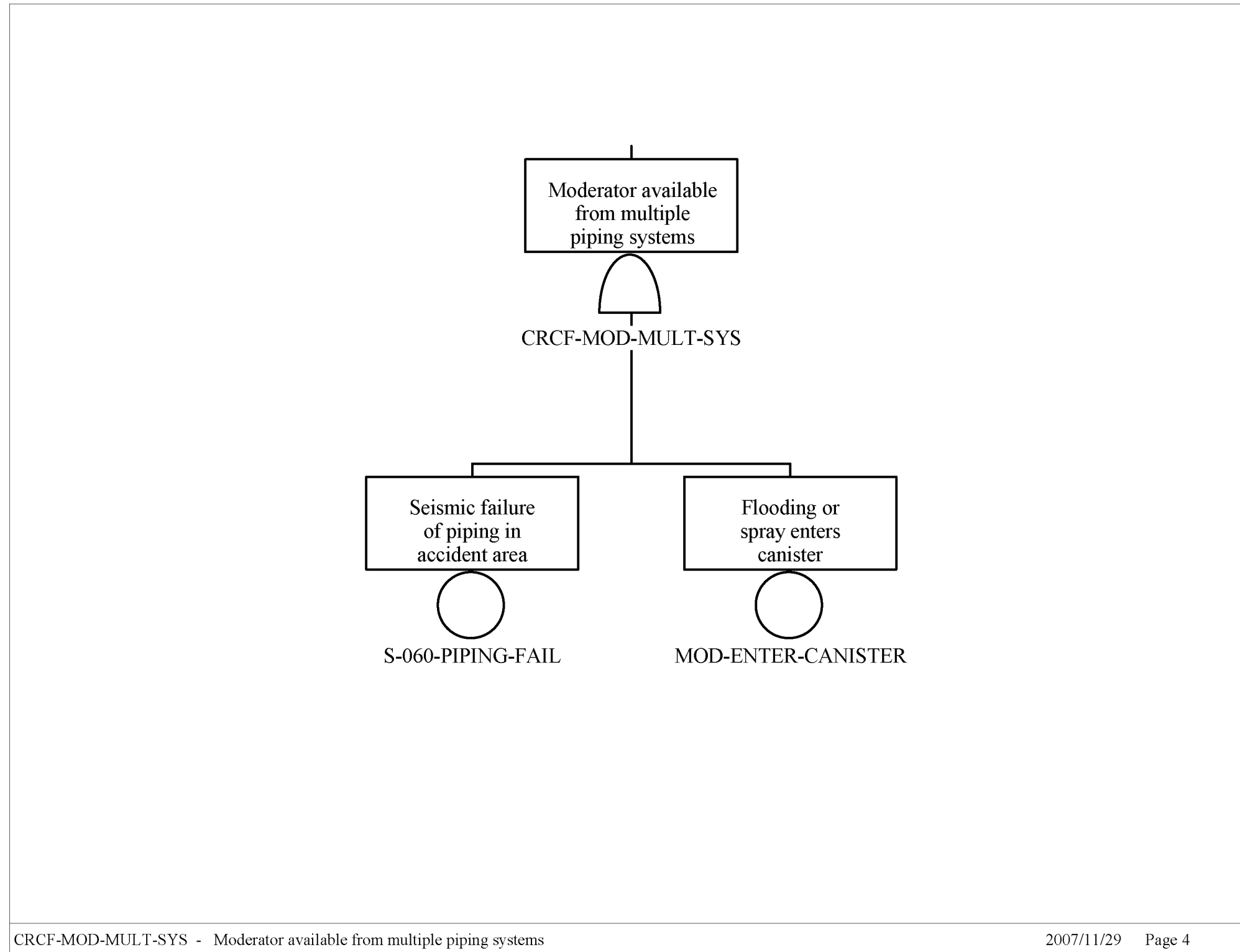

Source: Original

Figure C1.2-1. Fault Tree CRCF-MOD-MULT-SYS – Moderator Available from Multiple Piping Systems

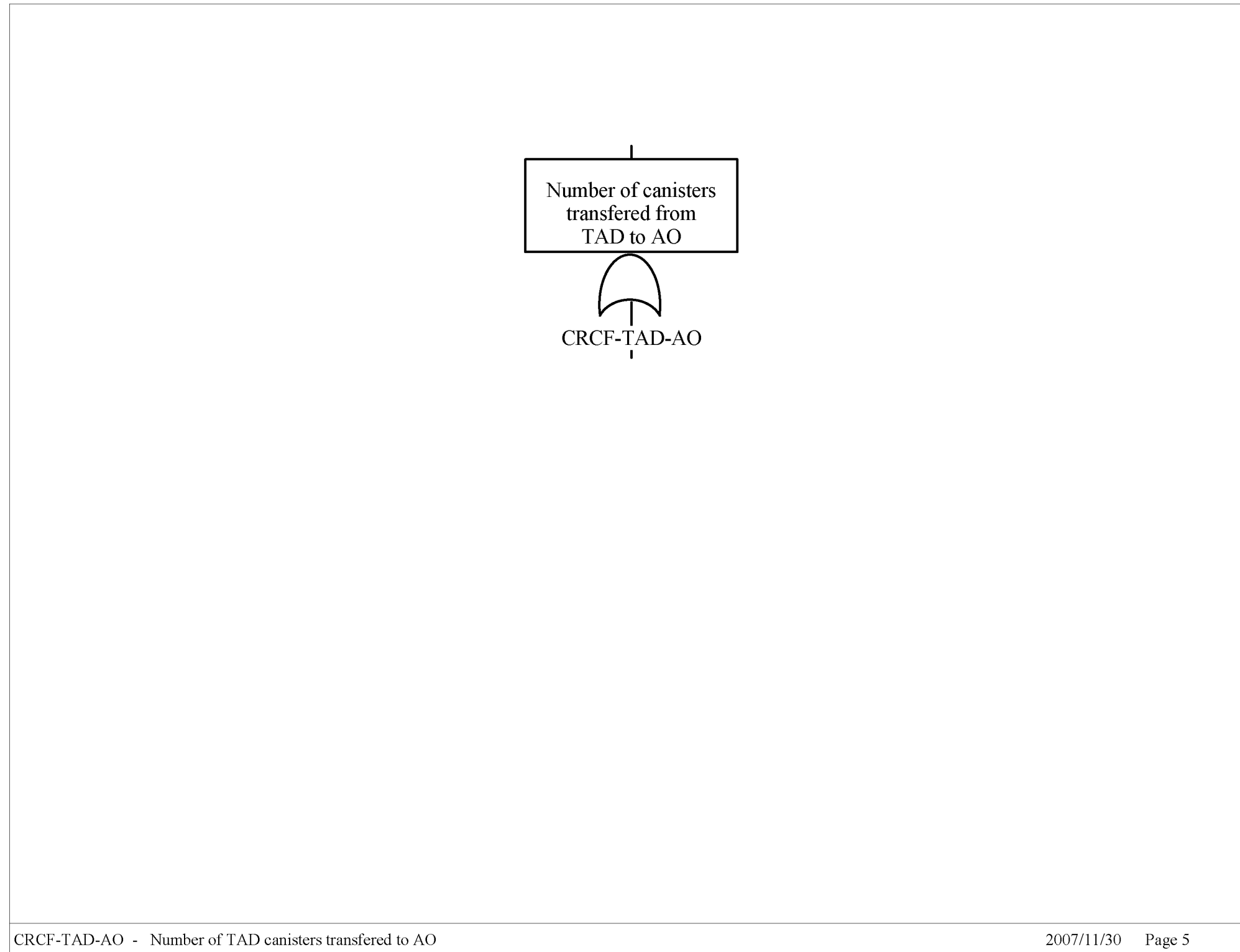

Source: Original

Figure C1.2-2. CRCF-TAD-AO – Number of TAD Canisters Transferred to AO

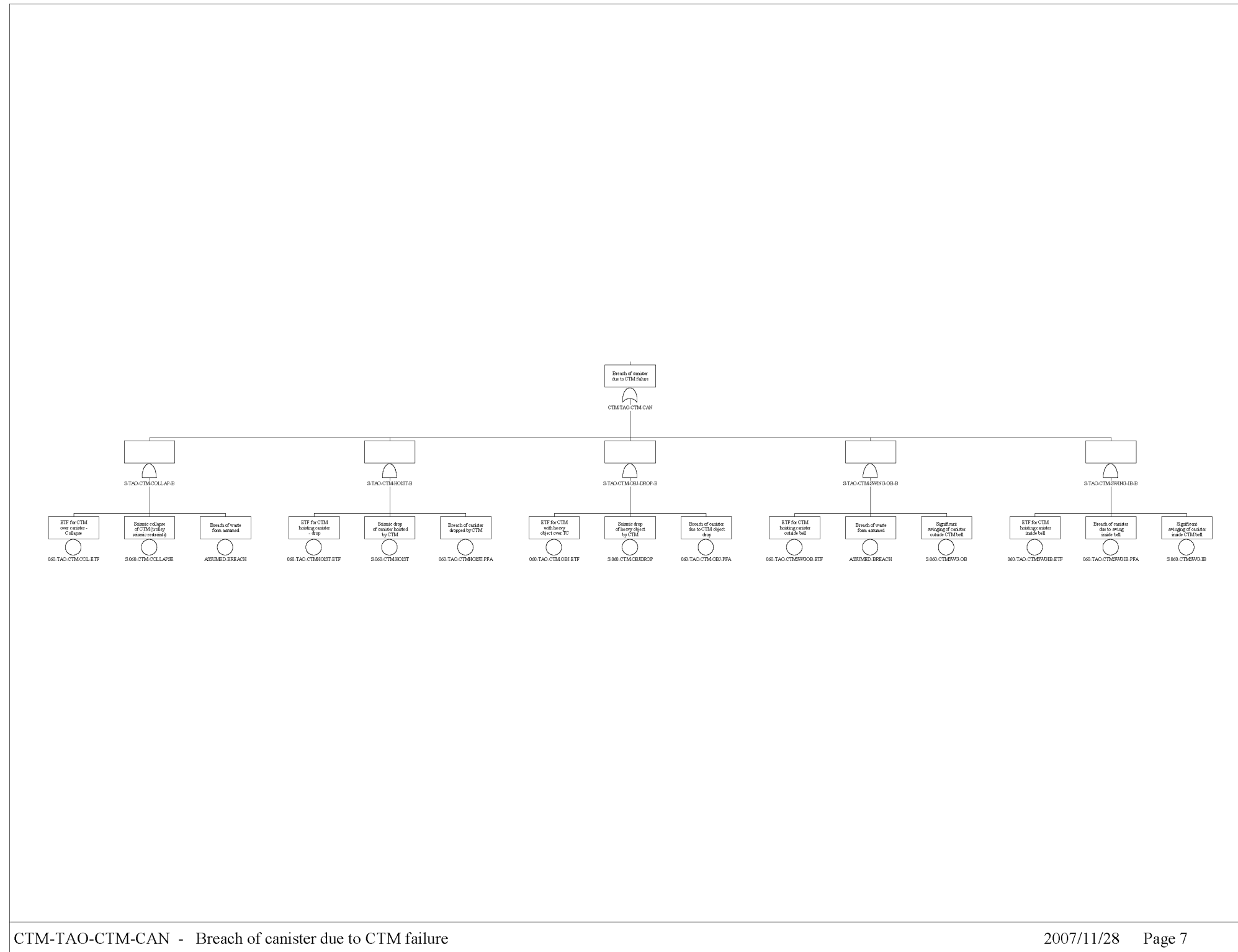

Source: Original

Figure C1.2-3. CTM-TAO-CTM-CAN – Breach of Canister due to CTM Failure

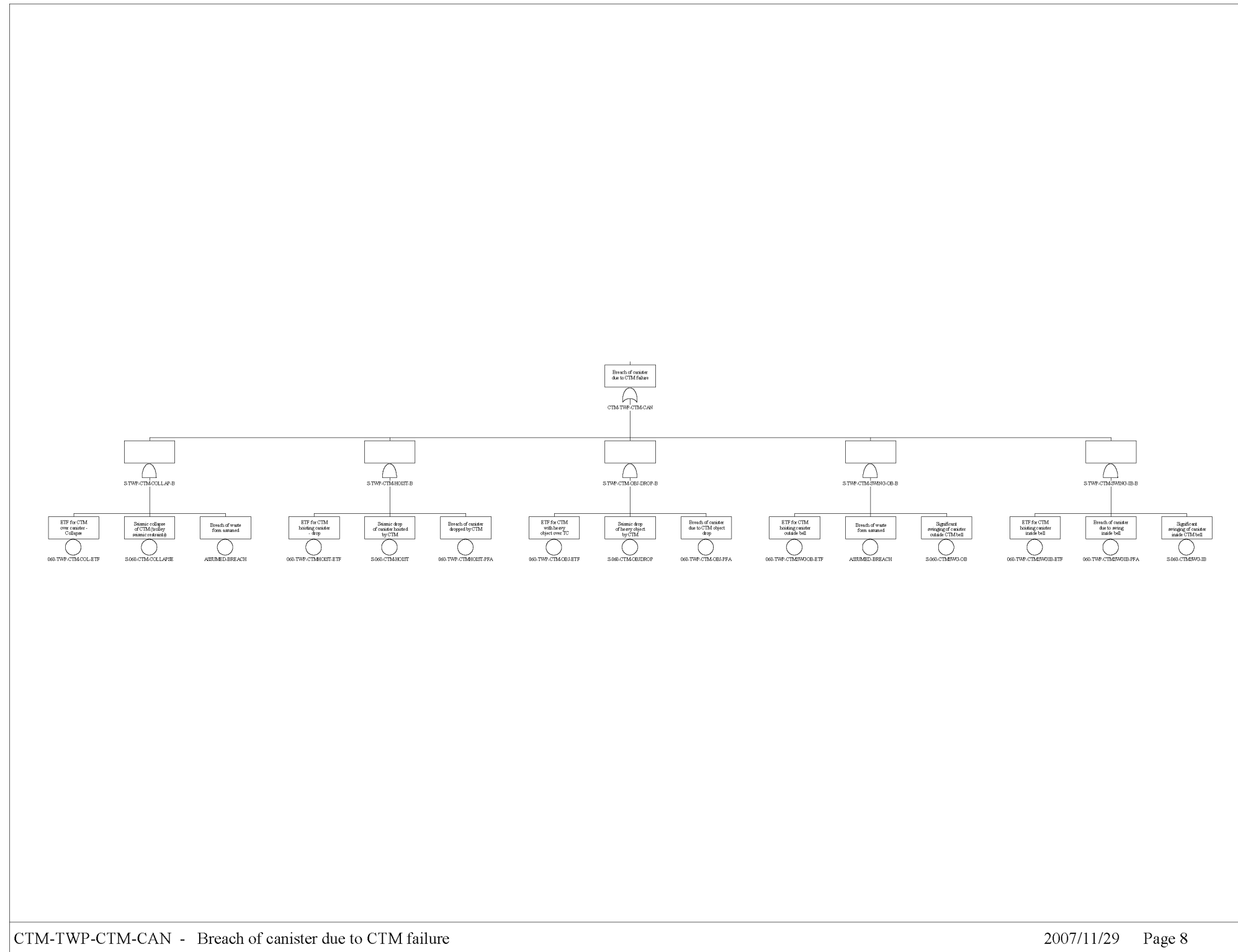

Source: Original

Figure C1.2-4. CTM-TWP-CTM-CAN – Breach of Canister due to CTM Failure

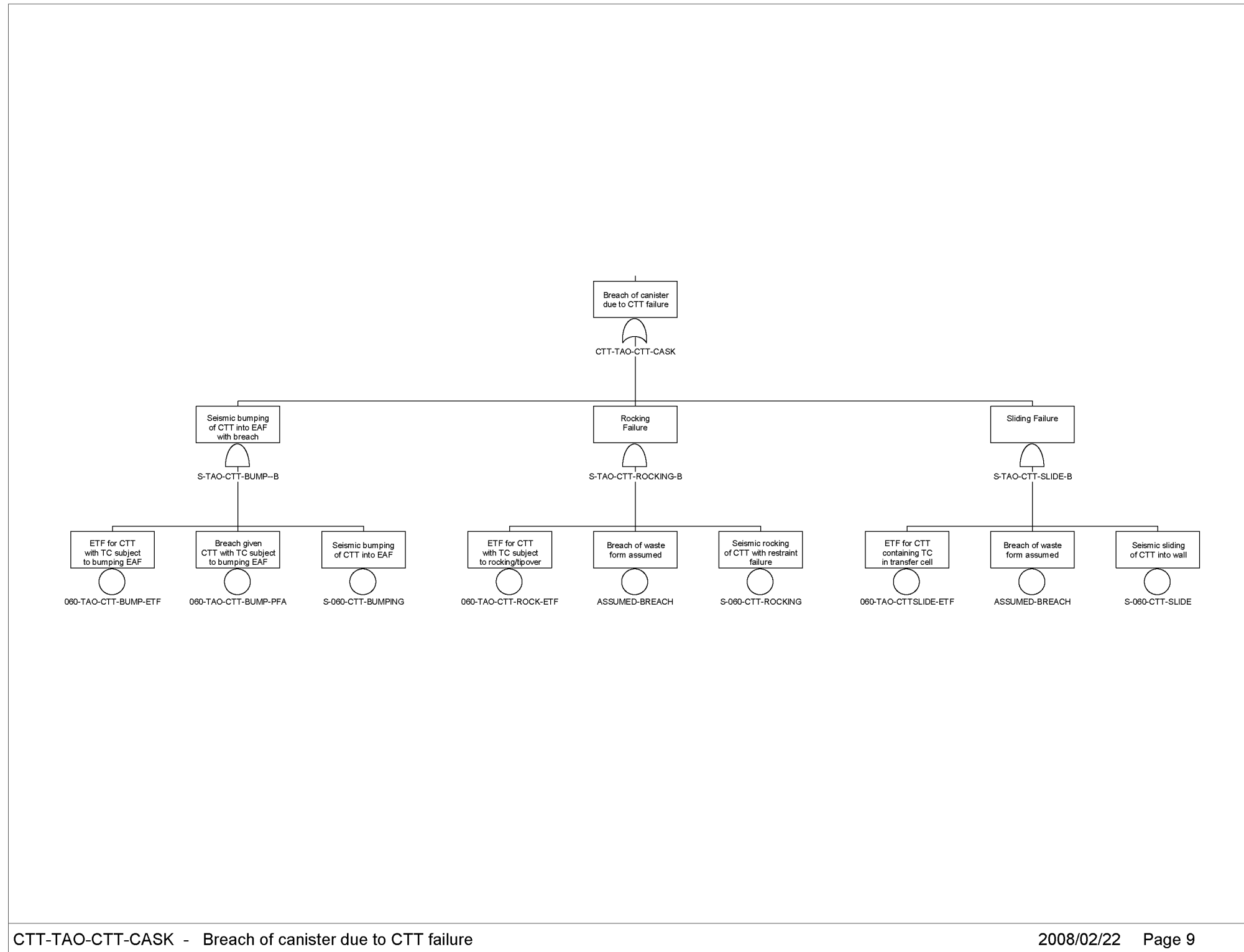

Source: Original

Figure C1.2-5. CTT-TAO-CTT-CASK – Breach of Canister due to CTT Failure

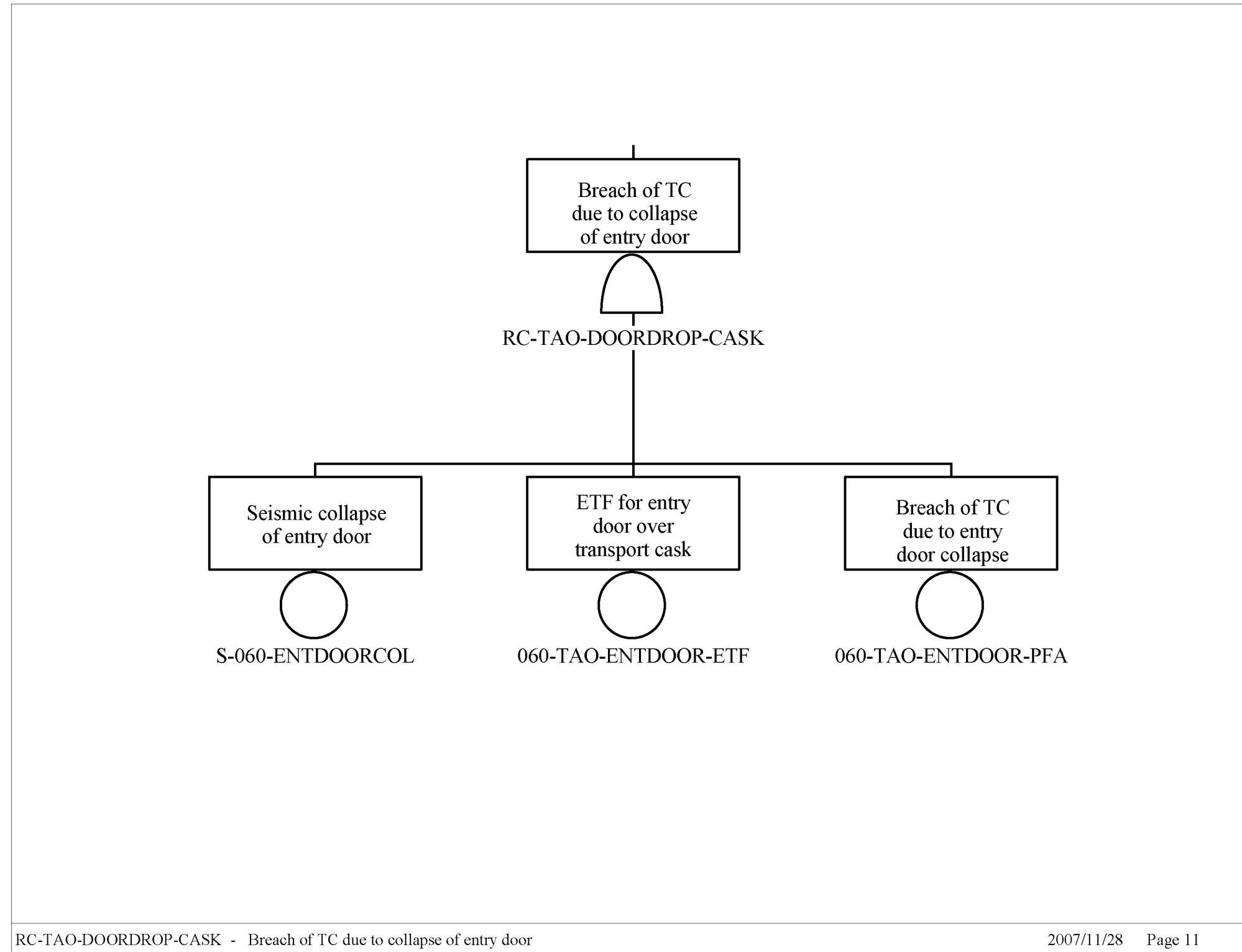

Source: Original

Figure C1.2-6. RC-TAO-DOORDROP-CASK – Breach of TC due to Collapse of Entry Door

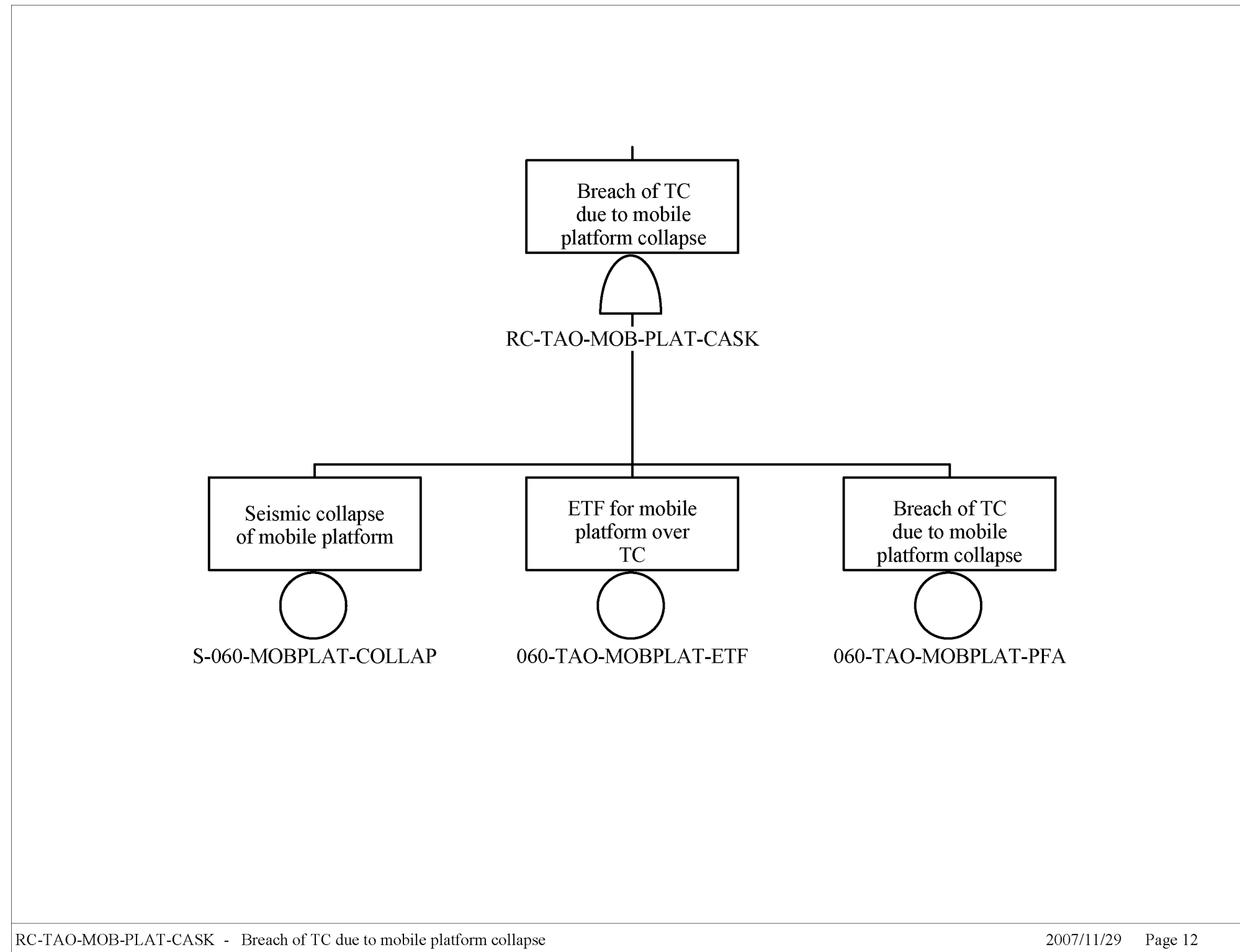

Source: Original

Figure C1.2-7. RC-TAO-MOB-PLAT-CASK – Breach of TC due to Mobile Platform Collapse

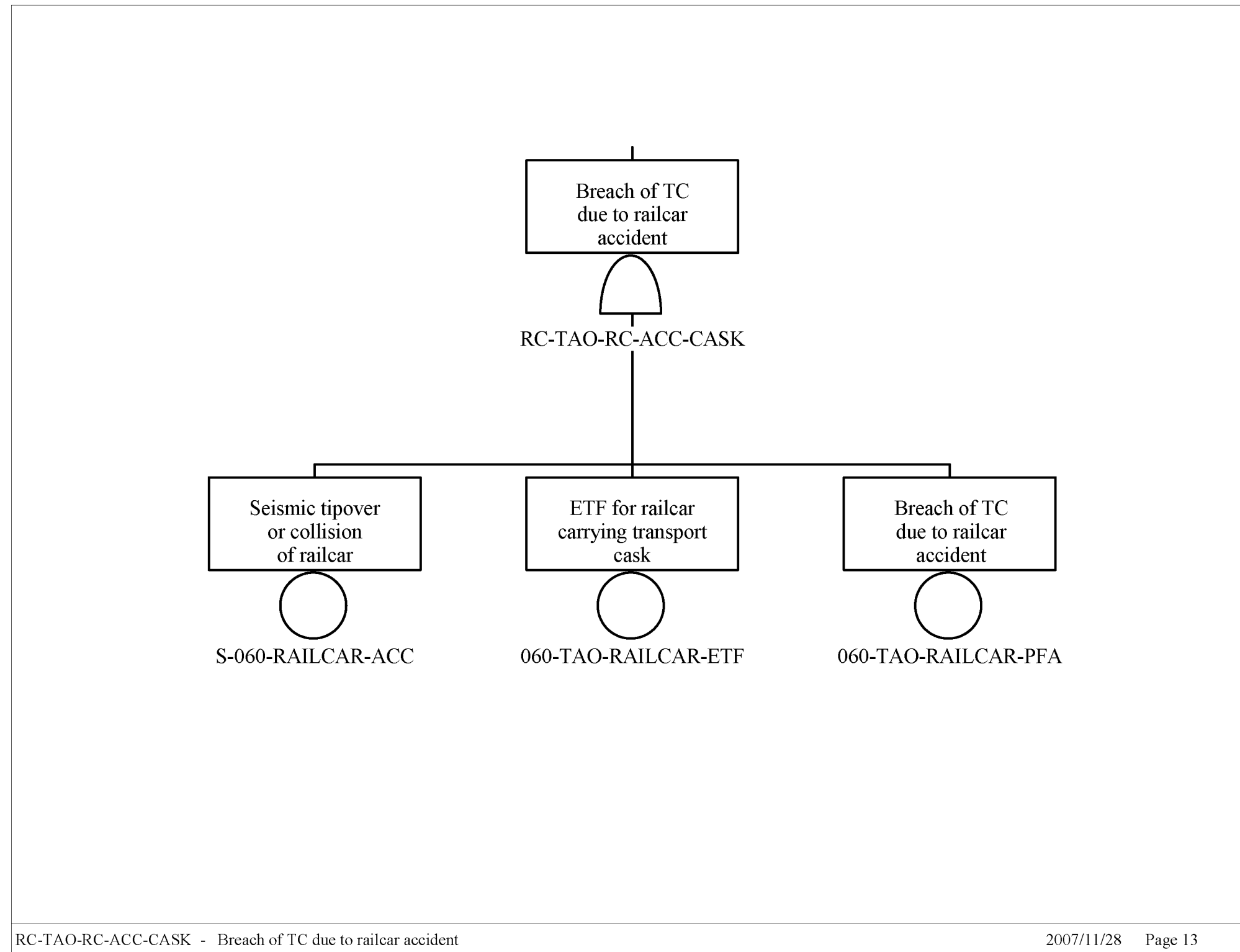

Source: Original

Figure C1.2-8. RC-TAO-RC-ACC-CASK – Breach of TC due to Railcar Accident

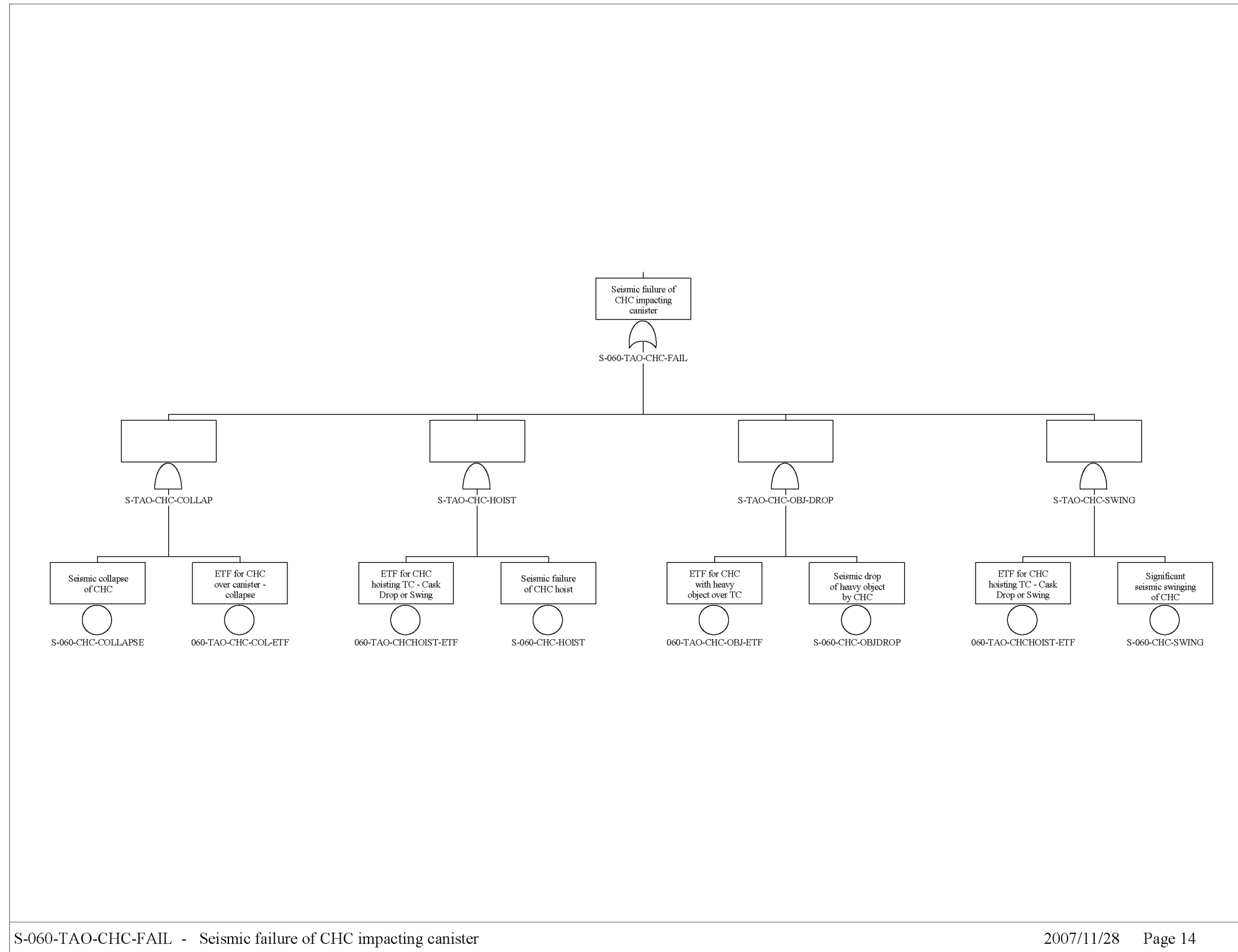

Source: Original

Figure C1.2-9. S-060-TAO-CHC-FAIL – Seismic Failure of CHC Impacting Canister

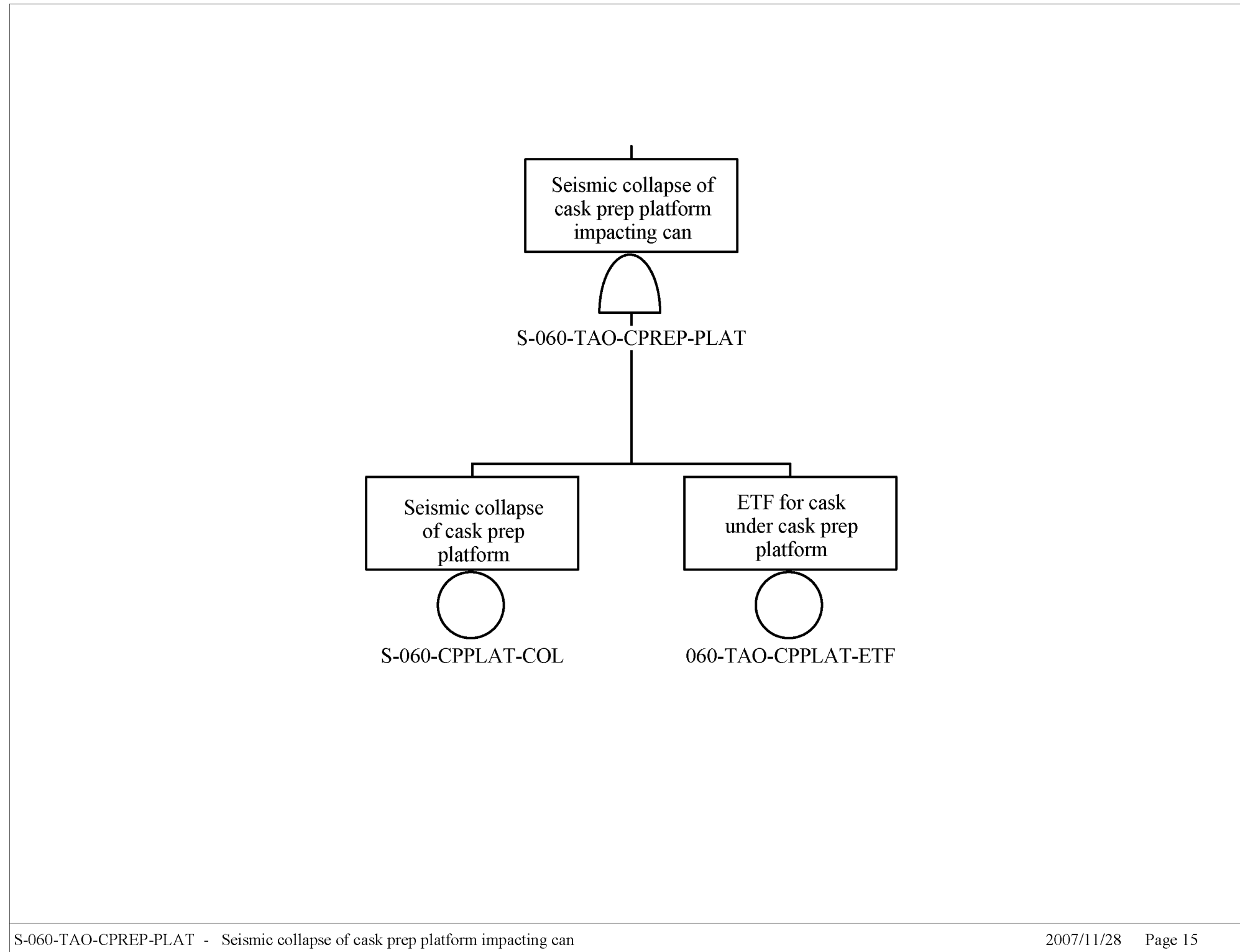

Source: Original

Figure C1.2-10. S-060-TAO-CPREP-PLAT – Seismic Collapse of Cask Prep Platform Impacting Can

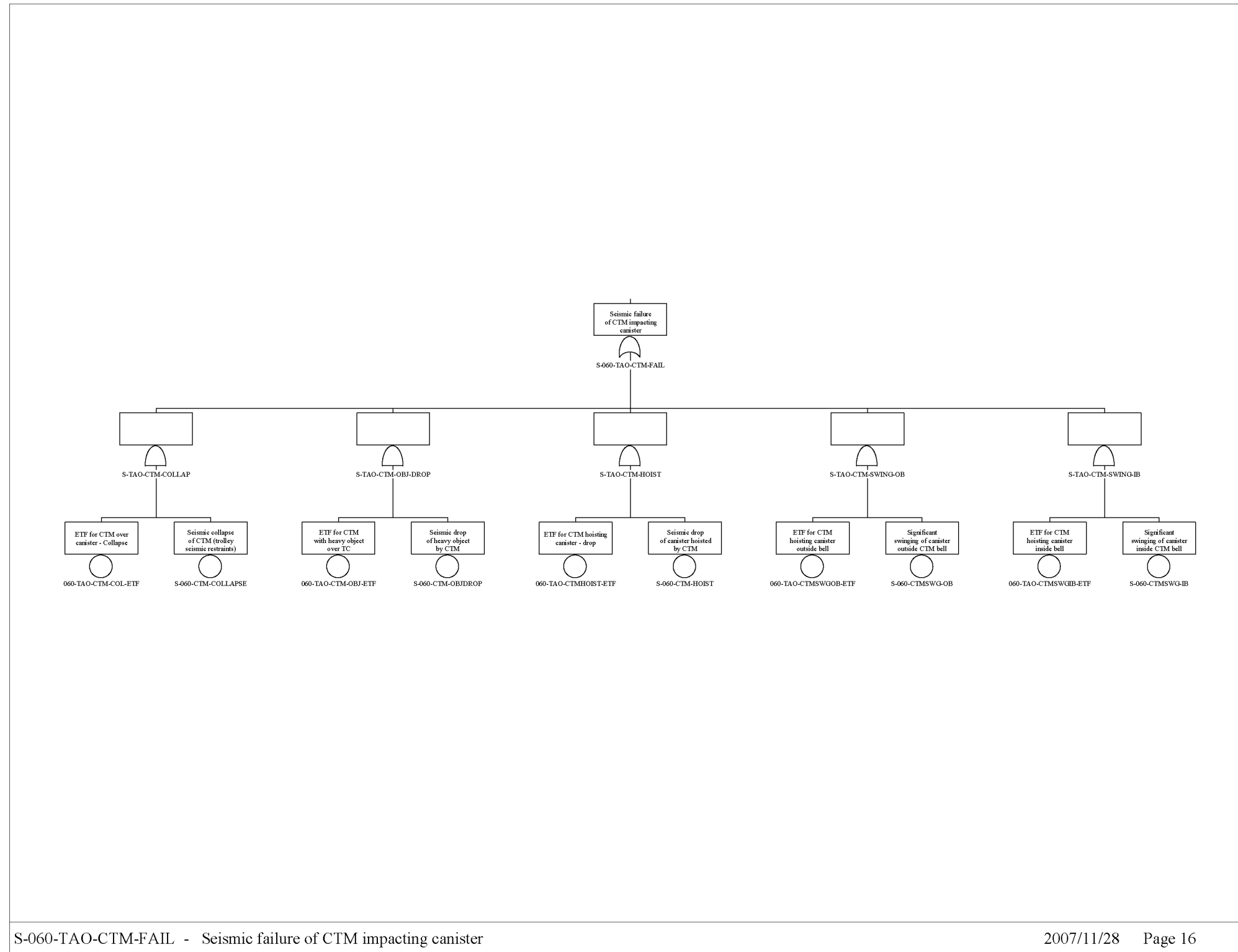

Source: Original

Figure C1.2-11. S-060-TAO-CTM-FAIL – Seismic Failure of CTM Impacting Canister

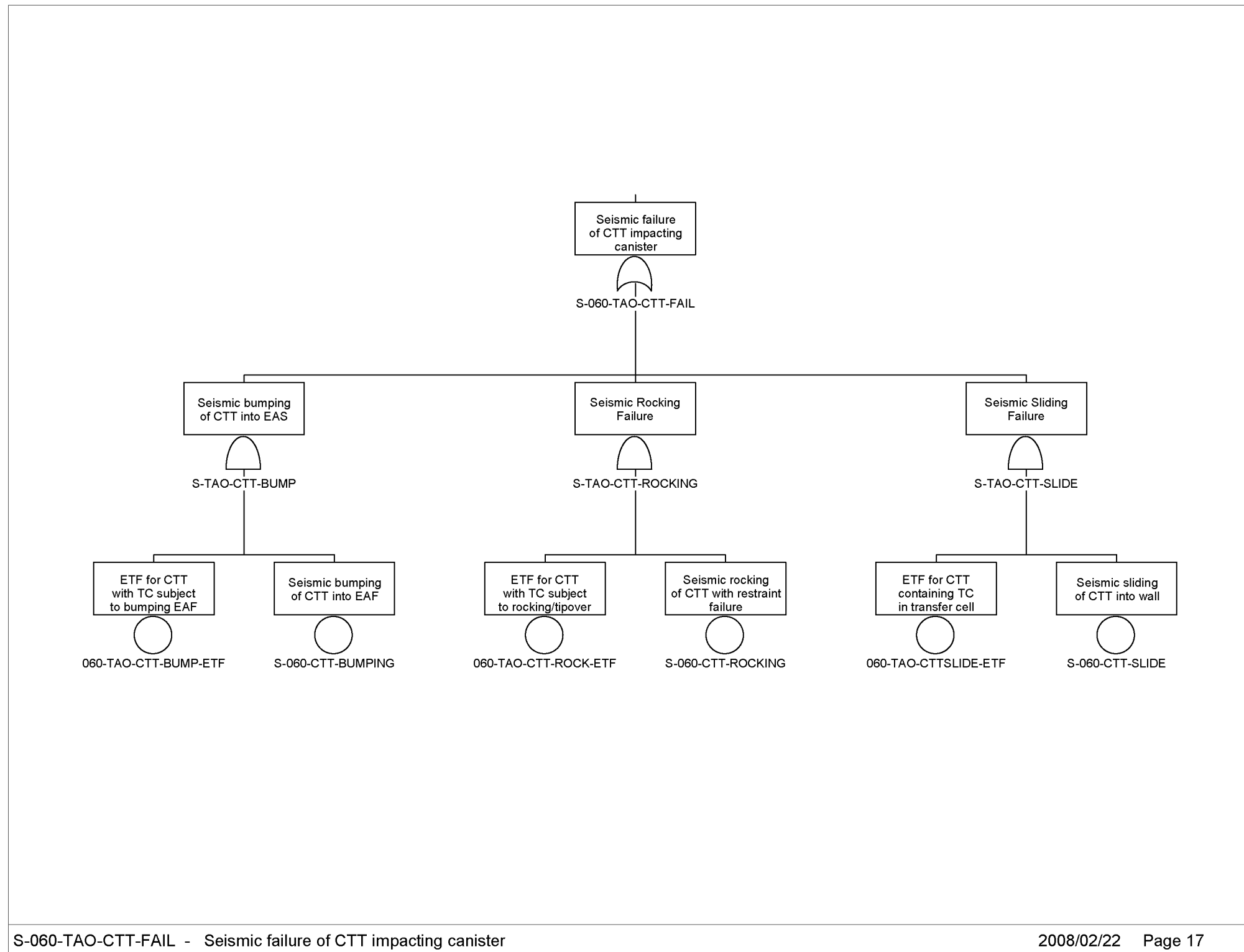

Source: Original

Figure C1.2-12. S-060-TAO-CTT-FAIL – Seismic Failure of CTT Impacting Canister

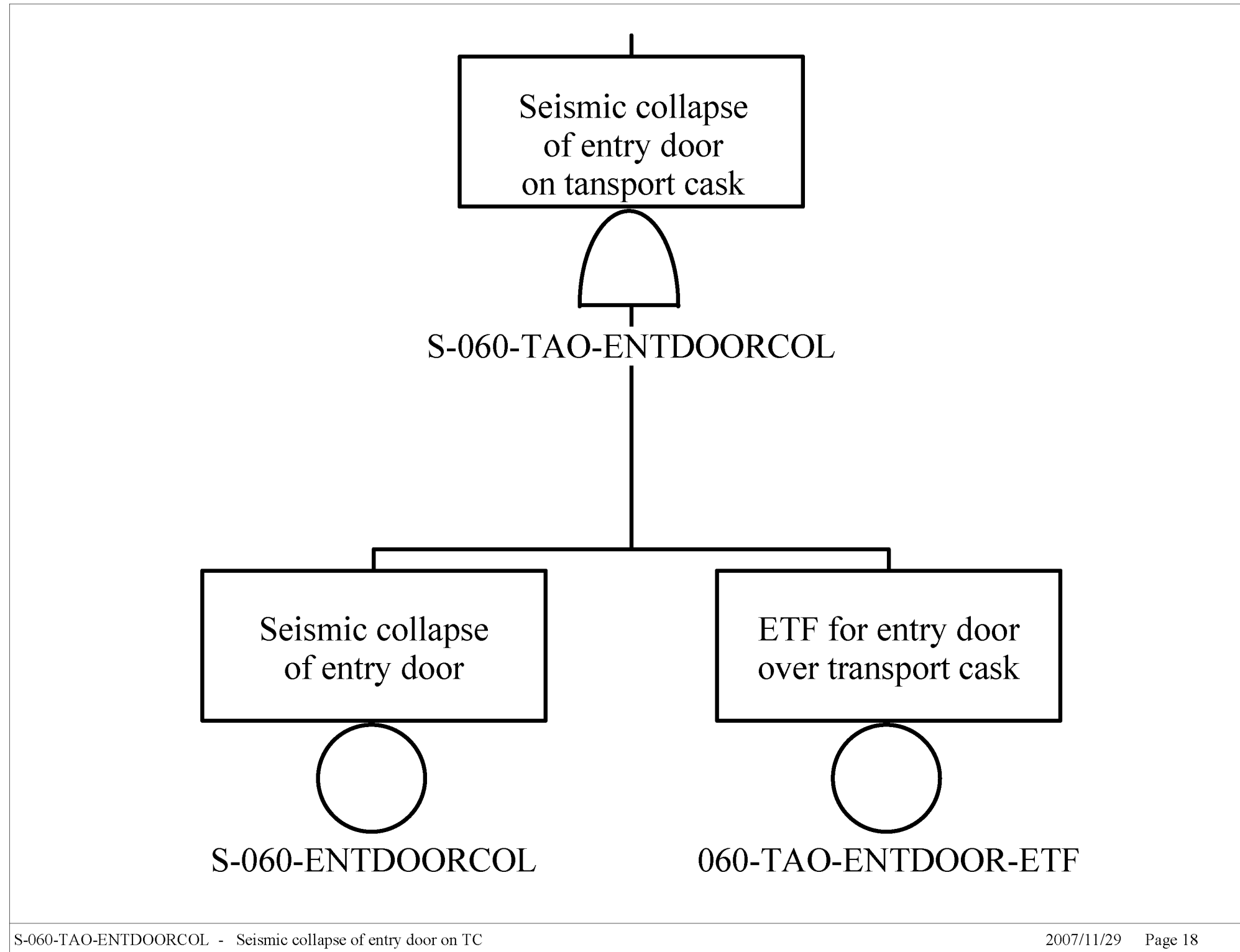

Source: Original

Figure C1.2-13. S-060-TAO-ENTDOORCOL – Seismic Collapse of Entry Door on TC

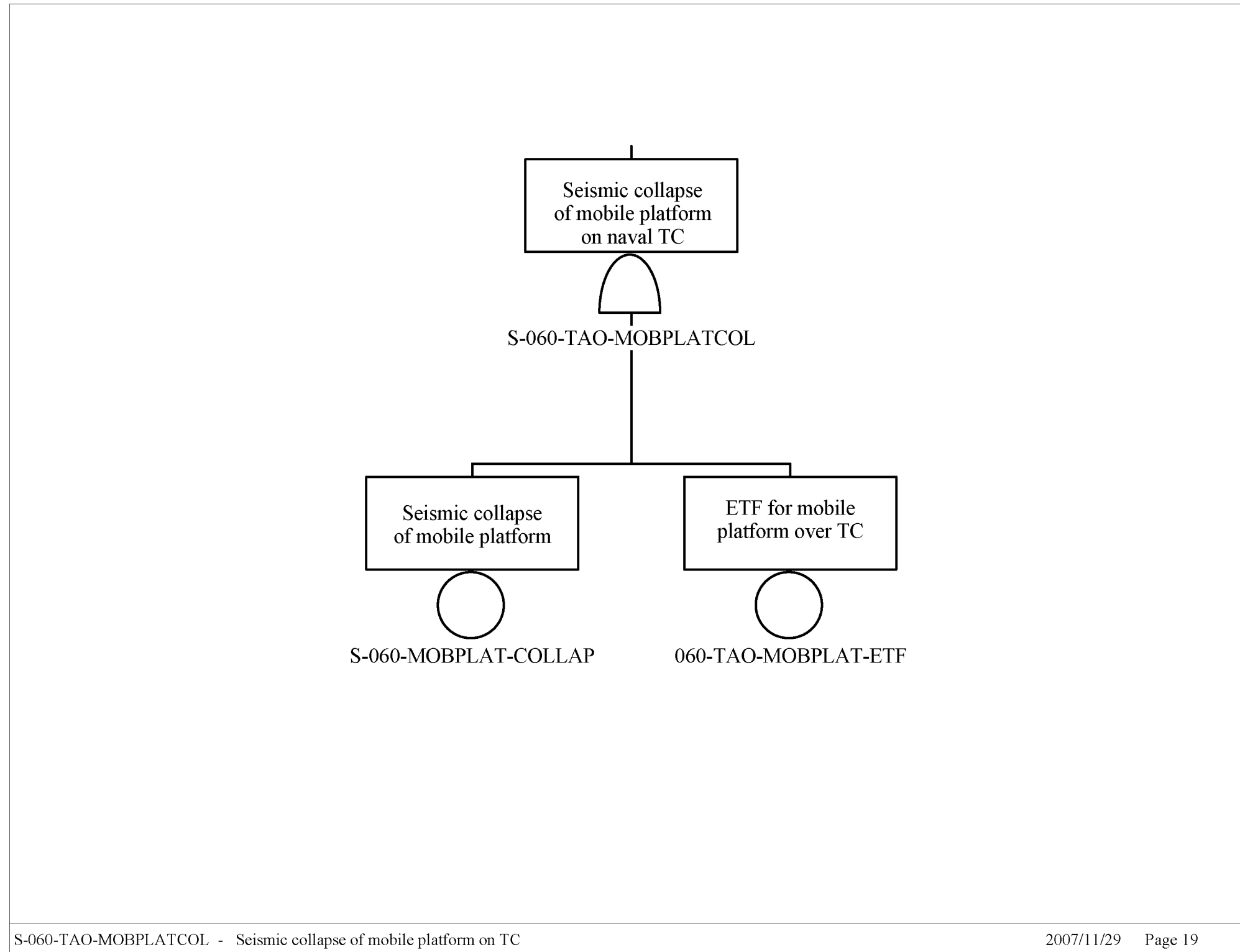

Source: Original

Figure C1.2-14. S-060-TAO-MOBPLATCOL – Seismic Collapse of Mobile Platform on TC

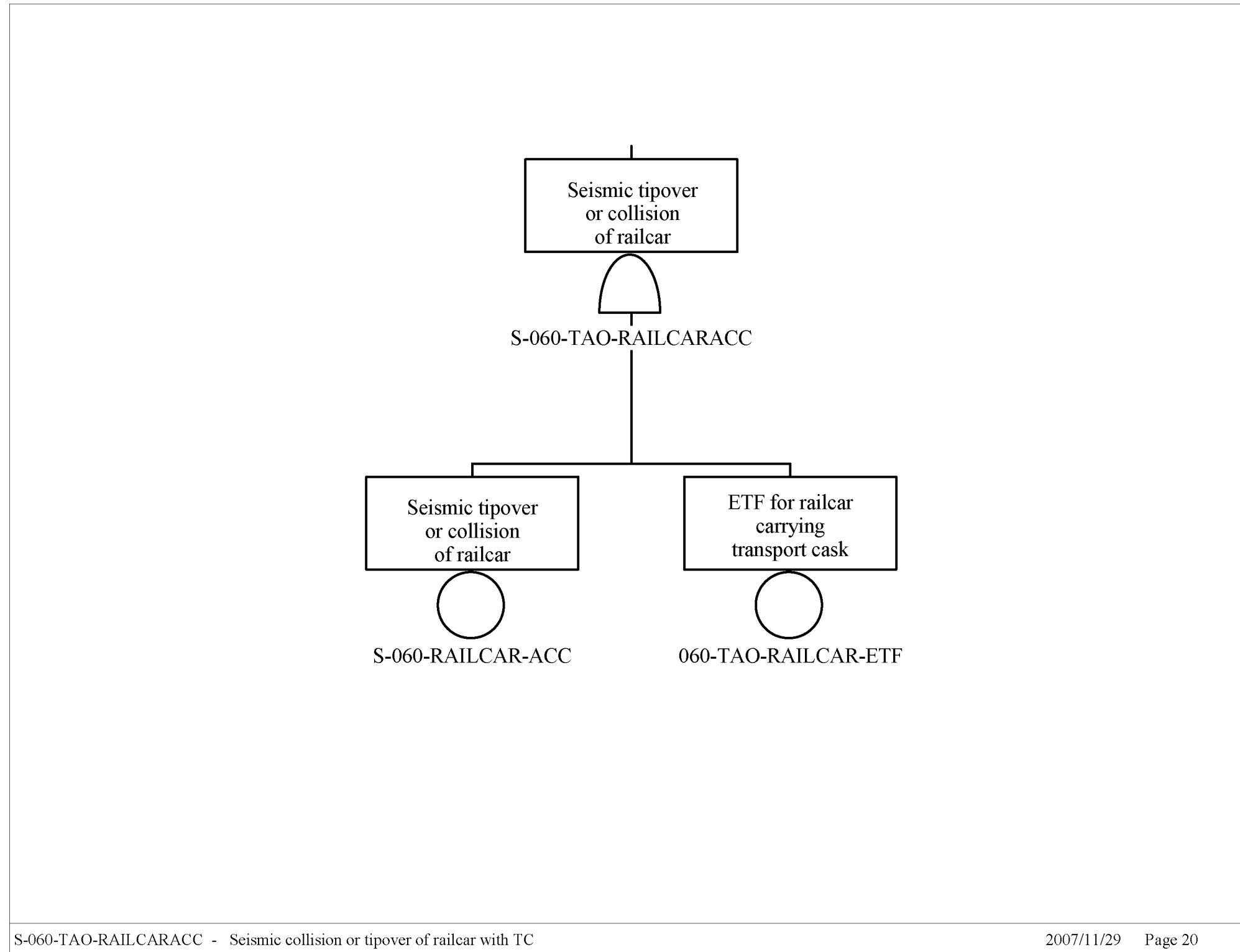

Source: Original

Figure C1.2-15. S-060-TAO-RAILCARACC – Seismic Collision or Tipover of Railcar with TC

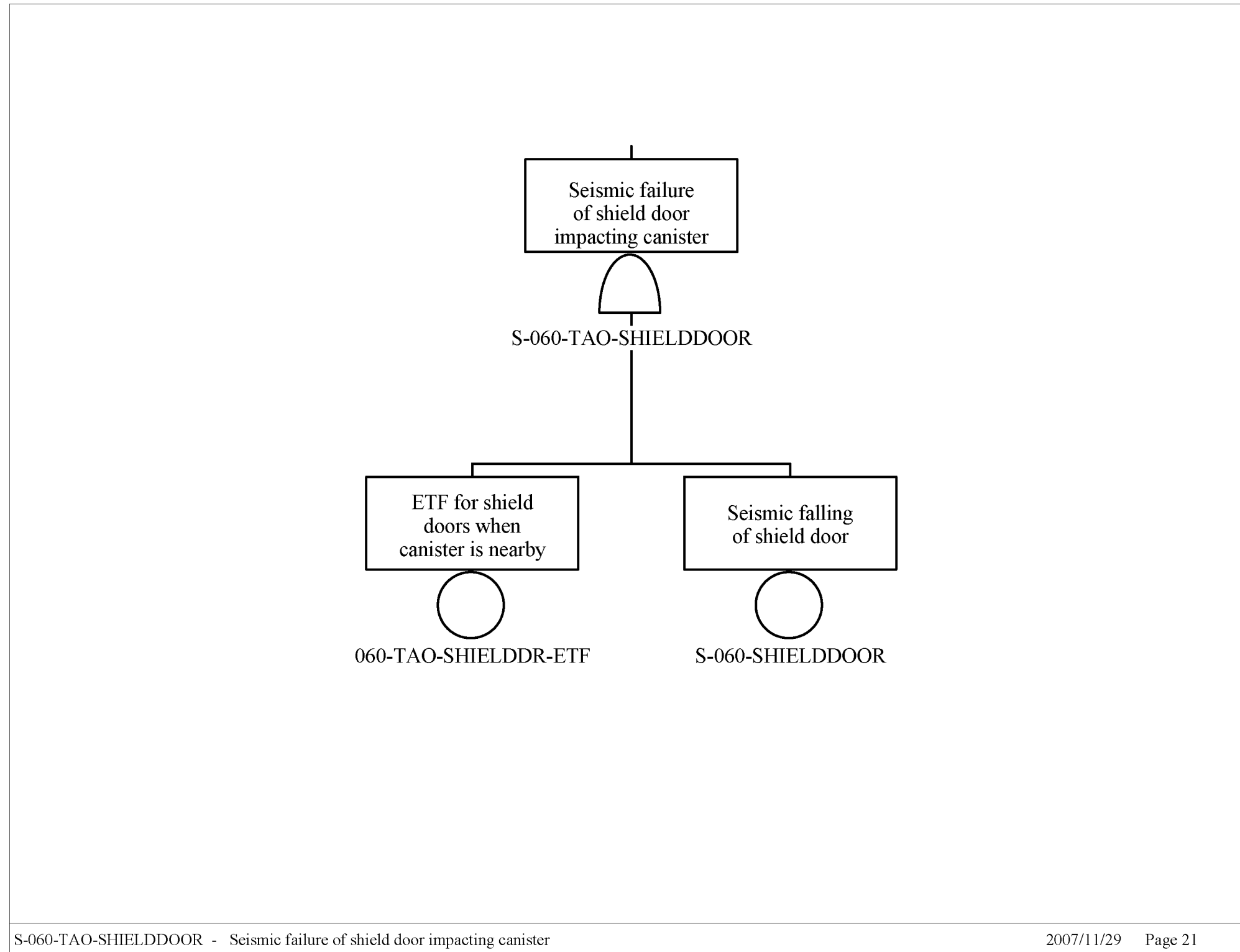

Source: Original

Figure C1.2-16. S-060-TAO-SHIELDDOOR–
Seismic Failure of Shield Door
Impacting Canister

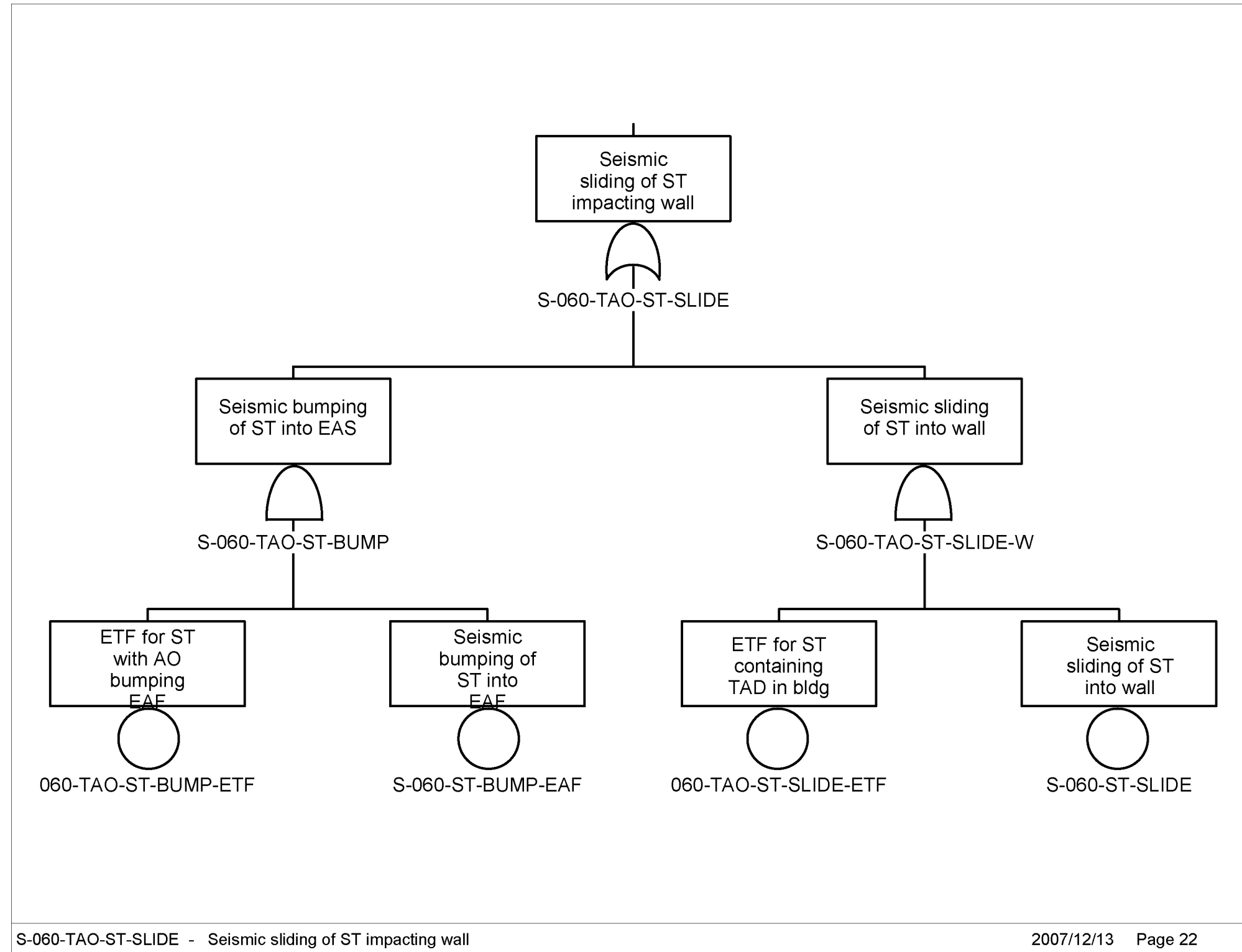

Source: Original

Figure C1.2-17. S-060-TAO-ST-SLIDE – Seismic Sliding of ST Impacting Wall

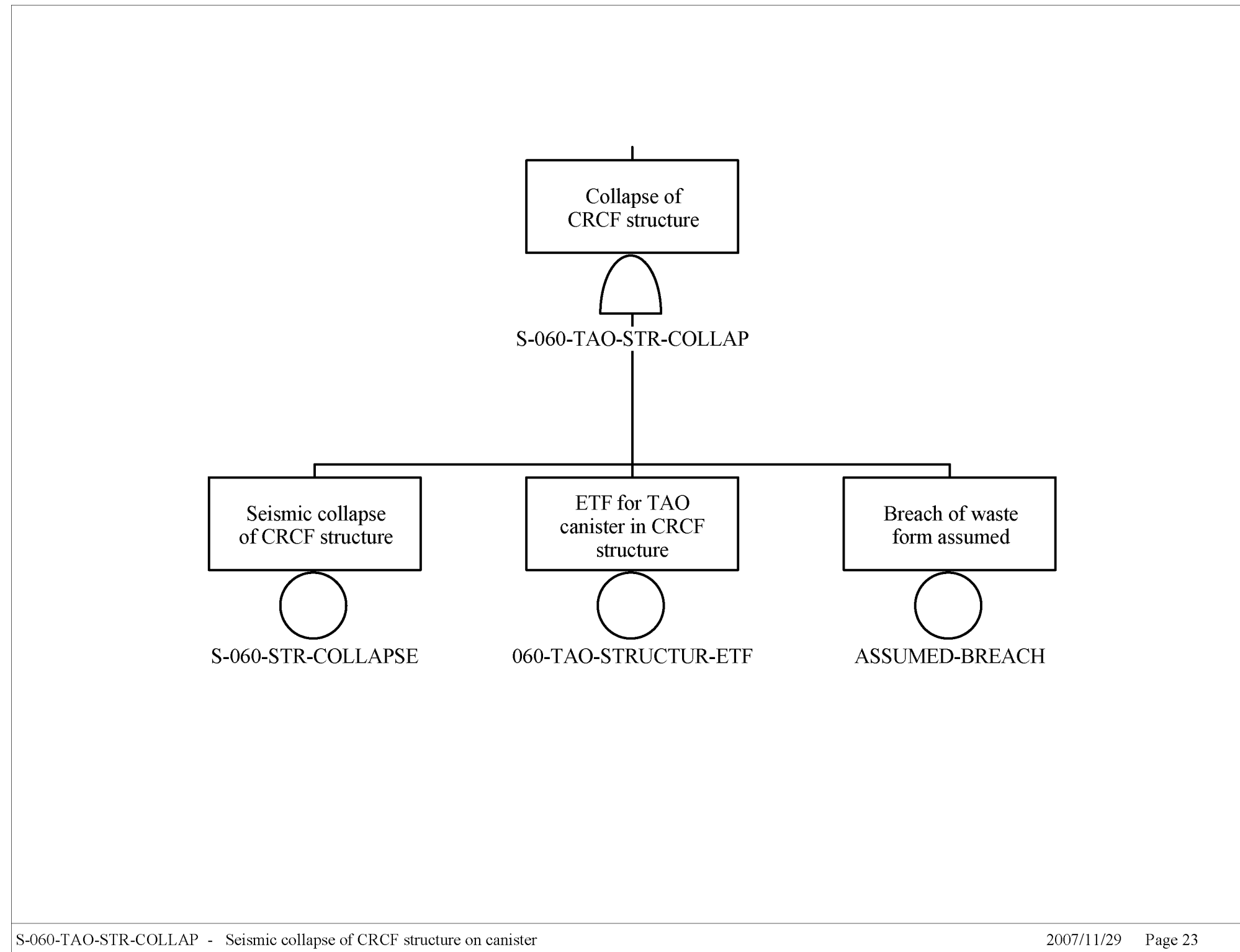

S-060-TAO-STR-COLLAP - Seismic collapse of CRCF structure on canister

2007/11/29 Page 23

Source: Original

Figure C1.2-18. S-060-TAO-STR-COLLAP - Seismic Collapse of CRCF Structure on Canister

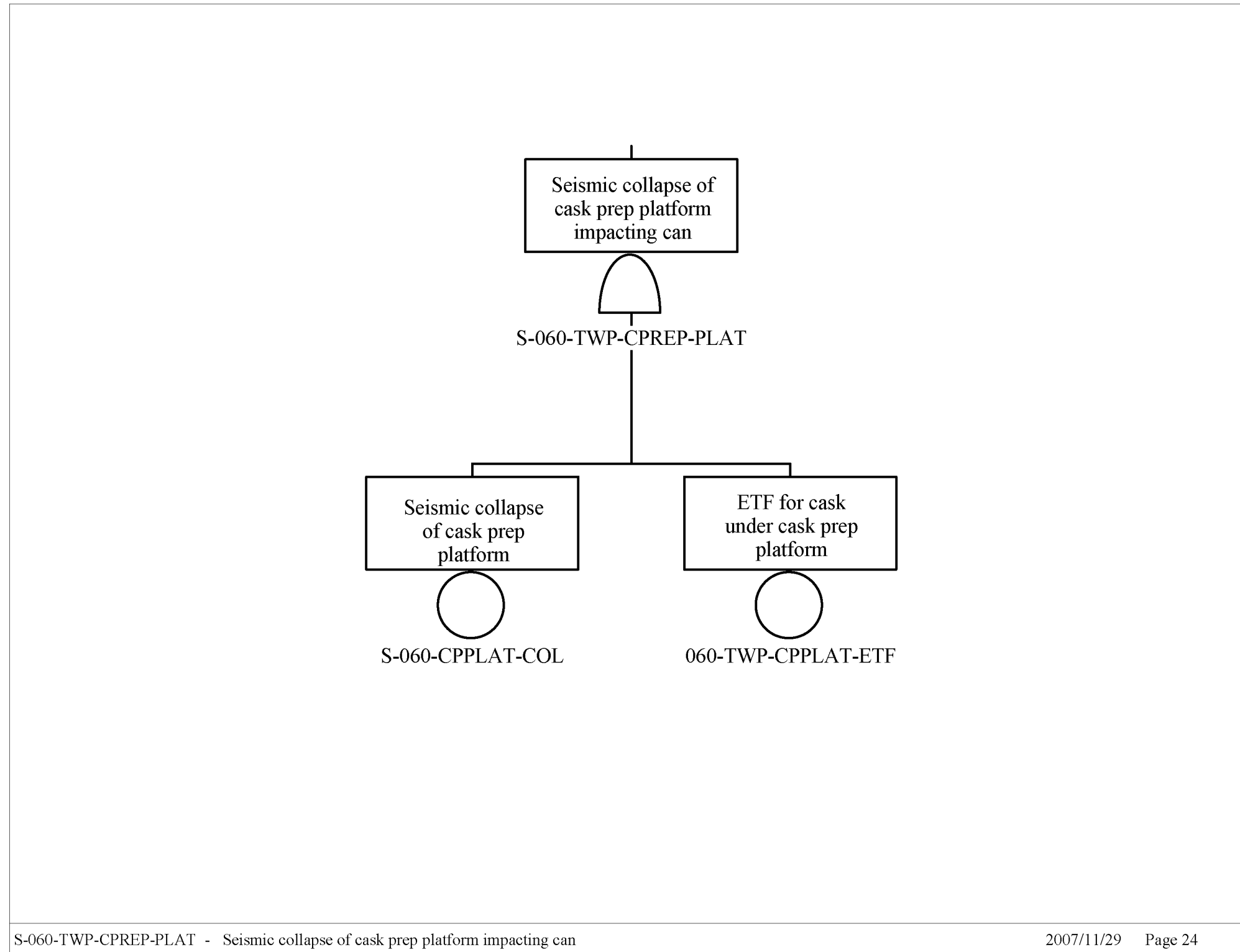

Source: Original

Figure C1.2-19. S-060-TWP-CPREP-PLAT – Seismic Collapse of Cask Prep Platform Impacting Can

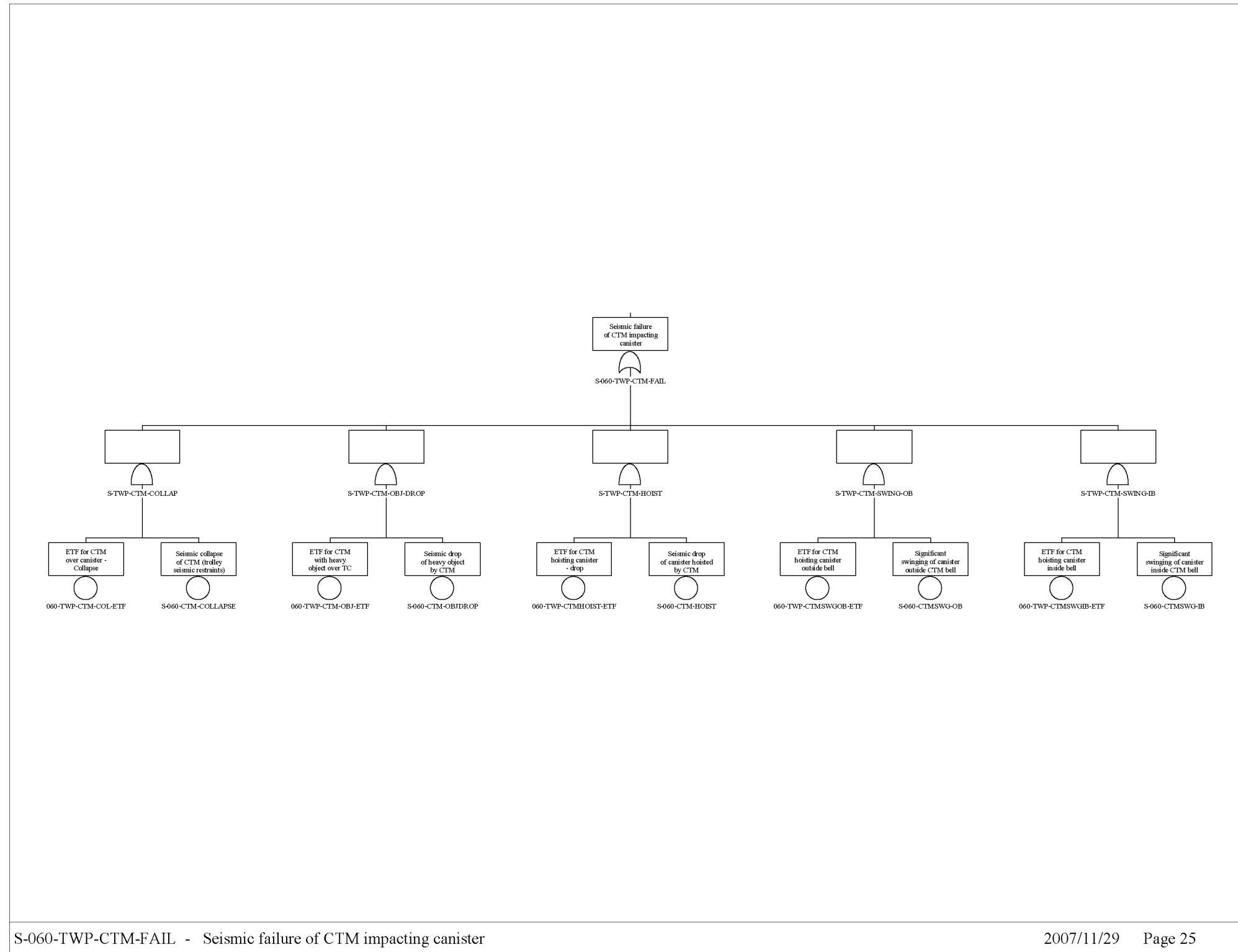

Source: Original

Figure C1.2-20. S-060-TWP-CTM-FAIL – Seismic Failure of CTM Impacting Canister

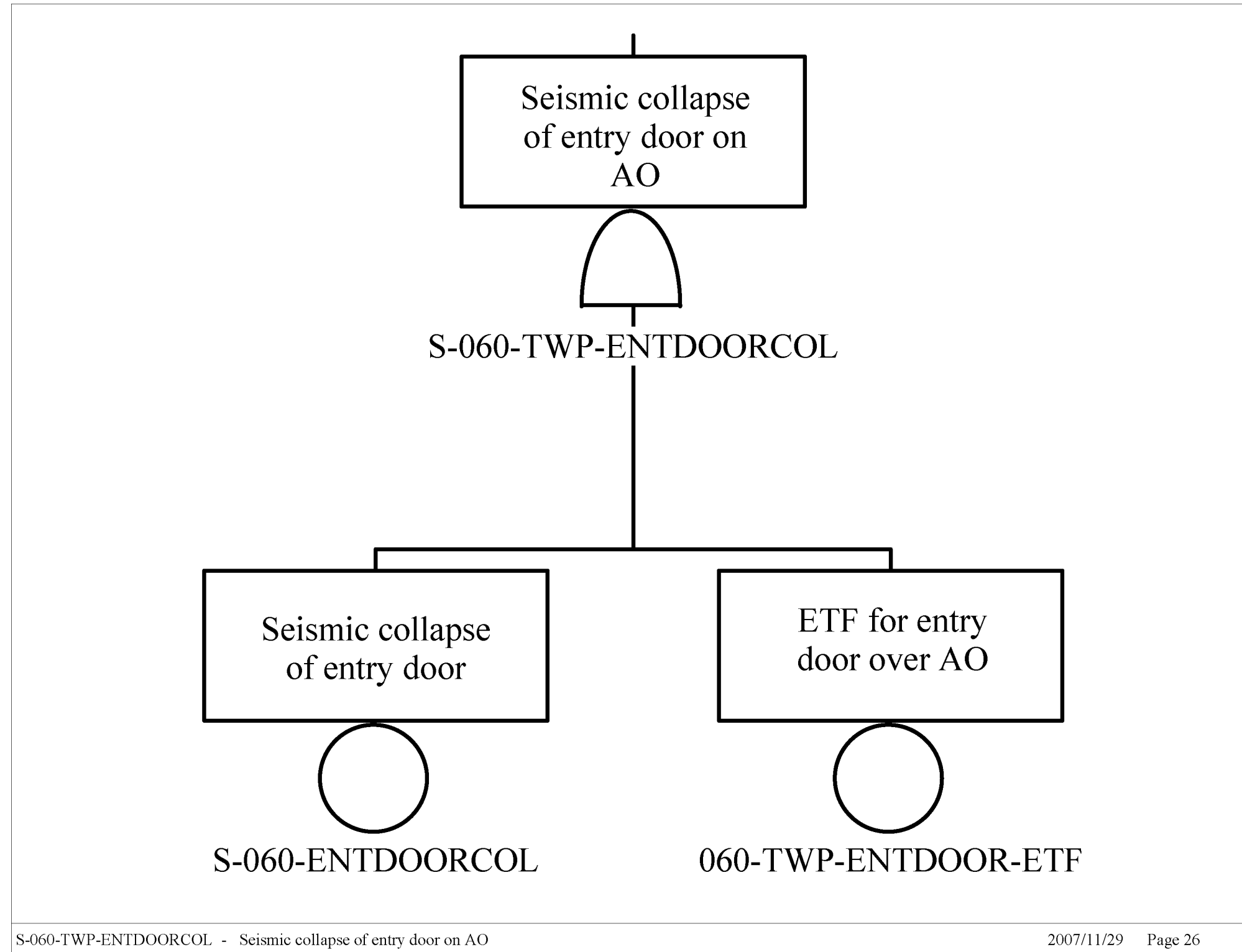

Source: Original

Figure C1.2-21. S-060-TWP-ENTDOORCOL – Seismic Collapse of Entry Door on AO

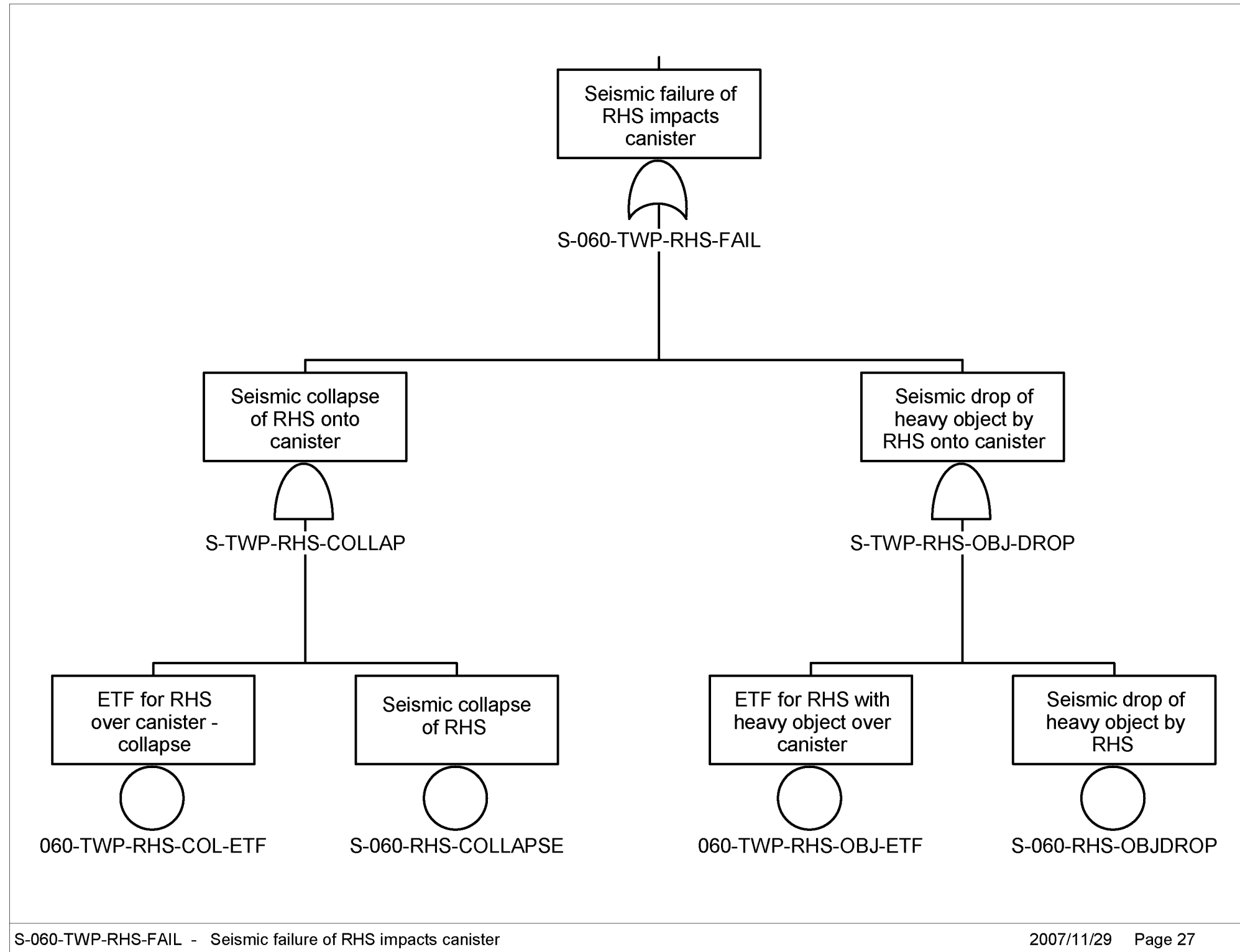

Source: Original

Figure C1.2-22. S-060-TWP-RHS-FAIL – Seismic Failure of RHS Impacts Canister

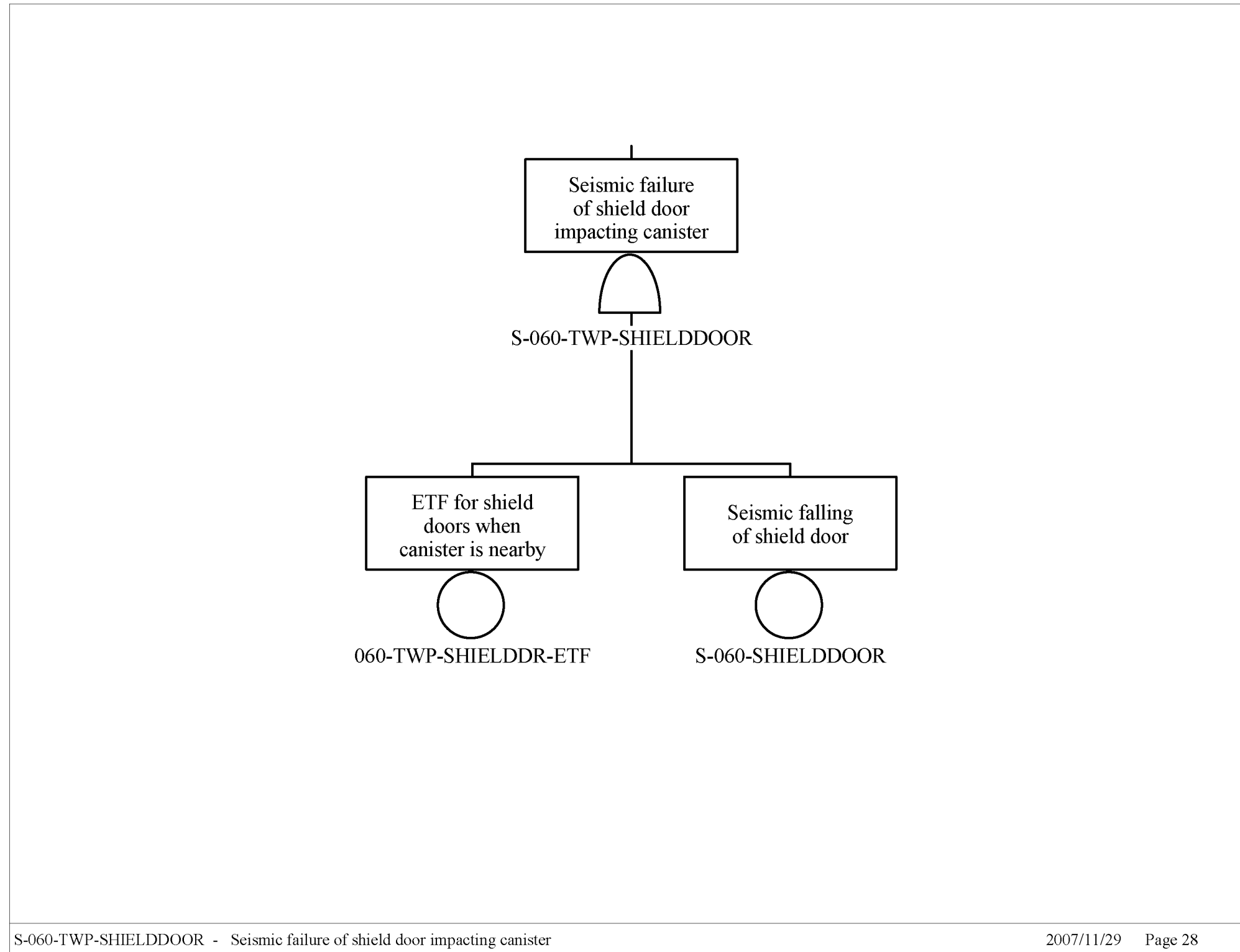

Source: Original

Figure C1.2-23. S-060-TWP-SHIELDDOOR – Seismic Failure of Shield Door Impacting Canister

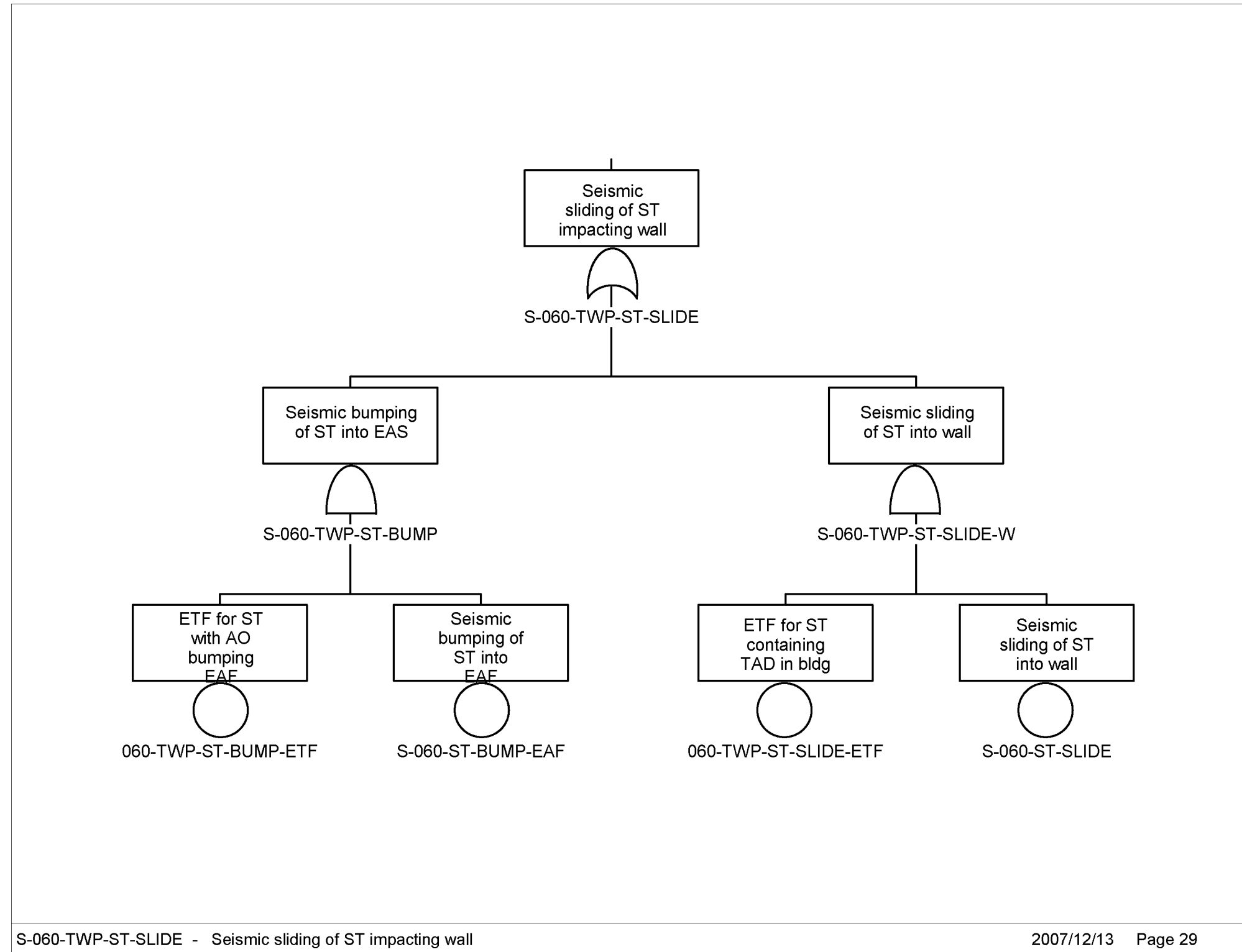

Source: Original

Figure C1.2-24 S-060-TWP-ST-SLIDE – Seismic Sliding of ST Impacting Wall

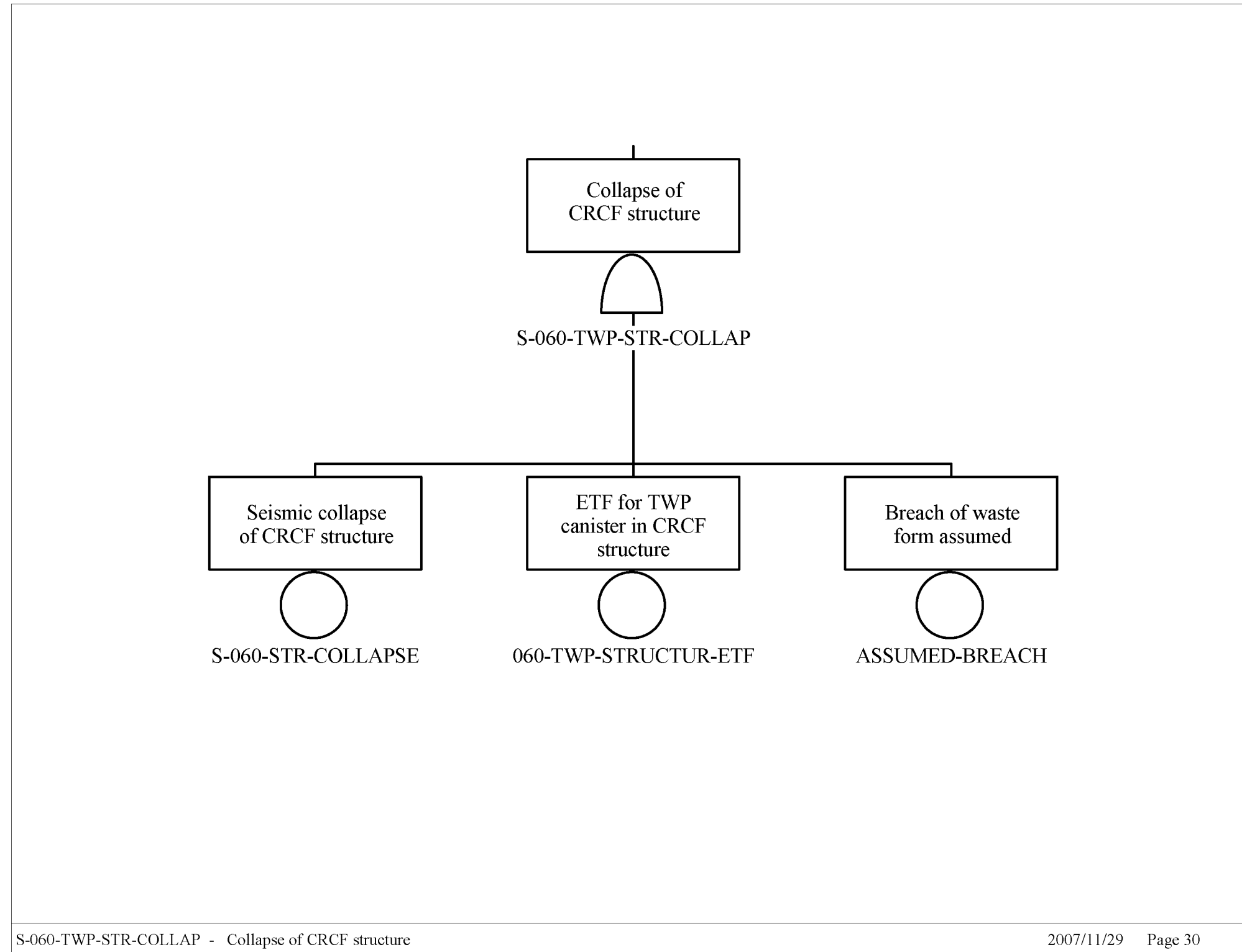

Source: Original

Figure C1.2-25. S-060-TWP-STR-COLLAP– Collapse of CRCF Structure

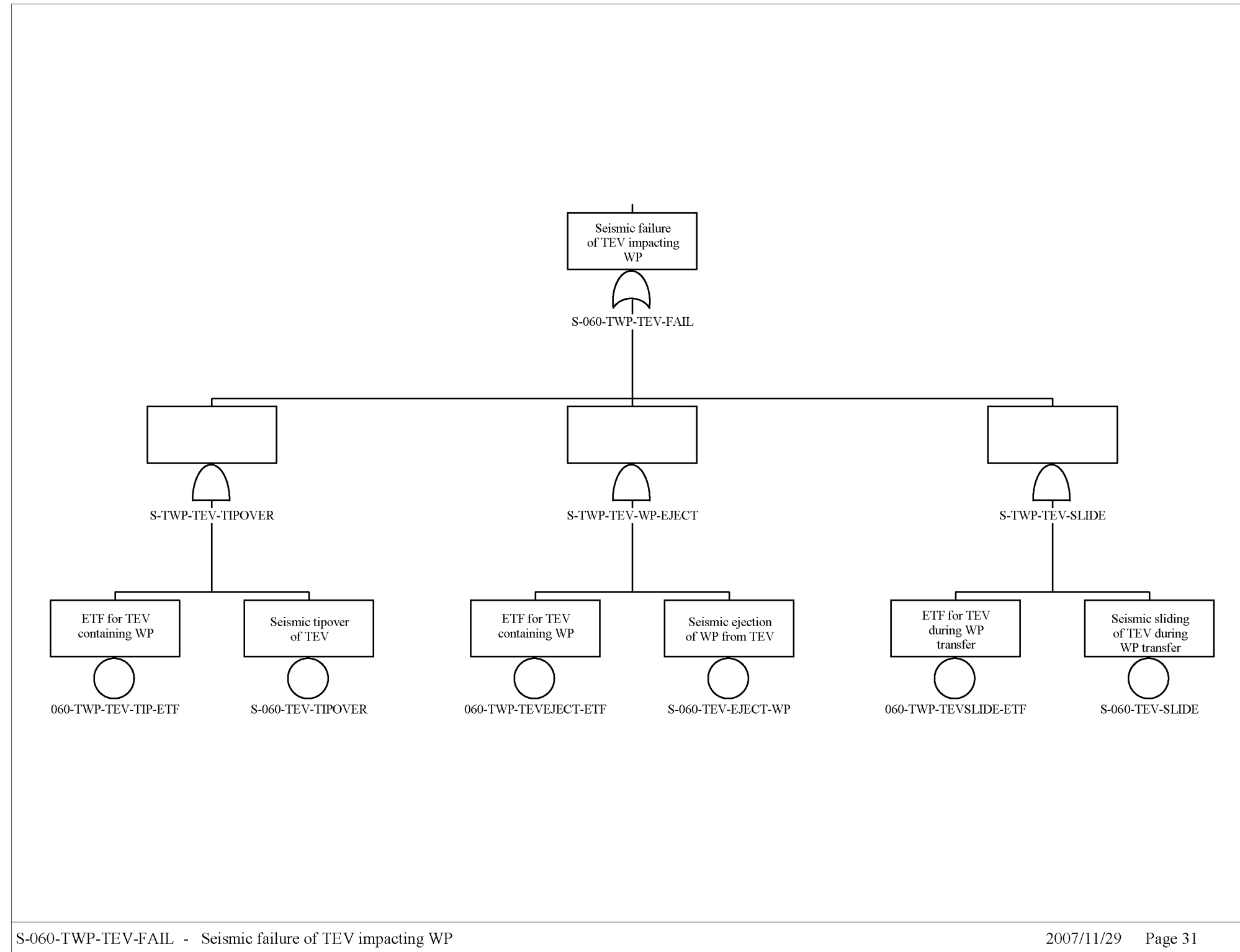

Source: Original

Figure C1.2-26. S-060-TWP-TEV-FAIL – Seismic Failure of TEV Impacting WP

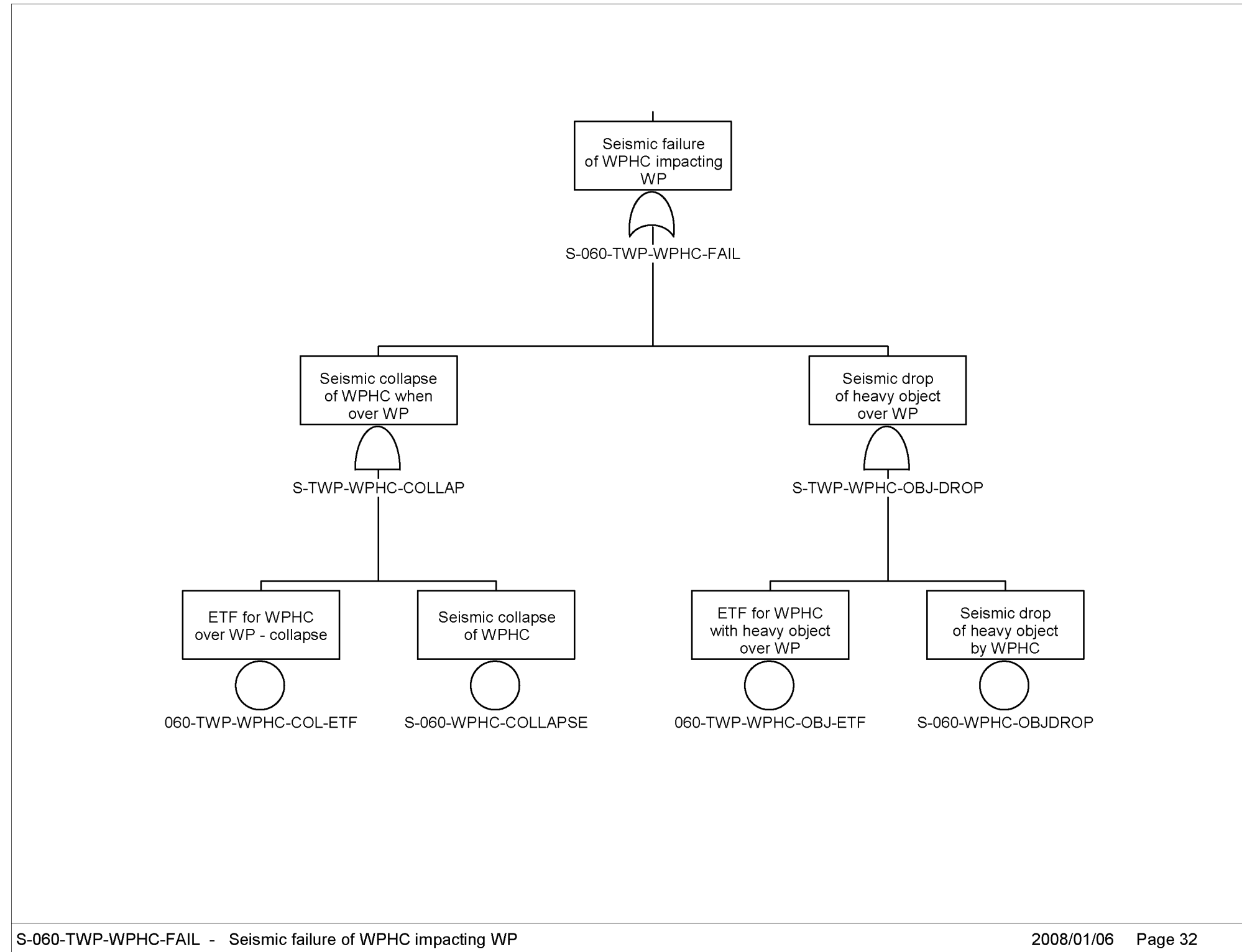

Source: Original

Figure C1.2-27. S-060-TWP-WPHC-FAIL – Seismic Failure of WPHC Impacting WP

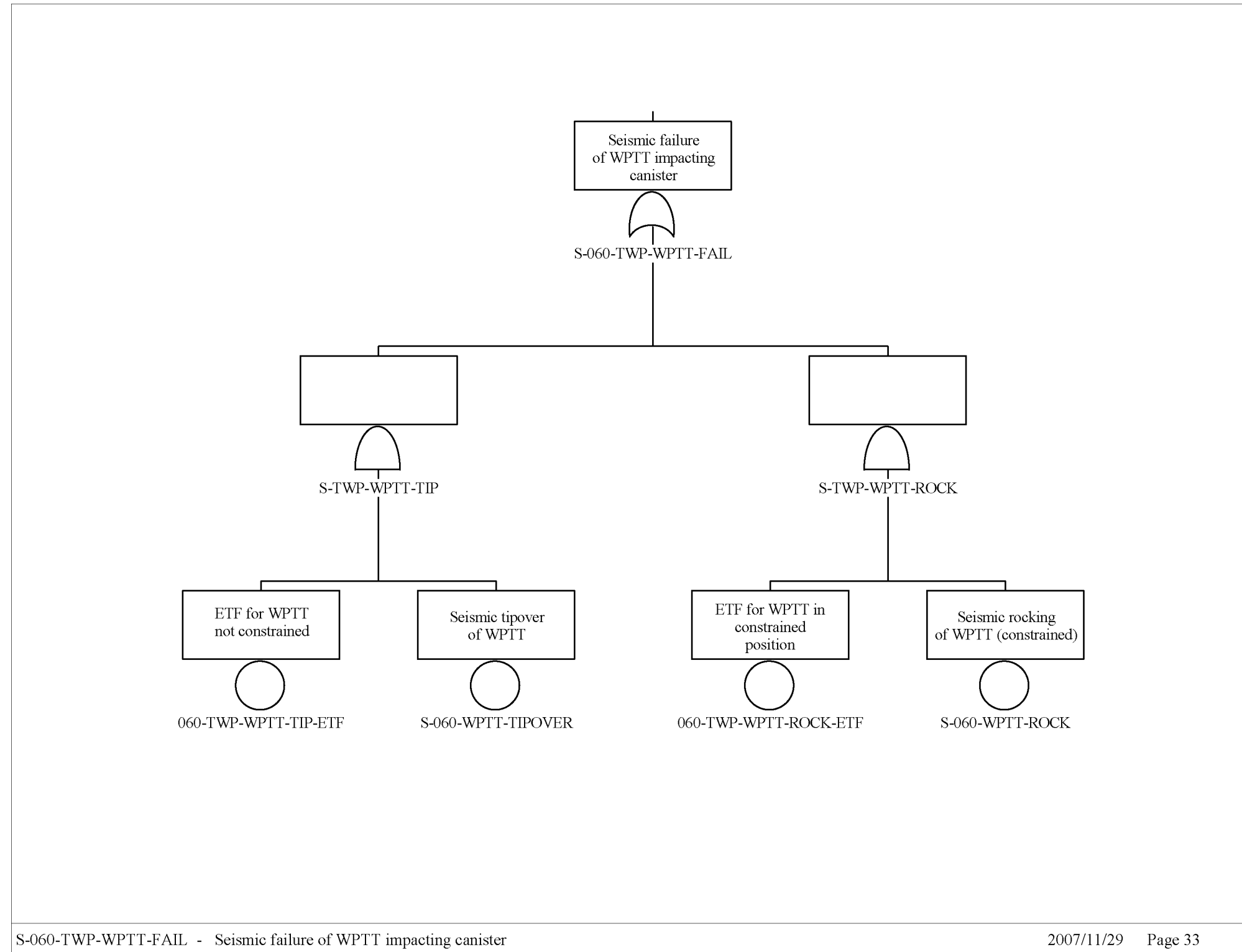

Source: Original

Figure C1.2-28. S-060-TWP-WPTT-FAIL – Seismic Failure of WPTT Impacting Canister

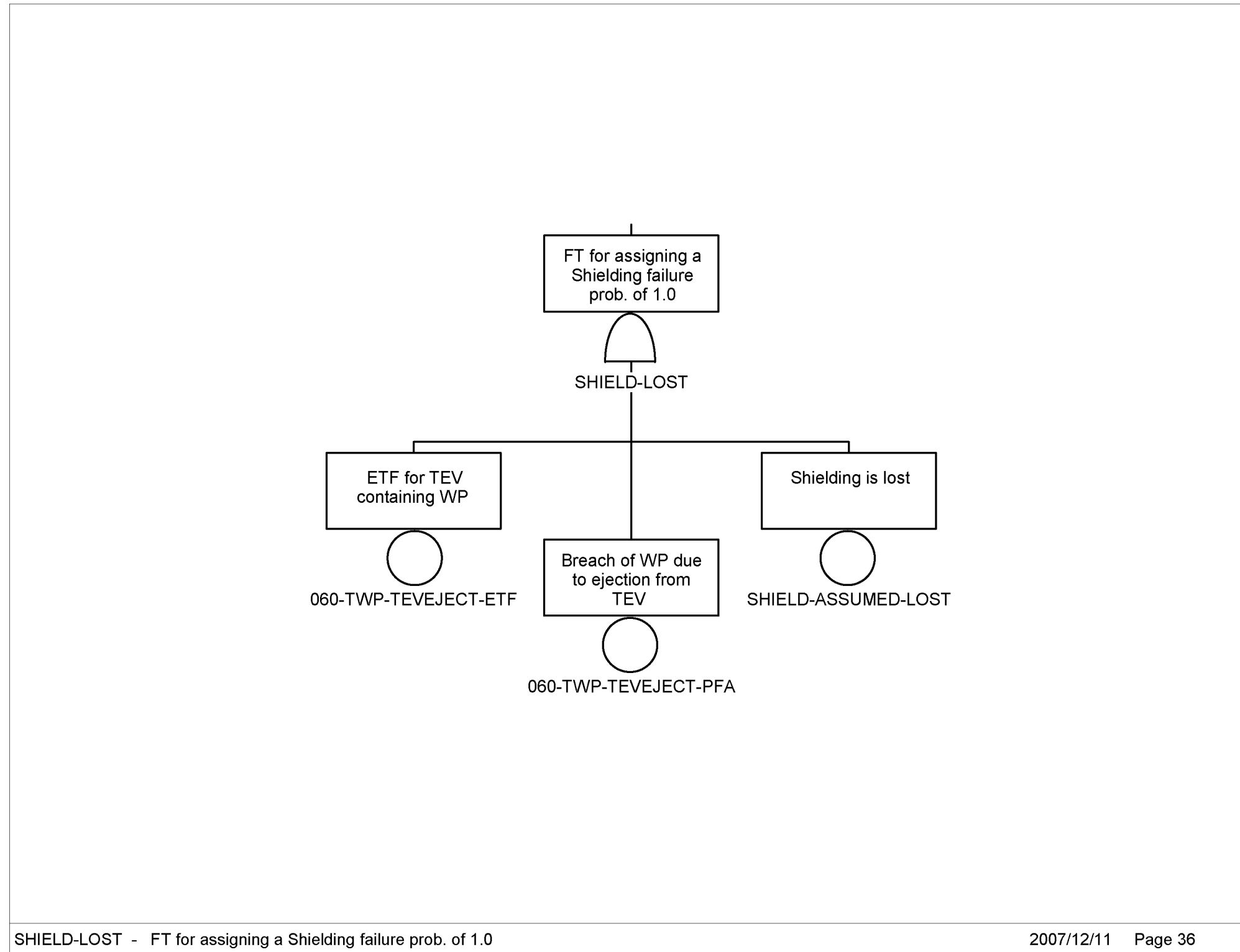

SHIELD-LOST - FT for assigning a Shielding failure prob. of 1.0

2007/12/11 Page 36

Source: Original

Figure C1.2-29. SHIELD-LOST – FT for Assigning a Shielding Failure Prob. of 1.0

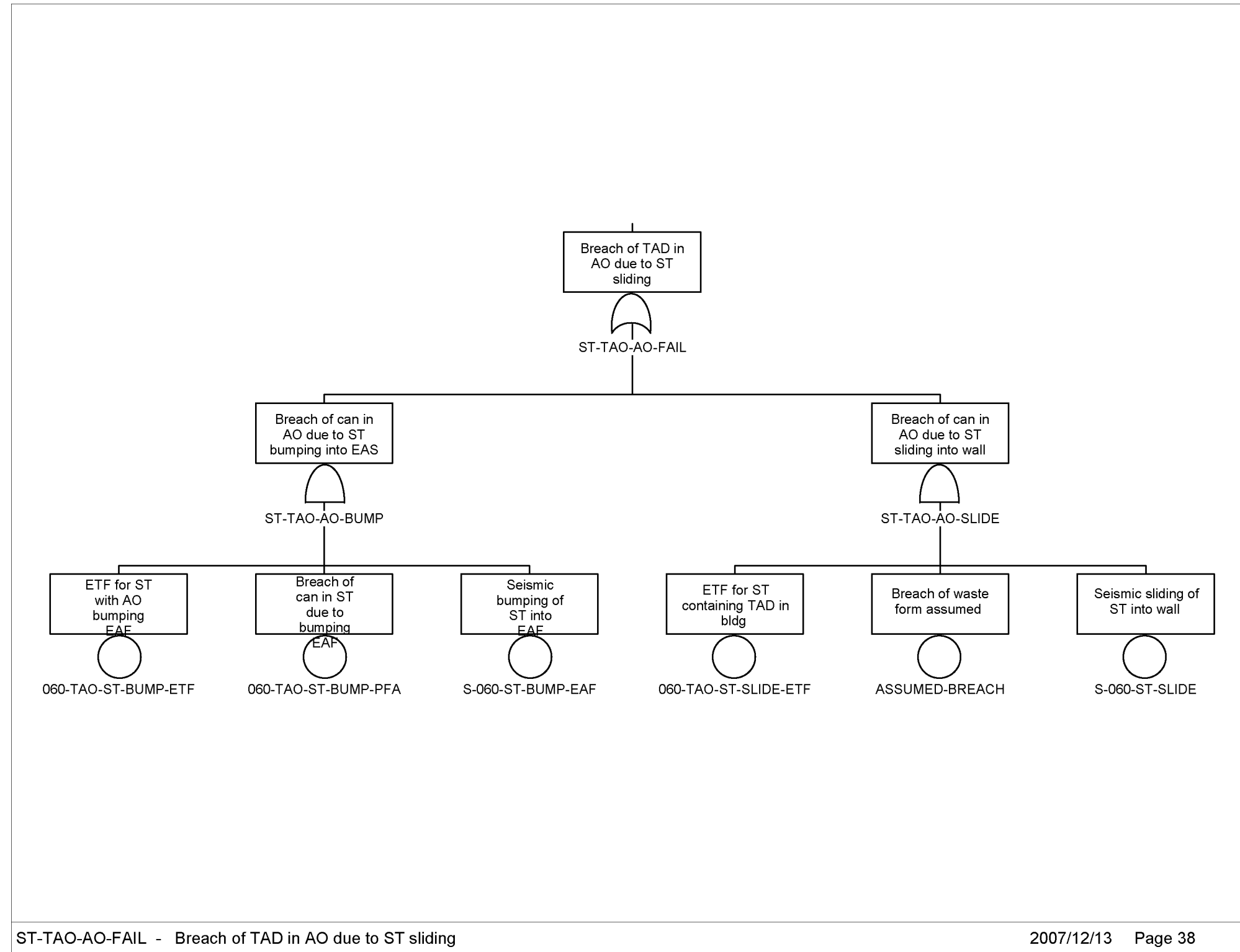

Source: Original

Figure C1.2-30. ST-TAO-AO-FAIL – Breach of TAD in AO due to ST Sliding

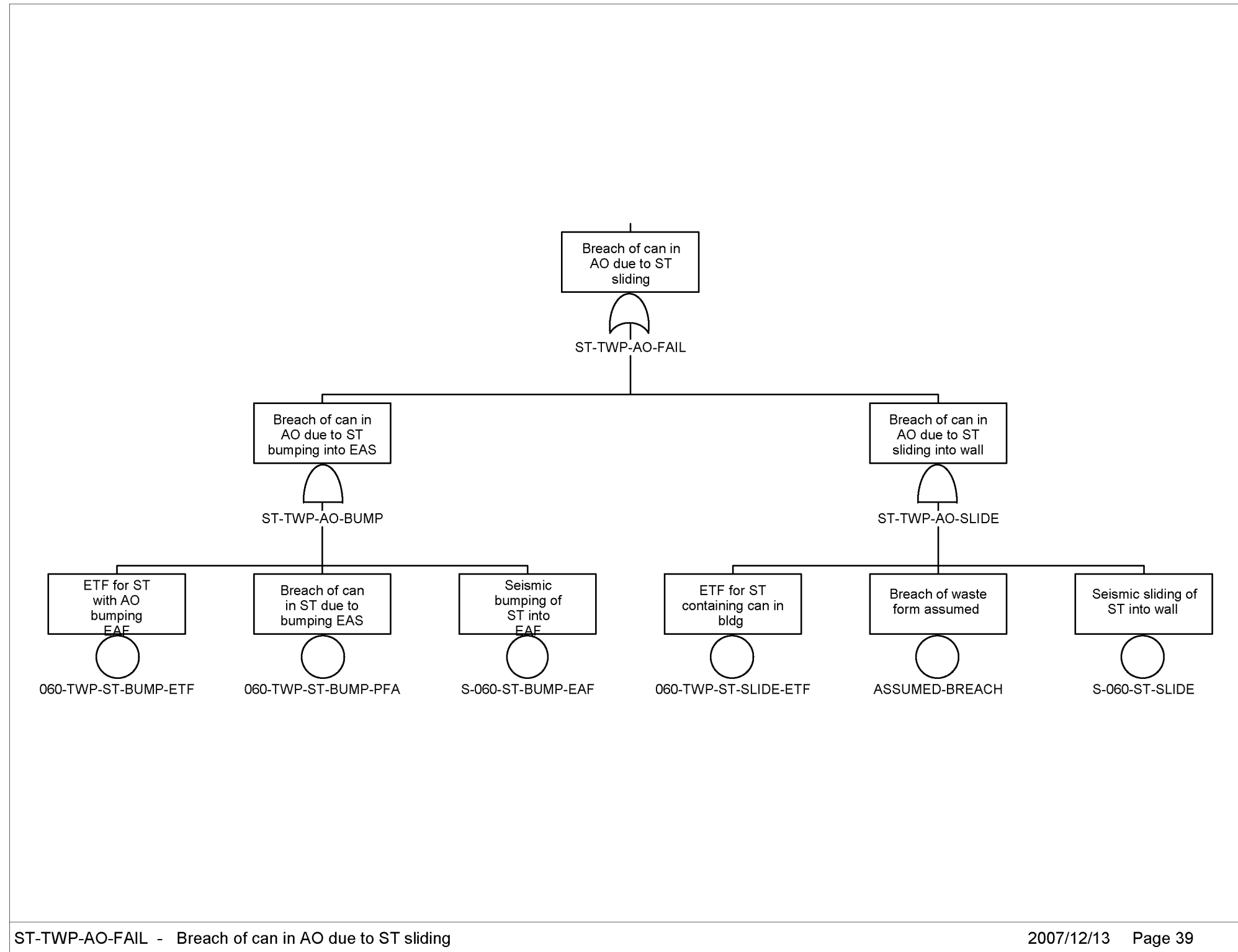

Source: Original

Figure C1.2-31. ST-TWP-AO-FAIL – Breach of Can in AO due to ST Sliding

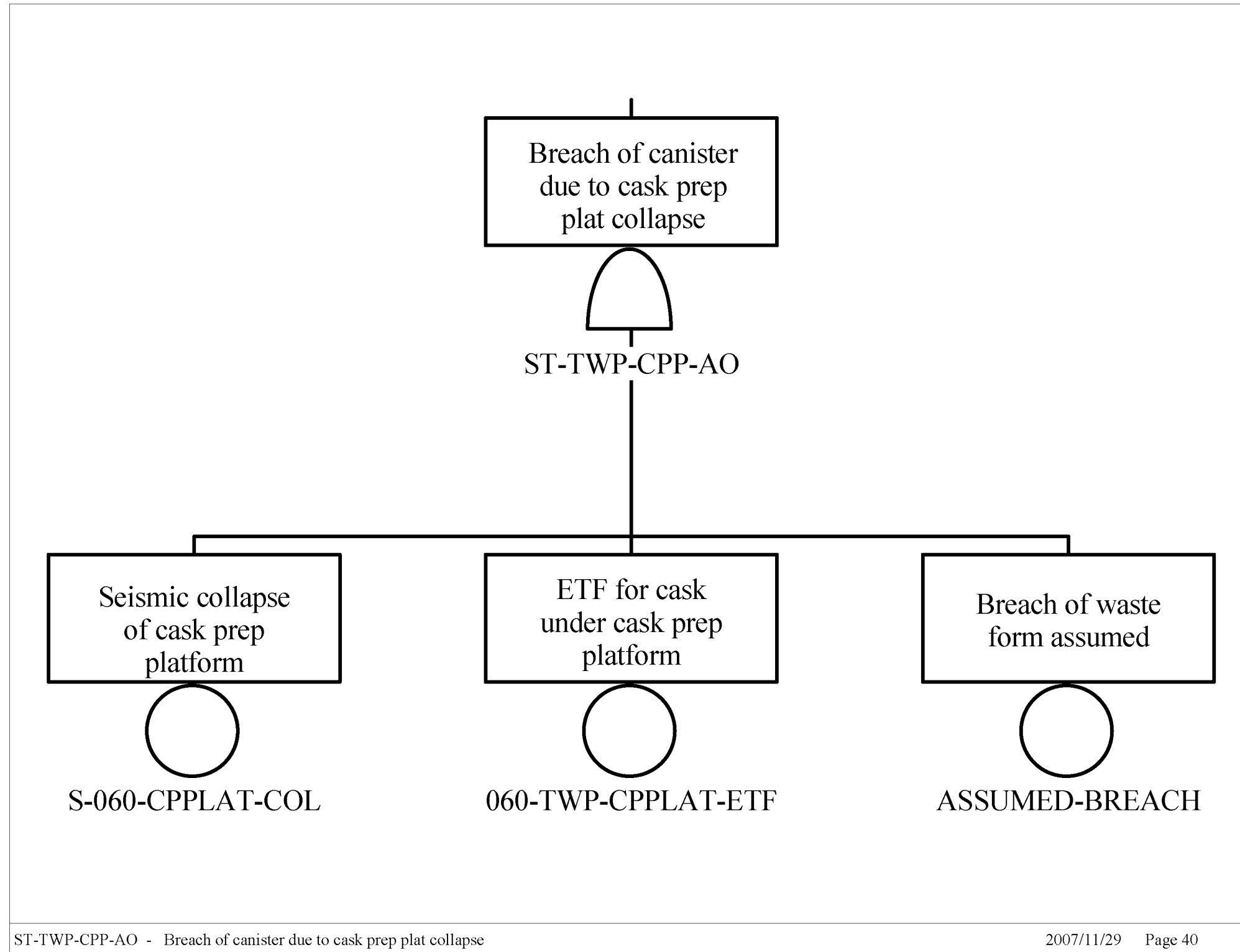

Source: Original

Figure C1.2-32. ST-TWP-CPP-AO – Breach of Canister due to Cask Prep Plat Collapse

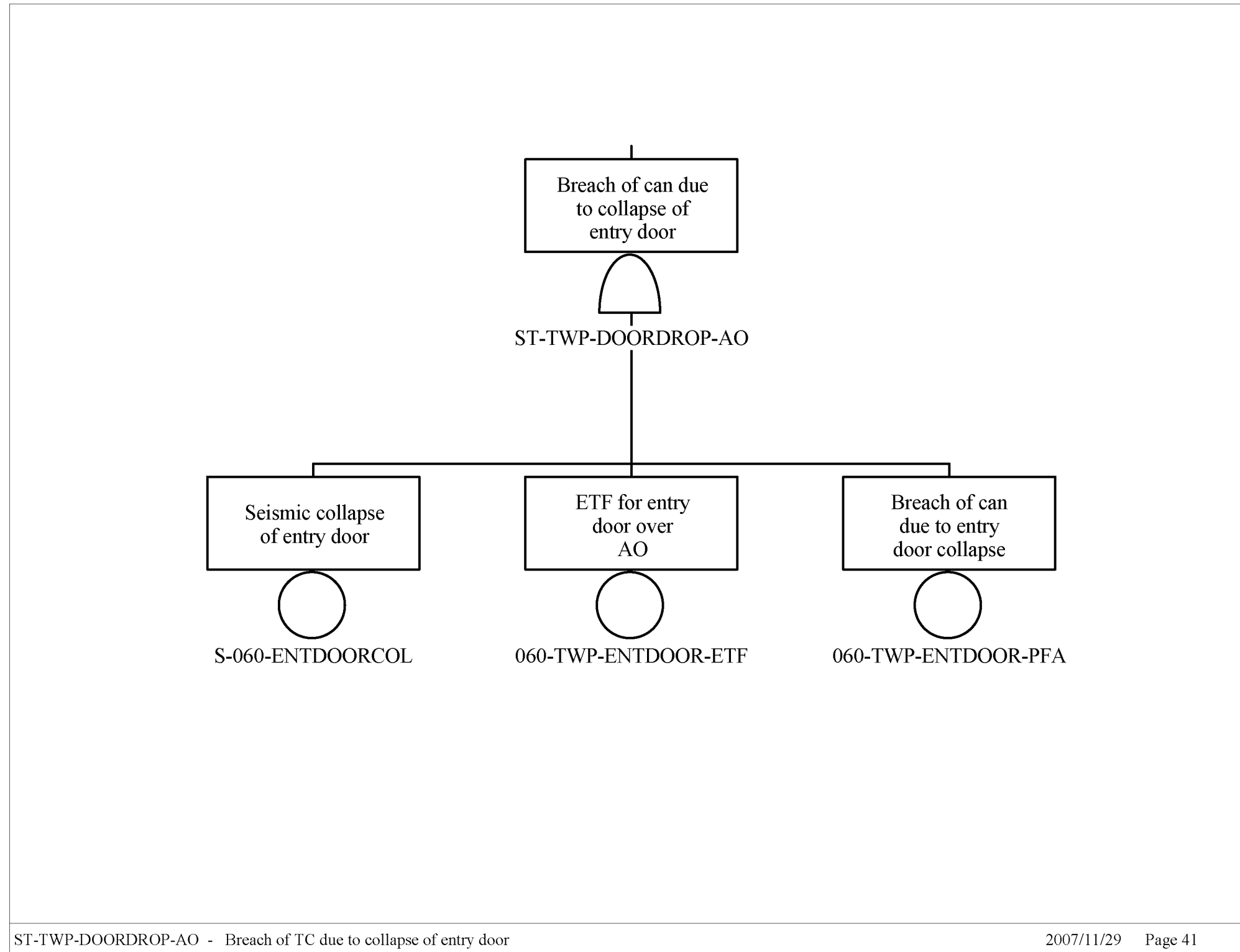

Source: Original

Figure C1.2-33. ST-TWP-DOORDROP-AO – Breach of TC due to Collapse of Entry Door

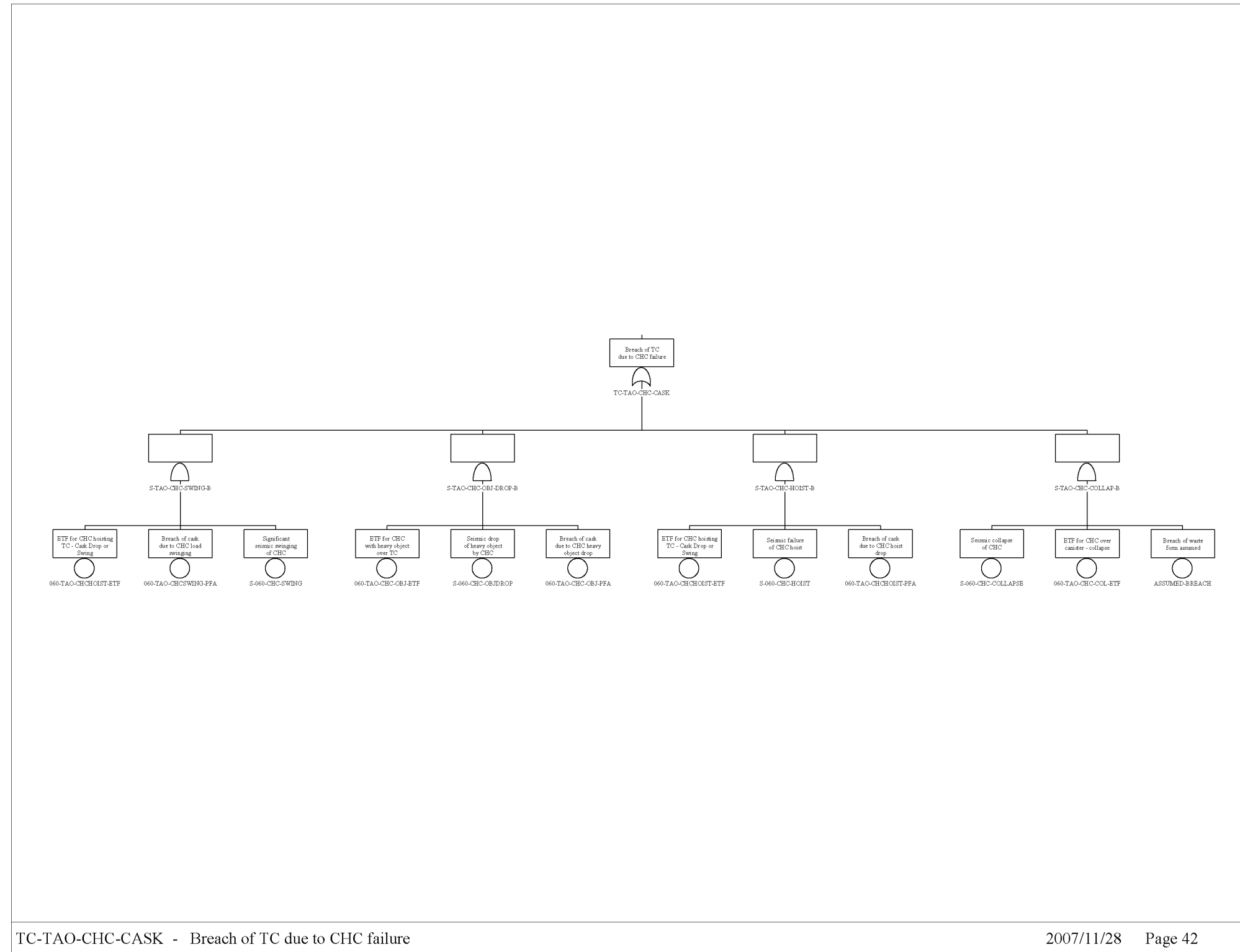

Source: Original

Figure C1.2-34. TC-TAO-CHC-CASK – Breach of TC due to CHC Failure

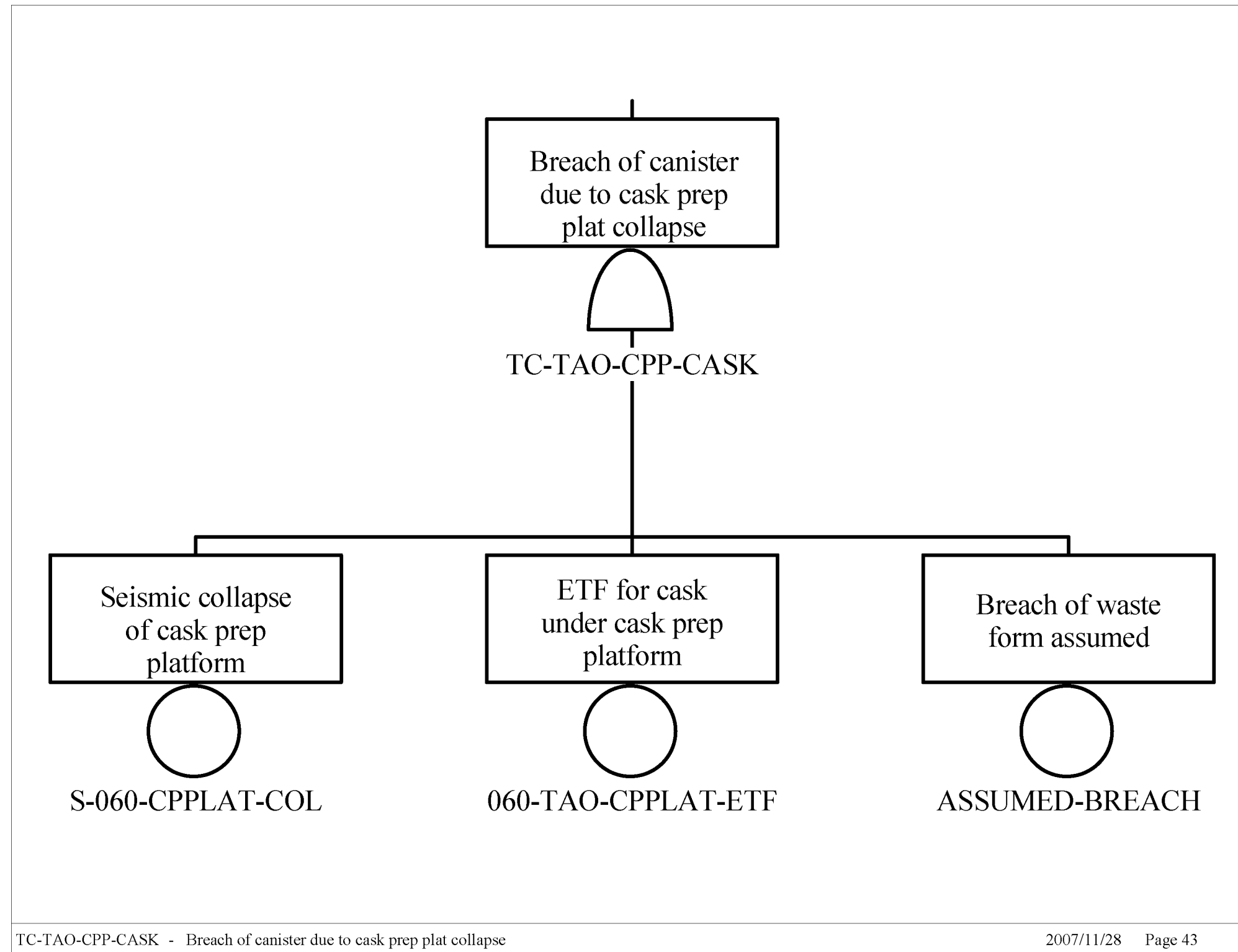

Source: Original

Figure C1.2-35. TC-TAO-CPP-CASK – Breach of Canister due to Cask Prep Plat Collapse

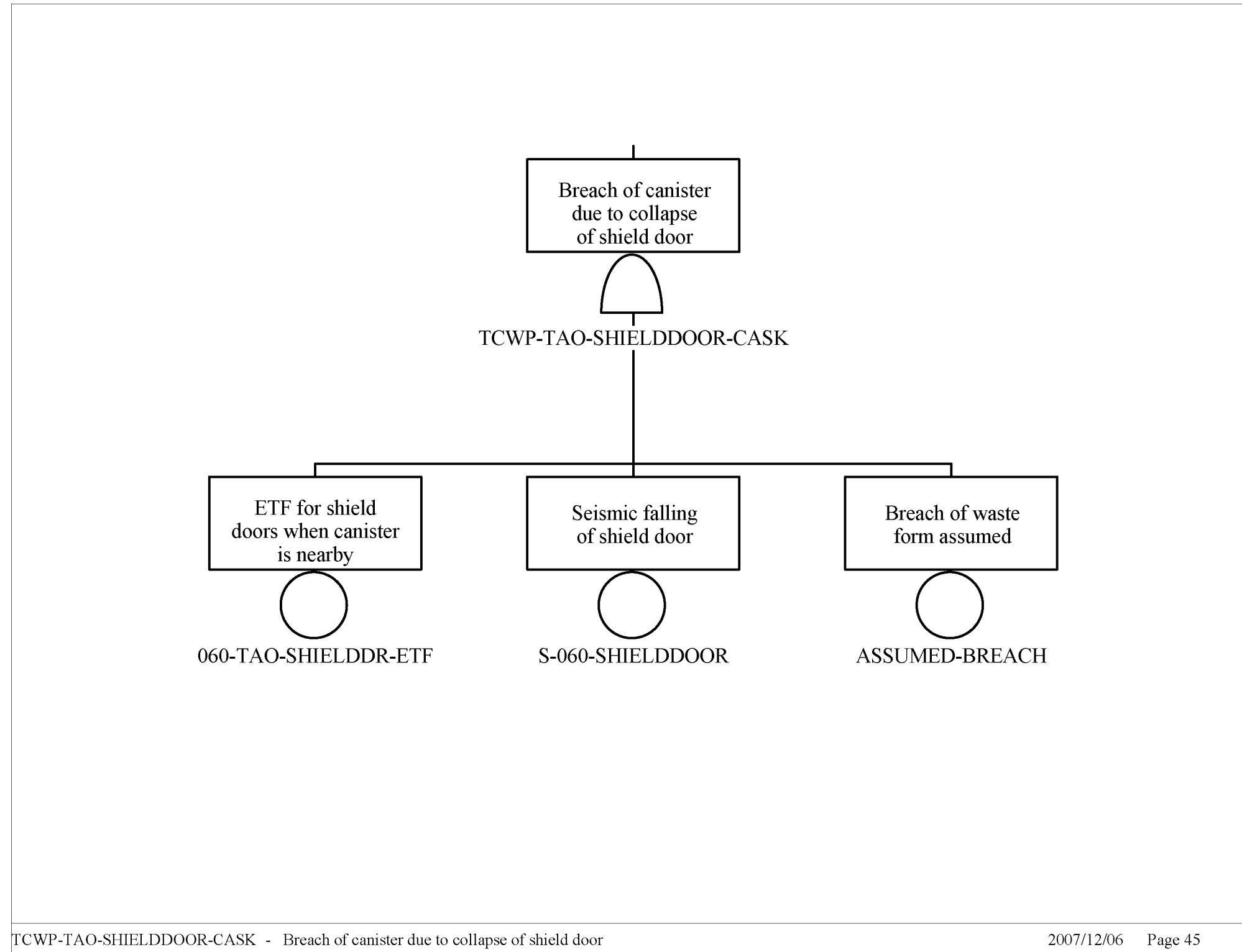

Source: Original

Figure C1.2-36. TCWP-TAO-SHIELDDOOR-CASK – Breach of Canister due to Collapse of Shield Door

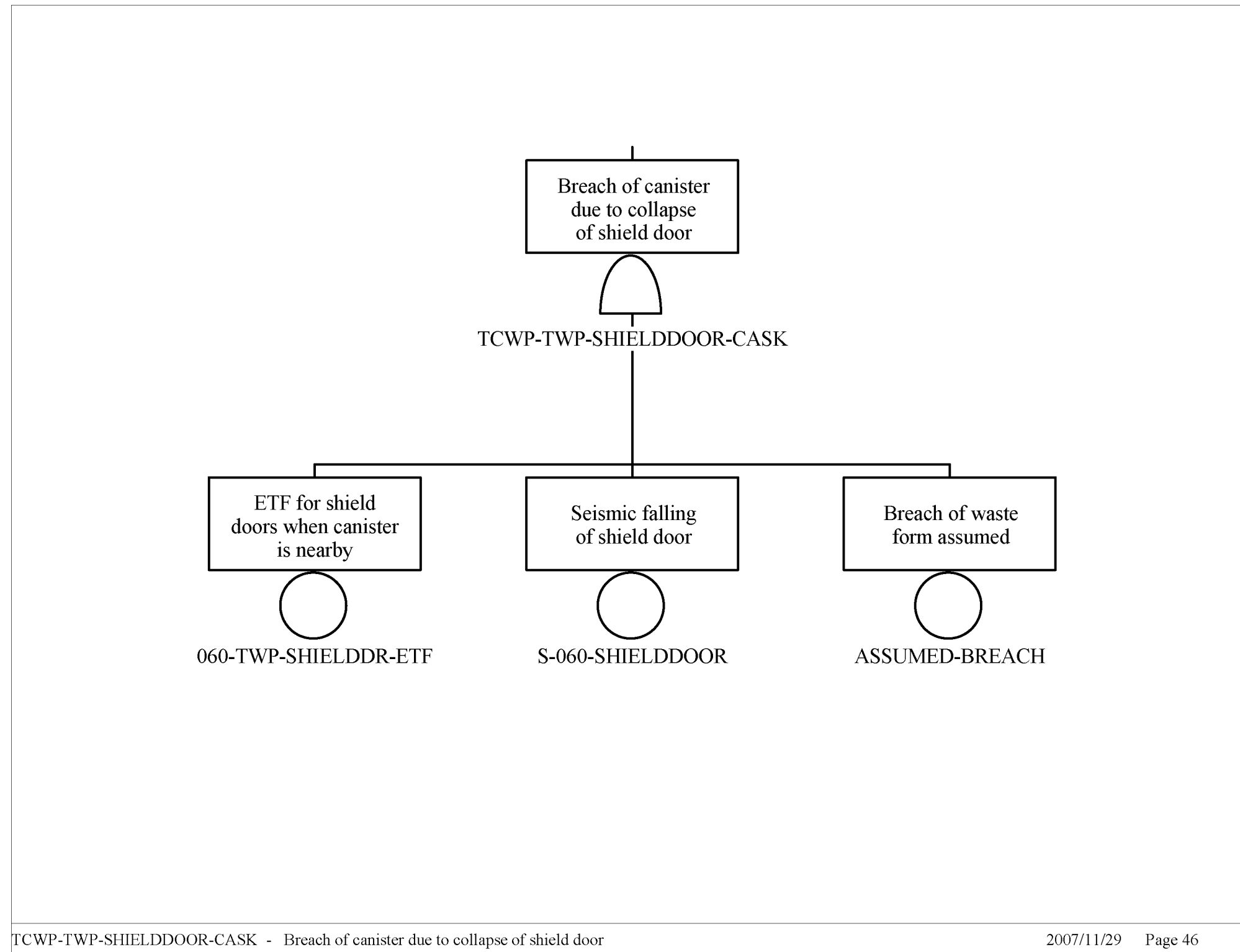

Source: Original

Figure C1.2-37. TCWP-TWP-SHIELDDOOR-CASK – Breach of Canister due to Collapse of Shield Door

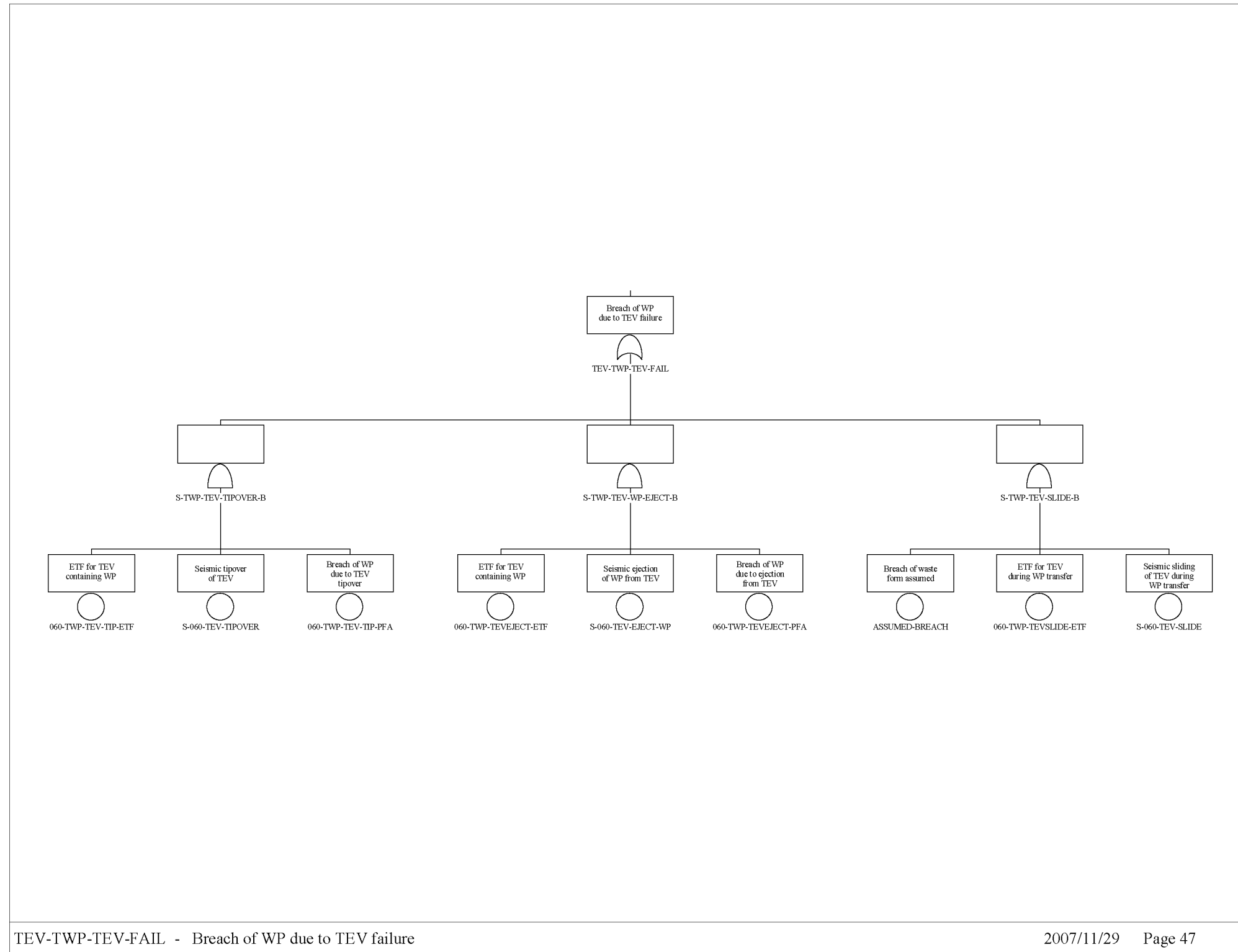

Source: Original

Figure C1.2-38. TEV-TWP-TEV-FAIL – Breach of WP due to TEV Failure

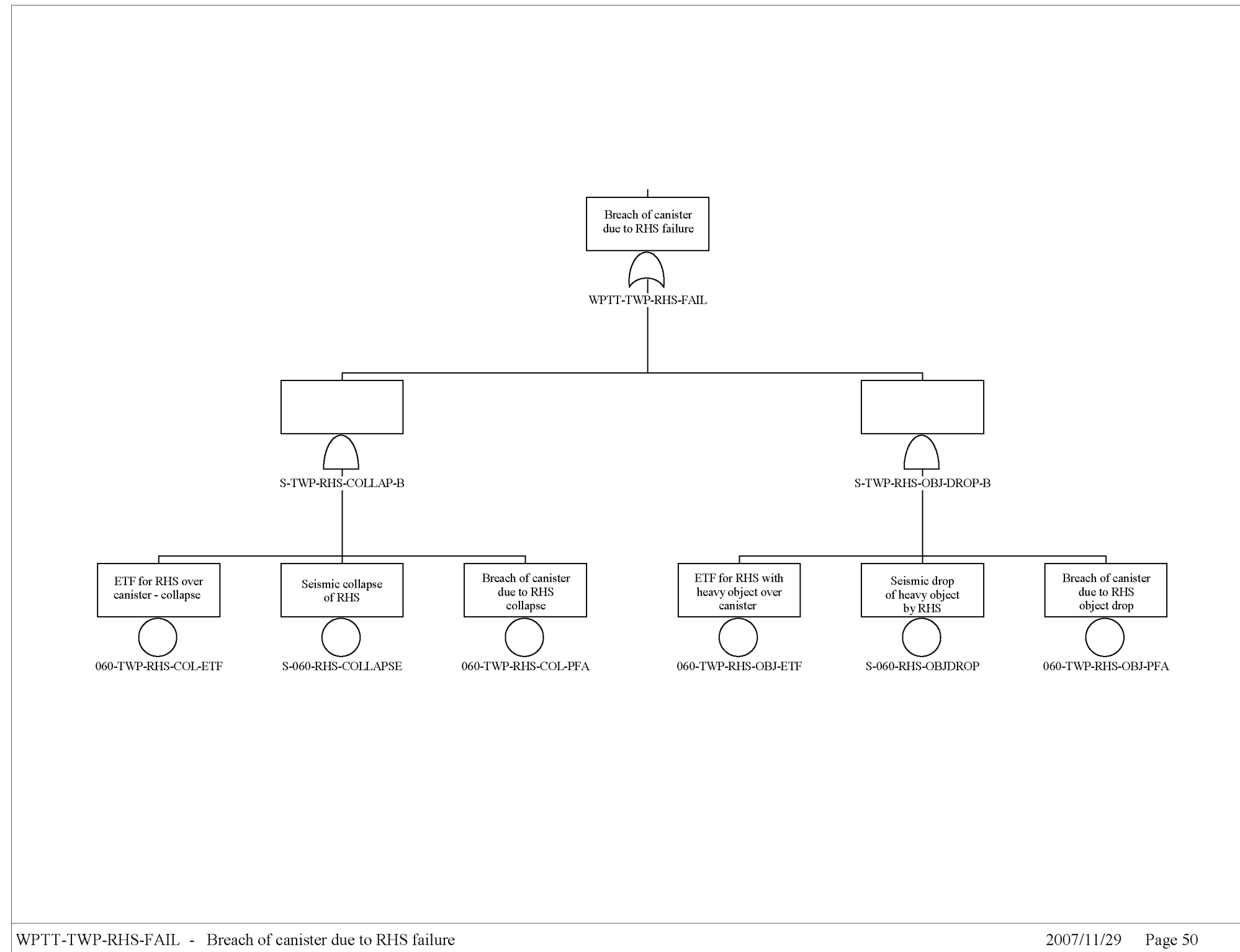

Source: Original

Figure C1.2-39. WPTT-TWP-RHS-FAIL – Breach of Canister due to RHS Failure

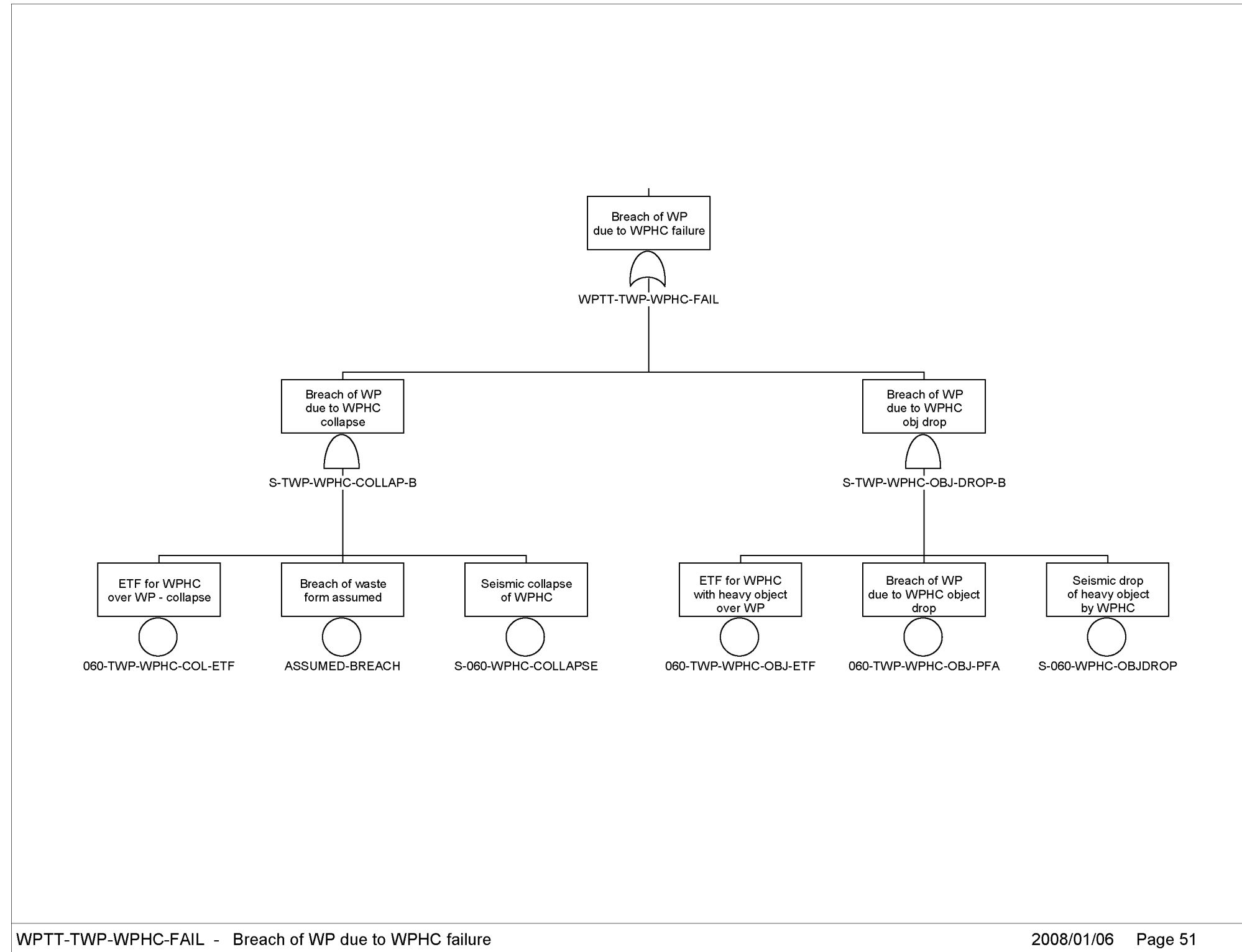

Source: Original

Figure C1.2-40 WPTT-TWP-WPHC-FAIL – Breach of WP due to WPHC Failure

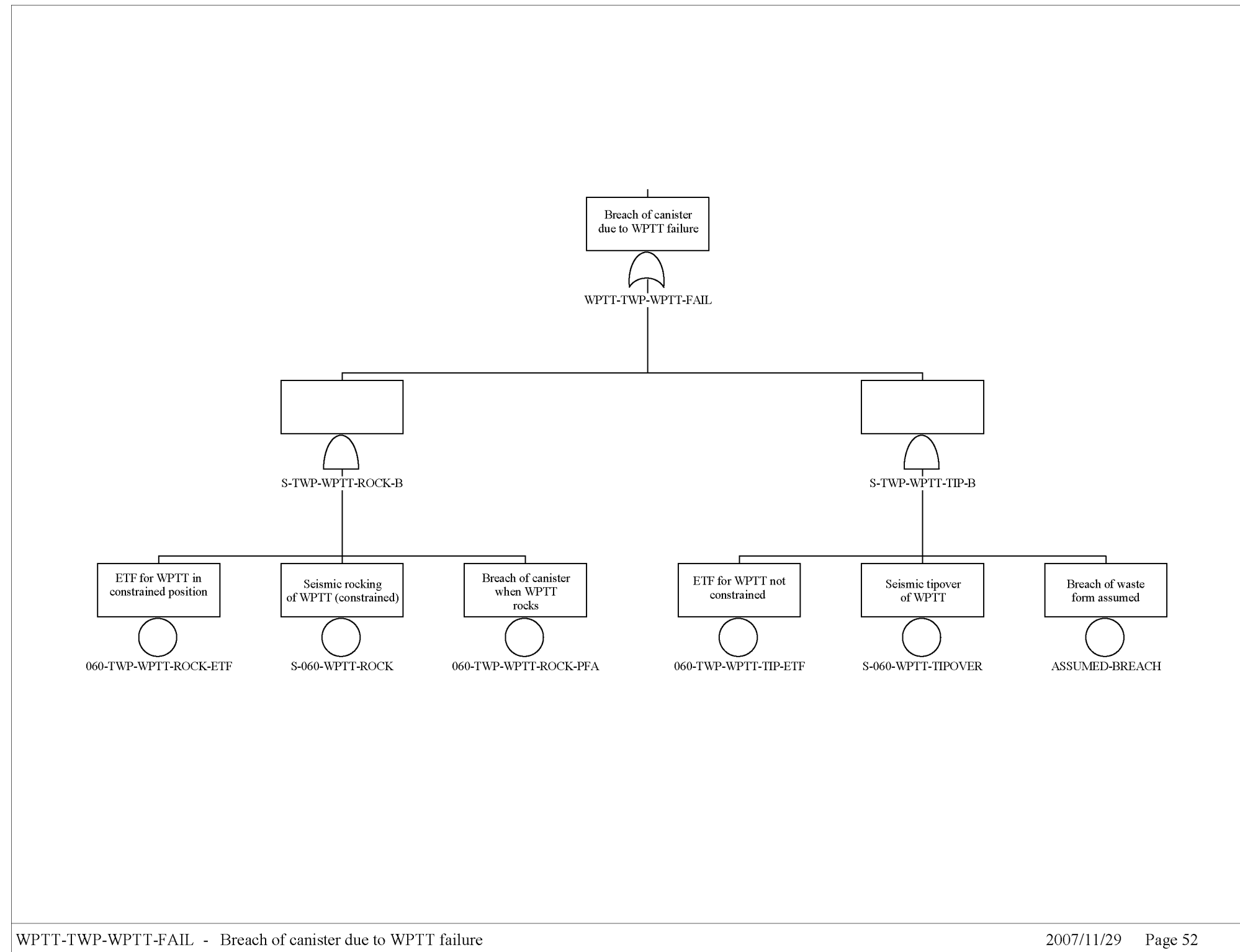

Source: Original

Figure C1.2-41. WPTT-TWP-WPTT-FAIL – Breach of Canister due to WPTT Failure

C1.3 BASIC EVENTS DATA

C1.3.1 Non-seismic Basic Event Data

The following table presents the basic event identifier used in the fault trees, the description of the basic event, and the failure probability (or other numeric data) of the basic event. For exposure time factors (denoted with “ETF” at the end of the basic event identifier), the value given is the time, in years, that one waste form container is exposed to the seismic failure mode.

Table C1.3-1. Non-seismic Basic Event Data

Name	Description	Calc. Probability
060-TAO-CHC-COL-ETF	ETF for CHC over canister - collapse	9.570E-004
060-TAO-CHC-OBJ-ETF	ETF for CHC with heavy object over TC	1.430E-004
060-TAO-CHC-OBJ-PFA	Breach of cask due to CHC heavy object drop	1.000E-005
060-TAO-CHCHOIST-ETF	ETF for CHC hoisting TC - cask drop or swing	1.050E-004
060-TAO-CHCHOIST-PFA	Breach of cask due to CHC hoist drop	1.000E-005
060-TAO-CHCSWING-PFA	Breach of cask due to CHC load swinging	1.000E-005
060-TAO-CPPLAT-ETF	ETF for cask under cask prep platform	9.510E-004
060-TAO-CTM-COL-ETF	ETF for CTM over canister - collapse	3.040E-004
060-TAO-CTM-OBJ-ETF	ETF for CTM with heavy object over TC	6.850E-005
060-TAO-CTM-OBJ-PFA	Breach of canister due to CTM object drop	1.000E-005
060-TAO-CTMHOIST-ETF	ETF for CTM hoisting canister - drop	5.520E-005
060-TAO-CTMHOIST-PFA	Breach of canister dropped by CTM	1.000E-005
060-TAO-CTMSWGIB-ETF	ETF for CTM hoisting canister inside bell	5.520E-005
060-TAO-CTMSWGIB-PFA	Breach of canister due to swing inside bell	1.000E-005
060-TAO-CTMSWGOB-ETF	ETF for CTM hoisting canister outside bell	3.810E-005
060-TAO-CTT-BUMP-ETF	ETF for CTT with TC subject to bumping EAF	5.920E-004
060-TAO-CTT-BUMP-PFA	Breach given CTT with TC subject to bumping EAF	1.000E-005
060-TAO-CTT-ROCK-ETF	ETF for CTT with TC subject to rocking/tipover	4.760E-005
060-TAO-CTTSLIDE-ETF	ETF for CTT containing TC in transfer cell	1.900E-004
060-TAO-ENTDOOR-ETF	ETF for entry door over transport cask	6.470E-005
060-TAO-ENTDOOR-PFA	Breach of TC due to entry door collapse	1.000E-005
060-TAO-MOBPLAT-ETF	ETF for mobile platform over TC	4.530E-004
060-TAO-MOBPLAT-PFA	Breach of TC due to mobile platform collapse	1.000E-005
060-TAO-RAILCAR-ETF	ETF for railcar carrying transport cask	8.010E-004
060-TAO-RAILCAR-PFA	Breach of TC due to railcar accident	1.000E-005
060-TAO-SHIELD-ETF	ETF for shield doors when canister is nearby	1.040E-003
060-TAO-ST-BUMP-ETF	ETF for ST with AO bumping EAF	3.440E-004
060-TAO-ST-BUMP-PFA	Breach of can in ST due to bumping EAF	1.000E-005

Table C1.3-1. Non-seismic Basic Event Data (Continued)

Name	Description	Calc. Probability
060-TAO-ST-SLIDE-ETF	ETF for ST containing TAD in bldg	2.640E-004
060-TAO-STRUCTUR-ETF	ETF for TAO canister in CRCF structure	2.430E-003
060-TWP-CPPLAT-ETF	ETF for cask under cask prep platform	3.220E-004
060-TWP-CTM-COL-ETF	ETF for CTM over canister - collapse	2.260E-004
060-TWP-CTM-OBJ-ETF	ETF for CTM with heavy object over TC	5.520E-005
060-TWP-CTM-OBJ-PFA	Breach of canister due to CTM object drop	1.000E-005
060-TWP-CTMHOIST-ETF	ETF for CTM hoisting canister - drop	5.520E-005
060-TWP-CTMHOIST-PFA	Breach of canister dropped by CTM	1.000E-005
060-TWP-CTMSWGIB-ETF	ETF for CTM hoisting canister inside bell	5.520E-005
060-TWP-CTMSWGIB-PFA	Breach of canister due to swing inside bell	1.000E-005
060-TWP-CTMSWGOB-ETF	ETF for CTM hoisting canister outside bell	3.810E-005
060-TWP-ENTDOOR-ETF	ETF for entry door over AO	4.760E-005
060-TWP-ENTDOOR-PFA	Breach of can due to entry door collapse	1.000E-005
060-TWP-RHS-COL-ETF	ETF for RHS over canister - collapse	3.230E-004
060-TWP-RHS-COL-PFA	Breach of canister due to RHS collapse	1.000E-005
060-TWP-RHS-OBJ-ETF	ETF for RHS with heavy object over canister	8.560E-005
060-TWP-RHS-OBJ-PFA	Breach of canister due to RHS object drop	1.000E-005
060-TWP-SHIELD-ETF	ETF for shield doors when canister is nearby	6.200E-004
060-TWP-ST-BUMP-ETF	ETF for ST with AO bumping EAF	3.310E-004
060-TWP-ST-BUMP-PFA	Breach of can in ST due to bumping EAS	1.000E-005
060-TWP-ST-SLIDE-ETF	ETF for ST containing can in bldg	2.360E-004
060-TWP-STRUCTUR-ETF	ETF for TWP canister in CRCF structure	5.880E-003
060-TWP-TEV-TIP-ETF	ETF for TEV containing WP	9.700E-005
060-TWP-TEV-TIP-PFA	Breach of WP due to TEV tipover	1.000E-005
060-TWP-TEVEJECT-ETF	ETF for TEV containing WP	8.750E-005
060-TWP-TEVEJECT-PFA	Breach of WP due to ejection from TEV	5.000E-003
060-TWP-TEVSLIDE-ETF	ETF for TEV during WP transfer	9.510E-006
060-TWP-WPHC-COL-ETF	ETF for WPHC over WP - collapse	7.610E-005
060-TWP-WPHC-OBJ-ETF	ETF for WPHC with heavy object over WP	7.610E-005
060-TWP-WPHC-OBJ-PFA	Breach of WP due to WPHC object drop	1.000E-005
060-TWP-WPTT-ROCK-ETF	ETF for WPTT in constrained position	5.140E-003
060-TWP-WPTT-ROCK-PFA	Breach of canister when WPTT rocks	1.000E-005
060-TWP-WPTT-TIP-ETF	ETF for WPTT not constrained	2.990E-004
ASSUMED-BREACH	Breach of waste form assumed	1.000E+000
CRCF-DP-CAN	Number of DP canisters transferred to AO	3.460E+002
CRCF-TAD-AO	Number of TAD canisters transferred to AO	6.978E+003
CRCF-TAO-CAN	Number of TADs from AO to WP	8.143E+003
MOD-ENTER-CANISTER	Flooding or spray enters canister	1.000E-002
SHIELD-AO	Shielding remains intact	1.000E-005

Table C1.3-1. Non-seismic Basic Event Data (Continued)

Name	Description	Calc. Probability
SHIELDING	Shielding remains intact	1.000E-005
060-TAO-CHC-COL-ETF	ETF for CHC over canister - collapse	9.570E-004

NOTE: The basic event "ASSUMED-BREACH" is not an assumption, but is common terminology used to denote a scenario where the waste container is conservatively considered to be breached; AO = aging overpack; CHC = cask handling crane; CRCF = Canister Receipt and Closure Facility; CTM = canister transfer machine; CTT = cask transfer trolley; DP = dual-purpose; EAF = energy absorbing feature; ETF = exposure time factor; FPW = fire protection water; RHS = remote handling system; ST = site transporter; TAD = transportation, aging, and disposal; TC = transportation cask; TEV = transport and emplacement vehicle; TWP = TAD-to-waste-package; WP = waste package; WPHC = waste package handling crane; WPTT = waste package transfer trolley.

Source: Sections 6.2.2.23 and 6.3.3, Table 6.3-1, Table 6.3-2, Table 6.6-1

C1.3.2 Seismic Basic Event Fragility Data

The following table provides the seismic failure basic event identifier, description, median fragility, and composite uncertainty.

Table C1.3-2. Seismic Basic Event Fragility Data

Event Name	Description	Med. Fragility (g)	Beta C
S-060-CHC-COLLAPSE	Seismic collapse of CHC	2.790E+000	4.500E-001
S-060-CHC-HOIST	Seismic failure of CHC hoist	2.280E+000	5.000E-001
S-060-CHC-OBJDROP	Seismic drop of heavy object by CHC	2.280E+000	5.000E-001
S-060-CHC-SWING	Significant seismic swinging of CHC	1.140E+000	4.000E-001
S-060-CPPLAT-COL	Seismic collapse of cask prep platform	3.500E+000	4.000E-001
S-060-CTM-COLLAPSE	Seismic collapse of CTM (trolley seismic restraints)	2.390E+000	4.500E-001
S-060-CTM-HOIST	Seismic drop of canister hoisted by CTM	2.280E+000	5.000E-001
S-060-CTM-OBJDROP	Seismic drop of heavy object by CTM	2.280E+000	5.000E-001
S-060-CTMSWG-IB	Significant swinging of canister inside CTM bell	1.140E+000	4.000E-001
S-060-CTMSWG-OB	Significant swinging of canister outside CTM bell	9.100E-001	4.000E-001
S-060-CTT-BUMPING	Seismic bumping of CTT into EAF	2.250E+000	4.100E-001
S-060-CTT-ROCKING	Seismic rocking of CTT with restraint failure	2.250E+000	4.100E-001
S-060-CTT-SLIDE	Seismic sliding of CTT into wall	3.080E+000	5.800E-001
S-060-ENTDOORCOL	Seismic collapse of entry door	3.700E-001	4.000E-001
S-060-MOBPLAT-COLLAP	Seismic collapse of mobile platform	3.700E-001	4.000E-001
S-060-PIPING-FAIL	Seismic failure of piping in accident area	7.600E-001	4.000E-001
S-060-RAILCAR-ACC	Seismic tipover or collision of railcar	4.500E-001	4.000E-001
S-060-RHS-COLLAPSE	Seismic collapse of RHS	2.790E+000	4.500E-001
S-060-RHS-OBJDROP	Seismic drop of heavy object by RHS	1.140E+000	4.000E-001

Table C1.3-2. Seismic Basic Event Fragility Data (Continued)

Event Name	Description	Med. Fragility (g)	Beta C
S-060-SHIELDDOOR	Seismic falling of shield door	2.920E+000	4.400E-001
S-060-ST-BUMP-EAF	Seismic bumping of ST into EAF	1.890E+000	4.200E-001
S-060-ST-SLIDE	Seismic sliding of ST into wall	1.890E+000	4.200E-001
S-060-STR-COLLAPSE	Seismic collapse of CRCF structure	4.610E+000	4.000E-001
S-060-TEV-EJECT-WP	Seismic ejection of WP from TEV	7.600E-001	4.000E-001
S-060-TEV-SLIDE	Seismic sliding of TEV during WP transfer	1.120E+000	4.300E-001
S-060-TEV-TIPOVER	Seismic tipover of TEV	5.000E+000	4.000E-001
S-060-WPHC-COLLAPSE	Seismic collapse of WPHC	2.790E+000	4.500E-001
S-060-WPHC-OBJDROP	Seismic drop of heavy object by WPHC	1.140E+000	4.000E-001
S-060-WPTT-ROCK	Seismic rocking of WPTT (constrained)	1.850E+000	3.700E-001
S-060-WPTT-TIPOVER	Seismic tipover of WPTT	3.410E+000	4.000E-001

NOTE: AO = aging overpack; CHC = cask handling crane; CRCF = Canister Receipt and Closure Facility; CTM = canister transfer machine; CTT = cask transfer trolley; DP = dual-purpose; EAF = energy absorbing feature; RHS = remote handling system; ST = site transporter; TAD = transportation, aging, and disposal; TEV = transport and emplacement vehicle; WP = waste package; WPHC = waste package handling crane; WPTT = waste package transfer trolley.

Source: Table 6.2-1 and Table 6.2-2

C1.4 EVENT SEQUENCE QUANTIFICATION

This section provides the quantification results by sequence. The event sequence probabilities are provided first, and the cut sets are provided afterwards.

C1.4.1 Sequence Level Results

Table C1.4-1. Sequence Level Results

Event Tree	Sequence	Base Min. Cut	Base Cut Sets
CRCF-S-IE-DPAO	03	6.582E-007	1
CRCF-S-IE-DPAO	04-2	2.256E-010	1
CRCF-S-IE-DPAO	04-3	+0.000E+000	1
CRCF-S-IE-DPAO	04-4	+0.000E+000	1
CRCF-S-IE-DPAO	04-5	+0.000E+000	1
CRCF-S-IE-DPAO	04-6	2.256E-010	1
CRCF-S-IE-DPAO	04-7	4.559E-013	1
CRCF-S-IE-DPAO	05-2	1.915E-009	1
CRCF-S-IE-DPAO	05-3	+0.000E+000	1
CRCF-S-IE-DPAO	05-4	+0.000E+000	1
CRCF-S-IE-DPAO	05-5	+0.000E+000	1
CRCF-S-IE-DPAO	05-6	1.915E-009	1

Table C1.4-1. Sequence Level Results (Continued)

Event Tree	Sequence	Base Min. Cut	Base Cut Sets
CRCF-S-IE-DPAO	05-7	5.173E-012	1
CRCF-S-IE-DPAO	06-2	1.580E-009	1
CRCF-S-IE-DPAO	06-3	+0.000E+000	1
CRCF-S-IE-DPAO	06-4	+0.000E+000	1
CRCF-S-IE-DPAO	06-5	+0.000E+000	1
CRCF-S-IE-DPAO	06-6	1.580E-009	1
CRCF-S-IE-DPAO	06-7	3.192E-012	1
CRCF-S-IE-DPAO	07-2	4.767E-011	3
CRCF-S-IE-DPAO	07-3	+0.000E+000	1
CRCF-S-IE-DPAO	07-4	+0.000E+000	1
CRCF-S-IE-DPAO	07-5	+0.000E+000	1
CRCF-S-IE-DPAO	07-6	2.599E-006	4
CRCF-S-IE-DPAO	07-7	2.445E-008	4
CRCF-S-IE-DPAO	08-2		0
CRCF-S-IE-DPAO	08-3	+0.000E+000	1
CRCF-S-IE-DPAO	08-4	+0.000E+000	1
CRCF-S-IE-DPAO	08-5	+0.000E+000	1
CRCF-S-IE-DPAO	08-6	8.674E-007	1
CRCF-S-IE-DPAO	08-7	8.514E-009	1
CRCF-S-IE-DPAO	09-2	2.780E-011	1
CRCF-S-IE-DPAO	09-3	+0.000E+000	1
CRCF-S-IE-DPAO	09-4	+0.000E+000	1
CRCF-S-IE-DPAO	09-5	+0.000E+000	1
CRCF-S-IE-DPAO	09-6	9.022E-007	3
CRCF-S-IE-DPAO	09-7	7.957E-009	3
CRCF-S-IE-DPAO	10-2		0
CRCF-S-IE-DPAO	10-3	+0.000E+000	1
CRCF-S-IE-DPAO	10-4	+0.000E+000	1
CRCF-S-IE-DPAO	10-5	+0.000E+000	1
CRCF-S-IE-DPAO	10-6	2.308E-006	1
CRCF-S-IE-DPAO	10-7	2.198E-008	1
CRCF-S-IE-DPAO	11-2	2.464E-011	3
CRCF-S-IE-DPAO	11-3	+0.000E+000	1
CRCF-S-IE-DPAO	11-4	+0.000E+000	1
CRCF-S-IE-DPAO	11-5	3.355E-006	5
CRCF-S-IE-DPAO	11-6	2.482E-008	5
CRCF-S-IE-DPAO	12-2	2.846E-011	1
CRCF-S-IE-DPAO	12-3	+0.000E+000	1
CRCF-S-IE-DPAO	12-4	+0.000E+000	1
CRCF-S-IE-DPAO	12-5	2.184E-006	2
CRCF-S-IE-DPAO	12-6	1.936E-008	2

Table C1.4-1. Sequence Level Results (Continued)

Event Tree	Sequence	Base Min. Cut	Base Cut Sets
CRCF-S-IE-TAD-AO	03	1.328E-005	1
CRCF-S-IE-TAD-AO	04-2	4.550E-009	1
CRCF-S-IE-TAD-AO	04-3	+0.000E+000	1
CRCF-S-IE-TAD-AO	04-4	+0.000E+000	1
CRCF-S-IE-TAD-AO	04-5	+0.000E+000	1
CRCF-S-IE-TAD-AO	04-6	4.550E-009	1
CRCF-S-IE-TAD-AO	04-7	9.194E-012	1
CRCF-S-IE-TAD-AO	05-2	3.862E-008	1
CRCF-S-IE-TAD-AO	05-3	+0.000E+000	1
CRCF-S-IE-TAD-AO	05-4	+0.000E+000	1
CRCF-S-IE-TAD-AO	05-5	+0.000E+000	1
CRCF-S-IE-TAD-AO	05-6	3.862E-008	1
CRCF-S-IE-TAD-AO	05-7	1.043E-010	1
CRCF-S-IE-TAD-AO	06-2	3.186E-008	1
CRCF-S-IE-TAD-AO	06-3	+0.000E+000	1
CRCF-S-IE-TAD-AO	06-4	+0.000E+000	1
CRCF-S-IE-TAD-AO	06-5	+0.000E+000	1
CRCF-S-IE-TAD-AO	06-6	3.186E-008	1
CRCF-S-IE-TAD-AO	06-7	6.437E-011	1
CRCF-S-IE-TAD-AO	07-2	9.613E-010	3
CRCF-S-IE-TAD-AO	07-3	+0.000E+000	1
CRCF-S-IE-TAD-AO	07-4	+0.000E+000	1
CRCF-S-IE-TAD-AO	07-5	+0.000E+000	1
CRCF-S-IE-TAD-AO	07-6	5.241E-005	4

Table C1.4-1. Sequence Level Results (Continued)

Event Tree	Sequence	Base Min. Cut	Base Cut Sets
CRCF-S-IE-TAD-AO	07-7	4.932E-007	4
CRCF-S-IE-TAD-AO	08-2		0
CRCF-S-IE-TAD-AO	08-3	+0.000E+000	1
CRCF-S-IE-TAD-AO	08-4	+0.000E+000	1
CRCF-S-IE-TAD-AO	08-5	+0.000E+000	1
CRCF-S-IE-TAD-AO	08-6	1.749E-005	1
CRCF-S-IE-TAD-AO	08-7	1.717E-007	1
CRCF-S-IE-TAD-AO	09-2	5.607E-010	1
CRCF-S-IE-TAD-AO	09-3	+0.000E+000	1
CRCF-S-IE-TAD-AO	09-4	+0.000E+000	1
CRCF-S-IE-TAD-AO	09-5	+0.000E+000	1
CRCF-S-IE-TAD-AO	09-6	1.704E-005	3
CRCF-S-IE-TAD-AO	09-7	1.604E-007	3
CRCF-S-IE-TAD-AO	10-2		0
CRCF-S-IE-TAD-AO	10-3	+0.000E+000	1
CRCF-S-IE-TAD-AO	10-4	+0.000E+000	1
CRCF-S-IE-TAD-AO	10-5	+0.000E+000	1
CRCF-S-IE-TAD-AO	10-6	4.655E-005	1
CRCF-S-IE-TAD-AO	10-7	4.432E-007	1
CRCF-S-IE-TAD-AO	11-2	4.969E-010	3
CRCF-S-IE-TAD-AO	11-3	+0.000E+000	1
CRCF-S-IE-TAD-AO	11-4	+0.000E+000	1
CRCF-S-IE-TAD-AO	11-5	6.170E-005	5
CRCF-S-IE-TAD-AO	11-6	5.000E-007	5

Table C1.4-1. Sequence Level Results (Continued)

Event Tree	Sequence	Base Min. Cut	Base Cut Sets
CRCF-S-IE-TAD-AO	12-2	5.739E-010	1
CRCF-S-IE-TAD-AO	12-3	+0.000E+000	1
CRCF-S-IE-TAD-AO	12-4	+0.000E+000	1
CRCF-S-IE-TAD-AO	12-5	4.404E-005	2
CRCF-S-IE-TAD-AO	12-6	3.904E-007	2
CRCF-S-IE-TWP	03	3.749E-005	1
CRCF-S-IE-TWP	04-2	3.906E-009	1
CRCF-S-IE-TWP	04-3	+0.000E+000	1
CRCF-S-IE-TWP	04-4	+0.000E+000	1
CRCF-S-IE-TWP	04-5	3.906E-009	1
CRCF-S-IE-TWP	04-6	7.893E-012	1
CRCF-S-IE-TWP	05-2		0
CRCF-S-IE-TWP	05-3	+0.000E+000	1
CRCF-S-IE-TWP	05-4	+0.000E+000	1
CRCF-S-IE-TWP	05-5	6.912E-006	1
CRCF-S-IE-TWP	05-6	6.784E-008	1
CRCF-S-IE-TWP	06-2	6.444E-010	1
CRCF-S-IE-TWP	06-3	+0.000E+000	1
CRCF-S-IE-TWP	06-4	+0.000E+000	1
CRCF-S-IE-TWP	06-5	4.594E-005	2
CRCF-S-IE-TWP	06-6	4.073E-007	2
CRCF-S-IE-TWP	07-2		0
CRCF-S-IE-TWP	07-3	+0.000E+000	1
CRCF-S-IE-TWP	07-4	+0.000E+000	1
CRCF-S-IE-TWP	07-5	+0.000E+000	1
CRCF-S-IE-TWP	07-6	3.239E-005	1
CRCF-S-IE-TWP	07-7	3.083E-007	1
CRCF-S-IE-TWP	08-2	5.603E-010	3
CRCF-S-IE-TWP	08-3	+0.000E+000	1
CRCF-S-IE-TWP	08-4	+0.000E+000	1
CRCF-S-IE-TWP	08-5	6.471E-005	5
CRCF-S-IE-TWP	08-6	5.080E-007	5
CRCF-S-IE-TWP	09-2	8.224E-010	2
CRCF-S-IE-TWP	09-3	+0.000E+000	1
CRCF-S-IE-TWP	09-4	+0.000E+000	1
CRCF-S-IE-TWP	09-5	+0.000E+000	1
CRCF-S-IE-TWP	09-6	8.224E-010	2
CRCF-S-IE-TWP	09-7	6.409E-012	2

Table C1.4-1. Sequence Level Results (Continued)

Event Tree	Sequence	Base Min. Cut	Base Cut Sets
CRCF-S-IE-TWP	10-2	9.186E-009	1
CRCF-S-IE-TWP	10-3	+0.000E+000	1
CRCF-S-IE-TWP	10-4	+0.000E+000	1
CRCF-S-IE-TWP	10-5	+0.000E+000	1
CRCF-S-IE-TWP	10-6	7.140E-006	2
CRCF-S-IE-TWP	10-7	6.999E-008	2
CRCF-S-IE-TWP	11-2	5.476E-010	1
CRCF-S-IE-TWP	11-3	+0.000E+000	1
CRCF-S-IE-TWP	11-4	+0.000E+000	1
CRCF-S-IE-TWP	11-5	+0.000E+000	1
CRCF-S-IE-TWP	11-6	4.864E-006	2
CRCF-S-IE-TWP	11-7	4.577E-008	2
CRCF-S-IE-TWP	12-2	1.636E-004	2
CRCF-S-IE-TWP	12-4	+0.000E+000	1
CRCF-S-IE-TWP	12-5	+0.000E+000	1
CRCF-S-IE-TWP	12-6	+0.000E+000	1
CRCF-S-IE-TWP	12-7	8.438E-006	3
CRCF-S-IE-TWP	12-8	5.654E-008	3

Source: Original

C1.4.2 Cut Set Level Results by Sequence

Note that the SAPHIRE software does not provide special tables for seismic cut sets. Therefore, the “Cut Set %” given in the third column of this table is not correct for seismic events, although it does provide the approximate rank order for the cut sets.

Table C1.4-2. Cut Set Level Results by Sequence

Event Tree	Sequence	Cut Set %	Basic Event	Description
CRCF-S-IE-DPAO	03	100.00	060-TAO-STRUCTUR-ETF	ETF for TAO canister in CRCF structure
			CRCF-DP-CAN	Number of DP canisters transferred to AO
			S-060-STR-COLLAPSE	Seismic collapse of CRCF structure
			= Total	
	04-2	100.00	060-TAO-ENTDOOR-ETF	ETF for entry door over transport cask
			CRCF-DP-CAN	Number of DP canisters transferred to AO
			S-060-ENTDOORCOL	Seismic collapse of entry door
			SHIELDING	Shielding remains intact
			= Total	

Table C1.4-2. Cut Set Level Results by Sequence (Continued)

Event Tree	Sequence	Cut Set %	Basic Event	Description
	04-3	0.00	<FALSE>	System Generated Success Event
			= Total	
	04-4	0.00	<FALSE>	System Generated Success Event
			= Total	
	04-5	0.00	<FALSE>	System Generated Success Event
			= Total	
	04-6	100.00	060-TAO-ENTDOOR-ETF	ETF for entry door over transport cask
			060-TAO-ENTDOOR-PFA	Breach of TC due to entry door collapse
			CRCF-DP-CAN	Number of DP canisters transferred to AO
			S-060-ENTDOORCOL	Seismic collapse of entry door
			= Total	
	04-7	100.00	060-TAO-ENTDOOR-ETF	ETF for entry door over transport cask
			060-TAO-ENTDOOR-PFA	Breach of TC due to entry door collapse
			CRCF-DP-CAN	Number of DP canisters transferred to AO
			MOD-ENTER-CANISTER	Flooding or spray enters canister
			S-060-ENTDOORCOL	Seismic collapse of entry door
			S-060-PIPING-FAIL	Seismic failure of piping in accident area
			= Total	
	05-2	100.00	060-TAO-RAILCAR-ETF	ETF for railcar carrying transport cask
			CRCF-DP-CAN	Number of DP canisters transferred to AO
			S-060-RAILCAR-ACC	Seismic tipover or collision of railcar
			SHIELDING	Shielding remains intact
			= Total	
	05-3	0.00	<FALSE>	System Generated Success Event
			= Total	
	05-4	0.00	<FALSE>	System Generated Success Event
			= Total	
	05-5	0.00	<FALSE>	System Generated Success Event
			= Total	

Table C1.4-2. Cut Set Level Results by Sequence (Continued)

Event Tree	Sequence	Cut Set %	Basic Event	Description
	05-6	100.00	060-TAO-RAILCAR-ETF	ETF for railcar carrying transport cask
			060-TAO-RAILCAR-PFA	Breach of TC due to railcar accident
			CRCF-DP-CAN	Number of DP canisters transferred to AO
			S-060-RAILCAR-ACC	Seismic tipover or collision of railcar
			= Total	
	05-7	100.00	060-TAO-RAILCAR-ETF	ETF for railcar carrying transport cask
			060-TAO-RAILCAR-PFA	Breach of TC due to railcar accident
			CRCF-DP-CAN	Number of DP canisters transferred to AO
			MOD-ENTER-CANISTER	Flooding or spray enters canister
			S-060-PIPING-FAIL	Seismic failure of piping in accident area
			S-060-RAILCAR-ACC	Seismic tipover or collision of railcar
			= Total	
	06-2	100.00	060-TAO-MOBPLAT-ETF	ETF for mobile platform over TC
			CRCF-DP-CAN	Number of DP canisters transferred to AO
			S-060-MOBPLAT-COLLAP	Seismic collapse of mobile platform
			SHIELDING	Shielding remains intact
			= Total	
	06-3	0.00	<FALSE>	System Generated Success Event
			= Total	
	06-4	0.00	<FALSE>	System Generated Success Event
			= Total	
	06-5	0.00	<FALSE>	System Generated Success Event
			= Total	
	06-6	100.00	060-TAO-MOBPLAT-ETF	ETF for mobile platform over TC
			060-TAO-MOBPLAT-PFA	Breach of TC due to mobile platform collapse
			CRCF-DP-CAN	Number of DP canisters transferred to AO
			S-060-MOBPLAT-COLLAP	Seismic collapse of mobile platform
			= Total	

Table C1.4-2. Cut Set Level Results by Sequence (Continued)

Event Tree	Sequence	Cut Set %	Basic Event	Description
	06-7	100.00	060-TAO-MOBPLAT-ETF	ETF for mobile platform over TC
			060-TAO-MOBPLAT-PFA	Breach of TC due to mobile platform collapse
			CRCF-DP-CAN	Number of DP canisters transferred to AO
			MOD-ENTER-CANISTER	Flooding or spray enters canister
			S-060-MOBPLAT-COLLAP	Seismic collapse of mobile platform
			S-060-PIPING-FAIL	Seismic failure of piping in accident area
			= Total	
	07-2	87.88	060-TAO-CHCHOIST-ETF	ETF for CHC hoisting TC - cask drop or swing
			CRCF-DP-CAN	Number of DP canisters transferred to AO
			S-060-CHC-SWING	Significant seismic swinging of CHC
			SHIELDING	Shielding remains intact
		6.99	060-TAO-CHC-OBJ-ETF	ETF for CHC with heavy object over TC
			CRCF-DP-CAN	Number of DP canisters transferred to AO
			S-060-CHC-OBJDROP	Seismic drop of heavy object by CHC
			SHIELDING	Shielding remains intact
		5.13	060-TAO-CHCHOIST-ETF	ETF for CHC hoisting TC - cask drop or swing
			CRCF-DP-CAN	Number of DP canisters transferred to AO
			S-060-CHC-HOIST	Seismic failure of CHC hoist
			SHIELDING	Shielding remains intact
			= Total	
	07-3	0.00	<FALSE>	System Generated Success Event
			= Total	
	07-4	0.00	<FALSE>	System Generated Success Event
			= Total	
	07-5	0.00	<FALSE>	System Generated Success Event
			= Total	
	07-6	99.95	060-TAO-CHC-COL-ETF	ETF for CHC over canister - collapse
			CRCF-DP-CAN	Number of DP canisters transferred to AO
			S-060-CHC-COLLAPSE	Seismic collapse of CHC

Table C1.4-2. Cut Set Level Results by Sequence (Continued)

Event Tree	Sequence	Cut Set %	Basic Event	Description
		0.04	060-TAO-CHCHOIST-ETF	ETF for CHC hoisting TC - cask drop or swing
			060-TAO-CHCSWING-PFA	Breach of cask due to CHC load swinging
			CRCF-DP-CAN	Number of DP canisters transferred to AO
			S-060-CHC-SWING	Significant seismic swinging of CHC
		0.00	060-TAO-CHC-OBJ-ETF	ETF for CHC with heavy object over TC
			060-TAO-CHC-OBJ-PFA	Breach of cask due to CHC heavy object drop
			CRCF-DP-CAN	Number of DP canisters transferred to AO
			S-060-CHC-OBJDROP	Seismic drop of heavy object by CHC
		0.00	060-TAO-CHCHOIST-ETF	ETF for CHC hoisting TC - cask drop or swing
			060-TAO-CHCHOIST-PFA	Breach of cask due to CHC hoist drop
			CRCF-DP-CAN	Number of DP canisters transferred to AO
			S-060-CHC-HOIST	Seismic failure of CHC hoist
			= Total	
	07-7	99.95	060-TAO-CHC-COL-ETF	ETF for CHC over canister - collapse
			CRCF-DP-CAN	Number of DP canisters transferred to AO
			MOD-ENTER-CANISTER	Flooding or spray enters canister
			S-060-CHC-COLLAPSE	Seismic collapse of CHC
			S-060-PIPING-FAIL	Seismic failure of piping in accident area
		0.04	060-TAO-CHCHOIST-ETF	ETF for CHC hoisting TC - cask drop or swing
			060-TAO-CHCSWING-PFA	Breach of cask due to CHC load swinging
			CRCF-DP-CAN	Number of DP canisters transferred to AO
			MOD-ENTER-CANISTER	Flooding or spray enters canister
			S-060-CHC-SWING	Significant seismic swinging of CHC
			S-060-PIPING-FAIL	Seismic failure of piping in accident area
		0.00	060-TAO-CHC-OBJ-ETF	ETF for CHC with heavy object over TC
			060-TAO-CHC-OBJ-PFA	Breach of cask due to CHC heavy object drop

Table C1.4-2. Cut Set Level Results by Sequence (Continued)

Event Tree	Sequence	Cut Set %	Basic Event	Description
			CRCF-DP-CAN	Number of DP canisters transferred to AO
			MOD-ENTER-CANISTER	Flooding or spray enters canister
			S-060-CHC-OBJDROP	Seismic drop of heavy object by CHC
			S-060-PIPING-FAIL	Seismic failure of piping in accident area
		0.00	060-TAO-CHCHOIST-ETF	ETF for CHC hoisting TC - cask drop or swing
			060-TAO-CHCHOIST-PFA	Breach of cask due to CHC hoist drop
			CRCF-DP-CAN	Number of DP canisters transferred to AO
			MOD-ENTER-CANISTER	Flooding or spray enters canister
			S-060-CHC-HOIST	Seismic failure of CHC hoist
			S-060-PIPING-FAIL	Seismic failure of piping in accident area
			= Total	
	08-2			
	08-3	0.00	<FALSE>	System Generated Success Event
			= Total	
	08-4	0.00	<FALSE>	System Generated Success Event
			= Total	
	08-5	0.00	<FALSE>	System Generated Success Event
			= Total	
	08-6	100.00	060-TAO-CPPLAT-ETF	ETF for cask under cask prep platform
			CRCF-DP-CAN	Number of DP canisters transferred to AO
			S-060-CPPLAT-COL	Seismic collapse of cask prep platform
			= Total	
	08-7	100.00	060-TAO-CPPLAT-ETF	ETF for cask under cask prep platform
			CRCF-DP-CAN	Number of DP canisters transferred to AO
			MOD-ENTER-CANISTER	Flooding or spray enters canister
			S-060-CPPLAT-COL	Seismic collapse of cask prep platform
			S-060-PIPING-FAIL	Seismic failure of piping in accident area
			= Total	

Table C1.4-2. Cut Set Level Results by Sequence (Continued)

Event Tree	Sequence	Cut Set %	Basic Event	Description
	09-2	100.00	060-TAO-CTT-BUMP-ETF	ETF for CTT with TC subject to bumping EAF
			CRCF-DP-CAN	Number of DP canisters transferred to AO
			S-060-CTT-BUMPING	Seismic bumping of CTT into EAF
			SHIELDING	Shielding remains intact
			= Total	
	09-3	0.00	<FALSE>	System Generated Success Event
			= Total	
	09-4	0.00	<FALSE>	System Generated Success Event
			= Total	
	09-5	0.00	<FALSE>	System Generated Success Event
			= Total	
	09-6	97.62	060-TAO-CTTSLIDE-ETF	ETF for CTT containing TC in transfer cell
			CRCF-DP-CAN	Number of DP canisters transferred to AO
			S-060-CTT-SLIDE	Seismic sliding of CTT into wall
		2.38	060-TAO-CTT-ROCK-ETF	ETF for CTT with TC subject to rocking/tipover
			CRCF-DP-CAN	Number of DP canisters transferred to AO
			S-060-CTT-ROCKING	Seismic rocking of CTT with restraint failure
		0.00	060-TAO-CTT-BUMP-ETF	ETF for CTT with TC subject to bumping EAF
			060-TAO-CTT-BUMP-PFA	Breach given CTT with TC subject to bumping EAF
			CRCF-DP-CAN	Number of DP canisters transferred to AO
			S-060-CTT-BUMPING	Seismic bumping of CTT into EAF
			= Total	
	09-7	97.62	060-TAO-CTTSLIDE-ETF	ETF for CTT containing TC in transfer cell
			CRCF-DP-CAN	Number of DP canisters transferred to AO
			MOD-ENTER-CANISTER	Flooding or spray enters canister
			S-060-CTT-SLIDE	Seismic sliding of CTT into wall
			S-060-PIPING-FAIL	Seismic failure of piping in accident area
		2.38	060-TAO-CTT-ROCK-ETF	ETF for CTT with TC subject to rocking/tipover

Table C1.4-2. Cut Set Level Results by Sequence (Continued)

Event Tree	Sequence	Cut Set %	Basic Event	Description
			CRCF-DP-CAN	Number of DP canisters transferred to AO
			MOD-ENTER-CANISTER	Flooding or spray enters canister
			S-060-CTT-ROCKING	Seismic rocking of CTT with restraint failure
			S-060-PIPING-FAIL	Seismic failure of piping in accident area
		0.00	060-TAO-CTT-BUMP-ETF	ETF for CTT with TC subject to bumping EAF
			060-TAO-CTT-BUMP-PFA	Breach given CTT with TC subject to bumping EAF
			CRCF-DP-CAN	Number of DP canisters transferred to AO
			MOD-ENTER-CANISTER	Flooding or spray enters canister
			S-060-CTT-BUMPING	Seismic bumping of CTT into EAF
			S-060-PIPING-FAIL	Seismic failure of piping in accident area
			= Total	
	10-2			
	10-3	0.00	<FALSE>	System Generated Success Event
			= Total	
	10-4	0.00	<FALSE>	System Generated Success Event
			= Total	
	10-5	0.00	<FALSE>	System Generated Success Event
			= Total	
	10-6	100.00	060-TAO-SHIELDDR-ETF	ETF for shield doors when canister is nearby
			CRCF-DP-CAN	Number of DP canisters transferred to AO
			S-060-SHIELDDOOR	Seismic falling of shield door
			= Total	
	10-7	100.00	060-TAO-SHIELDDR-ETF	ETF for shield doors when canister is nearby
			CRCF-DP-CAN	Number of DP canisters transferred to AO
			MOD-ENTER-CANISTER	Flooding or spray enters canister
			S-060-PIPING-FAIL	Seismic failure of piping in accident area
			S-060-SHIELDDOOR	Seismic falling of shield door
			= Total	

Table C1.4-2. Cut Set Level Results by Sequence (Continued)

Event Tree	Sequence	Cut Set %	Basic Event	Description
	11-2	88.43	060-TAO-CTMSWGIB-ETF	ETF for CTM hoisting canister inside bell
			CRCF-DP-CAN	Number of DP canisters transferred to AO
			S-060-CTMSWG-IB	Significant swinging of canister inside CTM bell
			SHIELDING	Shielding remains intact
		6.41	060-TAO-CTM-OBJ-ETF	ETF for CTM with heavy object over TC
			CRCF-DP-CAN	Number of DP canisters transferred to AO
			S-060-CTM-OBJDROP	Seismic drop of heavy object by CTM
			SHIELDING	Shielding remains intact
		5.16	060-TAO-CTMHOIST-ETF	ETF for CTM hoisting canister - drop
			CRCF-DP-CAN	Number of DP canisters transferred to AO
			S-060-CTM-HOIST	Seismic drop of canister hoisted by CTM
			SHIELDING	Shielding remains intact
			= Total	
	11-3	0.00	<FALSE>	System Generated Success Event
			= Total	
	11-4	0.00	<FALSE>	System Generated Success Event
			= Total	
	11-5	97.89	060-TAO-CTMSWGOB-ETF	ETF for CTM hoisting canister outside bell
			CRCF-DP-CAN	Number of DP canisters transferred to AO
			S-060-CTMSWG-OB	Significant swinging of canister outside CTM bell
		2.11	060-TAO-CTM-COL-ETF	ETF for CTM over canister - collapse
			CRCF-DP-CAN	Number of DP canisters transferred to AO
			S-060-CTM-COLLAPSE	Seismic collapse of CTM (trolley seismic restraints)
		0.00	060-TAO-CTMSWGIB-ETF	ETF for CTM hoisting canister inside bell
			060-TAO-CTMSWGIB-PFA	Breach of canister due to swing inside bell
			CRCF-DP-CAN	Number of DP canisters transferred to AO
			S-060-CTMSWG-IB	Significant swinging of canister inside CTM bell

Table C1.4-2. Cut Set Level Results by Sequence (Continued)

Event Tree	Sequence	Cut Set %	Basic Event	Description
		0.00	060-TAO-CTM-OBJ-ETF	ETF for CTM with heavy object over TC
			060-TAO-CTM-OBJ-PFA	Breach of canister due to CTM object drop
			CRCF-DP-CAN	Number of DP canisters transferred to AO
			S-060-CTM-OBJDROP	Seismic drop of heavy object by CTM
		0.00	060-TAO-CTMHOIST-ETF	ETF for CTM hoisting canister - drop
			060-TAO-CTMHOIST-PFA	Breach of canister dropped by CTM
			CRCF-DP-CAN	Number of DP canisters transferred to AO
			S-060-CTM-HOIST	Seismic drop of canister hoisted by CTM
			= Total	
	11-6	97.89	060-TAO-CTMSWGOB-ETF	ETF for CTM hoisting canister outside bell
			CRCF-DP-CAN	Number of DP canisters transferred to AO
			MOD-ENTER-CANISTER	Flooding or spray enters canister
			S-060-CTMSWG-OB	Significant swinging of canister outside CTM bell
			S-060-PIPING-FAIL	Seismic failure of piping in accident area
		2.11	060-TAO-CTM-COL-ETF	ETF for CTM over canister - collapse
			CRCF-DP-CAN	Number of DP canisters transferred to AO
			MOD-ENTER-CANISTER	Flooding or spray enters canister
			S-060-CTM-COLLAPSE	Seismic collapse of CTM (trolley seismic restraints)
			S-060-PIPING-FAIL	Seismic failure of piping in accident area
		0.00	060-TAO-CTMSWGIB-ETF	ETF for CTM hoisting canister inside bell
			060-TAO-CTMSWGIB-PFA	Breach of canister due to swing inside bell
			CRCF-DP-CAN	Number of DP canisters transferred to AO
			MOD-ENTER-CANISTER	Flooding or spray enters canister
			S-060-CTMSWG-IB	Significant swinging of canister inside CTM bell
			S-060-PIPING-FAIL	Seismic failure of piping in accident area

Table C1.4-2. Cut Set Level Results by Sequence (Continued)

Event Tree	Sequence	Cut Set %	Basic Event	Description
		0.00	060-TAO-CTM-OBJ-ETF	ETF for CTM with heavy object over TC
			060-TAO-CTM-OBJ-PFA	Breach of canister due to CTM object drop
			CRCF-DP-CAN	Number of DP canisters transferred to AO
			MOD-ENTER-CANISTER	Flooding or spray enters canister
			S-060-CTM-OBJDROP	Seismic drop of heavy object by CTM
			S-060-PIPING-FAIL	Seismic failure of piping in accident area
		0.00	060-TAO-CTMHOIST-ETF	ETF for CTM hoisting canister - drop
			060-TAO-CTMHOIST-PFA	Breach of canister dropped by CTM
			CRCF-DP-CAN	Number of DP canisters transferred to AO
			MOD-ENTER-CANISTER	Flooding or spray enters canister
			S-060-CTM-HOIST	Seismic drop of canister hoisted by CTM
			S-060-PIPING-FAIL	Seismic failure of piping in accident area
			= Total	
	12-2	100.00	060-TAO-ST-BUMP-ETF	ETF for ST with AO bumping EAF
			CRCF-DP-CAN	Number of DP canisters transferred to AO
			S-060-ST-BUMP-EAF	Seismic bumping of ST into EAF
			SHIELD-AO	Shielding remains intact
			= Total	
	12-3	0.00	<FALSE>	System Generated Success Event
			= Total	
	12-4	0.00	<FALSE>	System Generated Success Event
			= Total	
	12-5	100.00	060-TAO-ST-SLIDE-ETF	ETF for ST containing TAD in bldg
			CRCF-DP-CAN	Number of DP canisters transferred to AO
			S-060-ST-SLIDE	Seismic sliding of ST into wall
		0.00	060-TAO-ST-BUMP-ETF	ETF for ST with AO bumping EAF
			060-TAO-ST-BUMP-PFA	Breach of can in ST due to bumping EAF

Table C1.4-2. Cut Set Level Results by Sequence (Continued)

Event Tree	Sequence	Cut Set %	Basic Event	Description
			CRCF-DP-CAN	Number of DP canisters transferred to AO
			S-060-ST-BUMP-EAF	Seismic bumping of ST into EAF
			= Total	
	12-6	100.00	060-TAO-ST-SLIDE-ETF	ETF for ST containing TAD in bldg
			CRCF-DP-CAN	Number of DP canisters transferred to AO
			MOD-ENTER-CANISTER	Flooding or spray enters canister
			S-060-PIPING-FAIL	Seismic failure of piping in accident area
			S-060-ST-SLIDE	Seismic sliding of ST into wall
		0.00	060-TAO-ST-BUMP-ETF	ETF for ST with AO bumping EAF
			060-TAO-ST-BUMP-PFA	Breach of can in ST due to bumping EAF
			CRCF-DP-CAN	Number of DP canisters transferred to AO
			MOD-ENTER-CANISTER	Flooding or spray enters canister
			S-060-PIPING-FAIL	Seismic failure of piping in accident area
			S-060-ST-BUMP-EAF	Seismic bumping of ST into EAF
			= Total	
CRCF-S-IE-TAD-AO	03	100.00	060-TAO-STRUCTUR-ETF	ETF for TAO canister in CRCF structure
			CRCF-TAD-AO	Number of TAD canisters transferred to AO
			S-060-STR-COLLAPSE	Seismic collapse of CRCF structure
			= Total	
	04-2	100.00	060-TAO-ENTDOOR-ETF	ETF for entry door over transport cask
			CRCF-TAD-AO	Number of TAD canisters transferred to AO
			S-060-ENTDOORCOL	Seismic collapse of entry door
			SHIELDING	Shielding remains intact
			= Total	
	04-3	0.00	<FALSE>	System Generated Success Event
			= Total	
	04-4	0.00	<FALSE>	System Generated Success Event
			= Total	

Table C1.4-2. Cut Set Level Results by Sequence (Continued)

Event Tree	Sequence	Cut Set %	Basic Event	Description
	04-5	0.00	<FALSE>	System Generated Success Event
			= Total	
	04-6	100.00	060-TAO-ENTDOOR-ETF	ETF for entry door over transport cask
			060-TAO-ENTDOOR-PFA	Breach of TC due to entry door collapse
			CRCF-TAD-AO	Number of TAD canisters transferred to AO
			S-060-ENTDOORCOL	Seismic collapse of entry door
			= Total	
	04-7	100.00	060-TAO-ENTDOOR-ETF	ETF for entry door over transport cask
			060-TAO-ENTDOOR-PFA	Breach of TC due to entry door collapse
			CRCF-TAD-AO	Number of TAD canisters transferred to AO
			MOD-ENTER-CANISTER	Flooding or spray enters canister
			S-060-ENTDOORCOL	Seismic collapse of entry door
			S-060-PIPING-FAIL	Seismic failure of piping in accident area
			= Total	
	05-2	100.00	060-TAO-RAILCAR-ETF	ETF for railcar carrying transport cask
			CRCF-TAD-AO	Number of TAD canisters transferred to AO
			S-060-RAILCAR-ACC	Seismic tipover or collision of railcar
			SHIELDING	Shielding remains intact
			= Total	
	05-3	0.00	<FALSE>	System Generated Success Event
			= Total	
	05-4	0.00	<FALSE>	System Generated Success Event
			= Total	
	05-5	0.00	<FALSE>	System Generated Success Event
			= Total	
	05-6	100.00	060-TAO-RAILCAR-ETF	ETF for railcar carrying transport cask
			060-TAO-RAILCAR-PFA	Breach of TC due to railcar accident
			CRCF-TAD-AO	Number of TAD canisters transferred to AO
			S-060-RAILCAR-ACC	Seismic tipover or collision of railcar

Table C1.4-2. Cut Set Level Results by Sequence (Continued)

Event Tree	Sequence	Cut Set %	Basic Event	Description
			= Total	
	05-7	100.00	060-TAO-RAILCAR-ETF	ETF for railcar carrying transport cask
			060-TAO-RAILCAR-PFA	Breach of TC due to railcar accident
			CRCF-TAD-AO	Number of TAD canisters transferred to AO
			MOD-ENTER-CANISTER	Flooding or spray enters canister
			S-060-PIPING-FAIL	Seismic failure of piping in accident area
			S-060-RAILCAR-ACC	Seismic tipover or collision of railcar
			= Total	
	06-2	100.00	060-TAO-MOBPLAT-ETF	ETF for mobile platform over TC
			CRCF-TAD-AO	Number of TAD canisters transferred to AO
			S-060-MOBPLAT-COLLAP	Seismic collapse of mobile platform
			SHIELDING	Shielding remains intact
			= Total	
	06-3	0.00	<FALSE>	System Generated Success Event
			= Total	
	06-4	0.00	<FALSE>	System Generated Success Event
			= Total	
	06-5	0.00	<FALSE>	System Generated Success Event
			= Total	
	06-6	100.00	060-TAO-MOBPLAT-ETF	ETF for mobile platform over TC
			060-TAO-MOBPLAT-PFA	Breach of TC due to mobile platform collapse
			CRCF-TAD-AO	Number of TAD canisters transferred to AO
			S-060-MOBPLAT-COLLAP	Seismic collapse of mobile platform
			= Total	
	06-7	100.00	060-TAO-MOBPLAT-ETF	ETF for mobile platform over TC
			060-TAO-MOBPLAT-PFA	Breach of TC due to mobile platform collapse
			CRCF-TAD-AO	Number of TAD canisters transferred to AO
			MOD-ENTER-CANISTER	Flooding or spray enters canister

Table C1.4-2. Cut Set Level Results by Sequence (Continued)

Event Tree	Sequence	Cut Set %	Basic Event	Description
			S-060-MOBPLAT-COLLAP	Seismic collapse of mobile platform
			S-060-PIPING-FAIL	Seismic failure of piping in accident area
			= Total	
	07-2	87.88	060-TAO-CHCHOIST-ETF	ETF for CHC hoisting TC - cask drop or swing
			CRCF-TAD-AO	Number of TAD canisters transferred to AO
			S-060-CHC-SWING	Significant seismic swinging of CHC
			SHIELDING	Shielding remains intact
		6.99	060-TAO-CHC-OBJ-ETF	ETF for CHC with heavy object over TC
			CRCF-TAD-AO	Number of TAD canisters transferred to AO
			S-060-CHC-OBJDROP	Seismic drop of heavy object by CHC
			SHIELDING	Shielding remains intact
		5.13	060-TAO-CHCHOIST-ETF	ETF for CHC hoisting TC - cask drop or swing
			CRCF-TAD-AO	Number of TAD canisters transferred to AO
			S-060-CHC-HOIST	Seismic failure of CHC hoist
			SHIELDING	Shielding remains intact
			= Total	
	07-3	0.00	<FALSE>	System Generated Success Event
			= Total	
	07-4	0.00	<FALSE>	System Generated Success Event
			= Total	
	07-5	0.00	<FALSE>	System Generated Success Event
			= Total	
	07-6	99.95	060-TAO-CHC-COL-ETF	ETF for CHC over canister - collapse
			CRCF-TAD-AO	Number of TAD canisters transferred to AO
			S-060-CHC-COLLAPSE	Seismic collapse of CHC
		0.04	060-TAO-CHCHOIST-ETF	ETF for CHC hoisting TC - cask drop or swing
			060-TAO-CHCSWING-PFA	Breach of cask due to CHC load swinging
			CRCF-TAD-AO	Number of TAD canisters transferred to AO
			S-060-CHC-SWING	Significant seismic swinging of CHC

Table C1.4-2. Cut Set Level Results by Sequence (Continued)

Event Tree	Sequence	Cut Set %	Basic Event	Description
		0.00	060-TAO-CHC-OBJ-ETF	ETF for CHC with heavy object over TC
			060-TAO-CHC-OBJ-PFA	Breach of cask due to CHC heavy object drop
			CRCF-TAD-AO	Number of TAD canisters transferred to AO
			S-060-CHC-OBJDROP	Seismic drop of heavy object by CHC
		0.00	060-TAO-CHCHOIST-ETF	ETF for CHC hoisting TC - cask drop or swing
			060-TAO-CHCHOIST-PFA	Breach of cask due to CHC hoist drop
			CRCF-TAD-AO	Number of TAD canisters transferred to AO
			S-060-CHC-HOIST	Seismic failure of CHC hoist
			= Total	
	07-7	99.95	060-TAO-CHC-COL-ETF	ETF for CHC over canister - collapse
			CRCF-TAD-AO	Number of TAD canisters transferred to AO
			MOD-ENTER-CANISTER	Flooding or spray enters canister
			S-060-CHC-COLLAPSE	Seismic collapse of CHC
			S-060-PIPING-FAIL	Seismic failure of piping in accident area
		0.04	060-TAO-CHCHOIST-ETF	ETF for CHC hoisting TC - cask drop or swing
			060-TAO-CHCSWING-PFA	Breach of cask due to CHC load swinging
			CRCF-TAD-AO	Number of TAD canisters transferred to AO
			MOD-ENTER-CANISTER	Flooding or spray enters canister
			S-060-CHC-SWING	Significant seismic swinging of CHC
			S-060-PIPING-FAIL	Seismic failure of piping in accident area
		0.00	060-TAO-CHC-OBJ-ETF	ETF for CHC with heavy object over TC
			060-TAO-CHC-OBJ-PFA	Breach of cask due to CHC heavy object drop
			CRCF-TAD-AO	Number of TAD canisters transferred to AO
			MOD-ENTER-CANISTER	Flooding or spray enters canister
			S-060-CHC-OBJDROP	Seismic drop of heavy object by CHC
			S-060-PIPING-FAIL	Seismic failure of piping in accident area

Table C1.4-2. Cut Set Level Results by Sequence (Continued)

Event Tree	Sequence	Cut Set %	Basic Event	Description
		0.00	060-TAO-CHCHOIST-ETF	ETF for CHC hoisting TC - cask drop or swing
			060-TAO-CHCHOIST-PFA	Breach of cask due to CHC hoist drop
			CRCF-TAD-AO	Number of TAD canisters transferred to AO
			MOD-ENTER-CANISTER	Flooding or spray enters canister
			S-060-CHC-HOIST	Seismic failure of CHC hoist
			S-060-PIPING-FAIL	Seismic failure of piping in accident area
			= Total	
	08-2			
	08-3	0.00	<FALSE>	System Generated Success Event
			= Total	
	08-4	0.00	<FALSE>	System Generated Success Event
			= Total	
	08-5	0.00	<FALSE>	System Generated Success Event
			= Total	
	08-6	100.00	060-TAO-CPPLAT-ETF	ETF for cask under cask prep platform
			CRCF-TAD-AO	Number of TAD canisters transferred to AO
			S-060-CPPLAT-COL	Seismic collapse of cask prep platform
			= Total	
	08-7	100.00	060-TAO-CPPLAT-ETF	ETF for cask under cask prep platform
			CRCF-TAD-AO	Number of TAD canisters transferred to AO
			MOD-ENTER-CANISTER	Flooding or spray enters canister
			S-060-CPPLAT-COL	Seismic collapse of cask prep platform
			S-060-PIPING-FAIL	Seismic failure of piping in accident area
			= Total	
	09-2	100.00	060-TAO-CTT-BUMP-ETF	ETF for CTT with TC subject to bumping EAF
			CRCF-TAD-AO	Number of TAD canisters transferred to AO
			S-060-CTT-BUMPING	Seismic bumping of CTT into EAF
			SHIELDING	Shielding remains intact
			= Total	

Table C1.4-2. Cut Set Level Results by Sequence (Continued)

Event Tree	Sequence	Cut Set %	Basic Event	Description
	09-3	0.00	<FALSE>	System Generated Success Event
			= Total	
	09-4	0.00	<FALSE>	System Generated Success Event
			= Total	
	09-5	0.00	<FALSE>	System Generated Success Event
			= Total	
	09-6	97.62	060-TAO-CTTSLIDE-ETF	ETF for CTT containing TC in transfer cell
			CRCF-TAD-AO	Number of TAD canisters transferred to AO
			S-060-CTT-SLIDE	Seismic sliding of CTT into wall
		2.38	060-TAO-CTT-ROCK-ETF	ETF for CTT with TC subject to rocking/tipover
			CRCF-TAD-AO	Number of TAD canisters transferred to AO
			S-060-CTT-ROCKING	Seismic rocking of CTT with restraint failure
		0.00	060-TAO-CTT-BUMP-ETF	ETF for CTT with TC subject to bumping EAF
			060-TAO-CTT-BUMP-PFA	Breach given CTT with TC subject to bumping EAF
			CRCF-TAD-AO	Number of TAD canisters transferred to AO
			S-060-CTT-BUMPING	Seismic bumping of CTT into EAF
			= Total	
	09-7	97.62	060-TAO-CTTSLIDE-ETF	ETF for CTT containing TC in transfer cell
			CRCF-TAD-AO	Number of TAD canisters transferred to AO
			MOD-ENTER-CANISTER	Flooding or spray enters canister
			S-060-CTT-SLIDE	Seismic sliding of CTT into wall
			S-060-PIPING-FAIL	Seismic failure of piping in accident area
		2.38	060-TAO-CTT-ROCK-ETF	ETF for CTT with TC subject to rocking/tipover
			CRCF-TAD-AO	Number of TAD canisters transferred to AO
			MOD-ENTER-CANISTER	Flooding or spray enters canister
			S-060-CTT-ROCKING	Seismic rocking of CTT with restraint failure
			S-060-PIPING-FAIL	Seismic failure of piping in accident area

Table C1.4-2. Cut Set Level Results by Sequence (Continued)

Event Tree	Sequence	Cut Set %	Basic Event	Description
		0.00	060-TAO-CTT-BUMP-ETF	ETF for CTT with TC subject to bumping EAF
			060-TAO-CTT-BUMP-PFA	Breach given CTT with TC subject to bumping EAF
			CRCF-TAD-AO	Number of TAD canisters transferred to AO
			MOD-ENTER-CANISTER	Flooding or spray enters canister
			S-060-CTT-BUMPING	Seismic bumping of CTT into EAF
			S-060-PIPING-FAIL	Seismic failure of piping in accident area
			= Total	
	10-2			
	10-3	0.00	<FALSE>	System Generated Success Event
			= Total	
	10-4	0.00	<FALSE>	System Generated Success Event
			= Total	
	10-5	0.00	<FALSE>	System Generated Success Event
			= Total	
	10-6	100.00	060-TAO-SHIELDDR-ETF	ETF for shield doors when canister is nearby
			CRCF-TAD-AO	Number of TAD canisters transferred to AO
			S-060-SHIELDDOOR	Seismic falling of shield door
			= Total	
	10-7	100.00	060-TAO-SHIELDDR-ETF	ETF for shield doors when canister is nearby
			CRCF-TAD-AO	Number of TAD canisters transferred to AO
			MOD-ENTER-CANISTER	Flooding or spray enters canister
			S-060-PIPING-FAIL	Seismic failure of piping in accident area
			S-060-SHIELDDOOR	Seismic falling of shield door
			= Total	
	11-2	88.43	060-TAO-CTMSWGIB-ETF	ETF for CTM hoisting canister inside bell
			CRCF-TAD-AO	Number of TAD canisters transferred to AO
			S-060-CTMSWG-IB	Significant swinging of canister inside CTM bell
			SHIELDING	Shielding remains intact
		6.41	060-TAO-CTM-OBJ-ETF	ETF for CTM with heavy object over TC

Table C1.4-2. Cut Set Level Results by Sequence (Continued)

Event Tree	Sequence	Cut Set %	Basic Event	Description
			CRCF-TAD-AO	Number of TAD canisters transferred to AO
			S-060-CTM-OBJDROP	Seismic drop of heavy object by CTM
			SHIELDING	Shielding remains intact
		5.16	060-TAO-CTMHOIST-ETF	ETF for CTM hoisting canister - drop
			CRCF-TAD-AO	Number of TAD canisters transferred to AO
			S-060-CTM-HOIST	Seismic drop of canister hoisted by CTM
			SHIELDING	Shielding remains intact
			= Total	
	11-3	0.00	<FALSE>	System Generated Success Event
			= Total	
	11-4	0.00	<FALSE>	System Generated Success Event
			= Total	
	11-5	97.91	060-TAO-CTMSWGOB-ETF	ETF for CTM hoisting canister outside bell
			CRCF-TAD-AO	Number of TAD canisters transferred to AO
			S-060-CTMSWG-OB	Significant swinging of canister outside CTM bell
		2.11	060-TAO-CTM-COL-ETF	ETF for CTM over canister - collapse
			CRCF-TAD-AO	Number of TAD canisters transferred to AO
			S-060-CTM-COLLAPSE	Seismic collapse of CTM (trolley seismic restraints)
		0.00	060-TAO-CTMSWGIB-ETF	ETF for CTM hoisting canister inside bell
			060-TAO-CTMSWGIB-PFA	Breach of canister due to swing inside bell
			CRCF-TAD-AO	Number of TAD canisters transferred to AO
			S-060-CTMSWG-IB	Significant swinging of canister inside CTM bell
		0.00	060-TAO-CTM-OBJ-ETF	ETF for CTM with heavy object over TC
			060-TAO-CTM-OBJ-PFA	Breach of canister due to CTM object drop
			CRCF-TAD-AO	Number of TAD canisters transferred to AO
			S-060-CTM-OBJDROP	Seismic drop of heavy object by CTM

Table C1.4-2. Cut Set Level Results by Sequence (Continued)

Event Tree	Sequence	Cut Set %	Basic Event	Description
		0.00	060-TAO-CTMHOIST-ETF	ETF for CTM hoisting canister - drop
			060-TAO-CTMHOIST-PFA	Breach of canister dropped by CTM
			CRCF-TAD-AO	Number of TAD canisters transferred to AO
			S-060-CTM-HOIST	Seismic drop of canister hoisted by CTM
			= Total	
	11-6	97.89	060-TAO-CTMSWGOB-ETF	ETF for CTM hoisting canister outside bell
			CRCF-TAD-AO	Number of TAD canisters transferred to AO
			MOD-ENTER-CANISTER	Flooding or spray enters canister
			S-060-CTMSWG-OB	Significant swinging of canister outside CTM bell
			S-060-PIPING-FAIL	Seismic failure of piping in accident area
		2.11	060-TAO-CTM-COL-ETF	ETF for CTM over canister - collapse
			CRCF-TAD-AO	Number of TAD canisters transferred to AO
			MOD-ENTER-CANISTER	Flooding or spray enters canister
			S-060-CTM-COLLAPSE	Seismic collapse of CTM (trolley seismic restraints)
			S-060-PIPING-FAIL	Seismic failure of piping in accident area
		0.00	060-TAO-CTMSWGIB-ETF	ETF for CTM hoisting canister inside bell
			060-TAO-CTMSWGIB-PFA	Breach of canister due to swing inside bell
			CRCF-TAD-AO	Number of TAD canisters transferred to AO
			MOD-ENTER-CANISTER	Flooding or spray enters canister
			S-060-CTMSWG-IB	Significant swinging of canister inside CTM bell
			S-060-PIPING-FAIL	Seismic failure of piping in accident area
		0.00	060-TAO-CTM-OBJ-ETF	ETF for CTM with heavy object over TC
			060-TAO-CTM-OBJ-PFA	Breach of canister due to CTM object drop
			CRCF-TAD-AO	Number of TAD canisters transferred to AO
			MOD-ENTER-CANISTER	Flooding or spray enters canister

Table C1.4-2. Cut Set Level Results by Sequence (Continued)

Event Tree	Sequence	Cut Set %	Basic Event	Description
			S-060-CTM-OBJDROP	Seismic drop of heavy object by CTM
			S-060-PIPING-FAIL	Seismic failure of piping in accident area
		0.00	060-TAO-CTMHOIST-ETF	ETF for CTM hoisting canister - drop
			060-TAO-CTMHOIST-PFA	Breach of canister dropped by CTM
			CRCF-TAD-AO	Number of TAD canisters transferred to AO
			MOD-ENTER-CANISTER	Flooding or spray enters canister
			S-060-CTM-HOIST	Seismic drop of canister hoisted by CTM
			S-060-PIPING-FAIL	Seismic failure of piping in accident area
			= Total	
	12-2	100.00	060-TAO-ST-BUMP-ETF	ETF for ST with AO bumping EAF
			CRCF-TAD-AO	Number of TAD canisters transferred to AO
			S-060-ST-BUMP-EAF	Seismic bumping of ST into EAF
			SHIELD-AO	Shielding remains intact
			= Total	
	12-3	0.00	<FALSE>	System Generated Success Event
			= Total	
	12-4	0.00	<FALSE>	System Generated Success Event
			= Total	
	12-5	100.00	060-TAO-ST-SLIDE-ETF	ETF for ST containing TAD in bldg
			CRCF-TAD-AO	Number of TAD canisters transferred to AO
			S-060-ST-SLIDE	Seismic sliding of ST into wall
		0.00	060-TAO-ST-BUMP-ETF	ETF for ST with AO bumping EAF
			060-TAO-ST-BUMP-PFA	Breach of can in ST due to bumping EAF
			CRCF-TAD-AO	Number of TAD canisters transferred to AO
			S-060-ST-BUMP-EAF	Seismic bumping of ST into EAF
			= Total	
	12-6	100.00	060-TAO-ST-SLIDE-ETF	ETF for ST containing TAD in bldg

Table C1.4-2. Cut Set Level Results by Sequence (Continued)

Event Tree	Sequence	Cut Set %	Basic Event	Description
			CRCF-TAD-AO	Number of TAD canisters transferred to AO
			MOD-ENTER-CANISTER	Flooding or spray enters canister
			S-060-PIPING-FAIL	Seismic failure of piping in accident area
			S-060-ST-SLIDE	Seismic sliding of ST into wall
		0.00	060-TAO-ST-BUMP-ETF	ETF for ST with AO bumping EAF
			060-TAO-ST-BUMP-PFA	Breach of can in ST due to bumping EAF
			CRCF-TAD-AO	Number of TAD canisters transferred to AO
			MOD-ENTER-CANISTER	Flooding or spray enters canister
			S-060-PIPING-FAIL	Seismic failure of piping in accident area
			S-060-ST-BUMP-EAF	Seismic bumping of ST into EAF
			= Total	
CRCF-S-IE-TWP	03	100.00	060-TWP-STRUCTUR-ETF	ETF for TWP canister in CRCF structure
			CRCF-TAO-CAN	Number of TADs from AO to WP
			S-060-STR-COLLAPSE	Seismic collapse of CRCF structure
			= Total	
	04-2	100.00	060-TWP-ENTDOOR-ETF	ETF for entry door over AO
			CRCF-TAO-CAN	Number of TADs from AO to WP
			S-060-ENTDOORCOL	Seismic collapse of entry door
			SHIELD-AO	Shielding remains intact
			= Total	
	04-3	0.00	<FALSE>	System Generated Success Event
			= Total	
	04-4	0.00	<FALSE>	System Generated Success Event
			= Total	
	04-5	100.00	060-TWP-ENTDOOR-ETF	ETF for entry door over AO
			060-TWP-ENTDOOR-PFA	Breach of can due to entry door collapse
			CRCF-TAO-CAN	Number of TADs from AO to WP
			S-060-ENTDOORCOL	Seismic collapse of entry door
			= Total	

Table C1.4-2. Cut Set Level Results by Sequence (Continued)

Event Tree	Sequence	Cut Set %	Basic Event	Description
	04-6	100.00	060-TWP-ENTDOOR-ETF	ETF for entry door over AO
			060-TWP-ENTDOOR-PFA	Breach of can due to entry door collapse
			CRCF-TAO-CAN	Number of TADs from AO to WP
			MOD-ENTER-CANISTER	Flooding or spray enters canister
			S-060-ENTDOORCOL	Seismic collapse of entry door
			S-060-PIPING-FAIL	Seismic failure of piping in accident area
			= Total	
	05-2			
	05-3	0.00	<FALSE>	System Generated Success Event
			= Total	
	05-4	0.00	<FALSE>	System Generated Success Event
			= Total	
	05-5	100.00	060-TWP-CPPLAT-ETF	ETF for cask under cask prep platform
			CRCF-TAO-CAN	Number of TADs from AO to WP
			S-060-CPPLAT-COL	Seismic collapse of cask prep platform
			= Total	
	05-6	100.00	060-TWP-CPPLAT-ETF	ETF for cask under cask prep platform
			CRCF-TAO-CAN	Number of TADs from AO to WP
			MOD-ENTER-CANISTER	Flooding or spray enters canister
			S-060-CPPLAT-COL	Seismic collapse of cask prep platform
			S-060-PIPING-FAIL	Seismic failure of piping in accident area
			= Total	
	06-2	100.00	060-TWP-ST-BUMP-ETF	ETF for ST with AO bumping EAF
			CRCF-TAO-CAN	Number of TADs from AO to WP
			S-060-ST-BUMP-EAF	Seismic bumping of ST into EAF
			SHIELD-AO	Shielding remains intact
			= Total	
	06-3	0.00	<FALSE>	System Generated Success Event
			= Total	

Table C1.4-2. Cut Set Level Results by Sequence (Continued)

Event Tree	Sequence	Cut Set %	Basic Event	Description
	06-4	0.00	<FALSE>	System Generated Success Event
			= Total	
	06-5	100.00	060-TWP-ST-SLIDE-ETF	ETF for ST containing can in bldg
			CRCF-TAO-CAN	Number of TADs from AO to WP
			S-060-ST-SLIDE	Seismic sliding of ST into wall
		0.00	060-TWP-ST-BUMP-ETF	ETF for ST with AO bumping EAF
			060-TWP-ST-BUMP-PFA	Breach of can in ST due to bumping EAS
			CRCF-TAO-CAN	Number of TADs from AO to WP
			S-060-ST-BUMP-EAF	Seismic bumping of ST into EAF
			= Total	
	06-6	100.00	060-TWP-ST-SLIDE-ETF	ETF for ST containing can in bldg
			CRCF-TAO-CAN	Number of TADs from AO to WP
			MOD-ENTER-CANISTER	Flooding or spray enters canister
			S-060-PIPING-FAIL	Seismic failure of piping in accident area
			S-060-ST-SLIDE	Seismic sliding of ST into wall
		0.00	060-TWP-ST-BUMP-ETF	ETF for ST with AO bumping EAF
			060-TWP-ST-BUMP-PFA	Breach of can in ST due to bumping EAS
			CRCF-TAO-CAN	Number of TADs from AO to WP
			MOD-ENTER-CANISTER	Flooding or spray enters canister
			S-060-PIPING-FAIL	Seismic failure of piping in accident area
			S-060-ST-BUMP-EAF	Seismic bumping of ST into EAF
			= Total	
	07-2			
	07-3	0.00	<FALSE>	System Generated Success Event
			= Total	
	07-4	0.00	<FALSE>	System Generated Success Event
			= Total	
	07-5	0.00	<FALSE>	System Generated Success Event

Table C1.4-2. Cut Set Level Results by Sequence (Continued)

Event Tree	Sequence	Cut Set %	Basic Event	Description
			= Total	
	07-6	100.00	060-TWP-SHIELDDR-ETF	ETF for shield doors when canister is nearby
			CRCF-TAO-CAN	Number of TADs from AO to WP
			S-060-SHIELDDOOR	Seismic falling of shield door
			= Total	
	07-7	100.00	060-TWP-SHIELDDR-ETF	ETF for shield doors when canister is nearby
			CRCF-TAO-CAN	Number of TADs from AO to WP
			MOD-ENTER-CANISTER	Flooding or spray enters canister
			S-060-PIPING-FAIL	Seismic failure of piping in accident area
			S-060-SHIELDDOOR	Seismic falling of shield door
			= Total	
	08-2	89.54	060-TWP-CTMSWGIB-ETF	ETF for CTM hoisting canister inside bell
			CRCF-TAO-CAN	Number of TADs from AO to WP
			S-060-CTMSWG-IB	Significant swinging of canister inside CTM bell
			SHIELDING	Shielding remains intact
		5.23	060-TWP-CTM-OBJ-ETF	ETF for CTM with heavy object over TC
			CRCF-TAO-CAN	Number of TADs from AO to WP
			S-060-CTM-OBJDROP	Seismic drop of heavy object by CTM
			SHIELDING	Shielding remains intact
		5.23	060-TWP-CTMHOIST-ETF	ETF for CTM hoisting canister - drop
			CRCF-TAO-CAN	Number of TADs from AO to WP
			S-060-CTM-HOIST	Seismic drop of canister hoisted by CTM
			SHIELDING	Shielding remains intact
			= Total	
	08-3	0.00	<FALSE>	System Generated Success Event
			= Total	
	08-4	0.00	<FALSE>	System Generated Success Event
			= Total	
	08-5	98.44	060-TWP-CTMSWGOB-ETF	ETF for CTM hoisting canister outside bell

Table C1.4-2. Cut Set Level Results by Sequence (Continued)

Event Tree	Sequence	Cut Set %	Basic Event	Description
			CRCF-TAO-CAN	Number of TADs from AO to WP
			S-060-CTMSWG-OB	Significant swinging of canister outside CTM bell
		1.58	060-TWP-CTM-COL-ETF	ETF for CTM over canister - Collapse
			CRCF-TAO-CAN	Number of TADs from AO to WP
			S-060-CTM-COLLAPSE	Seismic collapse of CTM (trolley seismic restraints)
		0.00	060-TWP-CTMSWGIB-ETF	ETF for CTM hoisting canister inside bell
			060-TWP-CTMSWGIB-PFA	Breach of canister due to swing inside bell
			CRCF-TAO-CAN	Number of TADs from AO to WP
			S-060-CTMSWG-IB	Significant swinging of canister inside CTM bell
		0.00	060-TWP-CTM-OBJ-ETF	ETF for CTM with heavy object over TC
			060-TWP-CTM-OBJ-PFA	Breach of canister due to CTM object drop
			CRCF-TAO-CAN	Number of TADs from AO to WP
			S-060-CTM-OBJDROP	Seismic drop of heavy object by CTM
		0.00	060-TWP-CTMHOIST-ETF	ETF for CTM hoisting canister - drop
			060-TWP-CTMHOIST-PFA	Breach of canister dropped by CTM
			CRCF-TAO-CAN	Number of TADs from AO to WP
			S-060-CTM-HOIST	Seismic drop of canister hoisted by CTM
			= Total	
	08-6	98.42	060-TWP-CTMSWGOB-ETF	ETF for CTM hoisting canister outside bell
			CRCF-TAO-CAN	Number of TADs from AO to WP
			MOD-ENTER-CANISTER	Flooding or spray enters canister
			S-060-CTMSWG-OB	Significant swinging of canister outside CTM bell
			S-060-PIPING-FAIL	Seismic failure of piping in accident area
		1.58	060-TWP-CTM-COL-ETF	ETF for CTM over canister - Collapse
			CRCF-TAO-CAN	Number of TADs from AO to WP

Table C1.4-2. Cut Set Level Results by Sequence (Continued)

Event Tree	Sequence	Cut Set %	Basic Event	Description
			MOD-ENTER-CANISTER	Flooding or spray enters canister
			S-060-CTM-COLLAPSE	Seismic collapse of CTM (trolley seismic restraints)
			S-060-PIPING-FAIL	Seismic failure of piping in accident area
		0.00	060-TWP-CTMSWGIB-ETF	ETF for CTM hoisting canister inside bell
			060-TWP-CTMSWGIB-PFA	Breach of canister due to swing inside bell
			CRCF-TAO-CAN	Number of TADs from AO to WP
			MOD-ENTER-CANISTER	Flooding or spray enters canister
			S-060-CTMSWG-IB	Significant swinging of canister inside CTM bell
			S-060-PIPING-FAIL	Seismic failure of piping in accident area
		0.00	060-TWP-CTM-OBJ-ETF	ETF for CTM with heavy object over TC
			060-TWP-CTM-OBJ-PFA	Breach of canister due to CTM object drop
			CRCF-TAO-CAN	Number of TADs from AO to WP
			MOD-ENTER-CANISTER	Flooding or spray enters canister
			S-060-CTM-OBJDROP	Seismic drop of heavy object by CTM
			S-060-PIPING-FAIL	Seismic failure of piping in accident area
		0.00	060-TWP-CTMHOIST-ETF	ETF for CTM hoisting canister - drop
			060-TWP-CTMHOIST-PFA	Breach of canister dropped by CTM
			CRCF-TAO-CAN	Number of TADs from AO to WP
			MOD-ENTER-CANISTER	Flooding or spray enters canister
			S-060-CTM-HOIST	Seismic drop of canister hoisted by CTM
			S-060-PIPING-FAIL	Seismic failure of piping in accident area
			= Total	
	09-2	99.05	060-TWP-RHS-OBJ-ETF	ETF for RHS with heavy object over canister
			CRCF-TAO-CAN	Number of TADs from AO to WP
			S-060-RHS-OBJDROP	Seismic drop of heavy object by RHS

Table C1.4-2. Cut Set Level Results by Sequence (Continued)

Event Tree	Sequence	Cut Set %	Basic Event	Description
			SHIELDING	Shielding remains intact
		0.95	060-TWP-RHS-COL-ETF	ETF for RHS over canister - collapse
			CRCF-TAO-CAN	Number of TADs from AO to WP
			S-060-RHS-COLLAPSE	Seismic collapse of RHS
			SHIELDING	Shielding remains intact
			= Total	
	09-3	0.00	<FALSE>	System Generated Success Event
			= Total	
	09-4	0.00	<FALSE>	System Generated Success Event
			= Total	
	09-5	0.00	<FALSE>	System Generated Success Event
			= Total	
	09-6	99.05	060-TWP-RHS-OBJ-ETF	ETF for RHS with heavy object over canister
			060-TWP-RHS-OBJ-PFA	Breach of canister due to RHS object drop
			CRCF-TAO-CAN	Number of TADs from AO to WP
			S-060-RHS-OBJDROP	Seismic drop of heavy object by RHS
		0.95	060-TWP-RHS-COL-ETF	ETF for RHS over canister - collapse
			060-TWP-RHS-COL-PFA	Breach of canister due to RHS collapse
			CRCF-TAO-CAN	Number of TADs from AO to WP
			S-060-RHS-COLLAPSE	Seismic collapse of RHS
			= Total	
	09-7	99.05	060-TWP-RHS-OBJ-ETF	ETF for RHS with heavy object over canister
			060-TWP-RHS-OBJ-PFA	Breach of canister due to RHS object drop
			CRCF-TAO-CAN	Number of TADs from AO to WP
			MOD-ENTER-CANISTER	Flooding or spray enters canister
			S-060-PIPING-FAIL	Seismic failure of piping in accident area
			S-060-RHS-OBJDROP	Seismic drop of heavy object by RHS
		0.95	060-TWP-RHS-COL-ETF	ETF for RHS over canister - collapse

Table C1.4-2. Cut Set Level Results by Sequence (Continued)

Event Tree	Sequence	Cut Set %	Basic Event	Description
			060-TWP-RHS-COL-PFA	Breach of canister due to RHS collapse
			CRCF-TAO-CAN	Number of TADs from AO to WP
			MOD-ENTER-CANISTER	Flooding or spray enters canister
			S-060-PIPING-FAIL	Seismic failure of piping in accident area
			S-060-RHS-COLLAPSE	Seismic collapse of RHS
			= Total	
	10-2	100.00	060-TWP-WPTT-ROCK-ETF	ETF for WPTT in constrained position
			CRCF-TAO-CAN	Number of TADs from AO to WP
			S-060-WPTT-ROCK	Seismic rocking of WPTT (constrained)
			SHIELDING	Shielding remains intact
			= Total	
	10-3	0.00	<FALSE>	System Generated Success Event
			= Total	
	10-4	0.00	<FALSE>	System Generated Success Event
			= Total	
	10-5	0.00	<FALSE>	System Generated Success Event
			= Total	
	10-6	94.82	060-TWP-WPTT-TIP-ETF	ETF for WPTT not constrained
			CRCF-TAO-CAN	Number of TADs from AO to WP
			S-060-WPTT-TIPOVER	Seismic tipover of WPTT
		5.18	060-TWP-WPTT-ROCK-ETF	ETF for WPTT in constrained position
			060-TWP-WPTT-ROCK-PFA	Breach of canister when WPTT rocks
			CRCF-TAO-CAN	Number of TADs from AO to WP
			S-060-WPTT-ROCK	Seismic rocking of WPTT (constrained)
			= Total	
	10-7	94.82	060-TWP-WPTT-TIP-ETF	ETF for WPTT not constrained
			CRCF-TAO-CAN	Number of TADs from AO to WP
			MOD-ENTER-CANISTER	Flooding or spray enters canister
			S-060-PIPING-FAIL	Seismic failure of piping in accident area

Table C1.4-2. Cut Set Level Results by Sequence (Continued)

Event Tree	Sequence	Cut Set %	Basic Event	Description
			S-060-WPTT-TIPOVER	Seismic tipover of WPTT
		5.18	060-TWP-WPTT-ROCK-ETF	ETF for WPTT in constrained position
			060-TWP-WPTT-ROCK-PFA	Breach of canister when WPTT rocks
			CRCF-TAO-CAN	Number of TADs from AO to WP
			MOD-ENTER-CANISTER	Flooding or spray enters canister
			S-060-PIPING-FAIL	Seismic failure of piping in accident area
			S-060-WPTT-ROCK	Seismic rocking of WPTT (constrained)
			= Total	
	11-2	100.00	060-TWP-WPHC-OBJ-ETF	ETF for WPHC with heavy object over WP
			CRCF-TAO-CAN	Number of TADs from AO to WP
			S-060-WPHC-OBJDROP	Seismic drop of heavy object by WPHC
			SHIELDING	Shielding remains intact
			= Total	
	11-3	0.00	<FALSE>	System Generated Success Event
			= Total	
	11-4	0.00	<FALSE>	System Generated Success Event
			= Total	
	11-5	0.00	<FALSE>	System Generated Success Event
			= Total	
	11-6	99.61	060-TWP-WPHC-COL-ETF	ETF for WPHC over WP - collapse
			CRCF-TAO-CAN	Number of TADs from AO to WP
			S-060-WPHC-COLLAPSE	Seismic collapse of WPHC
		0.39	060-TWP-WPHC-OBJ-ETF	ETF for WPHC with heavy object over WP
			060-TWP-WPHC-OBJ-PFA	Breach of WP due to WPHC object drop
			CRCF-TAO-CAN	Number of TADs from AO to WP
			S-060-WPHC-OBJDROP	Seismic drop of heavy object by WPHC
			= Total	
	11-7	99.61	060-TWP-WPHC-COL-ETF	ETF for WPHC over WP - collapse

Table C1.4-2. Cut Set Level Results by Sequence (Continued)

Event Tree	Sequence	Cut Set %	Basic Event	Description
			CRCF-TAO-CAN	Number of TADs from AO to WP
			MOD-ENTER-CANISTER	Flooding or spray enters canister
			S-060-PIPING-FAIL	Seismic failure of piping in accident area
			S-060-WPHC-COLLAPSE	Seismic collapse of WPHC
		0.39	060-TWP-WPHC-OBJ-ETF	ETF for WPHC with heavy object over WP
			060-TWP-WPHC-OBJ-PFA	Breach of WP due to WPHC object drop
			CRCF-TAO-CAN	Number of TADs from AO to WP
			MOD-ENTER-CANISTER	Flooding or spray enters canister
			S-060-PIPING-FAIL	Seismic failure of piping in accident area
			S-060-WPHC-OBJDROP	Seismic drop of heavy object by WPHC
			= Total	
	12-2	100.00	060-TWP-TEVEJECT-ETF	ETF for TEV containing WP
			CRCF-TAO-CAN	Number of TADs from AO to WP
			S-060-TEV-EJECT-WP	Seismic ejection of WP from TEV
		0.00	060-TWP-TEV-TIP-ETF	ETF for TEV containing WP
			CRCF-TAO-CAN	Number of TADs from AO to WP
			S-060-TEV-TIPOVER	Seismic tipover of TEV
			= Total	
	12-4	0.00	<FALSE>	System Generated Success Event
			= Total	
	12-5	0.00	<FALSE>	System Generated Success Event
			= Total	
	12-6	0.00	<FALSE>	System Generated Success Event
			= Total	
	12-7	79.68	060-TWP-TEVSLIDE-ETF	ETF for TEV during WP transfer
			CRCF-TAO-CAN	Number of TADs from AO to WP
			S-060-TEV-SLIDE	Seismic sliding of TEV during WP transfer
		20.34	060-TWP-TEVEJECT-ETF	ETF for TEV containing WP

Table C1.4-2. Cut Set Level Results by Sequence (Continued)

Event Tree	Sequence	Cut Set %	Basic Event	Description
			060-TWP-TEVEJECT-PFA	Breach of WP due to ejection from TEV
			CRCF-TAO-CAN	Number of TADs from AO to WP
			S-060-TEV-EJECT-WP	Seismic ejection of WP from TEV
		0.00	060-TWP-TEV-TIP-ETF	ETF for TEV containing WP
			060-TWP-TEV-TIP-PFA	Breach of WP due to TEV tipover
			CRCF-TAO-CAN	Number of TADs from AO to WP
			S-060-TEV-TIPOVER	Seismic tipover of TEV
			= Total	
	12-8	79.66	060-TWP-TEVSLIDE-ETF	ETF for TEV during WP transfer
			CRCF-TAO-CAN	Number of TADs from AO to WP
			MOD-ENTER-CANISTER	Flooding or spray enters canister
			S-060-PIPING-FAIL	Seismic failure of piping in accident area
			S-060-TEV-SLIDE	Seismic sliding of TEV during WP transfer
		20.34	060-TWP-TEVEJECT-ETF	ETF for TEV containing WP
			060-TWP-TEVEJECT-PFA	Breach of WP due to ejection from TEV
			CRCF-TAO-CAN	Number of TADs from AO to WP
			MOD-ENTER-CANISTER	Flooding or spray enters canister
			S-060-PIPING-FAIL	Seismic failure of piping in accident area
			S-060-TEV-EJECT-WP	Seismic ejection of WP from TEV
		0.00	060-TWP-TEV-TIP-ETF	ETF for TEV containing WP
			060-TWP-TEV-TIP-PFA	Breach of WP due to TEV tipover
			CRCF-TAO-CAN	Number of TADs from AO to WP
			MOD-ENTER-CANISTER	Flooding or spray enters canister
			S-060-PIPING-FAIL	Seismic failure of piping in accident area
			S-060-TEV-TIPOVER	Seismic tipover of TEV
			= Total	
CRCF-S-IE-DPAO	03	100.00	060-TAO-STRUCTUR-ETF	ETF for TAO canister in CRCF structure

Table C1.4-2. Cut Set Level Results by Sequence (Continued)

Event Tree	Sequence	Cut Set %	Basic Event	Description
			CRCF-DP-CAN	Number of DP canisters transferred to AO
			S-060-STR-COLLAPSE	Seismic collapse of CRCF structure
			= Total	
	04-2	100.00	060-TAO-ENTDOOR-ETF	ETF for entry door over transport cask
			CRCF-DP-CAN	Number of DP canisters transferred to AO
			S-060-ENTDOORCOL	Seismic collapse of entry door
			SHIELDING	Shielding remains intact

NOTE: AO = aging overpack; CHC = cask handling crane; CPC = cask preparation crane; CRCF = Canister Receipt and Closure Facility; CTM = canister transfer machine; CTT = cask transfer trolley; DP = dual-purpose; EAF = energy absorbing feature; ETF = exposure time factor; FPW = fire protection water; NVL = naval; RHS = remote handling system; ST = site transporter; TAD = transportation, aging, and disposal; TC = transportation cask; TEV = transport and emplacement vehicle; TWP = TAD-to-waste-package; WP = waste package; WPHC = waste package handling crane; WPTT = waste package transfer trolley.

Source: Original

C2 DOE SNF (CRCF-DSNF)

This section provides the detailed information used to develop the event sequences for the analysis of processing of the DSNF canisters inside the CRCF. DSNF canisters inside a transportation cask are received on railcars, and are transferred into a waste package, sealed, and then transported in a TEV out of the CRCF. Transport to the emplacement drifts is not included in this section.

C2.1 EVENT TREES

The IET and SRETs are presented in this section. The tables provide the assignments between the event tree branches and the fault trees given in the next section.

Seismic Event	Number of DOE SNF canisters	Identify initiating seismic failure		
SEIS-EVENT	CRCF-DOE-SNF	SEIS-FAIL	#	END-STATE
			1	OK
		CRCF building collapse	2	OK
		Entry door seismic collapse	3	RR-UNF
		Railcar accident	4	T => 2 CRCF-S-R-TC1
		Mobile platform seismic collapse	5	T => 2 CRCF-S-R-TC1
		CHC seismic failures	6	T => 2 CRCF-S-R-TC1
		Cask prep platform collapse	7	T => 2 CRCF-S-R-TC1
		CTT seismic failures	8	T => 2 CRCF-S-R-TC1
		Shield door seismic failure	9	T => 2 CRCF-S-R-TC1
		CTM seismic failure	10	T => 3 CRCF-S-R-SD1
		Staging rack failure	11	T => 4 CRCF-S-R-CTM
		RHS-robotic arm seismic failure	12	T => 5 CRCF-S-R-CAN
		WPTT tipover	13	T => 6 CRCF-S-R-WP1
		WPHC seismic failure	14	T => 6 CRCF-S-R-WP1
		TEV seismic failure	15	T => 6 CRCF-S-R-WP1
			16	T => 7 CRCF-S-R-TEV

CRCF-S-IE-DOE-SNF - CRCF Seismic Event Tree - Initiating Seismic Failures - DOE SNF

2007/12/14 Page 1

NOTE: Event tree branch captions are associated with the branch line below the caption.

CAN = canister; CHC = cask handling crane; CRCF = Canister Receipt and Closure Facility; CTM = canister transfer machine; CTT = cask transfer trolley; DOE = U.S. Department of Energy; IE = initiating event; RHS = remote handling system; SD = shield door; SEIS = seismic; TC = transportation cask; T = transfer; TEV = transport and emplacement vehicle; UNF = unfiltered; WP = waste package; WPHC = waste package handling crane; WPTT = waste package transfer trolley.

Source: Original

Figure C2.1-1. CRCF Seismic Event Tree
 CRCF-S-IE-DOE-SNF-
 Initiating Seismic Failures –
 DOE SNF

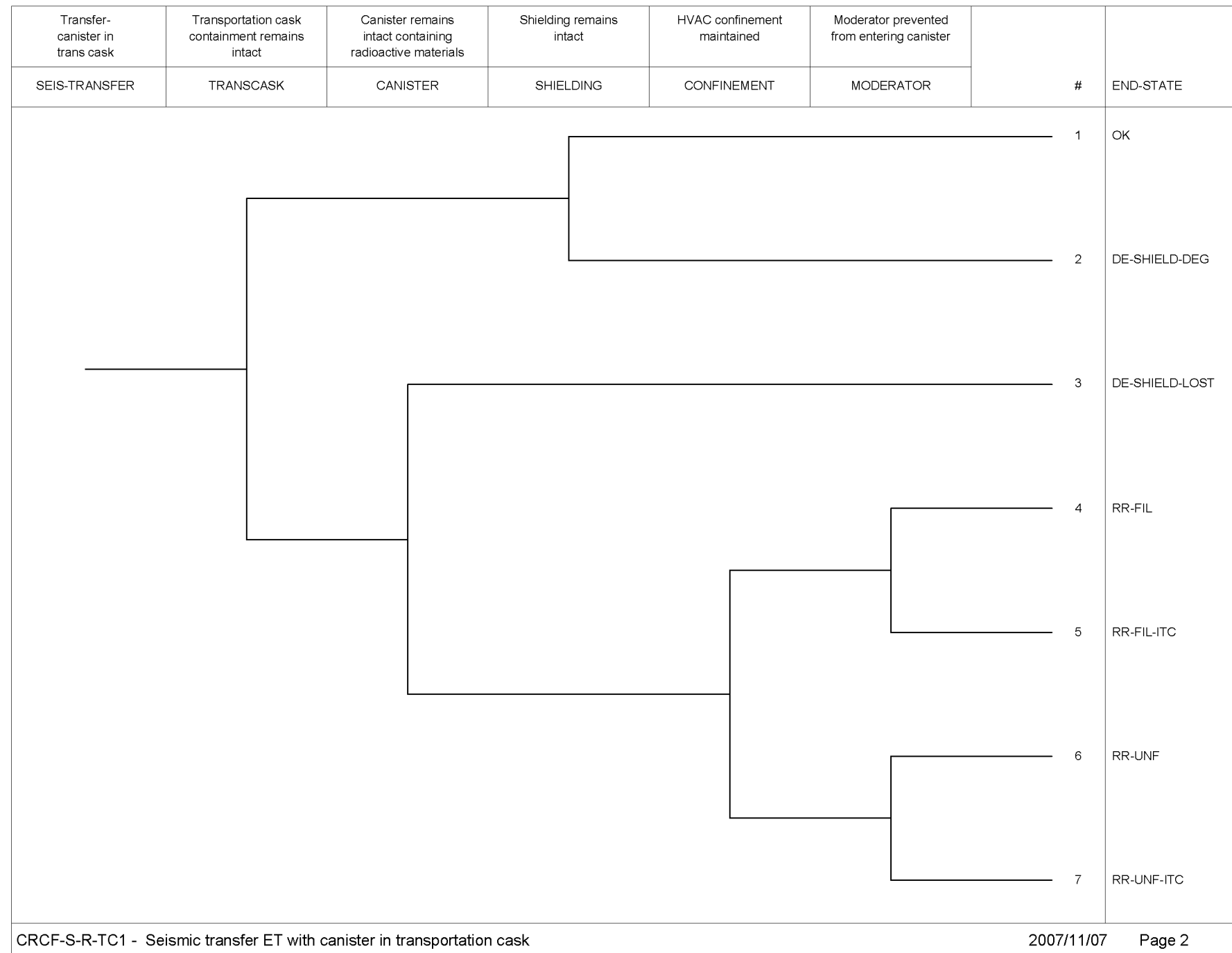

NOTE: CRCF = Canister Receipt and Closure Facility; DE = direct exposure; DEG = degradation; ET = event tree; FIL = filtered; HVAC = heating, ventilation and air conditioning; ITC = important to criticality; RR = radioactive release; SEIS = seismic; TC = transportation cask; UNF = unfiltered.

Source: Original

Figure C2.1-2. CRCF Seismic Event Tree
 CRCF-S-R-TC1 – Seismic
 Transfer ET with Canister in
 Transportation Cask

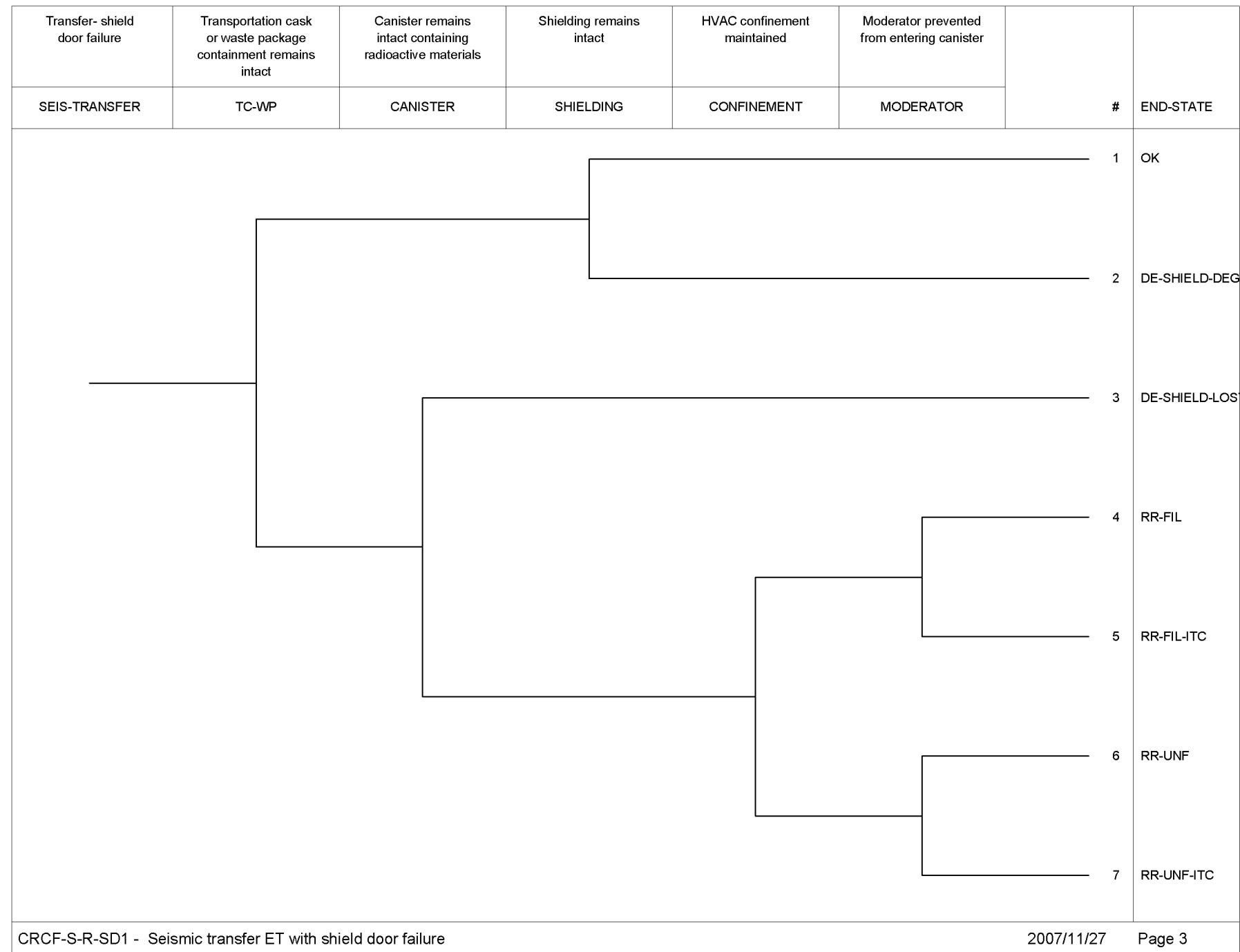

NOTE: CRCF = Canister Receipt and Closure Facility; DE = direct exposure; ET = event tree; FIL = filtered; HVAC = heating, ventilation and air conditioning; ITC = important to criticality; RR = radioactive release; SD = shield door; SEIS = seismic; TC = transportation cask; UNF = unfiltered; WP = waste package.

Source: Original

Figure C2.1-3. CRCF Seismic Event Tree
 CRCF-S-R-SD1 – Seismic
 Transfer ET with Shield Door
 Failure

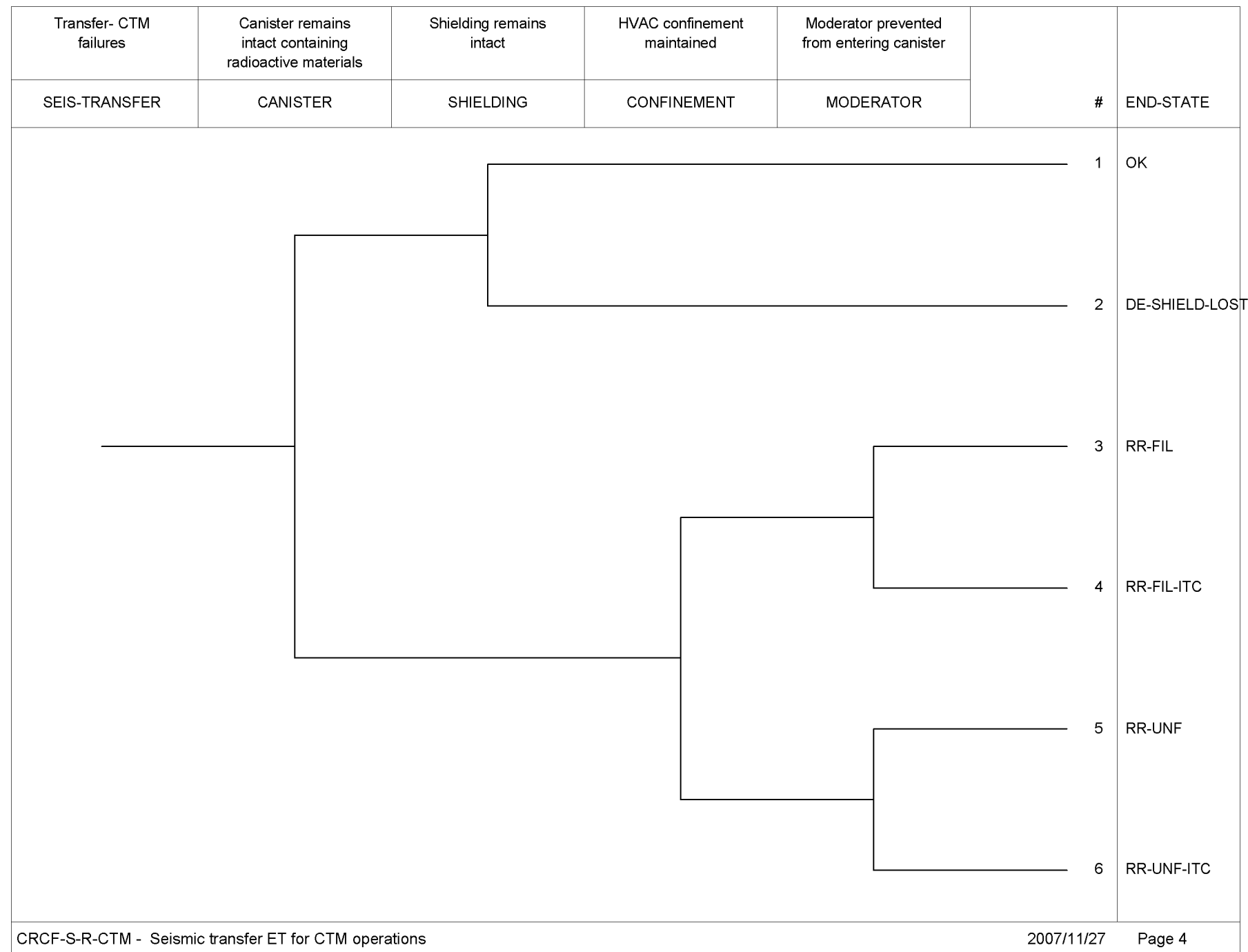

NOTE: CRCF = Canister Receipt and Closure Facility; CTM = canister transfer machine; DE = direct exposure; ET = event tree; FIL = filtered; ITC = important to criticality; RR = radioactive release; SEIS = seismic; UNF = unfiltered.

Source: Original

Figure C2.1-4. CRCF Seismic Event Tree
CRCF-S-R-CTM – Seismic
Transfer ET for CTM Operations

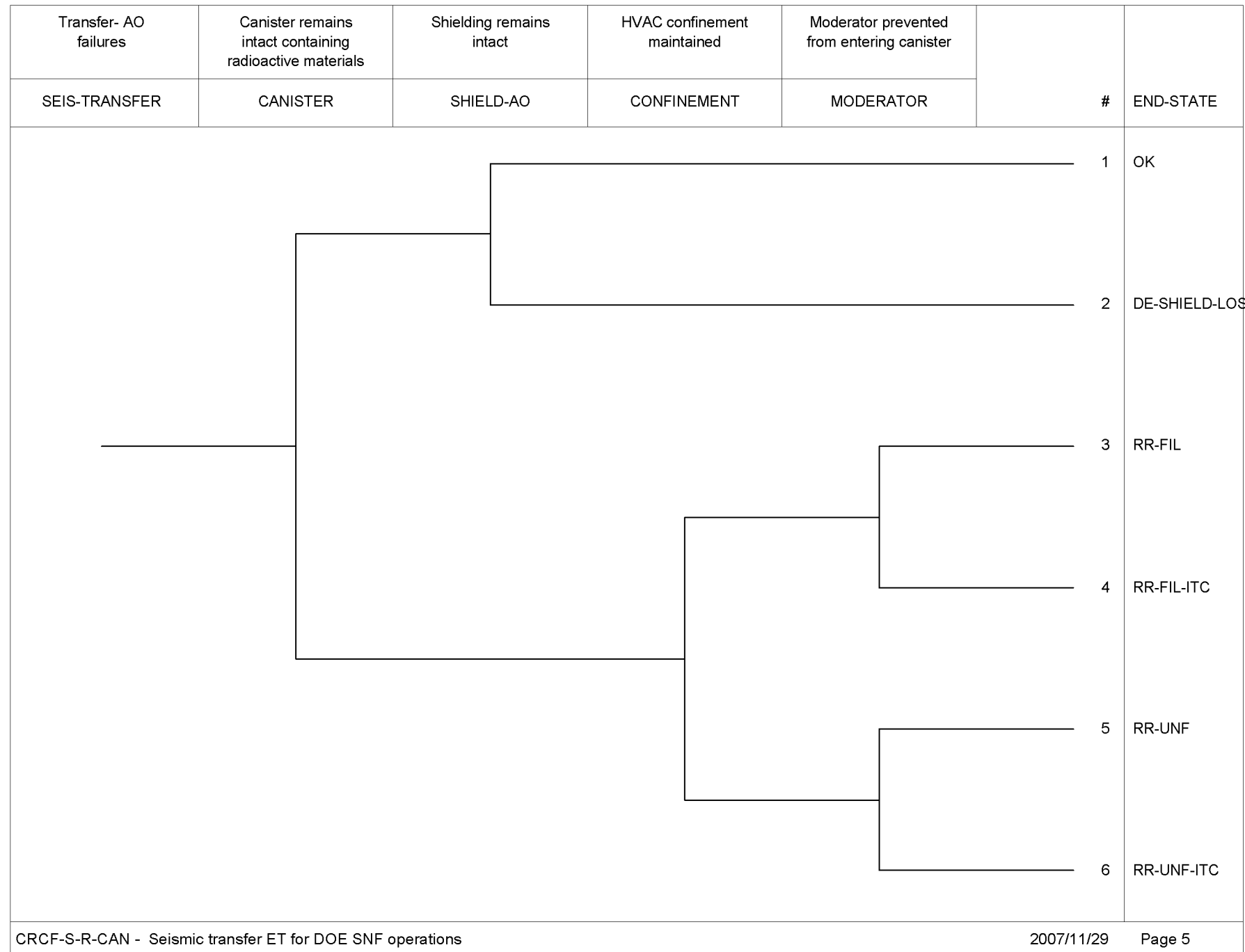

NOTE: AO = aging overpack; CAN = canister; CRCF = Canister Receipt and Closure Facility; CTM = canister transfer machine; DE = direct exposure; DOE = U.S. Department of Energy; ET = event tree; FIL = filtered; HVAC = heating, ventilation and air conditioning; ITC = important to criticality; RR = radioactive release; SEIS = seismic; SNF = spent nuclear fuel; UNF = unfiltered.

Source: Original

Figure C2.1-5. CRCF Seismic Event Tree
 CRCF-S-R-CAN – Seismic
 Transfer ET for DOE SNF
 Operations

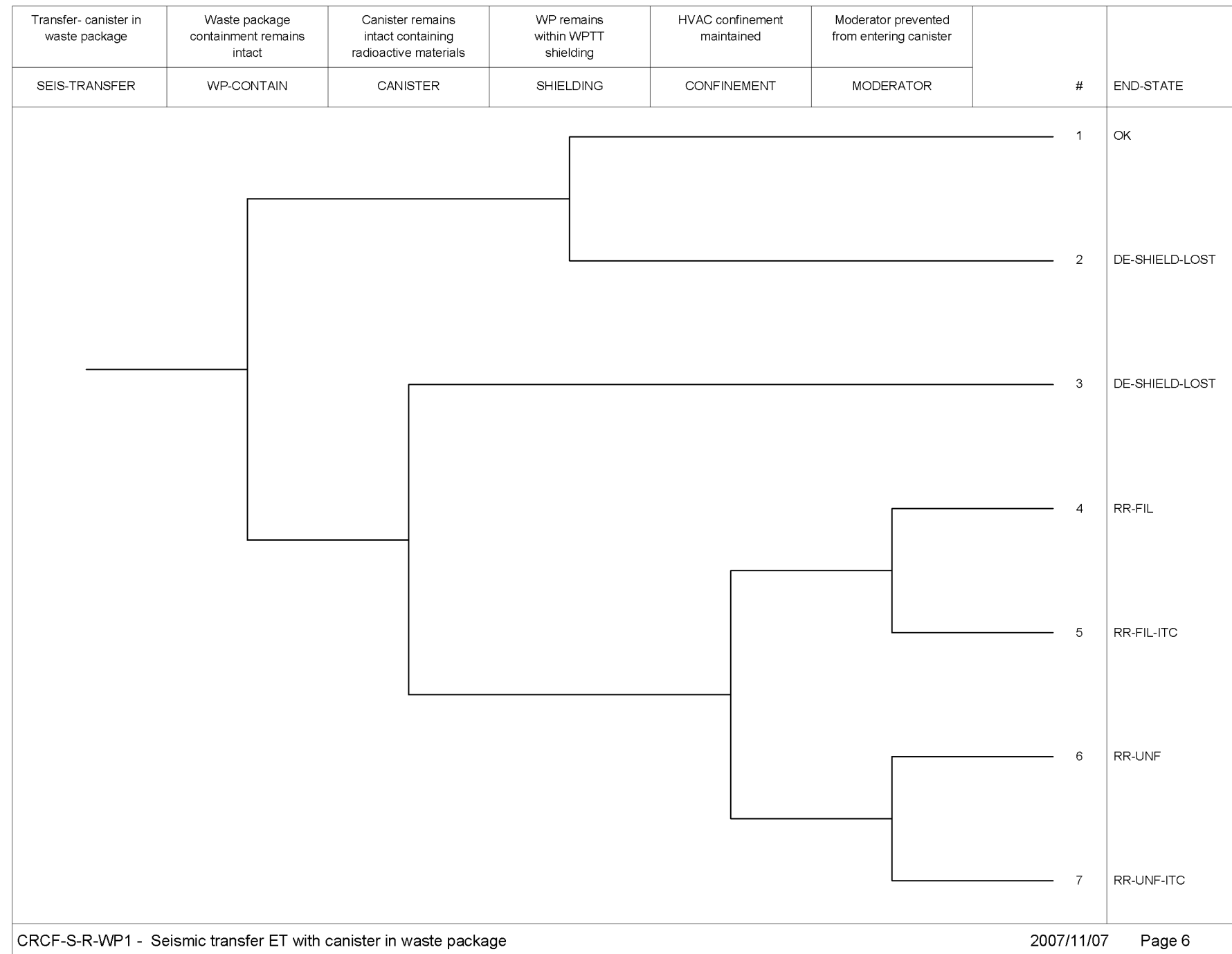

NOTE: AO = aging overpack; CRCF = Canister Receipt and Closure Facility; CTM = canister transfer machine; DE = direct exposure; ET = event tree; FIL = filtered; HVAC = heating, ventilation and air conditioning; ITC = important to criticality; RR = radioactive release; SEIS = seismic; UNF = unfiltered; WP = waste package; WPTT = waste package transfer trolley.

Source: Original

Figure C2.1-6. CRCF Seismic Event Tree
 CRCF-S-R-WP1 – Seismic
 Transfer ET with Canister in
 Waste Package

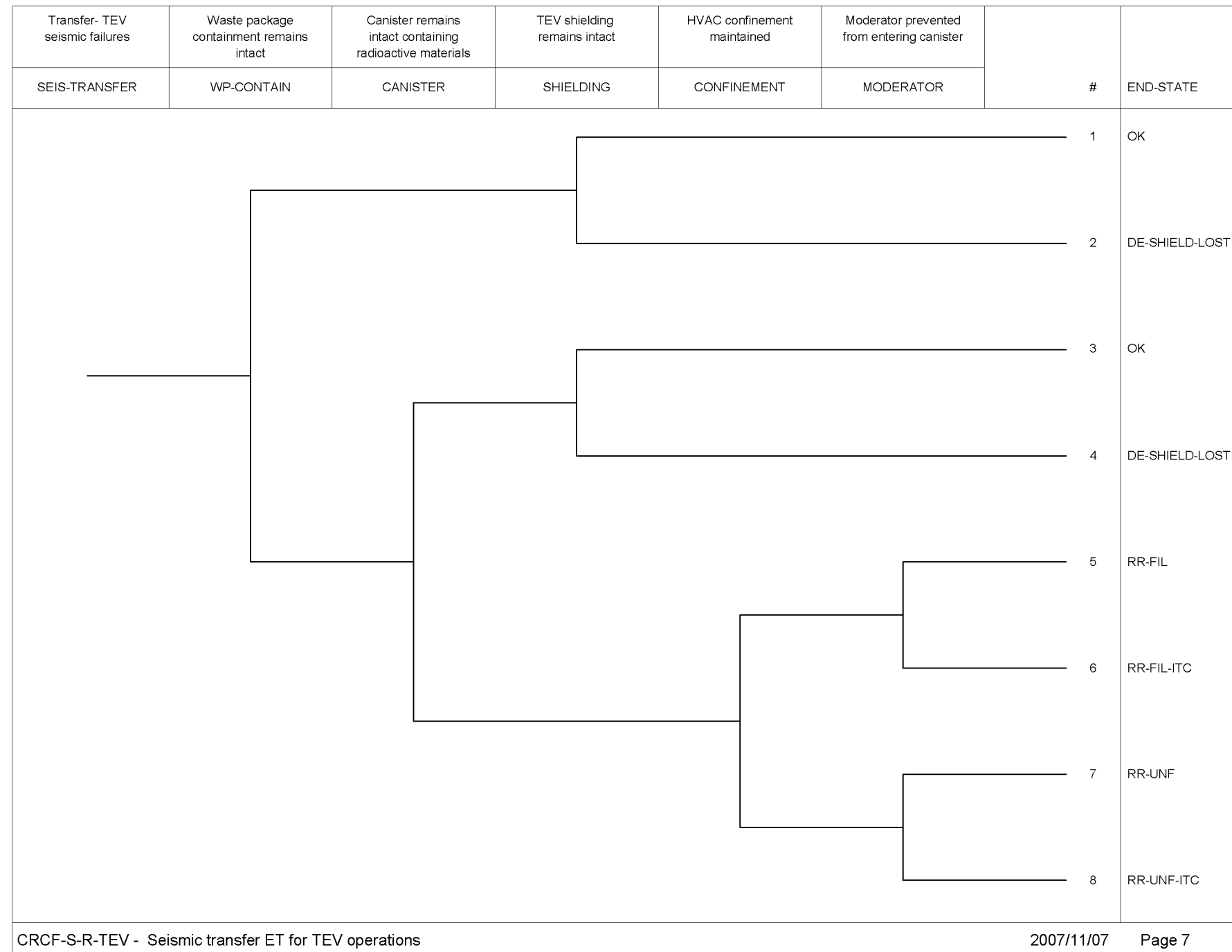

NOTE: CRCF = Canister Receipt and Closure Facility; CTM = canister transfer machine; DE = direct exposure; ET = event tree; FIL = filtered; HVAC = heating, ventilation and air conditioning; ITC = important to criticality; RR = radioactive release; SEIS = seismic; TEV = transport and emplacement vehicle; UNF = unfiltered; WP = waste package.

Source: Original

Figure C2.1-7. CRCF Seismic Event Tree
 CRCF-S-R-TEV – Seismic
 Transfer ET for TEV Operations

Table C2.1-1. Fault Trees Assigned for Initiating Seismic Failures for the CRCF

Process	Initiator Event Tree	Initiating Seismic Failure	Associated Fault Tree
DOE SNF	CRCF-S-IE-DOE-SNF	CRCF building collapse	S-060-DSNF-STR-COLLAP
		Entry door seismic collapse	S-060-DSNF-ENTDOORCOL
		Railcar accident	S-060-DSNF-RAILCARACC
		Mobile platform seismic collapse	S-060-DSNF-MOBPLATCOL
		CHC seismic failures	S-060-DSNF-CHC-FAIL
		Cask prep platform collapse	S-060-DSNF-CPREP-PLAT
		CTT seismic failures	S-060-DSNF-CTT-FAIL
		Shield door seismic failure	S-060-DSNF-SHIELDDOOR
		CTM seismic failures	S-060-DSNF-CTM-FAIL
		Staging rack failure	S-060-DSNF-SRACK-FAIL
		RHS-robotic arm seismic failures	= S-060-DSNF-RHS-FAIL
		WPTT tipover	S-060-DSNF-WPTT-FAIL
		WPHC seismic failures	S-060-DSNF-WPHC-FAIL
TEV seismic failures	S-060-DSNF-TEV-FAIL		

NOTE: CRCF = Canister Receipt and Closure Facility; CHC = cask handling crane; CTM = canister transfer machine; CTT = cask transfer trolley; DOE = U.S. Department of Energy; RHS = remote handling system; SNF = spent nuclear fuel; TEV = transport and emplacement vehicle; WP = waste package; WPHC = waste package handling crane; WPTT = waste package transfer trolley.

Source: Original

Table C2.1-2. Fault Trees Assigned for Pivotal Events for CRCF-S-IE-DOE-SNF Initiating Event Tree

Initiating Seismic Failure	TRANSCASK	MODERATOR
CRCF building collapse	N/A	N/A
Entry door seismic collapse	RC-DSNF-DOORDROP-CASK	CRCF-MOD-MULT-SYS
Railcar accident	RC-DSNF-RC-ACC-CASK	CRCF-MOD-MULT-SYS
Mobile platform seismic collapse	RC-DSNF-MOB-PLAT-CASK	CRCF-MOD-MULT-SYS
CHC seismic failures	TC-DSNF-CHC-CASK	CRCF-MOD-MULT-SYS
Cask prep platform collapse	TC-DSNF-CPP-CASK	CRCF-MOD-MULT-SYS
CTT seismic failures	CTT-DSNF-CTT-CASK	CRCF-MOD-MULT-SYS
	TC-WP	
Shield door seismic failure	TCWP-DSNF-SHIELDDOOR	CRCF-MOD-MULT-SYS
	CANISTER	
CTM seismic failures	CTM-DSNF-CTM-CAN	CRCF-MOD-MULT-SYS
Staging rack failure	CAN-DSNF-SRACK-FAIL	CRCF-MOD-MULT-SYS
	WP-CONTAIN	
RHS-robotic arm seismic failures	WPTT-DSNF-RHS-FAIL;	CRCF-MOD-MULT-SYS
WPTT tipover	WPTT-DSNF-WPTT-FAIL	CRCF-MOD-MULT-SYS
WPHC seismic failures	WPTT-DSNF-WPHC-FAIL	CRCF-MOD-MULT-SYS
TEV seismic failures	TEV-DSNF-TEV-FAIL	CRCF-MOD-MULT-SYS

NOTE: CRCF = Canister Receipt and Closure Facility; CHC = cask handling crane; CTM = canister transfer machine; CTT = cask transfer trolley; RHS = remote handling system; SNF = spent nuclear fuel; TC = transportation cask; TEV = transport and emplacement vehicle; WP = waste package; WPHC = waste package handling crane; WPTT = waste package transfer trolley.

Source: Original

C2.2 FAULT TREES

Seismic fault trees for the processing of DSNF canisters in the CRCF are presented in alphanumeric order in this section.

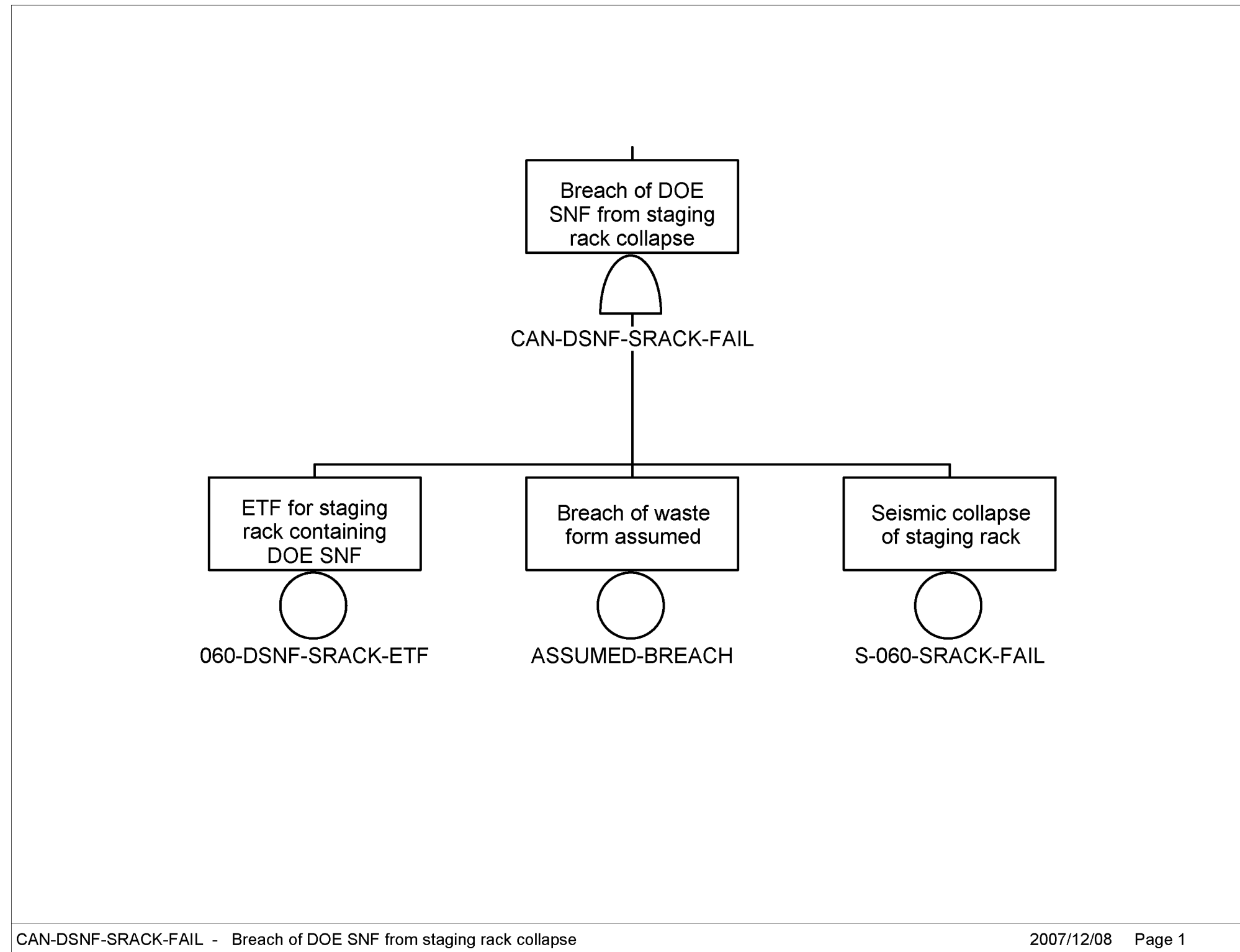

Source: Original

Figure C2.2-1. Fault Tree CAN-DSNF-SRACK-FAIL – Breach of DOE SNF from Staging Rack Collapse

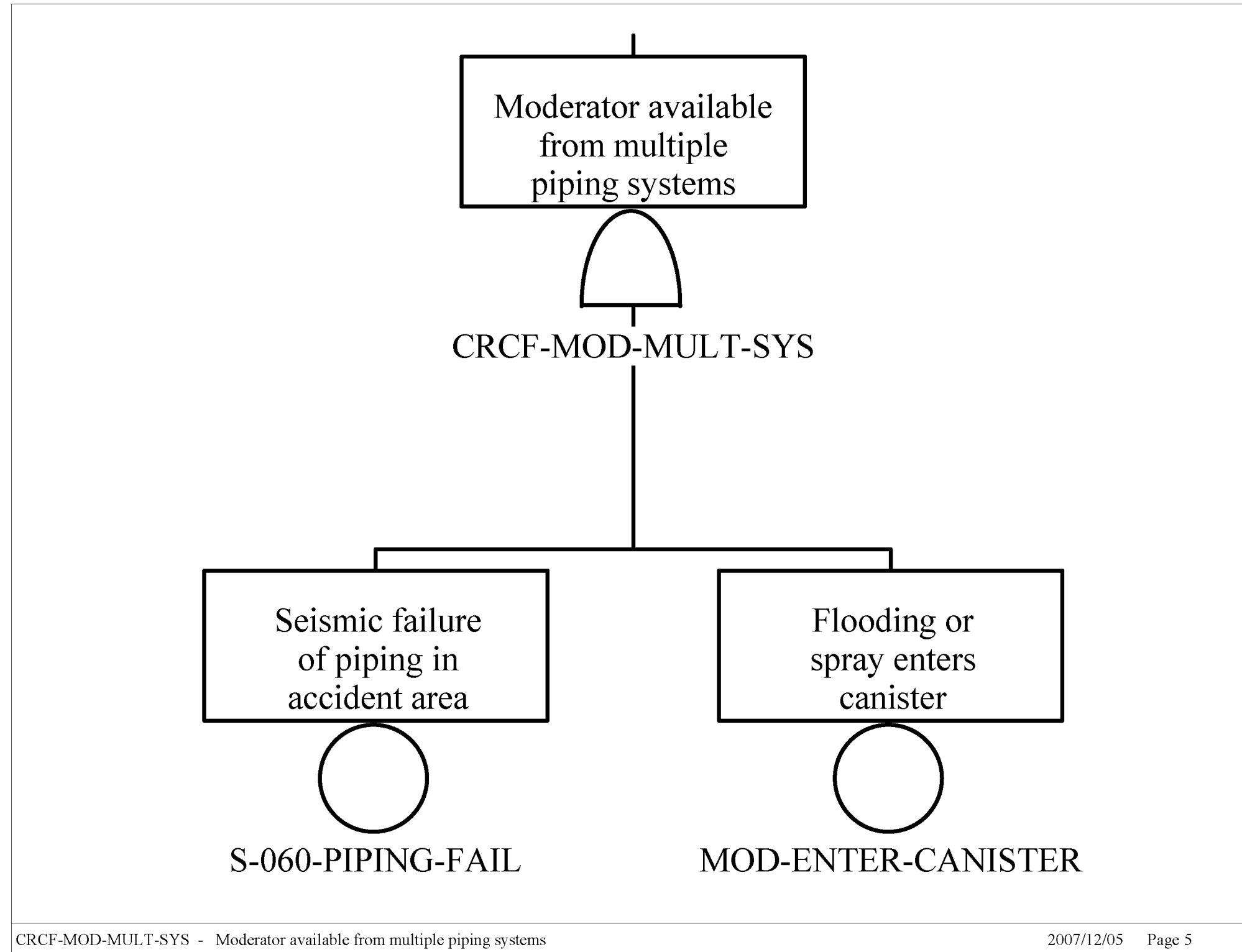

Source: Original

Figure C2.2-2. CRCF-MOD-MULT-SYS – Moderator Available from Multiple Piping Systems

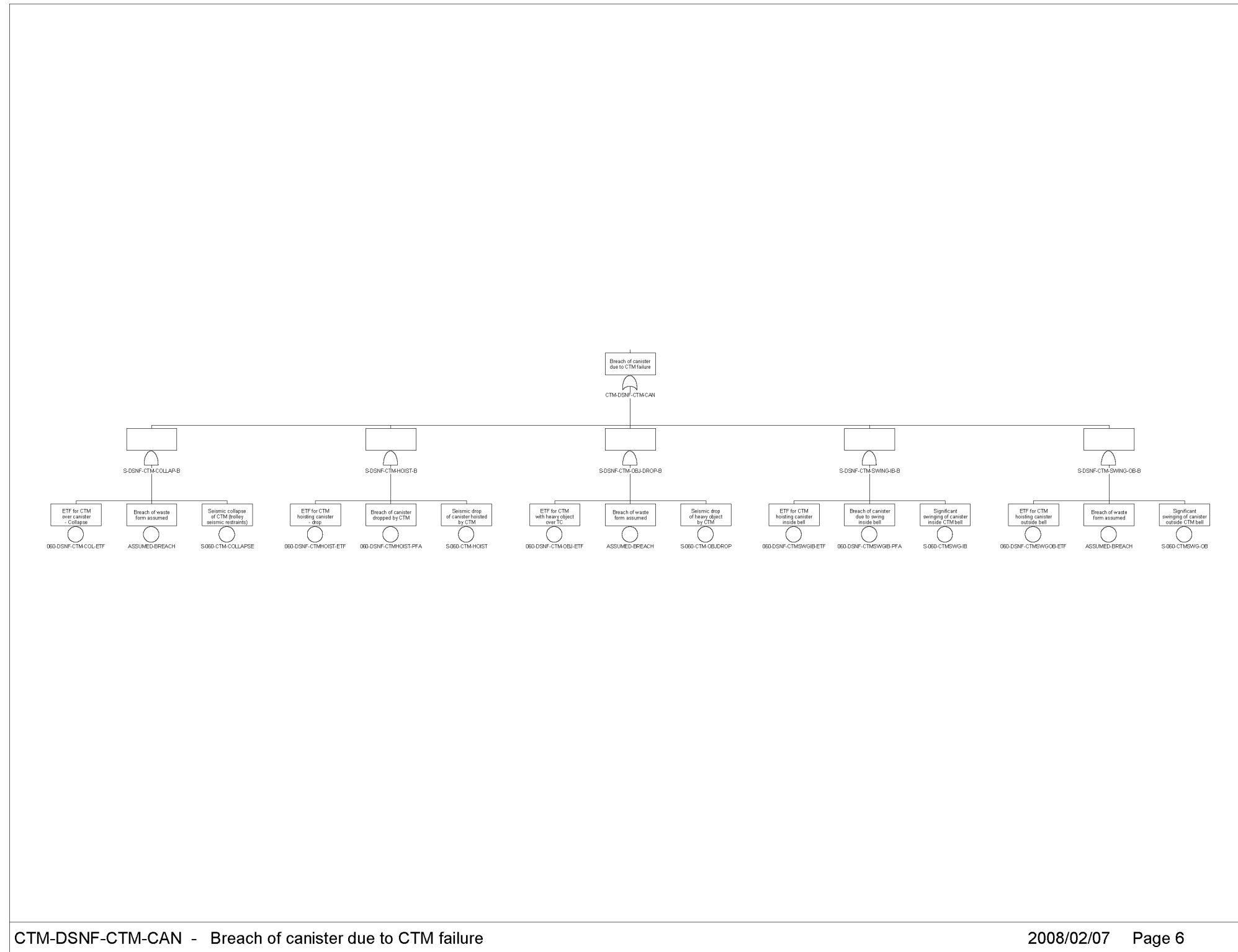

Source: Original

Figure C2.2-3. CTM-DSNF-CTM-CAN – Breach of Canister due to CTM Failure

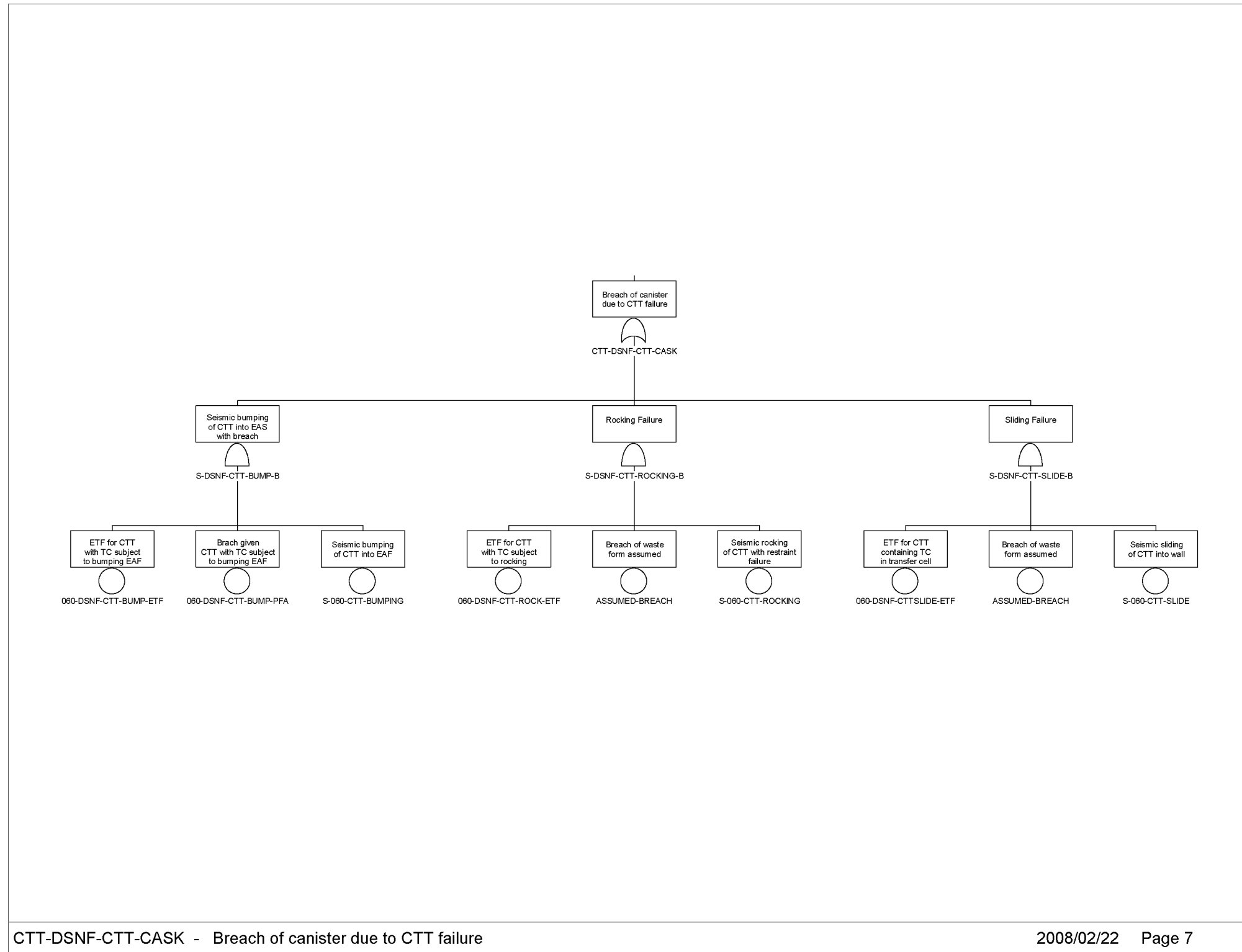

Source: Original

Figure C2.2-4. CTT-DSNF-CTT-CASK – Breach of Canister due to CTT Failure

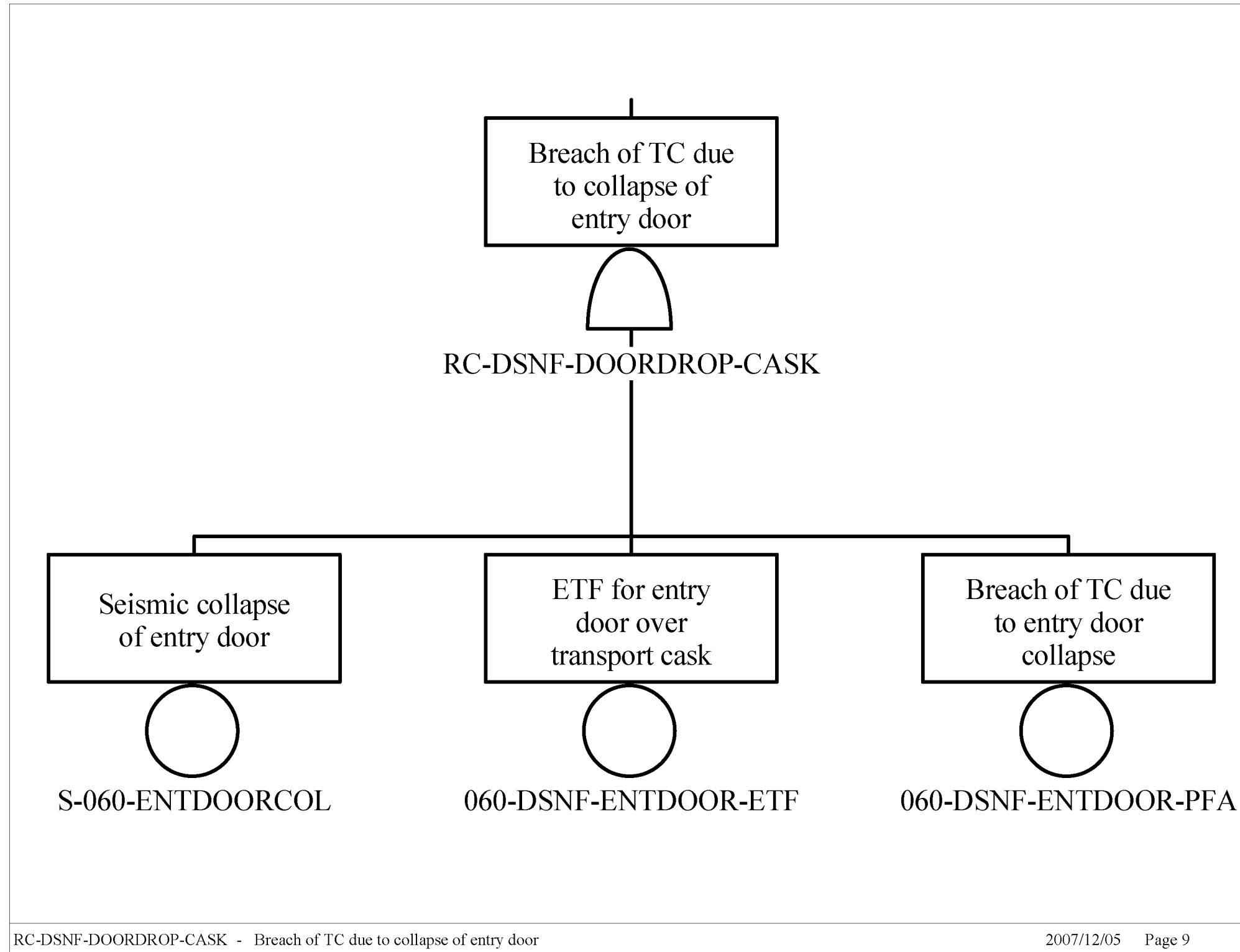

Source: Original

Figure C2.2-5. RC-DSNF-DOORDROP-CASK – Breach of TC due to Collapse of Entry Door

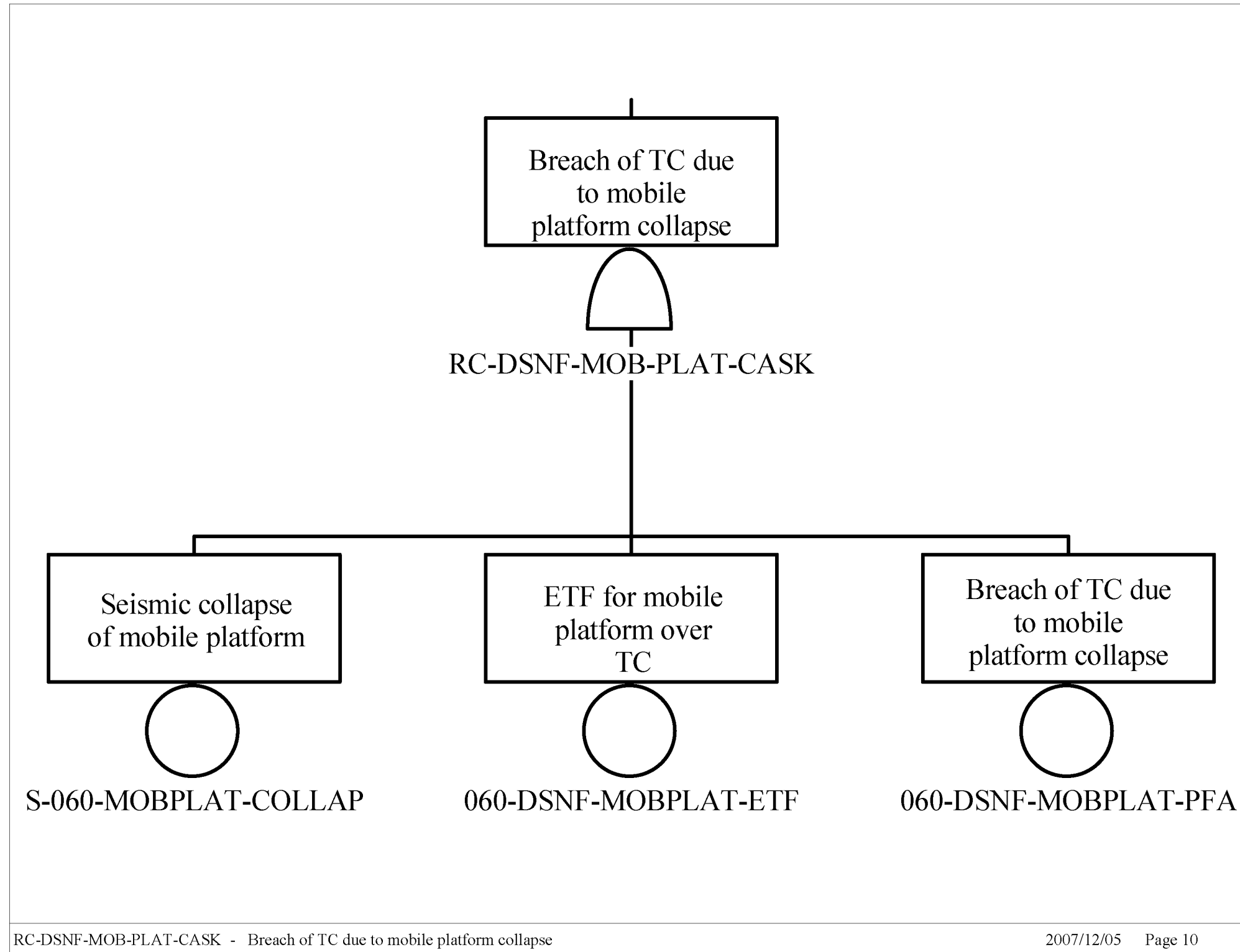

Source: Original

Figure C2.2-6. RC-DSNF-MOB-PLAT-CASK – Breach of TC due to Mobile Platform Collapse

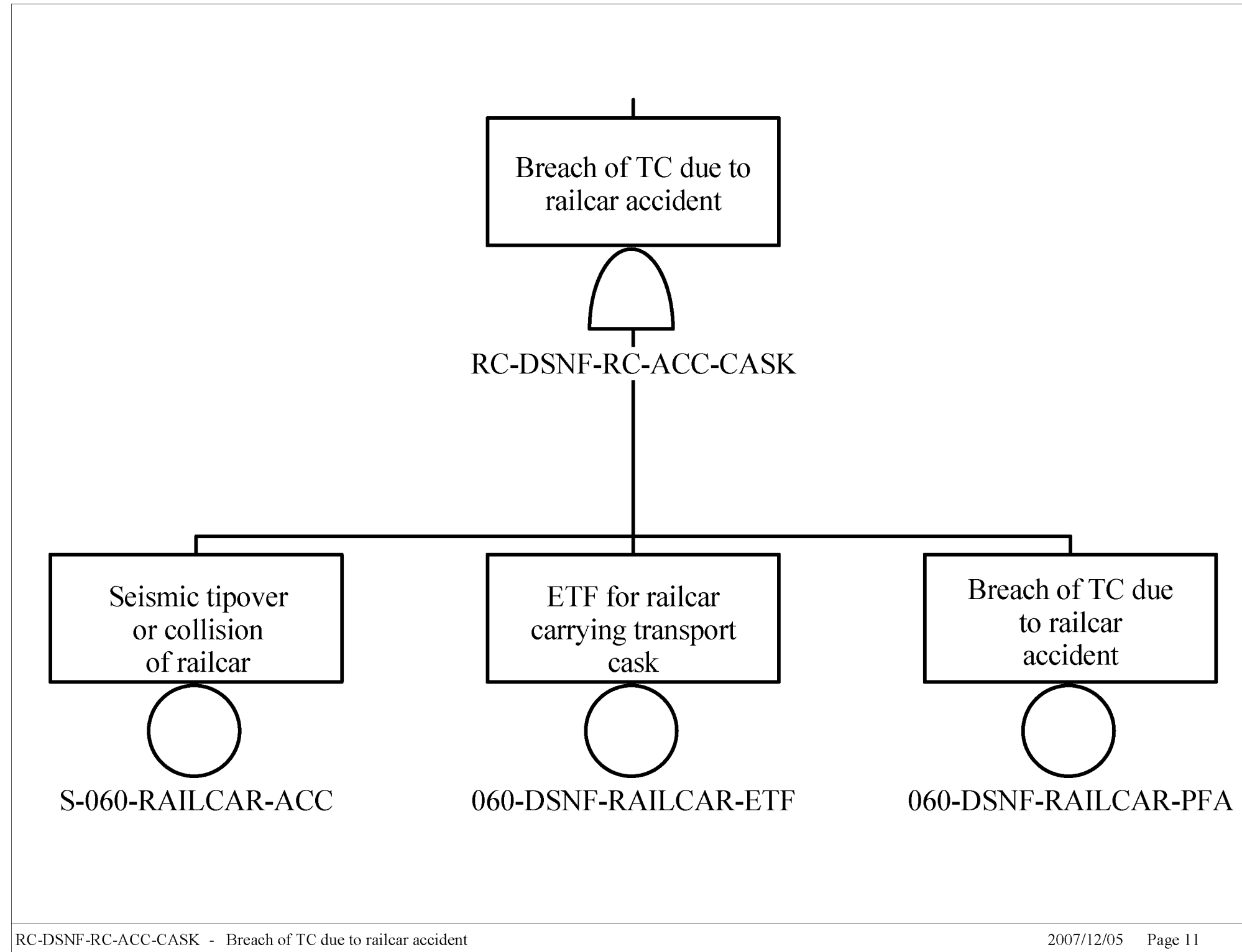

Source: Original

Figure C2.2-7. RC-DSNF-RC-ACC-CASK – Breach of TC due to Railcar Accident

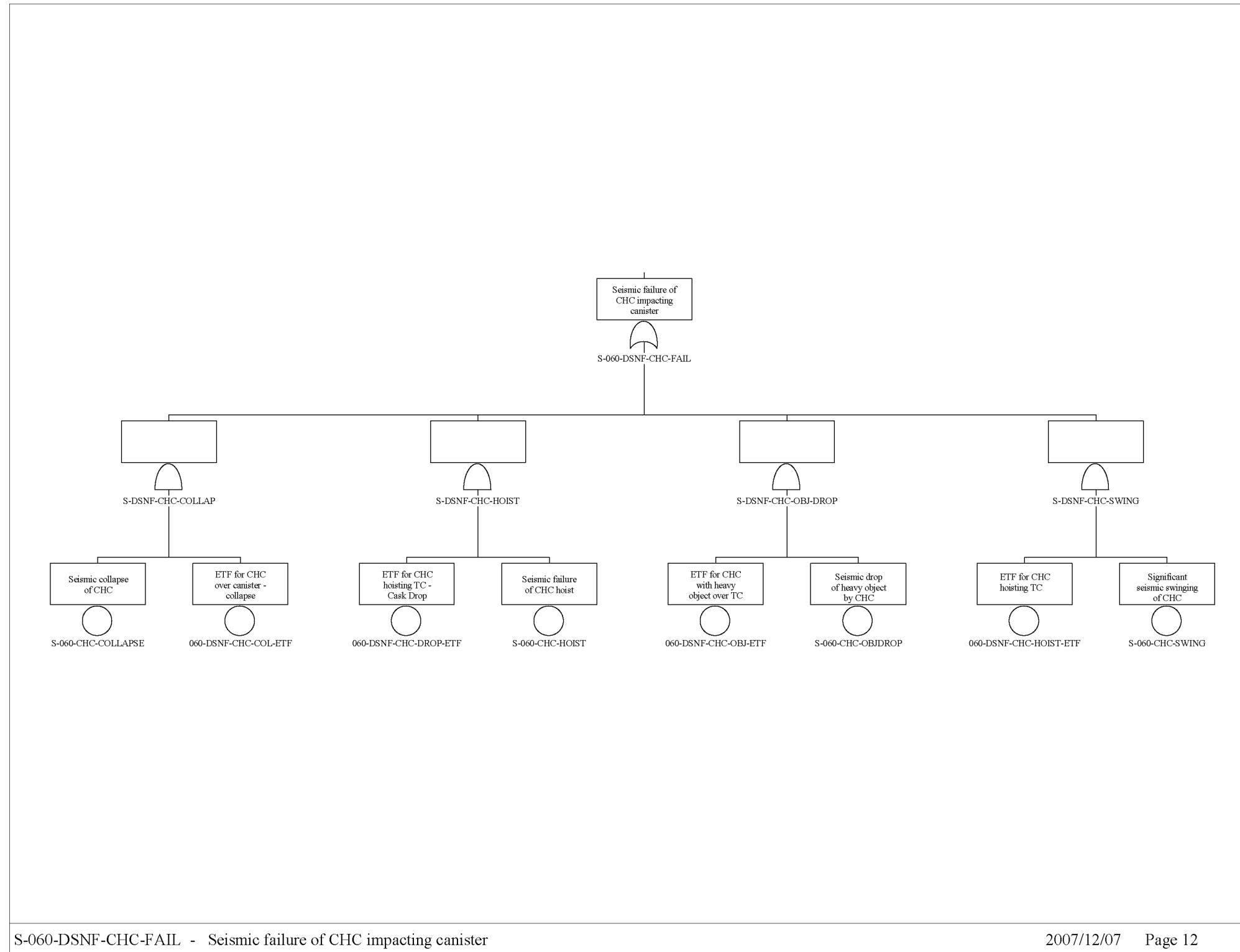

Source: Original

Figure C2.2-8. S-060-DSNF-CHC-FAIL – Seismic Failure of CHC Impacting Canister

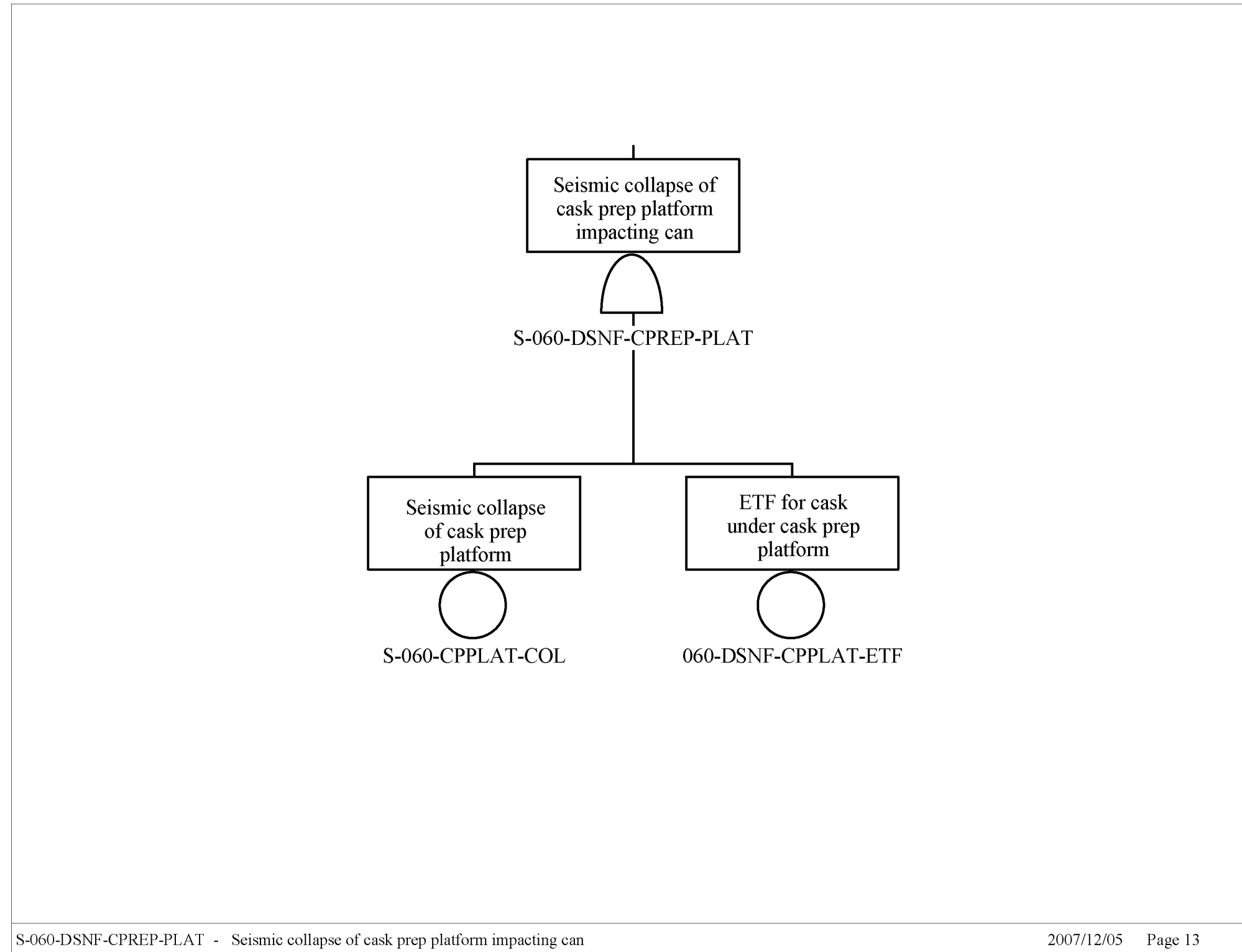

Source: Original

Figure C2.2-9. S-060-DSNF-CPREP-PLAT – Seismic Collapse of Cask Prep Platform Impacting Can

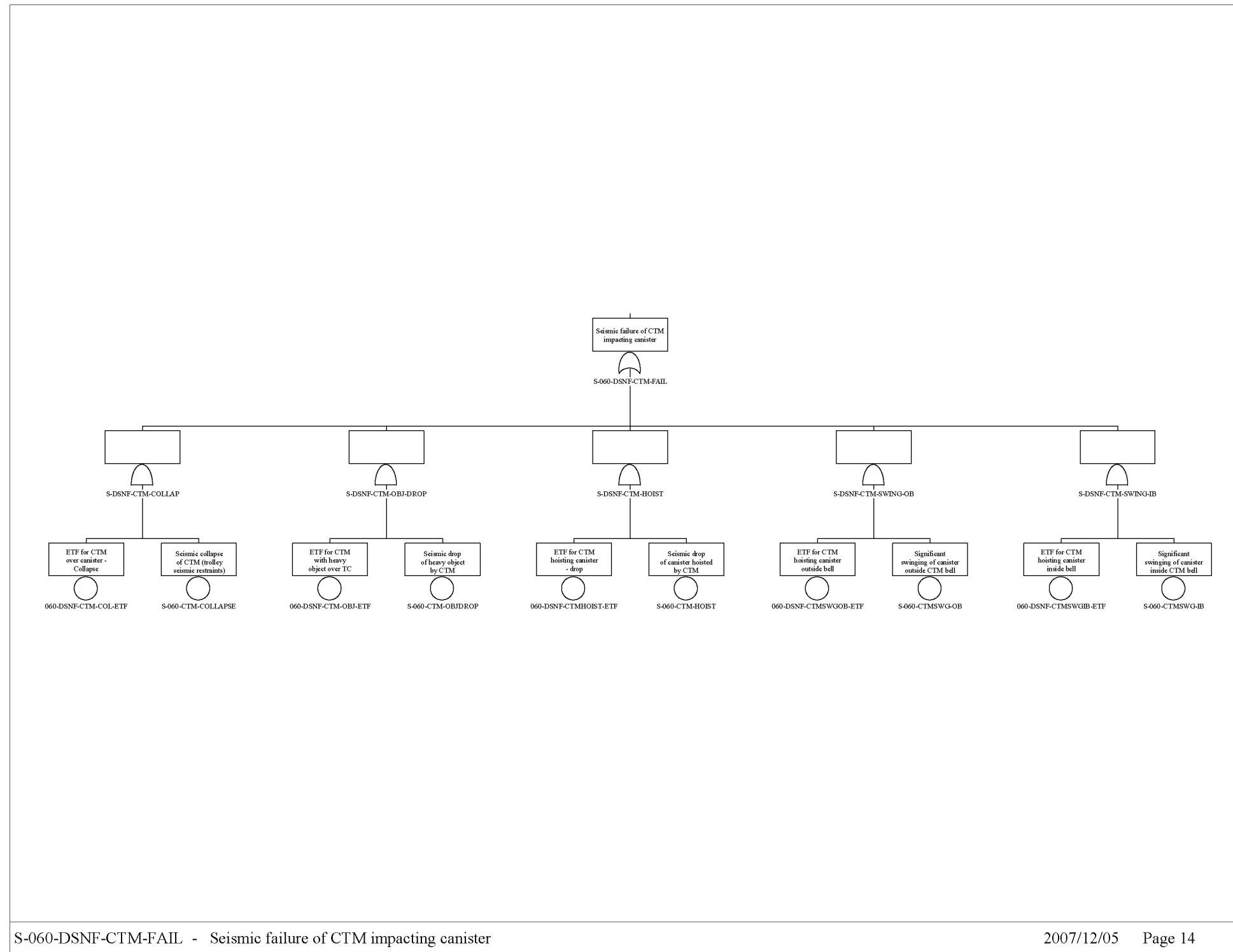

Source: Original

Figure C2.2-10. S-060-DSNF-CTM-FAIL – Seismic Failure of CTM Impacting Canister

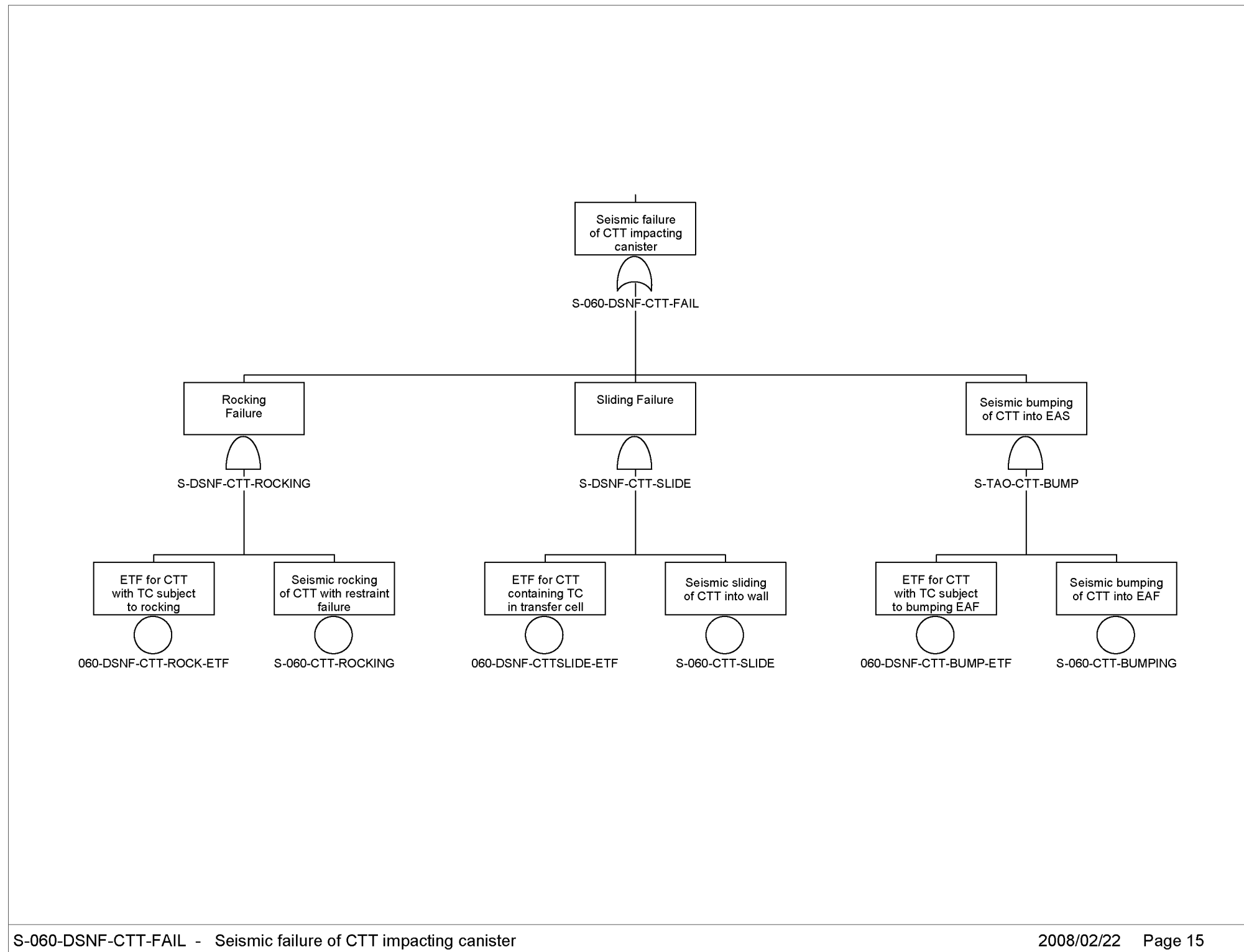

Source: Original

Figure C2.2-11. S-060-DSNF-CTT-FAIL – Seismic Failure of CTT Impacting Canister

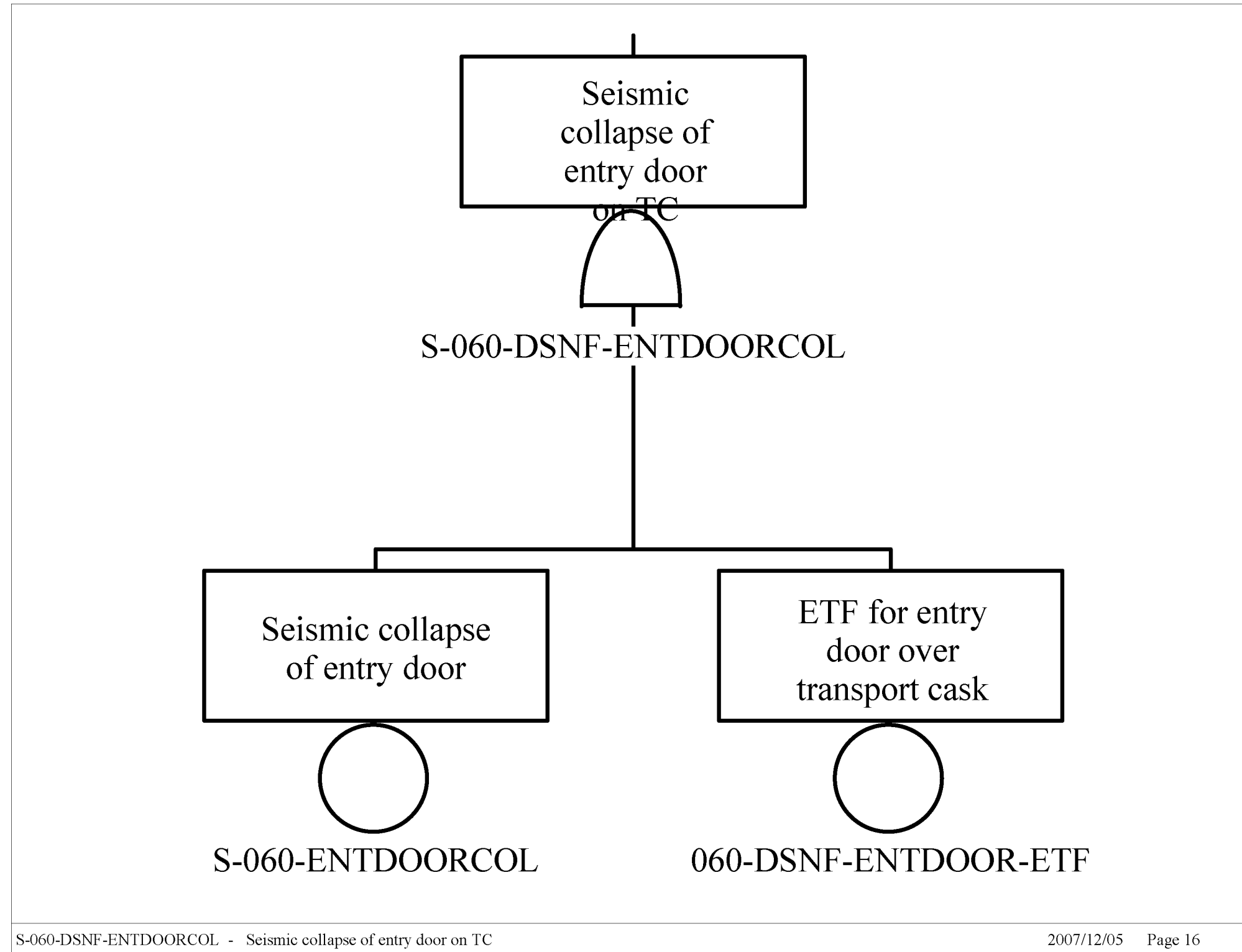

Source: Original

Figure C2.2-12. S-060-DSNF-ENTDOORCOL – Seismic Collapse of Entry Door on TC

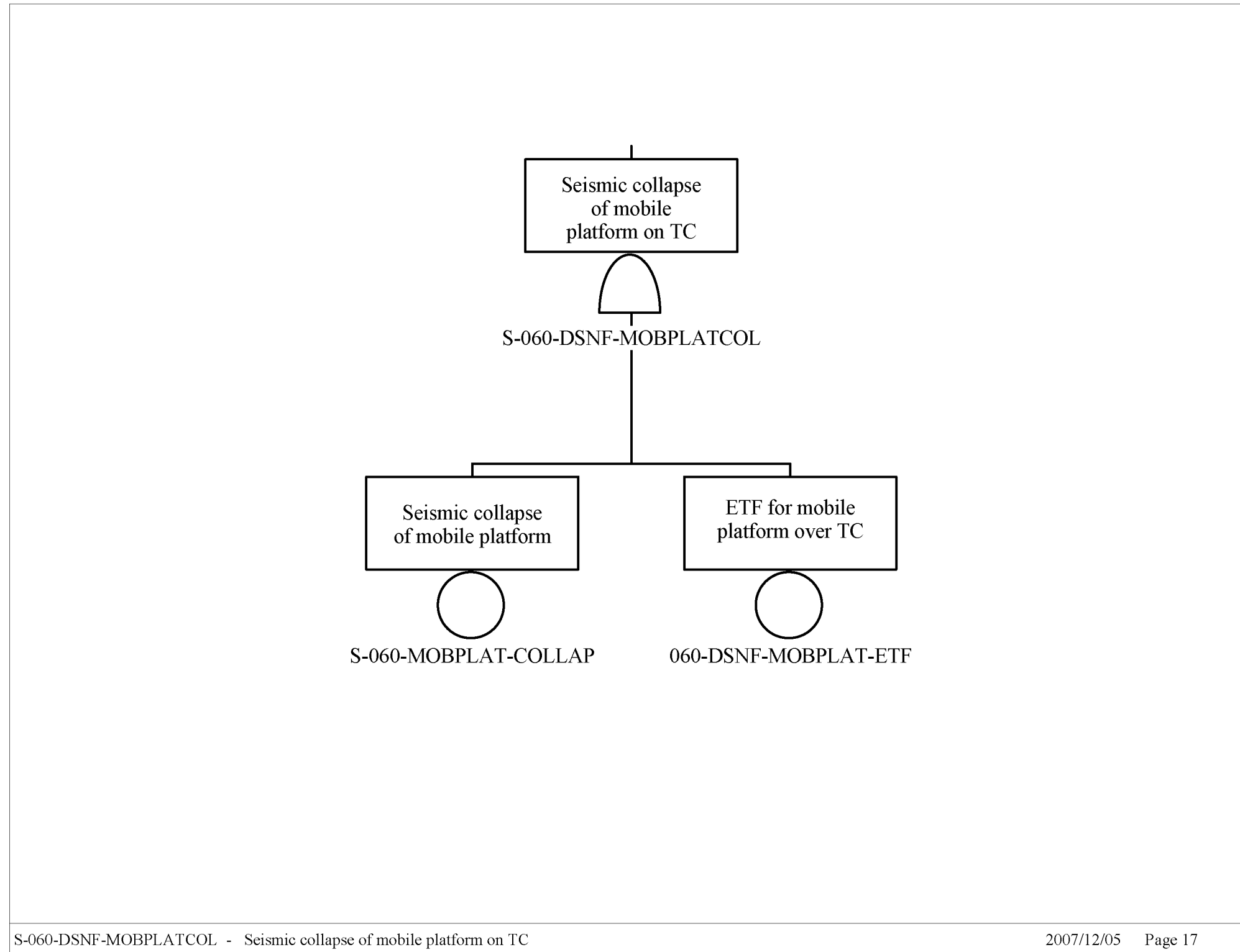

Source: Original

Figure C2.2-13. S-060-DSNF-MOBPLATCOL – Seismic Collapse of Mobile Platform on TC

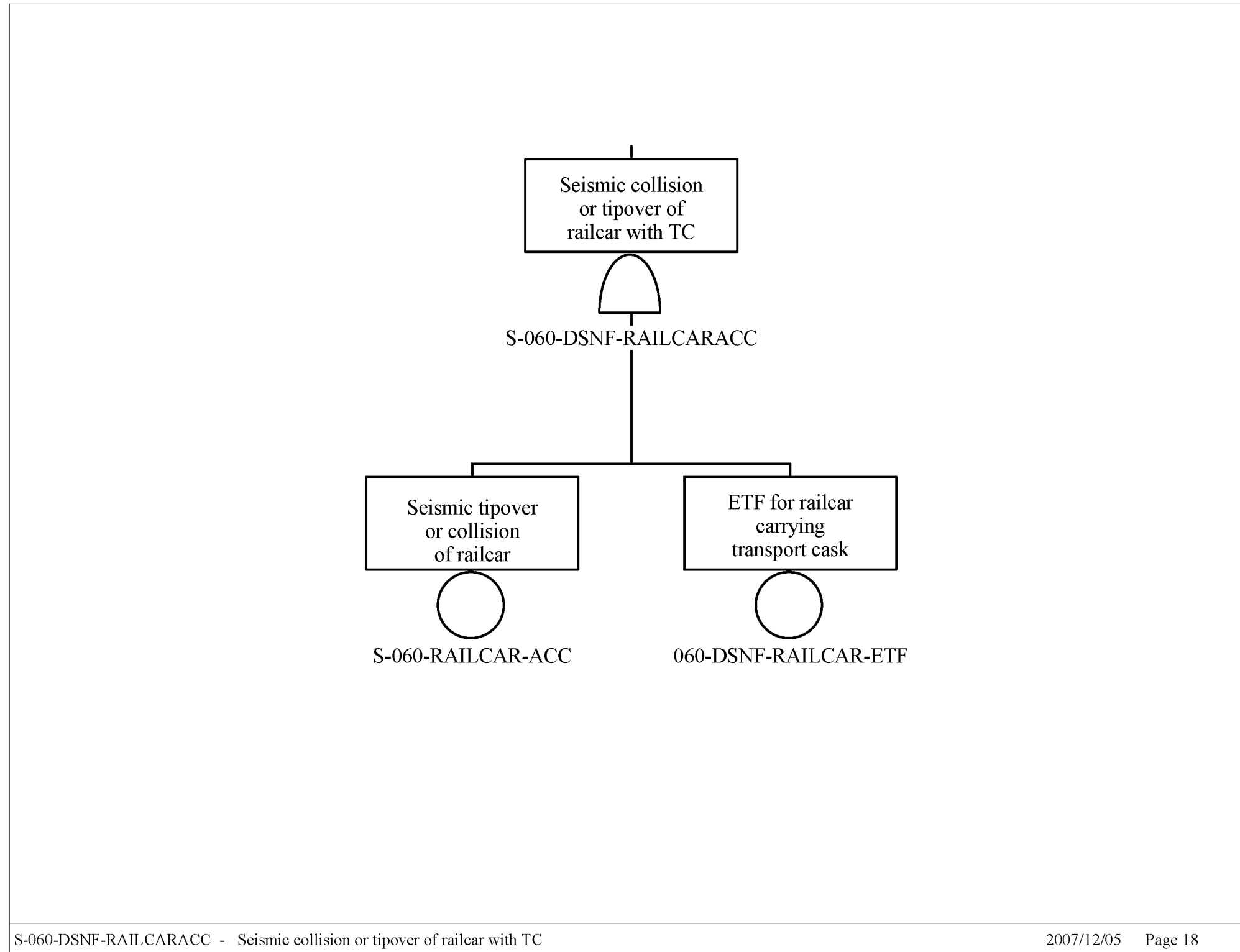

Source: Original

Figure C2.2-14. S-060-DSNF-RAILCARACC – Seismic Collision or Tipover of Railcar with TC

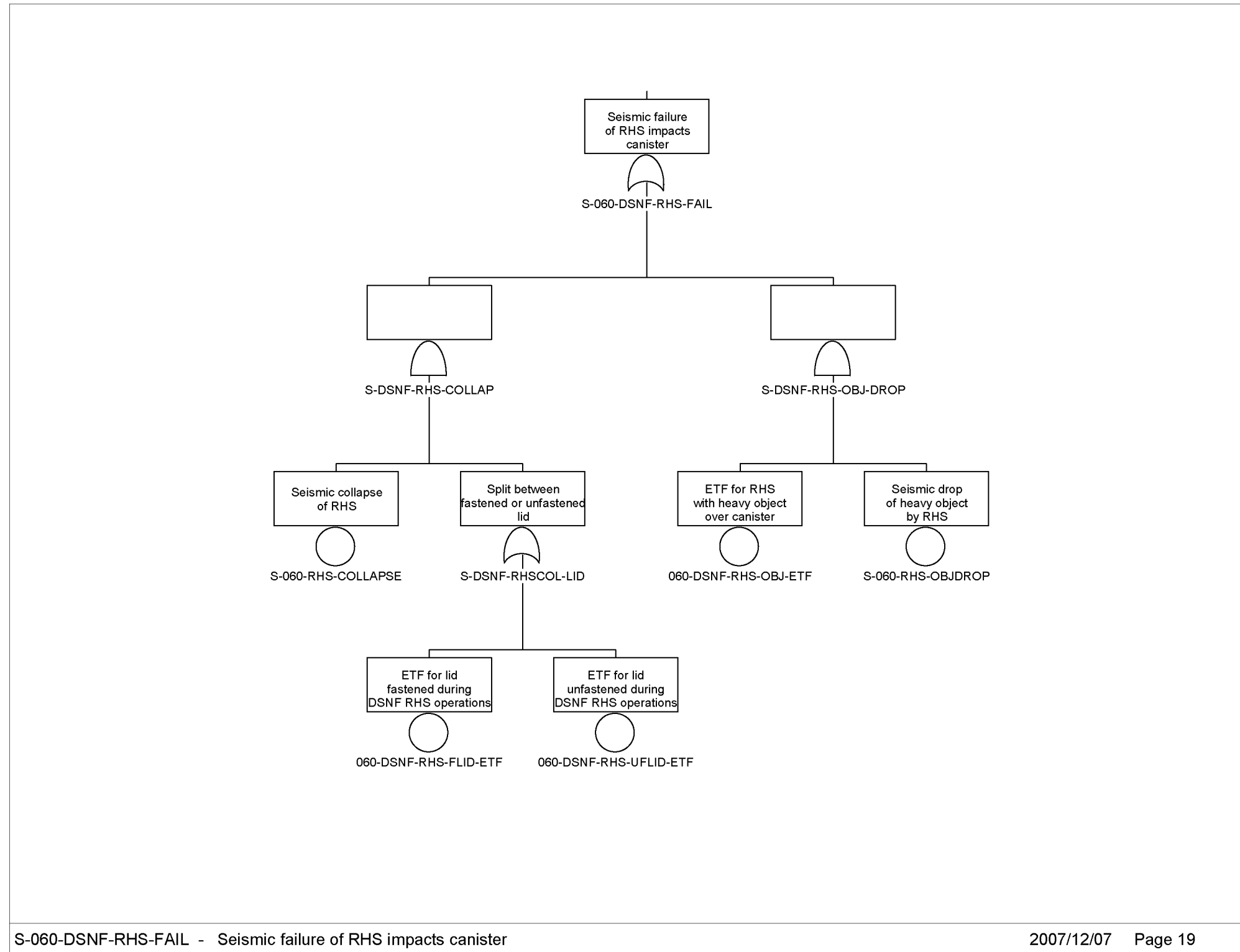

Source: Original

Figure C2.2-15. S-060-DSNF-RHS-FAIL – Seismic Failure of RHS Impacts Canister

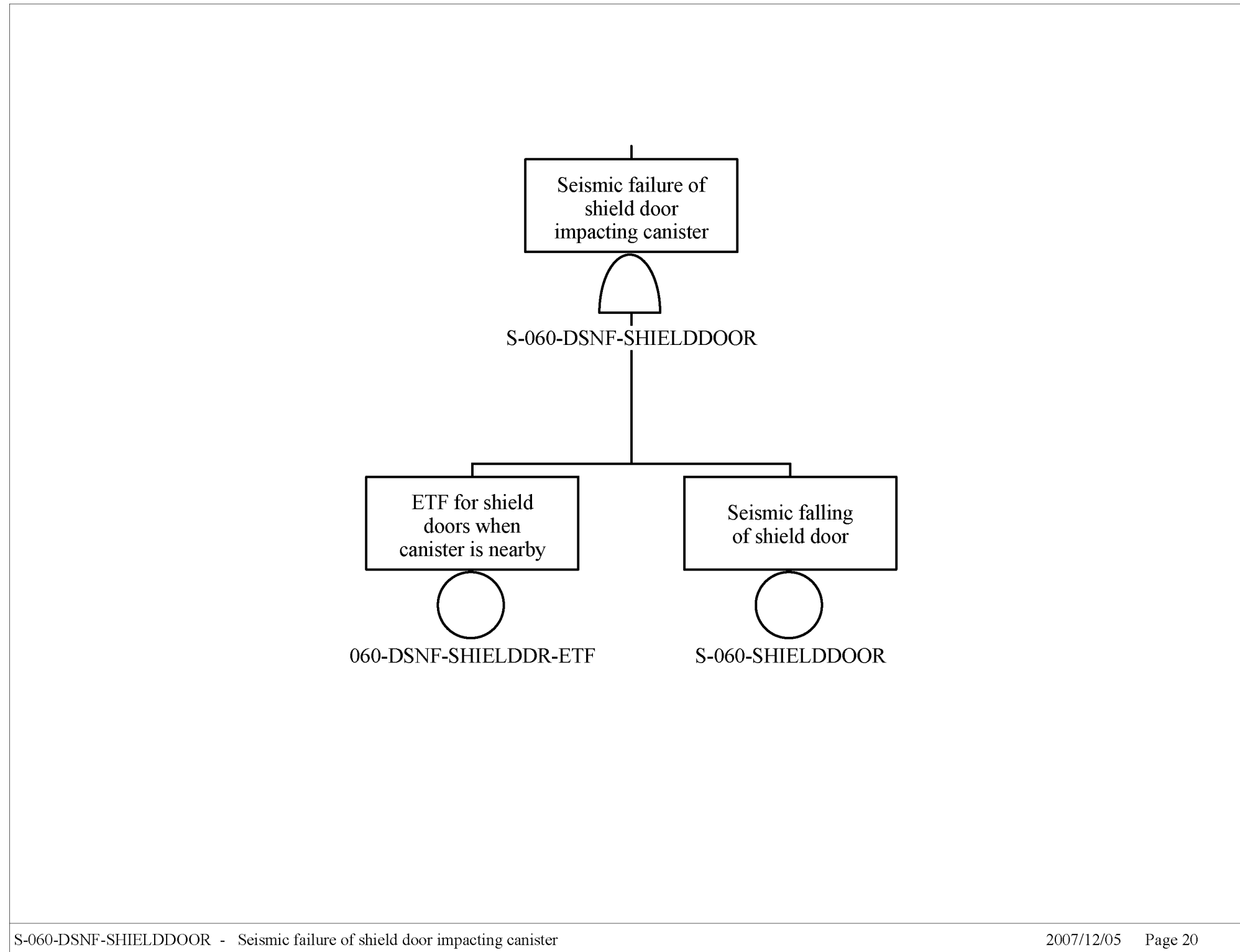

Source: Original

Figure C2.2-16. S-060-DSNF-SHIELDDOOR – Seismic Failure of Shield Door Impacting Canister

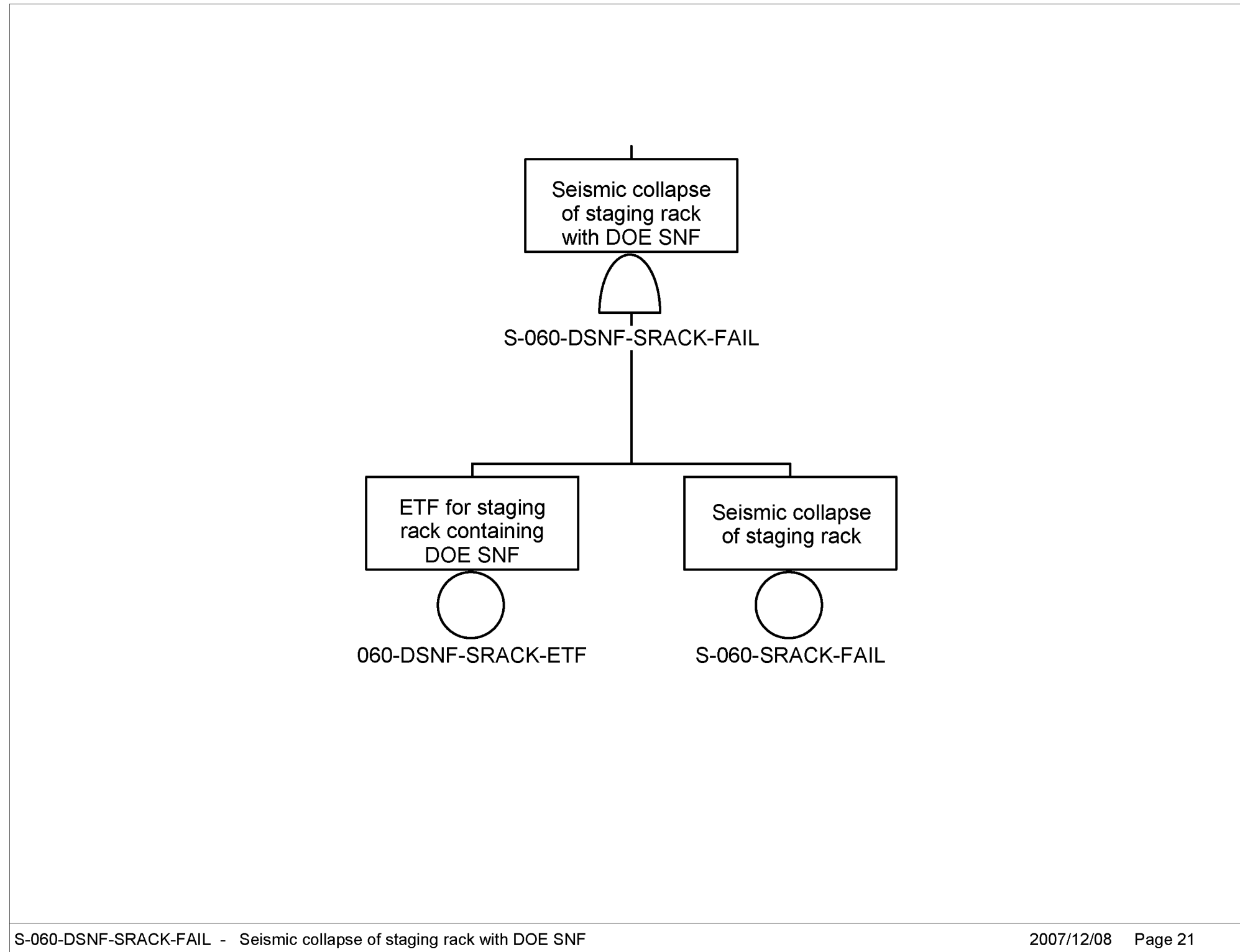

S-060-DSNF-SRACK-FAIL - Seismic collapse of staging rack with DOE SNF

2007/12/08 Page 21

Source: Original

Figure C2.2-17. S-060-DSNF-SRACK-FAIL – Seismic Collapse of Staging Rack with DOE SNF

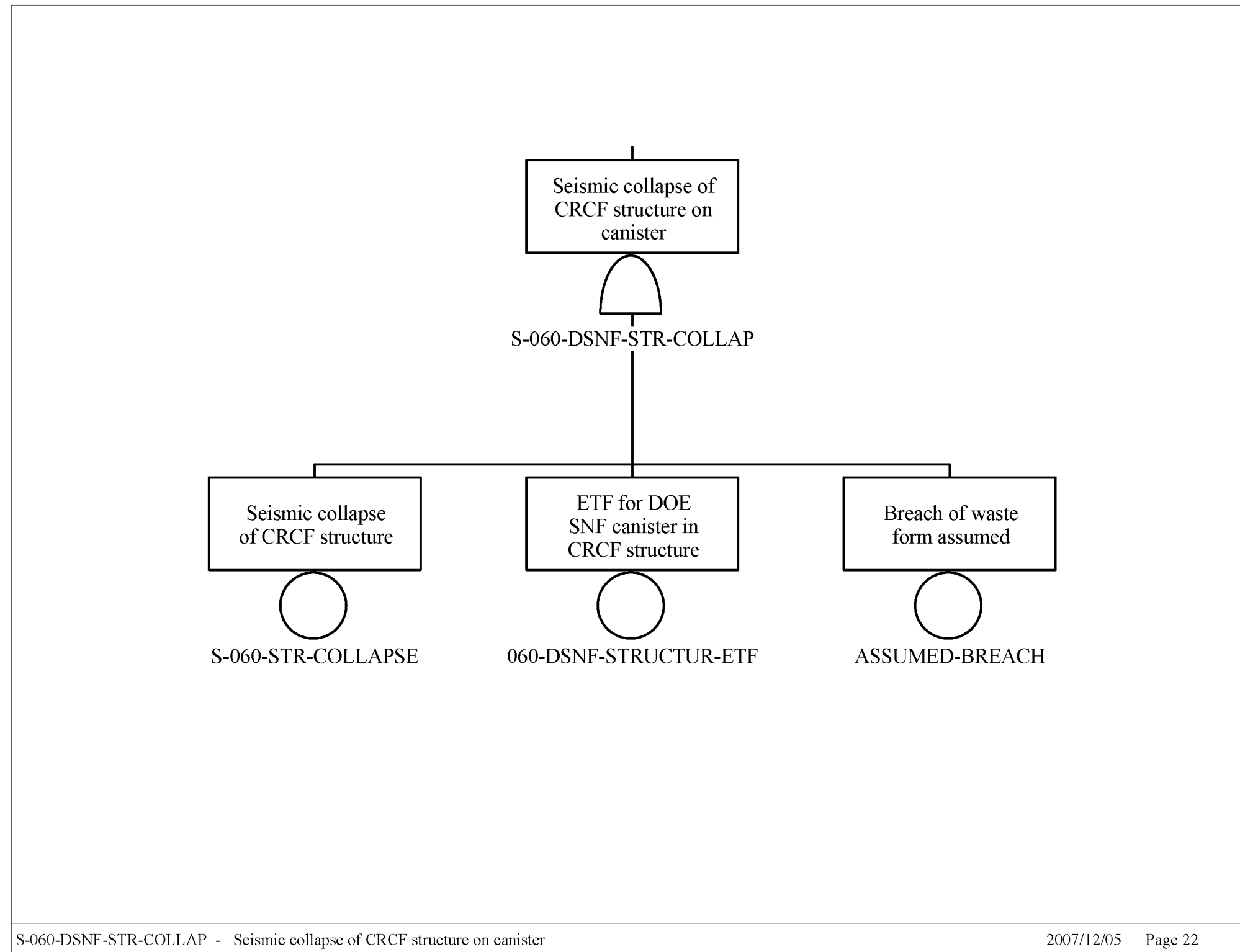

Source: Original

Figure C2.2-18. S-060-DSNF-STR-COLLAP – Seismic Collapse of CRCF Structure on Canister

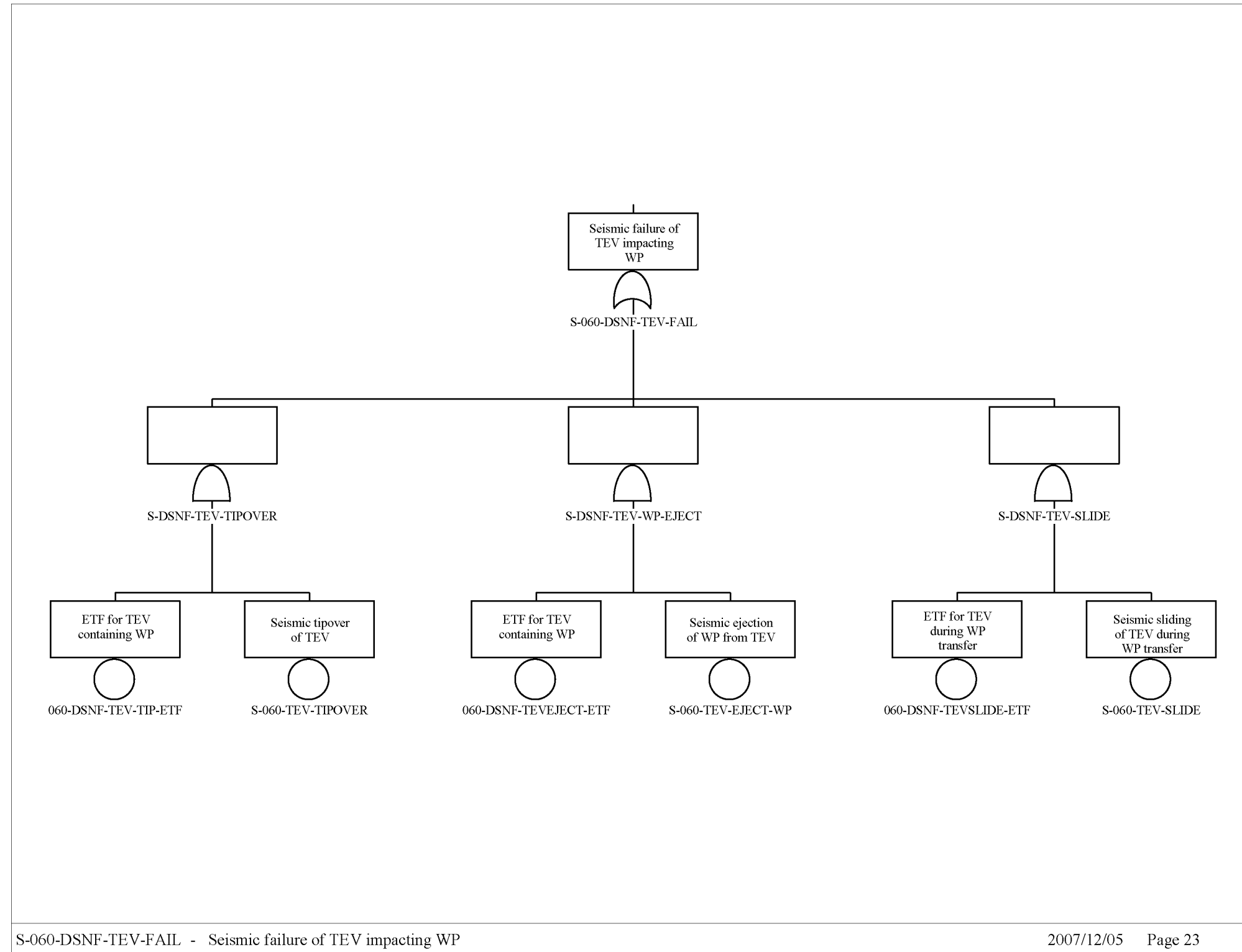

Source: Original

Figure C2.2-19. S-060-DSNF-TEV-FAIL – Seismic Failure of TEV Impacting WP

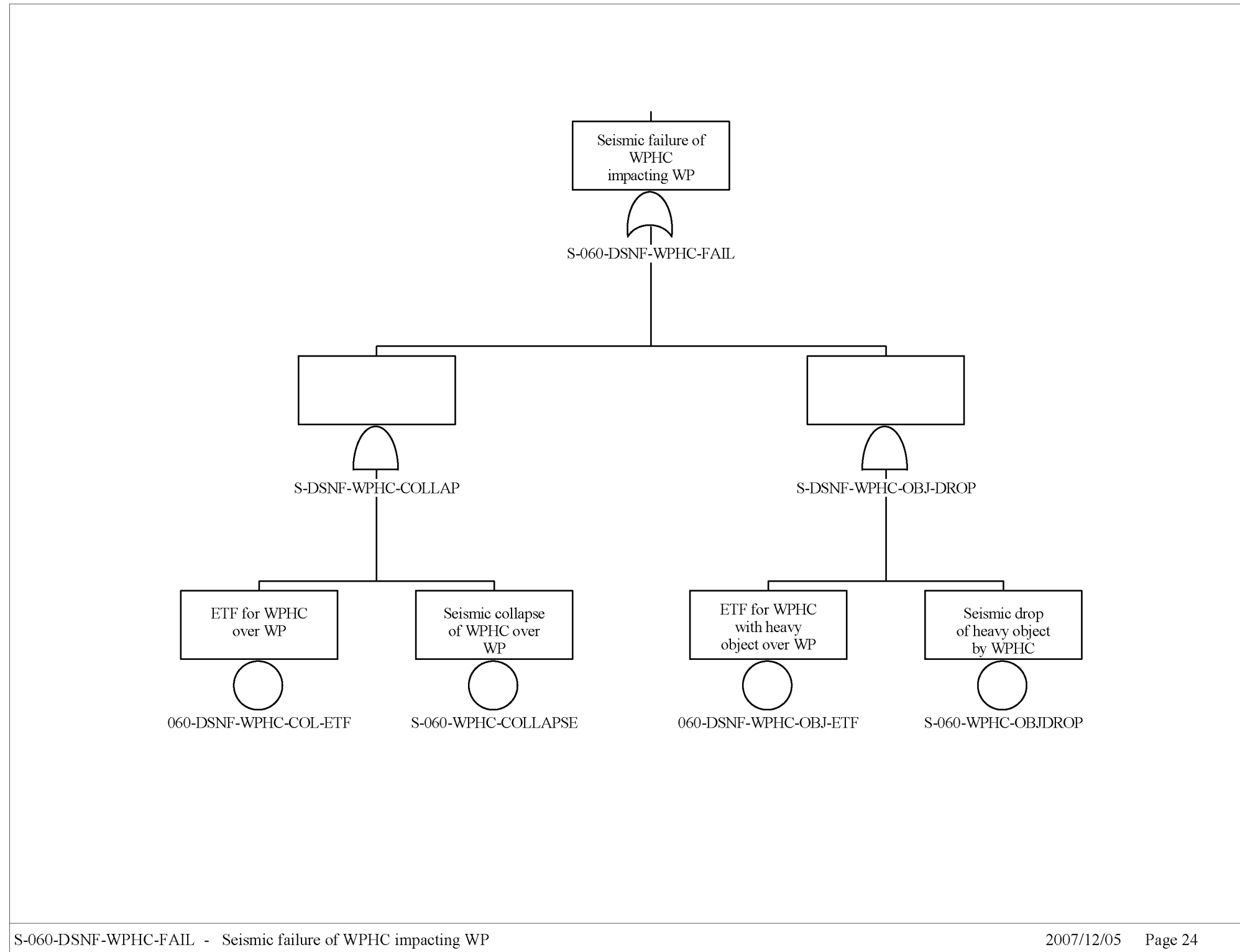

Source: Original

Figure C2.2-20. S-060-DSNF-WPHC-FAIL–
Seismic Failure of WPHC
Impacting WP

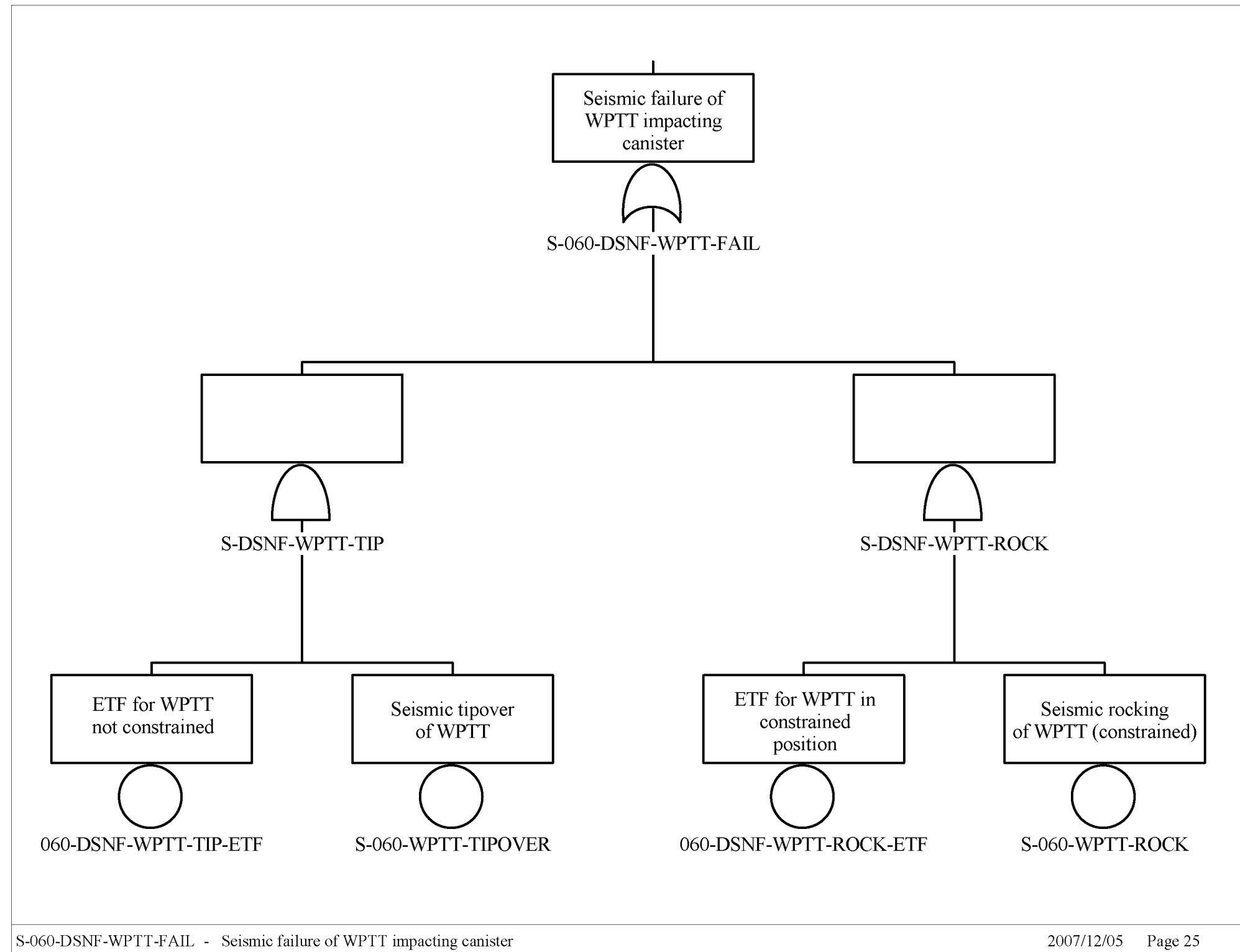

Source: Original

Figure C2.2-21. S-060-DSNF-WPTT-FAIL – Seismic Failure of WPTT Impacting Canister

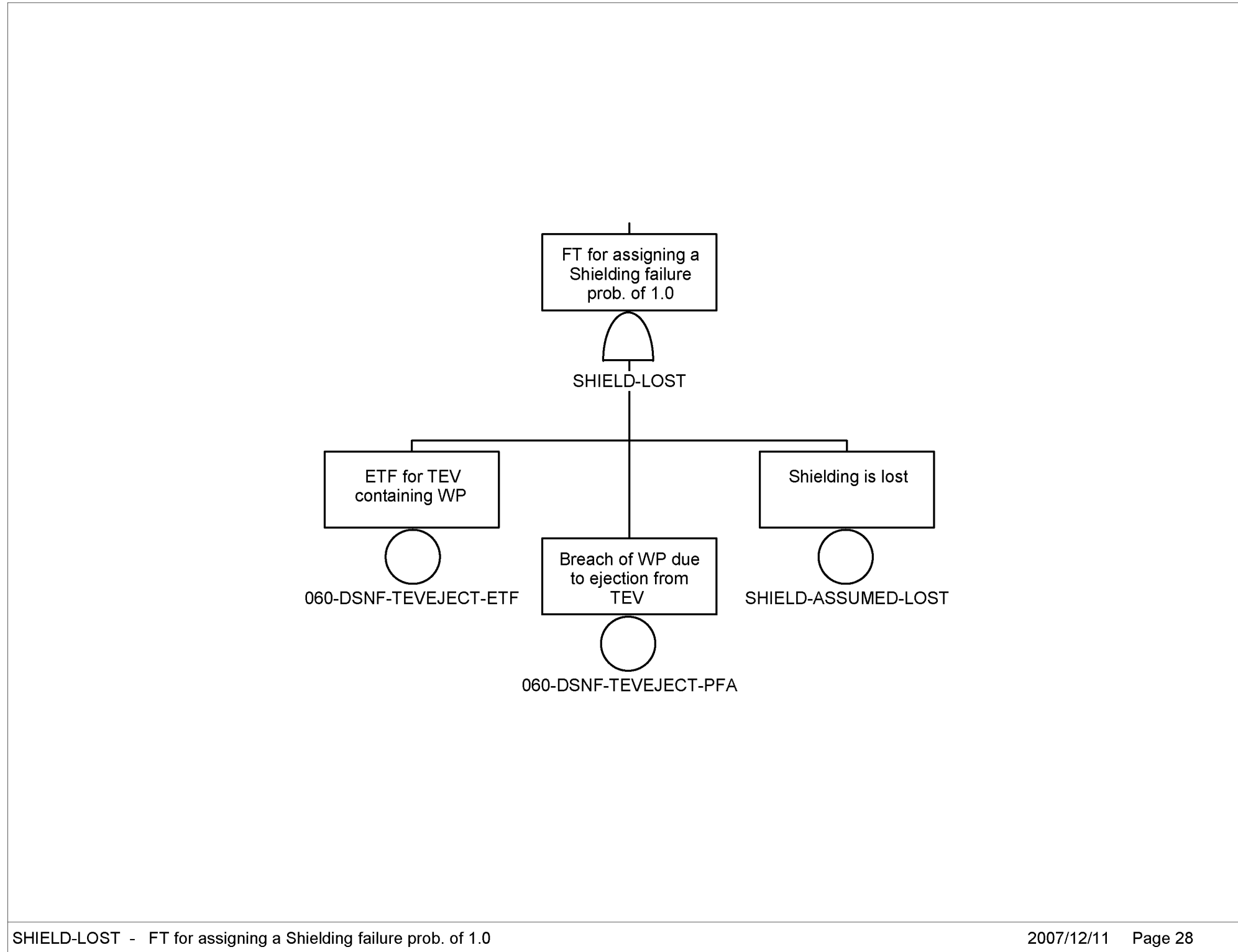

Source: Original

Figure C2.2-22. SHIELD-LOST- FT for Assigning a Shielding Failure Prob. of 1.0

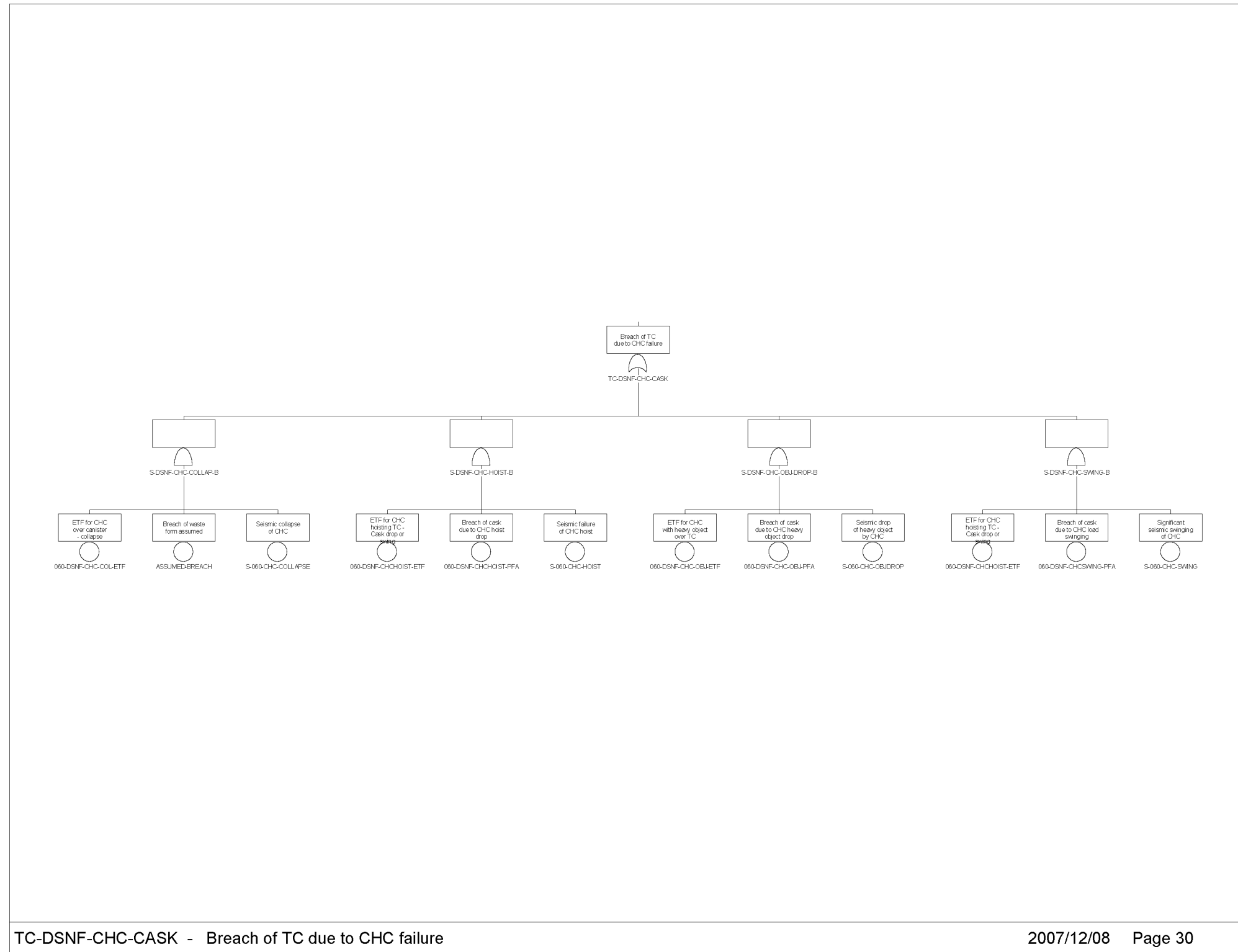

Source: Original

Figure C2.2-23. TC-DSNF-CHC-CASK – Breach of TC due to CHC Failure

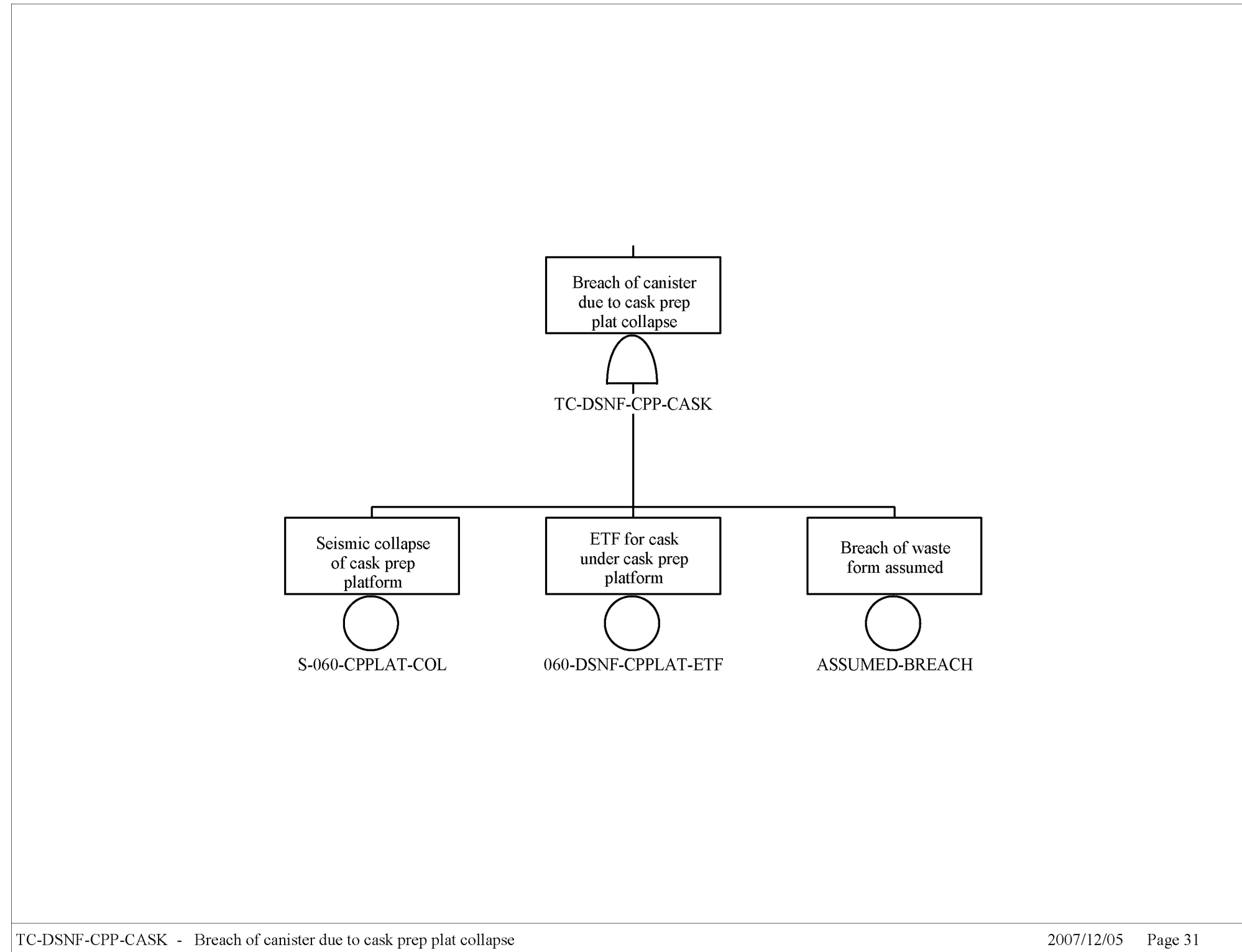

Source: Original

Figure C2.2-24. TC-DSNF-CPP-CASK – Breach of Canister due to Cask Prep Plat Collapse

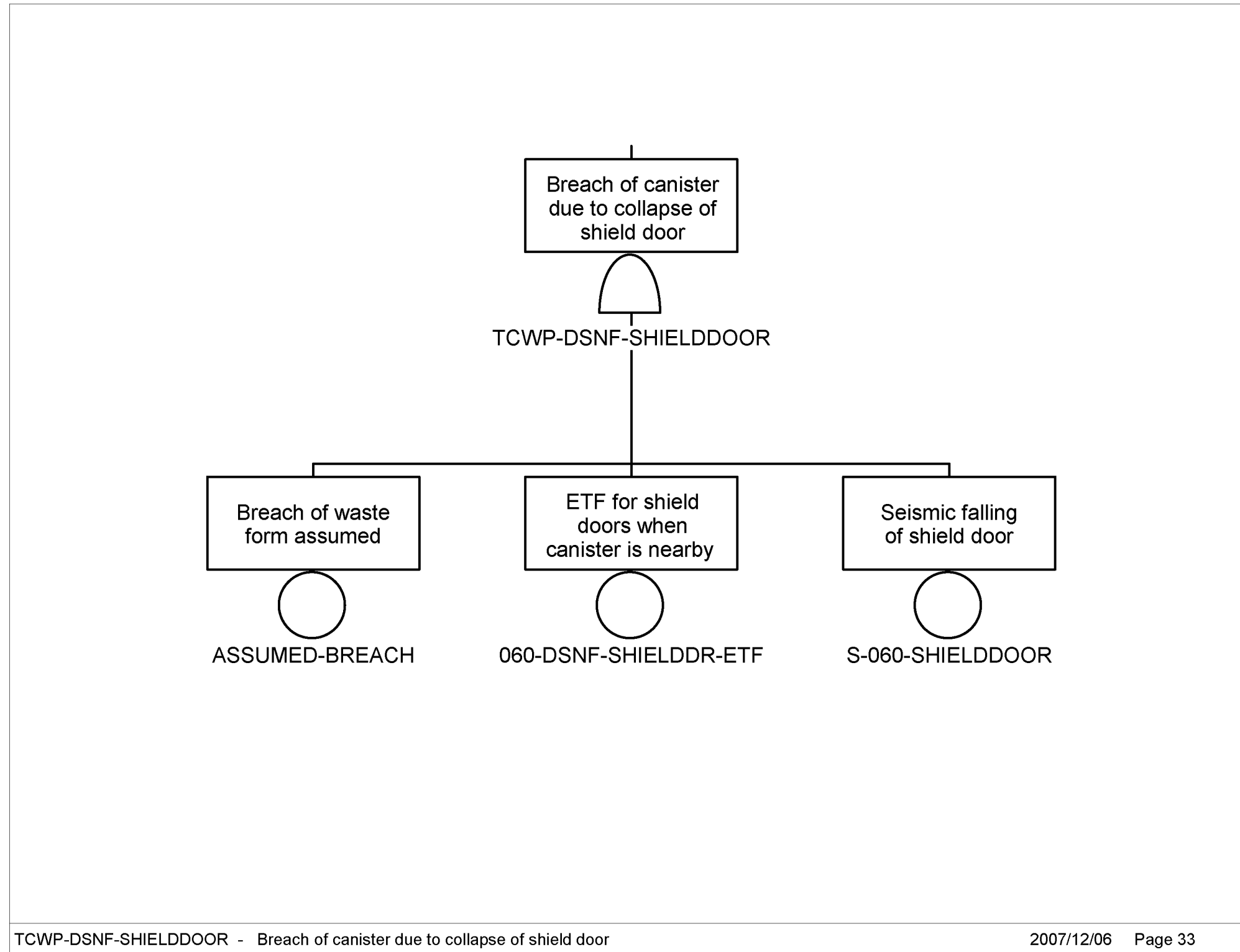

Source: Original

Figure C2.2-25. TCWP-DSNF-SHIELDDOOR – Breach of Canister due to Collapse of Shield Door

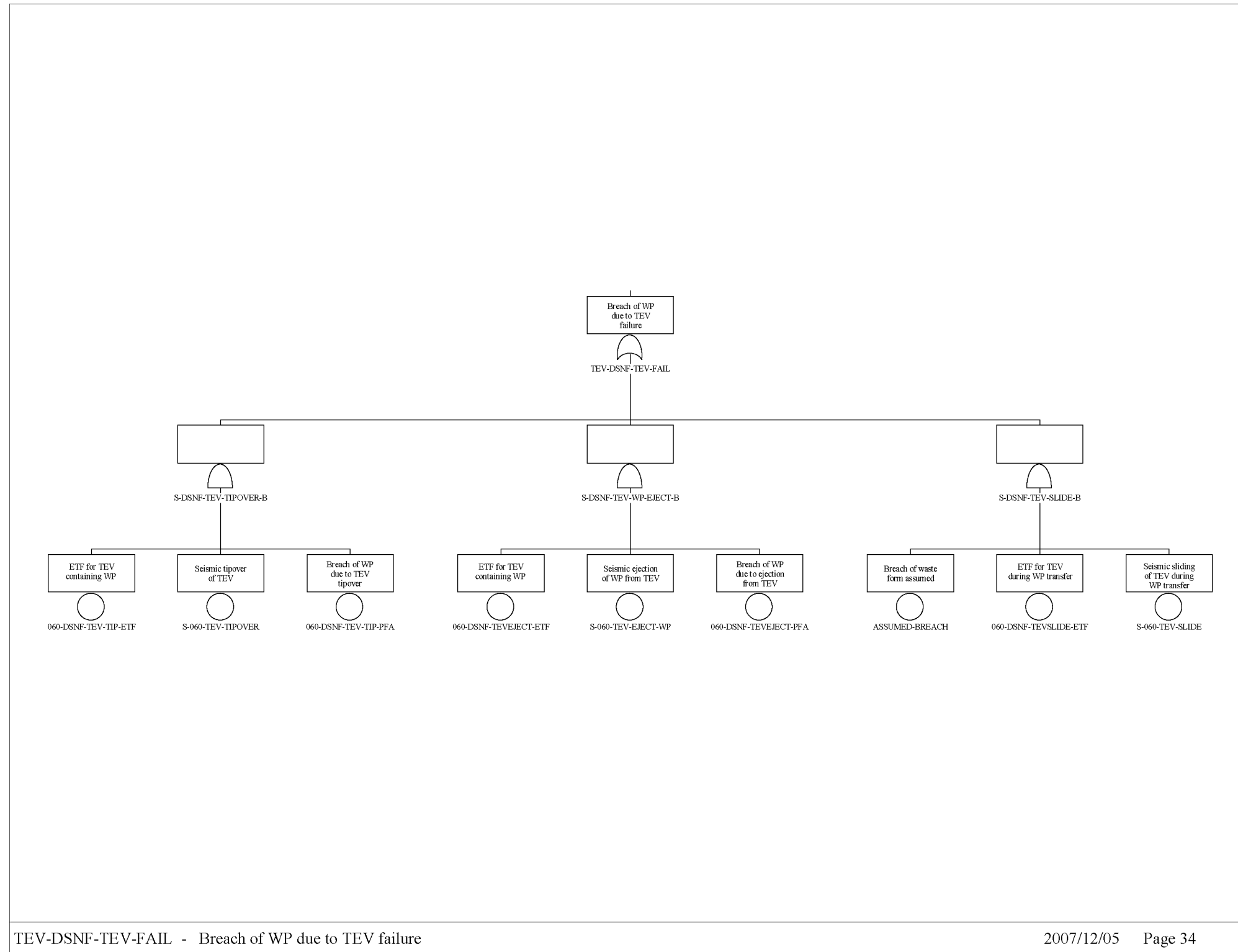

Source: Original

Figure C2.2-26. TEV-DSNF-TEV-FAIL – Breach of WP due to TEV Failure

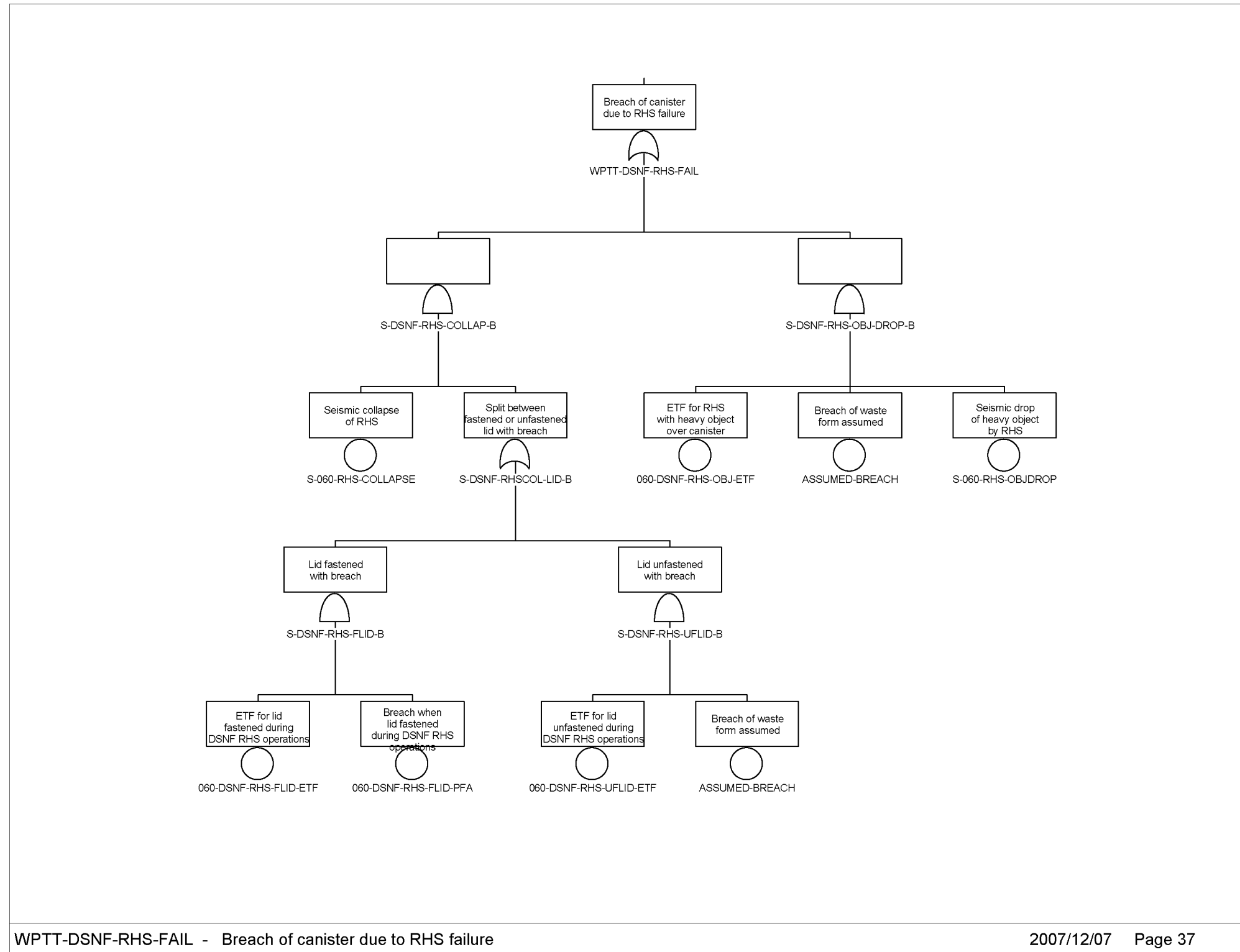

Source: Original

Figure C2.2-27. WPTT-DSNF-RHS-FAIL – Breach of Canister due to RHS Failure

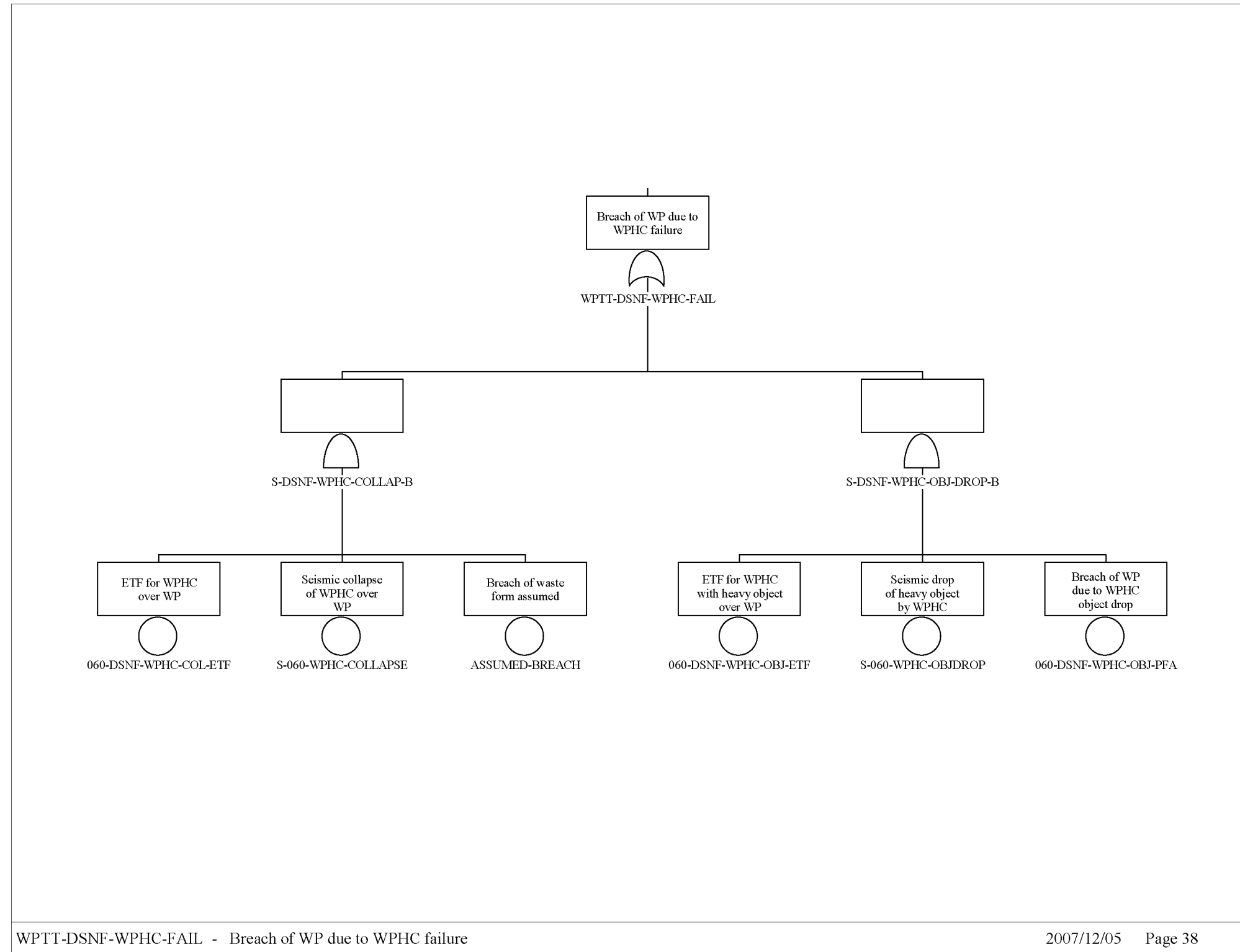

Source: Original

Figure C2.2-28. WPTT-DSNF-WPHC-FAIL – Breach of WP due to WPHC Failure

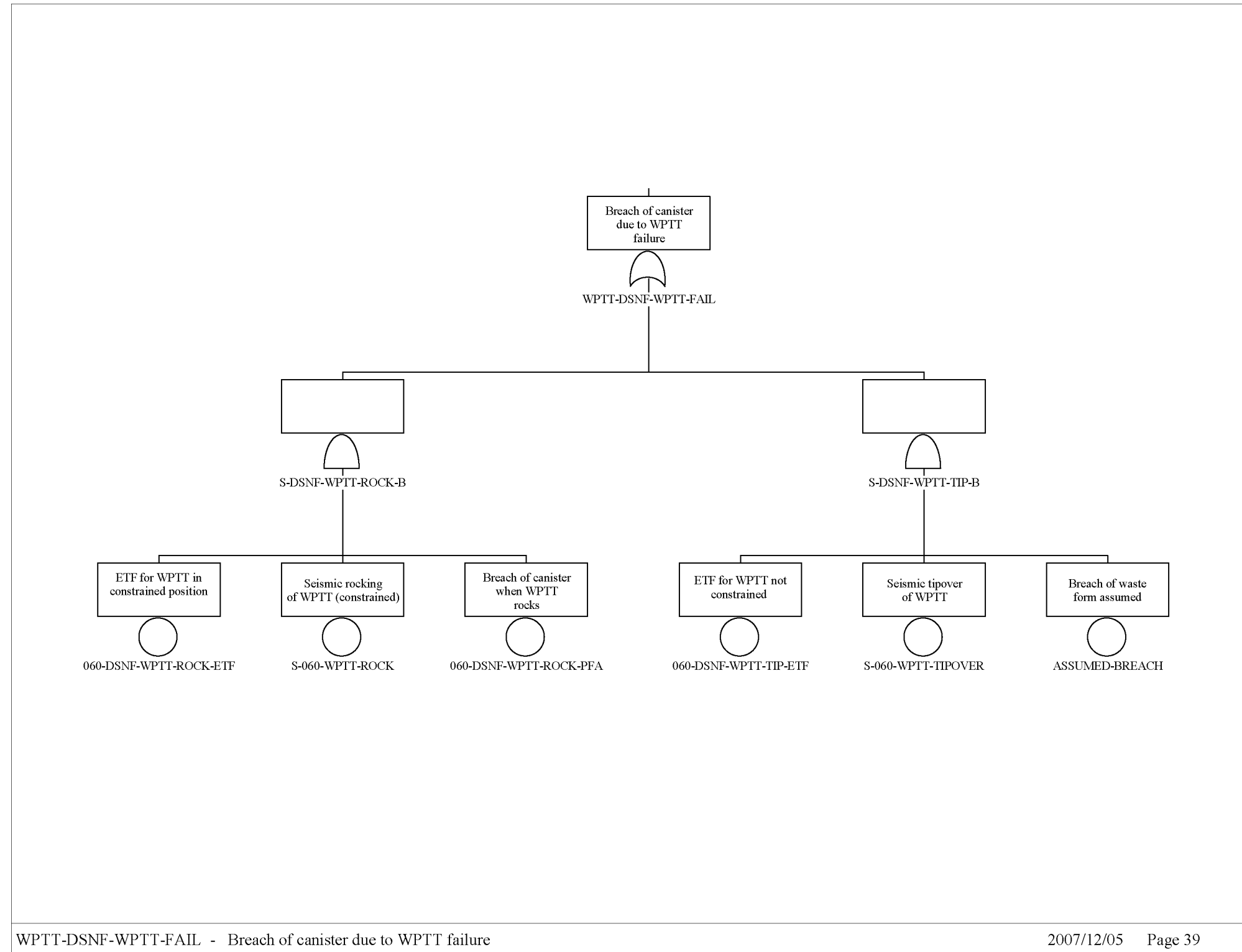

Source: Original

Figure C2.2-29. WPTT-DSNF-WPTT-FAIL – Breach of Canister due to WPTT Failure

C2.3 BASIC EVENT DATA

C2.3.1 Non-seismic Basic Event Data

The following table presents the basic event identifier used in the fault trees, the description of the basic event, and the failure probability (or other numeric data) of the basic event. For exposure time factors (denoted with “ETF” at the end of the basic event identifier), the value given is the time, in years, that one waste form container is exposed to the seismic failure mode.

Table C2.3-1. Non-seismic Basic Event Data

Name	Description	Calc. Probability
060-DSNF-CHC-COL-ETF	ETF for CHC over canister - collapse	1.050E-004
060-DSNF-CHC-OBJ-ETF	ETF for CHC with heavy object over TC	1.690E-005
060-DSNF-CHC-OBJ-PFA	Breach of cask due to CHC heavy object drop	1.000E-005
060-DSNF-CHCHOIST-ETF	ETF for CHC hoisting TC - cask drop or swing	1.270E-005
060-DSNF-CHCHOIST-PFA	Breach of cask due to CHC hoist drop	1.000E-005
060-DSNF-CHCSWING-PFA	Breach of cask due to CHC load swinging	1.000E-005
060-DSNF-CPPLAT-ETF	ETF for cask under cask prep platform	6.890E-005
060-DSNF-CTM-COL-ETF	ETF for CTM over canister - collapse	3.520E-004
060-DSNF-CTM-OBJ-ETF	ETF for CTM with heavy object over TC	9.030E-005
060-DSNF-CTMHOIST-ETF	ETF for CTM hoisting canister - drop	1.100E-004
060-DSNF-CTMHOIST-PFA	Breach of canister dropped by CTM	1.000E-005
060-DSNF-CTMSWGIB-ETF	ETF for CTM hoisting canister inside bell	1.100E-004
060-DSNF-CTMSWGIB-PFA	Breach of canister due to swing inside bell	1.000E-005
060-DSNF-CTMSWGOB-ETF	ETF for CTM hoisting canister outside bell	7.610E-005
060-DSNF-CTT-BUMP-ETF	ETF for CTT with TC subject to bumping EAF	6.680E-005
060-DSNF-CTT-BUMP-PFA	Brach given CTT with TC subject to bumping EAF	1.000E-005
060-DSNF-CTT-ROCK-ETF	ETF for CTT with TC subject to rocking	5.280E-006
060-DSNF-CTTSLIDE-ETF	ETF for CTT containing TC in transfer cell	1.190E-004
060-DSNF-ENTDOOR-ETF	ETF for entry door over transport cask	1.250E-005
060-DSNF-ENTDOOR-PFA	Breach of TC due to entry door collapse	1.000E-005
060-DSNF-MOBPLAT-ETF	ETF for mobile platform over TC	1.160E-004
060-DSNF-MOBPLAT-PFA	Breach of TC due to mobile platform collapse	1.000E-005
060-DSNF-RAILCAR-ETF	ETF for railcar carrying transport cask	8.900E-005
060-DSNF-RAILCAR-PFA	Breach of TC due to railcar accident	1.000E-005
060-DSNF-RHS-FLID-ETF	ETF for lid fastened during DSNF RHS operations	2.320E-004
060-DSNF-RHS-FLID-PFA	Breach when lid fastened during DSNF RHS operations	1.000E-005
060-DSNF-RHS-OBJ-ETF	ETF for RHS with heavy object over canister	5.710E-005
060-DSNF-RHS-UFLID-ETF	ETF for lid unfastened during DSNF RHS operations	5.140E-005
060-DSNF-SHIELDDR-ETF	ETF for shield doors when canister is nearby	1.260E-004
060-DSNF-SRACK-ETF	ETF for staging rack containing DOE SNF	7.670E-003
060-DSNF-STRUCTUR-ETF	ETF for DOE SNF canister in CRCF structure	8.410E-003
060-DSNF-TEV-TIP-ETF	ETF for TEV containing WP	9.700E-005

Table C2.3-1. Non-seismic Basic Event Data (Continued)

Name	Description	Calc. Probability
060-DSNF-TEV-TIP-PFA	Breach of WP due to TEV tipover	1.000E-005
060-DSNF-TEVEJECT-ETF	ETF for TEV containing WP	8.750E-005
060-DSNF-TEVEJECT-PFA	Breach of WP due to ejection from TEV	5.000E-003
060-DSNF-TEVSLIDE-ETF	ETF for TEV during WP transfer	9.510E-006
060-DSNF-WPHC-COL-ETF	ETF for WPHC over WP	7.610E-005
060-DSNF-WPHC-OBJ-ETF	ETF for WPHC with heavy object over WP	7.610E-005
060-DSNF-WPHC-OBJ-PFA	Breach of WP due to WPHC object drop	1.000E-005
060-DSNF-WPTT-ROCK-ETF	ETF for WPTT in constrained position	5.130E-003
060-DSNF-WPTT-ROCK-PFA	Breach of canister when WPTT rocks	1.000E-005
060-DSNF-WPTT-TIP-ETF	ETF for WPTT not constrained	2.460E-004
ASSUMED-BREACH	Breach of waste form assumed	1.000E+000
CRCF-DOE-SNF	Number of DOE SNF canisters	3.300E+003
MOD-ENTER-CANISTER	Flooding or spray enters canister	1.000E-002
SHIELD-AO	Shielding remains intact	1.000E-005
SHIELDING	Shielding remains intact	1.000E-005
060-DSNF-CHC-COL-ETF	ETF for CHC over canister - collapse	1.050E-004
060-DSNF-CHC-OBJ-ETF	ETF for CHC with heavy object over TC	1.690E-005

NOTE: The basic event "ASSUMED-BREACH" is not an assumption, but is common terminology used to denote a scenario where the waste container is conservatively considered to be breached; CHC = cask handling crane; CRCF = Canister Receipt and Closure Facility; CTM = canister transfer machine; CTT = cask transfer trolley; DSNF = Department of Energy spent nuclear fuel; EAF = energy absorbing feature; ETF = exposure time factor; FT = fault tree; RHS = remote handling system; SNF = spent nuclear fuel; ST = site transporter; TC = transportation cask; TEV = transport and emplacement vehicle; WP = waste package; WPHC = waste package handling crane; WPTT = waste package transfer trolley.

Source: Sections 6.2.2.23 and 6.3.3, Table 6.3-1, Table 6.3-2, Table 6.6-1

C2.3.2 Seismic Basic Event Fragility Data

The following table provides the seismic failure basic event identifier, description, median fragility, and composite uncertainty.

Table C2.3-2. Seismic Basic Event Fragility Data

Event Name	Description	Med. Fragility (g)	Beta C
S-060-CHC-COLLAPSE	Seismic collapse of CHC	2.790E+000	4.500E-001
S-060-CHC-HOIST	Seismic failure of CHC hoist	2.280E+000	5.000E-001
S-060-CHC-OBJDROP	Seismic drop of heavy object by CHC	2.280E+000	5.000E-001
S-060-CHC-SWING	Significant seismic swinging of CHC	1.140E+000	4.000E-001
S-060-CPPLAT-COL	Seismic collapse of cask prep platform	3.500E+000	4.000E-001
S-060-CTM-COLLAPSE	Seismic collapse of CTM (trolley seismic restraints)	2.390E+000	4.500E-001
S-060-CTM-HOIST	Seismic drop of canister hoisted by CTM	2.280E+000	5.000E-001
S-060-CTM-OBJDROP	Seismic drop of heavy object by CTM	2.280E+000	5.000E-001
S-060-CTMSWG-IB	Significant swinging of canister inside CTM bell	1.140E+000	4.000E-001
S-060-CTMSWG-OB	Significant swinging of canister outside CTM bell	9.100E-001	4.000E-001
S-060-CTT-BUMPING	Seismic bumping of CTT into EAF	2.250E+000	4.100E-001
S-060-CTT-ROCKING	Seismic rocking of CTT with restraint failure	2.250E+000	4.100E-001
S-060-CTT-SLIDE	Seismic sliding of CTT into wall	3.080E+000	5.800E-001
S-060-ENTDOORCOL	Seismic collapse of entry door	3.700E-001	4.000E-001
S-060-MOBPLAT-COLLAP	Seismic collapse of mobile platform	3.700E-001	4.000E-001
S-060-PIPING-FAIL	Seismic failure of piping in accident area	7.600E-001	4.000E-001
S-060-RAILCAR-ACC	Seismic tipover or collision of railcar	4.500E-001	4.000E-001
S-060-RHS-COLLAPSE	Seismic collapse of RHS	2.790E+000	4.500E-001
S-060-RHS-OBJDROP	Seismic drop of heavy object by RHS	1.140E+000	4.000E-001
S-060-SHIELDDOOR	Seismic falling of shield door	2.920E+000	4.400E-001
S-060-STR-COLLAPSE	Seismic collapse of CRCF structure	1.890E+000	4.000E-001
S-060-TEV-EJECT-WP	Seismic ejection of WP from TEV	1.890E+000	4.000E-001
S-060-TEV-SLIDE	Seismic sliding of TEV during WP transfer	4.610E+000	4.300E-001
S-060-TEV-TIPOVER	Seismic tipover of TEV	7.600E-001	4.000E-001
S-060-WPHC-COLLAPSE	Seismic collapse of WPHC over WP	1.120E+000	4.500E-001
S-060-WPHC-OBJDROP	Seismic drop of heavy object by WPHC	5.000E+000	4.000E-001
S-060-WPTT-ROCK	Seismic rocking of WPTT (constrained)	2.790E+000	3.700E-001
S-060-WPTT-TIPOVER	Seismic tipover of WPTT	1.140E+000	4.000E-001

NOTE: CHC = cask handling crane; CRCF = Canister Receipt and Closure Facility; CTM = canister transfer machine; CTT = cask transfer trolley; EAF = energy absorbing feature; RHS = remote handling system; TEV = transport and emplacement vehicle; WP = waste package; WPHC = waste package handling crane; WPTT = waste package transfer trolley.

Source: Table 6.2-1 and Table 6.2-2

C2.4 EVENT SEQUENCE QUANTIFICATION

This section provides the quantification results by sequence. The event sequence probabilities are provided first, and the cut sets are provided afterwards.

C2.4.1 Sequence Level Results

Table C2.4-1. Sequence Level Results

Event Tree	Sequence	Base Min. Cut	Base Cut Sets
CRCF-S-IE-DOE-SNF	03	2.173E-005	1
CRCF-S-IE-DOE-SNF	04-2	4.157E-010	1
CRCF-S-IE-DOE-SNF	04-3	+0.000E+000	1
CRCF-S-IE-DOE-SNF	04-4	+0.000E+000	1
CRCF-S-IE-DOE-SNF	04-5	+0.000E+000	1
CRCF-S-IE-DOE-SNF	04-6	4.157E-010	1
CRCF-S-IE-DOE-SNF	04-7	8.400E-013	1
CRCF-S-IE-DOE-SNF	05-2	2.029E-009	1
CRCF-S-IE-DOE-SNF	05-3	+0.000E+000	1
CRCF-S-IE-DOE-SNF	05-4	+0.000E+000	1
CRCF-S-IE-DOE-SNF	05-5	+0.000E+000	1
CRCF-S-IE-DOE-SNF	05-6	2.029E-009	1
CRCF-S-IE-DOE-SNF	05-7	5.482E-012	1
CRCF-S-IE-DOE-SNF	06-2	3.858E-009	1
CRCF-S-IE-DOE-SNF	06-3	+0.000E+000	1
CRCF-S-IE-DOE-SNF	06-4	+0.000E+000	1
CRCF-S-IE-DOE-SNF	06-5	+0.000E+000	1
CRCF-S-IE-DOE-SNF	06-6	3.858E-009	1
CRCF-S-IE-DOE-SNF	06-7	7.795E-012	1
CRCF-S-IE-DOE-SNF	07-2	5.475E-011	3
CRCF-S-IE-DOE-SNF	07-3	+0.000E+000	1
CRCF-S-IE-DOE-SNF	07-4	+0.000E+000	1
CRCF-S-IE-DOE-SNF	07-5	+0.000E+000	1
CRCF-S-IE-DOE-SNF	07-6	2.719E-006	4
CRCF-S-IE-DOE-SNF	07-7	2.559E-008	4
CRCF-S-IE-DOE-SNF	08-2		0
CRCF-S-IE-DOE-SNF	08-3	+0.000E+000	1
CRCF-S-IE-DOE-SNF	08-4	+0.000E+000	1
CRCF-S-IE-DOE-SNF	08-5	+0.000E+000	1
CRCF-S-IE-DOE-SNF	08-6	5.993E-007	1
CRCF-S-IE-DOE-SNF	08-7	5.883E-009	1
CRCF-S-IE-DOE-SNF	09-2	2.992E-011	1
CRCF-S-IE-DOE-SNF	09-3	+0.000E+000	1
CRCF-S-IE-DOE-SNF	09-4	+0.000E+000	1
CRCF-S-IE-DOE-SNF	09-5	+0.000E+000	1
CRCF-S-IE-DOE-SNF	09-6	4.289E-006	3
CRCF-S-IE-DOE-SNF	09-7	3.731E-008	3

Table C2.4-1. Sequence Level Results (Continued)

Event Tree	Sequence	Base Min. Cut	Base Cut Sets
CRCF-S-IE-DOE-SNF	10-2		0
CRCF-S-IE-DOE-SNF	10-3	+0.000E+000	1
CRCF-S-IE-DOE-SNF	10-4	+0.000E+000	1
CRCF-S-IE-DOE-SNF	10-5	+0.000E+000	1
CRCF-S-IE-DOE-SNF	10-6	2.667E-006	1
CRCF-S-IE-DOE-SNF	10-7	2.539E-008	1
CRCF-S-IE-DOE-SNF	11-2	3.866E-010	2
CRCF-S-IE-DOE-SNF	11-3	+0.000E+000	1
CRCF-S-IE-DOE-SNF	11-4	+0.000E+000	1
CRCF-S-IE-DOE-SNF	11-5	5.326E-005	5
CRCF-S-IE-DOE-SNF	11-6	4.188E-007	5
CRCF-S-IE-DOE-SNF	12-2		0
CRCF-S-IE-DOE-SNF	12-3	+0.000E+000	1
CRCF-S-IE-DOE-SNF	12-4	+0.000E+000	1
CRCF-S-IE-DOE-SNF	12-5	3.230E-005	1
CRCF-S-IE-DOE-SNF	12-6	3.174E-007	1
CRCF-S-IE-DOE-SNF	13-2	6.009E-011	1
CRCF-S-IE-DOE-SNF	13-3	+0.000E+000	1
CRCF-S-IE-DOE-SNF	13-4	+0.000E+000	1
CRCF-S-IE-DOE-SNF	13-5	+0.000E+000	1
CRCF-S-IE-DOE-SNF	13-6	1.778E-005	3
CRCF-S-IE-DOE-SNF	13-7	1.332E-007	3
CRCF-S-IE-DOE-SNF	14-2	3.715E-009	1
CRCF-S-IE-DOE-SNF	14-3	+0.000E+000	1
CRCF-S-IE-DOE-SNF	14-4	+0.000E+000	1
CRCF-S-IE-DOE-SNF	14-5	+0.000E+000	1
CRCF-S-IE-DOE-SNF	14-6	2.382E-006	2
CRCF-S-IE-DOE-SNF	14-7	2.334E-008	2
CRCF-S-IE-DOE-SNF	15-2	2.219E-010	1
CRCF-S-IE-DOE-SNF	15-3	+0.000E+000	1
CRCF-S-IE-DOE-SNF	15-4	+0.000E+000	1
CRCF-S-IE-DOE-SNF	15-5	+0.000E+000	1
CRCF-S-IE-DOE-SNF	15-6	1.971E-006	2
CRCF-S-IE-DOE-SNF	15-7	1.855E-008	2
CRCF-S-IE-DOE-SNF	16-2	6.636E-005	2
CRCF-S-IE-DOE-SNF	16-4	+0.000E+000	1
CRCF-S-IE-DOE-SNF	16-5	+0.000E+000	1
CRCF-S-IE-DOE-SNF	16-6	+0.000E+000	1
CRCF-S-IE-DOE-SNF	16-7	3.424E-006	3
CRCF-S-IE-DOE-SNF	16-8	2.291E-008	3

Source: Original

C2.4.2 Cut Set Level Results by Sequence

Note that the SAPHIRE software does not provide special tables for seismic cut sets. Therefore, the “Cut Set %” given in the third column of this table is not correct for seismic events, although it does provide the approximate rank order for the cut sets.

Table C2.4-2. Cut Set Level Results by Sequence

Event Tree	Sequence	Cut Set %	Basic Event	Description
CRCF-S-IE-DOE-SNF	03	100.00	060-DSNF-STRUCTUR-ETF	ETF for DOE SNF canister in CRCF structure
			CRCF-DOE-SNF	Number of DOE SNF canisters
			S-060-STR-COLLAPSE	Seismic collapse of CRCF structure
			= Total	
04-2	100.00		060-DSNF-ENTDOOR-ETF	ETF for entry door over transport cask
			CRCF-DOE-SNF	Number of DOE SNF canisters
			S-060-ENTDOORCOL	Seismic collapse of entry door
			SHIELDING	Shielding remains intact
			= Total	
04-3	0.00		<FALSE>	System Generated Success Event
			= Total	
04-4	0.00		<FALSE>	System Generated Success Event
			= Total	
04-5	0.00		<FALSE>	System Generated Success Event
			= Total	
04-6	100.00		060-DSNF-ENTDOOR-ETF	ETF for entry door over transport cask
			060-DSNF-ENTDOOR-PFA	Breach of TC due to entry door collapse
			CRCF-DOE-SNF	Number of DOE SNF canisters
			S-060-ENTDOORCOL	Seismic collapse of entry door
			= Total	
04-7	100.00		060-DSNF-ENTDOOR-ETF	ETF for entry door over transport cask
			060-DSNF-ENTDOOR-PFA	Breach of TC due to entry door collapse
			CRCF-DOE-SNF	Number of DOE SNF canisters
			MOD-ENTER-CANISTER	Flooding or spray enters canister
			S-060-ENTDOORCOL	Seismic collapse of entry door
			S-060-PIPING-FAIL	Seismic failure of piping in accident area
= Total				

Table C2.4-2. Cut Set Level Results by Sequence (Continued)

Event Tree	Sequence	Cut Set %	Basic Event	Description
	05-2	100.00	060-DSNF-RAILCAR-ETF	ETF for railcar carrying transport cask
			CRCF-DOE-SNF	Number of DOE SNF canisters
			S-060-RAILCAR-ACC	Seismic tipover or collision of railcar
			SHIELDING	Shielding remains intact
			= Total	
	05-3	0.00	<FALSE>	System Generated Success Event
			= Total	
	05-4	0.00	<FALSE>	System Generated Success Event
			= Total	
	05-5	0.00	<FALSE>	System Generated Success Event
			= Total	
	05-6	100.00	060-DSNF-RAILCAR-ETF	ETF for railcar carrying transport cask
			060-DSNF-RAILCAR-PFA	Breach of TC due to railcar accident
			CRCF-DOE-SNF	Number of DOE SNF canisters
			S-060-RAILCAR-ACC	Seismic tipover or collision of railcar
			= Total	
	05-7	100.00	060-DSNF-RAILCAR-ETF	ETF for railcar carrying transport cask
			060-DSNF-RAILCAR-PFA	Breach of TC due to railcar accident
			CRCF-DOE-SNF	Number of DOE SNF canisters
			MOD-ENTER-CANISTER	Flooding or spray enters canister
			S-060-PIPING-FAIL	Seismic failure of piping in accident area
			S-060-RAILCAR-ACC	Seismic tipover or collision of railcar
			= Total	
	06-2	100.00	060-DSNF-MOBPLAT-ETF	ETF for mobile platform over TC
			CRCF-DOE-SNF	Number of DOE SNF canisters
			S-060-MOBPLAT-COLLAP	Seismic collapse of mobile platform
			SHIELDING	Shielding remains intact
			= Total	
	06-3	0.00	<FALSE>	System Generated Success Event
			= Total	

Table C2.4-2. Cut Set Level Results by Sequence (Continued)

Event Tree	Sequence	Cut Set %	Basic Event	Description
	06-4	0.00	<FALSE>	System Generated Success Event
			= Total	
	06-5	0.00	<FALSE>	System Generated Success Event
			= Total	
	06-6	100.00	060-DSNF-MOBPLAT-ETF	ETF for mobile platform over TC
			060-DSNF-MOBPLAT-PFA	Breach of TC due to mobile platform collapse
			CRCF-DOE-SNF	Number of DOE SNF canisters
			S-060-MOBPLAT-COLLAP	Seismic collapse of mobile platform
			= Total	
	06-7	100.00	060-DSNF-MOBPLAT-ETF	ETF for mobile platform over TC
			060-DSNF-MOBPLAT-PFA	Breach of TC due to mobile platform collapse
			CRCF-DOE-SNF	Number of DOE SNF canisters
			MOD-ENTER-CANISTER	Flooding or spray enters canister
			S-060-MOBPLAT-COLLAP	Seismic collapse of mobile platform
			S-060-PIPING-FAIL	Seismic failure of piping in accident area
			= Total	
	07-2	88.02	060-DSNF-CHCHOIST-ETF	ETF for CHC hoisting TC - cask drop or swing
			CRCF-DOE-SNF	Number of DOE SNF canisters
			S-060-CHC-SWING	Significant seismic swinging of CHC
			SHIELDING	Shielding remains intact
		6.84	060-DSNF-CHC-OBJ-ETF	ETF for CHC with heavy object over TC
			CRCF-DOE-SNF	Number of DOE SNF canisters
			S-060-CHC-OBJDROP	Seismic drop of heavy object by CHC
			SHIELDING	Shielding remains intact
		5.14	060-DSNF-CHCHOIST-ETF	ETF for CHC hoisting TC - cask drop or swing
			CRCF-DOE-SNF	Number of DOE SNF canisters
			S-060-CHC-HOIST	Seismic failure of CHC hoist
			SHIELDING	Shielding remains intact
			= Total	
	07-3	0.00	<FALSE>	System Generated Success Event

Table C2.4-2. Cut Set Level Results by Sequence (Continued)

Event Tree	Sequence	Cut Set %	Basic Event	Description
			= Total	
	07-4	0.00	<FALSE>	System Generated Success Event
			= Total	
	07-5	0.00	<FALSE>	System Generated Success Event
			= Total	
	07-6	99.95	060-DSNF-CHC-COL-ETF	ETF for CHC over canister - collapse
			CRCF-DOE-SNF	Number of DOE SNF canisters
			S-060-CHC-COLLAPSE	Seismic collapse of CHC
		0.05	060-DSNF-CHCHOIST-ETF	ETF for CHC hoisting TC - cask drop or swing
			060-DSNF-CHCSWING-PFA	Breach of cask due to CHC load swinging
			CRCF-DOE-SNF	Number of DOE SNF canisters
			S-060-CHC-SWING	Significant seismic swinging of CHC
		0.00	060-DSNF-CHC-OBJ-ETF	ETF for CHC with heavy object over TC
			060-DSNF-CHC-OBJ-PFA	Breach of cask due to CHC heavy object drop
			CRCF-DOE-SNF	Number of DOE SNF canisters
			S-060-CHC-OBJDROP	Seismic drop of heavy object by CHC
		0.00	060-DSNF-CHCHOIST-ETF	ETF for CHC hoisting TC - cask drop or swing
			060-DSNF-CHCHOIST-PFA	Breach of cask due to CHC hoist drop
			CRCF-DOE-SNF	Number of DOE SNF canisters
			S-060-CHC-HOIST	Seismic failure of CHC hoist
			= Total	
	07-7	99.95	060-DSNF-CHC-COL-ETF	ETF for CHC over canister - collapse
			CRCF-DOE-SNF	Number of DOE SNF canisters
			MOD-ENTER-CANISTER	Flooding or spray enters canister
			S-060-CHC-COLLAPSE	Seismic collapse of CHC
			S-060-PIPING-FAIL	Seismic failure of piping in accident area
		0.05	060-DSNF-CHCHOIST-ETF	ETF for CHC hoisting TC - Cask drop or swing
			060-DSNF-CHCSWING-PFA	Breach of cask due to CHC load swinging
			CRCF-DOE-SNF	Number of DOE SNF canisters

Table C2.4-2. Cut Set Level Results by Sequence (Continued)

Event Tree	Sequence	Cut Set %	Basic Event	Description
			MOD-ENTER-CANISTER	Flooding or spray enters canister
			S-060-CHC-SWING	Significant seismic swinging of CHC
			S-060-PIPING-FAIL	Seismic failure of piping in accident area
		0.00	060-DSNF-CHC-OBJ-ETF	ETF for CHC with heavy object over TC
			060-DSNF-CHC-OBJ-PFA	Breach of cask due to CHC heavy object drop
			CRCF-DOE-SNF	Number of DOE SNF canisters
			MOD-ENTER-CANISTER	Flooding or spray enters canister
			S-060-CHC-OBJDROP	Seismic drop of heavy object by CHC
			S-060-PIPING-FAIL	Seismic failure of piping in accident area
		0.00	060-DSNF-CHCHOIST-ETF	ETF for CHC hoisting TC - cask drop or swing
			060-DSNF-CHCHOIST-PFA	Breach of cask due to CHC hoist drop
			CRCF-DOE-SNF	Number of DOE SNF canisters
			MOD-ENTER-CANISTER	Flooding or spray enters canister
			S-060-CHC-HOIST	Seismic failure of CHC hoist
			S-060-PIPING-FAIL	Seismic failure of piping in accident area
			= Total	
	08-2			
	08-3	0.00	<FALSE>	System Generated Success Event
			= Total	
	08-4	0.00	<FALSE>	System Generated Success Event
			= Total	
	08-5	0.00	<FALSE>	System Generated Success Event
			= Total	
	08-6	100.00	060-DSNF-CPPLAT-ETF	ETF for cask under cask prep platform
			CRCF-DOE-SNF	Number of DOE SNF canisters
			S-060-CPPLAT-COL	Seismic collapse of cask prep platform
			= Total	
	08-7	100.00	060-DSNF-CPPLAT-ETF	ETF for cask under cask prep platform
			CRCF-DOE-SNF	Number of DOE SNF canisters

Table C2.4-2. Cut Set Level Results by Sequence (Continued)

Event Tree	Sequence	Cut Set %	Basic Event	Description
			MOD-ENTER-CANISTER	Flooding or spray enters canister
			S-060-CPPLAT-COL	Seismic collapse of cask prep platform
			S-060-PIPING-FAIL	Seismic failure of piping in accident area
			= Total	
	09-2	100.00	060-DSNF-CTT-BUMP-ETF	ETF for CTT with TC subject to bumping EAF
			CRCF-DOE-SNF	Number of DOE SNF canisters
			S-060-CTT-BUMPING	Seismic bumping of CTT into EAF
			SHIELDING	Shielding remains intact
			= Total	
	09-3	0.00	<FALSE>	System Generated Success Event
			= Total	
	09-4	0.00	<FALSE>	System Generated Success Event
			= Total	
	09-5	0.00	<FALSE>	System Generated Success Event
			= Total	
	09-6	99.57	060-DSNF-CTTSLIDE-ETF	ETF for CTT containing TC in transfer cell
			CRCF-DOE-SNF	Number of DOE SNF canisters
			S-060-CTT-SLIDE	Seismic sliding of CTT into wall
		0.43	060-DSNF-CTT-ROCK-ETF	ETF for CTT with TC subject to rocking
			CRCF-DOE-SNF	Number of DOE SNF canisters
			S-060-CTT-ROCKING	Seismic rocking of CTT with restraint failure
		0.00	060-DSNF-CTT-BUMP-ETF	ETF for CTT with TC subject to bumping EAF
			060-DSNF-CTT-BUMP-PFA	Brach given CTT with TC subject to bumping EAF
			CRCF-DOE-SNF	Number of DOE SNF canisters
			S-060-CTT-BUMPING	Seismic bumping of CTT into EAF
			= Total	
	09-7	99.57	060-DSNF-CTTSLIDE-ETF	ETF for CTT containing TC in transfer cell
			CRCF-DOE-SNF	Number of DOE SNF canisters
			MOD-ENTER-CANISTER	Flooding or spray enters canister
			S-060-CTT-SLIDE	Seismic sliding of CTT into wall

Table C2.4-2. Cut Set Level Results by Sequence (Continued)

Event Tree	Sequence	Cut Set %	Basic Event	Description
			S-060-PIPING-FAIL	Seismic failure of piping in accident area
		0.43	060-DSNF-CTT-ROCK-ETF	ETF for CTT with TC subject to rocking
			CRCF-DOE-SNF	Number of DOE SNF canisters
			MOD-ENTER-CANISTER	Flooding or spray enters canister
			S-060-CTT-ROCKING	Seismic rocking of CTT with restraint failure
			S-060-PIPING-FAIL	Seismic failure of piping in accident area
		0.00	060-DSNF-CTT-BUMP-ETF	ETF for CTT with TC subject to bumping EAF
			060-DSNF-CTT-BUMP-PFA	Brach given CTT with TC subject to bumping EAF
			CRCF-DOE-SNF	Number of DOE SNF canisters
			MOD-ENTER-CANISTER	Flooding or spray enters canister
			S-060-CTT-BUMPING	Seismic bumping of CTT into EAF
			S-060-PIPING-FAIL	Seismic failure of piping in accident area
			= Total	
	10-2			
	10-3	0.00	<FALSE>	System Generated Success Event
			= Total	
	10-4	0.00	<FALSE>	System Generated Success Event
			= Total	
	10-5	0.00	<FALSE>	System Generated Success Event
			= Total	
	10-6	100.00	060-DSNF-SHIELDDR-ETF	ETF for shield doors when canister is nearby
			CRCF-DOE-SNF	Number of DOE SNF canisters
			S-060-SHIELDDOOR	Seismic falling of shield door
			= Total	
	10-7	100.00	060-DSNF-SHIELDDR-ETF	ETF for shield doors when canister is nearby
			CRCF-DOE-SNF	Number of DOE SNF canisters
			MOD-ENTER-CANISTER	Flooding or spray enters canister
			S-060-PIPING-FAIL	Seismic failure of piping in accident area
			S-060-SHIELDDOOR	Seismic falling of shield door

Table C2.4-2. Cut Set Level Results by Sequence (Continued)

Event Tree	Sequence	Cut Set %	Basic Event	Description
			= Total	
	11-2	94.48	060-DSNF-CTMSWGIB-ETF	ETF for CTM hoisting canister inside bell
			CRCF-DOE-SNF	Number of DOE SNF canisters
			S-060-CTMSWG-IB	Significant swinging of canister inside CTM bell
			SHIELDING	Shielding remains intact
		5.52	060-DSNF-CTMHOIST-ETF	ETF for CTM hoisting canister - drop
			CRCF-DOE-SNF	Number of DOE SNF canisters
			S-060-CTM-HOIST	Seismic drop of canister hoisted by CTM
			SHIELDING	Shielding remains intact
			= Total	
	11-3	0.00	<FALSE>	System Generated Success Event
			= Total	
	11-4	0.00	<FALSE>	System Generated Success Event
			= Total	
	11-5	97.07	060-DSNF-CTMSWGOB-ETF	ETF for CTM hoisting canister outside bell
			CRCF-DOE-SNF	Number of DOE SNF canisters
			S-060-CTMSWG-OB	Significant swinging of canister outside CTM bell
		1.74	060-DSNF-CTM-OBJ-ETF	ETF for CTM with heavy object over TC
			CRCF-DOE-SNF	Number of DOE SNF canisters
			S-060-CTM-OBJDROP	Seismic drop of heavy object by CTM
		1.21	060-DSNF-CTM-COL-ETF	ETF for CTM over canister - collapse
			CRCF-DOE-SNF	Number of DOE SNF canisters
			S-060-CTM-COLLAPSE	Seismic collapse of CTM (trolley seismic restraints)
		0.00	060-DSNF-CTMSWGIB-ETF	ETF for CTM hoisting canister inside bell
			060-DSNF-CTMSWGIB-PFA	Breach of canister due to swing inside bell
			CRCF-DOE-SNF	Number of DOE SNF canisters
			S-060-CTMSWG-IB	Significant swinging of canister inside CTM bell
		0.00	060-DSNF-CTMHOIST-ETF	ETF for CTM hoisting canister - drop
			060-DSNF-CTMHOIST-PFA	Breach of canister dropped by CTM

Table C2.4-2. Cut Set Level Results by Sequence (Continued)

Event Tree	Sequence	Cut Set %	Basic Event	Description
			CRCF-DOE-SNF	Number of DOE SNF canisters
			S-060-CTM-HOIST	Seismic drop of canister hoisted by CTM
			= Total	
	11-6	97.04	060-DSNF-CTMSWGOB-ETF	ETF for CTM hoisting canister outside bell
			CRCF-DOE-SNF	Number of DOE SNF canisters
			MOD-ENTER-CANISTER	Flooding or spray enters canister
			S-060-CTMSWG-OB	Significant swinging of canister outside CTM bell
			S-060-PIPING-FAIL	Seismic failure of piping in accident area
		1.74	060-DSNF-CTM-OBJ-ETF	ETF for CTM with heavy object over TC
			CRCF-DOE-SNF	Number of DOE SNF canisters
			MOD-ENTER-CANISTER	Flooding or spray enters canister
			S-060-CTM-OBJDROP	Seismic drop of heavy object by CTM
			S-060-PIPING-FAIL	Seismic failure of piping in accident area
		1.21	060-DSNF-CTM-COL-ETF	ETF for CTM over canister - collapse
			CRCF-DOE-SNF	Number of DOE SNF canisters
			MOD-ENTER-CANISTER	Flooding or spray enters canister
			S-060-CTM-COLLAPSE	Seismic collapse of CTM (trolley seismic restraints)
			S-060-PIPING-FAIL	Seismic failure of piping in accident area
		0.00	060-DSNF-CTMSWGIB-ETF	ETF for CTM hoisting canister inside bell
			060-DSNF-CTMSWGIB-PFA	Breach of canister due to swing inside bell
			CRCF-DOE-SNF	Number of DOE SNF canisters
			MOD-ENTER-CANISTER	Flooding or spray enters canister
			S-060-CTMSWG-IB	Significant swinging of canister inside CTM bell
			S-060-PIPING-FAIL	Seismic failure of piping in accident area
		0.00	060-DSNF-CTMHOIST-ETF	ETF for CTM hoisting canister - drop
			060-DSNF-CTMHOIST-PFA	Breach of canister dropped by CTM
			CRCF-DOE-SNF	Number of DOE SNF canisters

Table C2.4-2. Cut Set Level Results by Sequence (Continued)

Event Tree	Sequence	Cut Set %	Basic Event	Description
			MOD-ENTER-CANISTER	Flooding or spray enters canister
			S-060-CTM-HOIST	Seismic drop of canister hoisted by CTM
			S-060-PIPING-FAIL	Seismic failure of piping in accident area
			= Total	
	12-2			
	12-3	0.00	<FALSE>	System Generated Success Event
			= Total	
	12-4	0.00	<FALSE>	System Generated Success Event
			= Total	
	12-5	100.00	060-DSNF-SRACK-ETF	ETF for staging rack containing DOE SNF
			CRCF-DOE-SNF	Number of DOE SNF canisters
			S-060-SRACK-FAIL	Seismic collapse of staging rack
			= Total	
	12-6	100.00	060-DSNF-SRACK-ETF	ETF for staging rack containing DOE SNF
			CRCF-DOE-SNF	Number of DOE SNF canisters
			MOD-ENTER-CANISTER	Flooding or spray enters canister
			S-060-PIPING-FAIL	Seismic failure of piping in accident area
			S-060-SRACK-FAIL	Seismic collapse of staging rack
			= Total	
	13-2	100.00	060-DSNF-RHS-FLID-ETF	ETF for lid fastened during DSNF RHS operations
			CRCF-DOE-SNF	Number of DOE SNF canisters
			S-060-RHS-COLLAPSE	Seismic collapse of RHS
			SHIELDING	Shielding remains intact
			= Total	
	13-3	0.00	<FALSE>	System Generated Success Event
			= Total	
	13-4	0.00	<FALSE>	System Generated Success Event
			= Total	
	13-5	0.00	<FALSE>	System Generated Success Event
			= Total	
	13-6	99.77	060-DSNF-RHS-OBJ-ETF	ETF for RHS with heavy object over canister

Table C2.4-2. Cut Set Level Results by Sequence (Continued)

Event Tree	Sequence	Cut Set %	Basic Event	Description
			CRCF-DOE-SNF	Number of DOE SNF canisters
			S-060-RHS-OBJDROP	Seismic drop of heavy object by RHS
		0.23	060-DSNF-RHS-UFLID-ETF	ETF for lid unfastened during DSNF RHS operations
			CRCF-DOE-SNF	Number of DOE SNF canisters
			S-060-RHS-COLLAPSE	Seismic collapse of RHS
		0.00	060-DSNF-RHS-FLID-ETF	ETF for lid fastened during DSNF RHS operations
			060-DSNF-RHS-FLID-PFA	Breach when lid fastened during DSNF RHS operations
			CRCF-DOE-SNF	Number of DOE SNF canisters
			S-060-RHS-COLLAPSE	Seismic collapse of RHS
			= Total	
	13-7	99.77	060-DSNF-RHS-OBJ-ETF	ETF for RHS with heavy object over canister
			CRCF-DOE-SNF	Number of DOE SNF canisters
			MOD-ENTER-CANISTER	Flooding or spray enters canister
			S-060-PIPING-FAIL	Seismic failure of piping in accident area
			S-060-RHS-OBJDROP	Seismic drop of heavy object by RHS
		0.23	060-DSNF-RHS-UFLID-ETF	ETF for lid unfastened during DSNF RHS operations
			CRCF-DOE-SNF	Number of DOE SNF canisters
			MOD-ENTER-CANISTER	Flooding or spray enters canister
			S-060-PIPING-FAIL	Seismic failure of piping in accident area
			S-060-RHS-COLLAPSE	Seismic collapse of RHS
		0.00	060-DSNF-RHS-FLID-ETF	ETF for lid fastened during DSNF RHS operations
			060-DSNF-RHS-FLID-PFA	Breach when lid fastened during DSNF RHS operations
			CRCF-DOE-SNF	Number of DOE SNF canisters
			MOD-ENTER-CANISTER	Flooding or spray enters canister
			S-060-PIPING-FAIL	Seismic failure of piping in accident area
			S-060-RHS-COLLAPSE	Seismic collapse of RHS
			= Total	
	14-2	100.00	060-DSNF-WPTT-ROCK-ETF	ETF for WPTT in constrained position
			CRCF-DOE-SNF	Number of DOE SNF canisters

Table C2.4-2. Cut Set Level Results by Sequence (Continued)

Event Tree	Sequence	Cut Set %	Basic Event	Description
			S-060-WPTT-ROCK	Seismic rocking of WPTT (constrained)
			SHIELDING	Shielding remains intact
			= Total	
	14-3	0.00	<FALSE>	System Generated Success Event
			= Total	
	14-4	0.00	<FALSE>	System Generated Success Event
			= Total	
	14-5	0.00	<FALSE>	System Generated Success Event
			= Total	
	14-6	93.78	060-DSNF-WPTT-TIP-ETF	ETF for WPTT not constrained
			CRCF-DOE-SNF	Number of DOE SNF canisters
			S-060-WPTT-TIPOVER	Seismic tipover of WPTT
		6.22	060-DSNF-WPTT-ROCK-ETF	ETF for WPTT in constrained position
			060-DSNF-WPTT-ROCK-PFA	Breach of canister when WPTT rocks
			CRCF-DOE-SNF	Number of DOE SNF canisters
			S-060-WPTT-ROCK	Seismic rocking of WPTT (constrained)
			= Total	
	14-7	93.78	060-DSNF-WPTT-TIP-ETF	ETF for WPTT not constrained
			CRCF-DOE-SNF	Number of DOE SNF canisters
			MOD-ENTER-CANISTER	Flooding or spray enters canister
			S-060-PIPING-FAIL	Seismic failure of piping in accident area
			S-060-WPTT-TIPOVER	Seismic tipover of WPTT
		6.22	060-DSNF-WPTT-ROCK-ETF	ETF for WPTT in constrained position
			060-DSNF-WPTT-ROCK-PFA	Breach of canister when WPTT rocks
			CRCF-DOE-SNF	Number of DOE SNF canisters
			MOD-ENTER-CANISTER	Flooding or spray enters canister
			S-060-PIPING-FAIL	Seismic failure of piping in accident area
			S-060-WPTT-ROCK	Seismic rocking of WPTT (constrained)
			= Total	

Table C2.4-2. Cut Set Level Results by Sequence (Continued)

Event Tree	Sequence	Cut Set %	Basic Event	Description
	15-2	100.00	060-DSNF-WPHC-OBJ-ETF	ETF for WPHC with heavy object over WP
			CRCF-DOE-SNF	Number of DOE SNF canisters
			S-060-WPHC-OBJDROP	Seismic drop of heavy object by WPHC
			SHIELDING	Shielding remains intact
			= Total	
	15-3	0.00	<FALSE>	System Generated Success Event
			= Total	
	15-4	0.00	<FALSE>	System Generated Success Event
			= Total	
	15-5	0.00	<FALSE>	System Generated Success Event
			= Total	
	15-6	99.61	060-DSNF-WPHC-COL-ETF	ETF for WPHC over WP
			CRCF-DOE-SNF	Number of DOE SNF canisters
			S-060-WPHC-COLLAPSE	Seismic collapse of WPHC over WP
		0.39	060-DSNF-WPHC-OBJ-ETF	ETF for WPHC with heavy object over WP
			060-DSNF-WPHC-OBJ-PFA	Breach of WP due to WPHC object drop
			CRCF-DOE-SNF	Number of DOE SNF canisters
			S-060-WPHC-OBJDROP	Seismic drop of heavy object by WPHC
			= Total	
	15-7	99.61	060-DSNF-WPHC-COL-ETF	ETF for WPHC over WP
			CRCF-DOE-SNF	Number of DOE SNF canisters
			MOD-ENTER-CANISTER	Flooding or spray enters canister
			S-060-PIPING-FAIL	Seismic failure of piping in accident area
			S-060-WPHC-COLLAPSE	Seismic collapse of WPHC over WP
		0.39	060-DSNF-WPHC-OBJ-ETF	ETF for WPHC with heavy object over WP
			060-DSNF-WPHC-OBJ-PFA	Breach of WP due to WPHC object drop
			CRCF-DOE-SNF	Number of DOE SNF canisters
			MOD-ENTER-CANISTER	Flooding or spray enters canister
			S-060-PIPING-FAIL	Seismic failure of piping in accident area

Table C2.4-2. Cut Set Level Results by Sequence (Continued)

Event Tree	Sequence	Cut Set %	Basic Event	Description
			S-060-WPHC- OBJDROP	Seismic drop of heavy object by WPHC
			= Total	
	16-2	100.00	060-DSNF-TEVEJECT- ETF	ETF for TEV containing WP
			CRCF-DOE-SNF	Number of DOE SNF canisters
			S-060-TEV-EJECT-WP	Seismic ejection of WP from TEV
			SHIELD-LOST	FT for assigning a Shielding failure prob. of 1.0
		0.00	060-DSNF-TEV-TIP-ETF	ETF for TEV containing WP
			CRCF-DOE-SNF	Number of DOE SNF canisters
			S-060-TEV-TIPOVER	Seismic tipover of TEV
			SHIELD-LOST	FT for assigning a Shielding failure prob. of 1.0
			= Total	
	16-4	0.00	<FALSE>	System Generated Success Event
			= Total	
	16-5	0.00	<FALSE>	System Generated Success Event
			= Total	
	16-6	0.00	<FALSE>	System Generated Success Event
			= Total	
	16-7	79.67	060-DSNF-TEVSLIDE- ETF	ETF for TEV during WP transfer
			CRCF-DOE-SNF	Number of DOE SNF canisters
			S-060-TEV-SLIDE	Seismic sliding of TEV during WP transfer
		20.34	060-DSNF-TEVEJECT- ETF	ETF for TEV containing WP
			060-DSNF-TEVEJECT- PFA	Breach of WP due to ejection from TEV
			CRCF-DOE-SNF	Number of DOE SNF canisters
			S-060-TEV-EJECT-WP	Seismic ejection of WP from TEV
		0.00	060-DSNF-TEV-TIP-ETF	ETF for TEV containing WP
			060-DSNF-TEV-TIP- PFA	Breach of WP due to TEV tipover
			CRCF-DOE-SNF	Number of DOE SNF canisters
			S-060-TEV-TIPOVER	Seismic tipover of TEV
			= Total	

Table C2.4-2. Cut Set Level Results by Sequence (Continued)

Event Tree	Sequence	Cut Set %	Basic Event	Description
	16-8	79.66	060-DSNF-TEVSLIDE-ETF	ETF for TEV during WP transfer
			CRCF-DOE-SNF	Number of DOE SNF canisters
			MOD-ENTER-CANISTER	Flooding or spray enters canister
			S-060-PIPING-FAIL	Seismic failure of piping in accident area
			S-060-TEV-SLIDE	Seismic sliding of TEV during WP transfer
		20.34	060-DSNF-TEVEJECT-ETF	ETF for TEV containing WP
			060-DSNF-TEVEJECT-PFA	Breach of WP due to ejection from TEV
			CRCF-DOE-SNF	Number of DOE SNF canisters
			MOD-ENTER-CANISTER	Flooding or spray enters canister
			S-060-PIPING-FAIL	Seismic failure of piping in accident area
			S-060-TEV-EJECT-WP	Seismic ejection of WP from TEV
		0.00	060-DSNF-TEV-TIP-ETF	ETF for TEV containing WP
			060-DSNF-TEV-TIP-PFA	Breach of WP due to TEV tipover
			CRCF-DOE-SNF	Number of DOE SNF canisters
			MOD-ENTER-CANISTER	Flooding or spray enters canister
			S-060-PIPING-FAIL	Seismic failure of piping in accident area
			S-060-TEV-TIPOVER	Seismic tipover of TEV
			= Total	
CRCF-S-IE-DOE-SNF	03	100.00	060-DSNF-STRUCTUR-ETF	ETF for DOE SNF canister in CRCF structure
			CRCF-DOE-SNF	Number of DOE SNF canisters
			S-060-STR-COLLAPSE	Seismic collapse of CRCF structure
			= Total	

NOTE: CHC = cask handling crane; CRCF = Canister Receipt and Closure Facility; CTM = canister transfer machine; CTT = cask transfer trolley; DOE = Department of Energy; DSNF = Department of Energy spent nuclear fuel; EAF = energy absorbing feature; ETF = exposure time factor; FT = fault tree; RHS = remote handling system; SNF = spent nuclear fuel; ST = site transporter; TAD = transportation, aging, and disposal; TC = transportation cask; TEV = transport and emplacement vehicle; WP = waste package; WPHC = waste package handling crane; WPTT = waste package transfer trolley.

Source: Original

C3 HIGH-LEVEL RADIOACTIVE WASTE (CRCF-HLW)

This section provides the detailed information used to develop the event sequences for the analysis of processing of the HLW canisters inside the CRCF. HLW canisters inside a transportation cask are received on railcars, and are transferred into a waste package, sealed, and then transported in a TEV out of the CRCF. Transport to the emplacement drifts is not included in this section.

C3.1 EVENT TREES

The IET and SRETs are presented in this section. The tables provide the assignments between the event tree branches and the fault trees given in the next section.

Seismic Event	Number of HLW canisters	Identify initiating seismic failure		
SEIS-EVENT	CRCF-HLW-CAN	SEIS-FAIL	#	END-STATE
			1	OK
			2	OK
		CRCF building collapse	3	RR-UNF
		Entry door seismic collapse	4	T => 2 CRCF-S-R-TC1
		Railcar accident	5	T => 2 CRCF-S-R-TC1
		Mobile platform seismic collapse	6	T => 2 CRCF-S-R-TC1
		CHC seismic failures	7	T => 2 CRCF-S-R-TC1
		Cask prep platform collapse	8	T => 2 CRCF-S-R-TC1
		CTT seismic failures	9	T => 2 CRCF-S-R-TC1
		Shield door seismic failure	10	T => 3 CRCF-S-R-SD1
		CTM seismic failure	11	T => 4 CRCF-S-R-CTM
		Staging rack failure	12	T => 5 CRCF-S-R-CAN
		WPTT tipover	13	T => 6 CRCF-S-R-WP1

CRCF-S-IE-HLW - CRCF Seismic Event Tree - Initiating Seismic Failures - HLW

2007/12/14 Page 1

NOTE: Event tree branch captions are associated with the branch line below the caption.

CAN = canister; CHC = cask handling crane; CRCF = Canister Receipt and Closure Facility; CTM = canister transfer machine; CTT = cask transfer trolley; HLW= high-level radioactive waste; IE = initiating event; SD = shield door; SEIS = seismic; T = transfer; TC = transportation cask; UNF = unfiltered; WP = waste package; WPTT = waste package transfer trolley.

Source: Original

Figure C3.1-1. CRCF Seismic Event Tree
 CRCF-S-IE-HLW – Initiating
 Seismic Failures – HLW

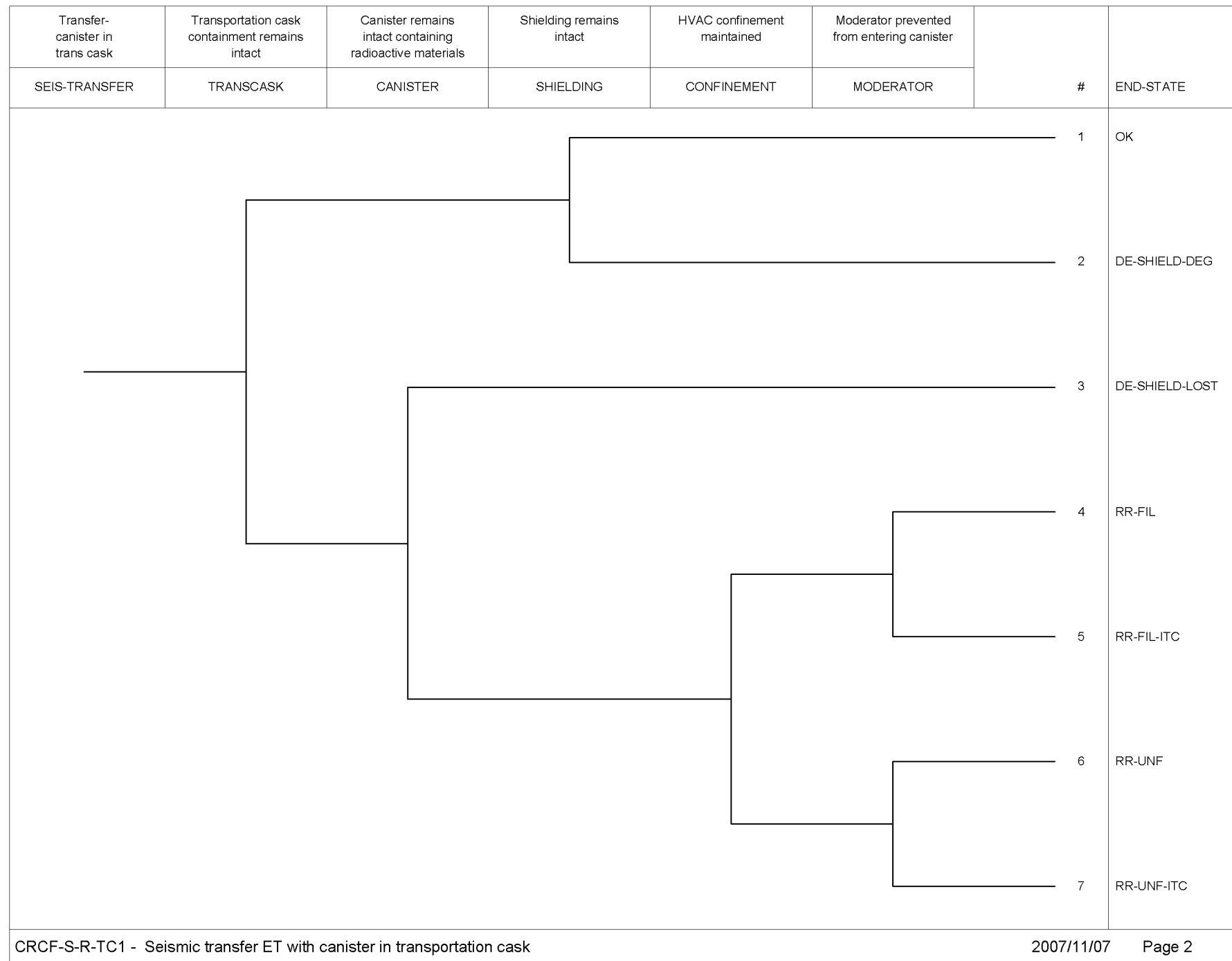

NOTE: CRCF = Canister Receipt and Closure Facility; DE = direct exposure; DEG = degradation; ET = event tree; FIL = filtered; HVAC = heating, ventilation and air conditioning; ITC = important to criticality; RR = radioactive release; SEIS = seismic; TC = transportation cask; UNF = unfiltered.

Source: Original

Figure C3.1-2. CRCF Seismic Event Tree
CRCF-S-R-TC1 – Seismic
Transfer ET with Canister in
Transportation Cask

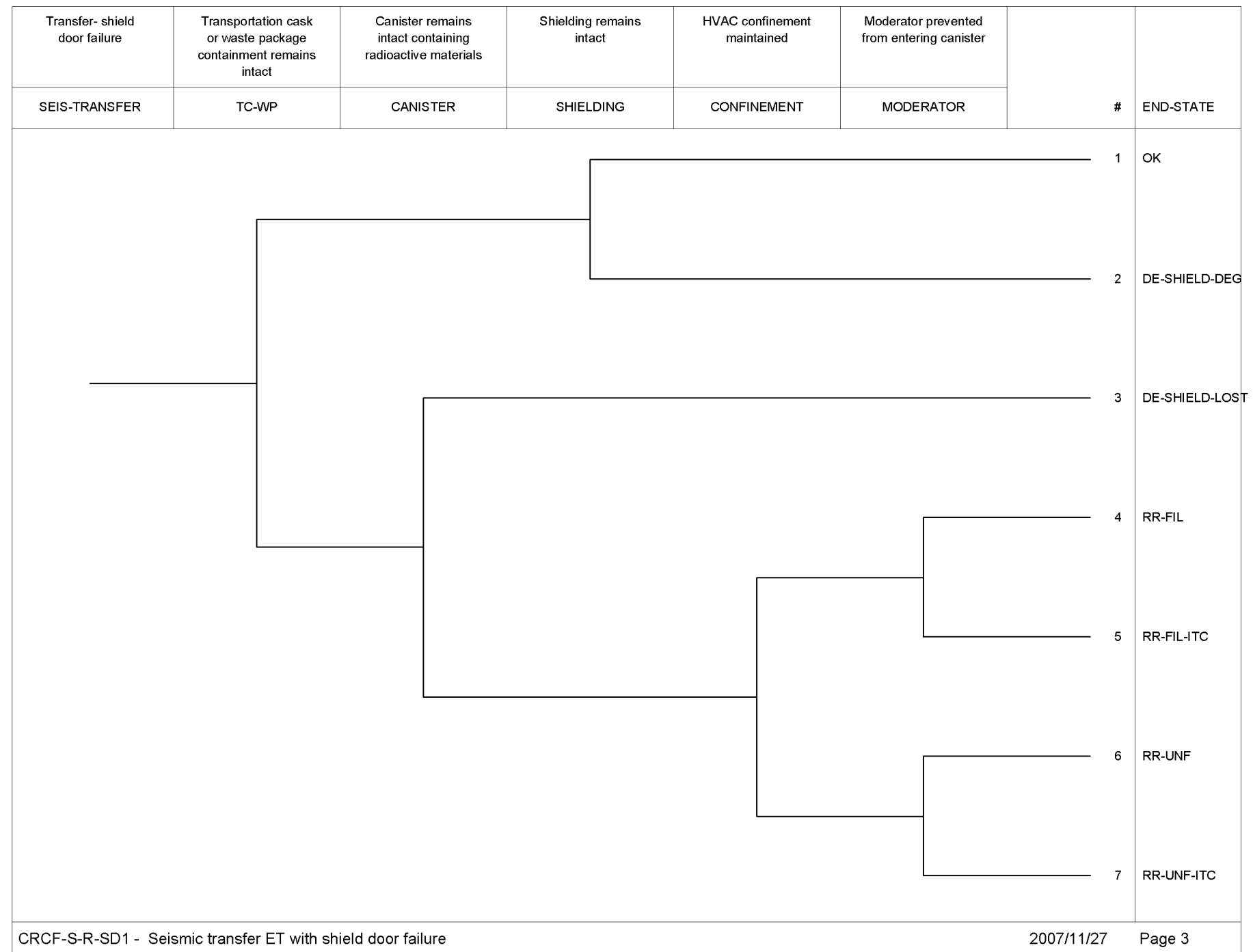

NOTE: CRCF = Canister Receipt and Closure Facility; DE = direct exposure; DEG = degradation; ET = event tree; FIL = filtered; HVAC = heating, ventilation and air conditioning; ITC = important to criticality; RR = radioactive release; SD = shield door; SEIS = seismic; TC = transportation cask; UNF = unfiltered; WP = waste package.

Source: Original

Figure C3.1-3. CRCF Seismic Event Tree
CRCF-S-R-SD1 – Seismic
Transfer ET with Shield Door
Failure

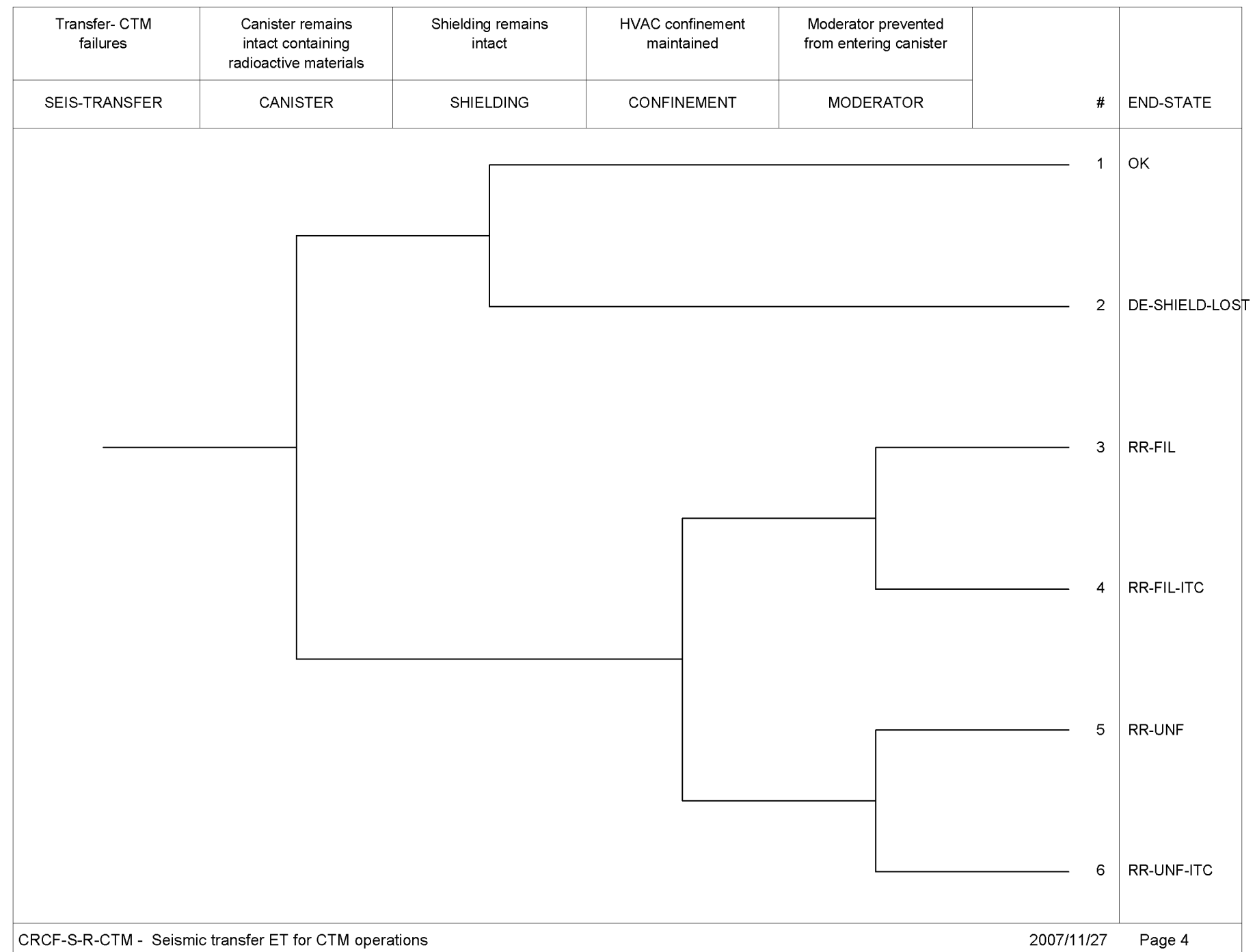

NOTE: CRCF = Canister Receipt and Closure Facility; CTM = canister transfer machine; DE = direct exposure; ET = event tree; FIL = filtered; HVAC = heating, ventilation and air conditioning; ITC = important to criticality; RR = radioactive release; SEIS = seismic; UNF = unfiltered.

Source: Original

Figure C3.1-4. CRCF Seismic Event Tree
 CRCF-S-R-CTM – Seismic
 Transfer ET for CTM Operations

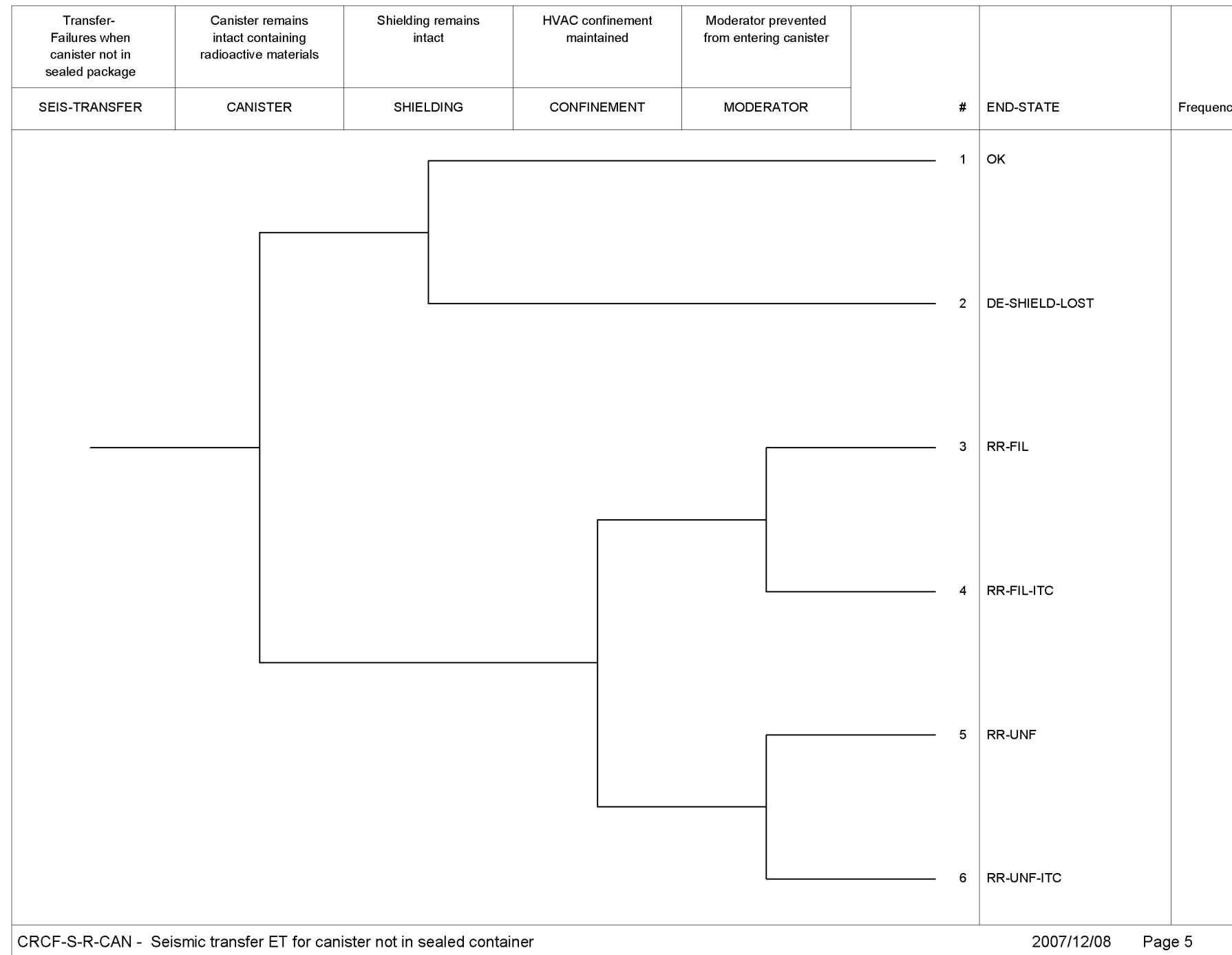

NOTE: CAN = canister; CRCF = Canister Receipt and Closure Facility; DE = direct exposure; ET = event tree; FIL = filtered; HVAC = heating, ventilation and air conditioning; ITC = important to criticality; RR = radioactive release; SEIS = seismic; UNF = unfiltered.

Source: Original

Figure C3.1-5. CRCF Seismic Event Tree
CRCF-S-R-CAN – Seismic
Transfer ET for Canister not in
Sealed Container

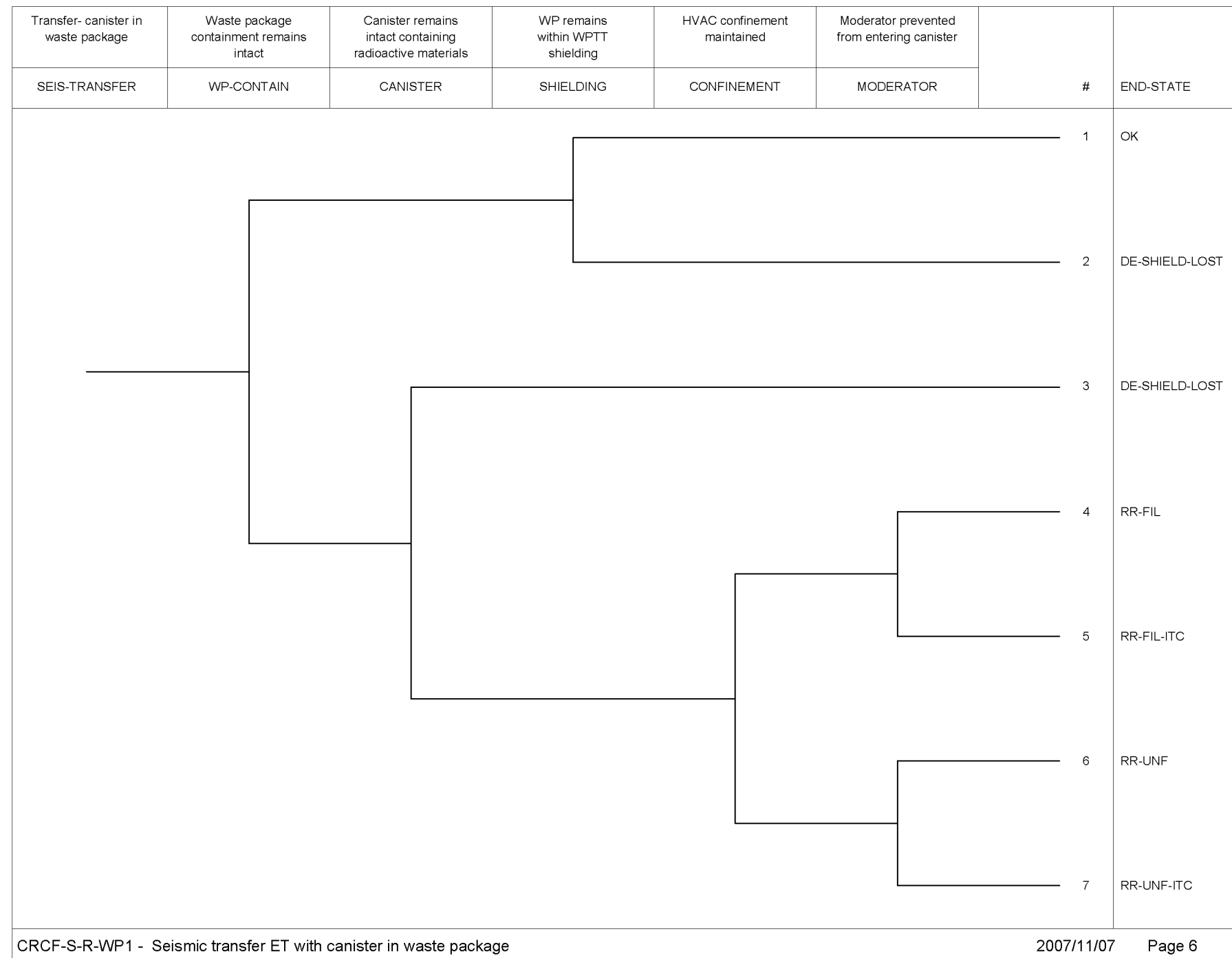

NOTE: CRCF = Canister Receipt and Closure Facility; DE = direct exposure; ET = event tree; FIL = filtered; HVAC = heating, ventilation and air conditioning; ITC = important to criticality; RR = radioactive release; SEIS = seismic; UNF = unfiltered; WP = waste package; WPTT = waste package transfer trolley.

Source: Original

Figure C3.1-6. CRCF Seismic Event Tree
 CRCF-S-R-WP1 – Seismic
 Transfer ET with Canister in
 Waste Package

Table C3.1-1. Fault Trees Assigned for Initiating Seismic Failures for the CRCF

Process	Initiator Event Tree	Initiating Seismic Failure	Associated Fault Tree
HLW	CRCF-S-IE-HLW	CRCF building collapse	S-060-HLW-STR-COLLAP
		Entry door seismic collapse	S-060-HLW-ENTDOORCOL
		Railcar accident	S-060-HLW-RAILCARACC
		Mobile platform seismic collapse	S-060-HLW-MOBPLATCOL
		CHC seismic failures	S-060-HLW-CHC-FAIL
		Cask prep platform collapse	S-060-HLW-CPREP-PLAT
		CTT seismic failures	S-060-HLW-CTT-FAIL
		Shield door seismic failure	S-060-HLW-SHIELDDOOR
		CTM seismic failures	S-060-HLW-CTM-FAIL
		Staging rack failure	S-060-HLW-SRACK-FAIL
		WPTT tipover	S-060-HLW-WPTT-FAIL

NOTE: CRCF = Canister Receipt and Closure Facility; CHC = cask handling crane; CTM = canister transfer machine; CTT = cask transfer trolley; HLW = high-level radioactive waste; WPTT = waste package transfer trolley.

Source: Original

Table C3.1-2. Fault Trees Assigned for Pivotal Events for CRCF-S-IE-HLW Initiating Event Tree

Initiating Seismic Failure	TRANSCASK	MODERATOR
CRCF building collapse	N/A	N/A
Entry door seismic collapse	RC-HLW-DOORDROP-CASK	N/A
Railcar accident	RC-HLW-RC-ACC-CASK	N/A
Mobile platform seismic collapse	RC-HLW-MOB-PLAT-CASK	N/A
CHC seismic failures	TC-HLW-CHC-CASK	N/A
Cask prep platform collapse	TC-HLW-CPP-CASK	N/A
CTT seismic failures	CTT-HLW-CTT-CASK	N/A
	TC-WP	
Shield door seismic failure	TCWP-HLW-SHIELDDOOR	N/A
	CANISTER	
CTM seismic failures	CTM-HLW-CTM-CAN	N/A
Staging rack failure	CAN-HLW-SRACK-FAIL	N/A
	WP-CONTAIN	
WPTT tipover	WPTT-HLW-WPTT-FAIL	N/A

NOTE: CRCF = Canister Receipt and Closure Facility; CHC = cask handling crane; CTM = canister transfer machine; CTT = cask transfer trolley; HLW = high-level radioactive waste; TC = transportation cask; WP = waste package; WPTT = waste package transfer trolley.

Source: Original

C3.2 Fault Trees

Seismic fault trees for the processing of HLW canisters in the CRCF are presented in alphanumeric order in this section.

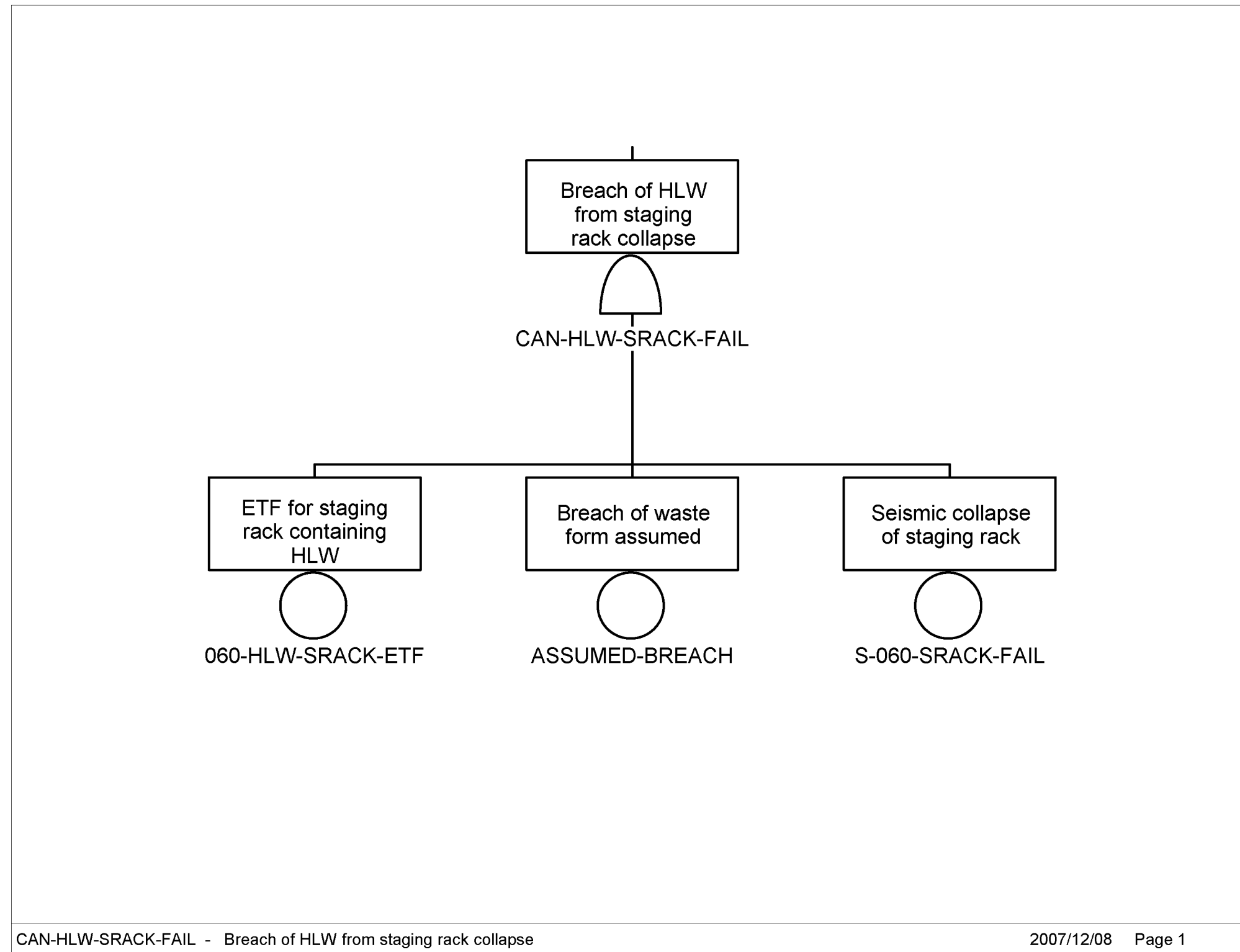

Source: Original

Figure C3.2-1. Fault Tree CAN-HLW-SRACK-FAIL – Breach of HLW from Staging Rack Collapse

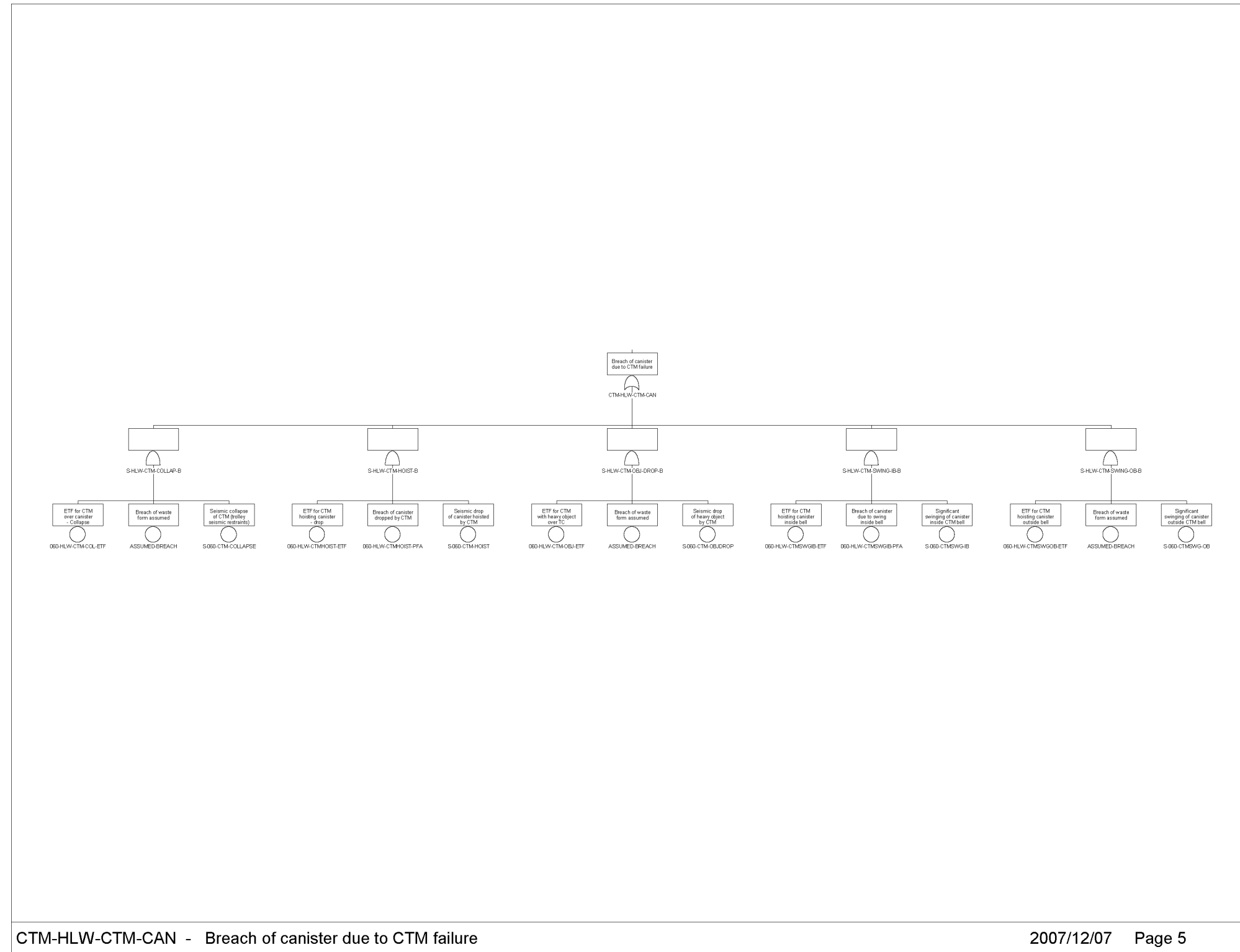

Source: Original

Figure C3.2-2. CTM-HLW-CTM-CAN – Breach of Canister due to CTM Failure

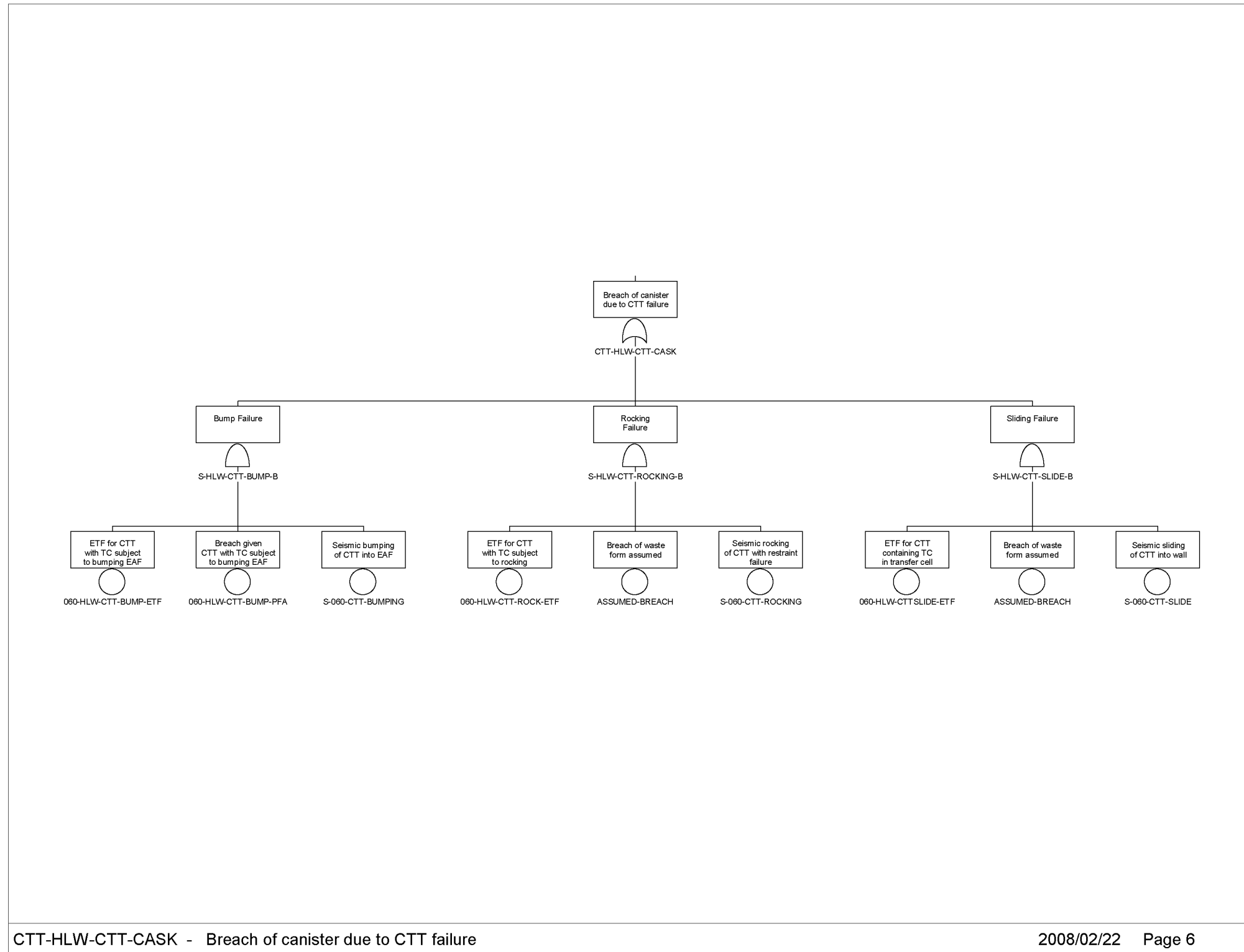

Source: Original

Figure C3.2-3. CTT-HLW-CTT-CASK – Breach of Canister due to CTT Failure

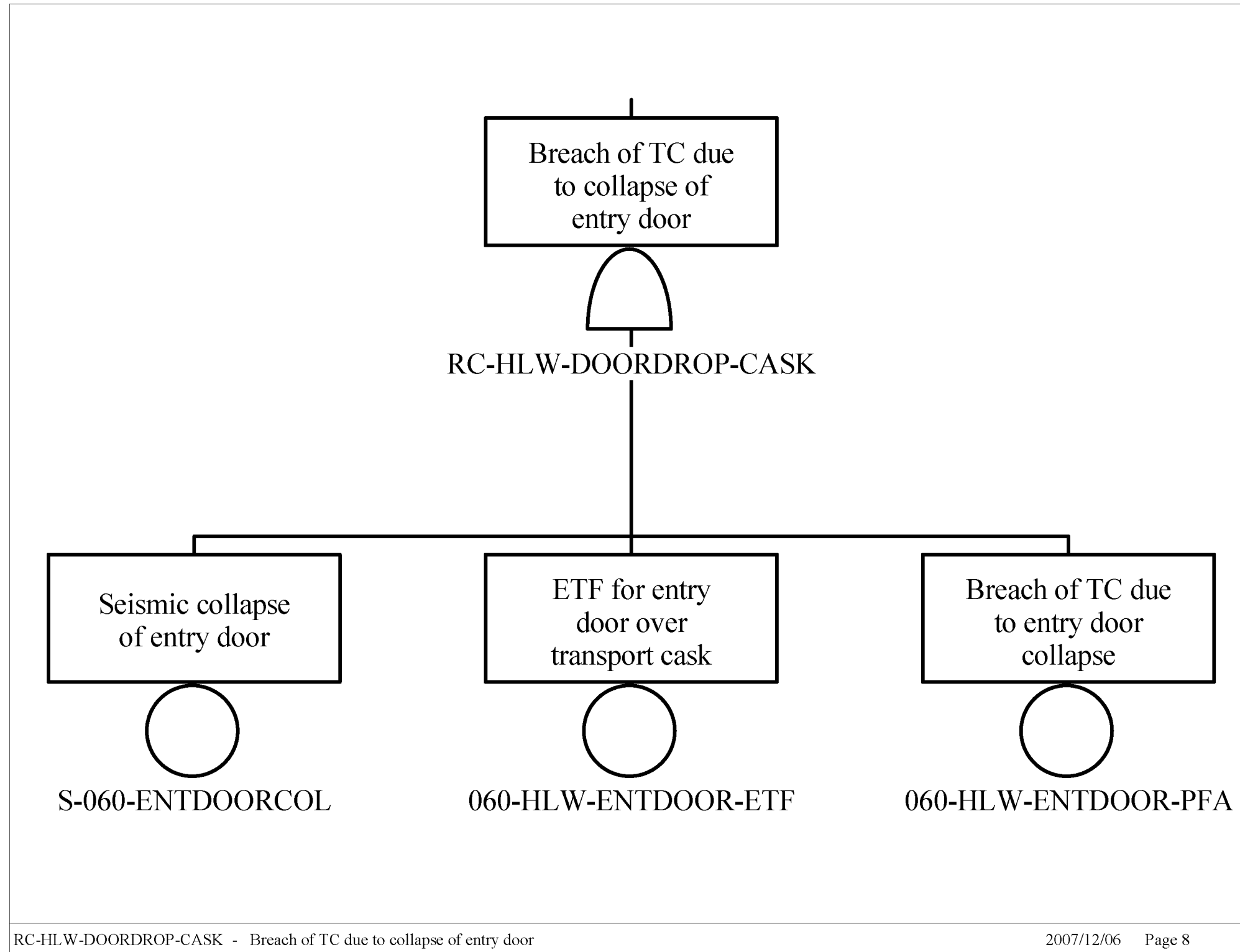

Source: Original

Figure C3.2-4. RC-HLW-DOORDROP-CASK – Breach of TC due to Collapse of Entry Door

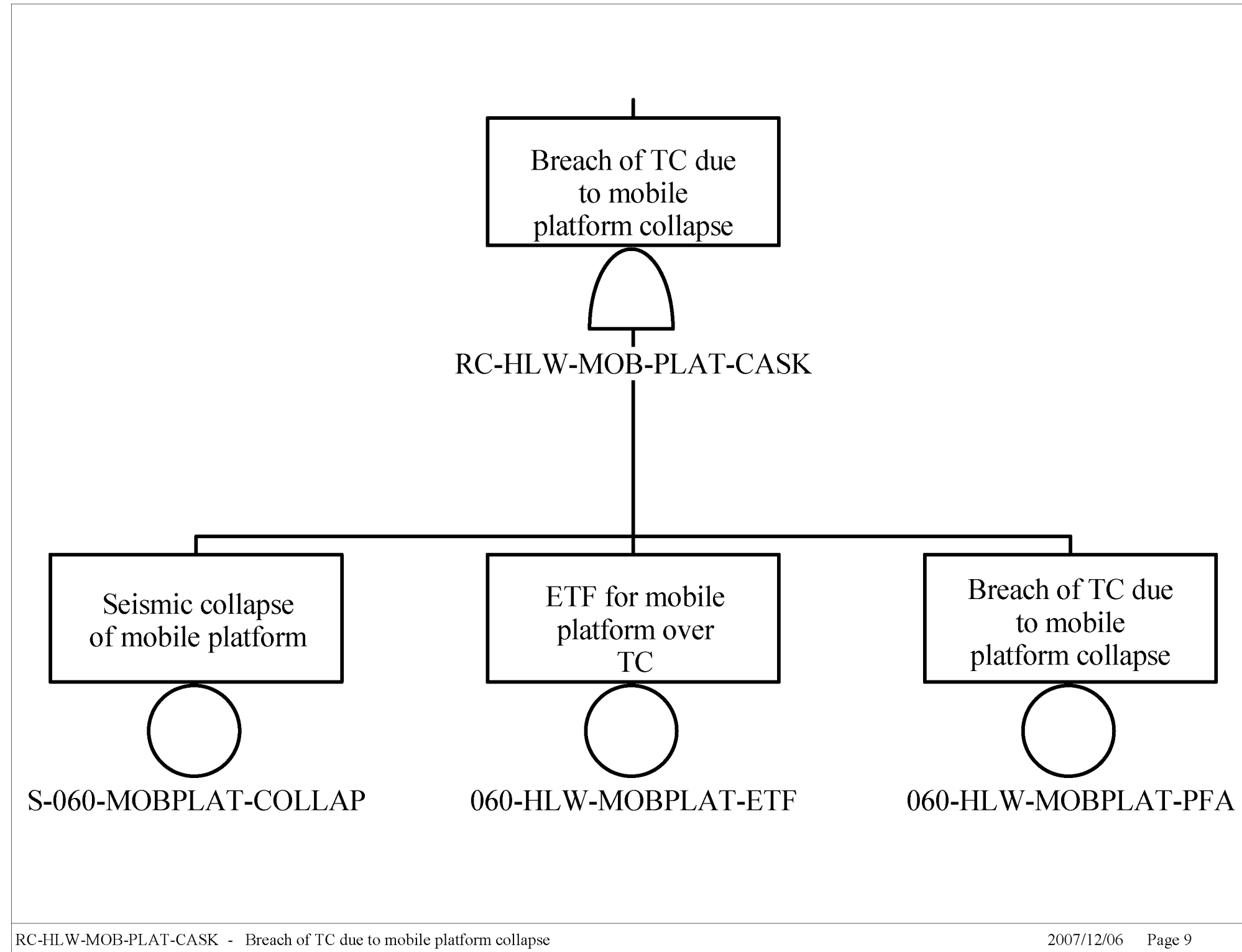

Source: Original

Figure C3.2-5. RC-HLW-MOB-PLAT-CASK– Breach of TC due to Mobile Platform Collapse

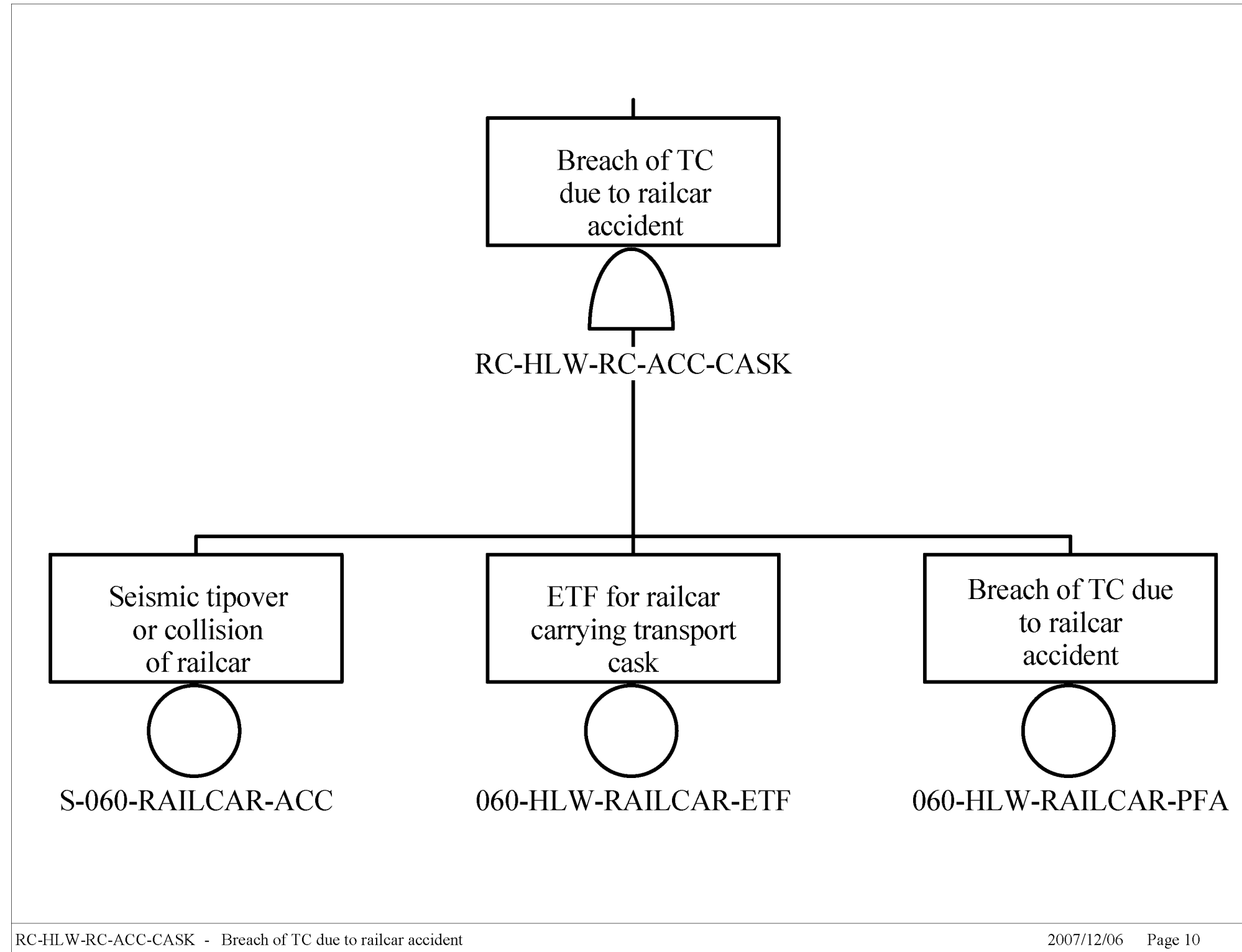

Source: Original

Figure C3.2-6. RC-HLW-RC-ACC-CASK – Breach of TC due to Railcar Accident

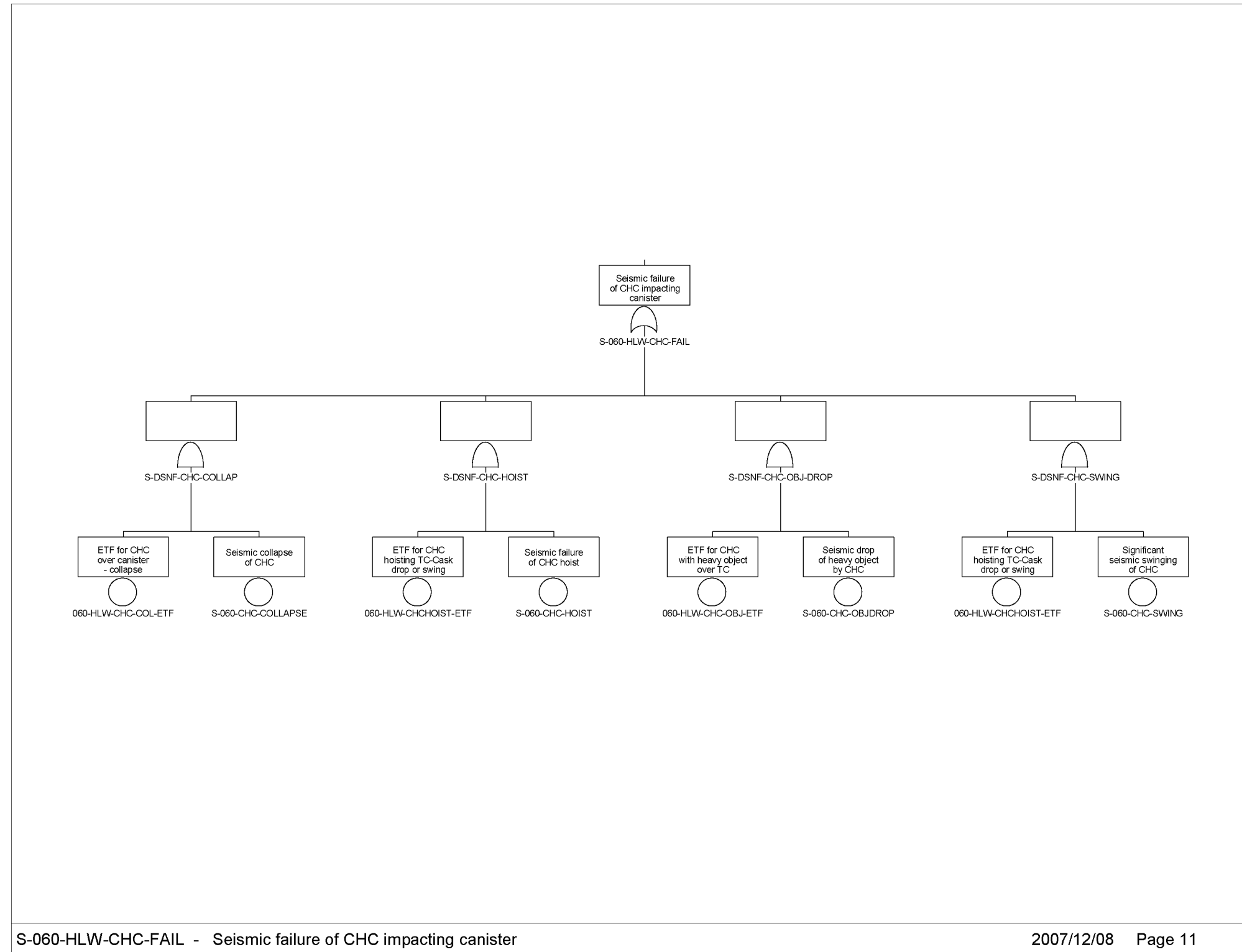

Source: Original

Figure C3.2-7. S-060-HLW-CHC-FAIL – Seismic Failure of CHC Impacting Canister

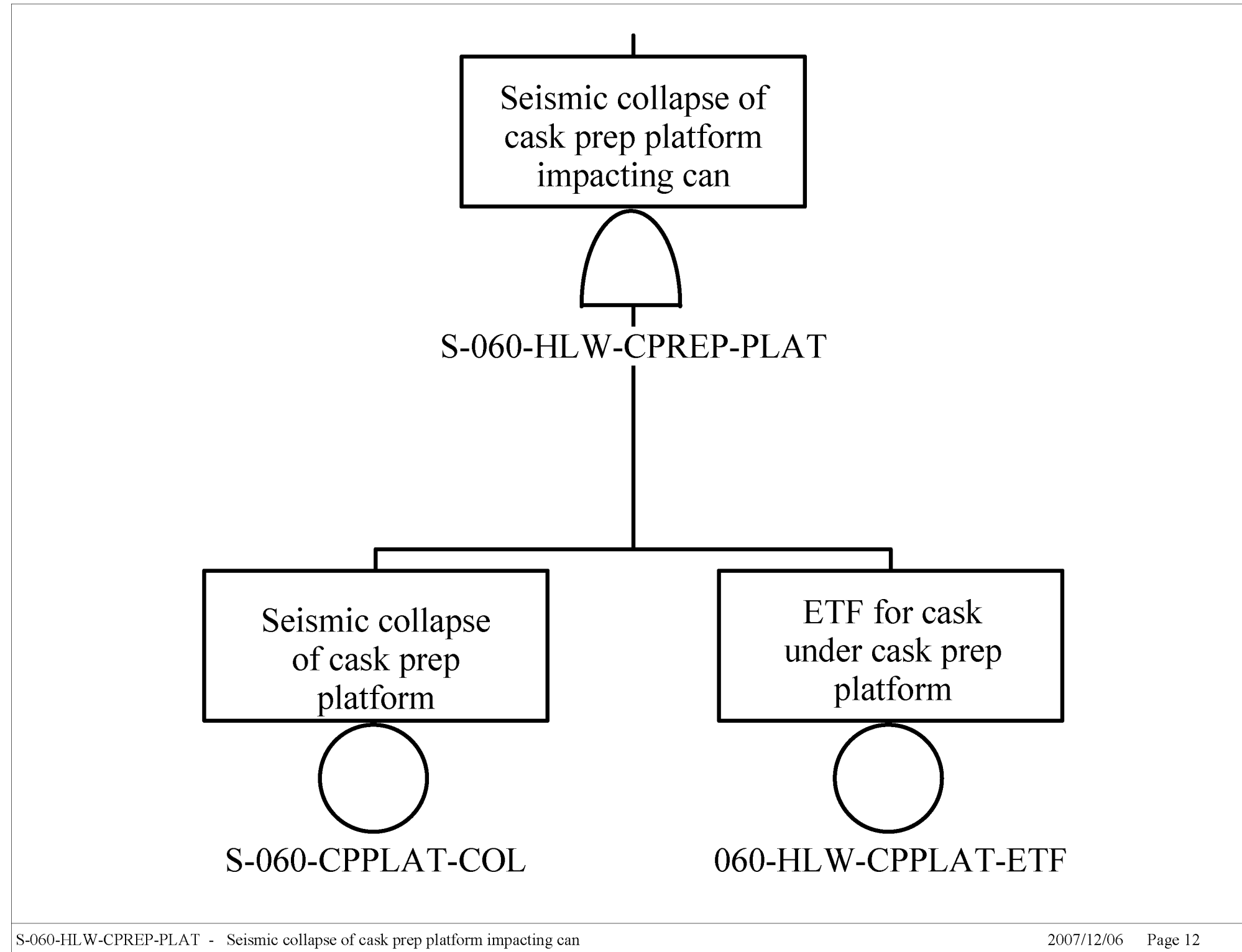

Source: Original

Figure C3.2-8. S-060-HLW-CPREP-PLAT – Seismic Collapse of Cask Prep Platform Impacting Can

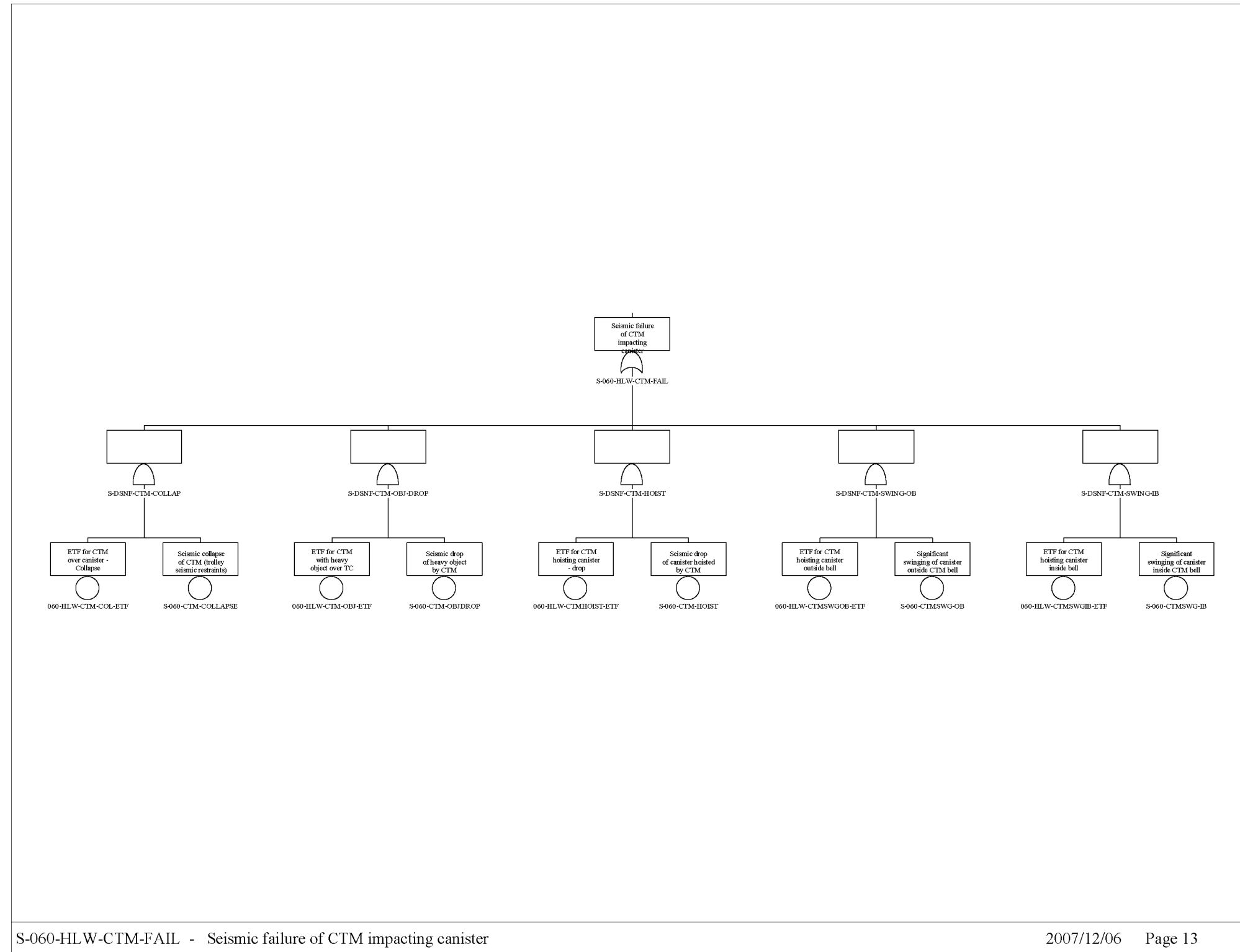

Source: Original

Figure C3.2-9. S-060-HLW-CTM-FAIL – Seismic Failure of CTM Impacting Canister

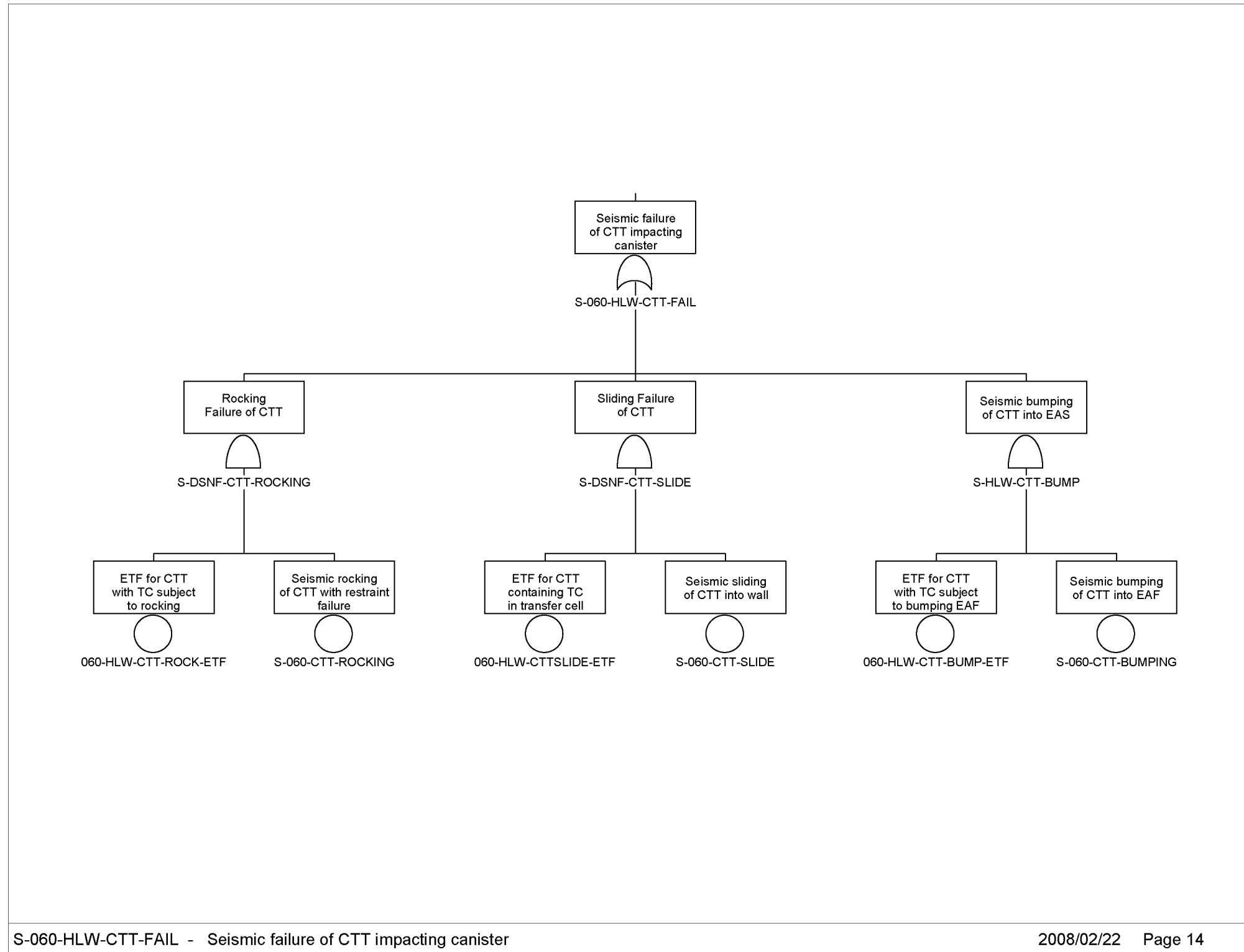

Source: Original

Figure C3.2-10. S-060-HLW-CTT-FAIL – Seismic Failure of CTT Impacting Canister

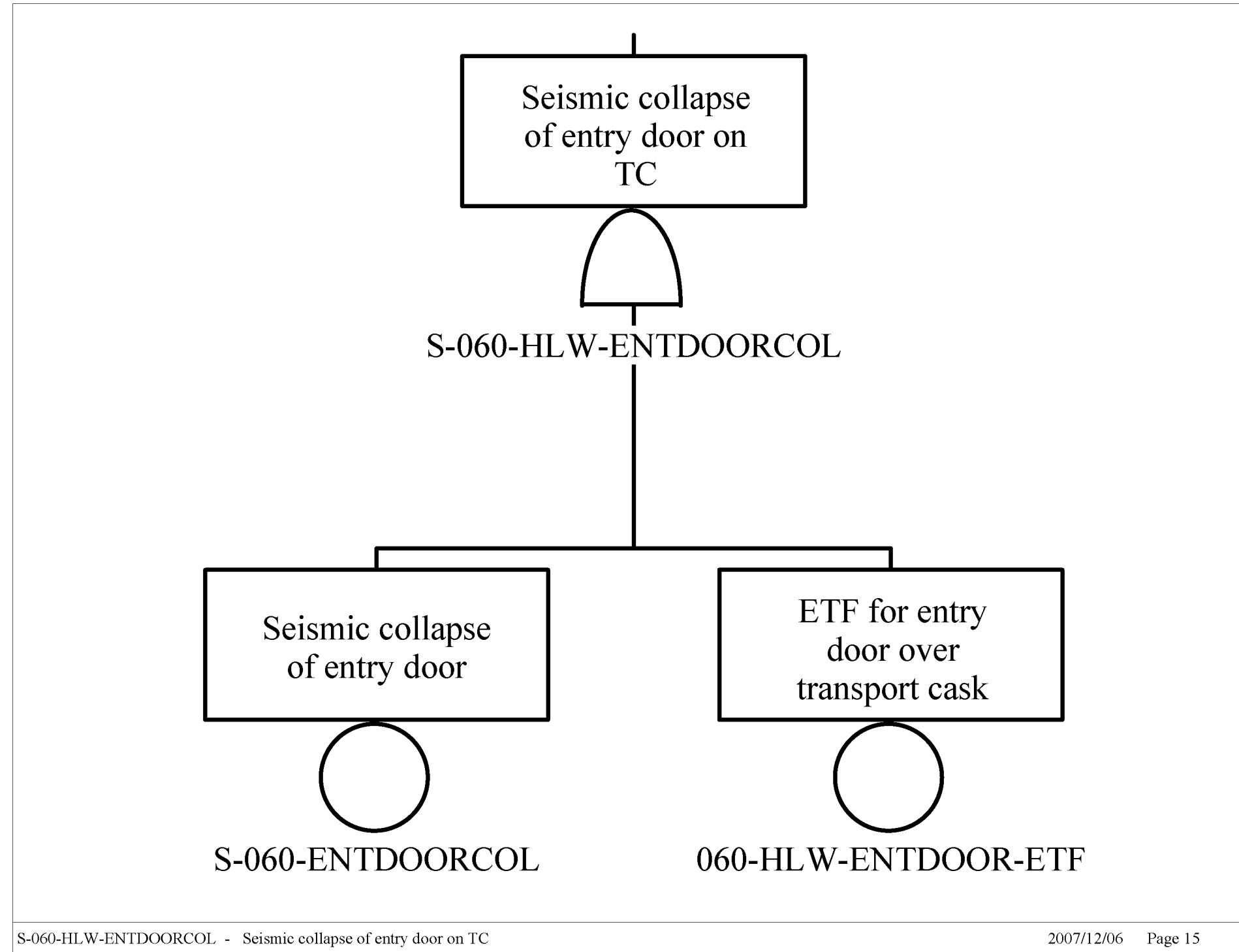

Source: Original

Figure C3.2-11. S-060-HLW-ENTDOORCOL – Seismic Collapse of Entry Door on TC

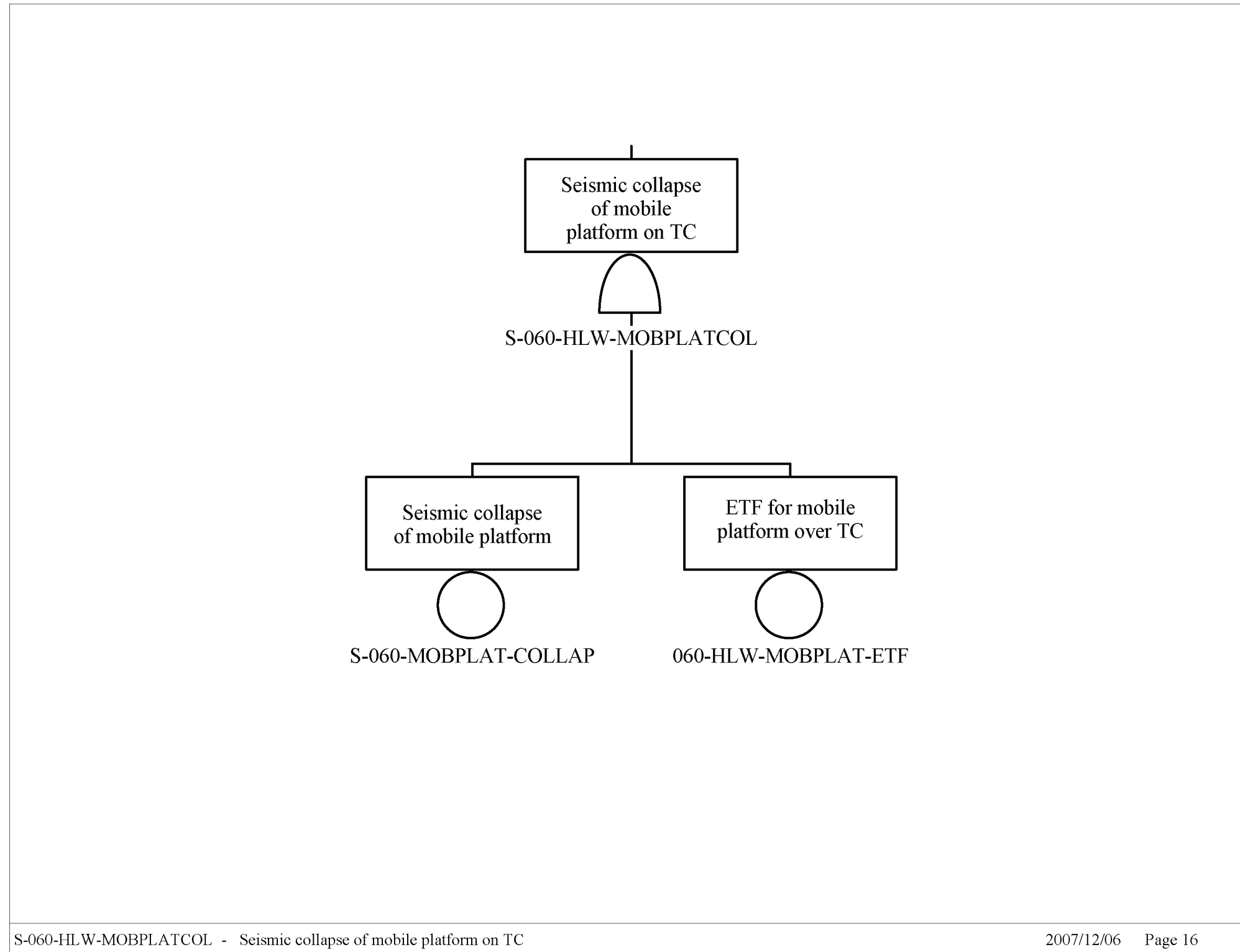

Source: Original

Figure C3.2-12. S-060-HLW-MOBPLATCOL – Seismic Collapse of Mobile Platform on TC

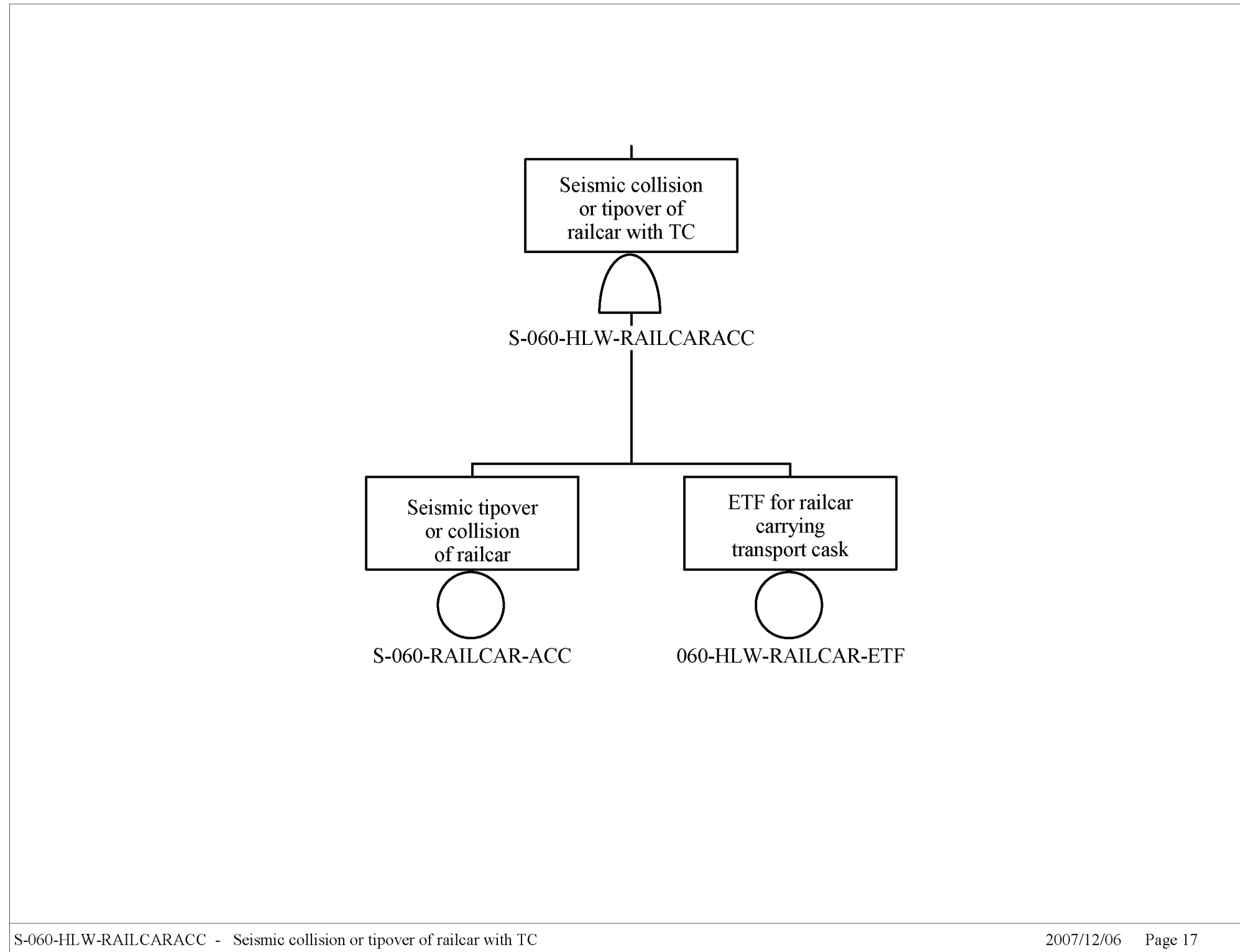

Source: Original

Figure C3.2-13. S-060-HLW-RAILCARACC – Seismic Collision or Tipover of Railcar with TC

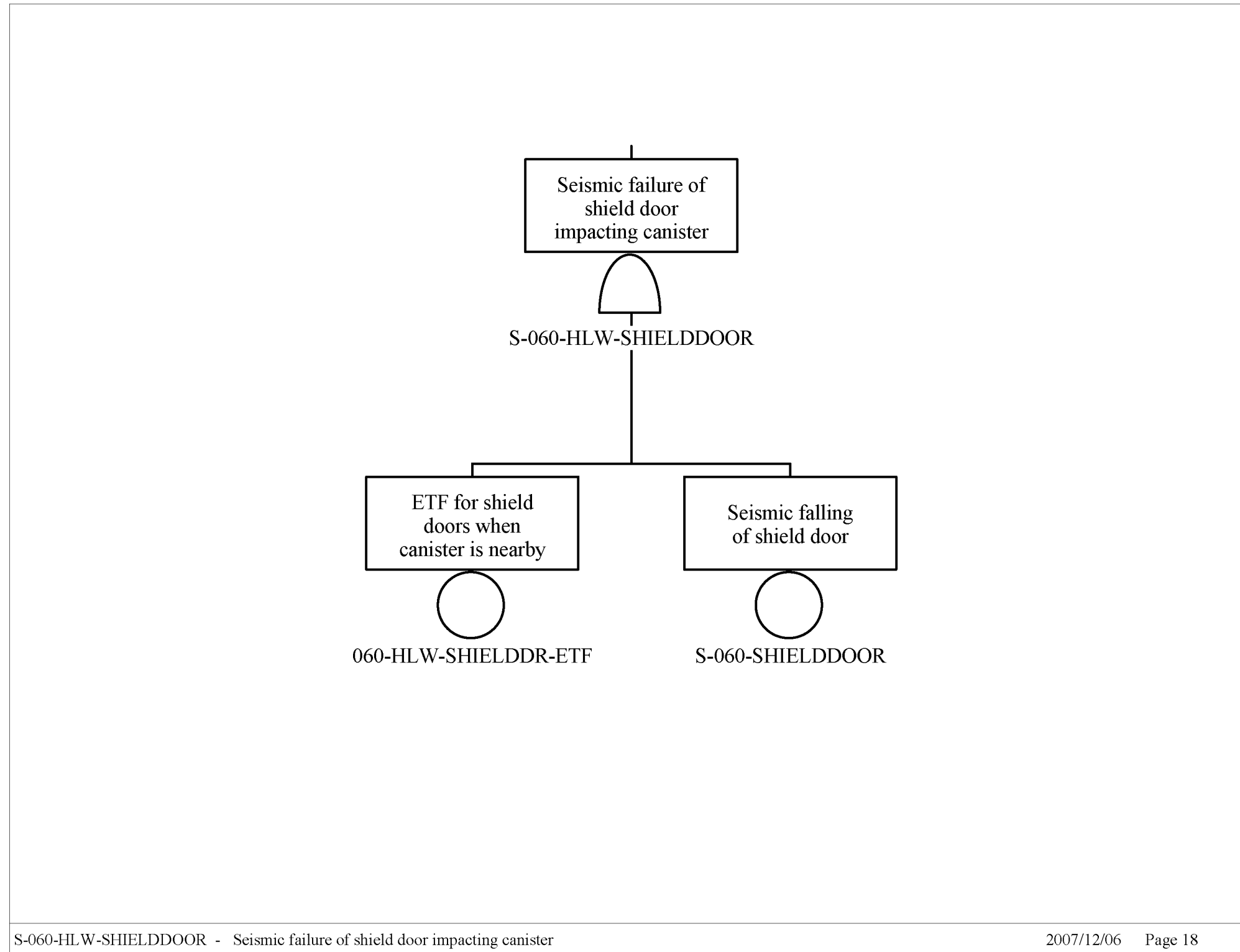

Source: Original

Figure C3.2-14. S-060-HLW-SHIELDDOOR – Seismic Failure of Shield Door Impacting Canister

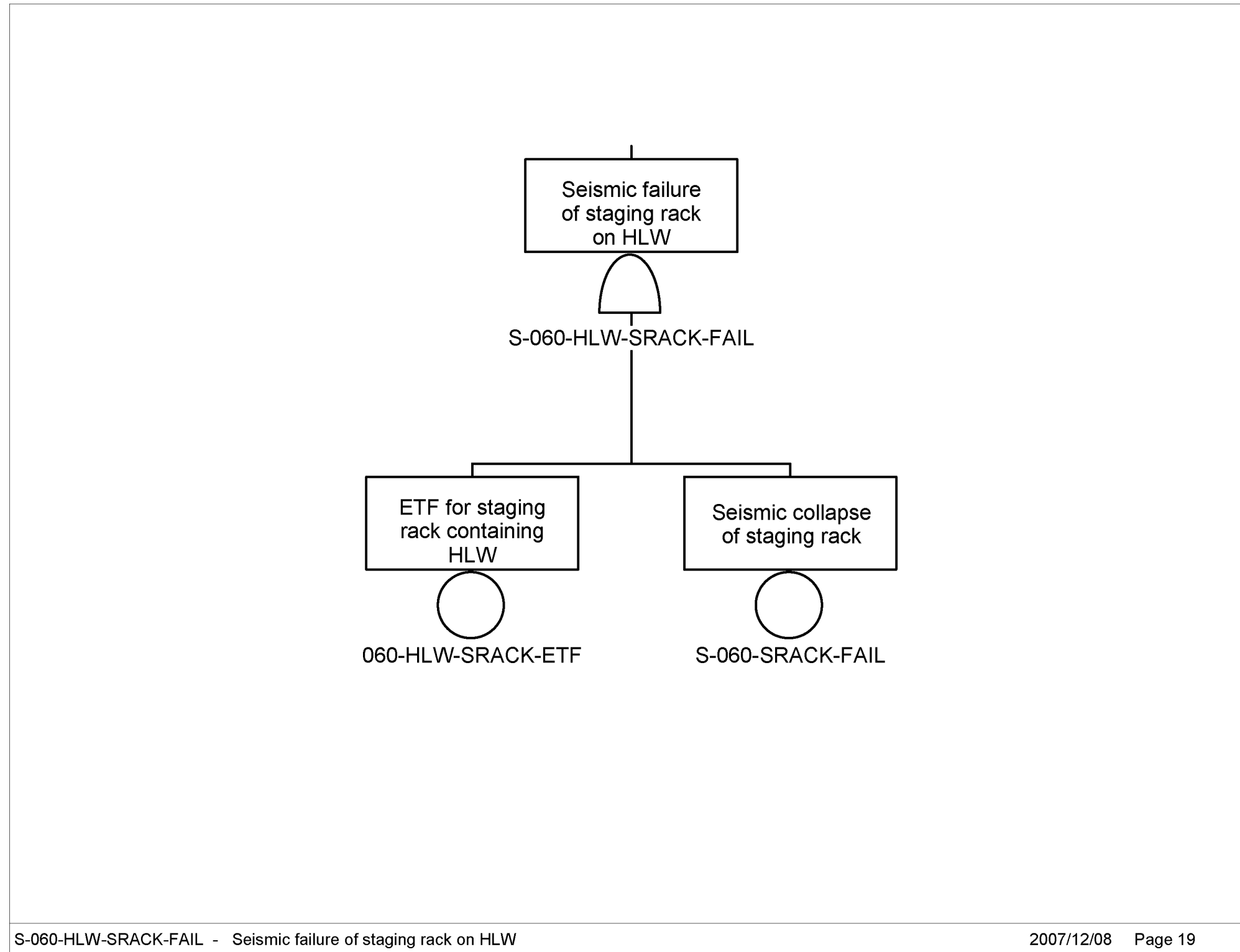

Source: Original

Figure C3.2-15. S-060-HLW-SRACK-FAIL – Seismic Failure of Staging Rack on HLW

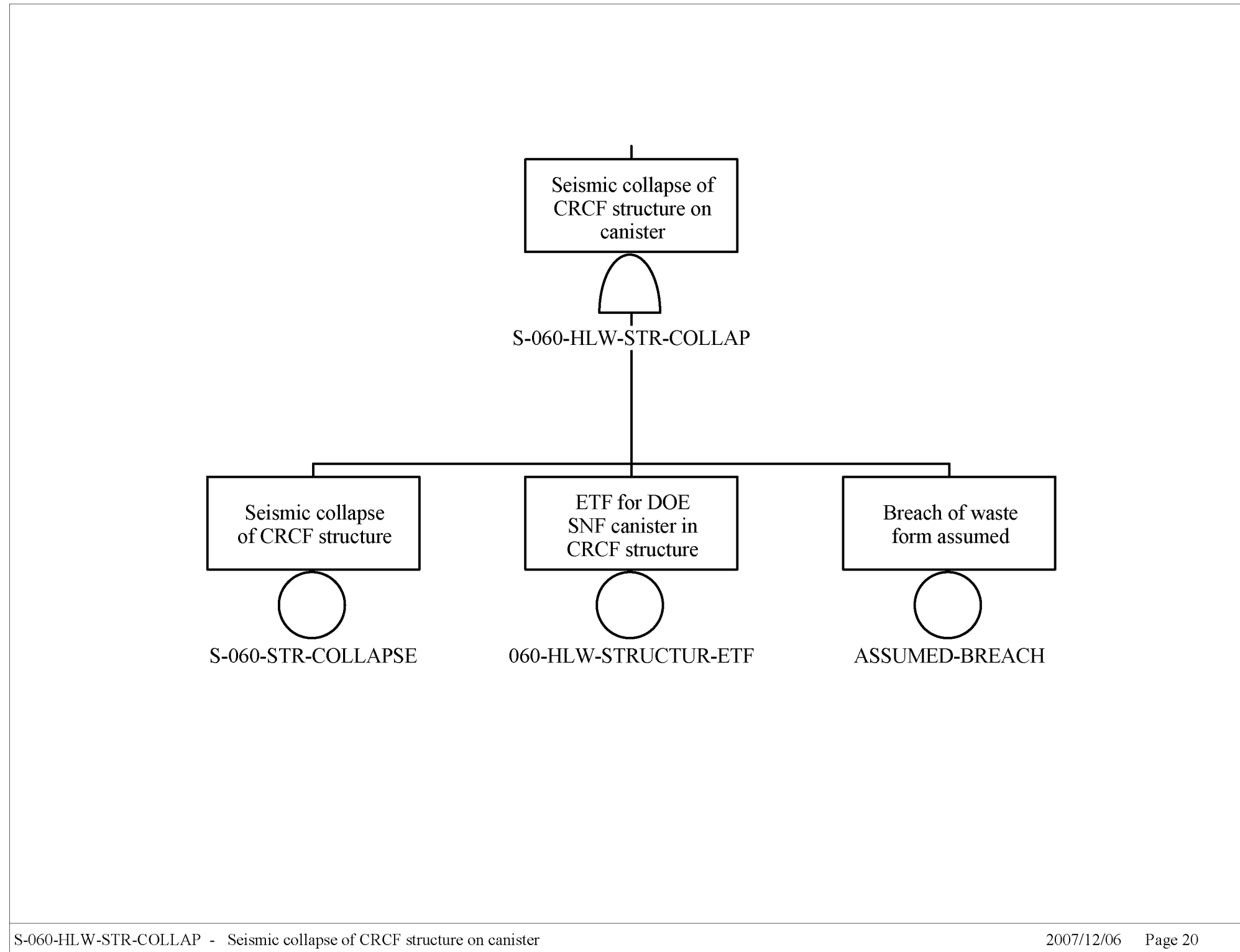

Source: Original

Figure C3.2-16. S-060-HLW-STR-COLLAP – Seismic Collapse of CRCF Structure on Canister

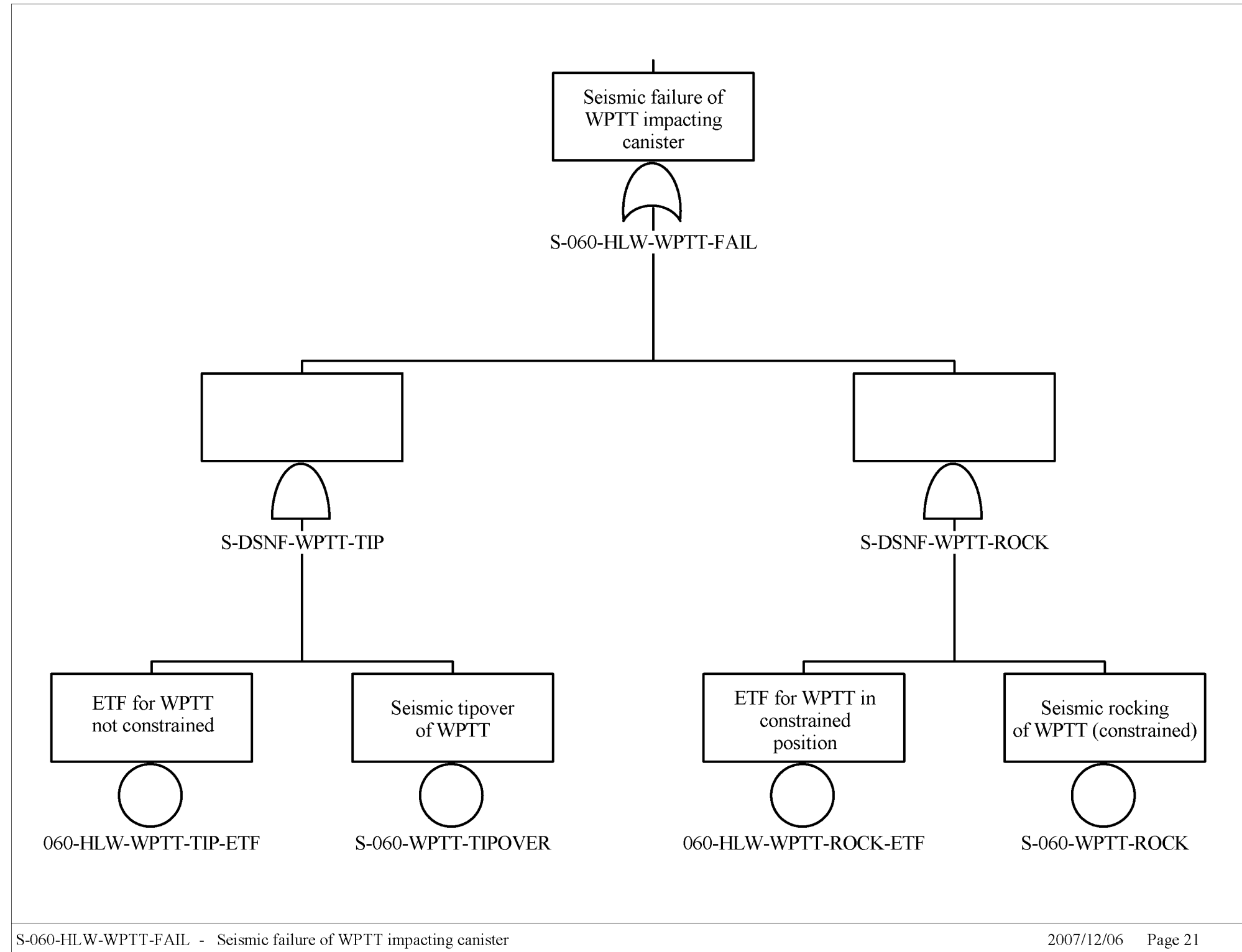

Source: Original

Figure C3.2-17. S-060-HLW-WPTT-FAIL – Seismic Failure of WPTT Impacting Canister

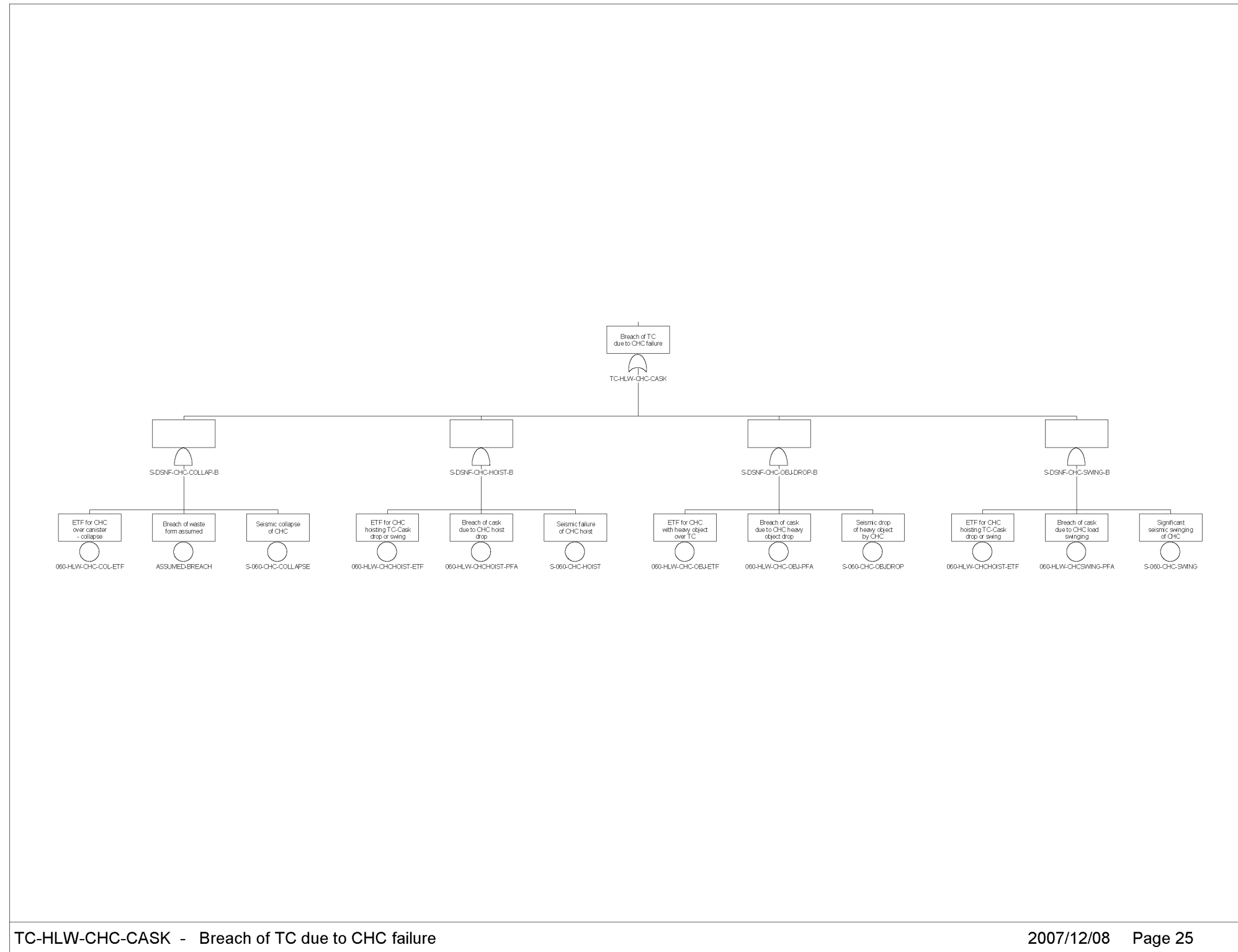

Source: Original

Figure C3.2-18. TC-HLW-CHC-CASK– Breach of TC due to CHC Failure

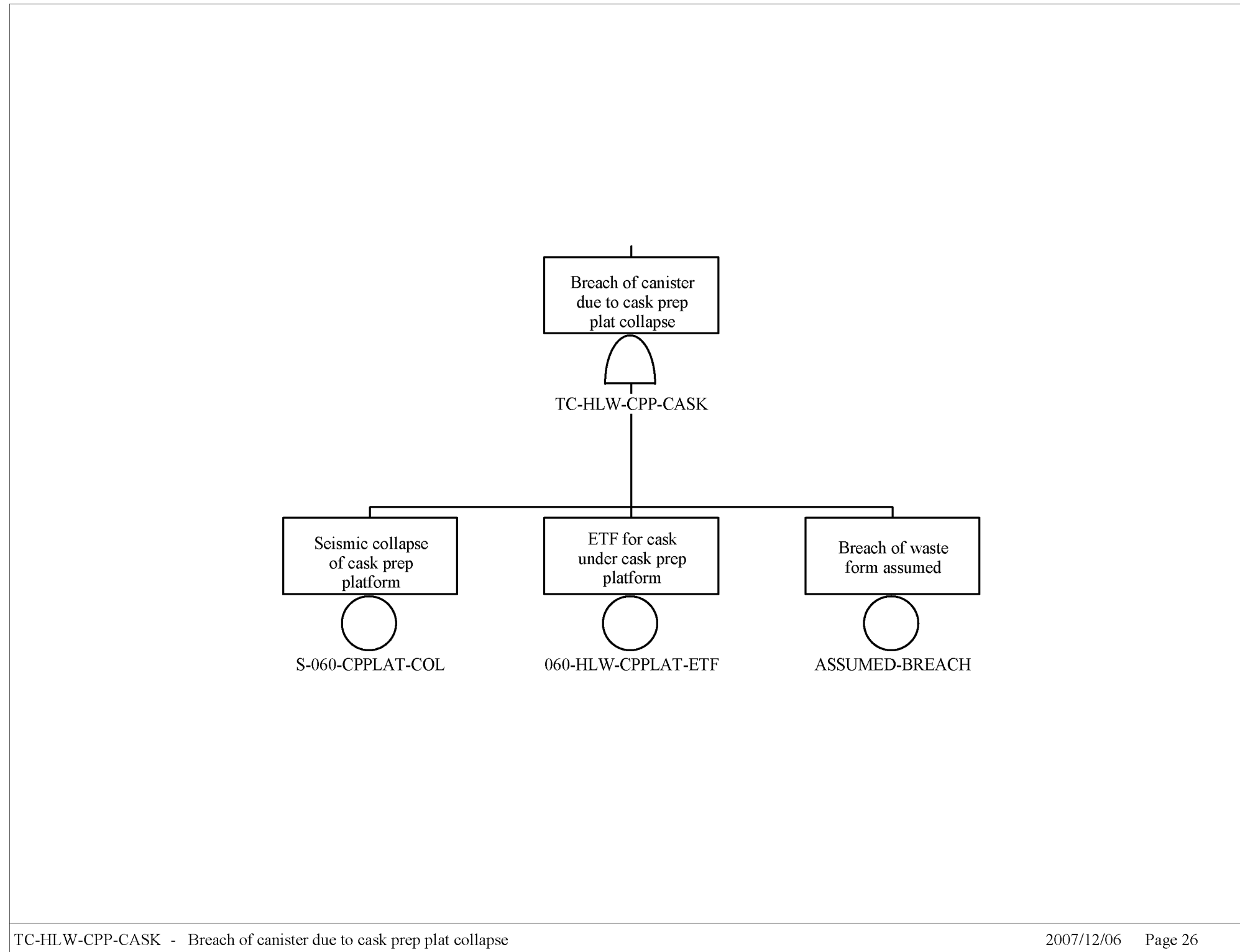

Source: Original

Figure C3.2-19. TC-HLW-CPP-CASK – Breach of Canister due to Cask Prep Plat Collapse

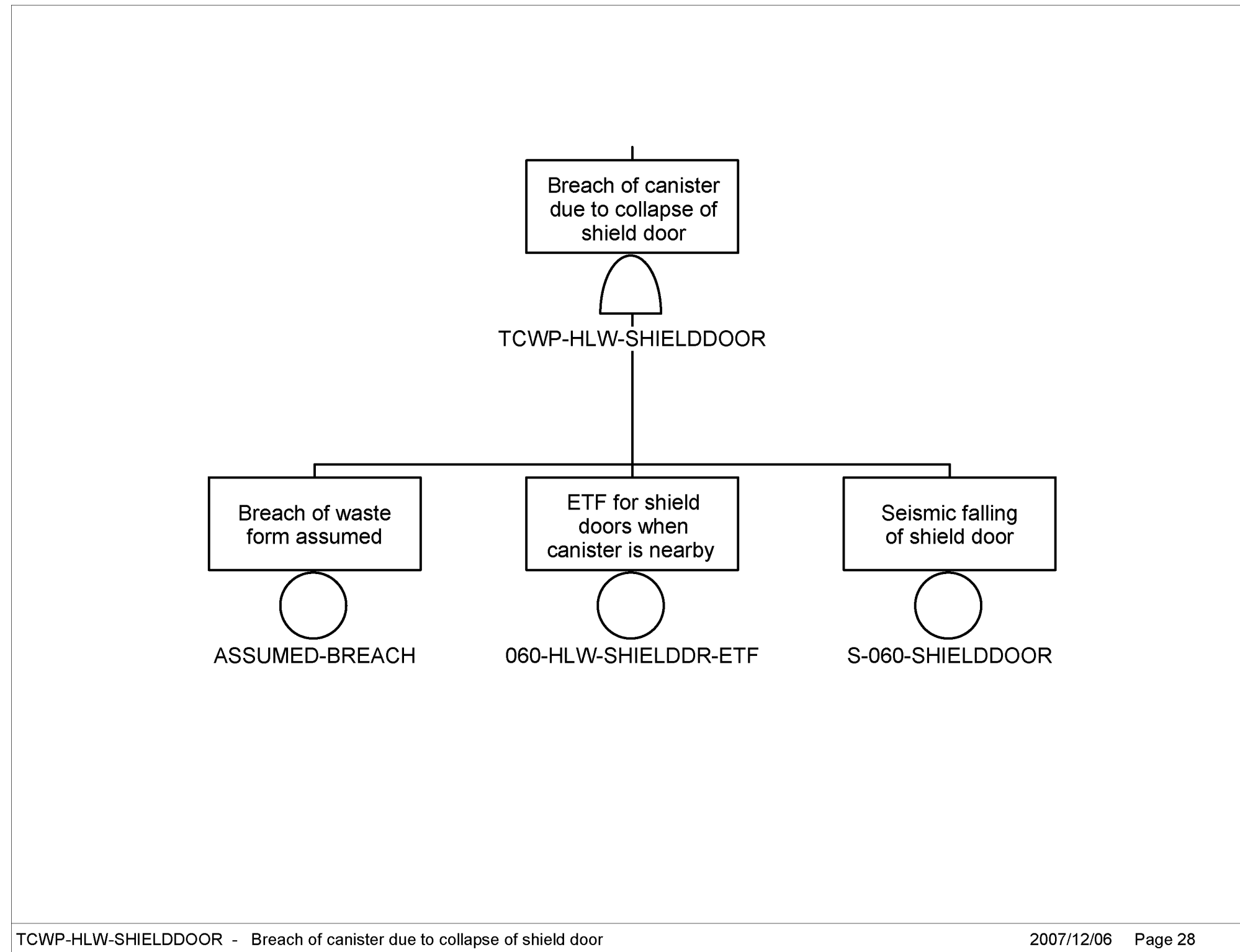

Source: Original

Figure C3.2-20. TCWP-HLW-SHIELDDOOR – Breach of Canister due to Collapse of Shield Door

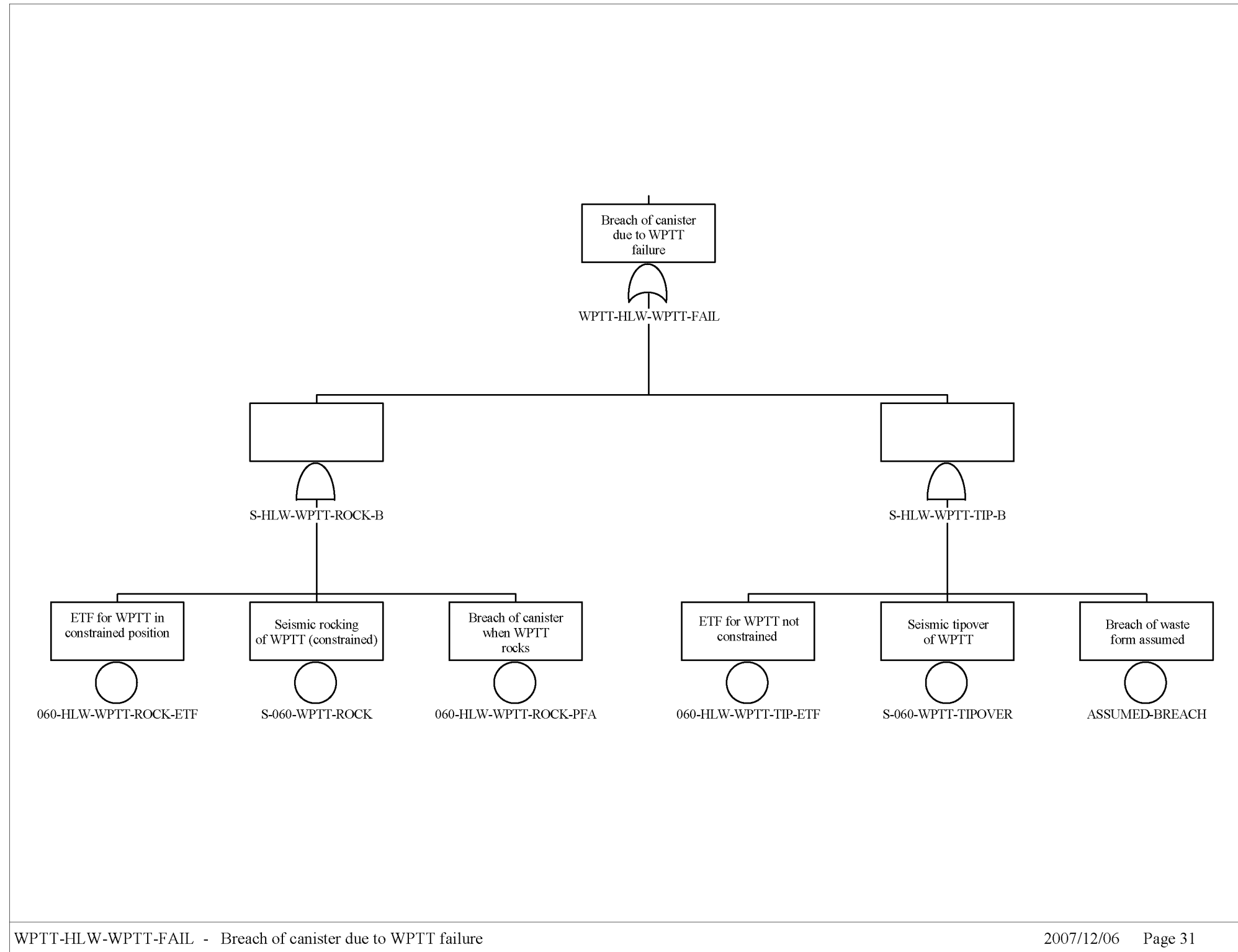

Source: Original

Figure C3.2-21. WPTT-HLW-WPTT-FAIL – Breach of Canister due to WPTT Failure

C3.3 BASIC EVENT DATA

C3.3.1 Non-seismic Basic Event Data

The following table presents the basic event identifier used in the fault trees, the description of the basic event, and the failure probability (or other numeric data) of the basic event. For exposure time factors (denoted with “ETF” at the end of the basic event identifier), the value given is the time, in years, that one waste form container is exposed to the seismic failure mode.

Table C3.3-1. Non-seismic Basic Event Data

Name	Description	Calc. Probability
060-HLW-CHC-COL-ETF	ETF for CHC over canister - collapse	1.890E-004
060-HLW-CHC-OBJ-ETF	ETF for CHC with heavy object over TC	2.850E-005
060-HLW-CHC-OBJ-PFA	Breach of cask due to CHC heavy object drop	1.000E-005
060-HLW-CHCHOIST-ETF	ETF for CHC hoisting TC-cask drop or swing	2.090E-005
060-HLW-CHCHOIST-PFA	Breach of cask due to CHC hoist drop	1.000E-005
060-HLW-CHCSWING-PFA	Breach of cask due to CHC load swinging	1.000E-005
060-HLW-CPPLAT-ETF	ETF for cask under cask prep platform	1.070E-004
060-HLW-CTM-COL-ETF	ETF for CTM over canister - collapse	3.100E-004
060-HLW-CTM-OBJ-ETF	ETF for CTM with heavy object over TC	5.400E-005
060-HLW-CTMHOIST-ETF	ETF for CTM hoisting canister - drop	1.160E-004
060-HLW-CTMHOIST-PFA	Breach of canister dropped by CTM	3.000E-002
060-HLW-CTMSWGIB-ETF	ETF for CTM hoisting canister inside bell	1.160E-004
060-HLW-CTMSWGIB-PFA	Breach of canister due to swing inside bell	1.000E-005
060-HLW-CTMSWGOB-ETF	ETF for CTM hoisting canister outside bell	6.660E-005
060-HLW-CTT-BUMP-ETF	ETF for CTT with TC subject to bumping EAF	1.030E-004
060-HLW-CTT-BUMP-PFA	Breach given CTT with TC subject to bumping EAF	1.000E-005
060-HLW-CTT-ROCK-ETF	ETF for CTT with TC subject to rocking	2.850E-005
060-HLW-CTTSLIDE-ETF	ETF for CTT containing TC in transfer cell	1.600E-004
060-HLW-ENTDOOR-ETF	ETF for entry door over transport cask	5.330E-006
060-HLW-ENTDOOR-PFA	Breach of TC due to entry door collapse	1.000E-005
060-HLW-MOBPLAT-ETF	ETF for mobile platform over TC	9.820E-005
060-HLW-MOBPLAT-PFA	Breach of TC due to mobile platform collapse	1.000E-005
060-HLW-RAILCAR-ETF	ETF for railcar carrying transport cask	1.810E-004
060-HLW-RAILCAR-PFA	Breach of TC due to railcar accident	1.000E-005
060-HLW-SHIELDDR-ETF	ETF for shield doors when canister is nearby	1.160E-004
060-HLW-SRACK-ETF	ETF for staging rack containing HLW	2.950E-003
060-HLW-STRUCTUR-ETF	ETF for DOE SNF canister in CRCF structure	2.010E-003
060-HLW-WPTT-ROCK-ETF	ETF for WPTT in constrained position	0.000E+000
060-HLW-WPTT-ROCK-PFA	Breach of canister when WPTT rocks	1.000E-005
060-HLW-WPTT-TIP-ETF	ETF for WPTT not constrained	8.940E-005

Table C3.3-1. Non-seismic Basic Event Data (Continued)

Name	Description	Calc. Probability
ASSUMED-BREACH	Breach of waste form assumed	1.000E+000
CRCF-HLW-CAN	Number of HLW canisters	9.801E+003
MODERATOR	Moderator prevented from entering canister	0.000E+000
SHIELDING	Shielding remains intact	1.000E-005
060-HLW-CHC-COL-ETF	ETF for CHC over canister - collapse	1.890E-004

NOTE: The basic event "ASSUMED-BREACH" is not an assumption, but is common terminology used to denote a scenario where the waste container is conservatively considered to be breached; CHC = cask handling crane; CRCF = Canister Receipt and Closure Facility; CTM = canister transfer machine; CTT = cask transfer trolley; DOE = Department of Energy; DSNF = Department of Energy spent nuclear fuel; EAF = energy absorbing feature; ETF = exposure time factor; HLW = high-level radioactive waste; SNF = spent nuclear fuel; ST = site transporter; TC = transportation cask; WPTT = waste package transfer trolley.

Source: Sections 6.2.2.23 and 6.3.3, Table 6.3-1, Table 6.3-2, Table 6.6-1

C3.3.2 Seismic Basic Event Fragility Data

The following table provides the seismic failure basic event identifier, description, median fragility, and composite uncertainty.

Table C3.3-2. Seismic Basic Event Fragility Data

Event Name	Description	Med. Fragility (g)	Beta C
S-060-CHC-COLLAPSE	Seismic collapse of CHC	2.790E+000	4.500E-001
S-060-CHC-HOIST	Seismic failure of CHC hoist	2.280E+000	5.000E-001
S-060-CHC-OBJDROP	Seismic drop of heavy object by CHC	2.280E+000	5.000E-001
S-060-CHC-SWING	Significant seismic swinging of CHC	1.140E+000	4.000E-001
S-060-CPPLAT-COL	Seismic collapse of cask prep platform	3.500E+000	4.000E-001
S-060-CTM-COLLAPSE	Seismic collapse of CTM (trolley seismic restraints)	2.390E+000	4.500E-001
S-060-CTM-HOIST	Seismic drop of canister hoisted by CTM	2.280E+000	5.000E-001
S-060-CTM-OBJDROP	Seismic drop of heavy object by CTM	2.280E+000	5.000E-001
S-060-CTMSWG-IB	Significant swinging of canister inside CTM bell	1.140E+000	4.000E-001
S-060-CTMSWG-OB	Significant swinging of canister outside CTM bell	9.100E-001	4.000E-001
S-060-CTT-BUMPING	Seismic bumping of CTT into EAF	2.250E+000	4.100E-001
S-060-CTT-ROCKING	Seismic rocking of CTT with restraint failure	2.250E+000	4.100E-001
S-060-CTT-SLIDE	Seismic sliding of CTT into wall	3.080E+000	5.800E-001
S-060-ENTDOORCOL	Seismic collapse of entry door	3.700E-001	4.000E-001
S-060-MOBPLAT-COLLAP	Seismic collapse of mobile platform	3.700E-001	4.000E-001
S-060-RAILCAR-ACC	Seismic tipover or collision of railcar	4.500E-001	4.000E-001

Table C3.3-2. Seismic Basic Event Fragility Data (Continued)

Event Name	Description	Med. Fragility (g)	Beta C
S-060-SHIELDDOOR	Seismic falling of shield door	2.920E+000	4.400E-001
S-060-STR-COLLAPSE	Seismic collapse of CRCF structure	4.610E+000	4.000E-001
S-060-WPTT-ROCK	Seismic rocking of WPTT (constrained)	1.850E+000	3.700E-001
S-060-WPTT-TIPOVER	Seismic tipover of WPTT	3.410E+000	4.000E-001

NOTE: CHC = cask handling crane; CRCF = Canister Receipt and Closure Facility; CTM = canister transfer machine; CTT = cask transfer trolley; WPTT = waste package transfer trolley.

Source: Table 6.2-1 and Table 6.2-2

C3.4 EVENT SEQUENCE QUANTIFICATION

This section provides the quantification results by sequence. The event sequence probabilities are provided first, and the cut sets are provided afterwards.

C3.4.1 Sequence Level Results

Table C3.4-1. Sequence Level Results

Event Tree	Sequence	Base Min. Cut	Base Cut Sets
CRCF-S-IE-HLW	03	1.542E-005	1
CRCF-S-IE-HLW	04-2	5.265E-010	1
CRCF-S-IE-HLW	04-3	+0.000E+000	1
CRCF-S-IE-HLW	04-4	+0.000E+000	1
CRCF-S-IE-HLW	04-5	+0.000E+000	1
CRCF-S-IE-HLW	04-6	5.265E-010	1
CRCF-S-IE-HLW	04-7	+0.000E+000	1
CRCF-S-IE-HLW	05-2	1.226E-008	1
CRCF-S-IE-HLW	05-3	+0.000E+000	1
CRCF-S-IE-HLW	05-4	+0.000E+000	1
CRCF-S-IE-HLW	05-5	+0.000E+000	1
CRCF-S-IE-HLW	05-6	1.226E-008	1
CRCF-S-IE-HLW	05-7	+0.000E+000	1
CRCF-S-IE-HLW	06-2	9.699E-009	1
CRCF-S-IE-HLW	06-3	+0.000E+000	1
CRCF-S-IE-HLW	06-4	+0.000E+000	1
CRCF-S-IE-HLW	06-5	+0.000E+000	1
CRCF-S-IE-HLW	06-6	9.699E-009	1
CRCF-S-IE-HLW	06-7	+0.000E+000	1
CRCF-S-IE-HLW	07-2	2.688E-010	3
CRCF-S-IE-HLW	07-3	+0.000E+000	1
CRCF-S-IE-HLW	07-4	+0.000E+000	1
CRCF-S-IE-HLW	07-5	+0.000E+000	1

Table C3.4-1. Sequence Level Result (Continued)

Event Tree	Sequence	Base Min. Cut	Base Cut Sets
CRCF-S-IE-HLW	07-6	1.454E-005	4
CRCF-S-IE-HLW	07-7	+0.000E+000	1
CRCF-S-IE-HLW	08-2		0
CRCF-S-IE-HLW	08-3	+0.000E+000	1
CRCF-S-IE-HLW	08-4	+0.000E+000	1
CRCF-S-IE-HLW	08-5	+0.000E+000	1
CRCF-S-IE-HLW	08-6	2.764E-006	1
CRCF-S-IE-HLW	08-7	+0.000E+000	1
CRCF-S-IE-HLW	09-2	1.370E-010	1
CRCF-S-IE-HLW	09-3	+0.000E+000	1
CRCF-S-IE-HLW	09-4	+0.000E+000	1
CRCF-S-IE-HLW	09-5	+0.000E+000	1
CRCF-S-IE-HLW	09-6	1.885E-005	3
CRCF-S-IE-HLW	09-7	+0.000E+000	1
CRCF-S-IE-HLW	10-2		0
CRCF-S-IE-HLW	10-3	+0.000E+000	1
CRCF-S-IE-HLW	10-4	+0.000E+000	1
CRCF-S-IE-HLW	10-5	+0.000E+000	1
CRCF-S-IE-HLW	10-6	7.293E-006	1
CRCF-S-IE-HLW	10-7	+0.000E+000	1
CRCF-S-IE-HLW	11-2	1.211E-009	2
CRCF-S-IE-HLW	11-3	+0.000E+000	1
CRCF-S-IE-HLW	11-4	+0.000E+000	1
CRCF-S-IE-HLW	11-5	1.189E-004	5
CRCF-S-IE-HLW	11-6	+0.000E+000	1
CRCF-S-IE-HLW	12-2		0
CRCF-S-IE-HLW	12-3	+0.000E+000	1
CRCF-S-IE-HLW	12-4	+0.000E+000	1
CRCF-S-IE-HLW	12-5	3.690E-005	1
CRCF-S-IE-HLW	12-6	+0.000E+000	1
CRCF-S-IE-HLW	13-2	+0.000E+000	1
CRCF-S-IE-HLW	13-3	+0.000E+000	1
CRCF-S-IE-HLW	13-4	+0.000E+000	1
CRCF-S-IE-HLW	13-5	+0.000E+000	1
CRCF-S-IE-HLW	13-6	2.567E-006	2
CRCF-S-IE-HLW	13-7	+0.000E+000	1

Source: Original

C3.4.2 Cut Set Level Results by Sequence

Note that the SAPHIRE software does not provide special tables for seismic cut sets. Therefore, the “Cut Set %” given in the third column of this table is not correct for seismic events, although it does provide the approximate rank order for the cut sets.

Table C3.4-2. Cut Set Level Results by Sequence

Event Tree	Sequence	Cut Set %	Basic Event	Description
CRCF-S-IE-HLW	03	100.00	060-HLW-STRUCTUR-ETF	ETF for DOE SNF canister in CRCF structure
			CRCF-HLW-CAN	Number of HLW canisters
			S-060-STR-COLLAPSE	Seismic collapse of CRCF structure
			= Total	
04-2	100.00	060-HLW-ENTDOOR-ETF	060-HLW-ENTDOOR-ETF	ETF for entry door over transport cask
			CRCF-HLW-CAN	Number of HLW canisters
			S-060-ENTDOORCOL	Seismic collapse of entry door
			SHIELDING	Shielding remains intact
			= Total	
04-3	0.00	<FALSE>		System Generated Success Event
			= Total	
04-4	0.00	<FALSE>		System Generated Success Event
			= Total	
04-5	0.00	<FALSE>		System Generated Success Event
			= Total	
04-6	100.00	060-HLW-ENTDOOR-ETF	060-HLW-ENTDOOR-ETF	ETF for entry door over transport cask
			060-HLW-ENTDOOR-PFA	Breach of TC due to entry door collapse
			CRCF-HLW-CAN	Number of HLW canisters
			S-060-ENTDOORCOL	Seismic collapse of entry door
			= Total	
04-7	0.00	<FALSE>		System Generated Success Event
			= Total	
05-2	100.00	060-HLW-RAILCAR-ETF	060-HLW-RAILCAR-ETF	ETF for railcar carrying transport cask
			CRCF-HLW-CAN	Number of HLW canisters
			S-060-RAILCAR-ACC	Seismic tipover or collision of railcar
			SHIELDING	Shielding remains intact
			= Total	
05-3	0.00	<FALSE>		System Generated Success Event
			= Total	
05-4	0.00	<FALSE>		System Generated Success Event
			= Total	

Table C3.4-2. Cut Set Level Results by Sequence (Continued)

Event Tree	Sequence	Cut Set %	Basic Event	Description
	05-5	0.00	<FALSE>	System Generated Success Event
			= Total	
	05-6	100.00	060-HLW-RAILCAR-ETF	ETF for railcar carrying transport cask
			060-HLW-RAILCAR-PFA	Breach of TC due to railcar accident
			CRCF-HLW-CAN	Number of HLW canisters
			S-060-RAILCAR-ACC	Seismic tipover or collision of railcar
			= Total	
	05-7	0.00	<FALSE>	System Generated Success Event
			= Total	
	06-2	100.00	060-HLW-MOBPLAT-ETF	ETF for mobile platform over TC
			CRCF-HLW-CAN	Number of HLW canisters
			S-060-MOBPLAT-COLLAP	Seismic collapse of mobile platform
			SHIELDING	Shielding remains intact
			= Total	
	06-3	0.00	<FALSE>	System Generated Success Event
			= Total	
	06-4	0.00	<FALSE>	System Generated Success Event
			= Total	
	06-5	0.00	<FALSE>	System Generated Success Event
			= Total	
	06-6	100.00	060-HLW-MOBPLAT-ETF	ETF for mobile platform over TC
			060-HLW-MOBPLAT-PFA	Breach of TC due to mobile platform collapse
			CRCF-HLW-CAN	Number of HLW canisters
			S-060-MOBPLAT-COLLAP	Seismic collapse of mobile platform
			= Total	
	06-7	0.00	<FALSE>	System Generated Success Event
			= Total	
	07-2	87.87	060-HLW-CHCHOIST-ETF	ETF for CHC hoisting TC-cask drop or swing
			CRCF-HLW-CAN	Number of HLW canisters
			S-060-CHC-SWING	Significant seismic swinging of CHC
			SHIELDING	Shielding remains intact
		7.00	060-HLW-CHC-OBJ-ETF	ETF for CHC with heavy object over TC
			CRCF-HLW-CAN	Number of HLW canisters
			S-060-CHC-OBJDROP	Seismic drop of heavy object by CHC

Table C3.4-2. Cut Set Level Results by Sequence (Continued)

Event Tree	Sequence	Cut Set %	Basic Event	Description
			SHIELDING	Shielding remains intact
		5.13	060-HLW-CHCHOIST-ETF	ETF for CHC hoisting TC-cask drop or swing
			CRCF-HLW-CAN	Number of HLW canisters
			S-060-CHC-HOIST	Seismic failure of CHC hoist
			SHIELDING	Shielding remains intact
			= Total	
	07-3	0.00	<FALSE>	System Generated Success Event
			= Total	
	07-4	0.00	<FALSE>	System Generated Success Event
			= Total	
	07-5	0.00	<FALSE>	System Generated Success Event
			= Total	
	07-6	99.95	060-HLW-CHC-COL-ETF	ETF for CHC over canister - collapse
			CRCF-HLW-CAN	Number of HLW canisters
			S-060-CHC-COLLAPSE	Seismic collapse of CHC
		0.04	060-HLW-CHCHOIST-ETF	ETF for CHC hoisting TC-Cask drop or swing
			060-HLW-CHCSWING-PFA	Breach of cask due to CHC load swinging
			CRCF-HLW-CAN	Number of HLW canisters
			S-060-CHC-SWING	Significant seismic swinging of CHC
		0.00	060-HLW-CHC-OBJ-ETF	ETF for CHC with heavy object over TC
			060-HLW-CHC-OBJ-PFA	Breach of cask due to CHC heavy object drop
			CRCF-HLW-CAN	Number of HLW canisters
			S-060-CHC-OBJDROP	Seismic drop of heavy object by CHC
		0.00	060-HLW-CHCHOIST-ETF	ETF for CHC hoisting TC-cask drop or swing
			060-HLW-CHCHOIST-PFA	Breach of cask due to CHC hoist drop
			CRCF-HLW-CAN	Number of HLW canisters
			S-060-CHC-HOIST	Seismic failure of CHC hoist
			= Total	
	07-7	0.00	<FALSE>	System Generated Success Event
			= Total	
	08-2			
	08-3	0.00	<FALSE>	System Generated Success Event
			= Total	
	08-4	0.00	<FALSE>	System Generated Success Event
			= Total	

Table C3.4-2. Cut Set Level Results by Sequence (Continued)

Event Tree	Sequence	Cut Set %	Basic Event	Description
	08-5	0.00	<FALSE>	System Generated Success Event
			= Total	
	08-6	100.00	060-HLW-CPPLAT-ETF	ETF for cask under cask prep platform
			CRCF-HLW-CAN	Number of HLW canisters
			S-060-CPPLAT-COL	Seismic collapse of cask prep platform
			= Total	
	08-7	0.00	<FALSE>	System Generated Success Event
			= Total	
	09-2	100.00	060-HLW-CTT-BUMP-ETF	ETF for CTT with TC subject to bumping EAF
			CRCF-HLW-CAN	Number of HLW canisters
			S-060-CTT-BUMPING	Seismic bumping of CTT into EAF
			SHIELDING	Shielding remains intact
			= Total	
	09-3	0.00	<FALSE>	System Generated Success Event
			= Total	
	09-4	0.00	<FALSE>	System Generated Success Event
			= Total	
	09-5	0.00	<FALSE>	System Generated Success Event
			= Total	
	09-6	98.30	060-HLW-CTTSLIDE-ETF	ETF for CTT containing TC in transfer cell
			CRCF-HLW-CAN	Number of HLW canisters
			S-060-CTT-SLIDE	Seismic sliding of CTT into wall
		1.71	060-HLW-CTT-ROCK-ETF	ETF for CTT with TC subject to rocking
			CRCF-HLW-CAN	Number of HLW canisters
			S-060-CTT-ROCKING	Seismic rocking of CTT with restraint failure
		0.00	060-HLW-CTT-BUMP-ETF	ETF for CTT with TC subject to bumping EAF
			060-HLW-CTT-BUMP-PFA	Breach given CTT with TC subject to bumping EAF
			CRCF-HLW-CAN	Number of HLW canisters
			S-060-CTT-BUMPING	Seismic bumping of CTT into EAF
			= Total	
	09-7	0.00	<FALSE>	System Generated Success Event
			= Total	
	10-2			
	10-3	0.00	<FALSE>	System Generated Success Event
			= Total	
	10-4	0.00	<FALSE>	System Generated Success Event

Table C3.4-2. Cut Set Level Results by Sequence (Continued)

Event Tree	Sequence	Cut Set %	Basic Event	Description
			= Total	
	10-5	0.00	<FALSE>	System Generated Success Event
			= Total	
	10-6	100.00	060-HLW-SHIELDDR-ETF	ETF for shield doors when canister is nearby
			CRCF-HLW-CAN	Number of HLW canisters
			S-060-SHIELDDOOR	Seismic falling of shield door
			= Total	
	10-7	0.00	<FALSE>	System Generated Success Event
			= Total	
	11-2	94.48	060-HLW-CTMSWGIB-ETF	ETF for CTM hoisting canister inside bell
			CRCF-HLW-CAN	Number of HLW canisters
			S-060-CTMSWG-IB	Significant swinging of canister inside CTM bell
			SHIELDING	Shielding remains intact
		5.52	060-HLW-CTMHOIST-ETF	ETF for CTM hoisting canister - drop
			CRCF-HLW-CAN	Number of HLW canisters
			S-060-CTM-HOIST	Seismic drop of canister hoisted by CTM
			SHIELDING	Shielding remains intact
			= Total	
	11-3	0.00	<FALSE>	System Generated Success Event
			= Total	
	11-4	0.00	<FALSE>	System Generated Success Event
			= Total	
	11-5	97.57	060-HLW-CTMSWGOB-ETF	ETF for CTM hoisting canister outside bell
			CRCF-HLW-CAN	Number of HLW canisters
			S-060-CTMSWG-OB	Significant swinging of canister outside CTM bell
		1.23	060-HLW-CTM-COL-ETF	ETF for CTM over canister - collapse
			CRCF-HLW-CAN	Number of HLW canisters
			S-060-CTM-COLLAPSE	Seismic collapse of CTM (trolley seismic restraints)
		1.20	060-HLW-CTM-OBJ-ETF	ETF for CTM with heavy object over TC
			CRCF-HLW-CAN	Number of HLW canisters
			S-060-CTM-OBJDROP	Seismic drop of heavy object by CTM
		0.08	060-HLW-CTMHOIST-ETF	ETF for CTM hoisting canister - drop
			060-HLW-CTMHOIST-PFA	Breach of canister dropped by CTM

Table C3.4-2. Cut Set Level Results by Sequence (Continued)

Event Tree	Sequence	Cut Set %	Basic Event	Description
			CRCF-HLW-CAN	Number of HLW canisters
			S-060-CTM-HOIST	Seismic drop of canister hoisted by CTM
		0.00	060-HLW-CTMSWGIB-ETF	ETF for CTM hoisting canister inside bell
			060-HLW-CTMSWGIB-PFA	Breach of canister due to swing inside bell
			CRCF-HLW-CAN	Number of HLW canisters
			S-060-CTMSWG-IB	Significant swinging of canister inside CTM bell
			= Total	
	11-6	0.00	<FALSE>	System Generated Success Event
			= Total	
	12-2			
	12-3	0.00	<FALSE>	System Generated Success Event
			= Total	
	12-4	0.00	<FALSE>	System Generated Success Event
			= Total	
	12-5	100.00	060-HLW-SRACK-ETF	ETF for staging rack containing HLW
			CRCF-HLW-CAN	Number of HLW canisters
			S-060-SRACK-FAIL	Seismic collapse of staging rack
			= Total	
	12-6	0.00	<FALSE>	System Generated Success Event
			= Total	
	13-2	0.00	060-HLW-WPTT-ROCK-ETF	ETF for WPTT in constrained position
			CRCF-HLW-CAN	Number of HLW canisters
			S-060-WPTT-ROCK	Seismic rocking of WPTT (constrained)
			SHIELDING	Shielding remains intact
			= Total	
	13-3	0.00	<FALSE>	System Generated Success Event
			= Total	
	13-4	0.00	<FALSE>	System Generated Success Event
			= Total	
	13-5	0.00	<FALSE>	System Generated Success Event
			= Total	
	13-6	100.00	060-HLW-WPTT-TIP-ETF	ETF for WPTT not constrained
			CRCF-HLW-CAN	Number of HLW canisters
			S-060-WPTT-TIPOVER	Seismic tipover of WPTT
		0.00	060-HLW-WPTT-ROCK-ETF	ETF for WPTT in constrained position

Table C3.4-2. Cut Set Level Results by Sequence (Continued)

Event Tree	Sequence	Cut Set %	Basic Event	Description
			060-HLW-WPTT-ROCK-PFA	Breach of canister when WPTT rocks
			CRCF-HLW-CAN	Number of HLW canisters
			S-060-WPTT-ROCK	Seismic rocking of WPTT (constrained)
			= Total	
	13-7	0.00	<FALSE>	System Generated Success Event
			= Total	
CRCF-S-IE-HLW	03	100.00	060-HLW-STRUCTUR-ETF	ETF for DOE SNF canister in CRCF structure
			CRCF-HLW-CAN	Number of HLW canisters

NOTE: CHC = cask handling crane; CRCF = Canister Receipt and Closure Facility; CTM = canister transfer machine; CTT = cask transfer trolley; DOE = Department of Energy; DSNF = Department of Energy spent nuclear fuel; ETF = exposure time factor; HLW = high-level radioactive waste; SNF = spent nuclear fuel; TC = transportation cask; WP = waste package; WPTT = waste package transfer trolley.

Source: Original

C4 MULTICANISTER OVERPACKS (CRCF-MCO)

This section provides the detailed information used to develop the event sequences for the analysis of processing of the MCO canisters inside the CRCF. MCO canisters inside a transportation cask are received on railcars, and are transferred into a waste package, sealed, and then transported in a TEV out of the CRCF. Transport to the emplacement drifts is not included in this section.

C4.1 EVENT TREES

The IET and SRETs are presented in this section. The tables provide the assignments between the event tree branches and the fault trees given in the next section.

Seismic Event	Number of MCO canisters	Identify initiating seismic failure			
SEIS-EVENT	CRCF-MCO-CAN	SEIS-FAIL	#	END-STATE	
			1	OK	
			2	OK	
			3	RR-UNF	
			4	T => 2	CRCF-S-R-TC1
			5	T => 2	CRCF-S-R-TC1
			6	T => 2	CRCF-S-R-TC1
			7	T => 2	CRCF-S-R-TC1
			8	T => 2	CRCF-S-R-TC1
			9	T => 2	CRCF-S-R-TC1
			10	T => 3	CRCF-S-R-SD1
			11	T => 4	CRCF-S-R-CTM
			12	T => 5	CRCF-S-R-WP1
			13	T => 5	CRCF-S-R-WP1
			14	T => 5	CRCF-S-R-WP1
			15	T => 6	CRCF-S-R-TEV

CRCF-S-IE-MCO - CRCF Seismic Event Tree - Initiating Seismic Failures - MCO

2007/12/07 Page 1

NOTE: Event tree branch captions are associated with the branch line below the caption.

CAN = canister; CHC = cask handling crane; CRCF = Canister Receipt and Closure Facility; CTM = canister transfer machine; IE = initiating event; MCO = multicanister overpack; RHS = remote handling system; SD = shield door; SEIS = seismic; TC = transportation cask; TEV = transport and emplacement vehicle; T = transfer; UNF = unfiltered; WP = waste package; WPHC = waste package handling crane; WPTT = waste package transfer trolley.

Source: Original

Figure C4.1-1. CRCF Seismic Event Tree
 CRCF-S-IE-MCO – Initiating
 Seismic Failures – MCO

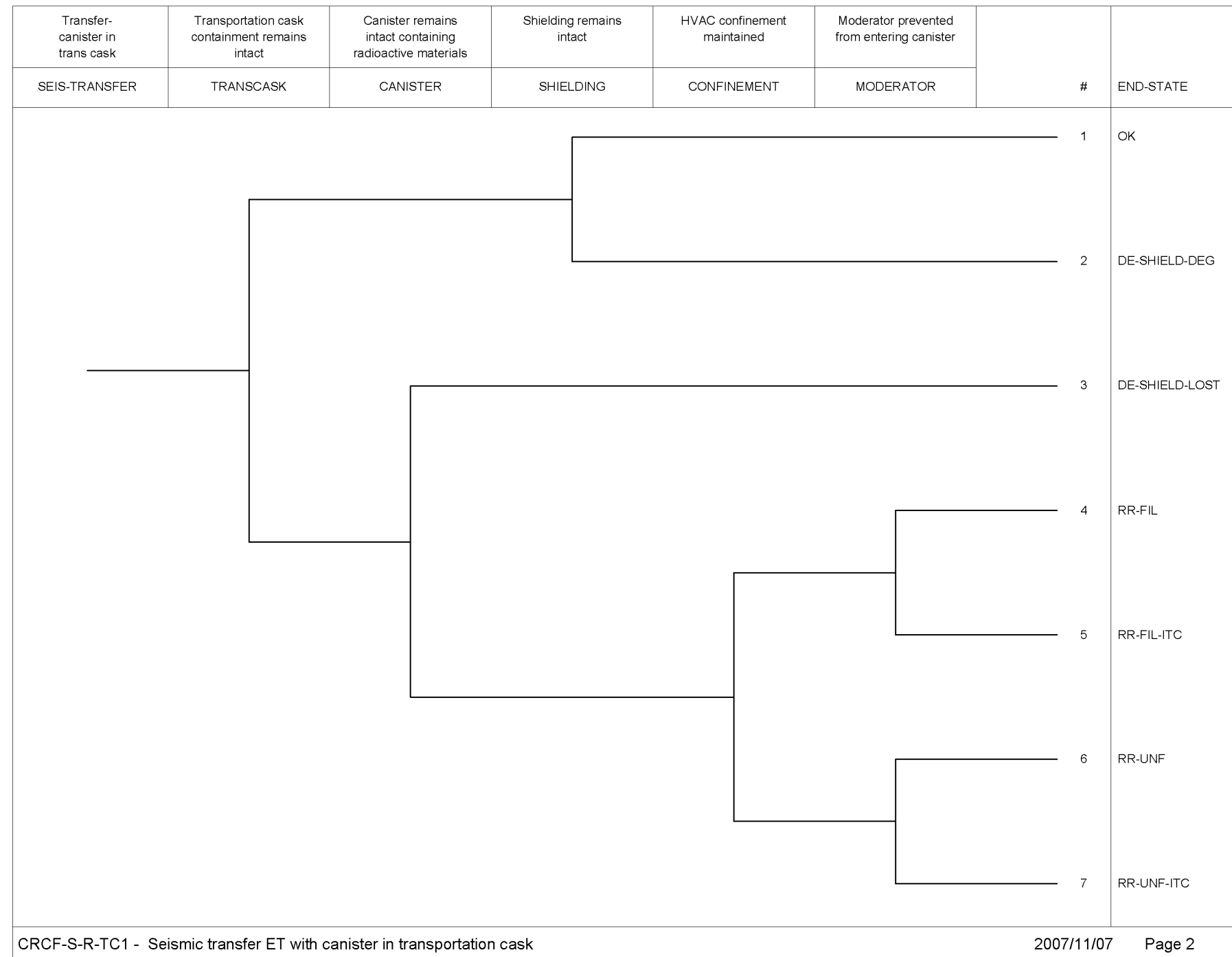

NOTE: CRCF = Canister Receipt and Closure Facility; DE = direct exposure; DEG = degradation; ET = event tree; FIL = filtered; HVAC = heating, ventilation and air conditioning; ITC = important to criticality; RR = radioactive release; SEIS = seismic; TC = transportation cask; UNF = unfiltered.

Source: Original

Figure C4.1-2. CRCF Seismic Event Tree
 CRCF-S-R-TC1 – Seismic
 Transfer ET with Canister in
 Transportation Cask

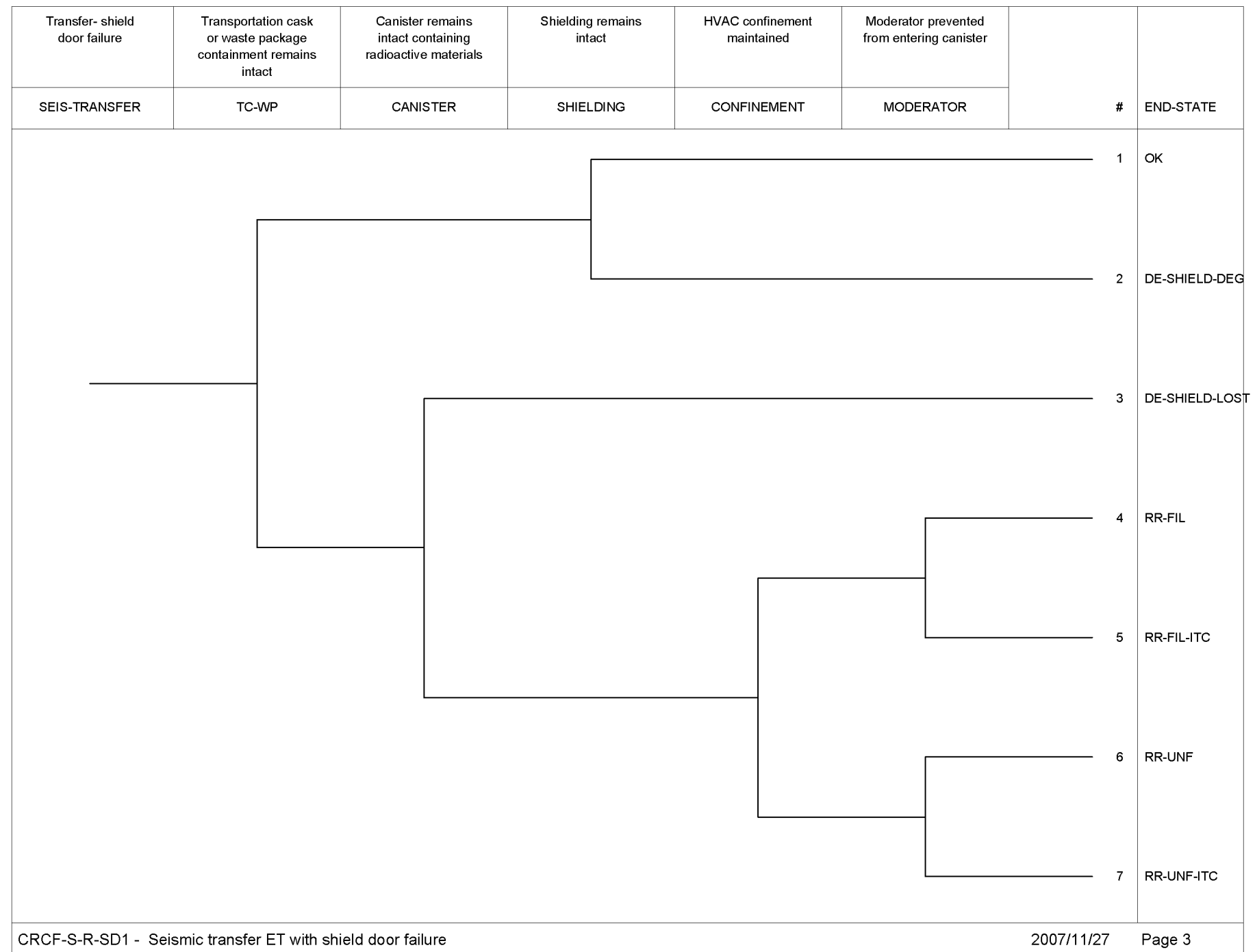

NOTE: CRCF = Canister Receipt and Closure Facility; DE = direct exposure; ET = event tree; FIL = filtered; HVAC = heating, ventilation and air-conditioning; ITC = important to criticality; RR = radioactive release; SD = shield door; SEIS = seismic; TC = transportation cask; UNF = unfiltered; WP = waste package.

Source: Original

Figure C4.1-3. CRCF Seismic Event Tree
CRCF-S-R-SD1 – Seismic
Transfer ET with Shield Door
Failure

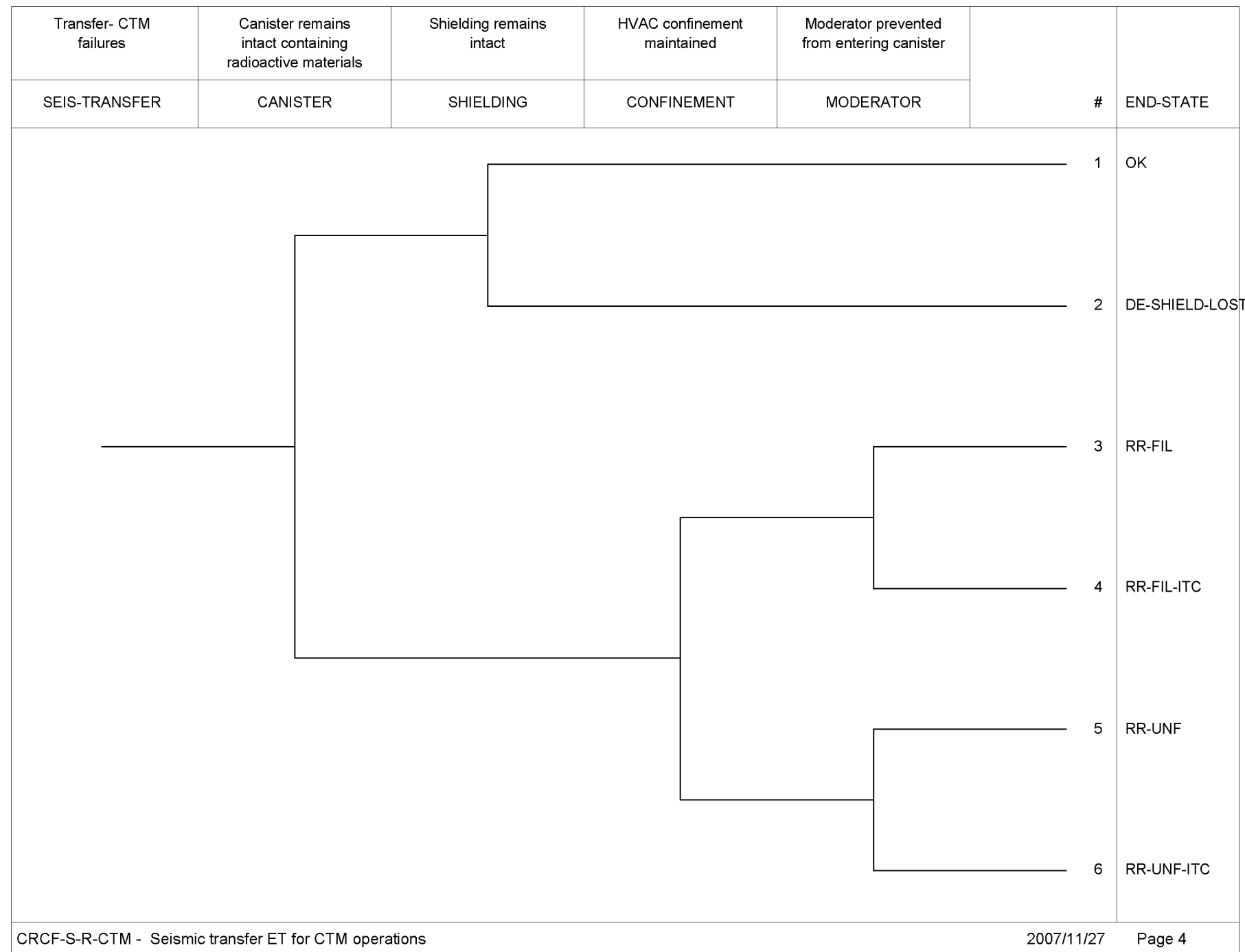

NOTE: CRCF = Canister Receipt and Closure Facility; CTM = canister transfer machine; DE = direct exposure; ET = event tree; FIL = filtered; HVAC = heating, ventilation and air-conditioning; ITC = important to criticality; RR = radioactive release; SEIS = seismic; UNF = unfiltered.

Source: Original

Figure C4.1-4. CRCF Seismic Event Tree
 CRCF-S-R-CTM – Seismic
 Transfer ET for CTM Operations

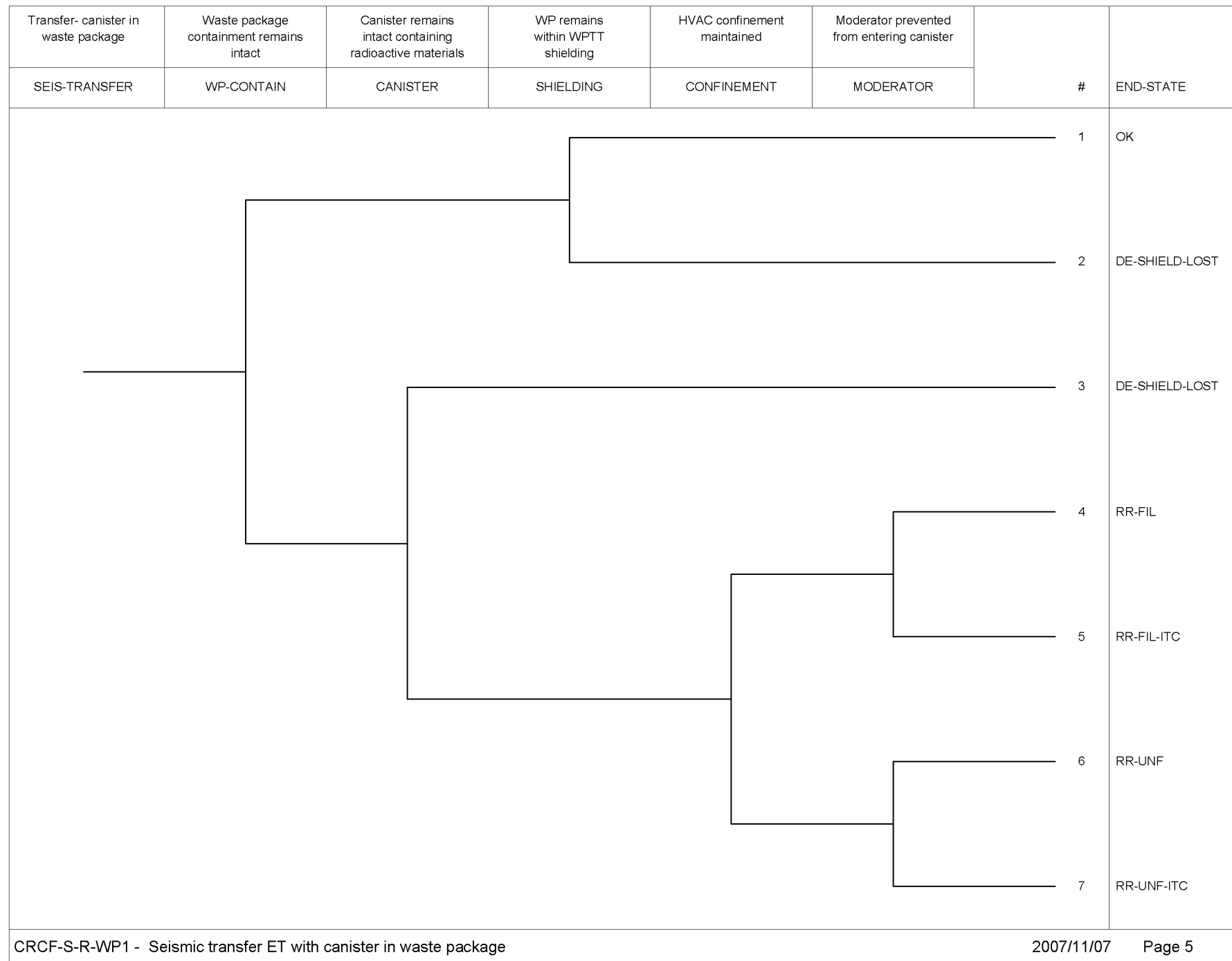

NOTE: CRCF = Canister Receipt and Closure Facility; CTM = canister transfer machine; DE = direct exposure; ET = event tree; FIL = filtered; HVAC = heating, ventilation and air conditioning; ITC = important to criticality; RR = radioactive release; SEIS = seismic; UNF = unfiltered; WP = waste package; WPTT = waste package transfer trolley.

Source: Original

Figure C4.1-5. CRCF Seismic Event Tree
 CRCF-S-R-WP1 – Seismic
 Transfer ET with Canister in
 Waste Package

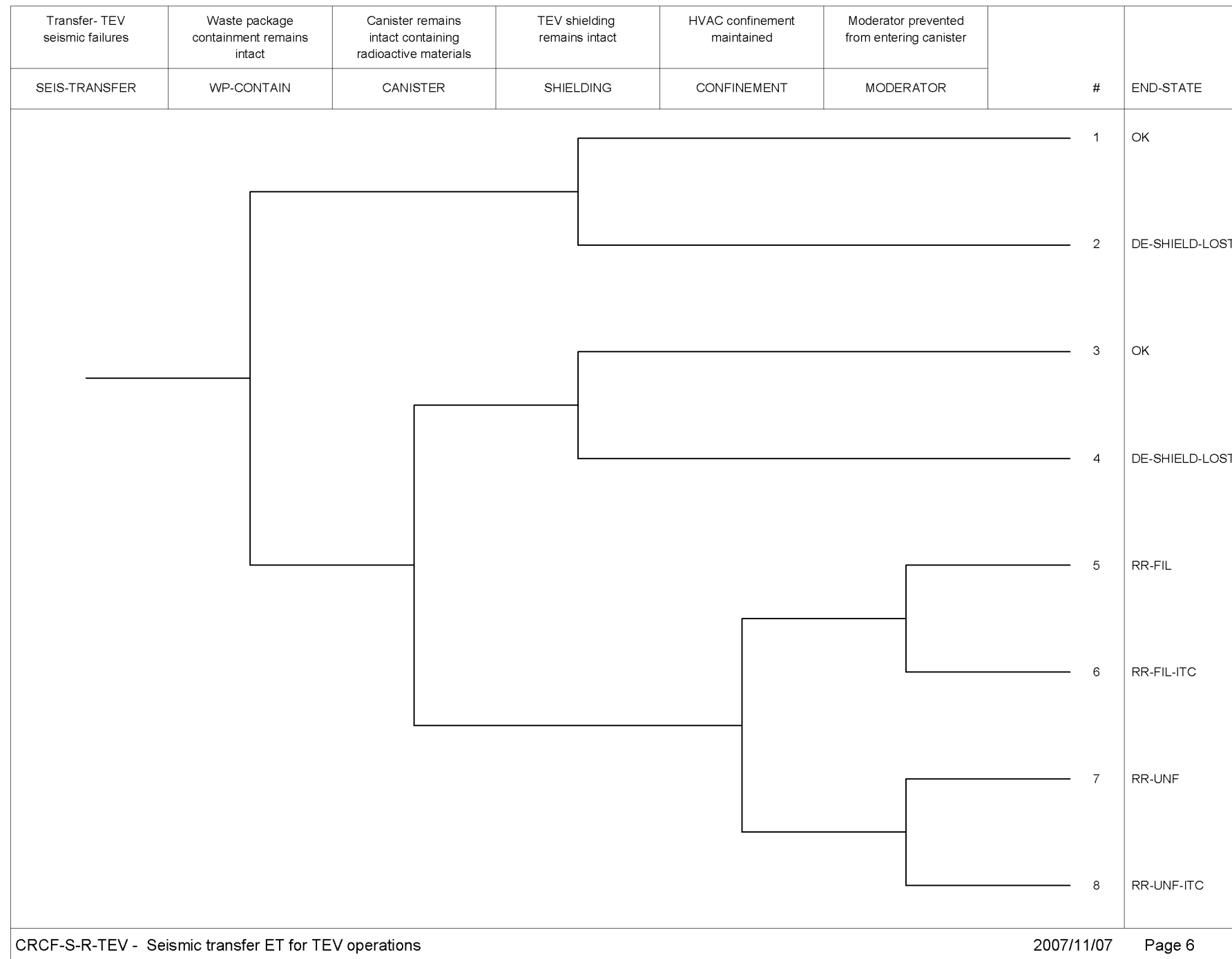

NOTE: CRCF = Canister Receipt and Closure Facility; DE = direct exposure; ET = event tree; FIL = filtered; HVAC = heating, ventilation and air conditioning; ITC = important to criticality; RR = radioactive release; SEIS = seismic; TEV = transport and emplacement vehicle; UNF = unfiltered; WP = waste package.

Source: Original

Figure C4.1-6. CRCF Seismic Event Tree
 CRCF-S-R-TEV – Seismic
 Transfer ET for TEV Operations

Table C4.1-1. Fault Trees Assigned for Initiating Seismic Failures for the CRCF

Process	Initiator Event Tree	Initiating Seismic Failure	Associated Fault Tree
MCO	CRCF-S-IE-MCO	CRCF building collapse	S-060-MCO-STR-COLLAP
		Entry door seismic collapse	S-060-MCO-ENTDOORCOL
		Railcar accident	S-060-MCO-RAILCARACC
		Mobile platform seismic collapse	S-060-MCO-MOBPLATCOL
		CHC seismic failures	S-060-MCO-CHC-FAIL
		Cask prep platform collapse	S-060-MCO-CPREP-PLAT
		CTT seismic failures	S-060-MCO-CTT-FAIL
		Shield door seismic failure	S-060-MCO-SHIELDDOOR
		CTM seismic failures	S-060-MCO-CTM-FAIL
		RHS-robotic arm seismic failures	S-060-MCO-RHS-FAIL
		WPTT tipover	S-060-MCO-WPTT-FAIL
		WPHC seismic failures	S-060-MCO-WPHC-FAIL
		TEV seismic failures	S-060-MCO-TEV-FAIL

NOTE: CRCF = Canister Receipt and Closure Facility; CHC = cask handling crane; CTM = canister transfer machine; CTT = cask transfer trolley; IE = initiating event; MCO = multicanister overpack; RHS = remote handling system; TEV = transport and emplacement vehicle; WPHC = waste package handling crane; WPTT = waste package transfer trolley.

Source: Original

Table C4.1-1. Fault Trees Assigned for Pivotal Events for CRCF-S-IE-MCO Initiating Event Tree

Initiating Seismic Failure	TRANSCASK	MODERATOR
CRCF building collapse	N/A	N/A
Entry door seismic collapse	RC-MCO-DOORDROP-CASK	CRCF-MOD-MULT-SYS
Railcar accident	RC-MCO-RC-ACC-CASK	CRCF-MOD-MULT-SYS
Mobile platform seismic collapse	RC-MCO-MOB-PLAT-CASK	CRCF-MOD-MULT-SYS
CHC seismic failures	TC-MCO-CHC-CASK	CRCF-MOD-MULT-SYS
Cask prep platform collapse	TC-MCO-CPP-CASK	CRCF-MOD-MULT-SYS
CTT seismic failures	CTT-MCO-CTT-CASK	CRCF-MOD-MULT-SYS
	TC-WP	
Shield door seismic failure	TCWP-MCO-SHIELDDOOR	CRCF-MOD-MULT-SYS
	CANISTER	
CTM seismic failures	CTM-MCO-CTM-CAN	CRCF-MOD-MULT-SYS
	WP-CONTAIN	
RHS-robotic arm seismic failures	WPTT-MCO-RHS-FAIL	CRCF-MOD-MULT-SYS
WPTT tipover	WPTT-MCO-WPTT-FAIL	CRCF-MOD-MULT-SYS
WPHC seismic failures	WPTT-MCO-WPHC-FAIL	CRCF-MOD-MULT-SYS
TEV seismic failures	TEV-MCO-TEV-FAIL	CRCF-MOD-MULT-SYS

NOTE: CRCF = Canister Receipt and Closure Facility; CHC = cask handling crane; CTM = canister transfer machine; CTT = cask transfer trolley; MCO = multicask overpack; RHS = remote handling system; TC = transportation cask; TEV = transport and emplacement vehicle; WP = waste package; WPHC = waste package handling crane; WPTT = waste package transfer trolley.

Source: Original

C4.2 FAULT TREES

Seismic fault trees for the processing of MCO canisters in the CRCF are presented in alphanumeric order in this section.

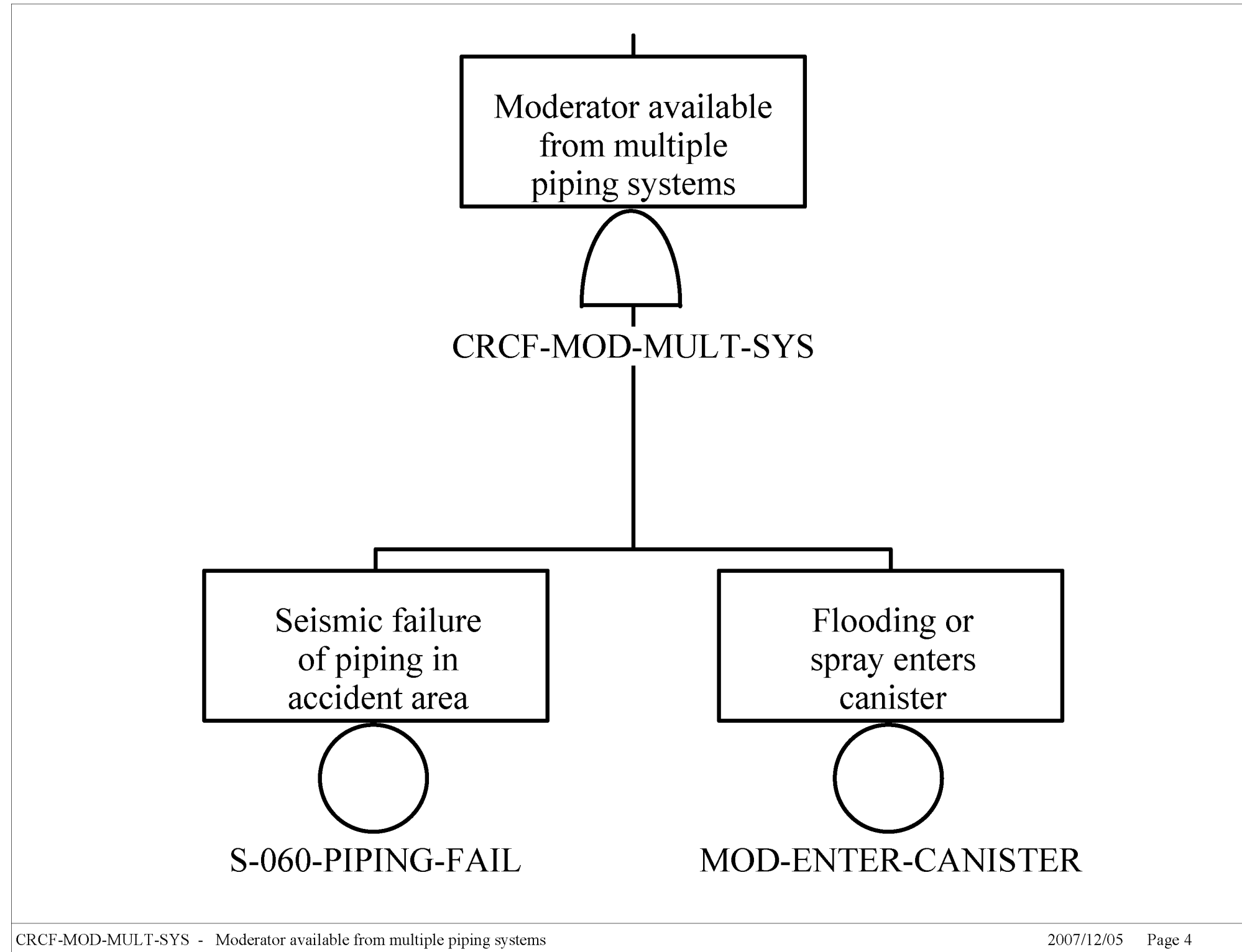

Source: Original

Figure C4.2-1. Fault Tree CRCF-MOD-MULT-SYS- Moderator Available from Multiple Piping Systems

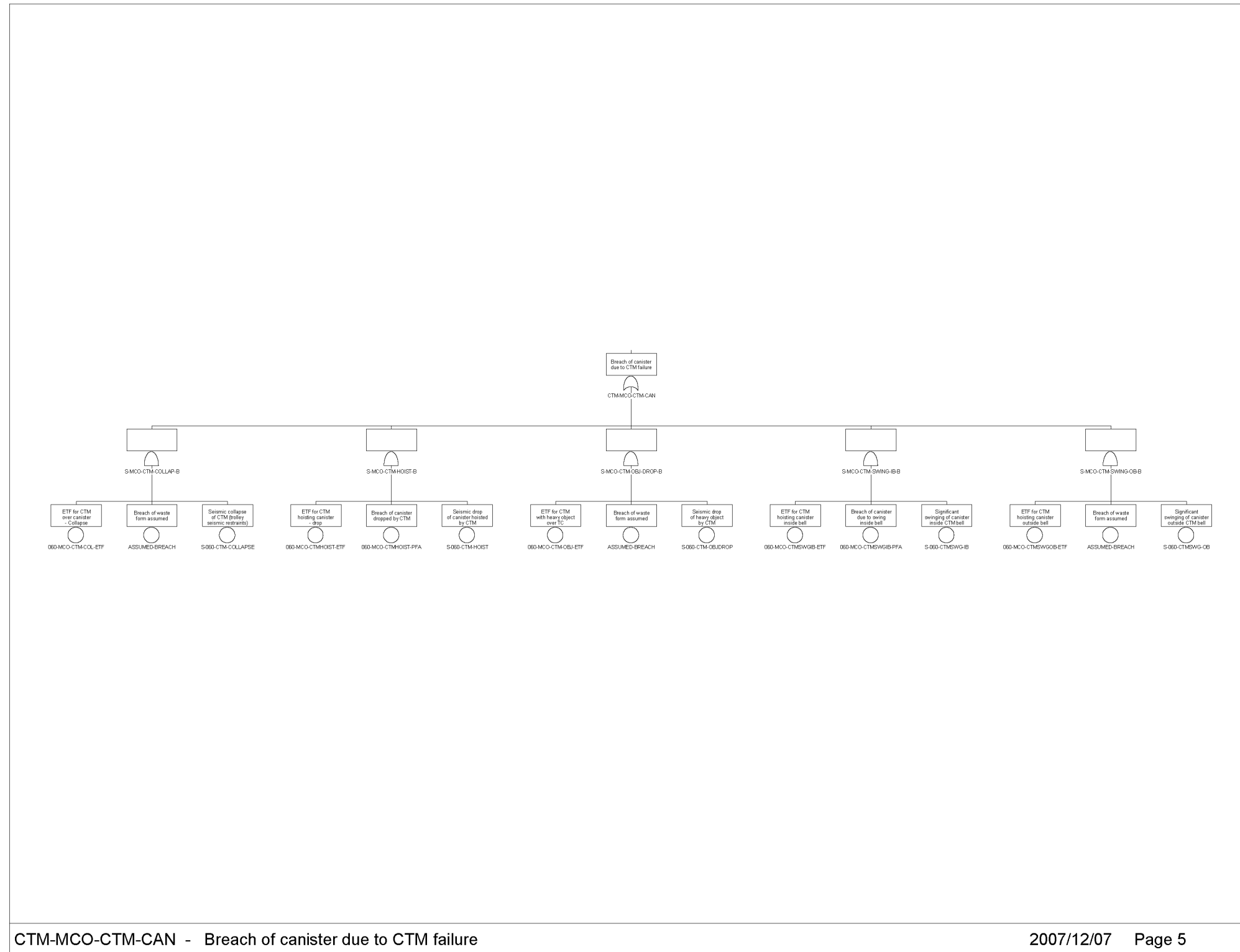

Source: Original

Figure C4.2-2. CTM-MCO-CTM-CAN – Breach of Canister due to CTM Failure

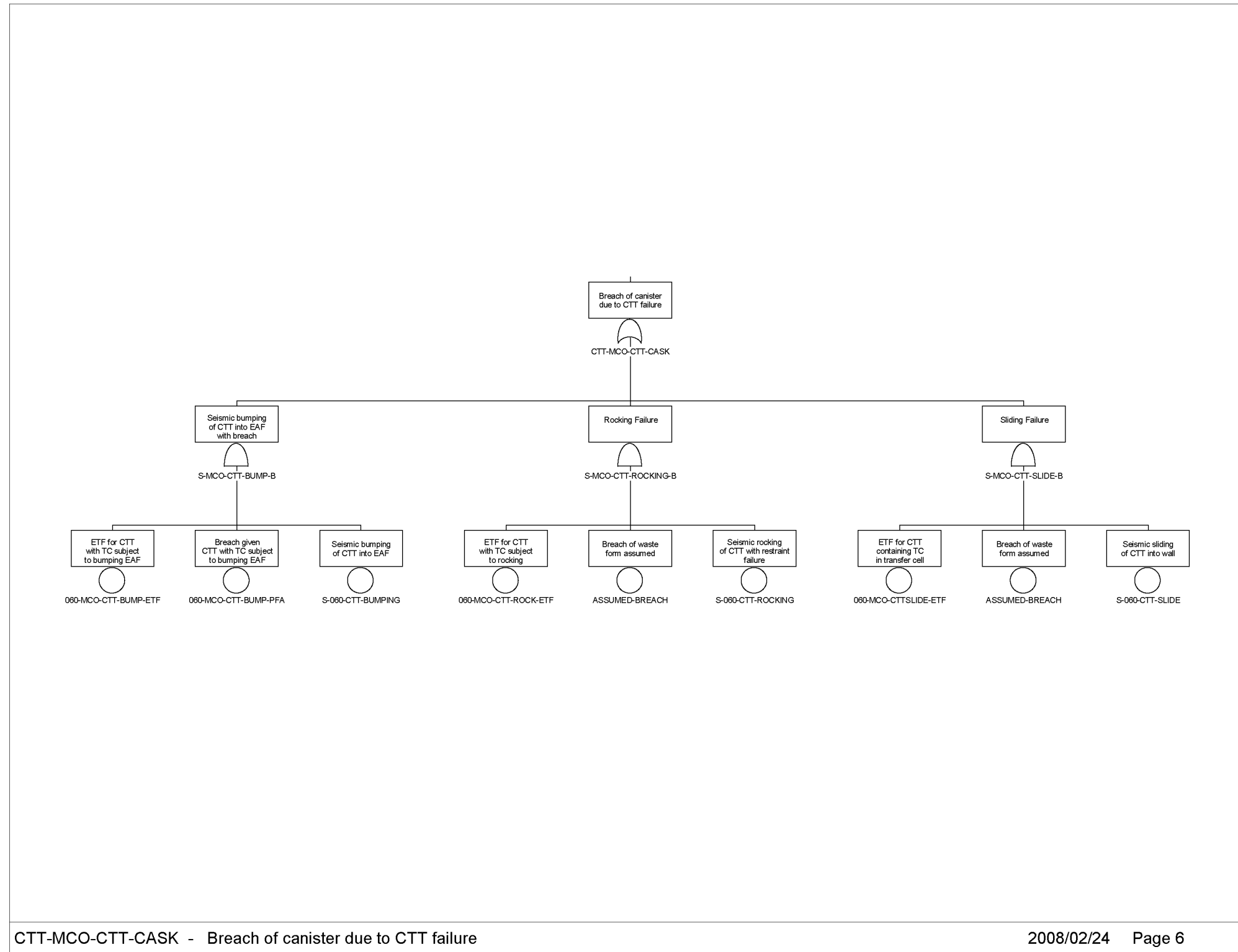

Source: Original

Figure C4.2-3. CTT-MCO-CTT-CASK – Breach of Canister due to CTT Failure

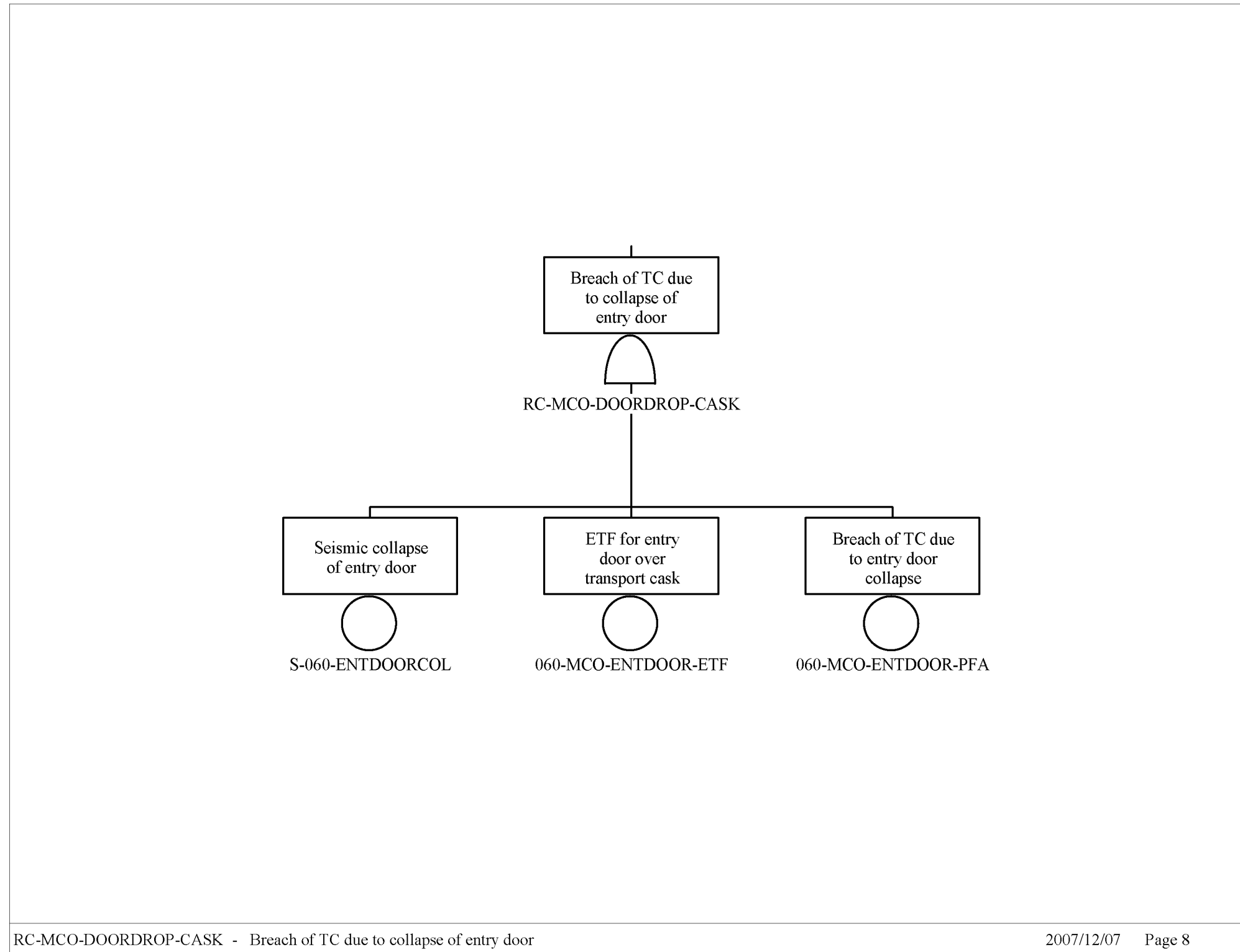

Source: Original

Figure C4.2-4. RC-MCO-DOORDROP-CASK – Breach of TC due to Collapse of Entry Door

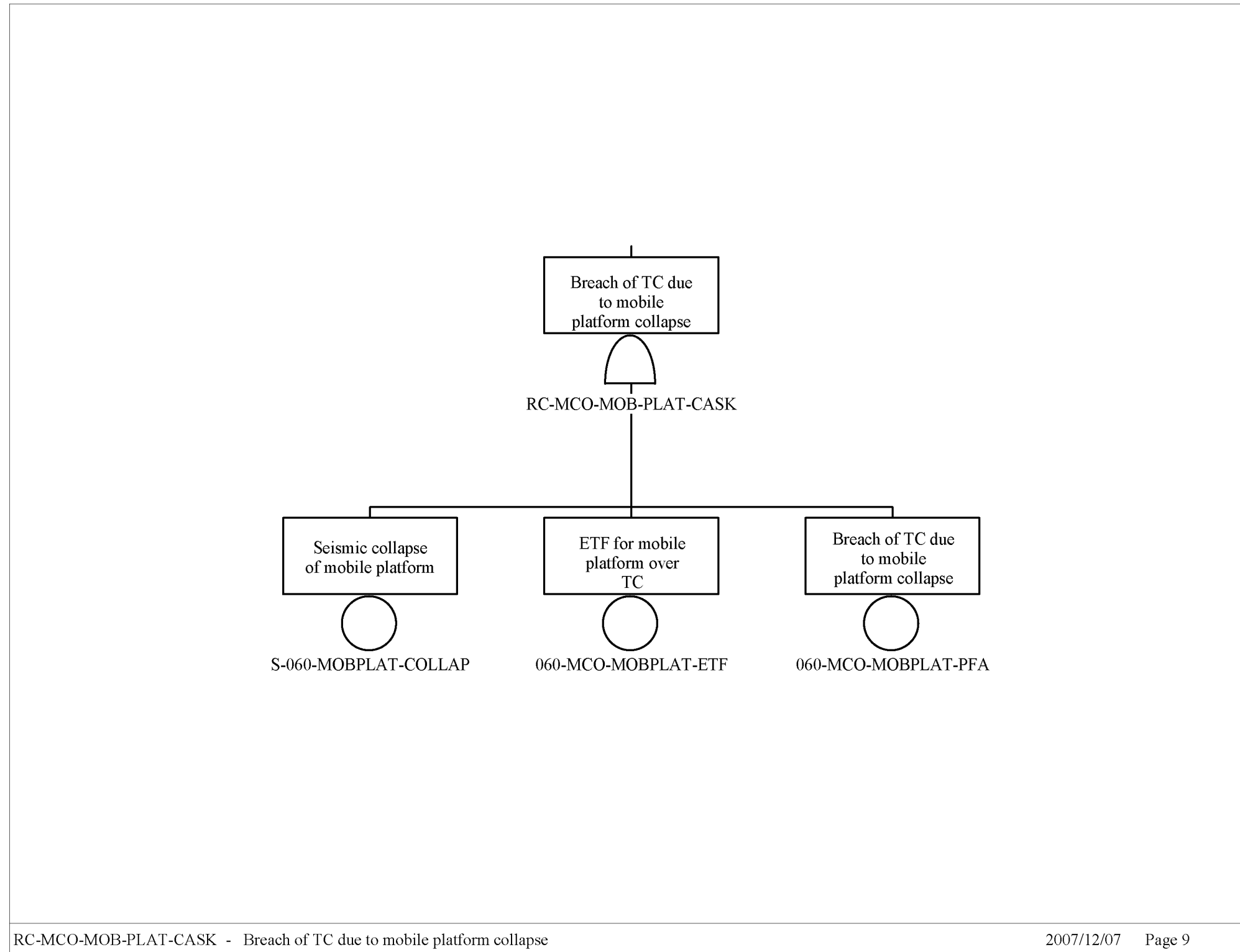

Source: Original

Figure C4.2-5. RC-MCO-MOB-PLAT-CASK – Breach of TC due to Mobile Platform Collapse

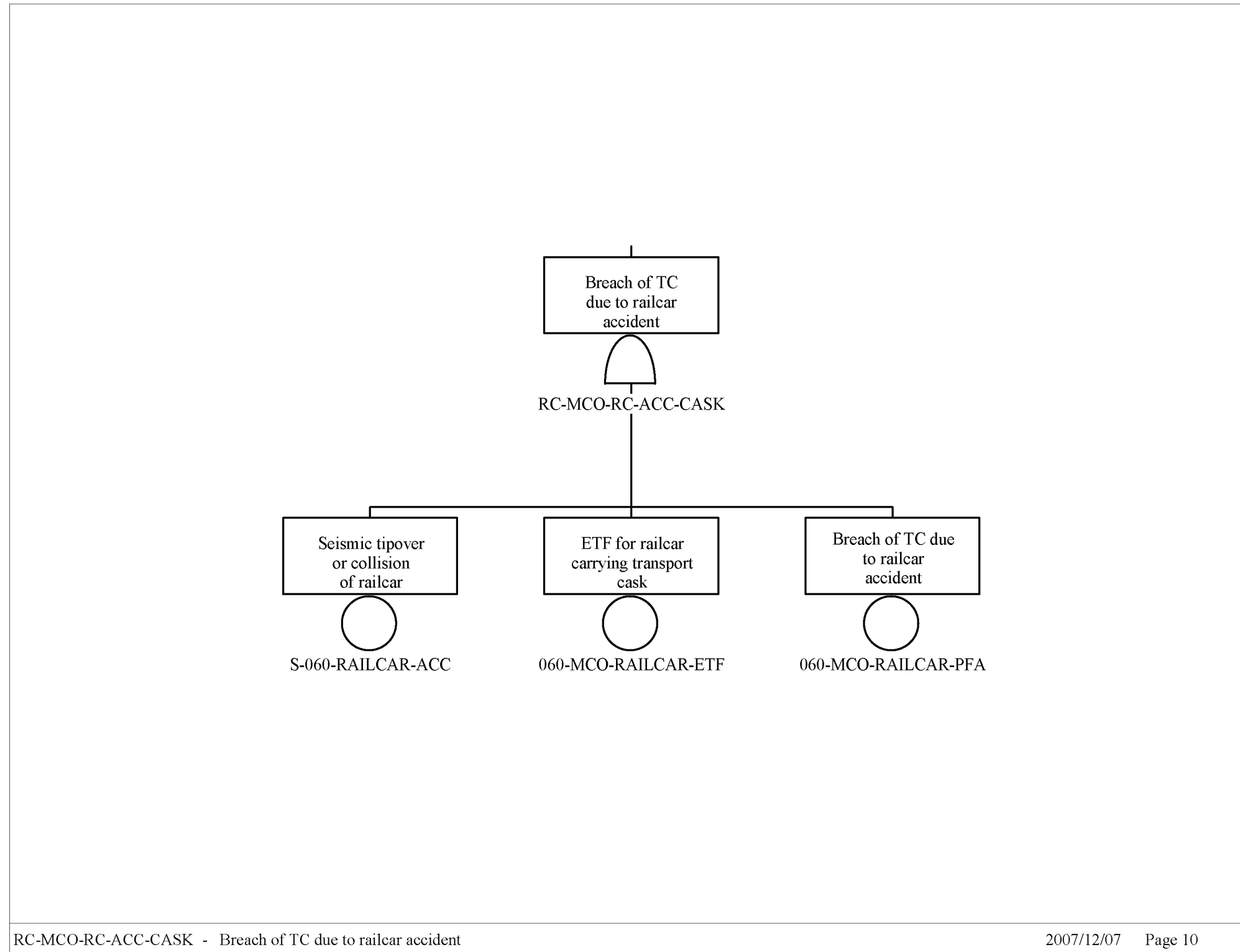

Source: Original

Figure C4.2-6. RC-MCO-RC-ACC-CASK – Breach of TC due to Railcar Accident

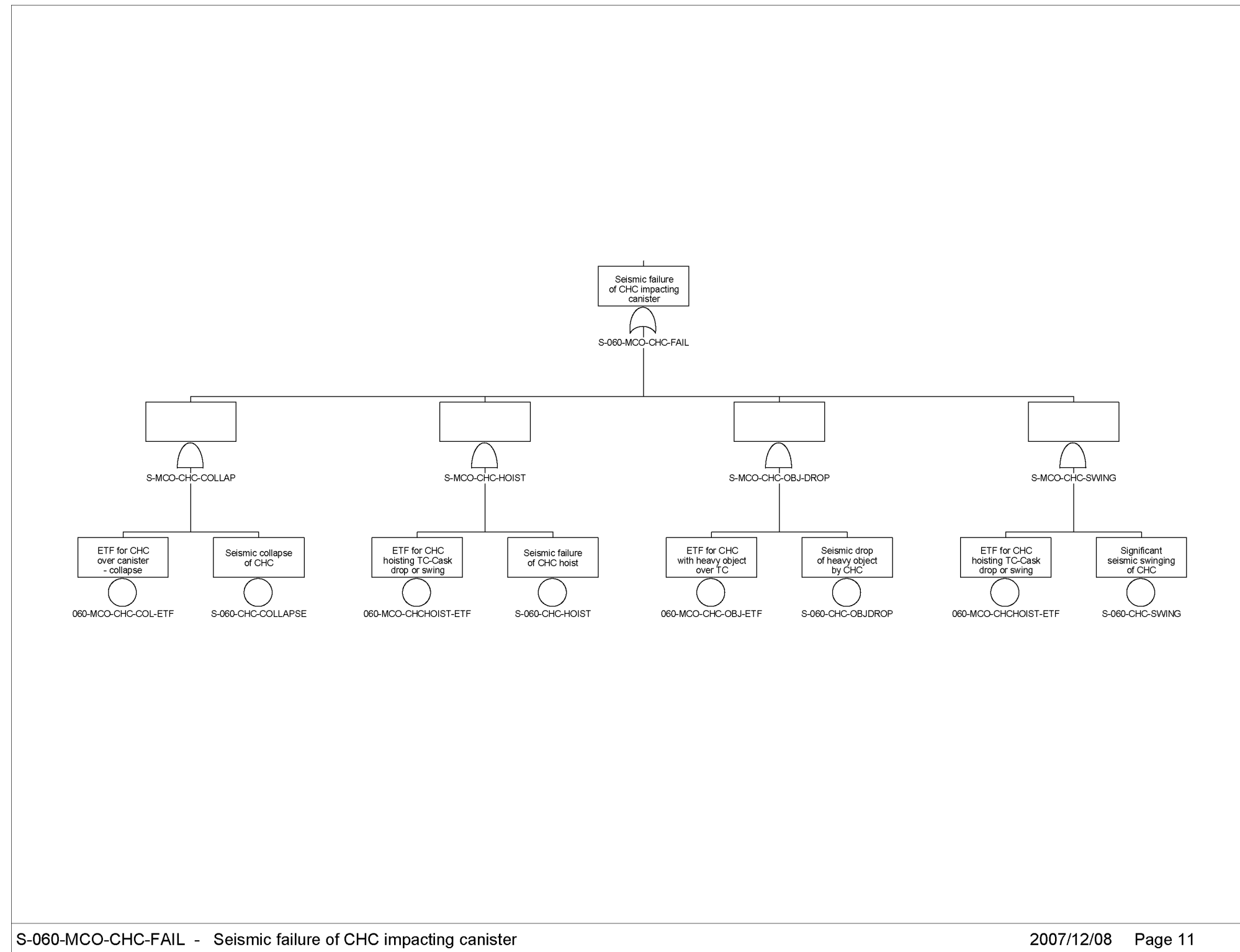

Source: Original

Figure C4.2-7. S-060-MCO-CHC-FAIL – Seismic Failure of CHC Impacting Canister

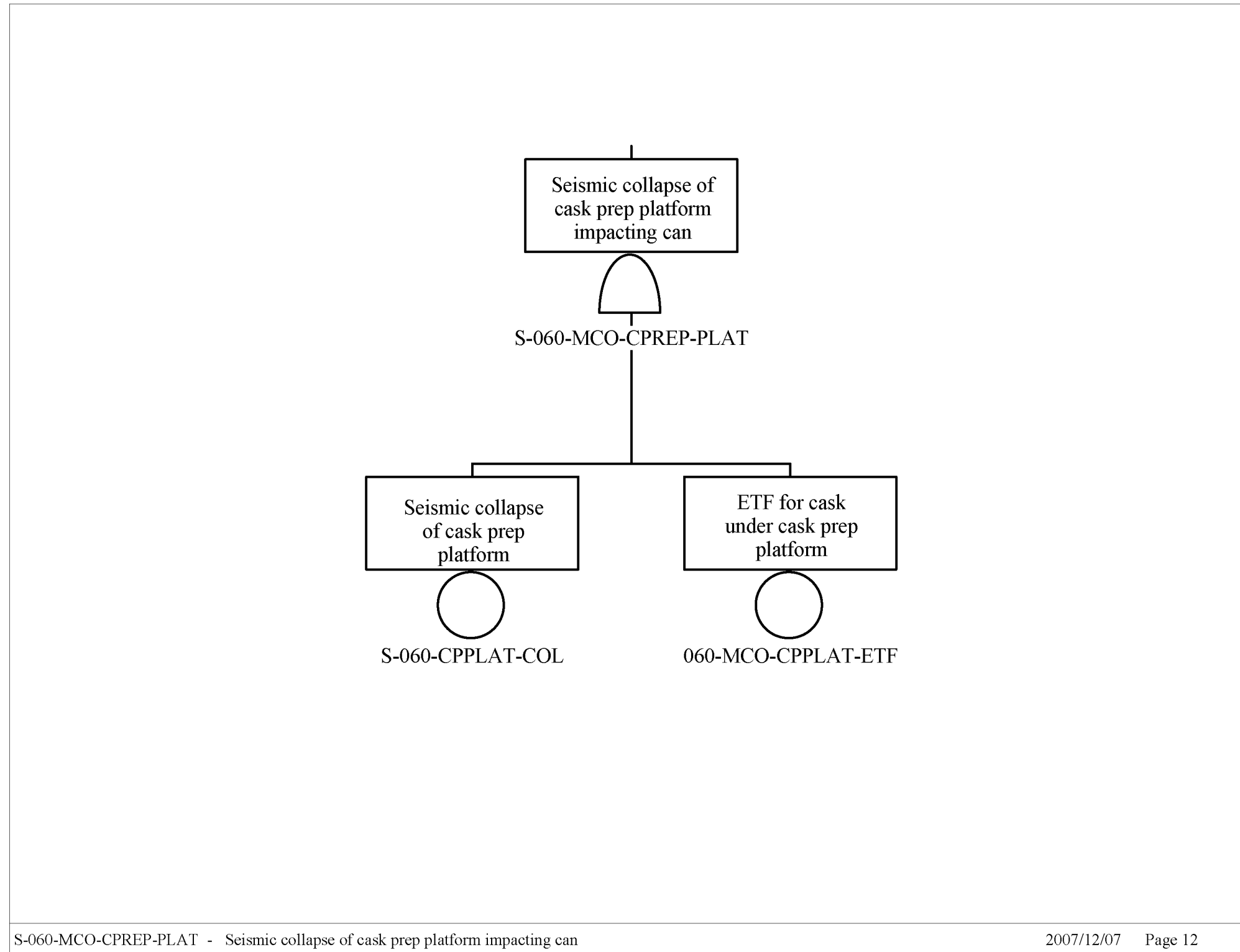

S-060-MCO-CPREP-PLAT - Seismic collapse of cask prep platform impacting can

2007/12/07 Page 12

Source: Original

Figure C4.2-8. S-060-MCO-CPREP-PLAT – Seismic Collapse of Cask Prep Platform Impacting Can

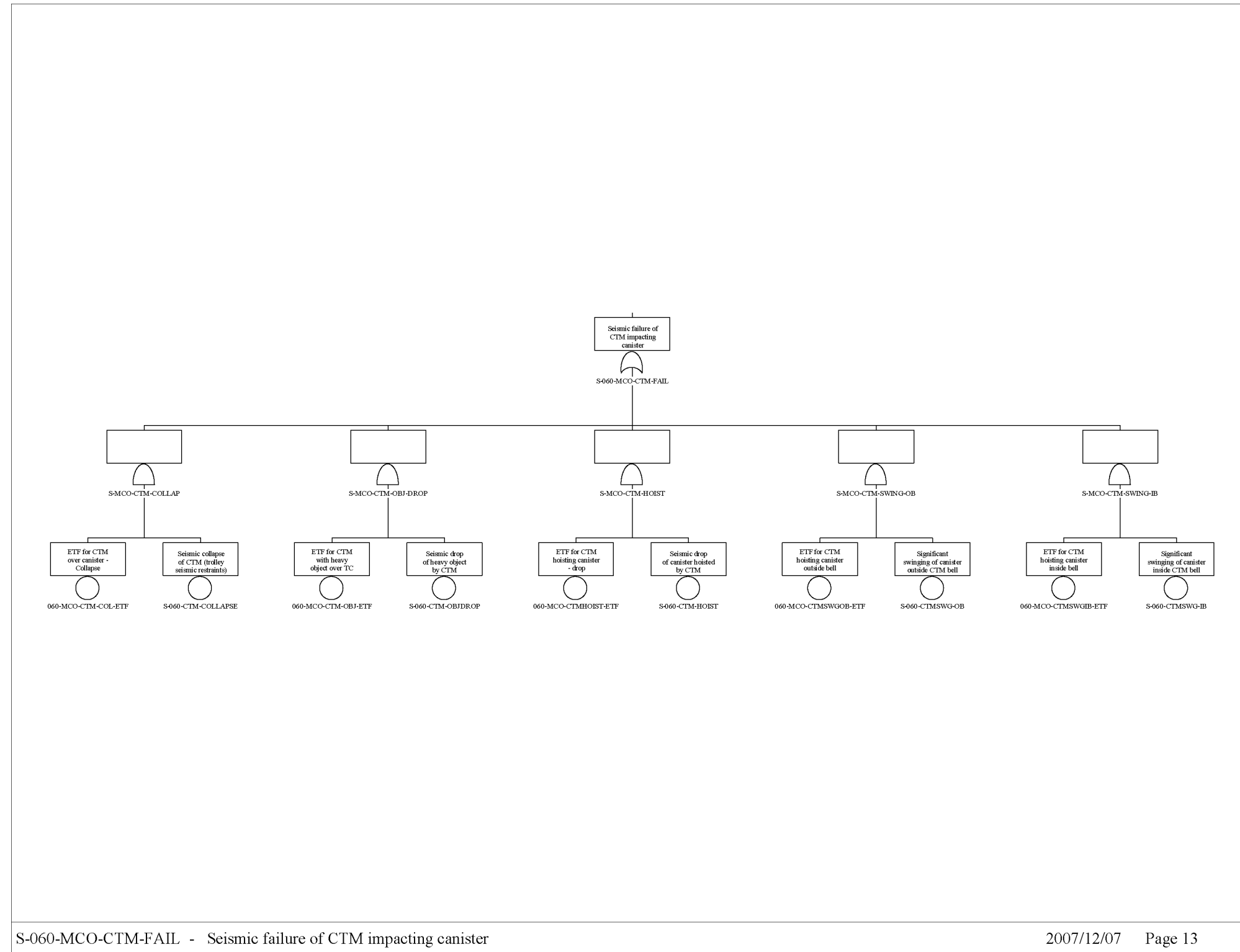

Source: Original

Figure C4.2-9. S-060-MCO-CTM-FAIL – Seismic Failure of CTM Impacting Canister

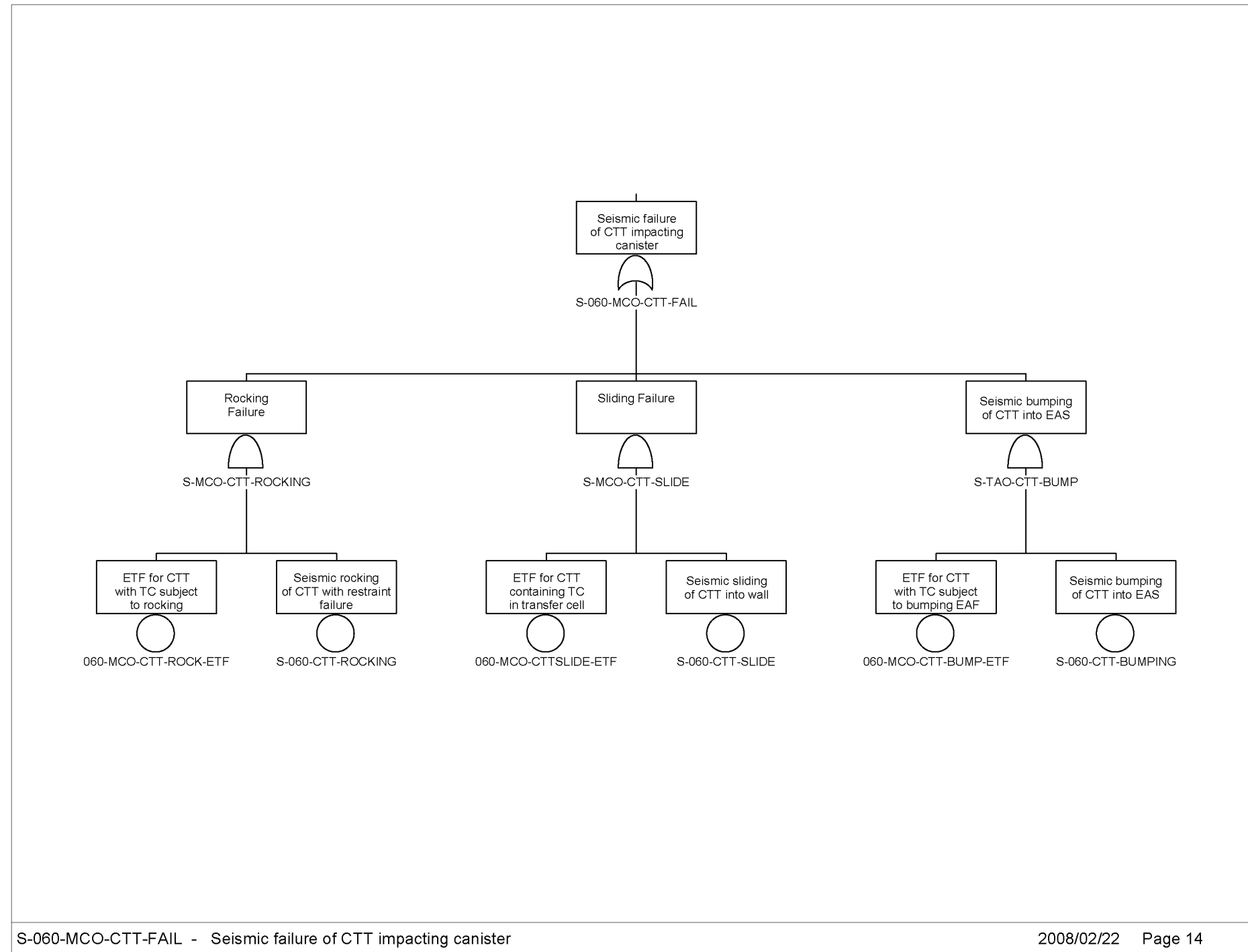

Source: Original

Figure C4.2-10. S-060-MCO-CTT-FAIL – Seismic Failure of CTT Impacting Canister

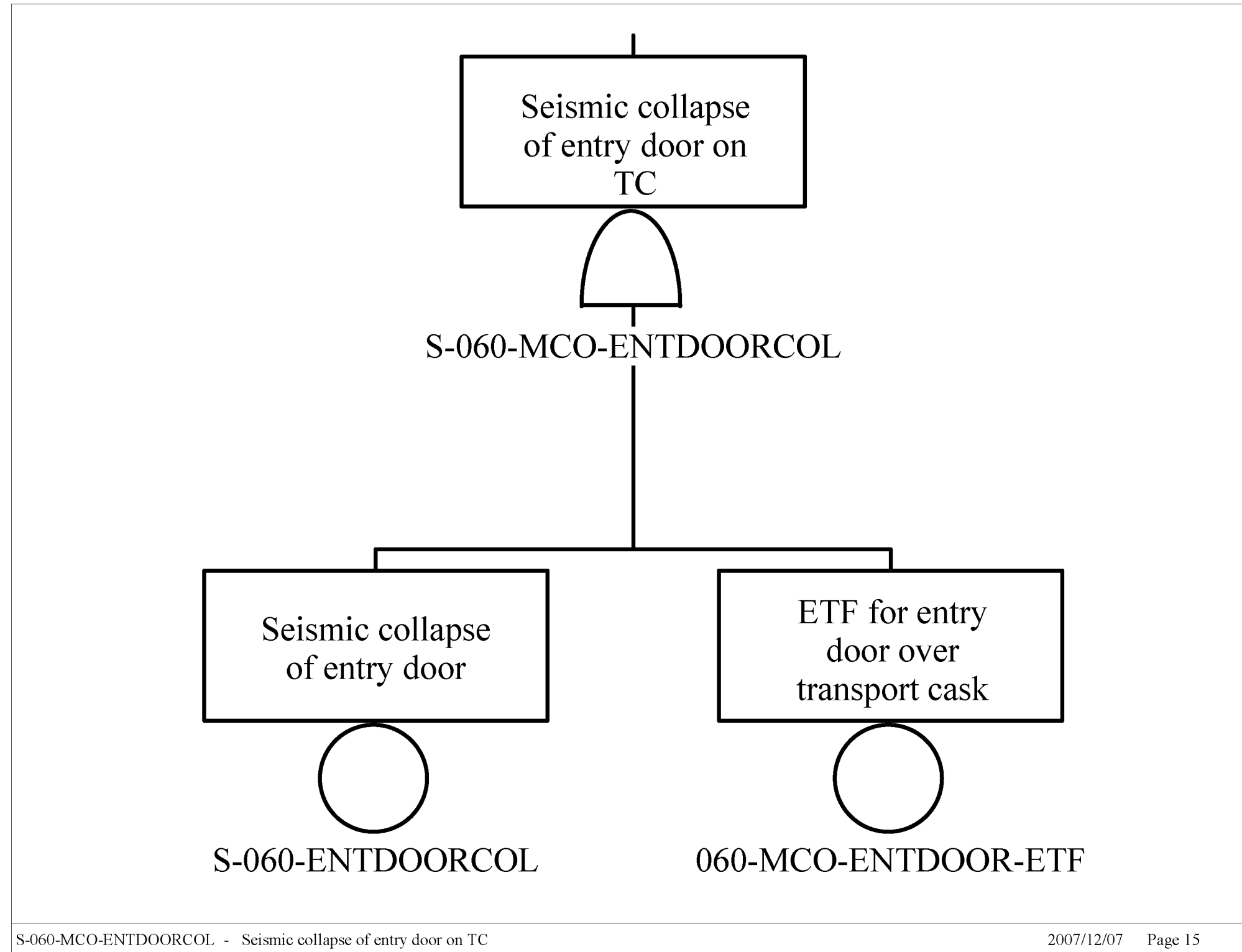

Source: Original

Figure C4.2-11. S-060-MCO-ENTDOORCOL – Seismic Collapse of Entry Door on TC

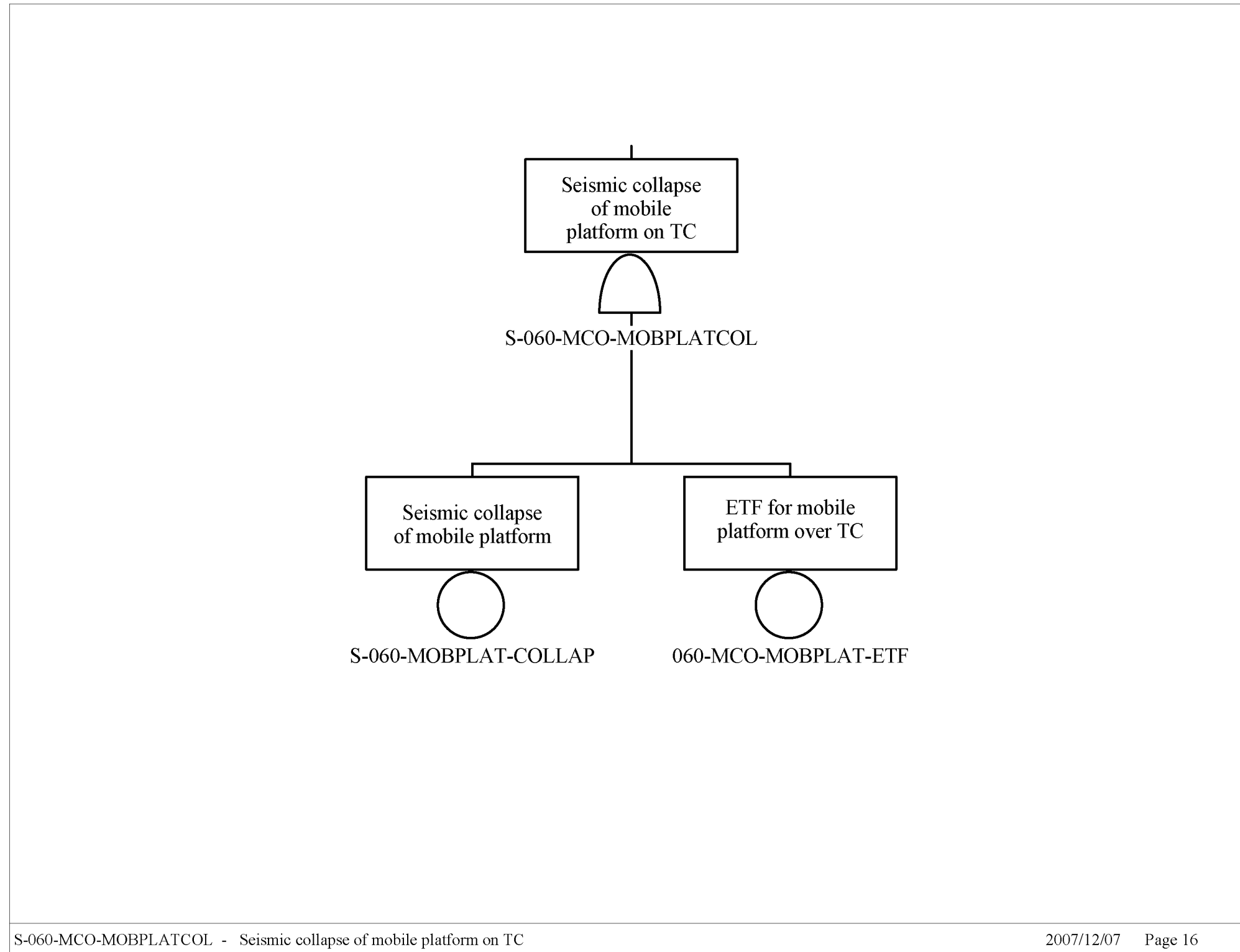

S-060-MCO-MOBPLATCOL - Seismic collapse of mobile platform on TC

2007/12/07 Page 16

Source: Original

Figure C4.2-12. S-060-MCO-MOBPLATCOL – Seismic Collapse of Mobile Platform on TC

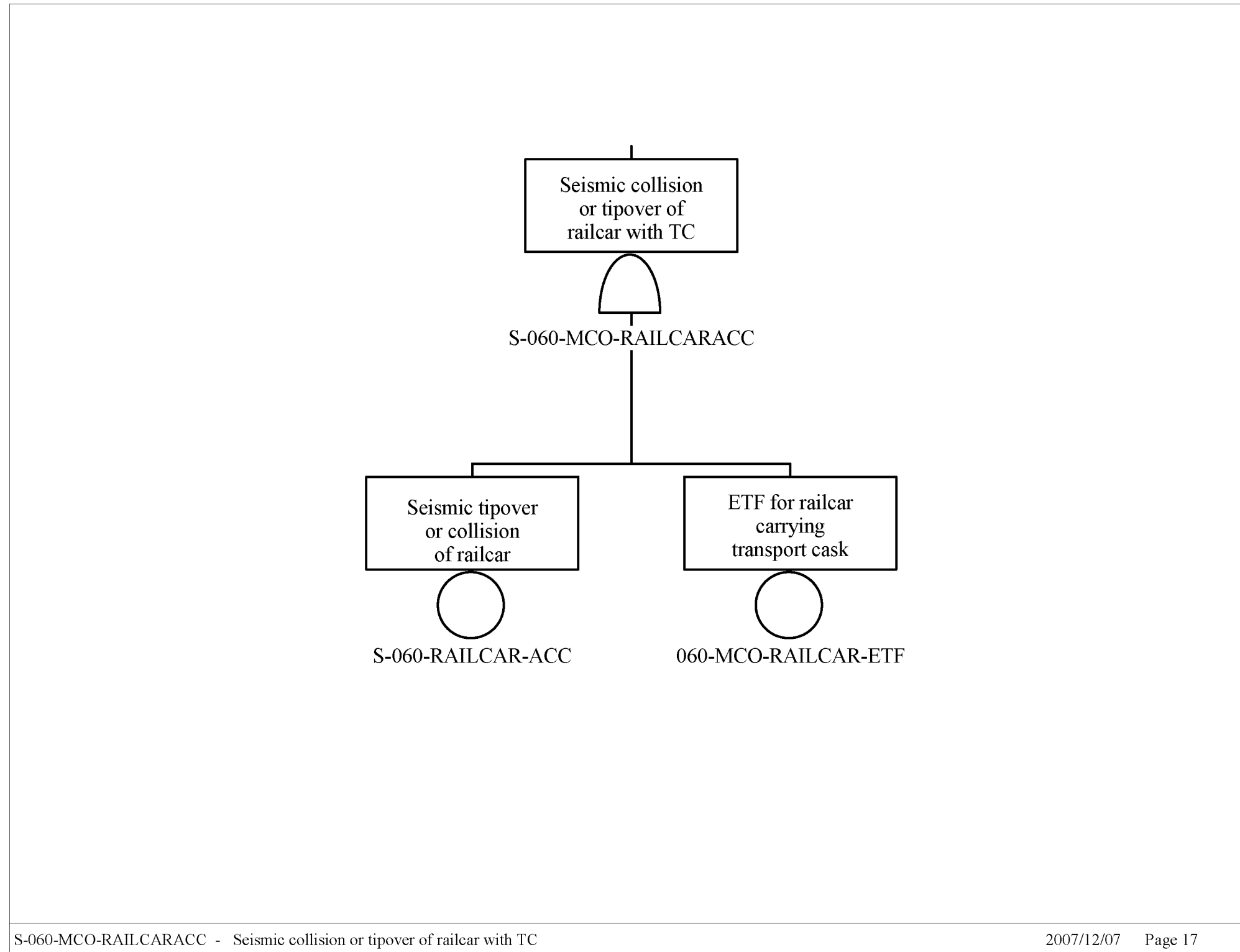

Source: Original

Figure C4.2-13. S-060-MCO-RAILCARACC – Seismic Collision or Tipover of Railcar with TC

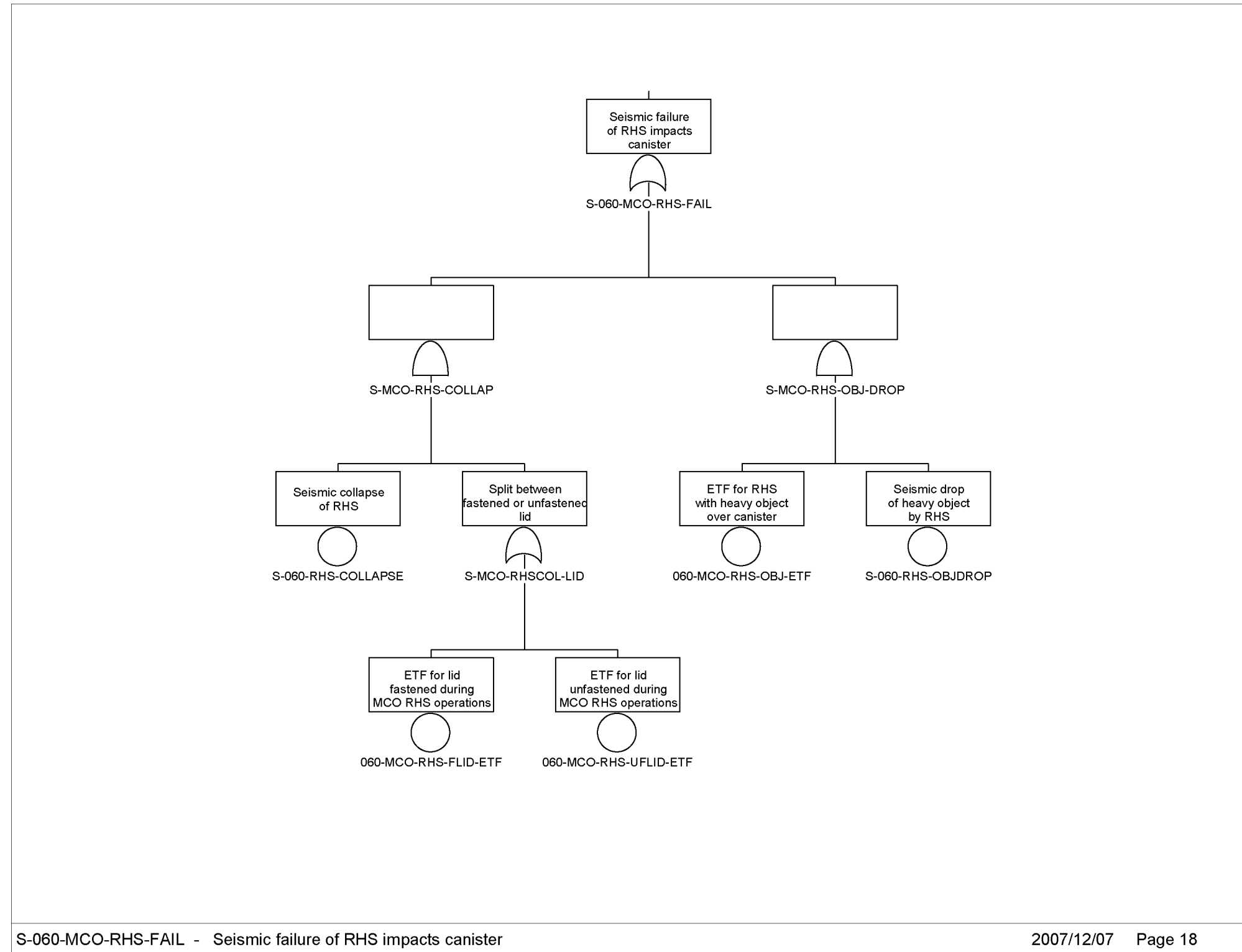

Source: Original

Figure C4.2-14. S-060-MCO-RHS-FAIL – Seismic Failure of RHS Impacts Canister

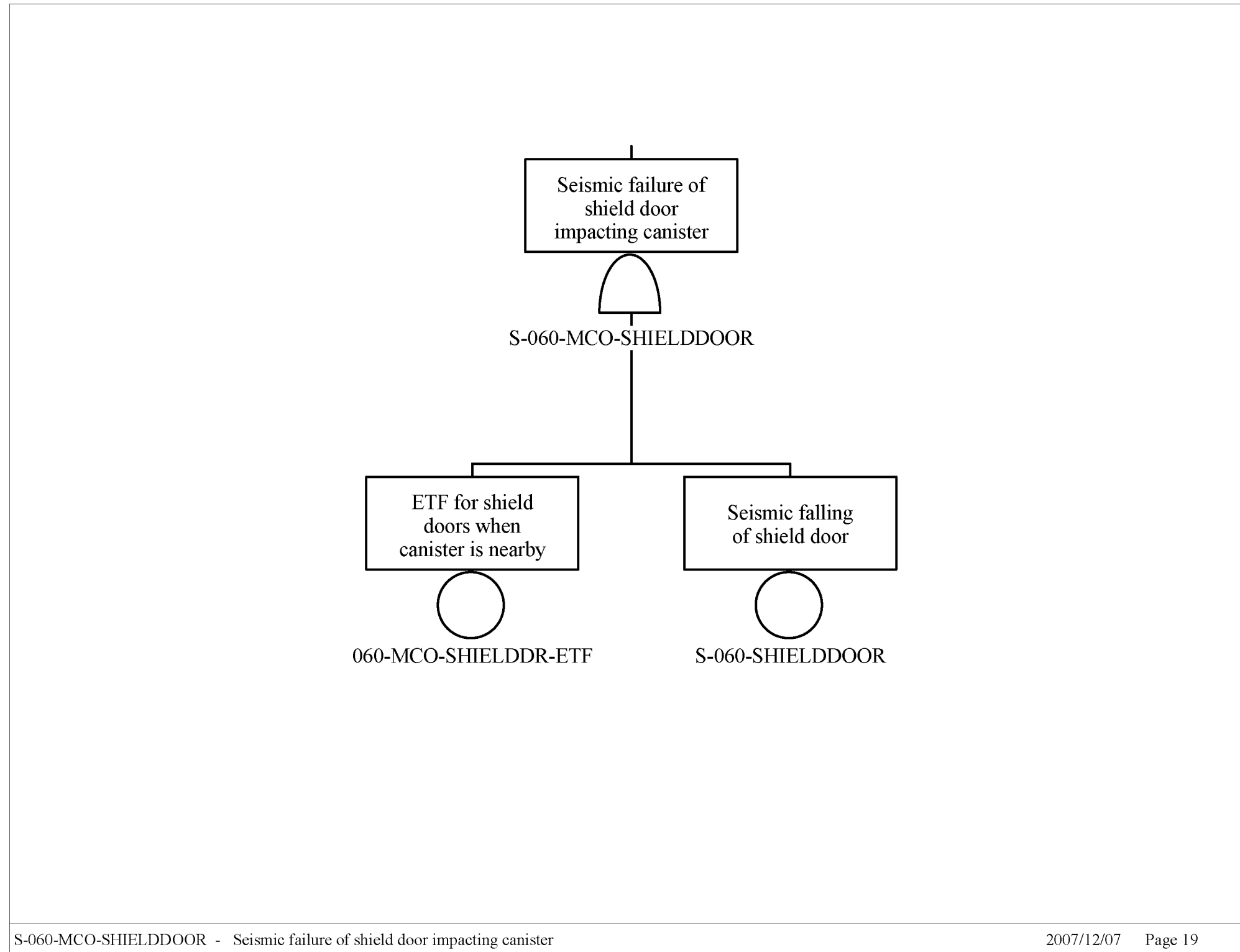

Source: Original

Figure C4.2-15. S-060-MCO-SHIELDDOOR – Seismic Failure of Shield Door Impacting Canister

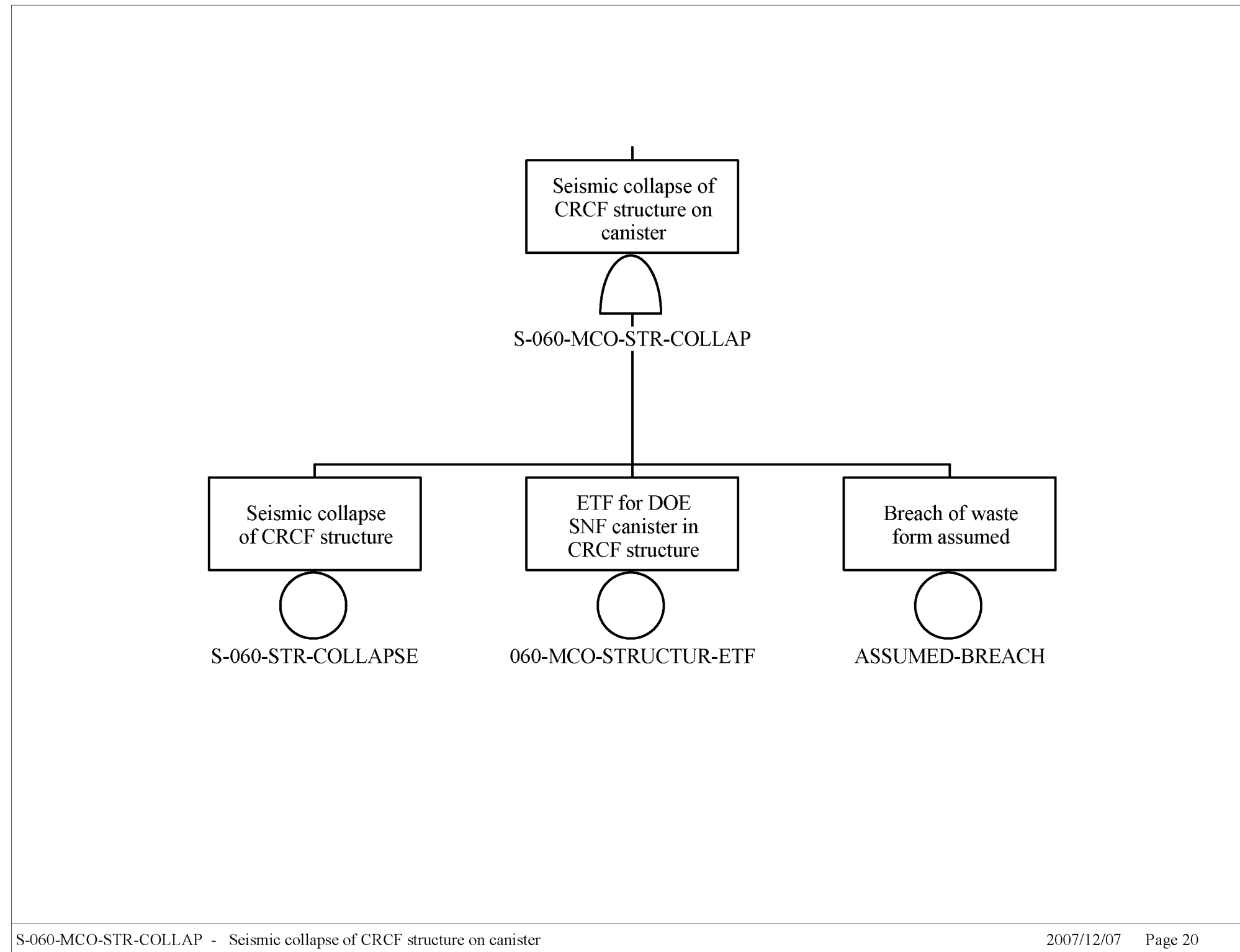

Source: Original

Figure C4.2-16. S-060-MCO-STR-COLLAP – Seismic Collapse of CRCF Structure on Canister

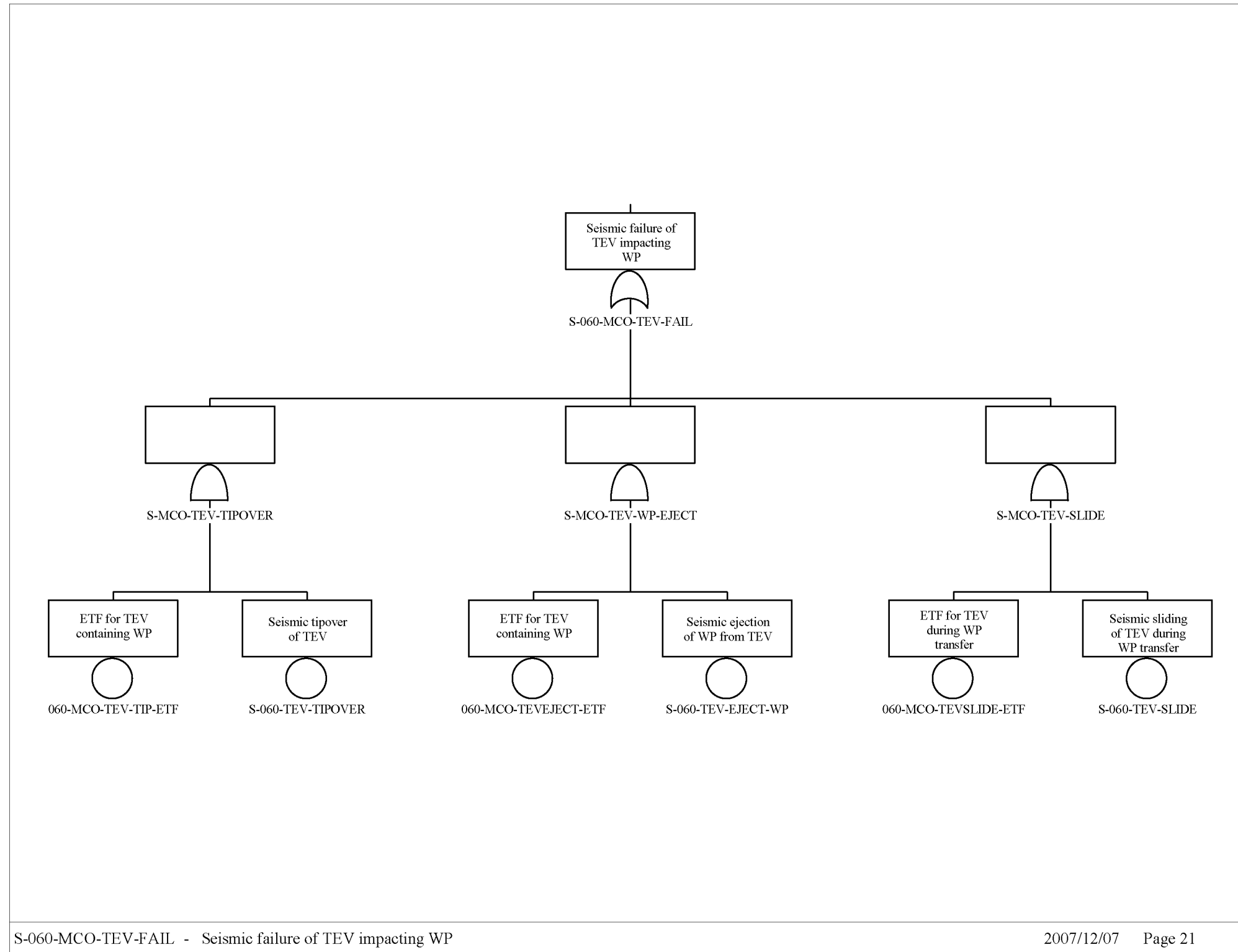

Source: Original

Figure C4.2-17. S-060-MCO-TEV-FAIL – Seismic Failure of TEV Impacting WP

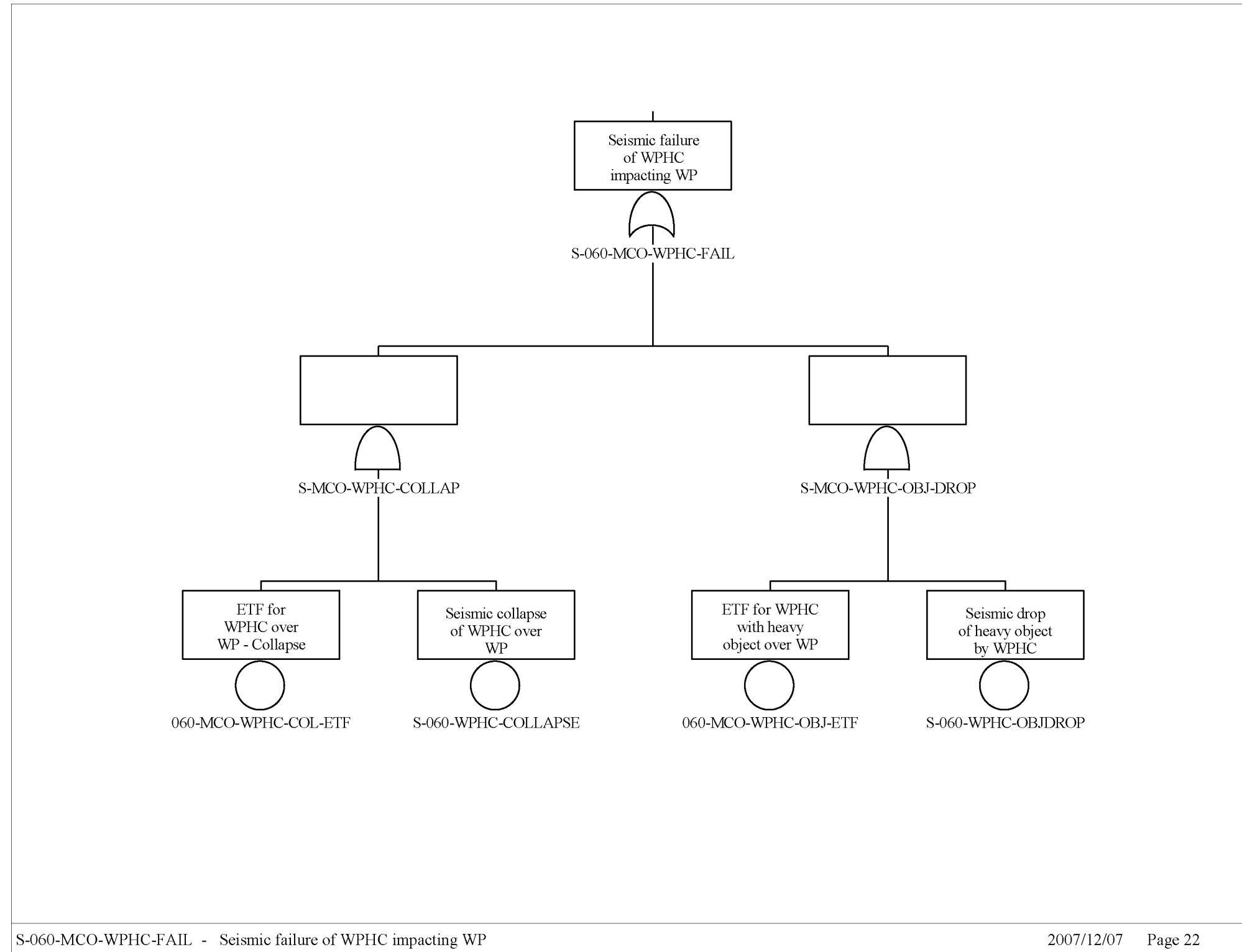

Source: Original

Figure C4.2-18. S-060-MCO-WPHC-FAIL-
Seismic Failure of WPHC
Impacting WP

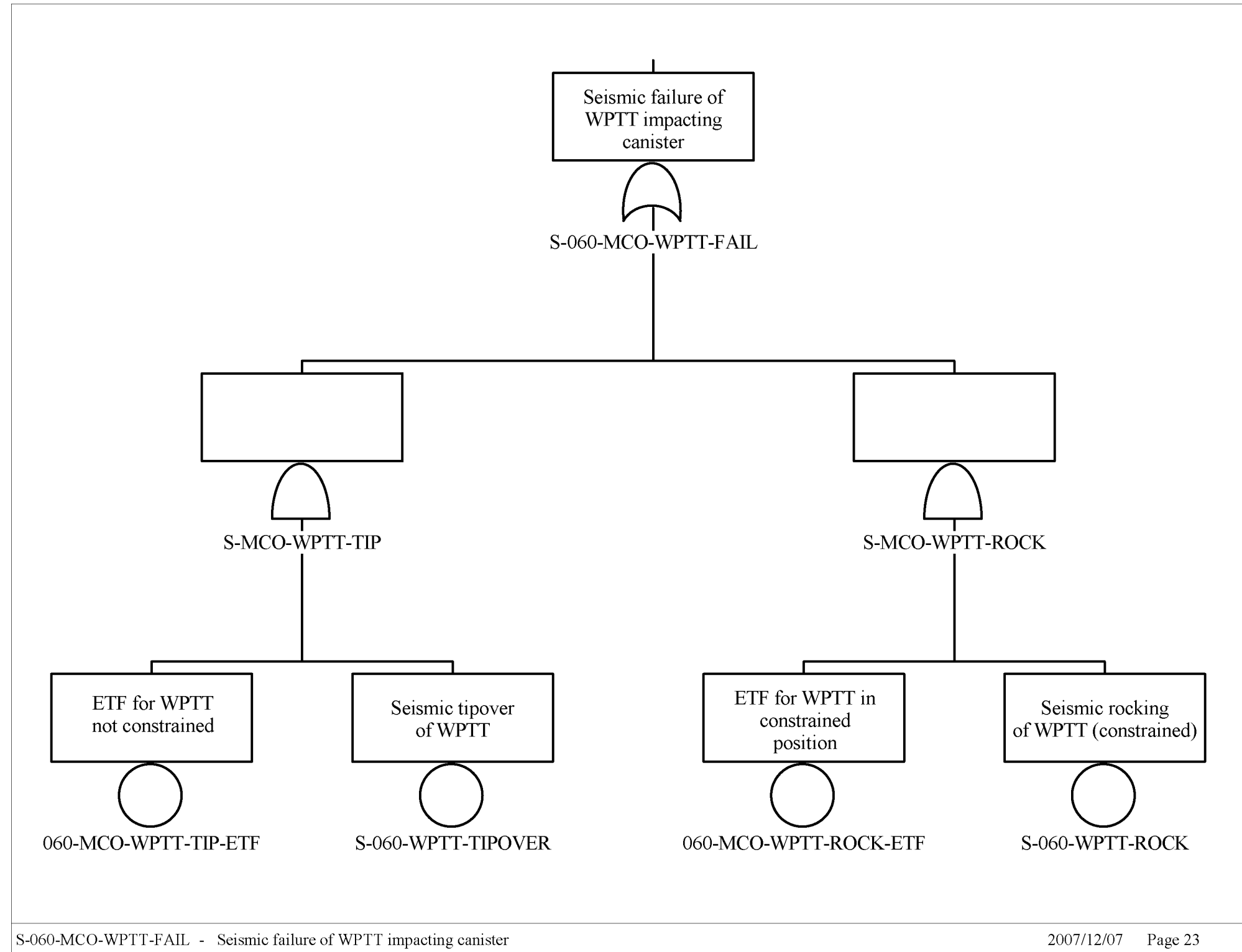

Source: Original

Figure C4.2-19. S-060-MCO-WPTT-FAIL – Seismic Failure of WPTT Impacting Canister

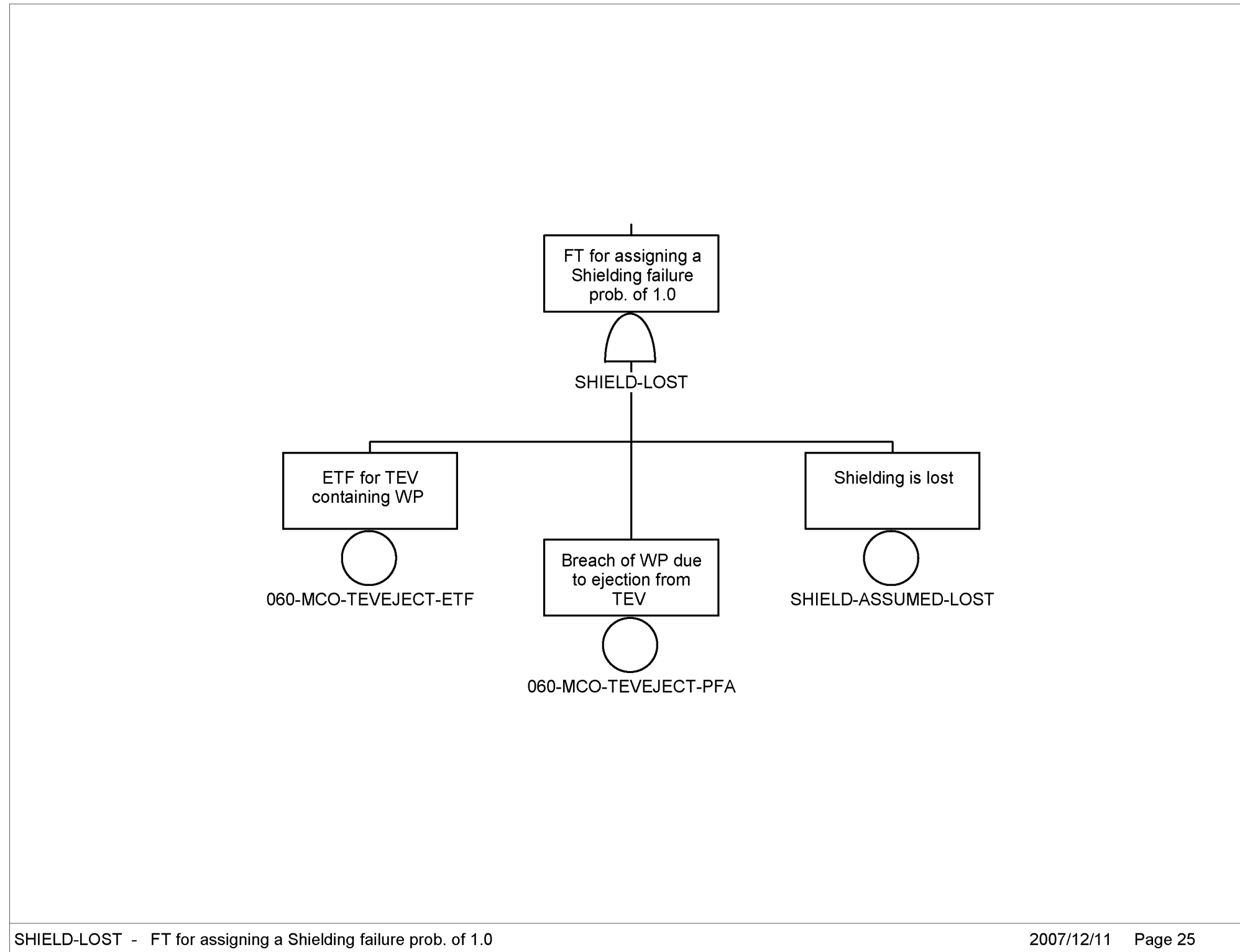

SHIELD-LOST - FT for assigning a Shielding failure prob. of 1.0

2007/12/11 Page 25

Source: Original

Figure C4.2-20. SHIELD-LOST – FT for Assigning a Shielding Failure Prob. of 1.0

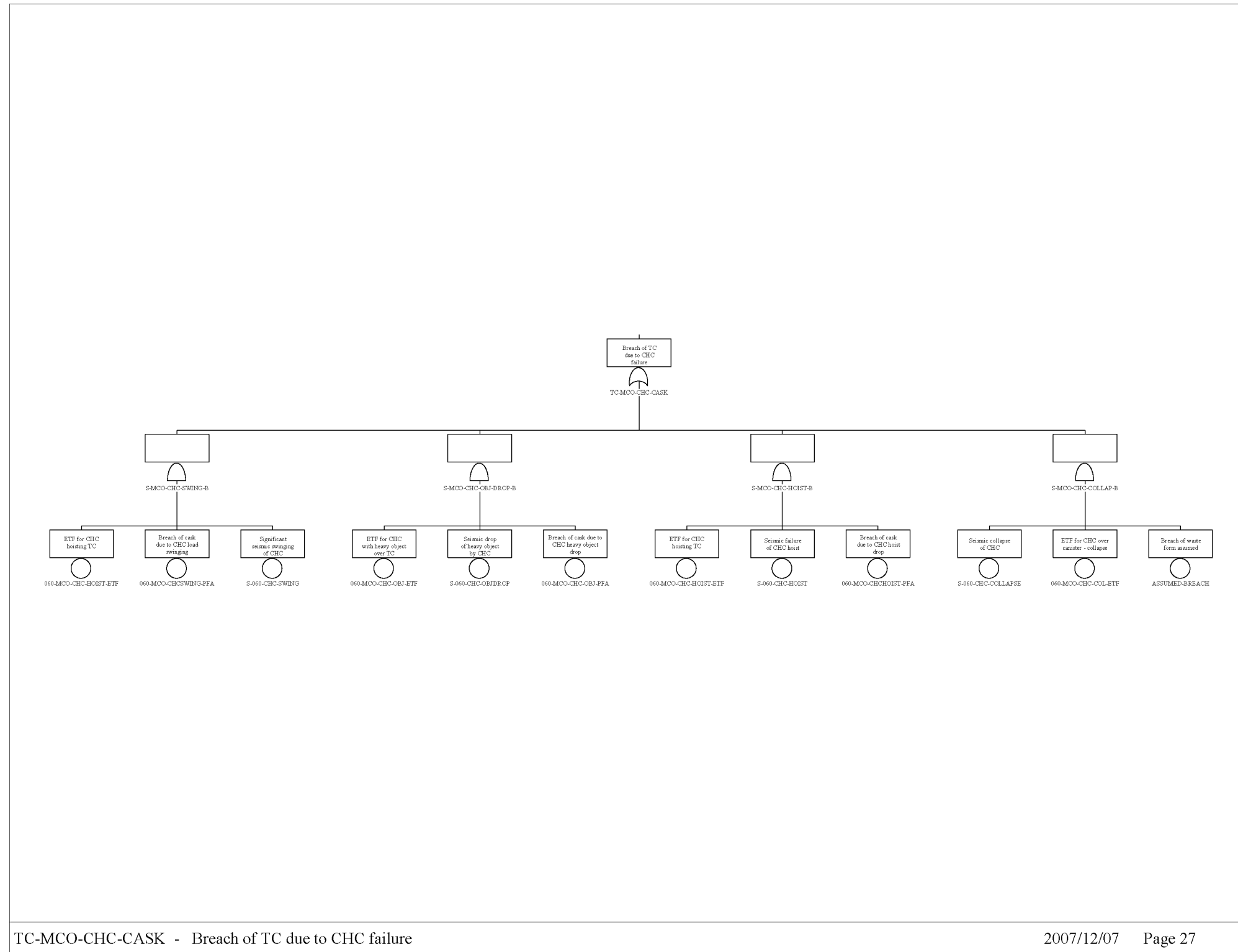

Source: Original

Figure C4.2-21. TC-MCO-CHC-CASK – Breach of TC due to CHC Failure

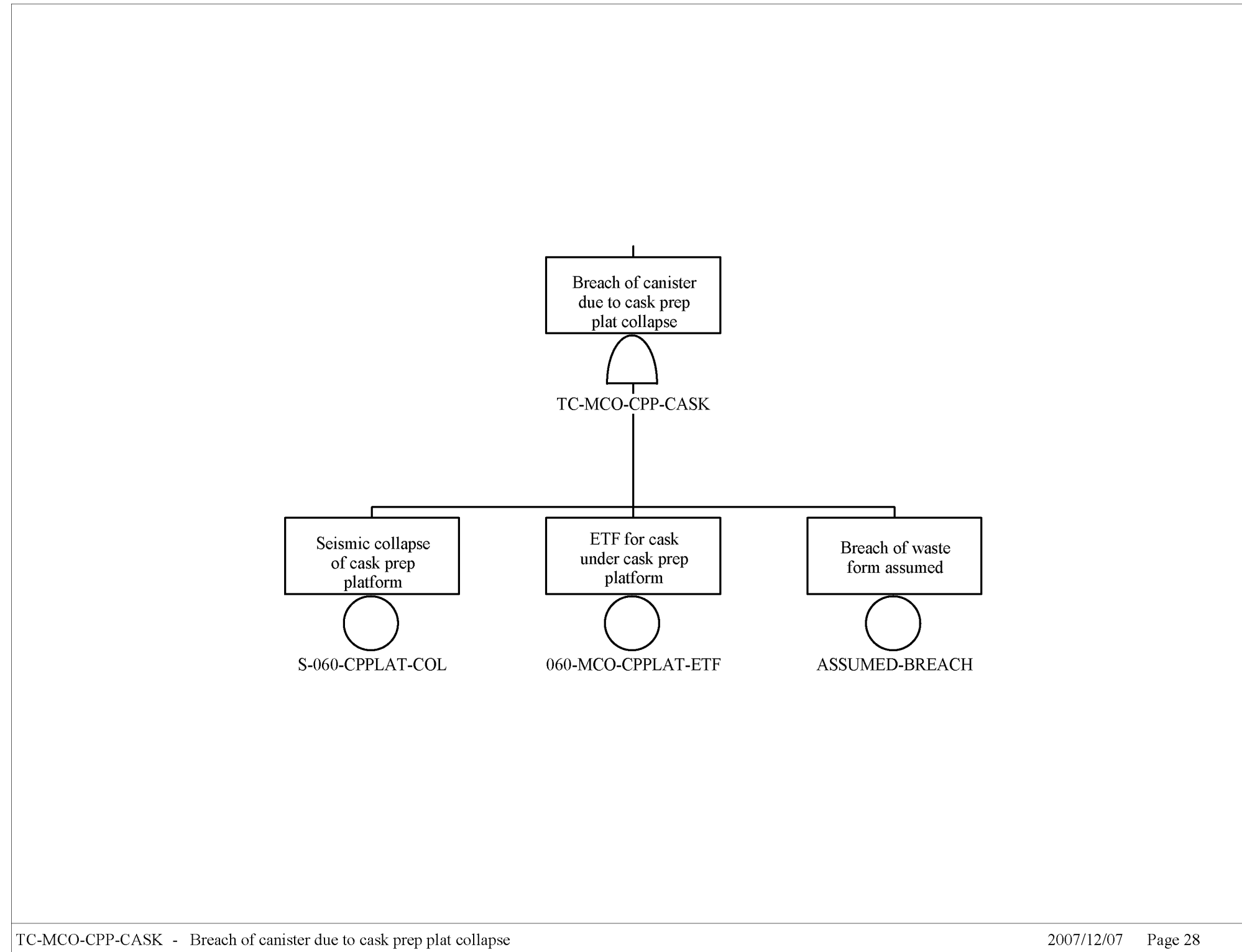

Source: Original

Figure C4.2-22. TC-MCO-CPP-CASK – Breach of Canister due to Cask Prep Plat Collapse

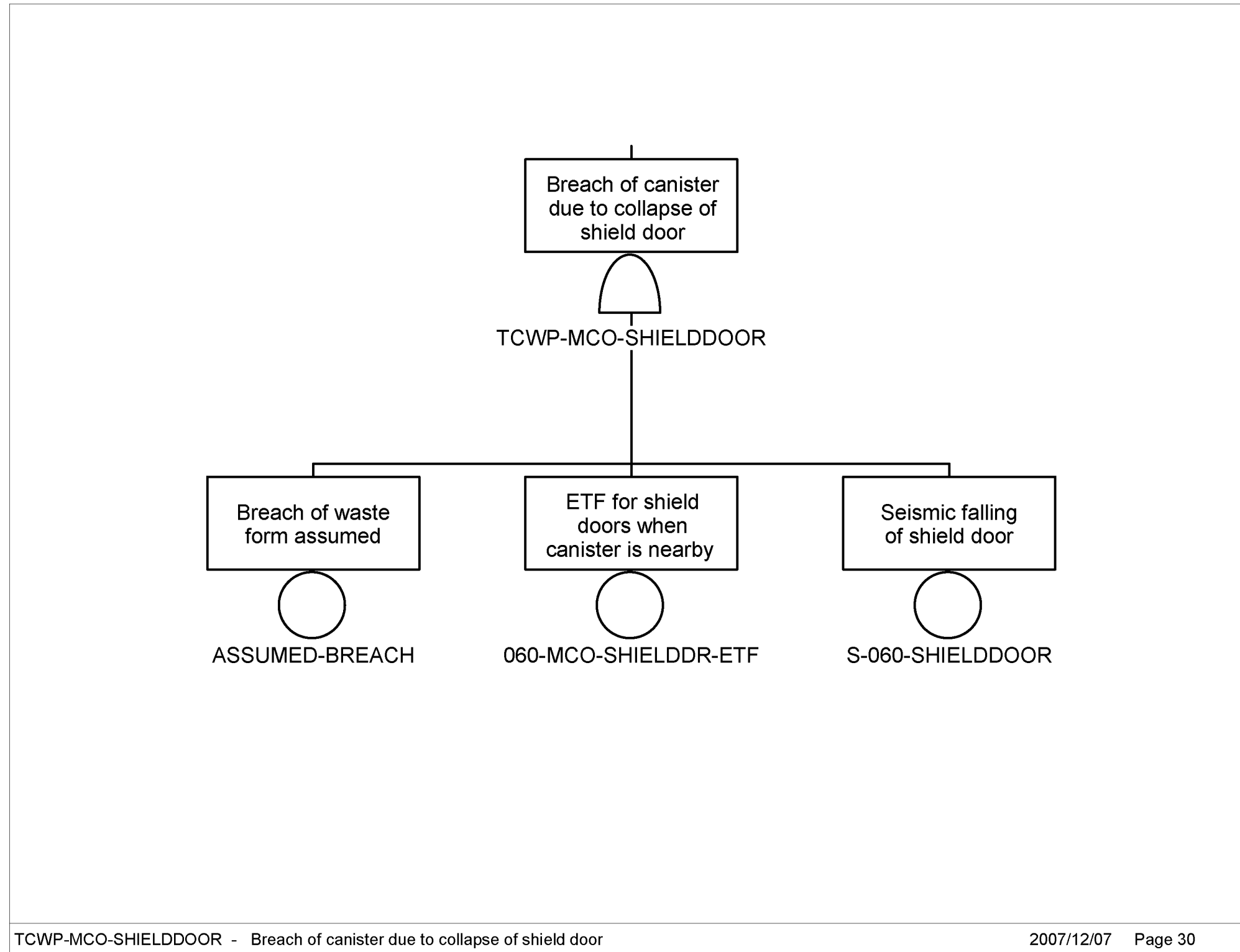

Source: Original

Figure C4.2-23. TCWP-MCO-SHIELDDOOR – Breach of Canister due to Collapse of Shield Door

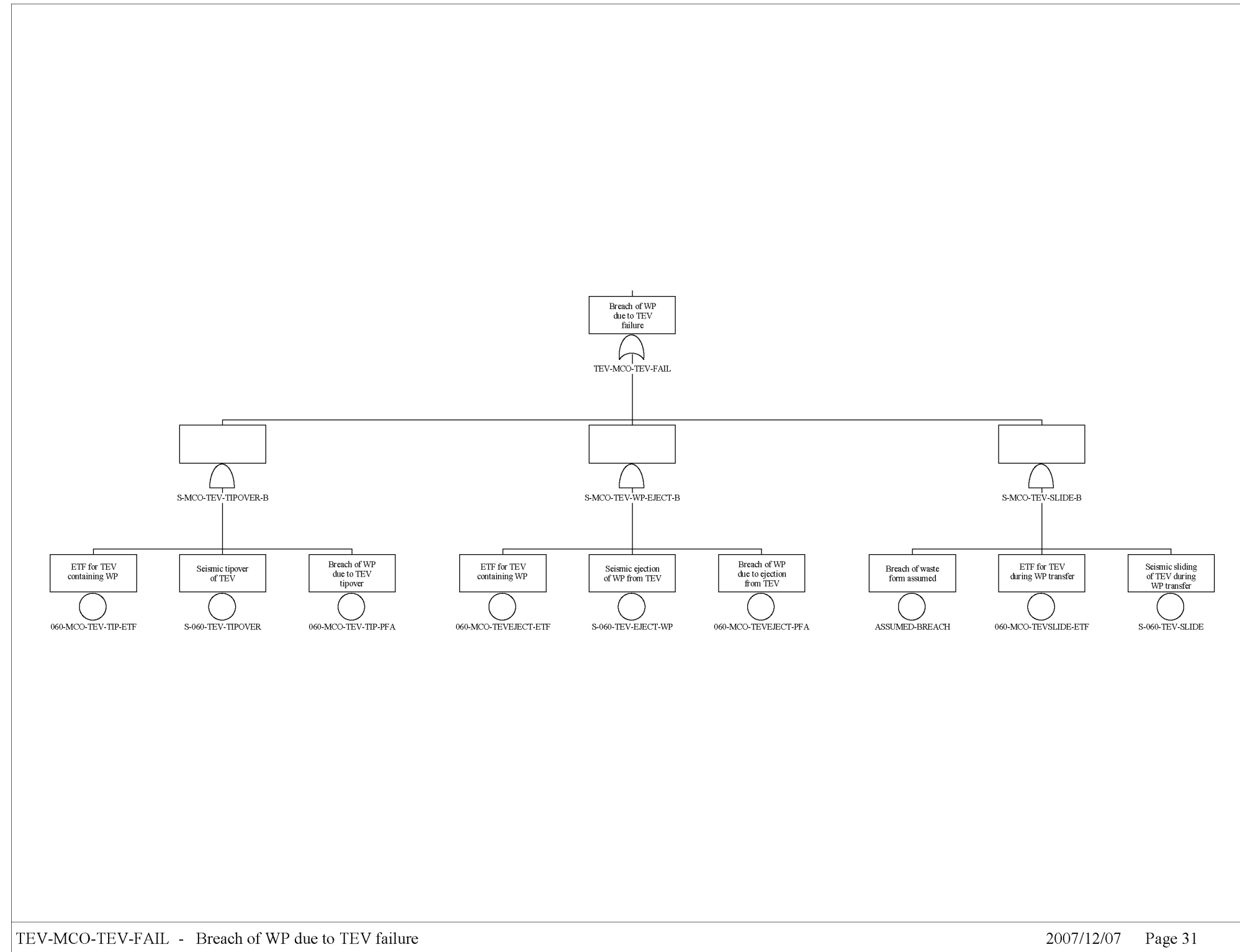

Source: Original

Figure C4.2-24 TEV-MCO-TEV-FAIL – Breach of WP due to TEV Failure

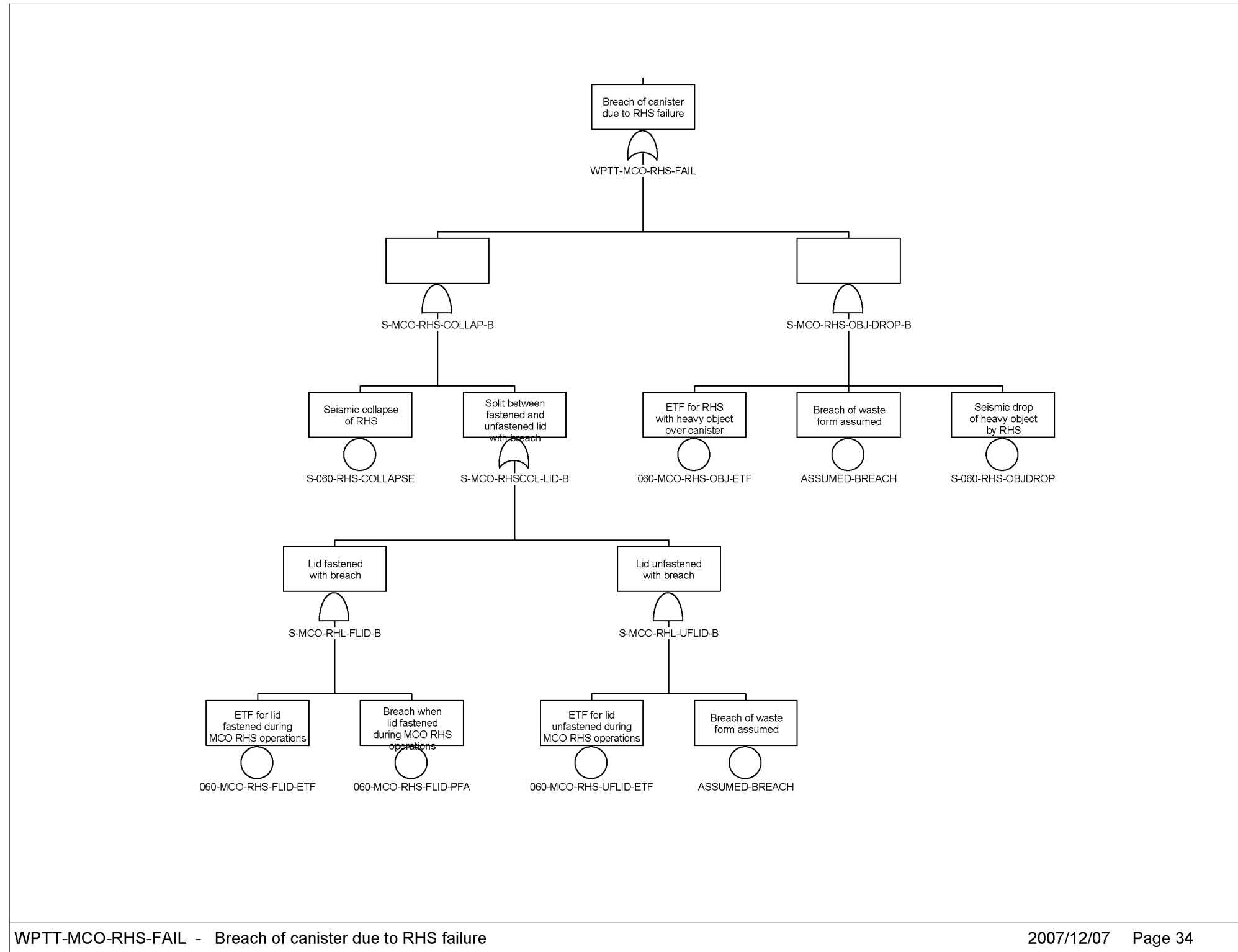

Source: Original

Figure C4.2-25. WPTT-MCO-RHS-FAIL – Breach of Canister due to RHS Failure

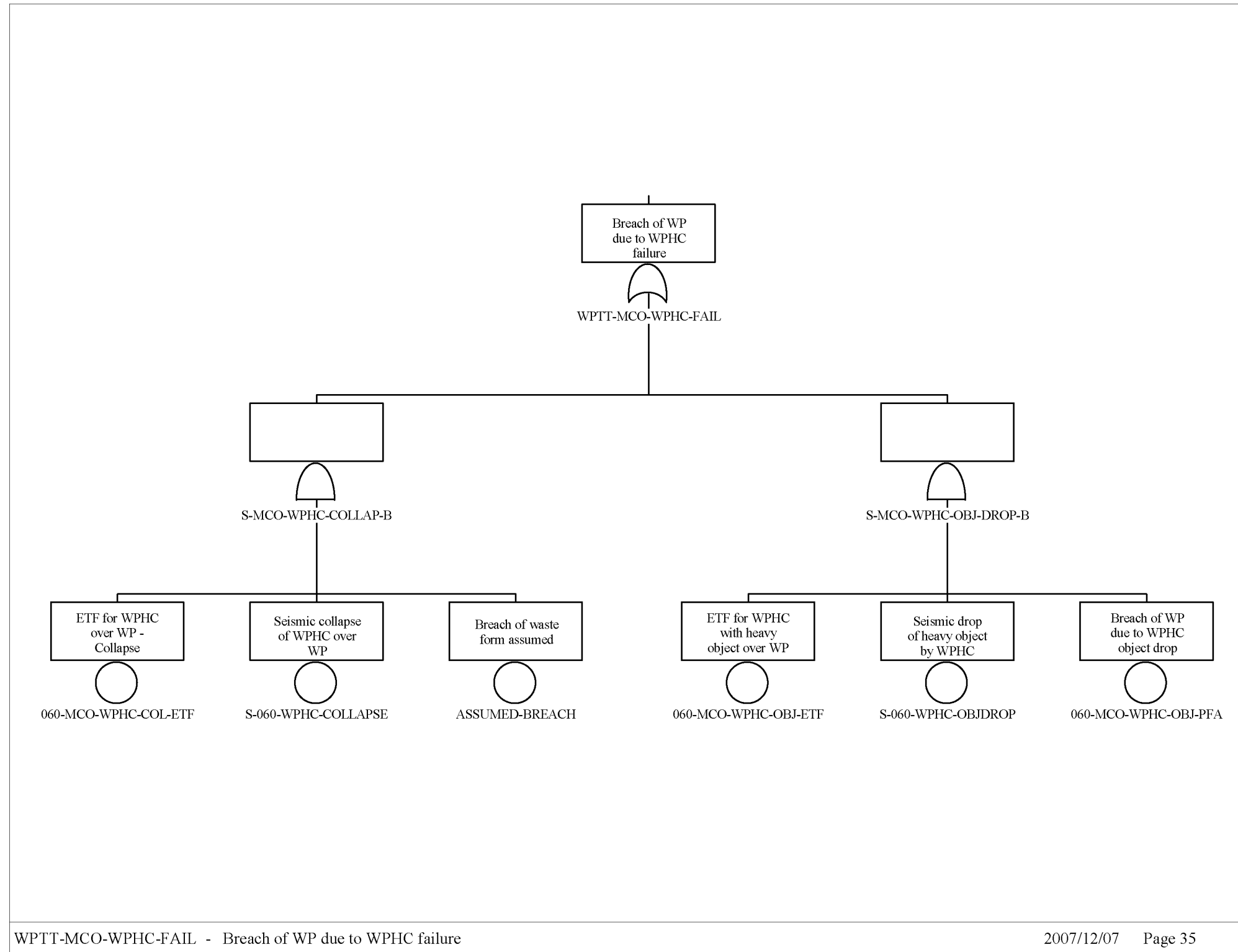

Source: Original

Figure C4.2-26. WPTT-MCO-WPHC-FAIL – Breach of WP due to WPHC Failure

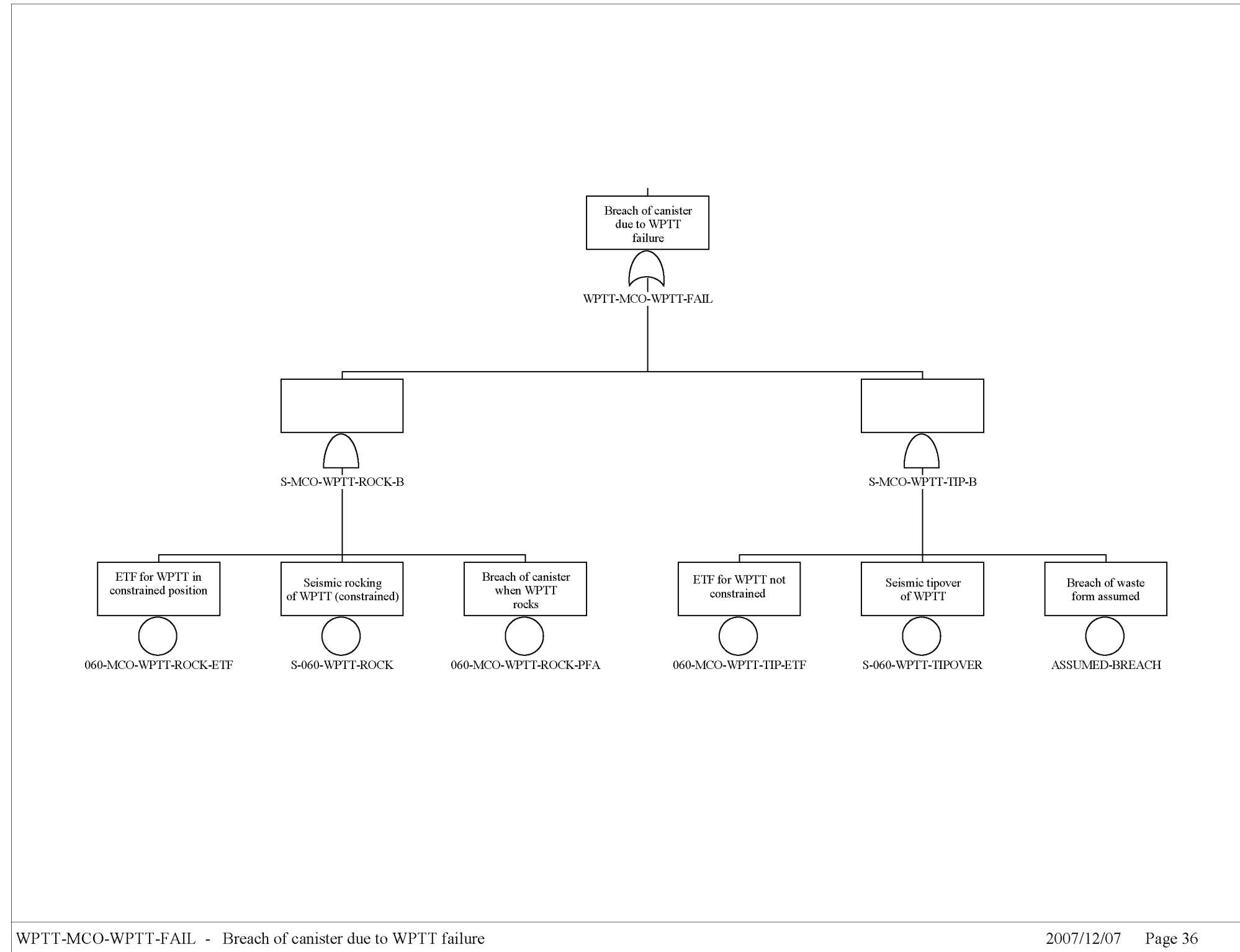

Source: Original

Figure C4.2-27. WPTT-MCO-WPTT-FAIL – Breach of Canister due to WPTT Failure

C4.3 BASIC EVENTS DATA

C4.3.1 Non-seismic Basic Event Data

The following table presents the basic event identifier used in the fault trees, the description of the basic event, and the failure probability (or other numeric data) of the basic event. For exposure time factors (denoted with “ETF” at the end of the basic event identifier), the value given is the time, in years, that one waste form container is exposed to the seismic failure mode.

Table C4.3-1. Non-seismic Basic Event Data

Name	Description	Calc. Probability
060-MCO-CHC-COL-ETF	ETF for CHC over canister - collapse	2.370E-004
060-MCO-CHC-OBJ-ETF	ETF for CHC with heavy object over TC	3.810E-005
060-MCO-CHC-OBJ-PFA	Breach of cask due to CHC heavy object drop	1.000E-005
060-MCO-CHCHOIST-ETF	ETF for CHC hoisting TC-cask drop or swing	2.620E-005
060-MCO-CHCHOIST-PFA	Breach of cask due to CHC hoist drop	1.000E-005
060-MCO-CHCSWING-PFA	Breach of cask due to CHC load swinging	1.000E-005
060-MCO-CPPLAT-ETF	ETF for cask under cask prep platform	1.550E-004
060-MCO-CTM-COL-ETF	ETF for CTM over canister - collapse	1.320E-004
060-MCO-CTM-OBJ-ETF	ETF for CTM with heavy object over TC	3.280E-005
060-MCO-CTMHOIST-ETF	ETF for CTM hoisting canister - drop	5.520E-005
060-MCO-CTMHOIST-PFA	Breach of canister dropped by CTM	1.000E-001
060-MCO-CTMSWIB-ETF	ETF for CTM hoisting canister inside bell	5.520E-005
060-MCO-CTMSWIB-PFA	Breach of canister due to swing inside bell	1.000E-005
060-MCO-CTMSWGOB-ETF	ETF for CTM hoisting canister outside bell	3.810E-005
060-MCO-CTT-BUMP-ETF	ETF for CTT with TC subject to bumping EAF	1.500E-004
060-MCO-CTT-BUMP-PFA	Breach given CTT with TC subject to bumping EAF	1.000E-005
060-MCO-CTT-ROCK-ETF	ETF for CTT with TC subject to rocking	1.190E-005
060-MCO-CTTSLIDE-ETF	ETF for CTT containing TC in transfer cell	1.290E-004
060-MCO-ENTDOOR-ETF	ETF for entry door over transport cask	9.040E-006
060-MCO-ENTDOOR-PFA	Breach of TC due to entry door collapse	1.000E-005
060-MCO-MOBPLAT-ETF	ETF for mobile platform over TC	1.130E-004
060-MCO-MOBPLAT-PFA	Breach of TC due to mobile platform collapse	1.000E-005
060-MCO-RAILCAR-ETF	ETF for railcar carrying transport cask	2.000E-004
060-MCO-RAILCAR-PFA	Breach of TC due to railcar accident	1.000E-005
060-MCO-RHS-FLID-ETF	ETF for lid fastened during MCO RHS operations	5.660E-005
060-MCO-RHS-FLID-PFA	Breach when lid fastened during MCO RHS operations	1.000E-005
060-MCO-RHS-OBJ-ETF	ETF for RHS with heavy object over canister	1.430E-005
060-MCO-RHS-UFLID-ETF	ETF for lid unfastened during MCO RHS operations	1.280E-005
060-MCO-SHIELD-ETF	ETF for shield doors when canister is nearby	1.800E-004
060-MCO-STRUCTUR-ETF	ETF for DOE SNF canister in CRFC structure	1.800E-003
060-MCO-TEV-TIP-ETF	ETF for TEV containing WP	2.430E-005
060-MCO-TEV-TIP-PFA	Breach of WP due to TEV tipover	1.000E-005

Table C4.3-1. Non-seismic Basic Event Data (Continued)

Name	Description	Calc. Probability
060-MCO-TEVEJECT-ETF	ETF for TEV containing WP	2.190E-005
060-MCO-TEVEJECT-PFA	Breach of WP due to ejection from TEV	5.000E-003
060-MCO-TEVSLIDE-ETF	ETF for TEV during WP transfer	2.380E-006
060-MCO-WPHC-COL-ETF	ETF for WPHC over WP - collapse	1.900E-005
060-MCO-WPHC-OBJ-ETF	ETF for WPHC with heavy object over WP	1.900E-005
060-MCO-WPHC-OBJ-PFA	Breach of WP due to WPHC object drop	1.000E-005
060-MCO-WPTT-ROCK-ETF	ETF for WPTT in constrained position	1.250E-003
060-MCO-WPTT-ROCK-PFA	Breach of canister when WPTT rocks	1.000E-005
060-MCO-WPTT-TIP-ETF	ETF for WPTT not constrained	5.710E-005
ASSUMED-BREACH	Breach of waste form assumed	1.000E+000
CRCF-MCO-CAN	Number of MCO canisters	4.510E+002
MOD-ENTER-CANISTER	Flooding or spray enters canister	1.000E-002
SHIELD-LOST	FT for assigning a shielding failure prob. of 1.0	1.000E+000
SHIELDING	WP remains within WPTT shielding	1.000E-005

NOTE: The basic event "ASSUMED-BREACH" is not an assumption, but is common terminology used to denote a scenario where the waste container is conservatively considered to be breached; CHC = cask handling crane; CRCF = Canister Receipt and Closure Facility; CTM = canister transfer machine; CTT = cask transfer trolley; DOE = Department of Energy; ETF = exposure time factor; MCO = multicanister overpack; RHS = remote handling system; SNF = spent nuclear fuel; TC = transportation cask; TEV = transport and emplacement vehicle; WP = waste package; WPHC = waste package handling crane; WPTT = waste package transfer trolley.

Source: Sections 6.2.2.23 and 6.3.3, Table 6.3-1, Table 6.3-2, Table 6.6-1

C4.3.2 Seismic Basic Event Fragility Data

The following table provides the seismic failure basic event identifier, description, median fragility, and composite uncertainty.

Table C4.3-2. Seismic Basic Event Fragility Data

Event Name	Description	Med. Fragility (g)	Beta C
S-060-CHC-COLLAPSE	Seismic collapse of CHC	2.790E+000	4.500E-001
S-060-CHC-HOIST	Seismic failure of CHC hoist	2.280E+000	5.000E-001
S-060-CHC-OBJDROP	Seismic drop of heavy object by CHC	2.280E+000	5.000E-001
S-060-CHC-SWING	Significant seismic swinging of CHC	1.140E+000	4.000E-001
S-060-CPPLAT-COL	Seismic collapse of cask prep platform	3.500E+000	4.000E-001
S-060-CTM-COLLAPSE	Seismic collapse of CTM (trolley seismic restraints)	2.390E+000	4.500E-001
S-060-CTM-HOIST	Seismic drop of canister hoisted by CTM	2.280E+000	5.000E-001
S-060-CTM-OBJDROP	Seismic drop of heavy object by CTM	2.280E+000	5.000E-001
S-060-CTMSWG-IB	Significant swinging of canister inside CTM bell	1.140E+000	4.000E-001
S-060-CTMSWG-OB	Significant swinging of canister outside CTM bell	9.100E-001	4.000E-001
S-060-CTT-BUMPING	Seismic bumping of CTT into EAF	2.250E+000	4.100E-001
S-060-CTT-ROCKING	Seismic rocking of CTT with restraint failure	2.250E+000	4.100E-001
S-060-CTT-SLIDE	Seismic sliding of CTT into wall	3.080E+000	5.800E-001
S-060-ENTDOORCOL	Seismic collapse of entry door	3.700E-001	4.000E-001
S-060-MOBPLAT-COLLAP	Seismic collapse of mobile platform	3.700E-001	4.000E-001
S-060-PIPING-FAIL	Seismic failure of piping in accident area	7.600E-001	4.000E-001
S-060-RAILCAR-ACC	Seismic tipover or collision of railcar	4.500E-001	4.000E-001
S-060-RHS-COLLAPSE	Seismic collapse of RHS	2.790E+000	4.500E-001
S-060-RHS-OBJDROP	Seismic drop of heavy object by RHS	1.140E+000	4.000E-001
S-060-SHIELDDOOR	Seismic falling of shield door	2.920E+000	4.400E-001
S-060-STR-COLLAPSE	Seismic collapse of CRCF structure	4.610E+000	4.000E-001
S-060-TEV-EJECT-WP	Seismic ejection of WP from TEV	7.600E-001	4.000E-001
S-060-TEV-SLIDE	Seismic sliding of TEV during WP transfer	1.120E+000	4.300E-001
S-060-TEV-TIPOVER	Seismic tipover of TEV	5.000E+000	4.000E-001
S-060-WPHC-COLLAPSE	Seismic collapse of WPHC over WP	2.790E+000	4.500E-001
S-060-WPHC-OBJDROP	Seismic drop of heavy object by WPHC	1.140E+000	4.000E-001
S-060-WPTT-ROCK	Seismic rocking of WPTT (constrained)	1.850E+000	3.700E-001
S-060-WPTT-TIPOVER	Seismic tipover of WPTT	3.410E+000	4.000E-001

NOTE: CHC = cask handling crane; CRCF = Canister Receipt and Closure Facility; CTM = canister transfer machine; CTT = cask transfer trolley; RHS = remote handling system; TC = transportation cask; TEV = transport and emplacement vehicle; WP = waste package; WPHC = waste package handling crane; WPTT = waste package transfer trolley.

Source: Table 6.2-1 and Table 6.2-2

C4.4 EVENT SEQUENCE QUANTIFICATION

This section provides the quantification results by sequence. The event sequence probabilities are provided first, and the cut sets are provided afterwards.

C4.4.1 Sequence Level Results

Table C4.4-1. Sequence Level Results

Event Tree	Sequence	Base Min. Cut	Base Cut Sets
CRCF-S-IE-MCO	03	6.355E-007	1
CRCF-S-IE-MCO	04-2	4.109E-011	1
CRCF-S-IE-MCO	04-3	+0.000E+000	1
CRCF-S-IE-MCO	04-4	+0.000E+000	1
CRCF-S-IE-MCO	04-5	+0.000E+000	1
CRCF-S-IE-MCO	04-6	4.109E-011	1
CRCF-S-IE-MCO	04-7	8.302E-014	1
CRCF-S-IE-MCO	05-2	6.233E-010	1
CRCF-S-IE-MCO	05-3	+0.000E+000	1
CRCF-S-IE-MCO	05-4	+0.000E+000	1
CRCF-S-IE-MCO	05-5	+0.000E+000	1
CRCF-S-IE-MCO	05-6	6.233E-010	1
CRCF-S-IE-MCO	05-7	1.684E-012	1
CRCF-S-IE-MCO	06-2	5.136E-010	1
CRCF-S-IE-MCO	06-3	+0.000E+000	1
CRCF-S-IE-MCO	06-4	+0.000E+000	1
CRCF-S-IE-MCO	06-5	+0.000E+000	1
CRCF-S-IE-MCO	06-6	5.136E-010	1
CRCF-S-IE-MCO	06-7	1.038E-012	1
CRCF-S-IE-MCO	07-2	1.570E-011	3
CRCF-S-IE-MCO	07-3	+0.000E+000	1
CRCF-S-IE-MCO	07-4	+0.000E+000	1
CRCF-S-IE-MCO	07-5	+0.000E+000	1
CRCF-S-IE-MCO	07-6	8.389E-007	4
CRCF-S-IE-MCO	07-7	7.893E-009	4
CRCF-S-IE-MCO	08-2		0
CRCF-S-IE-MCO	08-3	+0.000E+000	1
CRCF-S-IE-MCO	08-4	+0.000E+000	1
CRCF-S-IE-MCO	08-5	+0.000E+000	1
CRCF-S-IE-MCO	08-6	1.843E-007	1
CRCF-S-IE-MCO	08-7	1.809E-009	1
CRCF-S-IE-MCO	09-2	9.182E-012	1
CRCF-S-IE-MCO	09-3	+0.000E+000	1
CRCF-S-IE-MCO	09-4	+0.000E+000	1

Table C4.4-1. Sequence Level Results (Continued)

Event Tree	Sequence	Base Min. Cut	Base Cut Sets
CRCF-S-IE-MCO	09-5	+0.000E+000	1
CRCF-S-IE-MCO	09-6	6.752E-007	3
CRCF-S-IE-MCO	09-7	5.879E-009	3
CRCF-S-IE-MCO	10-2		0
CRCF-S-IE-MCO	10-3	+0.000E+000	1
CRCF-S-IE-MCO	10-4	+0.000E+000	1
CRCF-S-IE-MCO	10-5	+0.000E+000	1
CRCF-S-IE-MCO	10-6	5.207E-007	1
CRCF-S-IE-MCO	10-7	4.958E-009	1
CRCF-S-IE-MCO	11-2	2.651E-011	2
CRCF-S-IE-MCO	11-3	+0.000E+000	1
CRCF-S-IE-MCO	11-4	+0.000E+000	1
CRCF-S-IE-MCO	11-5	3.679E-006	5
CRCF-S-IE-MCO	11-6	2.583E-008	5
CRCF-S-IE-MCO	12-2	2.003E-012	1
CRCF-S-IE-MCO	12-3	+0.000E+000	1
CRCF-S-IE-MCO	12-4	+0.000E+000	1
CRCF-S-IE-MCO	12-5	+0.000E+000	1
CRCF-S-IE-MCO	12-6	6.150E-007	3
CRCF-S-IE-MCO	12-7	4.559E-009	3
CRCF-S-IE-MCO	13-2	1.237E-010	1
CRCF-S-IE-MCO	13-3	+0.000E+000	1
CRCF-S-IE-MCO	13-4	+0.000E+000	1
CRCF-S-IE-MCO	13-5	+0.000E+000	1
CRCF-S-IE-MCO	13-6	7.556E-008	2
CRCF-S-IE-MCO	13-7	7.405E-010	2
CRCF-S-IE-MCO	14-2	7.572E-012	1
CRCF-S-IE-MCO	14-3	+0.000E+000	1
CRCF-S-IE-MCO	14-4	+0.000E+000	1
CRCF-S-IE-MCO	14-5	+0.000E+000	1
CRCF-S-IE-MCO	14-6	6.726E-008	2
CRCF-S-IE-MCO	14-7	6.328E-010	2
CRCF-S-IE-MCO	15-2	2.272E-006	2
CRCF-S-IE-MCO	15-4	+0.000E+000	1
CRCF-S-IE-MCO	15-5	+0.000E+000	1
CRCF-S-IE-MCO	15-6	+0.000E+000	1
CRCF-S-IE-MCO	15-7	1.172E-007	3
CRCF-S-IE-MCO	15-8	7.836E-010	3

Source: Original

C4.4.2 Cut Set Level Results by Sequence

Note that the SAPHIRE software does not provide special tables for seismic cut sets. Therefore, the “Cut Set %” given in the third column of this table is not correct for seismic events, although it does provide the approximate rank order for the cut sets.

Table C4.4-2. Cut Set Level Results by Sequence

Event Tree	Sequence	Cut Set %	Basic Event	Description
CRCF-S-IE-MCO	03	100.00	060-MCO-STRUCTUR-ETF	ETF for DOE SNF canister in CRCF structure
			CRCF-MCO-CAN	Number of MCO canisters
			S-060-STR-COLLAPSE	Seismic collapse of CRCF structure
			= Total	
	04-2	100.00	060-MCO-ENTDOOR-ETF	ETF for entry door over transport cask
			CRCF-MCO-CAN	Number of MCO canisters
			S-060-ENTDOORCOL	Seismic collapse of entry door
			SHIELDING	WP remains within WPTT shielding
			= Total	
	04-3	0.00	<FALSE>	System Generated Success Event
			= Total	
	04-4	0.00	<FALSE>	System Generated Success Event
			= Total	
	04-5	0.00	<FALSE>	System Generated Success Event
			= Total	
	04-6	100.00	060-MCO-ENTDOOR-ETF	ETF for entry door over transport cask
			060-MCO-ENTDOOR-PFA	Breach of TC due to entry door collapse
			CRCF-MCO-CAN	Number of MCO canisters
			S-060-ENTDOORCOL	Seismic collapse of entry door
			= Total	
	04-7	100.00	060-MCO-ENTDOOR-ETF	ETF for entry door over transport cask
			060-MCO-ENTDOOR-PFA	Breach of TC due to entry door collapse
			CRCF-MCO-CAN	Number of MCO canisters
			MOD-ENTER-CANISTER	Flooding or spray enters canister
			S-060-ENTDOORCOL	Seismic collapse of entry door
			S-060-PIPING-FAIL	Seismic failure of piping in accident area
			= Total	
	05-2	100.00	060-MCO-RAILCAR-ETF	ETF for railcar carrying transport cask
			CRCF-MCO-CAN	Number of MCO canisters

Table C4.4-2. Cut Set Level Results by Sequence (Continued)

Event Tree	Sequence	Cut Set %	Basic Event	Description
			S-060-RAILCAR-ACC	Seismic tipover or collision of railcar
			SHIELDING	WP remains within WPTT shielding
			= Total	
	05-3	0.00	<FALSE>	System Generated Success Event
			= Total	
	05-4	0.00	<FALSE>	System Generated Success Event
			= Total	
	05-5	0.00	<FALSE>	System Generated Success Event
			= Total	
	05-6	100.00	060-MCO-RAILCAR-ETF	ETF for railcar carrying transport cask
			060-MCO-RAILCAR-PFA	Breach of TC due to railcar accident
			CRCF-MCO-CAN	Number of MCO canisters
			S-060-RAILCAR-ACC	Seismic tipover or collision of railcar
			= Total	
	05-7	100.00	060-MCO-RAILCAR-ETF	ETF for railcar carrying transport cask
			060-MCO-RAILCAR-PFA	Breach of TC due to railcar accident
			CRCF-MCO-CAN	Number of MCO canisters
			MOD-ENTER-CANISTER	Flooding or spray enters canister
			S-060-PIPING-FAIL	Seismic failure of piping in accident area
			S-060-RAILCAR-ACC	Seismic tipover or collision of railcar
			= Total	
	06-2	100.00	060-MCO-MOBPLAT-ETF	ETF for mobile platform over TC
			CRCF-MCO-CAN	Number of MCO canisters
			S-060-MOBPLAT-COLLAP	Seismic collapse of mobile platform
			SHIELDING	WP remains within WPTT shielding
			= Total	
	06-3	0.00	<FALSE>	System Generated Success Event
			= Total	
	06-4	0.00	<FALSE>	System Generated Success Event
			= Total	
	06-5	0.00	<FALSE>	System Generated Success Event
			= Total	
	06-6	100.00	060-MCO-MOBPLAT-ETF	ETF for mobile platform over TC
			060-MCO-MOBPLAT-PFA	Breach of TC due to mobile platform collapse
			CRCF-MCO-CAN	Number of MCO canisters

Table C4.4-2. Cut Set Level Results by Sequence (Continued)

Event Tree	Sequence	Cut Set %	Basic Event	Description
			S-060-MOBPLAT-COLLAP	Seismic collapse of mobile platform
			= Total	
	06-7	100.00	060-MCO-MOBPLAT-ETF	ETF for mobile platform over TC
			060-MCO-MOBPLAT-PFA	Breach of TC due to mobile platform collapse
			CRCF-MCO-CAN	Number of MCO canisters
			MOD-ENTER-CANISTER	Flooding or spray enters canister
			S-060-MOBPLAT-COLLAP	Seismic collapse of mobile platform
			S-060-PIPING-FAIL	Seismic failure of piping in accident area
			= Total	
	07-2	87.46	060-MCO-CHCHOIST-ETF	ETF for CHC hoisting TC-Cask drop or swing
			CRCF-MCO-CAN	Number of MCO canisters
			S-060-CHC-SWING	Significant seismic swinging of CHC
			SHIELDING	WP remains within WPTT shielding
		7.43	060-MCO-CHC-OBJ-ETF	ETF for CHC with heavy object over TC
			CRCF-MCO-CAN	Number of MCO canisters
			S-060-CHC-OBJDROP	Seismic drop of heavy object by CHC
			SHIELDING	WP remains within WPTT shielding
		5.11	060-MCO-CHCHOIST-ETF	ETF for CHC hoisting TC-cask drop or swing
			CRCF-MCO-CAN	Number of MCO canisters
			S-060-CHC-HOIST	Seismic failure of CHC hoist
			SHIELDING	WP remains within WPTT shielding
			= Total	
	07-3	0.00	<FALSE>	System Generated Success Event
			= Total	
	07-4	0.00	<FALSE>	System Generated Success Event
			= Total	
	07-5	0.00	<FALSE>	System Generated Success Event
			= Total	
	07-6	99.95	060-MCO-CHC-COL-ETF	ETF for CHC over canister - collapse
			CRCF-MCO-CAN	Number of MCO canisters
			S-060-CHC-COLLAPSE	Seismic collapse of CHC
		0.04	060-MCO-CHCHOIST-ETF	ETF for CHC hoisting TC-cask drop or swing
			060-MCO-CHCSWING-PFA	Breach of cask due to CHC load swinging
			CRCF-MCO-CAN	Number of MCO canisters

Table C4.4-2. Cut Set Level Results by Sequence (Continued)

Event Tree	Sequence	Cut Set %	Basic Event	Description
			S-060-CHC-SWING	Significant seismic swinging of CHC
		0.00	060-MCO-CHC-OBJ-ETF	ETF for CHC with heavy object over TC
			060-MCO-CHC-OBJ-PFA	Breach of cask due to CHC heavy object drop
			CRCF-MCO-CAN	Number of MCO canisters
			S-060-CHC-OBJDROP	Seismic drop of heavy object by CHC
		0.00	060-MCO-CHCHOIST-ETF	ETF for CHC hoisting TC-cask drop or swing
			060-MCO-CHCHOIST-PFA	Breach of cask due to CHC hoist drop
			CRCF-MCO-CAN	Number of MCO canisters
			S-060-CHC-HOIST	Seismic failure of CHC hoist
			= Total	
	07-7	99.95	060-MCO-CHC-COL-ETF	ETF for CHC over canister - collapse
			CRCF-MCO-CAN	Number of MCO canisters
			MOD-ENTER-CANISTER	Flooding or spray enters canister
			S-060-CHC-COLLAPSE	Seismic collapse of CHC
			S-060-PIPING-FAIL	Seismic failure of piping in accident area
		0.04	060-MCO-CHCHOIST-ETF	ETF for CHC hoisting TC-cask drop or swing
			060-MCO-CHCSWING-PFA	Breach of cask due to CHC load swinging
			CRCF-MCO-CAN	Number of MCO canisters
			MOD-ENTER-CANISTER	Flooding or spray enters canister
			S-060-CHC-SWING	Significant seismic swinging of CHC
			S-060-PIPING-FAIL	Seismic failure of piping in accident area
		0.00	060-MCO-CHC-OBJ-ETF	ETF for CHC with heavy object over TC
			060-MCO-CHC-OBJ-PFA	Breach of cask due to CHC heavy object drop
			CRCF-MCO-CAN	Number of MCO canisters
			MOD-ENTER-CANISTER	Flooding or spray enters canister
			S-060-CHC-OBJDROP	Seismic drop of heavy object by CHC
			S-060-PIPING-FAIL	Seismic failure of piping in accident area
		0.00	060-MCO-CHCHOIST-ETF	ETF for CHC hoisting TC-cask drop or swing
			060-MCO-CHCHOIST-PFA	Breach of cask due to CHC hoist drop

Table C4.4-2. Cut Set Level Results by Sequence (Continued)

Event Tree	Sequence	Cut Set %	Basic Event	Description
			CRCF-MCO-CAN	Number of MCO canisters
			MOD-ENTER-CANISTER	Flooding or spray enters canister
			S-060-CHC-HOIST	Seismic failure of CHC hoist
			S-060-PIPING-FAIL	Seismic failure of piping in accident area
			= Total	
	08-2			
	08-3	0.00	<FALSE>	System Generated Success Event
			= Total	
	08-4	0.00	<FALSE>	System Generated Success Event
			= Total	
	08-5	0.00	<FALSE>	System Generated Success Event
			= Total	
	08-6	100.00	060-MCO-CPPLAT-ETF	ETF for cask under cask prep platform
			CRCF-MCO-CAN	Number of MCO canisters
			S-060-CPPLAT-COL	Seismic collapse of cask prep platform
			= Total	
	08-7	100.00	060-MCO-CPPLAT-ETF	ETF for cask under cask prep platform
			CRCF-MCO-CAN	Number of MCO canisters
			MOD-ENTER-CANISTER	Flooding or spray enters canister
			S-060-CPPLAT-COL	Seismic collapse of cask prep platform
			S-060-PIPING-FAIL	Seismic failure of piping in accident area
			= Total	
	09-2	100.00	060-MCO-CTT-BUMP-ETF	ETF for CTT with TC subject to bumping EAF
			CRCF-MCO-CAN	Number of MCO canisters
			S-060-CTT-BUMPING	Seismic bumping of CTT into EAF
			SHIELDING	WP remains within WPTT shielding
			= Total	
	09-3	0.00	<FALSE>	System Generated Success Event
			= Total	
	09-4	0.00	<FALSE>	System Generated Success Event
			= Total	
	09-5	0.00	<FALSE>	System Generated Success Event
			= Total	
	09-6	99.11	060-MCO-CTTSLIDE-ETF	ETF for CTT containing TC in transfer cell
			CRCF-MCO-CAN	Number of MCO canisters
			S-060-CTT-SLIDE	Seismic sliding of CTT into wall

Table C4.4-2. Cut Set Level Results by Sequence (Continued)

Event Tree	Sequence	Cut Set %	Basic Event	Description
		0.89	060-MCO-CTT-ROCK-ETF	ETF for CTT with TC subject to rocking
			CRCF-MCO-CAN	Number of MCO canisters
			S-060-CTT-ROCKING	Seismic rocking of CTT with restraint failure
		0.00	060-MCO-CTT-BUMP-ETF	ETF for CTT with TC subject to bumping EAF
			060-MCO-CTT-BUMP-PFA	Breach given CTT with TC subject to bumping EAF
			CRCF-MCO-CAN	Number of MCO canisters
			S-060-CTT-BUMPING	Seismic bumping of CTT into EAF
			= Total	
	09-7	99.11	060-MCO-CTTSLIDE-ETF	ETF for CTT containing TC in transfer cell
			CRCF-MCO-CAN	Number of MCO canisters
			MOD-ENTER-CANISTER	Flooding or spray enters canister
			S-060-CTT-SLIDE	Seismic sliding of CTT into wall
			S-060-PIPING-FAIL	Seismic failure of piping in accident area
		0.89	060-MCO-CTT-ROCK-ETF	ETF for CTT with TC subject to rocking
			CRCF-MCO-CAN	Number of MCO canisters
			MOD-ENTER-CANISTER	Flooding or spray enters canister
			S-060-CTT-ROCKING	Seismic rocking of CTT with restraint failure
			S-060-PIPING-FAIL	Seismic failure of piping in accident area
		0.00	060-MCO-CTT-BUMP-ETF	ETF for CTT with TC subject to bumping EAF
			060-MCO-CTT-BUMP-PFA	Breach given CTT with TC subject to bumping EAF
			CRCF-MCO-CAN	Number of MCO canisters
			MOD-ENTER-CANISTER	Flooding or spray enters canister
			S-060-CTT-BUMPING	Seismic bumping of CTT into EAF
			S-060-PIPING-FAIL	Seismic failure of piping in accident area
			= Total	
	10-2			
	10-3	0.00	<FALSE>	System Generated Success Event
			= Total	
	10-4	0.00	<FALSE>	System Generated Success Event
			= Total	
	10-5	0.00	<FALSE>	System Generated Success Event
			= Total	

Table C4.4-2. Cut Set Level Results by Sequence (Continued)

Event Tree	Sequence	Cut Set %	Basic Event	Description
	10-6	100.00	060-MCO-SHIELDDR-ETF	ETF for shield doors when canister is nearby
			CRCF-MCO-CAN	Number of MCO canisters
			S-060-SHIELDDOOR	Seismic falling of shield door
			= Total	
	10-7	100.00	060-MCO-SHIELDDR-ETF	ETF for shield doors when canister is nearby
			CRCF-MCO-CAN	Number of MCO canisters
			MOD-ENTER-CANISTER	Flooding or spray enters canister
			S-060-PIPING-FAIL	Seismic failure of piping in accident area
			S-060-SHIELDDOOR	Seismic falling of shield door
			= Total	
	11-2	94.48	060-MCO-CTMSWGIB-ETF	ETF for CTM hoisting canister inside bell
			CRCF-MCO-CAN	Number of MCO canisters
			S-060-CTMSWG-IB	Significant swinging of canister inside CTM bell
			SHIELDING	WP remains within WPTT shielding
		5.52	060-MCO-CTMHOIST-ETF	ETF for CTM hoisting canister - drop
			CRCF-MCO-CAN	Number of MCO canisters
			S-060-CTM-HOIST	Seismic drop of canister hoisted by CTM
			SHIELDING	WP remains within WPTT shielding
			= Total	
	11-3	0.00	<FALSE>	System Generated Success Event
			= Total	
	11-4	0.00	<FALSE>	System Generated Success Event
			= Total	
	11-5	97.60	060-MCO-CTMSWGOB-ETF	ETF for CTM hoisting canister outside bell
			CRCF-MCO-CAN	Number of MCO canisters
			S-060-CTMSWG-OB	Significant swinging of canister outside CTM bell
		1.27	060-MCO-CTM-OBJ-ETF	ETF for CTM with heavy object over TC
			CRCF-MCO-CAN	Number of MCO canisters
			S-060-CTM-OBJDROP	Seismic drop of heavy object by CTM
		0.91	060-MCO-CTM-COL-ETF	ETF for CTM over canister - collapse
			CRCF-MCO-CAN	Number of MCO canisters

Table C4.4-2. Cut Set Level Results by Sequence (Continued)

Event Tree	Sequence	Cut Set %	Basic Event	Description
			S-060-CTM-COLLAPSE	Seismic collapse of CTM (trolley seismic restraints)
		0.21	060-MCO-CTMHOIST-ETF	ETF for CTM hoisting canister - drop
			060-MCO-CTMHOIST-PFA	Breach of canister dropped by CTM
			CRCF-MCO-CAN	Number of MCO canisters
			S-060-CTM-HOIST	Seismic drop of canister hoisted by CTM
		0.00	060-MCO-CTMSWGIB-ETF	ETF for CTM hoisting canister inside bell
			060-MCO-CTMSWGIB-PFA	Breach of canister due to swing inside bell
			CRCF-MCO-CAN	Number of MCO canisters
			S-060-CTMSWG-IB	Significant swinging of canister inside CTM bell
			= Total	
	11-6	97.60	060-MCO-CTMSWGOB-ETF	ETF for CTM hoisting canister outside bell
			CRCF-MCO-CAN	Number of MCO canisters
			MOD-ENTER-CANISTER	Flooding or spray enters canister
			S-060-CTMSWG-OB	Significant swinging of canister outside CTM bell
			S-060-PIPING-FAIL	Seismic failure of piping in accident area
		1.27	060-MCO-CTM-OBJ-ETF	ETF for CTM with heavy object over TC
			CRCF-MCO-CAN	Number of MCO canisters
			MOD-ENTER-CANISTER	Flooding or spray enters canister
			S-060-CTM-OBJDROP	Seismic drop of heavy object by CTM
			S-060-PIPING-FAIL	Seismic failure of piping in accident area
		0.91	060-MCO-CTM-COL-ETF	ETF for CTM over canister - collapse
			CRCF-MCO-CAN	Number of MCO canisters
			MOD-ENTER-CANISTER	Flooding or spray enters canister
			S-060-CTM-COLLAPSE	Seismic collapse of CTM (trolley seismic restraints)
			S-060-PIPING-FAIL	Seismic failure of piping in accident area
		0.21	060-MCO-CTMHOIST-ETF	ETF for CTM hoisting canister - drop
			060-MCO-CTMHOIST-PFA	Breach of canister dropped by CTM
			CRCF-MCO-CAN	Number of MCO canisters
			MOD-ENTER-CANISTER	Flooding or spray enters canister
			S-060-CTM-HOIST	Seismic drop of canister hoisted by CTM

Table C4.4-2. Cut Set Level Results by Sequence (Continued)

Event Tree	Sequence	Cut Set %	Basic Event	Description
			S-060-PIPING-FAIL	Seismic failure of piping in accident area
		0.00	060-MCO-CTMSWGIB-ETF	ETF for CTM hoisting canister inside bell
			060-MCO-CTMSWGIB-PFA	Breach of canister due to swing inside bell
			CRCF-MCO-CAN	Number of MCO canisters
			MOD-ENTER-CANISTER	Flooding or spray enters canister
			S-060-CTMSWG-IB	Significant swinging of canister inside CTM bell
			S-060-PIPING-FAIL	Seismic failure of piping in accident area
			= Total	
	12-2	100.00	060-MCO-RHS-FLID-ETF	ETF for lid fastened during MCO RHS operations
			CRCF-MCO-CAN	Number of MCO canisters
			S-060-RHS-COLLAPSE	Seismic collapse of RHS
			SHIELDING	WP remains within WPTT shielding
			= Total	
	12-3	0.00	<FALSE>	System Generated Success Event
			= Total	
	12-4	0.00	<FALSE>	System Generated Success Event
			= Total	
	12-5	0.00	<FALSE>	System Generated Success Event
			= Total	
	12-6	99.77	060-MCO-RHS-OBJ-ETF	ETF for RHS with heavy object over canister
			CRCF-MCO-CAN	Number of MCO canisters
			S-060-RHS-OBJDROP	Seismic drop of heavy object by RHS
		0.23	060-MCO-RHS-UFLID-ETF	ETF for lid unfastened during MCO RHS operations
			CRCF-MCO-CAN	Number of MCO canisters
			S-060-RHS-COLLAPSE	Seismic collapse of RHS
		0.00	060-MCO-RHS-FLID-ETF	ETF for lid fastened during MCO RHS operations
			060-MCO-RHS-FLID-PFA	Breach when lid fastened during MCO RHS operations
			CRCF-MCO-CAN	Number of MCO canisters
			S-060-RHS-COLLAPSE	Seismic collapse of RHS
			= Total	
	12-7	99.77	060-MCO-RHS-OBJ-ETF	ETF for RHS with heavy object over canister
			CRCF-MCO-CAN	Number of MCO canisters

Table C4.4-2. Cut Set Level Results by Sequence (Continued)

Event Tree	Sequence	Cut Set %	Basic Event	Description
			MOD-ENTER-CANISTER	Flooding or spray enters canister
			S-060-PIPING-FAIL	Seismic failure of piping in accident area
			S-060-RHS-OBJDROP	Seismic drop of heavy object by RHS
		0.23	060-MCO-RHS-UFLID-ETF	ETF for lid unfastened during MCO RHS operations
			CRCF-MCO-CAN	Number of MCO canisters
			MOD-ENTER-CANISTER	Flooding or spray enters canister
			S-060-PIPING-FAIL	Seismic failure of piping in accident area
			S-060-RHS-COLLAPSE	Seismic collapse of RHS
		0.00	060-MCO-RHS-FLID-ETF	ETF for lid fastened during MCO RHS operations
			060-MCO-RHS-FLID-PFA	Breach when lid fastened during MCO RHS operations
			CRCF-MCO-CAN	Number of MCO canisters
			MOD-ENTER-CANISTER	Flooding or spray enters canister
			S-060-PIPING-FAIL	Seismic failure of piping in accident area
			S-060-RHS-COLLAPSE	Seismic collapse of RHS
			= Total	
	13-2	100.00	060-MCO-WPTT-ROCK-ETF	ETF for WPTT in constrained position
			CRCF-MCO-CAN	Number of MCO canisters
			S-060-WPTT-ROCK	Seismic rocking of WPTT (constrained)
			SHIELDING	WP remains within WPTT shielding
			= Total	
	13-3	0.00	<FALSE>	System Generated Success Event
			= Total	
	13-4	0.00	<FALSE>	System Generated Success Event
			= Total	
	13-5	0.00	<FALSE>	System Generated Success Event
			= Total	
	13-6	93.50	060-MCO-WPTT-TIP-ETF	ETF for WPTT not constrained
			CRCF-MCO-CAN	Number of MCO canisters
			S-060-WPTT-TIPOVER	Seismic tipover of WPTT
		6.50	060-MCO-WPTT-ROCK-ETF	ETF for WPTT in constrained position
			060-MCO-WPTT-ROCK-PFA	Breach of canister when WPTT rocks
			CRCF-MCO-CAN	Number of MCO canisters
			S-060-WPTT-ROCK	Seismic rocking of WPTT (constrained)
			= Total	

Table C4.4-2. Cut Set Level Results by Sequence (Continued)

Event Tree	Sequence	Cut Set %	Basic Event	Description
	13-7	93.49	060-MCO-WPTT-TIP-ETF	ETF for WPTT not constrained
			CRCF-MCO-CAN	Number of MCO canisters
			MOD-ENTER-CANISTER	Flooding or spray enters canister
			S-060-PIPING-FAIL	Seismic failure of piping in accident area
			S-060-WPTT-TIPOVER	Seismic tipover of WPTT
		6.50	060-MCO-WPTT-ROCK-ETF	ETF for WPTT in constrained position
			060-MCO-WPTT-ROCK-PFA	Breach of canister when WPTT rocks
			CRCF-MCO-CAN	Number of MCO canisters
			MOD-ENTER-CANISTER	Flooding or spray enters canister
			S-060-PIPING-FAIL	Seismic failure of piping in accident area
			S-060-WPTT-ROCK	Seismic rocking of WPTT (constrained)
			= Total	
	14-2	100.00	060-MCO-WPHC-OBJ-ETF	ETF for WPHC with heavy object over WP
			CRCF-MCO-CAN	Number of MCO canisters
			S-060-WPHC-OBJDROP	Seismic drop of heavy object by WPHC
			SHIELDING	WP remains within WPTT shielding
			= Total	
	14-3	0.00	<FALSE>	System Generated Success Event
			= Total	
	14-4	0.00	<FALSE>	System Generated Success Event
			= Total	
	14-5	0.00	<FALSE>	System Generated Success Event
			= Total	
	14-6	99.61	060-MCO-WPHC-COL-ETF	ETF for WPHC over WP - Collapse
			CRCF-MCO-CAN	Number of MCO canisters
			S-060-WPHC-COLLAPSE	Seismic collapse of WPHC over WP
		0.39	060-MCO-WPHC-OBJ-ETF	ETF for WPHC with heavy object over WP
			060-MCO-WPHC-OBJ-PFA	Breach of WP due to WPHC object drop
			CRCF-MCO-CAN	Number of MCO canisters
			S-060-WPHC-OBJDROP	Seismic drop of heavy object by WPHC
			= Total	
	14-7	99.61	060-MCO-WPHC-COL-ETF	ETF for WPHC over WP - collapse
			CRCF-MCO-CAN	Number of MCO canisters

Table C4.4-2. Cut Set Level Results by Sequence (Continued)

Event Tree	Sequence	Cut Set %	Basic Event	Description
			MOD-ENTER-CANISTER	Flooding or spray enters canister
			S-060-PIPING-FAIL	Seismic failure of piping in accident area
			S-060-WPHC-COLLAPSE	Seismic collapse of WPHC over WP
		0.39	060-MCO-WPHC-OBJ-ETF	ETF for WPHC with heavy object over WP
			060-MCO-WPHC-OBJ-PFA	Breach of WP due to WPHC object drop
			CRCF-MCO-CAN	Number of MCO canisters
			MOD-ENTER-CANISTER	Flooding or spray enters canister
			S-060-PIPING-FAIL	Seismic failure of piping in accident area
			S-060-WPHC-OBJDROP	Seismic drop of heavy object by WPHC
			= Total	
	15-2	100.00	060-MCO-TEVEJECT-ETF	ETF for TEV containing WP
			CRCF-MCO-CAN	Number of MCO canisters
			S-060-TEV-EJECT-WP	Seismic ejection of WP from TEV
		0.00	060-MCO-TEV-TIP-ETF	ETF for TEV containing WP
			CRCF-MCO-CAN	Number of MCO canisters
			S-060-TEV-TIPOVER	Seismic tipover of TEV
			= Total	
	15-4	0.00	<FALSE>	System Generated Success Event
			= Total	
	15-5	0.00	<FALSE>	System Generated Success Event
			= Total	
	15-6	0.00	<FALSE>	System Generated Success Event
			= Total	
	15-7	79.66	060-MCO-TEVSLIDE-ETF	ETF for TEV during WP transfer
			CRCF-MCO-CAN	Number of MCO canisters
			S-060-TEV-SLIDE	Seismic sliding of TEV during WP transfer
		20.34	060-MCO-TEVEJECT-ETF	ETF for TEV containing WP
			060-MCO-TEVEJECT-PFA	Breach of WP due to ejection from TEV
			CRCF-MCO-CAN	Number of MCO canisters
			S-060-TEV-EJECT-WP	Seismic ejection of WP from TEV
		0.00	060-MCO-TEV-TIP-ETF	ETF for TEV containing WP
			060-MCO-TEV-TIP-PFA	Breach of WP due to TEV tipover
			CRCF-MCO-CAN	Number of MCO canisters
			S-060-TEV-TIPOVER	Seismic tipover of TEV
			= Total	

Table C4.4-2. Cut Set Level Results by Sequence (Continued)

Event Tree	Sequence	Cut Set %	Basic Event	Description
	15-8	79.66	060-MCO-TEVSLIDE-ETF	ETF for TEV during WP transfer
			CRCF-MCO-CAN	Number of MCO canisters
			MOD-ENTER-CANISTER	Flooding or spray enters canister
			S-060-PIPING-FAIL	Seismic failure of piping in accident area
			S-060-TEV-SLIDE	Seismic sliding of TEV during WP transfer
		20.34	060-MCO-TEVEJECT-ETF	ETF for TEV containing WP
			060-MCO-TEVEJECT-PFA	Breach of WP due to ejection from TEV
			CRCF-MCO-CAN	Number of MCO canisters
			MOD-ENTER-CANISTER	Flooding or spray enters canister
			S-060-PIPING-FAIL	Seismic failure of piping in accident area
			S-060-TEV-EJECT-WP	Seismic ejection of WP from TEV
		0.00	060-MCO-TEV-TIP-ETF	ETF for TEV containing WP
			060-MCO-TEV-TIP-PFA	Breach of WP due to TEV tipover
			CRCF-MCO-CAN	Number of MCO canisters
			MOD-ENTER-CANISTER	Flooding or spray enters canister
			S-060-PIPING-FAIL	Seismic failure of piping in accident area
			S-060-TEV-TIPOVER	Seismic tipover of TEV
			= Total	
CRCF-S-IE-MCO	03	100.00	060-MCO-STRUCTUR-ETF	ETF for DOE SNF canister in CRCF structure
			CRCF-MCO-CAN	Number of MCO canisters
			S-060-STR-COLLAPSE	Seismic collapse of CRCF structure
			= Total	

NOTE: CHC = cask handling crane; CRCF = Canister Receipt and Closure Facility; CTM = canister transfer machine; CTT = cask transfer trolley; DOE = Department of Energy; EAF = energy absorbing feature; ETF = exposure time factor; MCO = multicanister overpack; RHS = remote handling system; SNF = spent nuclear fuel; TC = transportation cask; TEV = transport and emplacement vehicle; WP = waste package; WPHC = waste package handling crane; WPTT = waste package transfer trolley.

Source: Original

ATTACHMENT D WET HANDLING FACILITY ANALYSES

This attachment contains detailed information for the WHF seismic event sequence analysis:

- IET and SRETs
- Event tree to fault tree assignment tables
- Fault trees
- Non-seismic basic event tables
- Seismic basic event tables
- Event sequence probability tables
- Event sequence cut set tables.

The WHF analysis covers processing of DPCs and bare spent fuel, and includes the following:

- 1 Processing of DPCs from railcar with transportation cask entering the WHF to opened DPC in STC in WHF pool
- 2 Processing of transportation casks with bare SNF assemblies on truck entering the WHF to opened transportation cask with bare SNF in WHF pool
- 3 Processing of SNF assemblies from DPC in STC, or transportation cask with bare SNF assemblies, in pool to spent fuel rack, and transferred back to open TAD in STC in WHF pool
- 4 Processing of open TAD with SNF assemblies in STC in WHF pool to aging overpack in site transporter leaving the WHF.

In addition, the loss of WHF HVAC system integrity, resulting in a radiological release, is included in the assessment as part of process 3 above.

Note that there are other process variations, but these cover all of the equipment and waste forms used in the various processes.

D1 DUAL-PURPOSE CANISTERS

This section provides the detailed information used to develop the event sequences for the analysis of processing of the DPCs inside the WHF. DPCs inside a transportation cask are received on railcars, are transferred into a STC, opened, and then placed in the pool.

D1.1 EVENT TREES

The IET and SRETs are presented in this section. The tables provide the assignments between the event tree branches and the fault trees given in the next section.

Seismic Event	Number of DP canisters processed in WHF	Identify initiating seismic failure			
SEIS-EVENT	WHF-DPC-CAN	SEIS-FAIL		#	END-STATE
				1	OK
				2	OK
		WHF building collapse		3	RR-UNF
		Entry door seismic collapse		4	T => 2 WHF-S-R-TC1
		Railcar accident		5	T => 2 WHF-S-R-TC1
		Mobile platform seismic collapse		6	T => 2 WHF-S-R-TC1
		Entrance Vestibule Crane		7	T => 2 WHF-S-R-TC1
		CHC seismic failures		8	T => 2 WHF-S-R-TC1
		Horizontal cask stand tipover		9	T => 2 WHF-S-R-TC1
		CTT seismic failures		10	T => 2 WHF-S-R-TC1
		Preparation station #1 collapse		11	T => 2 WHF-S-R-TC1
		Jib cranes seismic failures		12	RR-UNF
		Shield door seismic failure		13	T => 3 WHF-S-R-SD1
		CTM seismic failures		14	T => 4 WHF-S-R-CTM
		Cutting station collapse		15	RR-UNF
		DPC transfer station collapse		16	T => 6 WHF-S-R-POOL
		Auxiliary pool crane		17	T => 6 WHF-S-R-POOL
		Spent fuel transfer machine		18	T => 6 WHF-S-R-POOL

WHF-S-IE-DPC - WHF Seismic Event Tree - Initiating seismic failures - DPC 2007/12/19 WHF p. 1

NOTE: Event tree branch captions are associated with the branch line below the caption.

CAN = canister; CHC = cask handling crane; CTM = canister transfer machine; CTT = cask transfer trolley; DP = dual-purpose; DPC = dual-purpose canister; IE = initiating event; RR = radioactive release; SD = shield door; SEIS = seismic; TC = transportation cask; UNF = unfiltered; WHF = Wet Handling Facility.

Source: Original

Figure D1.1-1. WHF Seismic Event Tree WHF-S-IE-DPC – Initiating Seismic Failures – DPC

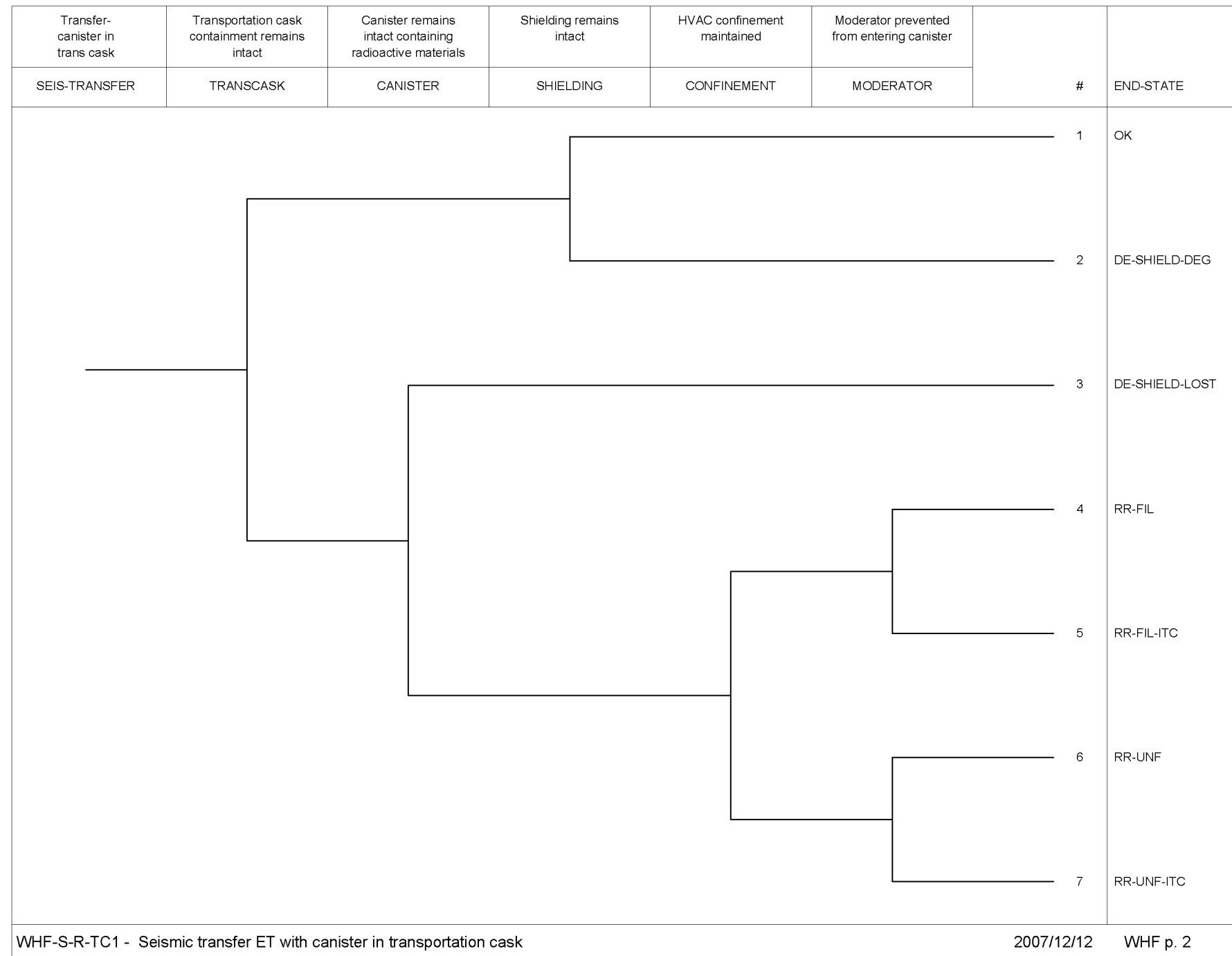

NOTE: DE = direct exposure; DEG = degradation; ET = event tree; FIL = filtered; HVAC = heating, ventilation and air conditioning; ITC = important to criticality; RR = radioactive release; SEIS = seismic; TC = transportation cask; UNF = unfiltered; WHF = Wet Handling Facility.

Source: Original

Figure D1.1-2. WHF Seismic Event Tree WHF-S-R-TC1 – Seismic Transfer ET with Canister in Transportation Cask

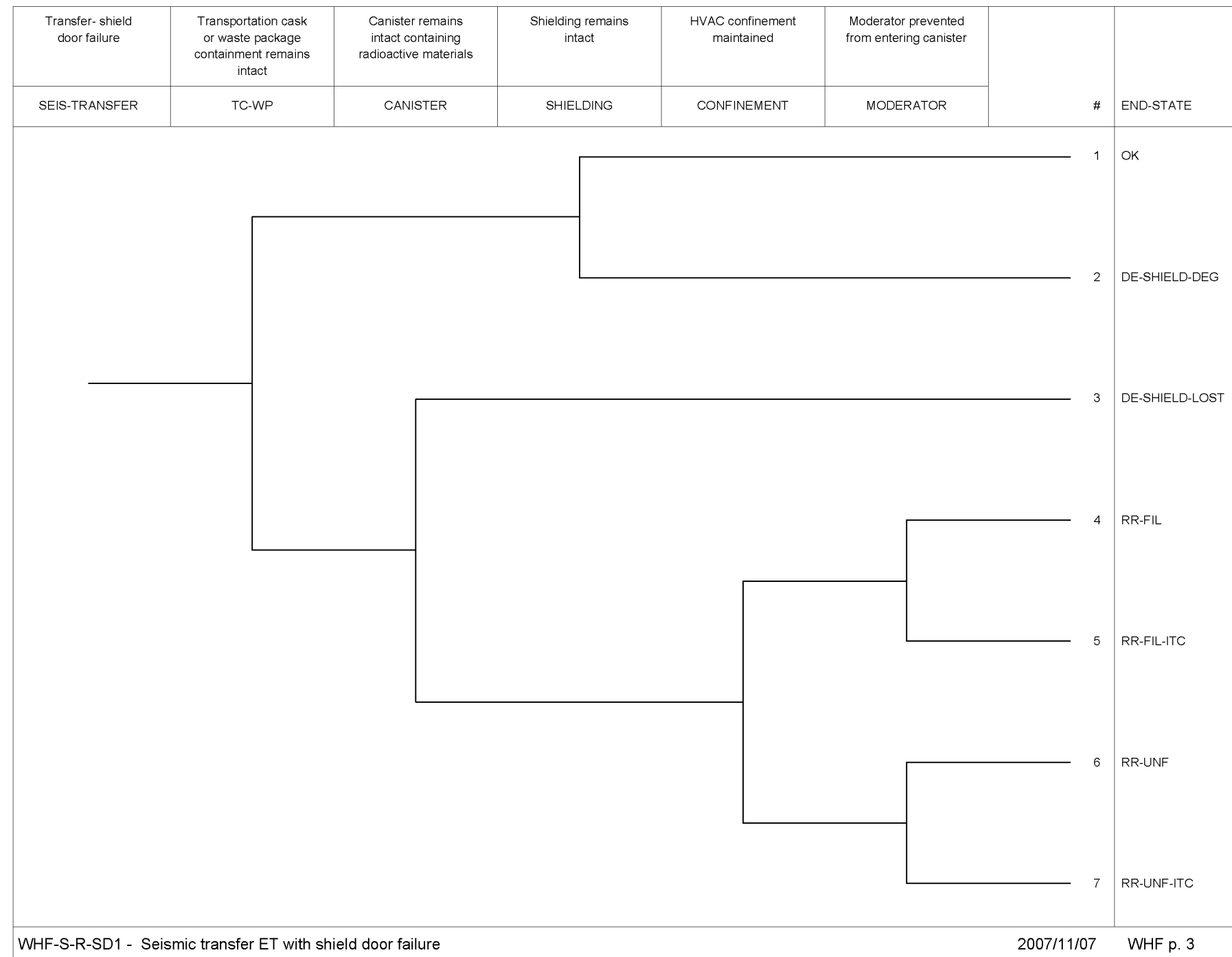

NOTE: DE = direct exposure; ET = event tree; FIL = filtered; INIT = initiating; HVAC = heating, ventilation, and air conditioning; ITC = important to criticality; RR = radioactive release; SD = shield door; SEIS = seismic; TC = transportation cask; WHF = Wet Handling Facility; WP = waste package.

Source: Original

Figure D1.1-3. WHF Seismic Event Tree WHF-S-R-SD1 – Seismic Transfer ET with Shield Door Failure

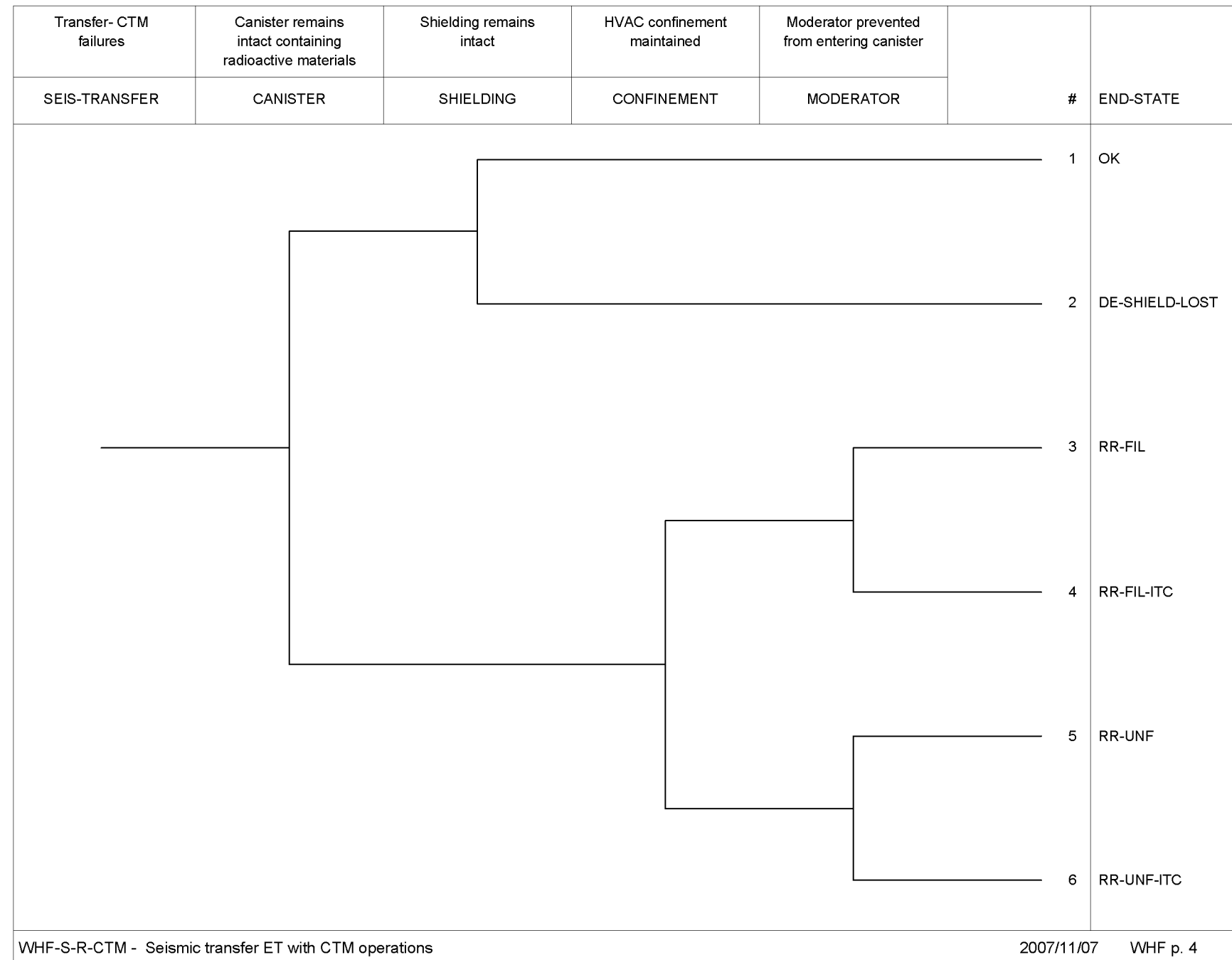

NOTE: CTM = canister transfer machine; DE = direct exposure; ET = event tree; FIL = filtered; HVAC = heating, ventilation and air conditioning; ITC = important to criticality; RR = radioactive release; SEIS = seismic; UNF = unfiltered; WHF = Wet Handling Facility.

Source: Original

Figure D1.1-4. WHF Seismic Event Tree WHF-S-R-CTM – Seismic Transfer ET with CTM Operations

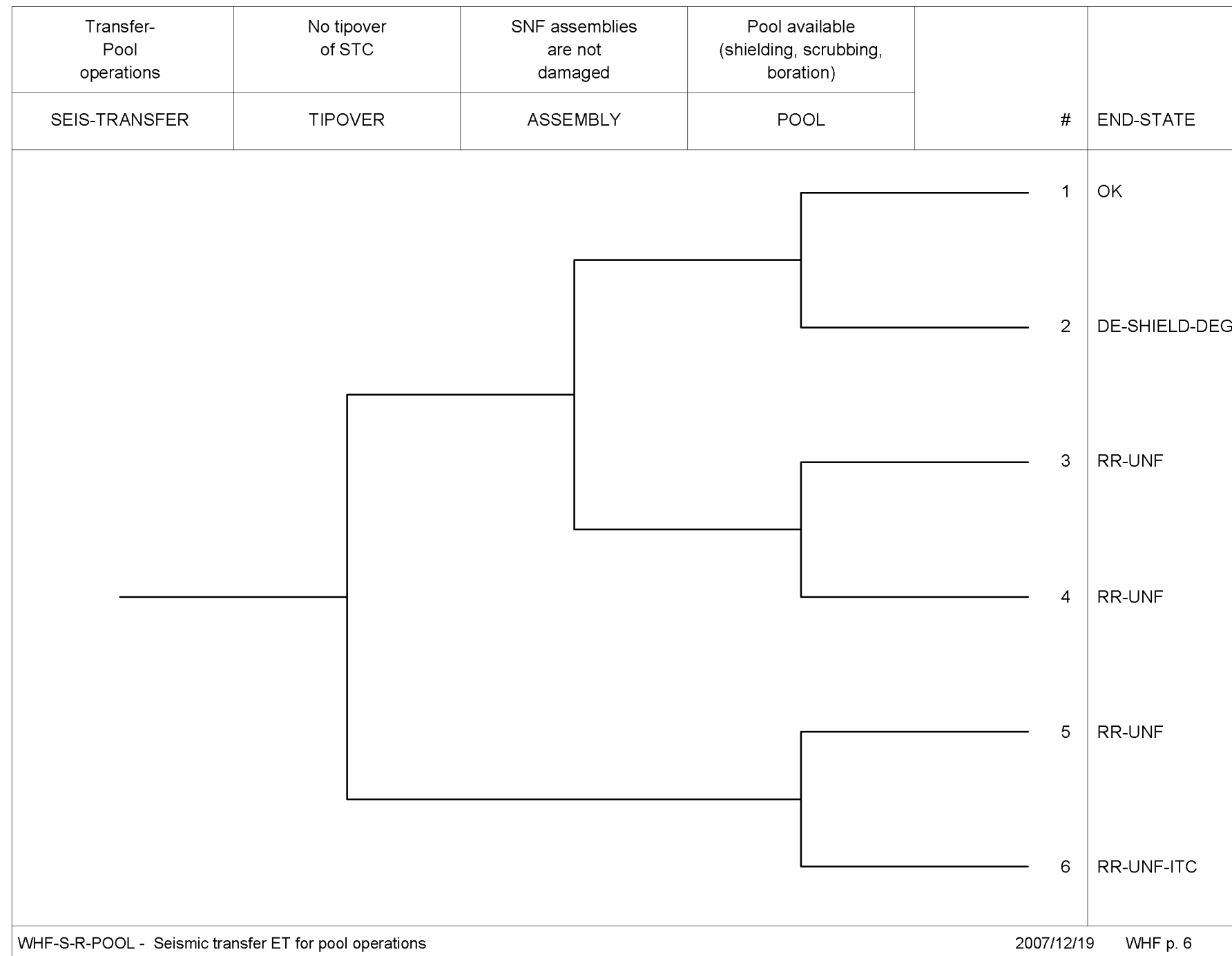

NOTE: DE = direct exposure; DEG = degradation; ET = event tree; FIL = filtered; ITC = important to criticality; RR = radioactive release; SEIS = seismic; SNF = spent nuclear fuel; STC = shielded transfer cask; UNF = unfiltered; WHF = Wet Handling Facility.

Source: Original

Figure D1.1-5. WHF Seismic Event Tree WHF-S-R-POOL – Seismic Transfer ET for Pool Operations

Table D1.1-1. Fault Trees Assigned for Initiating Seismic Failures for the WHF

Process	Initiator Event Tree	Initiating Seismic Failure	Associated Fault Tree
DPC	WHF-S-IE-DPC	WHF building collapse	S-050-DPC-STR-COLLAP
		Entry door collapse	S-050-DPC-ENTDOORCOL
		Railcar accident	S-050-DPC-RAILCARACC
		Mobile platform seismic collapse	S-050-DPC-MOBPLATCOL
		Entrance Vestibule crane	S-050-DPC-EVC-FAIL
		CHC seismic failures	S-050-DPC-CHC-FAIL
		Horizontal cask stand tipover	S-050-DPC-CSTAND-TIP
		CTT seismic failures	S-050-DPC-CTT-FAIL
		Preparation station #1 collapse	S-050-DPC-PS1-COL
		Jib cranes seismic failure	S-050-DPC-JIBC-FAIL
		Shield door seismic failure	S-050-DPC-SHIELDDOOR
		CTM seismic failure	S-050-DPC-CTM-FAIL
		Cutting station collapse	S-050-DPC-CUTS-COL
		DPC transfer station collapse	S-050-DPC-DPCTS-COL
		Auxiliary pool crane	S-050-DPC-APC-FAIL
Spent fuel transfer machine	S-050-DPC-SFTM-FAIL		

NOTE: CHC = cask handling crane; CTM = canister transfer machine; CTT = cask transfer trolley; DPC = dual-purpose canister; IE = initiating event; WHF = Wet Handling Facility.

Source: Original

Table D1.1-2. Fault Trees Assigned for Pivotal Events for WHF-S-IE-DPC Initiating Event Tree

Initiating Seismic Failure	TRANSCASK	MODERATOR
WHF building collapse	N/A	N/A
Entry door collapse	RC-DPC-DOORDROP-CASK	WHF-MOD-MULT-SYS
Railcar accident	RC-DPC-RC-ACC-CASK	WHF-MOD-MULT-SYS
Mobile platform seismic collapse	RC-DPC-MOB-PLAT-CASK	WHF-MOD-MULT-SYS
Entrance Vestibule crane	TC-DPC-EVC-CASK	WHF-MOD-MULT-SYS
CHC seismic failures	TC-DPC-CHC-CASK	WHF-MOD-MULT-SYS
Horizontal cask stand tipover	TC-DPC-CSTAND-CASK	WHF-MOD-MULT-SYS
CTT seismic failures	CTT-DPC-CTT-CASK	WHF-MOD-MULT-SYS
Preparation station #1 collapse	STC-DPC-PS1-CASK	WHF-MOD-MULT-SYS
Jib cranes seismic failure	N/A	N/A
	CANISTER	
Shield door seismic failure	TCWP-DPC-SHIELDDOOR	WHF-MOD-MULT-SYS
CTM seismic failure	CTM-DPC-CTM-CAN	WHF-MOD-FPW-ONLY
Cutting station collapse	N/A	N/A
	TIPOVER	POOL
DPC transfer station collapse	STC-DPC-DPCTS-FAIL	WHF-POOL-FAIL
Auxiliary pool crane	STC-DPC-APC-FAIL	WHF-POOL-FAIL
Spent fuel transfer machine	STC-DPC-SFTM-FAIL	WHF-POOL-FAIL

NOTE: CHC = cask handling crane; CTM = canister transfer machine; CTT = cask transfer trolley; DPC = dual-purpose canister; WHF = Wet Handling Facility.

Source: Original

D1.2 FAULT TREES

Seismic fault trees for the processing of DPCs in the WHF are presented in alpha-numeric order in this section.

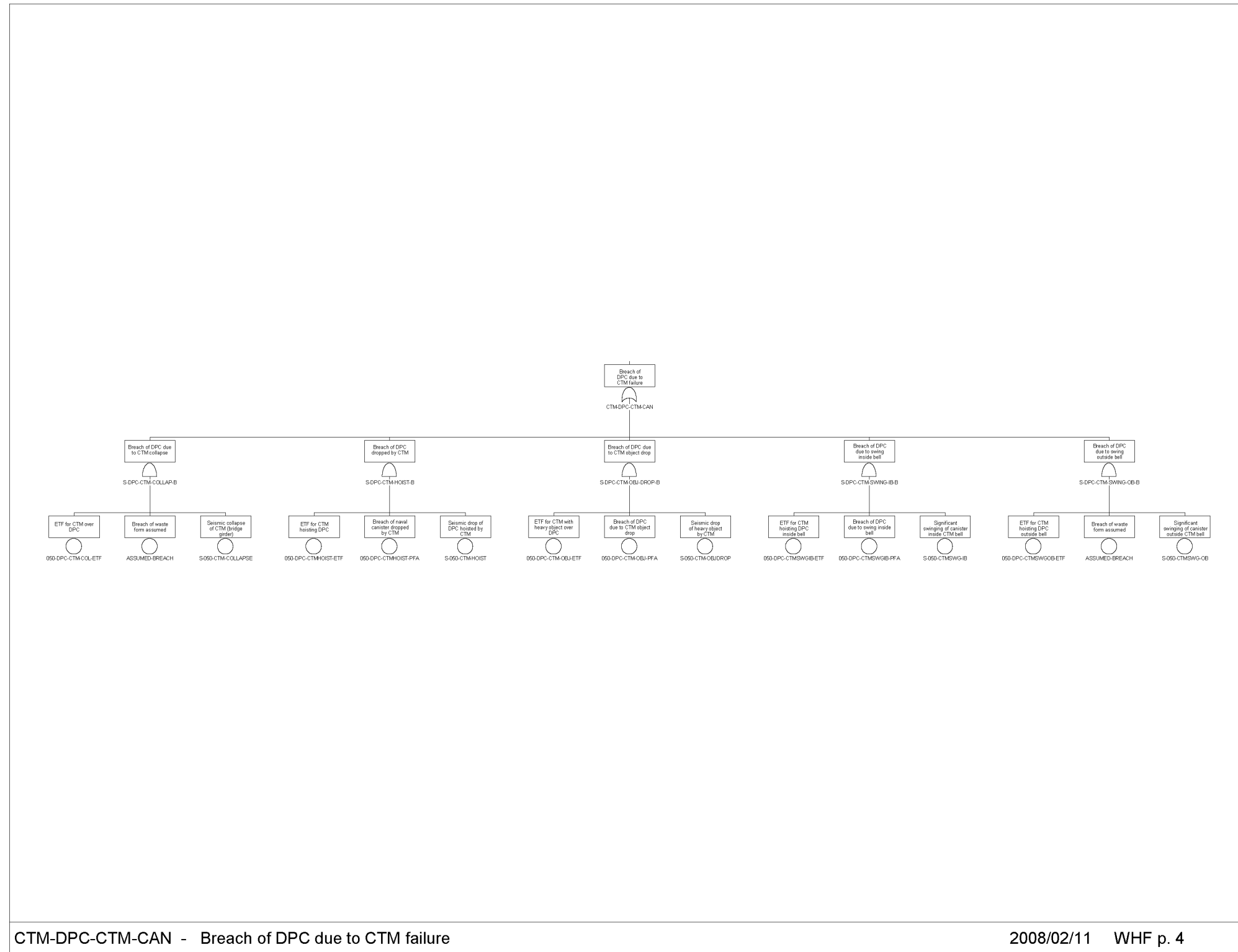

Source: Original

Figure D1.2-1. Fault Tree WHF-DPC-CTM-CAN – Breach of DPC due to CTM Failure

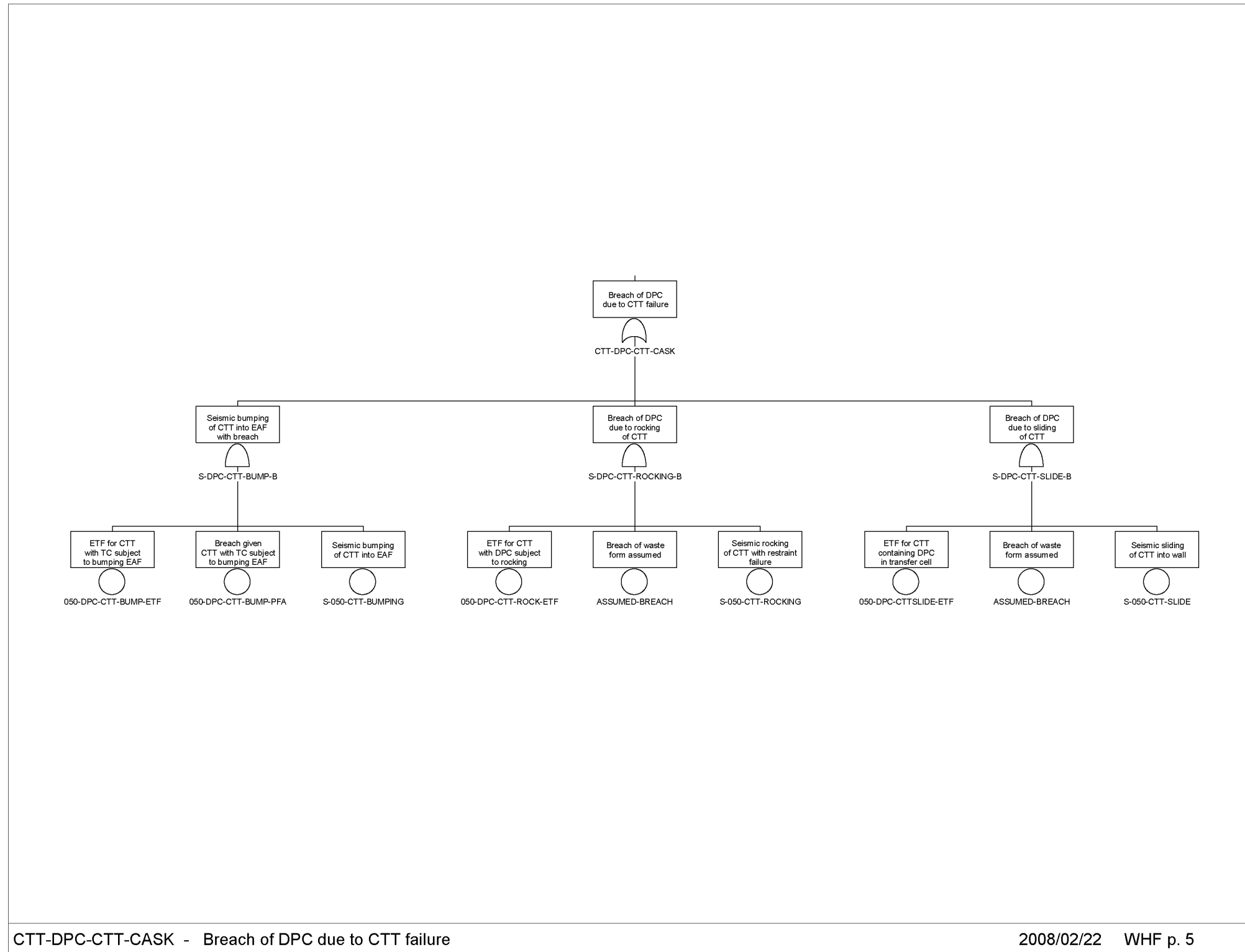

Source: Original

Figure D1.2-2. WHF-DPC-CTT-CASK – Breach of DPC due to CTT Failure

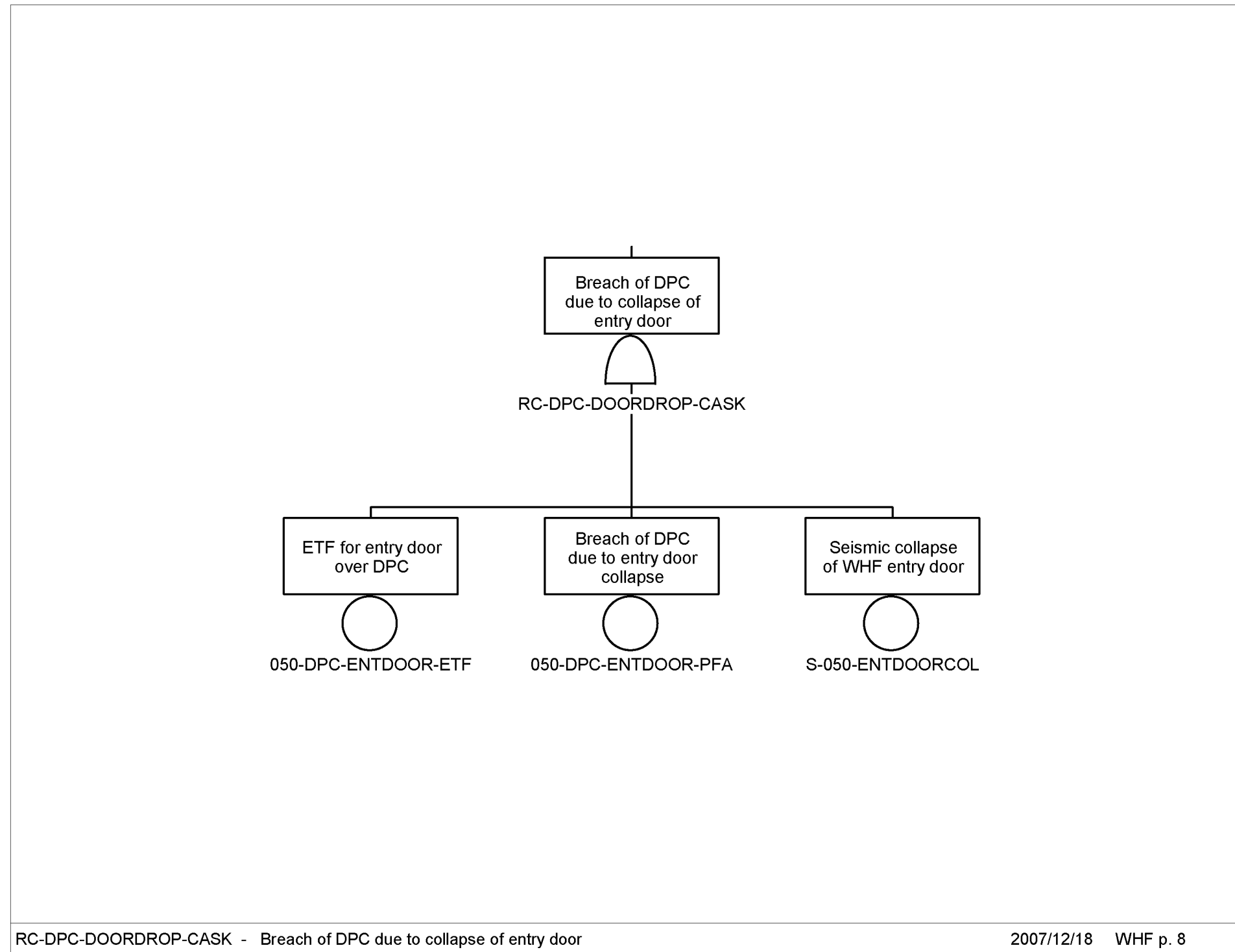

Source: Original

Figure D1.2-3 RC-DPC-DOORDROP-CASK – Breach of DPC due to Collapse of Entry Door

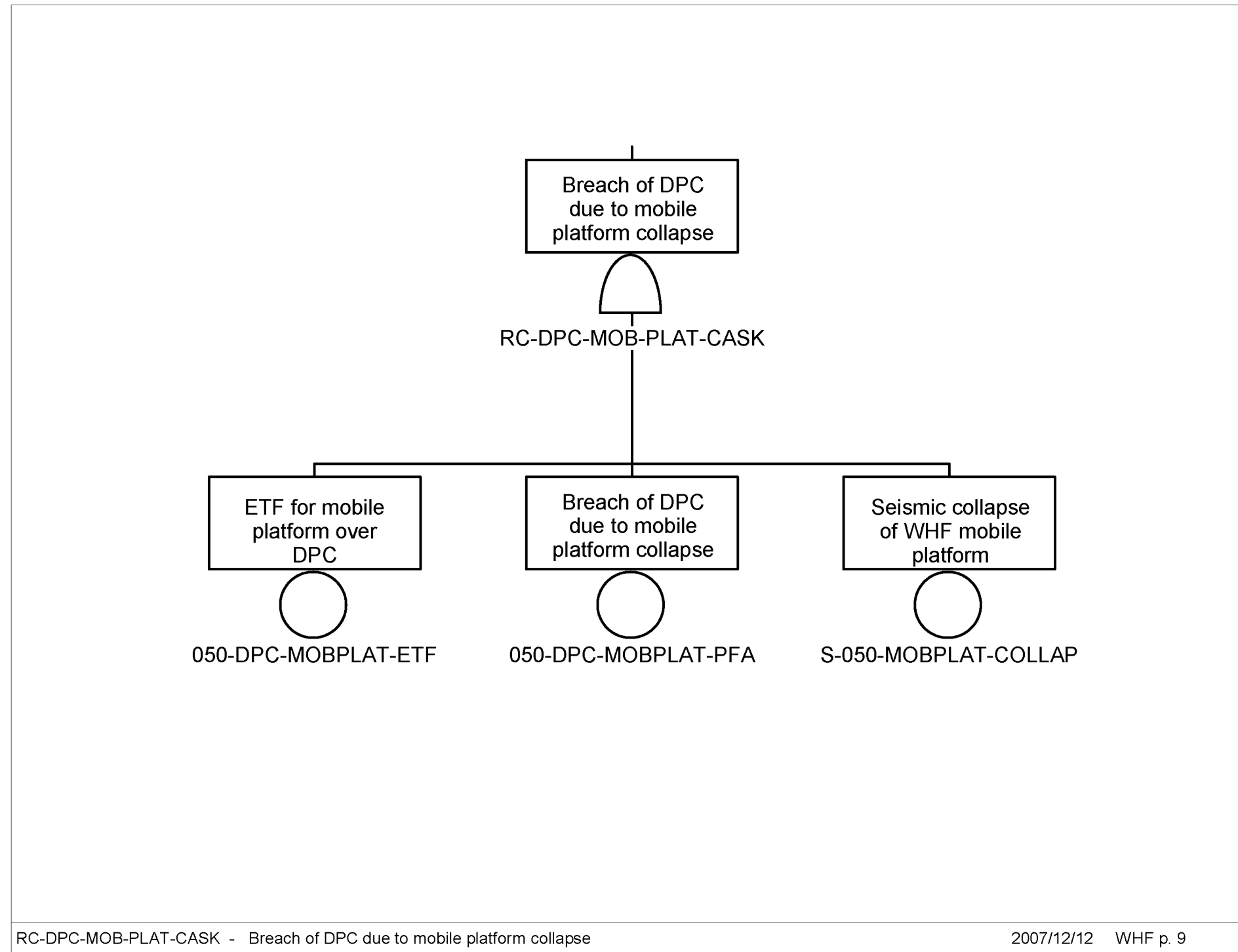

Source: Original

Figure D1.2-4. RC-DPC-MOB-PLAT-CASK – Breach of DPC due to Mobile Platform Collapse

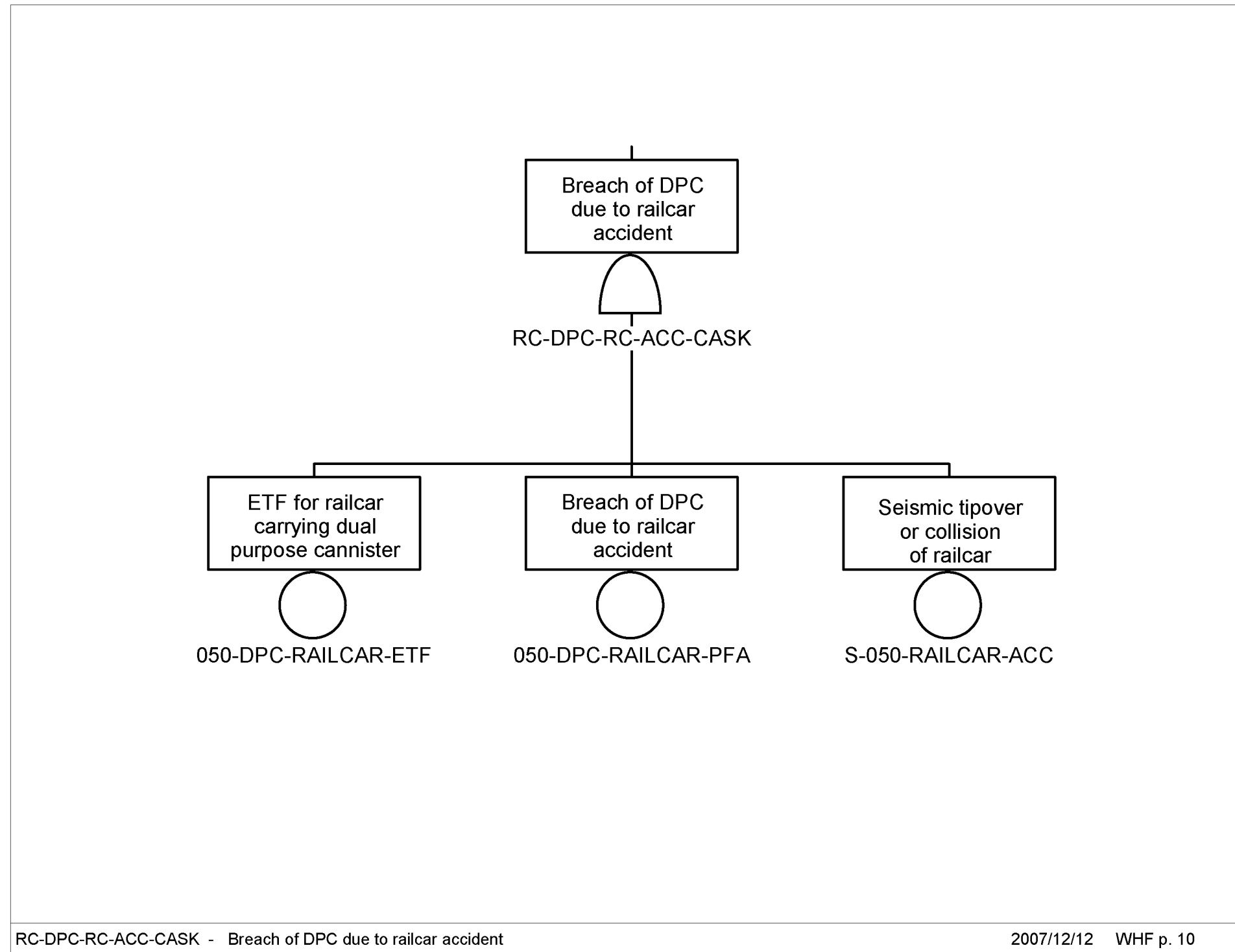

Source: Original

Figure D1.2-5. RC-DPC-RC-ACC-CASK – Breach of DPC due to Railcar Accident

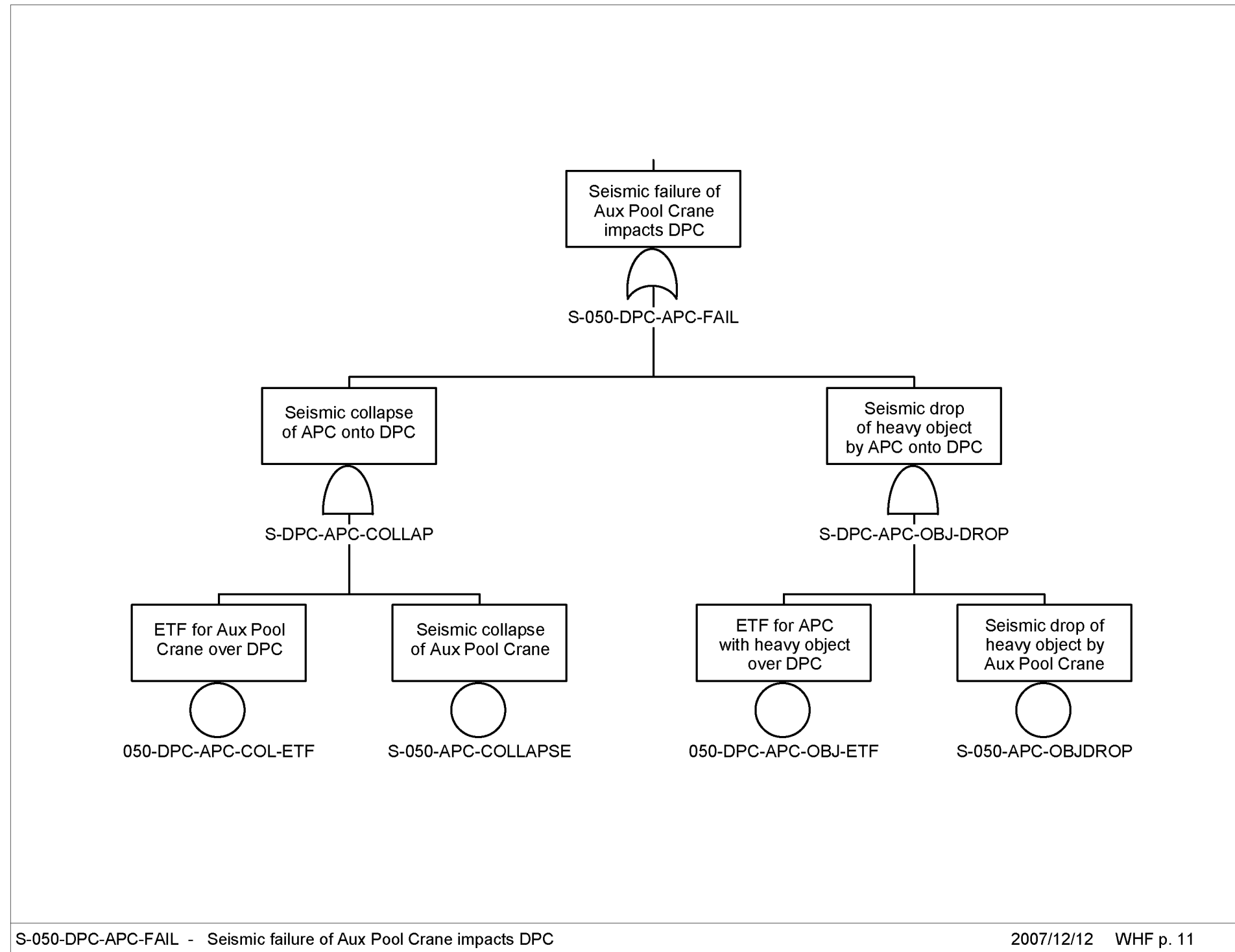

Source: Original

Figure D1.2-6. S-050-DPC-APC-FAIL – Seismic Failure of Aux Pool Crane Impacts DPC

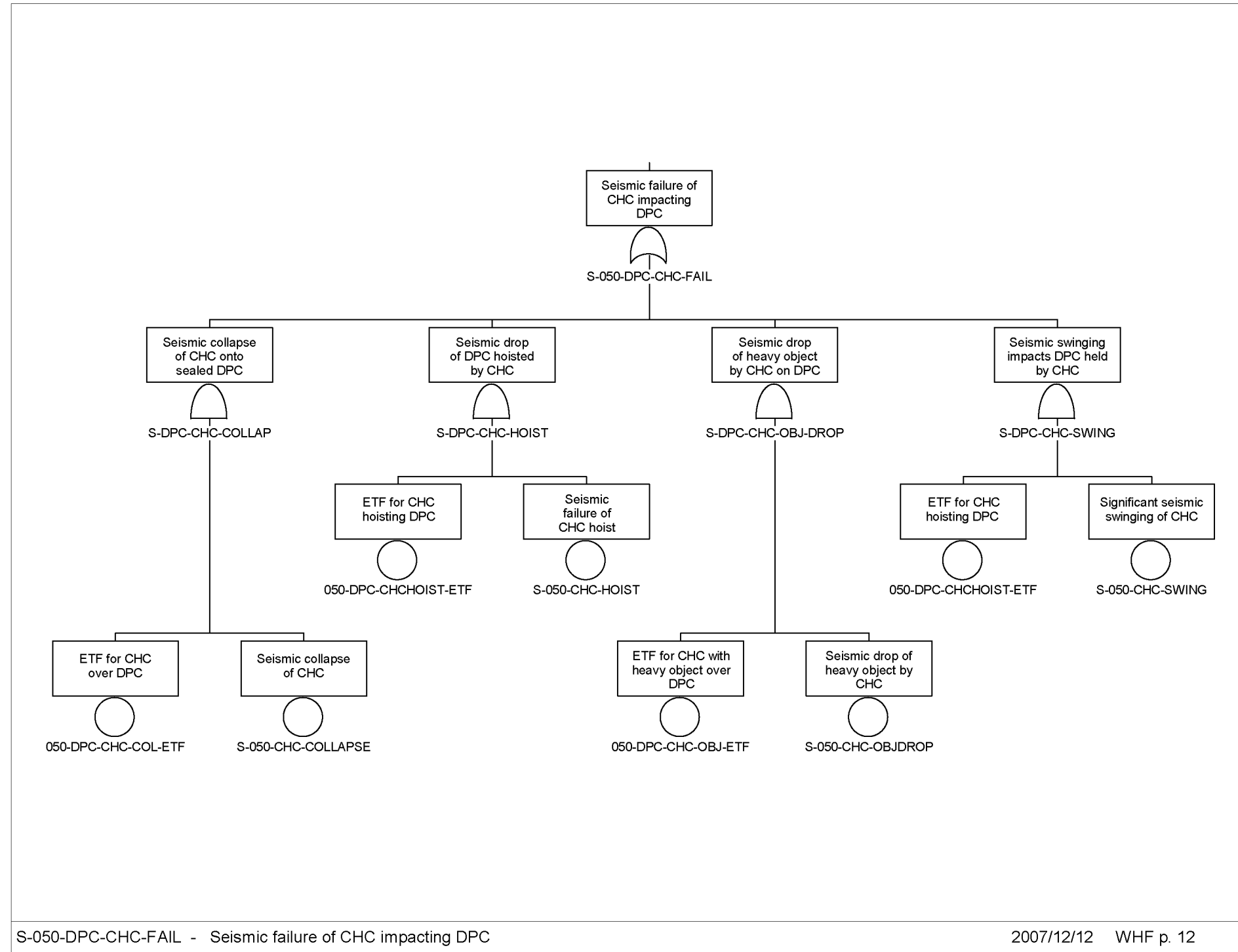

Source: Original

Figure D1.2-7. S-050-DPC-CHC-FAIL – Seismic Failure of CHC Impacting DPC

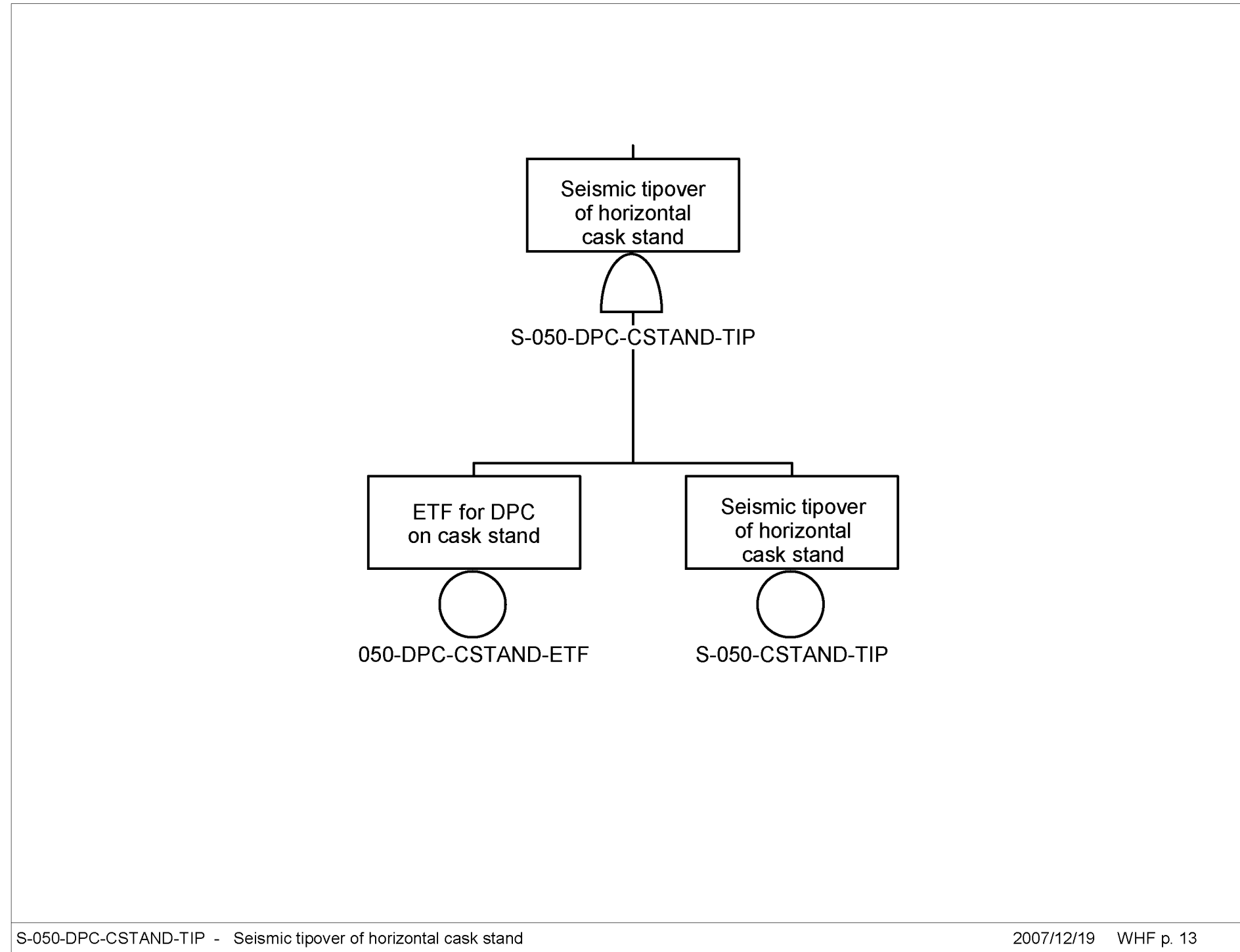

Source: Original

Figure D1.2-8. S-050-DPC-CSTAND-TIP – Seismic Tipover of Horizontal Cask Stand

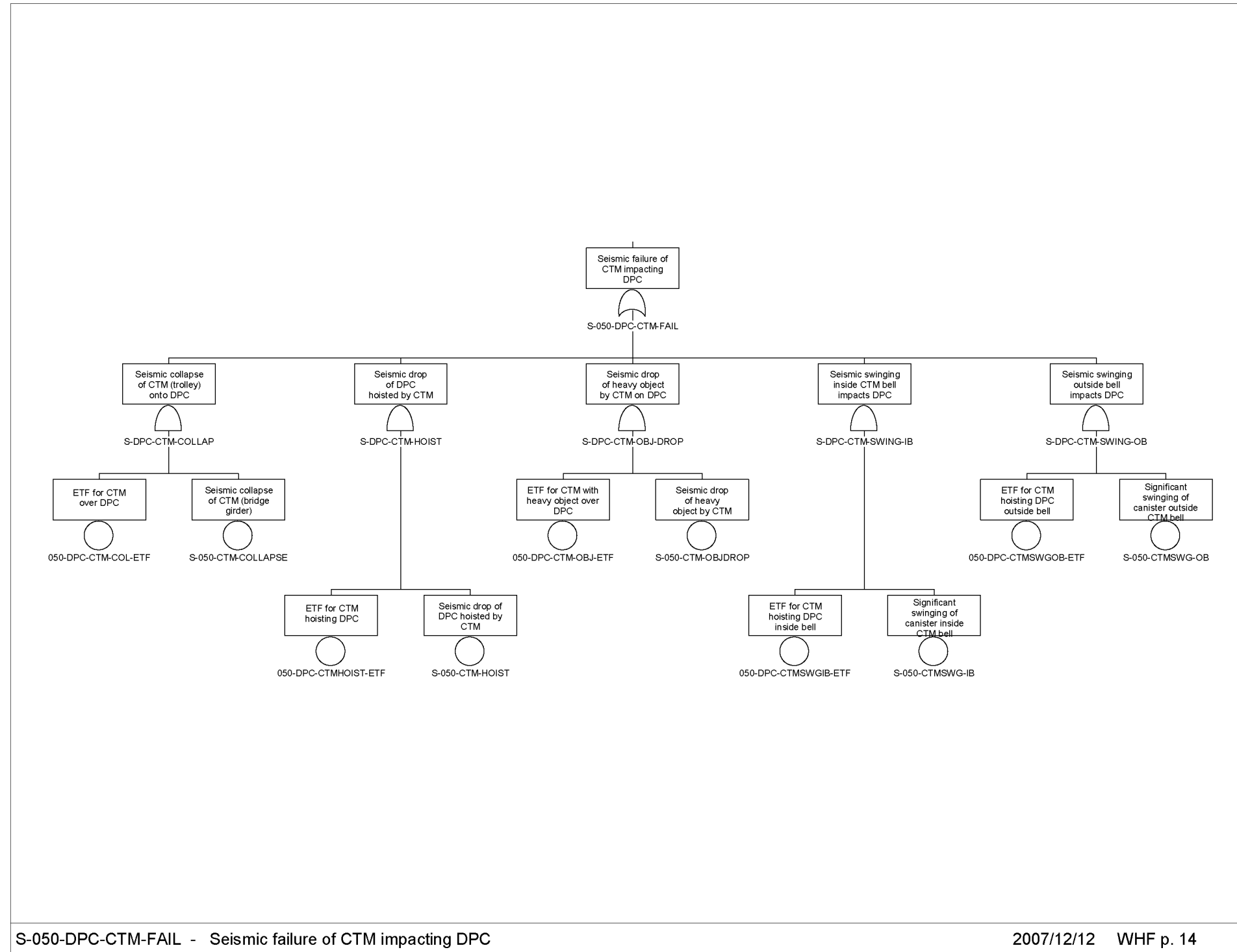

Source: Original

Figure D1.2-9. S-050-DPC-CTM-FAIL – Seismic Failure of CTM Impacting DPC

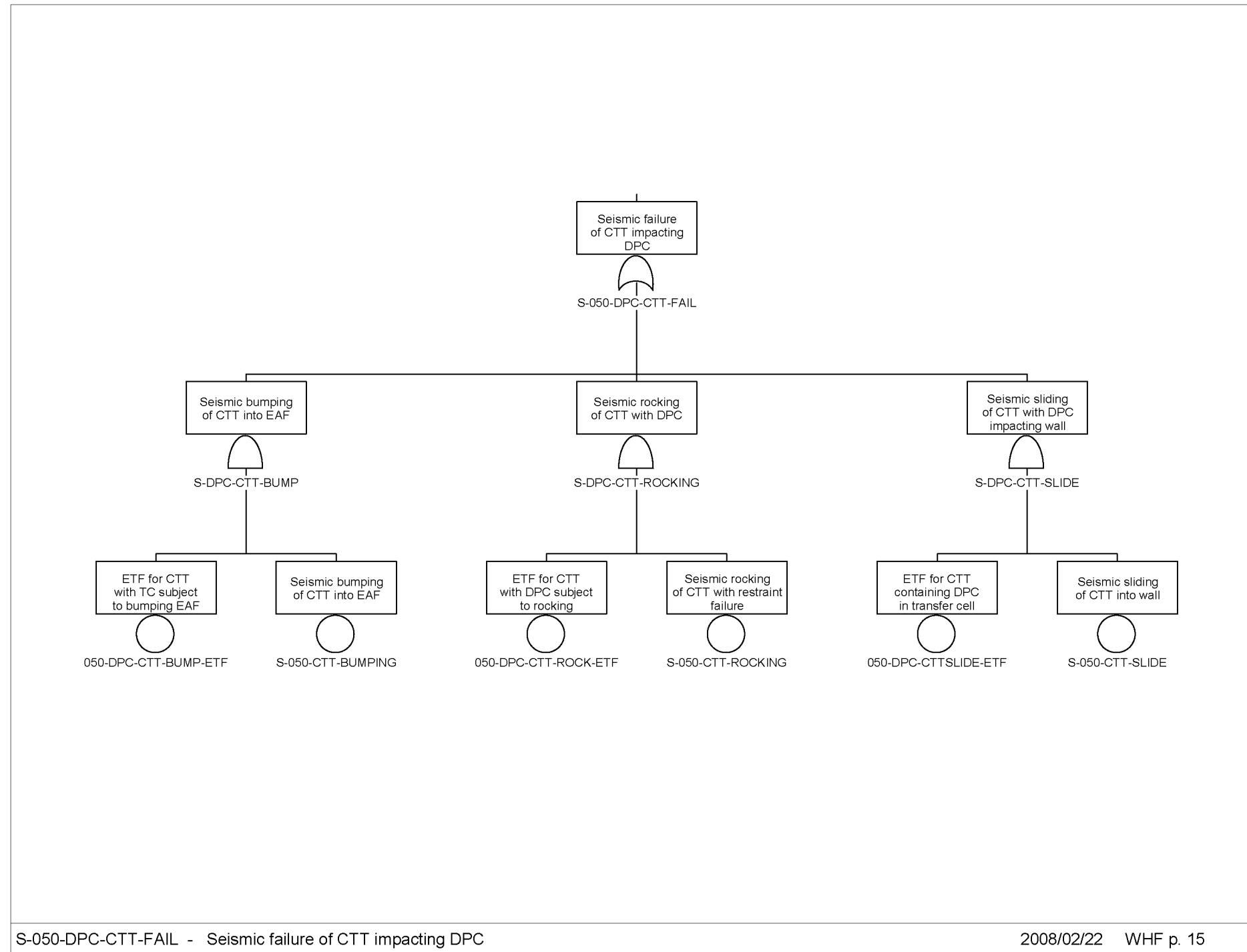

Source: Original

Figure D1.2-10. S-050-DPC-CTT-FAIL – Seismic Failure of CTT Impacting DPC

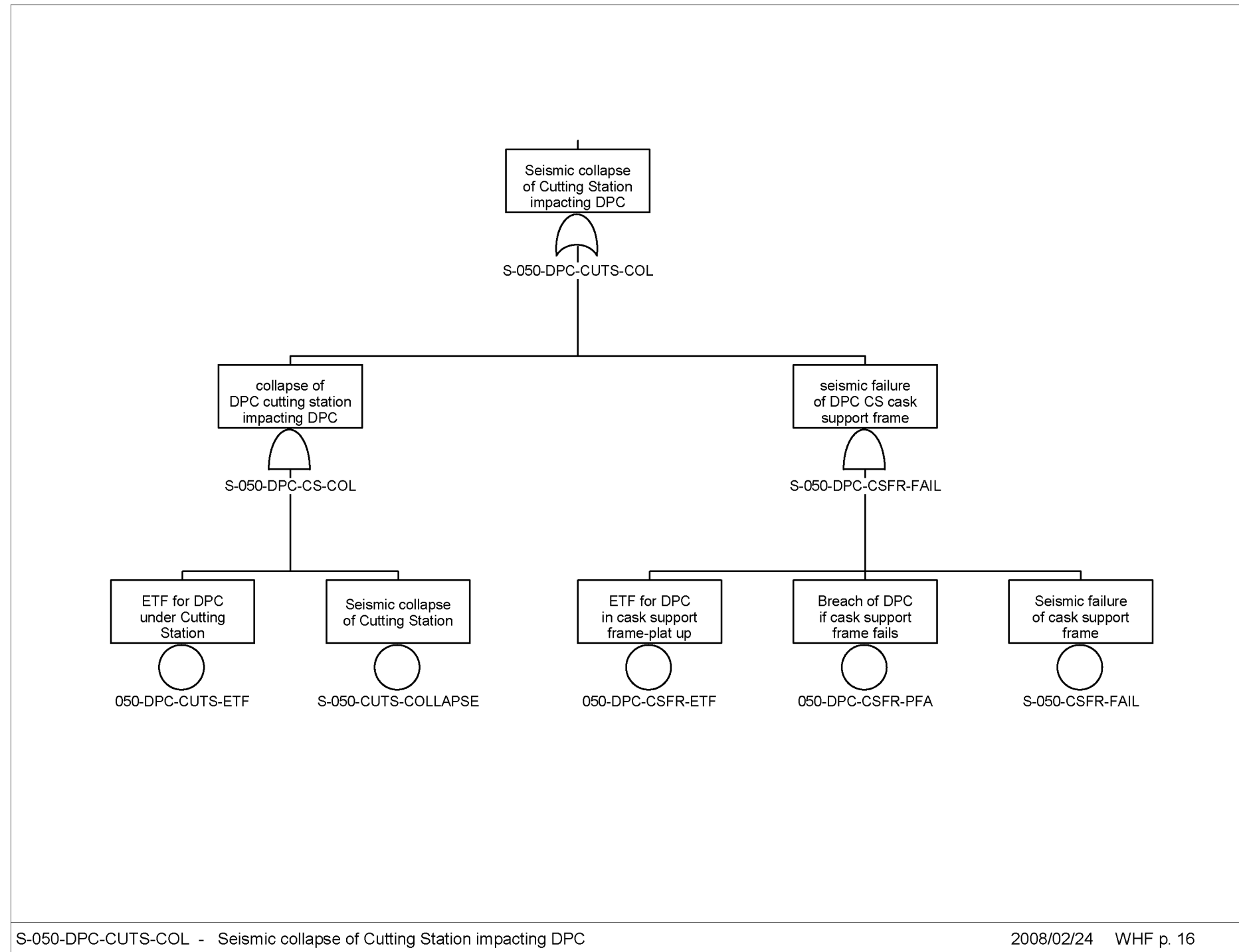

Source: Original

Figure D1.2-11. S-050-DPC-CUTS-COL – Seismic Collapse of Cutting Station Impacting DPC

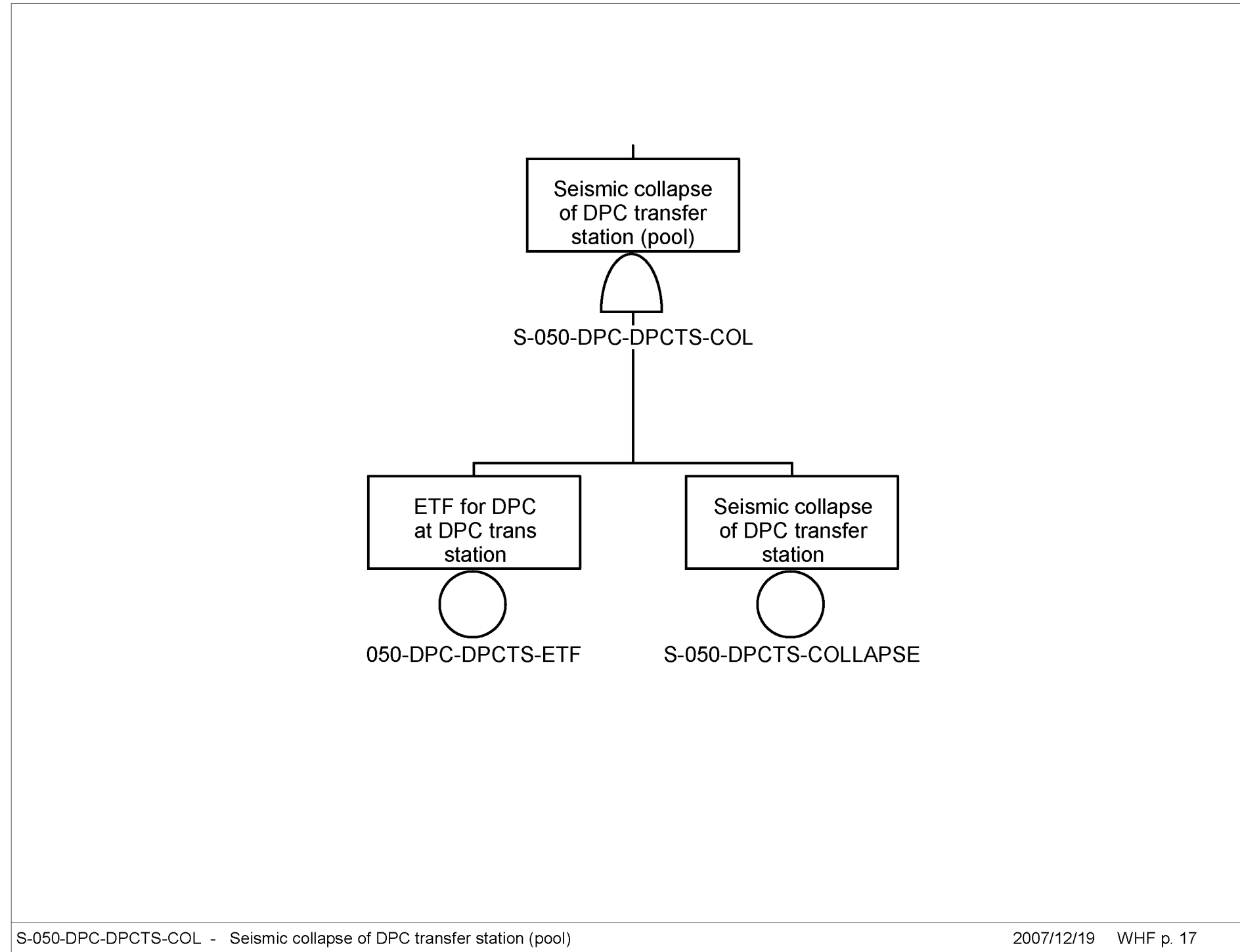

S-050-DPC-DPCTS-COL - Seismic collapse of DPC transfer station (pool)

2007/12/19 WHF p. 17

Source: Original

Figure D1.2-12. S-050-DPC-DPCTS-COL – Seismic Collapse of DPC Transfer Station (Pool)

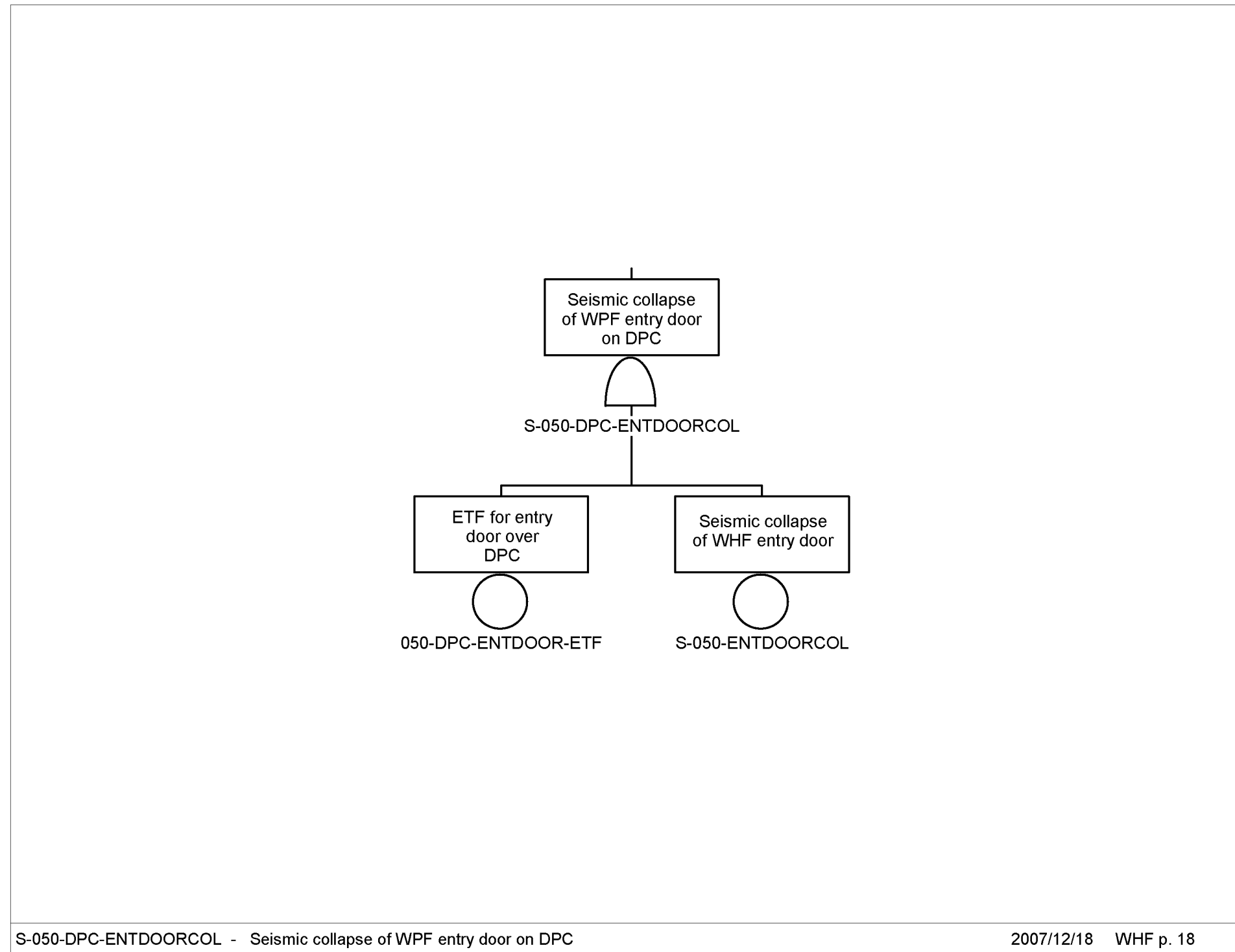

Source: Original

Figure D1.2-13. S-050-DPC-ENTDOORCOL – Seismic Collapse of WPF Entry Door on DPC

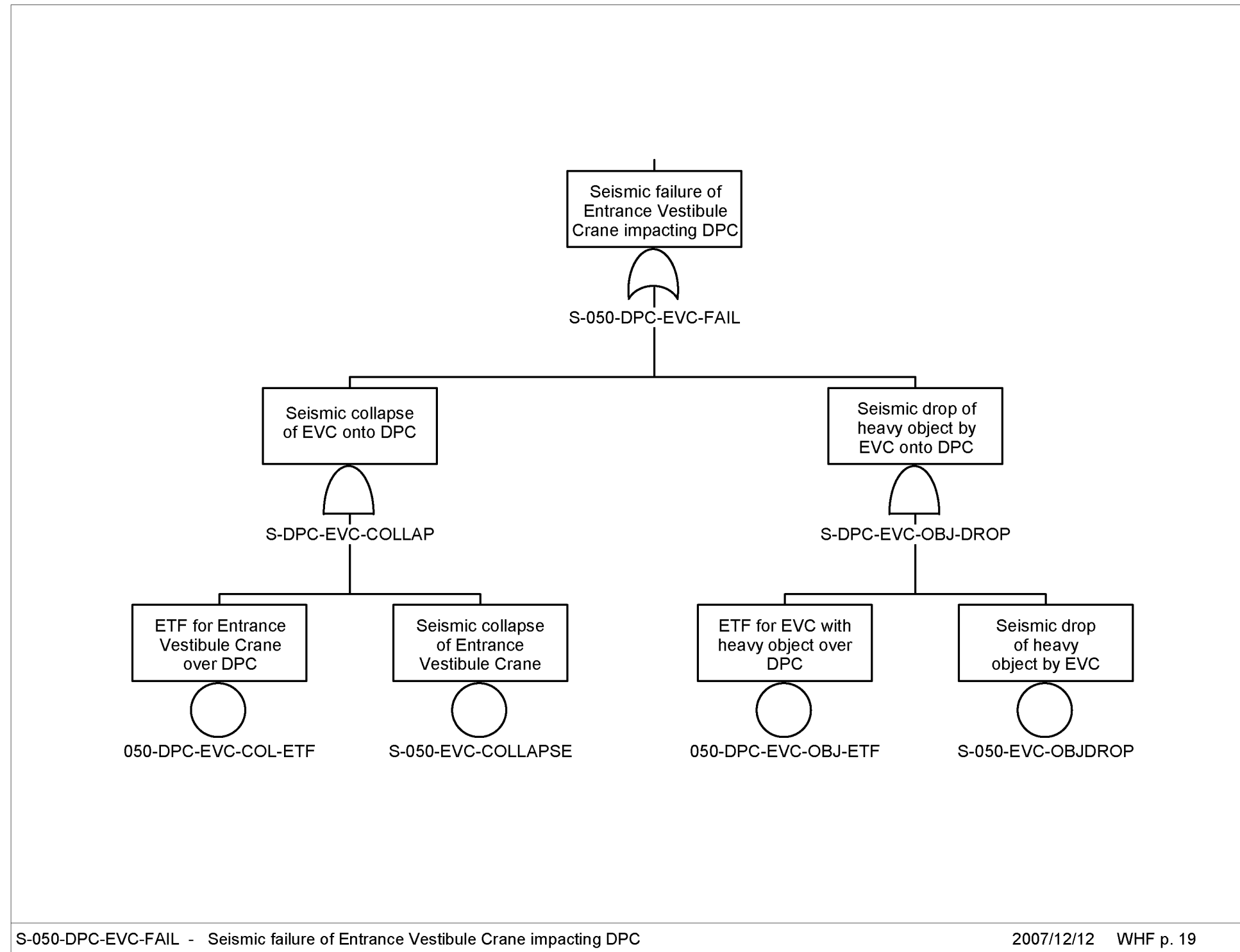

Source: Original

Figure D1.2-14. S-050-DPC-EVC-FAIL – Seismic Failure of Entrance Vestibule Crane Impacting DPC

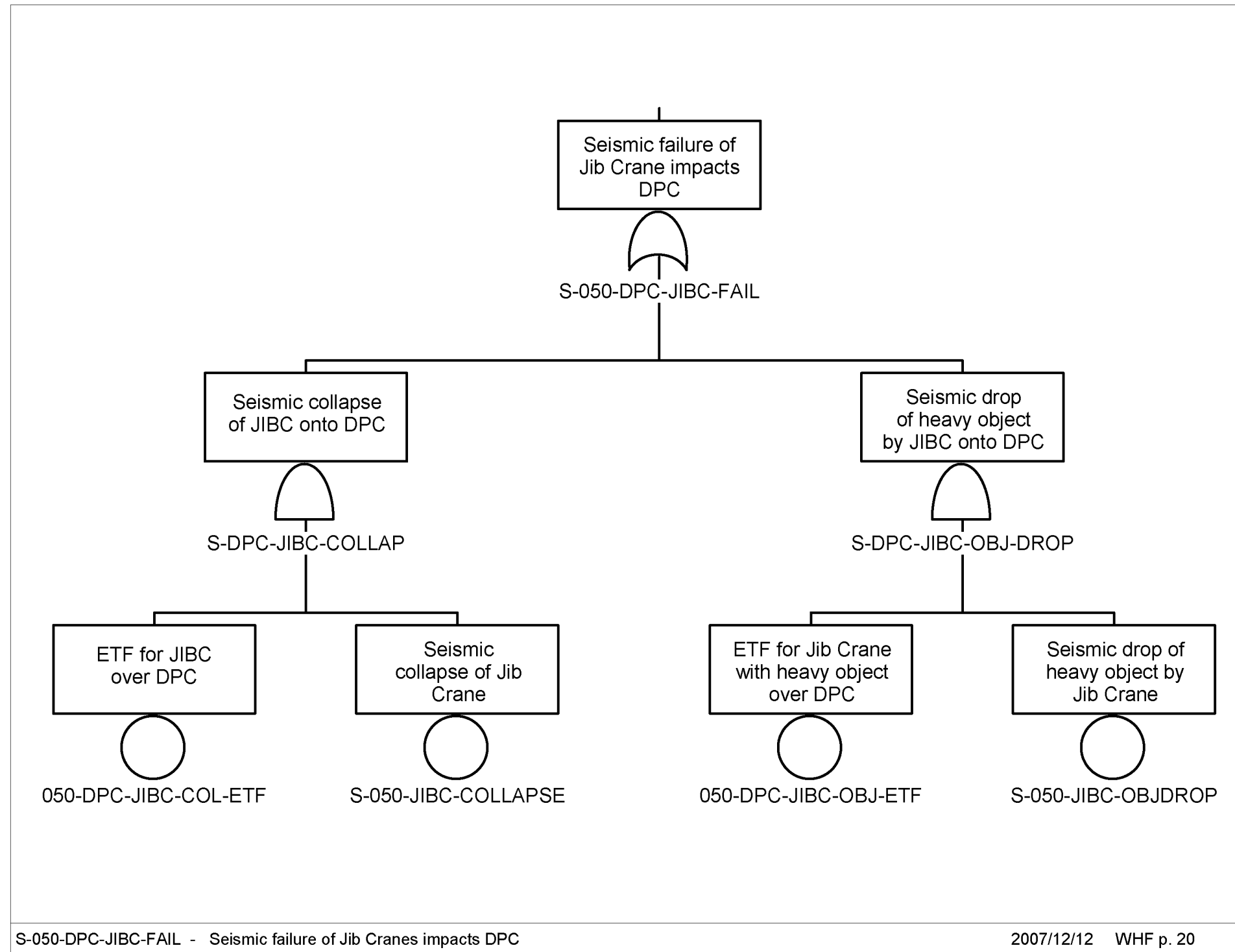

Source: Original

Figure D1.2-15. S-050-DPC-JIBC-FAIL – Seismic Failure of Jib Cranes Impacts DPC

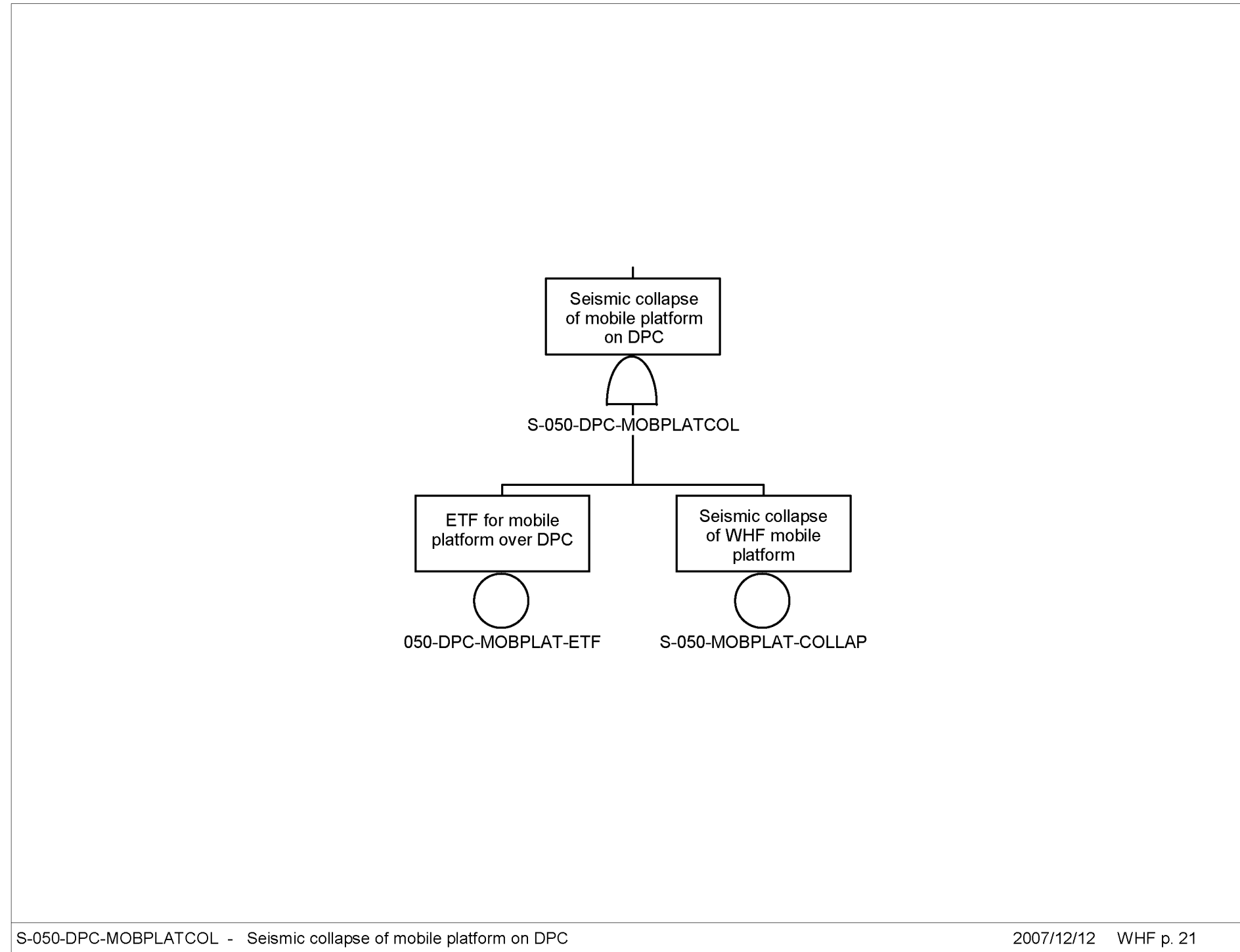

Source: Original

Figure D1.2-16. S-050-DPC-MOBPLATCOL–
Seismic Collapse of Mobile
Platform on DPC

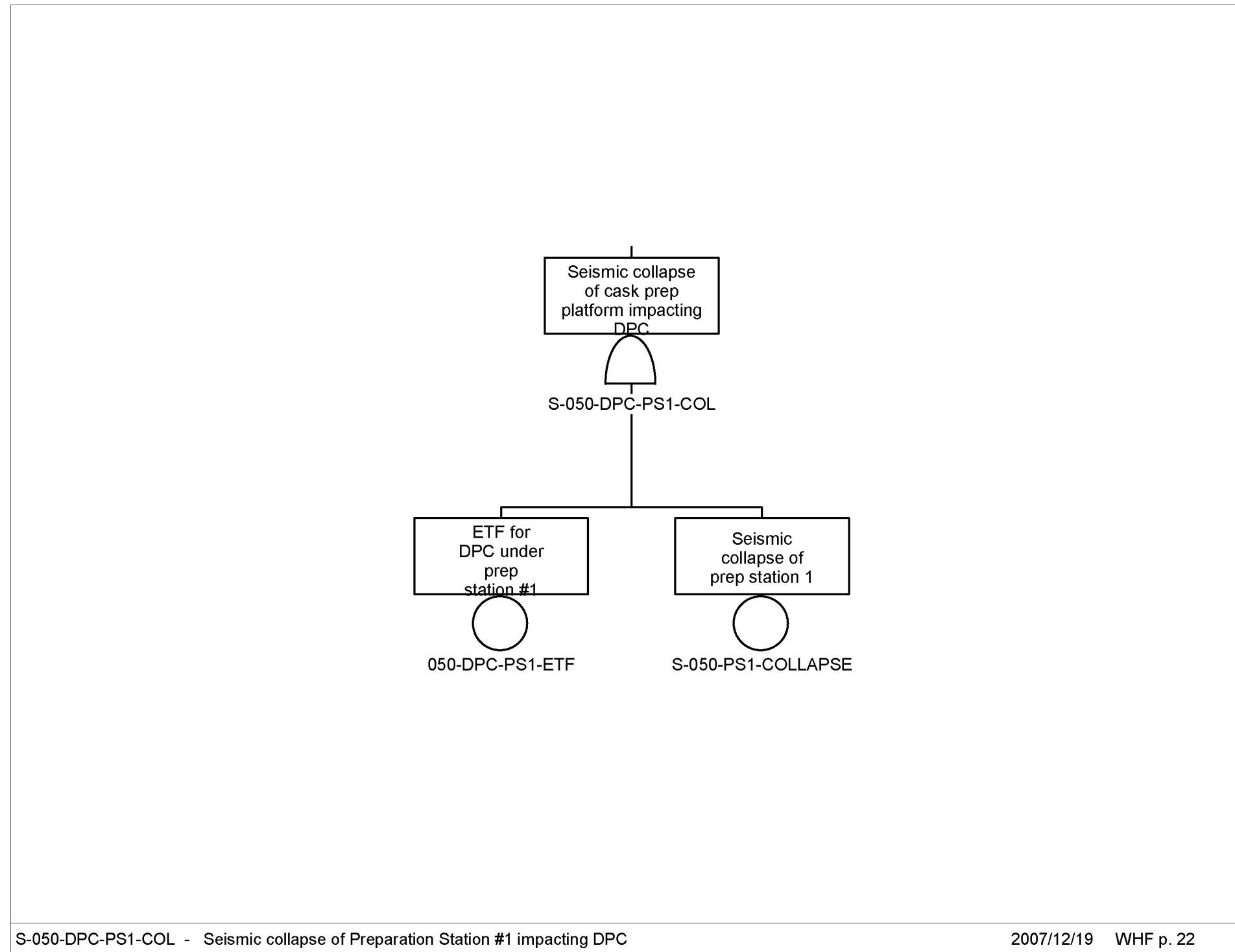

S-050-DPC-PS1-COL - Seismic collapse of Preparation Station #1 impacting DPC

2007/12/19 WHF p. 22

Source: Original

Figure D1.2-17. S-050-DPC-PS1-COL – Seismic Collapse of Preparation Station #1 Impacting DPC

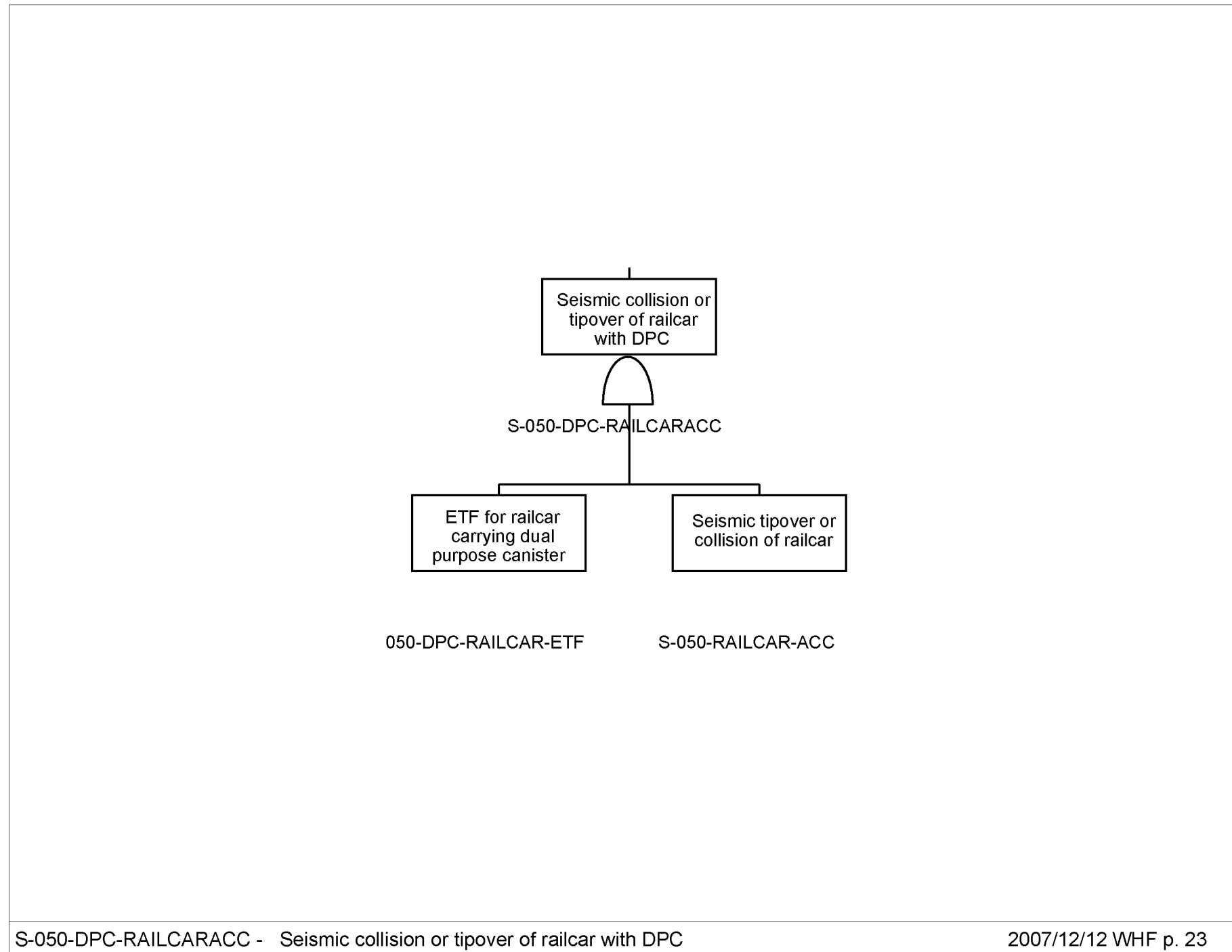

Source: Original

Figure D1.2-18. S-050-DPC-RAILCARACC— Seismic Collision or Tipover of Railcar with DPC

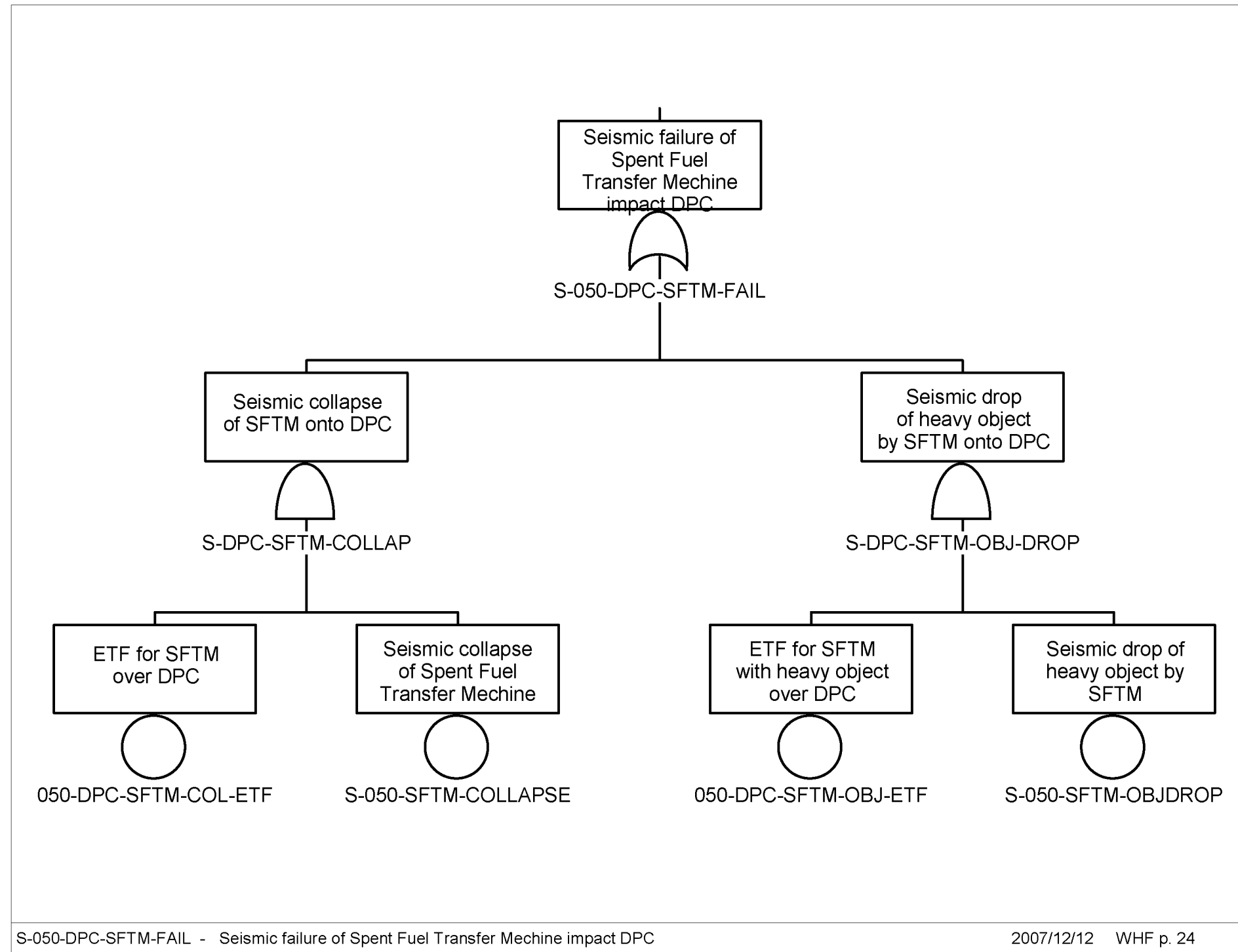

Source: Original

Figure D1.2-19. S-050-DPC-SFTM-FAIL – Seismic Failure of Spent Fuel Transfer Machine Impacts DPC

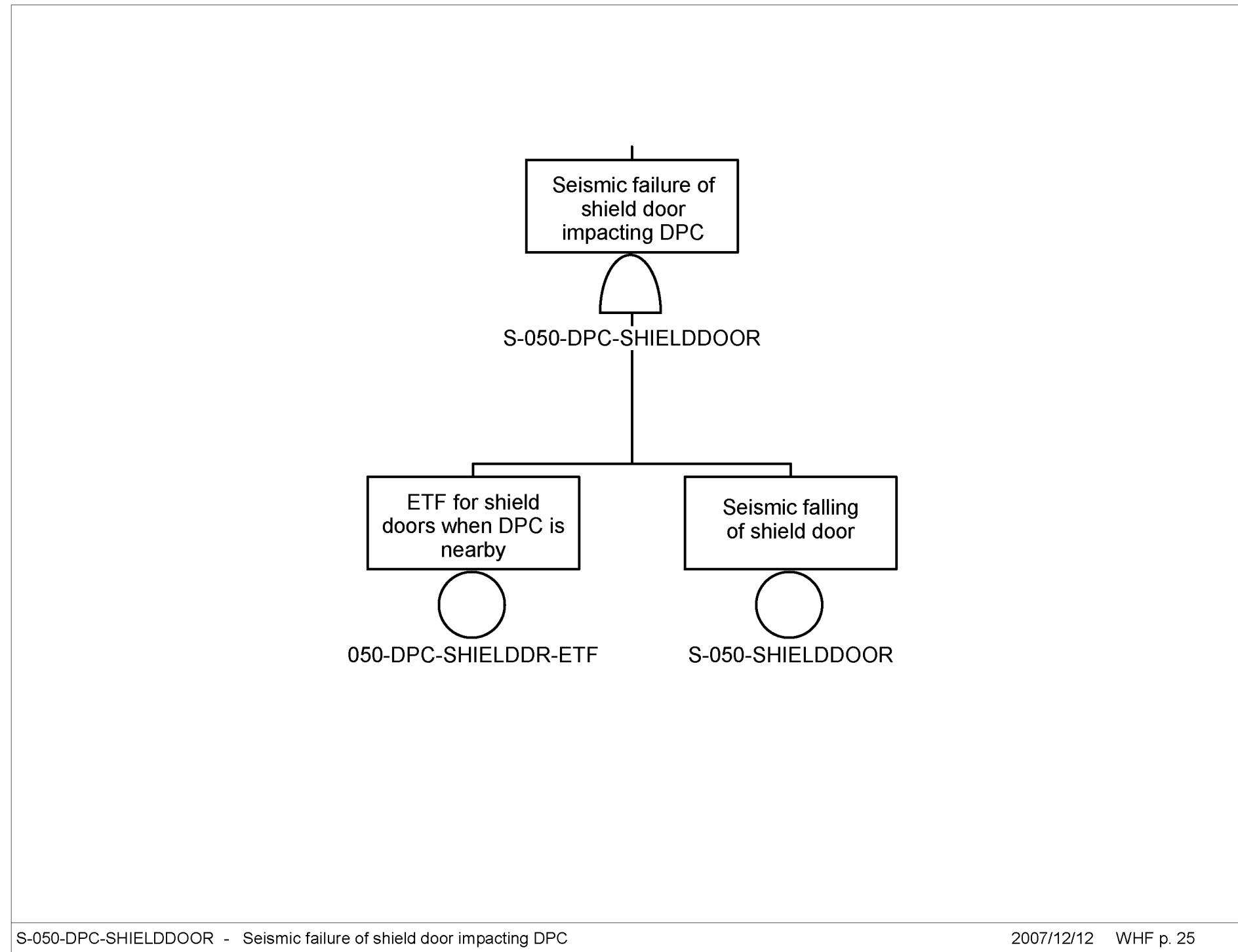

Source: Original

Figure D1.2-20. S-050-DPC-SHIELDDOOR – Seismic Failure of Shield Door Impacting DPC

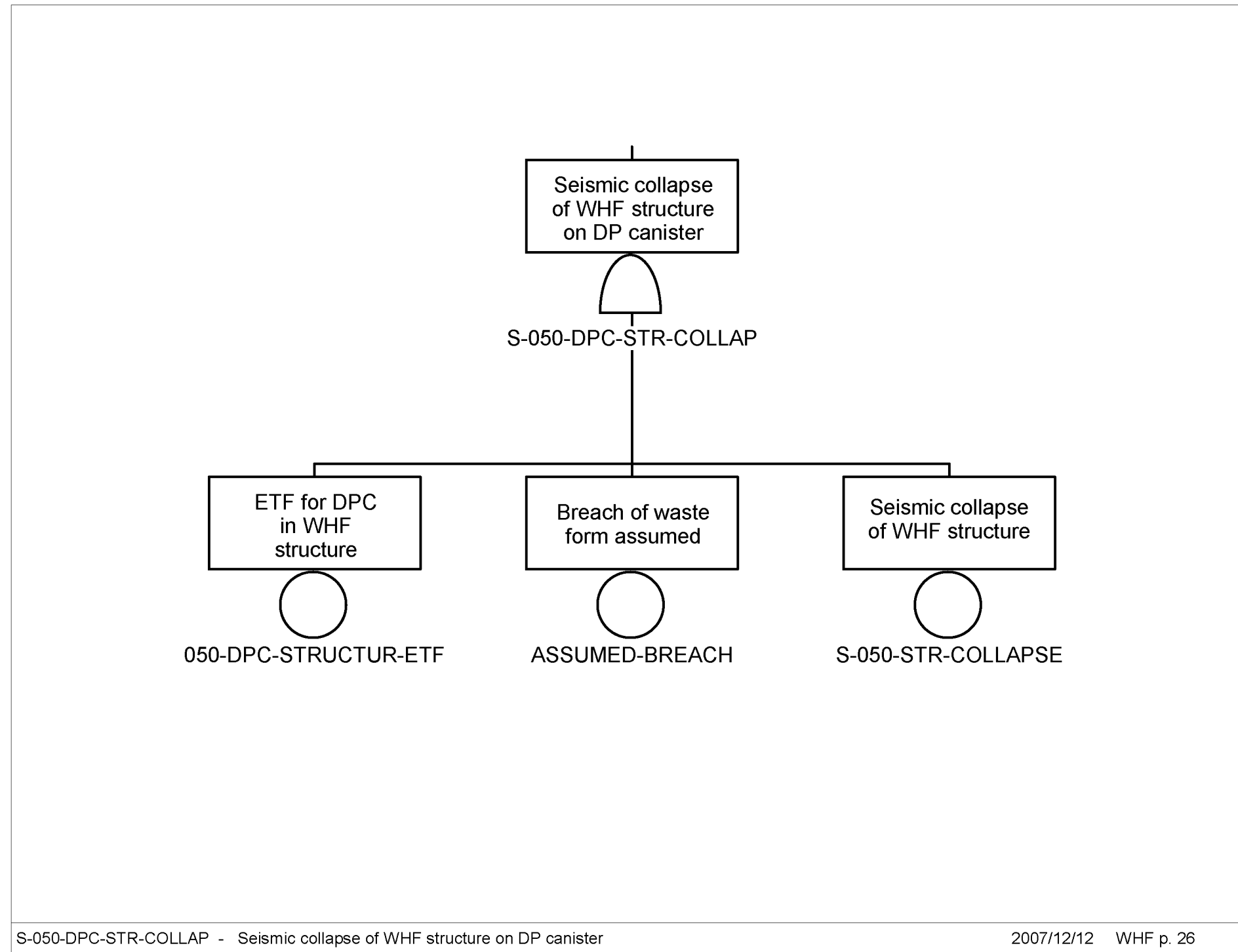

Source: Original

Figure D1.2-21. S-050-DPC-STR-COLLAP—
Seismic Collapse of WHF
Structure on DP Canister

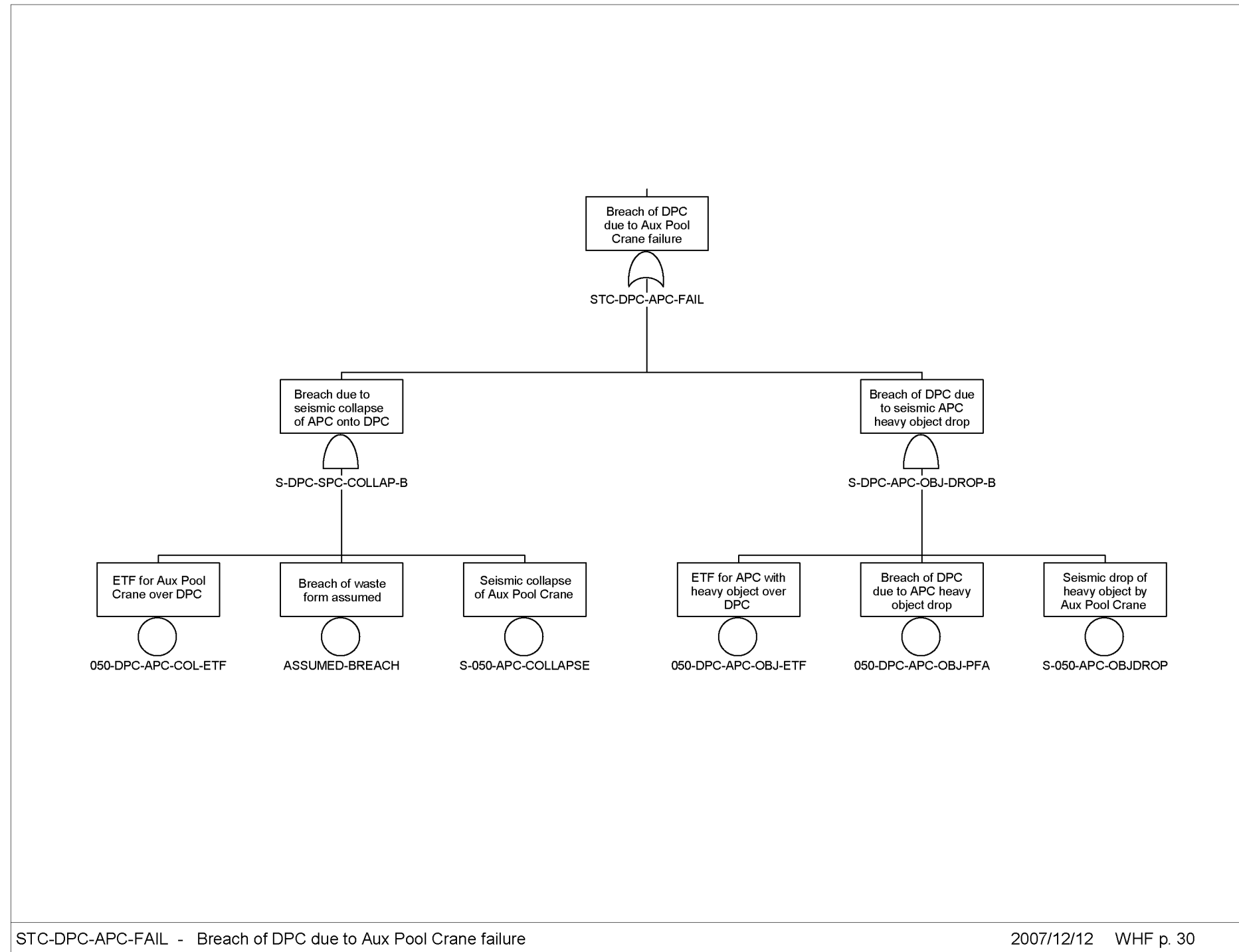

Source: Original

Figure D1.2-22. STC-DPC-APC-FAIL – Breach of DPC due to Aux Pool Crane Failure

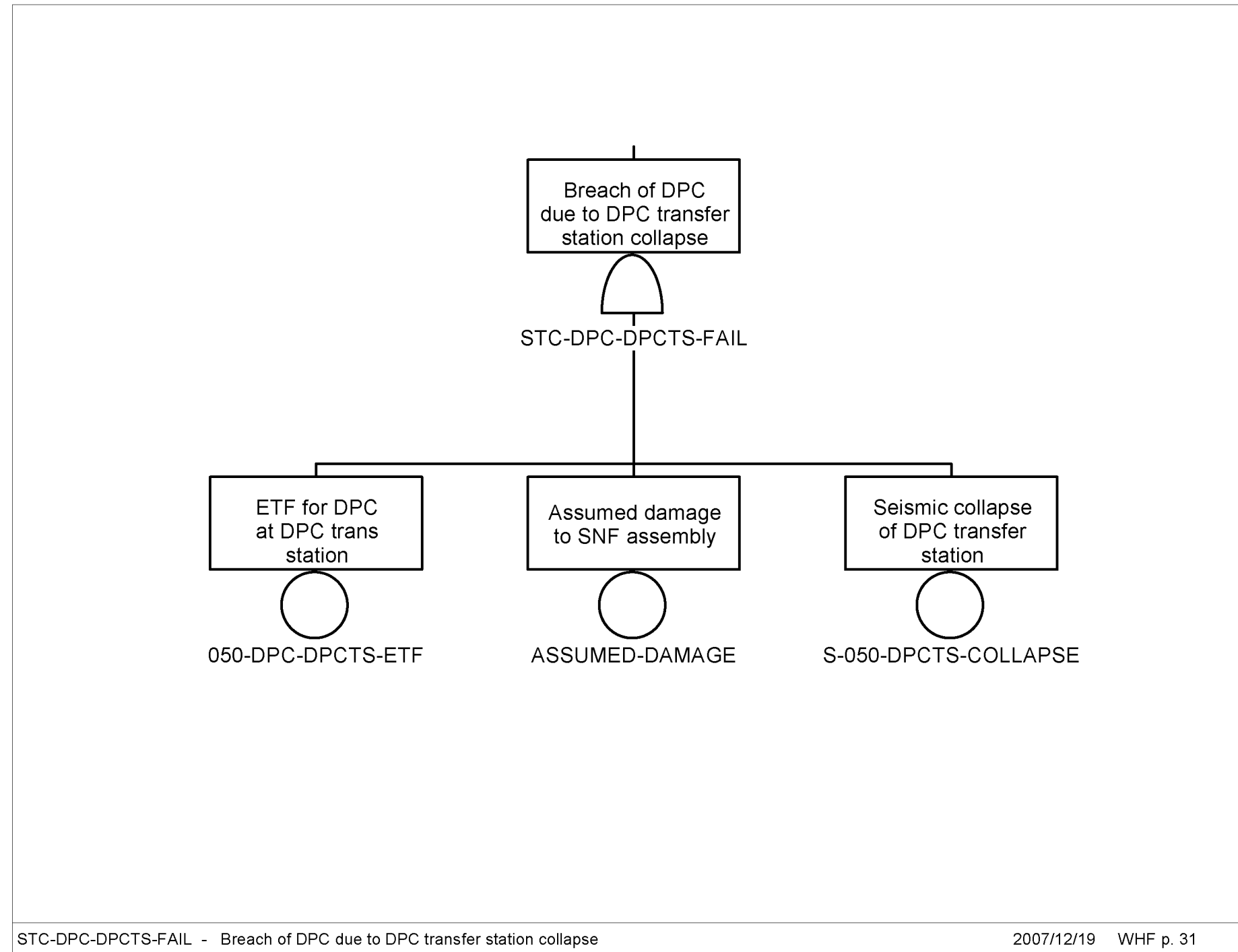

Source: Original

Figure D1.2-23. STC-DPC-DPCTS-FAIL – Breach of DPC due to DPC Transfer Station Collapse

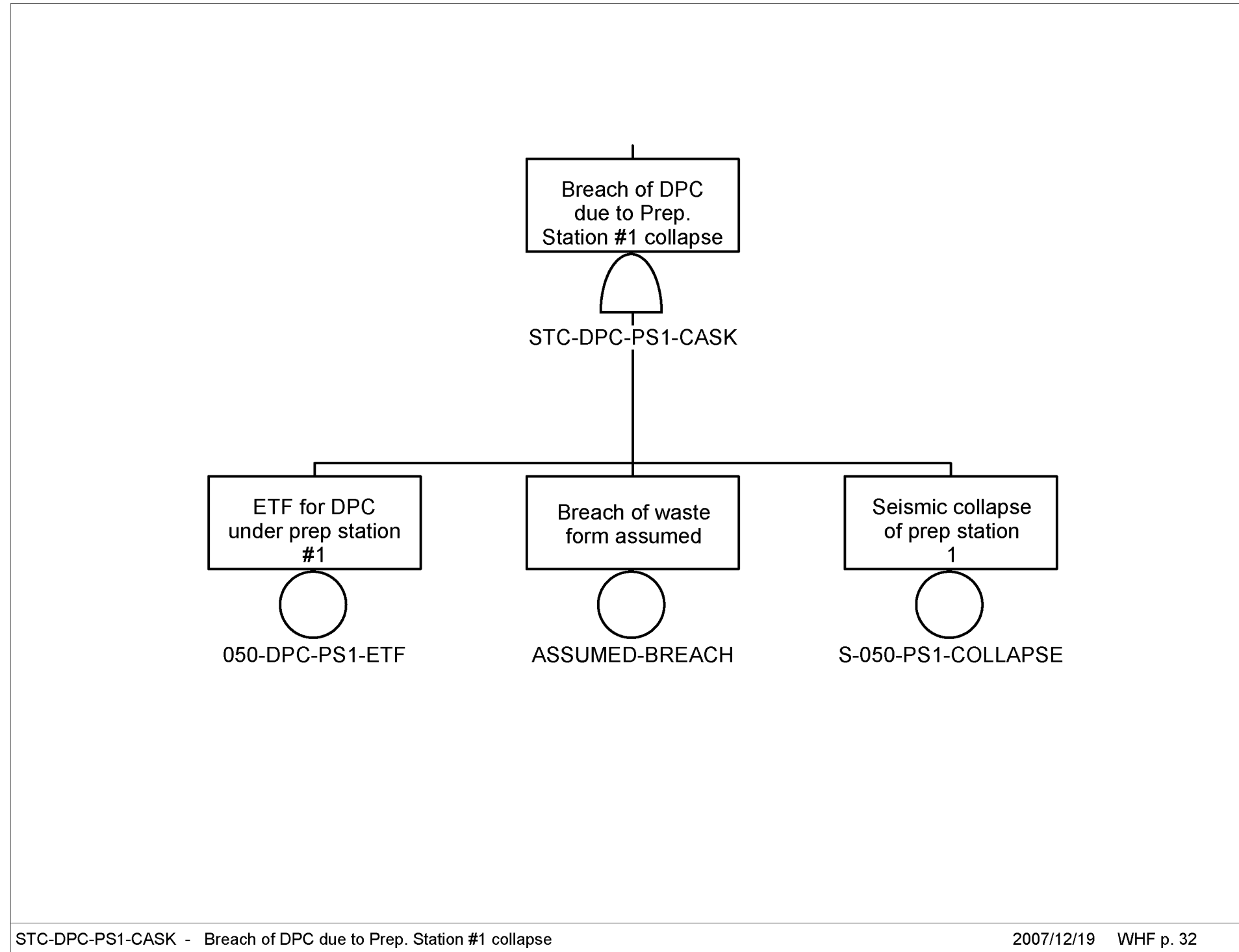

Source: Original

Figure D1.2-24 STC-DPC-PS1-CASK – Breach of DPC due to Prep Station #1 Collapse

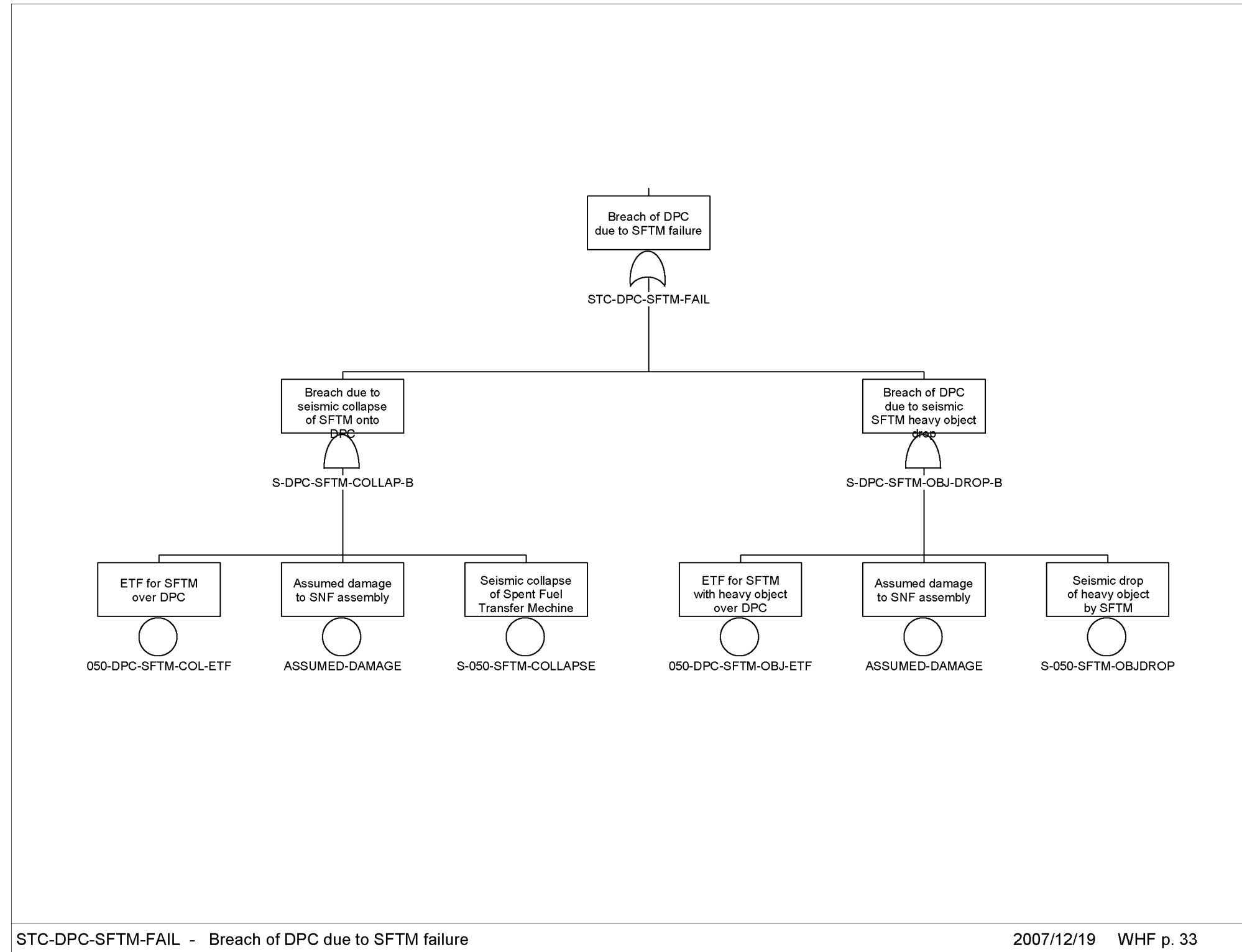

Source: Original

Figure D1.2-25. STC-DPC-SFTM-FAIL– Breach of DPC due to SFTM Failure

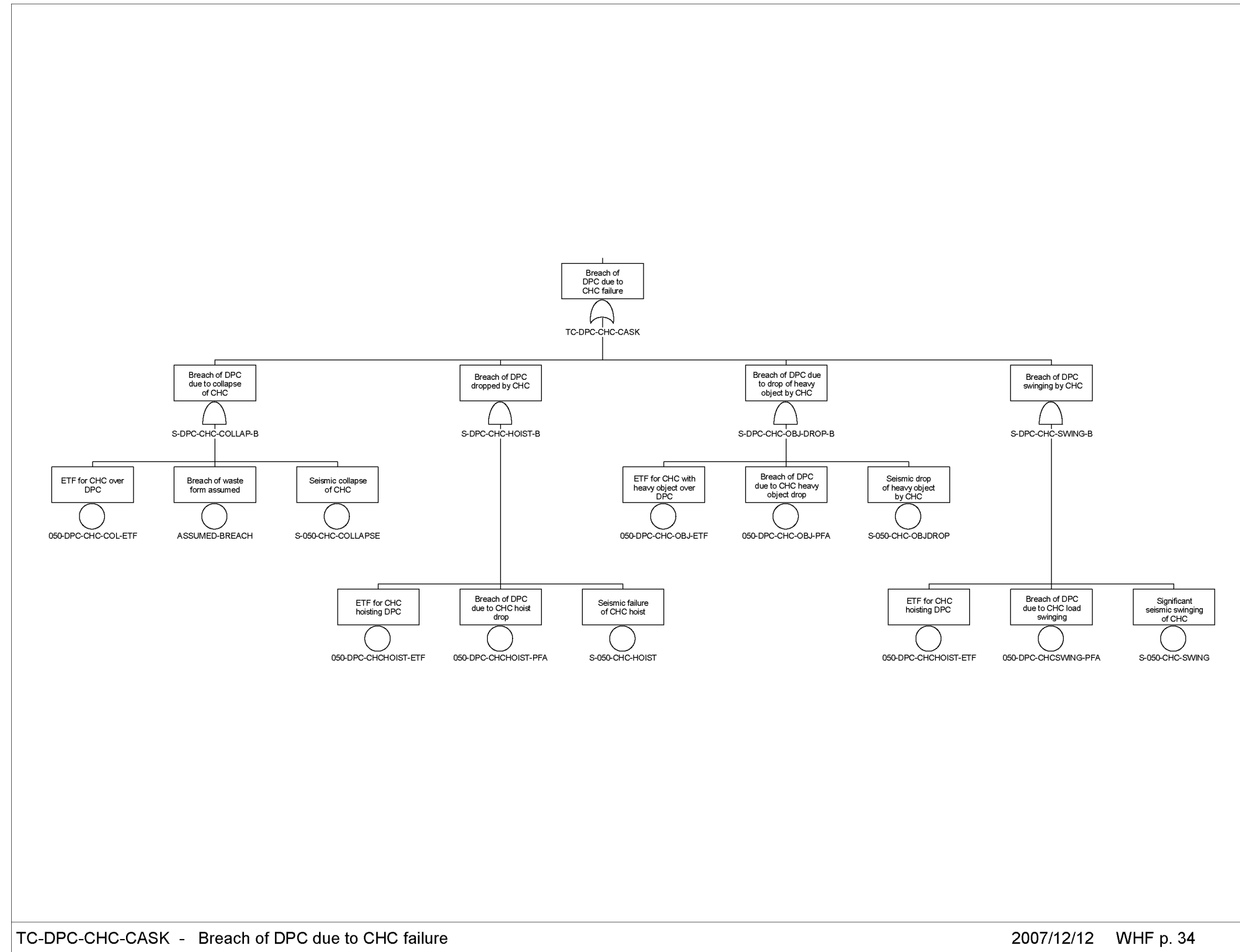

Source: Original

Figure D1.2-26. TC-DPC-CHC-CASK – Breach of DPC due to CHC Failure

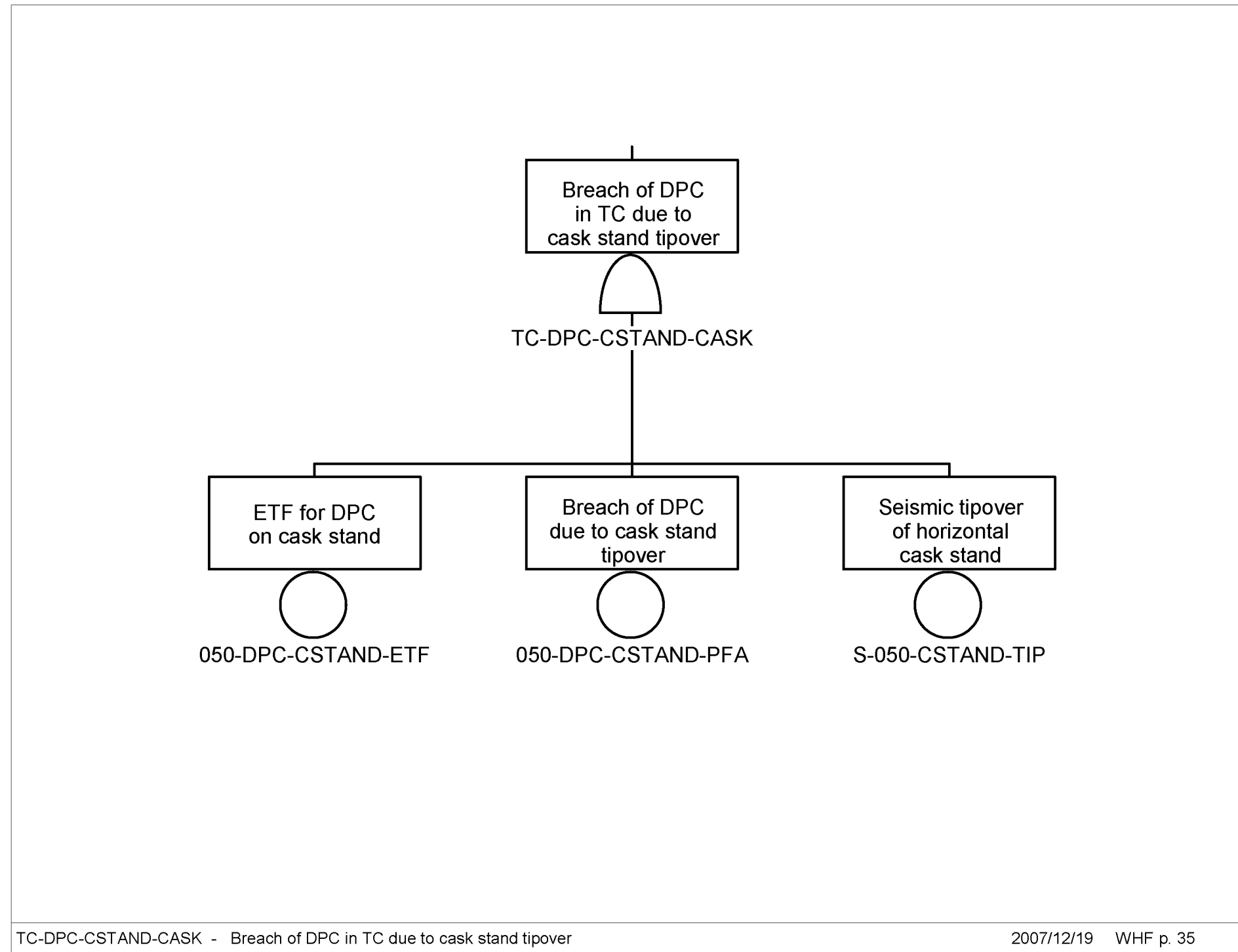

Source: Original

Figure D1.2-27. TC-DPC-CSTAND-CASK – Breach of DPC in TC due to Cask Stand Tipover

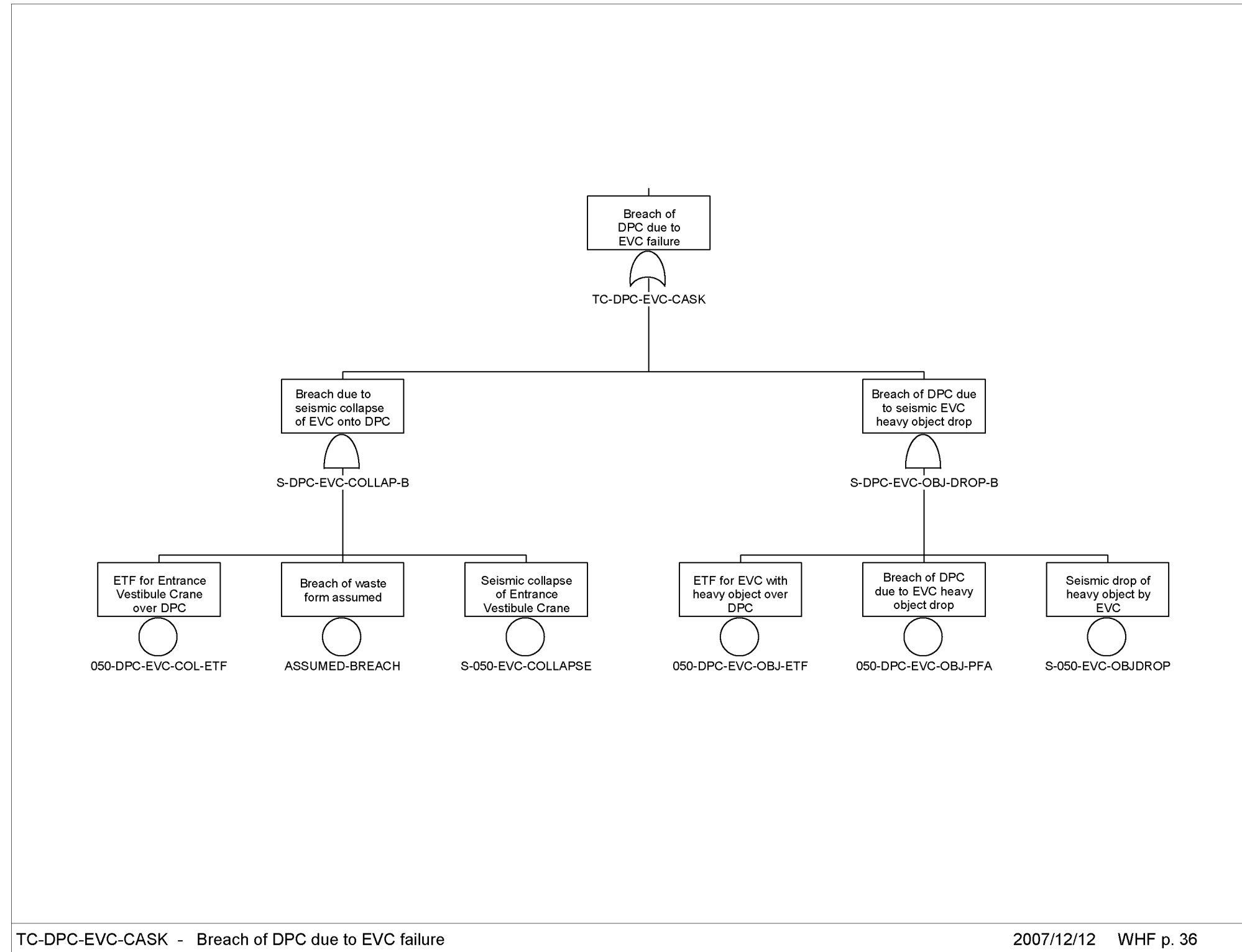

Source: Original

Figure D1.2-28. TC-DPC-EVC-CASK – Breach of DPC due to EVC Failure

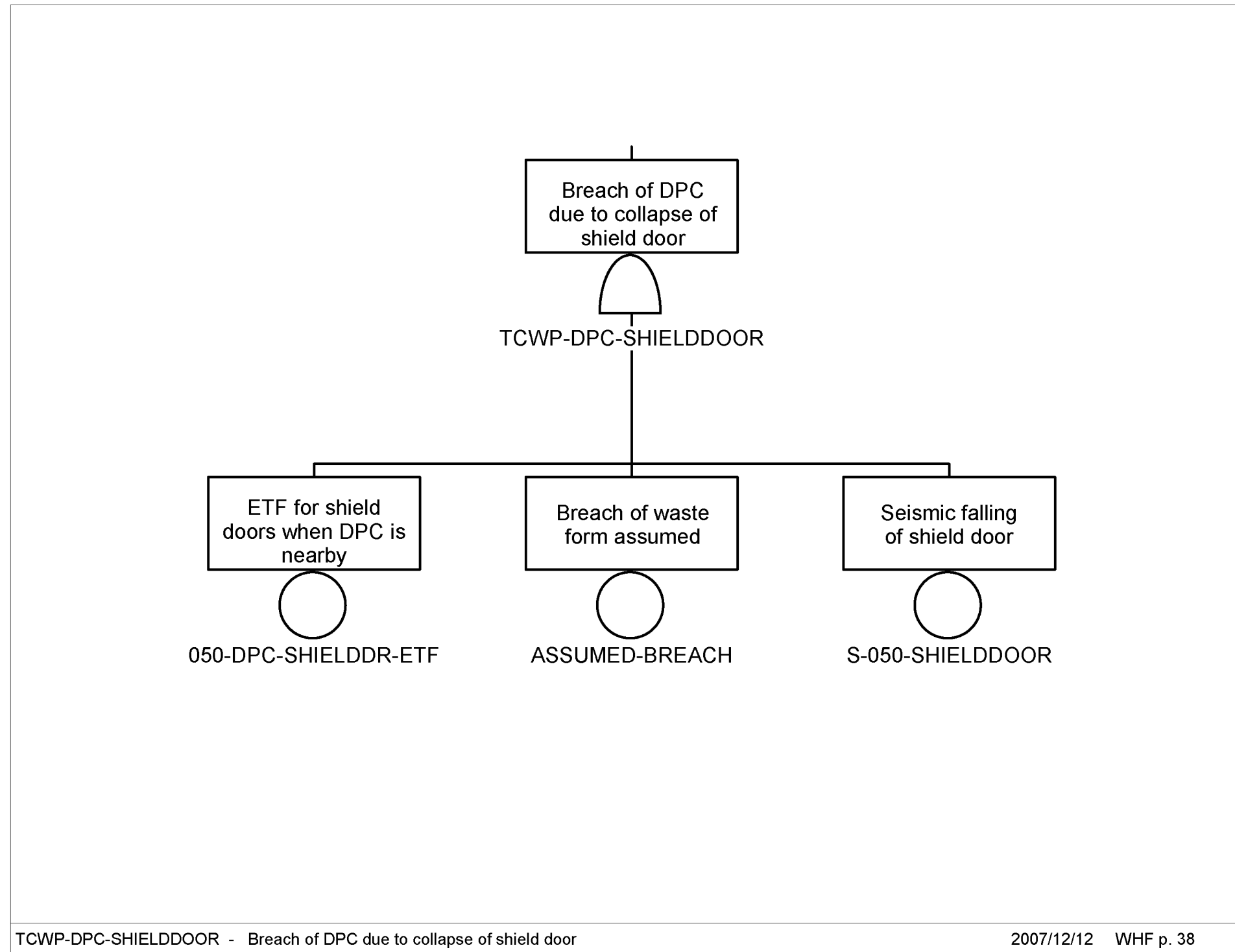

Source: Original

Figure D1.2-29. TCWP-DPC-SHIELDDOOR – Breach of DPC due to Collapse of Shield Door

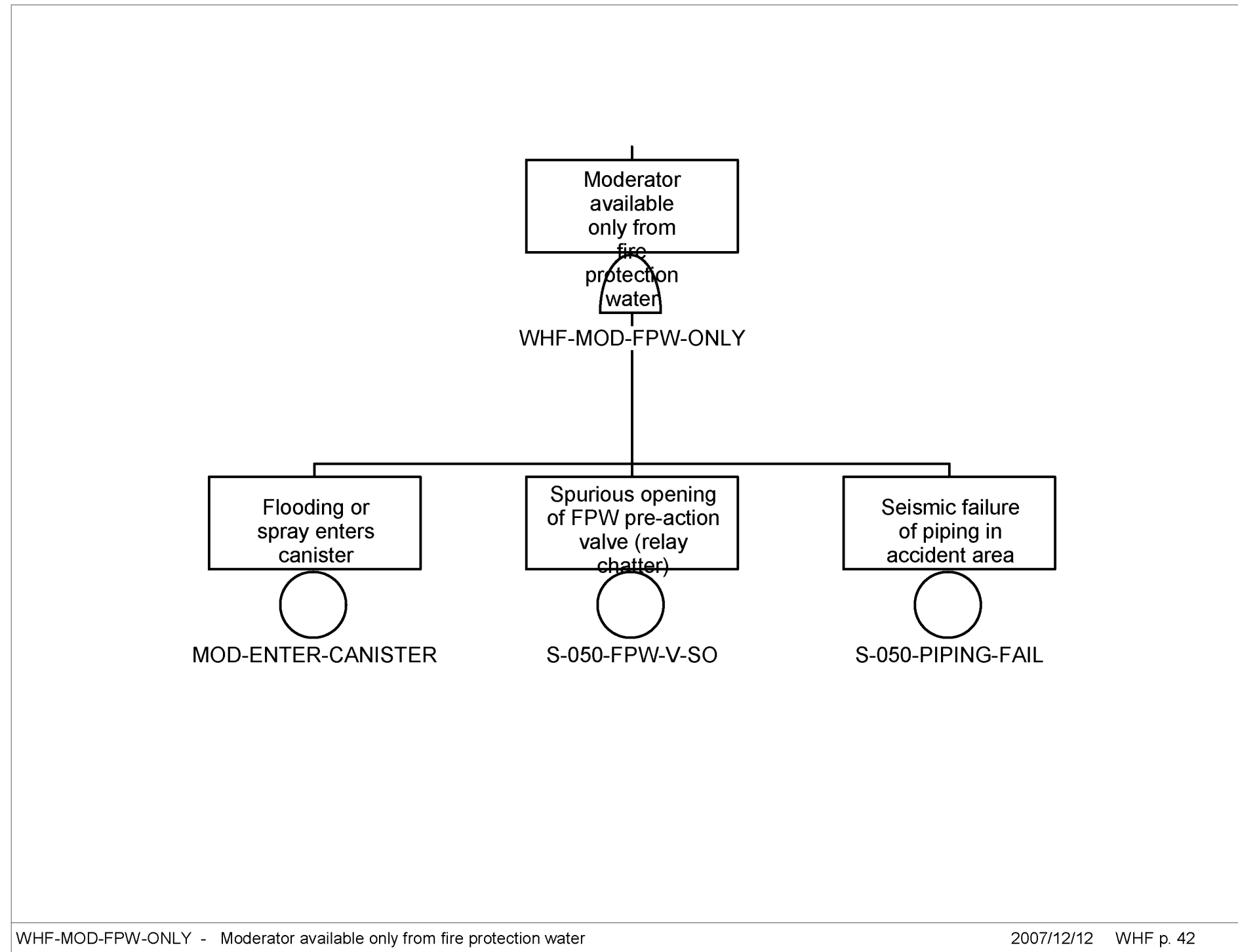

Source: Original

Figure D1.2-30. WHF-MOD-FPW-ONLY – Moderator Available Only from Fire Protection Water

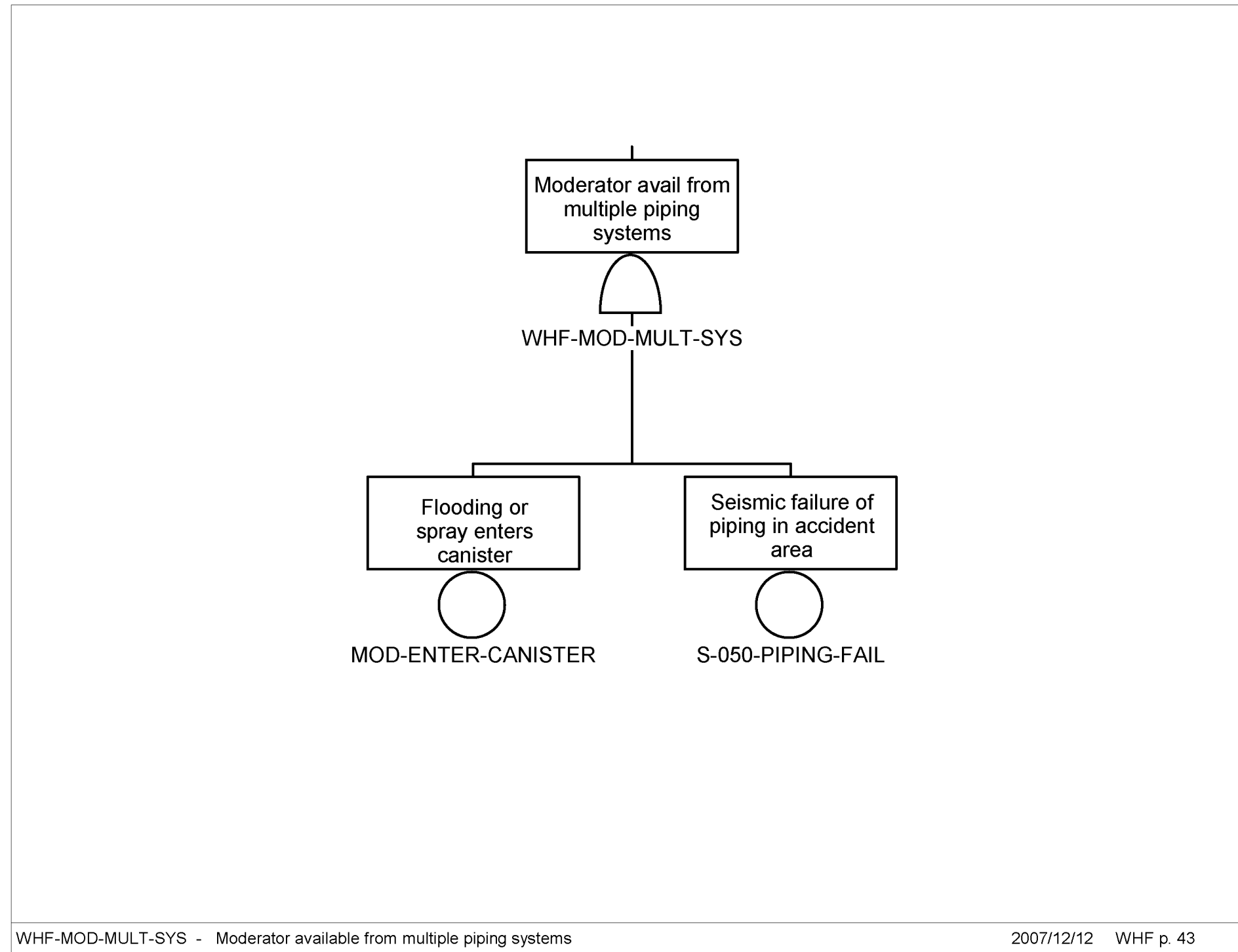

Source: Original

Figure D1.2-31. WHF-MOD-MULT-SYS – Moderator Available from Multiple Piping Systems

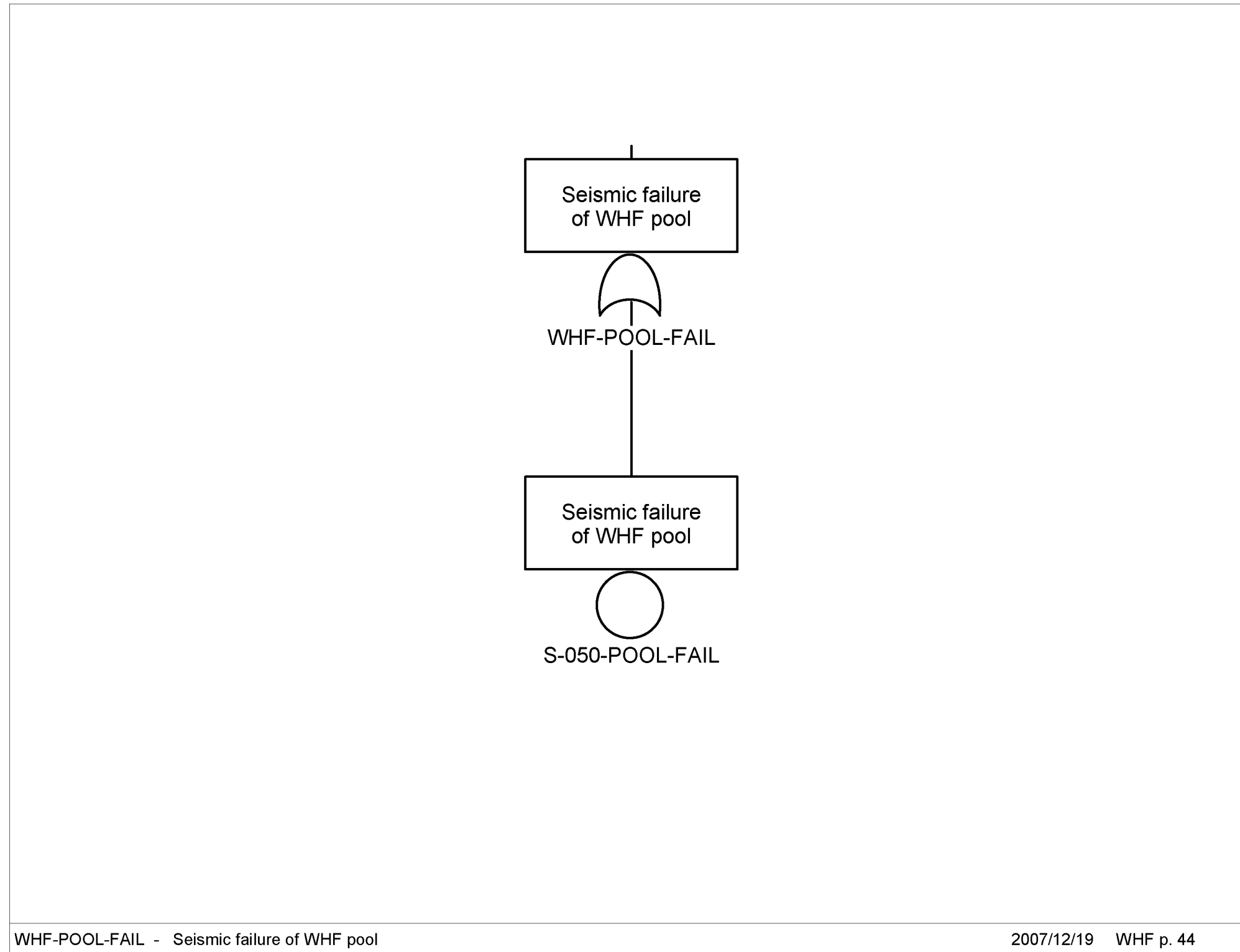

Source: Original

Figure D1.2-32. WHF-POOL-FAIL – Seismic Failure of WHF Pool

D1.3 BASIC EVENTS DATA

D1.3.1 Non-seismic Basic Event Data

The following table presents the basic event identifier used in the fault trees, the description of the basic event, and the failure probability (or other numeric data) of the basic event. For exposure time factors (denoted with “ETF” at the end of the basic event identifier), the value given is the time, in years, that one waste form container is exposed to the seismic failure mode.

Table D1.3-1. Non-seismic Basic Event Data

Name	Description	Calc. Probability
050-DPC-APC-COL-ETF	ETF for aux pool crane over DPC	2.090E-003
050-DPC-APC-OBJ-ETF	ETF for APC with heavy object over DPC	2.280E-004
050-DPC-APC-OBJ-PFA	Breach of DPC due to APC heavy object drop	1.000E+000
050-DPC-CHC-COL-ETF	ETF for CHC over DPC	1.700E-003
050-DPC-CHC-OBJ-ETF	ETF for CHC with heavy object over DPC	1.620E-004
050-DPC-CHC-OBJ-PFA	Breach of DPC due to CHC heavy object drop	1.000E-005
050-DPC-CHCHOIST-ETF	ETF for CHC hoisting DPC	3.710E-004
050-DPC-CHCHOIST-PFA	Breach of DPC due to CHC hoist drop	1.000E-005
050-DPC-CHCSWING-PFA	Breach of DPC due to CHC load swinging	1.000E-005
050-DPC-CSFR-ETF	ETF for DPC in cask support frame-plat up	5.710E-005
050-DPC-CSFR-PFA	Breach of DPC if cask support frame fails	1.000E-005
050-DPC-CSTAND-ETF	ETF for DPC on cask stand	5.710E-004
050-DPC-CSTAND-PFA	Breach of DPC due to cask stand tipover	1.000E-005
050-DPC-CTM-COL-ETF	ETF for CTM over DPC	2.500E-003
050-DPC-CTM-OBJ-ETF	ETF for CTM with heavy object over DPC	6.090E-005
050-DPC-CTM-OBJ-PFA	Breach of DPC due to CTM object drop	1.000E-005
050-DPC-CTMHOIST-ETF	ETF for CTM hoisting DPC	2.260E-003
050-DPC-CTMHOIST-PFA	Breach of naval canister dropped by CTM	1.000E-005
050-DPC-CTMSWGIB-ETF	ETF for CTM hoisting DPC inside bell	2.260E-003
050-DPC-CTMSWGIB-PFA	Breach of DPC due to swing inside bell	1.000E-005
050-DPC-CTMSWGOB-ETF	ETF for CTM hoisting DPC outside bell	2.850E-005
050-DPC-CTT-BUMP-ETF	ETF for CTT with TC subject to bumping EAF	1.320E-003
050-DPC-CTT-BUMP-PFA	Breach given CTT with TC subject to bumping EAF	1.000E-005
050-DPC-CTT-ROCK-ETF	ETF for CTT with DPC subject to rocking	1.050E-004
050-DPC-CTTSLIDE-ETF	ETF for CTT containing DPC in transfer cell	3.310E-004
050-DPC-CUTS-ETF	ETF for DPC under Cutting Station	3.970E-003
050-DPC-DPCTS-ETF	ETF for DPC at DPC trans station	7.320E-004
050-DPC-ENTDOOR-ETF	ETF for entry door over DPC	1.140E-005
050-DPC-ENTDOOR-PFA	Breach of DPC due to entry door collapse	1.000E-005
050-DPC-EVC-COL-ETF	ETF for Entrance Vestibule crane over DPC	3.270E-004
050-DPC-EVC-OBJ-ETF	ETF for EVC with heavy object over DPC	3.270E-004

Table D1.3-1. Non-seismic Basic Event Data (Continued)

Name	Description	Calc. Probability
050-DPC-EVC-OBJ-PFA	Breach of DPC due to EVC heavy object drop	1.000E-005
050-DPC-JIBC-COL-ETF	ETF for JIBC over DPC	5.140E-004
050-DPC-JIBC-OBJ-ETF	ETF for jib crane with heavy object over DPC	1.710E-004
050-DPC-MOBPLAT-ETF	ETF for mobile platform over DPC	6.750E-004
050-DPC-MOBPLAT-PFA	Breach of DPC due to mobile platform collapse	1.000E-005
050-DPC-PS1-ETF	ETF for DPC under prep station #1	1.450E-003
050-DPC-RAILCAR-ETF	ETF for railcar carrying dual purpose canister	6.070E-004
050-DPC-RAILCAR-PFA	Breach of DPC due to railcar accident	1.000E-005
050-DPC-SFTM-COL-ETF	ETF for SFTM over DPC	4.760E-005
050-DPC-SFTM-OBJ-ETF	ETF for SFTM with heavy object over DPC	9.510E-006
050-DPC-SHIELD-ETF	ETF for shield doors when DPC is nearby	1.450E-003
050-DPC-STRUCTUR-ETF	ETF for DPC in WHF structure	1.150E-002
ASSEMBLY	SNF assemblies are not damaged	1.000E+000
ASSUMED-BREACH	Breach of waste form assumed	1.000E+000
ASSUMED-DAMAGE	Assumed damage to SNF assembly	1.000E+000
MOD-ENTER-CANISTER	Flooding or spray enters canister	1.000E-002
SHIELDING	Shielding remains intact	1.000E-005
WHF-DPC-CAN	Number of DP canisters processed in WHF	3.460E+002
050-DPC-APC-COL-ETF	ETF for aux pool crane over DPC	2.090E-003

NOTE: The basic events "ASSUMED-BREACH" and ASSUMED-DAMAGE" are not assumptions, but are common terminology used to denote a scenario where the waste container is conservatively considered to be breached, or assemblies are considered to be damaged; APC = auxiliary pool crane; CHC = cask handling crane; CTM = canister transfer machine; CTT = cask transfer trolley; DP = dual-purpose; DPC = dual-purpose canister; ETF = exposure time factor; EVC = Entrance Vestibule crane; JIBC = jib crane; SFTM = spent fuel transfer machine; SNF = spent nuclear fuel; TC = transportation cask; WHF = Wet Handling Facility.

Source: Sections 6.2.2.23 and 6.3.3, Table 6.3-1, Table 6.3-2, Table 6.7-1

D1.3.2 Seismic Basic Event Fragility Data

The following table provides the seismic failure basic event identifier, description, median fragility, and composite uncertainty.

Table D1.3-2. Seismic Basic Event Fragility Data

Event Name	Description	Med. Fragility (g)	Beta C
S-050-APC-COLLAPSE	Seismic collapse of aux pool crane	2.790E+000	4.500E-001
S-050-APC-OBJDROP	Seismic drop of heavy object by APC	2.280E+000	5.000E-001
S-050-CHC-COLLAPSE	Seismic collapse of CHC	2.790E+000	4.500E-001
S-050-CHC-HOIST	Seismic failure of CHC hoist	2.280E+000	5.000E-001
S-050-CHC-OBJDROP	Seismic drop of heavy object by CHC	2.280E+000	5.000E-001
S-050-CHC-SWING	Significant seismic swinging of CHC	1.140E+000	4.000E-001

Table D1.3-2. Seismic Basic Event Fragility Data (Continued)

Event Name	Description	Med. Fragility (g)	Beta C
S-050-CSFR-FAIL	Seismic failure of cask support frame	3.030E+000	6.000E-001
S-050-CSTAND-TIP	Seismic tipover of horizontal cask stand	3.700E-001	4.000E-001
S-050-CTM-COLLAPSE	Seismic collapse of CTM (bridge girder)	2.390E+000	4.500E-001
S-050-CTM-HOIST	Seismic drop of DPC hoisted by CTM	2.280E+000	5.000E-001
S-050-CTM-OBJDROP	Seismic drop of heavy object by CTM	2.280E+000	5.000E-001
S-050-CTMSWG-IB	Significant swinging of canister inside CTM bell	1.140E+000	4.000E-001
S-050-CTMSWG-OB	Significant swinging of canister outside CTM bell	9.100E-001	4.000E-001
S-050-CTT-BUMPING	Seismic bumping of CTT into EAF	2.250E+000	4.100E-001
S-050-CTT-ROCKING	Seismic rocking of CTT with restraint failure	2.250E+000	4.100E-001
S-050-CTT-SLIDE	Seismic sliding of CTT into wall	3.080E+000	5.800E-001
S-050-CUTS-COLLAPSE	Seismic collapse of cutting station	3.500E+000	4.000E-001
S-050-DPCTS-COLLAPSE	Seismic collapse of DPC transfer station	1.410E+000	4.600E-001
S-050-ENTDOORCOL	Seismic collapse of WHF entry door	3.700E-001	4.000E-001
S-050-EVC-COLLAPSE	Seismic collapse of Entrance Vestibule crane	2.790E+000	4.500E-001
S-050-EVC-OBJDROP	Seismic drop of heavy object by EVC	1.140E+000	4.000E-001
S-050-FPW-V-SO	Spurious opening of FPW pre-action valve (relay chatter)	3.000E+000	4.000E-001
S-050-JIBC-COLLAPSE	Seismic collapse of jib crane	2.790E+000	4.500E-001
S-050-JIBC-OBJDROP	Seismic drop of heavy object by jib crane	2.280E+000	5.000E-001
S-050-MOBPLAT-COLLAP	Seismic collapse of WHF mobile platform	3.700E-001	4.000E-001
S-050-PIPING-FAIL	Seismic failure of piping in accident area	7.600E-001	4.000E-001
S-050-POOL-FAIL	Seismic failure of WHF pool	4.510E+000	4.000E-001
S-050-PS1-COLLAPSE	Seismic collapse of prep station #1	3.500E+000	4.000E-001
S-050-RAILCAR-ACC	Seismic tipover or collision of railcar	4.500E-001	4.000E-001
S-050-SFTM-COLLAPSE	Seismic collapse of SFTM	2.190E+000	4.700E-001
S-050-SFTM-OBJDROP	Seismic drop of heavy object by SFTM	2.280E+000	5.000E-001
S-050-SHIELDDOOR	Seismic falling of shield door	2.920E+000	4.400E-001
S-050-STR-COLLAPSE	Seismic collapse of WHF structure	4.510E+000	4.000E-001

NOTE: APC = auxiliary pool crane; CHC = cask handling crane; CTM = canister transfer machine; CTT = cask transfer trolley; DPC = dual-purpose canister; EAF = energy absorbing feature; EVC = Entrance Vestibule crane; FPW = fire protection water; SFTM = spent fuel transfer machine; WHF = Wet Handling Facility.

Source: Table 6.2-1 and Table 6.2-2

D1.4 EVENT SEQUENCE QUANTIFICATION

This section provides the quantification results by sequence. The event sequence probabilities are provided first, and the cut sets are provided afterwards.

D1.4.1 Sequence Level Results

Table D1.4-1. Sequence Level Results

Event Tree	Sequence	Base Min. Cut	Base Cut Sets
WHF-S-IE-DPC	03	3.455E-006	1
WHF-S-IE-DPC	04-2	3.975E-011	1
WHF-S-IE-DPC	04-3	+0.000E+000	1
WHF-S-IE-DPC	04-4	+0.000E+000	1
WHF-S-IE-DPC	04-5	+0.000E+000	1
WHF-S-IE-DPC	04-6	3.975E-011	1
WHF-S-IE-DPC	04-7	8.032E-014	1
WHF-S-IE-DPC	05-2	1.451E-009	1
WHF-S-IE-DPC	05-3	+0.000E+000	1
WHF-S-IE-DPC	05-4	+0.000E+000	1
WHF-S-IE-DPC	05-5	+0.000E+000	1
WHF-S-IE-DPC	05-6	1.451E-009	1
WHF-S-IE-DPC	05-7	3.920E-012	1
WHF-S-IE-DPC	06-2	2.354E-009	1
WHF-S-IE-DPC	06-3	+0.000E+000	1
WHF-S-IE-DPC	06-4	+0.000E+000	1
WHF-S-IE-DPC	06-5	+0.000E+000	1
WHF-S-IE-DPC	06-6	2.354E-009	1
WHF-S-IE-DPC	06-7	4.756E-012	1
WHF-S-IE-DPC	07-2	9.998E-011	1
WHF-S-IE-DPC	07-3	+0.000E+000	1
WHF-S-IE-DPC	07-4	+0.000E+000	1
WHF-S-IE-DPC	07-5	+0.000E+000	1
WHF-S-IE-DPC	07-6	8.880E-007	2
WHF-S-IE-DPC	07-7	8.356E-009	2
WHF-S-IE-DPC	08-2	1.469E-010	3
WHF-S-IE-DPC	08-3	+0.000E+000	1
WHF-S-IE-DPC	08-4	+0.000E+000	1
WHF-S-IE-DPC	08-5	+0.000E+000	1
WHF-S-IE-DPC	08-6	4.616E-006	4
WHF-S-IE-DPC	08-7	4.344E-008	4

Table D1.4-1. Sequence Level Results (Continued)

Event Tree	Sequence	Base Min. Cut	Base Cut Sets
WHF-S-IE-DPC	09-2	1.991E-009	1
WHF-S-IE-DPC	09-3	+0.000E+000	1
WHF-S-IE-DPC	09-4	+0.000E+000	1
WHF-S-IE-DPC	09-5	+0.000E+000	1
WHF-S-IE-DPC	09-6	1.991E-009	1
WHF-S-IE-DPC	09-7	4.023E-012	1
WHF-S-IE-DPC	10-2	6.199E-011	1
WHF-S-IE-DPC	10-3	+0.000E+000	1
WHF-S-IE-DPC	10-4	+0.000E+000	1
WHF-S-IE-DPC	10-5	+0.000E+000	1
WHF-S-IE-DPC	10-6	1.669E-006	3
WHF-S-IE-DPC	10-7	1.483E-008	3
WHF-S-IE-DPC	11-2		0
WHF-S-IE-DPC	11-3	+0.000E+000	1
WHF-S-IE-DPC	11-4	+0.000E+000	1
WHF-S-IE-DPC	11-5	+0.000E+000	1
WHF-S-IE-DPC	11-6	1.323E-006	1
WHF-S-IE-DPC	11-7	1.298E-008	1
WHF-S-IE-DPC	12	2.439E-006	2
WHF-S-IE-DPC	13-2	+0.000E+000	1
WHF-S-IE-DPC	13-3		0
WHF-S-IE-DPC	13-4	+0.000E+000	1
WHF-S-IE-DPC	13-5	+0.000E+000	1
WHF-S-IE-DPC	13-6	3.218E-006	1
WHF-S-IE-DPC	13-7	3.064E-008	1
WHF-S-IE-DPC	14-2	8.366E-010	3
WHF-S-IE-DPC	14-3	+0.000E+000	1
WHF-S-IE-DPC	14-4	+0.000E+000	1
WHF-S-IE-DPC	14-5	1.265E-005	5
WHF-S-IE-DPC	14-6	1.726E-008	5
WHF-S-IE-DPC	15	3.621E-006	2
WHF-S-IE-DPC	16-2	+0.000E+000	1
WHF-S-IE-DPC	16-3		0
WHF-S-IE-DPC	16-4		0
WHF-S-IE-DPC	16-5	1.513E-005	1

Table D1.4-1. Sequence Level Results (Continued)

Event Tree	Sequence	Base Min. Cut	Base Cut Sets
WHF-S-IE-DPC	16-6	1.896E-007	1
WHF-S-IE-DPC	17-2	+0.000E+000	1
WHF-S-IE-DPC	17-3		0
WHF-S-IE-DPC	17-4		0
WHF-S-IE-DPC	17-5	6.942E-006	2
WHF-S-IE-DPC	17-6	3.159E-007	2
WHF-S-IE-DPC	18-2	+0.000E+000	1
WHF-S-IE-DPC	18-3		0
WHF-S-IE-DPC	18-4		0
WHF-S-IE-DPC	18-5	3.607E-007	2
WHF-S-IE-DPC	18-6	1.048E-008	2

Source: Original

D1.4.2 Cut Set Level Results by Sequence

Note that the SAPHIRE software does not provide special tables for seismic cut sets. Therefore, the “Cut Set %” given in the third column of this table is not correct for seismic events, although it does provide the approximate rank order for the cut sets.

Table D1.4-2. Cut Set Level Results by Sequence

Event Tree	Sequence	Cut Set %	Basic Event	Description
WHF-S-IE-DPC	03	100.00	050-DPC-STRUCTUR-ETF	ETF for DPC in WHF structure
			S-050-STR-COLLAPSE	Seismic collapse of WHF structure
			WHF-DPC-CAN	Number of DP canisters processed in WHF
			= Total	
04-2	100.00		050-DPC-ENTDOOR-ETF	ETF for entry door over DPC
			S-050-ENTDOORCOL	Seismic collapse of WHF entry door
			SHIELDING	Shielding remains intact
			WHF-DPC-CAN	Number of DP canisters processed in WHF
			= Total	
04-3	0.00		<FALSE>	System Generated Success Event
			= Total	
04-4	0.00		<FALSE>	System Generated Success Event
			= Total	
04-5	0.00		<FALSE>	System Generated Success Event
			= Total	
04-6	100.00		050-DPC-ENTDOOR-ETF	ETF for entry door over DPC
			050-DPC-ENTDOOR-PFA	Breach of DPC due to entry door collapse
			S-050-ENTDOORCOL	Seismic collapse of WHF entry door
			WHF-DPC-CAN	Number of DP canisters processed in WHF
			= Total	
04-7	100.00		050-DPC-ENTDOOR-ETF	ETF for entry door over DPC
			050-DPC-ENTDOOR-PFA	Breach of DPC due to entry door collapse
			MOD-ENTER-CANISTER	Flooding or spray enters canister
			S-050-ENTDOORCOL	Seismic collapse of WHF entry door
			S-050-PIPING-FAIL	Seismic failure of piping in accident area
			WHF-DPC-CAN	Number of DP canisters processed in WHF
			= Total	
05-2	100.00		050-DPC-RAILCAR-ETF	ETF for railcar carrying dual purpose canister
			S-050-RAILCAR-ACC	Seismic tipover or collision of railcar
			SHIELDING	Shielding remains intact
			WHF-DPC-CAN	Number of DP canisters processed in WHF
			= Total	
05-3	0.00		<FALSE>	System Generated Success Event
			= Total	
05-4	0.00		<FALSE>	System Generated Success Event
			= Total	
05-5	0.00		<FALSE>	System Generated Success Event
			= Total	

Table D1.4-2. Cut Set Level Results by Sequence (Continued)

Event Tree	Sequence	Cut Set %	Basic Event	Description
	05-6	100.00	050-DPC-RAILCAR-ETF	ETF for railcar carrying dual purpose canister
			050-DPC-RAILCAR-PFA	Breach of DPC due to railcar accident
			S-050-RAILCAR-ACC	Seismic tipover or collision of railcar
			WHF-DPC-CAN	Number of DP canisters processed in WHF
			= Total	
	05-7	100.00	050-DPC-RAILCAR-ETF	ETF for railcar carrying dual purpose canister
			050-DPC-RAILCAR-PFA	Breach of DPC due to railcar accident
			MOD-ENTER-CANISTER	Flooding or spray enters canister
			S-050-PIPING-FAIL	Seismic failure of piping in accident area
			S-050-RAILCAR-ACC	Seismic tipover or collision of railcar
			WHF-DPC-CAN	Number of DP canisters processed in WHF
			= Total	
	06-2	100.00	050-DPC-MOBPLAT-ETF	ETF for mobile platform over DPC
			S-050-MOBPLAT-COLLAP	Seismic collapse of WHF mobile platform
			SHIELDING	Shielding remains intact
			WHF-DPC-CAN	Number of DP canisters processed in WHF
			= Total	
	06-3	0.00	<FALSE>	System Generated Success Event
			= Total	
	06-4	0.00	<FALSE>	System Generated Success Event
			= Total	
	06-5	0.00	<FALSE>	System Generated Success Event
			= Total	
	06-6	100.00	050-DPC-MOBPLAT-ETF	ETF for mobile platform over DPC
			050-DPC-MOBPLAT-PFA	Breach of DPC due to mobile platform collapse
			S-050-MOBPLAT-COLLAP	Seismic collapse of WHF mobile platform
			WHF-DPC-CAN	Number of DP canisters processed in WHF
			= Total	
	06-7	100.00	050-DPC-MOBPLAT-ETF	ETF for mobile platform over DPC
			050-DPC-MOBPLAT-PFA	Breach of DPC due to mobile platform collapse
			MOD-ENTER-CANISTER	Flooding or spray enters canister
			S-050-MOBPLAT-COLLAP	Seismic collapse of WHF mobile platform
			S-050-PIPING-FAIL	Seismic failure of piping in accident area
			WHF-DPC-CAN	Number of DP canisters processed in WHF
			= Total	
	07-2	100.00	050-DPC-EVC-OBJ-ETF	ETF for EVC with heavy object over DPC
			S-050-EVC-OBJDROP	Seismic drop of heavy object by EVC
			SHIELDING	Shielding remains intact

Table D1.4-2. Cut Set Level Results by Sequence (Continued)

Event Tree	Sequence	Cut Set %	Basic Event	Description
			WHF-DPC-CAN	Number of DP canisters processed in WHF
			= Total	
	07-3	0.00	<FALSE>	System Generated Success Event
			= Total	
	07-4	0.00	<FALSE>	System Generated Success Event
			= Total	
	07-5	0.00	<FALSE>	System Generated Success Event
			= Total	
	07-6	99.61	050-DPC-EVC-COL-ETF	ETF for Entrance Vestibule Crane over DPC
			S-050-EVC-COLLAPSE	Seismic collapse of Entrance Vestibule Crane
			WHF-DPC-CAN	Number of DP canisters processed in WHF
		0.39	050-DPC-EVC-OBJ-ETF	ETF for EVC with heavy object over DPC
			050-DPC-EVC-OBJ-PFA	Breach of DPC due to EVC heavy object drop
			S-050-EVC-OBJDROP	Seismic drop of heavy object by EVC
			WHF-DPC-CAN	Number of DP canisters processed in WHF
			= Total	
	07-7	99.61	050-DPC-EVC-COL-ETF	ETF for Entrance Vestibule crane over DPC
			MOD-ENTER-CANISTER	Flooding or spray enters canister
			S-050-EVC-COLLAPSE	Seismic collapse of Entrance Vestibule crane
			S-050-PIPING-FAIL	Seismic failure of piping in accident area
			WHF-DPC-CAN	Number of DP canisters processed in WHF
		0.39	050-DPC-EVC-OBJ-ETF	ETF for EVC with heavy object over DPC
			050-DPC-EVC-OBJ-PFA	Breach of DPC due to EVC heavy object drop
			MOD-ENTER-CANISTER	Flooding or spray enters canister
			S-050-EVC-OBJDROP	Seismic drop of heavy object by EVC
			S-050-PIPING-FAIL	Seismic failure of piping in accident area
			WHF-DPC-CAN	Number of DP canisters processed in WHF
			= Total	
	08-2	92.26	050-DPC-CHCHOIST-ETF	ETF for CHC hoisting DPC
			S-050-CHC-SWING	Significant seismic swinging of CHC
			SHIELDING	Shielding remains intact
			WHF-DPC-CAN	Number of DP canisters processed in WHF
		5.39	050-DPC-CHCHOIST-ETF	ETF for CHC hoisting DPC
			S-050-CHC-HOIST	Seismic failure of CHC hoist
			SHIELDING	Shielding remains intact
			WHF-DPC-CAN	Number of DP canisters processed in WHF
		2.35	050-DPC-CHC-OBJ-ETF	ETF for CHC with heavy object over DPC

Table D1.4-2. Cut Set Level Results by Sequence (Continued)

Event Tree	Sequence	Cut Set %	Basic Event	Description
			S-050-CHC-OBJDROP	Seismic drop of heavy object by CHC
			SHIELDING	Shielding remains intact
			WHF-DPC-CAN	Number of DP canisters processed in WHF
			= Total	
	08-3	0.00	<FALSE>	System Generated Success Event
			= Total	
	08-4	0.00	<FALSE>	System Generated Success Event
			= Total	
	08-5	0.00	<FALSE>	System Generated Success Event
			= Total	
	08-6	99.91	050-DPC-CHC-COL-ETF	ETF for CHC over DPC
			S-050-CHC-COLLAPSE	Seismic collapse of CHC
			WHF-DPC-CAN	Number of DP canisters processed in WHF
		0.09	050-DPC-CHCHOIST-ETF	ETF for CHC hoisting DPC
			050-DPC-CHCSWING-PFA	Breach of DPC due to CHC load swinging
			S-050-CHC-SWING	Significant seismic swinging of CHC
			WHF-DPC-CAN	Number of DP canisters processed in WHF
		0.01	050-DPC-CHCHOIST-ETF	ETF for CHC hoisting DPC
			050-DPC-CHCHOIST-PFA	Breach of DPC due to CHC hoist drop
			S-050-CHC-HOIST	Seismic failure of CHC hoist
			WHF-DPC-CAN	Number of DP canisters processed in WHF
		0.00	050-DPC-CHC-OBJ-ETF	ETF for CHC with heavy object over DPC
			050-DPC-CHC-OBJ-PFA	Breach of DPC due to CHC heavy object drop
			S-050-CHC-OBJDROP	Seismic drop of heavy object by CHC
			WHF-DPC-CAN	Number of DP canisters processed in WHF
			= Total	
	08-7	99.91	050-DPC-CHC-COL-ETF	ETF for CHC over DPC
			MOD-ENTER-CANISTER	Flooding or spray enters canister
			S-050-CHC-COLLAPSE	Seismic collapse of CHC
			S-050-PIPING-FAIL	Seismic failure of piping in accident area
			WHF-DPC-CAN	Number of DP canisters processed in WHF
		0.09	050-DPC-CHCHOIST-ETF	ETF for CHC hoisting DPC
			050-DPC-CHCSWING-PFA	Breach of DPC due to CHC load swinging
			MOD-ENTER-CANISTER	Flooding or spray enters canister
			S-050-CHC-SWING	Significant seismic swinging of CHC
			S-050-PIPING-FAIL	Seismic failure of piping in accident area
			WHF-DPC-CAN	Number of DP canisters processed in WHF
		0.01	050-DPC-CHCHOIST-ETF	ETF for CHC hoisting DPC
			050-DPC-CHCHOIST-PFA	Breach of DPC due to CHC hoist drop
			MOD-ENTER-CANISTER	Flooding or spray enters canister

Table D1.4-2. Cut Set Level Results by Sequence (Continued)

Event Tree	Sequence	Cut Set %	Basic Event	Description
			S-050-CHC-HOIST	Seismic failure of CHC hoist
			S-050-PIPING-FAIL	Seismic failure of piping in accident area
			WHF-DPC-CAN	Number of DP canisters processed in WHF
		0.00	050-DPC-CHC-OBJ-ETF	ETF for CHC with heavy object over DPC
			050-DPC-CHC-OBJ-PFA	Breach of DPC due to CHC heavy object drop
			MOD-ENTER-CANISTER	Flooding or spray enters canister
			S-050-CHC-OBJDROP	Seismic drop of heavy object by CHC
			S-050-PIPING-FAIL	Seismic failure of piping in accident area
			WHF-DPC-CAN	Number of DP canisters processed in WHF
			= Total	
	09-2	100.00	050-DPC-CSTAND-ETF	ETF for DPC on cask stand
			S-050-CSTAND-TIP	Seismic tipover of horizontal cask stand
			SHIELDING	Shielding remains intact
			WHF-DPC-CAN	Number of DP canisters processed in WHF
			= Total	
	09-3	0.00	<FALSE>	System Generated Success Event
			= Total	
	09-4	0.00	<FALSE>	System Generated Success Event
			= Total	
	09-5	0.00	<FALSE>	System Generated Success Event
			= Total	
	09-6	100.00	050-DPC-CSTAND-ETF	ETF for DPC on cask stand
			050-DPC-CSTAND-PFA	Breach of DPC due to cask stand tipover
			S-050-CSTAND-TIP	Seismic tipover of horizontal cask stand
			WHF-DPC-CAN	Number of DP canisters processed in WHF
			= Total	
	09-7	100.00	050-DPC-CSTAND-ETF	ETF for DPC on cask stand
			050-DPC-CSTAND-PFA	Breach of DPC due to cask stand tipover
			MOD-ENTER-CANISTER	Flooding or spray enters canister
			S-050-CSTAND-TIP	Seismic tipover of horizontal cask stand
			S-050-PIPING-FAIL	Seismic failure of piping in accident area
			WHF-DPC-CAN	Number of DP canisters processed in WHF
			= Total	
	10-2	100.00	050-DPC-CTT-BUMP-ETF	ETF for CTT with TC subject to bumping EAF
			S-050-CTT-BUMPING	Seismic bumping of CTT into EAF
			SHIELDING	Shielding remains intact
			WHF-DPC-CAN	Number of DP canisters processed in WHF
			= Total	
	10-3	0.00	<FALSE>	System Generated Success Event
			= Total	

Table D1.4-2. Cut Set Level Results by Sequence (Continued)

Event Tree	Sequence	Cut Set %	Basic Event	Description
	10-4	0.00	<FALSE>	System Generated Success Event
			= Total	
	10-5	0.00	<FALSE>	System Generated Success Event
			= Total	
	10-6	97.00	050-DPC-CTTSLIDE-ETF	ETF for CTT containing DPC in transfer cell
			S-050-CTT-SLIDE	Seismic sliding of CTT into wall
			WHF-DPC-CAN	Number of DP canisters processed in WHF
		3.00	050-DPC-CTT-ROCK-ETF	ETF for CTT with DPC subject to rocking
			S-050-CTT-ROCKING	Seismic rocking of CTT with restraint failure
			WHF-DPC-CAN	Number of DP canisters processed in WHF
		0.00	050-DPC-CTT-BUMP-ETF	ETF for CTT with TC subject to bumping EAF
			050-DPC-CTT-BUMP-PFA	Breach given CTT with TC subject to bumping EAF
			S-050-CTT-BUMPING	Seismic bumping of CTT into EAF
			WHF-DPC-CAN	Number of DP canisters processed in WHF
			= Total	
	10-7	97.00	050-DPC-CTTSLIDE-ETF	ETF for CTT containing DPC in transfer cell
			MOD-ENTER-CANISTER	Flooding or spray enters canister
			S-050-CTT-SLIDE	Seismic sliding of CTT into wall
			S-050-PIPING-FAIL	Seismic failure of piping in accident area
			WHF-DPC-CAN	Number of DP canisters processed in WHF
		3.00	050-DPC-CTT-ROCK-ETF	ETF for CTT with DPC subject to rocking
			MOD-ENTER-CANISTER	Flooding or spray enters canister
			S-050-CTT-ROCKING	Seismic rocking of CTT with restraint failure
			S-050-PIPING-FAIL	Seismic failure of piping in accident area
			WHF-DPC-CAN	Number of DP canisters processed in WHF
		0.00	050-DPC-CTT-BUMP-ETF	ETF for CTT with TC subject to bumping EAF
			050-DPC-CTT-BUMP-PFA	Breach given CTT with TC subject to bumping EAF
			MOD-ENTER-CANISTER	Flooding or spray enters canister
			S-050-CTT-BUMPING	Seismic bumping of CTT into EAF
			S-050-PIPING-FAIL	Seismic failure of piping in accident area
			WHF-DPC-CAN	Number of DP canisters processed in WHF
			= Total	
	11-2			
	11-3	0.00	<FALSE>	System Generated Success Event
			= Total	
	11-4	0.00	<FALSE>	System Generated Success Event
			= Total	

Table D1.4-2. Cut Set Level Results by Sequence (Continued)

Event Tree	Sequence	Cut Set %	Basic Event	Description
	11-5	0.00	<FALSE>	System Generated Success Event
			= Total	
	11-6	100.00	050-DPC-PS1-ETF	ETF for DPC under prep station #1
			S-050-PS1-COLLAPSE	Seismic collapse of prep station 1
			WHF-DPC-CAN	Number of DP canisters processed in WHF
			= Total	
	11-7	100.00	050-DPC-PS1-ETF	ETF for DPC under prep station #1
			MOD-ENTER-CANISTER	Flooding or spray enters canister
			S-050-PIPING-FAIL	Seismic failure of piping in accident area
			S-050-PS1-COLLAPSE	Seismic collapse of prep station 1
			WHF-DPC-CAN	Number of DP canisters processed in WHF
			= Total	
	12	88.43	050-DPC-JIBC-OBJ-ETF	ETF for Jib Crane with heavy object over DPC
			S-050-JIBC-OBJDROP	Seismic drop of heavy object by Jib Crane
			WHF-DPC-CAN	Number of DP canisters processed in WHF
		11.57	050-DPC-JIBC-COL-ETF	ETF for JIBC over DPC
			S-050-JIBC-COLLAPSE	Seismic collapse of jib crane
			WHF-DPC-CAN	Number of DP canisters processed in WHF
			= Total	
	13-2	0.00	<FALSE>	System Generated Success Event
			= Total	
	13-3			
	13-4	0.00	<FALSE>	System Generated Success Event
			= Total	
	13-5	0.00	<FALSE>	System Generated Success Event
			= Total	
	13-6	100.00	050-DPC-SHIELDDR-ETF	ETF for shield doors when DPC is nearby
			S-050-SHIELDDOOR	Seismic falling of shield door
			WHF-DPC-CAN	Number of DP canisters processed in WHF
			= Total	
	13-7	100.00	050-DPC-SHIELDDR-ETF	ETF for shield doors when DPC is nearby
			MOD-ENTER-CANISTER	Flooding or spray enters canister
			S-050-PIPING-FAIL	Seismic failure of piping in accident area
			S-050-SHIELDDOOR	Seismic falling of shield door
			WHF-DPC-CAN	Number of DP canisters processed in WHF
			= Total	
	14-2	94.34	050-DPC-CTMSWGIB-ETF	ETF for CTM hoisting DPC inside bell
			S-050-CTMSWG-IB	Significant swinging of canister inside CTM bell
			SHIELDING	Shielding remains intact
			WHF-DPC-CAN	Number of DP canisters processed in WHF

Table D1.4-2. Cut Set Level Results by Sequence (Continued)

Event Tree	Sequence	Cut Set %	Basic Event	Description
		5.51	050-DPC-CTMHOIST-ETF	ETF for CTM hoisting DPC
			S-050-CTM-HOIST	Seismic drop of DPC hoisted by CTM
			SHIELDING	Shielding remains intact
			WHF-DPC-CAN	Number of DP canisters processed in WHF
		0.15	050-DPC-CTM-OBJ-ETF	ETF for CTM with heavy object over DPC
			S-050-CTM-OBJDROP	Seismic drop of heavy object by CTM
			SHIELDING	Shielding remains intact
			WHF-DPC-CAN	Number of DP canisters processed in WHF
			= Total	
	14-3	0.00	<FALSE>	System Generated Success Event
			= Total	
	14-4	0.00	<FALSE>	System Generated Success Event
			= Total	
	14-5	80.85	050-DPC-CTMSWGOB-ETF	ETF for CTM hoisting DPC outside bell
			S-050-CTMSWG-OB	Significant swinging of canister outside CTM bell
			WHF-DPC-CAN	Number of DP canisters processed in WHF
		19.14	050-DPC-CTM-COL-ETF	ETF for CTM over DPC
			S-050-CTM-COLLAPSE	Seismic collapse of CTM (bridge girder)
			WHF-DPC-CAN	Number of DP canisters processed in WHF
		0.02	050-DPC-CTMSWGIB-ETF	ETF for CTM hoisting DPC inside bell
			050-DPC-CTMSWGIB-PFA	Breach of DPC due to swing inside bell
			S-050-CTMSWG-IB	Significant swinging of canister inside CTM bell
			WHF-DPC-CAN	Number of DP canisters processed in WHF
		0.00	050-DPC-CTMHOIST-ETF	ETF for CTM hoisting DPC
			050-DPC-CTMHOIST-PFA	Breach of naval canister dropped by CTM
			S-050-CTM-HOIST	Seismic drop of DPC hoisted by CTM
			WHF-DPC-CAN	Number of DP canisters processed in WHF
		0.00	050-DPC-CTM-OBJ-ETF	ETF for CTM with heavy object over DPC
			050-DPC-CTM-OBJ-PFA	Breach of DPC due to CTM object drop
			S-050-CTM-OBJDROP	Seismic drop of heavy object by CTM
			WHF-DPC-CAN	Number of DP canisters processed in WHF
			= Total	
	14-6	80.83	050-DPC-CTMSWGOB-ETF	ETF for CTM hoisting DPC outside bell
			MOD-ENTER-CANISTER	Flooding or spray enters canister
			S-050-CTMSWG-OB	Significant swinging of canister outside CTM bell
			S-050-FPW-V-SO	Spurious opening of FPW pre-action valve (relay chatter)
			S-050-PIPING-FAIL	Seismic failure of piping in accident area
			WHF-DPC-CAN	Number of DP canisters processed in WHF

Table D1.4-2. Cut Set Level Results by Sequence (Continued)

Event Tree	Sequence	Cut Set %	Basic Event	Description
		19.14	050-DPC-CTM-COL-ETF	ETF for CTM over DPC
			MOD-ENTER-CANISTER	Flooding or spray enters canister
			S-050-CTM-COLLAPSE	Seismic collapse of CTM (bridge girder)
			S-050-FPW-V-SO	Spurious opening of FPW pre-action valve (relay chatter)
			S-050-PIPING-FAIL	Seismic failure of piping in accident area
			WHF-DPC-CAN	Number of DP canisters processed in WHF
		0.02	050-DPC-CTMSWGIB-ETF	ETF for CTM hoisting DPC inside bell
			050-DPC-CTMSWGIB-PFA	Breach of DPC due to swing inside bell
			MOD-ENTER-CANISTER	Flooding or spray enters canister
			S-050-CTMSWG-IB	Significant swinging of canister inside CTM bell
			S-050-FPW-V-SO	Spurious opening of FPW pre-action valve (relay chatter)
			S-050-PIPING-FAIL	Seismic failure of piping in accident area
			WHF-DPC-CAN	Number of DP canisters processed in WHF
		0.00	050-DPC-CTMHOIST-ETF	ETF for CTM hoisting DPC
			050-DPC-CTMHOIST-PFA	Breach of naval canister dropped by CTM
			MOD-ENTER-CANISTER	Flooding or spray enters canister
			S-050-CTM-HOIST	Seismic drop of DPC hoisted by CTM
			S-050-FPW-V-SO	Spurious opening of FPW pre-action valve (relay chatter)
			S-050-PIPING-FAIL	Seismic failure of piping in accident area
			WHF-DPC-CAN	Number of DP canisters processed in WHF
		0.00	050-DPC-CTM-OBJ-ETF	ETF for CTM with heavy object over DPC
			050-DPC-CTM-OBJ-PFA	Breach of DPC due to CTM object drop
			MOD-ENTER-CANISTER	Flooding or spray enters canister
			S-050-CTM-OBJDROP	Seismic drop of heavy object by CTM
			S-050-FPW-V-SO	Spurious opening of FPW pre-action valve (relay chatter)
			S-050-PIPING-FAIL	Seismic failure of piping in accident area
			WHF-DPC-CAN	Number of DP canisters processed in WHF
			= Total	
	15	99.93	050-DPC-CUTS-ETF	ETF for DPC under cutting station
			S-050-CUTS-COLLAPSE	Seismic collapse of cutting station
			WHF-DPC-CAN	Number of DP canisters processed in WHF
		0.07	050-DPC-CSFR-ETF	ETF for DPC in cask support frame-plat up
			050-DPC-CSFR-PFA	Breach of DPC if cask support frame fails
			S-050-CSFR-FAIL	Seismic failure of cask support frame
			WHF-DPC-CAN	Number of DP canisters processed in WHF
			= Total	

Table D1.4-2. Cut Set Level Results by Sequence (Continued)

Event Tree	Sequence	Cut Set %	Basic Event	Description
	16-2	0.00	<FALSE>	System Generated Success Event
			= Total	
	16-3			
	16-4			
	16-5	100.00	050-DPC-DPCTS-ETF	ETF for DPC at DPC trans station
			S-050-DPCTS-COLLAPSE	Seismic collapse of DPC transfer station
			WHF-DPC-CAN	Number of DP canisters processed in WHF
			= Total	
	16-6	100.00	050-DPC-DPCTS-ETF	ETF for DPC at DPC trans station
			S-050-DPCTS-COLLAPSE	Seismic collapse of DPC transfer station
			S-050-POOL-FAIL	Seismic failure of WHF pool
			WHF-DPC-CAN	Number of DP canisters processed in WHF
			= Total	
	17-2	0.00	<FALSE>	System Generated Success Event
			= Total	
	17-3			
	17-4			
	17-5	71.48	050-DPC-APC-OBJ-ETF	ETF for APC with heavy object over DPC
			S-050-APC-OBJDROP	Seismic drop of heavy object by Aux Pool Crane
			WHF-DPC-CAN	Number of DP canisters processed in WHF
		28.52	050-DPC-APC-COL-ETF	ETF for aux pool crane over DPC
			S-050-APC-COLLAPSE	Seismic collapse of aux pool crane
			WHF-DPC-CAN	Number of DP canisters processed in WHF
			= Total	
	17-6	71.47	050-DPC-APC-OBJ-ETF	ETF for APC with heavy object over DPC
			S-050-APC-OBJDROP	Seismic drop of heavy object by aux pool crane
			S-050-POOL-FAIL	Seismic failure of WHF pool
			WHF-DPC-CAN	Number of DP canisters processed in WHF
		28.52	050-DPC-APC-COL-ETF	ETF for aux pool crane over DPC
			S-050-APC-COLLAPSE	Seismic collapse of aux pool crane
			S-050-POOL-FAIL	Seismic failure of WHF pool
			WHF-DPC-CAN	Number of DP canisters processed in WHF
			= Total	
	18-2	0.00	<FALSE>	System Generated Success Event
			= Total	
	18-3			
	18-4			
	18-5	76.52	050-DPC-SFTM-COL-ETF	ETF for SFTM over DPC
			S-050-SFTM-COLLAPSE	Seismic collapse of spent fuel transfer machine

Table D1.4-2. Cut Set Level Results by Sequence (Continued)

Event Tree	Sequence	Cut Set %	Basic Event	Description
			WHF-DPC-CAN	Number of DP canisters processed in WHF
		23.48	050-DPC-SFTM-OBJ-ETF	ETF for SFTM with heavy object over DPC
			S-050-SFTM-OBJDROP	Seismic drop of heavy object by SFTM
			WHF-DPC-CAN	Number of DP canisters processed in WHF
			= Total	
	18-6	76.45	050-DPC-SFTM-COL-ETF	ETF for SFTM over DPC
			S-050-POOL-FAIL	Seismic failure of WHF pool
			S-050-SFTM-COLLAPSE	Seismic collapse of Spent Fuel Transfer Machine
			WHF-DPC-CAN	Number of DP canisters processed in WHF
		23.46	050-DPC-SFTM-OBJ-ETF	ETF for SFTM with heavy object over DPC
			S-050-POOL-FAIL	Seismic failure of WHF pool
			S-050-SFTM-OBJDROP	Seismic drop of heavy object by SFTM
			WHF-DPC-CAN	Number of DP canisters processed in WHF
			= Total	

NOTE: APC = auxiliary pool crane; CHC = cask handling crane; CTM = canister transfer machine; CTT = cask transfer trolley; DPC = dual-purpose canister; EAF = energy absorbing feature; ETF = exposure time factor; EVC = Entrance Vestibule crane; FPW = fire protection water; SFTM = spent fuel transfer machine; WHF = Wet Handling Facility.

Source: Original

D2 BARE (WHF-BARE)

This section provides the detailed information used to develop the event sequences for the analysis of processing of the bare spent fuel inside the WHF. Transportation casks filled with bare spent fuel are received on trucks, are opened, and then placed in the pool.

D2.1 EVENT TREES

The IET and SRETs are presented in this section. The tables provide the assignments between the event tree branches and the fault trees given in the next section.

Seismic Event	Number of TCs with bare SNF processed in WHF	Identify initiating seismic failure		
SEIS-EVENT	WHF-BARE-CASK	SEIS-FAIL	#	END-STATE
			1	OK
		WHF building collapse	2	OK
		Entry door seismic collapse	3	RR-UNF
		Truck tipover	4	T => 2 WHF-S-R-TC1
		Mobile platform seismic collapse	5	T => 2 WHF-S-R-TC1
		Entrance Vestibule Crane	6	T => 2 WHF-S-R-TC1
		CHC seismic failures	7	T => 2 WHF-S-R-TC1
		CTT seismic failures	8	T => 2 WHF-S-R-TC1
		Preparation station #1 collapse	9	T => 2 WHF-S-R-TC1
		Jib cranes seismic failures	10	T => 2 WHF-S-R-TC1
		Shield door seismic failure	11	T => 2 WHF-S-R-TC1
		TC transfer stations	12	T => 2 WHF-S-R-TC1
		Auxiliary pool crane	13	T => 3 WHF-S-R-POOL
		Spent fuel transfer machine	14	T => 3 WHF-S-R-POOL
			15	T => 3 WHF-S-R-POOL

WHF-S-IE-BARE - WHF Seismic Event Tree - Initiating seismic failures - Bare SNF 2007/12/19 WHF-Bare 1

NOTE: Event tree branch captions are associated with the branch line below the caption.

CHC = cask handling crane; CTM = canister transfer machine; CTT = cask transfer trolley; IE = initiating event; RR = radioactive release; SEIS = seismic; SNF = spent nuclear fuel; TC = transportation cask; UNF = unfiltered; WHF = Wet Handling Facility.

Source: Original

Figure D2.1-1. WHF Seismic Event Tree WHF-S-IE-BARE – Initiating Seismic Failures – Bare SNF

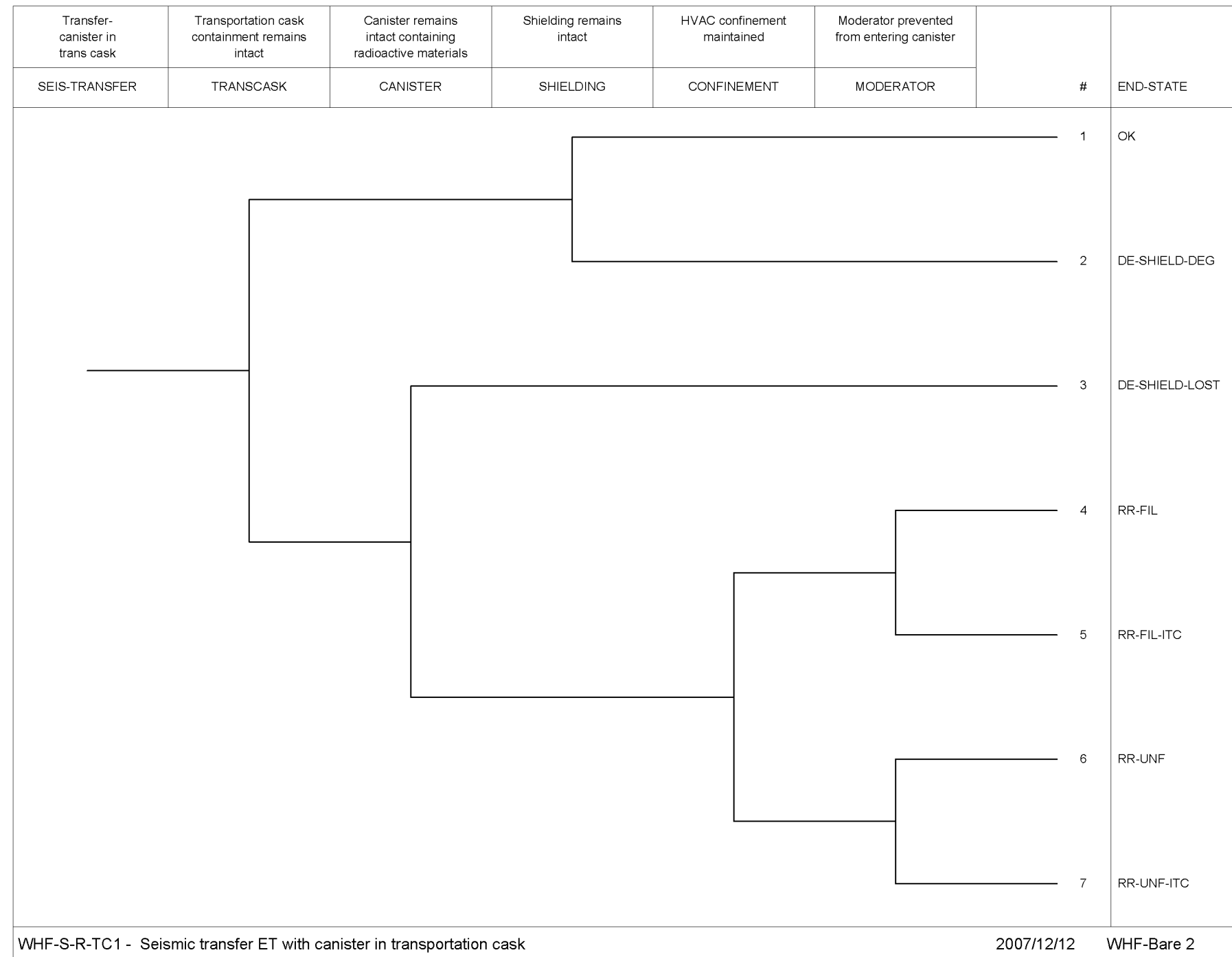

NOTE: DE = direct exposure; DEG = degradation; ET = event tree; FIL = filtered; HVAC = heating, ventilation and air conditioning; ITC = important to criticality; RR = radioactive release; SEIS = seismic; TC = transportation cask; UNF = unfiltered; WHF = Wet Handling Facility.

Source: Original

Figure D2.1-2. WHF Seismic Event Tree WHF-S-R-TC1 – Seismic Transfer ET with Canister in Transportation Cask

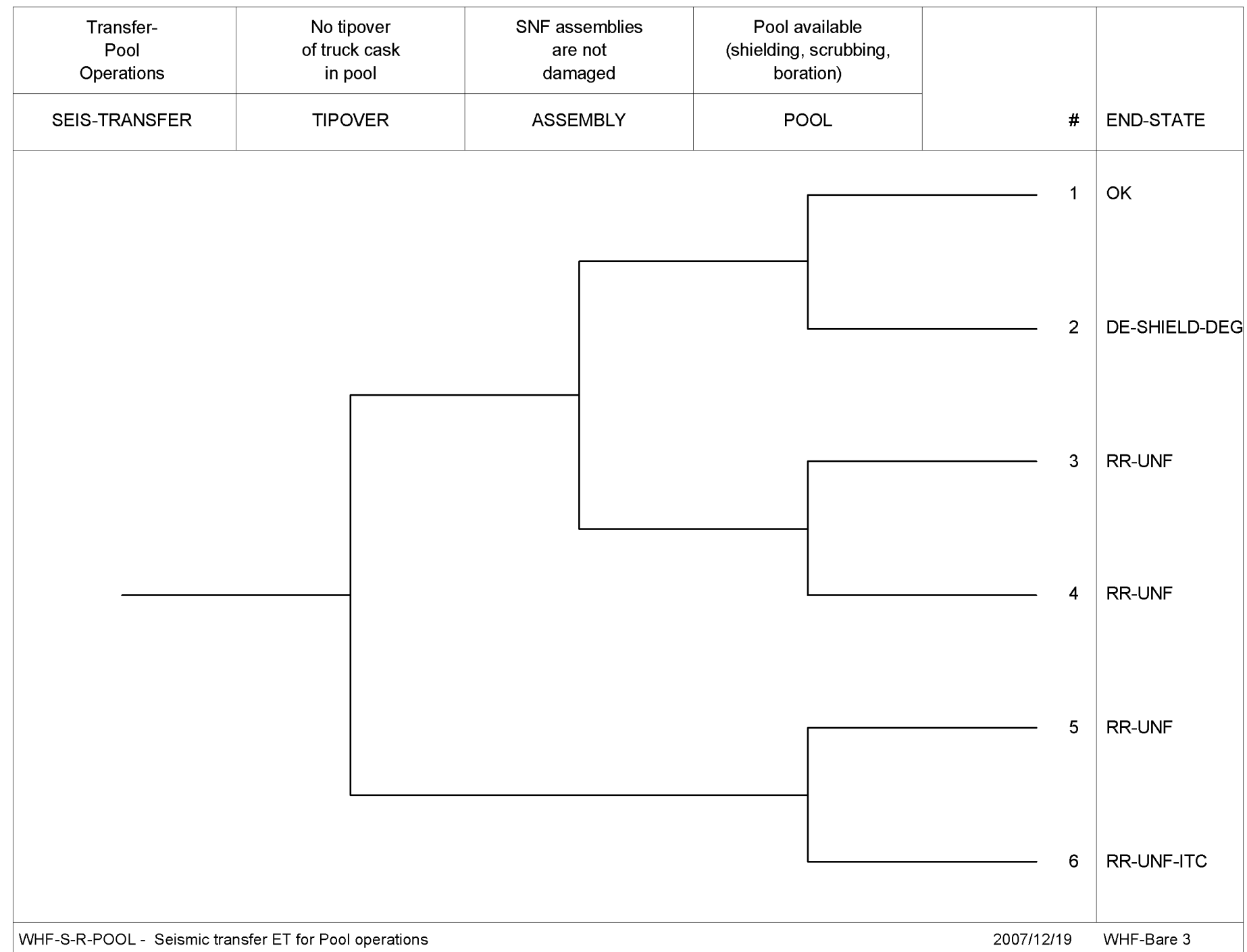

NOTE: DE = direct exposure; DEG = degradation; ET = event tree; ITC = important to criticality; RR = radioactive release; SEIS = seismic; SNF = spent nuclear fuel; WHF = Wet Handling Facility.

Source: Original

Figure D2.1-3. WHF Seismic Event Tree WHF-S-R-POOL – Seismic Transfer ET for Pool Operations

Table D2.1-1. Fault Trees Assigned for Initiating Seismic Failures for the WHF

Process	Initiator Event Tree	Initiating Seismic Failure	Associated Fault Tree
Bare SNF	WHF-S-IE-BARE	WHF building collapse	S-050-BARE-STR-COLLAP
		Entry door collapse	S-050-BARE-ENTDOORCOL
		Truck tipover	S-050-BARE-TRUCK-TIP
		Mobile platform seismic collapse	S-050-BARE-MOBPLATCOL
		Entrance Vestibule crane	S-050-BARE-EVC-FAIL
		CHC seismic failures	S-050-BARE-CHC-FAIL
		CTT seismic failures	S-050-BARE-CTT-FAIL
		Preparation station #1 collapse	S-050-BARE-PS1-COL
		Jib cranes seismic failure	S-050-BARE-JIBC-FAIL
		Shield door seismic failure	S-050-BARE-SHIELDDOOR
		TC transfer stations	S-050-BARE-TCTS-COL
		Auxiliary pool crane	S-050-BARE-APC-FAIL
		Spent fuel transfer machine	S-050-DPC-SFTM-FAIL

NOTE: CHC = cask handling crane; CTT = cask transfer trolley; IE = initiating event; SNF = spent nuclear fuel; TC = transportation cask; WHF = Wet Handling Facility.

Source: Original

Table D2.1-2. Fault Trees Assigned for Pivotal Events for WHF-S-IE-BARE Initiating Event Tree

Initiating Seismic Failure	TRANSCASK	MODERATOR
WHF building collapse	N/A	N/A
Entry door collapse	RC-BARE-DOORDROP-CASK	WHF-MOD-MULT-SYS
Truck tipover	RC-BARE-TRUCK-CASK	WHF-MOD-MULT-SYS
Mobile platform seismic collapse	RC-BARE-MOB-PLAT-CASK	WHF-MOD-MULT-SYS
Entrance Vestibule crane	TC-BARE-EVC-CASK	WHF-MOD-MULT-SYS
CHC seismic failures	TC-BARE-CHC-CASK	WHF-MOD-MULT-SYS
CTT seismic failures	CTT-BARE-CTT-CASK	WHF-MOD-MULT-SYS
Preparation station #1 collapse	STC-BARE-PS1-CASK	WHF-MOD-MULT-SYS
Jib cranes seismic failure	STC-BARE-JIBC-CASK	WHF-MOD-MULT-SYS
Shield door seismic failure	TCWP-BARE-SHIELDDOOR	WHF-MOD-MULT-SYS
	TIPOVER	POOL
TC transfer stations	STC-BARE-TCTS-COL	WHF-POOL-FAIL
Auxiliary pool crane	STC-BARE-APC-FAIL	WHF-POOL-FAIL
Spent fuel transfer machine	STC-BARE-SFTM-FAIL	WHF-POOL-FAIL

NOTE: CHC = cask handling crane; CTT = cask transfer trolley; TC = transportation cask; WHF = Wet Handling Facility.

Source: Original

D2.2 FAULT TREES

Seismic fault trees for the processing of bare spent fuel in the WHF are presented in alpha-numeric order in this section.

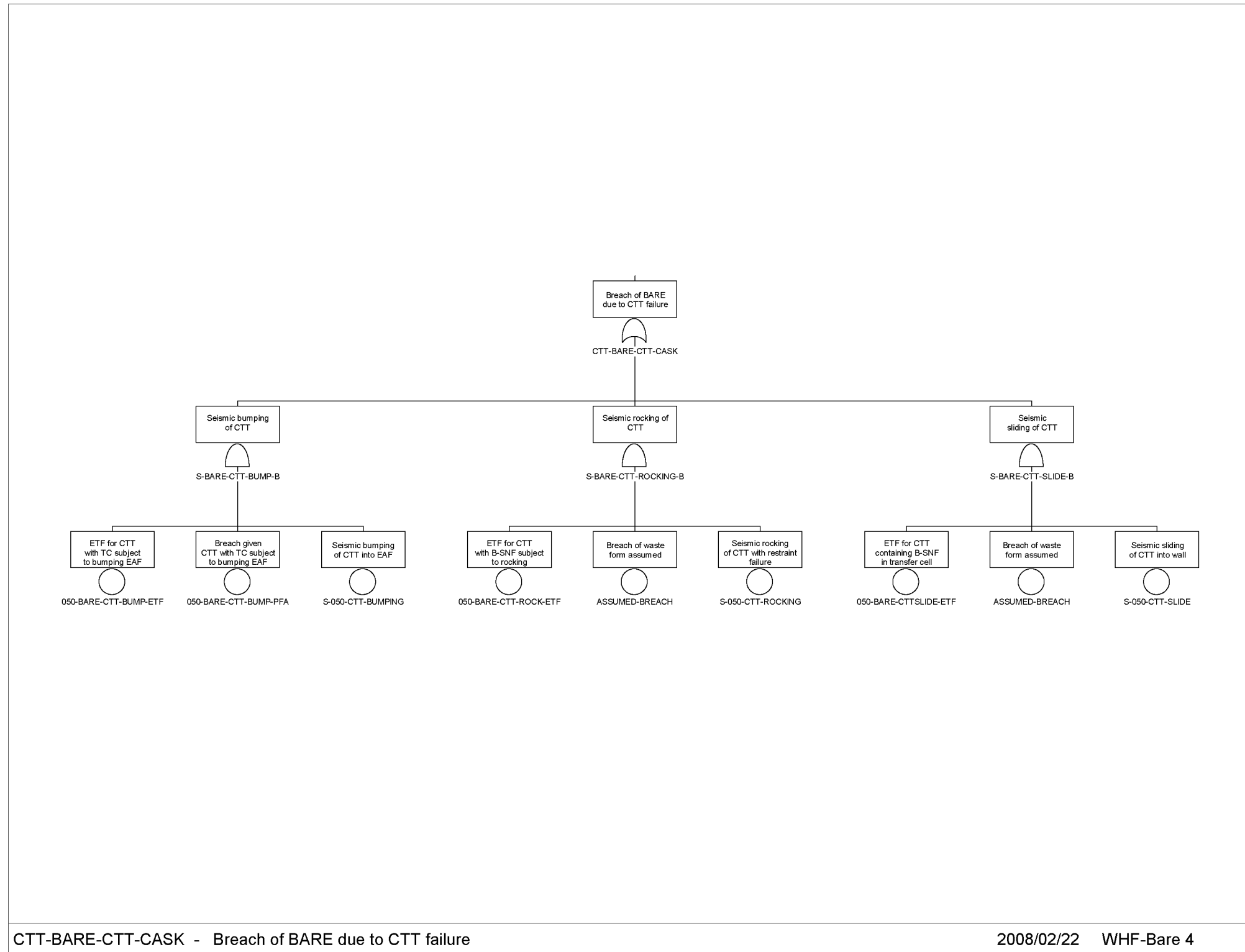

Source: Original

Figure D2.2-1. Fault Tree CTT-BARE-CTT-CASK – Breach of BARE due to CTT Failure

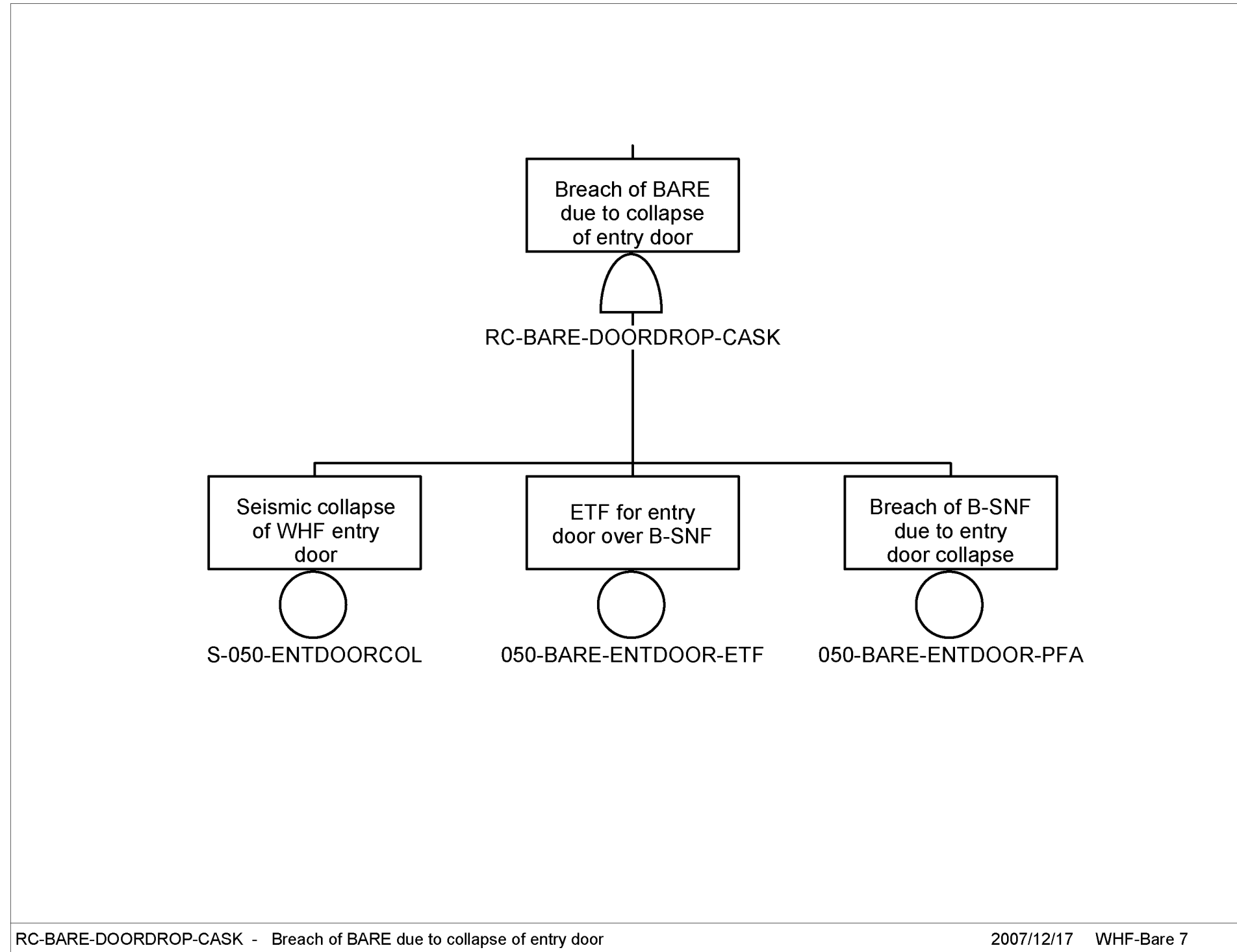

Source: Original

Figure D2.2-2. RC-BARE-DOORDROP-CASK
– Breach of BARE due to
Collapse of Entry Door

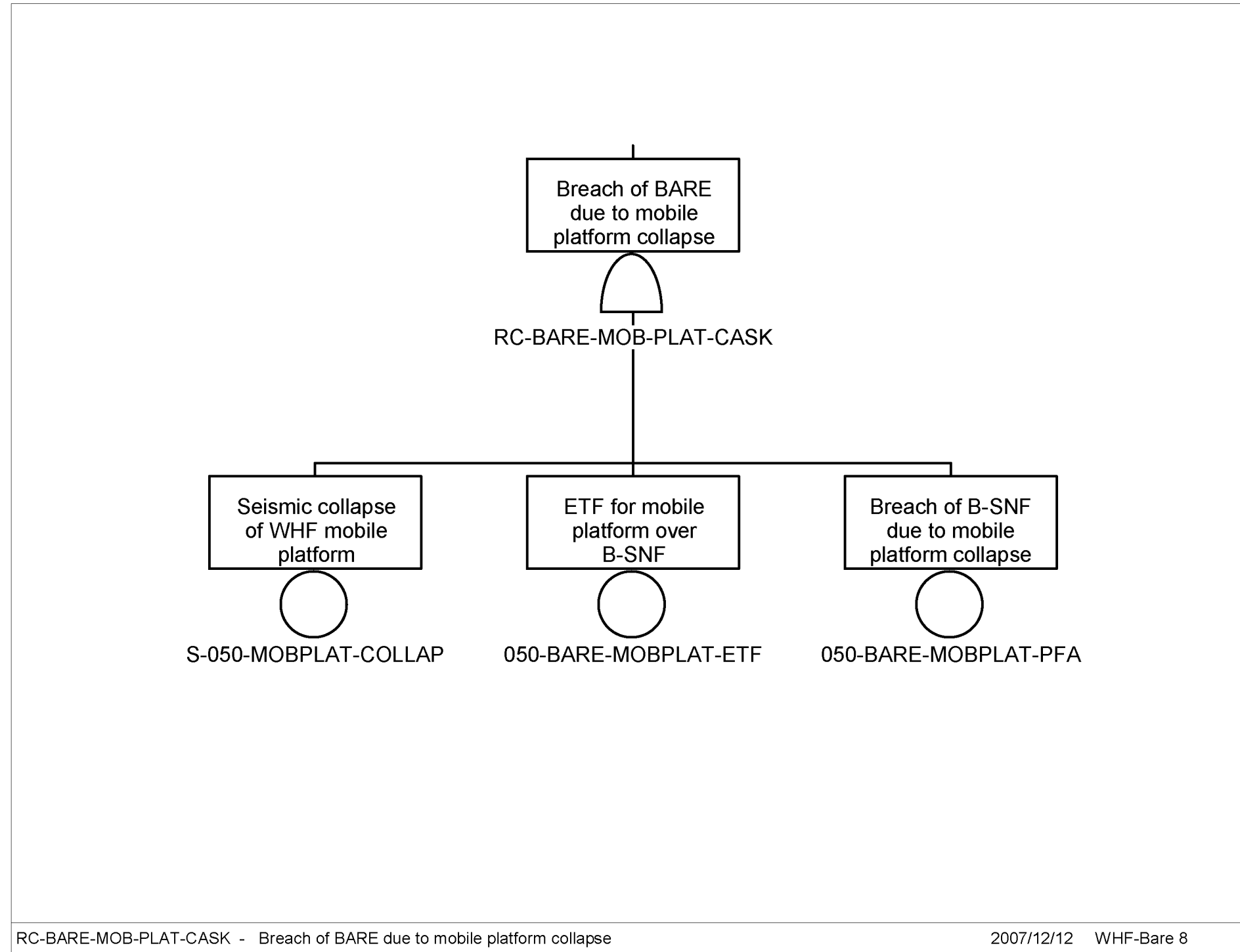

Source: Original

Figure D2.2-3 RC-BARE-MOB-PLAT-CASK – Breach of BARE due to Mobile Platform Collapse

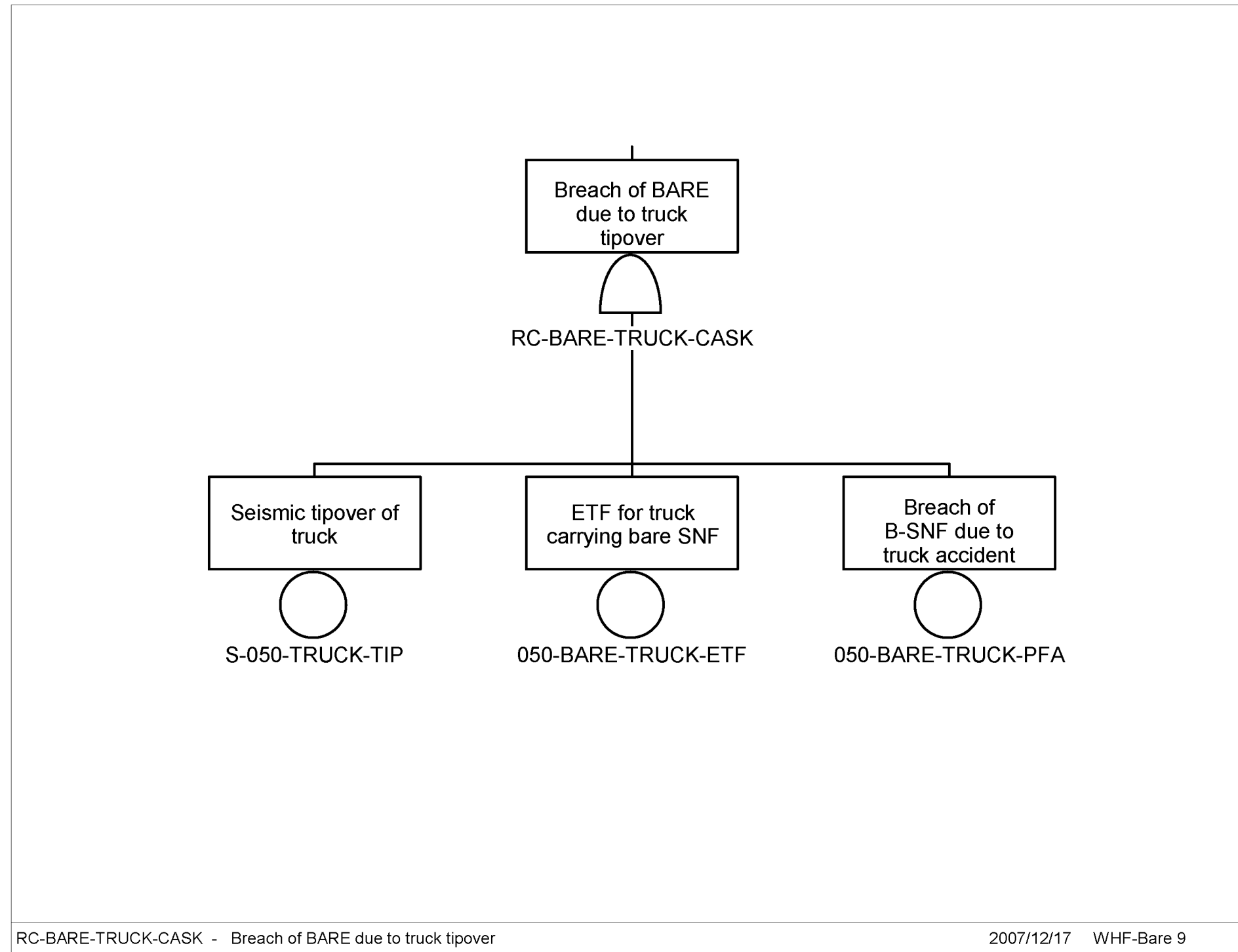

Source: Original

Figure D2.2-4. RC-BARE-TRUCK-CASK – Breach of BARE due to Truck Tipover

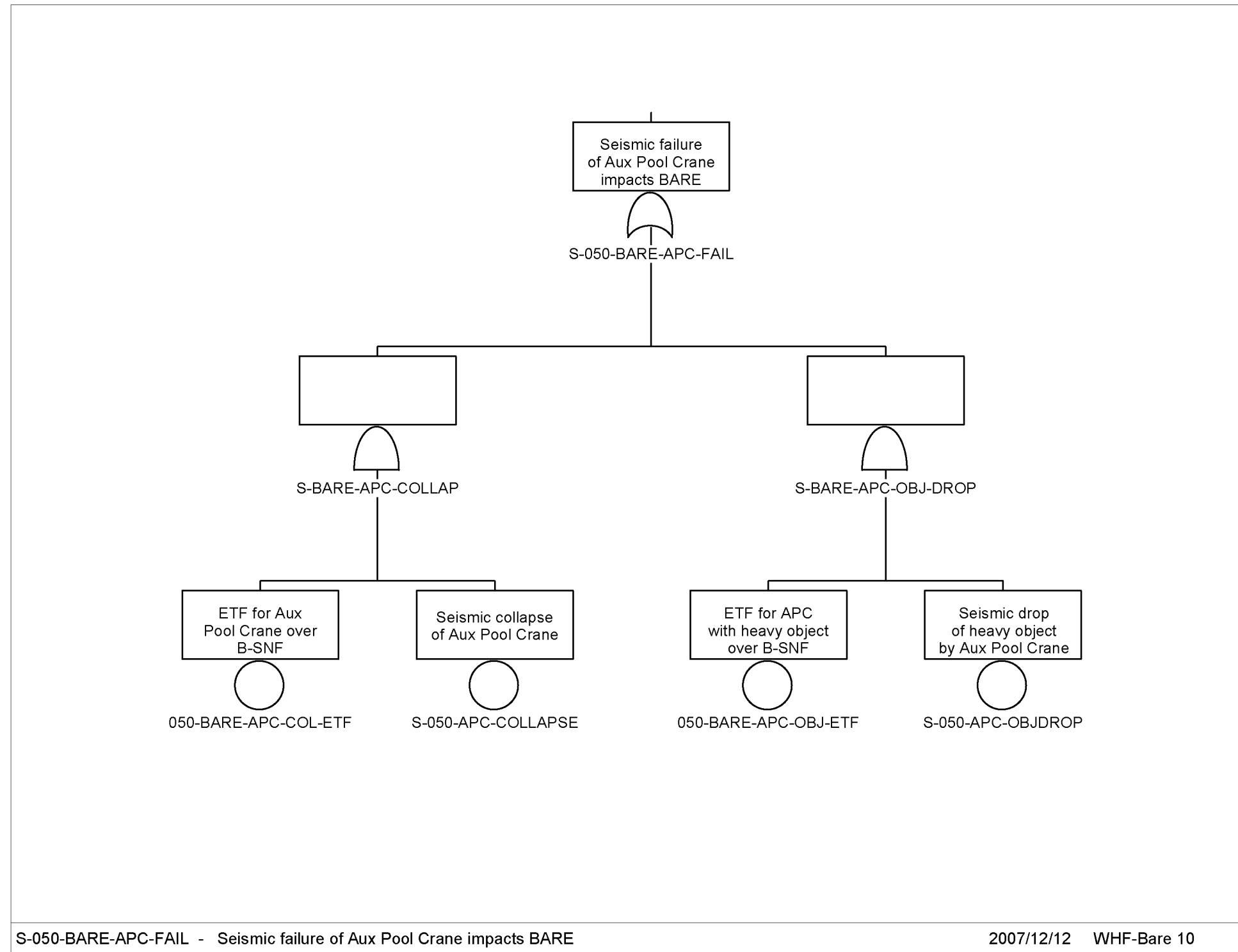

Source: Original

Figure D2.2-5. S-050-BARE-APC-FAIL – Seismic Failure of Aux Pool Crane Impacts BARE

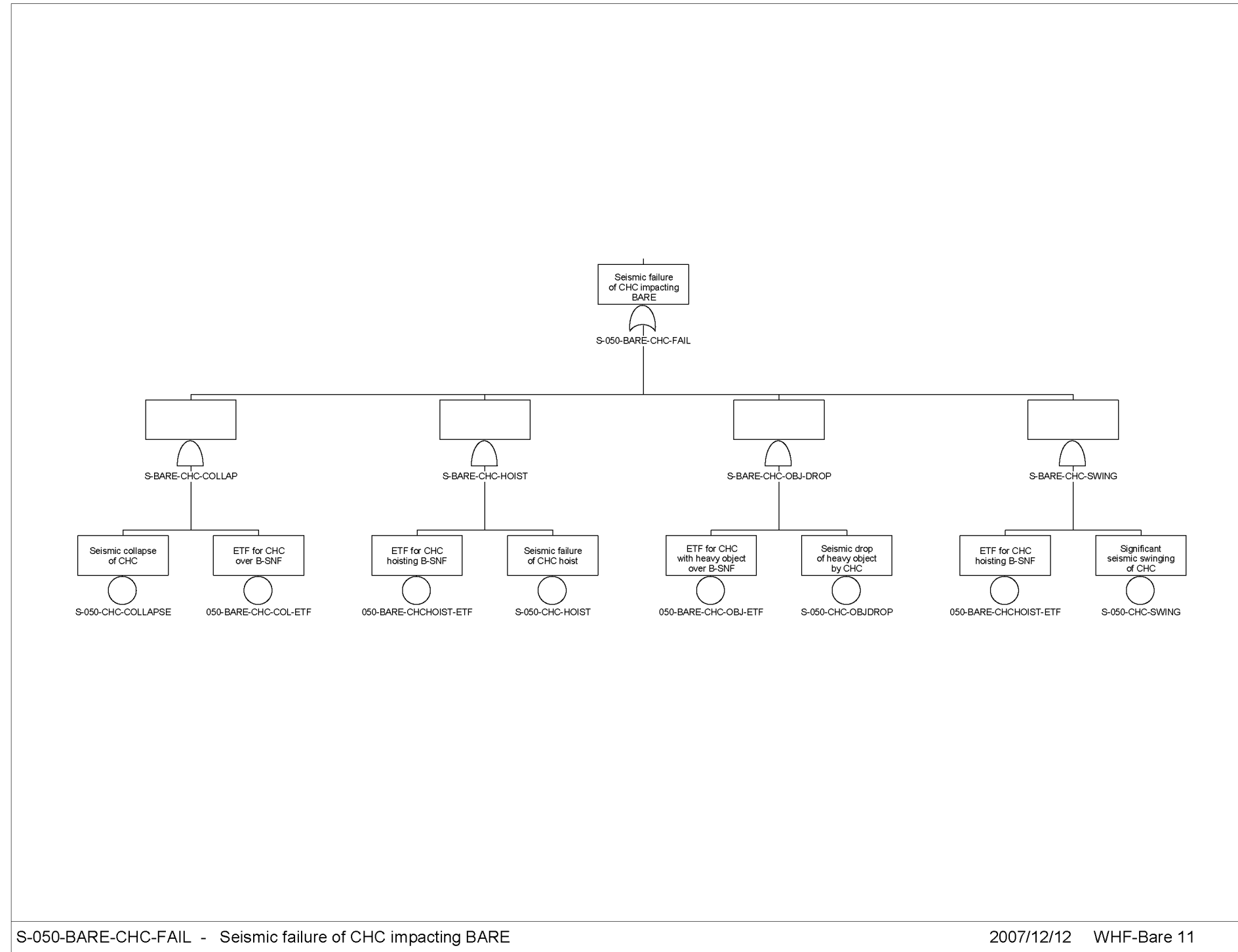

Source: Original

Figure D2.2-6. S-050-BARE-CHC-FAIL – Seismic Failure of CHC Impacting BARE

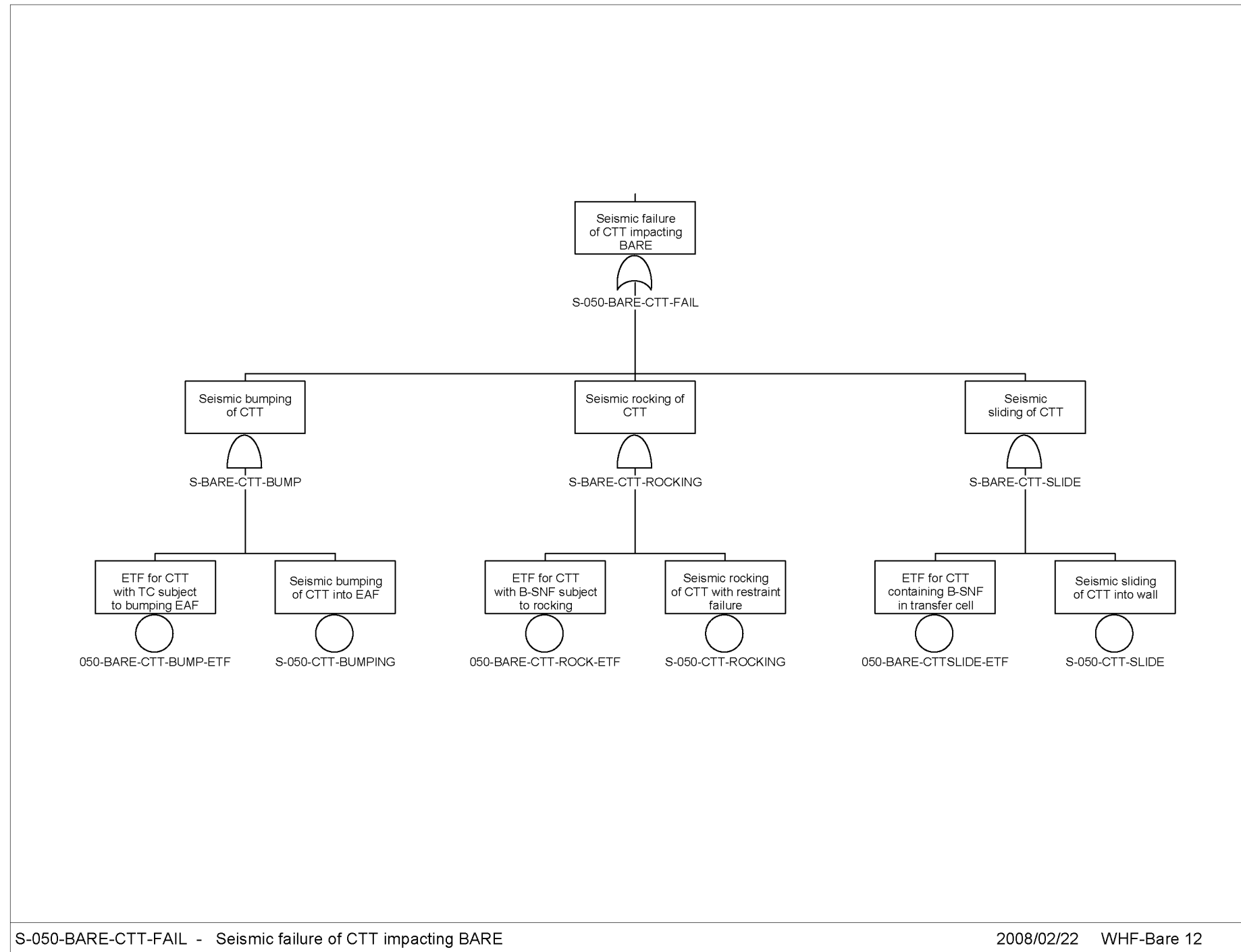

Source: Original

Figure D2.2-7. S-050-BARE-CTT-FAIL – Seismic Failure of CTT Impacting BARE

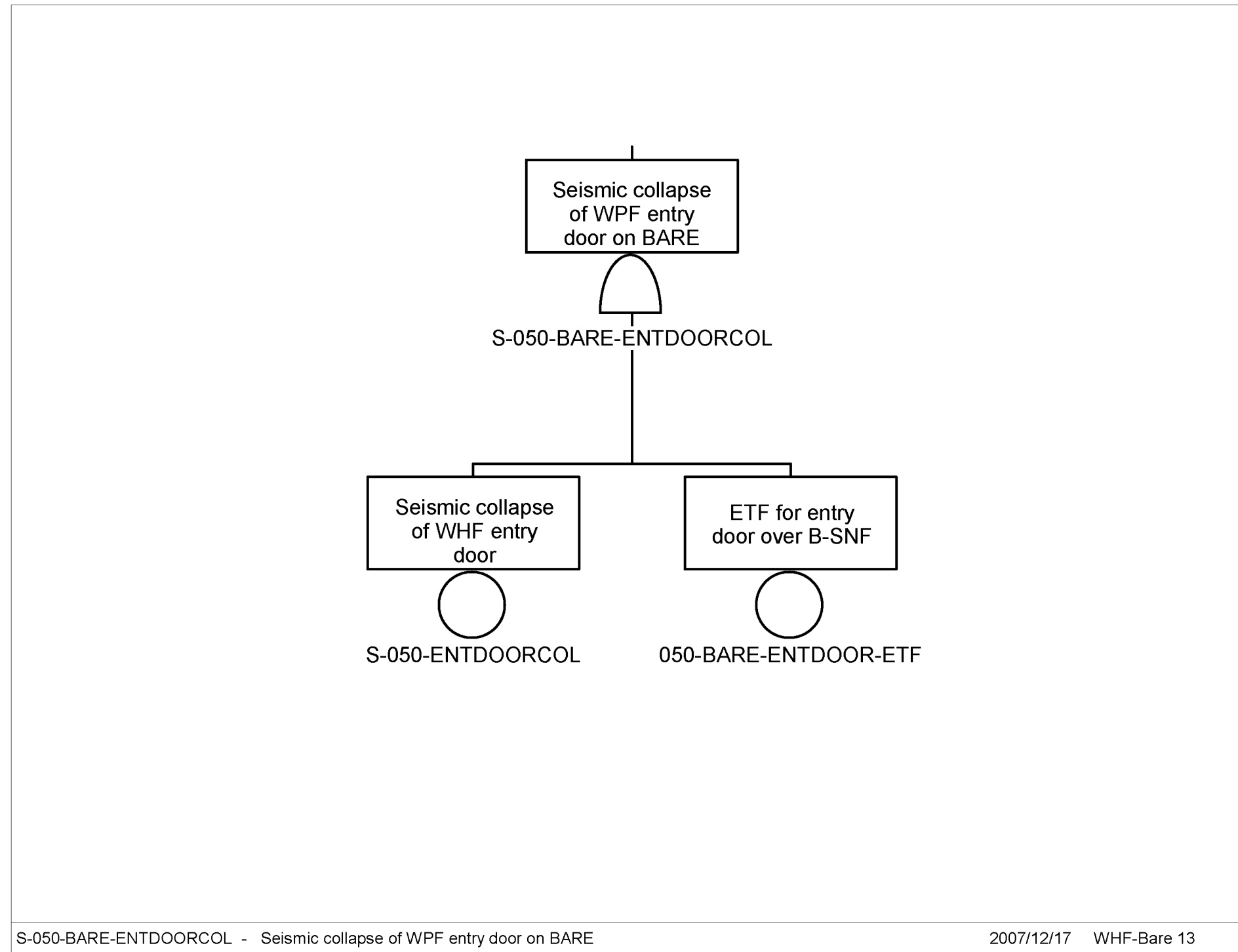

Source: Original

Figure D2.2-8. S-050-BARE-ENTDOORCOL – Seismic Collapse of WPF Entry Door on BARE

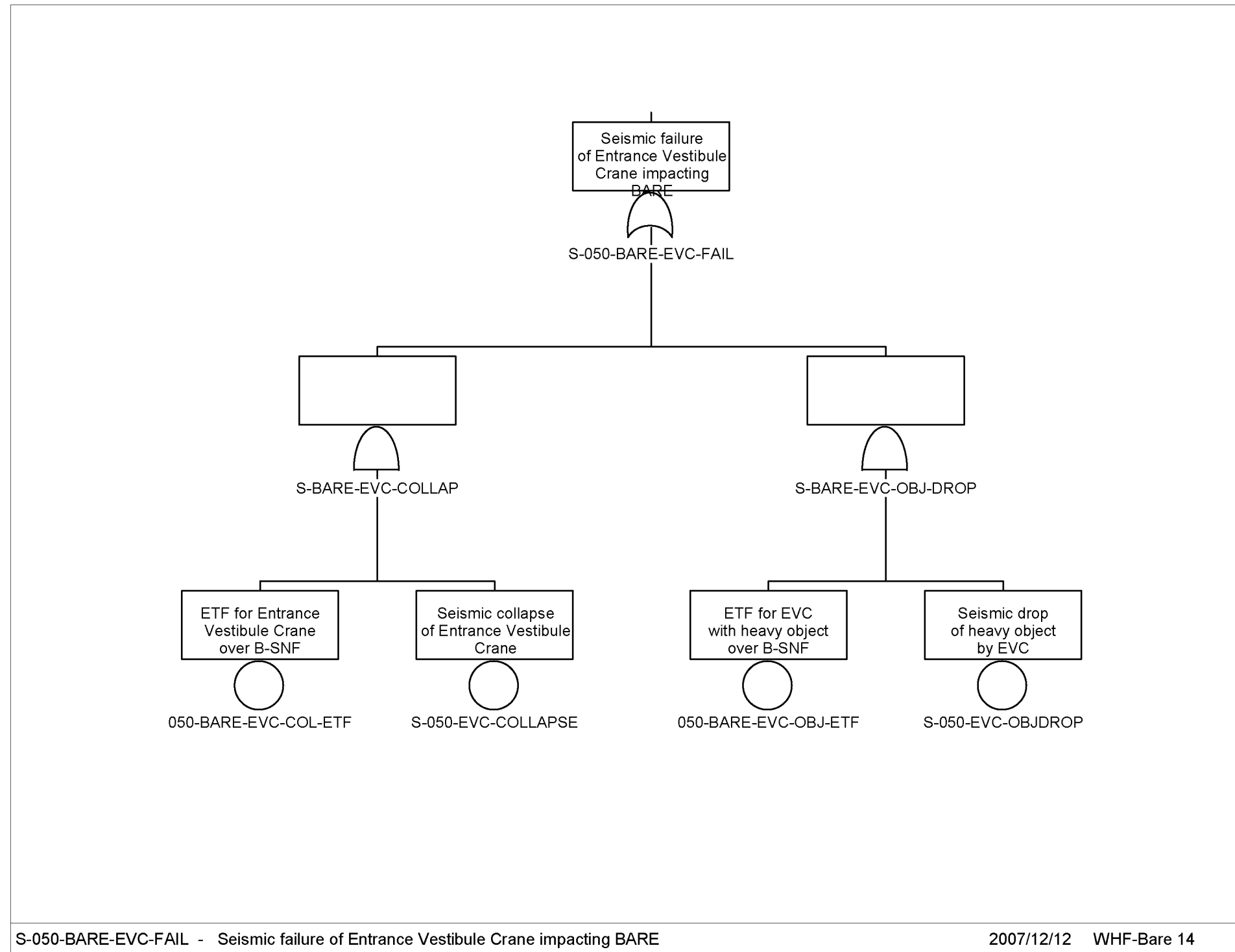

Source: Original

Figure D2.2-9. S-050-BARE-EVC-FAIL – Seismic Failure of Entrance Vestibule Crane Impacting BARE

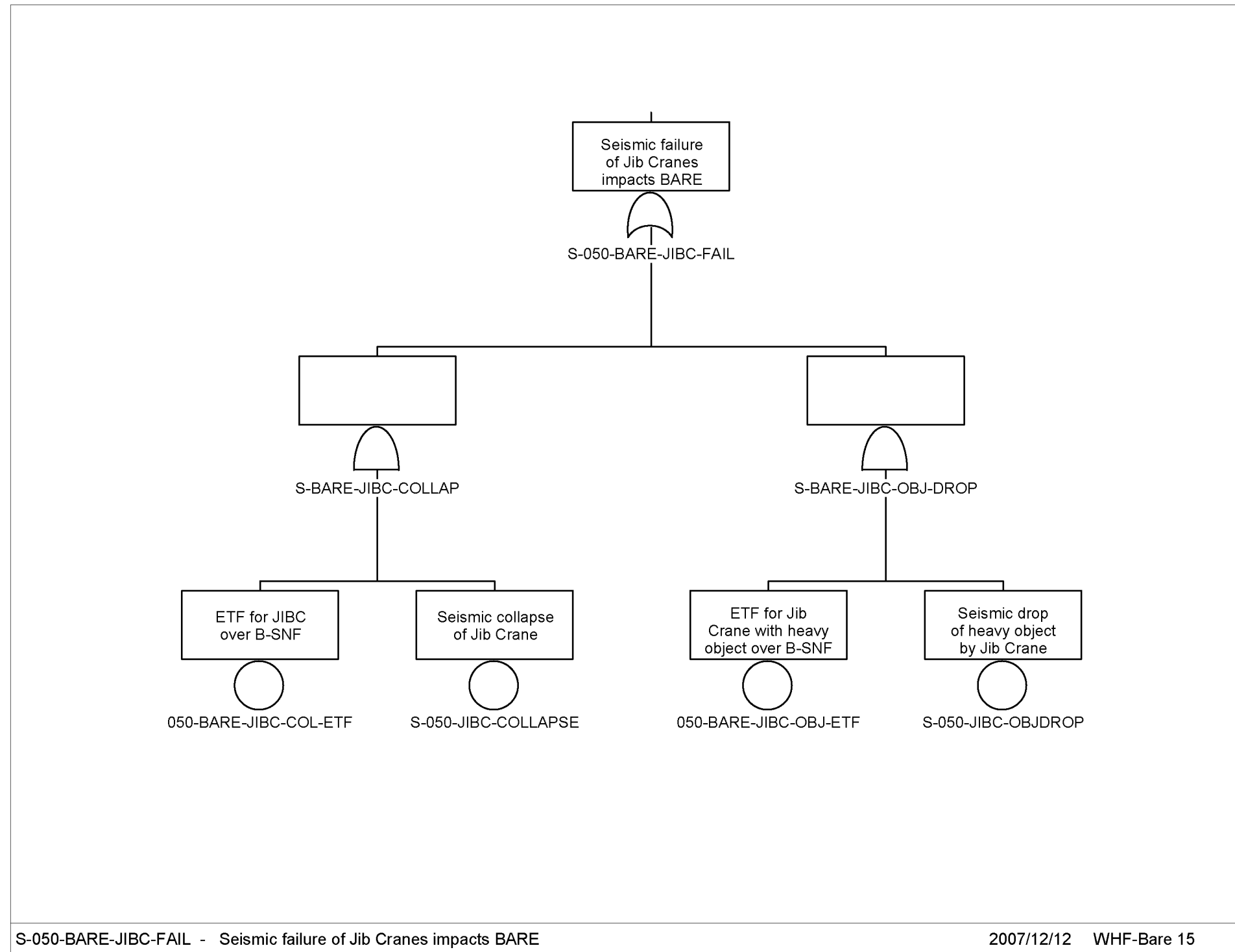

Source: Original

Figure D2.2-10. S-050-BARE-JIBC-FAIL – Seismic Failure of Jib Cranes Impacts BARE

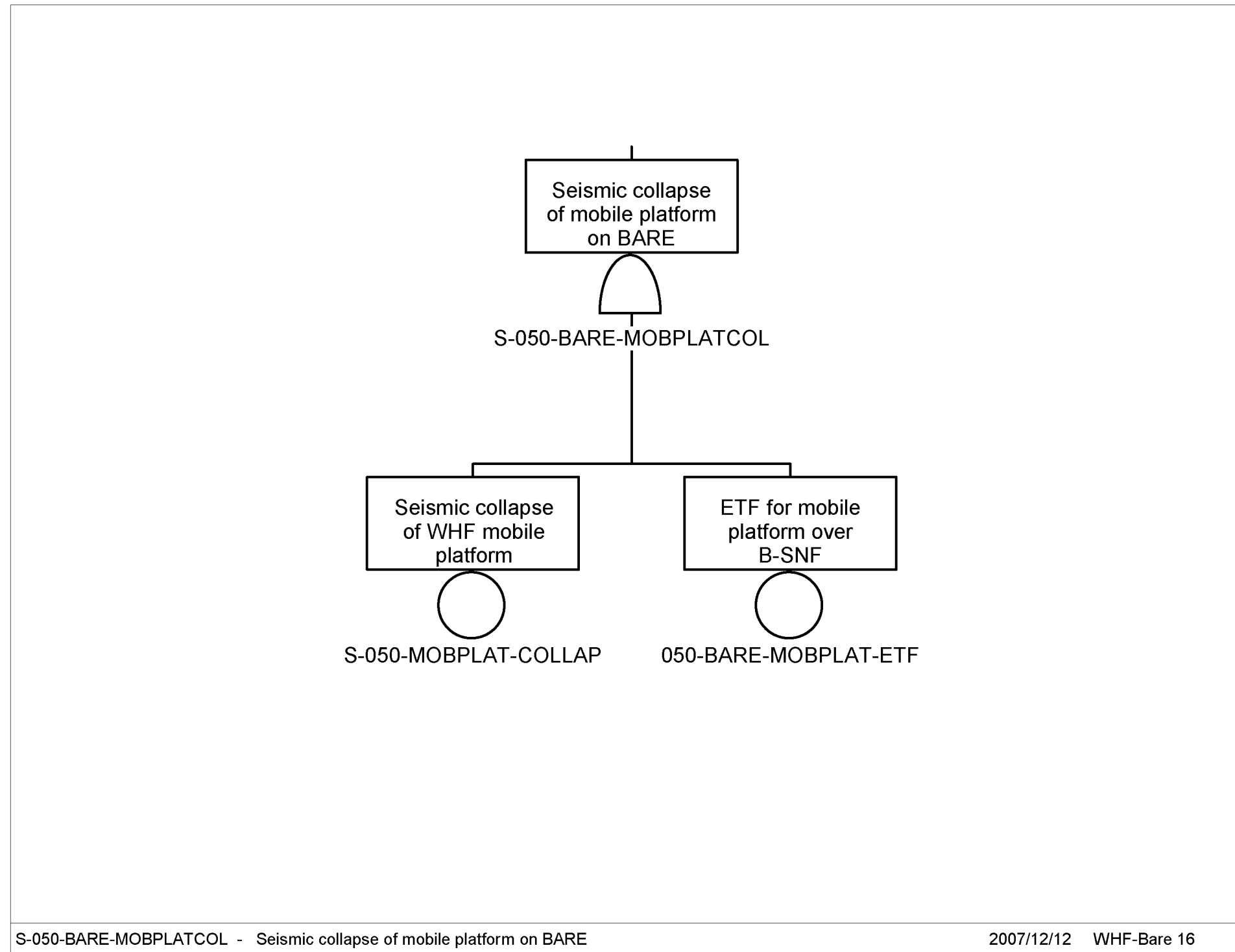

Source: Original

Figure D2.2-11. S-050-BARE-MOBPLATCOL – Seismic Collapse of Mobile Platform on BARE

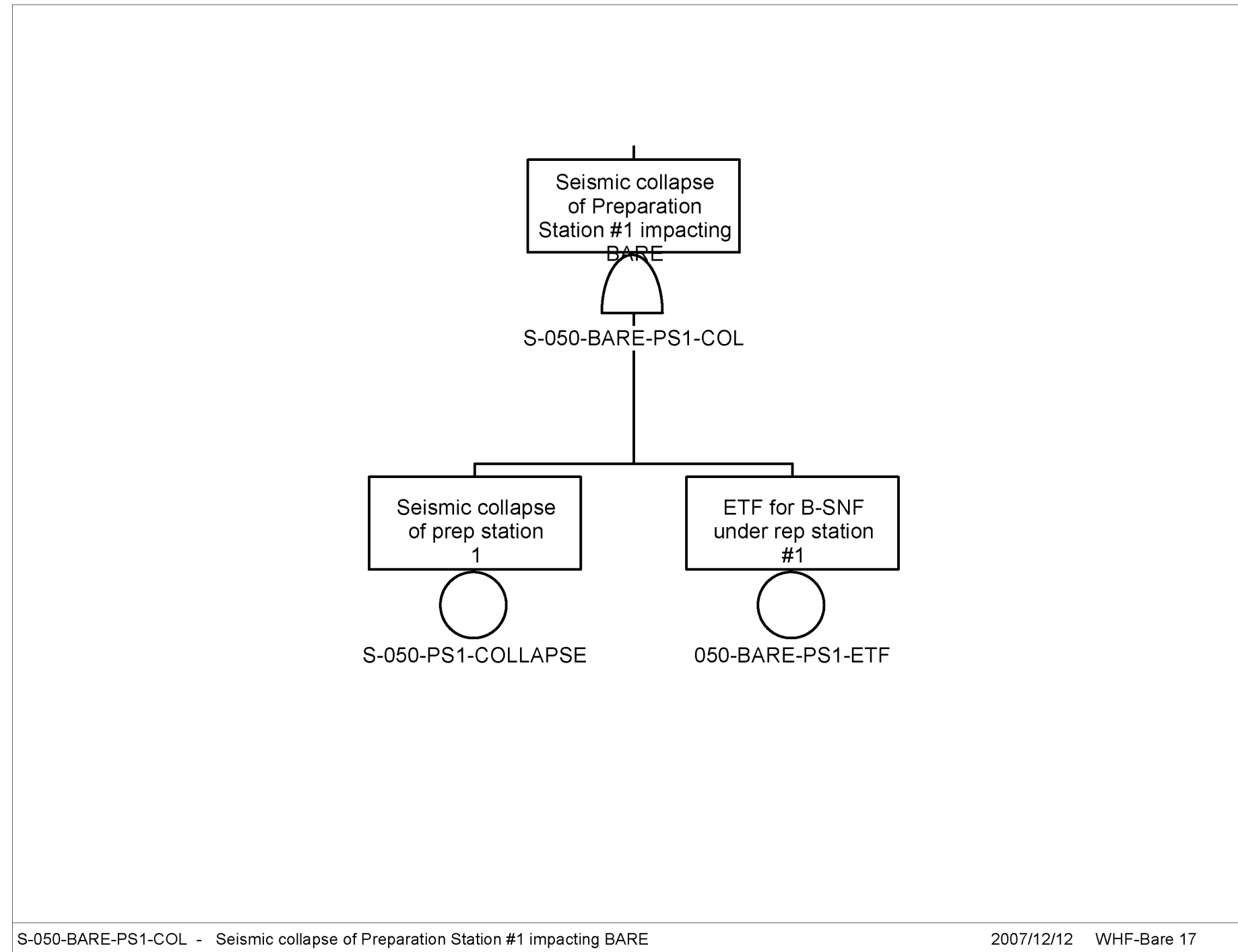

Source: Original

Figure D2.2-12. S-050-BARE-PS1-COL – Seismic Collapse of Preparation Station #1 Impacting BARE

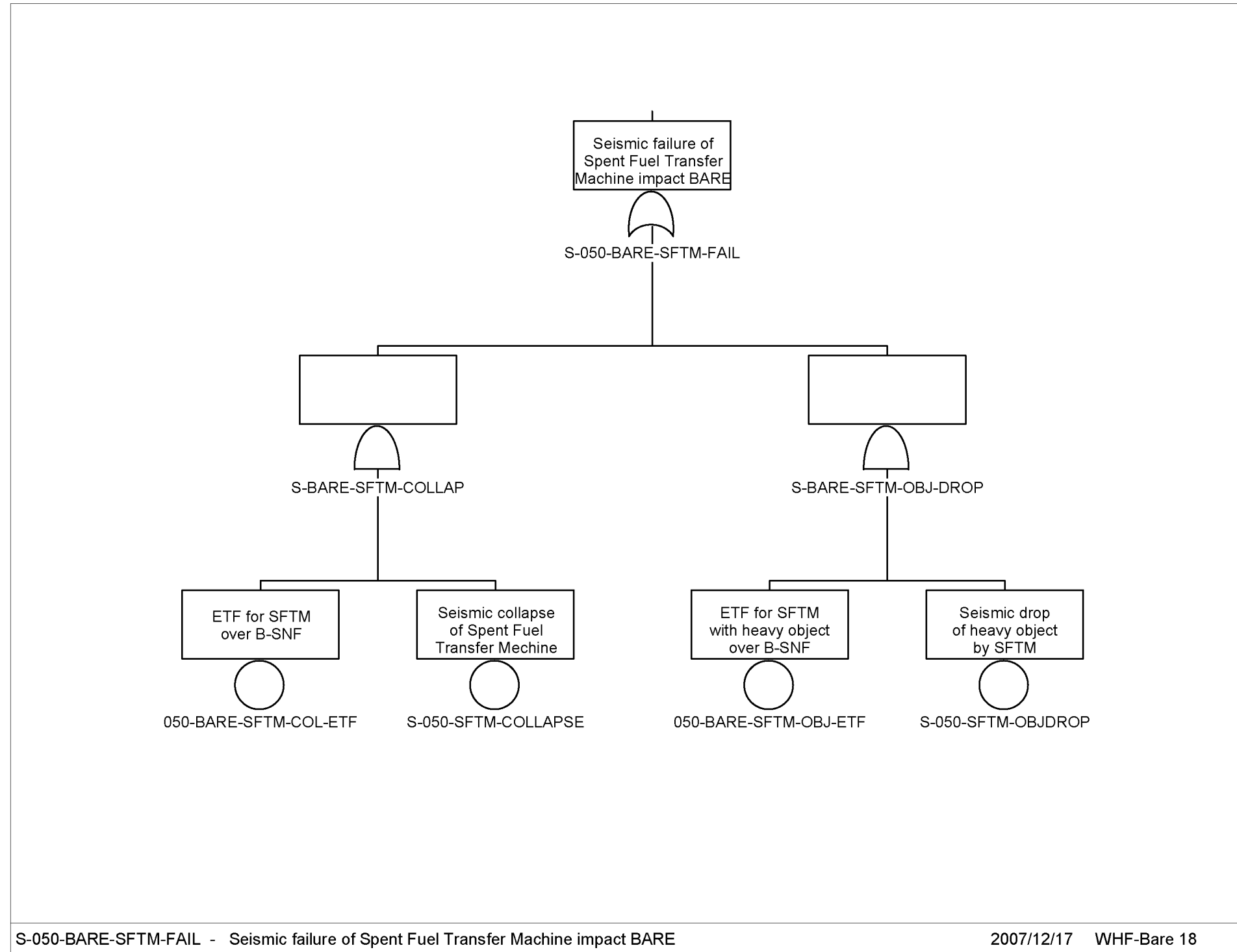

Source: Original

Figure D2.2-13. S-050-BARE-SFTM-FAIL – Seismic Failure of Spent Fuel Transfer Machine Impacts BARE

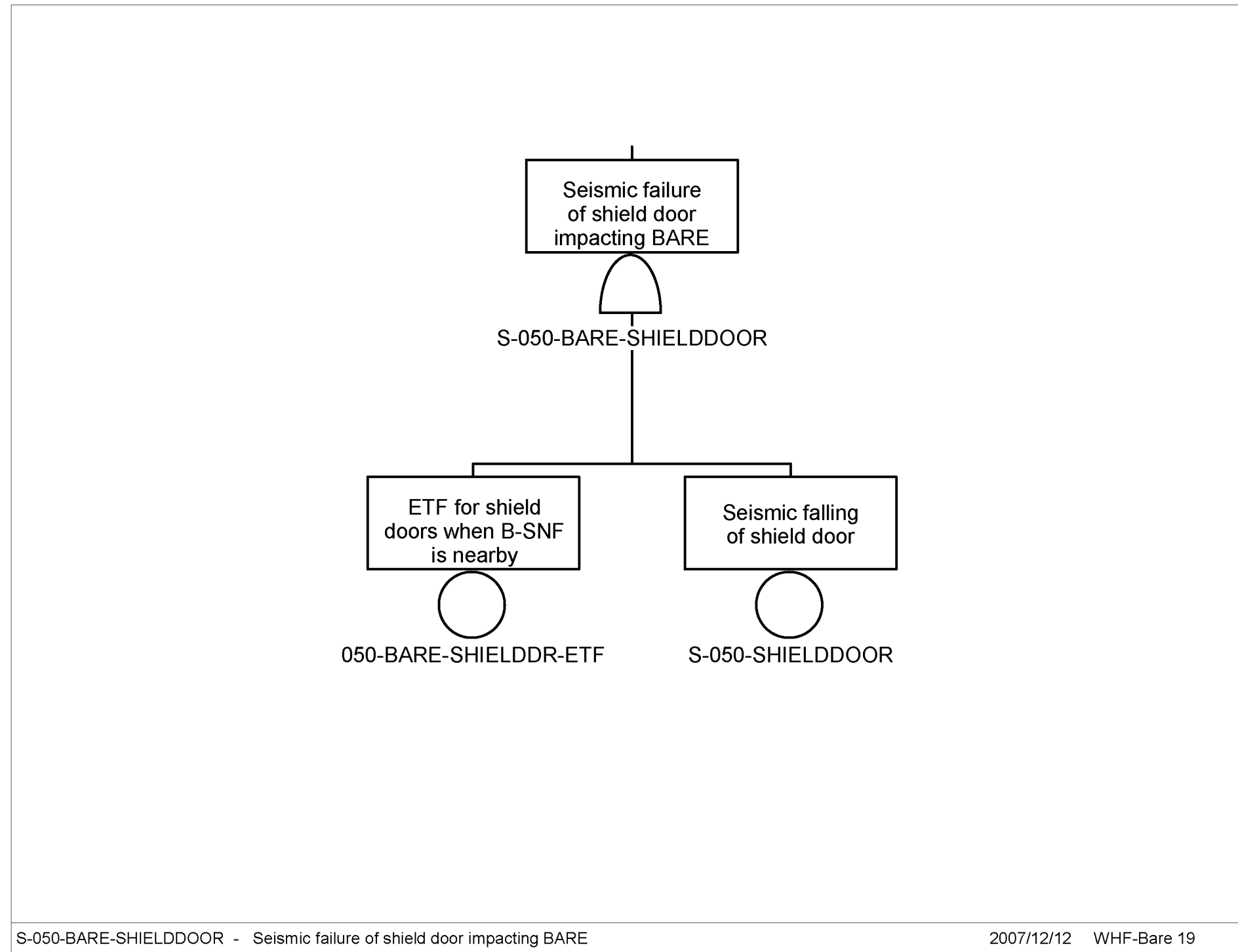

Source: Original

Figure D2.2-14. S-050-BARE-SHIELDDOOR – Seismic Failure of Shield Door Impacting BARE

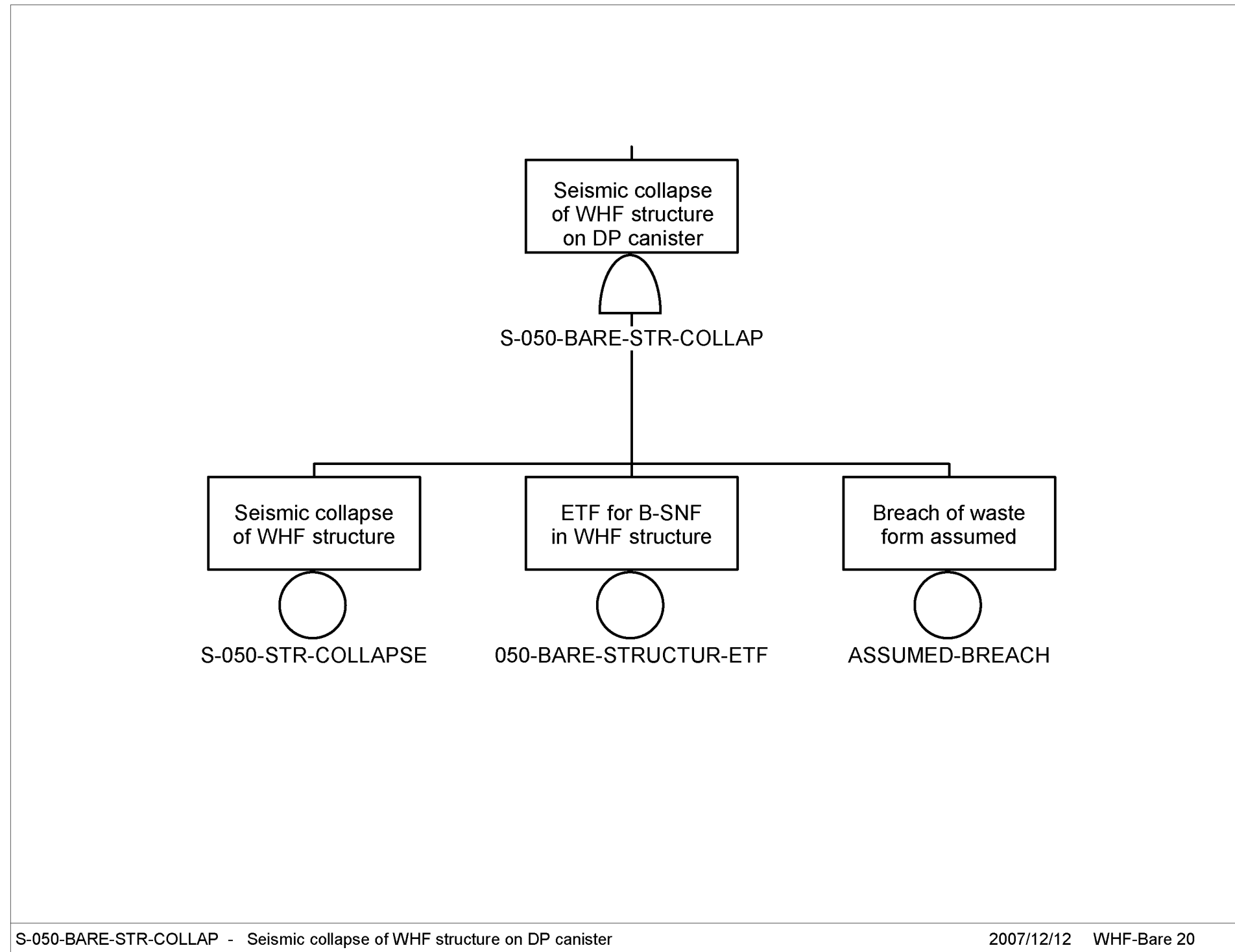

Source: Original

Figure D2.2-15. S-050-BARE-STR-COLLAP – Seismic Collapse of WHF Structure on DP Canister

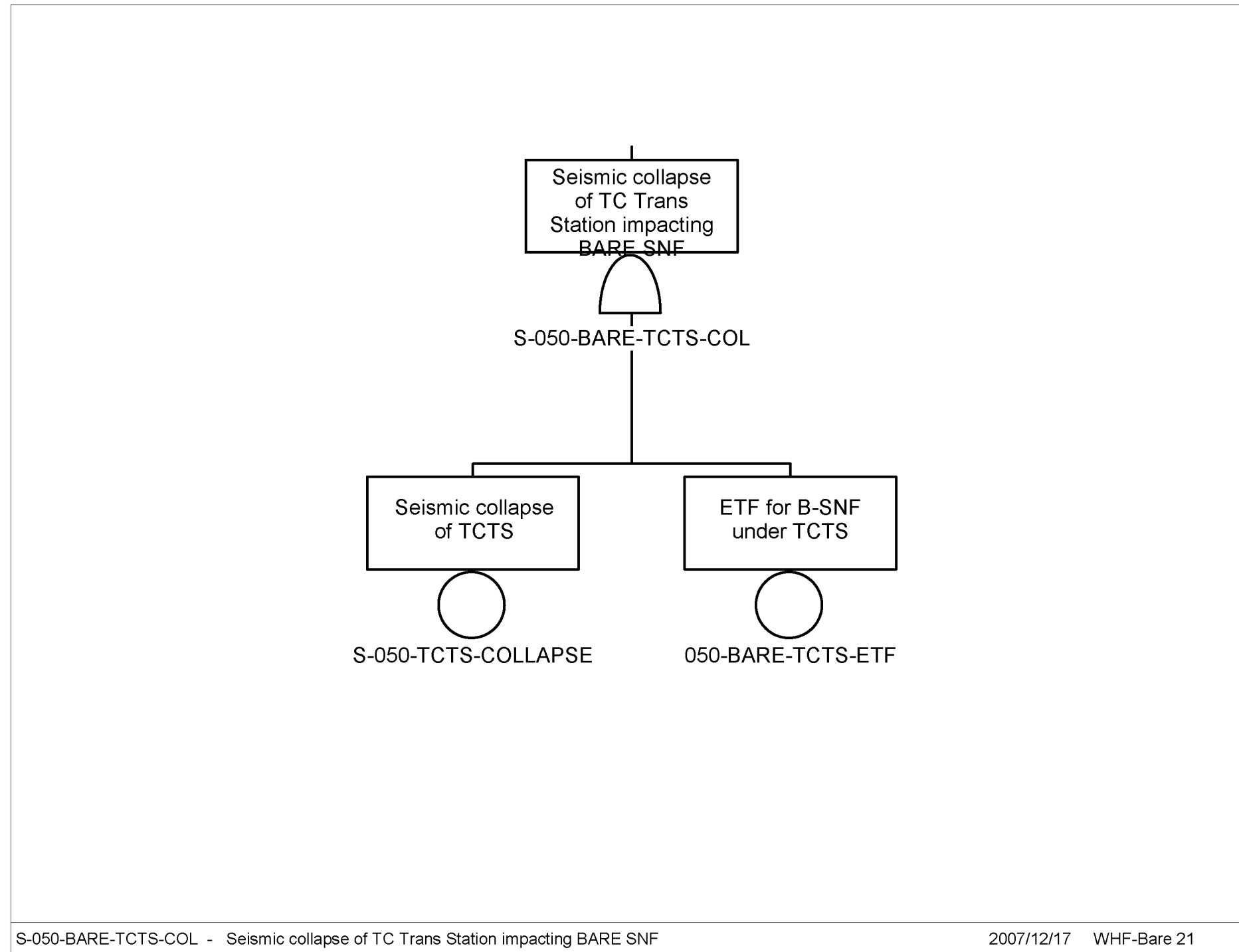

Source: Original

Figure D2.2-16. S-050-BARE-TCTS-COL–
Seismic Collapse of TC Trans
Station Impacting BARE SNF

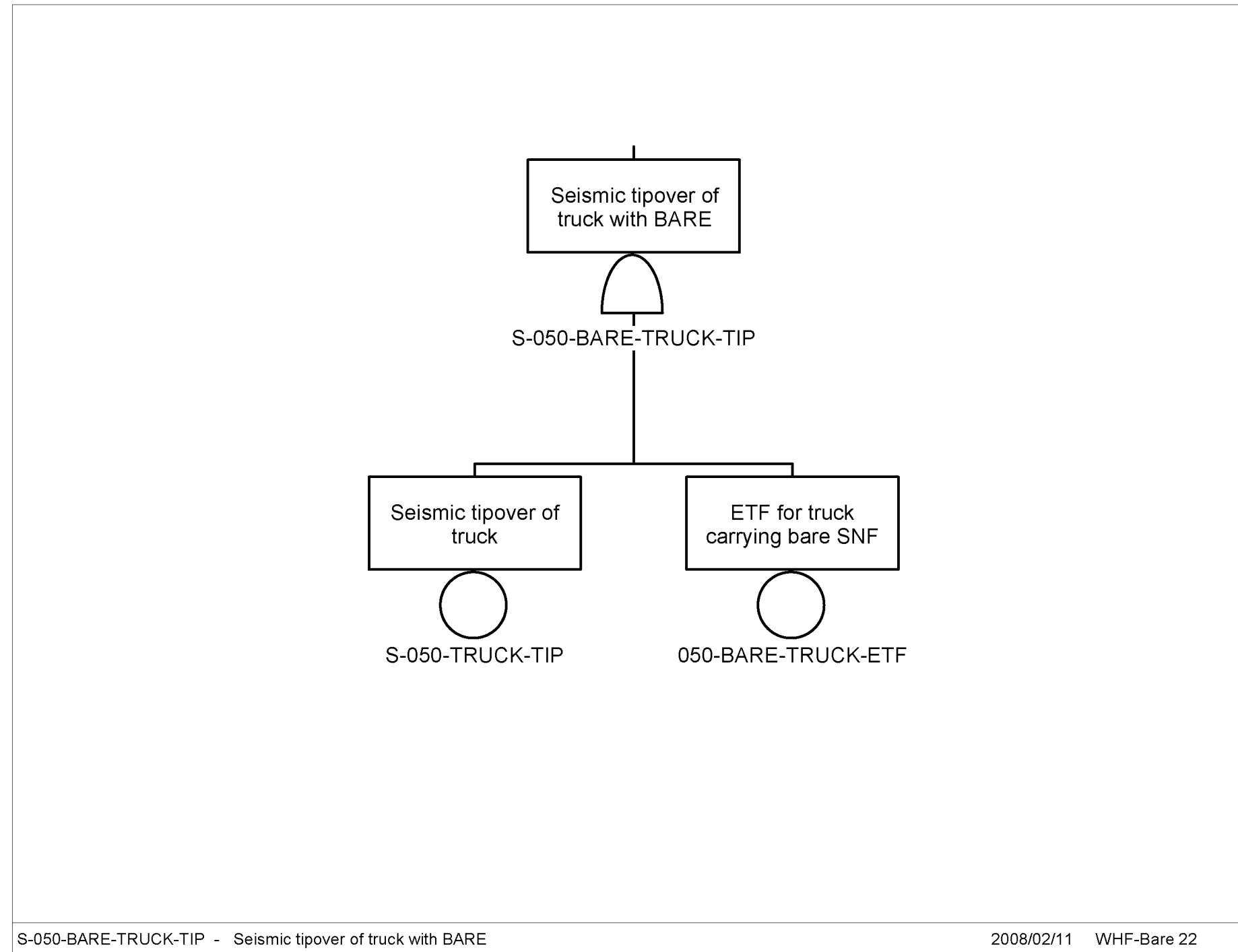

Source: Original

Figure D2.2-17. S-050-BARE-TRUCK-TIP – Seismic Tipover of Truck with BARE

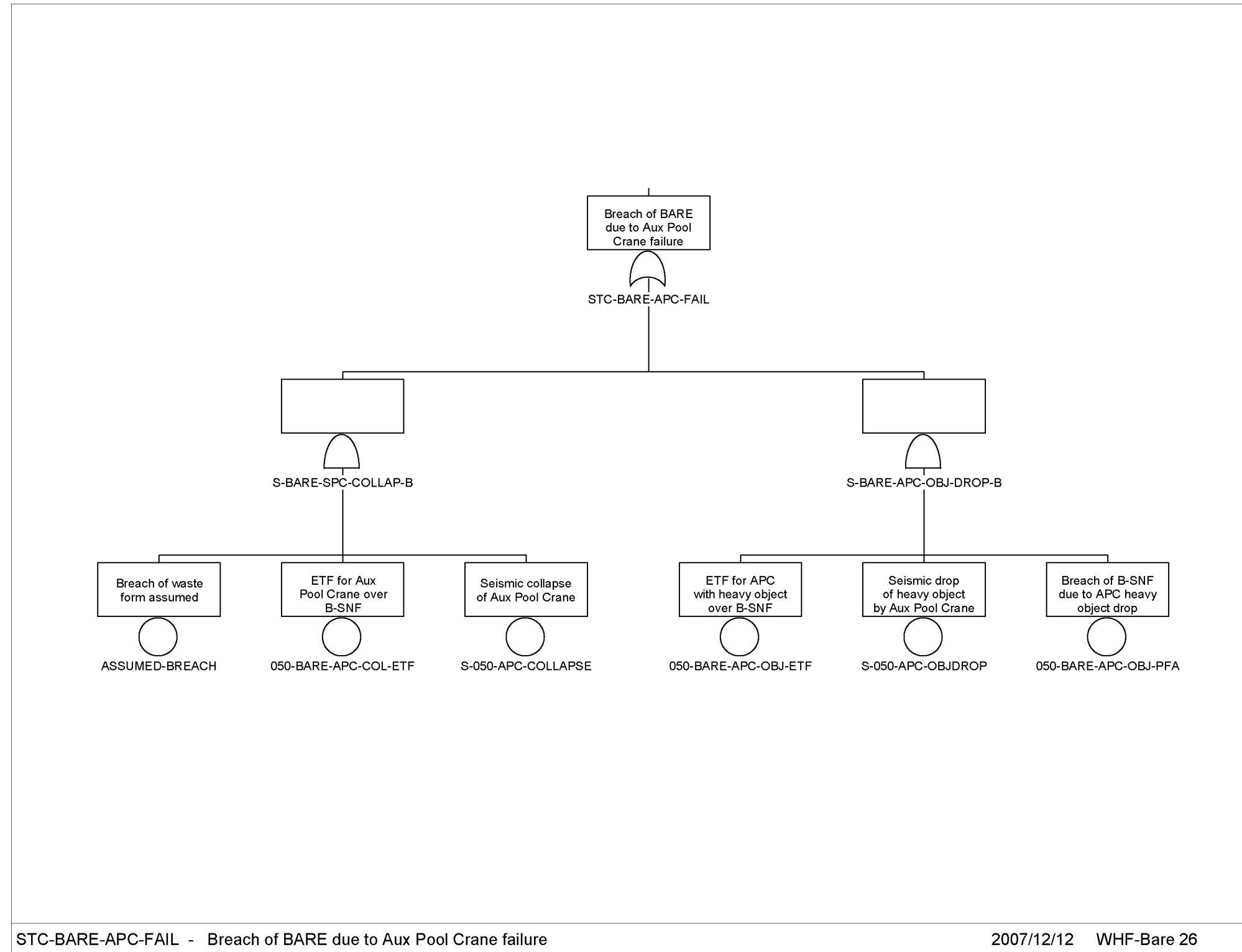

Source: Original

Figure D2.2-18. STC-BARE-APC-FAIL– Breach of BARE due to Aux Pool Crane Failure

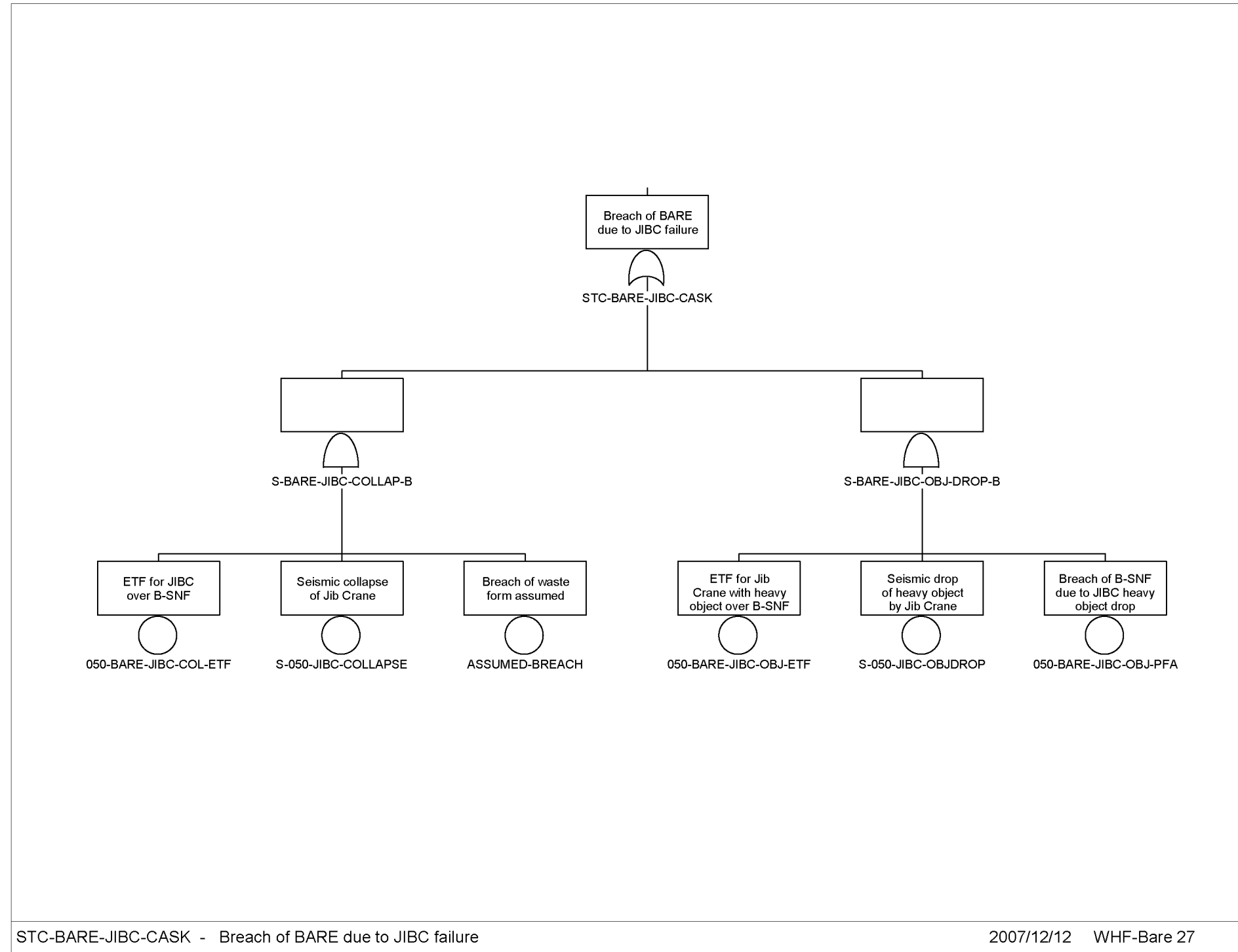

Source: Original

Figure D2.2-19. STC-BARE-JIBC-CASK–
Breach of BARE due to JIBC
Failure

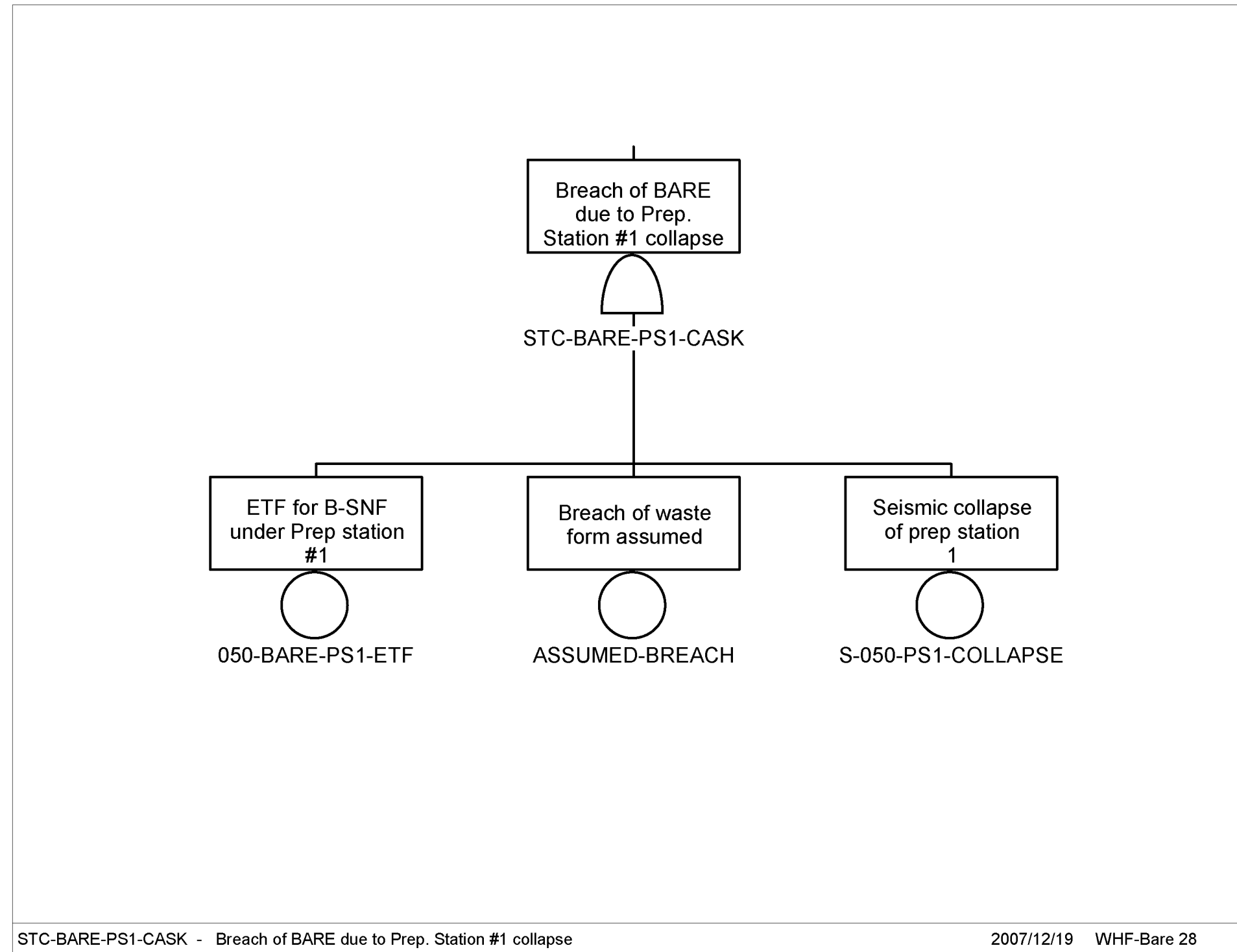

Source: Original

Figure D2.2-20. STC-BARE-PS1-CASK – Breach of BARE due to Prep Station #1 Collapse

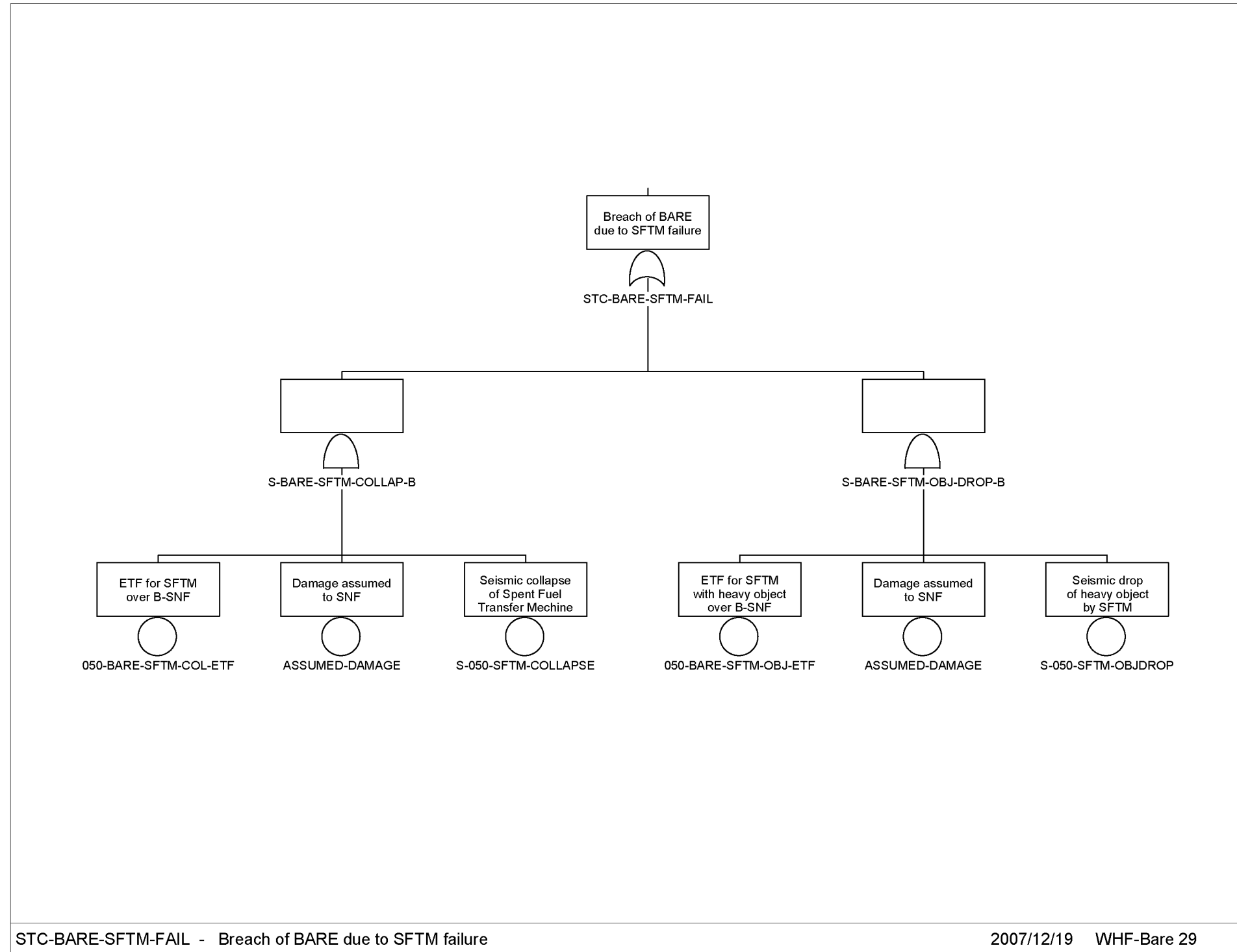

Source: Original

Figure D2.2-21. STC-BARE-SFTM-FAIL – Breach of BARE due to SFTM Failure

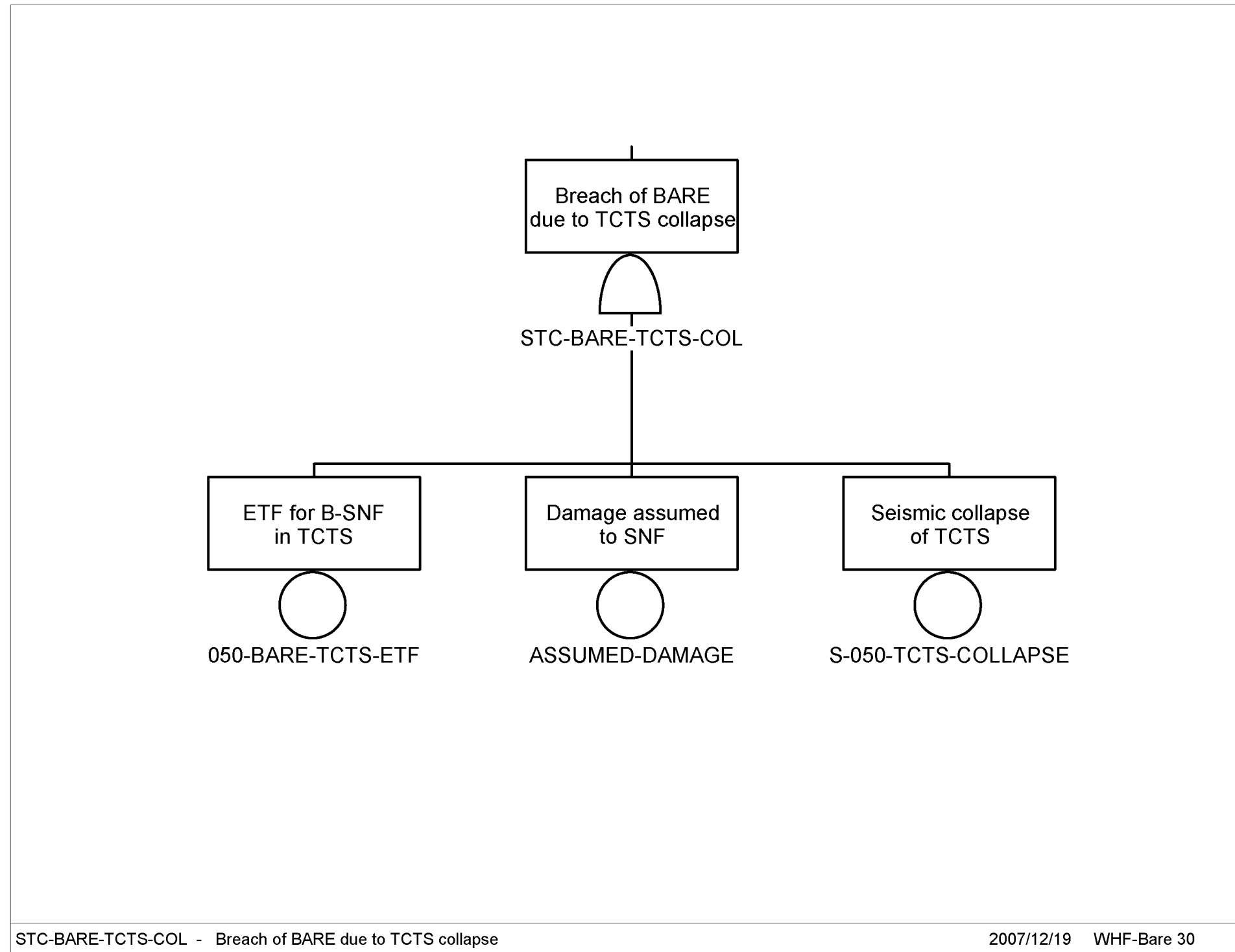

STC-BARE-TCTS-COL - Breach of BARE due to TCTS collapse

2007/12/19 WHF-Bare 30

Source: Original

Figure D2.2-22. STC-BARE-TCTS-COL – Breach of BARE due to TCTS Collapse

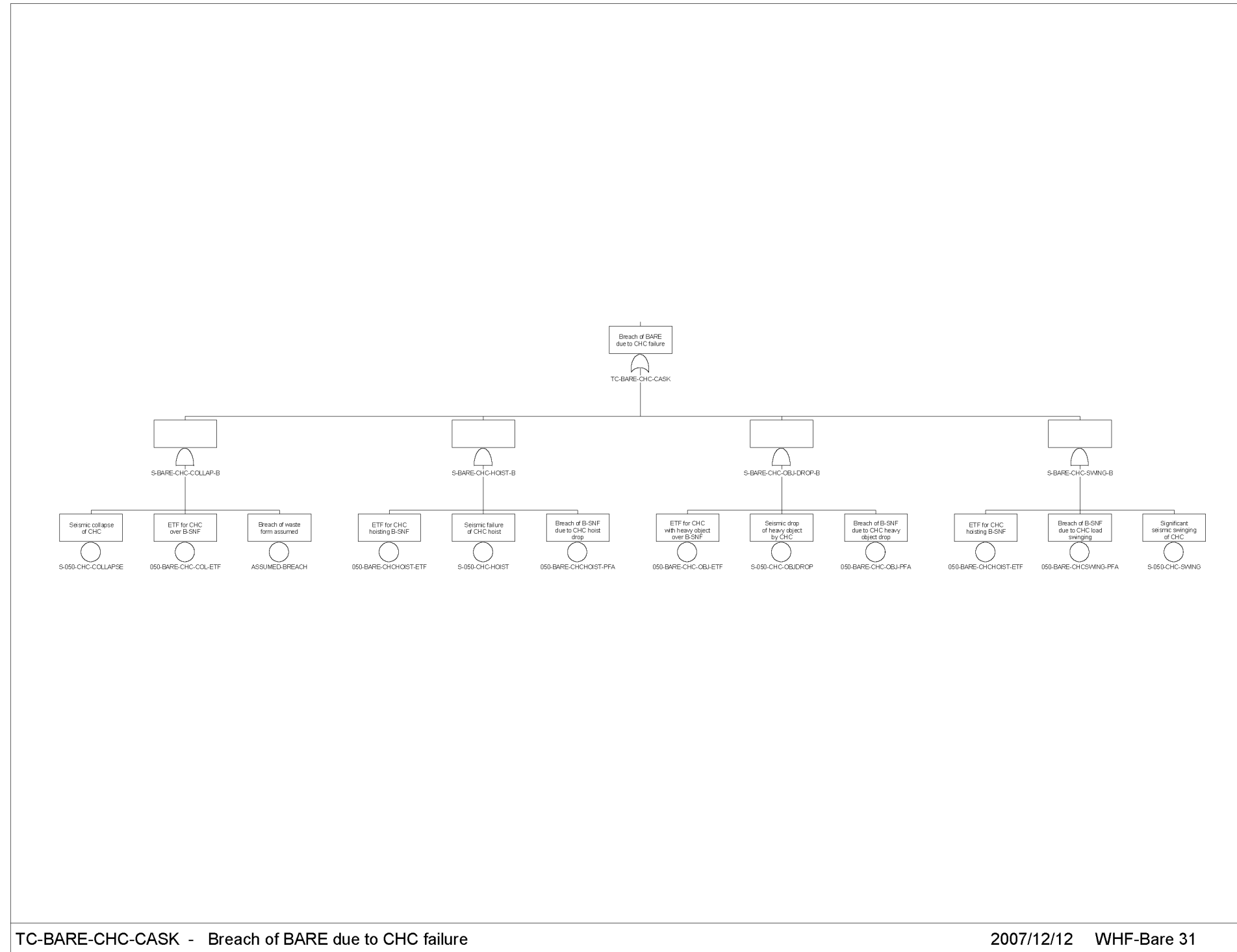

Source: Original

Figure D2.2-23. TC-BARE-CHC-CASK – Breach of BARE due to CHC Failure

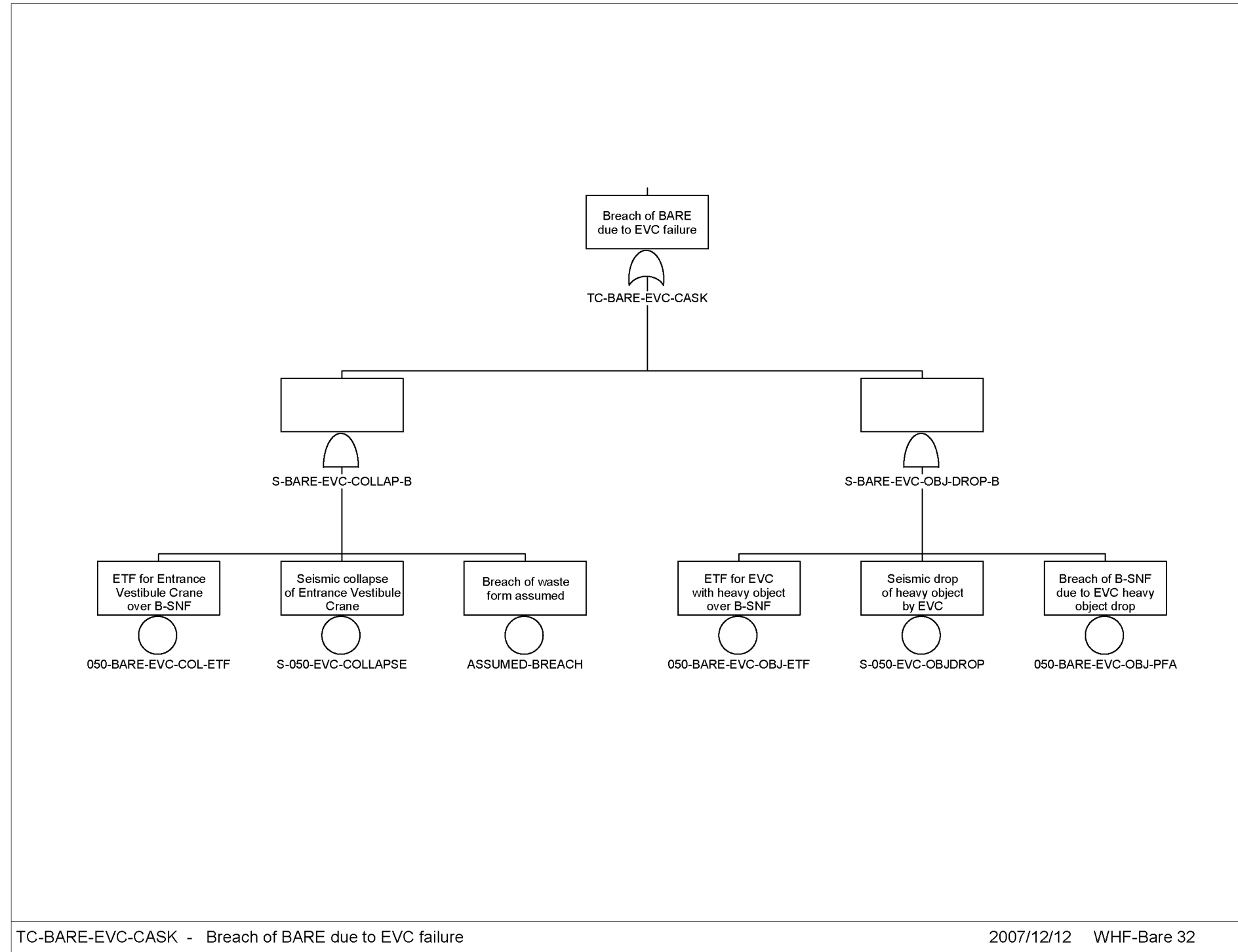

Source: Original

Figure D2.2-24 TC-BARE-EVC-CASK – Breach of BARE due to EVC Failure

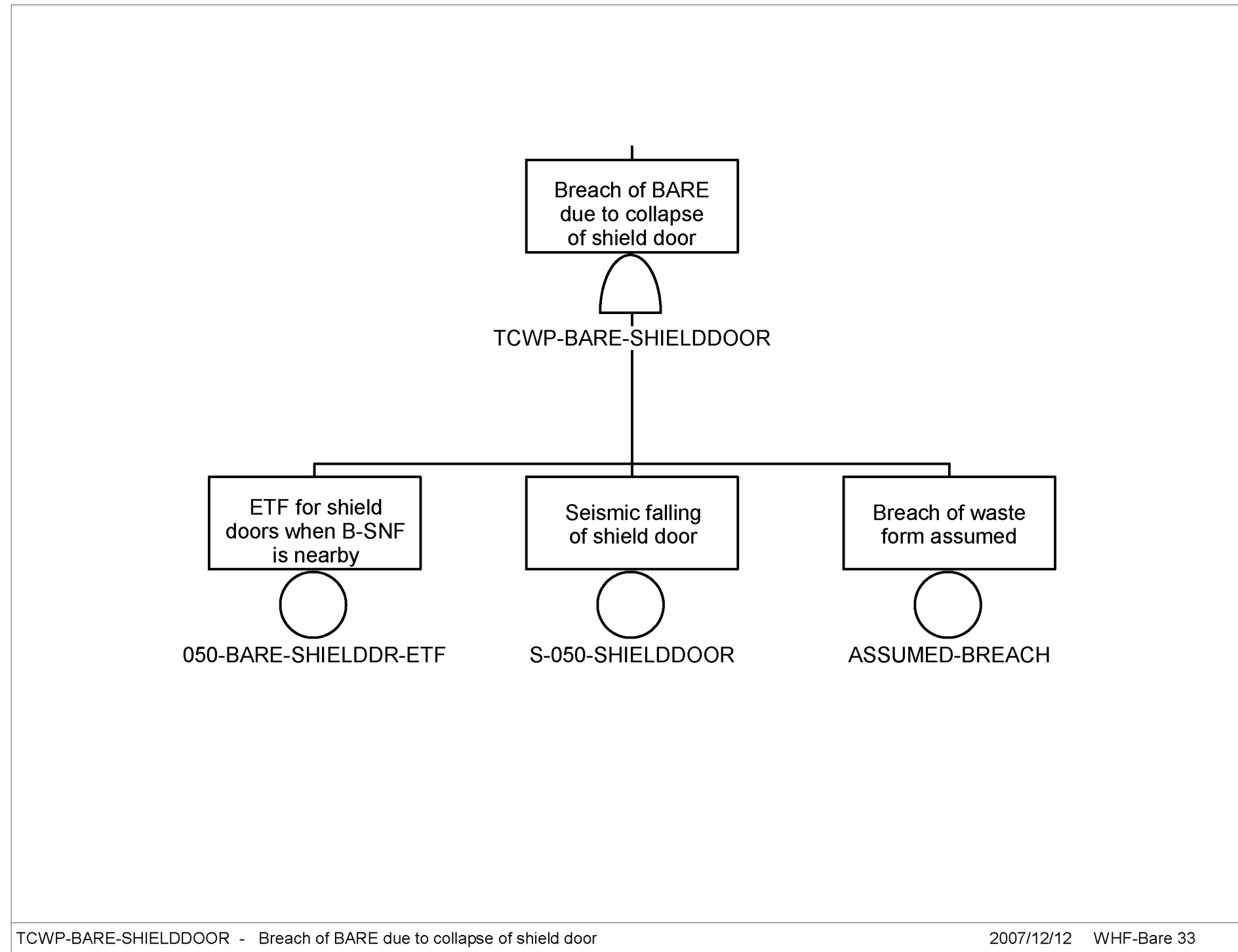

Source: Original

Figure D2.2-25. TCWP-BARE-SHIELDDOOR– Breach of BARE due to Collapse of Shield Door

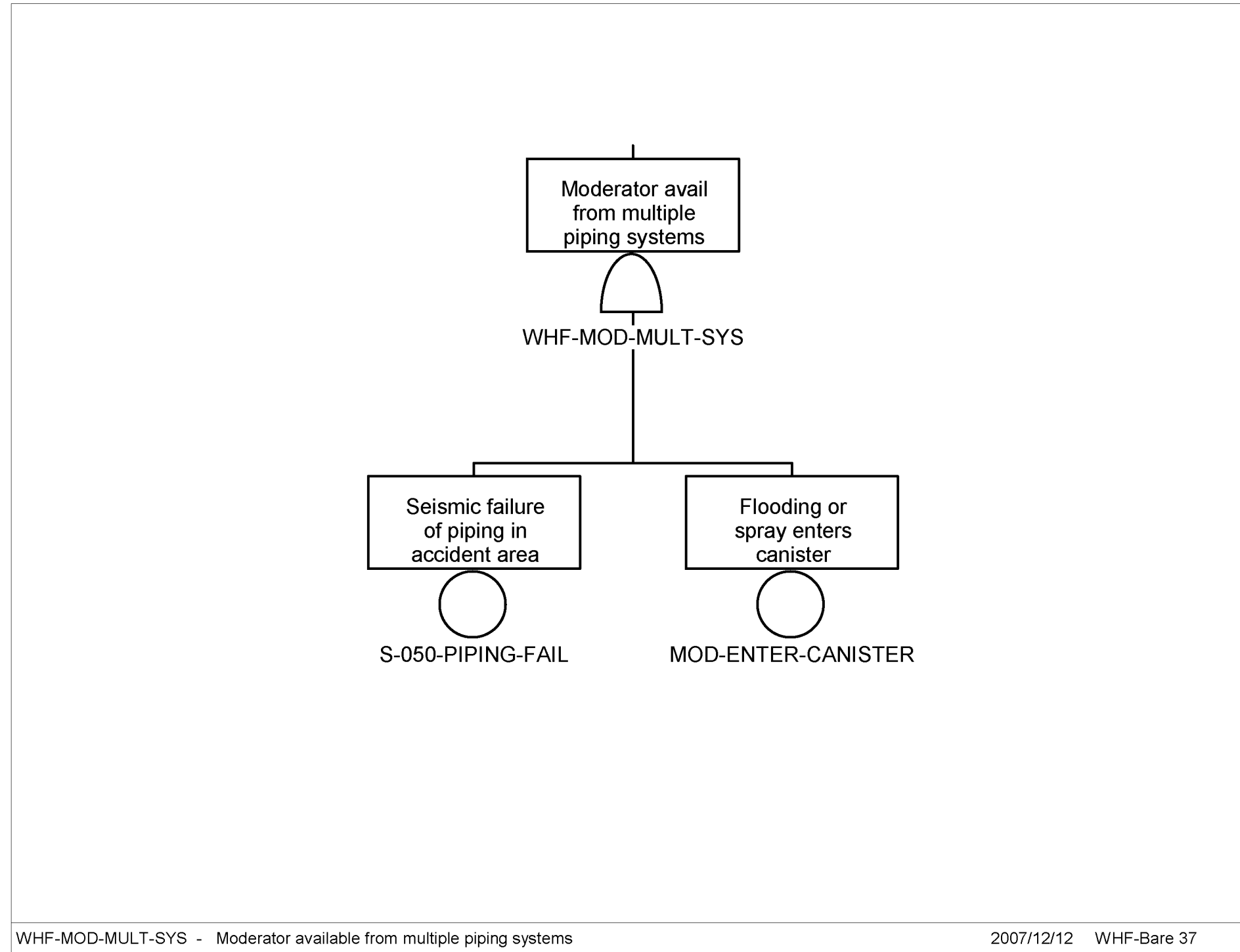

Source: Original

Figure D2.2-26. WHF-MOD-MULT-SYS – Moderator Available from Multiple Piping Systems

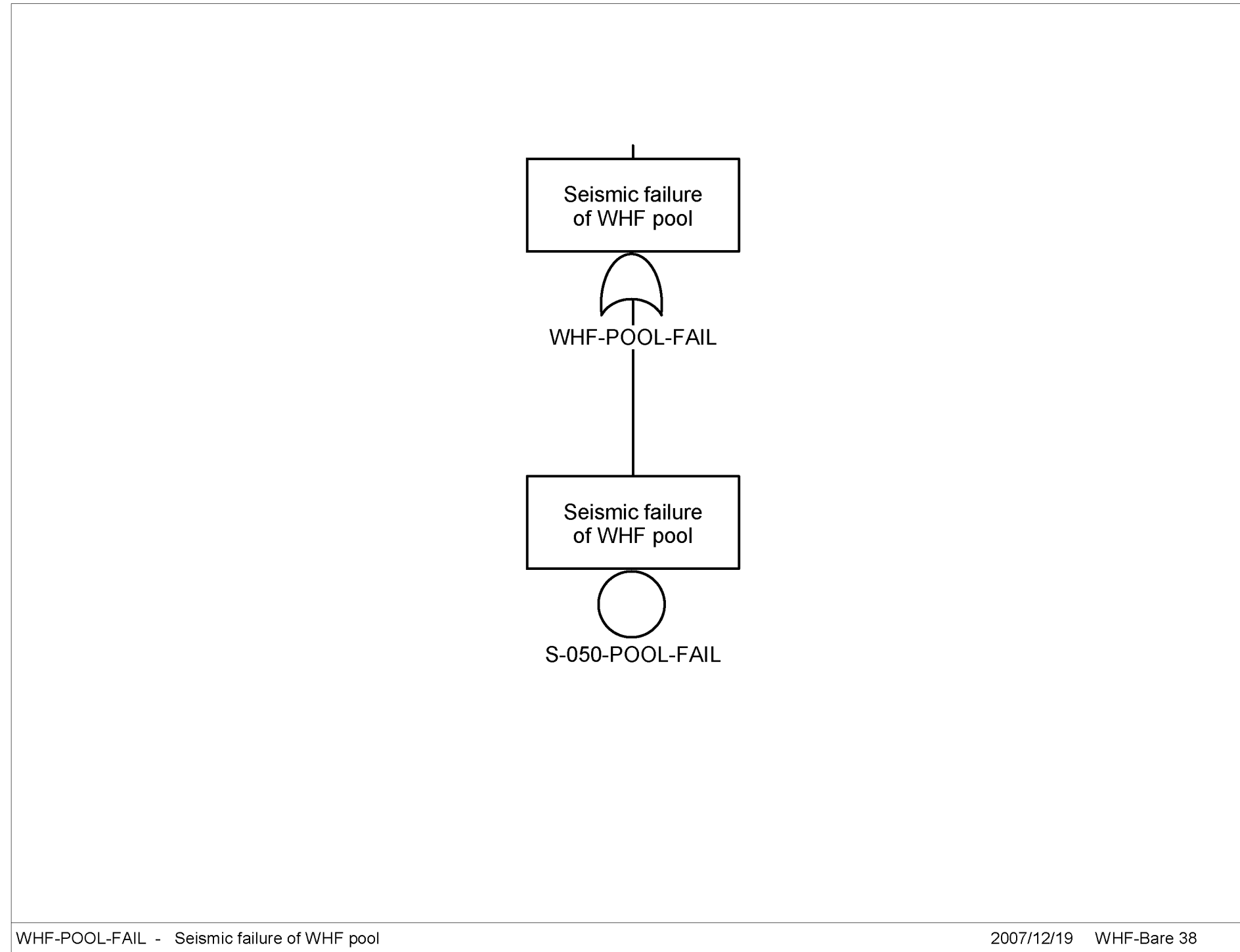

Source: Original

Figure D2.2-27. WHF-POOL-FAIL – Seismic Failure of WHF Pool

D2.3 BASIC EVENTS DATA

D2.3.1 Non-seismic Basic Event Data

The following table presents the basic event identifier used in the fault trees, the description of the basic event, and the failure probability (or other numeric data) of the basic event. For exposure time factors (denoted with “ETF” at the end of the basic event identifier), the value given is the time, in years, that one waste form container is exposed to the seismic failure mode.

Table D2.3-1. Non-seismic Basic Event Data

Name	Description	Calc. Probability
050-BARE-APC-COL-ETF	ETF for aux pool crane over B-SNF	1.900E-004
050-BARE-APC-OBJ-ETF	ETF for APC with heavy object over B-SNF	7.610E-005
050-BARE-APC-OBJ-PFA	Breach of B-SNF due to APC heavy object drop	1.000E+000
050-BARE-CHC-COL-ETF	ETF for CHC over B-SNF	6.720E-004
050-BARE-CHC-OBJ-ETF	ETF for CHC with heavy object over B-SNF	1.810E-004
050-BARE-CHC-OBJ-PFA	Breach of B-SNF due to CHC heavy object drop	1.000E-005
050-BARE-CHCHOIST-ETF	ETF for CHC hoisting B-SNF	2.090E-004
050-BARE-CHCHOIST-PFA	Breach of B-SNF due to CHC hoist drop	1.000E-005
050-BARE-CHCSWING-PFA	Breach of B-SNF due to CHC load swinging	1.000E-005
050-BARE-CTT-BUMP-ETF	ETF for CTT with TC subject to bumping EAF	3.900E-004
050-BARE-CTT-BUMP-PFA	Breach given CTT with TC subject to bumping EAF	1.000E-005
050-BARE-CTT-ROCK-ETF	ETF for CTT with B-SNF subject to rocking	4.760E-005
050-BARE-CTTSLIDE-ETF	ETF for CTT containing B-SNF in transfer cell	4.760E-005
050-BARE-ENTDOOR-ETF	ETF for entry door over B-SNF	1.140E-005
050-BARE-ENTDOOR-PFA	Breach of B-SNF due to entry door collapse	1.000E-005
050-BARE-EVC-COL-ETF	ETF for Entrance Vestibule crane over B-SNF	3.040E-004
050-BARE-EVC-OBJ-ETF	ETF for EVC with heavy object over B-SNF	3.000E-004
050-BARE-EVC-OBJ-PFA	Breach of B-SNF due to EVC heavy object drop	1.000E-005
050-BARE-JIBC-COL-ETF	ETF for JIBC over B-SNF	8.560E-005
050-BARE-JIBC-OBJ-ETF	ETF for jib crane with heavy object over B-SNF	9.510E-006
050-BARE-JIBC-OBJ-PFA	Breach of B-SNF due to JIBC heavy object drop	1.000E-005
050-BARE-MOBPLAT-ETF	ETF for mobile platform over B-SNF	5.040E-004
050-BARE-MOBPLAT-PFA	Breach of B-SNF due to mobile platform collapse	1.000E-005
050-BARE-PS1-ETF	ETF for B-SNF under prep station #1	4.380E-004
050-BARE-SFTM-COL-ETF	ETF for SFTM over B-SNF	1.010E-004
050-BARE-SFTM-OBJ-ETF	ETF for SFTM with heavy object over B-SNF	9.510E-006
050-BARE-SHIELDDR-ETF	ETF for shield doors when B-SNF is nearby	4.380E-004
050-BARE-STRUCTUR-ETF	ETF for B-SNF in WHF structure	1.940E-003
050-BARE-TCTS-ETF	ETF for B-SNF in TCTS	7.950E-004
050-BARE-TRUCK-ETF	ETF for truck carrying bare SNF	4.740E-004
050-BARE-TRUCK-PFA	Breach of B-SNF due to truck accident	1.000E-005
ASSEMBLY	SNF assemblies are not damaged	1.000E+000

Table D2.3-1. Non-seismic Basic Event Data (Continued)

Name	Description	Calc. Probability
ASSUMED-BREACH	Breach of waste form assumed	1.000E+000
ASSUMED-DAMAGE	Damage assumed to SNF	1.000E+000
MOD-ENTER-CANISTER	Flooding or spray enters canister	1.000E-002
SHIELDING	Shielding remains intact	1.000E-005
WHF-BARE-CASK	Number of TCs with bare SNF processed in WHF	3.775E+003
050-BARE-APC-COL-ETF	ETF for aux pool crane over B-SNF	1.900E-004
050-BARE-APC-OBJ-ETF	ETF for APC with heavy object over B-SNF	7.610E-005

NOTE: The basic events "ASSUMED-BREACH" and "ASSUMED-DAMAGE" are not assumptions, but are common terminology used to denote a scenario where the waste container is conservatively considered to be breached, or assemblies are considered to be damaged; APC = auxiliary pool crane; B-SNF = bare spent nuclear fuel; CHC = cask handling crane; CTT = cask transfer trolley; DPC = dual-purpose canister; ETF = exposure time factor; EVC = Entrance Vestibule crane; SFTM = spent fuel transfer machine; SNF = spent nuclear fuel; TC = transportation cask; TCTS = transportation cask transfer station; WHF = Wet Handling Facility.

Source: Sections 6.2.2.23 and 6.3.3, Table 6.3-1, Table 6.3-2, Table 6.7-1

D2.3.2 Seismic Basic Event Fragility Data

The following table provides the seismic failure basic event identifier, description, median fragility, and composite uncertainty.

Table D2.3-2. Seismic Basic Event Fragility Data

Event Name	Description	Med. Fragility (g)	Beta C
S-050-APC-COLLAPSE	Seismic collapse of aux pool crane	2.790E+000	4.500E-001
S-050-APC-OBJDROP	Seismic drop of heavy object by aux pool crane	2.280E+000	5.000E-001
S-050-CHC-COLLAPSE	Seismic collapse of CHC	2.790E+000	4.500E-001
S-050-CHC-HOIST	Seismic failure of CHC hoist	2.280E+000	5.000E-001
S-050-CHC-OBJDROP	Seismic drop of heavy object by CHC	2.280E+000	5.000E-001
S-050-CHC-SWING	Significant seismic swinging of CHC	1.140E+000	4.000E-001
S-050-CTT-BUMPING	Seismic bumping of CTT into EAF	2.250E+000	4.100E-001
S-050-CTT-ROCKING	Seismic rocking of CTT with restraint failure	2.250E+000	4.100E-001
S-050-CTT-SLIDE	Seismic sliding of CTT into wall	3.080E+000	5.800E-001
S-050-ENTDOORCOL	Seismic collapse of WHF entry door	3.700E-001	4.000E-001
S-050-EVC-COLLAPSE	Seismic collapse of Entrance Vestibule crane	2.790E+000	4.500E-001
S-050-EVC-OBJDROP	Seismic drop of heavy object by EVC	1.140E+000	4.000E-001
S-050-JIBC-COLLAPSE	Seismic collapse of jib crane	2.790E+000	4.500E-001
S-050-JIBC-OBJDROP	Seismic drop of heavy object by jib crane	2.280E+000	5.000E-001
S-050-MOBPLAT-COLLAP	Seismic collapse of WHF mobile platform	3.700E-001	4.000E-001
S-050-PIPING-FAIL	Seismic failure of piping in accident area	7.600E-001	4.000E-001

Table D2.3-2. Seismic Basic Event Fragility Data (Continued)

Event Name	Description	Med. Fragility (g)	Beta C
S-050-POOL-FAIL	Seismic failure of WHF pool	4.510E+000	4.000E-001
S-050-PS1-COLLAPSE	Seismic collapse of prep station 1	3.500E+000	4.000E-001
S-050-SFTM-COLLAPSE	Seismic collapse of spent fuel transfer machine	2.190E+000	4.700E-001
S-050-SFTM-OBJDROP	Seismic drop of heavy object by SFTM	2.280E+000	5.000E-001
S-050-SHIELDDOOR	Seismic falling of shield door	2.920E+000	4.400E-001
S-050-STR-COLLAPSE	Seismic collapse of WHF structure	4.510E+000	4.000E-001
S-050-TCTS-COLLAPSE	Seismic collapse of TCTS	1.410E+000	4.600E-001
S-050-TRUCK-TIP	Seismic tipover of truck	4.500E-001	4.000E-001

NOTE: CHC = cask handling crane; CTT = cask transfer trolley; EAF = energy absorbing feature; EVC = Entrance Vestibule crane; SFTM = spent fuel transfer machine; TCTS = transportation cask transfer station; WHF = Wet Handling Facility.

Source: Table 6.2-1 and Table 6.2-2

D2.4 EVENT SEQUENCE QUANTIFICATION

This section provides the quantification results by sequence. The event sequence probabilities are provided first, and the cut sets are provided afterwards.

D2.4.1 Sequence Level Results

Table D2.4-1. Sequence Level Results

Event Tree	Sequence	Base Min. Cut	Base Cut Sets
WHF-S-IE-BARE	03	6.359E-006	1
WHF-S-IE-BARE	04-2	4.337E-010	1
WHF-S-IE-BARE	04-3	+0.000E+000	1
WHF-S-IE-BARE	04-4	+0.000E+000	1
WHF-S-IE-BARE	04-5	+0.000E+000	1
WHF-S-IE-BARE	04-6	4.337E-010	1
WHF-S-IE-BARE	04-7	8.763E-013	1
WHF-S-IE-BARE	05-2	1.236E-008	1
WHF-S-IE-BARE	05-3	+0.000E+000	1
WHF-S-IE-BARE	05-4	+0.000E+000	1
WHF-S-IE-BARE	05-5	+0.000E+000	1
WHF-S-IE-BARE	05-6	1.236E-008	1
WHF-S-IE-BARE	05-7	3.340E-011	1
WHF-S-IE-BARE	06-2	1.917E-008	1
WHF-S-IE-BARE	06-3	+0.000E+000	1
WHF-S-IE-BARE	06-4	+0.000E+000	1
WHF-S-IE-BARE	06-5	+0.000E+000	1
WHF-S-IE-BARE	06-6	1.917E-008	1
WHF-S-IE-BARE	06-7	3.874E-011	1
WHF-S-IE-BARE	07-2	1.001E-009	1
WHF-S-IE-BARE	07-3	+0.000E+000	1
WHF-S-IE-BARE	07-4	+0.000E+000	1
WHF-S-IE-BARE	07-5	+0.000E+000	1
WHF-S-IE-BARE	07-6	9.007E-006	2
WHF-S-IE-BARE	07-7	8.475E-008	2
WHF-S-IE-BARE	08-2	9.642E-010	3
WHF-S-IE-BARE	08-3	+0.000E+000	1
WHF-S-IE-BARE	08-4	+0.000E+000	1
WHF-S-IE-BARE	08-5	+0.000E+000	1
WHF-S-IE-BARE	08-6	1.991E-005	4
WHF-S-IE-BARE	08-7	1.873E-007	4
WHF-S-IE-BARE	09-2	1.998E-010	1
WHF-S-IE-BARE	09-3	+0.000E+000	1
WHF-S-IE-BARE	09-4	+0.000E+000	1

Table D2.4-1. Sequence Level Results (Continued)

Event Tree	Sequence	Base Min. Cut	Base Cut Sets
WHF-S-IE-BARE	09-5	+0.000E+000	1
WHF-S-IE-BARE	09-6	4.213E-006	3
WHF-S-IE-BARE	09-7	3.875E-008	3
WHF-S-IE-BARE	10-2		0
WHF-S-IE-BARE	10-3	+0.000E+000	1
WHF-S-IE-BARE	10-4	+0.000E+000	1
WHF-S-IE-BARE	10-5	+0.000E+000	1
WHF-S-IE-BARE	10-6	4.359E-006	1
WHF-S-IE-BARE	10-7	4.278E-008	1
WHF-S-IE-BARE	11-2	6.511E-012	1
WHF-S-IE-BARE	11-3	+0.000E+000	1
WHF-S-IE-BARE	11-4	+0.000E+000	1
WHF-S-IE-BARE	11-5	+0.000E+000	1
WHF-S-IE-BARE	11-6	2.536E-006	2
WHF-S-IE-BARE	11-7	2.386E-008	2
WHF-S-IE-BARE	12-2		0
WHF-S-IE-BARE	12-3	+0.000E+000	1
WHF-S-IE-BARE	12-4	+0.000E+000	1
WHF-S-IE-BARE	12-5	+0.000E+000	1
WHF-S-IE-BARE	12-6	1.061E-005	1
WHF-S-IE-BARE	12-7	1.010E-007	1
WHF-S-IE-BARE	13-2	+0.000E+000	1
WHF-S-IE-BARE	13-3		0
WHF-S-IE-BARE	13-4		0
WHF-S-IE-BARE	13-5	1.792E-004	1
WHF-S-IE-BARE	13-6	2.247E-006	1
WHF-S-IE-BARE	14-2	+0.000E+000	1
WHF-S-IE-BARE	14-3		0
WHF-S-IE-BARE	14-4		0
WHF-S-IE-BARE	14-5	1.025E-005	2
WHF-S-IE-BARE	14-6	4.100E-007	2
WHF-S-IE-BARE	15-2	+0.000E+000	1
WHF-S-IE-BARE	15-3		0
WHF-S-IE-BARE	15-4		0
WHF-S-IE-BARE	15-5	7.557E-006	2
WHF-S-IE-BARE	15-6	2.212E-007	2

Source: Original

D2.4.2 Cut Set Level Results by Sequence

Note that the SAPHIRE software does not provide special tables for seismic cut sets. Therefore, the “Cut Set %” given in the third column of this table is not correct for seismic events, although it does provide the approximate rank order for the cut sets.

Table D2.4-2. Cut Set Level Results by Sequence

Event Tree	Sequence	Cut Set %	Basic Event	Description
WHF-S-IE-BARE	03	100.00	050-BARE-STRUCTUR-ETF	ETF for B-SNF in WHF structure
			S-050-STR-COLLAPSE	Seismic collapse of WHF structure
			WHF-BARE-CASK	Number of TCs with bare SNF processed in WHF
			= Total	
	04-2	100.00	050-BARE-ENTDOOR-ETF	ETF for entry door over B-SNF
			S-050-ENTDOORCOL	Seismic collapse of WHF entry door
			SHIELDING	Shielding remains intact
			WHF-BARE-CASK	Number of TCs with bare SNF processed in WHF
			= Total	
	04-3	0.00	<FALSE>	System Generated Success Event
			= Total	
	04-4	0.00	<FALSE>	System Generated Success Event
			= Total	
	04-5	0.00	<FALSE>	System Generated Success Event
			= Total	
	04-6	100.00	050-BARE-ENTDOOR-ETF	ETF for entry door over B-SNF
			050-BARE-ENTDOOR-PFA	Breach of B-SNF due to entry door collapse
			S-050-ENTDOORCOL	Seismic collapse of WHF entry door
			WHF-BARE-CASK	Number of TCs with bare SNF processed in WHF
			= Total	
	04-7	100.00	050-BARE-ENTDOOR-ETF	ETF for entry door over B-SNF
			050-BARE-ENTDOOR-PFA	Breach of B-SNF due to entry door collapse
			MOD-ENTER-CANISTER	Flooding or spray enters canister

Table D2.4-2. Cut Set Level Results by Sequence (Continued)

Event Tree	Sequence	Cut Set %	Basic Event	Description
			S-050-ENTDOORCOL	Seismic collapse of WHF entry door
			S-050-PIPING-FAIL	Seismic failure of piping in accident area
			WHF-BARE-CASK	Number of TCs with bare SNF processed in WHF
			= Total	
	05-2	100.00	050-BARE-TRUCK-ETF	ETF for truck carrying bare SNF
			S-050-TRUCK-TIP	Seismic tipover of truck
			SHIELDING	Shielding remains intact
			WHF-BARE-CASK	Number of TCs with bare SNF processed in WHF
			= Total	
	05-3	0.00	<FALSE>	System Generated Success Event
			= Total	
	05-4	0.00	<FALSE>	System Generated Success Event
			= Total	
	05-5	0.00	<FALSE>	System Generated Success Event
			= Total	
	05-6	100.00	050-BARE-TRUCK-ETF	ETF for truck carrying bare SNF
			050-BARE-TRUCK-PFA	Breach of B-SNF due to truck accident
			S-050-TRUCK-TIP	Seismic tipover of truck
			WHF-BARE-CASK	Number of TCs with bare SNF processed in WHF
			= Total	
	05-7	100.00	050-BARE-TRUCK-ETF	ETF for truck carrying bare SNF
			050-BARE-TRUCK-PFA	Breach of B-SNF due to truck accident
			MOD-ENTER-CANISTER	Flooding or spray enters canister
			S-050-PIPING-FAIL	Seismic failure of piping in accident area
			S-050-TRUCK-TIP	Seismic tipover of truck
			WHF-BARE-CASK	Number of TCs with bare SNF processed in WHF
			= Total	

Table D2.4-2. Cut Set Level Results by Sequence (Continued)

Event Tree	Sequence	Cut Set %	Basic Event	Description
	06-2	100.00	050-BARE-MOBPLAT-ETF	ETF for mobile platform over B-SNF
			S-050-MOBPLAT-COLLAP	Seismic collapse of WHF mobile platform
			SHIELDING	Shielding remains intact
			WHF-BARE-CASK	Number of TCs with bare SNF processed in WHF
			= Total	
	06-3	0.00	<FALSE>	System Generated Success Event
			= Total	
	06-4	0.00	<FALSE>	System Generated Success Event
			= Total	
	06-5	0.00	<FALSE>	System Generated Success Event
			= Total	
	06-6	100.00	050-BARE-MOBPLAT-ETF	ETF for mobile platform over B-SNF
			050-BARE-MOBPLAT-PFA	Breach of B-SNF due to mobile platform collapse
			S-050-MOBPLAT-COLLAP	Seismic collapse of WHF mobile platform
			WHF-BARE-CASK	Number of TCs with bare SNF processed in WHF
			= Total	
	06-7	100.00	050-BARE-MOBPLAT-ETF	ETF for mobile platform over B-SNF
			050-BARE-MOBPLAT-PFA	Breach of B-SNF due to mobile platform collapse
			MOD-ENTER-CANISTER	Flooding or spray enters canister
			S-050-MOBPLAT-COLLAP	Seismic collapse of WHF mobile platform
			S-050-PIPING-FAIL	Seismic failure of piping in accident area
			WHF-BARE-CASK	Number of TCs with bare SNF processed in WHF
			= Total	
	07-2	100.00	050-BARE-EVC-OBJ-ETF	ETF for EVC with heavy object over B-SNF
			S-050-EVC-OBJDROP	Seismic drop of heavy object by EVC
			SHIELDING	Shielding remains intact

Table D2.4-2. Cut Set Level Results by Sequence (Continued)

Event Tree	Sequence	Cut Set %	Basic Event	Description
			WHF-BARE-CASK	Number of TCs with bare SNF processed in WHF
			= Total	
	07-3	0.00	<FALSE>	System Generated Success Event
			= Total	
	07-4	0.00	<FALSE>	System Generated Success Event
			= Total	
	07-5	0.00	<FALSE>	System Generated Success Event
			= Total	
	07-6	99.61	050-BARE-EVC-COL-ETF	ETF for Entrance Vestibule Crane over B-SNF
			S-050-EVC-COLLAPSE	Seismic collapse of Entrance Vestibule crane
			WHF-BARE-CASK	Number of TCs with bare SNF processed in WHF
		0.39	050-BARE-EVC-OBJ-ETF	ETF for EVC with heavy object over B-SNF
			050-BARE-EVC-OBJ-PFA	Breach of B-SNF due to EVC heavy object drop
			S-050-EVC-OBJDROP	Seismic drop of heavy object by EVC
			WHF-BARE-CASK	Number of TCs with bare SNF processed in WHF
			= Total	
	07-7	99.61	050-BARE-EVC-COL-ETF	ETF for Entrance Vestibule crane over B-SNF
			MOD-ENTER-CANISTER	Flooding or spray enters canister
			S-050-EVC-COLLAPSE	Seismic collapse of Entrance Vestibule crane
			S-050-PIPING-FAIL	Seismic failure of piping in accident area
			WHF-BARE-CASK	Number of TCs with bare SNF processed in WHF
		0.39	050-BARE-EVC-OBJ-ETF	ETF for EVC with heavy object over B-SNF
			050-BARE-EVC-OBJ-PFA	Breach of B-SNF due to EVC heavy object drop
			MOD-ENTER-CANISTER	Flooding or spray enters canister
			S-050-EVC-OBJDROP	Seismic drop of heavy object by EVC

Table D2.4-2. Cut Set Level Results by Sequence (Continued)

Event Tree	Sequence	Cut Set %	Basic Event	Description
			S-050-PIPING-FAIL	Seismic failure of piping in accident area
			WHF-BARE-CASK	Number of TCs with bare SNF processed in WHF
			= Total	
	08-2	90.17	050-BARE-CHCHOIST-ETF	ETF for CHC hoisting B-SNF
			S-050-CHC-SWING	Significant seismic swinging of CHC
			SHIELDING	Shielding remains intact
			WHF-BARE-CASK	Number of TCs with bare SNF processed in WHF
		5.27	050-BARE-CHCHOIST-ETF	ETF for CHC hoisting B-SNF
			S-050-CHC-HOIST	Seismic failure of CHC hoist
			SHIELDING	Shielding remains intact
			WHF-BARE-CASK	Number of TCs with bare SNF processed in WHF
		4.56	050-BARE-CHC-OBJ-ETF	ETF for CHC with heavy object over B-SNF
			S-050-CHC-OBJDROP	Seismic drop of heavy object by CHC
			SHIELDING	Shielding remains intact
			WHF-BARE-CASK	Number of TCs with bare SNF processed in WHF
			= Total	
	08-3	0.00	<FALSE>	System Generated Success Event
			= Total	
	08-4	0.00	<FALSE>	System Generated Success Event
			= Total	
	08-5	0.00	<FALSE>	System Generated Success Event
			= Total	
	08-6	99.86	050-BARE-CHC-COL-ETF	ETF for CHC over B-SNF
			S-050-CHC-COLLAPSE	Seismic collapse of CHC
			WHF-BARE-CASK	Number of TCs with bare SNF processed in WHF
		0.12	050-BARE-CHCHOIST-ETF	ETF for CHC hoisting B-SNF
			050-BARE-CHCSWING-PFA	Breach of B-SNF due to CHC load swinging

Table D2.4-2. Cut Set Level Results by Sequence (Continued)

Event Tree	Sequence	Cut Set %	Basic Event	Description
			S-050-CHC-SWING	Significant seismic swinging of CHC
			WHF-BARE-CASK	Number of TCs with bare SNF processed in WHF
		0.01	050-BARE-CHCHOIST-ETF	ETF for CHC hoisting B-SNF
			050-BARE-CHCHOIST-PFA	Breach of B-SNF due to CHC hoist drop
			S-050-CHC-HOIST	Seismic failure of CHC hoist
			WHF-BARE-CASK	Number of TCs with bare SNF processed in WHF
		0.01	050-BARE-CHC-OBJ-ETF	ETF for CHC with heavy object over B-SNF
			050-BARE-CHC-OBJ-PFA	Breach of B-SNF due to CHC heavy object drop
			S-050-CHC-OBJDROP	Seismic drop of heavy object by CHC
			WHF-BARE-CASK	Number of TCs with bare SNF processed in WHF
			= Total	
	08-7	99.86	050-BARE-CHC-COL-ETF	ETF for CHC over B-SNF
			MOD-ENTER-CANISTER	Flooding or spray enters canister
			S-050-CHC-COLLAPSE	Seismic collapse of CHC
			S-050-PIPING-FAIL	Seismic failure of piping in accident area
			WHF-BARE-CASK	Number of TCs with bare SNF processed in WHF
		0.12	050-BARE-CHCHOIST-ETF	ETF for CHC hoisting B-SNF
			050-BARE-CHCSWING-PFA	Breach of B-SNF due to CHC load swinging
			MOD-ENTER-CANISTER	Flooding or spray enters canister
			S-050-CHC-SWING	Significant seismic swinging of CHC
			S-050-PIPING-FAIL	Seismic failure of piping in accident area
			WHF-BARE-CASK	Number of TCs with bare SNF processed in WHF
		0.01	050-BARE-CHCHOIST-ETF	ETF for CHC hoisting B-SNF
			050-BARE-CHCHOIST-PFA	Breach of B-SNF due to CHC hoist drop

Table D2.4-2. Cut Set Level Results by Sequence (Continued)

Event Tree	Sequence	Cut Set %	Basic Event	Description
			MOD-ENTER-CANISTER	Flooding or spray enters canister
			S-050-CHC-HOIST	Seismic failure of CHC hoist
			S-050-PIPING-FAIL	Seismic failure of piping in accident area
			WHF-BARE-CASK	Number of TCs with bare SNF processed in WHF
		0.01	050-BARE-CHC-OBJ-ETF	ETF for CHC with heavy object over B-SNF
			050-BARE-CHC-OBJ-PFA	Breach of B-SNF due to CHC heavy object drop
			MOD-ENTER-CANISTER	Flooding or spray enters canister
			S-050-CHC-OBJDROP	Seismic drop of heavy object by CHC
			S-050-PIPING-FAIL	Seismic failure of piping in accident area
			WHF-BARE-CASK	Number of TCs with bare SNF processed in WHF
			= Total	
	09-2	100.00	050-BARE-CTT-BUMP-ETF	ETF for CTT with TC subject to bumping EAF
			S-050-CTT-BUMPING	Seismic bumping of CTT into EAF
			SHIELDING	Shielding remains intact
			WHF-BARE-CASK	Number of TCs with bare SNF processed in WHF
			= Total	
	09-3	0.00	<FALSE>	System Generated Success Event
			= Total	
	09-4	0.00	<FALSE>	System Generated Success Event
			= Total	
	09-5	0.00	<FALSE>	System Generated Success Event
			= Total	
	09-6	91.12	050-BARE-CTTSLIDE-ETF	ETF for CTT containing B-SNF in transfer cell
			S-050-CTT-SLIDE	Seismic sliding of CTT into wall
			WHF-BARE-CASK	Number of TCs with bare SNF processed in WHF
		8.88	050-BARE-CTT-ROCK-ETF	ETF for CTT with B-SNF subject to rocking

Table D2.4-2. Cut Set Level Results by Sequence (Continued)

Event Tree	Sequence	Cut Set %	Basic Event	Description
			S-050-CTT-ROCKING	Seismic rocking of CTT with restraint failure
			WHF-BARE-CASK	Number of TCs with bare SNF processed in WHF
		0.00	050-BARE-CTT-BUMP-ETF	ETF for CTT with TC subject to bumping EAF
			050-BARE-CTT-BUMP-PFA	Breach given CTT with TC subject to bumping EAF
			S-050-CTT-BUMPING	Seismic bumping of CTT into EAF
			WHF-BARE-CASK	Number of TCs with bare SNF processed in WHF
			= Total	
	09-7	91.12	050-BARE-CTTSLIDE-ETF	ETF for CTT containing B-SNF in transfer cell
			MOD-ENTER-CANISTER	Flooding or spray enters canister
			S-050-CTT-SLIDE	Seismic sliding of CTT into wall
			S-050-PIPING-FAIL	Seismic failure of piping in accident area
			WHF-BARE-CASK	Number of TCs with bare SNF processed in WHF
		8.88	050-BARE-CTT-ROCK-ETF	ETF for CTT with B-SNF subject to rocking
			MOD-ENTER-CANISTER	Flooding or spray enters canister
			S-050-CTT-ROCKING	Seismic rocking of CTT with restraint failure
			S-050-PIPING-FAIL	Seismic failure of piping in accident area
			WHF-BARE-CASK	Number of TCs with bare SNF processed in WHF
		0.00	050-BARE-CTT-BUMP-ETF	ETF for CTT with TC subject to bumping EAF
			050-BARE-CTT-BUMP-PFA	Breach given CTT with TC subject to bumping EAF
			MOD-ENTER-CANISTER	Flooding or spray enters canister
			S-050-CTT-BUMPING	Seismic bumping of CTT into EAF
			S-050-PIPING-FAIL	Seismic failure of piping in accident area
			WHF-BARE-CASK	Number of TCs with bare SNF processed in WHF

Table D2.4-2. Cut Set Level Results by Sequence (Continued)

Event Tree	Sequence	Cut Set %	Basic Event	Description
			= Total	
	10-2			
	10-3	0.00	<FALSE>	System Generated Success Event
			= Total	
	10-4	0.00	<FALSE>	System Generated Success Event
			= Total	
	10-5	0.00	<FALSE>	System Generated Success Event
			= Total	
	10-6	100.00	050-BARE-PS1-ETF	ETF for B-SNF under prep station #1
			S-050-PS1-COLLAPSE	Seismic collapse of prep station #1
			WHF-BARE-CASK	Number of TCs with bare SNF processed in WHF
			= Total	
	10-7	100.00	050-BARE-PS1-ETF	ETF for B-SNF under prep station #1
			MOD-ENTER-CANISTER	Flooding or spray enters canister
			S-050-PIPING-FAIL	Seismic failure of piping in accident area
			S-050-PS1-COLLAPSE	Seismic collapse of prep station #1
			WHF-BARE-CASK	Number of TCs with bare SNF processed in WHF
			= Total	
	11-2	100.00	050-BARE-JIBC-OBJ-ETF	ETF for jib crane with heavy object over B-SNF
			S-050-JIBC-OBJDROP	Seismic drop of heavy object by jib crane
			SHIELDING	Shielding remains intact
			WHF-BARE-CASK	Number of TCs with bare SNF processed in WHF
			= Total	
	11-3	0.00	<FALSE>	System Generated Success Event
			= Total	
	11-4	0.00	<FALSE>	System Generated Success Event
			= Total	
	11-5	0.00	<FALSE>	System Generated Success Event

Table D2.4-2. Cut Set Level Results by Sequence (Continued)

Event Tree	Sequence	Cut Set %	Basic Event	Description
			= Total	
	11-6	100.00	050-BARE-JIBC-COL-ETF	ETF for JIBC over B-SNF
			S-050-JIBC-COLLAPSE	Seismic collapse of jib crane
			WHF-BARE-CASK	Number of TCs with bare SNF processed in WHF
		0.00	050-BARE-JIBC-OBJ-ETF	ETF for jib crane with heavy object over B-SNF
			050-BARE-JIBC-OBJ-PFA	Breach of B-SNF due to JIBC heavy object drop
			S-050-JIBC-OBJDROP	Seismic drop of heavy object by jib crane
			WHF-BARE-CASK	Number of TCs with bare SNF processed in WHF
			= Total	
	11-7	100.00	050-BARE-JIBC-COL-ETF	ETF for JIBC over B-SNF
			MOD-ENTER-CANISTER	Flooding or spray enters canister
			S-050-JIBC-COLLAPSE	Seismic collapse of jib crane
			S-050-PIPING-FAIL	Seismic failure of piping in accident area
			WHF-BARE-CASK	Number of TCs with bare SNF processed in WHF
		0.00	050-BARE-JIBC-OBJ-ETF	ETF for jib crane with heavy object over B-SNF
			050-BARE-JIBC-OBJ-PFA	Breach of B-SNF due to JIBC heavy object drop
			MOD-ENTER-CANISTER	Flooding or spray enters canister
			S-050-JIBC-OBJDROP	Seismic drop of heavy object by jib crane
			S-050-PIPING-FAIL	Seismic failure of piping in accident area
			WHF-BARE-CASK	Number of TCs with bare SNF processed in WHF
			= Total	
	12-2			
	12-3	0.00	<FALSE>	System Generated Success Event
			= Total	
	12-4	0.00	<FALSE>	System Generated Success Event
			= Total	

Table D2.4-2. Cut Set Level Results by Sequence (Continued)

Event Tree	Sequence	Cut Set %	Basic Event	Description
	12-5	0.00	<FALSE>	System Generated Success Event
			= Total	
	12-6	100.00	050-BARE-SHIELDDR-ETF	ETF for shield doors when B-SNF is nearby
			S-050-SHIELDDOOR	Seismic falling of shield door
			WHF-BARE-CASK	Number of TCs with bare SNF processed in WHF
			= Total	
	12-7	100.00	050-BARE-SHIELDDR-ETF	ETF for shield doors when B-SNF is nearby
			MOD-ENTER-CANISTER	Flooding or spray enters canister
			S-050-PIPING-FAIL	Seismic failure of piping in accident area
			S-050-SHIELDDOOR	Seismic falling of shield door
			WHF-BARE-CASK	Number of TCs with bare SNF processed in WHF
			= Total	
	13-2	0.00	<FALSE>	System Generated Success Event
			= Total	
	13-3			
	13-4			
	13-5	100.00	050-BARE-TCTS-ETF	ETF for B-SNF in TCTS
			S-050-TCTS-COLLAPSE	Seismic collapse of TCTS
			WHF-BARE-CASK	Number of TCs with bare SNF processed in WHF
			= Total	
	13-6	100.00	050-BARE-TCTS-ETF	ETF for B-SNF in TCTS
			S-050-POOL-FAIL	Seismic failure of WHF pool
			S-050-TCTS-COLLAPSE	Seismic collapse of TCTS
			WHF-BARE-CASK	Number of TCs with bare SNF processed in WHF
			= Total	
	14-2	0.00	<FALSE>	System Generated Success Event
			= Total	
	14-3			

Table D2.4-2. Cut Set Level Results by Sequence (Continued)

Event Tree	Sequence	Cut Set %	Basic Event	Description
	14-4			
	14-5	90.20	050-BARE-APC- OBJ-ETF	ETF for APC with heavy object over B-SNF
			S-050-APC- OBJDROP	Seismic drop of heavy object by aux pool crane
			WHF-BARE-CASK	Number of TCs with bare SNF processed in WHF
		9.80	050-BARE-APC- COL-ETF	ETF for aux pool crane over B-SNF
			S-050-APC- COLLAPSE	Seismic collapse of aux pool crane
			WHF-BARE-CASK	Number of TCs with bare SNF processed in WHF
			= Total	
	14-6	90.20	050-BARE-APC- OBJ-ETF	ETF for APC with heavy object over B-SNF
			S-050-APC- OBJDROP	Seismic drop of heavy object by aux pool crane
			S-050-POOL-FAIL	Seismic failure of WHF pool
			WHF-BARE-CASK	Number of TCs with bare SNF processed in WHF
		9.80	050-BARE-APC- COL-ETF	ETF for aux pool crane over B-SNF
			S-050-APC- COLLAPSE	Seismic collapse of aux pool crane
			S-050-POOL-FAIL	Seismic failure of WHF pool
			WHF-BARE-CASK	Number of TCs with bare SNF processed in WHF
			= Total	
	15-2	0.00	<FALSE>	System Generated Success Event
			= Total	
	15-3			
	15-4			
	15-5	87.37	050-BARE-SFTM- COL-ETF	ETF for SFTM over B-SNF
			S-050-SFTM- COLLAPSE	Seismic collapse of spent fuel transfer machine
			WHF-BARE-CASK	Number of TCs with bare SNF processed in WHF
		12.63	050-BARE-SFTM- OBJ-ETF	ETF for SFTM with heavy object over B-SNF
			S-050-SFTM- OBJDROP	Seismic drop of heavy object by SFTM
			WHF-BARE-CASK	Number of TCs with bare SNF processed in WHF
			= Total	

Table D2.4-2. Cut Set Level Results by Sequence (Continued)

Event Tree	Sequence	Cut Set %	Basic Event	Description
	15-6	87.37	050-BARE-SFTM-COL-ETF	ETF for SFTM over B-SNF
			S-050-POOL-FAIL	Seismic failure of WHF pool
			S-050-SFTM-COLLAPSE	Seismic collapse of spent fuel transfer machine
			WHF-BARE-CASK	Number of TCs with bare SNF processed in WHF
		12.63	050-BARE-SFTM-OBJ-ETF	ETF for SFTM with heavy object over B-SNF
			S-050-POOL-FAIL	Seismic failure of WHF pool
			S-050-SFTM-OBJDROP	Seismic drop of heavy object by SFTM
			WHF-BARE-CASK	Number of TCs with bare SNF processed in WHF
			= Total	

NOTE: APC = auxiliary pool crane; CHC = cask handling crane; CTM = canister transfer machine; CTT = cask transfer trolley; DP = dual-purpose; DPC = dual-purpose canister; EAF = energy absorbing feature; ETF = exposure time factor; EVC = Entrance Vestibule crane; FPW = fire protection water; JIBC = jib crane; SFTM = spent fuel transfer machine; TC = transportation cask; WHF = Wet Handling Facility.

Source: Original

D3 ASSEMBLY TRANSFER (WHF-XFER)

This section provides the detailed information used to develop the event sequences for the analysis of the processing of SNF assemblies in the WHF. In the pool, SNF assemblies are transferred from a DPC in a STC, or from a transportation cask containing bare SND assemblies, to the spent fuel rack and then to an open TAD in a STC.

D3.1 EVENT TREES

The IET and SRETs are presented in this section. The tables provide the assignments between the event tree branches and the fault trees given in the next section.

Seismic Event	Time waste forms potentially at risk in WHF	Identify initiating seismic failure			
SEIS-EVENT	WHF-POOL-OPS	SEIS-FAIL	#	END-STATE	
			1	OK	
			2	OK	
			3	T => 2	WHF-S-R-POOL
			4	T => 2	WHF-S-R-POOL
			5	T => 2	WHF-S-R-POOL
			6		OK
			7		RR-UNF
			8		RR-UNF
			9		RR-UNF-ITC
			10		RR-UNF
WHF-S-IE-SNF-XFER - WHF Seismic Event Tree - Initiating Seismic Failures - SNF transfer			2007/12/20	WHF-TAD 1	

NOTE: Event tree branch captions are associated with the branch line below the caption.

HVAC = heating, ventilation and air conditioning; IE = initiating event; ITC = important to criticality; OPS = operations; RR = radioactive release; SEIS = seismic; SNF = spent nuclear fuel; TAD = transportation, aging and disposal; UNF = unfiltered; WHF = Wet Handling Facility; XFER = transfer.

Source: Original

Figure D3.1-1. WHF Seismic Event Tree WHF-S-IE-SNF-XFER – Initiating Seismic Failures – SNF Transfer

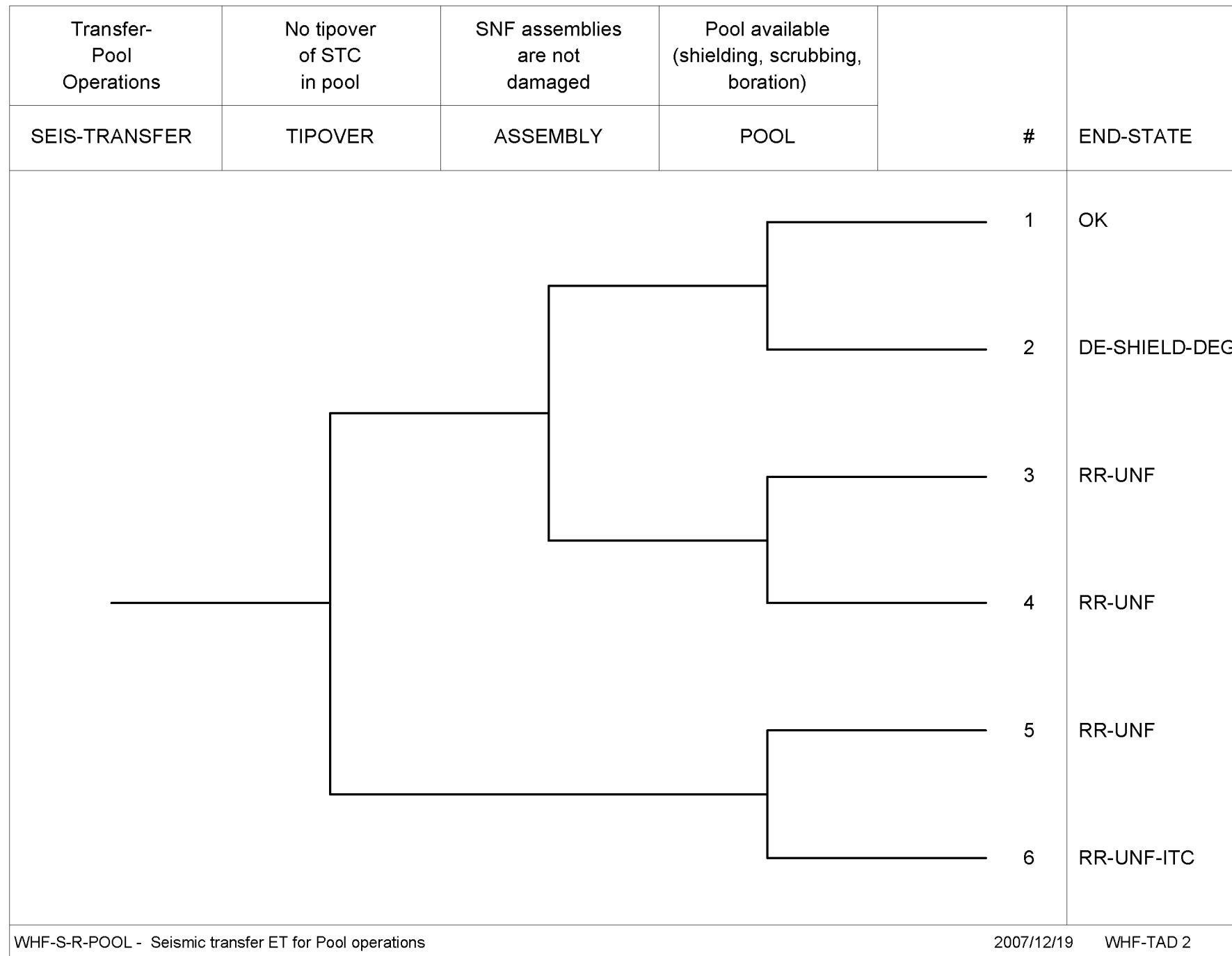

NOTE: DE = direct exposure; DEG = degradation; ET = event tree; FIL = filtered; ITC = important to criticality; RR = radioactive release; SEIS = seismic; SNF = spent nuclear fuel; STC = shielded transfer cask; UNF = unfiltered; WHF = Wet Handling Facility.

Source: Original

Figure B3.1-2. WHF Seismic Event Tree WHF-S-R-POOL – Seismic Transfer ET for Pool Operations

Table D3.1-1. Fault Trees Assigned for Initiating Seismic Failures for the WHF

Process	Initiator Event Tree	Initiating Seismic Failure	Associated Fault Tree
SNF Transfer – Assembly Transfer Operations	WHF-S-IE-SNF-XFER	Incoming transfer station (pool)	S-050-XFER-SNF-TS-COL
		Spent fuel transfer machine	S-050-XFER-SFTM-FAIL
		TAD transfer station	S-050-XFER-TAD-TS-COL
SNF Transfer – Continuous Exposure	WHF-S-IE-SNF-XFER	WHF building collapse	S-050-XFER-STR-COLLAP
		Pool failure	S-050-XFER-POOL-FAIL
		SNF staging rack collapse	S-050-XFER-SRACK-FAIL
		HVAC isolation failure	S-050-XFER-HVAC-FAIL

NOTE: HVAC = heating, ventilation and air conditioning; SNF = spent nuclear fuel; TAD = transportation, aging and disposal; WHF = Wet Handling Facility.

Source: Original

Table D3.1-2. Fault Trees Assigned for Pivotal Events for WHF-S-IE-SNF-XFER Initiating Event Tree

Initiating Seismic Failure	TIPOVER	MODERATOR
Assembly Transfer Operation Events		
Incoming transfer station (pool)	STC-XFER-SNF-TS-COL	N/A
Spent fuel transfer machine	STC-XFER-SFTM-FAIL	N/A
TAD transfer station	STC-XFER-TAD-TS-COL	N/A
Continuous Exposure Events		
WHF building collapse	N/A	N/A
Pool failure	N/A	N/A
SNF staging rack collapse	N/A	N/A
HVAC isolation failure	N/A	N/A

NOTE: HVAC = heating, ventilation and air conditioning; SNF = spent nuclear fuel; TAD = transportation, aging and disposal; WHF = Wet Handling Facility.

Source: Original

D3.2 FAULT TREES

Seismic fault trees for the processing of SNF assemblies in the WHF are presented in alphanumeric order in this section.

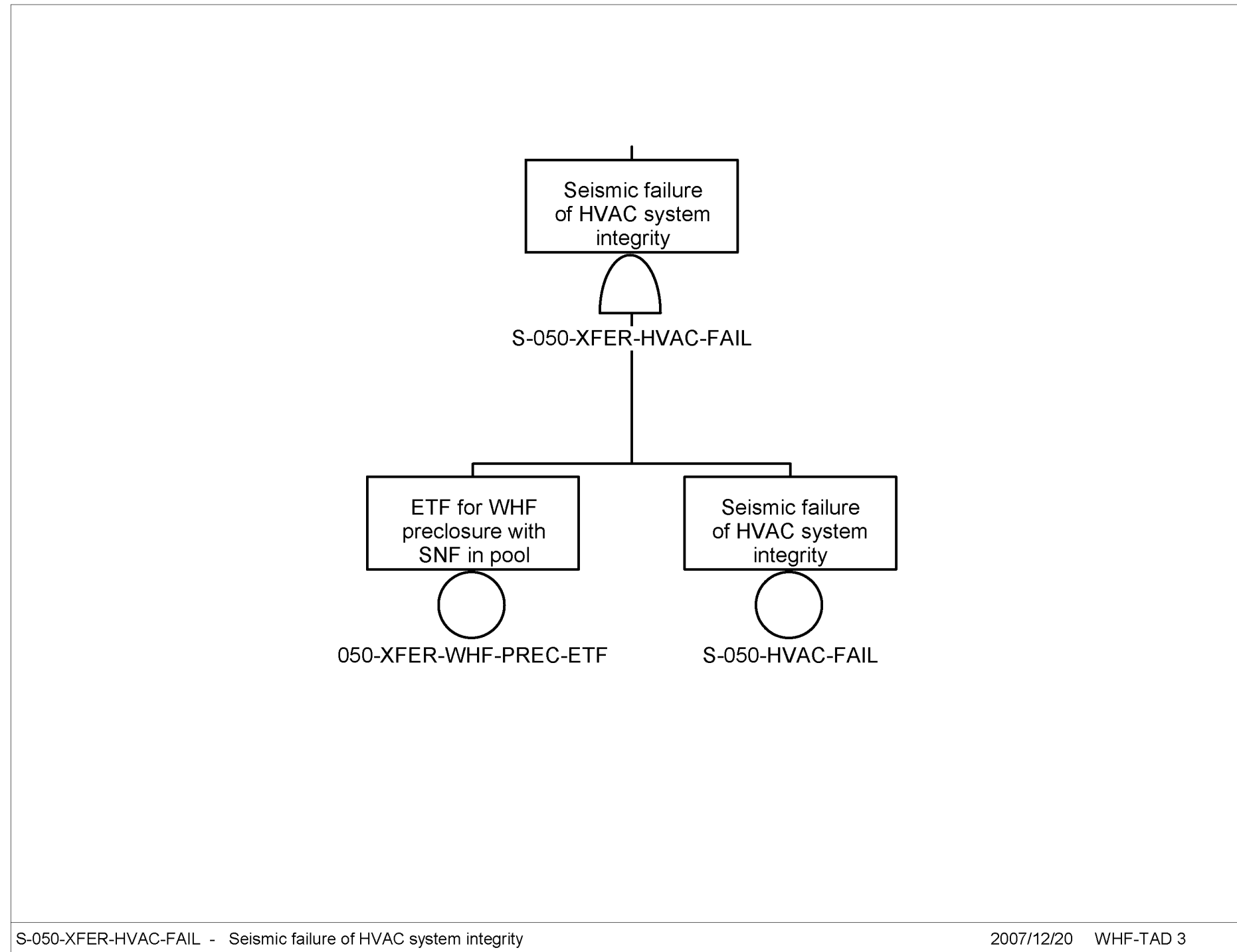

Source: Original

Figure D3.2-1. Fault Tree S-050-XFER-HVAC-FAIL – Seismic Failure of HVAC System Integrity

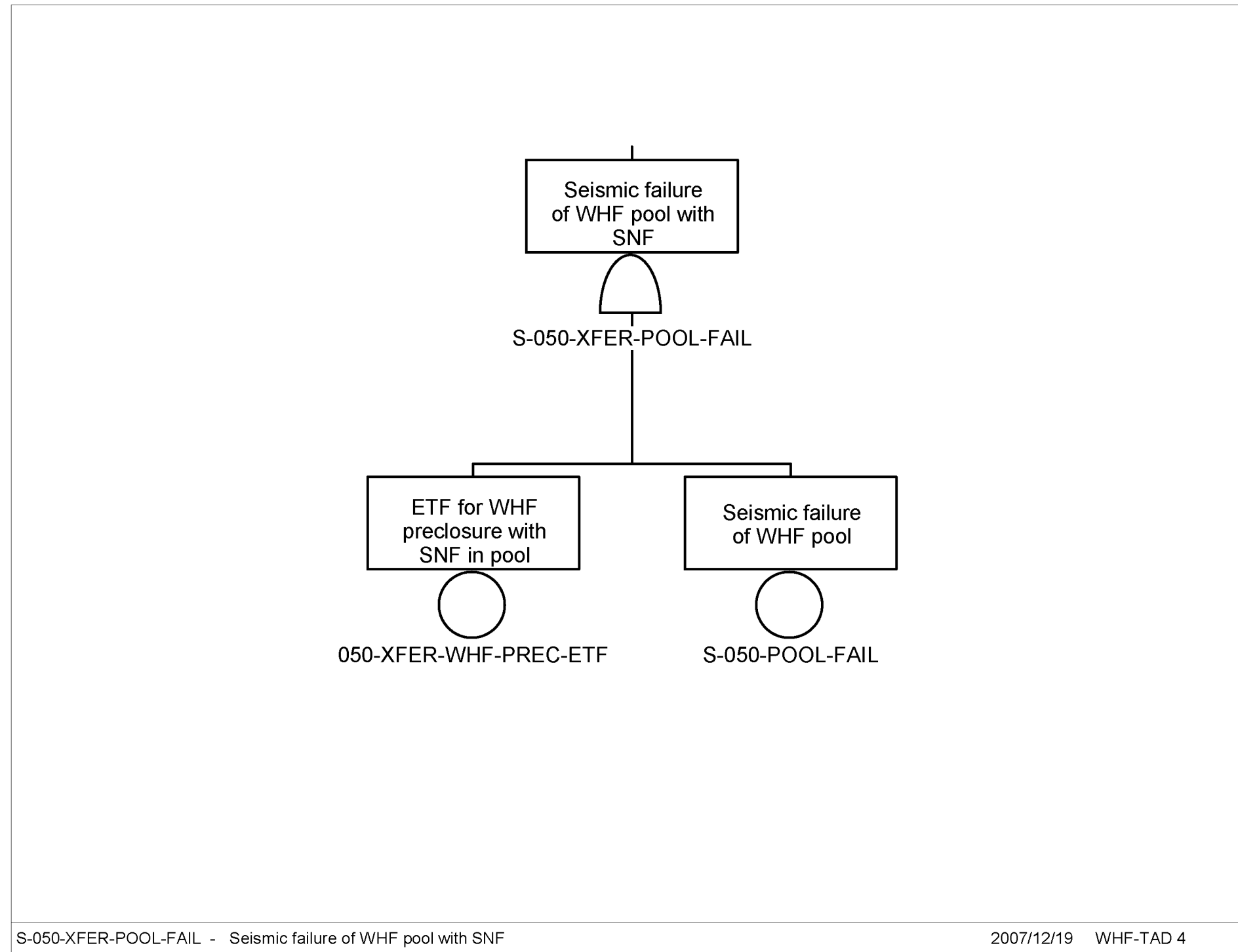

Source: Original

Figure D3.2-2. S-050-XFER-POOL-FAIL – Seismic Failure of WHF Pool with SNF

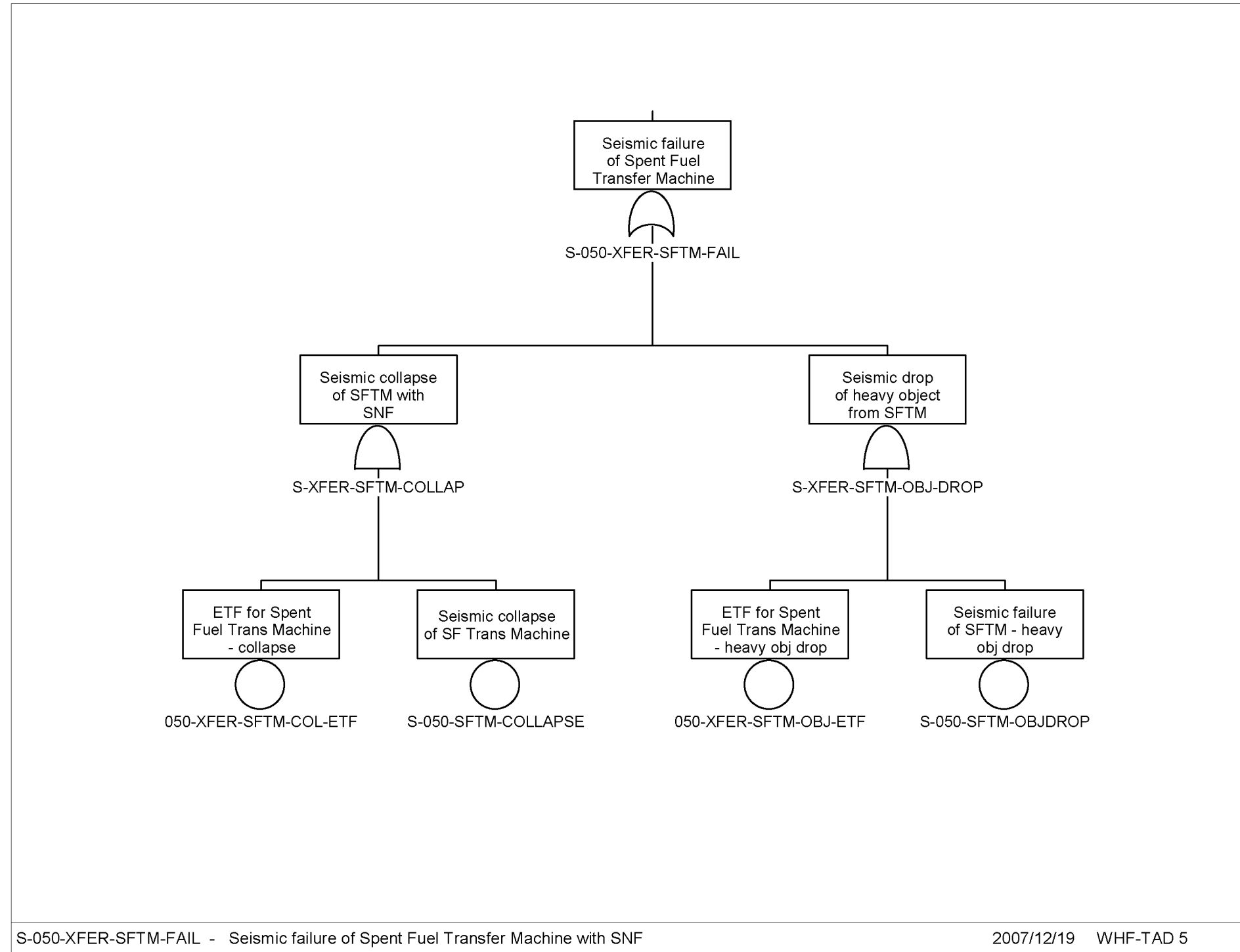

Source: Original

Figure D3.2-3 S-050-XFER-SFTM-FAIL – Seismic Failure of Spent Fuel Transfer Machine with SNF

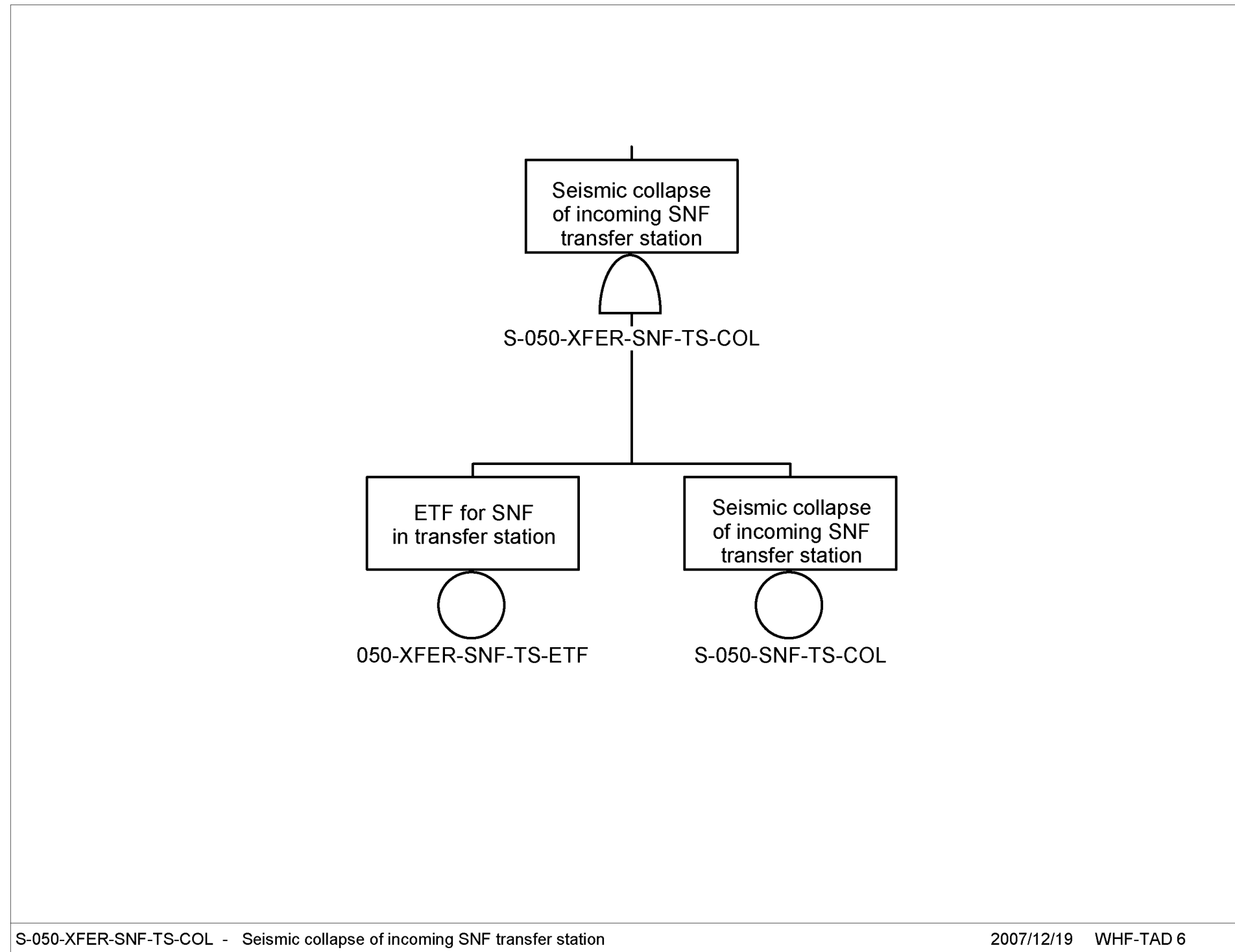

Source: Original

Figure D3.2-4. S-050-XFER-SNF-TS-COL – Seismic Collapse of Incoming SNF Transfer Station

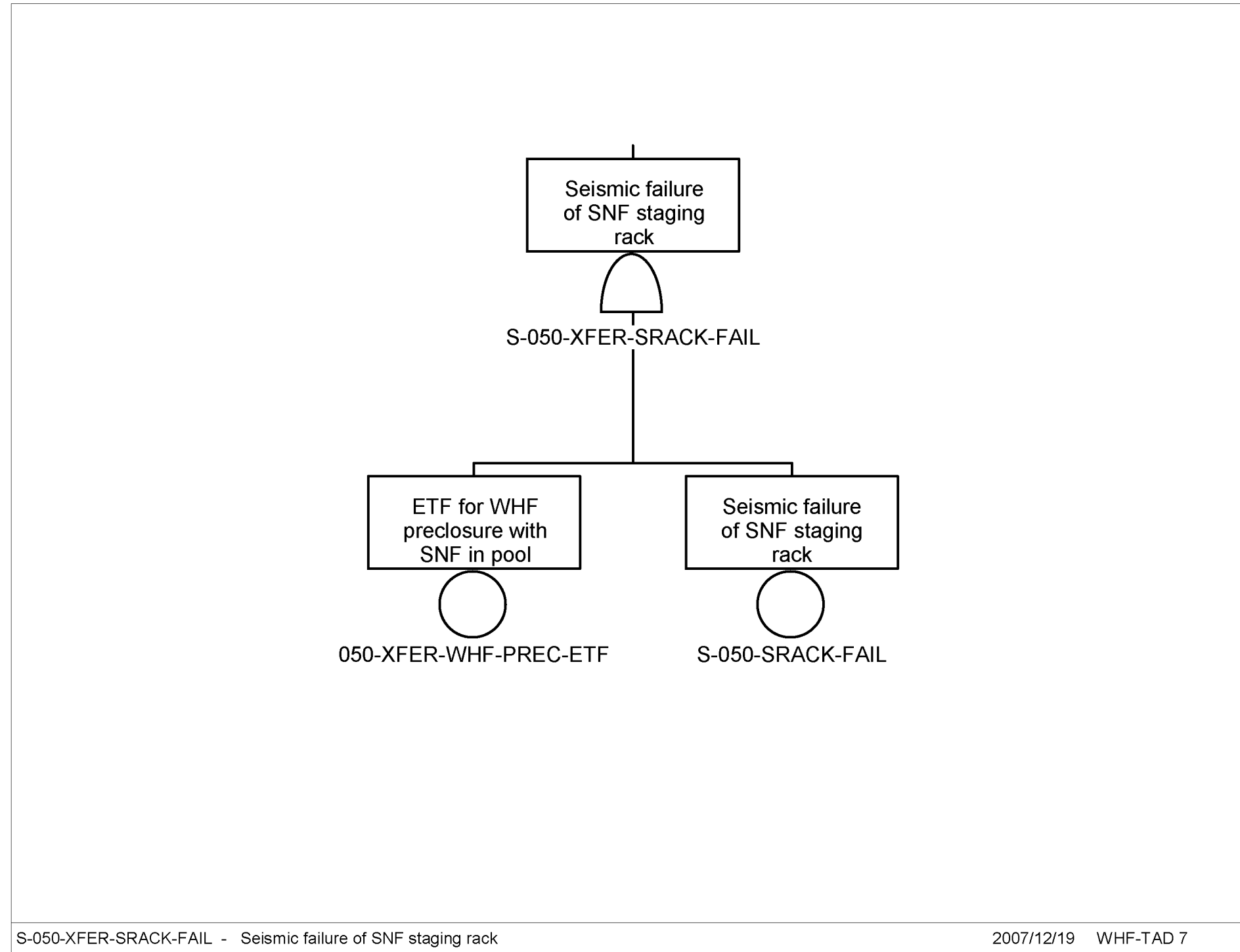

Source: Original

Figure D3.2-5. S-050-XFER-SRACK-FAIL – Seismic Failure of SNF Staging Rack

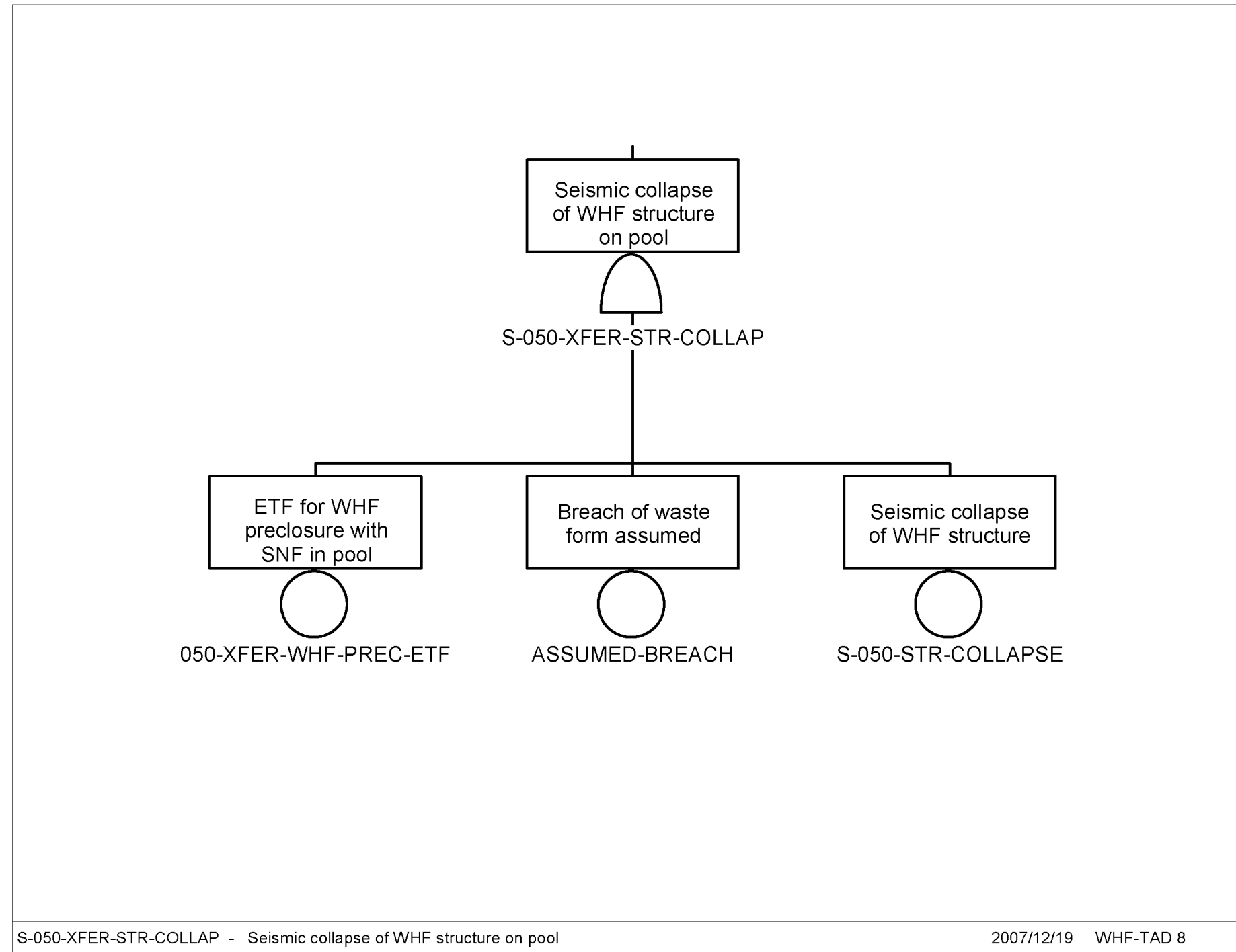

Source: Original

Figure D3.2-6. S-050-XFER-STR-COLLAP – Seismic Collapse of WHF Structure on Pool

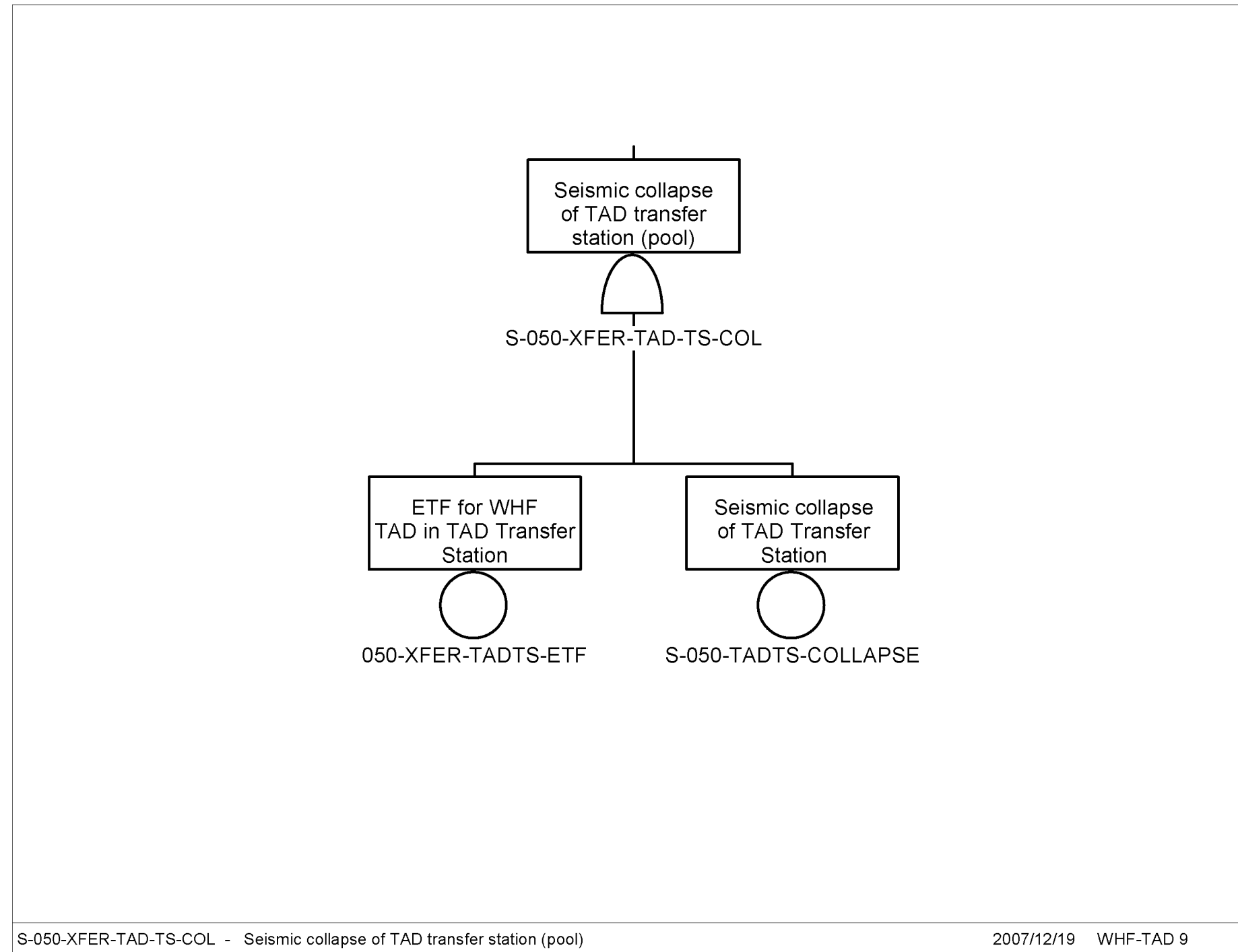

Source: Original

Figure D3.2-7. S-050-XFER-TAD-TS-COL – Seismic Collapse of TAD Transfer Station (Pool)

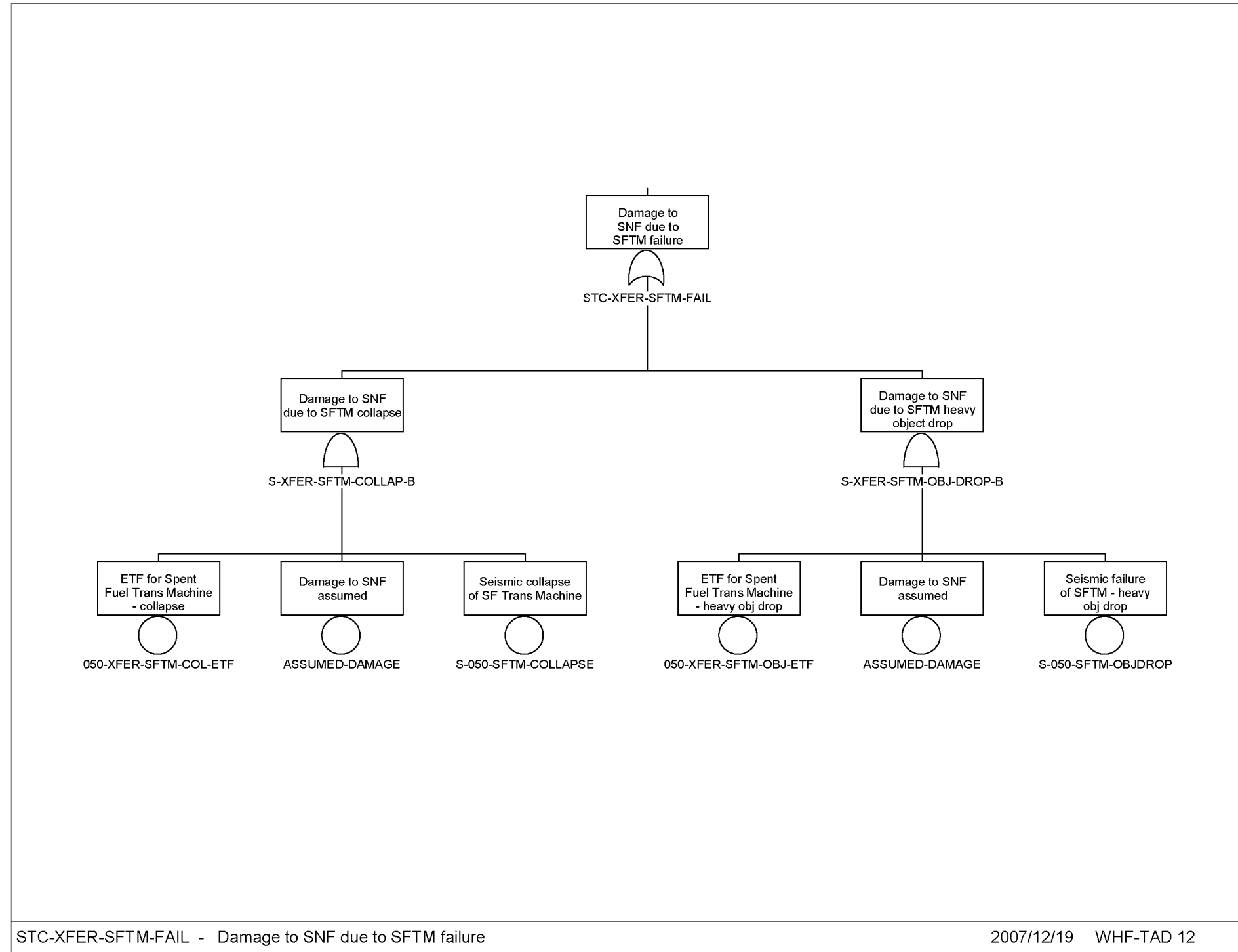

Source: Original

Figure D3.2-8. STC-XFER-SFTM-FAIL – Damage to SNF due to SFTM Failure

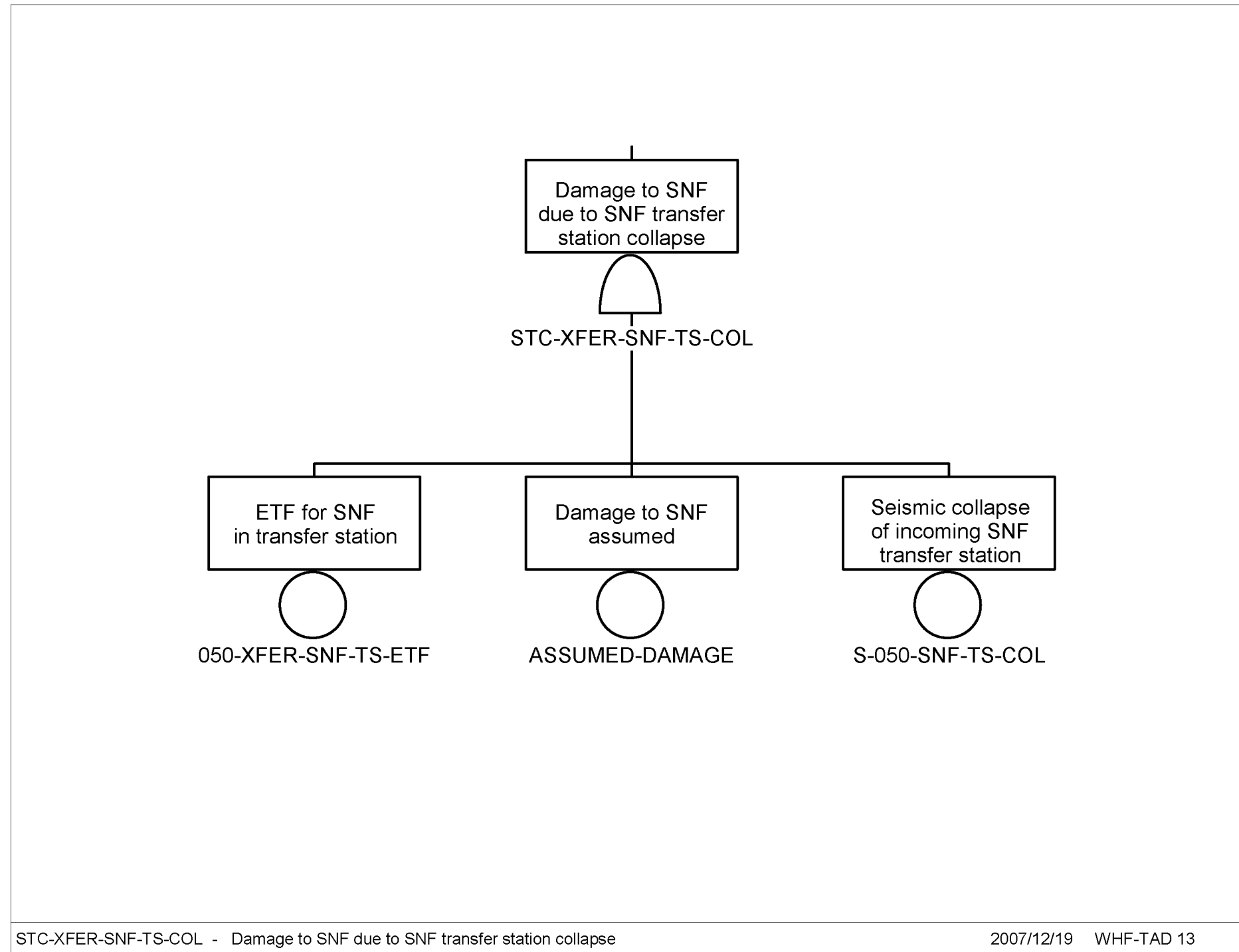

Source: Original

Figure D3.2-9. STC-XFER-SNF-TS-COL – Damage to SNF due to SNF Transfer Station Collapse

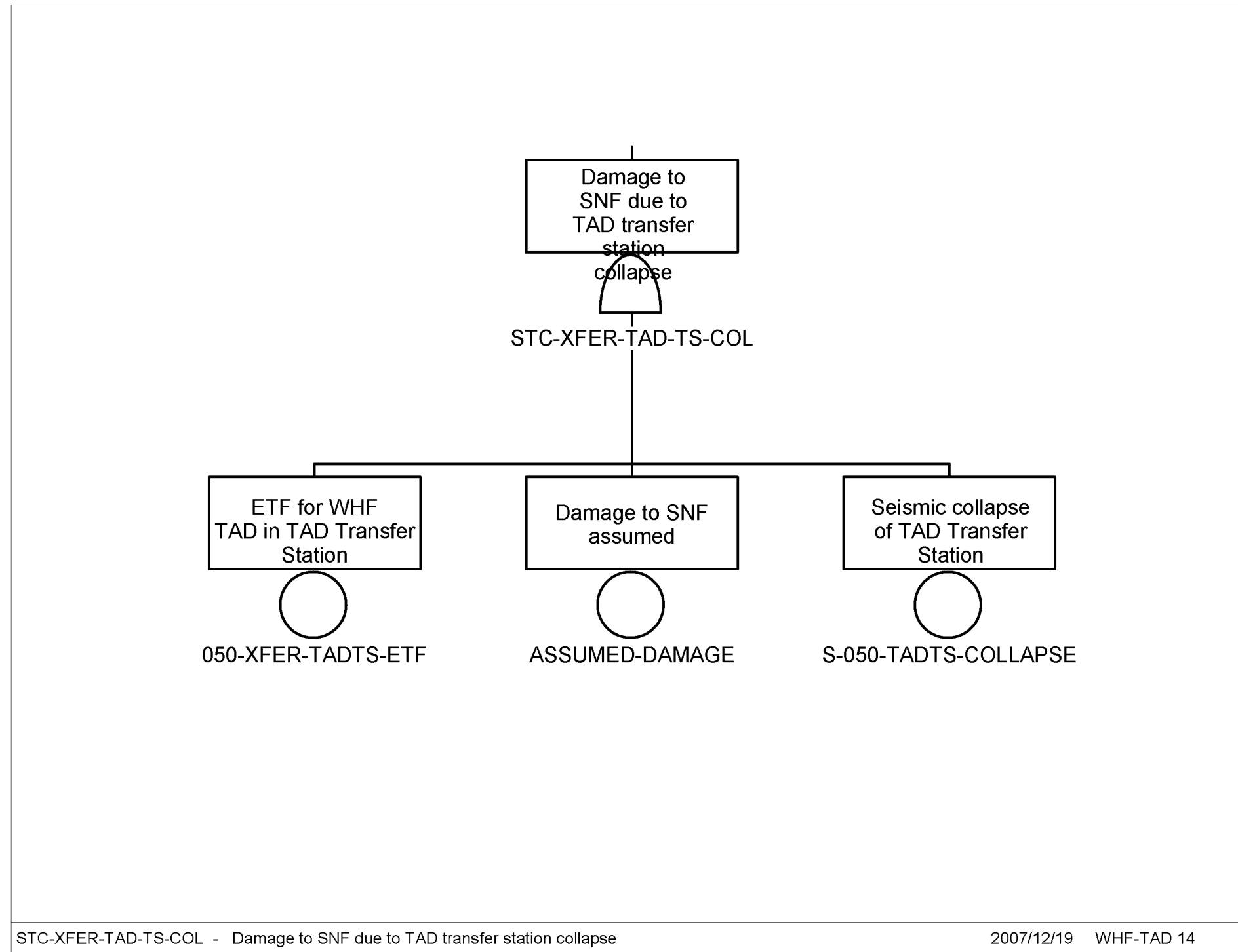

Source: Original

Figure D3.2-10. STC-XFER-TAD-TS-COL – Damage to SNF due to TAD Transfer Station Collapse

D3.3 BASIC EVENTS DATA

D3.3.1 Non-seismic Basic Event Data

The following table presents the basic event identifier used in the fault trees, the description of the basic event, and the failure probability (or other numeric data) of the basic event. For exposure time factors (denoted with "ETF" at the end of the basic event identifier), the value given is the time, in years, that one waste form container is exposed to the seismic failure mode.

Table D3.3-1. Non-seismic Basic Event Data

Name	Description	Calc. Probability
050-XFER-SFTM-COL-ETF	ETF for spent fuel trans machine - collapse	9.52E-05
050-XFER-SFTM-OBJ-ETF	ETF for spent fuel trans machine - heavy obj drop	9.52E-05
050-XFER-SNF-TS-ETF	ETF for SNF in transfer station	9.52E-05
050-XFER-TADTS-ETF	ETF for WHF TAD in TAD transfer station	9.52E-05
050-XFER-WHF-PREC-ETF	ETF for WHF preclosure with SNF in pool	5.00E+01
ASSUMED-BREACH	Breach of waste form assumed	1.00E+00
ASSUMED-DAMAGE	Damage to SNF assumed	1.00E+00
WHF-SNF-XFER	Number of SNF assemblies transferred	3.31E+04

NOTE: The basic events "ASSUMED-BREACH" and ASSUMED-DAMAGE" are not assumptions, but are common terminology used to denote a scenario where the waste container is conservatively considered to be breached, or assemblies are considered to be damaged; ETF = exposure time factor; SNF = spent nuclear fuel; TAD = transportation, aging and disposal; WHF = Wet Handling Facility.

Source: Table 6.3-1, Table 6.7-1

D3.3.2 Seismic Basic Event Fragility Data

The following table provides the seismic failure basic event identifier, description, median fragility, and composite uncertainty.

Table D3.3-2. Seismic Basic Event Fragility Data

Event Name	Description	Med. Fragility (g)	Beta C
S-050-HVAC-FAIL	Seismic failure of HVAC system integrity	2.690E+000	6.600E-001
S-050-POOL-FAIL	Seismic failure of WHF pool	4.510E+000	4.000E-001
S-050-SFTM-COLLAPSE	Seismic collapse of SFTM	2.190E+000	4.700E-001
S-050-SFTM-OBJDROP	Seismic failure of SFTM - heavy obj drop	2.280E+000	5.000E-001
S-050-SNF-TS-COL	Seismic collapse of incoming SNF transfer station	1.410E+000	4.000E-001
S-050-SRACK-FAIL	Seismic failure of SNF staging rack	4.500E+000	4.000E-001
S-050-STR-COLLAPSE	Seismic collapse of WHF structure	4.510E+000	4.000E-001
S-050-TADTS-COLLAPSE	Seismic collapse of TAD transfer station	1.410E+000	4.000E-001

NOTE: HVAC = heating, ventilation and air-conditioning; SFTM = spent fuel transfer machine; SNF = spent nuclear fuel; TAD = transportation, aging and disposal; WHF = Wet Handling Facility.

Source: Table 6.2-1 and Table 6.2-2

D3.4 EVENT SEQUENCE QUANTIFICATION

This section provides the quantification results by sequence. The event sequence probabilities are provided first, and the cut sets are provided afterwards.

D3.4.1 Sequence Level Results

Table D3.4-1. Sequence Level Results

Event Tree	Sequence	Base Min. Cut	Base Cut Sets
WHF-S-IE-SNF-XFER	03-2	+0.000E+000	1
WHF-S-IE-SNF-XFER	03-3		0
WHF-S-IE-SNF-XFER	03-4	+0.000E+000	1
WHF-S-IE-SNF-XFER	03-5	1.882E-004	1
WHF-S-IE-SNF-XFER	03-6	+0.000E+000	1
WHF-S-IE-SNF-XFER	04-2	+0.000E+000	1
WHF-S-IE-SNF-XFER	04-3		0
WHF-S-IE-SNF-XFER	04-4	+0.000E+000	1
WHF-S-IE-SNF-XFER	04-5	6.501E-005	2
WHF-S-IE-SNF-XFER	04-6	+0.000E+000	1
WHF-S-IE-SNF-XFER	05-2	+0.000E+000	1
WHF-S-IE-SNF-XFER	05-3		0
WHF-S-IE-SNF-XFER	05-4	+0.000E+000	1
WHF-S-IE-SNF-XFER	05-5	1.882E-004	1
WHF-S-IE-SNF-XFER	05-6	+0.000E+000	1
WHF-S-IE-SNF-XFER	07	4.341E-005	1
WHF-S-IE-SNF-XFER	08	4.341E-005	1
WHF-S-IE-SNF-XFER	09	4.387E-005	1
WHF-S-IE-SNF-XFER	10	1.086E-003	1

Source: Original

D3.4.2 Cut Set Level Results by Sequence

Note that the SAPHIRE software does not provide special tables for seismic cut sets. Therefore, the “Cut Set %” given in the third column of this table is not correct for seismic events, although it does provide the approximate rank order for the cut sets.

Table D3.4-2. Cut Set Level Results by Sequence

Event Tree	Sequence	Cut Set %	Basic Event	Description
WHF-S-IE-SNF-XFER	03-2	0.00	<FALSE>	System Generated Success Event
			= Total	
	03-3			
	03-4	0.00	<FALSE>	System Generated Success Event
			= Total	
	03-5	100.00	050-XFER-SNF-TS-ETF	ETF for SNF in transfer station
			S-050-SNF-TS-COL	Seismic collapse of incoming SNF transfer station
			WHF-SNF-XFER	Number of SNF assemblies transferred
			= Total	
	03-6	0.00	<FALSE>	System Generated Success Event
			= Total	
	04-2	0.00	<FALSE>	System Generated Success Event
			= Total	
	04-3			
	04-4	0.00	<FALSE>	System Generated Success Event
			= Total	
	04-5	60.61	050-XFER-SFTM-OBJ-ETF	ETF for spent fuel transfer machine - heavy obj. drop
			S-050-SFTM-OBJDROP	Seismic failure of SFTM - heavy obj. drop
			WHF-SNF-XFER	Number of SNF assemblies transferred
		39.47	050-XFER-SFTM-COL-ETF	ETF for spent fuel trans machine - collapse
			S-050-SFTM-COLLAPSE	Seismic collapse of SF trans machine
			WHF-SNF-XFER	Number of SNF assemblies transferred
			= Total	
	04-6	0.00	<FALSE>	System Generated Success Event
			= Total	
	05-2	0.00	<FALSE>	System Generated Success Event
			= Total	

Table D3.4-2. Cut Set Level Results by Sequence (Continued)

Event Tree	Sequence	Cut Set %	Basic Event	Description
	05-3			
	05-4	0.00	<FALSE>	System Generated Success Event
			= Total	
	05-5	100.00	050-XFER-TADTS-ETF	ETF for WHF TAD in TAD transfer station
			S-050-TADTS-COLLAPSE	Seismic collapse of TAD transfer station
			WHF-SNF-XFER	Number of SNF assemblies transferred
			= Total	
	05-6	0.00	<FALSE>	System Generated Success Event
			= Total	
	07	100.00	050-XFER-WHF-PREC-ETF	ETF for WHF preclosure with SNF in pool
			S-050-STR-COLLAPSE	Seismic collapse of WHF structure
			WHF-PRECLOSURE	Events with continuous exposure over preclosure
			= Total	
	08	100.00	050-XFER-WHF-PREC-ETF	ETF for WHF preclosure with SNF in pool
			S-050-POOL-FAIL	Seismic failure of WHF pool
			WHF-PRECLOSURE	Events with continuous exposure over preclosure
			= Total	
	09	100.00	050-XFER-WHF-PREC-ETF	ETF for WHF preclosure with SNF in pool
			S-050-SRACK-FAIL	Seismic failure of SNF staging rack
			WHF-PRECLOSURE	Events with continuous exposure over preclosure
			= Total	
	10	100.00	050-XFER-WHF-PREC-ETF	ETF for WHF preclosure with SNF in pool
			S-050-HVAC-FAIL	Seismic failure of HVAC system integrity
			WHF-PRECLOSURE	Events with continuous exposure over preclosure
			= Total	

NOTE: ETF = exposure time factor; HVAC = heating, ventilation and air-conditioning; SFTM = spent fuel transfer machine; SNF = spent nuclear fuel; TAD = transportation, aging and disposal; WHF = Wet Handling Facility.

Source: Original

D4 TRANSPORTATION, AGING AND DISPOSAL (CANISTERS)

This section provides the detailed information used to develop the event sequences for the analysis of processing of the TAD canisters inside the WHF. TAD canisters, filled with SNF assemblies, inside STCs are transferred from the pool, the TADs are closed, transferred to an aging overpack and then exported from the facility in a site transporter.

D4.1 EVENT TREES

The IET and SRETs are presented in this section. The tables provide the assignments between the event tree branches and the fault trees given in the next section.

Seismic Event	Number of TAD canisters transferred to AO	Identify initiating seismic failure		
SEIS-EVENT	WHF-TAD-AO	SEIS-FAIL	#	END-STATE
			1	OK
			2	OK
		WHF building collapse	3	RR-UNF
		TAD transfer station (pool)	4	T => 2 WHF-S-R-POOL
		Auxiliary pool crane	5	T => 2 WHF-S-R-POOL
		Spent fuel transfer machine	6	T => 2 WHF-S-R-POOL
		Cask handling crane	7	T => 3 WHF-S-R-STC
		TAD closure or prep station #2	8	RR-UNF
		Jib cranes	9	RR-UNF
		Cask transfer trolley	10	T => 4 WHF-S-R-CTM
		Preparation station #1	11	T => 4 WHF-S-R-CTM
		Shield door seismic failure	12	T => 4 WHF-S-R-CTM
		Canister transfer machine	13	T => 4 WHF-S-R-CTM
		Site transporter	14	T => 5 WHF-S-R-AO
		Aging overpack access platform	15	T => 5 WHF-S-R-AO
		Entry door seismic collapse	16	T => 5 WHF-S-R-AO

WHF-S-IE-TAD-AO - WHF Seismic Event Tree - Initiating Seismic Failures - TAD to AO 2007/12/18 WHF-TAD 1

NOTE: Event tree branch captions are associated with the branch line below the caption.

AO = aging overpack; CTM = canister transfer machine; IE = initiating event; RR = radioactive release; SEIS = seismic; STC = shielded transfer cask; TAD = transportation, aging and disposal; UNF = unfiltered; WHF = Wet Handling Facility.

Source: Original

Figure D4.1-1. WHF Seismic Event Tree WHF-S-IE-TAD-AO – Initiating Seismic Failures – TAD to AO

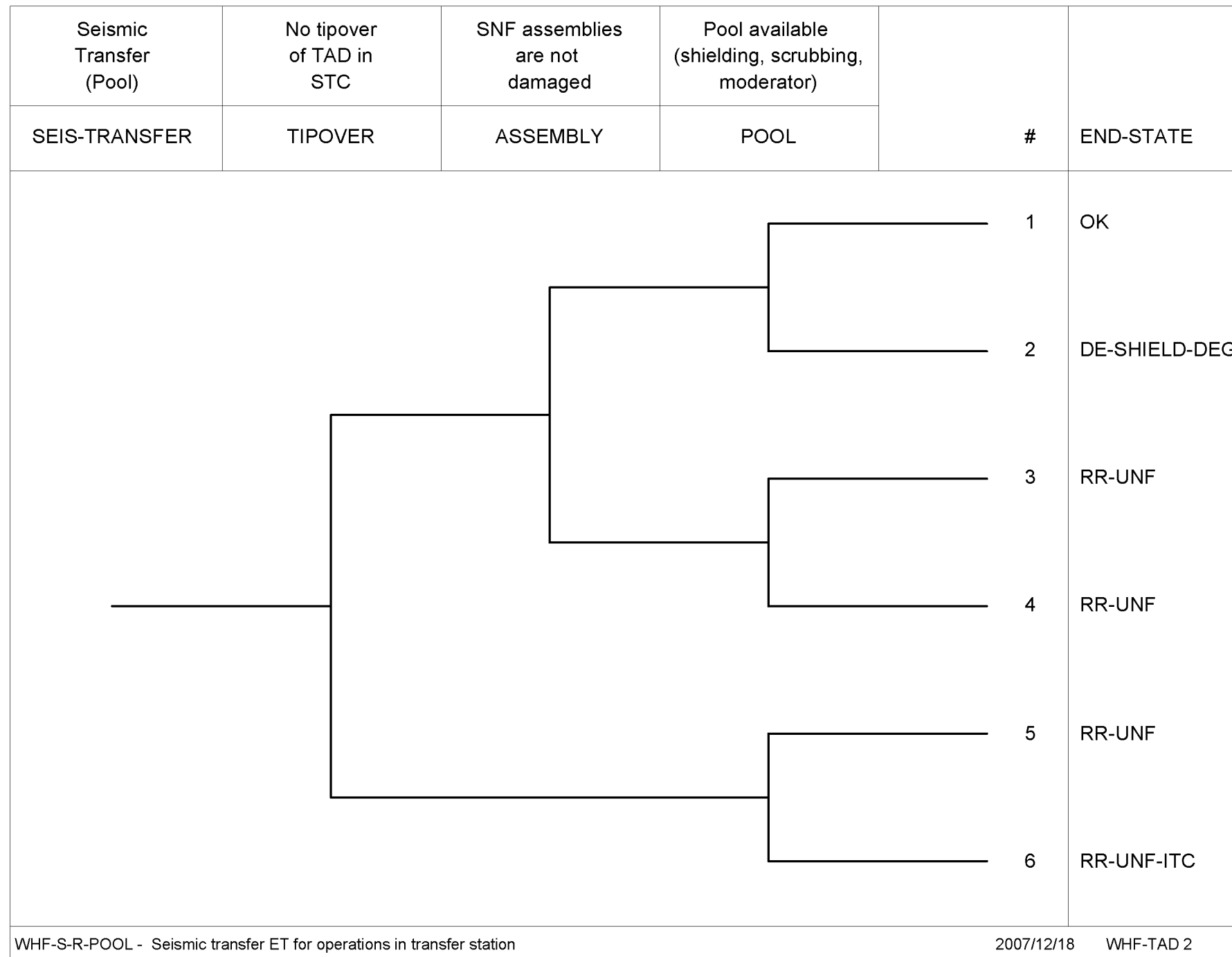

NOTE: DE = direct exposure; DEG = degradation; ET = event tree; ITC = important to criticality; RR = radioactive release; SEIS = seismic; SNF = spent nuclear fuel; STC = shielded transfer cask; TAD = transportation, aging and disposal; UNF = unfiltered; WHF = Wet Handling Facility.

Source: Original

Figure D4.1-2. WHF Seismic Event Tree WHF-S-R-POOL – Seismic Transfer ET for Operations in Transfer Station

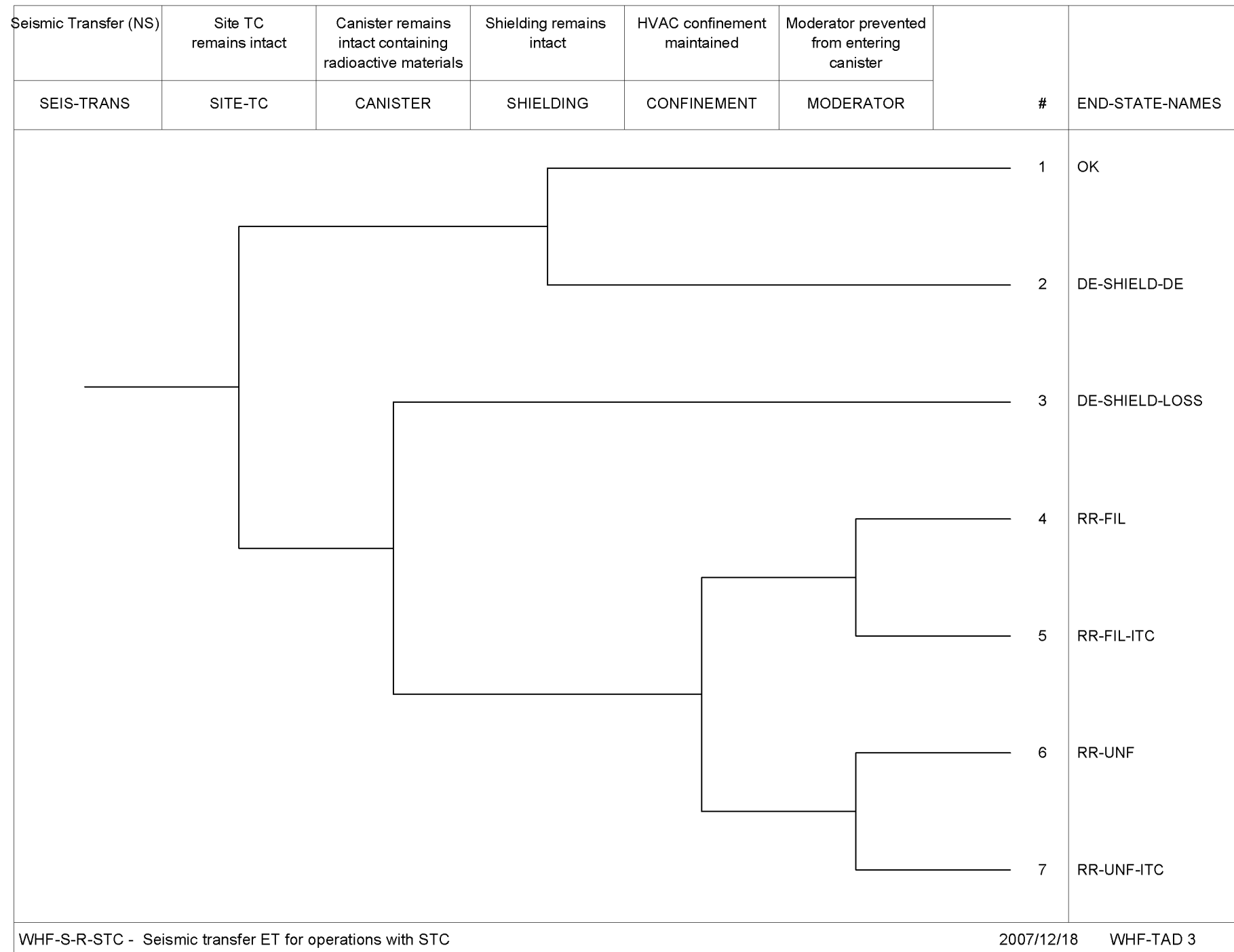

NOTE: DE = direct exposure; ET = event tree; FIL = filtered; HVAC = heating, ventilation and air conditioning; ITC = important to criticality; RR = radioactive release; SEIS = seismic; STC = shielded transfer cask; TC = transportation cask; UNF = unfiltered; WHF = Wet Handling Facility.

Source: Original

Figure D4.1-3. WHF Seismic Event Tree WHF-S-R-STC – Seismic Transfer ET for Operations with STC

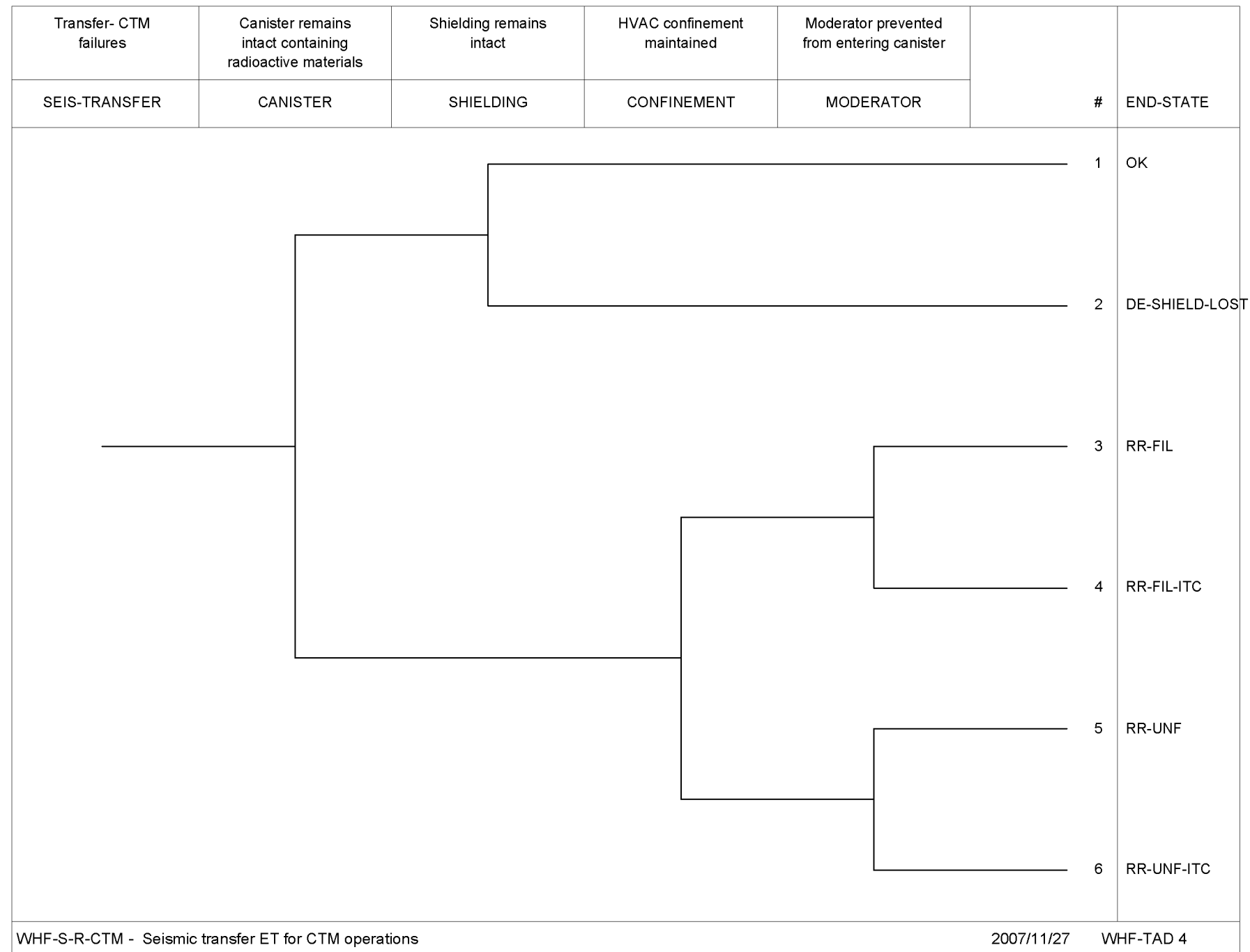

NOTE: CTM = canister transfer machine; DE = direct exposure; ET = event tree; FIL = filtered; HVAC = heating, ventilation and air conditioning; ITC = important to criticality; RR = radioactive release; SEIS = seismic; UNF = unfiltered; WHF = Wet Handling Facility.

Source: Original

Figure D4.1-4. RF Seismic Event Tree RF-S-R-CTM – Seismic Transfer ET with CTM Operations

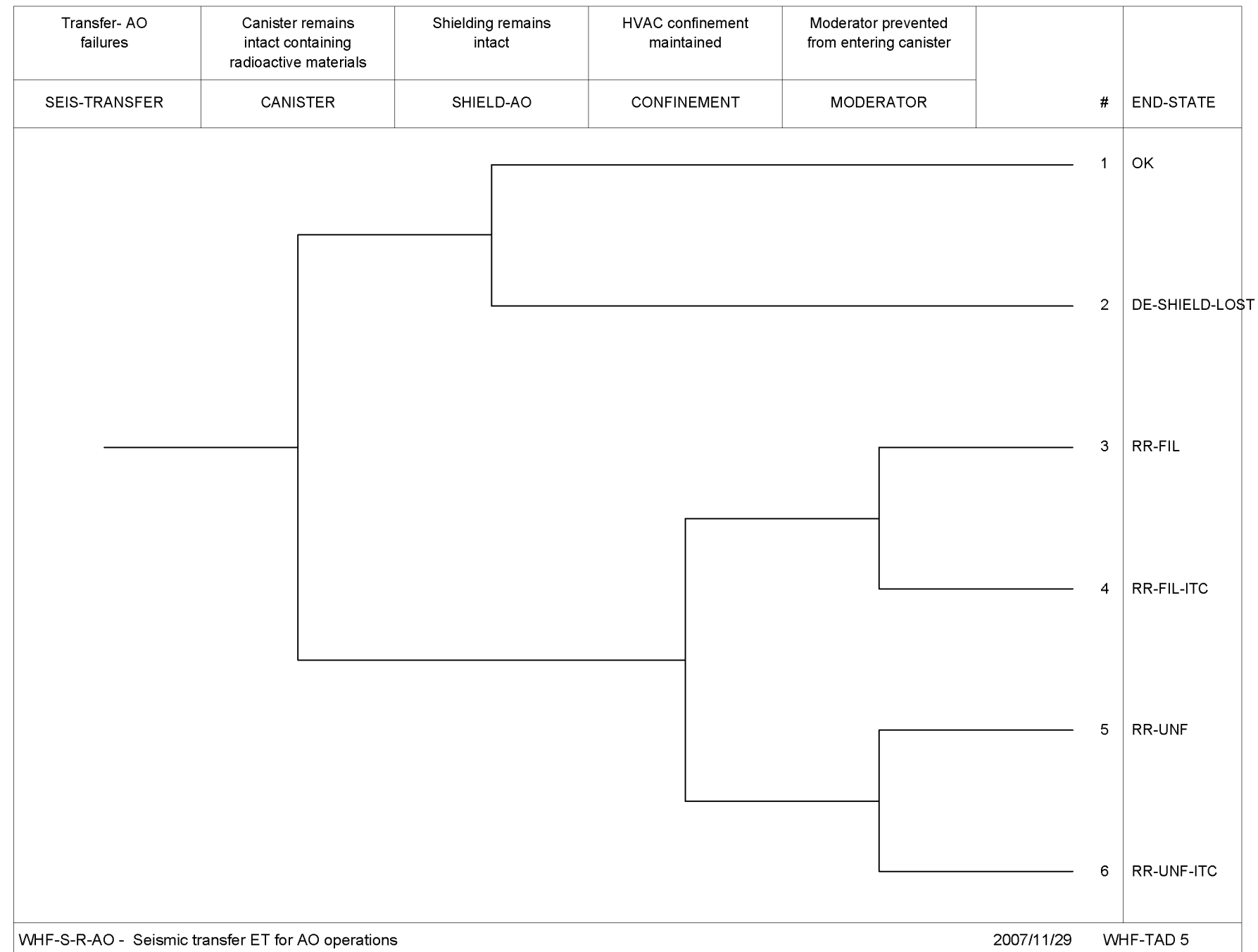

NOTE: AO= aging overpack; DE = direct exposure; ET = event tree; FIL = filtered; HVAC = heating, ventilation and air conditioning; ITC = important to criticality; RR = radioactive release; SEIS = seismic; UNF = unfiltered; WHF = Wet Handling Facility.

Source: Original

Figure D4.1-5. WHF Seismic Event Tree WHF-S-R-AO – Seismic Transfer ET for AO Operations

	Seismic Transfer (CHC)	Shielded Transfer Cask in Pool	Tipover of Canister		
	SEIS-TRANS	STC-POOL	TIPOVER	#	END-STATE
WHF-S-R-CHC - Seismic transfer ET for Cask Handling Crane operations				2007/12/13	WHF-TAD 6

NOTE: CHC = cask handling crane; ET = event tree; ITC = important to criticality; RR = radioactive release; SEIS = seismic; UNF = unfiltered; WHF = Wet Handling Facility.

Source: Original

Figure D4.1-6. WHF Seismic Event Tree WHF-S-R-CHC – Seismic Transfer ET for Cask Handling Crane Operations

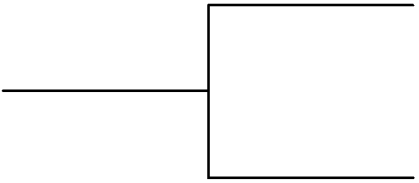
	Seismic Transfer (NS)	Tipover of TAD		
	SEIS-TRANS	TIPOVER	#	END-STATE
				<p>1 RR-UNF</p> <p>2 RR-UNF-ITC</p>
<p>WHF-S-R-NS - Seismic transfer ET for operations with canister Not Sealed</p>				<p>2007/12/13 WHF-TAD 7</p>

NOTE: ET = event tree; ITC = important to criticality; NS = not sealed; RR = radioactive release; SEIS = seismic; TAD = transportation, aging and disposal; UNF = unfiltered; WHF = Wet Handling Facility.

Source: Original

Figure D4.1-7. WHF Seismic Event Tree WHF-S-R-NS – Seismic Transfer ET for Operations with Canister Not Sealed

Table D4.1-1. Fault Trees Assigned for Initiating Seismic Failures for the WHF

Process	Initiator Event Tree	Initiating Seismic Failure	Associated Fault Tree
TAD to AO	WHF-S-IE-TAD-AO	WHF building collapse	S-050-WHF-STR-COLLAP
		TAD transfer station (pool)	S-050-WHF-TADTS-COL
		Auxiliary pool crane	S-050-WHF-APC-FAIL
		Spent fuel transfer machine	S-050-WHF-SFTM-FAIL
		Cask handling crane	S-050-WHF-CHC-FAIL
		TAD closure or prep station #2	S-050-WHF-TC-PS2-COL
		Jib cranes	S-050-WHF-JIBC-FAIL
		Cask transfer trolley	S-050-WHF-CTT-FAIL
		Preparation station #1	S-050-WHF-PS1-COL
		Shield door seismic failure	S-050-WHF-SHIELDDOOR
		Canister transfer machine	S-050-WHF-CTM-FAIL
		Site transporter	S-050-WHF-ST-SLIDE
		Aging overpack access platform	S-050-WHF-AOAP-COL
		Entry door seismic collapse	S-050-WHF-ENTDOORCOL

NOTE: AO = aging overpack; IE = initiating event; TAD = transportation, aging and disposal; WHF = Wet Handling Facility.

Source: Original

Table D4.1-2. Fault Trees Assigned for Pivotal Events for WHF-S-IE-TAD-AO Initiating Event Tree

Initiating Seismic Failure	TIPOVER	POOL
WHF building collapse	N/A	N/A
TAD transfer station (pool)	STC-WHF-TADTS-TAO	WHF-POOL-FAIL
Auxiliary pool crane	STC-WHF-APC-TAO	WHF-POOL-FAIL
Spent fuel transfer machine	STC-WHF-SFTM-TAO	WHF-POOL-FAIL
	SITE-TC	MODERATOR
Cask handling crane	STC-WHF-CHC-TAO	WHF-MOD-MULT-SYS
TAD closure or prep station #2	N/A	N/A
Jib cranes	N/A	N/A
	CANISTER	
Cask transfer trolley	STC-WHF-CTT-TAO	WHF-MOD-MULT-SYS

Table D4.1-2. Fault Trees Assigned for Pivotal Events for WHF-S-IE-TAD-AO Initiating Event Tree (Continued)

Initiating Seismic Failure	TIPOVER	POOL
Preparation station #1	STC-WHF-PS1-TAO	WHF-MOD-MULT-SYS
Shield door seismic failure	STC-WHF-SHIELDDOOR-TAO	WHF-MOD-MULT-SYS
Canister transfer machine	CTM-WHF-CTM-CAN	WHF-MOD-FPW-ONLY
Site transporter	ST-WHF-ST-SLIDE	WHF-MOD-MULT-SYS
Aging overpack access platform	ST-WHF-AOAP-COL	WHF-MOD-MULT-SYS
Entry door seismic collapse	ST-WHF-DOORDROP-CASK	WHF-MOD-MULT-SYS

NOTE: TAD = transportation, aging and disposal; TC = transportation cask; WHF = Wet Handling Facility.

Source: Original

D4.2 FAULT TREES

Seismic fault trees for the processing of TAD canisters in the WHF are presented in alphanumeric order in this section.

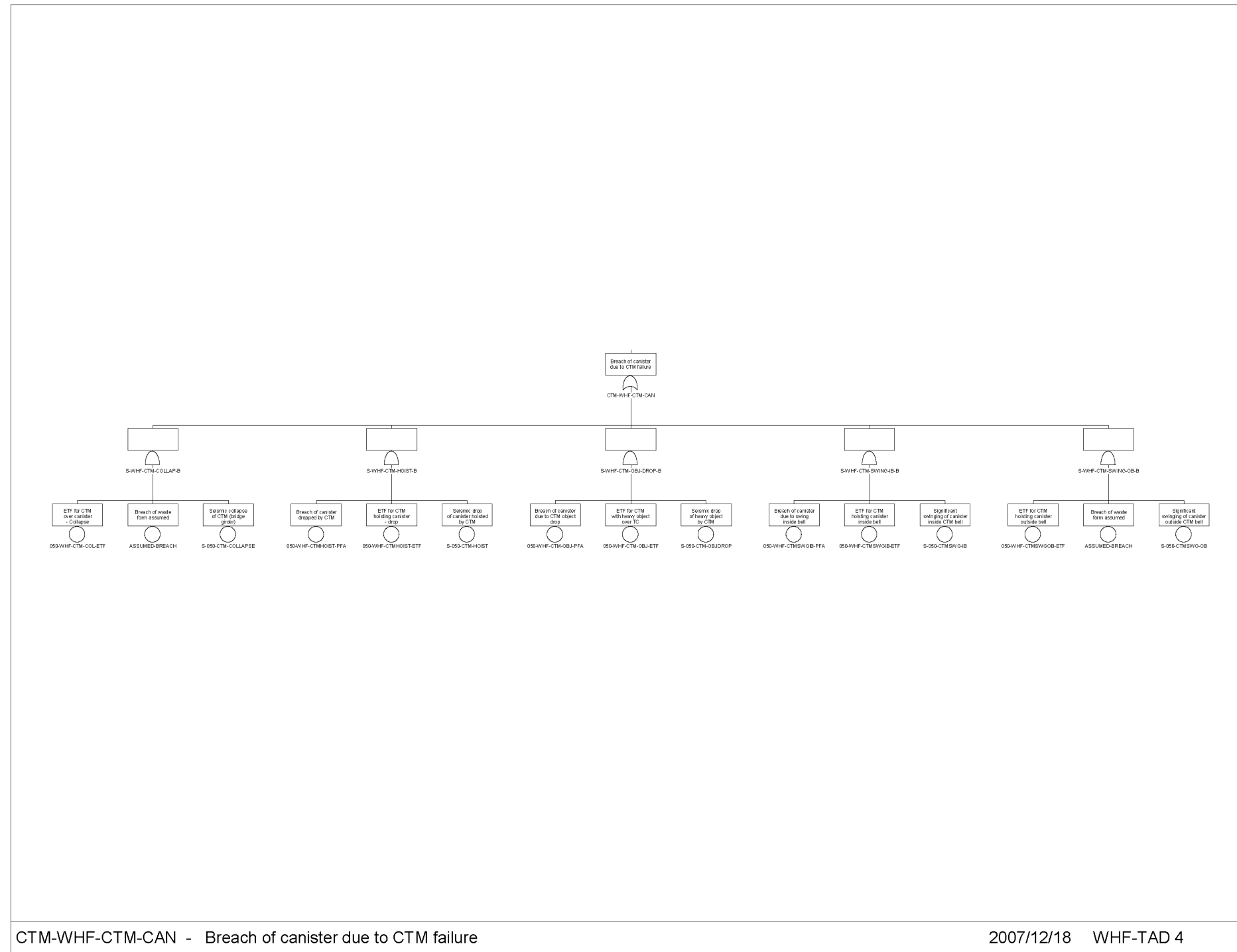

Source: Original

Figure D4.2-1. Fault Tree CTM-WHF-CTM-CAN – Breach of Canister Due to CTM Failure

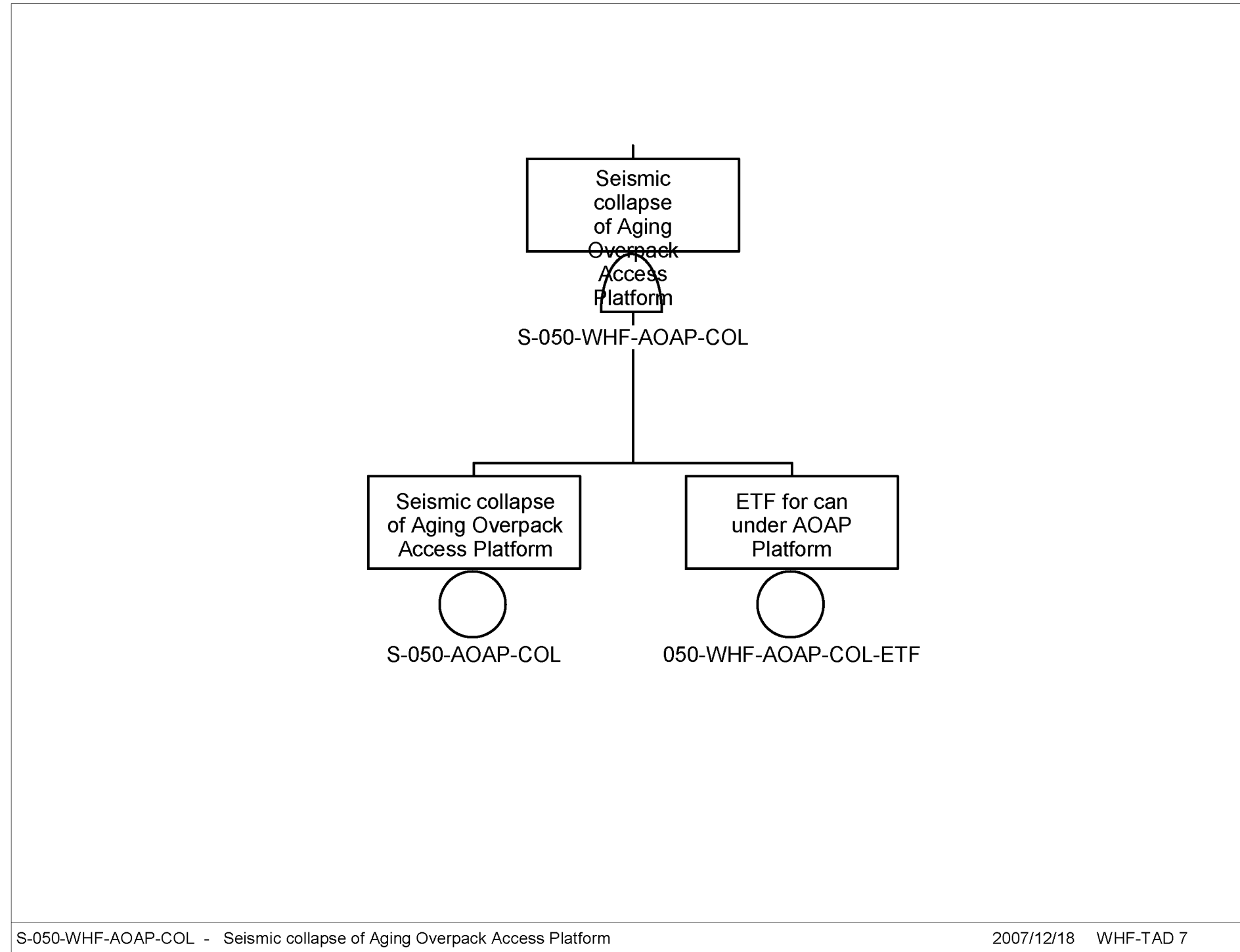

Source: Original

Figure D4.2-2. S-050-WHF-AOAP-COL – Seismic Collapse of Aging Overpack Access Platform

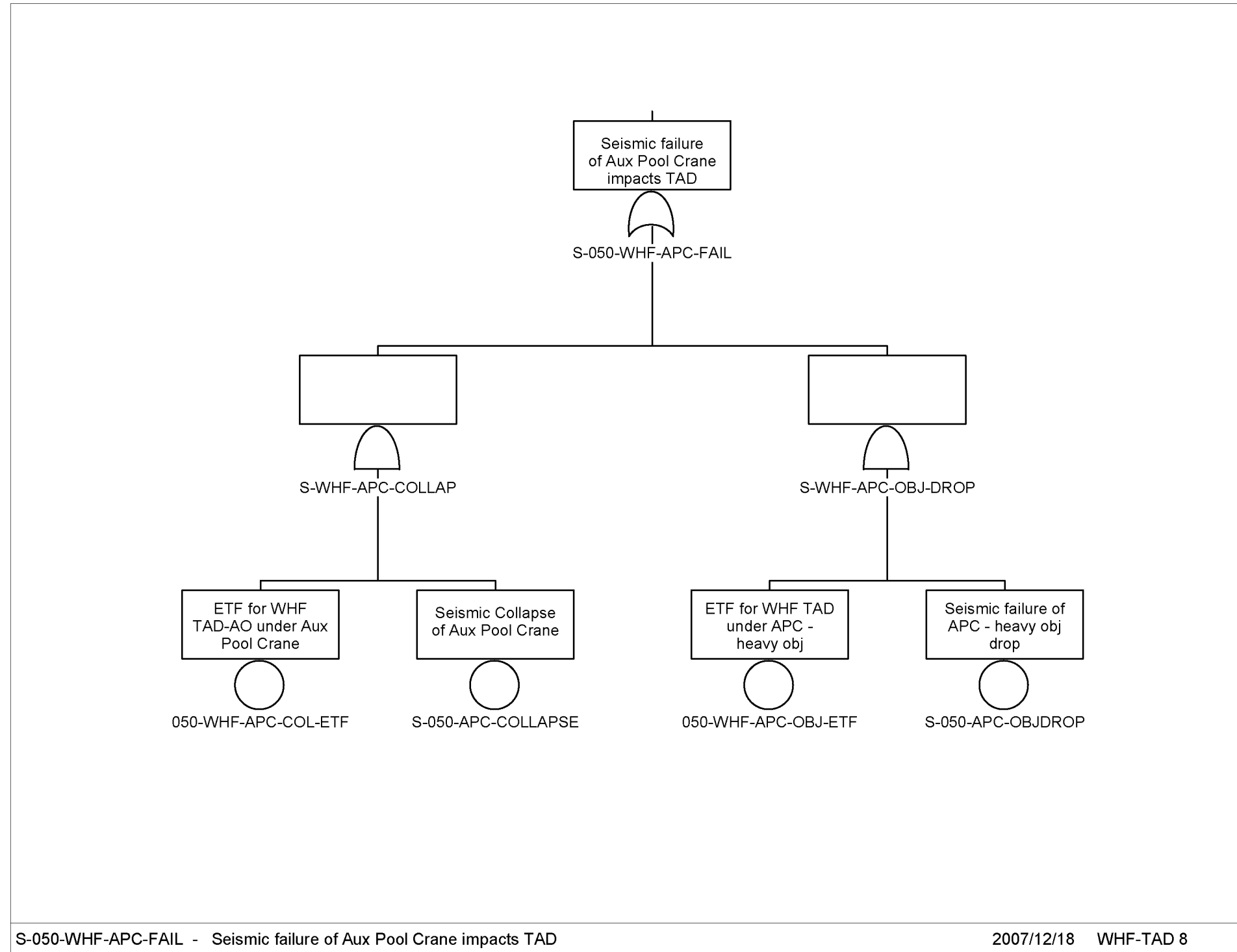

Source: Original

Figure D4.2-3 S- 050-WHF-APC-FAIL – Seismic Failure of Aux Pool Crane Impacts TAD

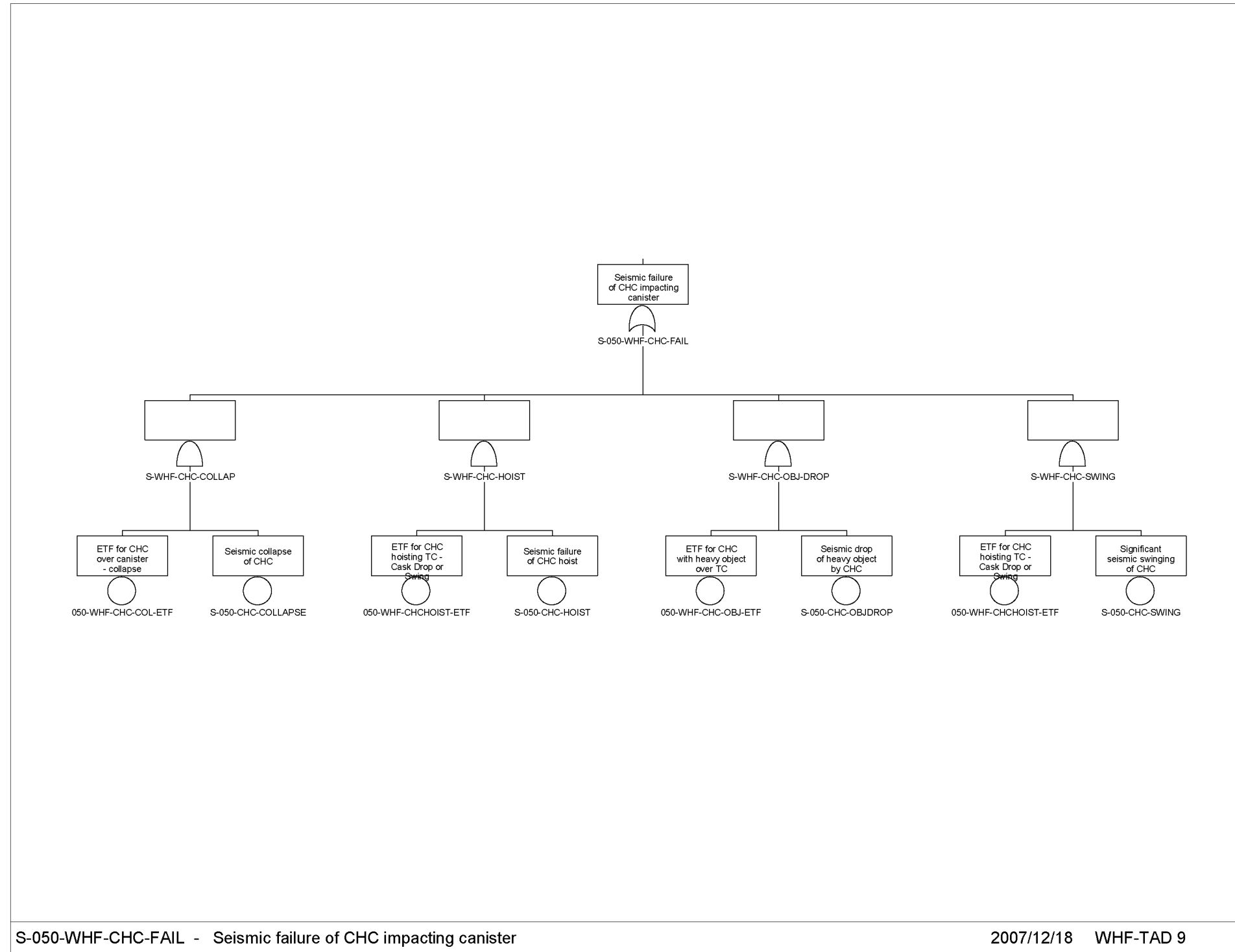

Source: Original

Figure D4.2-4. S-050-WHF-CHC-FAIL – Seismic Failure of CHC Impacting Canister

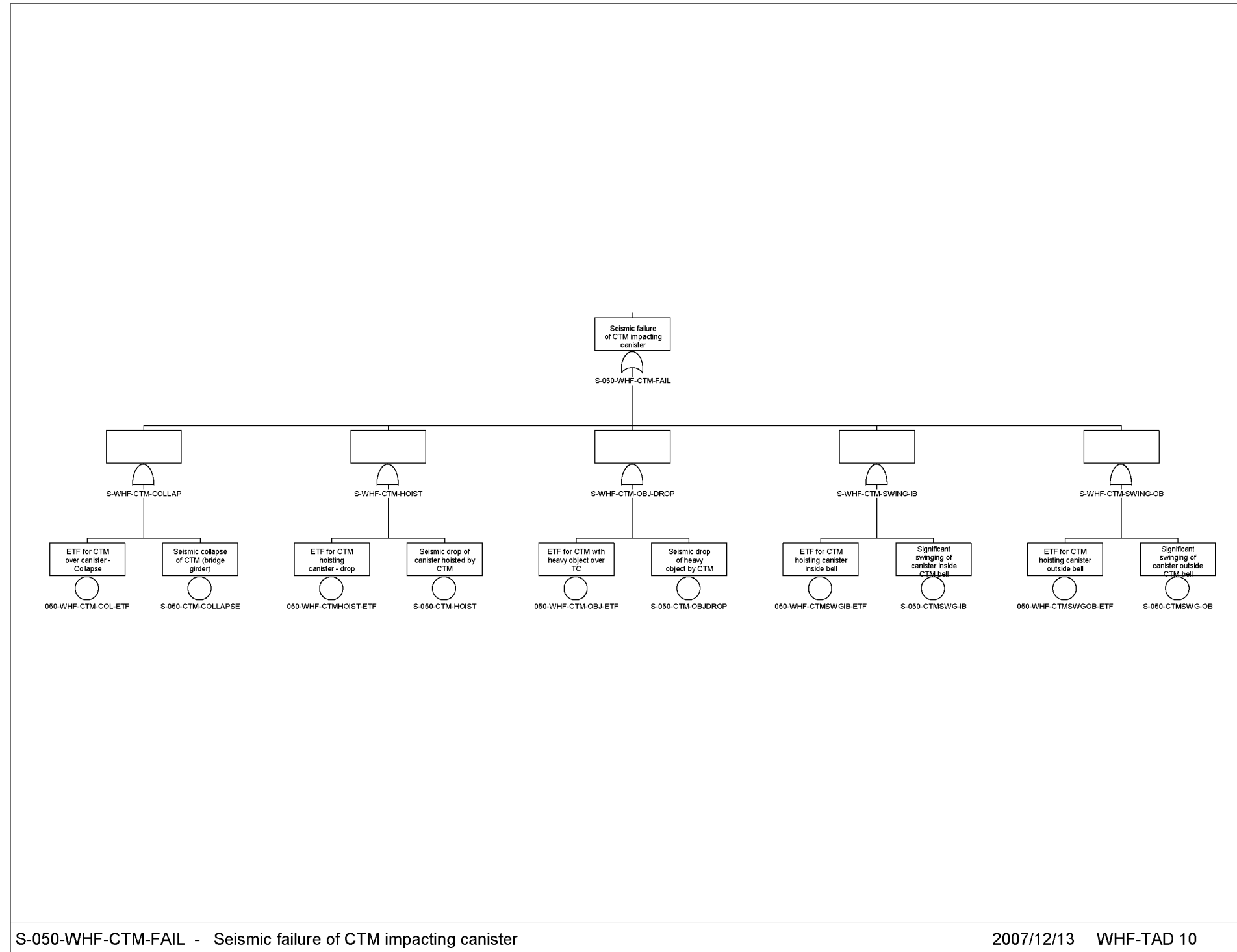

Source: Original

Figure D4.2-5. S-050-WHF-CTM-FAIL – Seismic Failure of CTM Impacting Canister

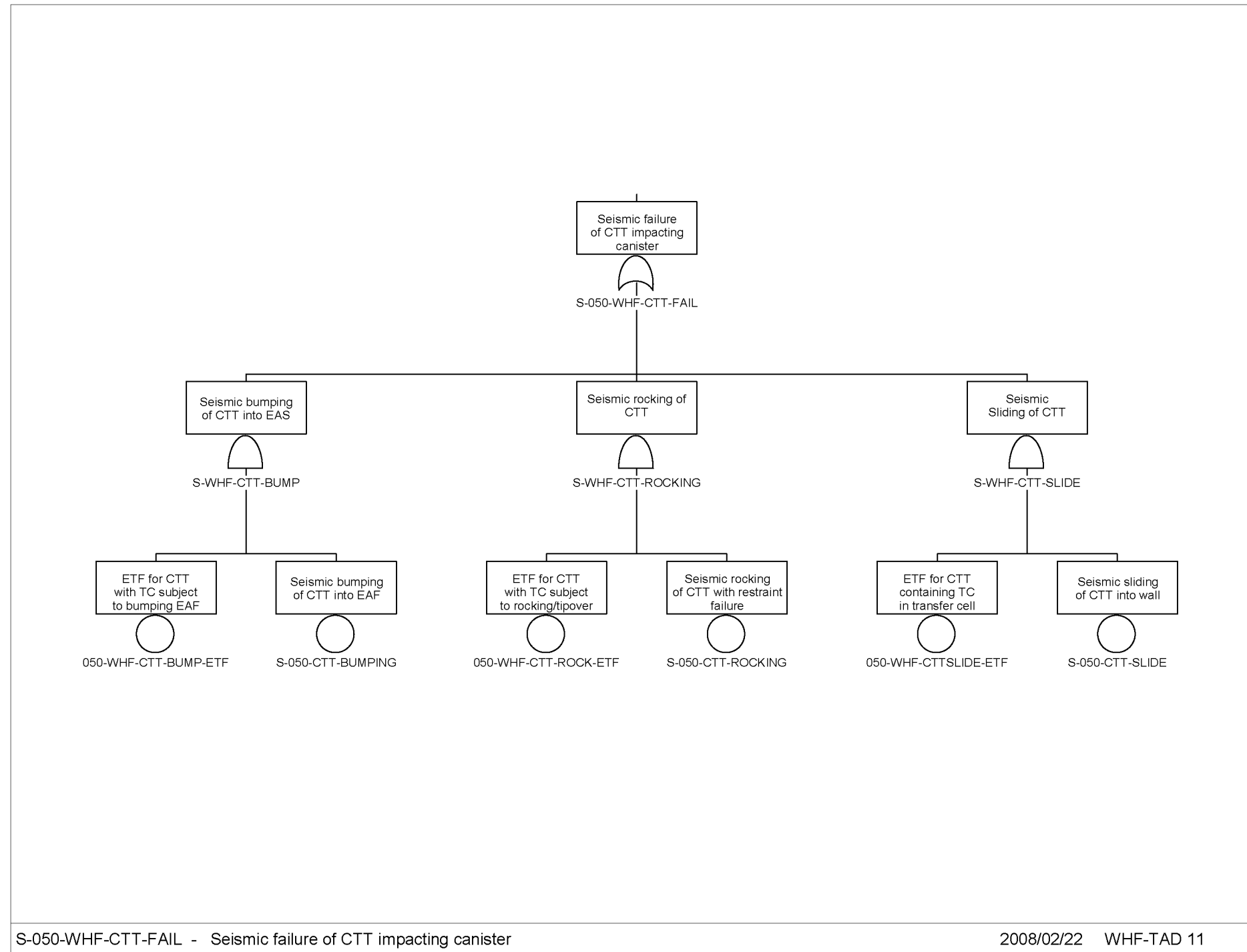

Source: Original

Figure D4.2-6. S-050-WHF-CTT-FAIL – Seismic Failure of CTT Impacting Canister

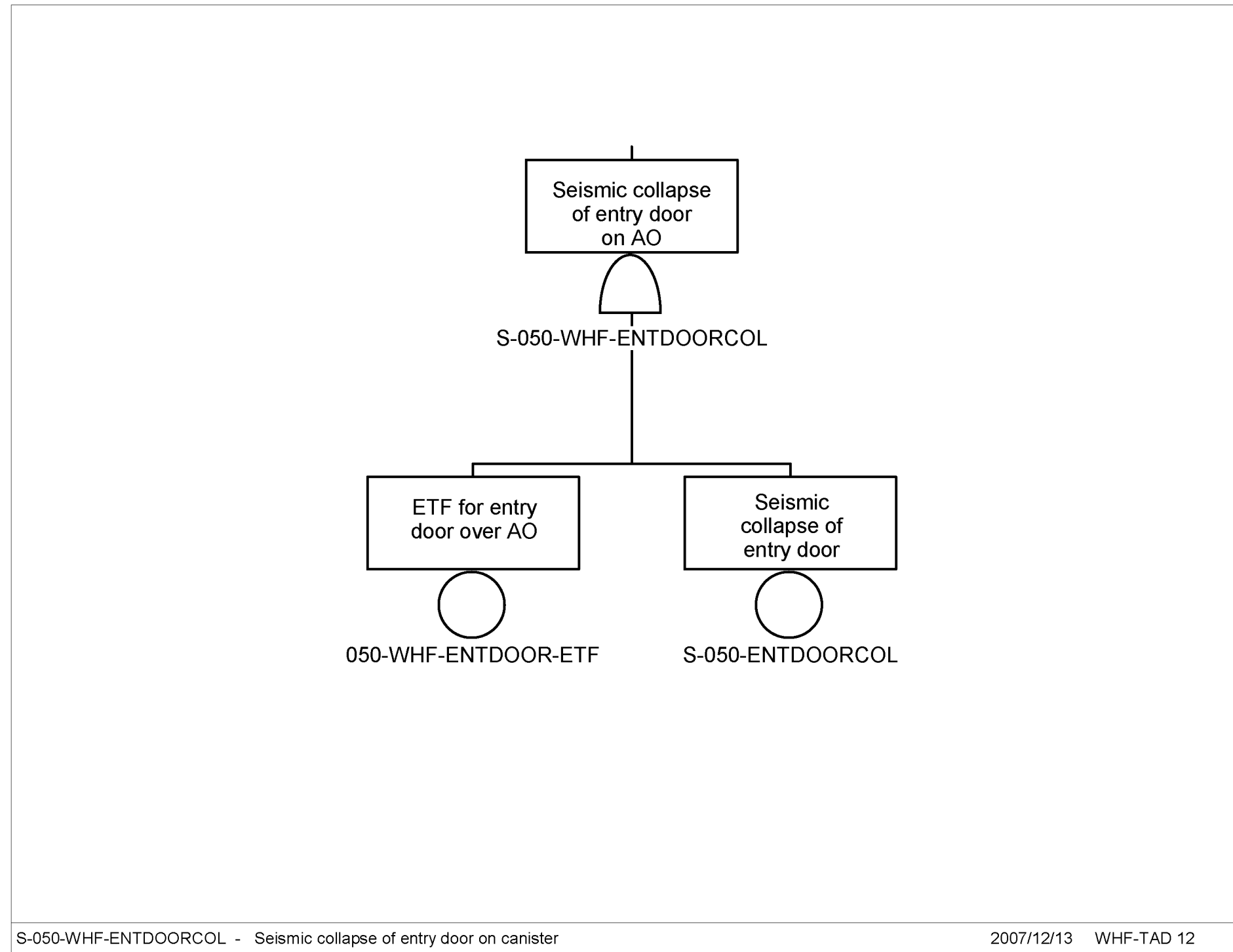

Source: Original

Figure D4.2-7. S-050-WHF-ENTDOORCOL – Seismic Collapse of Entry Door on Canister

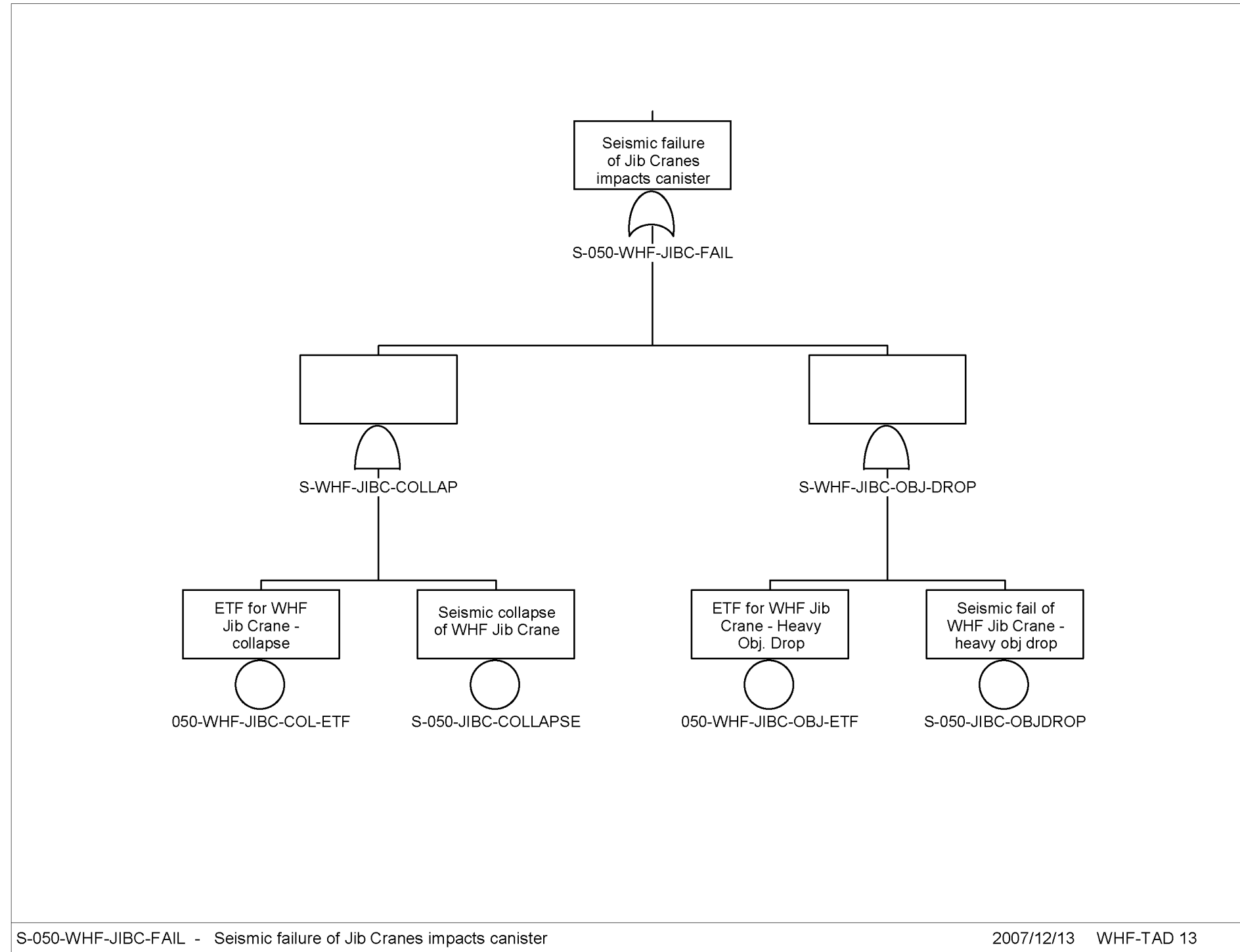

Source: Original

Figure D4.2-8. S-050-WHF-JIBC-FAIL – Seismic Failure of Jib Cranes Impacts Canister

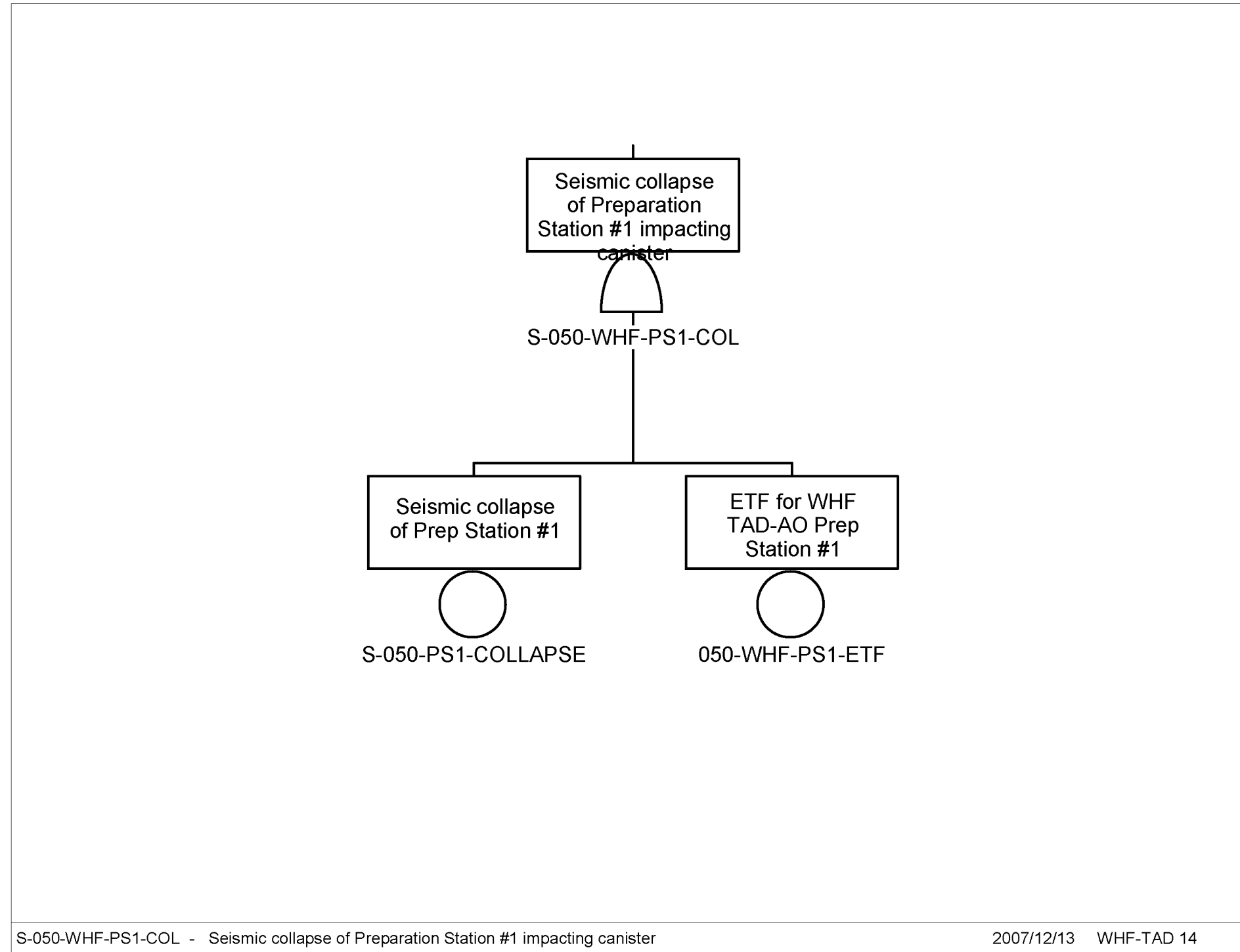

Source: Original

Figure D4.2-9. S-050-WHF-PS1-COL – Seismic Collapse of Preparation Station #1 Impacting Canister

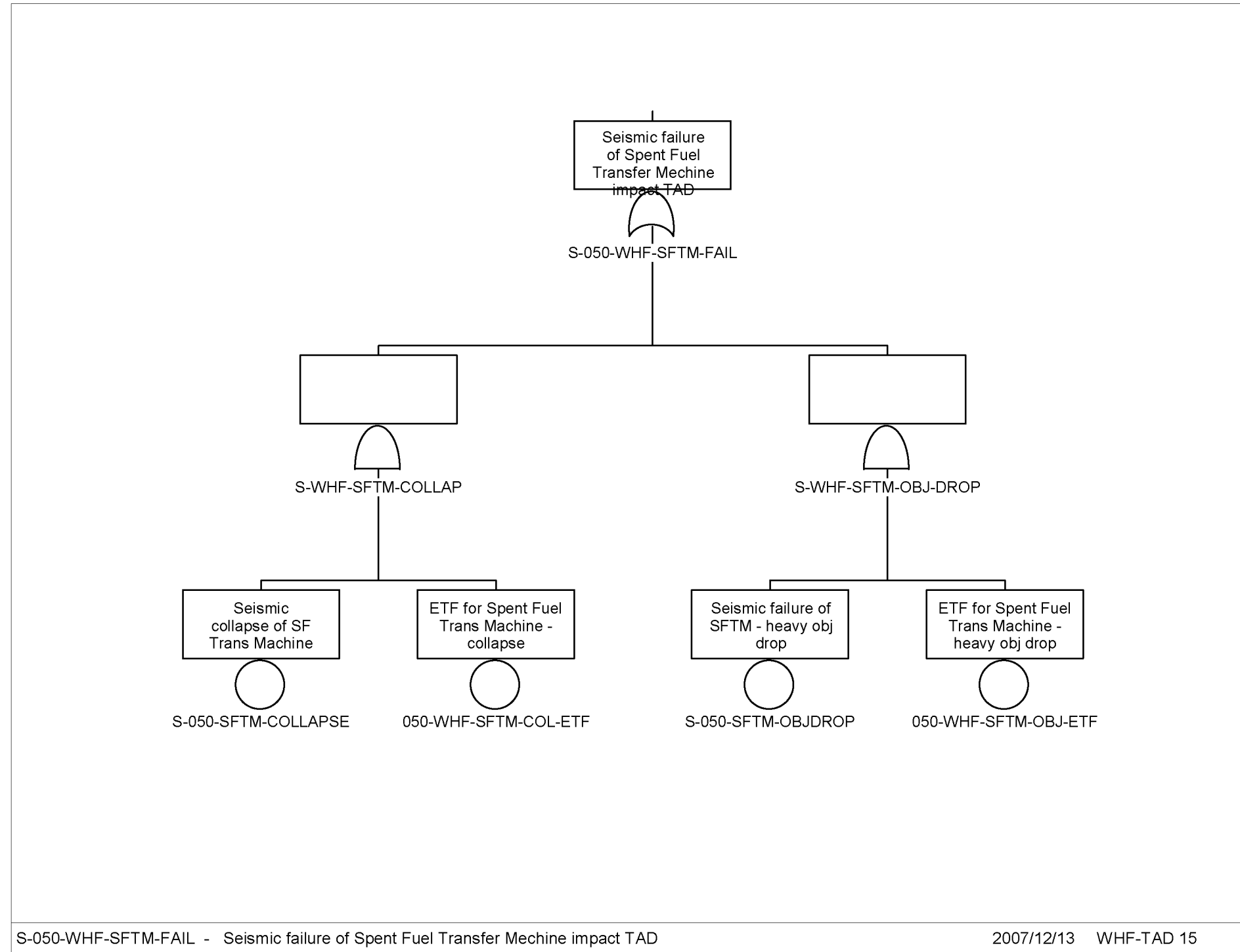

Source: Original

Figure D4.2-10. S-050-WHF-SFTM-FAIL – Seismic Failure of Spent Fuel Transfer Machine Impacts TAD

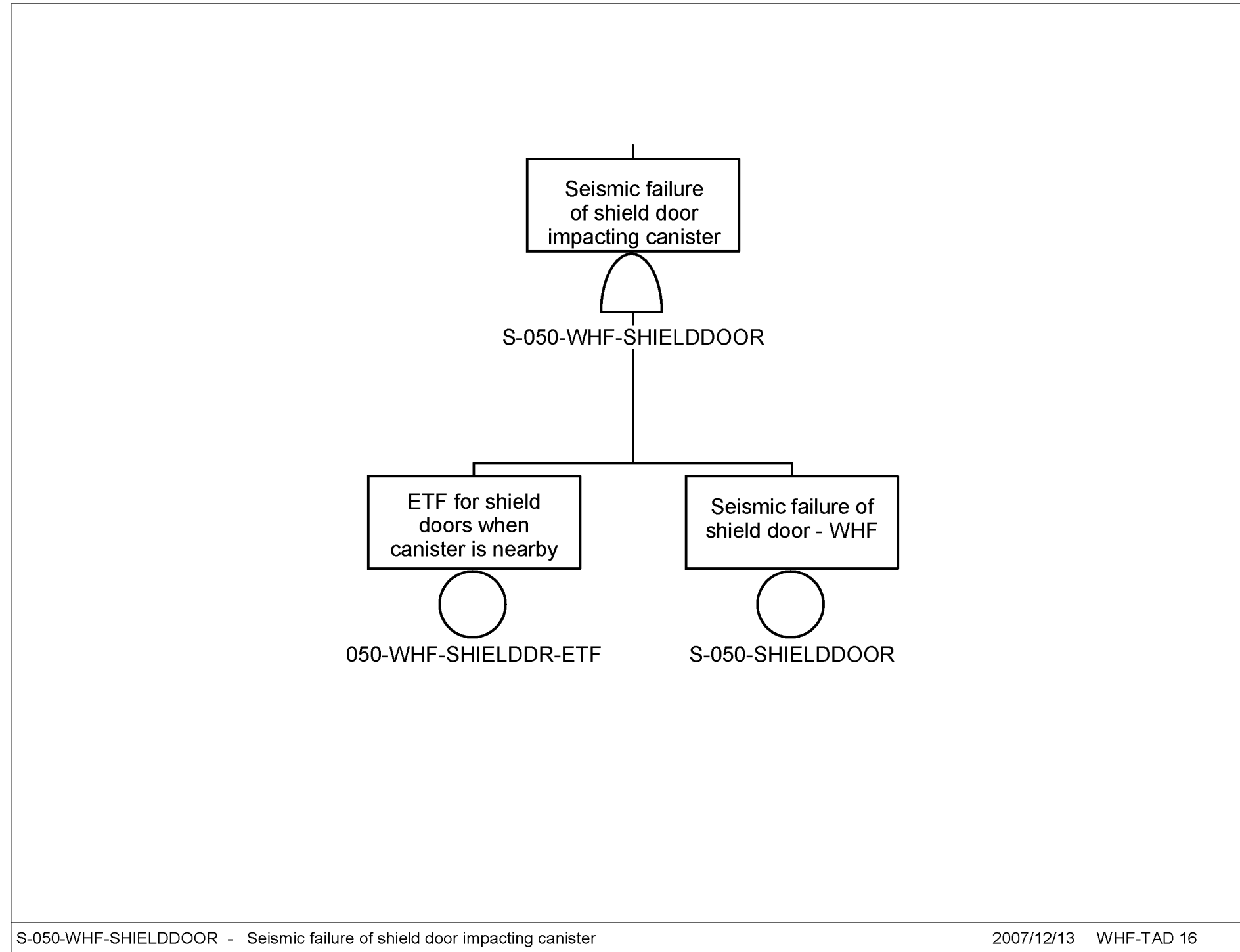

Source: Original

Figure D4.2-11. S-050-WHF-SHIELDDOOR – Seismic Failure of Shield Door Impacting Canister

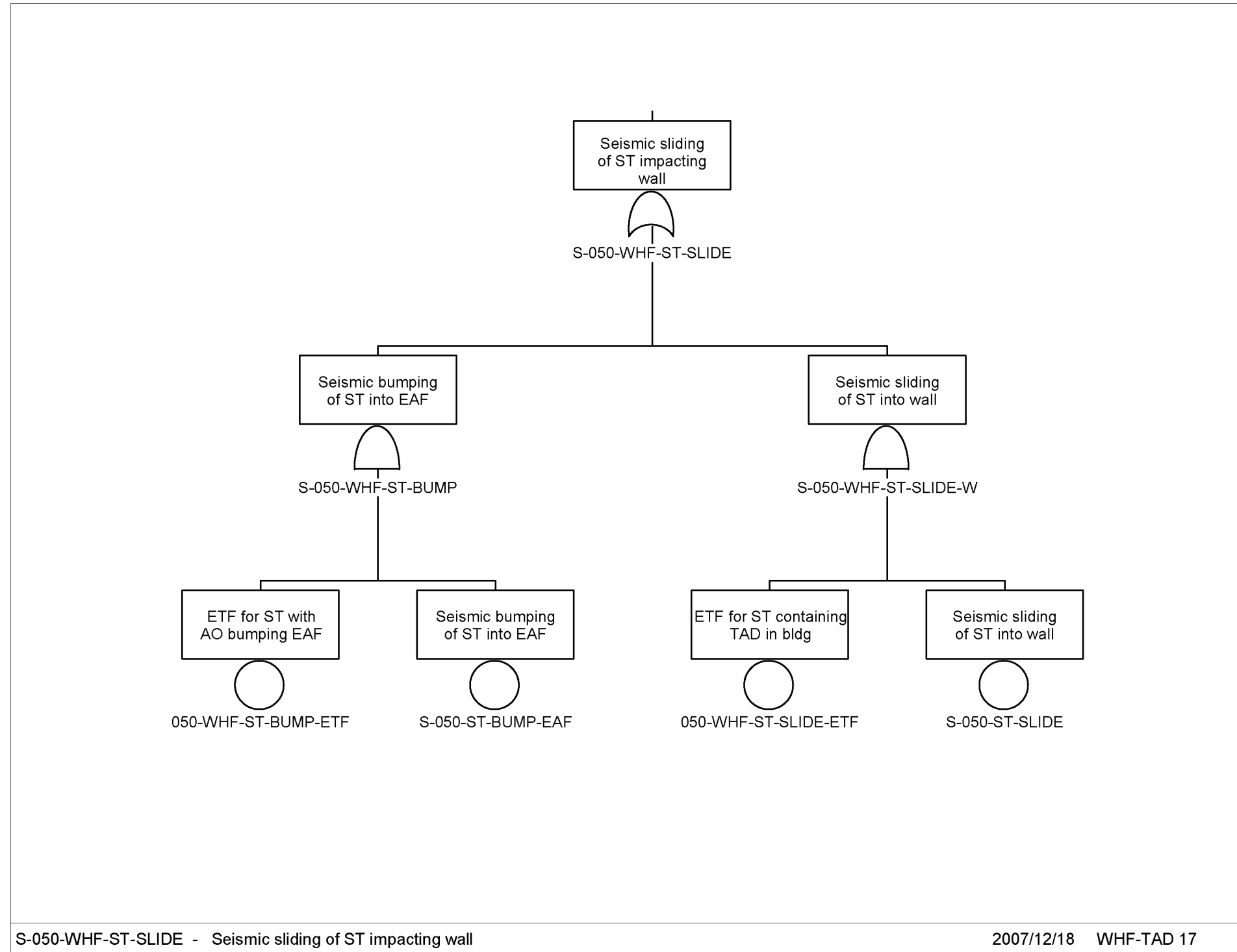

Source: Original

Figure D4.2-12. S-050-WHF-ST-SLIDE – Seismic Sliding of ST Impacting Wall

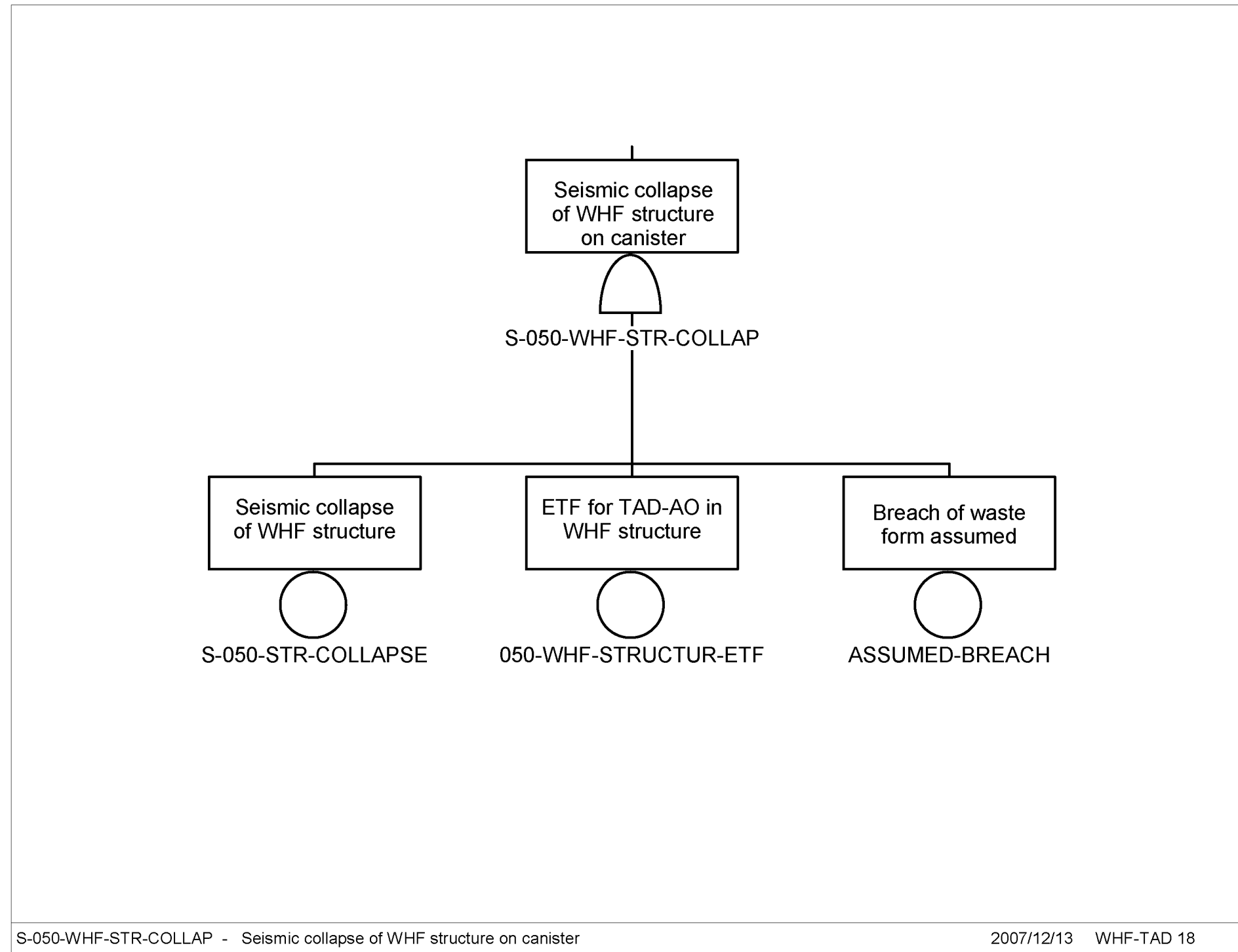

Source: Original

Figure D4.2-13. S-050-WHF-STR-COLLAP – Seismic Collapse of WHF Structure on Canister

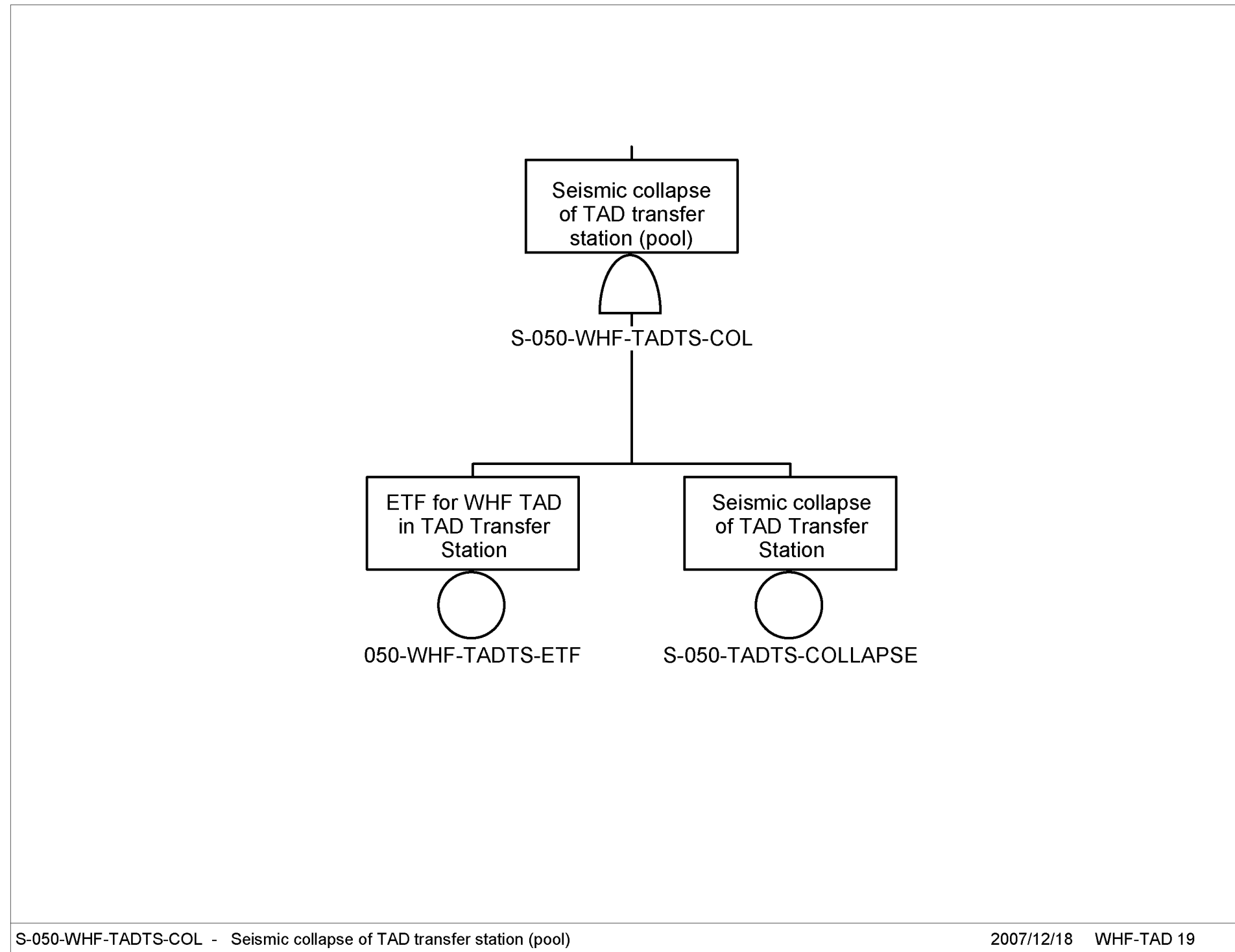

Source: Original

Figure D4.2-14. S-050-WHF-TADTS-COL – Seismic Collapse of TAD Transfer Station (Pool)

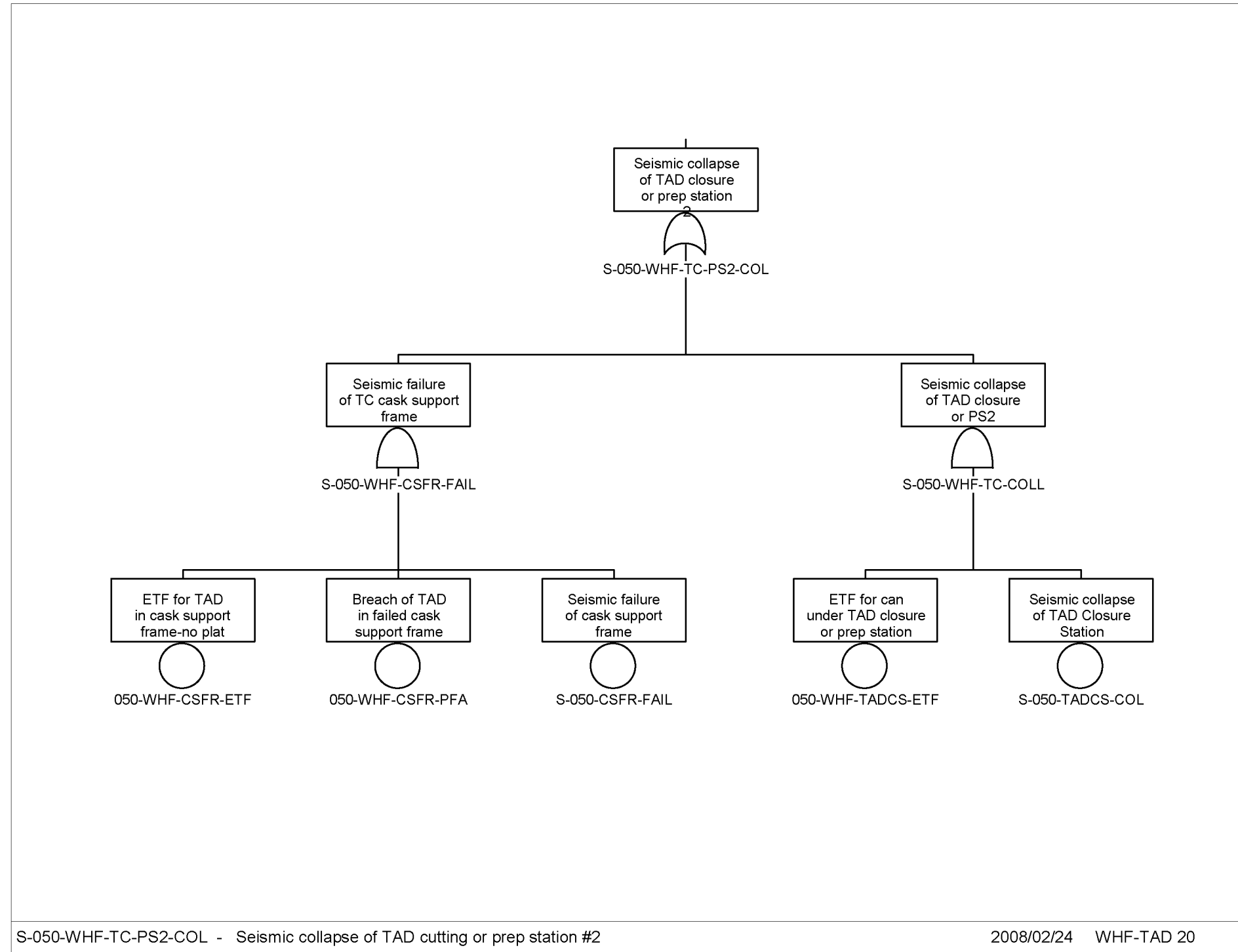

Source: Original

Figure D4.2-15. S-050-WHF-TC-PS2-COL – Seismic Collapse of TAD Cutting or Prep Station #2

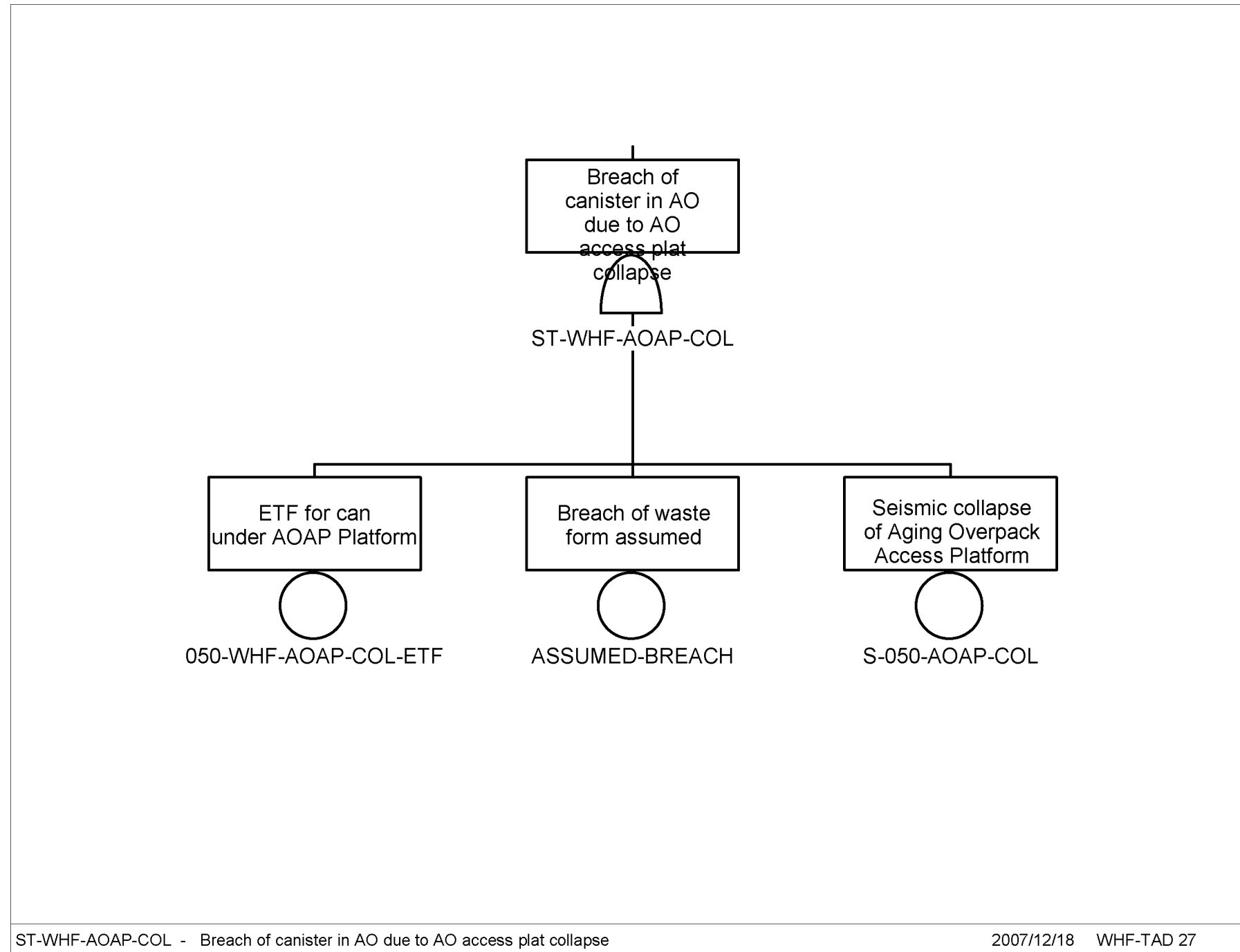

Source: Original

Figure D4.2-16. ST-WHF-AOAP-COL – Breach of Canister in AO due to AO Access Plat Collapse

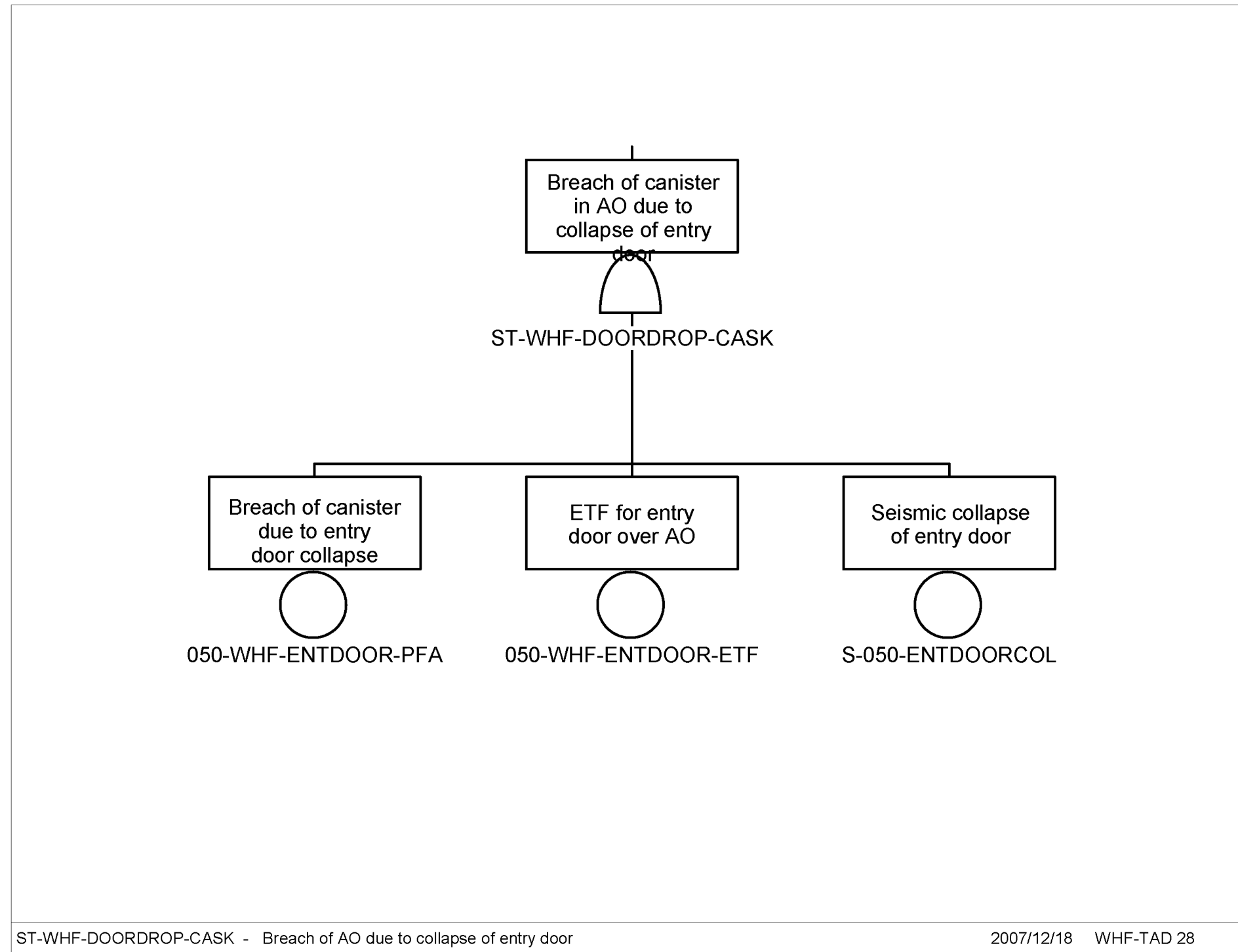

Source: Original

Figure D4.2-17. ST-WHF-DOORDROP-CASK – Breach of AO due to Collapse of Entry Door

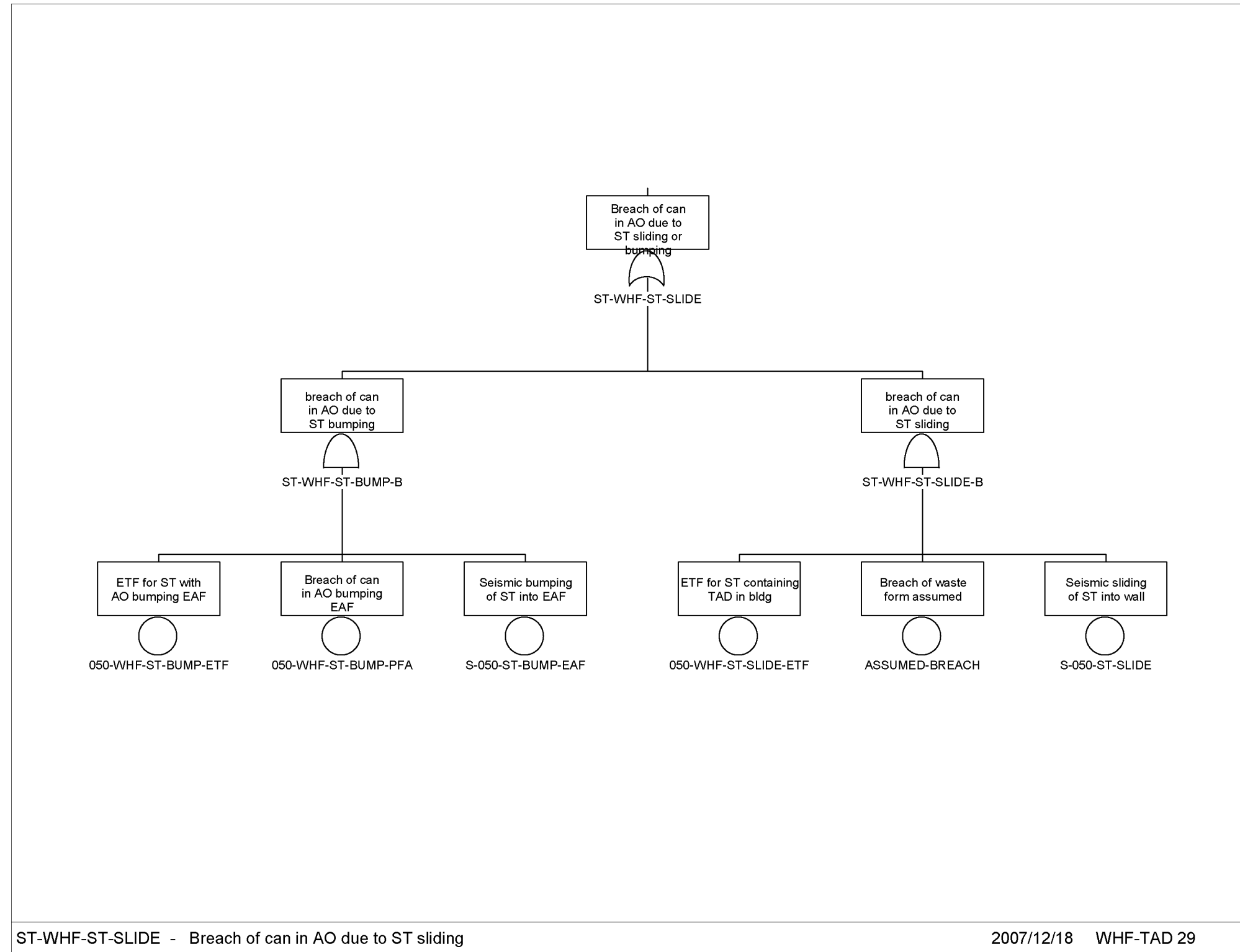

Source: Original

Figure D4.2-18. ST-WHF-ST-SLIDE– Breach of Can in AO due to ST Sliding

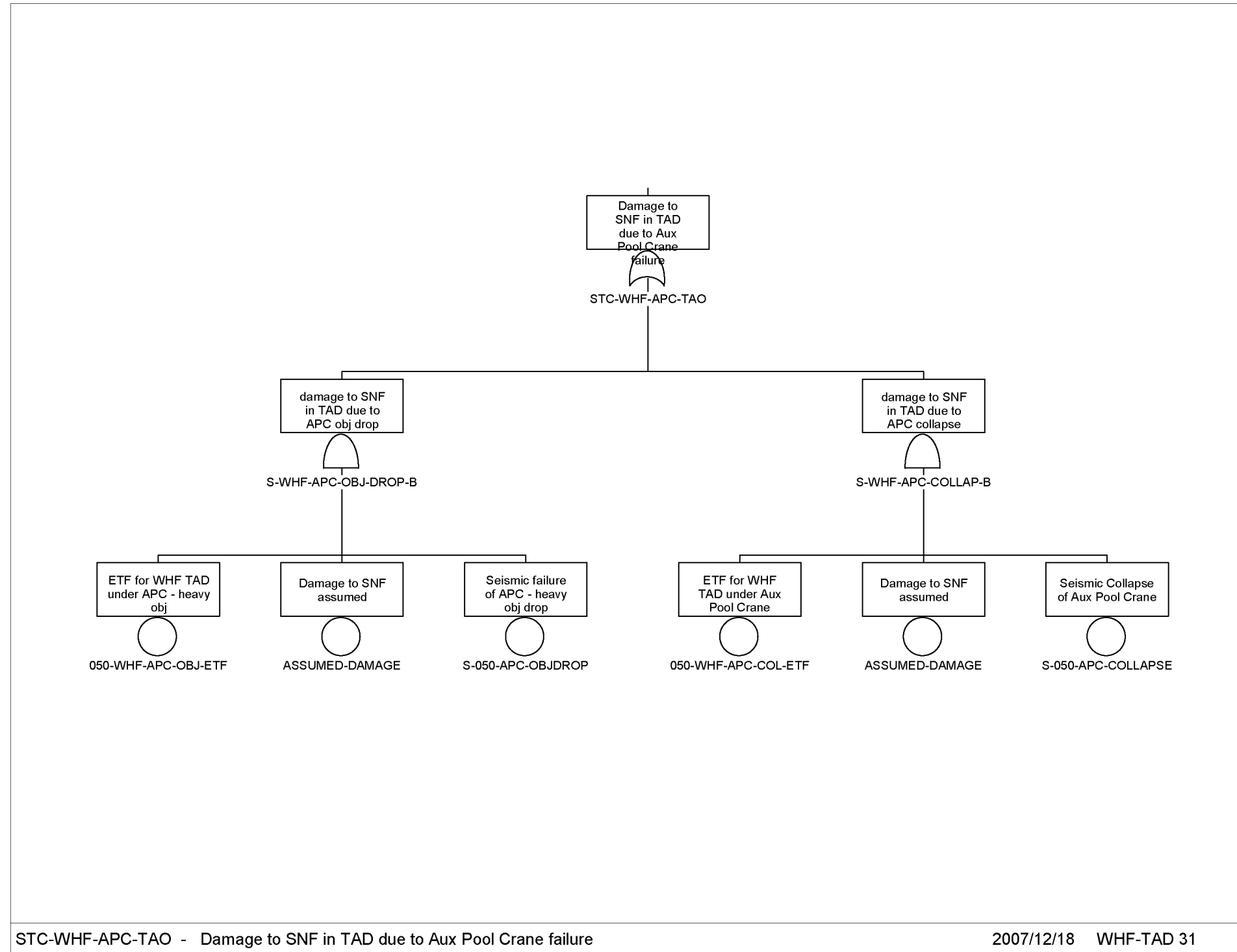

Source: Original

Figure D4.2-19. STC-WHF-APC-TAO – Damage to SNF in TAD due to Aux Pool Crane Failure

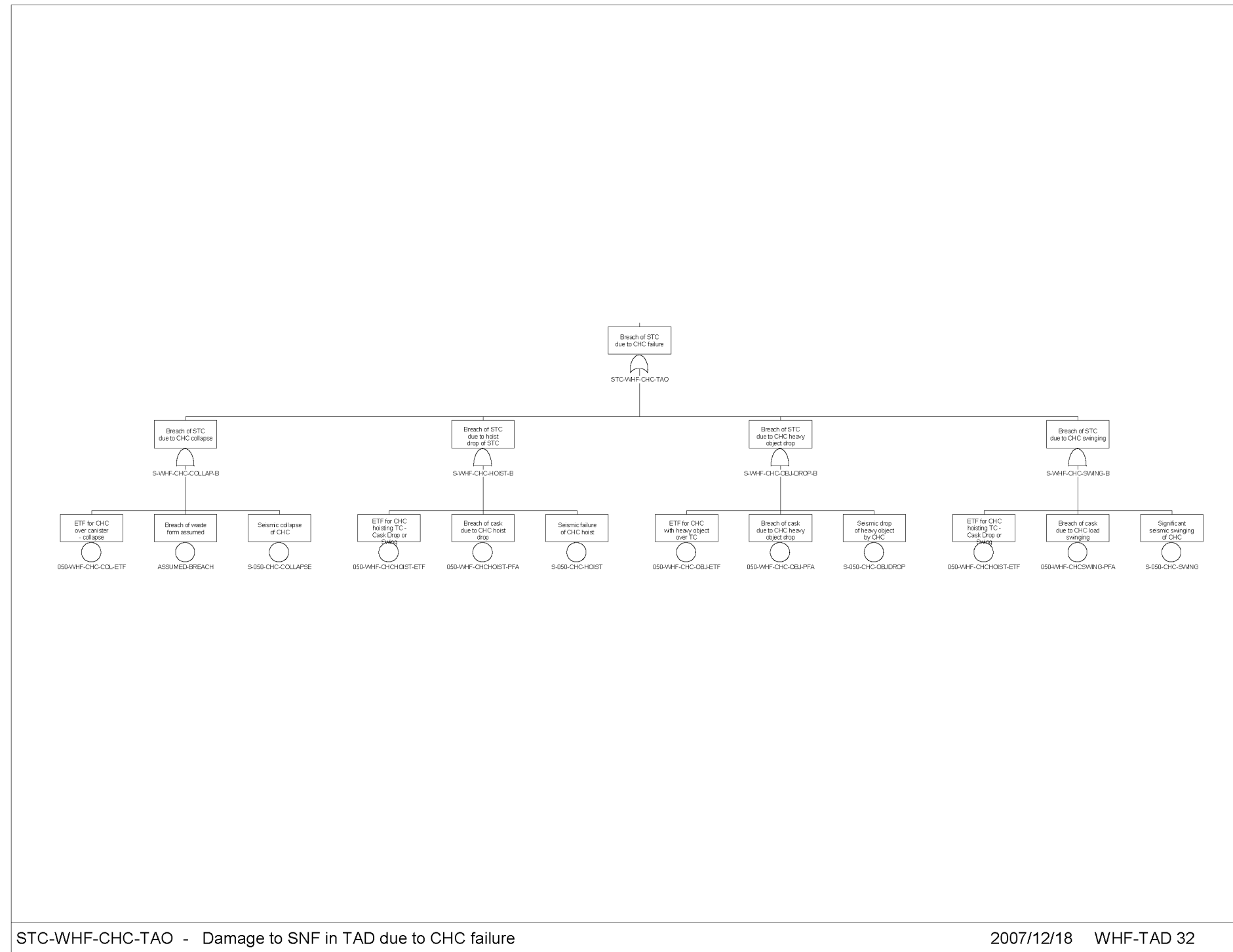

Source: Original

Figure D4.2-20. STC-WHF-CHC-TAO – Damage to SNF in TAD due to CHC Failure

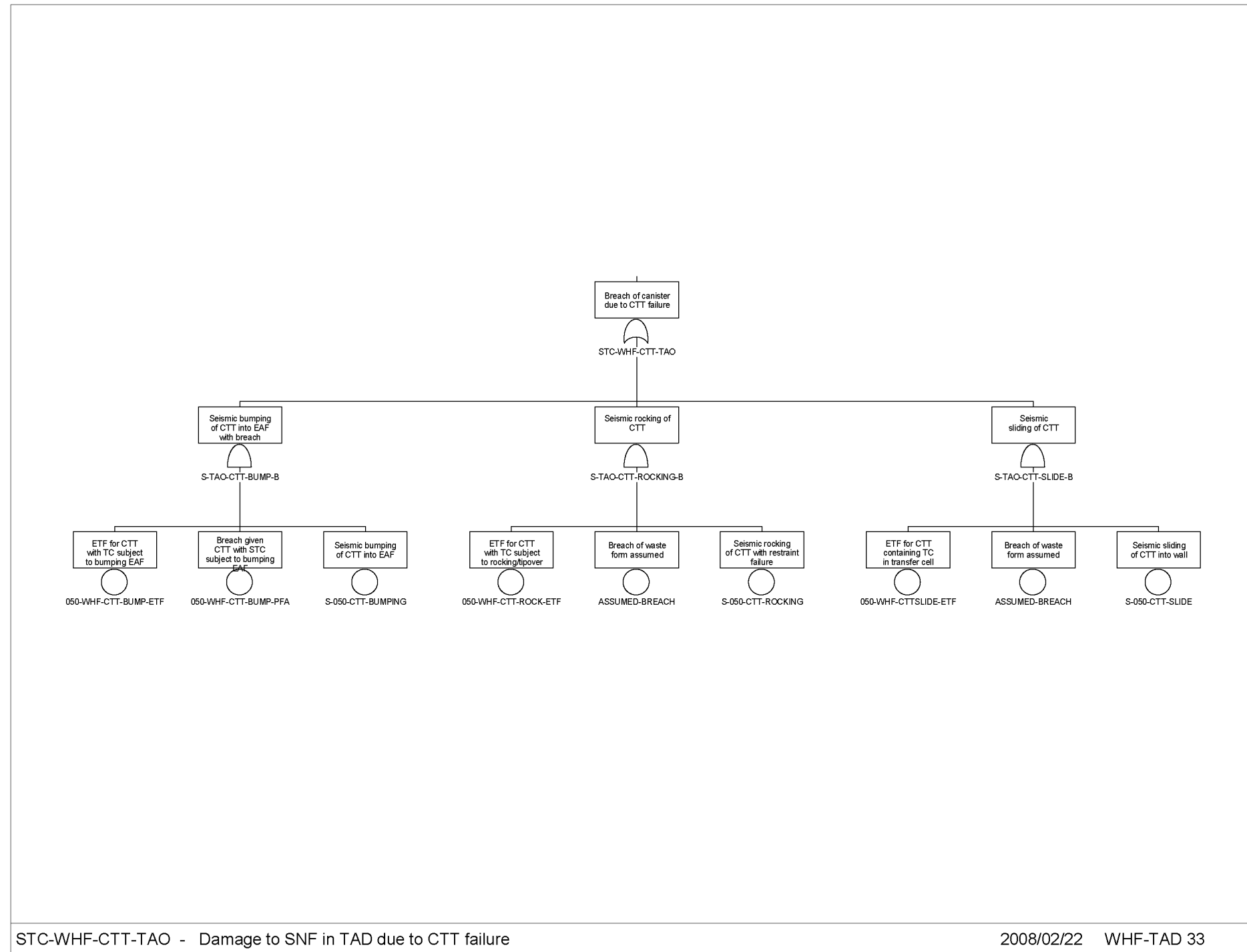

Source: Original

Figure D4.2-21. STC-WHF-CTT-TAO – Damage to SNF in TAD due to CTT Failure

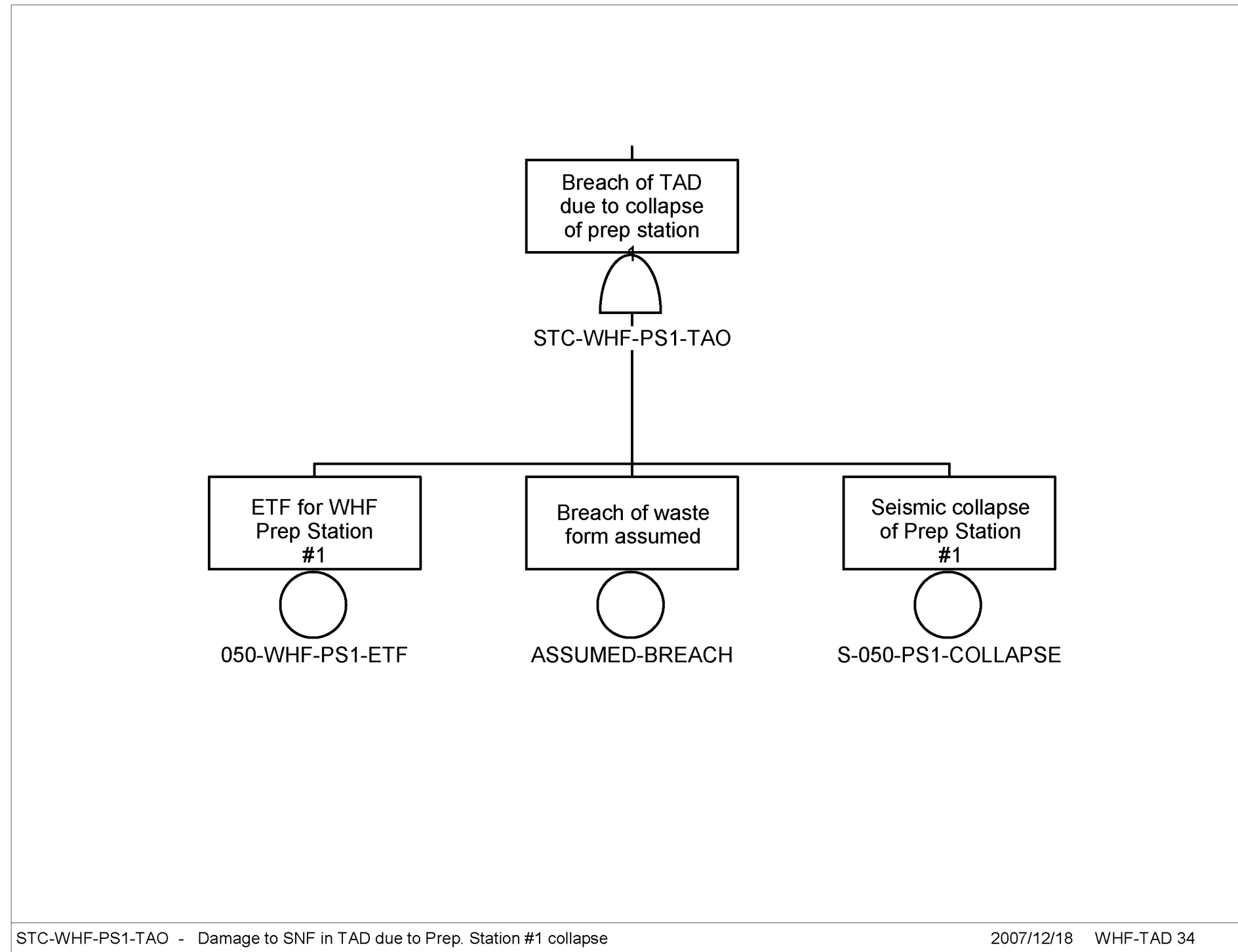

Source: Original

Figure D4.2-22. STC-WHF-PS1-TAO – Damage to SNF in TAD due to Prep. Station #1 Collapse

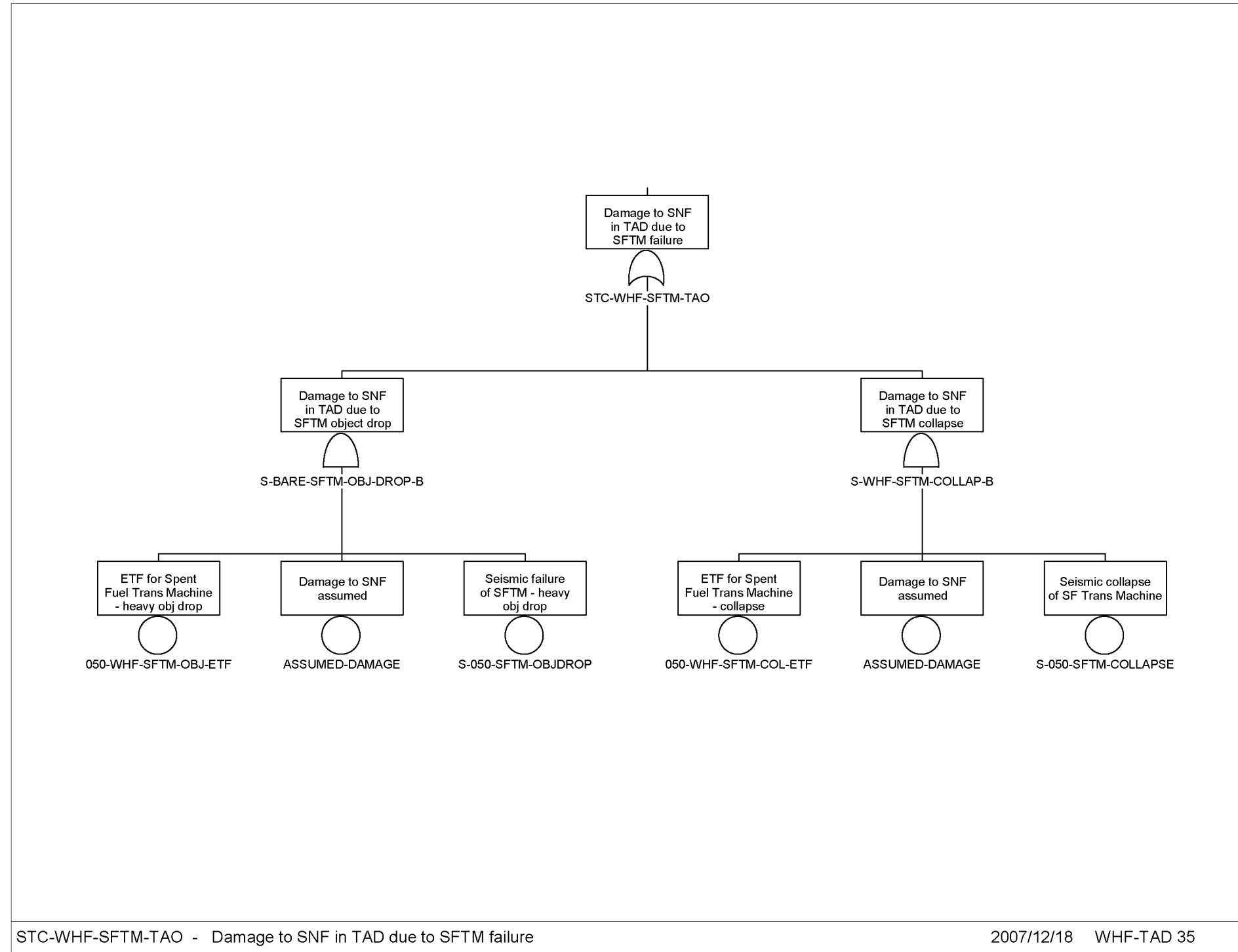

Source: Original

Figure D4.2-23. STC-WHF-SFTM-TAO – Damage to SNF in TAD due to SFTM Failure

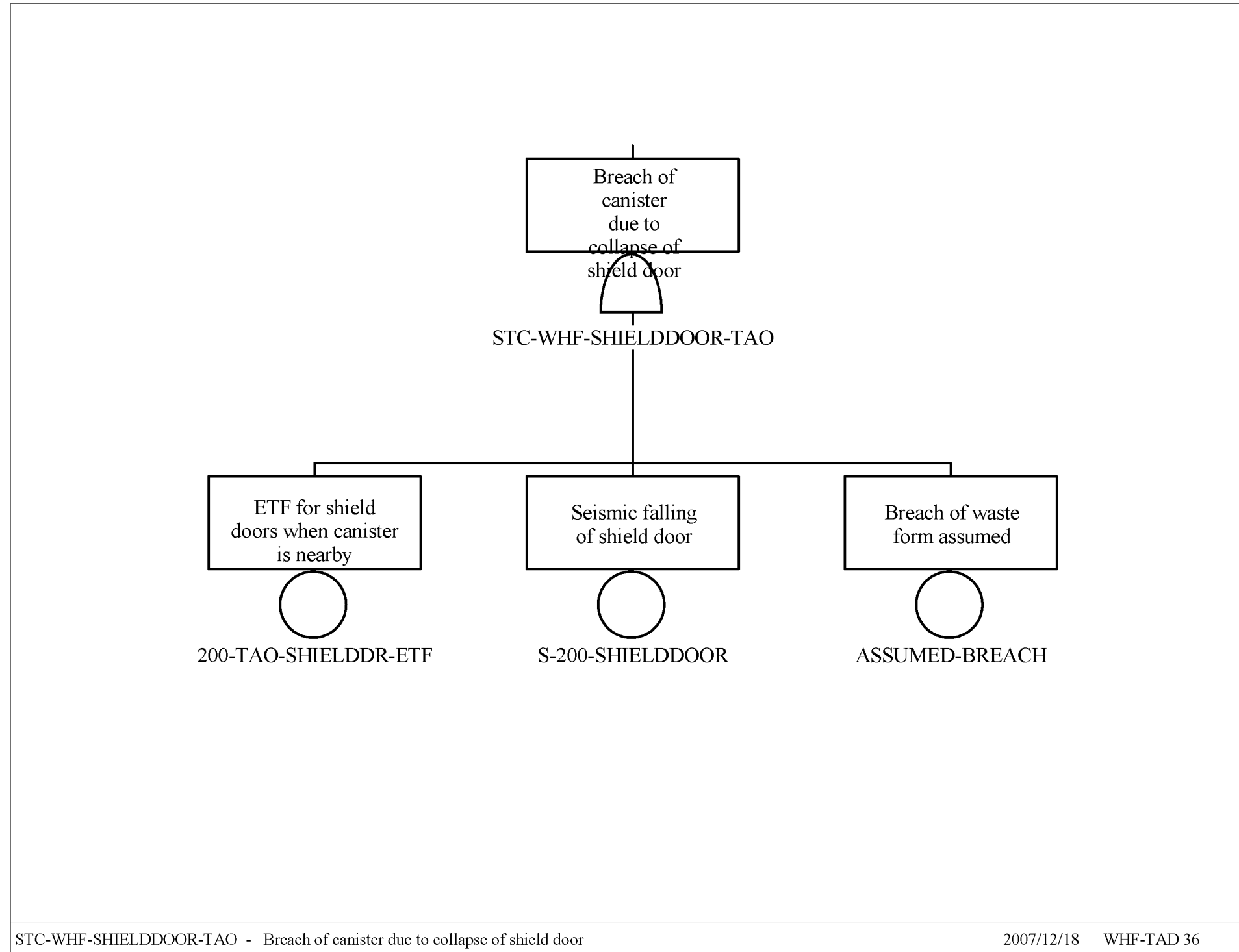

Source: Original

Figure D4.2-24 STC-WHF-SHIELDDOOR-TAO – Breach of Canister due to Collapse of Shield Door

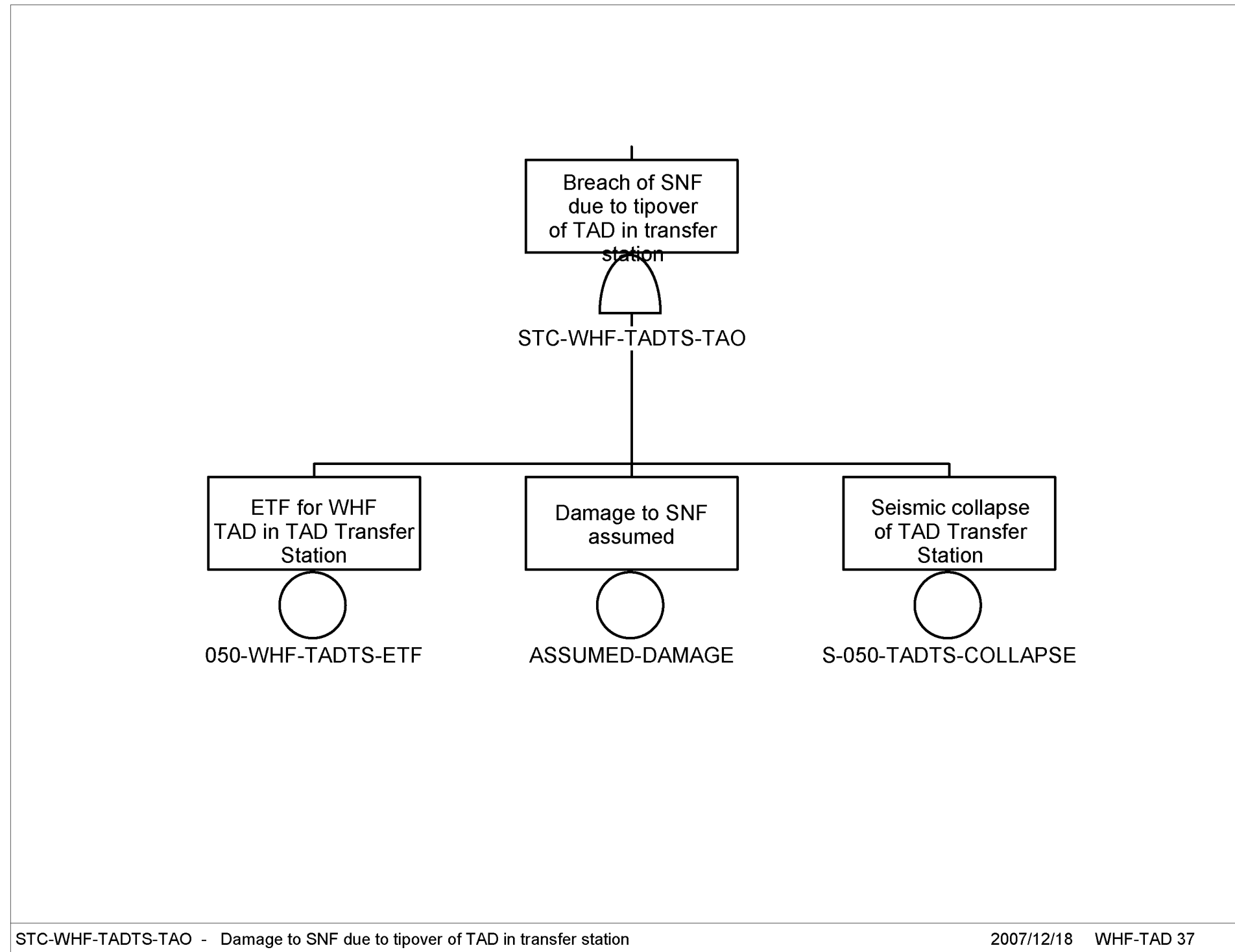

Source: Original

Figure D4.2-25. STC-WHF-TADTS-TAO – Damage to SNF due to Tipover of TAD in Transfer Station

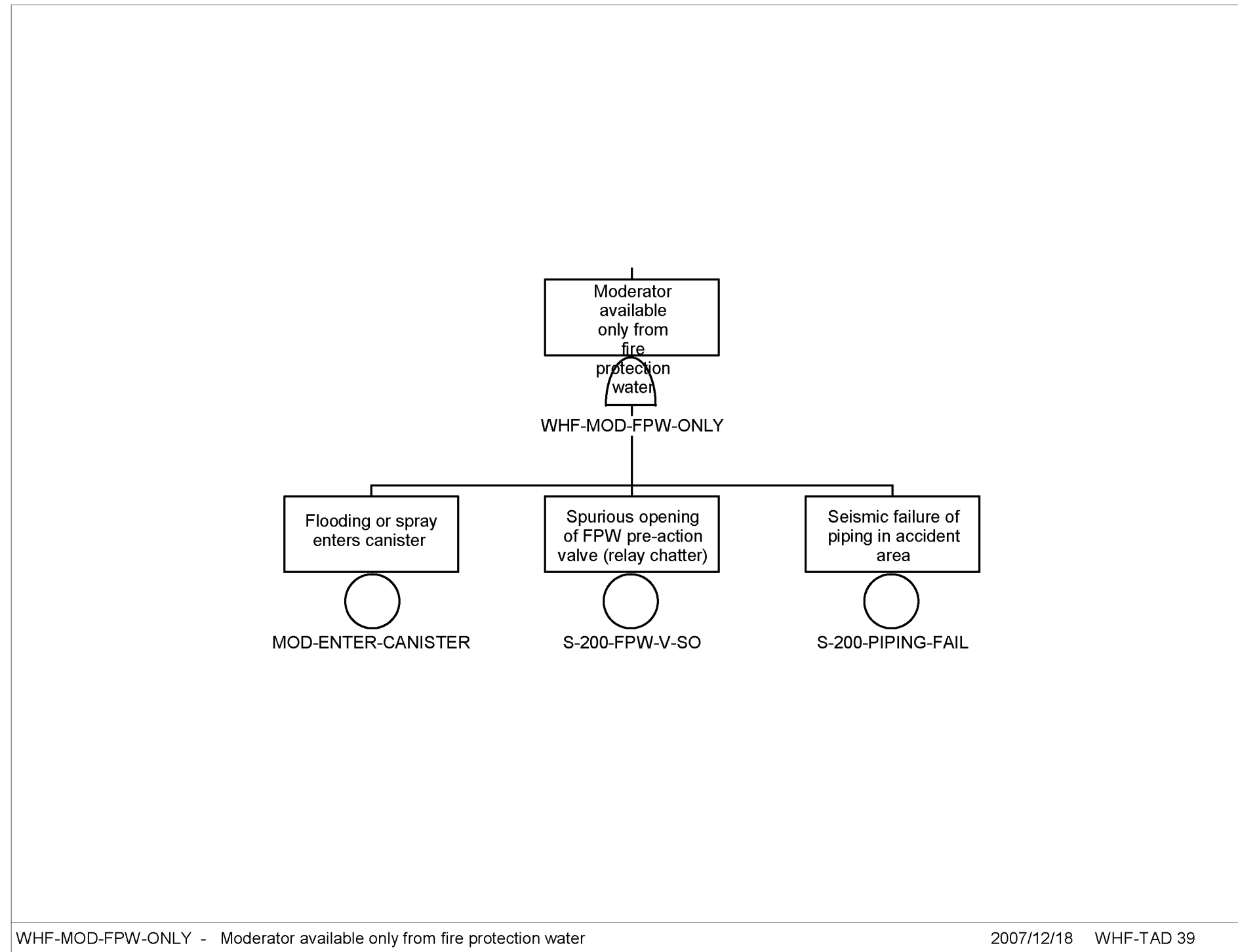

Source: Original

Figure D4.2-26. WHF-MOD-FPW-ONLY – Moderator Available Only from Fire Protection Water

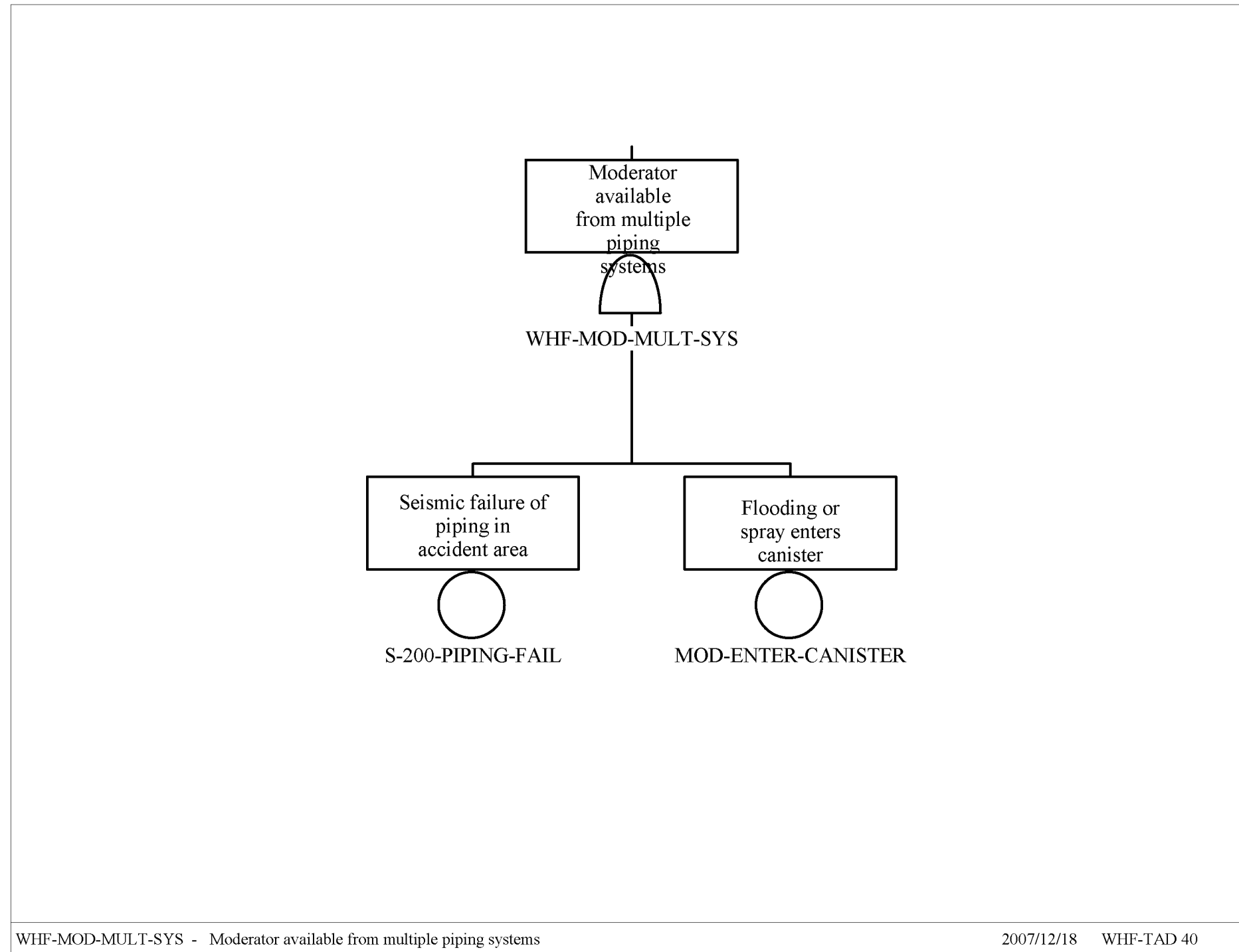

WHF-MOD-MULT-SYS - Moderator available from multiple piping systems

2007/12/18 WHF-TAD 40

Source Original

Figure D4.2-27. WHF-MOD-MULT-SYS – Moderator Available from Multiple Piping Systems

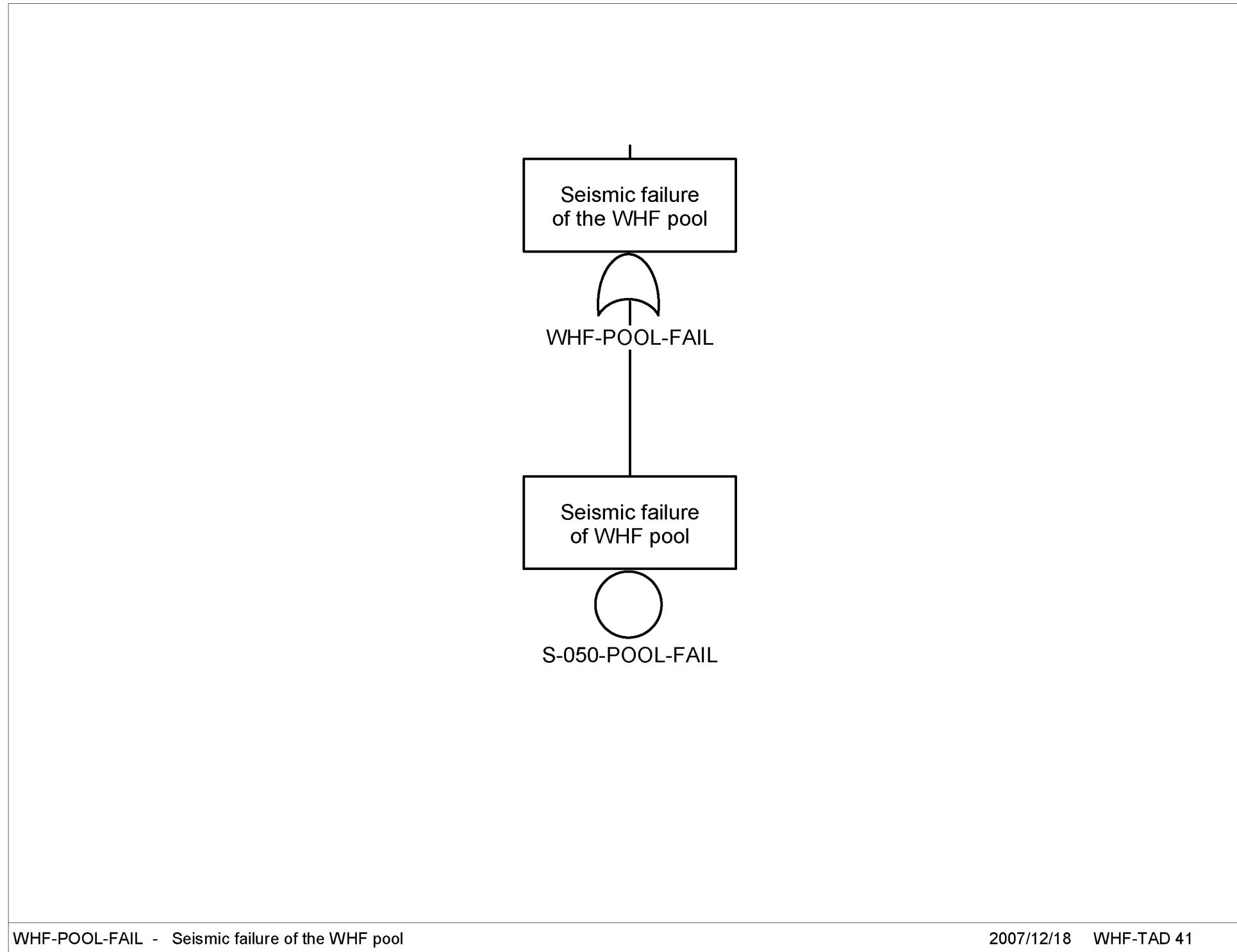

Source: Original

Figure D4.2-28. WHF-POOL-FAIL – Seismic Failure of WHF Pool

D4.3 BASIC EVENTS DATA

D4.3.1 Non-seismic Basic Event Data

The following table presents the basic event identifier used in the fault trees, the description of the basic event, and the failure probability (or other numeric data) of the basic event. For exposure time factors (denoted with “ETF” at the end of the basic event identifier), the value given is the time, in years, that one waste form container is exposed to the seismic failure mode.

Table D4.3-1. Non-seismic Basic Event Data

Name	Description	Calc. Probability
050-WHF-AOAP-COL-ETF	ETF for can under AOAP platform	4.640E-004
050-WHF-APC-COL-ETF	ETF for WHF TAD under aux pool crane	1.810E-004
050-WHF-APC-OBJ-ETF	ETF for WHF TAD under APC - heavy object	7.610E-005
050-WHF-CHC-COL-ETF	ETF for CHC over canister - collapse	5.230E-004
050-WHF-CHC-OBJ-ETF	ETF for CHC with heavy object over TC	6.660E-005
050-WHF-CHC-OBJ-PFA	Breach of cask due to CHC heavy object drop	1.000E-005
050-WHF-CHCHOIST-ETF	ETF for CHC hoisting TC - cask drop or swing	2.190E-004
050-WHF-CHCHOIST-PFA	Breach of cask due to CHC hoist drop	1.000E-005
050-WHF-CHCSWING-PFA	Breach of cask due to CHC load swinging	1.000E-005
050-WHF-CSFR-ETF	ETF for TAD in cask support frame-no plat	5.710E-005
050-WHF-CSFR-PFA	Breach of TAD in failed cask support frame	1.000E-005
050-WHF-CTM-COL-ETF	ETF for CTM over canister - collapse	2.910E-004
050-WHF-CTM-OBJ-ETF	ETF for CTM with heavy object over TC	6.660E-005
050-WHF-CTM-OBJ-PFA	Breach of canister due to CTM object drop	1.000E-005
050-WHF-CTMHOIST-ETF	ETF for CTM hoisting canister - drop	4.570E-005
050-WHF-CTMHOIST-PFA	Breach of canister dropped by CTM	1.000E-005
050-WHF-CTMSWGIB-ETF	ETF for CTM hoisting canister inside bell	4.570E-005
050-WHF-CTMSWGIB-PFA	Breach of canister due to swing inside bell	1.000E-005
050-WHF-CTMSWGOB-ETF	ETF for CTM hoisting canister outside bell	2.850E-005
050-WHF-CTT-BUMP-ETF	ETF for CTT with TC subject to bumping EAF	1.120E-004
050-WHF-CTT-BUMP-PFA	Breach given CTT with STC subject to bumping EAF	1.000E-005
050-WHF-CTT-ROCK-ETF	ETF for CTT with TC subject to rocking/tipover	2.850E-005
050-WHF-CTTSLIDE-ETF	ETF for CTT containing TC in transfer cell	1.460E-004
050-WHF-ENTDOOR-ETF	ETF for entry door over AO	1.900E-005
050-WHF-ENTDOOR-PFA	Breach of canister due to entry door collapse	1.000E-005
050-WHF-JIBC-COL-ETF	ETF for WHF jib crane - collapse	2.180E-003
050-WHF-JIBC-OBJ-ETF	ETF for WHF jib crane - heavy obj. drop	3.610E-004
050-WHF-PS1-ETF	ETF for WHF prep station #1	9.320E-005
050-WHF-SFTM-COL-ETF	ETF for spent fuel trans machine - collapse	1.140E-004
050-WHF-SFTM-OBJ-ETF	ETF for spent fuel trans machine - heavy object drop	0.000E+000
050-WHF-SHIELD-ETF	ETF for shield doors when canister is nearby	1.310E-004
050-WHF-ST-BUMP-ETF	ETF for ST with AO bumping EAF	4.570E-004

Table D4.3-1. Non-seismic Basic Event Data (Continued)

Name	Description	Calc. Probability
050-WHF-ST-BUMP-PFA	Breach of can in AO bumping EAF	1.000E-005
050-WHF-ST-SLIDE-ETF	ETF for ST containing TAD in bldg	2.090E-004
050-WHF-STRUCTUR-ETF	ETF for TAD-AO in WHF structure	6.570E-003
050-WHF-TADCS-ETF	ETF for can under TAD closure or prep station	4.660E-003
050-WHF-TADTS-ETF	ETF for WHF TAD in TAD transfer station	7.710E-004
ASSEMBLY	SNF assemblies are not damaged	0.000E+000
ASSUMED-BREACH	Breach of waste form assumed	1.000E+000
ASSUMED-DAMAGE	Damage to SNF assumed	1.000E+000
MOD-ENTER-CANISTER	Flooding or spray enters canister	1.000E-002
SHIELD-AO	Shielding remains intact	1.000E-005

NOTE: The basic events "ASSUMED-BREACH" and "ASSUMED-DAMAGE" are not assumptions, but are common terminology used to denote a scenario where the waste container is conservatively considered to be breached, or assemblies are considered to be damaged; AO = aging overpack; AOAP = aging overpack access platform; APC = auxiliary pool crane; CHC = cask handling crane; CTM = canister transfer machine; CTT = cask transfer trolley; EAF = energy absorbing feature; ETF = exposure time factor; SNF = spent nuclear fuel; ST = site transporter; STC = shielded transfer cask; TAD = transportation, aging, and disposal; TC = transportation cask; WHF = Wet Handling Facility.

Source: Sections 6.2.2.23 and 6.3.3, Table 6.3-1, Table 6.3-2, Table 6.7-1

D4.3.2 Seismic Basic Event Fragility Data

The following table provides the seismic failure basic event identifier, description, median fragility, and composite uncertainty.

Table D4.3-2. Seismic Basic Event Fragility Data

Event Name	Description	Med. Fragility (g)	Beta C
S-050-AOAP-COL	Seismic collapse of aging overpack access platform	3.500E+000	4.000E-001
S-050-APC-COLLAPSE	Seismic collapse of aux pool crane	2.790E+000	4.500E-001
S-050-APC-OBJDROP	Seismic failure of APC - heavy obj drop	2.280E+000	5.000E-001
S-050-CHC-COLLAPSE	Seismic collapse of CHC	2.790E+000	4.500E-001
S-050-CHC-HOIST	Seismic failure of CHC hoist	2.280E+000	5.000E-001
S-050-CHC-OBJDROP	Seismic drop of heavy object by CHC	2.280E+000	5.000E-001
S-050-CHC-SWING	Significant seismic swinging of CHC	1.140E+000	4.000E-001
S-050-CSFR-FAIL	Seismic failure of the cask support frame	3.030E+000	6.000E-001
S-050-CTM-COLLAPSE	Seismic collapse of CTM (bridge girder)	2.390E+000	4.500E-001
S-050-CTM-HOIST	Seismic drop of canister hoisted by CTM	2.280E+000	5.000E-001

Table D4.3-2. Seismic Basic Event Fragility Data (Continued)

Event Name	Description	Med. Fragility (g)	Beta C
S-050-CTM-OBJDROP	Seismic drop of heavy object by CTM	2.280E+000	5.000E-001
S-050-CTMSWG-IB	Significant swinging of canister inside CTM bell	1.140E+000	4.000E-001
S-050-CTMSWG-OB	Significant swinging of canister outside CTM bell	9.100E-001	4.000E-001
S-050-CTT-BUMPING	Seismic bumping of CTT into EAF	2.250E+000	4.100E-001
S-050-CTT-ROCKING	Seismic rocking of CTT with restraint failure	2.250E+000	4.100E-001
S-050-CTT-SLIDE	Seismic sliding of CTT into wall	3.080E+000	5.800E-001
S-050-ENTDOORCOL	Seismic collapse of entry door	3.700E-001	4.000E-001
S-050-FPW-V-SO	Spurious opening of FPW pre-action valve (relay chatter)	3.000E+000	4.000E-001
S-050-JIBC-COLLAPSE	Seismic collapse of WHF jib crane	2.790E+000	4.500E-001
S-050-JIBC-OBJDROP	Seismic fail of WHF jib crane - heavy obj drop	2.280E+000	5.000E-001
S-050-PIPING-FAIL	Seismic failure of piping in accident area	7.600E-001	4.000E-001
S-050-POOL-FAIL	Seismic failure of WHF pool	4.510E+000	4.000E-001
S-050-PS1-COLLAPSE	Seismic collapse of prep station #1	3.500E+000	4.000E-001
S-050-SFTM-COLLAPSE	Seismic collapse of SFTM	2.190E+000	4.700E-001
S-050-SFTM-OBJDROP	Seismic failure of SFTM - heavy obj drop	2.280E+000	5.000E-001
S-050-SHIELDDOOR	Seismic failure of shield door - WHF	2.920E+000	4.400E-001
S-050-ST-BUMP-EAF	Seismic bumping of ST into EAF	1.890E+000	4.200E-001
S-050-ST-SLIDE	Seismic sliding of ST into wall	1.890E+000	4.200E-001
S-050-STR-COLLAPSE	Seismic collapse of WHF structure	4.510E+000	4.000E-001
S-050-TADCS-COL	Seismic collapse of TAD closure station	3.500E+000	4.000E-001
S-050-TADTS-COLLAPSE	Seismic collapse of TAD transfer station	1.410E+000	4.600E-001

NOTE: APC = auxiliary pool crane; CHC = cask handling crane; CTM = canister transfer machine; CTT = cask transfer trolley; EAF = energy absorbing feature; ETF = exposure time factor; FPW = fire protection water; SFTM = spent fuel transfer machine; ST = site transporter; TAD = transportation, aging, and disposal; WHF = Wet Handling Facility.

Source: Table 6.2-1 and Table 6.2-2

D4.4 EVENT SEQUENCE QUANTIFICATION

This section provides the quantification results by sequence. The event sequence probabilities are provided first, and the cut sets are provided afterwards.

D4.4.1 Sequence Level Results

Table D4.4-1. Sequence Level Results

Event Tree	Sequence	Base Min. Cut	Base Cut Sets
WHF-S-IE-TAD-AO	03	6.646E-006	1
WHF-S-IE-TAD-AO	04-2		0
WHF-S-IE-TAD-AO	04-3		0
WHF-S-IE-TAD-AO	04-4		0
WHF-S-IE-TAD-AO	04-5	5.364E-005	1
WHF-S-IE-TAD-AO	04-6	6.726E-007	1
WHF-S-IE-TAD-AO	05-2		0
WHF-S-IE-TAD-AO	05-3		0
WHF-S-IE-TAD-AO	05-4		0
WHF-S-IE-TAD-AO	05-5	3.209E-006	2
WHF-S-IE-TAD-AO	05-6	1.253E-007	2
WHF-S-IE-TAD-AO	06-2		0
WHF-S-IE-TAD-AO	06-3		0
WHF-S-IE-TAD-AO	06-4		0
WHF-S-IE-TAD-AO	06-5	2.429E-006	2
WHF-S-IE-TAD-AO	06-6	7.108E-008	2
WHF-S-IE-TAD-AO	07-2	2.858E-010	3
WHF-S-IE-TAD-AO	07-3	+0.000E+000	1
WHF-S-IE-TAD-AO	07-4	+0.000E+000	1
WHF-S-IE-TAD-AO	07-5	+0.000E+000	1
WHF-S-IE-TAD-AO	07-6	4.782E-006	4
WHF-S-IE-TAD-AO	07-7	4.500E-008	4
WHF-S-IE-TAD-AO	08	1.431E-005	2
WHF-S-IE-TAD-AO	09	2.448E-005	2
WHF-S-IE-TAD-AO	10-2	1.771E-011	1
WHF-S-IE-TAD-AO	10-3	+0.000E+000	1
WHF-S-IE-TAD-AO	10-4	+0.000E+000	1
WHF-S-IE-TAD-AO	10-5	2.199E-006	3
WHF-S-IE-TAD-AO	10-6	1.940E-008	3
WHF-S-IE-TAD-AO	11-2		0
WHF-S-IE-TAD-AO	11-3	+0.000E+000	1
WHF-S-IE-TAD-AO	11-4	+0.000E+000	1
WHF-S-IE-TAD-AO	11-5	2.862E-007	1
WHF-S-IE-TAD-AO	11-6	2.809E-009	1
WHF-S-IE-TAD-AO	12-2		0
WHF-S-IE-TAD-AO	12-3	+0.000E+000	1
WHF-S-IE-TAD-AO	12-4	+0.000E+000	1
WHF-S-IE-TAD-AO	12-5	9.790E-007	1
WHF-S-IE-TAD-AO	12-6	9.320E-009	1

Table D4.4-1. Sequence Level Results (Continued)

Event Tree	Sequence	Base Min. Cut	Base Cut Sets
WHF-S-IE-TAD-AO	13-2	7.078E-011	3
WHF-S-IE-TAD-AO	13-3	+0.000E+000	1
WHF-S-IE-TAD-AO	13-4	+0.000E+000	1
WHF-S-IE-TAD-AO	13-5	9.328E-006	5
WHF-S-IE-TAD-AO	13-6	8.067E-009	5
WHF-S-IE-TAD-AO	14-2	1.273E-010	1
WHF-S-IE-TAD-AO	14-3	+0.000E+000	1
WHF-S-IE-TAD-AO	14-4	+0.000E+000	1
WHF-S-IE-TAD-AO	14-5	5.821E-006	2
WHF-S-IE-TAD-AO	14-6	5.160E-008	2
WHF-S-IE-TAD-AO	15-2		0
WHF-S-IE-TAD-AO	15-3	+0.000E+000	1
WHF-S-IE-TAD-AO	15-4	+0.000E+000	1
WHF-S-IE-TAD-AO	15-5	1.425E-006	1
WHF-S-IE-TAD-AO	15-6	1.399E-008	1
WHF-S-IE-TAD-AO	16-2	2.231E-010	1
WHF-S-IE-TAD-AO	16-3	+0.000E+000	1
WHF-S-IE-TAD-AO	16-4	+0.000E+000	1
WHF-S-IE-TAD-AO	16-5	2.231E-010	1
WHF-S-IE-TAD-AO	16-6	4.508E-013	1

Source: Original

D4.4.2 Cut Set Level Results by Sequence

Note that the SAPHIRE software does not provide special tables for seismic cut sets. Therefore, the “Cut Set %” given in the third column of this table is not correct for seismic events, although it does provide the approximate rank order for the cut sets.

Table D4.4-2. Cut Set Level Results by Sequence

Event Tree	Sequence	Cut Set %	Basic Event	Description
WHF-S-IE-TAD-AO	03	100.00	050-WHF-STRUCTUR-ETF	ETF for TAD-AO in WHF structure
			S-050-STR-COLLAPSE	Seismic collapse of RF structure
			WHF-TAD-AO	Number of TAD canisters transferred to AO
			= Total	
	04-2			
	04-3			
	04-4			
	04-5	100.00	050-WHF-TADTS-ETF	ETF for WHF TAD in TAD transfer station

Table D4.4-2. Cut Set Level Results by Sequence (Continued)

Event Tree	Sequence	Cut Set %	Basic Event	Description
			S-050-TADTS-COLLAPSE	Seismic collapse of TAD transfer station
			WHF-TAD-AO	Number of TAD canisters transferred to AO
			= Total	
	04-6	100.00	050-WHF-TADTS-ETF	ETF for WHF TAD in TAD transfer station
			S-050-POOL-FAIL	Seismic failure of WHF pool
			S-050-TADTS-COLLAPSE	Seismic collapse of TAD transfer station
			WHF-TAD-AO	Number of TAD canisters transferred to AO
			= Total	
	05-2			
	05-3			
	05-4			
	05-5	90.62	050-WHF-APC-OBJ-ETF	ETF for WHF TAD under APC - heavy object
			S-050-APC-OBJDROP	Seismic failure of APC - heavy object drop
			WHF-TAD-AO	Number of TAD canisters transferred to AO
		9.38	050-WHF-APC-COL-ETF	ETF for WHF TAD under aux pool crane
			S-050-APC-COLLAPSE	Seismic collapse of aux pool crane
			WHF-TAD-AO	Number of TAD canisters transferred to AO
			= Total	
	05-6	90.61	050-WHF-APC-OBJ-ETF	ETF for WHF TAD under APC - heavy object
			S-050-APC-OBJDROP	Seismic failure of APC - heavy object drop
			S-050-POOL-FAIL	Seismic failure of WHF pool
			WHF-TAD-AO	Number of TAD canisters transferred to AO
		9.38	050-WHF-APC-COL-ETF	ETF for WHF TAD under aux pool crane
			S-050-APC-COLLAPSE	Seismic collapse of aux pool crane
			S-050-POOL-FAIL	Seismic failure of WHF pool
			WHF-TAD-AO	Number of TAD canisters transferred to AO
			= Total	
	06-2			
	06-3			
	06-4			

Table D4.4-2. Cut Set Level Results by Sequence (Continued)

Event Tree	Sequence	Cut Set %	Basic Event	Description
	06-5	100.00	050-WHF-SFTM-COL-ETF	ETF for spent fuel trans machine - collapse
			S-050-SFTM-COLLAPSE	Seismic collapse of SF trans machine
			WHF-TAD-AO	Number of TAD canisters transferred to AO
		0.00	050-WHF-SFTM-OBJ-ETF	ETF for spent fuel trans machine - heavy object drop
			S-050-SFTM-OBJDROP	Seismic failure of SFTM - heavy object drop
			WHF-TAD-AO	Number of TAD canisters transferred to AO
			= Total	
	06-6	99.99	050-WHF-SFTM-COL-ETF	ETF for spent fuel trans machine - collapse
			S-050-POOL-FAIL	Seismic failure of WHF pool
			S-050-SFTM-COLLAPSE	Seismic collapse of SF trans machine
			WHF-TAD-AO	Number of TAD canisters transferred to AO
		0.00	050-WHF-SFTM-OBJ-ETF	ETF for spent fuel trans machine - heavy object drop
			S-050-POOL-FAIL	Seismic failure of WHF pool
			S-050-SFTM-OBJDROP	Seismic failure of SFTM - heavy object drop
			WHF-TAD-AO	Number of TAD canisters transferred to AO
			= Total	
	07-2	92.92	050-WHF-CHCHOIST-ETF	ETF for CHC hoisting TC - cask drop or swing
			S-050-CHC-SWING	Significant seismic swinging of CHC
			SHIELDING	Shielding remains intact
			WHF-TAD-AO	Number of TAD canisters transferred to AO
		5.43	050-WHF-CHCHOIST-ETF	ETF for CHC hoisting TC - cask drop or swing
			S-050-CHC-HOIST	Seismic failure of CHC hoist
			SHIELDING	Shielding remains intact
			WHF-TAD-AO	Number of TAD canisters transferred to AO
		1.65	050-WHF-CHC-OBJ-ETF	ETF for CHC with heavy object over TC
			S-050-CHC-OBJDROP	Seismic drop of heavy object by CHC
			SHIELDING	Shielding remains intact

Table D4.4-2. Cut Set Level Results by Sequence (Continued)

Event Tree	Sequence	Cut Set %	Basic Event	Description
			WHF-TAD-AO	Number of TAD canisters transferred to AO
			= Total	
	07-3	0.00	<FALSE>	System Generated Success Event
			= Total	
	07-4	0.00	<FALSE>	System Generated Success Event
			= Total	
	07-5	0.00	<FALSE>	System Generated Success Event
			= Total	
	07-6	99.82	050-WHF-CHC-COL-ETF	ETF for CHC over canister - collapse
			S-050-CHC-COLLAPSE	Seismic collapse of CHC
			WHF-TAD-AO	Number of TAD canisters transferred to AO
		0.16	050-WHF-CHCHOIST-ETF	ETF for CHC hoisting TC - cask drop or swing
			050-WHF-CHCSWING-PFA	Breach of cask due to CHC load swinging
			S-050-CHC-SWING	Significant seismic swinging of CHC
			WHF-TAD-AO	Number of TAD canisters transferred to AO
		0.01	050-WHF-CHCHOIST-ETF	ETF for CHC hoisting TC - cask drop or swing
			050-WHF-CHCHOIST-PFA	Breach of cask due to CHC hoist drop
			S-050-CHC-HOIST	Seismic failure of CHC hoist
			WHF-TAD-AO	Number of TAD canisters transferred to AO
		0.00	050-WHF-CHC-OBJ-ETF	ETF for CHC with heavy object over TC
			050-WHF-CHC-OBJ-PFA	Breach of cask due to CHC heavy object drop
			S-050-CHC-OBJDROP	Seismic drop of heavy object by CHC
			WHF-TAD-AO	Number of TAD canisters transferred to AO
			= Total	
	07-7	99.82	050-WHF-CHC-COL-ETF	ETF for CHC over canister - collapse
			MOD-ENTER-CANISTER	Flooding or spray enters canister
			S-050-CHC-COLLAPSE	Seismic collapse of CHC
			S-050-PIPING-FAIL	Seismic failure of piping in accident area
			WHF-TAD-AO	Number of TAD canisters transferred to AO

Table D4.4-2. Cut Set Level Results by Sequence (Continued)

Event Tree	Sequence	Cut Set %	Basic Event	Description
		0.16	050-WHF-CHCHOIST-ETF	ETF for CHC hoisting TC - cask drop or swing
			050-WHF-CHCSWING-PFA	Breach of cask due to CHC load swinging
			MOD-ENTER-CANISTER	Flooding or spray enters canister
			S-050-CHC-SWING	Significant seismic swinging of CHC
			S-050-PIPING-FAIL	Seismic failure of piping in accident area
			WHF-TAD-AO	Number of TAD canisters transferred to AO
		0.01	050-WHF-CHCHOIST-ETF	ETF for CHC hoisting TC - cask drop or swing
			050-WHF-CHCHOIST-PFA	Breach of cask due to CHC hoist drop
			MOD-ENTER-CANISTER	Flooding or spray enters canister
			S-050-CHC-HOIST	Seismic failure of CHC hoist
			S-050-PIPING-FAIL	Seismic failure of piping in accident area
			WHF-TAD-AO	Number of TAD canisters transferred to AO
		0.00	050-WHF-CHC-OBJ-ETF	ETF for CHC with heavy object over TC
			050-WHF-CHC-OBJ-PFA	Breach of cask due to CHC heavy object drop
			MOD-ENTER-CANISTER	Flooding or spray enters canister
			S-050-CHC-OBJDROP	Seismic drop of heavy object by CHC
			S-050-PIPING-FAIL	Seismic failure of piping in accident area
			WHF-TAD-AO	Number of TAD canisters transferred to AO
			= Total	
	08	99.94	050-WHF-TADCS-ETF	ETF for can under TAD closure or prep station
			S-050-TADCS-COL	Seismic collapse of TAD closure station
			WHF-TAD-AO	Number of TAD canisters transferred to AO
		0.06	050-WHF-CSFR-ETF	ETF for TAD in cask support frame-no plat
			050-WHF-CSFR-PFA	Breach of TAD in failed cask support frame
			S-050-CSFR-FAIL	Seismic failure of cask support frame

Table D4.4-2. Cut Set Level Results by Sequence (Continued)

Event Tree	Sequence	Cut Set %	Basic Event	Description
			WHF-TAD-AO	Number of TAD canisters transferred to AO
			= Total	
	09	79.19	050-WHF-JIBC-OBJ-ETF	ETF for WHF jib crane - heavy obj. drop
			S-050-JIBC-OBJDROP	Seismic fail of WHF jib crane - heavy object drop
			WHF-TAD-AO	Number of TAD canisters transferred to AO
		20.82	050-WHF-JIBC-COL-ETF	ETF for WHF jib crane - collapse
			S-050-JIBC-COLLAPSE	Seismic collapse of WHF jib crane
			WHF-TAD-AO	Number of TAD canisters transferred to AO
			= Total	
	10-2	100.00	050-WHF-CTT-BUMP-ETF	ETF for CTT with TC subject to bumping EAF
			S-050-CTT-BUMPING	Seismic bumping of CTT into EAF
			SHIELDING	Shielding remains intact
			WHF-TAD-AO	Number of TAD canisters transferred to AO
			= Total	
	10-3	0.00	<FALSE>	System Generated Success Event
			= Total	
	10-4	0.00	<FALSE>	System Generated Success Event
			= Total	
	10-5	98.13	050-WHF-CTTSLIDE-ETF	ETF for CTT containing TC in transfer cell
			S-050-CTT-SLIDE	Seismic sliding of CTT into wall
			WHF-TAD-AO	Number of TAD canisters transferred to AO
		1.87	050-WHF-CTT-ROCK-ETF	ETF for CTT with TC subject to rocking/tipover
			S-050-CTT-ROCKING	Seismic rocking of CTT with restraint failure
			WHF-TAD-AO	Number of TAD canisters transferred to AO
		0.00	050-WHF-CTT-BUMP-ETF	ETF for CTT with TC subject to bumping EAF
			050-WHF-CTT-BUMP-PFA	Breach given CTT with STC subject to bumping EAF
			S-050-CTT-BUMPING	Seismic bumping of CTT into EAF
			WHF-TAD-AO	Number of TAD canisters transferred to AO
			= Total	
	10-6	98.13	050-WHF-CTTSLIDE-ETF	ETF for CTT containing TC in transfer cell

Table D4.4-2. Cut Set Level Results by Sequence (Continued)

Event Tree	Sequence	Cut Set %	Basic Event	Description
			MOD-ENTER-CANISTER	Flooding or spray enters canister
			S-050-CTT-SLIDE	Seismic sliding of CTT into wall
			S-050-PIPING-FAIL	Seismic failure of piping in accident area
			WHF-TAD-AO	Number of TAD canisters transferred to AO
		1.87	050-WHF-CTT-ROCK-ETF	ETF for CTT with TC subject to rocking/tipover
			MOD-ENTER-CANISTER	Flooding or spray enters canister
			S-050-CTT-ROCKING	Seismic rocking of CTT with restraint failure
			S-050-PIPING-FAIL	Seismic failure of piping in accident area
			WHF-TAD-AO	Number of TAD canisters transferred to AO
		0.00	050-WHF-CTT-BUMP-ETF	ETF for CTT with TC subject to bumping EAF
			050-WHF-CTT-BUMP-PFA	Breach given CTT with STC subject to bumping EAF
			MOD-ENTER-CANISTER	Flooding or spray enters canister
			S-050-CTT-BUMPING	Seismic bumping of CTT into EAF
			S-050-PIPING-FAIL	Seismic failure of piping in accident area
			WHF-TAD-AO	Number of TAD canisters transferred to AO
			= Total	
	11-2			
	11-3	0.00	<FALSE>	System Generated Success Event
			= Total	
	11-4	0.00	<FALSE>	System Generated Success Event
			= Total	
	11-5	100.00	050-WHF-PS1-ETF	ETF for WHF prep station #1
			S-050-PS1-COLLAPSE	Seismic collapse of prep station #1
			WHF-TAD-AO	Number of TAD canisters transferred to AO
			= Total	
	11-6	100.00	050-WHF-PS1-ETF	ETF for WHF prep station #1
			MOD-ENTER-CANISTER	Flooding or spray enters canister
			S-050-PIPING-FAIL	Seismic failure of piping in accident area
			S-050-PS1-COLLAPSE	Seismic collapse of prep station #1
			WHF-TAD-AO	Number of TAD canisters transferred to AO
			= Total	
	12-2			

Table D4.4-2. Cut Set Level Results by Sequence (Continued)

Event Tree	Sequence	Cut Set %	Basic Event	Description
	12-3	0.00	<FALSE>	System Generated Success Event
			= Total	
	12-4	0.00	<FALSE>	System Generated Success Event
			= Total	
	12-5	100.00	050-WHF-SHIELDDR-ETF	ETF for shield doors when canister is nearby
			S-050-SHIELDDOOR	Seismic failure of shield door - WHF
			WHF-TAD-AO	Number of TAD canisters transferred to AO
			= Total	
	12-6	100.00	050-WHF-SHIELDDR-ETF	ETF for shield doors when canister is nearby
			MOD-ENTER-CANISTER	Flooding or spray enters canister
			S-050-PIPING-FAIL	Seismic failure of piping in accident area
			S-050-SHIELDDOOR	Seismic failure of shield door - WHF
			WHF-TAD-AO	Number of TAD canisters transferred to AO
			= Total	
	13-2	87.45	050-WHF-CTMSWGIB-ETF	ETF for CTM hoisting canister inside bell
			S-050-CTMSWG-IB	Significant swinging of canister inside CTM bell
			SHIELDING	Shielding remains intact
			WHF-TAD-AO	Number of TAD canisters transferred to AO
		7.44	050-WHF-CTM-OBJ-ETF	ETF for CTM with heavy object over TC
			S-050-CTM-OBJDROP	Seismic drop of heavy object by CTM
			SHIELDING	Shielding remains intact
			WHF-TAD-AO	Number of TAD canisters transferred to AO
		5.11	050-WHF-CTMHOIST-ETF	ETF for CTM hoisting canister - drop
			S-050-CTM-HOIST	Seismic drop of canister hoisted by CTM
			SHIELDING	Shielding remains intact
			WHF-TAD-AO	Number of TAD canisters transferred to AO
			= Total	
	13-3	0.00	<FALSE>	System Generated Success Event
			= Total	
	13-4	0.00	<FALSE>	System Generated Success Event

Table D4.4-2. Cut Set Level Results by Sequence (Continued)

Event Tree	Sequence	Cut Set %	Basic Event	Description
			= Total	
	13-5	97.32	050-WHF-CTMSWGOB-ETF	ETF for CTM hoisting canister outside bell
			S-050-CTMSWG-OB	Significant swinging of canister outside CTM bell
			WHF-TAD-AO	Number of TAD canisters transferred to AO
		2.68	050-WHF-CTM-COL-ETF	ETF for CTM over canister - collapse
			S-050-CTM-COLLAPSE	Seismic collapse of CTM (bridge girder)
			WHF-TAD-AO	Number of TAD canisters transferred to AO
		0.00	050-WHF-CTMSWGIB-ETF	ETF for CTM hoisting canister inside bell
			050-WHF-CTMSWGIB-PFA	Breach of canister due to swing inside bell
			S-050-CTMSWG-IB	Significant swinging of canister inside CTM bell
			WHF-TAD-AO	Number of TAD canisters transferred to AO
		0.00	050-WHF-CTM-OBJ-ETF	ETF for CTM with heavy object over TC
			050-WHF-CTM-OBJ-PFA	Breach of canister due to CTM object drop
			S-050-CTM-OBJDROP	Seismic drop of heavy object by CTM
			WHF-TAD-AO	Number of TAD canisters transferred to AO
		0.00	050-WHF-CTMHOIST-ETF	ETF for CTM hoisting canister - drop
			050-WHF-CTMHOIST-PFA	Breach of canister dropped by CTM
			S-050-CTM-HOIST	Seismic drop of canister hoisted by CTM
			WHF-TAD-AO	Number of TAD canisters transferred to AO
			= Total	
	13-6	97.31	050-WHF-CTMSWGOB-ETF	ETF for CTM hoisting canister outside bell
			MOD-ENTER-CANISTER	Flooding or spray enters canister
			S-050-CTMSWG-OB	Significant swinging of canister outside CTM bell
			S-050-FPW-V-SO	Spurious opening of FPW pre-action valve (relay chatter)
			S-050-PIPING-FAIL	Seismic failure of piping in accident area

Table D4.4-2. Cut Set Level Results by Sequence (Continued)

Event Tree	Sequence	Cut Set %	Basic Event	Description
			WHF-TAD-AO	Number of TAD canisters transferred to AO
		2.68	050-WHF-CTM-COL-ETF	ETF for CTM over canister - collapse
			MOD-ENTER-CANISTER	Flooding or spray enters canister
			S-050-CTM-COLLAPSE	Seismic collapse of CTM (bridge girder)
			S-050-FPW-V-SO	Spurious opening of FPW pre-action valve (relay chatter)
			S-050-PIPING-FAIL	Seismic failure of piping in accident area
			WHF-TAD-AO	Number of TAD canisters transferred to AO
		0.00	050-WHF-CTMSWGIB-ETF	ETF for CTM hoisting canister inside bell
			050-WHF-CTMSWGIB-PFA	Breach of canister due to swing inside bell
			MOD-ENTER-CANISTER	Flooding or spray enters canister
			S-050-CTMSWG-IB	Significant swinging of canister inside CTM bell
			S-050-FPW-V-SO	Spurious opening of FPW pre-action valve (relay chatter)
			S-050-PIPING-FAIL	Seismic failure of piping in accident area
			WHF-TAD-AO	Number of TAD canisters transferred to AO
		0.00	050-WHF-CTM-OBJ-ETF	ETF for CTM with heavy object over TC
			050-WHF-CTM-OBJ-PFA	Breach of canister due to CTM object drop
			MOD-ENTER-CANISTER	Flooding or spray enters canister
			S-050-CTM-OBJDROP	Seismic drop of heavy object by CTM
			S-050-FPW-V-SO	Spurious opening of FPW pre-action valve (relay chatter)
			S-050-PIPING-FAIL	Seismic failure of piping in accident area
			WHF-TAD-AO	Number of TAD canisters transferred to AO
		0.00	050-WHF-CTMHOIST-ETF	ETF for CTM hoisting canister - drop
			050-WHF-CTMHOIST-PFA	Breach of canister dropped by CTM
			MOD-ENTER-CANISTER	Flooding or spray enters canister
			S-050-CTM-HOIST	Seismic drop of canister hoisted by CTM

Table D4.4-2. Cut Set Level Results by Sequence (Continued)

Event Tree	Sequence	Cut Set %	Basic Event	Description
			S-050-FPW-V-SO	Spurious opening of FPW pre-action valve (relay chatter)
			S-050-PIPING-FAIL	Seismic failure of piping in accident area
			WHF-TAD-AO	Number of TAD canisters transferred to AO
			= Total	
	14-2	100.00	050-WHF-ST-BUMP-ETF	ETF for ST with AO bumping EAF
			S-050-ST-BUMP-EAF	Seismic bumping of ST into EAF
			SHIELD-AO	Shielding remains intact
			WHF-TAD-AO	Number of TAD canisters transferred to AO
			= Total	
	14-3	0.00	<FALSE>	System Generated Success Event
			= Total	
	14-4	0.00	<FALSE>	System Generated Success Event
			= Total	
	14-5	100.00	050-WHF-ST-SLIDE-ETF	ETF for ST containing TAD in bldg
			S-050-ST-SLIDE	Seismic sliding of ST into wall
			WHF-TAD-AO	Number of TAD canisters transferred to AO
		0.00	050-WHF-ST-BUMP-ETF	ETF for ST with AO bumping EAF
			050-WHF-ST-BUMP-PFA	Breach of can in AO bumping EAF
			S-050-ST-BUMP-EAF	Seismic bumping of ST into EAF
			WHF-TAD-AO	Number of TAD canisters transferred to AO
			= Total	
	14-6	100.00	050-WHF-ST-SLIDE-ETF	ETF for ST containing TAD in bldg
			MOD-ENTER-CANISTER	Flooding or spray enters canister
			S-050-PIPING-FAIL	Seismic failure of piping in accident area
			S-050-ST-SLIDE	Seismic sliding of ST into wall
			WHF-TAD-AO	Number of TAD canisters transferred to AO
		0.00	050-WHF-ST-BUMP-ETF	ETF for ST with AO bumping EAF
			050-WHF-ST-BUMP-PFA	Breach of can in AO bumping EAF
			MOD-ENTER-CANISTER	Flooding or spray enters canister
			S-050-PIPING-FAIL	Seismic failure of piping in accident area
			S-050-ST-BUMP-EAF	Seismic bumping of ST into EAF
			WHF-TAD-AO	Number of TAD canisters transferred to AO
			= Total	

Table D4.4-2. Cut Set Level Results by Sequence (Continued)

Event Tree	Sequence	Cut Set %	Basic Event	Description
	15-2			
	15-3	0.00	<FALSE>	System Generated Success Event
			= Total	
	15-4	0.00	<FALSE>	System Generated Success Event
			= Total	
	15-5	100.00	050-WHF-AOAP-COL-ETF	ETF for can under AOAP platform
			S-050-AOAP-COL	Seismic collapse of aging overpack access platform
			WHF-TAD-AO	Number of TAD canisters transferred to AO
			= Total	
	15-6	100.00	050-WHF-AOAP-COL-ETF	ETF for can under AOAP platform
			MOD-ENTER-CANISTER	Flooding or spray enters canister
			S-050-AOAP-COL	Seismic collapse of aging overpack access platform
			S-050-PIPING-FAIL	Seismic failure of piping in accident area
			WHF-TAD-AO	Number of TAD canisters transferred to AO
			= Total	
	16-2	100.00	050-WHF-ENTDOOR-ETF	ETF for entry door over AO
			S-050-ENTDOORCOL	Seismic collapse of entry door
			SHIELD-AO	Shielding remains intact
			WHF-TAD-AO	Number of TAD canisters transferred to AO
			= Total	
	16-3	0.00	<FALSE>	System Generated Success Event
			= Total	
	16-4	0.00	<FALSE>	System Generated Success Event
			= Total	
	16-5	100.00	050-WHF-ENTDOOR-ETF	ETF for entry door over AO
			050-WHF-ENTDOOR-PFA	Breach of canister due to entry door collapse
			S-050-ENTDOORCOL	Seismic collapse of entry door
			WHF-TAD-AO	Number of TAD canisters transferred to AO
			= Total	
	16-6	100.00	050-WHF-ENTDOOR-ETF	ETF for entry door over AO

Table D4.4-2. Cut Set Level Results by Sequence (Continued)

Event Tree	Sequence	Cut Set %	Basic Event	Description
			050-WHF-ENTDOOR-PFA	Breach of canister due to entry door collapse
			MOD-ENTER-CANISTER	Flooding or spray enters canister
			S-050-ENTDOORCOL	Seismic collapse of entry door
			S-050-PIPING-FAIL	Seismic failure of piping in accident area
			WHF-TAD-AO	Number of TAD canisters transferred to AO
			= Total	

NOTE: AO = aging overpack; AOAP = aging overpack access platform; APC = auxiliary pool crane; CHC = cask handling crane; CTM = canister transfer machine; CTT = cask transfer trolley; EAF = energy absorbing feature; ETF = exposure time factor; FPW = fire protection water; SFTM = spent fuel transfer machine; ST = site transporter; STC = shielded transfer cask; TAD = transportation, aging, and disposal; TC = transportation cask; WHF = Wet Handling Facility.

Source: Original

ATTACHMENT E

INTRA-SITE OPERATIONS AND BALANCE OF PLANT ANALYSES

This attachment contains detailed information for the Intra-Site Operations seismic event sequence analysis:

- IET and SRET
- Event tree to fault tree assignment tables
- Fault trees
- Non-seismic basic event tables
- Seismic basic event tables
- Event sequence probability tables
- Event sequence cut set tables.

E1 INTRA-SITE

This section provides the detailed information used to develop the event sequences for the analysis of Intra-Site activities including:

- 1 Movement of aging overpacks (with TAD or DPC) on site transporter to and from Aging Facility
- 2 Storage of aging overpack at Aging Facility
- 3 Movement of horizontal transportation casks (with DPC) on horizontal cask transport trailer to and from Aging Facility
- 4 Storage of DPCs in horizontal aging module (HAM) at Aging Facility
- 5 Storage of LLW at LLW facility
- 6 Temporary storage of transportation casks on railcars and trucks in buffer yard (before processing)
- 7 Movement of incoming railcars and truck trailers with transportation casks to the processing facilities.

E1.1 EVENT TREES

The IET and SRETs are presented in this section. The tables provide the assignments between the event tree branches and the fault trees given in the next section.

Seismic Event	Time waste forms potentially at risk	Identify initiating seismic failure			
SEIS-EVENT	ISO-IE	SEIS-FAIL	#	END-STATE	
			1	OK	
			2	OK	
			LLW building collapse	3	RR-UNF
			Site transporter en route	4	RR-UNF
			Horizontal trailer failure	5	RR-UNF
			AO failure	6	RR-UNF
			HAM structure failure	7	RR-UNF
			Railcar and truck yard failures	8	RR-UNF
			Moving railcar and trailer failure	9	RR-UNF
ISO-IE-S-MAIN - ISO Seismic Event Tree - Initiating Seismic Failures - Intrasite			2008/02/24	Page 1	

NOTE: Event tree branch captions are associated with the branch line below the caption.

AO = aging overpack; HAM = horizontal aging module; IE = initiating event; ISO = Intra-Site Operations; LLW = low-level radioactive waste; RR = radioactive release; SEIS = seismic; UNF = unfiltered.

Source: Original

Figure E1.1-1. Intra-Site Seismic Event Tree
ISO-IE-S-MAIN – Initiating
Seismic Failures – Intra-Site

Table E1.1-1. Fault Trees Assigned for Initiating Seismic Failures for Intra-Site

Process	Initiator Event Tree	Initiating Seismic Failure	Associated Fault Tree
Intra-Site	ISO-IE-S-MAIN	LLW building collapse	S-ISO-LLW-STR-COL-FT
		Site transporter en route	S-ISO-ST-FAIL-FT
		Horizontal trailer failure	S-ISO-HTLR-TIP-FT
		AO failure	S-ISO-AO-FAIL-FT
		HAM structure failure	S-ISO-HAM-COL-FT
		Railcar and truck yard failures	S-ISO-RAIL-T-YARD-FT

NOTE: AO = aging overpack; HAM = horizontal aging module; IE = initiating event; LLW = low level (radioactive) waste.

Source: Original

E1.2 FAULT TREES

Seismic fault trees for Intra-Site activities are presented in alpha-numeric order in this section.

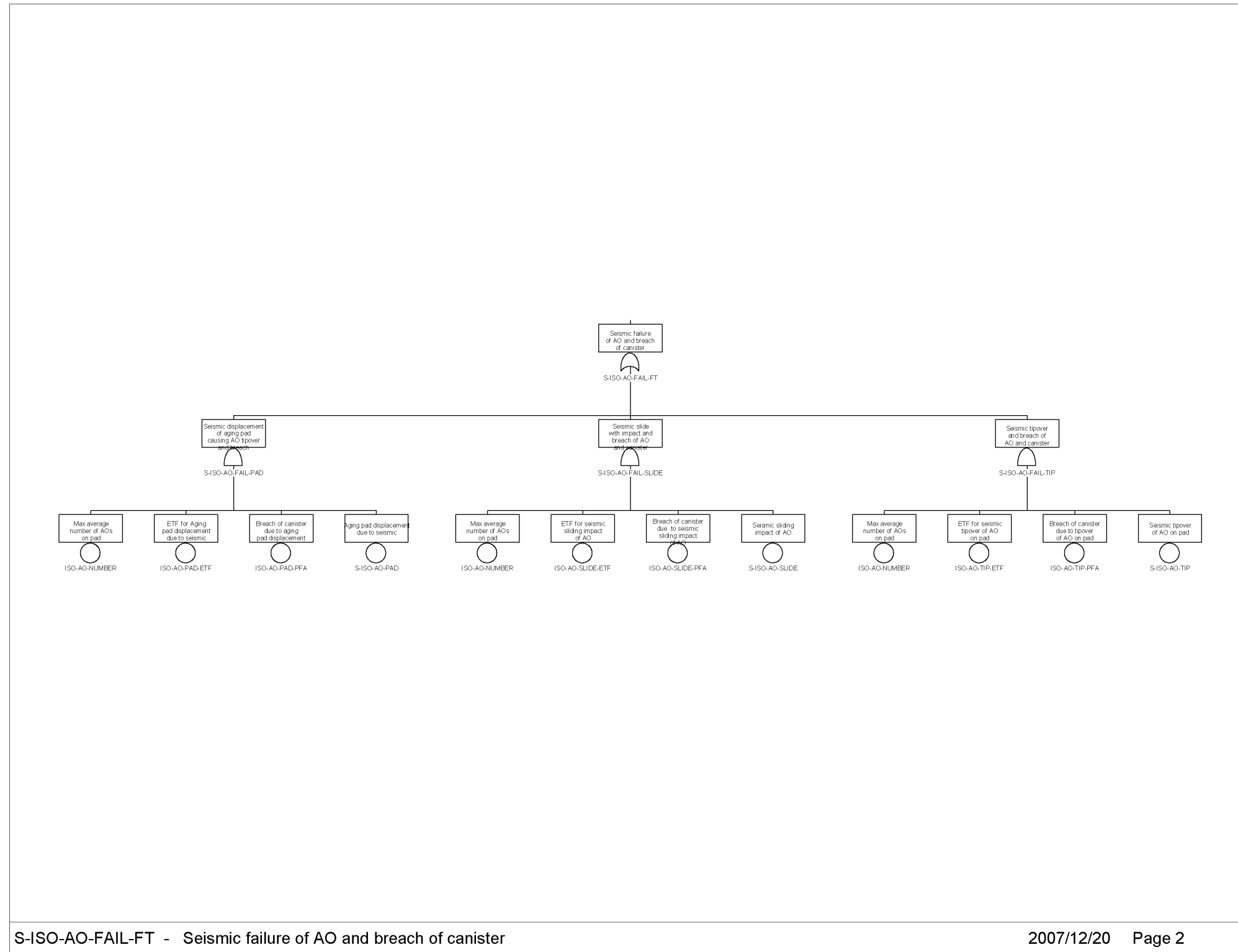

Source: Original

Figure E1.2-1. Fault Tree S-ISO-AO-FAIL-FT – Seismic Failure of AO and Breach of Canister

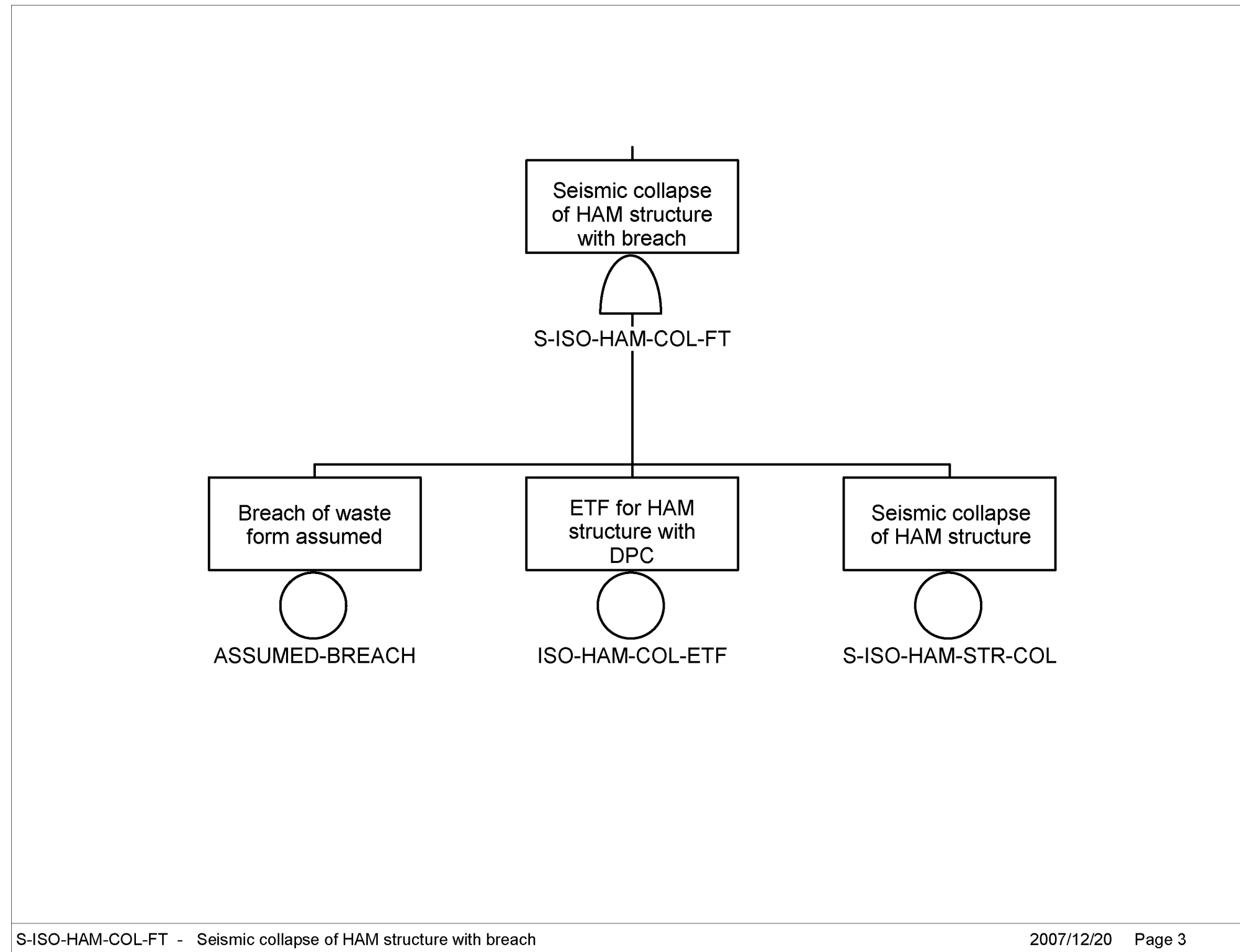

Source: Original

Figure E1.2-2. S-ISO-HAM-COL-FT – Seismic Collapse of HAM Structure with Breach

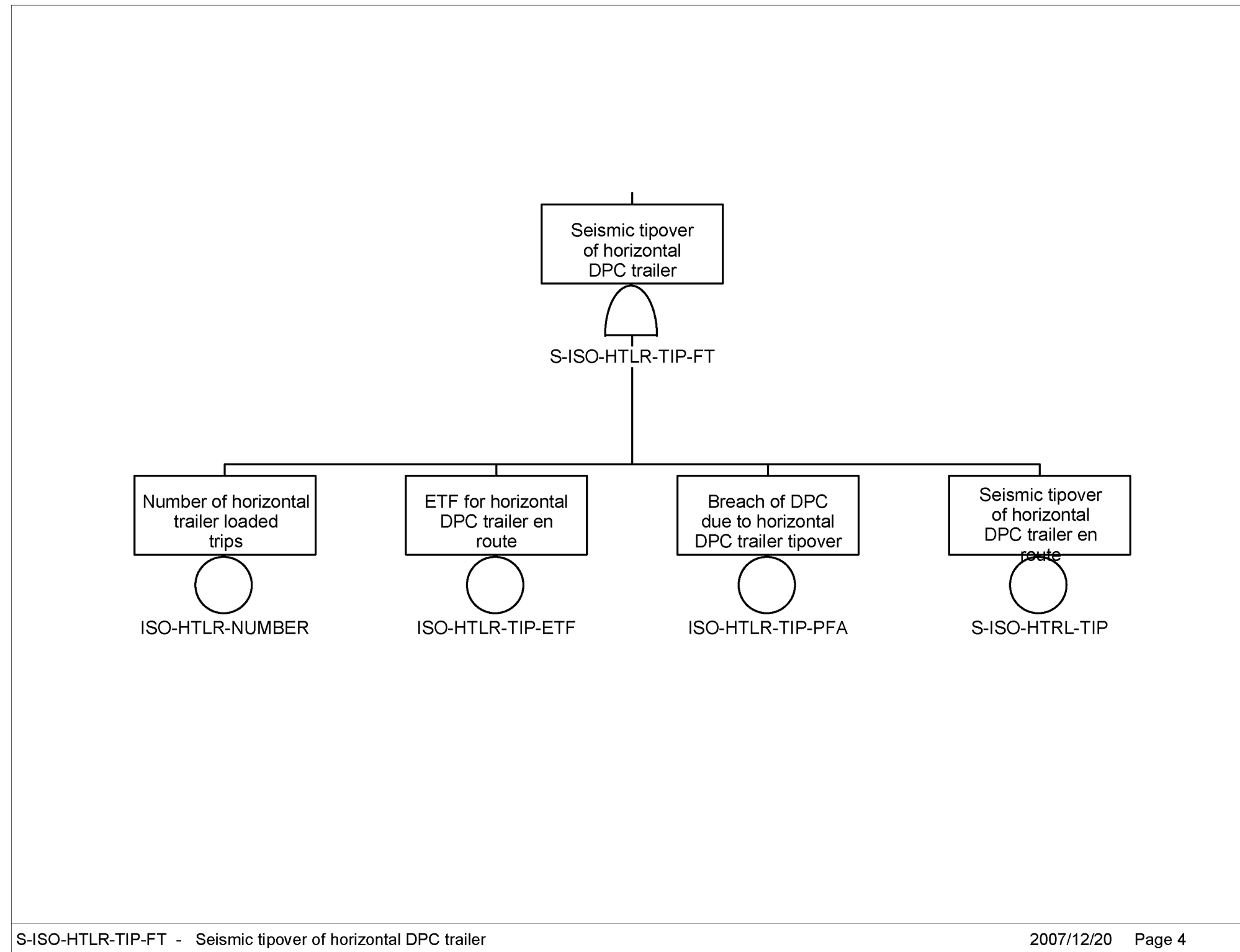

Source: Original

Figure E1.2-3 S-ISO-HTLR-TIP-FT – Seismic Tipover of Horizontal DPC Trailer

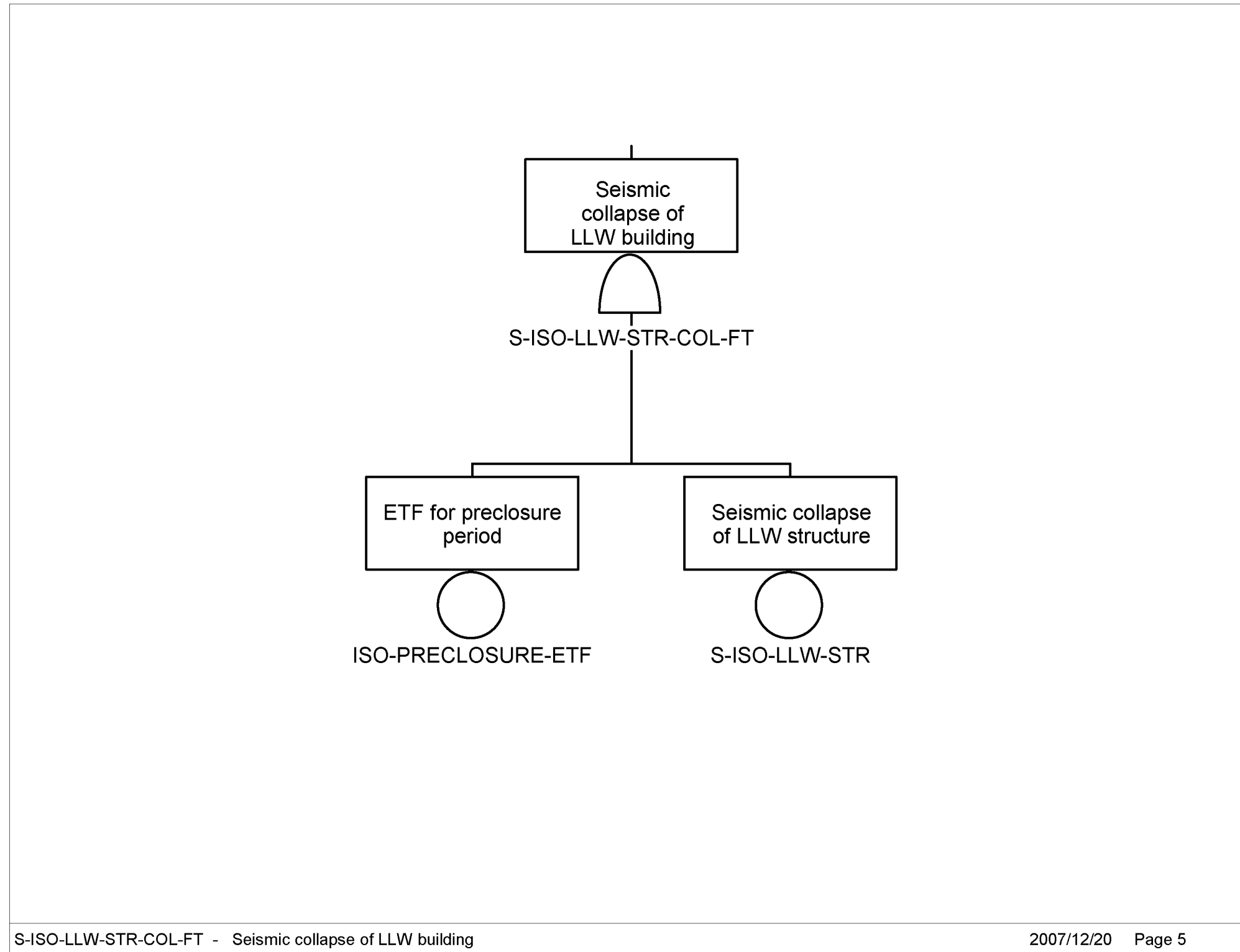

Source: Original

Figure E1.2-4. S-ISO-LLW-STR-COL-FT – Seismic Collapse of LLW Building

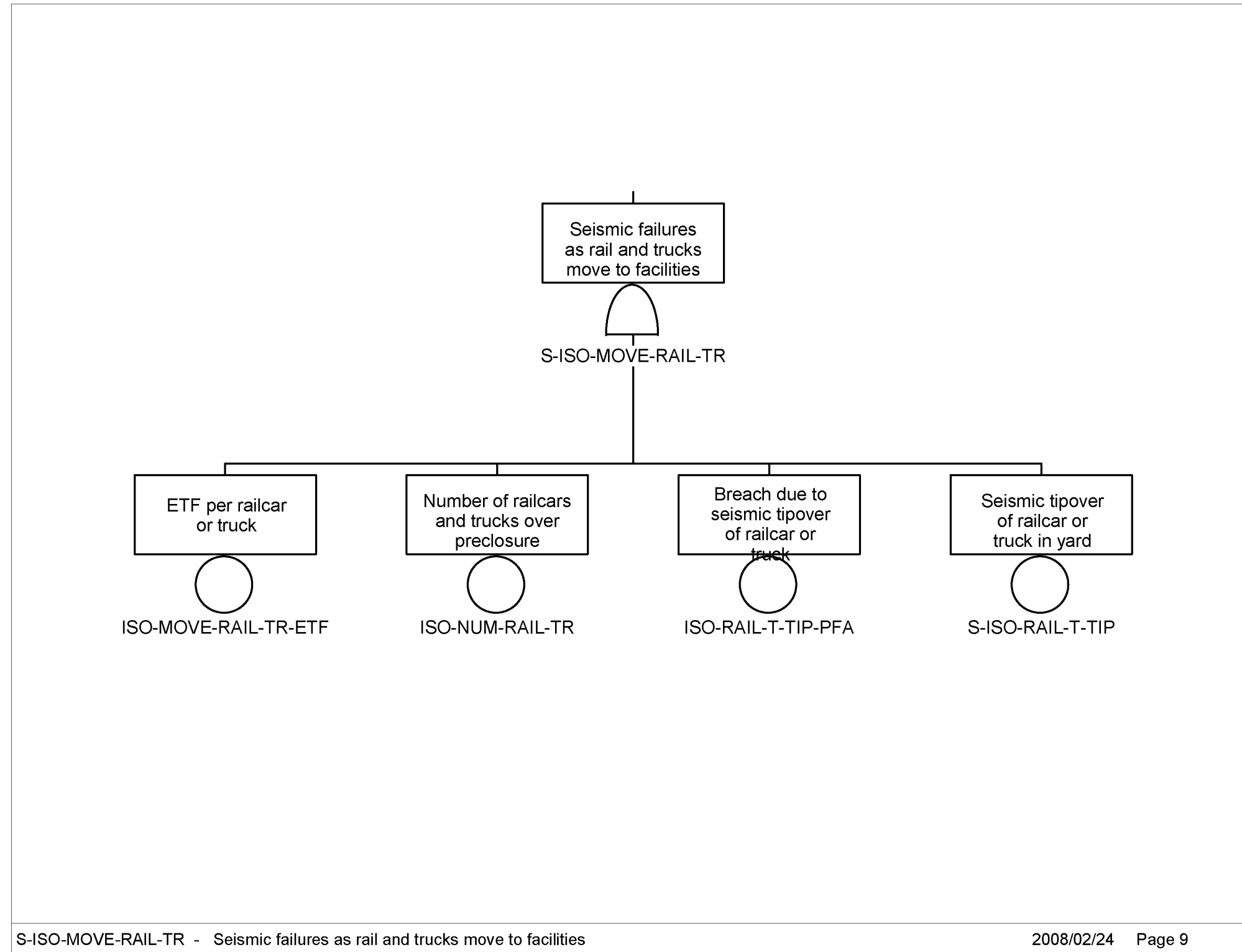

Source: Original

Figure E1.2-5. S-ISO-MOVE-RAIL-TR – Seismic Failures as Rail and Trucks Move to Facilities

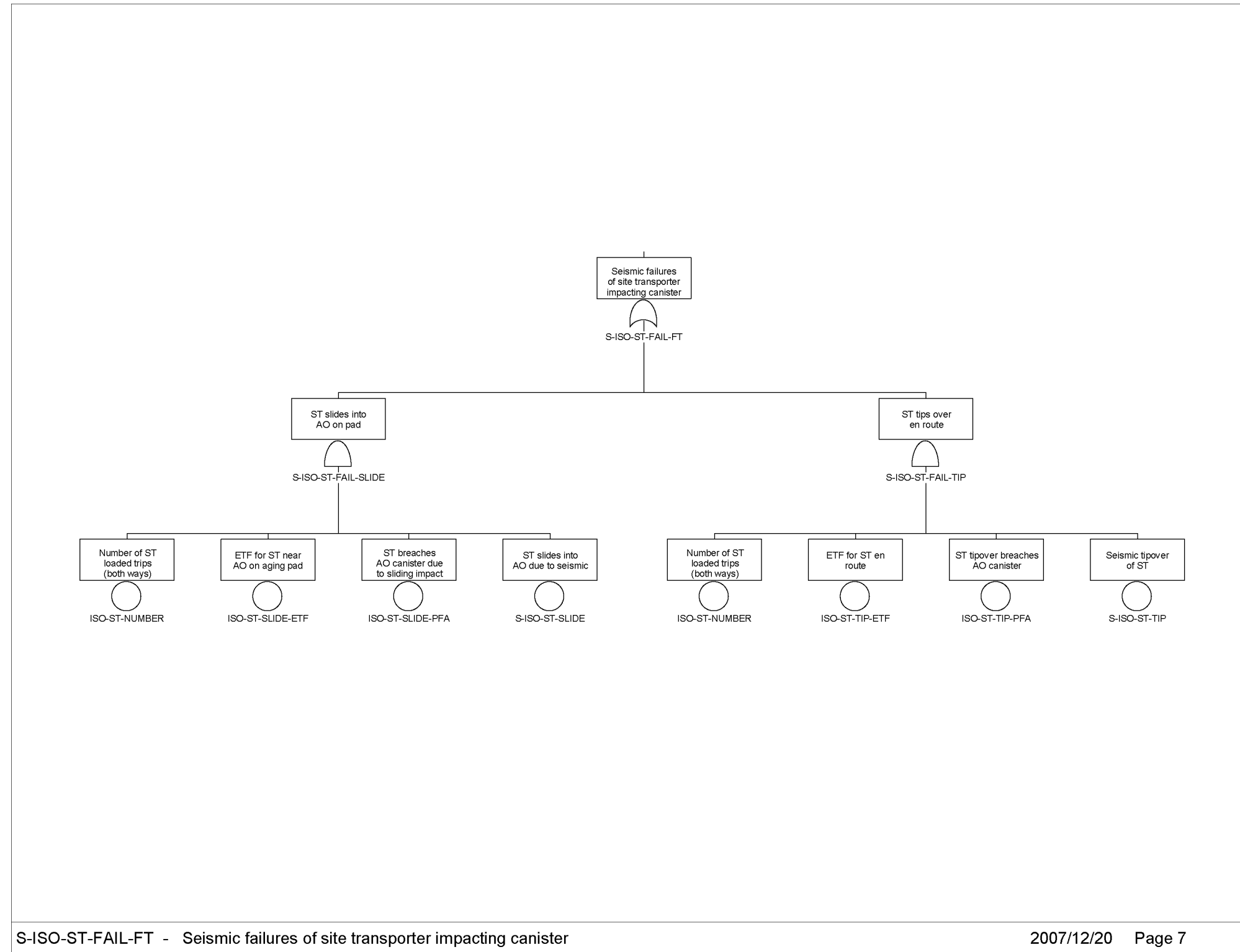

Source: Original

Figure E1.2-6. S-ISO-ST-FAIL-FT – Seismic Failures of Site Transporter Impacting Canister

E1.3 BASIC EVENT DATA

E1.3.1 Non-seismic Basic Event Data

The following table presents the basic event identifier used in the fault trees, the description of the basic event, and the failure probability (or other numeric data) of the basic event. For exposure time factors (denoted with “ETF” at the end of the basic event identifier), the value given is the time, in years, that one waste form container is exposed to the seismic failure mode.

Table E1.3-1. Non-seismic Basic Event Data

Name	Description	Calc. Probability
ASSUMED-BREACH	Breach of waste form assumed	1.000E+000
ISO-AO-NUMBER	Max average number of AOs on pad	1.920E+003
ISO-AO-PAD-ETF	ETF for aging pad displacement due to seismic	5.000E+001
ISO-AO-PAD-PFA	Breach of canister due to aging pad displacement	1.000E-005
ISO-AO-SLIDE-ETF	ETF for seismic sliding impact of AO	5.000E+001
ISO-AO-SLIDE-PFA	Breach of canister due to seismic sliding impact of AO	1.000E-005
ISO-AO-TIP-ETF	ETF for seismic tipover of AO on pad	5.000E+001
ISO-AO-TIP-PFA	Breach of canister due to tipover of AO on pad	1.000E-005
ISO-HAM-COL-ETF	ETF for HAM structure with DPC	5.000E+001
ISO-HTLR-NUMBER	Number of horizontal trailer loaded trips	6.920E+002
ISO-HTLR-TIP-ETF	ETF for horizontal DPC trailer en route	2.280E-004
ISO-HTLR-TIP-PFA	Breach of DPC due to horizontal DPC trailer tipover	1.000E-005
ISO-MOVE-RAIL-TR-ETF	ETF per railcar or truck	6.200E-005
ISO-NUM-RAIL-TR	Number of railcars and trucks over preclosure	1.435E+004
ISO-PRECLOSURE-ETF	ETF for preclosure period	5.000E+001
ISO-RAIL-T-NUMBER	Average number of railcars or trucks in yard	3.000E+001
ISO-RAIL-T-TIP-ETF	ETF for seismic tipover of railcar or truck in yard	5.000E+001
ISO-RAIL-T-TIP-PFA	Breach due to seismic tipover of railcar or truck	1.000E-005
ISO-ST-NUMBER	Number of ST loaded trips (both ways)	1.700E+004
ISO-ST-SLIDE-ETF	ETF for ST near AO on aging pad	1.140E-004
ISO-ST-SLIDE-PFA	ST breaches AO canister due to sliding impact	1.000E-005
ISO-ST-TIP-ETF	ETF for ST en route	1.140E-004

NOTE: The basic event "ASSUMED-BREACH" is not an assumption, but is common terminology used to denote a scenario where the waste container is conservatively considered to be breached; AO = aging overpack; DPC = dual-purpose canister; ETF = exposure time factor; HAM = horizontal aging module; ST = site transporter.

Source: Sections 6.2.2.23 and 6.3.3, Table 6.3-1, Table 6.3-2, Table 6.8-1

E1.3.2 Seismic Basic Event Fragility Data

The following table provides the seismic failure basic event identifier, description, median fragility, and composite uncertainty.

Table E1.3-2. Seismic Basic Event Fragility Data

Event Name	Med. Fragility (g)	Beta C
S-ISO-AO-PAD	2.460E+000	4.000E-001
S-ISO-AO-SLIDE	3.050E+000	4.000E-001
S-ISO-AO-TIP	7.620E+000	4.000E-001
S-ISO-HAM-STR-COL	4.500E+000	4.000E-001
S-ISO-HTRL-TIP	4.500E-001	4.000E-001
S-ISO-LLW-STR	8.900E-001	4.000E-001
S-ISO-RAIL-T-TIP	4.500E-001	4.000E-001
S-ISO-ST-SLIDE	1.890E+000	4.200E-001
S-ISO-ST-TIP	5.000E+000	4.000E-001

Source: Table 6.2-1 and Table 6.2-2

E1.4 EVENT SEQUENCE QUANTIFICATION

This section provides the quantification results by sequence. The event sequence probabilities are provided first, and the cut sets are provided afterwards.

E1.4.1 Sequence Level Results

Table E1.4-1. Sequence Level Results

Event Tree	Sequence	Base Min. Cut	Base Cut Sets
ISO-IE-S-MAIN	3	8.004E-003	1
ISO-IE-S-MAIN	4	4.736E-010	2
ISO-IE-S-MAIN	5	1.090E-009	1
ISO-IE-S-MAIN	6	1.211E-005	3
ISO-IE-S-MAIN	7	4.387E-005	1
ISO-IE-S-MAIN	8	1.037E-005	1

Source: Original

E1.4.2 Cut Set Level Results by Sequence

Note that the SAPHIRE software does not provide special tables for seismic cut sets. Therefore, the “Cut Set %” given in the third column of this table is not correct for seismic events, although it does provide the approximate rank order for the cut sets.

Table E1.4-2. Cut Set Level Results by Sequence

Event Tree	Sequence	Cut Set %	Basic Event	Description
ISO-IE-S-MAIN	3	100.00	ISO-IE	Time waste forms potentially at risk
			ISO- PRECLOSURE- ETF	ETF for preclosure period
			S-ISO-LLW-STR	Seismic collapse of LLW structure
			= Total	
	4	100.00	ISO-IE	Time waste forms potentially at risk
			ISO-ST-NUMBER	Number of ST loaded trips (both ways)
			ISO-ST-SLIDE-ETF	ETF for ST near AO on aging pad
			ISO-ST-SLIDE-PFA	ST breaches AO canister due to sliding impact
			S-ISO-ST-SLIDE	ST slides into AO due to seismic
		0.00	ISO-IE	Time waste forms potentially at risk
			ISO-ST-NUMBER	Number of ST loaded trips (both ways)
			ISO-ST-TIP-ETF	ETF for ST en route
			ISO-ST-TIP-PFA	ST tipover breaches AO canister
			S-ISO-ST-TIP	Seismic tipover of ST
			= Total	
	5	100.00	ISO-HTLR- NUMBER	Number of horizontal trailer loaded trips
			ISO-HTLR-TIP-ETF	ETF for horizontal DPC trailer en route
			ISO-HTLR-TIP-PFA	Breach of DPC due to horizontal DPC trailer tipover
			ISO-IE	Time waste forms potentially at risk
			S-ISO-HTRL-TIP	Seismic tipover of horizontal DPC trailer en route
			= Total	
	6	92.61	ISO-AO-NUMBER	Max. average number of AOs on pad
			ISO-AO-PAD-ETF	ETF for aging pad displacement due to seismic
			ISO-AO-PAD-PFA	Breach of canister due to aging pad displacement
			ISO-IE	Time waste forms potentially at risk
			S-ISO-AO-PAD	Aging pad displacement due to seismic
		7.39	ISO-AO-NUMBER	Max average number of AOs on pad
			ISO-AO-SLIDE-ETF	ETF for seismic sliding impact of AO
			ISO-AO-SLIDE-PFA	Breach of canister due to seismic sliding impact of AO
			ISO-IE	Time waste forms potentially at risk
			S-ISO-AO-SLIDE	Seismic sliding impact of AO

Table E1.4-2. Cut Set Level Results by Sequence (Continued)

Event Tree	Sequence	Cut Set %	Basic Event	Description
ISO-IE-S-MAIN	3	100.00	ISO-IE	Time waste forms potentially at risk
			ISO- PRECLOSURE- ETF	ETF for preclosure period
			S-ISO-LLW-STR	Seismic collapse of LLW structure
			= Total	
	4	100.00	ISO-IE	Time waste forms potentially at risk
			ISO-ST-NUMBER	Number of ST loaded trips (both ways)
			ISO-ST-SLIDE-ETF	ETF for ST near AO on aging pad
			ISO-ST-SLIDE-PFA	ST breaches AO canister due to sliding impact
			S-ISO-ST-SLIDE	ST slides into AO due to seismic
		0.00	ISO-IE	Time waste forms potentially at risk
			ISO-ST-NUMBER	Number of ST loaded trips (both ways)
			ISO-ST-TIP-ETF	ETF for ST en route
			ISO-ST-TIP-PFA	ST tipover breaches AO canister
			S-ISO-ST-TIP	Seismic tipover of ST
			= Total	
	5	100.00	ISO-HTLR- NUMBER	Number of horizontal trailer loaded trips

NOTE: AO = aging overpack; DPC = dual-purpose canister; ETF = exposure time factor; HAM = horizontal aging module; LLW = low-level radioactive waste; ST = site transporter.

Source: Original

E1.5 RESIDENCE TIME FACTORS

Estimates of residence time of the transit of the site transporter (crawler) to and from the aging pad were computed based on available data and engineering judgment. For the transit of the crawler along designated roadways from the RF to the entrance of Aging Pad 17P, travel times are shown in Table E1.5-1, and supporting data in Table E1.5-2.

Table E1.5-1. Site Transporter Movement on Surface

WBS	BFD	Task Name	Op Time (min)
1	From 1.5.3	Site transporter (crawler) moves to aging pad	
1.1	1.6.1	Move loaded aging overpack to aging pad edge	43
1.1.1		Movement along track at operational speed from RF to Aging Pad 17P	37*
1.1.2		Stops at roadway/rail crossings	6

NOTE: * Moving at 180 ft/min.; BFD = block flow diagram; RF = Receipt Facility; WBS = work breakdown system.

Source: Original

Table E1.5-2. Intra-Site Surface Times

Reference Data	Value	Notes
Site transporter (crawler) maximum speed (mph)	2.5	Ref. 2.2.35
Site transporter (crawler) operational speed (ft/min)	180	Computed from above using a 20% reduction from maximum speed and rounded as operational speed
Stop time at roadway crossing (min)	2	Value based on engineering judgment – transporter can stop in less than a minute (on the order of 0.5 seconds, based on similar equipment). Time to allow for operator to react and inspect area.
Approximate distance from RF to Aging Pad 17P entrance/pad edge (ft)	6610	Ref. 2.2.63 Scaled from drawing
		Ref. 2.2.64 Scaled from drawing
Approximate distance from RF to Aging Pad 17R entrance/pad edge (ft)	4980	As above – Scaled from drawing
Number of roadway crossings from RF to Aging Pad 17P	3	Ref. 2.2.63 By inspection
Block Flow Diagram	-	Ref. 2.2.22

Source: Original

ATTACHMENT F SUBSURFACE OPERATIONS ANALYSES

This attachment contains detailed information for the Subsurface Operations seismic event sequence analysis:

- IET
- Event tree to fault tree assignment table
- Fault trees
- Non-seismic basic event table
- Seismic basic event table
- Event sequence probability table
- Event sequence cut set table.

In Section F2, the data and calculations for developing the exposure/residence times are provided.

The Subsurface Operations seismic event sequence evaluation covers the following processes:

- Movement of the TEV with waste packages from the CRCF or IHF to the subsurface emplacement drifts
- Storage of the waste packages in the emplacement drifts (preclosure phase)
 - Waste package stability during seismic events
 - Rockfall impacts (physical and thermal)
- Installation of drip shields over the waste packages in the emplacement drifts.

The first process, TEV transfer of waste packages from the facilities to the subsurface drifts, is quantified in Section F1. The other event sequences have been evaluated in detail by other calculations. The evaluation of Subsurface Operations includes quantitative screening of potential rockfall events (see Section F3) and waste package impacts in the subsurface drifts (Section 6.9.2).

F1 TEV OPERATIONS

This section covers TEV operations, starting from leaving the CRCF or IHF, and traveling to the emplacement drifts. Collapse of the drift emplacement access door onto the TEV is included.

F1.1 EVENT TREE

The IET is presented in this section. Table F1.1-1 provides the assignments between the event tree branches and the fault trees given in the next section.

Seismic Event	Time waste forms potentially at risk	Identify initiating seismic failure	WP containment remains intact	Shielding is maintained	#	END-STATE
SEIS-EVENT	SSO-IE	SEIS-FAIL	WP-CONTAIN	SHIELDING		
					1	OK
					2	OK
					3	OK
					4	DE-SHIELD-LOSS
					5	RR-UNF
					6	RR-UNF
					7	RR-UNF
					8	RR-UNF
					9	RR-UNF
					10	LONG-TERM
SSO-IE-S-MAIN - SSO Seismic Event Tree - Initiating Seismic Failures - Subsurface					2008/02/25	Page 1

NOTE: Event tree branch captions are associated with the branch line below the caption.
 DE= direct exposure; IE = initiating event; RR = radionuclide release; SEIS = seismic; SSO = Subsurface Operations; TEV = transport and emplacement vehicle;
 UNF = unfiltered; WP = waste package.

Source: Original

Figure F1.1-1. SSO Seismic Event Tree SSO-IE-S-MAIN – Initiating Seismic Failures - Subsurface

Table F1.1-1. Fault Trees Assigned for Initiating Seismic Failures for the SSO

Process	Initiator Event Tree	Initiating Seismic Failure or Top Event	Associated Fault Tree
Waste package	SSO-IE-S-MAIN	TEV failures	S-SSO-FT-TEV-ACC
		Emplacement access door	S-SSO-FT-EA-DOOR
		WP-CONTAIN	S-SSO-FT-TEV-FAIL
		SHIELDING	SHIELDING

NOTE: SSO = Subsurface Operations; TEV = transport and emplacement vehicle; WP = waste package.

Source: Original

F1.2 FAULT TREES

Seismic fault trees for Subsurface Operations activities are presented in alpha-numeric order in this section.

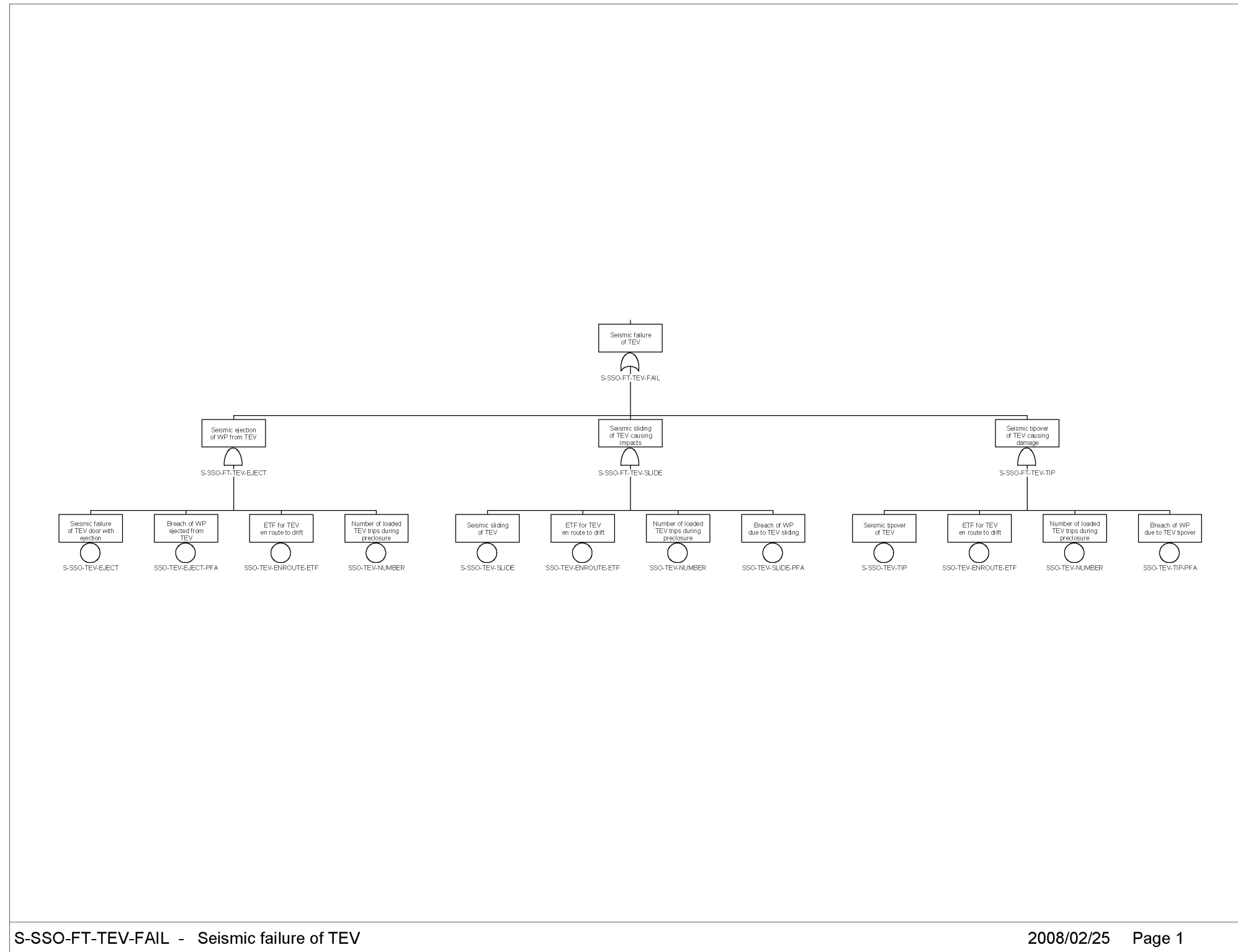

Source: Original

Figure F1.2-1. S-SSO-FT-TEV-FAIL – Seismic Failure of TEV

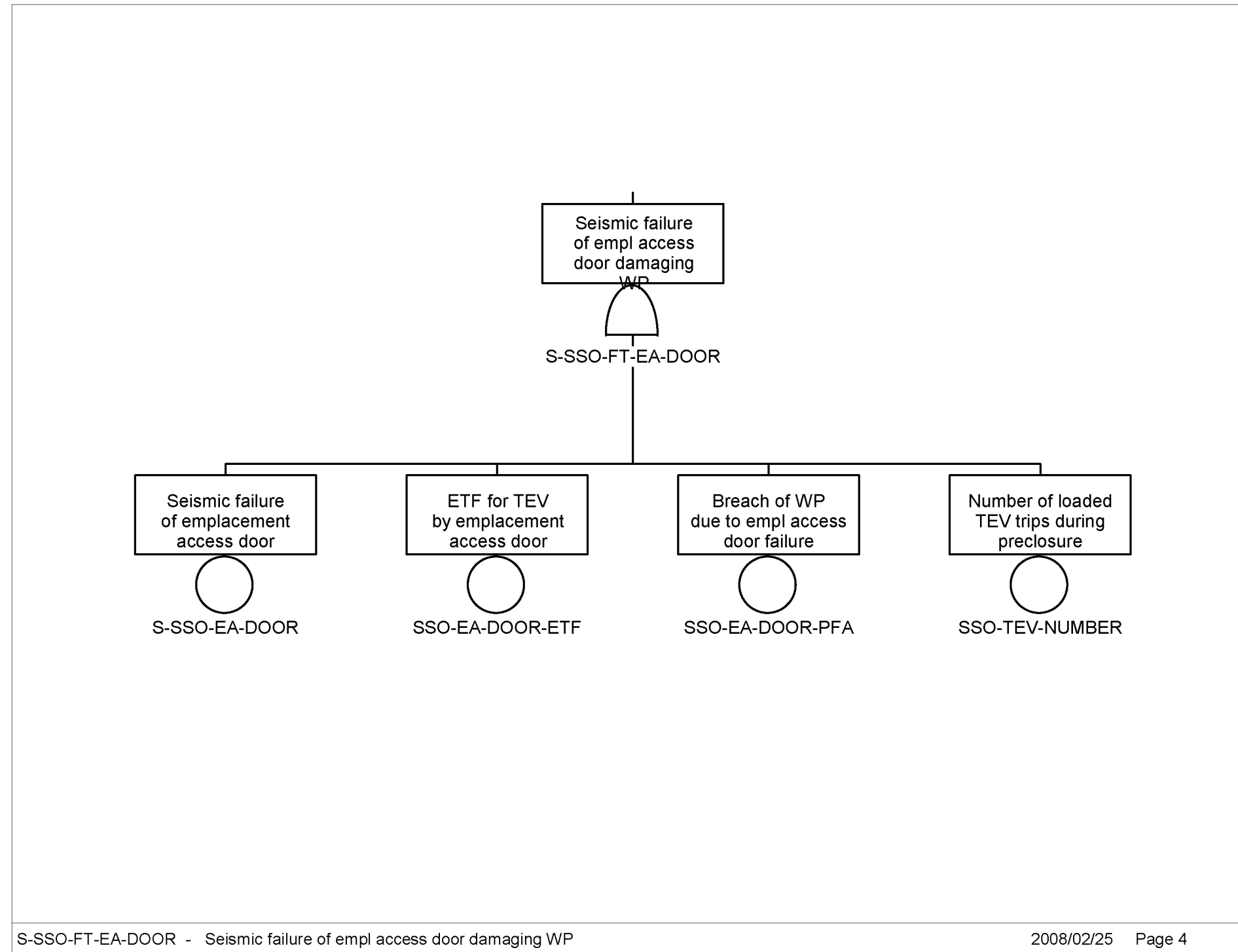

Source: Original

Figure F1.2-2. S-SSO-FT-EA-DOOR – Seismic Failure of Empl Access Door Damaging WP

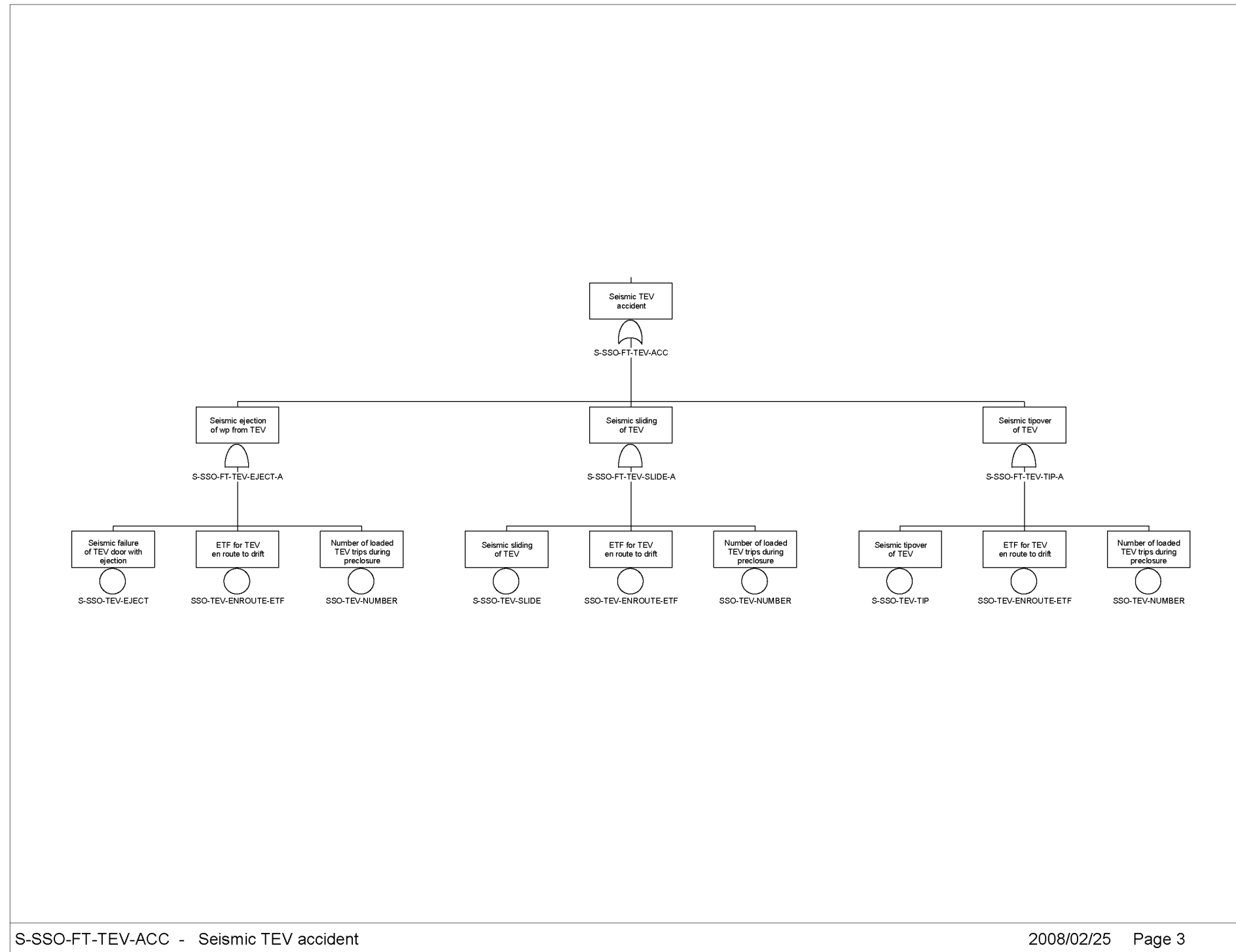

Source: Original

Figure F1.2-3. S-SSO-FT-TEV-ACC – Seismic TEV Accident

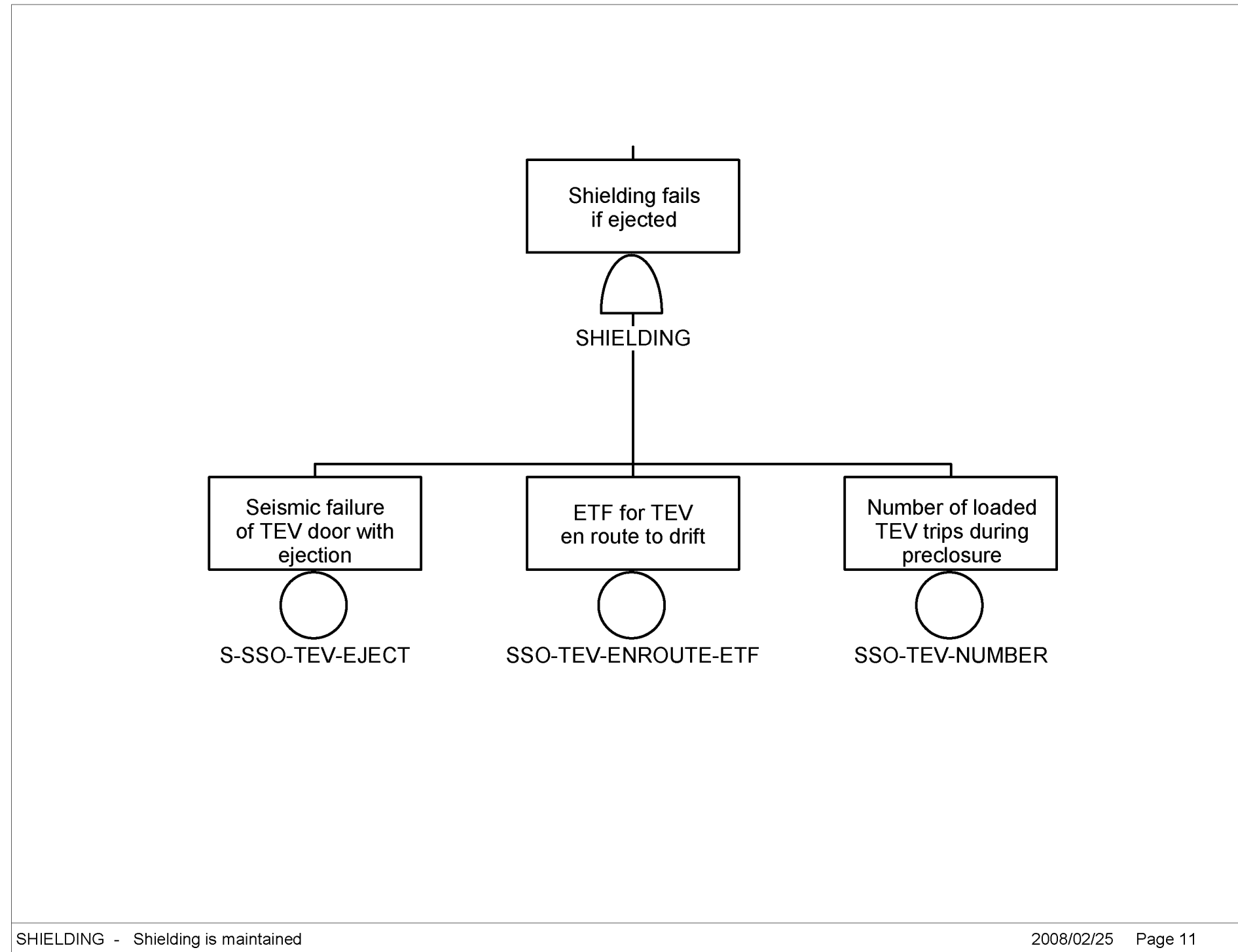

Source: Original

Figure F1.2-4. SHIELDING – Shielding is Maintained

F1.3 BASIC EVENT DATA

F1.3.1 Non-seismic Basic Event Data

The following table presents the basic event identifiers used in the fault trees, the description of the basic events and the failure probability (or other numeric data) of the basic events. For exposure time factors (denoted with “ETF” at the end of the basic event identifier), the value given is the time, in years, that one waste form container is exposed to the seismic failure mode.

Table F1.3-1. Non-seismic Basic Event Data

Name	Description	Calc. Probability
SCREEN	Event sequence is screened out	0.000E+000
SSO-EA-DOOR-ETF	ETF for TEV by emplacement access door	3.800E-006
SSO-EA-DOOR-PFA	Breach of WP due to empl access door failure	1.000E-005
SSO-IE	Time waste forms potentially at risk	1.000E+000
SSO-TEV-EJECT-PFA	Breach of WP ejected from TEV	5.000E-003
SSO-TEV-ENROUTE-ETF	ETF for TEV en route to drift	3.300E-004
SSO-TEV-NUMBER	Number of loaded TEV trips during preclosure	1.207E+004
SSO-TEV-SLIDE-PFA	Breach of WP due to TEV sliding	1.000E-005
SSO-TEV-TIP-PFA	Breach of WP due to TEV tipover	1.000E-005

NOTE: ETF = exposure time factor; TEV = transport and emplacement vehicle; WP = waste package.

Source: Sections 6.2.2.23 and 6.3.3, Table 6.3-1, Table 6.3-2, Table 6.9-1

F1.3.2 Seismic Basic Event Fragility Data

The following table provides the seismic failure basic event identifier, description, median fragility, and composite uncertainty.

Table F1.3-2. Seismic Basic Event Fragility Data

Event Name	Description	Med. Fragility (g)	Beta C
S-SSO-EA-DOOR	Seismic failure of emplacement access door	3.700E-001	4.000E-001
S-SSO-TEV-EJECT	Seismic failure of TEV door with ejection	7.600E-001	4.000E-001
S-SSO-TEV-SLIDE	Seismic sliding of TEV	1.120E+000	4.300E-001
S-SSO-TEV-TIP	Seismic tipover of TEV	5.000E+000	4.000E-001

NOTE: TEV = transport and emplacement vehicle.

Source: Table 6.2-2

F1.4 EVENT SEQUENCE QUANTIFICATION

This section provides the quantification results by sequence. The event sequence probabilities are provided first, and the cut sets are provided afterwards.

F1.4.1 Sequence Level Results

Table F1.4-1. Sequence Level Results

Event Tree	Sequence	Base Min. Cut	Base Cut Sets
SSO-IE-S-MAIN	04	9.130E-004	1
SSO-IE-S-MAIN	05	4.569E-006	3
SSO-IE-S-MAIN	06	+0.000E+000	1
SSO-IE-S-MAIN	07	+0.000E+000	1
SSO-IE-S-MAIN	08	4.618E-010	1
SSO-IE-S-MAIN	09	+0.000E+000	1
SSO-IE-S-MAIN	10	+0.000E+000	1

Source: Original

F1.4.2 Cut Set Level Results by Sequence

Note that the SAPHIRE software does not provide special tables for seismic cut sets. Therefore, the “Cut Set %” given in the third column of this table is not correct for seismic events, although it does provide the approximate rank order for the cut sets.

Table F1.4-2. Cut Set Level Results by Sequence

Event Tree	Sequence	Cut Set %	Basic Event	Description	
SSO-IE-S-MAIN	04	100.00	S-SSO-TEV-EJECT	Seismic failure of TEV door with ejection	
			SSO-IE	Time waste forms potentially at risk	
			SSO-TEV-ENROUTE-ETF	ETF for TEV en route to drift	
			SSO-TEV-NUMBER	Number of loaded TEV trips during preclosure	
			= Total		
SSO-IE-S-MAIN	05	99.96	S-SSO-TEV-EJECT	Seismic failure of TEV door with ejection	
			SSO-IE	Time waste forms potentially at risk	
			SSO-TEV-EJECT-PFA	Breach of WP ejected from TEV	
			SSO-TEV-ENROUTE-ETF	ETF for TEV en route to drift	
			SSO-TEV-NUMBER	Number of loaded TEV trips during preclosure	
			0.04	S-SSO-TEV-SLIDE	Seismic sliding of TEV
				SSO-IE	Time waste forms potentially at risk
				SSO-TEV-ENROUTE-ETF	ETF for TEV en route to drift
	SSO-TEV-NUMBER	Number of loaded TEV trips during preclosure			

Table F1.4-2. Cut Set Level Results by Sequence (Continued)

Event Tree	Sequence	Cut Set %	Basic Event	Description
			SSO-TEV-SLIDE-PFA	Breach of WP due to TEV sliding
		0.00	S-SSO-TEV-TIP	Seismic tipover of TEV
			SSO-IE	Time waste forms potentially at risk
			SSO-TEV-ENROUTE-ETF	ETF for TEV en route to drift
			SSO-TEV-NUMBER	Number of loaded TEV trips during preclosure
			SSO-TEV-TIP-PFA	Breach of WP due to TEV tipover
			= Total	
	06	0.00	<FALSE>	System Generated Success Event
			= Total	
	07	0.00	<FALSE>	System Generated Success Event
			= Total	
	08	100.00	S-SSO-EA-DOOR	Seismic failure of emplacement access door
			SSO-EA-DOOR-ETF	ETF for TEV by emplacement access door
			SSO-EA-DOOR-PFA	Breach of WP due to empl access door failure
			SSO-IE	Time waste forms potentially at risk
			SSO-TEV-NUMBER	Number of loaded TEV trips during preclosure
			= Total	
	09	0.00	<FALSE>	System Generated Success Event
			= Total	
	10	0.00	<FALSE>	System Generated Success Event
			= Total	

NOTE: ETF = exposure time factor; TEV = transport and emplacement vehicle; WP = waste package.

Source: Original

F2 RESIDENCE TIME FACTORS

Estimates of residence time of the transit of the TEV on the surface and subsurface were computed based on available data and engineering judgment. For the transit of the TEV on the surface rail from various waste handling facilities to the North Portal, the transit times are shown in Table F2-1, and supporting data in Table F2-2. Transit times of the TEV on the subsurface rail from various waste handling facilities to the North Portal are shown in Table F2-3, and supporting data in Table F2-4. The average surface time from the surface facilities was estimated by summing the shortest and longest times, and averaging $((33 + 62) / 2 = 48 \text{ min})$.

The total transit time was the sum of surface time and the access main time (48 + 123 = 171 min).

Table F2-1. TEV Transit Times on Surface Rail

WBS	BFD	Activity	Duration (min)
1	1.2.1	TEV travel to North Portal	
1.1	4.2.2	TEV leaves Initial Handling Facility	33
1.1.1		Check switches are in correct orientation	2
1.1.2		Movement along track at operational speed (divide travel distance by operational speed)	16
1.1.3		Stops at roadway crossings	5
1.1.4		Stops at switch crossings	0
1.1.5		Inspection and survey at North Portal	10
1.2	4.2.2	TEV leaves CRCF-1	38
1.2.1		Check switches are in correct orientation	2
1.2.2		Radiation survey	0
1.2.3		Movement along track at operational speed	15
1.2.4		Stops at roadway crossings	6
1.2.5		Stops at switch crossings	5
1.2.6		Inspection and survey at North Portal	10
1.3	4.2.2	TEV leaves CRCF-2	57
1.3.1		Check switches are in correct orientation	2
1.3.2		Radiation survey	0
1.3.3		Movement along track at operational speed	25
1.3.4		Stops at roadway crossings	12
1.3.5		Stops at switch crossings	8
1.3.6		Inspection and survey at North Portal	10
1.4	4.2.2	TEV leaves CRCF-3	62
1.4.1		Check switches are in correct orientation	2
1.4.2		Radiation survey	0
1.4.3		Movement along track at operational speed	30
1.4.4		Stops at roadway crossings	12
1.4.5		Stops at switch crossings	8
1.4.6		Inspection and survey at North Portal	10

NOTE: CRCF = Canister Receipt and Closure Facility; TEV = transport and emplacement vehicle.

Source: Original

Table F2-2. Data Basis for TEV Transit Times on Surface Rail

Description	Value	Comments
TEV speed (ft/min)	150	From Ref. 2.2.36, Section 2.5.3.
Stop time at roadway crossing (min)	2	Value based on engineering judgment - TEV can stop in less than a minute. Time is to allow for operator to react and inspect area. Expect remote operation to stop TEV at each roadway crossing to prevent collisions.

Table F2-2. Data Basis for TEV Transit Times on Surface Rail (Continued)

Description	Value	Comments
Stop time at switch (min)	1	Value based on engineering judgment. The TEV may be halted to allow operator to examine switch setting is correct and to look for another rail traffic.
Time to check rail switches are in correct orientation (min)	2	Value based on engineering judgment. Identified task on block diagram, but extent of activity is not identified. Time indicated allows operator to confirm that switch displays are all green and displays confirm these readings.
Time for inspection and survey at North Portal (min)	10	Value based on engineering judgment. The TEV stops at the North Portal for an inspection and remote monitoring check of TEV systems by operators in the central control center prior to descent of the North Ramp. The TEV must also pass through two security gates. Expect survey to primarily visual supported by remote readout of important operational parameters.
Approximate distance from CRCF-1 to North Portal (ft) - including reverse at North Portal	2170	Value measured from Ref. 2.2.63
Approximate distance from CRCF-2 to North Portal (ft) - including reverse at North Portal	3650	Value measured from Ref. 2.2.63
Approximate distance from CRCF-3 to North Portal (ft) - including reverse at North Portal	4450	Value measured from Ref. 2.2.63
Approximate distance from IHF to North Portal (ft) - including reversal at North Portal	2320	Value measured from Ref. 2.2.63
Number of switches from CRCF-1 to North Portal (including reversal in front of North Portal and second rail line at CRCF-1)	5	Switches are identified at each rail intersection, and include switches for reversal of TEV orientation at North Portal, based on Ref. 2.2.63
Number of switches from CRCF-2 to North Portal (Including reversal in front of North Portal)	8	Switches are identified at each rail intersection, and include switches for reversal of TEV orientation at North Portal, based on Ref. 2.2.63
Number of switches from CRCF-3 to North Portal (including reversal in front of North Portal)	8	Switches are identified at each rail intersection, and include switches for reversal of TEV orientation at North Portal, based on Ref. 2.2.63
Number of switches from IHF to North Portal (including reversal in front of North Portal)	5	Switches are identified at each rail intersection, and include switches for reversal of TEV orientation at North Portal, based on Ref. 2.2.63
Number of Roadway Crossings from CRCF-1 to North Portal (including crossing in Lot)	3	Crossing identified at each road intersection, based on Ref. 2.2.63
Number of roadway crossings from CRCF-2 to North Portal	6	Crossing identified at each road intersection, based on Ref. 2.2.63

Table F2-2. Data Basis for TEV Transit Times on Surface Rail (Continued)

Description	Value	Comments
Number of roadway crossings from CRCF-3 to North Portal	6	Crossing identified at each road intersection, based on Ref. 2.2.63
Number of roadway crossings from IHF to North Portal	0	Crossing identified at each road intersection, based on Ref. 2.2.63
Block Flow Diagram	---	Block flow as shown in Ref. 2.2.53.

NOTE: CRCF = Canister Receipt and Closure Facility, IHF = Initial Handling Facility; TEV = transport and emplacement vehicle.

Source:

Table F2-3. TEV Transit Times on Subsurface Rail

WBS	BFD	Activity	Duration (min)
2	1.2.2	TEV travels along access mains	123
2.1		Movement along track at operational speed - expected distance ^a	120
2.1.1		Stops at switch crossings ^b	3
Additional Items			
---		Movement along track at operational speed - minimum distance (min) ^c	65
---		Movement along track at operational speed - median distance (min) ^d	112
---		Movement along track at operational speed - maximum distance (min) ^e	159

NOTE: ^a Moving at 150 ft/min for distance of 18,000 ft.
^b Maximum number of switches on any route = 3.
^c The shortest distance is to Drift 1-1 = 9,607 ft.
^d The median distance is $(23,783 + 9,607) / 2 = 16,695$ ft.
^e The longest travel distance is to Drift 4-1 = 23,783 ft.
 TEV = transport and emplacement vehicle.

Source: Original

Table F2-4. Data Basis for TEV Transit Times on Subsurface Rail

Description	Value	Comments
TEV speed (ft/minute)	150	From Ref. 2.2.36, Section 2.5.3.
Stop time at switch (min)	1	Value based on engineering judgment. The TEV may be halted to allow operator to examine switch setting is correct and to look for other rail traffic.
Check rail switches are in correct orientation	2	Value based on engineering judgment. Identified task on block diagram, but extent of activity is not identified. Time indicated allows operator to confirm that switch displays are all green and displays confirm these readings.
Distance from North Portal to Panel #1, Drift #6 (ft)	11,032	Distance from Ref. 2.2.46 Panel 1 Plan.
Distance from North Portal to Panel #1, Drift #1 (ft)	9,607	Computed, considering spacing between emplacement drifts and inclination between access main and emplacement drift; 5 emplacement drifts are between above value and Drift 1-1.
Distance from North Portal to Panel #2, Drift #26 (ft)	18,402	Distance from Ref. 2.2.46, Panel 2 Plan.
Distance from North Portal to Panel #3 (East), Drift #1E (ft)	16,167	Distance from Ref. 2.2.46, Panel 3 Plan, East Emplacement Drifts.
Distance from North Portal to Panel #3 (West), Drift #1W (ft)	17,223	Distance from Ref. 2.2.46 Panel 3 Plan, West Emplacement Drifts.
Distance from North Portal to Panel #4, Drift #1 (ft)	23,783	Distance from Ref. 2.2.46, Panel 4 Plan.
Avg. emplacement drift spacing (ft) [m]	266 [81]	Spacing from Ref. 2.2.24, Section, 8.2.1.8.
Access Main Panel #1 orientation - azimuth (degree)	183	Orientation from Ref. 2.2.46, Panel 1 Plan.
Emplacement drift orientation Panel #1 - azimuth (degree)	252	Orientation from Ref. 2.2.49, Table 1.
Inclination difference - Panel 1 (degrees)	69	Difference of above values.
Block Flow Diagram	---	From Ref. 2.2.53.

NOTE: TEV = transport and emplacement vehicle.

Source: Original

F3 SCREENING OF SUBSURFACE OPERATIONS EVENT SEQUENCES

This section provides an evaluation of the following Subsurface Operations activities:

- Rockfall impacts on the waste package
- Rockfall impacts on ventilation and thermal impacts on the waste package.

Not all seismically-induced event sequences are evaluated in terms of their expected number of occurrences over the preclosure period. There are situations where, consistent with the risk-informed intention of 10 CFR Part 63 (Ref. 2.3.1), a qualitative or semi-quantitative evaluation is used to categorize an event sequence. This approach is used for evaluating the event sequences associated with a seismically-induced rock fall onto waste packages in the emplacement drifts, including both physical impacts and thermal impacts. Evaluations show that a wide range of rock sizes could be produced as a result of a seismic event, depending on several parameters, including, for example, the severity of the earthquake, the nature of the rock (lithophysal or nonlithophysal) and the fracture geometry in a given emplacement drift. This multitude of parameters makes the use of the stress-strength interference integral rather complex to evaluate the probability that one or more waste packages would breach as a result of a rock fall impact.

Since detailed studies, both deterministic and probabilistic in nature, have been performed on rockfall impacts, there exists sufficient information to evaluate and screen the rockfall event sequences as beyond Category 2. The following sections describe the existing information, and provide the risk-informed justification for categorizing the rockfall sequences as beyond Category 2.

F3.1 SCREENING EVALUATION OF ROCKFALL IMPACTS IN EMPLACEMENT DRIFTS

For rockfall impacts, the basis of the compliance demonstration is focused on defining a bounding rockfall event together with the design strength of the waste package and the residence time that the waste package is present such that the entire event sequence will have a mean probability of less than $1E-06/\text{yr}$, or less than 1 chance in 10,000 over the preclosure period of 100 years.

The ground support systems, such as the rockbolts and stainless steel sheeting, in emplacement and access drifts are designed to protect against rockfall during the service life and against the effects of design basis earthquakes for both vibratory ground motion and fault displacements. These designs reduce the occurrence of events such as massive rockfall due to an earthquake or collapse of ground support systems that could impact one or more waste packages. In addition, the design basis of the waste package includes the consideration of rockfall, including for the postclosure phase when the ground support systems may have deteriorated. Therefore, the likelihood of having a radionuclide release event initiated by rockfall during the preclosure phase is expected (qualitatively) to be very small.

However, for compliance to 10 CFR Part 63 (Ref. 2.3.1), it is necessary to demonstrate that the frequency of such an event sequence as initiated by a rockfall is below the 1 chance in 10,000 threshold for Category 2 event sequences (e.g., that the sequence is beyond Category 2), and can be screened from further consideration.

F3.1.1 Determination of Bounding Rockfall Loadings

In the preclosure period, rockfall can occur:

- Upon entry into the subsurface at the North Portal

- During transit in the subsurface prior to emplacement
- Within the emplacement drifts.

The various possible rockfall scenarios are examined to determine the bounding rockfall induced by credible seismic events for evaluating impact loads upon the waste package over the preclosure period.

F3.1.1.1 Rockfall within an Emplacement Drift

A large seismic event during the preclosure period could cause a rockfall in an emplacement drift onto one or more emplaced waste packages prior to deployment of the drip shields. Waste package emplacement operations are expected to last up to 50 years with a total preclosure period for subsurface facilities of 100 years (Ref. 2.2.12). For most of the preclosure period, waste packages are present in emplacement drifts, for a residence factor (the potential time that the event can occur divided by the entire preclosure period) of essentially one.

As noted in *Probabilistic Characterization of Preclosure Rockfalls in Emplacement Drifts* (Ref. 2.2.45, Section 6.1.1), and explained further in *Drift Degradation Analysis* (Ref. 2.2.12, p. vii and Section 6.1.2), the repository horizon essentially consists of two main types of rock: nonlithophysal tuff rock units and lithophysal tuff rock units. The nonlithophysal rock units comprise roughly 15% of the emplacement area, and are hard, strong, jointed rock. In contrast, the lithophysal rock units comprise approximately 85% of the emplacement area, and are relatively a more deformable material with lower compressive strength. These units also contain various small cavities (lithophysae), connected by intense fracturing (Ref. 2.2.12, Sections 6.1.2 and 6.4.1.1).

This difference in rock fabric results in differing impact loadings from the different rock types. The fracture surfaces in the stronger nonlithophysal rock units control rock movement, and the failure mode consists of distinct rock blocks (ranging from large to small) which can impact the waste package. In contrast, the intense small-scale fracturing in the lithophysal rock combined with the presence of lithophysae in a relatively weaker material, results in a relatively smaller block size from a rockfall (essentially a rubble) (Ref. 2.2.12, Section 6.4.1.1), which in turn significantly reduces the impact loads to the waste package.

Analysis of seismic response and rockfall in emplacement drifts were conducted with representative geometries for both types of rock units, employing computer models that could simulate the discontinuous fabric of the rock mass (Ref. 2.2.45, Sections 6.3.1 and 6.4.2). Rockfall in response to site-specific ground motions were considered in these analyses, as defined for five levels of annual probability of exceedance, 5E-04, 1E-04, 1E-05, 1E-06, and 1E-07 (Ref. 2.2.11).

Lithophysal Rock: For lithophysal units, the analyses indicated that ground motion levels with probabilities of 5E-04 and 1E-04 did not induce any rockfall for most of the rock mass strength categories with only a relatively small amount of rockfall from the drift walls in the weakest category representing less than 5 percent lithophysal rock (Ref. 2.2.12, Section 6.4.2.2.1). For ground motions associated with a seismic event of 1E-05 APE the analyses show that for unsupported drifts, the resulting impacts appeared to be primarily related to the magnitude of

peak ground velocity, and ranged from little damage to complete collapse. Analyses at ground motions associated with a seismic event of $1E-06$ APE indicated the almost to complete collapse of the opening for all simulations (e.g., Ref. 2.2.12, Figure 6-132). Static loading (dead weight) exerted by the rock from a collapsed drift onto a buried waste package (without the drip shield) has been conservatively evaluated as 0.34 MPa (Ref. 2.2.45, Sections 7.0, 6.3.4 and 6.3.5).

Nonlithophysal Rock: In the nonlithophysal rock units, the impact loading by falling rocks was higher than for the lithophysal rock. Again, numerical simulations indicated the resulting impacts increased with increasing magnitude of the seismic event (and decreasing annual probability of the event). For the ground motions associated with a seismic event of $1E-06$ APE, the mean rockfall on the drip shield was a rock block of 0.43 metric tons with a standard deviation of 1.3. Further, a statistical and probabilistic evaluation of these data was conducted to evaluate the bounding rockfall on the waste package (Ref. 2.2.45). In these analyses, uncertainty in key parameters was considered by accounting for their variability, and by introducing conservatism as needed in the calculation. It was found that the most severe credible rockfall would have a mean kinetic energy on the order of $1.1E05$ J to $5.6E05$ J, depending on the severity of the specific event (Ref. 2.2.45, Section 7). Representing a kinetic energy of $1E06$ J, a rockfall with a mass of 20 metric tons and a velocity at impact on a waste package of 10 m/s was selected as an acceptable realization of an extreme bounding rockfall. This kinetic energy was found to be near the 99th percentile of the bounding credible rockfall kinetic energy distributions resulting from ground motions associated with a seismic event of $1E-06$ APE (Ref. 2.2.45, Section 6.4.5).

Recent changes in the seismic hazard increase the conservatism in these conclusions. The rockfall simulations described were conducted using these ground motions based on the site seismic hazard as defined in 2004 (Ref. 2.2.11). These older ground motions are based on the probabilistic seismic hazard assessment, with extrapolations to very low probabilities without consideration of upper constraints on physical ground motion processes, and therefore these ground motions are termed “unconstrained.” Upon re-evaluation, the extrapolations of ground motions were deemed not representative or credible for the site, and constrained ground motions were established based on geologic evidence of past seismic events, including rock testing data, geologic data, and ground-motion site response data (Ref. 2.2.14). This re-evaluation has significantly reduced the peak ground motions at the emplacement level for a specific level of annual probability, especially at very low probabilities (e.g., at $1E-05$ APE and below), thereby significantly reducing the related expected rockfall effects at a specific annual probability from those presented in the simulations.

F3.1.1.2 Rockfall in Access Mains

Each waste package is transported from a waste handling facility (either from the CRCF or the IHF) and moved directly into the emplacement drift within the shielded enclosure of the TEV. The TEV travels down the North Ramp and along access mains in the subsurface before entering the desired emplacement drift. Both the access mains and the North Ramp have a design diameter of 7.62 m (25 ft) in contrast to an emplacement drift which has a diameter of 5.5 m (18 ft) (Ref. 2.2.49, Table 1). As the geometry of the opening will influence rock block movement, larger excavations have the potential for generating larger rockfall loads when induced by the same earthquake.

However, the exposure (or residence) time for the waste package travel within these excavations is relatively short. As identified in *Repository Subsurface Transport and Emplacement Vehicle (TEV) Routes Details* (Ref. 2.2.46), the maximum subsurface travel distance along the access mains and ramps for the TEV is from the North Portal to Drift 4-1, for a distance of 7,249 m (23,783 ft). At the TEV operational speed of 45.7 m/min (150 ft/min) (Ref. 2.2.36, Section 2.5.3), the maximum one way travel time along the access mains and North Ramp is approximately 2.7 hours ($23,783/150 = 158 \text{ min} = 2.64 \text{ hrs}$). Conservatively, allowing for stops, a trip time of 3 hours can be taken as bounding duration of one trip in the subsurface. Over the preclosure period, the repository will emplace approximately 11,200 waste packages, which results in a total maximum time for the TEV (with the waste package) to be in transit in the subsurface of approximately 3.9 years (i.e. $(11,200 \times 3 \text{ hrs}) / (24 \times 365 \text{ hrs/yr}) = 3.84 \text{ yrs}$) for a residence factor of less than 0.1 ($3.84/100 = 0.038$) during the preclosure period.

In demonstrating compliance to the requirements of 10 CFR Part 63 (Ref. 2.3.1), the residence factor is multiplied with the earthquake frequency in the determination of the event sequence probability. With a reduced residency factor, a more frequent seismic event can be employed to define a bounding rock impact energy (than for the emplacement drift event sequence) and still demonstrate compliance. Specifically, selecting a bounding rockfall associated with an event with an APE of $1\text{E-}05$ times a residence factor of less than 0.1 results in an event sequence probability of less than $1\text{E-}06/\text{yr}$, i.e., beyond Category 2.

Analyses of rockfall potential in nonlithophysal rock along non-emplacment drifts due to a seismic event with an APE of $1\text{E-}05$ have been conducted (Ref. 2.2.40). The rockfall in the access main/turnout intersection, which has the largest roof span, are considered the most severe case (Ref. 2.2.40, Section 6.1). From an evaluation of the rockfall analyses above the springline (i.e., the location of rock blocks which would strike the TEV), the 95th percentile rock block that would impact the TEV and the contained waste package has a mass and velocity of 2.29 metric tons and 7.67 m/s respectively (Ref. 2.2.25, Section 6.3, 6.4).

To further bound the possible ground motions, the TEV or waste package can be understood to be moving upwards due to vibratory ground motion at a similar velocity as the rock block is falling downward, doubling the apparent velocity at impact. Using the 95th percentile value as bounding, the resulting kinetic energy ($\frac{1}{2} m v^2$) at impact is therefore approximately $2.7\text{E}05 \text{ J}$. As a further conservatism for the considering the bounding impact to the waste package, the resistance of the TEV to the rockfall can be discounted and the rockfall can be taken to fall directly on the contained waste package. Therefore, a bounding impact energy of $3\text{E}05 \text{ J}$ can be selected as an extreme bounding rockfall on a TEV in a nonlithophysal rock unit. Note that this value is significantly smaller than the $1\text{E}06 \text{ J}$ impact energy value calculated for the potential rockfall in an emplacement drift, identified in the previous section. Thus, rockfall on the TEV during transit to the emplacement drifts is not further considered.

Again as described in the previous section, it should be noted that recent changes in the seismic hazard have reduced the apparent ground motions at a specified APE, adding to the conservative nature of stated conclusions.

F3.1.1.3 Rockfall at the North Portal

The TEV moves the waste package from the surface into the subsurface by passing through the North Portal. The North Portal area represents a combination of exposed rock faces and engineered soil slopes which could potentially fall onto the TEV. However, the portal excavations are well supported and without visible evidence of major defect/fault. The rock slopes in this area are supported by grouted rock bolts, wire mesh and fibercrete (Ref. 2.2.39, Section 5.4.3), and the soil slopes are excavated and graded into a stable configuration with slopes of 2:1 (horizontal to vertical) or greater. The North Portal is assessed to be stable without the support features (Ref. 2.2.39, Section 5.4.3).

In addition, the exposure (or residence) time for the waste package travel within the North Portal area is extremely short. The distance of travel within the immediate proximity of the entrance is less than about 60 meters (200 ft). At the TEV operational speed of 45.7 m/min (150 ft/min) (Ref. 2.2.36, Section 2.5.3), the maximum travel time in the area is less than 2 minutes ($200/150 = 1.3$ min). Allowing 10 minutes for a brief stop at the portal for a survey or check of the TEV, an exposure time of 0.25 hours can be taken as bounding duration of one trip through the portal. Over the preclosure period, the repository will emplace approximately 11,200 waste packages, which results in a total maximum time for the TEV (with the waste package) to be in transit into the portal of approximately 0.4 years (i.e. $(11,200 \times 0.25 \text{ hrs}) / (24 \times 365 \text{ hrs/yr}) = 0.32$ yrs) for a residence factor of about 0.004 ($0.4/100 = 0.004$) during the preclosure period.

As described in the prior section, the probability of the event sequence involving a rockfall in this area is again influenced by the very short residence time. Specifically, selecting a bounding rockfall associated with an event with an APE of $1E-04$ times a residence factor of less than 0.004 results in an event sequence probability of less than $1E-06/\text{yr}$, that is, beyond Category 2.

To assess the stability of the exposed rock faces, the North Portal configuration was analyzed with a continuum model to identify any zones of concern. Under static in situ conditions (e.g., directly after excavation), the stress states for the model were completely elastic and stresses were small compared to rock cohesion, even in the case of the poorest-quality rock mass (Ref. 2.2.31, Section 6.5.3.1.6). Subjecting the model to vibratory ground motions from a $1E-04$ APE seismic event, the configuration remained essentially elastic, and developed no plastic zones with respect to a Mohr-Coulomb shear failure criterion (Ref. 2.2.31, Section 6.5.3.3.6). Again as described, it should be noted that recent changes in the seismic hazard have reduced the apparent ground motions at a specified APE, adding to conservative nature of stated conclusions.

Given the extremely short residence time and the available analyses, it is concluded that the slope is generally stable and a large rockfall on the TEV carrying a waste package is not considered likely. While the specific magnitude of a rockfall in this area has not been evaluated, it is concluded that the rockfall for any Category 2 event sequence will be smaller than the $1E06$ J impact energy value assessed for the potential rockfall in an emplacement drift, identified in the earlier section.

F3.1.1.4 Summary - Bounding Rockfall

From the discussions provided above, the bounding rockfall impact that the waste package must withstand without breach is identified as that occurring in an emplacement drift within a nonlithophysal rock unit. The bounding values of 1E06 J is identified as a conservative bound, representing approximately the 99th percentile of the bounding credible rockfall kinetic energy distribution resulting from ground motions associated with a seismic event of 1E-06 APE. This energy value is equivalent to a rockfall of 20 metric tons and a velocity at impact of 10 m/s.

F3.1.2 Probability of Waste Package Failure Due to a Rockfall

This section describes the analyses that have demonstrated that the waste package design can sustain impact loads of 1E06 J, and, therefore, that the probability of radionuclide release is beyond Category 2.

Finite element analyses of the structural response of 5 DHLW/DOE Co-Disposal Short and the TAD waste package configurations were conducted over a range of rock fall impacts (Ref. 2.2.52). Rock impact energies ranging up to 8.6E06 J were analyzed for both waste package configurations for impacts at the waste package lower end (directly above the lower sleeve in the region of the support ring); and at mid-length of the waste package. The expended toughness fraction is used as the measure of the damage to the waste package, and is defined as the ratio of the Demand Toughness Index to the Available Toughness Index. Expended toughness fraction values less than 1.0 do not indicate failure, while those values equal to or above 1.0 indicate failure.

The results indicated that the maximum element wall-averaged effective stresses (von Mises stress) generated by a rock impact event do not expend the total toughness allowed by the worst case triaxiality adjusted mean strength toughness of Alloy 22, when impacted by a rock of mean compressive strength for the range of impacts considered. Specifically, for a rock impact of 1E06 J (as represented by a 20 metric ton rock impacting with a velocity of 10 m/s), the measure of waste package strength, the expended toughness fraction, was equal or less than 0.1107 for both waste package configurations at either impact location (Ref. 2.2.52, Tables 4 and 5). This indicates a very substantial margin to failure, which would be represented by an expended toughness fraction value of 1.0.

The probability of failure for this expended toughness fraction can be estimated using a Gaussian distribution (Attachment H), expressed as:

$$\Phi_{\mu, \sigma^2}(x) = \int_{-\infty}^x \mathcal{G}_{\mu, \sigma^2}(u) du \quad \text{EQ. F3.1-1}$$

where:

$\Phi(x)$ = probability of failure for a value, x , for a distribution with a mean, μ , and a variance, σ^2 (i.e., the standard deviation squared)

$\mathcal{G}(u)$ = standard normal distribution with mean of μ and a variance, σ^2

u = variable of integration.

Using the standard normal form of the distribution (i.e., with a mean of zero and a standard distribution of one), and expressing the probability of failure as the inverse of the expended toughness fraction (i.e. = 1-ETF) in a normalized form:

$$x = \frac{ETF - 1}{\sigma} \quad \text{EQ. F3.1-2}$$

Allowing for significant variation in the analysis (a normalized deviation of 15%), x , can be computed as:

$$x = [0.1107 - 1.00] / 0.15 = -5.93$$

The resulting probability of failure, $\Phi(x)$, is computed (for example, by using NORMDIST in EXCEL) to be less than 1E-08, or considerably beyond Category 2.

F3.1.3 Conclusion: Rockfall Impact on Waste Package

This probabilistic analysis determined, for the range of credible seismic events that could occur over the preclosure period, the bounding characteristics of the credible rocks that could impact a waste package. A conservative analysis established that the bounding kinetic energy at impact on a waste package (e.g., for the rocks that would impact a waste package over the preclosure period, the kinetic energy that has a probability less than 1/10,000 of being exceeded) is one million joule, realized by a rock of 20 metric tons impacting a waste package at 10 m/s. A subsequent analysis established that a waste package subjected to such an impact would have a probability less than 1E-08 of losing its containment function. These two pieces of information were then combined to conclude, without actually calculating the stress-strength interference integral, that the seismically-induced event sequences leading to a breach of a waste package from impacts by rock falls over the preclosure period can be categorized as beyond Category 2.

F3.2 SCREENING EVALUATION OF LOSS OF VENTILATION IN AN EMPLACEMENT DRIFT

In addition to rockfall physical impacts to a waste package, seismically-induced rockfall can also accumulate around a waste package, potentially restricting air flow in the emplacement drift. In severe scenarios, the combined loss of air flow and the blanketing insulation could cause the temperature of the waste packages to increase, perhaps leading to a breach of the waste package due to rockfall-imposed stresses, overpressurization, or creep.

The following sections will examine the following aspects of this event sequence and demonstrate that it is beyond Category 2:

- Definition of Scenarios and Seismic Events
- Rockfall Burial
- Thermal Response and Thermal Limit
- Conclusion for Loss of Ventilation in Emplacement Drift.

F3.2.1 Definition of Scenarios and Seismic Events

The preclosure period for waste packages in the emplacement drifts is 100 years. The actual emplacement operations are estimated to take about 25 years. The hottest waste packages have a thermal loading of 18 kW when placed in the drifts, but these packages will cool to less than 14 kW in 10 years, and 7 kW in 55 years (Ref. 2.2.13, Table 7, as evaluated in Ref. 2.2.61, Figure 5). Therefore, there is a period of about 35 years when a waste package could have a thermal loading greater than 14 kW, and a period of 80 years when a waste package could have a thermal loading greater than 7 kW. Note that 14 kW and 7 kW are used since these levels of thermal loading can withstand higher burial levels without waste package failure or breach.

Therefore, three scenarios and time periods are defined for evaluation:

- 18 kW: The first 50 years of the 100 year preclosure period, when 18 kW waste packages may be in the drifts
- 14 kW: The next 30 years of the preclosure period, when all waste packages will be 14 kW or less
- 7 kW: The final 20 years of the preclosure period, when all waste packages will be 7 kW or less.

For the first 50 years, the seismic event to be considered is the 2E-06 APE seismic event in order to result in an event with a probability of 1 in 10,000 (i.e., $50 \text{ yr} \times 2\text{E-}06 \text{ /yr} = 1\text{E-}04 = 1/10,000$), such that the 10 CFR Part 63 criterion for beyond Category 2 would be met. Figure F3.2-1 provides the seismic hazard curve for the repository block, in this case using PGV as the ground motion parameter. From this figure, the 2E-06 APE seismic event would have a horizontal PGV of 1.35 m/s.

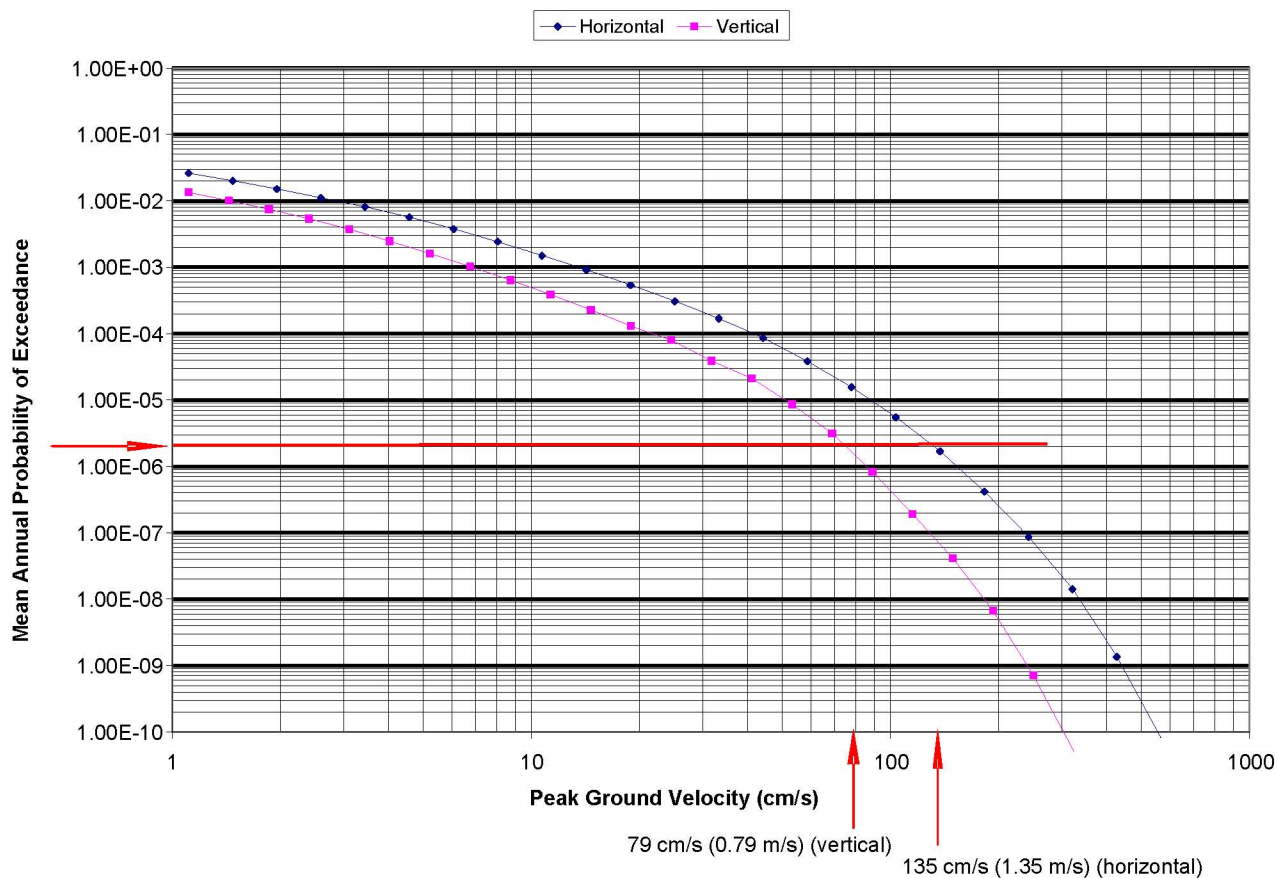

Source: Modified from Ref. 2.2.61

Figure F3.2-1. Seismic Hazard Curve – Repository Block

For the second scenario, the next 30 years, the $1.25E-06$ APE seismic event is used, to cover the 80 yr since repository emplacement began (i.e., $80 \times 1.25E-6 = 1E-04 = 1/10,000$). From Figure 6.9-3, the horizontal PGV for the $1.25E-06$ APE is about 1.55 m/s. The third scenario, the last 20 years, considers the $1E-06$ APE seismic event.

F3.2.2 Rockfall Burial

This section provides a description of the potential rockfall analyses and burial percentage. The burial percentage is a linear measure of the percent of the vertical diameter of the waste package that is covered by the fallen rubble, with a flat rubble horizon. Burial of 50% would mean that the rubble level is mid-way up the waste package, while 100% just covers the waste package.

As mentioned in the rockfall impact analysis, the difference in rock fabric between nonlithophysal and lithophysal rock units results in differing rockfall configurations. Of most concern to a loss of ventilation is a rockfall in the weaker lithophysal rock; rockfall in this unit has a relatively smaller block size which can potentially fill the excavation opening and blanket the waste package, reducing ventilation flow around the waste package. Even for large ground motions, burial in nonlithophysal rock units would not be significant (Ref. 2.2.61, Section 6.1.2).

Note that the following analyses did not include the effect of the ground support in the emplacement drifts (e.g., rock bolts and stainless steel sheeting). Ground support will significantly retard rockfall due to a seismic event and in most cases, prevent small rockfalls from detaching from the rock wall or crown.

Also note that forced ventilation from the drift ventilation system was not credited for these analyses.

From analyses of seismically induced rockfall in lithophysal units, the amount of rockfall generally varies with the peak ground velocities at the emplacement depth (Ref. 2.2.12, pp. 6-164). For low peak ground velocities, on the order of 50 cm/sec (1.6 ft/s) at the emplacement depth, simulations indicate no damage (rockfall) in lithophysal rock aside from some minor rock breakout (spall) in the weakest unit (Ref. 2.2.12, Section 6.4.2.2.1). Resulting diagrams indicate that excavations remain open and heat transfer around the waste package would be unaffected (Ref. 2.2.12, Figure 6-120).

2E-06 APE Seismic Event Rockfall: *Evaluation of an Event Sequence for Waste Package Burial* (Ref. 2.2.61), specifically evaluates large peak ground velocities and the resultant rockfall. This analysis demonstrates that for representative horizontal peak ground velocities of 1.5 m/s, rockfall should be less than 5 m³/m of tunnel and occur primarily in weaker rock units (Category 1, which only accounts for 5% of the drift lithophysal rock) (Ref. 2.2.61, Section 6.1.1). Since the 2E-06 APE PGV is only 1.35 m/s, the 5 m³/m rockfall would bound the expected rockfall. This 5 m³/m rockfall is then expanded by 25% to 6.25 m³/m to account for the bulking of the rubble. Rockfall of this amount will only partially bury the waste package, at about 80%, (Ref. 2.2.61, Figure 3) and leave the top of the waste package exposed to convective heat transport. The 80% coverage presumes a level horizon of rockfall in a perfectly round tunnel. Figure F3.2-2 provides a representation of the 80% coverage case, as used in the thermal analyses.

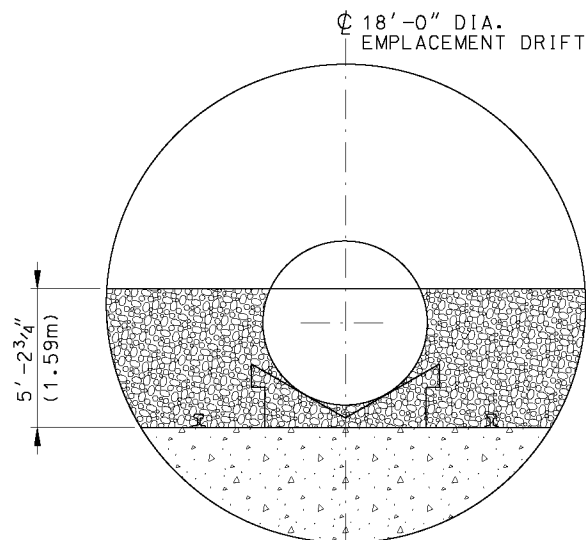

Source: (Ref. 2.2.61, Figure 3)

Figure F3.2-2. Representation of Level 80% Burial for 2E-06 APE Rockfall (6.25 m³/m)

However, when the failure pattern generated by the loose rock is considered, the expected final configuration is more elliptical in shape, exposing more of the waste package. Figure F3.2-3 provides a more likely failure pattern for the rockfall. For a rockfall event, the emplacement drift damage mechanism consists primarily of shear failure at the springline of the tunnel coinciding with passage of the compressive stress increase associated with PGV peaks. If the addition of dynamic plus in situ stress is large enough, shear failure occurs primarily at the springline, resulting in development of an elliptical shape of the opening as the rock mass yields, and rockfall occurs along the sides (Ref. 2.2.12, Section 6.4.2.2.1). Therefore, although the exact geometry of the rockfall cannot be predicted, the level representation used for the thermal analysis is considered conservative.

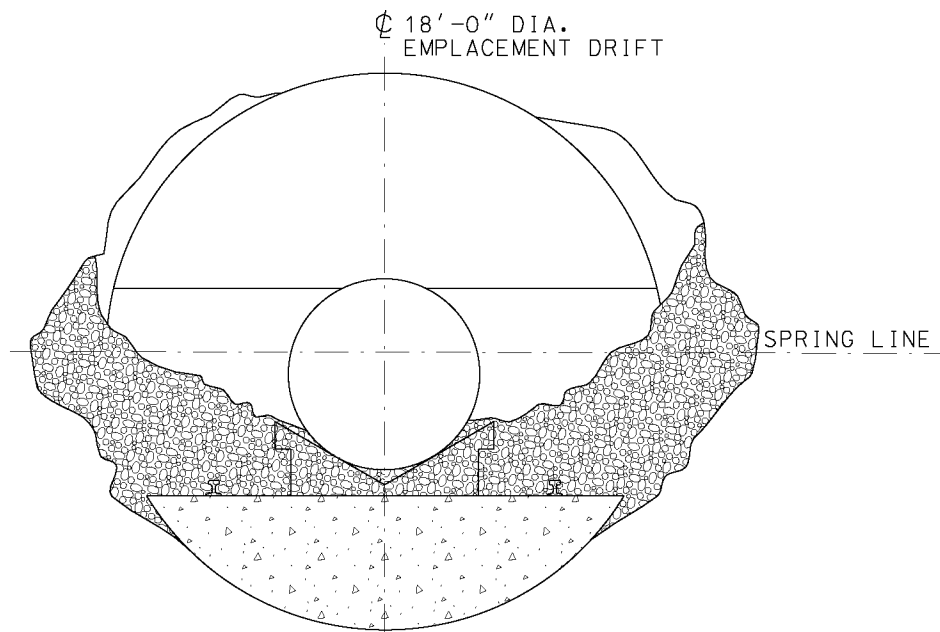

Source: (Ref. 2.2.61, Figure 4)

Figure F3.2-3. Possible Profile for 2E-06 APE Rockfall ($6.25 \text{ m}^3/\text{m}$)

1.25E-06 APE Seismic Event Rockfall: For the 1.25E-06 APE earthquake (over the first 80 years of preclosure), the peak ground velocities (1.55 m/s) are only 3% higher than the 1.5 m/s velocity that results in a bounding rockfall of $5 \text{ m}^3/\text{m}$, as discussed above. A 125% rockfall height would represent a bulked rubble volume of approximately $11 \text{ m}^3/\text{m}$, which equates to an in situ rockfall of $8.8 \text{ m}^3/\text{m}$ when the 25% bulking is removed ($11/1.25 = 8.8$). The $8.8 \text{ m}^3/\text{m}$ rockfall is approximately 75% higher than the $5 \text{ m}^3/\text{m}$ rockfall level that could occur at 1.5 m/s peak ground velocity. It is not reasonable to expect that a 3% increase in peak ground velocity would result in a 75% increase in rockfall volume. Therefore, the rockfall burial level over the first 80 years of the preclosure period would be expected to be less than 125% burial. Conservatively, the 125% burial level was selected to represent the maximum burial level during the 30 year period between 50 to 80 years.

1E-06 Seismic Event Rockfall: Rather than determine bounding rockfalls for the last 20 years of the 100 year preclosure period, the rockfall was conservatively selected to fill the entire drift (MAX rockfall).

F3.2.3 Thermal Response and Thermal Limit

With restricted airflow and with the increased insulation of the rockfall around the waste package, the waste package's temperature will increase with time. The waste package containment will potentially be challenged by the imposed stresses from the rockfall together with the time-dependent movement (creep) of the waste package materials. Containment may also be challenged by the increased internal pressurization of the canister induced by the higher temperatures. Both of these conditions were examined to identify a critical temperature at which loss of containment of the waste package (breach) can be expected.

The waste package will maintain containment over a wide range of the temperature and pressure, but at the temperatures and pressures at the extremes of these ranges, the containment of the waste package is challenged. Analyses of waste package response indicate that for the case that 100% of the fuel assemblies have ruptured (which generate large internal pressures), together with a loading of the rockfall, the waste package containment may fail at a temperature of 541°C for average strength (Ref.2.2.61, Section 6.2). Therefore, waste package survivability was defined as the peak outer corrosion barrier (Alloy 22) temperatures not exceeding 541°C.

As to the potential range of possible waste package temperatures, parametric thermal analyses have been conducted to evaluate the range of temperatures that can be induced by waste package burial. These analyses examined five levels of burial of the waste package, a temperature dependent effective thermal conductivity of the rockfall material and five levels of initial waste package heat loading for a TAD. Burial levels for the waste package included 40%, 80%, 100%, 125%, and MAX (which is rubble filling the entire area of the drift), and the heat loads included 6, 7, 8, 12, 14, 16 and 18 kW (Ref. 2.2.61, Section 6.2)

The waste form itself would not be critical under these conditions. At temperatures below 1000°C, criticality is not credible for the waste package. Commercial SNF is not expected to melt at temperatures on the order of 1200°C, and the zirconium in the cladding will not reduce UO₂ to produce uranium-zirconium alloy at temperatures below 800°C. Vitrified HLW would not flow as it has a melting point of just over 825°C (Ref. 2.2.108, pp. 2.2.1.1-4). Based on maintaining the internal configuration of the waste canister and cladding integrity for off-normal and accident conditions, a maximum cladding temperature is identified at 570°C (1058°F) in guidance from the U.S. Nuclear Regulatory Commission (Ref 2.2.99, Revision 3. p. 3). However, this maximum cladding temperature is quite conservative, and exceeding this temperature would not cause a radionuclide release. Therefore, criticality does not need to be considered further.

The thermal calculations for an emplaced waste package buried under rubble are summarized in Table F3.2-1 (Ref. 2.2.61, Table 4). Note that there are no MAX runs for the 100°C initial drift temperature, since the MAX burial scenario (complete drift collapse) is modeled with no convective heat transfer off of the waste package. Therefore, the drift air temperature is not relevant for the MAX scenarios, and the MAX scenarios are valid for both 50°C and 100°C drift air temperatures.

Table F3.2-1. Summary of Temperature Results for Waste Package Burial

Drift Temperature (°C)	WP Heat (kW)	Burial Depth (%)	Peak OCB Surface Temperature (°C)	Peak Fuel Temperature (°C)
50	18	MAX	955	1055
		125	595	675
		100	504	576
		80	428	492
		40	338	400
	16	MAX	869	956
		125	544	618
		100	462	527
	14	MAX	785	860
		125	493	560
		100	418	477
	12	125	442	501
	8	MAX	544	585
	7	MAX	507	542
6	MAX	471	500	
100	18	125	611	691
		100	523	594
		80	451	515
		40	366	429
	16	125	560	633
		100	481	545
	14	125	509	575
	12	125	458	516

Source: Ref. 2.2.61, Table 4

18 KW Waste Package Scenario: From Table F3.2-1 above, for a heat loading of 18 kW, the peak temperature value at the outer corrosion barrier is computed as 428°C and 451°C for the 80% burial case, and initial drift temperatures of 50°C and 100°C (respectively). As both these temperature values are well below the critical limit temperature, it is concluded that a waste package with nominal heat load of 18 kW can sustain without breach a rockfall resulting in a partial burial of the waste package (80%) which could be induced by a bounding seismic event of 2E-06 APE. Note that even at 100% burial, the peak 18 kW waste package temperature is 523°C, which is below the acceptable temperature limit of 541°C. While the maximum fuel temperature at 100% burial would be exceeded, this would not result in breach of the container, or a radionuclide release.

14 KW Waste Package Scenario: From Table F3.2-1 above, for a heat loading of 14 kW, the peak temperature value at the outer corrosion barrier is computed as 493°C and 509°C for the 125% burial case, and initial drift temperatures of 50°C and 100°C (respectively). As both these temperature values are below the critical limit temperature, it is concluded that a waste package with nominal heat load of 14 kW can sustain without breach a 1.25E-06 APE rockfall resulting in a 125% burial of the waste package.

7 KW Waste Package Scenario: From Table F3.2-1 above, for a heat loading of 7 kW, the peak temperature value at the outer corrosion barrier is computed as 507°C for the MAX burial case. As this temperature value is below the critical limit temperature, it is concluded that a waste package with nominal heat load of 7 kW can sustain without breach a complete drift collapse without failure due to overheating effects.

The analyses do not consider any post-rockfall actions to increase cooling of the repository excavations. Waste packages will take a period of months after a rockfall to reach peak temperatures or exceed the critical limit temperature, depending on the extent of burial and the initial thermal load of the waste package (Ref. 2.2.61, Attachment II, Table 7). Thus there is significant time for measures to be taken to establish cooling in the drifts. Conservatively, credit for such actions was not taken for this analysis.

It is also noted that the thermal output of the 18 kW package would decrease to approximately 14 kW over a period of 10 years, and to approximately 7 kW in 55 years (Ref. 2.2.61, Figure 5) so that the severity of the hazard decreases over the preclosure period.

F3.2.4 Conclusion for Loss of Ventilation in an Emplacement Drift

The potential for waste package temperature increases due to rockfall burial has been evaluated. For seismic events at 2E-06 APE, the level of burial of the waste package would be about 80% of the waste package. Based on a range of initial thermal loading conditions, the waste package peak temperatures would be well below the critical thermal limit of 541°C for breach of the waste package.

There are a number of conservatisms in this assessment, including:

- Burial levels in nonlithophysal rock units would not be significant (Section F3.2.2)
- Even in lithophysal rock units, the weakest rock (Category 1) represents only about 5% of the total emplacement drifts (Section F3.2.2). Burial levels in stronger lithophysal rock categories would generally be less than evaluated here.
- The thermal analysis selected a level burial horizon in the drift, while it is more likely that an elliptical horizon would occur, resulting in less burial of the waste package (Figures F3.2-2 and F3.2-3).
- The thermal analyses did not give credit for forced ventilation, or for long-term recovery actions.

Based on these conservative analyses, it is concluded that loss of ventilation due to rockfall burial of a waste package in the drifts would not cause breach of the waste package, and that this seismic event scenario can be screened out as beyond Category 2.

ATTACHMENT G THROUGHPUT ANALYSIS

G1 SUMMARY

Based on preliminary throughput estimates for various facilities, the exposure or residence times were evaluated for various operations of the waste handling process for use in SAPHIRE analyses. Specifically, throughput estimates for the CRCF (Ref. 2.2.41), IHF (Ref. 2.2.42), RF (Ref. 2.2.43) and WHF (Ref. 2.2.44) in Microsoft Project files were transcribed into Microsoft Excel files, and estimates for specific potential hazards were developed using a simple column-based format. The resulting evaluations are contained on the attached compact disk. In addition, comments from the BSC Nuclear Facilities Engineering Section on the remote handling system were incorporated, as to when this system is above the waste package. These comments were documented in an email, which is also included on the attached compact disk¹.

For this evaluation, the work breakdown structure (WBS) number, the activity number from the block flow diagram (BFD), the activity description and the activity duration (in minutes) were transferred from the source reference (in Microsoft Project) into Microsoft Excel file spreadsheets. WBS numbers were modified in limited instances from the source file for clarity but the relationship of WBS levels and the durations of the activities were not changed. The source references for the BFD activity numbers are provided in the source documents.

On the resulting individual spreadsheets, the potential hazards were identified for various columns across the top of the page. For example, a column labeled "Railcar - Collision/Tipover" is identified for the analysis of the TAD receipt on a railcar. Then, the activities were identified when this potential sequence could occur during the handling process, and the durations of these activities are indicated in this column. (Note that the activity levels are colored to assist identification of the activity levels of the list. Activity time is identified in the column at the highest applicable level and the color coding assists the user to not count an activity more than once.) The values at the base of the sheet under each column represent the sum of the entire column of the activity times when this potential hazard could occur, i.e. the total exposure or residence time. The time (in minutes) is divided by the number of minutes in a year ($60 \times 24 \times 365 = 525,600$) and the number of waste forms involved in the process to obtain the exposure time per year per canister or assembly, as appropriate.

Summary sheets were created to assist the user in review of the data or when several repetitive stages are required for the overall process. For example, in the case of handling SNF and HLW in the CRCF, nine stages are summarized which repeat the data from four spreadsheets.

Activities in each spread sheet generally describe the handling of a specific waste canister. Where separate activities interact (such as due to the loading of a waste package with two different types of canisters), delays on the sheet were identified as appropriate.

¹ The email is from James Canning (Nuclear Facilities Engineering) to David Moore (Preclosure Safety Analyses), dated 02/04/2008 with the subject line, "Waste Package Closure System - PCSA evaluation of RHS."

In some instances, it was necessary to re-order activities from the source study to correctly model the desired throughput process for the SAPHIRE analysis. In any re-ordering, the objective was to correctly model the sequence and when possible, minimize residence times by delaying secondary activities that not required directly by the handling process.

In one case, activity estimates were extrapolated from other handling operations. The source studies did not provide activity estimates for the handling of MCOs; in this case, the activity times for similar DSNF handling activities were used as a surrogate. This was considered appropriate given the current state of knowledge of these canisters.

G2 FILE CONVERSION

To provide for transparency in the residence time evaluations, the specific steps performed in the evaluation for each facility are provided in the following subsections.

G2.1 INITIAL HANDLING FACILITY

Throughput evaluations for the IHF are based on schedule estimates from *Preliminary Throughput Study for the Initial Handling Facility* (Ref. 2.2.42). The source file is an assessment of activity times for handling either HLW or naval canisters on a continuous, around-the-clock basis². The source file is labeled, “Time change-IHF Initial Throughput - 3 Shifts.mpp.”

The source file was divided into two parts: (1) handling activities for a naval spent fuel canister under the WBS 1 tasks, entitled, “Preliminary M-290 Process in IHF” and (2) HLW canister handling activities under the WBS 2 tasks, entitled, “Preliminary HLW Process in IHF.” Each part was placed on a separate spreadsheet. The two spreadsheets were labeled “Naval-cont” and “HLW-cont” for activities related to naval canisters and HLW canisters, respectively. The two spreadsheets were incorporated into a single Excel workbook.

For each WBS item, four columns in Microsoft Project were copied onto a Microsoft Excel spreadsheet. The four columns transferred into Excel were: (1) WBS number, (2) BFD identification number, (3) task name and (4) activity duration. After transfer, the various hierarchical WBS levels of the schedule were color coded to assist in identifying times and prevent double counting.³

For the IHF, activities and related times for the RHS (under closure of the waste package) were modified from the source file. Modifications were included to more accurately describe when the RHS resides over the waste package, based on input from Nuclear Facilities Engineering Section (shown in the attached email) and based on the *Remote Handling System Usage Report* (Ref. 2.2.111).

² While the concept of operations for the IHF is a single day shift operation (Ref. 2.2.57, p.6), this seismic event sequence evaluation examined a more continuous process, as given in the IHF throughput analysis (Ref. 2.2.42). The potential impacts of longer operational durations are addressed by safety controls as noted in Section 6.10.2.

³ Note that the each time level in a schedule encompasses the times of the sublevel which directly follows. For example, the times for an activity at level 3 in the WBS (e.g., WBS 1.3.3) represent the network sum of all of the sublevels which follow in the WBS (WBS 1.3.3.1, 1.3.3.2, 1.3.3.3...).

After establishing the activities and times, columns were added to the each spreadsheet for identified potential hazards that were to be evaluated. For handling a HLW canister or a naval canister, the list of identified potential hazards is shown in Table G2.1-1. Each of the activities was examined to determine which of the activities (from the source file) could be related to the identified potential hazard. For example when considering the potential drop of a cask from the cask handling crane, activities were identified when the cask was being lifted by the crane. The corresponding activity times were then listed in the appropriate column for the hazard. To assist traceability, a column providing the line numbers from the source file from where the information was taken and any modifications from the source file is shown at the far right in each of these spreadsheets, except the summary sheet.

At the bottom of the spreadsheet, the times for each column are summed to determine the total residence time for the specific potential hazard. The residence time of each column was divided by the residence time of structure collapse to determine the percentage of total residency time. Also, the residence time of each column was divided by the number of minutes in a year (i.e., 525,600 minutes/year) and the number of canisters involved in the process to obtain the residency time in years per canister. For the HLW handling process, there are five canisters in the cask; with the naval cask, there is one canister.

A summary sheet (labeled “IHF Summary”) was created in the Excel workbook which contains the column totals of the two spreadsheets, providing (for each potential hazard) the residence time of each column, the percentage of total residency time, and the residency time for SAPHIRE input (in years per canister).

Table G2.1-1. Equipment and Related Hazards Evaluated for Handling of HLW and Naval Canisters in the IHF

No.	Equipment - Related Hazard
1	Initial Handling Facility Structure - Collapse
2	Entry Door - Collapse onto Waste Form
3	Truck - Tipover
4	Mobile Platform - Collapse onto Waste Form
5	Cask Handling Crane - Collapse
6	Cask Handling Crane - Cask Drop
7	Cask Handling Crane - Heavy Object Drop
8	Cask Preparation Crane - Collapse
9	Cask Preparation Crane - Heavy Object Drop
10	Cask Preparation Platform - Collapse onto Waste Form
11	Cask Transfer Trolley - Slide
12	Cask Transfer Trolley - Bump Impact
13	Cask Transfer Trolley - Rocking Restraint Failure w. Drop
14	Shield Doors - Mount Failure
15	Canister Transfer Machine - Collapse onto Waste Form
16	Canister Transfer Machine - Canister Drop
17	Canister Transfer Machine - Heavy Object Drop
18	Canister Transfer Machine - Swing Inside Bell
19	Canister Transfer Machine - Swing Outside Bell
20	Remote Handling System - Collapse
21	Remote Handling System - Heavy Object Drop
22	Waste Package Transfer Trolley - Tipover
23	Waste Package Transfer Trolley - Rocking Impact
24	Waste Package Handling Crane - Collapse
25	Waste Package Handling Crane - Heavy Object Drop
26	Transport and Emplacement Vehicle - Tipover
27	Transport and Emplacement Vehicle - Sliding
28	Transport and Emplacement Vehicle - WP Ejection

NOTE: HLW = high-level radioactive waste; IHF = Initial Handling Facility; WP = waste package.

Source: Original

G2.2 RECEIPT FACILITY

Throughput evaluations for the RF are based on schedule estimates from *Preliminary Throughput Study for the Receipt Facility* (Ref. 2.2.43). The source file is an assessment of activity times for handling TAD or DPC canisters from receipt to transfer to aging pad. The source file is labeled, "Receipt Facility Throughput Layout 071022.mpp."

The source file was divided into four parts:

1. Receipt of a TAD cask on trailer in horizontal orientation and transfer to an aging overpack under tasks entitled, “TAD Transfer.”
2. Receipt of a DPC in a HI-STAR transportation cask in horizontal orientation and transfer to an aging overpack under tasks entitled, “DPC (High STAR) Transfer.”
3. Receipt of a DPC in a transportation cask in horizontal orientation and transfer to an aging overpack in a vertical orientation under tasks entitled, “DPC (Leaving Vertically) Transfer.”
4. Receipt of a DPC in a transportation cask in horizontal orientation and transfer to transfer trailer in a horizontal orientation under tasks, entitled, “DPC (Leaving Horizontally) Transfer.”

Each part was placed on a separate spreadsheet. The four spreadsheets were labeled “1 TAD Transfer,” “2 DPC Transfer (tilt frame),” “3 Export DPC V,” and “4 Export DPC H” for activities related to parts respectively. The four spreadsheets were incorporated into a single Excel workbook.

As the source file did not contain a WBS system, a WBS column was generated in Microsoft Project. Then, for each part, four columns in Microsoft Project were copied onto a Microsoft Excel spreadsheet. The four columns transferred into Excel were: (1) WBS number, (2) BFD identification number, (3) task name and (4) activity duration. After the transfer, the various hierarchical WBS levels of the schedule were color-coded to assist in identifying times and prevent double counting.

As described for the IHF, columns were added to the each spreadsheet for identified potential hazards that were to be evaluated. For handling a TAD canisters and DPCs exported in an aging overpack (in a vertical orientation), the list of identified potential hazards is shown in Table G2.2-1. For handling of DPCs exported on transfer trailer (in a horizontal orientation), the list of identified potential hazards is shown in Table G2.2-2. In addition, to assist traceability, a column providing the line numbers from the source file from where the information was taken and any modifications from the source file is shown at the far right in each of these spreadsheets, except the summary sheet.

Each of the activities was examined to determine which of the activities (from the source file) could be related to the identified potential hazard. For example when considering the potential drop of a cask from the cask handling crane, activities were identified when the cask was being lifted by the crane. The corresponding activity times were then listed in the appropriate column for the hazard.

At the bottom of the spreadsheet, the times for each column are summed to determine the total residence time for the specific potential hazard. The residence time of each column was divided by the residence time of structure collapse to determine the percentage of total residency time. Also, the residence time of each column was divided by the number of minutes in a year (i.e., 525,600 minutes/year) and the number of canisters involved in the process to obtain the

residency time in years per canister. For handling processes of either the DPC or the TAD, there is only one canister.

A summary sheet (labeled “RF Summary”) was created in the Excel workbook which contains the column totals of the four spreadsheets, providing (for each potential hazard) the residence time of each column, the percentage of total residency time, and the residency time for SAPHIRE input (in years per canister).

Table G2.2-1. Equipment and Related Hazards Evaluated for Handling TAD and DPC Canisters in the RF for Transfer to Aging Overpacks

No.	Equipment - Related Hazard
1	Receipt Facility Structure - Collapse onto Waste Form
2	Entry Door (Rollup and Confinement Doors) - Collapse onto Waste Form
3	Railcar - Tipover
4	Mobile Platform - Collapse onto Waste Form
5	Cask Handling Crane (CHC) - Collapse
6	Cask Handling Crane (CHC) - Cask Drop
7	Cask Handling Crane (CHC) - Heavy Object Drop
8	Cask Preparation Platform - Collapse
9	Cask Transfer Trolley - Slide
10	Cask Transfer Trolley - Bump Impact
11	Cask Transfer Trolley - Rocking Impact
12	Shield Doors - Mount Failure
13	Canister Transfer Machine - Collapse onto Waste Form
14	Canister Transfer Machine - Canister Drop
15	Canister Transfer Machine - Heavy Object Drop
16	Canister Transfer Machine - Swing Inside Bell
17	Canister Transfer Machine - Swing Outside Bell
18	Lid Bolting Platform - Collapse
19	Lid Bolting Room Crane - Collapse
20	Site Transporter - Sliding Impact
21	Site Transporter - Bump Impact

NOTE: DPC = dual-purpose canister; TAD = transportation, aging and disposal.

Source: Original

Table G2.2-2. Equipment and Related Hazards Evaluated for Handling DPC Canisters in the RF for Transfer to Transfer Trailers (in a Horizontal Orientation)

No.	Equipment - Related Hazard
1	Receipt Facility Structure - Collapse onto Waste Form
2	Entry Door - Collapse onto Waste Form
3	Railcar - Tipover
4	Mobile Platform - Collapse onto Waste Form
5	Cask Handling Crane - Collapse
6	Cask Handling Crane - Cask Drop
7	Cask Handling Crane - Heavy Object Drop
8	Cask Stand - Tipover
9	Cask Transfer Trailer - Tipover

NOTE: DPC = dual-purpose canister; RF = Receipt Facility.

Source: Original

G2.3 CANISTER RECEIPT AND CLOSURE FACILITY

Throughput evaluations for the CRCF are based on schedule estimates from *Preliminary Throughput Study for the Canister Receipt and Closure Facility* (Ref. 2.2.41). The source file is an assessment of activity times for handling TAD, SNF and HLW canisters received at the CRCF. The source file is labeled, "CRCF Initial Throughput Layout-101607-08h05m-FINAL."

The source file was divided into three major parts:

1. Receipt of a TAD cask on railcar at the CRCF, processing of the TAD canister into a waste package and the loading of the waste package into a transport and emplacement vehicle (for transport to the subsurface) entitled, "TAD on Railcar"
2. Receipt of a TAD in a shielded transfer cask at the CRCF, processing of the TAD canister into a waste package and the loading of the waste package into a transport and emplacement vehicle (for transport to the subsurface) entitled, "TAD on STC"
3. Receipt of a HLW and SNF canisters in a transportation casks at the CRCF, processing of the canisters into a single waste package and the loading of the waste package into a transport and emplacement vehicle (for transport to the subsurface) entitled, "DOE SNF and HLW (1 Campaign)."

Again, for each WBS item, four columns in Microsoft Project were copied onto a Microsoft Excel spreadsheet. The four columns transferred into Excel were: (1) WBS number, (2) BFD identification number, (3) task name and (4) activity duration. As the analysis required a different sequence of activities than provided in the source study, the parts of the source study were re-arranged when transferred into the Excel format.

Specifically, residence time analyses examined the following processes:

1. Processing of a TAD canister in the CRCF
2. Processing of SNF and HLW canisters in the CRCF in a nine-stage campaign
3. Processing of MCO and HLW canisters in the CRCF.

A separate Excel workbook was established for each process and is described in the following subsections.

Processing of a TAD canister in the CRCF: The first workbook focuses on two specific sub-processes of the handling a TAD canister: (a) Receipt of a TAD cask on a railcar and transfer of the canister into an aging overpack and (b) Receipt of a TAD canister in an aging overpack and transfer of the TAD canister into a waste package. A spreadsheet was dedicated for each of the sub-process, with the resulting spreadsheets labeled “1-TAD to Aging,” and “2-TAD from Aging.” Activities for receipt of a TAD canister in an aging overpack and handling until placed in a waste package was taken directly from the source file and copied to the second spreadsheet. As the activities for handling a TAD from receipt and transfer to an aging overpack were undefined in the source file, the activities for the first spreadsheet were compiled from other parts of the source file and in a limited number of instances, estimates were made based on the source values for similar activities.⁴ Also, activities and related times for the RHS (under closure of the waste package) were modified from the source file as described for the IHF.

Again, columns were added to the spreadsheets for identified potential hazards that were to be evaluated; these potential hazards are shown in Table G2.3-1. As for other spreadsheets, each of the activities was examined to determine which specific activities (from the source file) could be related to the identified potential hazard. The corresponding activity times were then listed in the appropriate column for the hazard. A summary sheet (labeled “Summary”) was created in this Excel workbook which contains the column totals of the two spreadsheets, providing (for each potential hazard) the residence time of each column, the percentage of total residency time, and the residency time for SAPHIRE input (in years per canister).

⁴ A column providing the line numbers from the source file from where the information was taken and any modifications from the source file was added and is shown at the far right in each of the basic spreadsheets.

Table G2.3-1. Equipment and Related Hazards Evaluated for the Handling TAD Canisters in the CRCF for Receipt on Railcar and Transfer to an Aging Overpack

No.	Equipment - Related Hazard
1	CRCF Structure - Collapse onto Waste Form
2	Entry Door (Rollup & Confinement Doors) - Collapse onto Waste Form
3	Railcar - Collision / Tipover
4	Mobile Platform - Collapse onto Waste Form
5	Cask Handling Crane - Collapse
6	Cask Handling Crane - Cask Drop / Swing
7	Cask Handling Crane - Heavy Object Drop
8	Cask Preparation Platform - Collapse
9	Cask Transfer Trolley - Slide
10	Cask Transfer Trolley - Bump Impact
11	Cask Transfer Trolley - Rocking Impact
12	Shield Doors - Mount Failure
13	Canister Transfer Machine - Collapse onto Waste Form
14	Canister Transfer Machine - Canister Drop
15	Canister Transfer Machine - Heavy Object Drop
16	Canister Transfer Machine - Swing Inside Bell
17	Canister Transfer Machine - Swing Outside Bell
18	Site Transporter - Sliding Impact
19	Site Transporter - Bump Impact

NOTE: CRCF = Canister Receipt and Closure Facility; TAD = transportation, aging and disposal.

Source: Original

Processing of SNF and HLW canisters in the CRCF: The second workbook focuses on the receipt of casks containing SNF and HLW canisters and considers the applicable handling operations to transfer these canisters into a waste package. As there are differences in the number of canisters of SNF received and SNF placed into a waste package, staging of SNF is required for these operations. (A cask of DSNF contains nine canisters while only one SNF canister is inserted into a waste package).

The source file for this evaluation considered a single-stage campaign⁵ of SNF and HLW receipt (i.e. the receipt of one SNF cask and five HLW casks); where at the end of the campaign, eight SNF canisters are left in staging. The current analysis expanded this campaign such that a nine-stage campaign was analyzed, so that at the end of the process, no SNF remains in staging. As this campaign included the repetitive processes of the HLW receipt and SNF transfer from staging several times, the source file was divided into five sheets, and the total campaign described on a summary sheet.

⁵ The term *campaign* is used to describe activities involving multiple receipts of casks at the facility.

Handling operations for the HLW cask and canisters were taken from the source file and placed on a separate spreadsheet, entitled, “4-HLW to WP⁶.” Handling operations for the SNF cask and canisters were further divided into two sheets. One sheet describes the receipt of the SNF cask and movement of the canisters into staging (labeled, “3-SNF import to WP”) and the other spreadsheet describes the movement of SNF from staging into a waste package. As this last task may not always have SNF in staging (for a portion of the time), the second spreadsheet was simply copied, creating a new spreadsheet; the resulting two sheets were labeled, “5A-Staged SNF to WP” and “5B-Staged SNF to WP.” The activities associated with the import of an empty waste package into the facility were also placed a separate spreadsheet as this task was not included with the receipt of HLW canisters. On these spreadsheets, activities and related times for the RHS (under closure of the waste package) were modified from the source file as described for the IHF. On all sheets, a column providing from where the activities were taken and any modifications from the source file was also added. Again, columns were added to the spreadsheets for identified potential hazards that were to be evaluated; these potential hazards are shown in Table G2.3-2. As for other spreadsheets, each of the activities was examined to determine which specific activities (from the source file) could be related to the identified potential hazard. The corresponding activity times were then listed in the appropriate column for the hazard.

A summary sheet (labeled “HLW & SNF Summary”) was created, and segmented to represent a nine-stage campaign:

Stage 1: Receipt of the SNF casks and the movement of one SNF canister into a waste package, together with the receipt of five HLW casks and the movement of HLW canisters into a waste package.⁷

Stages 2-8: The receipt of an empty waste package, followed by the receipt of five HLW casks, the movement of HLW canisters into a waste package, and the movement of one SNF canister from staging into a waste package. SNF is staged in the CRCF.

Stage 9: Similar to Stages 2 through 8, except for consideration the movement of the last SNF canister from staging into a waste package.

The summary spreadsheet contains links to the other spreadsheets as appropriate for each stage and the appropriate hazard. The summary spreadsheet sums the various stages and provides totals (for each potential hazard) of the residence time for each potential hazard, the percentage of total residency time, and the residency time for SAPHIRE input (in years per canister).

⁶ The “4” in the file name refers to fourth tab in the spreadsheet, not the number of HLW canisters to be transferred.

⁷ Note that the analysis consider that SNF is transferred from staging to the waste package only after the HLW canisters have been transferred into the waste package, and an appropriate delay is included in the spreadsheets to reflect this process.

Table G2.3-2. Equipment and Related Hazards Evaluated for Handling of High Level Waste and DOE Spent Nuclear Fuel Canisters in the CRCF

No.	Equipment - Related Hazard
1	Canister Receipt and Closure Facility Structure - Collapse onto Waste Form
2	Entry Door (Rollup & Confinement Doors) - Collapse onto Waste Form
3	Railcar - Tipover
4	Mobile Platform - Collapse onto Waste Form
5	Cask Handling Crane - Collapse
6	Cask Handling Crane - Cask Drop / Swing
7	Cask Handling Crane - Heavy Object Drop
8	Cask Preparation Platform - Collapse
9	Cask Transfer Trolley - Slide
10	Cask Transfer Trolley - Bump Impact
11	Cask Transfer Trolley - Rocking Impact
12	Shield Doors - Mount Failure
13	Canister Transfer Machine - Collapse onto Waste Form
14	Canister Transfer Machine - Canister Drop
15	Canister Transfer Machine - Heavy Object Drop
16	Canister Transfer Machine - Swing Inside Bell
17	Canister Transfer Machine - Swing Outside Bell
18	Canister Staging Racks - Collapse
19	Remote Handling System - Collapse - Lid Unfastened
20	Remote Handling System - Collapse - Lid Fastened
21	Remote Handling System - Heavy Object Drop
22	WP Transfer Trolley - Tipover
23	WP Transfer Trolley - Rocking Impact
24	WP Handling Crane - Collapse
25	WP Handling Crane - Heavy Object Drop
26	Transport and Emplacement Vehicle - Tipover
27	Transport and Emplacement Vehicle - Sliding
28	Transport and Emplacement Vehicle - WP Ejection

NOTE: WP = waste package.

Source: Original

Processing of MCO and HLW canisters in the CRCF: The third workbook considers the receipt of casks containing MCO and HLW canisters and the applicable handling operations to transfer these canisters into a waste package. The activity times for this evaluation are taken from the source file which considered a single-stage campaign of SNF and HLW receipt (e.g., the receipt of one SNF cask and five HLW casks).

The evaluation for this workbook was focused on estimating a three-stage campaign involving the receipt of a loaded HLW transportation cask (containing five canisters) on railcars together with the receipt of a MCO cask (containing four canisters) also on a railcar. The process is

constrained as MCO canisters are not to be staged, and only two MCO canisters are loaded into a single waste package. Therefore, a MCO campaign requires the utilization of both loadout lanes in the CRCF simultaneously. To prevent a HLW canister dropping on a MCO canister, the HLW canisters are imported first and staged, and then four HLW canisters will be moved into the two waste packages (two canisters in each waste package). Then the MCO cask is received and the four MCO canisters are moved into the two waiting waste packages and package are sealed and moved to the loadout. At the end of this campaign one HLW waste canister resides in staging racks.

In constructing this workbook, the activity times to place HLW into staging racks were considered to be essentially equal to the activity times for similar SNF tasks. Similarly, the activity times for MCO handling operations were considered to be essentially equal to the activity times for similar SNF operations. The sections of the source files were employed, with activity titles changed as appropriate.

In detail, handling operations for the receipt HLW cask and movement of the canisters into staging were taken from the source file and placed on a separate spreadsheet, entitled, “6-HLW to Staging.” Handling operations for the movement of the canisters from the staging area into waste packages were taken from the source file and placed on a spreadsheet entitled, “8-Staged HLW to WP [waste package].” Finally, handling operations for the MCO cask and canisters was placed on a separate spreadsheet, entitled, “7-MCO import to WP.” Activities and related times for the remote handling system (under closure of the waste package) were modified from the source file as described for the IHF. To assist traceability, a column providing the line numbers and modifications from the source file from where the information was taken is shown at the far right in each of these spreadsheets.

Columns were added to the detail spreadsheets for identified potential hazards that were to be evaluated; these potential hazards are shown in Table G2.3-3. As for other spreadsheets, each of the activities were examined to determine which specific activities (from the source file) could be related to the identified potential hazard. The corresponding activity times were then listed in the appropriate column for the hazard.

A summary sheet (labeled “MCO & HLW Summary”) was created in this excel workbook which contains the column totals of the three spreadsheets which comprise the campaign. For each spreadsheet, the residence time (for each potential hazard), the percentage of total residency time, and the residency time for SAPHIRE input (in years per canister) is provided. The HLW and MCO activities are summed at the base of the summary spreadsheet.

Table G2.3-3. Equipment and Related Hazards Evaluated for Handling of High Level Waste and Multicanister Overpack Canisters in the CRCF

No.	Equipment - Related Hazard
1	Mobile Platform - Collapse onto Waste Form
2	Cask Handling Crane - Collapse
3	Cask Handling Crane - Cask Drop / Swing
4	Cask Handling Crane - Heavy Object Drop
5	Cask Preparation Platform - Collapse
6	Cask Transfer Trolley - Slide
7	Cask Transfer Trolley - Bump Impact
8	Cask Transfer Trolley - Rocking Impact
9	Shield Doors - Mount Failure
10	Canister Transfer Machine - Collapse onto Waste Form
11	Canister Transfer Machine - Canister Drop
12	Canister Transfer Machine - Heavy Object Drop
13	Canister Transfer Machine - Swing Inside Bell
14	Canister Transfer Machine - Swing Outside Bell
15	Canister Staging Racks - Collapse
16	Remote Handling System - Collapse - Lid Unfastened
17	Remote Handling System - Collapse - Lid Fastened
18	Remote Handling System - Heavy Object Drop
19	WP Transfer Trolley - Tipover
20	WP Transfer Trolley - Rocking Impact
21	WP Handling Crane - Collapse
22	WP Handling Crane - Heavy Object Drop
23	Transport and Emplacement Vehicle - Tipover
24	Transport and Emplacement Vehicle - Sliding
25	Transport and Emplacement Vehicle - WP Ejection

NOTE: CRCF = Canister Receipt and Closure Facility; WP = waste package.

Source: Original

G2.4 WET HANDLING FACILITY

Throughput evaluations for the WHF are based on schedule estimates from *Preliminary Wet Handling Facility Throughput Study* (Ref. 2.2.44). The source file is an assessment of activity times for handling casks and DPCs from receipt to placement of assemblies in the staging rack (in the pool) and the movement of the assemblies into TAD for eventual transfer to aging overpack. The source file is labeled, "WHF Throughput Layout Rev02-102407_15h_05m_FINAL.mpp."

The source file was divided into six parts:

1. Receipt of a truck cask from a PWR, transfer of the assemblies from the cask into staging, movement of the assemblies from staging into a TAD, and the export of the sealed TAD in an aging overpack, under tasks entitled, “TC PWR TAD (in GA-4 Truck Cask).”
2. Receipt of a truck cask from a BWR, transfer of the assemblies from the cask into staging, movement of the assemblies from staging into a TAD, and the export of the sealed TAD in an aging overpack, under tasks entitled, “TC BWR TAD (in GA-4 Truck Cask).”
3. Receipt of a DPC from a PWR in a HI-STAR transportation cask, the opening of the DPC, transfer of the contained assemblies into the staging rack, the movement of the assemblies from staging into a TAD, and the export of the sealed TAD in an aging overpack, under tasks entitled, “Hi-Star PWR DPC TAD.”
4. Receipt of a DPC from a BWR in a HI-STAR transportation cask, the opening of the DPC, transfer of the contained assemblies into the staging rack, the movement of the assemblies from staging into a TAD, and the export of the sealed TAD in an aging overpack, under tasks entitled, “Hi-Star BWR DPC TAD.”
5. Receipt of a DPC from a PWR in a transportation cask loaded on a railcar, the opening of the DPC, transfer of the contained assemblies into the staging rack, the movement of the assemblies from staging into a TAD, and the export of the sealed TAD in an aging overpack, under tasks entitled, “PWR DPC (in Rail Cask).”
6. Receipt of a DPC from a BWR in a transportation cask loaded on a railcar, the opening of the DPC, transfer of the contained assemblies into the staging rack, the movement of the assemblies from staging into a TAD, and the export of the sealed TAD in an aging overpack, under tasks entitled, “BWR DPC (in Rail Cask).”

As the analysis required a different sequence of activities than provided in the source study, the parts of the source study were re-arranged when transferred into the Excel format. Specifically, residence time analyses examined the following processes:

1. Processing of a transportation cask with non-canistered assemblies in the WHF for the eventual transfer into a TAD canister and export of the canister in an aging overpack
2. Processing of a transportation cask with a DPC in the WHF for the eventual transfer into a TAD canister and export of the canister in an aging overpack.

Each part was placed on a separate spreadsheet. The two spreadsheets were labeled “1A-WHF Assembly Rec’d,” and “B-WHF DPC Rec’d” for activities related to two parts respectively. The two spreadsheets were incorporated into a single Excel workbook.

As the source file did not contain a WBS system, a WBS column was generated in Microsoft Project. Then, for each part, four columns in Microsoft Project were copied onto a Microsoft

Excel spreadsheet. The four columns transferred into Excel were: (1) WBS number, (2) BFD identification number, (3) task name and (4) activity duration. After the transfer, the various hierarchical WBS levels of the schedule were color coded to assist in identifying times and prevent double counting.

Thereafter, columns were added to the each spreadsheet for identified potential hazards that were to be evaluated. For handling non-canistered assemblies canisters and placement into a TAD, the list of identified potential hazards is shown in Table G2.4-1. For handling of DPC, the list of identified potential hazards is shown in Table G2.4-2.

At this point, some additional changes were made to activity times to allow for the appropriate input for SAPHIRE. Specifically, the activities for handling of bare assemblies were modified to obtain the exposure times for a handling a single assembly rather than series of assemblies. Similarly, activities for handling a transportation cask or TAD canister were modified to identify the residence times for a single cask or canister. Further, the transfer time for a single assembly was increased to be more conservative.

In addition, some activities were modified to represent the most current operational sequence. This included the reevaluation of the handling activities (and associated residence times) for electro-mechanical snubber-blocks. All changes to the source file were noted in a separate column at the far right of each spreadsheet.

In each spreadsheet, each of the activities was examined to determine which of the activities (from the source file) could be related to the identified potential hazard. For example when considering the potential drop of a cask from the cask handling crane, activities were identified when the cask was being lifted by the crane. The corresponding activity times were then listed in the appropriate column for the hazard.

At the bottom of the spreadsheet, the times for each column are summed to determine the total residence time for the specific potential hazard. The residence time of each column was divided by the residence time of structure collapse to determine the percentage of total residency time. Also, the residence time of each column was divided the number of minutes in a year (i.e., 525,600 minutes/year) and the number of canisters involved in the process to obtain the residency time in years per canister.

Two summary spreadsheet were created, one for each spreadsheet in the excel workbook. The summary page divides the processes in each spreadsheet into four sections:

1. Transfer from the transportation cask to the pool⁸
2. Transfer into the staging rack
3. Transfer out of the staging rack
4. Transfer into a TAD, closure of the canister and export in an aging overpack.

Each summary sheet contains the column totals of the related spreadsheet for each of these sections, providing (for each potential hazard) the residence time of each column, and the residency time for SAPHIRE input (in years per canister). The summary sheet for uncanistered

⁸ For DPCs, the activities include opening of the DPC.

assemblies is labeled, “A-Summary WHF”; for DPCs, the summary sheet is labeled, “B-Summary WHF.”

Table G2.4-1. Equipment and Related Hazards Evaluated for Fuel Assemblies in the WHF

No.	Equipment - Related Hazard
1	Wet Handling Facility Structure - Collapse onto Waste Form
2	Entry Door (Rollup & Confinement Doors) - Collapse onto Waste Form
3	Entrance Vestibule Crane - Collapse
4	Rail / Truck - Collision / Tipover
5	Mobile Access Platform - Collapse
6	Cask Stand - Collapse
7	Transfer Stations - In Pool - Collapse
8	Cask Handling Crane - Collapse
9	Cask Handling Crane - Cask Drop
10	Cask Handling Crane - Heavy Object Drop
11	Auxiliary Crane - Collapse
12	Auxiliary Crane - Heavy Object Drop
13	Preparation Station #1 - Collapse
14	TAD Closure & Preparation Station #2 - Collapse
15	Jib Cranes - Collapse
16	Jib Cranes - Heavy Object Drop
17	DPC Cutting Station - Collapse
18	Spent Fuel Transfer Machine - Collapse
19	Spent Fuel Transfer Machine - Heavy Object Drop
20	Spent Fuel Transfer Machine - SNF Assembly Drop
21	Staging Rack - Collapse
22	Cask Transfer Trolley (Air Pallet) - Slide
23	Cask Transfer Trolley (Air Pallet) - Bump Impact
24	Cask Transfer Trolley (Air Pallet) - Tipover
25	Shield Doors - Mount Failure
26	Canister Transfer Machine - Collapse onto Waste Form
27	Canister Transfer Machine - Canister Drop
28	Canister Transfer Machine - Heavy Object Drop
29	Canister Transfer Machine - Swing Inside Bell
30	Canister Transfer Machine - Swing Outside Bell
31	Aging Overpack Access Platform - Collapse
32	Site Transporter - Sliding Impact
33	Site Transporter - Bump Impact

Source: Original

Table G2.4-2. Equipment and Related Hazards Evaluated for Dual Purpose Canister in the WHF

No.	Equipment - Related Hazard
1	Wet Handling Facility Structure - Collapse onto Waste Form
2	Entry Door (Rollup & Confinement Doors) - Collapse onto Waste Form
3	Entrance Vestibule Crane - Collapse
4	Rail / Truck - Collision / Tipover
5	Mobile Access Platform - Collapse
6	Cask Stand - Collapse
7	Transfer Stations - In Pool - Collapse
8	Cask Handling Crane - Collapse
9	Cask Handling Crane - Cask Drop
10	Cask Handling Crane - Heavy Object Drop
11	Auxiliary Crane - Collapse
12	Auxiliary Crane - Heavy Object Drop
13	Preparation Station #1 - Collapse
14	TAD Closure & Preparation Station #2 - Collapse
15	Jib Cranes - Collapse
16	Jib Cranes - Heavy Object Drop
17	DPC Cutting Station - Collapse
18	Spent Fuel Transfer Machine - Collapse
19	Spent Fuel Transfer Machine - Heavy Object Drop
20	Spent Fuel Transfer Machine - SNF Assembly Drop
21	Staging Rack - Collapse
22	Cask Transfer Trolley (Air Pallet) - Slide
23	Cask Transfer Trolley (Air Pallet) - Bump Impact
24	Cask Transfer Trolley (Air Pallet) - Tipover
25	Shield Doors - Mount Failure

Source: Original

G3 THROUGHPUT TABLES

The remainder of this attachment is the CD containing the throughput estimates for the various facilities. The electronic files contained on the CD are identified below. Note that the first file, Ac 3-06 version.zip, is for Attachment J. The remainder of the files is the throughput tables for Attachment G, and the Attachment G email.

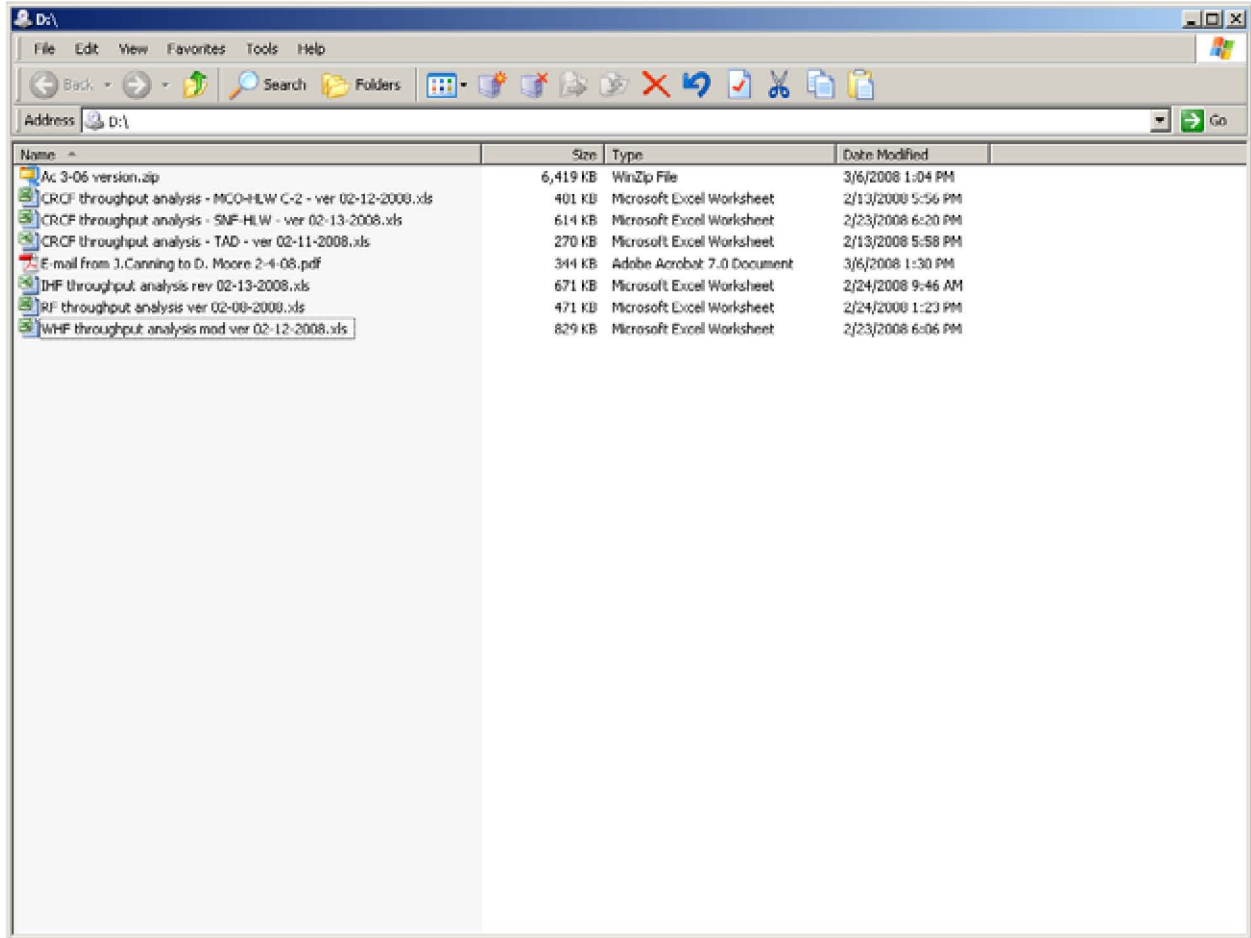

ATTACHMENT H

PASSIVE EQUIPMENT FAILURE ANALYSIS

Many event sequences described in Section 6.1 include pivotal events that arise from loss of integrity of a passive component, namely one of the aging overpacks, casks, or canisters that contain a radioactive waste form. Such pivotal events involve (1) loss of containment of radioactive material that may result in airborne releases, or (2) loss of shielding effectiveness. Both types of pivotal events may be failure modes caused by either physical impact to the container or by thermal energy transferred to the container. This attachment presents the results of passive failure analyses that provide conditional probability of loss of containment or loss of shielding. Many scenarios were selected for analysis as representative or bounding for anticipated scenarios in the risk assessment. Results of some scenarios may not have been used in the event sequence quantification.

H1 LOSS OF CONTAINMENT DUE TO DROPS AND IMPACTS

The category of passive equipment includes canisters and casks used during transport, aging, and disposal of SNF. The canisters and casks contain the spent fuel and provide containment of radioactive material. During transport and handling, the canisters and casks could be subjected to drops, impacts, or fires, which may result in loss of containment. The probabilities of loss of containment due to various physical or thermal challenges are evaluated primarily through structural and thermal analysis and drop test data.

Passive equipment (e.g., transportation casks, storage canisters, and waste packages) may fail from abnormal use such as defined by the event sequences. Studies were performed and passive equipment failure probabilities were determined using the methodologies summarized in Section 4.3.2.2. The probability of loss of containment (breach) was determined for several types of containers, including transportation casks (analyzed without impact limiters), shielded transfer casks, waste packages, TAD canisters, DPCs, DOE standardized canisters, MCOs, HLW canisters, and naval SNF canisters.

This attachment summarizes the results of these studies. The mechanical breach of TAD canisters, DPCs and naval SNF canisters was analyzed as representative canisters as described in Section H1.1. The structural analysis of DSNFs and MCOs for breaches is described in Section H1.2 and then the probabilistic methodology of Section H1.1 was applied. Transportation casks and STCs were analyzed as representative transportation casks as described in Section H1.1. The probabilistic estimation of breach from mechanical loads of all other waste containers is described in Sections H1.3 through H1.6. The analysis of loss or degradation of shielding of casks and overpacks due to impacts is described in Section H2.

H1.1 LAWRENCE LIVERMORE NATIONAL LABORATORY ANALYSIS OF CANISTERS AND CASKS

Lawrence Livermore National Laboratory (LLNL) performed the FEA using Livermore Software–Dynamic Finite Element Program (LS-DYNA) to model drops and impacts for casks and canisters with selected properties for use as representative containers expected to be delivered to Yucca Mountain (Ref. 2.2.71). LS-DYNA, which has been used in nuclear facility

and non-nuclear industrial applications, is appropriate to model nonlinear, transient responses of a passive component to a structural challenge such as a drop or an impact. Existing commercial casks and canisters that would likely be used on the YMP were identified and characterized. The cases analyzed are listed in Table H1.2-1.

Appropriate finite element models were developed for the representative cask, selected container types, configurations, and drop types. The level of detail for each model was selected to understand deformation and damage patterns, possible failure mode(s) in each structural element, and failure-related response. Special attention was required to properly model the bottom-weld and closure regions to ensure that the coarser mesh of the simplified model would capture failure-related response with acceptable accuracy. A consistent failure criterion for each case was identified as part of the detailed analyses. The effective plastic strain (EPS) in each element, in combination with material ductility data, was used to predict failure measures.

The maximum strain for each scenario was compared with the capacity distribution based on material properties to obtain containment failure probabilities using the methodology described in Section 4.3.2.2. For simplicity and consistency in interpreting results, the impact-surface conditions, including both the ground and the falling 10-ton load for the analyses, were considered infinitely stiff and unyielding, which is conservative.

The results of these cases are summarized in Tables H1.2-2 through H1.2-4. The bases for these results are summarized in the following paragraphs. If a probability for the event sequence is less than 1.0×10^{-8} , additional conservatism is incorporated in the PCSA by using a failure probability of 1.0×10^{-5} , which are termed “LLNL, adjusted”. This additional conservatism is added to account for a) future evolutions of cask and canister designs, and b) uncertainties, such as undetected material defects, undetected manufacturing deviations, and undetected damage associated with handling before the container reaches the repository, which are not included in the tensile elongation data.

LLNL developed a fragility curve for the base metal by fitting a mixture of two normal PDFs to the engineering (tensile) strain data (Ref. 2.2.5). Both the data and their corresponding log-transforms were found to be non-normally distributed ($p < 10^{-4}$) by the Shapiro-Wilk test (Ref. 2.2.105). These data collected at 100°F were determined to be reasonably well modeled as a sample from a weighted mixture of two normal distributions, one with a mean of 46% and a standard deviation of 2.24% (weight = 7.84%), and the other with a mean of 59.3% and a standard deviation of 4.22% (weight = 92.16%), with the goodness of fit ($p = 0.939$) assessed by the Kolmogorov-Smirnov 1 sample test (Ref. 2.2.88).

The stainless steel used in the LLNL (Ref. 2.2.71) analysis is Alloy 304L. The un-annealed alloys have relatively shorter elongations at failure than annealed 304L. Therefore, the base fragility CDF model was adjusted to different steels used in a typical design and to meet the code specification of the material model used in LS-DYNA. The adjustment consisted of shifting the distribution by -8.3% (Ref. 2.2.71, p. 93). Thus the initial fragility curve was shifted by 8.3% to a lower value of minimum elongation. The fragility curves before and after the shift are shown in Figure H1.1-1 and tabulated in Table H1.1-1. 316L stainless steel might be used for construction of some canisters and casks, but the stress-strain curves would be similar.

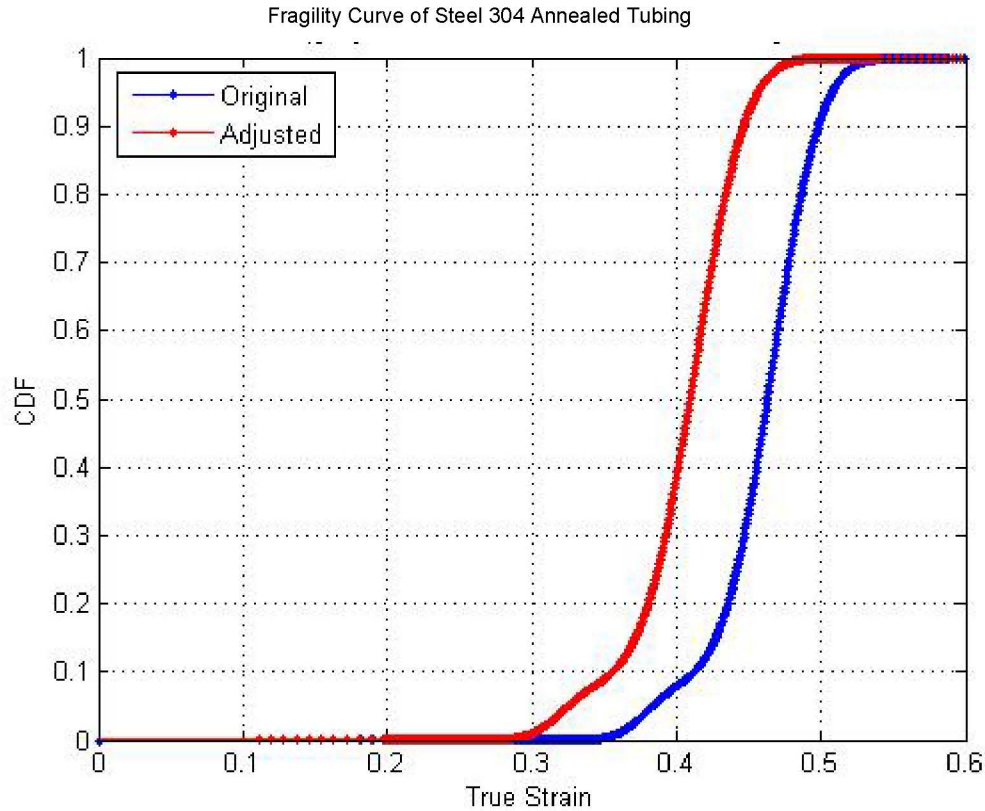

Source: (Ref. 2.2.71, Figure 6.3.7-3)

Figure H1.1-1. Original and Shifted Cumulative Distribution Functions (CDF) for Capacity (or Fragility) Plotted as a Function of True Strain

Table H1.1-1. Probability of Failure versus True Strain Tabulated for Figure H1.1-1

True Strain (TS)	$\frac{TS - TS_{mean}}{TS_{std}}$	Probability of Failure Original	Probability of Failure Adjusted (-8.3% shift)	True Strain (TS)	$\frac{TS - TS_{mean}}{TS_{std}}$	Probability of Failure Original	Probability of Failure Adjusted (-8.3% shift)
0.00	-1.70	0.0000E+00	1.6754E-15	0.36	0.05	1.0506E-02	1.0973E-01
0.01	-1.65	2.0924E-16	1.8688E-15	0.37	0.10	2.3978E-02	1.4282E-01
0.02	-1.60	4.1848E-16	2.0622E-15	0.38	0.15	4.3259E-02	1.9679E-01
0.03	-1.55	6.2772E-16	2.2555E-15	0.39	0.19	6.2863E-02	2.7687E-01
0.04	-1.50	8.3696E-16	2.4489E-15	0.40	0.24	7.9100E-02	3.8310E-01
0.05	-1.45	1.0462E-15	2.6422E-15	0.41	0.29	9.5539E-02	5.0814E-01
0.06	-1.41	1.2554E-15	2.8356E-15	0.42	0.34	1.2068E-01	6.3823E-01
0.07	-1.36	1.4647E-15	3.0290E-15	0.43	0.39	1.6410E-01	7.5736E-01
0.08	-1.31	1.6739E-15	3.2223E-15	0.44	0.44	2.3393E-01	8.5309E-01
0.09	-1.26	1.8832E-15	3.4157E-15	0.45	0.48	3.3371E-01	9.2036E-01
0.10	-1.21	2.0924E-15	3.6090E-15	0.46	0.53	4.5893E-01	9.6161E-01
0.11	-1.16	2.3016E-15	3.8024E-15	0.47	0.58	5.9615E-01	9.8363E-01

Table H1.1-1. Probability of Failure versus True Strain Tabulated for Figure H1.1-1 (Continued)

True Strain (TS)	$\frac{TS - TS_{mean}}{TS_{std}}$	Probability of Failure Original	Probability of Failure Adjusted (-8.3% shift)	True Strain (TS)	$\frac{TS - TS_{mean}}{TS_{std}}$	Probability of Failure Original	Probability of Failure Adjusted (-8.3% shift)
0.12	-1.11	2.5109E-15	2.8601E-14	0.48	0.63	7.2682E-01	9.9385E-01
0.13	-1.07	2.7201E-15	2.3645E-13	0.49	0.68	8.3454E-01	9.9797E-01
0.14	-1.02	2.9294E-15	1.6225E-12	0.50	0.73	9.1117E-01	9.9941E-01
0.15	-0.97	3.1386E-15	9.7686E-12	0.51	0.78	9.5806E-01	9.9985E-01
0.16	-0.92	3.3478E-15	5.2952E-11	0.52	0.82	9.8270E-01	9.9997E-01
0.17	-0.87	3.5571E-15	2.6233E-10	0.53	0.87	9.9379E-01	9.9999E-01
0.18	-0.82	3.7663E-15	1.2513E-09	0.54	0.92	9.9807E-01	1.0000E+00
0.19	-0.78	2.1733E-14	6.9107E-09	0.55	0.97	9.9948E-01	1.0000E+00
0.20	-0.73	2.1209E-13	2.6769E-08	0.56	1.02	9.9988E-01	1.0000E+00
0.21	-0.68	1.7358E-12	1.1600E-07	0.57	1.07	9.9998E-01	1.0000E+00
0.22	-0.63	1.1373E-11	4.8126E-07	0.58	1.11	1.0000E+00	1.0000E+00
0.23	-0.58	6.4625E-11	1.9316E-06	0.59	1.16	1.0000E+00	1.0000E+00
0.24	-0.53	4.1126E-10	7.5246E-06	0.60	1.21	1.0000E+00	1.0000E+00
0.25	-0.48	2.4773E-09	2.8566E-05	0.61	1.26	1.0000E+00	1.0000E+00
0.26	-0.44	1.2132E-08	1.0566E-04	0.62	1.31	1.0000E+00	1.0000E+00
0.27	-0.39	5.2343E-08	3.7635E-04	0.63	1.36	1.0000E+00	1.0000E+00
0.28	-0.34	2.4478E-07	1.2625E-03	0.64	1.41	1.0000E+00	1.0000E+00
0.29	-0.29	1.0945E-06	3.8474E-03	0.65	1.45	1.0000E+00	1.0000E+00
0.30	-0.24	4.7123E-06	1.0185E-02	0.66	1.50	1.0000E+00	1.0000E+00
0.31	-0.19	1.9709E-05	2.2466E-02	0.67	1.55	1.0000E+00	1.0000E+00
0.32	-0.15	7.9860E-05	4.0237E-02	0.68	1.60	1.0000E+00	1.0000E+00
0.33	-0.10	3.1104E-04	5.9110E-02	0.69	1.65	1.0000E+00	1.0000E+00
0.34	-0.05	1.1366E-03	7.5125E-02	0.70	1.70	1.0000E+00	1.0000E+00
0.35	0.00	3.7379E-03	8.9858E-02				

NOTE: The mean for true strain is 0.35, shown in bold. The standard deviation (std) of true strain is 0.21.

Source: (Ref. 2.2.71, Table 6.3.7.3-1).

The weldment at best can have the same mechanical properties as the hosting metal (native metal), but it is usually more brittle than the hosting metal. The failure likelihood of the weldment substructure was considered, reflecting weighting factors of both 1.0 and 0.75 applied to estimated true strain at failure.

The capacity function is based on coupon tensile strength tests in uniaxial tension. However, cracking of a stainless steel may not be determined simply by comparing the calculated plastic strain to the true strain of failure, because the EPS is calculated from a complex 3-D state of stress, while the true strain at failure was based on data from a 1-D state of stress. A 3-D state of stress may constrain plastic flow in the material and lower the EPS at which failure occurs. This loss of ductility is accounted for by the use of a triaxiality factor, which is the ratio of normal stress to shear stress on the octahedral plane, normalized to unity for simple tension. For the purpose of determining the probability of structural failure, LLNL (Ref. 2.2.71) set the ductility ratio to 0.5. This is equivalent to a triaxiality factor of 2, which corresponds to a state of biaxial tension.

Failure of containment can occur when strain in a component is of sufficient magnitude that it results in breakage or puncture of the container. The probability of failure is calculated based on the maximum strain for a single finite element brick obtained from LS-DYNA simulations. Fracture propagation takes place on the milliseconds time-scale and thus propagates across the canister wall thickness very quickly, compared to the time-frame of the LS-DYNA simulations. Furthermore, the fragility curve is obtained on the basis of a maximum average strain over the thickness of the respective specimens, which are 2 in. long stainless steel 304L specimens. Although LS-DYNA results provide multiple values of the strain through the thickness of the canister wall (the wall thickness being represented by multiple finite element layers), it is more conservative to use the maximum strain value at a single finite element brick than the average of the multiple values across the thickness of the wall.

The probability of failure for each impact scenario is evaluated by finding the maximum strain at a location in which a through-wall crack would constitute a radionuclide release. A probability of failure is determined from the CDF of capacity or fragility curve (as discussed below) from the global maximum strain.

A conservative approach and aid to computational efficiency is achieved by performing calculations focusing on the regions of the container having high strain (and deformation) after a drop (“hot zones”). An importance sampling strategy was used which places greater-than-random emphasis on ranges of input-variable values, and/or on combinations of such value ranges, that are more likely to affect output. This approach is an alternative to Monte Carlo methods with the important advantage that possible combinations of upper-bound variable values are in fact incorporated into each probabilistic estimate of expected model output (which is not always guaranteed by uniform sampling).

Using the general probabilistic approach summarized here, LLNL (Ref. 2.2.71) calculated failure probabilities for representative canisters in an aging overpack, and in a transportation cask, and for the representative canister itself as presented in Tables H1.2-2 through H1.2-5. For the drop of a 10-metric ton load onto a cask, the falling mass is modeled as a rigid (unyielding) wall, oriented normal to longitudinal axis of the cask.

H1.2 IDAHO NATIONAL LABORATORY ANALYSIS OF SPENT NUCLEAR FUEL CANISTERS AND MULTICANISTER OVERPACKS

Drop tests of prototype canisters conducted by the Idaho National Laboratory (INL) confirmed that the stainless steel shell material can undergo significant strains without material failure leading to loss of containment. These drop tests also validated analytical models used to predict strains under various drop scenarios. Table H1.2-6 shows scenarios selected to address potential drop scenarios at YMP facilities and the predicted strains.

INL performed FEA (using ABAQUS/Explicit, which, like LS-DYNA, has been used in nuclear facility and non-nuclear industrial applications, and is appropriate to model nonlinear, transient responses of a passive component to a structural challenge such as a drop or an impact) of 23-foot drops, three degrees off vertical, to determine the extent of strain at various positions in the bottom head, cylindrical shell, and joining weld. The strain was evaluated and reported for the inside, outside, and middle layers (Ref. 2.2.107). The DSNF canisters were modeled at 300°F, the maximum skin temperature expected due to the heat evolved by the fuel (based on review of thermal analyses performed by transportation casks vendors), resulting in diminished casing material strength. It was found that greater strains would be expected in the MCOs at ambient temperatures than at elevated temperatures.

During a canister drop event, the majority of the kinetic energy at impact performs work on the material, which causes the worst locations to exhibit plastic strain. A good measure of this work is equivalent plastic strain, which is a cumulative strain measure that takes into account the deformation history starting at impact. From the peak equivalent plastic strain, LLNL (Ref. 2.2.71) developed failure probabilities using the method described in Section H1.1 for an 18 in. and 24 in. DOE standard canister and a MCO. Results are summarized in Table H1.2-7.

Table H1.2-1. Container Configurations and Loading Conditions

Container	Configuration	Drop Type/Impact Condition ^a	Drop Height
AO (aging overpack) cell with canister inside	Representative canister inside AO	A IC 1: End with vertical orientation	3-ft vertical
		A IC 2: Slapdown from a vertical orientation and 2.5 mph horizontal velocity	0-ft vertical
Transportation cask with spent nuclear fuel (SNF) canister inside	Representative canister inside representative cask	T IC 1a: End, with 4 degree off-vertical orientation	12-ft vertical
		T.IC 1b: Same as T.IC 1a	13.1-ft vertical
		T.IC 1c: Same as T.IC 1a	30-ft vertical
		T IC 2a: End, with 4 degree off-vertical orientation, and approximated slapdown	13.1-ft vertical
		T.IC 2b: Same as T.IC 2a, with no free fall	0-ft vertical
		T IC 3: Side, with 3 degree off-horizontal orientation	6-ft vertical
DPC (Dual-purpose canister) TAD (Transportation, aging, and disposal) canister	Representative canister	D IC 1a: End, with vertical orientation	32.5-ft vertical
		D IC 1b: Same as D.IC 1a	40-ft vertical
		D IC 2a: End, with 4 degree off-vertical orientation	23-ft vertical
		D IC 2b: Same as D.IC 2a	10-ft vertical
		D IC 2c: Same as D.IC 2a	5-ft vertical
		D IC 3: 40 ft/min horizontal collision inside the CTM bell	No drop
		D IC 4: Drop of 10-metric ton load onto top of canister	10-ft vertical
		D.IC 2a: Hourglass-control study for end drop, with 4 degree off-vertical orientation	23-ft vertical
		D.IC 2a: Friction coefficient sensitivity study for end drop, with 4 degree off-vertical orientation	23-ft vertical
		D.IC 2a: Mesh density study for end drop, with 4 degree off-vertical orientation	23-ft vertical
D.IC 2a: Shell- and bottom-lid-thickness sensitivity study for end drop, with 4 degree off-vertical orientation	23-ft vertical		
DSNF (DOE spent nuclear fuel) canister	INL-analyzed case	O.IC 1: End, with a 3-degree-off vertical orientation	23-ft vertical

NOTE: A = aging overpack (AO); CTM = canister transfer machine; ft = foot; D = dual-purpose canister; IC = impact condition; min = minute; mph = miles per hour; O = DOE SNF canister; SNF = spent nuclear fuel; T = transportation cask.

Source: Ref. 2.2.71, Table 4.3.3-1a.

Table H1.2-2. Failure Probabilities with and without Triaxiality Factor, with and without the Fragility Curve Adjustment, for Representative Canister within an Aging Overpack

Container Type/ Impact Condition ^a	Impact Condition Description	Max EPS ^b	Failure Probability ^b			
			Original CDF Fragility Curve w/o Adjustment		CDF Fragility Curve Adjusted for Minimum Elongation (-8.3% Shift)	
			w/o Triaxiality	with Triaxiality	w/o Triaxiality	with Triaxiality
A.IC 1	3-ft end drop, with vertical orientation	0.16%	$<1 \times 10^{-8}$	$<1 \times 10^{-8}$	$<1 \times 10^{-8}$	$<1 \times 10^{-8}$
A.IC 2	Slapdown from a vertical orientation and 2.5-mph horizontal velocity	0.82%	$<1 \times 10^{-8}$	$<1 \times 10^{-8}$	$<1 \times 10^{-8}$	$<1 \times 10^{-8}$

NOTE: ^a“A” stands for aging overpack. “IC” stands for impact condition, which are defined in Table H1.2-1.
^bValues of maximum effective plastic strain (EPS) and failure probability are applicable to the SNF canister.

Source: Ref. 2.2.71, Table 6.3.7.6-1.

Table H1.2-3. Failure Probabilities with and without Triaxiality Factor, with and without Fragility Curve Adjustment, for Representative Canister

Container Type/ Impact Condition ^a	Impact Condition Description	Max EPS ^b	Failure Probability ^b			
			Original CDF Fragility Curve w/o Adjustment		CDF Fragility Curve Adjusted for Minimum Elongation (-8.3% Shift)	
			w/o Triaxiality	with Triaxiality	w/o Triaxiality	with Triaxiality
D.IC 1a	32.5-ft end drop, with vertical orientation	2.13%	$<1 \times 10^{-8}$	$<1 \times 10^{-8}$	$<1 \times 10^{-8}$	$<1 \times 10^{-8}$
D.IC 1b	40-ft end drop, with vertical orientation	2.65%	$<1 \times 10^{-8}$	$<1 \times 10^{-8}$	$<1 \times 10^{-8}$	$<1 \times 10^{-8}$
D.IC 2a	23-ft end drop, with 4-degree off-vertical orientation	24.19%	$<1 \times 10^{-8}$	7.71×10^{-1}	9.72×10^{-6}	9.96×10^{-1}
D.IC 2b	10-ft end drop, with 4-degree off-vertical orientation	19.71%	$<1 \times 10^{-8}$	7.01×10^{-2}	1.73×10^{-8}	3.19×10^{-1}
D.IC 2c	5-ft end drop, with 4-degree off-vertical orientation	15.76%	$<1 \times 10^{-8}$	4.10×10^{-5}	$<1 \times 10^{-8}$	3.12×10^{-2}
D.IC 3	40-ft/min horizontal side collision	0.16%	$<1 \times 10^{-8}$	$<1 \times 10^{-8}$	$<1 \times 10^{-8}$	$<1 \times 10^{-8}$
D.IC 4	10-ft drop of 10-metric-ton load onto top of canister	0.75%	$<1 \times 10^{-8}$	$<1 \times 10^{-8}$	$<1 \times 10^{-8}$	$<1 \times 10^{-8}$
D.IC 2a S1-L1	Same as D.IC 2a	24.19%	$<1 \times 10^{-8}$	7.71×10^{-1}	9.72×10^{-6}	9.96×10^{-1}

Table H1.2-3. Failure Probabilities with and without Triaxiality Factor, with and without Fragility Curve Adjustment, for Representative Canister (Continued)

Container Type/ Impact Condition ^a	Impact Condition Description	Max EPS ^b	Failure Probability ^b			
			Original CDF Fragility Curve w/o Adjustment		CDF Fragility Curve Adjusted for Minimum Elongation (-8.3% Shift)	
			w/o Triaxiality	with Triaxiality	w/o Triaxiality	with Triaxiality
D.IC 2a S2-L1	Same as D.IC 2a	21.52%	$<1 \times 10^{-8}$	1.66×10^{-1}	2.44×10^{-7}	7.62×10^{-1}
D.IC 2a S3-L1	Same as D.IC 2a	16.53%	$<1 \times 10^{-8}$	3.37×10^{-4}	$<1 \times 10^{-8}$	6.02×10^{-2}
D.IC 2a S1-L2	Same as D.IC 2a	23.34%	$<1 \times 10^{-8}$	5.52×10^{-1}	3.07×10^{-6}	9.78×10^{-1}
D.IC 2a S1-L3	Same as D.IC 2a	25.15%	$<1 \times 10^{-8}$	9.28×10^{-1}	3.48×10^{-5}	1.00
D.IC 2a S2-L3	Same as D.IC 2a	22.57%	$<1 \times 10^{-8}$	3.50×10^{-1}	1.07×10^{-6}	9.28×10^{-1}
D.IC 2a S3-L3	Same as D.IC 2a	18.08%	$<1 \times 10^{-8}$	1.22×10^{-2}	$<1 \times 10^{-8}$	1.14×10^{-1}
D.IC 2a S2-L4	Same as D.IC 2a	24.07%	$<1 \times 10^{-8}$	7.44×10^{-1}	8.27×10^{-6}	9.95×10^{-1}
D.IC 2a S3-L4	Same as D.IC 2a	19.50%	$<1 \times 10^{-8}$	6.29×10^{-2}	1.37×10^{-8}	2.77×10^{-1}

NOTE: ^a "D" stands for dual-purpose canister. "IC" stands for impact condition, which are defined in Table H1.2-1.

See Table 6.3.3.5-1 in Ref. 2.2.71 for definitions of H1, F1, M1, etc. See Table 6.3.3.6-1 in Ref. 2.2.71 for definitions of S1, L1, etc.

^b Values of maximum effective plastic strain (EPS) and failure probability are applicable to the SNF canister. A range of canister shell and bottom plate thicknesses were evaluated. The values shown are for the configuration that yielded the highest strains (0.5-inch shell thickness and 2.313 inch bottom plate thickness)

Source: Ref. 2.2.71, Table 6.3.7.6-3

Table H1.2-4. Failure Probabilities with and without Triaxiality Factor, with and without the Fragility Curve Adjustment, for the Representative Canister inside the Transportation Cask

Container Type/ Impact Condition ^a	Impact Condition Description	Max EPS ^b	Failure Probability ^b			
			Original CDF Fragility Curve w/o Adjustment		CDF Fragility Curve Adjusted for Minimum Elongation (-8.3% Shift)	
			w/o Triaxiality	with Triaxiality	w/o Triaxiality	with Triaxiality
T.IC 1a	12-ft end drop, with 4-degree off-vertical orientation	3.53%	$<1 \times 10^{-8}$	$<1 \times 10^{-8}$	$<1 \times 10^{-8}$	$<1 \times 10^{-8}$
T.IC 1b	13.1-ft end drop, with 4-degree off-vertical orientation	4.06%	$<1 \times 10^{-8}$	$<1 \times 10^{-8}$	$<1 \times 10^{-8}$	$<1 \times 10^{-8}$
T.IC 1c	30-ft end drop, with 4-degree off-vertical orientation	5.77%	$<1 \times 10^{-8}$	$<1 \times 10^{-8}$	$<1 \times 10^{-8}$	$<1 \times 10^{-8}$
T.IC 2a	13.1-ft end drop, with 4-degree off-vertical orientation, and approximated slapdown	4.35%	$<1 \times 10^{-8}$	$<1 \times 10^{-8}$	$<1 \times 10^{-8}$	$<1 \times 10^{-8}$
T.IC 2b	Approximated slapdown from vertical orientation	1.25%	$<1 \times 10^{-8}$	$<1 \times 10^{-8}$	$<1 \times 10^{-8}$	$<1 \times 10^{-8}$
T.IC 3	6-ft side drop, with 3-degree off-horizontal orientation	2.07%	$<1 \times 10^{-8}$	$<1 \times 10^{-8}$	$<1 \times 10^{-8}$	$<1 \times 10^{-8}$
T.IC 4	10-ft drop of 10-metric-ton load onto top of cask	0.96%	$<1 \times 10^{-8}$	$<1 \times 10^{-8}$	$<1 \times 10^{-8}$	$<1 \times 10^{-8}$
T.IC 5a	30-ft end drop, with vertical orientation	3.55%	$<1 \times 10^{-8}$	$<1 \times 10^{-8}$	$<1 \times 10^{-8}$	$<1 \times 10^{-8}$
T.IC 5b	30-ft end drop, with 4-degree off-vertical orientation	5.77%	$<1 \times 10^{-8}$	$<1 \times 10^{-8}$	$<1 \times 10^{-8}$	$<1 \times 10^{-8}$
T.IC 5c	30-ft end drop, with 45-degree off-vertical orientation	6.41%	$<1 \times 10^{-8}$	$<1 \times 10^{-8}$	$<1 \times 10^{-8}$	$<1 \times 10^{-8}$
T.IC 5d	30-ft end drop, with center of gravity over corner (i.e., point of impact)	6.63%	$<1 \times 10^{-8}$	$<1 \times 10^{-8}$	$<1 \times 10^{-8}$	$<1 \times 10^{-8}$

NOTE: ^a“T” stands for transportation cask. “IC” stands for impact condition, which are defined in Table H1.2-1.

^bValues of Max EPS and failure probability are applicable to the SNF canister.

Source: Ref. 2.2.71, Table 6.3.7.6-2

Table H1.2-5. Failure Probabilities with and without Triaxiality Factor, with and without the Fragility Curve Adjustment, for the Transportation Cask

Container Type/Impact Condition ^a	Impact Condition Description	Max EPS ^b	Failure Probability ^b	
			CDF Fragility Curve Adjusted for Minimum Elongation (-8.3% Shift)	
			w/o Triaxiality	with Triaxiality
T.IC 1a	12-ft end drop, with 4-degree off-vertical orientation	9.20%	$<1 \times 10^{-8}$	$<1 \times 10^{-8}$
T.IC 1b	13.1-ft end drop, with 4-degree off-vertical orientation	9.37%	$<1 \times 10^{-8}$	$<1 \times 10^{-8}$
T.IC 1c	30-ft end drop, with 4-degree off-vertical orientation	11.25%	$<1 \times 10^{-8}$	9×10^{-7}
T.IC 2a	13.1-ft end drop, with 4-degree off-vertical orientation, and approximated slapdown	9.94% ^c	$<1 \times 10^{-8}$	3×10^{-8}
T.IC 2b	Approximated slapdown from vertical orientation	5.30% ^c	$<1 \times 10^{-8}$	$<1 \times 10^{-8}$
T.IC 3	6-ft side drop, with 3-degree off-horizontal orientation	7.42% ^c	$<1 \times 10^{-8}$	$<1 \times 10^{-8}$
T.IC 4	10-ft drop of 10-metric-ton load onto top of cask	1.76%	$<1 \times 10^{-8}$	$<1 \times 10^{-8}$
T.IC 5a	30-ft end drop, with vertical orientation	3.17%	$<1 \times 10^{-8}$	$<1 \times 10^{-8}$
T.IC 5b	30-ft end drop, with 4-degree off-vertical orientation	11.25%	$<1 \times 10^{-8}$	9×10^{-7}
T.IC 5c	30-ft end drop, with 45-degree off-vertical orientation	70.56% ^c	1	1
T.IC 5d	30-ft end drop, with center of gravity over corner (i.e., point of impact)	44.88%	9×10^{-1}	1

NOTE: ^a "T" stands for transportation cask. "IC" stands for impact condition, which are defined in Table H1.2-1.

^b Values of maximum effective plastic strain (EPS) and failure probability are applicable to the structural body of a transportation cask which excludes the shield and shield shell. Values of EPS are from Ref. 2.2.71, Table 6.3.7.6-2.

^c Maximum strain in cask body (causing loss of containment) as opposed to complete cask assembly.

Source: Probabilities calculated using Table H1.1-1 based on strains reported in Ref. 2.2.71, Table 6.3.7.6-2.

Table H1.2-6. Strains at Various Canister Locations Due to Drops

Canister	Component	Maximum PEEQ Strains (%)			Load Case/ Conditions
		Outside Surface	Mid-Surface	Inside Surface	
18-inch DOE STD canister	Lower head	8	3	6	300°F, 23-foot drop, 3 degrees off-vertical Material: ASME Code minimum strengths
	Lower head-to-main shell weld	2	2	3	
	Main shell	2	2	3	
	Upper head-to-main shell weld	0	0	0	
	Upper head	1	0.2	2	
24-inch DOE STD canister	Lower head	2	0.7	1	300°F, 23-foot drop, 3 degrees off-vertical Material: ASME Code minimum strengths
	Lower head-to-main shell weld	0.2	0.3	0.5	
	Main shell	0.2	0.3	0.5	
	Upper head-to-main shell weld	0	0	0	
	Upper Head	0	0	0	
MCO	Lower head	35	16	14	70°F, 23-foot drop, 3 degrees off-vertical Material: Actual material properties (significantly higher than ASME Code minimums)
	Lower head-to-main shell weld	21	11	11	
	Main shell	13	15	29	
	Upper head-to-main shell weld	0	0	0	
	Upper head	0	0	0	

NOTE: ASME = American Society of Mechanical Engineers; DOE STD = U.S. Department of Energy standard; MCO = multiccanister overpack; PEEQ = peak equivalent.

Source: Ref. 2.2.107, Tables 13, 14, and 16

Table H1.2-7. Failure Probabilities for the DOE Spent Nuclear Fuel (DSNF) Canisters and Multicanister Overpack (MCO)

Component	Peak Equivalent Plastic Strain (%)			Probability of Failure					
				Original CDF			CDF adjusted to min elongation		
	Outside Surface	Middle	Inside Surface	Outside Surface	Middle	Inside Surface	Outside Surface	Middle	Inside Surface
18-inch standard canister containment PEEQ strains, 3 degrees off vertical drop, 300°F									
Lower Head	8	3	6	<1E-08	<1E-08	<1E-08	<1E-08	<1E-08	<1E-08
Lower Head-to-Main Shell Weld	2	2	3	<1E-08	<1E-08	<1E-08	<1E-08	<1E-08	<1E-08
Main Shell	2	2	3	<1E-08	<1E-08	<1E-08	<1E-08	<1E-08	<1E-08
Upper Head-to-Main Shell Weld	0	0	0	<1E-08	<1E-08	<1E-08	<1E-08	<1E-08	<1E-08
Upper Head	1	0.2	2	<1E-08	<1E-08	<1E-08	<1E-08	<1E-08	<1E-08
24-inch standard canister containment PEEQ strains, 3 degrees off vertical drop, 300°F									
Lower Head	2	0.7	1	<1E-08	<1E-08	<1E-08	<1E-08	<1E-08	<1E-08
Lower Head-to-Main Shell Weld	0.2	0.3	0.5	<1E-08	<1E-08	<1E-08	<1E-08	<1E-08	<1E-08
Main Shell	0.2	0.3	0.5	<1E-08	<1E-08	<1E-08	<1E-08	<1E-08	<1E-08
Upper Head-to-Main Shell Weld	0	0	0	<1E-08	<1E-08	<1E-08	<1E-08	<1E-08	<1E-08
Upper Head	0	0	0	<1E-08	<1E-08	<1E-08	<1E-08	<1E-08	<1E-08
4 MCO containment PEEQ strains, 3 degrees off vertical drop, 70°F									
Bottom	35	16	14	3.74E-03	<1E-08	<1E-08	8.99E-02	<1E-08	<1E-08
Bottom-to-Main Shell	21	11	11	<1E-08	<1E-08	<1E-08	1.16E-07	<1E-08	<1E-08
Main Shell	13	15	29	<1E-08	<1E-08	1.09E-06	<1E-08	<1E-08	3.85E-03
Collar	0	0	0	<1E-08	<1E-08	<1E-08	<1E-08	<1E-08	<1E-08
Cover	0	0	0	<1E-08	<1E-08	<1E-08	<1E-08	<1E-08	<1E-08

NOTE: ASME = American Society of Mechanical Engineers; CDF = cumulative distribution function; DOE STD = U.S. Department of Energy standard; MCO = multicanister overpack; PEEQ = peak equivalent.

Source: Ref. 2.2.107, Tables 6.3.7.6-4 and 6.3.7.6-5

H1.3 PROBABILITIES OF FAILURE OF HIGH LEVEL WASTE CANISTERS DUE TO DROPS

The probability of failure for drops of HLW canisters was assessed by evaluating actual drop test data. Several series of tests were conducted including vertical, top, and corner drops of steel containers. The reports on these tests are summarized in *Leak Path Factors for Radionuclide Releases from Breached Confinement Barriers and Confinement Areas* (Ref. 2.2.34). No leaks were found after 27 tests, 14 of which were from 23 feet and 13 of which were from 30 feet. These tests can be interpreted as a series of Bernoulli trials, for which the outcome is the breach, or not, of the tested canister. The observation of zero failures in 13 tests was interpreted using a beta-binomial conjugate distribution Bayes analysis.

A uniform prior distribution, which indicates prior knowledge that the probability of failure is between 0 and 1, may be represented as a Beta(r,s) distribution in which both r and s equals 1. The conjugate pair likelihood function for a Beta(r,s) distribution is a Binomial(n, N) where n represents the number of failures within the tests and N represents the number of tests. The posterior distribution resulting from the conjugate pairing is also a Beta distribution with parameters r' and s', which are defined as follows:

$$r' = r + n \quad \text{and} \quad s' = s + N - n \quad (\text{Eq. H-1})$$

The mean, μ , and standard deviation, σ , of the posterior distribution are determined using the following equations:

$$\mu = r' / (r' + s') \quad \text{and} \quad \sigma = \{r's' / [(r' + s' + 1)(r' + s')^2]\}^{1/2} \quad (\text{Eq. H-2})$$

For n = 0 and N = 13, Equation H-2 results in $\mu = 0.067$ and $\sigma = 0.062$. For n = 0 and N = 27, $\mu = 0.034$ and $\sigma = 0.033$. These values are used for the failure probability of a dropped HLW canister, for example during its transfer by a canister transfer machine.

One element of the Nuclear Safety Design Basis (Section 6.9) requires that the transportation cask, which will deliver HLW and DSNF canisters, be designed to preclude contact between the canister and a transportation cask lid or other heavy object that might fall. Similarly, other large heavy objects are precluded from damaging these canisters, when residing within a co-disposal waste package by the design of the waste package, which includes separator plates that extend well above the canisters. These scenarios are not quantitatively analyzed herein.

The combined INL and LLNL analyses discussed previously conclude that a DSNF canister has a probability of breach less than 1E-08 for a 23-foot drop, 4 degrees off-normal (i.e., 4 degrees from vertical) onto an unyielding rigid surface. The LLNL results demonstrate that generally strains from impact and probability of failure is higher for off-normal drops than normal (i.e., vertical) drops for the same height. The LLNL results further show that a 10 ton load dropped from 10 feet onto a representative canister also results in a probability of breach of less than 1E-08. INL analysis EDR-NSNF-087 entitled *Qualitative Analysis of the Standardized DSNF Canister for Specific Canister-on-Canister Drop Events at the Repository* states that canister integrity was maintained for a 30-foot drop test onto a rigid, unyielding surface. The report discusses drop of a HLW canister on a DSNF canister and drop of a DSNF canister onto another

one. Drops of these canisters onto canisters in the IHF or CRCF would occur with drop heights of less than 10 feet. Two main differences are noted between a drop of a DSNF and a drop of a HLW canister onto a DSNF. The first is that substantially lower kinetic energy of impact of the latter drop would result in significantly less skirt deformation. The non-flat bottom nature of the HLW/DSNF interaction would have a different skirt deformation pattern than the flat bottomed drop. INL concludes that the skirt would be expected to absorb the bulk of the heaviest HLW canister (4.6 tons) drop energy and DSNF canister integrity would be maintained. A difference between a 10-ton drop of a load onto a representative canister and a drop onto a DSNF canister results from the difference diameters of the target as well as different materials and lid thicknesses. Nevertheless, INL concludes that the impact from 10 feet of a HLW canister onto a DSNF canister is less challenging than impact from a 30-foot drop. Since the probability from a 23-foot drop was calculated to be less than 1E-08, it is conservative to use a value of 1E-05 for the probability of failure of an HLW on DSNF impact. The increased value is assigned to account for uncertainties owing to the differences noted above.

H1.4 PROBABILITIES OF FAILURE OF WASTE PACKAGES DUE TO DROPS AND IMPACTS

The probabilities of containment failure are evaluated by comparing the challenge load with the capacity of the waste package to withstand that challenge in a manner similar to that described in *Interim Staff Guidance HLWRS-ISG-02, Preclosure Safety Analysis - Level of Information and Reliability Estimation*. HLWRS-ISG-02 (Ref. 2.2.102), and summarized in Section 4.3.2.2. Three scenarios are evaluated for the potential loss of containment by waste packages due to drops and impacts:

- Six-foot horizontal drop
- 3.4 mph end-to-end impact
- Rockfall on waste package in subsurface tunnels.

An additional scenario, drop of a waste package shield ring onto a waste package, is considered in Section H1.4.5.

For this assessment, the potential load has been determined by FEA in the calculations cited below as the sources of inputs. The load is expressed in terms of stress intensities and as expended toughness fraction which is the ratio of the stress intensity to the true tensile strength. The expended toughness fraction is used to obtain the failure probability by the following:

$$P = \int_{-\infty}^x N(t) dt \quad \text{and} \quad x = \frac{ETF - 1}{COV} \quad (\text{Eq. H-3})$$

where

- P = probability of failure
- $N(t)$ = standard normal distribution with mean of zero and standard deviation of one
- t = variable of integration
- ETF = expended toughness fraction

COV = coefficient of variation = ratio of standard deviation to mean for strain capacity distribution, applied here to stress capacity or true tensile strength.

The capacity is the true tensile strength of the material, the stress the material can withstand before it separates. The minimum true tensile strength, σ_u , for the Alloy 22 typically used for the outer corrosion barrier (OCB) of the waste package is 971 MPa (Ref. 2.2.38, Section 7.7, p. 162). The variability in the capacity is expressed as the standard deviation of a normal distribution that includes strength variation data and variability of the toughness index, I_T , computed without triaxiality adjustments (uniaxial test data). The standard deviation as percent of the mean of σ_u is 7.3% (Ref. 2.2.38, Section 7.6, p. 162). The distribution of elongations used for defining the fragility curve in the LLNL analysis was expressed as two normal distributions, the larger of which was with a mean of 59.3% elongation and a standard distribution of 4.22% elongation, or a coefficient of variation (COV) of 0.0712 (Ref. 2.2.71, Section 6.3.7.3). Thus the 0.073 reported for the OCB material is conservative compared with the LLNL data and is used for the COV in the expression above. The possibility of waste package weld defects is not explicitly considered in the analysis. However, as noted in Section H.1.4.5, weld defects are not expected to contribute significantly to the probability of waste package failure due to drops or other impacts.

H1.4.1 Waste Package Drop

A study investigating the structural response of the naval long waste package to a drop while it is being carried on the emplacement pallet, found the maximum expended toughness fraction for the OCB to be 0.29 for a 10 m/s (32.8 ft/s) flat (vertical) impact (Ref. 2.2.38, Table 7-15, p. 117), equivalent to a 16.7-foot drop. This corresponds to a failure probability of less than 1×10^{-8} . The failure of the OCB is used to define the loss of containment, taking no credit for inner vessel and the canister within. The description of the TEV provided in *Mechanical Handling Design Report: Waste Package Transport and Emplacement Vehicle* (Ref. 2.2.36) mentions that the floor plate is lifted by four jacks and guided by a roller. The guide roller precludes tilted drops of the flat bed of the TEV. As was done for the results from LLNL, to introduce an additional measure of conservatism, a failure probability of 1×10^{-5} is used for the probability that the waste package containment would fail due to a six-foot horizontal drop. This is also bounding for the two-foot horizontal drop, which is much less severed than the modeled 16.7-foot drop.

H1.4.2 Waste Package End-to-End Impact

An oblique impact of a long naval SNF waste package inside a TEV was modeled to assess the structural response (Naval Long Oblique Impact inside TEV (Ref. 2.2.37)). Most of the runs were with initial impact velocity of 3.859 m/s corresponding to a drop height of 0.759 m (2.49 ft). The maximum expended toughness fraction for the 3.859 m/s (or 12.66 ft/sec) oblique impact in the OCB is about 0.7 (Ref 2.2.37, p. 37, Table 7-3, runs 1, 2, and 3), corresponding to a failure probability of about 2×10^{-5} . The oblique impact should be bounding for a direct end impact. Using equation H-3, an expended toughness fraction of 0.11 is estimated for the hypothesized 3.4 mph end-to-end collision (two TVs, each traveling 150 ft/min or 1.7 mph toward each other), corresponding to a failure probability of less than 1×10^{-8} . The failure of the OCB is used to define the loss of containment, taking no credit for the inner vessel and the canister within. As was done for the results from LLNL, to introduce an additional measure of

conservatism, a failure probability of 1×10^{-5} should be used for the probability that the waste package containment would fail due to a 3.4-mph end-to-end impact.

H1.4.3 Rockfall onto a Waste Package

A seismic event during the preclosure period could cause rocks to fall from the ceiling of a drift onto the waste packages stored there prior to deployment of the drip shields. The extent of damage has been predicted for several levels of impact energy of falling rocks (Ref. 2.2.52). The maximum credible impact energy from a falling rock is about 1×10^6 joules (J) (Ref. 2.2.45, p. 57). The maximum expended toughness fraction resulting from rockfall impacting with approximately 1×10^6 J is (conservatively) about 0.11 (Ref. 2.2.52, p. 54, Table 5¹), corresponding to a failure probability less than 1×10^{-8} . As was done for the results from LLNL, to introduce an additional measure of conservatism, a failure probability of 1×10^{-5} should be used for the probability that the waste package containment would fail due to rock fall on the waste package.

H1.4.4 Results for the Three Assessed Scenarios

The failure probabilities for the three scenarios, derived from the results in the cited reports, are summarized in Table H1.4-1.

¹ The expended toughness fraction value is from Ref. 2.2.52, Table 5, Case #23, Co-disposal Short, Lower Sleeve Hit, for a rock kinetic energy of 1.4×10^6 J.

Table H1.4-1. Waste Package Probabilities of Failure for Various Drop and Impact Events

Event	Probability of Failure
6-foot horizontal drop	$< 1 \times 10^{-8}$
3.4 mph end-to-end impact	$< 1 \times 10^{-8}$
20-metric ton (22-ton) rockfall on waste package with and without rock bolt ¹ impacting the waste package	$< 1 \times 10^{-8}$

NOTE: ¹A rock bolt is a long anchor bolt, for stabilizing rock excavations, which may be tunnels or rock cuts.

Source: Original.

H1.4.5 Drop of a Waste Package Shield Ring onto a Waste Package

After the co-disposal waste package has been welded closed in the Waste Package Positioning Room, the shield ring is lifted from it before the waste package transfer trolley is moved into the load out area. Grapple failures might cause the drop to occur at a variety of orientations relative to the top of the waste package. A frequency of canister breach from a potential drop as high as 10 feet is considered here. For a canister breach to occur, the shield ring must penetrate the 1-inch thick outer lid made of SB 575 (Alloy 22) and the 9-inch thick stainless steel inner lid (SA 240) before having an opportunity to impact the canister (Ref. 2.2.10). There are six inches separating the inner and outer lids. In the radial center area of that space, which would be directly above the DSNF canister, is a stainless steel lifting device attached to the inner lid. This adds another layer of energy absorption.

The shield ring weighs approximately 15 tons and is made of stainless steel with a lighter weight neutron absorber material. The impact energy of a 15-ton shield ring dropping 10 feet would be 0.4×10^6 J. The frequency of penetration of the sides of a waste package from a 20-metric ton (22-ton) rock impacting the side of the waste package with impact energy of 1×10^6 J is less than 1×10^{-8} (Table H1.4-1). The sides of a waste package are approximately three inches thick compared to a cumulative thickness (excluding lifting fixture) of 10 inches at the top. Although the impact energy could be more focused, the impact energy for the shield ring against the top of the waste package is less than the impact energy of the rockfall against the side and the top is much thicker than the side. The probability of failure due to shield ring impact against the top of the waste package is expected to be no worse than for the impact of a rock against the side. A conservative value of 1×10^{-5} is used in the analysis for this probability.

H1.4.6 Waste Package Weld Defects

Waste package closure involves engaging and welding the inner lid spread ring, inerting the waste package with helium, setting and welding the outer lid to the outer corrosion barrier, performing leak testing on the inner vessel closure, performing nondestructive examination of welds, and conducting postweld stress mitigation on the outer lid closure weld.

The weld process of the waste package closure subsystem is controlled as a special process by the Quality Assurance Program (Ref. 2.2.81, Section 9.0). The activities performed by the system are controlled by approved procedures.

The principal components of the system include welding equipment; nondestructive examination equipment for visual, eddy current, and ultrasonic inspections of the welds and leak detection; stress mitigation equipment for treatment of the outer lid weld; inerting equipment; and associated robotic arms. Other equipment includes the spread ring expander tool, leak detection tools, cameras, and the remote handling system. The system performs its functions through remote operation of the system components.

The capability of the waste package closure subsystem will be confirmed by demonstration testing of a full-scale prototype system. The prototype includes welding, nondestructive examinations, inerting, stress mitigation, material handling, and process controls subsystems. The objective of the waste package closure subsystem prototype program is to design, develop, and construct the complete system required to successfully close the waste package. An iterative process of revising and modifying the waste package closure subsystem prototype will be part of the design process. When prototype construction is finalized, a demonstration test of the closure operations will be performed on only the closure end of the waste package; thus, the mock-up will be full diameter but not full height as compared to the waste package. The purpose of the demonstration test is to verify that the individual subsystems and integrated system function in accordance with the design requirements and to establish closure operations procedures. This program is coordinated with the waste package prototype fabrication program.

The principal functions of the waste package closure subsystem are to:

- Perform a seal weld between the spread ring and the inner lid, the spread ring and the inner vessel, and the spread ring ends; perform a seal weld between the purge port cap and the inner lid; and perform a narrow groove weld between the outer lid and the outer corrosion barrier
- Perform nondestructive examination of the welds to verify the integrity of the welds and repair any minor weld defects found
- Purge and fill the waste package inner vessel with helium gas to inert the environment
- Perform a leak detection test of the inner lid seals to ensure the integrity of the helium environment in the inner vessel
- Perform stress mitigation of the outer lid groove closure weld to induce compressive residual stresses.

The gas tungsten arc welding process is used for waste package closure welds and weld repairs. Welding is performed in accordance with procedures qualified to the *2004 ASME Boiler and Pressure Vessel Code* (Ref. 2.2.6, Section IX), as noted below:

- The spread ring and purge port cap welds are two-pass seal welds
- The outer lid weld is a multipass full-thickness groove weld.

Welding process procedures will be developed that identify the required welding parameters. The process procedures will:

- Identify the parameters necessary to consistently achieve acceptable welds
- State the control method for each weld parameter and the acceptable range of values.

The welds are inspected in accordance with examination procedures developed using *2004 ASME Boiler and Pressure Vessel Code* (Ref. 2.2.6, Section V and Ref. 2.2.7, Section III, Division 1, Subsection NC) as a guide, with modification as appropriate:

- Seal welds—visual inspection
- Groove welds—visual, eddy current, and ultrasonic inspection.

A weld dressing end effector is used for weld repairs. The defect is removed, resulting in an excavated cavity of a predetermined contour. The excavated cavity surface is inspected using the eddy current inspection end effectors. Then the cavity is welded and inspected in accordance with the welding and inspection procedures.

The stress mitigation process for the outer lid closure weld is controlled plasticity burnishing. Controlled plasticity burnishing is a patented method of controlled burnishing to develop specifically tailored compressive residual stress with associated controlled amounts of cold work at the outer surface of the waste package outer lid closure weld.

The inner vessel of the waste package is evacuated and backfilled with helium through a purge port on the inner lid. The inerting process is in accordance with the inerting process described in NUREG-1536 (Ref. 2.2.98, Sections 8.0 and V.1). After the waste package inner vessel is backfilled by helium, both the spread ring welds and the purge port plug are leak tested in accordance with *2004 ASME Boiler and Pressure Vessel Code* (Ref. 2.2.6, Section V, Article 10, Appendix IX) to verify that no leakage can be detected that exceeds the rate of 10^{-6} std cm³/s.

Waste package closure welding, nondestructive examination, stress mitigation, and inerting are conducted in accordance with approved administrative controls. The processes for waste package closure welding, nondestructive examination, stress mitigation, and inerting will be developed in accordance with the codes and standards identified below. The processes are monitored by qualified operators, and resulting process data are checked and verified as acceptable by qualified individuals.

Waste package closure welding, nondestructive examination, stress mitigation, and inerting normal operating procedures will specify, for example, the welding procedure specification, nondestructive examination procedure, qualification and proficiency requirements for operators and inspectors, and acceptance and independent verification records for critical process steps.

The waste package closure subsystem–related welds, weld repairs, and inspections are performed in accordance with *2004 ASME Boiler and Pressure Vessel Code* (Ref. 2.2.6, Section II, Part C; Section III, Division I, Subsection NC; Section IX; Section V).

The inerting of the waste package is performed in accordance with the applicable sections of NUREG-1536 (Ref. 2.2.98).

PCSA event sequences involving waste packages include challenges ranging from low velocity collisions to a 20-metric ton rockfall to a spectrum of fires. Waste package failure probabilities are calculated to be very low. Furthermore, a significant conservatism in the analysis is that the containment associated with the canister is not included in the probability of containment breach. In other words, if the waste package breaches, radionuclide release is analyzed as if the canister has breached (if the event sequence is in Category 1 or 2). Analytically, the canister is not relied upon for event sequences involving waste packages. The analytical results from the LLNL analysis show a significant reduction in canister strains is achieved by transportation cask and aging overpack protection. Although not analyzed, a similar ameliorating effect on the canister would be expected to be provided by the waste package.

The weld, inspection and repair process ensures no significant defects to a high reliability. The event sequence analysis shows that all event sequences associated with waste package breach are beyond Category 2. In the context of the event sequence analysis, a significant defect is one that would have increased the probability of breach of the canister within the waste package by orders of magnitude. Even for significant weld defects, the protection offered by the waste package to the canister containment function would remain. Therefore, the effect of waste package weld failure on loss of canister containment during event sequences is not further considered.

H1.5 PREDICTING OUTCOMES OF OTHER SITUATIONS BY EXTRAPOLATING STRAINS FOR MODELED SCENARIOS

Equation 17 of Reference 2.2.59 demonstrates use of the probability of failure at a given drop height together with the COV to predict probabilities at other drop heights. A similar approach can be used to extrapolate from one strain to another to find the corresponding failure probability. The work done on damaging the container expressed in the form of strain should be roughly proportional to the energy input to the material due to the impact. The impact energy is proportional to the drop height or to the square of the impact velocity. Finite element modeling demonstrated that the increase in strain is actually less than proportional to increase in drop height (Ref. 2.2.71, Tables H1.2-3 and H1.2-4), so increasing the strain proportionally with drop height or the square of impact velocity is conservative. The strain is extrapolated by multiplying it by the square of the ratio of the velocity of interest to the reference velocity.

$$\tau_i = \tau_{ref} \left(\frac{v_i}{v_{ref}} \right)^2 \quad (\text{Eq. H-4})$$

where :

- τ_i = strain at velocity of interest (dimensionless)
- τ_{ref} = strain at reference velocity (dimensionless)
- v_i = velocity of interest (same units as v_{ref})
- v_{ref} = reference velocity (same units as v_i).

In case D.IC.3, a 0.16% strain (τ_{ref}) was predicted for a side impact of 40 ft/min (v_{ref}). Using Equation H-4 to extrapolate for an impact velocity of 2.5 miles/hr gives an estimated strain of 4.84%.

The estimated strain is then compared with the fragility curve tabulated in Table H1.1-1. A failure rate of less than 1×10^{-8} is predicted for a strain of 4.84%. Probabilities of failure for a range of impact velocities are listed in Table H1.5-1.

Table H1.5-1. Calculated Strains and Failure Probabilities for Given Side Impact Velocities

Impact Velocity		% strain	Probability of failure
(ft/sec)	(ft/min)		
0.67	40	0.16	$< 1 \times 10^{-8}$
1	60	0.36	$< 1 \times 10^{-8}$
2	120	1.44	$< 1 \times 10^{-8}$
4	240	5.76	$< 1 \times 10^{-8}$
6	360	13	$< 1 \times 10^{-8}$
8	480	23	$< 1 \times 10^{-5}$

Source: Original

A similar approach is applied to estimate failure probabilities for vertical drops greater than 40 feet. The strains are extrapolated using the ratio of drop heights rather than the squared ratio of impact velocities in Equation H-4.

For the DPC, the maximum EPS is 2.65% for a 40-foot end drop (case D.IC.1b in Table H1.2-3). Strains of 2.98% and 3.31% are estimated for 45- and 50-foot drops, respectively. Doubling the strains to account for triaxiality and comparing these strains with Table H1.1-1 shows the probabilities of failure are both $< 1 \times 10^{-8}$. As before, conservative probabilities of 1×10^{-5} are used in the event sequence quantification.

For the DOE standard canister the maximum strain is 8% in the lower head of the 18-inch canister resulting from a 23-foot drop 3 degrees off vertical (Table H1.2-6). By the same approach as above, 10.4%, 15.7%, and 17.4% strains are estimated for 30-foot, 45-foot, and 50-foot drops. Doubling these strains and comparing with Table H1.1-1 yields the failure probabilities of 1×10^{-7} , 3×10^{-2} , and 9×10^{-2} for the 30-foot, 45-foot, and 50-foot drops, respectively. A conservative probability of 1×10^{-5} is used for the 30-foot drop of the DOE standardized canister.

H1.6 MISCELLANEOUS SCENARIOS

H1.6.1 Localized Side Impact on a Transportation Cask

One of the requirements specified for transportation casks is they be robust enough to survive a 40-inch horizontal drop onto an unyielding 6-inch diameter upright cylinder (Ref. 2.3.2, Paragraph 71.73). The impact energy for such a scenario involving a 250,000-pound cask (a typical weight for a loaded cask) – the NAC STC has a loaded weight of 260,000 pounds (Ref. 2.2.97, page 1.1-1) is about 1.1×10^6 J. The maximum weight of a forklift is considerably

less than 44,000 pounds (20 metric tons). At a maximum speed of 2.5 mph (1.12 m/s), the maximum impact energy would be 12.5×10^3 J, a factor of 90 less than the impact energy for the 40-in. drop of the cask. If the resultant strain is proportional to the impact energy and the drop event in the Safety Analysis Report (SAR) is just below the failure threshold (i.e. the median impact energy for failure), the impact energy due to the 2.5-mph impact would be a maximum of $1/90^{\text{th}}$ of the median failure impact energy, or $1 - 1/90$ COV less than a normalized median of 1. Equation H-3 is applicable substituting the ratio of impact energy to median failure impact energy for the expended toughness factor. Using $1/90$ ($=0.011$) in place of the expended toughness fraction in Equation H-3 gives a probability of failure of much less than 1×10^{-8} due to impact of a forklift against a transportation cask. If the impact speed were 9 mph instead of 2.5 mph, the impact energy would be about $1/7^{\text{th}}$ of the energy in the SAR drop event, 0.14 would be used in place of the expended toughness fraction in Equation H-3, and the probability of failure would still be less than 1×10^{-8} .

H1.6.2 Screening Argument for TAD Weld Defects

TAD canister closure is the process that closes the loaded TAD canister by welding the shield plug and fully draining and drying the TAD canister interior, followed by backfilling the TAD canister with helium and fully welding the TAD canister lid around its circumference onto the body of the TAD canister.

The process control program for the closure welds produced by the TAD canister closure system is controlled as a special process by the Quality Assurance Program (Ref. 2.2.81, Section 9.0).

TAD canister closure is done at the TAD canister closure station in the Cask Preparation Area. The STC containing a loaded TAD canister is transferred from the pool to the TAD canister closure station using the CHC. The STC lid is unbolted and then removed using the TAD canister closure jib crane. The TAD canister is then partially drained via the siphon port in order to lower the water level below the shield plug in preparation for welding. The TAD canister welding machine is positioned onto the TAD canister shield plug using the TAD canister closure jib crane, and the shield plug is welded in place. After a weld is completed, visual examination of the weld is performed in addition to the eddy current testing and ultrasonic testing that are performed by the TAD canister welding machine.

A draining, drying, and inerting system is connected to the siphon and vent ports in the shield plug and used to dry the interior of the TAD canister, followed by backfilling it with helium gas. Port covers are then placed over the siphon and vent ports and welded in place using the TAD canister welding machine. The TAD canister welding machine is removed, and the outer lid is placed onto the TAD canister using the TAD canister closure jib crane. The TAD canister welding machine is positioned onto the TAD canister outer lid, and the lid is welded in place. The TAD canister welding machine is removed, and the STC lid is placed onto the shielded transfer cask using the TAD canister closure jib crane and installed. Hoses are connected to the fill and drain ports on the STC, and the water is sampled for contamination. If the water is clean, the ports are opened to drain the annulus between the TAD canister and the shielded transfer cask. If the water is contaminated, then the annulus is flushed with treated borated water as needed. A drying system is then used to dry the annulus. The potential for contamination is kept to a minimum by the use of the inflatable seal.

The qualification of the TAD canister final closure welds is in accordance with *Interim Staff Guidance - 18. The Design/Qualification of Final Closure Welds on Austenitic Stainless Steel Canisters as Confinement Boundary for Spent Fuel Storage and Containment Boundary for Spent Fuel Transportation ISG-18* (Ref. 2.2.100) as specified in *Basis of Design for the TAD Canister-Based Repository Design Concept* (Ref. 2.2.24, Section 33.2.2.36). Adherence to this guidance is deemed to provide reasonable assurance that weld defects occur at a low rate. However, TAD canister weld cracks are considered an initiating event after the TAD canister welding process in the WHF. If this occurs, the radionuclide release would be minimal because the incoming casks and canisters have already been opened. After TAD canisters are welded, they are placed in aging overpacks and moved by the site transporter to the CRCF. The probability of TAD canister failure during removal from the aging overpack handling in the CRCF and placement into a waste package is considered in the CRCF event sequence analysis. The conditional probability of TAD canister failures during handling in the CRCF has been shown to be small. The low probability of weld defects and their size would not alter this result. After the TAD canister is placed in the waste package, the containment is considered to be the waste package and the TAD canister is no longer relied upon in event sequences involving mechanical impacts.

H2 SHIELDING DEGRADATION DUE TO IMPACTS

Table H2-1 summarizes the results on loss of shielding that could occur in event sequences for repository waste handling operations. The results are derived from transportation cask accident risk analyses. A more detailed discussion of the bases for these results is provided in Ref. 2.2.59, Section D3.4.

For all other cask types, the results of the transportation cask study indicate that the only mechanism for loss of shielding is streaming via closure failures and closure geometry changes. Therefore, the probability of loss of shielding can be equated to the probability of rupture/breach of such casks.

Table H2-1. Probabilities of Degradation of Shielding

Description	Probability	Note
Sealed transportation cask and shielded transfer casks, shielding degradation after structural challenge	1.0×10^{-5}	Ref. 2.2.59, Section D3.4
Aging overpack shielding loss after structural challenge	5×10^{-6}	Ref. 2.2.59, Section D3.4
CTM shielding loss after structural challenge	0	Structural challenge sufficiently mild to leave the shielding function intact ^a
WPTT shielding loss after structural challenge	0	Structural challenge sufficiently mild to leave the shielding function intact ^a
TEV shielding loss (shield end)	0	Structural challenge sufficiently mild to leave the shielding function intact ^a
Shielding loss by fire of waste forms in transportation casks or shielded transfer casks	1	Lead shielding could potentially expand and degrade. This probability is conservatively applied to transportation casks and STCs that do not use lead for shielding
Shielding loss by fire of aging overpacks, CTM shield bell and WPTT shielding	0	Type of concrete used for aging overpacks is not sensitive to spallation. Uranium used in CTM shield bell and WPTT shielding does not lose its shielding function as a result of fire

NOTE: ^aIn the event sequence diagrams of the PCSA, the shielding function for the CTM, WPTT and TEV is queried for the challenges that do not lead to a radioactive release. Such challenges, which were not sufficiently severe to cause a breach of containment of the waste form container, are also deemed mild enough to leave the shielding function of the CTM, WPTT and TEV intact.

CTM = canister transfer machine; STC = shielded transfer cask; TEV = transport and emplacement vehicle; WPTT = waste package transfer trolley.

Source: Original

ATTACHMENT I SEISMIC HAZARD CURVE ANALYSIS

This attachment provides the seismic hazard input used in quantification analyses performed using the SAPHIRE computer code.

I1 SEISMIC HAZARD DATA

Seismic hazard curves for this analysis were identified based on on-going assessments of the seismic hazard at the repository site for both surface and subsurface facilities. The seismic event sequence quantification used 2007 data for the seismic hazard:

- *Mean Hazard Curves and Mean Uniform Hazard Spectra for the Surface Facilities Area*, 11/01/2006 to 06/08/2007, TDIF 319830, DTN: MO0706HCUHSSFA.000
- *Hazard Curves and Mean Uniform Hazard Spectra for the Repository Block*, 11/01/2006 to 07/20/2007, TDIF 319899, DTN: MO0707HCUHSREB.000.

The values are used for input into the SAPHIRE code in this analysis and represent horizontal peak ground acceleration values for the repository. During the SAPHIRE analyses, updated seismic hazard values became available in 2008. These 2008 seismic hazard curves are provided in *Mean Hazard Curves and Mean Uniform Hazard Spectra for the Surface Facilities Area* (Ref. 2.2.93) and *Hazard Curves and Mean Uniform Hazard Spectra for the Repository Block* (Ref. 2.2.92) for surface and subsurface facilities, respectively, *IED Seismic and Seismic Consequence Data* (Ref. 2.2.66), and described in *Supplemental Earthquake Ground Motion Input for a Geologic Repository at Yucca Mountain, NV* (Ref. 2.2.73). Upon comparison of 2007 and 2008 data sets, little difference is noted; specifically, the 2007 data envelops the 2008 data for the surface facilities, and is essentially the same for the subsurface repository block, as shown in Figure 6.1-1 to 6.1-4. Therefore, the 2007 data (and the current SAPHIRE analyses) are considered appropriate for this calculation in comparison to the 2008 data.

I2 DISCRETIZATION OF SEISMIC HAZARD - SAPHIRE INPUT

While the seismic hazard curves are presented as points along a continuous curve in frequency of exceedance, input into the SAPHIRE seismic hazard convolution algorithm requires the frequency values to be provided in discrete acceleration intervals. Based on the seismic hazard data, an EXCEL spreadsheet was used to convert the frequency of exceedance format into discrete horizontal peak ground acceleration intervals and associated interval frequencies.

As the seismic hazard is a curve, a log-log interpolation formula was used to calculate the acceleration midpoint for each interval. For any shape hazard curve, the probability of unacceptable performance, P_f , may be expressed as an integral as (e.g., Ref. 2.2.89, Enclosure B, Eq. 6):

$$P_f = -\int_0^{\infty} \left(\frac{dH}{da} \right) P_{F/a} da \quad (\text{Eq. I-1})$$

where $H_{(a)}$ is the mean annual probability of exceedance¹ of a ground motion level a , $P_{F/a}$ is the probability of unacceptable performance of a SSC at a given ground motion level a , and a is seismic ground motion level (the ground motion parameter in this context is acceleration).

The equation may be obtained by numerically integrating Equation I-1 to obtain the following equation (e.g., Ref. 2.2.89, Enclosure B, Eq. 8):

$$P_f = \sum_1^{\infty} [H_{(a_i)} - H_{(a_{i+1})}] P_{F/a_{cgi}} \quad (\text{Eq. I-2})$$

where a_{cgi} is the center of gravity ground motion level between a_i and a_{i+1} .

The term a_{cgi} is defined by (Ref. 2.2.89, Enclosure B, Eq. 9):

$$a_{cgi} = \frac{\int_{a_i}^{a_{i+1}} H_{(a)} a da}{\int_{a_i}^{a_{i+1}} H_{(a)} da} \quad (\text{Eq. I-3})$$

employing a piecewise linear hazard curve, defined locally by $H_{(a)} = K_{Hi} a^{-kH}$ for the interval a_i to a_{i+1} , and defining the local slope, K_{Hi} , as a straight line in log-log space by:

$$K_{Hi} = \frac{\log(H_{(a_i)} / H_{(a_{i+1})})}{\log(a_{i+1} / a_i)} \quad (\text{Eq. I-4})$$

Then equation I-3 can be written for a_{cgi} as (e.g., Ref. 2.2.89, Enclosure B, Eq. 11):

$$a_{cgi} = \frac{(1 - K_{Hi}) [a_{i+1}^{(2-K_{Hi})} - a_i^{(2-K_{Hi})}]}{(2 - K_{Hi}) [a_{i+1}^{(1-K_{Hi})} - a_i^{(1-K_{Hi})}]} \quad (\text{Eq. I-5})$$

As shown in Tables I-1 and I-2, Equation I-5 was used to calculate center of gravity acceleration for frequency intervals taken the source data described earlier.

Specifically, the local slope value (K_{Hi}) described in Equation I-4 is calculated in Tables I2-1 and I2-2 from the values of the mean peak ground acceleration (a_i and a_{i+1}) in Column #1 (counting from the left) and the frequency of exceedance values ($H_{(a_i)}$ and $H_{(a_{i+1})}$) taken from Column #2, from two adjacent rows (i and $i+1$). The resulting slope value, K_{Hi} , is shown in Column #3 on a level in-between the i and $i+1$ value. The center of gravity acceleration is then computed using Equation I-5, and using the K_{Hi} value (in Column #3) and the acceleration values (a_i and a_{i+1}) in Column #1. The resulting value for center of gravity acceleration, a_{cgi} , is shown in Column #4. The frequency for this interval shown in Column #5 is taken as the simple difference of the upper and lower frequency values for the interval from Column #2 (i.e., $H_{(a_i)}$ and $H_{(a_{i+1})}$).

¹ The terms annual probability of exceedance and annual frequency of exceedance are used interchangeably in this context.

The 19 intervals for surface (18 for subsurface) of the mean annual probability of exceedance of horizontal peak ground acceleration are shown in Tables I2-1 and I2-2. These values were used in SAPHIRE to describe the seismic hazard over the range of 10^{-2} to 10^{-8} mean annual probability of exceedance.

Table I2-1. Discretization of Horizontal Mean Peak Acceleration Values for Surface Facilities

Mean Peak Ground Acceleration, a (g)	Exceedance Frequency, $H_{(a)}$ (/yr)	Local Slope Parameter, K_{HI}	Center of Gravity Acceleration, a^{cgl} (g)	Frequency Interval (/yr)
0.0410	2.1684E-02	1.134	0.047	5.53E-03
0.0532	1.6150E-02	1.227	0.061	4.41E-03
0.0690	1.1738E-02	1.273	0.079	3.31E-03
0.0894	8.4300E-03	1.400	0.102	2.57E-03
0.1160	5.8586E-03	1.564	0.132	1.96E-03
0.1504	3.9010E-03	1.669	0.171	1.37E-03
0.1951	2.5278E-03	1.767	0.222	9.31E-04
0.2531	1.5967E-03	1.870	0.288	6.15E-04
0.3282	9.8196E-04	2.074	0.373	4.09E-04
0.4256	5.7260E-04	2.190	0.483	2.49E-04
0.5520	3.2401E-04	2.253	0.626	1.44E-04
0.7160	1.8036E-04	2.463	0.811	8.53E-05
0.9286	9.5055E-05	2.699	1.050	4.79E-05
1.2043	4.7121E-05	2.976	1.360	2.54E-05
1.5619	2.1735E-05	3.561	1.758	1.31E-05
2.0257	8.6113E-06	4.844	2.264	6.17E-06
2.6272	2.4438E-06	6.185	2.916	1.95E-06

Table I2-1. Discretization of Horizontal Mean Peak Acceleration Values for Surface Facilities (Continued)

Mean Peak Ground Acceleration, a (g)	Exceedance Frequency, $H_{(a)}$ (/yr)	Local Slope Parameter, K_{Hi}	Center of Gravity Acceleration, a_{cgi} (g)	Frequency Interval (/yr)
3.4073	4.8939E-07	6.533	3.775	4.00E-07
4.4191	8.9523E-08	6.861	4.888	7.45E-08
5.7313	1.5039E-08			

NOTE: Mean horizontal peak ground acceleration (at 100 Hz) and frequency data are from *Mean Hazard Curves and Mean Uniform Hazard Spectra for the Surface Facilities Area* (Ref. 2.2.93).
 g = acceleration due to gravity [$g = 9.81 \text{ m/s}^2$ or 32.17 ft/s^2]; yr = year.

Source: Original

Table I2-2. Discretization of Horizontal Mean Peak Acceleration Values for Subsurface Emplacement Level

Mean Peak Ground Acceleration, a (g)	Exceedance Frequency, $H_{(a)}$ (/yr)	Local Slope Parameter, K_{Hi}	Center of Gravity Acceleration, a_{cgi} (g)	Frequency Interval (/yr)
3.66E-02	6.81E-03	1.463	0.041	1.96E-03
4.61E-02	4.85E-03	1.544	0.052	1.46E-03
5.81E-02	3.39E-03	1.608	0.065	1.05E-03
7.33E-02	2.34E-03	1.667	0.082	7.49E-04
9.23E-02	1.59E-03	1.692	0.104	5.16E-04
1.16E-01	1.07E-03	1.825	0.130	3.70E-04
1.47E-01	7.05E-04	2.034	0.164	2.65E-04
1.85E-01	4.40E-04	2.033	0.207	1.65E-04
2.33E-01	2.75E-04	2.075	0.261	1.05E-04
2.94E-01	1.70E-04	2.353	0.329	7.14E-05
3.70E-01	9.86E-05	2.618	0.414	4.48E-05

Table I2-2. Discretization of Horizontal Mean Peak Acceleration Values for Subsurface Emplacement Level (Continued)

Mean Peak Ground Acceleration, a (g)	Exceedance Frequency, $H_{(a)}$ (/yr)	Local Slope Parameter, K_{Hi}	Center of Gravity Acceleration, a_{cgi} (g)	Frequency Interval (/yr)
4.67E-01	5.38E-05	2.963	0.521	2.67E-05
5.88E-01	2.71E-05	3.447	0.655	1.49E-05
7.42E-01	1.22E-05	4.104	0.823	7.48E-06
9.35E-01	4.72E-06	4.999	1.034	3.23E-06
1.18E+00	1.48E-06	5.544	1.300	1.07E-06
1.49E+00	4.11E-07	5.889	1.636	3.06E-07
1.87E+00	1.05E-07	8.849	2.038	9.15E-08
2.36E+00	1.35E-08			

NOTE: Mean horizontal peak ground acceleration (at 100 Hz) and frequency data are from *Hazard Curves and Mean Uniform Hazard Spectra for the Repository Block* (Ref. 2.2.92).
 g = acceleration due to gravity [$g = 9.81 \text{ m/s}^2$ or 32.17 ft/s^2]; yr = year.

Source: Original

ATTACHMENT J

SAPHIRE MODEL AND SUPPORTING FILES

This attachment is the CD containing the SAPHIRE model and supporting files. The electronic files contained on the CD are identified below. The SAPHIRE files are in the first file, Ac 3-06 version.zip. (The other files on the CD are part of Attachment G.)

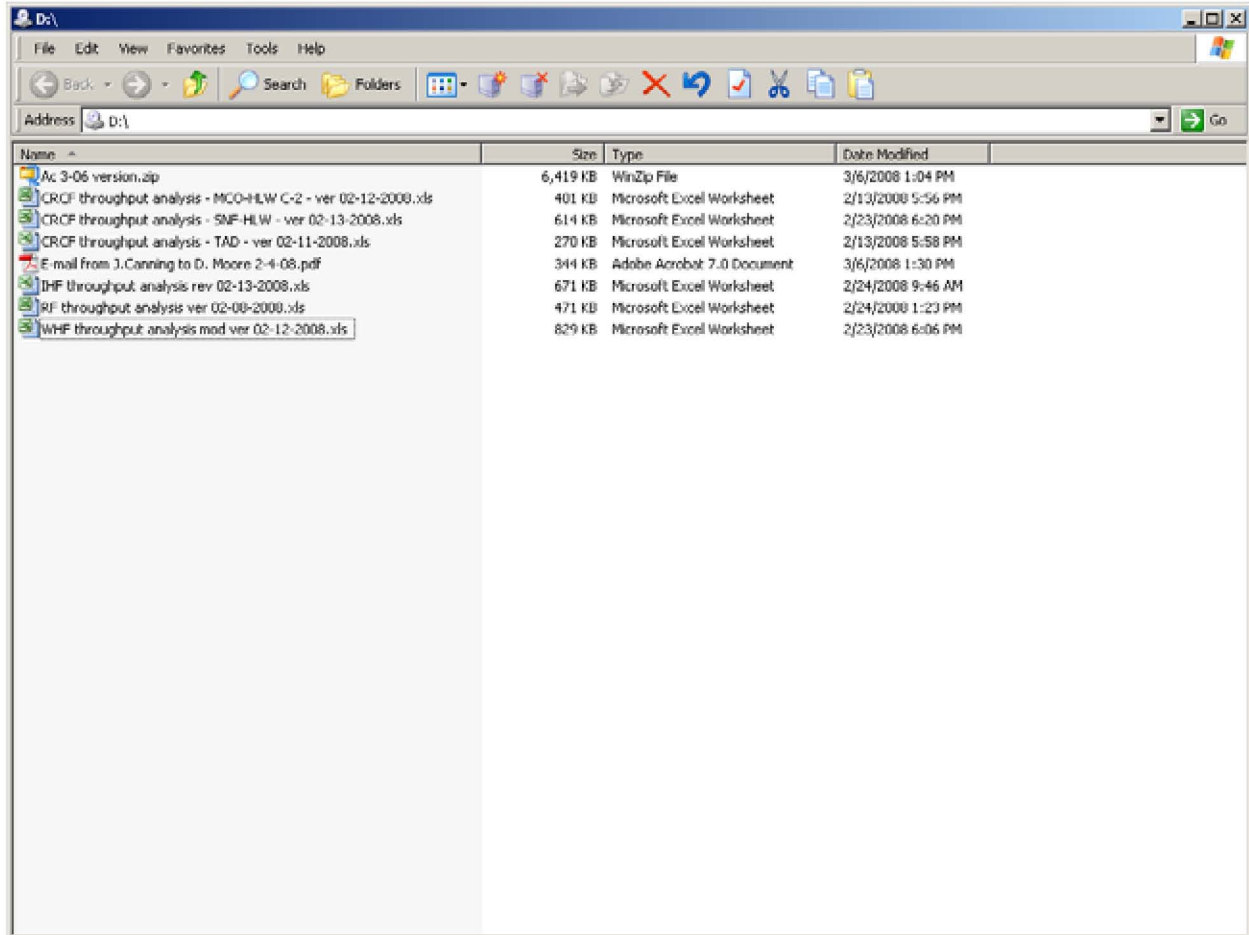

Name	Size	Type	Date Modified
Ac 3-06 version.zip	6,419 KB	WinZip File	3/6/2008 1:04 PM
CRCF throughput analysis - MCO-HLW C-2 - ver 02-12-2008.xls	401 KB	Microsoft Excel Worksheet	2/13/2008 5:56 PM
CRCF throughput analysis - SMF-HLW - ver 02-13-2008.xls	614 KB	Microsoft Excel Worksheet	2/23/2008 6:20 PM
CRCF throughput analysis - TAD - ver 02-11-2008.xls	270 KB	Microsoft Excel Worksheet	2/13/2008 5:58 PM
E-mail from J.Canning to D. Moore 2-4-08.pdf	344 KB	Adobe Acrobat 7.0 Document	3/6/2008 1:30 PM
IHF throughput analysis rev 02-13-2008.xls	671 KB	Microsoft Excel Worksheet	2/24/2008 9:46 AM
RF throughput analysis ver 02-08-2008.xls	471 KB	Microsoft Excel Worksheet	2/24/2008 1:23 PM
WHF throughput analysis mod ver 02-12-2008.xls	829 KB	Microsoft Excel Worksheet	2/23/2008 6:06 PM

OFFICE OF CIVILIAN RADIOACTIVE WASTE MANAGEMENT
SPECIAL INSTRUCTION SHEET

1. QA: QA
Page 1 of 1

This is a placeholder page for records that cannot be scanned.

2. Record Date 03/10/2008	3. Accession Number Att. To: ENG.20080311.0032
4. Author Name(s) Moore, D	5. Authorization Organization BSC/PCSA
6. Title/Description Seismic Event Sequence Quantification and Categorization Analysis	
7. Document Number(s) 000-PSA-MGR0-01100-000	8. Version Designator 00A
9. Document Type Data	10. Medium 2 CD's
11. Access Control Code PUB	
12. Traceability Designator 000-PSA-MGR0-01100-000-00A	
13. Comments 2 CD's: 1 Original, 1 Copy Validation of complete file transferred. All files copied. Software used: SAPHIRE Version 7.27; Visio Professional; Word 2003 and Excel 2003	
<p>THIS IS AN ELECTRONIC ATTACHMENT</p>	
14. RPC Electronic Media Verification	
<p>XREF MOL.20080312.0012</p> <p>MAR 13 2008 <i>T Church / BSC</i></p> <p>MD5 Validation</p>	

dir.txt

Volume in drive D is 080311_1756
Volume Serial Number is 88E6-F26D

Directory of D:\

03/06/2008	02:04 PM	6,572,655	Ac 3-06 version.zip
02/13/2008	06:56 PM	410,112	CRCF throughput analysis - MCO-HLW C-2 - ver
02-12-2008.xls			
02/23/2008	07:20 PM	628,736	CRCF throughput analysis - SNF-HLW - ver
02-13-2008.xls			
02/13/2008	06:58 PM	276,480	CRCF throughput analysis - TAD - ver
02-11-2008.xls			
03/06/2008	02:30 PM	352,130	E-mail from J.Canning to D. Moore 2-4-08.pdf
02/24/2008	10:46 AM	687,104	IHF throughput analysis rev 02-13-2008.xls
02/24/2008	02:23 PM	481,792	RF throughput analysis ver 02-08-2008.xls
02/23/2008	07:06 PM	848,896	WHF throughput analysis mod ver
02-12-2008.xls			
	8 File(s)	10,257,905	bytes
Total Files Listed:			
	8 File(s)	10,257,905	bytes
	0 Dir(s)		0 bytes free

BSC

Calculation/Analysis Change Notice Complete only applicable items.

1. QA: *QA*
2. Page 1 of *1*

3. Document Identifier: 000-PSA-MGR0-01100-000-00A	4. Rev.: 00A	5. CACN: 001
---	-----------------	-----------------

6. Title:
Seismic Event Sequence Quantification and Categorization *Analysis*

7. Reason for Change:
4/19/08

The revision is required to correct a transcription error, and to respond to CR 11958.

8. Supersedes Change Notice: Yes If, Yes, CACN No.: _____ No

9. Change Impact:

Inputs Changed: Yes No Results Impacted: Yes No

Assumptions Changed: Yes No Design Impacted: Yes No

10. Description of Change:

On Page 251, in Table 6.10-4, second line from bottom, in the description of item H.WH.01 on the Cask Support Frame, the number 1 should replace the number 6.

Specifically, the text is revised to state:

"H.WH.01 The mean frequency ...shall be less than or equal to 1×10^{-05} /yr" as shown in Table 6.2-2 on page 88. *4/4/08*

11. REVIEWS AND APPROVAL

Printed Name	Signature	Date
11a. Originator: Ernest Lindner	<i>[Signature]</i>	4/04/2008
11b. Checker: Phouc Le	<i>[Signature]</i>	4/04/2008
11c. EGS: Michael Frank	<i>[Signature]</i>	4/04/2008
11d. DEM: Donald Beckman	<i>Thomas C. Dunn for D. Beckman</i>	4/4/2008
11e. Design Authority: Barbara Rusinko	<i>BRusinko</i>	4/4/08