



Nye County Early Warning Drilling Program
Phase IV Drilling Report

NWRPO-2004-04

Nye County Nuclear Waste Repository Project Office
Grant No. DE-FC28-02RW12163

July 2005

DISCLAIMER

This report was prepared by the Nye County Department of Natural Resources and Federal Facilities, Nuclear Waste Repository Project Office, pursuant to a Cooperative Agreement funded by the U.S. Department of Energy, and neither Nye County nor any of its contractors or subcontractors nor the U.S. Department of Energy, nor any person acting on behalf of either, assumes any liabilities with respect to the use of, or for damages resulting from the use of, any information, apparatus, method, or process disclosed in this report. Reference herein to any specific commercial product, process, or service by trade name, trademark, manufacturer, or otherwise, does not necessarily constitute or imply its endorsement, recommendation, or favoring by the U.S. Department of Energy or Nye County. The views and opinions of authors expressed herein do not necessarily state or reflect those of the U.S. Department of Energy.

EXECUTIVE SUMMARY

Introduction

This report describes the methods and results of Phase IV of the Nye County Early Warning Drilling Program (EWDP), performed as part of the Nye County Nuclear Waste Repository Project Office (NWRPO) Independent Scientific Investigations Program (ISIP). The ISIP was funded by a cooperative agreement with the U.S. Department of Energy (DOE) to support the evaluation of a high-level nuclear waste repository at Yucca Mountain, Nevada. Goals of the EWDP include a better definition of the potential risks of repository activities on Nye County drinking water supplies and the design of a groundwater monitoring network along potential flowpaths between Yucca Mountain and populated areas of southern Nye County. A better understanding of the hydrogeologic flow system in this region is a necessary first step in achieving these goals and has been the primary focus of the EWDP to date.

Phase IV, conducted from late 2002 to late 2003, involved drilling, sampling, logging, and completing two types of boreholes. Five small-diameter exploratory boreholes that targeted volcanic aquifer rock units were advanced to depths ranging from 791 to 2,900 feet below ground surface (bgs), plugged back (i.e., grouted) to just below the volcanic aquifer water table, and completed with a small-diameter piezometer screen across the water table. These boreholes were drilled primarily with air-rotary dual-wall reverse circulation methods shown during Phase III to produce representative geologic samples. The exploratory boreholes were followed by the drilling of a single sonic corehole that penetrated the upper portion of the saturated alluvial aquifer and was completed with two nested piezometer screens beneath the water table.

All EWDP borehole names have a formal "NC-EWDP-" prefix; in this report the names will be given by number only.

The five exploratory boreholes were located in two areas along possible groundwater flowpaths between Yucca Mountain and populated areas of Amargosa Valley. Three of the exploratory boreholes (i.e., 16P, 27P, and 28P) were sited in an unnamed drainage, called Flat Tire Flat by the NWRPO, north of the Lathrop Wells cinder cone. The remaining two boreholes (i.e., 24P and 29P) were sited on the west side of Fortymile Wash, several miles north of U.S. Highway 95.

The exploratory boreholes were drilled to describe volcanic rocks that make up the uppermost aquifer, examine the stratigraphy of subsurface geologic units in proximity to a large northeast-trending gravity gradient and large east-west magnetic gradient near the southern end of Yucca Mountain, and provide future monitoring points for water levels and water chemistry in the geologic unit spanning the water table.

Sonic corehole 19PB was sited in lower Fortymile Wash at the Alluvium Testing Complex to support future tracer tests to be conducted there. Continuous core from saturated alluvium was collected to provide detailed textural layering information as well as other flow- and transport-related properties that support tracer test analysis and interpretation. Piezometers were designed and installed to serve as both aquifer monitoring and tracer injection points for future tests.

Exploratory borehole activities included the collection of drill cuttings at regular depth intervals in both alluvial and non-alluvial (i.e., underlying bedrock) units, collection of drive core at

selected intervals in the two Fortymile Wash boreholes, geologic logging and laboratory testing of drill cuttings and core, and borehole geophysical logging. Sonic corehole activities were similar, except that continuous sonic core was collected rather than drill cuttings, photographic and video logs were run, and field constant head permeability tests were conducted in the corehole after the installation of piezometer screens.

Drilling and Coring Results

Air-rotary dual-wall reverse circulation drilling proved to be relatively rapid and inexpensive, produced drill cuttings from both above and below the water table that were reasonably representative of in situ formation rock, minimized the disturbance of the formation rock and groundwater chemistry, and produced boreholes suitable for completing piezometer screens across the water table.

The feasibility of obtaining minimally disturbed drive core samples from unsaturated alluvium in uncased RC boreholes 24P and 29P was demonstrated. However, coring was time consuming and the core barrel, in nearly all cases, contained fill in addition to in situ formation material.

Sonic coring in 19PB was an unqualified success and produced nearly continuous core from the upper approximately 260 feet of saturated alluvium suitable for geologic, photographic, and video logging, as well as laboratory testing of flow-related parameters. This core was the first continuous core to be collected from alluvium in Fortymile Wash.

Geologic Logging Results

Geologic logs of both drill cuttings and core indicate that alluvium penetrated in Phase IV boreholes was composed solely of volcanic rocks, and non-alluvium (i.e., all other rock) was composed primarily of volcanic rocks or sediment derived from these rocks.

Little or no cementation was observed in unsaturated zone alluvial drill cuttings from Flat Tire Flat boreholes 16P, 27P and 28P; however, more intervals of weak and in some cases moderate cementation were noted in similar samples from Fortymile Wash boreholes 24P and 29P. In addition, more weak cementation was observed in sonic core from 19PB than in drill cuttings from adjacent boreholes previously drilled in that area. These differences are likely due to the difficulty of detecting cementation in drill cuttings that are significantly disturbed by the drilling process. The fact that strong cementation was not observed in either unsaturated alluvial drill cuttings or core suggests that little soil development is present in unsaturated alluvium in either Flat Tire Flat or Fortymile Wash.

There appears to be no correlation between hydrochloric acid reaction and observed cementation in unsaturated alluvium, which suggests that cementing agents other than calcium carbonate play a role in the alluvial sediments.

The colors of sonic core from the upper approximately 260 feet of saturated alluvium in 19PB indicate oxidizing conditions throughout this depth interval.

Laboratory Test Results

Bulk Density and Porosity

Drive core and repacked sonic core data suggest that dry bulk density and porosity values of 1.90 g/cm^3 and $0.25 \text{ cm}^3/\text{cm}^3$, respectively, are reasonably representative for alluvium penetrated by boreholes along the western portion of lower Fortymile Wash. Lower average dry bulk density values (i.e., approximately 1.80 g/cm^3) calculated from wet mass, volume, and water content data from sonic core runs in 19PB may be due to errors in estimated corehole diameters.

Particle Size Distribution

Overall, particle size distribution (PSD) data from unsaturated alluvial drill cuttings from 24P and 29P approximate the data from drive core from the same boreholes and intervals, and therefore approximate in situ conditions. These observations are consistent with findings from EWDP Phase III boreholes (NWRPO, 2003).

PSD tests of drill cuttings and drive core from exploratory boreholes indicate that unsaturated alluvial sediments consist of coarse-grained sands and gravels with approximately 5 to 30 percent fines by weight.

PSD depth profiles of alluvial drill cuttings are similar for Flat Tire Flat boreholes 16P, 27P, and 28P, but exhibit significantly more fines than Fortymile Wash boreholes 24P and 29P. These differences in PSD may be due to a number of factors, including differences in source rock and the size of the drainage basin.

PSD data from nearly continuous sonic core from saturated alluvium in 19PB show that all samples are coarse-grained and contain, on the average, approximately 14 percent fines, 46 percent sand, and 40 percent gravel. Fines and sand percentages increase slightly with depth and gravel decreases with depth.

PSD depth profile data vary significantly between sample depth intervals for both unsaturated zone alluvial drill cuttings and saturated zone alluvial sonic core, which indicates that this alluvium consists of numerous textural layers with likely different flow- and transport-related properties.

Electrical Conductivity

Depth profiles of electrical conductivity (EC) tests of water extracts from alluvial drill cuttings show peaks in EC values in the upper 15 feet of each borehole, indicating salt accumulation in the near surface. Flat Tire Flat boreholes exhibit a second major broad peak or series of peaks at depth, whereas the peaks at depth in Fortymile Wash boreholes are narrower or nonexistent. The reason for these differences may be due to differences in source rock and/or the size of the drainage basins.

Depth profiles of EC tests of sonic core from the lower part of the unsaturated zone immediately above the present water table in 19PB show several peaks in EC values. It is possible that paleo-water tables may be partially responsible for these variations.

Saturated Hydraulic Conductivity

Evidence was found for a linear correlation between the natural logarithm of saturated hydraulic conductivity (Ksat) and percentage of fines in drive core from 24P and sonic core segments repacked at air-dried and optimum water contents in 19PB. Similar trends of decreasing Ksat values with increasing fines percentages have been found in numerous other studies for a variety of sediments (Todd, 1980). Differences between arithmetic and geometric mean Ksat values for these samples suggest that the values are log-normally distributed.

Ksat values for drive core samples vary approximately four orders of magnitude and more than approximately two orders of magnitude for repacked sonic core samples.

Also as expected, mean Ksat values for sonic core samples repacked at optimum water contents were significantly (i.e., approximately 300 times) higher than those for drive core samples, which were significantly smaller in volume. Numerous workers have found that, on the average, the smaller the volume of the sample being tested, the lower the resulting Ksat value. Presumably, smaller samples are expected to contain fewer porosity-related heterogeneities and preferential flowpaths. However, the differences between drive core and repacked sonic core Ksat measurements are also likely in part due to the horizontally oriented textural layering resulting in Ksat anisotropy that is present in drive core samples and lacking in repacked sonic core samples.

Field Saturated Hydraulic Conductivity Test Results

Constant head injection tests conducted in 19PB produced Ksat values more than 10 times lower for the shallow piezometer screen than for the deep one. This difference was unexpected and may be related to the preferential accumulation of fines or smearing of fines on borehole walls of the shallow piezometer by a yet-to-be-defined mechanism.

A comparison of average Ksat values obtained from these tests with values from both smaller scale laboratory tests on core samples and a larger scale constant-rate 48-hour pump test in an immediately adjacent borehole suggests a direct relationship between measurement scale and Ksat value. Ksat anisotropy is also likely responsible in part for the differences in Ksat measurements in drive core and field measurements. Field Ksat measurements are primarily oriented in the horizontal direction parallel to alluvial textural layers; drive core measurements are oriented perpendicular to these layers.

Summary of Lithologic Logging Results

Boreholes 27P and 16P

The Miocene volcanic section stratigraphy penetrated by 27P and 16P is generally similar to other wells south of Yucca Mountain, such as WT-11 and -12.

The thickness of major pyroclastic flow deposits is consistent with like units within the main block of Yucca Mountain; the major exception is the relatively thin 150-foot section of Tiva Canyon Tuff in 27P, which suggests some restriction during deposition.

16P includes every major Miocene tuff unit from the Ammonia Tanks Tuff through the top of the Tram Tuff and penetrates nearly the entire 2,500- to 3,000-foot thickness of the upper volcanic

aquifer (i.e., the top of the water table in the Rainier Mesa Tuff to the top of the Pre-Tram Tuff sedimentary rocks).

Borehole 28P

28P penetrates the upper portion of the Miocene volcanic section from the Ammonia Tanks Tuff through the Topopah Spring Tuff. However, the Crater Flat Group tuff members are missing beneath the Topopah Spring Tuff. Instead, older sedimentary rocks are penetrated, similar to those encountered in deeper sections of Phase I and II boreholes 1DX, 3D, 2DB and 19D.

The fact that such an unconformity exists and the Crater Flat Group tuff members are missing in 28P but present in both 16P and 27P suggests that 28P is located on the footwall of a large buried syn-volcanic (i.e., growth) fault, while 16P and 27P are located on the hanging wall, with an approximate displacement of 1,500 feet or more.

The thickness of the volcanic aquifer is greatly diminished in comparison to 16P to the north. The aquifer (i.e., the top of the water table to the top of the Pre-Tram Tuff sedimentary rocks) at this location is less than 1,000 feet thick.

Borehole 24P

The first bedrock unit encountered in 24P is Bullfrog Tuff, at approximately 400 feet bgs. Several explanations for this anomalously shallow intersection are possible.

An explanation consistent with the apparent unconformity in the volcanic sequence in 28P is that 24P is also located on the footwall of a large growth fault, where lower tuff units of the Crater Flat Group were structurally uplifted and possibly eroded prior to the eruption of the Topopah Spring Tuff.

Gravity and magnetic data suggest that growth faulting could be responsible for the uplift in the Crater Flat Group-aged rocks to form a structural high and an associated basin trending southward from the east side of Yucca Mountain to the northwest side of Busted Butte and southwestward to the west side of the Lathrop Wells cinder cone.

Borehole 29P

Borehole 29P penetrated a relatively thin 380-foot section of Paintbrush Group tuffs before being terminated at 790 feet bgs due to flowing sands. The 230-foot-thick Topopah Spring Tuff, elsewhere up to 1,000 feet thick, indicates that some restriction in the basin occurs, possibly the paleotopographic high discussed in regard to 24P and 28P.

Corehole 19PB

In 19PB, intervals of gravels with clay, silt, and sand predominate between the water table and approximately 500 feet bgs. Between approximately 500 and 630 feet bgs, clayey sands with gravel predominate. The upper interval consists mainly of textural layers with less than 12 percent fines; the lower consists mostly of layers with 12 percent or more. Layers in these two intervals would be expected to exhibit different average Ksat values, based on laboratory tests conducted on small-scale repacked core samples. The division of the upper saturated alluvial aquifer into these two textural units may be useful in future modeling studies. However, this two-unit division may be an oversimplification, and alternative modeling approaches may be required to capture the previously described Ksat variability in the numerous textural layers.

Borehole Geophysical Logging Results

Borehole geophysical logs were used for lithologic characterization and stratigraphic correlations. Only qualitative interpretations of rock properties were made from the logs.

In Tertiary volcanic units, formation resistivity logs helped identify the degree of welding within ash-flow tuffs, and therefore stratigraphic correlation. Higher resistivity values correlated well with welded rocks identified in the drill cuttings; low resistivity values correlated with nonwelded rocks.

In some wells, fluid resistivity and temperature logs helped identify discrete intervals where warm groundwater flowed into the wellbore. Optical televiewer logs, though not always of usable quality, showed that these discrete flow zones are in some places open fractures. Discrete inflow zones were identified in 16P and 27P.

Geophysical and Geologic Features

Several geophysical features determined by previous workers correlate with geologic features observed in this study. For example, a northeast-trending feature on a magnetic map between 28P and 16P likely results from a buried fault. A large gradient on a gravity map trends northeastward from west of the Lathrop Wells cinder cone to south of Busted Butte on the western boundary of the Nevada Test Site and runs between 27P and 16P. This gravity lineament likely represents the steep contact between basin fill and Paleozoic rocks on the edge of the Crater Flat basin.

These geophysical lineaments, whether they represent a faulting or some other type of steep contact between the basin fill and Paleozoic rocks, could have significant control of groundwater flowpaths in this area south of Yucca Mountain.

Geologic Interpretations

Drilling data, combined with geophysical interpretations, suggest that Cenozoic deposits thicken across an interpreted fault between 16P and 28P. The fact that such an unconformity exists and the Crater Flat Group tuff members are missing in 28P but present in 16P and 27P suggests that 28P is located on the footwall of a large buried syn-volcanic (i.e., growth) fault, while 16P and 27P are located on the hanging wall, with an approximate displacement of 1,500 feet or more.

Displacement on the fault likely involves rocks as young as Crater Flat and Paintbrush Group units, but probably older than Tiva Canyon Tuff. The interpreted faulting between 16P and 28P is of pre-Basin and Range age.

The stratigraphic offset across the fault is conservatively approximately 1,500 feet bgs. The maximum extent of this offset may be larger; however, the stratigraphy and ages of the older rocks penetrated in the footwall block have not been determined. Rocks with low and high permeability are juxtaposed across this interpreted structure and potentially divert flow in highly permeable volcanic rocks to the southwest. 28P and 24P are located on a structurally high block, with relatively shallow Paleozoic rocks. Pre-Crater Flat Group units are interpreted to thicken markedly into a Crater Flat Group structural basin under 27P.

The water table transitions from Tertiary volcanic rocks to the north in 29P to alluvium to the south, in 19PB. The Highway 95 Fault is interpreted to mark the southern depositional boundary of the Tertiary volcanic aquifers as characterized within Yucca Mountain. The juxtaposition of volcanic aquifers north of the fault against less permeable, older Tertiary sedimentary rocks on the south side of the fault probably forces southward groundwater flow up into the alluvial aquifer system in lower Fortymile Wash and into Amargosa Valley.

Recommendations

Collecting drive core from unsaturated alluvium in uncased RC boreholes is not recommended. It is very difficult, if not impossible, to completely remove fill material from the borehole before coring, which results in collecting a significant amount of fill together with in situ formation material in the core barrel.

It is recommended that the realistic Phase IV sonic core density data be used to help assign accurate depths to future sonic core that has expanded during coring.

To avoid preferentially sampling the fines-rich outer surface or the fines-poor center of sonic core when collecting the grab samples in the field, it is recommended to split the core horizontally in half or collect pie-shaped samples with their apex terminating in the center of the core.

To minimize the effects of caving during well-completion activities in sonic coreholes, it is recommended that the drill casing be pulled back and completion material emplaced in short intervals (i.e., 20 to 40 feet), rather than longer ones.

To facilitate more aggressive development of small-diameter piezometer strings, the use of stainless steel blank casing and screen rather than PVC is recommended.

It is recommended that another exploratory borehole be drilled at the location of 29P, using casing-advance methods to penetrate and seal off flowing sands between approximately 700 and 790 feet bgs. Penetrating and characterizing the stratigraphy beneath the Paintbrush Group will help assess the structural orientation and possible erosional level of the footwall block in the area of 29P and 24P.

To help identify fracture flow zones, it is recommended that the optical televiewer or another borehole imaging tool be included in conjunction with groundwater flow logs.

It is recommended that modeling approaches be considered that capture the variability of Ksat and PSD parameters in the highly layered alluvial sediments in this study, as well as those that rely on average parameter values for thick intervals.

Finally, it is recommended that additional drilling and coring investigations be conducted in Fortymile Wash alluvium in conjunction with cross-hole tracer tests to better characterize the continuity or extent of coarse-grained textural layers with high Ksat values that could potentially act as preferential pathways for water and solutes.

CONTENTS

EXECUTIVE SUMMARY	i
FIGURES	xii
PLATES	xv
APPENDICES	xvi
ACRONYMS	xvii
1.0 INTRODUCTION	1
1.1 Program Background.....	1
1.2 Program Objectives	2
1.3 Pre-Phase IV Knowledge	3
1.3.1 Geologic Setting.....	3
1.3.1.1 Flat Tire Flat Boreholes.....	3
1.3.1.2 Fortymile Wash Boreholes.....	4
1.3.2 Subsurface Geophysical Interpretations	4
1.3.2.1 Gravity Data	4
1.3.2.2 Aeromagnetic Survey.....	5
1.3.3 Groundwater Flow System	5
1.4 Hydrogeologic Objectives of Phase IV Boreholes.....	6
1.5 Overview of Drilling, Coring, and Completion Activities.....	6
1.5.1 Reverse-Circulation Boreholes	6
1.5.2 Sonic Corehole.....	7
1.6 Quality Assurance Plans and Procedures	7
1.7 Report Organization	8
2.0 DRILLING, CORING, SAMPLING, LOGGING, AND TESTING	9
2.1 Drilling and Coring	9
2.1.1 Background Information.....	9
2.1.1.1 Air-Rotary Reverse-Circulation Drilling Methods.....	10
2.1.1.2 Drive Coring Methods.....	10
2.1.1.3 Sonic Coring Methods.....	11
2.1.2 Drilling Methods by Borehole Type	12
2.1.2.1 Reverse-Circulation Boreholes.....	12
2.1.2.2 Sonic Corehole	14
2.2 Geologic Sampling.....	14
2.2.1 Drill Cuttings	14
2.2.2 Drive Core.....	15
2.2.3 Sonic Core.....	16
2.3 Geologic and Photographic Logging.....	16
2.4 Hydraulic Parameter Laboratory Testing	17

CONTENTS (CONTINUED)

2.5 Borehole Geophysical Logging.....18

 2.5.1 Description of Borehole Geophysical Logs.....18

 2.5.1.1 Lithology Identification and Correlation.....18

 2.5.1.2 Water Production Zone Identification.....19

 2.5.1.3 Well Installation Support and Use19

 2.5.2 Suites of Borehole Geophysical Logs.....20

 2.5.3 Geophysical Log Comparison.....20

3.0 WELL COMPLETION, DEVELOPMENT, AND TESTING.....21

 3.1 Well Completion21

 3.2 Well Development.....23

 3.2.1 Reverse-Circulation Boreholes23

 3.2.2 Sonic Corehole.....23

 3.3 Constant Head Borehole Saturated Hydraulic Conductivity Tests24

4.0 GEOLOGIC SAMPLE LOGGING25

 4.1 Geologic Logging of Drill Cuttings25

 4.1.1 Geologic Logging and Drilling Data Censoring.....25

 4.1.2 Geologic Logging and Drilling Depth Profiles.....26

 4.1.2.1 Moisture Content Depth Profiles.....27

 4.1.2.2 Cementation and Hydrochloric Acid Reaction Depth Profiles27

 4.1.2.3 Drilling Rate Depth Profiles.....28

 4.1.2.4 Water Production Depth Profiles28

 4.2 Geologic and Photographic Logging Results on Core.....29

 4.2.1 Censored Geologic Logging Data for Core29

 4.2.2 Coring and Logging Data Trends29

 4.2.2.1 Drive Core Recovery and Dry Bulk Density30

 4.2.2.2 Sonic Core Bulk Density.....30

 4.2.2.3 Sonic Core Composition, Cementation, and Hydrochloric Acid Reaction Trends.....31

 4.2.2.4 Sonic Coring Rate and Run Length Trends32

 4.2.2.5 Sonic Core Disturbance.....32

5.0 LABORATORY TEST RESULTS33

 5.1 Laboratory Tests of Core Samples33

 5.1.1 Drive Core Test Results for 19PB, 24P, and 29P33

 5.1.1.1 Dry Bulk Density, Porosity, and Volumetric Water Content Data33

 5.1.1.2 Saturated Hydraulic Conductivity and Particle Size Distribution Data33

 5.1.2 Sonic Grab Core Test Results for 19PB35

 5.1.2.1 Particle Size Distribution Data.....35

 5.1.2.2 Electrical Conductivity Data35

 5.1.3 Repacked Sonic Core Tests for 19PB.....36

 5.1.3.1 Repacking Data36

 5.1.3.2 Laboratory Test Data.....37

CONTENTS (CONTINUED)

5.2 Laboratory Tests of Drill Cuttings39

 5.2.1 Particle Size Distribution Data from Alluvium39

 5.2.2 Electrical Conductivity Data from Unsaturated Alluvium40

 5.2.3 Gravimetric Water Content Data in Unsaturated Alluvium40

5.3 Constant Head Saturated Hydraulic Conductivity Tests in 19PB.....41

 5.3.1 Constant Head Data41

 5.3.2 Comparison of Saturated Hydraulic Conductivity Tests41

6.0 BOREHOLE LITHOLOGY43

 6.1 Summary Lithologic Logs.....43

 6.1.1 Borehole 27P.....43

 6.1.2 Borehole 16P.....44

 6.1.3 Borehole 28P.....45

 6.1.4 Borehole 24P.....46

 6.1.5 Borehole 29P.....48

 6.1.6 Corehole 19PB.....49

 6.2 Borehole Geophysical Logs50

 6.2.1 Geophysical Log Signatures and Interpretations for 27P51

 6.2.2 Geophysical Log Signatures and Interpretations for 16P52

 6.2.3 Geophysical Log Signatures and Interpretations for 28P53

 6.2.4 Geophysical Log Signatures and Interpretations for 24P55

 6.2.5 Geophysical Log Signatures and Interpretations for 29P56

 6.2.6 Geophysical Log Signatures and Interpretations for 19PB.....57

 6.3 Geologic Cross Sections.....58

 6.3.1 Cross Section A-A'.....59

 6.3.2 Conceptual Cross Section B-B'.....59

 6.3.3 Conceptual Cross Section C-C'.....60

 6.3.4 Cross Section Interpretation.....60

7.0 FINDINGS AND RECOMMENDATIONS.....62

 7.1 Findings.....62

 7.1.1 Drilling, Coring, and Well Construction.....62

 7.1.2 Geologic Logging63

 7.1.3 Dry Bulk Density Tests on Core Runs.....64

 7.1.4 Laboratory Tests on Core.....64

 7.1.5 Laboratory Tests on Drill Cuttings66

 7.1.6 Field Saturated Hydraulic Conductivity Tests at Site 19.....67

 7.1.7 Summary Lithology Logs67

 7.1.8 Borehole Geophysical Logging69

 7.1.9 Gravity and Magnetic Features.....69

 7.1.10 Geologic Interpretations from Drilling and Geophysical Data.....69

 7.2 Recommendations70

8.0 REFERENCES72

TABLES

1.3-1 Survey Coordinates and Well Completion Information1

1.6-1 Phase IV Quality Assurance Documents2

2.1-1 Summary of Drilling Equipment Used in Reverse-Circulation Boreholes.....3

2.2-1 Summary of Drill Cuttings Sampling, Splitting, and Testing.....4

2.2-2 Summary of Drive Core Sampling, Splitting, and Testing.....5

2.2-3 Summary of Sonic Core Sampling, Splitting, and Testing.....6

2.4-1 Summary of Laboratory Tests on Geologic Samples7

2.4-2 Laboratory Test Methods.....8

2.5-1 Description of Types and Applications of Geophysical Logs9

2.5-2 Summary of Phase IV Geophysical Logs10

3.1-1 Summary of Well Elevations and Water Levels.....13

4.1-1 Summary of Censored Geologic Data14

4.2-1 Drive Core Recovery and Density Data.....15

4.2-2 Saturated Formation Dry Bulk Density Data for 19PB Sonic Core Runs16

5.1-1 Laboratory Analysis Data for 19PB, 24P, and 29P Drive Core Samples17

5.1-2 Mean Dry Bulk Density and Saturated Hydraulic Conductivity Data for Drive Core Samples20

5.1-3 Laboratory Particle Size Distribution Data, Summary Statistics for 24P and 29P Drive Core Samples21

5.1-4 Laboratory Particle Size Distribution Data, Summary Statistics for 19PB Sonic Grab Core Samples22

5.1-5 Summary of Laboratory Analyses of 19PB Sonic Core Grab Samples Repacked to Target Densities at Air-Dried and Optimum Water Contents23

5.1-6 Mean Saturated Hydraulic Conductivity Data for 19PB Drive Core Samples and Repacked Laboratory Samples24

5.1-7 Comparison of Particle Size Distribution Data for 19PB Sonic Grab Core Samples and Repacked Laboratory Sample Splits.....25

5.2-1 Laboratory Particle Size Distribution Data, Summary Statistics for 16P, 27P, and 28P Drill Cuttings Samples.....26

5.2-2 Laboratory Particle Size Distribution Data, Summary Statistics for 24P and 29P Drill Cuttings Samples27

5.3-1 Hydraulic Conductivity Data from Constant Head Tests in 19PB Piezometers.....28

5.3-2 Laboratory Particle Size Distribution Data, Summary Statistics for 19PB Sonic Core Grab Samples from both Shallow and Deep Piezometer Sandpack Intervals29

5.3-3 Summary of Average Saturated Hydraulic Conductivity vs. Measurement Scale Data for Site 19 Core and In Situ Tests.....30

6.2-1 Summary of Censored Geophysical Logs.....31

FIGURES

1.1-1	Early Warning Drilling Program Region.....	1
1.3-1	Early Warning Drilling Program Well Locations.....	2
1.3-2	Geologic Map of the Yucca Mountain Area with Cross Section Locations.....	3
1.3-3	Depth to Paleozoic-Age Basement Rocks	4
1.3-4	Aeromagnetic Survey Map	5
1.3-5	Potentiometric Surface Map of the Yucca Mountain/Amargosa Desert Area.....	6
1.3-6	Modeled Potential Groundwater Flowpaths from the Yucca Mountain Repository	7
2.3-1	Example of Alluvium Drill Cuttings Geologic Logging Form.....	8
2.3-2	Example of Non-Alluvium Drill Cuttings Geologic Logging Form	9
2.3-3	Example of Alluvium Core Geologic Logging Form	10
3.1-1	Schematic Dual-String Piezometer Completion Diagram for 19PB.....	11
3.1-2	Schematic Single-String Piezometer Completion Diagram for 16P.....	12
4.1-1	Moisture Content vs. Depth for 27P Drill Cuttings Samples.....	13
4.1-2	Moisture Content vs. Depth for 29P Drill Cuttings Samples.....	14
4.1-3	Moisture Content vs. Depth for 16P Drill Cuttings Samples.....	15
4.1-4	Cementation vs. Depth for 27P and 28P Alluvial Drill Cuttings Samples	16
4.1-5	Cementation vs. Depth for 24P and 29P Alluvial Drill Cuttings Samples	17
4.1-6	Hydrochloric Acid Reaction vs. Depth for 16P and 28P Drill Cuttings Samples	18
4.1-7	Hydrochloric Acid Reaction vs. Depth for 24P and 29P Drill Cuttings Samples	19
4.1-8	Drilling Rate, Rock Unit, and Tuff Welding vs. Depth for 27P	20
4.1-9	Drilling Rate, Rock Unit, and Tuff Welding vs. Depth for 29P	21
4.1-10	Drilling Rate, Rock Unit, and Tuff Welding vs. Depth for 16P	22
4.1-11	Water Production, Rock Unit, and Tuff Welding vs. Depth for 16P.....	23
4.1-12	Water Production, Rock Unit, and Tuff Welding vs. Depth for 28P.....	24
4.2-1	Cementation vs. Depth for 19PB Alluvial Sonic Grab Core Samples.....	25
4.2-2	Cementation vs. Depth for 19IM1A and 19IM2A Alluvial Drill Cuttings Samples.....	26
4.2-3	Hydrochloric Acid Reaction vs. Depth for 19PB Alluvial Sonic Grab Core Samples.....	27
4.2-4	Hydrochloric Acid Reaction vs. Depth for 19IM1A and 19IM2A Alluvial Drill Cuttings Samples.....	28
4.2-5	Coring Rate vs. Run Length for 19PB.....	29
4.2-6	Example of Sample Disturbance in 19PB Sonic Core Segments	30
4.2-7	Examples of Textural Layers in 19PB Sonic Core Segments.....	31
5.1-1	Saturated Hydraulic Conductivity vs. Percentage of Fines for 24P, 29P, and 19PB Drive Core Samples	32

FIGURES (CONTINUED)

5.1-2 Laboratory Particle Size Distribution vs. Depth for 19PB Alluvial Sonic Grab Core Samples33

5.1-3 Clay and Fines Fractions for 19PB Sonic Grab Core Samples, based on Hydrometer and Wet Sieve Particle Size Distribution Data, Respectively34

5.1-4 Atterberg Limits-based Classification of Fines Fraction for 19PB Sonic Grab Core Samples35

5.1-5 Laboratory Particle Size Distribution vs. Depth for 19PB Alluvial Sonic Grab and Drive Core Samples36

5.1-6 Electrical Conductivity vs. Depth for 19PB Alluvial Sonic Grab Core Samples37

5.1-7 Saturated Hydraulic Conductivity vs. Fines Fraction for Repacked Sonic Core Samples38

5.1-8 Percentage of Fines in Sample Splits from Identical Depth Intervals39

5.2-1 Laboratory Particle Size Distribution vs. Depth for 28P and 16P Alluvial Drill Cuttings Samples40

5.2-2 Laboratory Particle Size Distribution vs. Depth for 28P and 27P Alluvial Drill Cuttings Samples41

5.2-3 Laboratory Particle Size Distribution vs. Depth for 24P and 29P Alluvial Drill Cuttings Samples42

5.2-4 Laboratory Particle Size Distribution vs. Depth for 28P and 29P Alluvial Drill Cuttings Samples43

5.2-5 Laboratory Particle Size Distribution vs. Depth for 24P Alluvial Drill Cuttings and Drive Core Samples, including Shoe Core Samples44

5.2-6 Laboratory Particle Size Distribution vs. Depth for 29P Alluvial Drill Cuttings and Drive Core Samples, including Shoe Core Samples45

5.2-7 Laboratory Particle Size Distribution vs. Depth for 19IM2A Alluvial Drill Cuttings and 19PB Grab Core Samples46

5.2-8 Electrical Conductivity vs. Depth for 28P and 16P Alluvial Drill Cuttings Samples47

5.2-9 Electrical Conductivity vs. Depth for 28P and 27P Alluvial Drill Cuttings Samples48

5.2-10 Electrical Conductivity vs. Depth for 24P and 29P Alluvial Drill Cuttings Samples49

5.2-11 Electrical Conductivity vs. Depth for 19IM2A and 29P Alluvial Drill Cuttings Samples50

5.2-12 Gravimetric Water Content vs. Depth for 24P Alluvial Drill Cuttings and Drive Core Samples51

5.2-13 Gravimetric Water Content vs. Depth for 29P Alluvial Drill Cuttings and Drive Core Samples52

5.2-14 Gravimetric Water Content vs. Depth in Alluvium and Non-Alluvium for 16P and 27P53

5.3-1 Geometric Mean of Saturated Hydraulic Conductivity vs. Measurement Scale for Site 19 Core and In Situ Tests54

FIGURES (CONTINUED)

5.3-2 Geometric Mean of Saturated Hydraulic Conductivity vs. Measurement Scale for Site 19 Core and In Situ Tests, Excluding Data from Core Repacked at Air-Dried Water Content..55

6.1-1 Preliminary Summary Lithologic Logs for 19PB56

6.2-1 Optical Televiwer Image for 27P from 1158.5 to 1165.5 Feet Below Ground Surface.....57

6.2-2 Optical Televiwer Image for 29P from 517 to 522 Feet Below Ground Surface.....58

6.2-3 Optical Televiwer Image for 29P from 483.0 to 489.5 Feet Below Ground Surface.....59

6.2-4 Dry Bulk Density Depth Profiles from 19PB using Different Measurement Methods.....60

6.3.1 Cross Section A-A'61

6.3.2 Conceptual Cross Section B-B'62

6.3.3 Conceptual Cross Section C-C'63

PLATES
(AT THE END OF THE DOCUMENT)

- 1 Comparison of Geophysical Logging, Lithology, and Well Completion Information for 27P
- 2 Comparison of Geophysical Logging, Lithology, and Well Completion Information for 16P
- 3 Comparison of Geophysical Logging, Lithology, and Well Completion Information for 28P
- 4 Comparison of Geophysical Logging, Lithology, and Well Completion Information for 24P
- 5 Comparison of Geophysical Logging, Lithology, and Well Completion Information for 29P
- 6 Comparison of Geophysical Logging, Lithology, and Well Completion Information for 19PB

APPENDICES

- A Summary of Drilling Additives
- B Well Completion and Wellhead Protection Diagrams
- C Geologic Logging Parameters for Drill Cuttings
- D Alluvium Core Logging Forms
- E Laboratory Analyses of Drive Core Samples
- F Laboratory Analyses of Sonic Repacked and Grab Core Samples
- G Repacking and Water Content/Density Data for Sonic Core
- H Laboratory Analyses of Drill Cuttings Samples
- I Summary Lithologic Logs

ACRONYMS

APH-DC	air percussion hammer-drive core
APH-RC	air-percussion-hammer reverse circulation
AR-RC	air-rotary dual-wall reverse circulation
ATC	Alluvium Testing Complex
bgs	below ground surface
cm ³ /cm ³	cubic centimeter per cubic centimeter
DOE	U.S. Department of Energy
EC	electrical conductivity
EWDP	Early Warning Drilling Program
GLS	Geophysical Logging Services
gpm	gallons per minute
GWC	gravimetric water content
g/cm ³	gram per cubic centimeter
HCl	hydrochloric acid
ID	inside diameter
ISIP	Independent Scientific Investigations Program
Ksat	saturated hydraulic conductivity
LANL	Los Alamos National Laboratory
Ma	million years old
NTS	Nevada Test Site
NWRPO	Nuclear Waste Repository Project Office
OD	outside diameter
PSD	particle size distribution
QA	quality assurance
QARC	Quality Assurance Records Center
RC	reverse circulation
RID	record index designator
SC-DC	sonic drive core
SMF	Sample Management Facility
TP	technical procedure
TPN	test plan
Ts	older sedimentary rock
Tvo	older volcanic rocks
USCS	Unified Soil Classification System
USGS	U.S. Geological Survey
VWC	volumetric water content
WP	work plan
YMP	Yucca Mountain Project

1.0 INTRODUCTION

This report describes activities performed during Phase IV of the Early Warning Drilling Program (EWDP), which include borehole drilling; geologic sampling, testing, and logging; and well completion. Phase IV field work began in October 2002 and continued through August 2003. These activities were performed as part of the Nye County Nuclear Waste Repository Project Office (NWRPO) Independent Scientific Investigations Program (ISIP), which was funded by a cooperative agreement with the U.S. Department of Energy (DOE) to support the evaluation of a high-level nuclear waste repository at Yucca Mountain, Nevada.

1.1 Program Background

The Yucca Mountain repository is located within Nye County. Because Nye County retains limited local jurisdiction over this site, the county has rights of participation, funding, and onsite representation in Yucca Mountain Project (YMP) policies and activities. Nye County began to exercise these rights in 1987 by creating the NWRPO. The major goals of the NWRPO are to provide an independent evaluation and review of activities and policies related to the transport, disposal, and storage of nuclear waste within Nye County, and to supplement federal studies about potential impacts of the repository.

The ISIP was initiated in 1994 with a technical grant from DOE to provide an independent evaluation of selected site characterization and repository design and performance issues potentially affecting human health, safety, and the environment in southern Nye County. Since 1994, several additional grants and cooperative agreements have been obtained from DOE to continue the ISIP.

The EWDP is a subregional-scale hydrogeologic study and monitoring program designed to help protect Nye County water supply interests. The program focuses primarily on the region between the Yucca Mountain repository and populated areas of the Town of Amargosa Valley, referred to as Amargosa Valley in this report, in southern Nye County. The closest Amargosa Valley community to Yucca Mountain is Lathrop Wells, which is approximately 12 miles southeast of Yucca Mountain and downgradient along potential groundwater flowpaths. Figure 1.1-1 shows the location of these areas, as well as the Nevada Test Site (NTS), areas of private land ownership, and the principal population centers within southern Nye County.

A major Nye County concern is whether future Yucca Mountain nuclear waste management activities have the potential to impact the groundwater and surface water supplies within the Amargosa Valley and, in turn, human health and the environment. Although Amargosa Valley is sparsely populated and largely undeveloped, significant economic development and population growth will likely occur. Amargosa Valley also contains important sensitive natural environments and habitats, including Ash Meadows National Wildlife Refuge, Devils Hole, the Amargosa River, and various springs and associated wetlands.

The first three phases of the EWDP, conducted October 1998 through March 2002, were funded by an earlier 5-year cooperative agreement with DOE. Selected results from Phases I and II are found on the NWRPO website (NWRPO, 2005a). In addition, an overview of Phases I and II can be found in the NWRPO report for fiscal years 1996 through 2001 (NWRPO, 2001a). Finally,

details of Phase III methods and results are found in NWRPO (2003). This document can also be found on the NWRPO website.

The work described herein was funded by a second 5-year cooperative agreement begun on April 1, 2002, and summarizes the methods and results of EWDP Phase IV, which were conducted October 2002 through August 2003.

1.2 Program Objectives

The overall objectives of the EWDP include the following:

- A better definition of the potential risk to Amargosa Valley drinking water supplies from high-level nuclear waste handling and disposal at the Yucca Mountain repository.
- The design of an appropriate "early warning" groundwater monitoring network between the repository and present and future populations in the Amargosa Valley area.

A better understanding of the hydrogeologic system is a necessary first step toward achieving these objectives and has been the focus of all EWDP phases to date.

Before initiating the EWDP, an evaluation of existing hydrogeologic data revealed a significant data gap in the region downgradient from Yucca Mountain, including part of southern Jackass Flats, southern Crater Flat, western Rock Valley, and the northern Amargosa Desert. In short, there were few or no subsurface hydrogeologic data for these areas. The EWDP has targeted basic hydrogeologic data deficiencies in this region and continues to study the origin of spring deposits, geologic and hydraulic properties of valley-fill sediments; groundwater depths, gradients, and flow patterns; and baseline water chemistry.

Specific objectives of the EWDP include determining the following.

- Flow and transport parameters needed to refine and reduce uncertainty in groundwater and performance assessment models that incorporate groundwater modeling results.
- Baseline water chemistry and water level data, and the capability to monitor trends in these data in strategically placed boreholes over time.
- A better understanding of the flowpaths between tuff and alluvium, the nature and continuity of alluvial textural layers, the hydrogeologic units underlying the alluvium, and hydraulic gradients within and between units.

Phases I and II, completed in 2000 and 2001, respectively, provided hydrogeologic and baseline water chemistry data for the region south of the repository and along U.S. Highway 95, which traverses the northern edge of Amargosa Valley.

Phase III, completed in 2002, focused on filling data gaps for the region along Fortymile Wash within and outside the NTS. Work for the region outside the NTS included establishing further testing and monitoring capabilities at the Alluvium Testing Complex (ATC) site. The ATC was

established for cooperative studies conducted by the DOE; U.S. Geological Survey (USGS); Los Alamos National Laboratory (LANL); University of Nevada, Las Vegas; and Nye County to characterize the hydraulic and transport properties of the saturated alluvium near the southwestern boundary of the NTS.

Phase IV activities included borehole drilling, drill cuttings and core collection, geologic logging and laboratory testing of selected samples, borehole geophysical logging, completion of single-screen and dual-screen piezometers, water chemistry and water level monitoring, and limited aquifer testing.

This report focuses on the scope, methods, and results of these activities, with the exception of water chemistry and water level monitoring, which will be described in future Nye County technical reports.

1.3 Pre-Phase IV Knowledge

1.3.1 Geologic Setting

The locations of the Phase IV boreholes are shown on Figure 1.3-1; their coordinates are given in Table 1.3-1. All EWDP borehole names have an "NC-EWDP-" prefix; in this report the names will be given by number only. The six Phase IV boreholes are:

- 16P
- 27P
- 28P
- 24P
- 29P
- 19PB

Three of the boreholes (i.e., 16P, 27P, and 28P) are in a relatively small, alluvium-filled valley, referred to herein as Flat Tire Flat, which is located north-northeast of the Lathrop Wells cinder cone. The remaining three boreholes (i.e., 19PB, 24P, and 29P) are east of the Lathrop Wells cinder cone on the western side of Fortymile Wash, which is the major topographic drainage system for Jackass Flats, the eastern side of Yucca Mountain, and the southwestern corner of the NTS.

Locations of the Phase IV boreholes with respect to surface geology are shown on a recent geologic map of the Yucca Mountain area by Potter and others (2002), which describes local stratigraphy and faults (Figure 1.3-2).

1.3.1.1 Flat Tire Flat Boreholes

The Flat Tire Flat boreholes are located on relatively thin surface alluvium overlying tilted fault blocks of Tertiary volcanic ash and pyroclastic flows. The volcanic rocks were mostly derived from eruptions of the Timber Mountain and Silent Canyon caldera complexes to the north of Yucca Mountain, and are generally the same stratigraphic units as those found in Yucca Mountain. The most recent eruption from the caldera complex was the Ammonia Tanks Tuff, which erupted 11.45 million years ago (Sawyer et al., 1994).

Subsequent faulting along northeast-striking, west-dipping normal faults disrupted the volcanic strata by breaking it into several blocks. The fault-bound blocks are tilted down toward the east, forming the Flat Tire Flat basin as a down-dropped topographic valley between two or more faults. To the west of Flat Tire Flat is Crater Flat, a much larger basin.

Outcrops surrounding Flat Tire Flat expose Ammonia Tanks and Timber Mountain Tuffs of the Timber Mountain Group on the south and east sides, and hills of Tiva Canyon Tuff of the Paintbrush Group on the west and north (Figure 1.3-2). The basin is defined on the east by a ridge east of the Stagecoach Road normal fault. The ridge is an uplifted fault block exposing older Paintbrush Group Topopah Spring Tuff and underlying Prow Pass Tuff of the Crater Flat Group. The south end of the flat is closed off by the Lathrop Wells Cone, a relatively young basalt lava flow and cinder cone eruption that is 77,000 years old (Heizler et al., 1999).

1.3.1.2 Fortymile Wash Boreholes.

The Fortymile Wash boreholes are on alluvium at the surface. Unlike the restricted alluvial environment of Flat Tire Flat, the Fortymile Wash exploratory boreholes are located in a much more well-developed basin; hence, greater thicknesses of alluvium are present. The boreholes are east of the Stagecoach Road and Paintbrush Canyon Faults that formed the ridge separating the two borehole sets. This ridge includes outcrops of Tertiary volcanic rocks in fault blocks tilted toward the Fortymile Wash boreholes (Figure 1.3-2). Outcrops consist mainly of Tiva Canyon Tuff and underlying Topopah Spring Tuff of the Paintbrush Group. Outcrops of Tiva and other Paintbrush Group rocks occur between 24P and 29P.

1.3.2 *Subsurface Geophysical Interpretations*

1.3.2.1 Gravity Data

A regional gravity study of the area performed by the USGS (Blakely and Ponce, 2001) produced a calculation of depth to basement, described as depth to the Paleozoic age rocks (Figure 1.3-3). The study delineates several subbasins of the Crater Flat basin defined by higher (i.e., greater) depth to basement. The subbasins, 4 kilometers or more deep, are thought to be filled with thick sections of Cenozoic volcanic and sedimentary rocks and alluvium.

Linear boundaries between shallow and deep basement rocks with steep gravity gradients are interpreted to be faults at depth, but which may not be exposed at the surface. A large gravity gradient, shown as a lineament on Figure 1.3-3, trends northeastward from west of the Lathrop Wells Cone to south of Busted Butte northeast of 18P. Flat Tire Flat boreholes 27P and 16P were drilled on opposite sides of this gravity lineament. It should be noted that this inferred fault is not parallel to the normal fault blocks expressed on the surface. The cause of this gravity gradient, whether it is a fault or some other type of steep contact between the basin fill and Paleozoic rocks, could have significant control on groundwater flowpaths in the area south of Yucca Mountain.

Figure 1.3-3 also shows a north-south-trending gravity gradient between low and moderate depths to basement on the east side of Fortymile Wash. This feature, which has long been recognized (Winograd and Thordarson, 1975) and is interpreted to be a buried normal fault, has

been termed the Gravity Fault. All Phase IV boreholes are located west of the Gravity Fault on the down-dropped side.

1.3.2.2 Aeromagnetic Survey

An airborne magnetic survey was also performed by the USGS (Blakely et al., 2000) (Figure 1.3-4). On this figure, more magnetic rocks are shown in pink and less magnetic rocks are green to blue. The more magnetic rocks are younger volcanic rocks, such as the basalts of Crater Flat and the Lathrop Wells cone.

A large east-west-trending magnetic gradient coincides roughly with the path of Stagecoach Road as it passes from Fortymile Wash, across Flat Tire Flat, and into Crater Flat. On Figure 1.3-4, it is shown as the middle deep-seated magnetic signature. In addition, this figure shows a prominent northeast trending magnetic lineament that is coincident with the gravity gradient shown on Figure 1.3-3.

Figure 1.3-4 shows that the Flat Tire Flat boreholes are located between the middle and southern deep-seated magnetic signatures. Site 27P is situated immediately south of the middle signature. Site 28P is separated from 16P by the northeast trending magnetic lineament. Two of the Fortymile Wash boreholes (i.e., 24P and 29P) are located between the middle and southern deep-seated magnetic signature, while 19PB is located just south of the southern signature.

1.3.3 Groundwater Flow System

The groundwater flow system in the Yucca Mountain/Amargosa Desert area is generally characterized by flow from north to south (Winograd and Thordarson, 1975). A potentiometric surface map of the area is shown on Figure 1.3-5 (DOE, 2003). The map shows a relatively steep potentiometric gradient north and west of Yucca Mountain. The steep gradient incorporates water level data from Phase I and II wells (i.e., 1DX, 2D, 3S, 7SC, 9SX, and 12PC). The figure shows that there are no water level data for Flat Tire Flat to constrain the potentiometric contours and the high gradient between Crater Flat and Flat Tire Flat.

The water table beneath Yucca Mountain is within volcanic rocks and interpreted to flow southeastward toward Fortymile Wash. The potentiometric gradient in Fortymile Wash is more moderate, with southward flow following the wash to Amargosa Valley. The southeast-trending potentiometric gradient on the western side of lower Fortymile Wash is also based on widely spaced data points and may not be an accurate representation of the potentiometric surface. Between Yucca Mountain and U.S. Highway 95, the water table crosses stratigraphically from volcanic rocks into alluvium.

Potential groundwater flowpaths from the Yucca Mountain repository are shown on Figure 1.3-6. The modeled particle flowpaths from the repository move downgradient southeastward and then flow southward toward and under Fortymile Wash. Other workers (NWRPO, 2005b) have recently presented geochemical evidence that flowpaths may also occur south from Yucca Mountain and pass through Flat Tire Flat towards Amargosa Valley.

1.4 Hydrogeologic Objectives of Phase IV Boreholes

Phase IV boreholes were sited to collect hydrogeologic information directly downgradient of Yucca Mountain, in both volcanic rocks and alluvium, in line with possible groundwater flowpaths between Yucca Mountain and Amargosa Valley. Specifically, hydrogeologic objectives for all boreholes except 19PB include the following.

- An examination of the volcanic rocks that make up the uppermost aquifer in Flat Tire Flat and the western side of Fortymile Wash.
- An examination of the stratigraphy of subsurface geologic units in proximity to the large northeast trending gravity gradient and the large east-west magnetic gradient near the southern end of Yucca Mountain.
- Provide future monitoring points for water levels and water chemistry in the geologic unit spanning the water table.

The boreholes in Flat Tire Flat were sited, to the extent possible, on opposite sides of the large northeast trending gravity gradient and prominent magnetic lineations to maximize information obtained about these features. A seventh borehole was sited on the north side of the middle deep-seated magnetic signature shown on Figure 1.3-4 immediately north of 27P; however, funds were not available to complete this borehole during Phase IV.

The Fortymile Wash boreholes were sited southeast of this large gravity gradient on the apparent footwall block in an area of alluvial cover, near the transition of saturated flow from the volcanic aquifer to the alluvial aquifer. Major objectives for these boreholes were to collect basic hydrogeologic data and serve as subsurface control points for future surface geophysical studies designed to characterize the contact between the uppermost volcanic and alluvial aquifers along the western edge of Fortymile Wash. Borehole 29P was also designed to test the aerial extent of an unusual Ashflow Tuff unit encountered below alluvial units at Site 19, approximately one mile to the south.

Corehole 19PB was located on the ATC, approximately 1 mile north of U.S. Highway 95 and adjacent to the braided channel of lower Fortymile Wash. The primary hydrogeologic objective of 19PB was to provide continuous sonic core from the upper portion of the alluvial aquifer to identify potential preferential flowpaths and small-scale estimates of flow and transport properties. These data will complement and support the interpretation of flow and transport data obtained on a much larger scale from previous single-hole tracer tests and future cross-hole tracer tests at this location. In addition, 19PB was positioned at an upgradient location on the ATC site to permit its use as an injection well in future tracer tests.

1.5 Overview of Drilling, Coring, and Completion Activities

1.5.1 Reverse-Circulation Boreholes

The Flat Tire Flat boreholes were drilled using air-rotary dual-wall reverse-circulation (AR-RC) drilling methods commonly used for mineral exploration. The Fortymile Wash boreholes were drilled similarly, except for several depth intervals in the unsaturated alluvium drilled with air-percussion-hammer dual-wall reverse-circulation (APH-RC) methods. APH-RC methods were

used to determine whether drill cuttings more representative of in situ conditions could be produced. In addition, selected short depth intervals of unsaturated alluvium in 24P and 29P were cored using drive core methods. In this report the term "alluvium" refers to unconsolidated rock and "non-alluvium" to consolidated rock.

AR-RC drilling methods have been described in detail in NRWPO (2003) and are summarized in Section 2.1. These methods are believed to provide reasonably representative drill cuttings for geologic logging from most formations, with the exception of saturated alluvium producing significant amounts of water. APH-RC methods have not been used previously in EWDP boreholes. For this report, boreholes drilled using AR-RC or both AR-RC and APH-RC will be referred to as reverse-circulation (RC) boreholes.

Drive coring methods used in selected short depth intervals in the unsaturated zones of 24P and 29P are also described in NRWPO (2003). These alluvial coring methods provide particle size distribution (PSD) data that are considered representative of in situ conditions, and therefore provide a standard by which to judge the disturbance of drill cuttings collected from the same or an adjacent depth interval. At the same time, the method is costly and not suited to providing continuous core.

RC boreholes were completed with a single-screen piezometer that extended across the water table. The term piezometer, denoted with P in the borehole name, refers herein to a small-diameter (i.e., approximately 2-inch inside diameter [ID]) monitor well with a screen and sandpack generally less than 50 feet long.

1.5.2 Sonic Corehole

The major portion of the unsaturated zone in 19PB was drilled with mud-rotary methods and cased off before coring began. Sonic methods were then used to obtain core from the lower approximately 20 feet of the unsaturated zone and the upper approximately 260 feet of the alluvial aquifer. 19PB was completed with dual piezometer screens whose depths correspond approximately to the depths of the upper two screens in previously constructed multiple screen boreholes at the ATC.

Sonic coring methods are suited to providing continuous core at a reasonable cost. Details of the sonic coring method used in 19PB are given in Section 2.1. This method provided the first continuous core from alluvium in the vicinity of Yucca Mountain. Although the method disturbs the porosity/density of the alluvial samples, it maintains intact textural layering and provides representative samples suitable for detailed geologic logging and laboratory testing of selected flow and transport parameters.

1.6 Quality Assurance Plans and Procedures

The NRWPO Quality Assurance (QA) Program Plan and quality administrative procedures outline QA management procedures for the collection and documentation of scientific data. These documents help to ensure that NRWPO scientific investigations provide valid data that are useful to Nye County and other potential users associated with the YMP. The U.S. Nuclear Regulatory Commission evaluated the Quality Assurance Program Plan in 1999 and issued a conditional acceptance statement (Reamer, 1999, personal communication).

Table 1.6-1 lists the specific work plans (WPs), technical procedures (TPs), and test plans (TPNs) pertinent to Phase IV. The WPs included in this table outline technical objectives and describe methods and procedures for accomplishing these objectives (e.g., scopes of work). In addition, WPs reference applicable TPs, which in turn provide detailed instructions for performing routine technical activities or tasks. TPNs document technical objectives and detailed instructions for one-of-a-kind technical activities. Some deviations from these WPs, TPs, and TPNs were found to be necessary due to conditions encountered in the field. Major deviations were documented on field change approval forms filed in the NWRPO Quality Assurance Records Center (QARC). In general, these deviations did not affect the achievement of project objectives and goals.

1.7 Report Organization

Section 1.0 of this report provides pertinent background information and describes the purpose and scope of EWDP Phase IV field and laboratory work. Section 2.0 summarizes field drilling, sampling, logging, and laboratory testing methods and procedures. Section 3.0 describes well completion, development, and preliminary field testing activities. Section 4.0 presents the results of geologic logging, Section 5.0 the results of laboratory and preliminary field testing, and Section 6.0 the results of geophysical and lithological logging and geologic cross-section interpretations. Section 7.0 summarizes major findings and recommendations.

2.0 DRILLING, CORING, SAMPLING, LOGGING, AND TESTING

This section describes Phase IV drilling, coring, sampling, geologic logging, laboratory testing, and geophysical logging methods. Further details about these methods can be found in the quality assurance (QA) documents listed in Table 1.6-1. The NWRPO On-Site Geotechnical Representative was responsible for program oversight and approval of procedural and scope changes necessitated by field conditions or findings. NWRPO field staff and contract geologists and technicians, referred to as NWRPO personnel in this report, were responsible for recording site management information, equipment calibrations, general observations, and progress notes in scientific field notebooks. Field forms were used by NWRPO personnel to record key drilling, sampling, and well completion data, including, but not limited to, depth control, geologic logging, and chain of custody. Completed forms and scientific notebooks are on file at the QARC.

2.1 Drilling and Coring

Under NWRPO oversight, drilling and coring were conducted by drilling contractors responsible for 1) implementation of the drilling/coring scope of work, 2) compliance with all applicable permit conditions and regulations, and 3) compliance with both their in-house health and safety plan and industry-standard work practices specified in contract documents. All contract documents are on file at the QARC.

Drilling and coring methods for Phase IV boreholes were based on a number of objectives, including the ability of the methods to:

- Yield drill cuttings and core as representative as possible of in situ formation rock.
- Minimize disturbance of the formation rock.
- Achieve target depths.
- Yield boreholes suitable for single- or dual-screen piezometer well completion.

With the exception of achieving target depths, these objectives had been used to select Phase III drilling and coring methods. These methods are described in NWRPO (2003), which includes a detailed discussion of drilling and drilling-related impacts that can potentially disturb the representativeness of drill cuttings and formation material.

The target depths for RC boreholes (i.e., all Phase IV boreholes except 19PB) were initially approximately 2,000 feet below ground surface (bgs), although several boreholes were drilled either deeper or shallower. The target depth for 19PB was approximately 650 feet bgs.

2.1.1 Background Information

This section provides background information about Phase IV drilling and coring methods, including AR-RC drilling and drive and sonic coring methods. Standard mud-rotary drilling methods used for the unsaturated zone in 19PB will not be discussed herein. This common drilling approach was used to rapidly and inexpensively drill a borehole suitable for a conductor casing to support sonic coring of the underlying saturated alluvium.

2.1.1.1 Air-Rotary Reverse-Circulation Drilling Methods

RC boreholes were drilled primarily with AR-RC, which is commonly used in the mineral exploration industry. It was demonstrated during Phase III drilling that this method could meet the objectives listed in Section 2.1 to an acceptable extent and was relatively fast and inexpensive compared with other methods (NWRPO, 2003). More specifically, it generally:

- Minimized cross-contamination between formation units.
- Provided drill cuttings that were relatively uncontaminated by drilling fluids.
- Provided drill cuttings from coarse-grained alluvium and underlying bedrock that contained a significant percentage of small gravel and sand particles suitable for visual logging, including identifying in situ rocks and minerals.

While AR-RC yields drill cuttings useful for identifying in situ rocks and minerals, it disturbs the particle size of alluvial drill cuttings from in situ conditions to varying degrees, primarily because of the grinding action of the drill bit on alluvial clasts. More specifically, data presented in NWRPO (2003) demonstrate that the grinding of clasts of relatively soft nonwelded tuff below the water table reduces a high percentage of gravel-sized particles to sand-sized, and significantly disturbs the PSD of alluvial drill cuttings.

NWRPO (2003) shows that AR-RC particle size reduction is not as significant in the unsaturated zone, where water is not available to facilitate grinding, or in the uppermost part of the unsaturated zone, where only small quantities of water are produced at the drill bit. However, this lack of water in the unsaturated zone causes both drilling-created and naturally occurring small (e.g., silt- and clay-sized) particles to be lost as dust from the sample collection system at the ground surface via a cyclone separator.

AR-RC uses compressed air as the drilling fluid when possible. Generally, compressed air minimizes the disturbance to formation rock permeability and water chemistry. However, air often erodes borehole walls and can create caving conditions, especially in the unsaturated zone. In these cases, drilling mud (i.e., sodium bentonite and polymer) was used to stabilize the walls of AR-RC drilled boreholes. The use of organic drilling fluids and additives, including foams, polymers, and lost circulation materials, was minimized to the extent possible. More details about drilling fluids are presented in Appendix A.

2.1.1.2 Drive Coring Methods

Obtaining representative core from coarse-grained alluvium is difficult and costly. Numerous coring methods have been attempted without success in the vicinity of Yucca Mountain, including split barrel (i.e., split spoon) sampling with a drop weight; hollow-stem auger with push-tube sampler; double- or triple-tube rotary coring; and Pitcher[®] or similar spring-loaded core barrel methods. During Phase III, the NWRPO demonstrated that drive coring methods using a solid-tube sampler with a downhole air-percussion hammer produced good core recovery of alluvium from selected depth intervals in boreholes drilled with casing-advance drilling methods (NWRPO, 2003).

Based on this success, air percussion hammer drive coring (APH-DC) was conducted in RC boreholes 24P and 29P to meet the following objectives.

- Demonstration of the feasibility of obtaining minimally disturbed drive core from alluvium in RC boreholes. It should be noted that drive coring in uncased RC boreholes has seldom, if ever, been attempted.
- Collection of samples from RC boreholes with representative PSD in order to judge the degree of particle size disturbance in drill cuttings obtained from the same or adjacent depth intervals.
- An approximation of alluvial in situ bulk density and porosity values at selected depth intervals.

Drive coring of selected depth intervals in 24P and 29P involved driving an approximately 4-inch-ID, 2-foot-long solid-tube core barrel into alluvium with a downhole air-percussion hammer. In sonic corehole 19PB, the same solid-tube core barrel was advanced by the sonic drive core (SC-DC) methods described in Section 2.1.1.3. In all cases, a beveled, hardened-steel drive shoe was attached to the downhole end of the solid-tube core barrel, and the core barrel was lined with thin-walled brass tubes cut into 6- and 3-inch-long segments. Upon completion of each core run, samples were removed from the core barrel by a hydraulic core extruder.

Drive coring at depths exceeding several 100 feet is extremely expensive, even under the most favorable subsurface geologic conditions. Caving and/or sloughing of unstable borehole wall material in open boreholes, such as the ones drilled in Phase IV, make drive coring of undisturbed alluvium even more difficult and expensive. For these reasons, drive coring methods are generally considered unsuitable for continuous coring.

2.1.1.3 Sonic Coring Methods

In contrast to drive coring, sonic coring has the capability of producing continuous core from coarse-grained alluvium at depths exceeding several 100 feet. Other investigators have demonstrated its capabilities in mine waste and ore dumps, at natural and artificial groundwater infiltration sites, and during numerous environmental studies. However, continuous sonic coring to significant depths had never been done at Yucca Mountain or other locations on the NTS.

Based on the success of others, sonic coring was used in 19PB to meet the following objectives.

- Demonstration of the capability of successful continuous sonic coring of the upper approximately 300 feet of saturated alluvium.
- Collection of coring-related data to permit the calculation of in situ dry bulk density and porosity values.
- Collection of core suitable for geologic, digital photographic, and video logging, and laboratory testing of parameters independent of porosity.
- Determination of laboratory PSD data to identify major hydrogeologic units that may act as preferential flowpaths or barriers.

Sonic coring uses a dual-pipe system consisting of a core pipe (i.e., the core barrel) inside a larger diameter drill pipe (i.e., the drill casing). Both pipes are advanced using a combination of mechanically driven oscillations (i.e., vibrations), slow rotation, and hydraulic pull-down pressure. A top-mounted, hydraulically powered drill head is used to transmit the vibratory force and pull-down pressure on the core and drill pipes. Sonic coring collects continuous core without using drilling fluids in most unconsolidated and many consolidated deposits.

During typical borehole advancement, the inner core pipe is advanced approximately 5 to 20 feet ahead of the outer drill pipe. The core pipe is then brought to the ground surface, where core is vibrated out of the pipe into polyethylene film tubing (i.e., a plastic sock) with a diameter slightly larger than the outside diameter (OD) of the core pipe. The outer drill pipe is then advanced to the bottom of the borehole and the inner core pipe is used to remove the disturbed fill material from the outer drill pipe. The above steps are then repeated to continue coring and advance the borehole downward.

2.1.2 Drilling Methods by Borehole Type

For all borehole types, NWRPO personnel and drilling contractors maintained depth control during drilling by measuring/recording drill string and downhole assembly lengths and, where practicable, depth sounding.

2.1.2.1 Reverse-Circulation Boreholes

RC boreholes 16P, 27P, and 28P were drilled by Eklund Drilling using AR-RC. Eklund drilled 24P and 29P similarly, except for several relatively short depth intervals where APH-RC methods were used. Drilling equipment included an Ingersoll Rand RD-10 drill rig, 4.5- and 4.75-inch-diameter dual-wall drill pipe, and several downhole bit assemblies, as summarized in Table 2.1-1.

After the upper 60 to 62.5 feet of each RC borehole was drilled and sampled with the 6.25- or 6.5-inch bit, the boreholes were reamed with a 12-inch reamer bit. Steel surface casing with an 8.625-inch OD was installed to a depth of approximately 60 feet bgs at 16P, 60.9 feet at 24P, 58.2 feet at 27P, 59.6 feet at 28P, and 57.7 feet at 29P. The annular space between the borehole and the surface casing was sealed with cement grout consisting of Portland cement and W-60[®] gypsum-based accelerant. Surface casings were necessary to prevent caving of relatively unstable near-surface sediments, maintain borehole air pressure while drilling the remaining portion of each borehole, and provide a surface-well seal for later installation of the piezometer.

After the surface casing was installed, a 6.25- or 6.5-inch tricone center-return bit on 4.75- and 4.5-inch dual-wall drill pipes was used to advance the boreholes. In general, smaller bits were used in the deeper portions of the boreholes (Table 2.1-1). For example, at 16P and 28P, the lower sections of the borehole were drilled with bits ranging in diameter from 6.125 to 5.625 inches.

Air was used as the primary drilling fluid to advance the boreholes. Small volumes of injected water were used in the upper portion of the saturated zone to facilitate sample return. In addition, small amounts of Max Gel[®], a sodium bentonite mud containing a small amount of organic

polymer, were used to condition portions of borehole walls in the unsaturated zone to minimize hole erosion and caving during drilling of alluvial portions of the boreholes. Hole conditioning methods and quantities used for specific depth intervals are summarized in Appendix A.

Drilling progressed relatively smoothly at 16P, 24P, and 27P to total depths of 2,900, 1,860, and 1,900 feet, respectively. However, at 28P problems occurred when a clay-rich layer was encountered at approximately 1,140 feet. The 6.5-inch drill bit continued to plug up with clay to a depth of 1,270.1 feet. In an attempt to continue to advance the borehole using only compressed air as the drilling fluid, a smaller, 6 $\frac{1}{8}$ -inch bit was used to drill approximately 13 additional feet to 1,282.6 feet. Due to these borehole conditions, the drill string was removed, and open-hole geophysical logs were run in the borehole to 1,196.5 feet. After running these logs, the borehole was conditioned with Max Gel and Poly-plus[®] polymer drilling muds, the bit size was reduced to 5 $\frac{5}{8}$ -inch, and drilling with compressed air was continued to the target depth of 2,080 feet.

At 29P, problems occurred below a contact between nonwelded tuff and poorly to non-cemented sandstone encountered at approximately 700 feet bgs. Below this point, drilling in flowing sands resulted in unstable borehole conditions. Drilling continued to 790.7 feet, until borehole caving prevented further advance. Two attempts were made to stabilize and seal off these flowing sands by grouting the borehole with Portland cement. In the first attempt, a tremmie line was installed to 789.3 feet and the borehole was plugged with a mix of 23 bags of Portland cement and 1 bag of Max Gel in approximately 140 gallons of water. After a 6-day break, the hardened grout was encountered at 720 feet. During cleanout of the borehole at 760 feet, flowing sands again became a problem and the drill string was removed for geophysical logging. After logging, a second attempt was made to grout the borehole and the 5-inch-OD casing was used as a tremmie line to pump cement slurry. Over a 24-hour period, 171 bags of Portland cement in approximately 1,440 gallons of water were used to set a grout plug from the bottom of the borehole to 560.5 feet. The following day, the drill string was used to drill out the cement grout from 560.5 to 710.3 feet. Flowing sand was again encountered, drilling was terminated, and well completion was started.

Table 2.1-1 lists the relatively short depth intervals in which APH-RC was used in place of AR-RC in unsaturated alluvium in 24P and 29P. APH-RC was used to determine which drilling method produced the least disturbance in the PSD of drill cuttings from in situ conditions. PSD data from drive core samples are considered to be representative of in situ conditions and serve as standards for estimating the disturbance of drill cuttings. Drive coring methods in RC boreholes are described in Section 2.2.

APH-RC methods in 24P and 29P proved to be problematic when drilling unsaturated alluvium. In general, bit plugging was the greatest problem, followed by plugging of the cuttings return cross-over to the dual wall drill pipe, and caving of loose, unsaturated sediments. Compounding the problem was the difficulty in cleaning caved material from the borehole. Borehole conditioning at the bit could have alleviated this problem; however, conditioning material could not be pumped through the air percussion hammer assembly to the bit.

2.1.2.2 Sonic Corehole

The upper 350 feet of unsaturated alluvium in 19PB was drilled by Boart Longyear with a Speed Star 1500 drill rig using mud-rotary methods. Boart Longyear then advanced the borehole from 350 to 634 feet using sonic coring methods and a GP24-300RS rig. The water table was encountered at approximately 368.5 feet.

After drilling the upper 18 feet of the borehole with a 17.5-inch bit, 14-inch-OD steel-surface casing was installed to approximately 18 feet bgs. The annular space between the borehole and surface casing was filled with cement grout consisting of Portland cement and bentonite.

After drilling to 350 feet with a 10⁵/₈-inch bit, the borehole was reamed with a 12¹/₂-inch bit and 8.625-inch-OD conductor casing was installed to 350 feet. The annular space between the borehole and conductor casing was again sealed with cement grout.

The sonic drill rig was then moved to the hole and continuous sonic core was collected from 350 to 634 feet. Starting at 350 feet, a 6.2-inch-OD core barrel and 8.1-inch-OD steel drill casing were advanced in 10-foot stages to 470.5 feet bgs. The core barrel was then advanced beyond the drill casing to 526 feet, where advancement was no longer feasible. A switch was then made to a 4.5-inch-OD core barrel and 5.8-inch-OD drill casing. The smaller core barrel and drill casing were then advanced in 10-foot stages to 619.9 feet, where the core barrel was advanced beyond the drill casing to a total depth of 634 feet.

2.2 Geologic Sampling

Drill cuttings were collected from all RC boreholes for continuous geologic logging and laboratory testing. In addition, drive core samples were collected using an air-percussion hammer from selected alluvial depth intervals in 24P and 29P to demonstrate the feasibility of this method in uncased RC boreholes, and for laboratory testing of flow-and-transport-related properties on small-scale samples. Drive core samples were also collected from selected depths in 19PB using sonic vibration and pull-down forces. These core samples were collected to provide an alternative means of calculating dry bulk density and porosity values, as well as small-scale samples for saturated hydraulic conductivity (K_{sat}) measurements. Finally, continuous sonic core samples were collected from the upper portion of the saturated zone in 19PB.

Geologic sampling and sample handling methods generally conformed to the applicable WPs, TPs, and TPNs listed in Table 1.6-1. Exceptions to these methods are described in geologic log form comments and/or scientific field notebooks. Sampling related processes (e.g., heat generation at the drill or core bit) that may have disturbed samples further from in situ conditions and affected geologic, photographic, or video logging descriptions and/or laboratory testing are also described in Sections 4.0 through 6.0.

2.2.1 Drill Cuttings

Table 2.2-1 summarizes the number of drill cuttings and sample splits and the number and types of laboratory tests conducted on drill cuttings from RC boreholes. Continuous drill cuttings were collected at 2.5-foot intervals in unsaturated alluvium and 5-foot intervals in unsaturated and

saturated rocks below the alluvium. A total of 2,176 drill cuttings samples were collected: 522 alluvial and 1,654 non-alluvial. With the addition of splits prepared for the NWRPO, DOE, and a contract laboratory (i.e., Nevada Geo-Tech, Inc., of Pahrump, Nevada), approximately 4,714 cuttings samples were packaged, labeled, and handled.

Drill cuttings were collected at the ground surface in a cyclone separator. In the unsaturated portion of RC boreholes, the entire alluvial sample from a particular depth interval was collected in 5-gallon buckets. Buckets from each depth interval were emptied onto a tarpaulin, mixed, and subsampled by the cone and quarter method.

Unsaturated zone alluvial drill cuttings were weighed in the field to provide data for calculation of in-situ bulk density values. Samples were weighed on an electronic digital scale, which measure in 0.1-pound or 0.01-kilogram increments. A second small scale was used to measure gravel sieve weights for field calculations of gravel percentages.

In the saturated, non-alluvium portion of RC boreholes, an Anaconda rotating wet splitter was attached beneath the cyclone separator to reduce the sample volume from a sample depth interval to a manageable number of 5-gallon buckets. The solid phase in the buckets was homogenized and subsampled over 5-foot depth intervals, as noted in Table 2.2-1.

Three split samples, each weighing approximately 5 pounds, were collected from each sample interval: two for the NWRPO and one for the DOE. A fourth split sample was collected from every second 2.5-foot interval in alluvium for NWRPO laboratory analysis.

The first NWRPO split was subsampled for field logging and the preparation of chip trays for future reference. The second NWRPO split was collected for archival at the DOE Sample Management Facility (SMF). The DOE split was collected onsite by DOE personnel. Both NWRPO and DOE splits sent to the SMF were sealed in olefin bags; splits for laboratory testing were sealed in double plastic bags. All samples were labeled with appropriate identification and shipped to their destinations under appropriate chain of custody.

2.2.2 Drive Core

Drive core sampling was conducted at selected depth intervals in the unsaturated zone alluvium portion of 24P and 29P and in the saturated alluvium portion of 19PB. All drive core was collected in 2-foot-long core barrels with a 0.26-inch-long drive shoe. The core barrels were lined with five 3.9-inch-ID brass sleeves in the following sequence, beginning with the core shoe end: three 6-inch-long sleeves followed by two 3-inch-long sleeves. All 6-inch sleeves and most drive shoe samples were designated for NWRPO use; the 3-inch sleeves were designated for the DOE. The drive shoe sample is referred to as "shoe core" herein.

Removing disturbed material from the bottom of the borehole prior to drive coring was difficult both in the open, uncased RC boreholes and in the cased sonic corehole. This difficulty was anticipated in the RC holes, but not in the sonic hole. As a result, disturbed fill material was found in the upper portion of the core barrel in almost every drive core run; in some cases the fill occupied most of the core barrel.

When possible after geologic logging of each core run, two of the least disturbed 6-inch-long core samples were labeled, sealed, and transported under chain of custody to the NWRPO testing laboratory for the analyses listed in Table 2.2-2. The remaining 6-inch core was labeled, sealed, and transmitted under chain of custody to the SMF for storage and possible future use by the NWRPO. All remaining samples containing representative formation material were labeled, sealed, and transmitted under chain of custody to the SMF for storage and use by DOE YMP contractors and other interested parties.

2.2.3 Sonic Core

After each sonic core run was brought to the ground surface, the approximately 2-foot-long segments were vibrated from the core barrel into plastic socks with an ID slightly larger than the OD of the core. The core segments were then moved to the core logging trailer, where depth intervals were assigned. The expansion in the length of the recovered core due to the sonic vibrations was corrected to the approximate true in situ length by methods described in TP-8.0, *Field Collection, Logging, and Processing of Borehole Geologic Samples*. Boundaries between alluvial layers with noticeably different PSD were identified using visual-manual logging methods based on American Society for Testing and Materials (ASTM) D-2488-93 (ASTM, 1993). These layers often extended across adjacent segments and ranged in length from less than 0.25 to more than 10 feet.

Representative grab samples from the major textural layers present in sonic core were then collected. Table 2.2-3 lists the number of samples and summarizes the tests conducted by the NWRPO testing laboratory.

The representative grab samples of textural layers were split for field geologic logging and NWRPO laboratory testing. The laboratory split was further split; one sample was used for gravimetric water content (GWC) analyses to support in situ dry bulk density calculations and the other was used for all remaining hydraulic-parameter-related tests (Table 2.2-3). Upon completion of the field logging activities described in Section 2.3, the geologic logging split (i.e., material not disturbed during logging) was recombined with the laboratory testing split designated for other hydraulic parameter laboratory tests.

The distribution of grab samples was controlled and documented with the NWRPO Transfer of Custody Form. After the removal of grab samples from core segments, digital photography, and video logging, the remaining portions of core segments were transferred from the site to the SMF under DOE chain of custody.

A number of core segments were later transferred from the SMF to the NWRPO testing laboratory under LANL custody for a cooperative testing program. The program involved repacking sonic core samples to target dry bulk density values and determining their volumetric water content (VWC) and Ksat values in addition to parameters also specified for grab samples (Table 2.2-3).

2.3 Geologic and Photographic Logging

Geologic logging and digital photography procedures are described in TP-8.0. Geologic logging data on drill cuttings collected from RC boreholes were recorded on the Alluvium and Non-

Alluvium Drill Cuttings Logging Forms (Figures 2.3-1 and 2.3-2). Geologic logging data on drive and sonic core collected from alluvium were recorded on the Alluvium Core Logging Form (Figure 2.3-3). Digital photographs of alluvial sonic core segments from 19PB were documented on the Field Digital Photography Log.

Procedures for geologic logging of alluvial samples are based on the visual-manual logging methods described in ASTM D-2488-93 (ASTM, 1993). The alluvium logging form records soil classification parameters, many of which are related to flow and transport properties of alluvial sediments. These parameters include color, moisture, PSD, cementation, hydrochloric acid (HCl) reaction, and other soil characteristics.

The non-alluvium logging form records parameters that support the identification of lithostratigraphic units, including color; moisture content; rock unit; weathering; structure; matrix porosity; and color, size, and volume of phenocrysts and clasts. Since most rock units in the vicinity of Yucca Mountain are volcanic tuffs, additional descriptive tuff parameters include mode of deposition, degree of welding, and alteration. In addition, both alluvium and non-alluvium logging forms include sample bulk-density-related measurements, and rates of drilling, coring, and water production.

Field estimates of PSD in alluvial samples were used to estimate gross textural variability over the sample interval. Since these were field estimates, they were not used for quantitative purposes; instead, laboratory PSD measurements were used where quantitative data were required. In general, field logging observations were valuable for qualitatively identifying trends in and between logged parameters versus depth. Trends in several of these logged parameters are described in Section 4.0.

2.4 Hydraulic Parameter Laboratory Testing

Table 2.4-1 summarizes the number and types of hydraulic property laboratory tests conducted on geologic samples collected during Phase IV. Nevada Geo-Tech conducted all laboratory tests on geologic samples from RC boreholes in accordance with industry-standard methods (Table 2.4-2). The NWRPO testing laboratory conducted tests on drive and sonic grab core samples from 19PB using the methods listed in Table 2.4-2; methods used to repack samples to target density values and measure Ksat and VWC are given in TPN-8.1, *Constant Head Saturated Hydraulic Conductivity Measurements on Repacked Samples*.

Tests were conducted on a selected subset of geologic samples from each borehole (Tables 2.2-1 through 2.2-3). For example, Table 2.2-1 shows that every other 2.5-foot sample interval of unsaturated alluvial drill cuttings from RC boreholes was analyzed for GWC, wet sieve PSD, and soil-water extract electrical conductivity (EC). In addition, six representative drill cuttings from unsaturated alluvium covering a range of estimated PSD were analyzed for silt/clay percentages using hydrometer methods. Saturated alluvium was not encountered.

Tests were not conducted on saturated non-alluvial samples. Tests on unsaturated non-alluvial drill cuttings collected over each 5-foot depth interval were limited to GWC measurements (Table 2.2-1).

Table 2.4-1 shows that tests conducted on sonic grab core samples of unsaturated and saturated alluvium were similar to those conducted on drill cuttings from RC boreholes, with the addition of grain density and Atterberg limits tests on selected samples. Grain density was added to the suite of tests to improve the accuracy of hydrometer test data and porosity calculations. Atterberg limits was added to the suite of tests to permit the systematic incorporation of plasticity into the classification of the fines fraction, as specified in ASTM D-2487 (ASTM, 2000a). Previously, the classification of fines from RC boreholes had used PSD from hydrometer testing to determine silt and clay percentages. That is, a particle size of 0.005 millimeter was used as the division between silt and clay. This approach was unsatisfactory, since it did not incorporate plasticity into the classification naming system.

Table 2.4-1 shows that tests conducted on sonic grab core samples were also used on drive core and repacked sonic core. In addition, porosity-dependent hydraulic tests (e.g., Ksat, VWC, and dry bulk density) were conducted on drive core and repacked core.

2.5 Borehole Geophysical Logging

The primary geophysical logging contractor, Geophysical Logging Services (GLS) of Prescott, Arizona, was responsible for conducting all Phase IV downhole logging in accordance with industry-standard procedures (ASTM, 1995; API, 1997). As a quality control check, Century Geophysical Corporation (Century) of Tulsa, Oklahoma was also contracted to conduct logging in several boreholes. The results of a comparison of GLS and Century logs are presented in Section 2.5.3.

Descriptions of methods, specifications, and quality controls are presented in the geophysical logging WP-8.0, *Field Logging and Handling of Borehole Samples*.

2.5.1 Description of Borehole Geophysical Logs

Table 2.5-1 summarizes the types, properties measured, and applications of the geophysical logs performed in Phase IV. A number of these logs measure similar or related parameters and have similar applications. These logs are run together in the same borehole to increase the level of confidence identified in trends. Individual logs are discussed in relation to major categories of use or application in the following section.

2.5.1.1 Lithology Identification and Correlation

Gamma, density, moisture, sonic, spectral gamma, spontaneous potential, fluid resistivity, formation-related resistivity (i.e., R8, R16, R32, or R64), and optical televiewer logs can help identify and confirm formation contacts and properties in areas where sample recovery is poor, lithologic units are similar or indistinct, or where bedded lithologic units are thinner than the sample interval. For example, density, moisture, and sonic log outputs are related to formation and/or layer porosity, which may vary between lithologic units.

Gamma logs help identify clay layers and indicate the natural changes in the gross radioactivity between differing volcanic units. Spectral gamma logs can be used to ascertain relative amounts of potassium, thorium, and uranium to aid in lithology identifications. Spectral gamma log data were obtained in Phase IV wells; however, only composite data were presented by GLS and the

data were not split into the three element channels. The composite data were used to corroborate the natural gamma logs.

Magnetic susceptibility logs indicate ferromagnetism of the rock and can help identify lithologic changes, such as mafic volcanic flows, within sedimentary deposits. However, the magnetic susceptibility logs run in Phase IV wells did not appear to correlate with changes in lithology and are not discussed herein.

Formation-related resistivity logs can indicate areas of increased welding in volcanic units, and also respond to the presence of clays. In addition, fluid resistivity, formation-related resistivity, and spontaneous potential log outputs may vary between formations and/or layers within a formation and can be used to identify and evaluate contacts between subsurface geologic units, thinly bedded sequences, and vertical facies changes in sedimentary sequences.

Caliper logs provide borehole diameter data necessary for the interpretation of many of the logs. For example, log responses to washout zones (i.e., intervals of borehole with significantly larger diameters) can be separated from actual responses to changes in formation and/or borehole fluid parameters. In addition, changes in borehole diameter are often related to lithology changes, especially contacts between unconsolidated and consolidated material.

Optical televiewer logs can provide a continuous 360-degree image of the reflection of the borehole wall via a prism mirror and camera, and can detect fractures, thin beds, and bedding dip. This log also provides caliper and deviation data.

2.5.1.2 Water Production Zone Identification

Several geophysical logs can provide information about water transmitting zones. For example, temperature logs can detect changes in subsurface temperature gradients at groundwater production zones (e.g., inflow from fractures). Fluid and formation resistivity logs can in some cases identify changes in salinity and total dissolved solids in water from different production zones. Formation resistivity logs can also potentially identify differences in groundwater chemistry at different distances outward from the borehole. Spontaneous potential logs can in some cases identify differences in borehole and formation fluid composition. Formation porosity information, which may be related to aquifer production, can be obtained from density, moisture, and sonic logs.

2.5.1.3 Well Installation Support and Use

A number of logs also provide valuable information that can be used for well design, installation, verification, and use. Caliper logs yield borehole diameter data, which are useful for the design and placement of well screens and sampling ports. Deviation logs provide information about the locations of notable borehole deviations from the vertical (e.g., doglegs) that may complicate the completion process. Borehole deviation data are also necessary to provide accurate elevations of geologic contacts, screened intervals, and water table and piezometric surfaces. Following well installation, gamma and density logs can also help confirm the location and integrity of bentonite seals and well-screen sandpacks in completed wells.

2.5.2 Suites of Borehole Geophysical Logs

Table 2.5-2 summarizes the three suites of geophysical logs used in Phase IV. Open-hole geophysical logs were run in open, uncased boreholes, where borehole stability was good and the drill pipe or casing could be removed before logging. In unstable boreholes, drill-string logs were run in drill pipe or drill casing in place of open-hole logs. After the completion of the well casing strings with sandpacks and seals, well-completion logs were run inside the well casing strings.

The drill-string logging suite generally includes moisture, density, gamma, temperature, and deviation logs. These logs were run in the drill string of all RC boreholes after reaching total depth and before completion.

The open-hole geophysical log suite generally includes drill-string logs plus formation resistivity, fluid resistivity, spontaneous potential, caliper, magnetic susceptibility, sonic, and optical televiewer logs. Temperature and fluid resistivity logs are typically run downhole in the first tool run to capture undisturbed temperature and salinity gradients in the water column. These open-hole logs were run in all RC boreholes, and a deviation log was run in 19PB from 0 to 350 feet bgs in the unsaturated zone.

The well-completion suite generally includes drill string logs plus magnetic susceptibility. This suite of logs was run in all wells following completion with well casing and screen.

In summary, the drill-string suite was run in all boreholes except 27P, the open-hole suite was run in all boreholes except 19PB, and the well-completion suite was run in all wells.

2.5.3 Geophysical Log Comparison

Neither the density nor the moisture logging tools used in Phase IV by GLS contain radioactive sources. The density and moisture tools run by Century use a cesium-137 and directed americium-beryllium source, respectively. Because these tools contained nuclear sources, and such sources are prohibited in open boreholes by Nevada State regulations, the comparison logs run by GLS and Century were conducted in drill pipe or casing.

A systematic comparison of GLS and Century moisture and density logs from 19PB, 24P, and 29P demonstrated that the Century nuclear tools produced logs with higher signal-to-noise ratios than the GLS non-nuclear tools. As a result, GLS density and moisture logs will not be discussed in this report. A comparison of the gamma logs determined that, in most cases, GLS logs showed responses comparable to those of Century. This agreement was expected, since both tools are of similar design.

3.0 WELL COMPLETION, DEVELOPMENT, AND TESTING

Well completion and development for Phase IV were conducted by drilling contractors under oversight by the NWRPO in accordance with applicable QA drilling and well construction plans (Table 1.6-1), except where deviations from these plans were necessitated by field conditions and/or findings.

3.1 Well Completion

All Phase IV boreholes were completed as piezometers and constructed in accordance with permit requirements and the Nevada Administrative Code (i.e., NAC 534.60–534.90). Table 1.3-1 summarizes completion data, including open-hole water levels, screened and sandpacked intervals, and formation units adjacent to these intervals. The completion diagrams in Appendix B contain the same information, with the exception of formation units. Table 3.1-1 contains reference point elevations (i.e., top of casing and ground surface) for water level measurements, as well as initial water level measurements. Depth data in Tables 1.3-1 and 3.1-1 and in Appendix B have not been corrected for borehole deviation.

Eklund Drilling completed single-string piezometers in RC boreholes and Boart Longyear completed dual-string (i.e., nested) piezometers in 19PB. Figure 3.1-1 shows the dual-string completion and Figure 3.1-2 shows the single-string completion in 16P, which is typical of completions in other RC boreholes. The piezometer casing strings consisted of 2-inch Schedule 80 flush joint PVC (i.e., 1.9-inch ID and 2.375-inch OD). The piezometer screens consisted of the same PVC casing with machined 0.020-inch horizontal slots and an open area of 6.3 square inches per foot.

Single-string RC borehole piezometers were completed in Tertiary tuff with screens straddling the water table. 16P was screened from 489.4 to 549.4 feet bgs, 24P from 400 to 440 feet bgs, 27P from 580.7 to 620.6 feet bgs, 28P from 370 to 449 feet bgs, and 29P from 340 to 390 feet bgs.

Dual-string piezometer 19PB was completed in alluvium with one screen from 375 to 395 feet bgs and the other from 514.7 to 534.7 feet bgs. The depth intervals of these screens correspond approximately to the upper two screens in the other multiple-screen boreholes located at the ATC.

Depth control for the emplacement of sandpacks and grout seal material was monitored by estimating downhole annular volumes, tracking volumes of emplaced materials, and frequently checking depths of emplaced materials by manual sounding methods. In all cases, these materials were emplaced using tremmie pipe methods. During emplacement, the bottom of the tremmie pipe was maintained approximately 10 to 30 feet above the level of completion materials to avoid plugging the pipe.

Sandpacks around the piezometer screens consisted of washed 8/12-mesh silica sand tremmied to a depth within 1 to 2 feet of the specified target depth. Target depths for sandpacks were generally 5 to 10 feet above and below well screens. In 28P, an 8-foot-thick interval of fine-grained, 60-mesh transition sandpack was tremmied in place above the 8/12-mesh sandpacks to help prevent bentonite infiltration into the coarse sandpack around the well screen.

Generally, grout seals in both the unsaturated and saturated zones of RC boreholes consisted of intervals of high solids (i.e., more than 30 percent solids) bentonite grout and intervals of a mixture of 8/12-mesh silica sand and 8-mesh granular bentonite at a ratio of approximately 2 to 1 by weight. The NWRPO refers to this mixture as Bensand. The lower portion of the boreholes was sealed primarily with high solids bentonite grout, with shorter intervals of Bensand serving as solid platforms for depth measurements and to support additional quantities of high solids bentonite grout. Bensand was also used to plug zones where large amounts of high solids grout were lost to the formation. Finally, Bensand was used to seal zones both below and above the sandpacks.

Grout seals in 28P were similar to those in the other RC boreholes, except for a cement grout interval from 618 to 662 feet bgs. This interval was emplaced to facilitate the removal of bentonite and polymer drilling fluid remaining in the borehole after drilling and plugging of the lower portion of the borehole. Section 2.1.2.1 describes the use of these drilling fluids to stabilize the borehole after penetrating a clay-rich layer from 1,140 to 1,283 feet bgs. After the emplacement of this cement plug and before the addition of more completion materials, the open borehole was developed by air lifting to remove the bentonite and polymer drilling fluids, as described in Section 3.2.

Both the sandpack and Bensand seal intervals were tremmied to the target depths using a centrifugal pump. Generally, water was initially pumped through the tremmie at approximately 25 to 50 gallons per minute (gpm), followed by the addition of dry completion materials to the water stream via an open "tee" connection on the water intake side of the centrifugal pump. High solids bentonite grout was tremmied using a standard grout (i.e., diaphragm) pump.

In 19PB, the approximately 5.5-inch sonic drill casing was removed from the borehole before the deep piezometer string was run in and the sandpack and Bensand seal emplaced above the deep piezometer screen. The larger diameter, approximately 8-inch sonic drill casing was also removed from the borehole before the shallow piezometer was run in and completion material emplaced around the shallow piezometer screen. Unfortunately, caving occurred over nearly a 90-foot interval upon removal of the 8-inch casing (Figure 3.1-1). Because of this caving, the piezometer was placed at a shallower depth interval than planned. Moreover, the sandpack was mistakenly extended above the shallow piezometer screen 26 feet rather than the target distance of 5 to 10 feet. As a result, the sandpack and associated well screen of the shallow piezometer string in this borehole do not correspond exactly to the shallow well screen/sandpack intervals in 19D, 19IM1, or 19IM2.

To protect the piezometer string wellheads extending above the ground surface, approximately 3 feet of protective steel surface casing was welded to the existing conductor casing installed during drilling. The annular space between the outer conductor casing and the piezometer casing was sealed with dry granular bentonite that was emplaced by gravity free-fall methods. For further protection, an approximately 4- by 4-foot by 8-inch-thick concrete pad was set around the surface casing. Wellhead completions vary slightly among piezometer sites, as shown in the as-built details in Appendix B. All surface casings are capped with locking well caps. Each wellhead is labeled with the well name in the cement pad. The wells were surveyed by a DOE contractor for location and elevation data according to QA standards (Table 1.3-1).

3.2 Well Development

3.2.1 Reverse-Circulation Boreholes

Air was used as the drilling fluid during borehole advancement beneath the water table in all RC boreholes. Borehole conditioning beneath the water table was limited to the use of bentonite and polymer in 28P as described in Section 3.1. Sonic coring methods used to penetrate the saturated zone in 19PB did not require the use of drilling fluids. As a result, completed Phase IV wells, with the exception of 28P, contain no drilling fluids in the saturated zone that could impact well screen permeability and/or water chemistry measurements. Due to the absence of drilling fluids in Phase IV wells other than 28P, initial development was limited to pumping with a small piston pump at approximately 0.5 gpm for a period ranging from 9.5 to 45.5 hours.

During the completion of 28P, the saturated interval above a cement plug set at 618 feet bgs was developed to remove bentonite and polymer drilling fluids before further completion activities. After injection with 2.5 quarts of Baroid AQUA-CLEAR™ diluted with 320 gallons of water, the saturated section of the borehole above 618 feet was air lifted for approximately 4.5 hours with the RC drill pipe. Approximately 5,000 gallons of water, containing suspended bentonite and polymer, were produced from the borehole during air lifting.

After completion, initial attempts to develop 16P with a small piston sample pump were unsuccessful. The NWRPO pumping contractor then further developed the piezometer screen by air lifting for 3 hours. The screen produced a relatively small quantity of water, necessitating a surging approach. At the end of the development period, suspended sediment in the produced water consisted mainly of reddish-brown, nonwelded tuff in the screened interval. Final development involved pumping with the small piston pump for several 8-hour periods before groundwater sampling. Even after these developing activities, the produced water was never completely free of suspended sediment.

3.2.2 Sonic Corehole

Initial development of 19PB was limited to pumping with the small piston pump for 23 hours in the shallow string and 30.5 hours in the deep string. However, subsequent constant-head injection tests in the two screens indicated much lower Ksat values than expected, based on the results of aquifer pump tests conducted previously in adjacent wells at this site (NWRPO, 2003). As described in Section 4.2, it was observed during geologic logging that fines migrate to the outside surface of the core during sonic coring (i.e., to the wall of the core barrel) and hypothesized that fines also accumulated on the borehole walls, thereby lowering the Ksat of the screened intervals.

Additional development was then conducted in both piezometer strings by the pumping contractor using air lifting and surge blocks for several hours. This development approach removed significant amounts of fine sediment from the screened intervals. However, it also resulted in cracking the casing of the deep piezometer string in the vicinity of the shallow piezometer string screen, thus establishing hydraulic communication between piezometer screens and precluding additional Ksat testing in 19PB.

3.3 Constant Head Borehole Saturated Hydraulic Conductivity Tests

Constant head borehole K_{sat} tests were conducted in 19PB after development with a low-flow-rate piston pump. These tests were the first phase of a larger program of K_{sat} testing planned for a number of small diameter wells (i.e., piezometers) where aquifer pump testing is not feasible.

Standard constant head borehole permeability test methods were followed (USBR, 1989). Before testing, approximately 750 gallons of groundwater were removed from the piezometer strings, using a piston pump, and stored in a clean, plastic 1,500-gallon tank. This water was then pumped back separately into each piezometer using a trash pump at rates that maintained constant heads significantly above each piezometer screen. Heads were measured in each piezometer with calibrated Westbay pressure transducers and flow rates were measured with a turbine water flow meter. The accuracy of the flow meter was checked by timing the filling of a 55-gallon drum.

Several tests were conducted in each piezometer string with varying water injection rates and applied water heads. K_{sat} values were calculated for each flow rate and head, and then averaged for each piezometer.

4.0 GEOLOGIC SAMPLE LOGGING

The results of field geologic and photographic logging activities on drill cuttings and core are presented in this section. The majority of data produced from these activities are technically defensible and of value to the scientific and engineering communities concerned with the Yucca Mountain repository. However, as in nearly all large hydrogeologic characterization efforts, some data were compromised or biased as a result of sampling, testing, and/or handling activities and are potentially confusing or not useful. To the extent possible, these data have been censored, are listed in Table 4.1-1, and will be discussed in more detail in Section 4.1.1. These data will not be made publicly available except in this report, where examples of censored data are presented in several summary tables and figures designed to illustrate the limitations of the data and the methods used to collect them. However, complete sets of Phase IV data, both censored and uncensored, can be viewed at the QARC.

Specific reasons for censoring various data types are listed in Table 4.1-1. Censored data are a relatively small subset of the data; uncensored data are the primary focus of this section.

4.1 Geologic Logging of Drill Cuttings

Examples of geologic logging data from drill cuttings, and descriptions of their limitations, trends, correlations, and significance, are presented in this section. Where appropriate, the possible bias that drilling methods and sample handling procedures introduce into geologic logging data and the ability of such data to accurately characterize in situ formation conditions and properties are described.

Examples of geologic logging forms for alluvial and non-alluvial drill cuttings are presented on Figures 2.3-1 and 2.3-2, respectively. As mentioned in Section 2.3, alluvium logging forms primarily record soil classification parameters, many of which are related to flow and transport properties of alluvial sediments. The non-alluvium logging forms primarily record lithology-related parameters to support identification of lithostratigraphic units. In addition, both forms include sample density measurements and rates of drilling, coring, and water production.

4.1.1 Data Censoring

All geologic logging and drilling data on the logging forms are considered to be useful in characterizing approximate in situ hydrogeologic conditions and properties, with some exceptions. One exception is sample density data (e.g., sample, tare, and sample plus tare weights) for drill cuttings from the unsaturated zone in RC boreholes, which were censored because a significant and variably sized portion of the total drill cuttings from each sample interval was not collected and weighed (Table 4.1-1). This portion not collected was lost in part as dust from the cyclone separator. The sample recovery data on Figure 2.3-1 illustrate the variably sized portions of drill cuttings that were lost. The lack of an accurate weight for the drill cuttings removed from a particular drilled interval, plus uncertainty in borehole volume estimates, precluded the calculation of meaningful in situ density values in cases where accurate water content and borehole volume values were known. In future EWDP phases, efforts will be made to minimize sample material lost as dust, maximize sample recovery, and obtain more accurate estimates of borehole volume for meaningful sample density data.

Sample density data are not collected from beneath the water table, due to the difficulty in separating water from the solid samples. However, the approximate volume of the sample can be calculated by dividing the sample recovery value on the logging form by the splitter ratio recorded in the comments section of the form. This calculated, approximate sample volume is also highly variable, which may be due in part to varying quantities of fine suspended material in water and/or material lost to the formation for different intervals.

In addition, logging parameters such as PSD for alluvial drill cuttings are difficult to determine accurately in the field. In these cases, PSD laboratory analyses are necessary in order to obtain accurate data. However, field logging PSD estimates, although approximations, provide data available for immediate use in the field for a variety of purposes, such as locating borehole instrumentation (e.g., air piezometer screens in unsaturated alluvium and well screens in saturated alluvium) (NWRPO, 2003).

When more accurate laboratory measurements of PSD are available, field logging estimates cease to be useful, except for documenting the rationale for borehole instrumentation decisions. Two sets of PSD data for one borehole can be confusing and may result in the misuse of data. For this reason, field logging estimates of drill cuttings PSD have been censored (Table 4.1-1). Since Unified Soil Classification System (USCS) group symbol data are based on these data, they have also been censored.

4.1.2 Geologic Logging and Drilling Depth Profiles

Depth profiles of selected geologic logging and drilling data that illustrate important trends with depth are shown in Appendix C. Examples of depth profiles for both alluvial and non-alluvial portions of the boreholes are presented, where applicable. Geologic logging parameter data for every sample interval of alluvial drill cuttings include field estimates of moisture content, cementation and HCl reaction. For every sample interval of non-alluvial drill cuttings, HCl reaction and the degree of welding in tuff, if present, are plotted. Drilling data are limited to measured drilling and water production rates.

The criteria used to describe geologic logging parameters are qualitative or semi-quantitative at best, and are subject to human error and inconsistency. Therefore, trends in these parameters are considered approximations and simplifications of in situ conditions. At the same time, geologic descriptions are useful for identifying drilling impacts and relative changes in hydrogeologic parameters with depth for both drill cuttings and the formation rock.

Drilling parameters recorded on logging forms are measured values; however, it should be noted that these measurements are in some cases approximate quantities. For example, water volumes are calculated from the number of nearly or partially full 5-gallon buckets containing varying amounts of drill cuttings sediment.

Finally, geologic logs from RC boreholes indicate that alluvial drill cuttings are composed of 100 percent volcanic rock, and non-alluvial drill cuttings are composed primarily of volcanic rock or sediment derived from volcanic rocks. Similar observations had been made in geologic samples from Phase III boreholes (NWRPO, 2003).

4.1.2.1 Moisture Content Depth Profiles

The moisture content of alluvial drill cuttings collected from RC boreholes was disturbed from in situ conditions to varying degrees by drilling. Alternating zones of dry to moist soil were encountered above the water table in all boreholes. The dry zones are likely the result of the drying effects of air drilling methods. In addition, zones of wet alluvium were encountered in 27P and 29P (Figures 4.1-1 and 4.1-2). These wet zones, and possibly some of the moist zones, are thought to be the result of the introduction of liquid drilling additives during borehole conditioning (Appendix A).

Undisturbed in situ alluvium is assumed to be moist throughout most of the unsaturated zone; that is, in the region below the effect of near-surface evapotranspiration and above the effect of any capillary fringe near the water table. Geologic logs of drive core from 24P and 29P support this assumption of moist in situ material. Zones of dry drill cuttings logged in this region clearly show the drying effects of air drilling due to heat generated at the drill bit, the elevated temperature of the compressed air, air movement around the drill cuttings as they were brought to the ground surface, and drying that may have occurred on the ground surface before samples were packaged in air-tight plastic bags. However, the criteria used to describe moisture in geologic logs (i.e., dry, moist, and wet) do not permit a quantitative calculation of the magnitude of this drying. In Section 5.0, a comparison of laboratory measurements of GWC in drill cuttings versus drive core from 24P and 29P provides an estimate of the amount of drying that occurred in drill cuttings.

Drill cuttings collected below the water table also show evidence of drying for distances ranging from approximately 5 to 50 feet into the saturated zone, depending on the borehole. The moisture depth profile for 16P shows the greatest effect of drying in the upper approximately 50 feet of the saturated zone (Figure 4.1-3). As the borehole penetrates the saturated zone, water production increases and eventually masks the drying effect of air drilling and handling.

4.1.2.2 Cementation and Hydrochloric Acid Reaction Depth Profiles

The degree of cementation logged in the alluvial portions of RC boreholes appears to be related to borehole location. For example, little or no cementation was observed in drill cuttings from boreholes in Flat Tire Flat; however, significant cementation was noted in boreholes in Fortymile Wash. More specifically, no cementation was observed within the alluvium of either 16P or 28P and only one zone of weakly cemented alluvium was observed in 27P (Figure 4.1-4). In contrast, weak to moderate zones of cementation were observed throughout the alluvium in 24P and 29P (Figure 4.1-5).

Zones of weak to strong reaction with HCl were observed in the drill cuttings of all RC boreholes. Depth profile plots of HCl reaction show no apparent trend with depth, nor does there appear to be a correlation between HCl reaction and cementation. For example, the alluvial portions of boreholes in Flat Tire Flat typically react with HCl, as shown for 16P and 28P (Figure 4.1-6). However, as noted previously, no cementation was observed in either of these boreholes. In addition, zones of weak to strong HCl reaction were also observed throughout the alluvial portions of 24P and 29P (Figure 4.1-7); however, zones reactive with HCl do not generally correlate with zones of cementation in these boreholes (Figure 4.1-5).

Since Phase IV alluvium does not contain carbonate rocks, HCl reaction indicates the presence of calcium carbonate, a potential cementing agent. However, the lack of correlation between HCl reaction and cementation indicates that calcium carbonate does not play a major role in the observed cementation, and that cementing agents other than calcium carbonate likely exist in these boreholes. This lack of correlation differs from that of Phase III boreholes located along Fortymile Wash, where trends in cementation were nearly mimicked by trends in HCl reaction (NWRPO, 2003).

4.1.2.3 Drilling Rate Depth Profiles

Numerous formation- and drilling-related factors affected drilling rates in RC boreholes. Drilling parameters include drill bit and dual-wall casing diameters and types, drill bit weights, air pressures and flow velocities, and rotation rates. It is assumed herein that drilling parameters remain approximately constant and variations in drilling rates are due primarily to differing rock properties and the decrease in drilling efficiency with increasing penetration depth.

Drilling penetration rates varied from less than 0.5 to greater than 6 feet per minute. Typically, the highest drilling rates (i.e., 1 foot per minute or greater) were recorded in alluvium, clastic sedimentary rocks (e.g., siltstone or claystone), volcanoclastic sedimentary rocks, and nonwelded intervals in volcanic tuffs. The lowest drilling rates (i.e., less than 1 foot per minute) were recorded in the welded portions of most tuff units. The inverse relationship between drilling rate and degree of welding in tuffs is most clearly illustrated throughout 27P and 29P (Figures 4.1-8 and 4.1-9). In the remaining boreholes, this relationship does not appear to hold at significant depths. For example, the thick nonwelded tuff from approximately 1,800 to 2,000 feet bgs in 16P does not affect drilling rates (Figure 4.1-10).

4.1.2.4 Water Production Depth Profiles

The rate of water production in RC boreholes is also a complicated function of a number of formation- and drilling-related parameters, including the variation in formation permeability with depth, depth below the water table, rate of drill bit advancement, drill bit diameter, air pressures and flow velocities, borehole conditioners and methods of conditioning, and the extent to which the drill bit and casing assembly sealed water off from the overlying formation. It is assumed herein that drilling-related parameters remain approximately the same for all boreholes, except the extent to which the drill bit and casing were sealed off.

Typically, water production increased with depth, especially in zones of moderately or densely welded tuff that are presumably highly fractured. Moreover, nonwelded tuffs generally appeared to slow water production to a nearly constant rate as they were penetrated. A good example of this trend is shown in data from borehole 16P (Figure 4.1-11), where water production initially increased with depth as welded tuff units were penetrated over the depth interval from approximately 800 to 1,800 feet bgs. Between approximately 1,800 and 2,200 feet bgs, the nonwelded tuff unit appeared to keep water production at a nearly constant rate. Below approximately 2,200 feet bgs, water production appeared to increase again as moderately and densely welded units were penetrated.

Nonwelded tuff may slow water production by partially sealing off the annular space between the drill rods and the formation, thereby slowing the flow of water from overlying zones into the open-faced drill bit. This sealing effect is likely even greater when plastic clay units are penetrated. The best example is found in 28P, where water production dramatically decreased from approximately 150 to 75 gpm at 1,974 feet bgs, as drilling intercepted a section of plastic, interbedded claystone and siltstone (Figure 4.1-12). In addition, the overlying zones of weakly welded and nonwelded tuff units between approximately 1,550 and 1,974 feet bgs served to keep water production at a nearly constant rate.

4.2 Geologic and Photographic Logging Results on Core

As described in Section 2.0, drive core from selected depth intervals was collected from unsaturated alluvium in 24P and 29P and saturated alluvium in 19PB. In addition, continuous sonic core was collected from the lower approximately 20 feet of unsaturated alluvium and upper approximately 260 feet of saturated alluvium in 19PB. If collected using appropriate equipment and procedures, alluvial drive and sonic core segments can provide subsurface formation material that is much less disturbed from in situ conditions than drill cuttings. This section presents examples of geologic logging and coring-related data for these core samples and discusses limitations, trends, and correlations, where applicable. In addition, selected photographic logs are presented to illustrate examples of coring-related disturbance of sonic core samples. Alluvial core logging data, like alluvial drill cuttings data, are considered useful in approximating in situ hydrogeologic conditions and properties, with several exceptions, which are described in Section 4.2.1.

4.2.1 Censored Geologic Logging Data for Core

As mentioned previously, Table 4.1-1 summarizes all censored Phase IV data and the reasons for censoring. The following summarizes core data that have been censored and the reasons for censoring.

PSD is difficult to accurately estimate in the field for alluvial core and PSD data on the Alluvium Core Logging Form (Figure 2.3-3) differ significantly from more accurate laboratory analyses of PSD. As a result, field logging estimates of PSD, including grading, on the form are not considered representative of in situ conditions and have been censored. In addition, because field-estimated USCS group symbol data on the form are based in part on field-estimated PSD data, these data have also been censored. Finally, Ksat data on 3-inch drive core samples from 19PB have been either not collected or censored because of the presence of preferential flowpaths likely caused by the coring process. Longer, 6-inch-long drive core samples did not appear to exhibit these types of flowpaths.

4.2.2 Coring and Logging Data Trends

An example geologic logging form for drive and sonic core is presented on Figure 2.3-3. The complete set of logging forms for this core is presented in Appendix D. These logs include core recovery and density data, as well as geologic descriptions, and contain the same information found on the geologic logging forms for alluvial drill cuttings previously discussed in Section

4.1.2, with the exception of drilling fluid injection and water production rates. These rates are not applicable to the coring methods used and were not included on the forms.

4.2.2.1 Drive Core Recovery and Dry Bulk Density

Phase IV drive core run recovery and bulk density data obtained from core barrel measurements are summarized in Table 4.2-1. This table shows that in nearly every core run, a significant amount of highly disturbed formation material (i.e., fill) was recovered, together with the minimally disturbed formation material (i.e., core). These recovery data reflect the difficulty of removing fill material from the bottom of each borehole before coring.

The density-related data in Table 4.2-1 include all material within the core barrel (i.e., both core and fill). The sample weights were determined in the field immediately after core barrels were brought to the ground surface and before they were disassembled and fill material was separated from in situ core material. Because of the presence of fill material in the core barrels, the density data presented in Table 4.2-1 are, at best, rough approximations of in situ conditions. This is especially the case in core runs where the amount of fill exceeds the amount of core. In subsequent sections of this report, these data will be compared with density data obtained by other methods, including density data determined in the laboratory for individual core segments not containing fill material.

In general, the calculated dry bulk density shown in Table 4.2-1 for core runs in 24P and 29P is slightly greater than that in 19PB, which may be due to the method of advancing the core barrel (i.e., APH-DC versus SC-DC) and/or the fact that core runs in 24P and 29P were in unsaturated alluvium and those in 19PB in saturated alluvium. For example, it is well known that the water content of unconsolidated porous media affects the degree to which the media can be compacted. Unconsolidated, saturated Phase IV fill material was recompacted by the drive coring process. However, due to the high water content of the saturated fill, the density of the recompacted fill was likely far less than the maximum achievable. The relation between water content and maximum compaction obtainable in the laboratory will be presented for sonic core from 19PB in Section 5.1.3.

4.2.2.2 Sonic Core Bulk Density

Table 4.2-2 summarizes calculated dry bulk density for the nearly continuous sonic core runs in 19PB. Bulk density values shown in this table are weighted averages of core segment lengths making up each core run. Core runs were 10 feet long or less and contained as many as seven individual core segments. Details of sonic core bulk density calculations are presented in documents assigned to QA record index designator (RID) 6504.

Table 4.2-2 shows that core collected with the smaller diameter core barrel (i.e., 4.5-inch-OD) yields dry bulk density values that are higher on the average than those on core collected with the larger diameter core barrel (i.e., 6.16-inch-OD). No other trends with depth are apparent. These differing bulk density values may be due in part to the greater difficulty in determining the amount of lost core when using the smaller diameter core barrel. For example, Table 4.2-2 shows that if smaller diameter core runs containing more than 0.2 foot of lost core are excluded from the average calculation, the average dry bulk density values for runs generated from both core

barrels are essentially the same (i.e., 1.80 versus 1.82 grams per cubic centimeter[g/cm^3]). TP-8.0 provides a detailed description of procedures for identifying lost core.

A comparison of dry bulk density values for sonic drive core with those for sonic core in 19PB shows general agreement between average values (Tables 4.2-1 and 4.2-2). This agreement may be simply coincidental. As mentioned previously, the large amount of fill in nearly every sonic drive core run calls into question the representativeness of the calculated dry bulk density values shown in Table 4.2-1. In addition, the representativeness of sonic core run density values in Table 4.2-2 may also be questionable, due to the assumptions required to make the density calculations. For example, the assumption made in RID 6504 that the corehole diameter equals the OD of the core barrel may not be correct. Assuming a slightly smaller diameter (e.g., the ID plus one wall thickness) or a slightly larger diameter (e.g., the OD plus one wall thickness) significantly changes the calculated dry bulk density values shown in Table 4.2-2. To reduce this uncertainty in future sonic coring programs, an effort will be made to obtain direct measurements of corehole diameters by caliper logging at least portions of uncased sonic coreholes.

4.2.2.3 Sonic Core Composition, Cementation, and Hydrochloric Acid Reaction Trends

The geologic logs of the nearly continuous sonic core collected from saturated alluvium in 19PB allow the determination of trends of selected geologic parameters with depth in the upper alluvial aquifer. Geologic logs of alluvial core from 19PB (Appendix D) show that the alluvium is composed of 100 percent volcanic rocks. This observation is consistent with a previous one based on geologic logs of drill cuttings from the entire alluvial sequence in exploratory Phase III RC boreholes at Site 19 (NWRPO, 2003).

In contrast to the lack of variation in rock composition, geologic logs of 19PB indicate some variation in cementation and HCl reaction with depth. Figure 4.2-1 shows that there are numerous weakly cemented zones in the upper approximately 260 feet of the saturated alluvium in 19PB. These zones were generally not observed in alluvial drill cuttings data from Phase III RC boreholes 19IM1A and 19IM2A, both within approximately 100 feet of 19PB on the Site 19 drill pad (Figure 4.2-2). Similarly, more HCl reaction is observed in 19PB core from alluvium beneath the water table (Figure 4.2-3) than previously found in drill cuttings from 19IM1A and 19IM2A (Figure 4.2-4). These findings likely do not indicate spatial variations within Site 19, but reflect the drilling-related disturbance of alluvial drill cuttings and the subsequent difficulty in detecting parameters such as cementation and HCL reaction in these samples, especially beneath the water table.

There was no visual evidence of cementation in the approximately 20 feet of unsaturated zone sonic core collected immediately above the water table in 19PB (Figure 4.2-1), and strong HCL reaction was observed only in one core segment collected at the water table (Figure 4.2-3). These findings indicate that significant calcic horizons are not present in the capillary fringe above the water table at 19PB. Moreover, the mechanism for precipitation of calcite at the water table in arid settings suggested by some workers, including Walvoord and others (2005), is not operative to a significant degree at 19PB. This in turn suggests that the water table has not dropped rapidly at 19PB in recent geologic time.

4.2.2.4 Sonic Coring Rate and Run Length Trends

Figure 4.2-5 shows evidence of a weak correlation between coring rate and run length. Some evidence for this correlation was expected because both parameters are related to the ease, or difficulty, of advancing the sonic core barrel. A number of related factors potentially affect core barrel advancement, including formation density, the amount of coarse gravel and cobbles present, gravel and cobble rock type, core barrel diameter, depth bgs and source of sonic vibration, and the coring methods used by the driller. However, a comparison of these factors, excluding density, with coring rate and run length data in the geologic core logs (Appendix D) suggest little if any correlation. Moreover, the errors inherent in the approaches used to calculate formation density mentioned previously preclude finding a meaningful correlation between formation density and coring rate and run length. It is possible that it is simply difficult to measure the effects of the factors affecting core barrel advancement, and that these factors are in fact operative and play an important role in determining coring rate and run length.

4.2.2.5 Sonic Core Disturbance

During geologic and photographic logging of sonic core, several types of sample disturbance were observed. First, as expected, the sonic coring process caused core to expand. Thus, the core run length measured in the logging trailer in all cases exceeded the field, or cut, core run length in the corehole. However, reasonably accurate depth intervals were assigned by assuming that expansion was constant throughout each core run and then systematically correcting for this expansion, as described in detail in TP-8.0.

Second, some particle size segregation occurred during sonic coring. Specifically, some fines generally migrated from the interior of the core to the outside edge of the core. This disturbance is recorded in many of the digital and video photographic logs of the core, such as the one shown on Figure 4.2-6. This migration of fines to the outer edge of the core complicated the process of sampling major textural layers and possibly introduced error into laboratory PSD measurements on these samples. Procedures for minimizing these errors in future sonic coreholes are described in Section 5.1.3.2.

There is no evidence from geologic or photographic logs that fines migrated along the length of the core. It was therefore assumed that textural layers remained intact in the sonic core, were representative of in situ conditions, and were suitable for detailed geologic logging and laboratory testing. Some good examples of textural layers present in approximately 2-foot-long core segments are illustrated on Figure 4.2-7. It should be noted that the cobble and gravel layer shown from 570.5 to 570.9 feet likely originates from a single cobble that was fragmented into smaller particles by the coring process.

Photographic logs also illustrate the effect of the heat generated from the coring process on the distribution of water in the core (Figure 4.2-6). Most heat was generated at the core bit, causing the temperature of the core adjacent to the core bit to increase more than core located further up the core barrel. This heat caused water to migrate from the region of the core bit upwards into core located in the uphole end of the core barrel. The additional water in the uphole portion of the core often resulted in darker colors, while the drier, downhole portion of the core exhibited lighter and more oxidized colors. Care was taken to air-dry the excessively wet core to a moist state and to consistently record only the Munsell colors of moist core.

5.0 LABORATORY TEST RESULTS

The results of laboratory data collection activities for core and drill cuttings samples are presented in this section. Censored laboratory test data and reasons for censoring are presented in Table 4.1-1.

5.1 Laboratory Tests of Core Samples

The results of laboratory hydraulic property tests of drive core segments from RC boreholes 24P and 29P and corehole 19PB are presented in Appendix E. Results of laboratory hydraulic property tests of sonic grab and repacked core samples from 19PB are presented in Appendix F. Sonic core repacking data, including water content versus density data, are presented in Appendix G. Appendix H consists of laboratory hydraulic property test data from RC borehole drill cuttings.

Because core samples are generally more representative of in situ conditions than drill cuttings, they can be used as a standard for estimating the disturbing effects of drilling on drill cuttings. Conducting laboratory tests (e.g., PSD and GWC) on core samples and drill cuttings from the same or nearly the same depth interval provides a way to gauge such disturbance. Drive core laboratory test results from 24P and 29P are presented in the following section; these results will be compared with results of tests on drill cuttings in Section 5.2.

5.1.1 Drive Core Test Results for 19PB, 24P, and 29P

5.1.1.1 Dry Bulk Density, Porosity, and Volumetric Water Content Data

Table 5.1-1 summarizes porosity-related measurements of drive core segments obtained by SC-DC methods in 19PB and by APH-DC methods in 24P and 29P. Core segment depth intervals are included in the sample number. A comparison of data from these boreholes shows the following: first, dry bulk density values are generally larger for drive core collected by APH-DC methods than for core collected by sonic drive core methods. This observation is supported by the mean dry bulk density values presented in Table 5.1-2, which are consistent with the dry bulk density data determined for entire core runs (i.e., core barrels) presented in Section 4.2.2.1.

Second, a comparison of saturated VWC values with porosity values calculated from density data in Table 5.1-1 shows that the former are in nearly every case larger in 19PB. This finding is often observed in laboratory tests conducted on unconfined samples where some sample expansion (i.e., volume increase) has occurred during testing. However, in 24P and 29P, a consistent trend in differences between saturated VWC and calculated porosity values was not observed. The differences between these parameters in 24P and 29P were generally less than those observed in 19PB, which suggests that core volume changes are lower during Ksat tests on samples from 24P and 29P, which in turn may be related to the higher dry bulk density values of the core samples from these boreholes compared to 19PB.

5.1.1.2 Saturated Hydraulic Conductivity and Particle Size Distribution Data

Figure 5.1-1 suggests a weak linear correlation between the natural logarithm of Ksat and fines percentages in drive core samples from 24P. Similar trends of decreasing Ksat with increasing

finer materials have been found in a variety of sediments in numerous other studies, such as Todd (1980). However, Figure 5.1-1 also shows little if any correlation between these parameters on drive core from 29P and 19PB. The reasons for this lack of correlation are unknown, but may be related to the smaller sample size in these boreholes and/or the disturbance of the core during coring. Regarding the latter, it is well known that the sonic coring process (i.e., vibration) rearranges clasts to some degree, which may in turn block naturally occurring preferential flowpaths in the core samples. This disturbance could account for the lower average Ksat values of core samples observed in 19PB (Figure 5.1-1 and Table 5.1-2).

The significantly higher average gravel content in the drive core from 29P compared to that of 24P (Table 5.1-3) may in part be responsible for the lower average Ksat values observed in 29P (Table 5.1-2). It is possible that the greater percentage of gravel clasts in 29P, in combination with well-graded gravel and sand clasts, facilitates the production of densely packed core, which in turn exhibits greater resistance to flow than is found in 24P.

Table 5.1-2 also shows that there is a noticeable difference between the arithmetic and geometric means of the Ksat values of core samples collected from different boreholes. This is especially true for 24P, where the sample size is larger than that of 29P and 19PB. If Ksat values were normally distributed, the mean values would be approximately equal (Davis, 1986). The fact that the arithmetic and geometric means are different, at least in 24P, suggests that Ksat values are log-normally distributed.

Table 5.1-1 shows that great differences in PSD data were obtained from drive core samples collected from the same core run, especially in 19PB. For example, in several samples separated by 6 inches or less, the fines and gravel content in adjacent core segments differed by a factor of approximately 2. This finding has important implications for laboratory testing of flow and transport parameters. Clearly, a number of short drive core segments must be tested from each core run to give a realistic picture of the variability in parameters measured over a 2.0-foot depth interval. On the relatively small scale of a drive core run, fluvial sedimentary processes clearly create, in some cases, a highly layered flow system with contrasting properties.

Moreover, 2.0-foot drive core intervals spaced 40 or more feet apart vertically in 19PB, 24P, and 29P are clearly not sufficient to characterize the highly layered alluvial systems penetrated by these boreholes. For this reason, continuous sonic core in 19PB was collected and tested to provide the detailed data necessary to characterize layering in the upper portion of the alluvial aquifer at Site 19. Laboratory test results from these continuous core will be discussed in the following sections.

In addition, NWRPO single- and cross-hole tracer tests and associated hydraulic testing begun in 2004 and ongoing in 2005 will be useful in characterizing the alluvial flow system on a much larger scale. Once tracer test data are collected, additional evaluations will be done to determine if average parameter values are appropriate for modeling thick intervals of these highly variable alluvial sequences, or if the more coarse-grained and poorly graded sequences represent fast pathways for groundwater flow that should be accounted for in the models.

5.1.2 Sonic Grab Core Test Results for 19PB

Unlike drive core samples, sonic grab core samples are not suitable for porosity-dependent tests, such as dry bulk density and Ksat. However, grab core samples are suitable for laboratory PSD tests and several other tests independent of porosity. Data from these tests are summarized in Appendix F.

5.1.2.1 Particle Size Distribution Data

Summary statistics for PSD data from 19PB sonic grab core samples are presented in Table 5.1-4. All samples are coarse-grained and, on the average, contain less than 15 percent fines and approximately 40 percent gravel and 46 percent sand. The USCS group name for the average PSD composition is a silty or clayey sand with gravel.

Gravel varies more than the other fraction sizes with depth. For example, the range in gravel extends from 3 to 83 percent and in some cases differs by more than 40 to 50 percent in adjacent depth intervals, as shown on Figure 5.1-2. On this graph, the area to the right of the No. 4 sieve curve represents gravel, the area between this curve and the No. 200 sieve curve represents sand, and the area to the left of the curve represents fines. This figure also shows a slight trend of increasing percentages of fines and sand with depth and a corresponding decrease in percentages of gravel with depth.

Figure 5.1-3 shows that clay is generally the major component of the fines fraction in sonic grab core samples in 19PB. The clay on this figure corresponds to material with a particle diameter of less than or equal to 0.005 millimeter, as determined from hydrometer data; fines were determined from wet sieve data (Appendix F).

The Atterberg limits-based classification of the fines fraction in sonic grab core samples from 19PB is summarized in Figure 5.1-4. This classification system is described in ASTM D-2487 (ASTM, 2000a). In general, this figure shows that clay (CL) predominates over silt (ML) and silty clay (CL-ML). This observation is consistent with the classification based on particle size (Figure 5.1-3).

Finally, Figure 5.1-5 shows a reasonable agreement in PSD data between sonic grab core and drive core samples. The limited number of drive core samples appear to be slightly coarser in texture than the grab samples, which may be due to a number of factors, including differing sample volumes and possibly sampling bias associated with grab core sampling. Sampling bias is described in Section 5.1.3.2.

5.1.2.2 Electrical Conductivity Data

EC measurements of soil-water extracts from unsaturated zone alluvial sediments can provide an approximate estimate of the presence of readily soluble salts, and therefore a possible insight into the location of paleo-soils (i.e., geologically ancient soils), the terminus of wetting fronts from paleo-recharge events along Fortymile Wash, and/or the location of paleo-water tables.

EC data from the lower part of the unsaturated zone immediately above the present water table in 19PB shows several spikes (i.e., high values) and valleys (i.e., low values) (Figure 5.1-6). Given

the locations of these data in the unsaturated zone alluvial profile, it is possible that paleo-water tables may be responsible in part for these great variations in EC values. For example, each EC spike and subsequent valley may indicate a very long period of water table stability followed by a relatively rapid decline. It is possible that salt could accumulate at the air/water interface during the stable water table period and not accumulate during the decline. It is important to note that numerous other factors, including paleo-soils and paleo-recharge events, may also play some role in the development and maintenance of these EC peaks and valleys.

5.1.3 Repacked Sonic Core Tests for 19PB

The NWRPO and LANL conducted a cooperative testing program that involved repacking sonic core samples to target dry bulk density values and determining the VWC and Ksat values of these samples. In addition, wet sieve and hydrometer PSD, Atterberg limits, and specific gravity tests were conducted on representative split samples from the repacked samples.

Fifteen sonic core segments covering the range in PSD encountered in 19PB were selected for repacking to target density values at air-dried water contents. After dry bulk density, VWC, and Ksat tests on these samples, a subset of seven samples was chosen for a second phase of repacking and testing. Repacking was conducted at the optimum water content for each sample to achieve higher dry bulk density and lower VWC values, which are more representative of in situ formation conditions. In addition, repacking was conducted to achieve lower and more realistic Ksat values for relatively small-scale samples.

5.1.3.1 Repacking Data

Procedures described in TPN-8.1, *Constant Head Saturated Hydraulic Conductivity Measurements on Repacked Samples* were followed to select and repack the fifteen representative air-dried samples from 19PB. Repacking target specifications and results are presented in Appendix G. Dry bulk density values averaged approximately 1.72 g/cm^3 , significantly less than the target dry bulk density values, which averaged 1.825 g/cm^3 .

Target dry bulk density values were based on data summarized in Table 4.2-2 for 19PB. However, dry bulk density data from 19PB drive core segments (Table 5.1-2) averaged 1.89 g/cm^3 , which is considerably higher than the average for sonic core runs with minimal lost core (i.e., 1.81 g/cm^3 in Table 4.2-2). In addition, geophysical logging data (Section 6.0) suggest that the achieved average repacked dry bulk density of 1.72 g/cm^3 is considerably lower than in situ formation dry bulk density values.

After completing Ksat and VWC tests on the original fifteen samples, three of the samples with representative PSD were selected for water content versus density tests. These tests were used to estimate optimum water contents at which maximum dry bulk density values could be achieved by repacking. Data collected from these tests are presented in Appendix G.

Water content versus density relationships were estimated by laboratory compaction tests following procedures similar to those described in ASTM D-1557 (ASTM, 2000b). The three samples were repacked at a range of water contents according to procedures described in TPN-8.1, except that force was applied to the repacking tool rather than using the free-fall method described in the TPN. Optimum GWC values were determined from water content

versus dry bulk density graphs and ranged from 10.7 to 12.5 percent; maximum dry bulk density values ranged from 1.88 to 1.96 g/cm³.

Based on the water content versus density data from these three samples, the optimum water contents required to achieve maximum repacked dry bulk density values were estimated for four additional samples with representative PSD values. These seven samples were then repacked at optimum water contents to a target dry bulk density of 1.90 g/cm³, based on the average value obtained from drive core samples and thought to be reasonably representative of in situ dry bulk density. Laboratory test data obtained from these samples, as well as data from the samples repacked at air-dried water contents, are presented and discussed briefly in the following.

5.1.3.2 Laboratory Test Data

Laboratory-determined dry bulk density, specific gravity, VWC, Ksat, Atterberg limits, and PSD data for 19PB repacked sonic core samples are presented in Appendix F and are summarized in Table 5.1-5. Sample numbers containing the suffix SCR are samples repacked at air-dried water contents; sample numbers with the suffix SCRM are those repacked at optimum water contents. SCR and SCRM samples with the same depth intervals are one sample repacked first at air-dried and later at optimum water content.

Table 5.1-5 shows that repacking to a density of 1.90 g/cm³ at optimum water content compared to repacking at air-dried water content significantly decreases calculated porosity and measured VWC, and drastically decreases Ksat measurements. Both calculated porosity and measured VWC values decrease on the average from approximately 0.33 to approximately 0.25 cubic centimeter per cubic centimeter (cm³/cm³). Ksat values decreased by factors ranging from 7 to 423.

Figure 5.1-7 suggests a linear correlation between the natural logarithm of Ksat and percentage of fines, both in samples repacked at air-dried water contents and those repacked at optimum water contents. A similar correlation was found for drive core samples from 24P (Figure 5.1-1) and by other workers (Todd, 1980). Moreover, Figure 5.1-7 clearly shows the significant effects of repacking at differing water contents on Ksat values.

Table 5.1-6 compares the geometric means of Ksat values determined for sonic drive core, sonic core repacked at air-dried water contents, and sonic core repacked at optimum water contents. The geometric means of Ksat values for both drive core and core repacked at optimum water content are significantly lower than for core repacked at air-dried water contents. As discussed previously, the low Ksat values for drive core may be a result of sonic vibrations causing the movement of small-particle clasts and subsequent blockage of preferential flowpaths in the core. A similar process may also occur to some extent when repacking core at optimum water content, thereby contributing to the observed low Ksat values. This process is likely aided by the thorough mixing of particle sizes in samples before and during repacking.

In contrast, larger void spaces and higher Ksat values are expected in air-dried repacked samples. Moreover, the potential for movement of small clasts under dry conditions into these void spaces and the subsequent blockage of these spaces is less likely.

Sample scale (i.e., volume) may also be partially responsible for the differences in mean Ksat values observed between drive and repacked core (Table 5.1-6). Numerous workers, such as Schulze-Makuch and others (1999), have found that, on the average, the smaller the volume of the sample being tested, the lower the resulting Ksat value. Presumably, smaller samples are expected to contain fewer porosity-related heterogeneities and preferential flowpaths.

However, the differences between drive core and repacked sonic core Ksat measurements are also likely in part due to the horizontally oriented textural layering resulting in Ksat anisotropy that is present in drive core samples and lacking in repacked sonic core samples.

Much greater sample volumes are tested in field aquifer tests and it can be expected that the resulting average Ksat values will be much higher than those measured in the laboratory on core samples collected from the aquifer in question. Moreover, Ksat measurements in the field are oriented parallel to textural layers in alluvium, whereas measurements in drive core are oriented perpendicular to these layers. Clearly, the relation between sample scale and Ksat, as well as Ksat anisotropy, should be taken into account when attempting to use laboratory core testing results to estimate field Ksat values. The relationship between sample scale and Ksat will be discussed further in Section 5.3.

According to Atterberg limits data shown in Table 5.1-5, the fines in the repacked samples are generally classified as ML. In contrast, the fines in sonic grab core samples are classified primarily as CL (Figure 5.1-4). This difference may be due in part to the sample size difference; that is, 13 samples with Atterberg limits data versus 45 grab samples. In addition, samples for Atterberg limits tests were randomly selected, whereas repacked samples were specifically selected to cover a range in PSD encountered in 19PB, and are therefore likely to be biased to some extent.

Table 5.1-7 compares major particle size fractions of sonic grab core samples with those of the sample split used for repacking samples. Both samples are from the same depth interval, except where the repacked sample is slightly shorter due to removal at the SMF of a sample from the downhole end of the core for USGS testing.

The grab samples shown in Table 5.1-7 were collected in the field for geologic logging and laboratory testing. After grab samples were removed from the sonic core, the remaining core segments were shipped to the SMF for storage until needed by the NWRPO for use in repacking core samples, or if other laboratories (e.g., the USGS) requested samples for testing.

The PSD data in Table 5.1-7 indicate notable differences in these supposedly identical sample splits. These differences are most easily observed in the fines fraction, as illustrated on Figure 5.1-8. The grab sample splits generally exhibited a wider range of fines than those from the repacked sample split. This wide range may result in part from fines migrating to the outer surface of the sonic core and the preferential sampling of either this fines-rich surface or the fines-poor center of the core. In future sonic coreholes, extra care will be taken to minimize this source of sample bias. For example, where possible, samples will be split in half horizontally. When splitting is not possible, pie-shaped samples, with their apex terminating in the center of the core, will be collected.

5.2 Laboratory Tests of Drill Cuttings

Laboratory hydraulic-property-related tests of drill cuttings from RC boreholes are presented in Appendix H. Selected data from this appendix are summarized in tables and figures and compared and discussed in the following sections.

5.2.1 Particle Size Distribution Data from Alluvium

Figures 5.2-1 and 5.2-2 compare PSD depth profiles of alluvial drill cuttings from 28P with 16P and 28P with 27P, respectively. These graphs show the similarity in PSD data for these Flat Tire Flat boreholes; the similarity is also illustrated in the summary statistics for PSD data from these boreholes (Table 5.2-1). The PSD depth profiles show that each borehole exhibits layers containing approximately 50 percent fines between 50 and 150 feet bgs. The summary statistics show that the average fines content in each profile equals or exceeds approximately 20 percent fines, which is significantly more than that observed in boreholes drilled to date in Fortymile Wash (NWRPO, 2003). Summary statistic data for 24P and 29P presented in Table 5.5-2 are generally representative of RC boreholes drilled in Fortymile Wash to date and show a lower average fines content (i.e., 11 to 14 percent). Figure 5.2-3 shows the general similarity in PSD depth profiles for these boreholes, with significant differences occurring only in gravel content between approximately 250 to 300 feet bgs.

The difference in fines content between drainages is also illustrated on Figure 5.2-4, which compares PSD profiles from 28P and 29P. This figure also shows that Fortymile Wash borehole 29P contains noticeably more gravel than Flat Tire Flat borehole 28P. A comparison of summary PSD statistics for boreholes in these different drainages (Tables 5.2-1 and 5.2-2) supports this observation regarding gravel content. These relative differences in PSD between Flat Tire Flat and Fortymile Wash may be due to a number of factors, including differences in source rock and the size of the drainage basins.

In summary, PSD data from drill cuttings indicate that Fortymile Wash boreholes penetrate unsaturated alluvium that is more coarse-grained than that of Flat Tire Flat. Exposed nonwelded tuffs on the upland margins of Flat Tire Flat may be the source of additional fines found in boreholes 16P, 27P, and 28P in the central portion of the drainage.

Figures 5.2-5 and 5.2-6 compare PSD depth profile data for drill cuttings and drive core in boreholes 24P and 29P, respectively. As mentioned in Section 5.1, core is generally considered more representative of in situ conditions than drill cuttings, and can therefore be used to estimate the disturbing effects of drilling. These figures show good agreement in fines content between drill cuttings and drive core and less agreement in gravel content, especially in 29P. Significantly more gravel is found in drive core than in drill cuttings in 29P, suggesting that the grinding action of drilling may reduce larger, gravel-sized particles into smaller, sand-sized particles. The potential impacts of AR-RC on the PSD of drill cuttings is discussed in detail in NWRPO, 2003.

Figures 5.2-5 and 5.2-6 show that, in general, unsaturated alluvial drill cuttings from RC boreholes yield PSD values that approximate those obtained from drive core, and therefore approximate in situ conditions. This is consistent with the findings from Phase III boreholes (NWRPO, 2003). In contrast, data from these Phase III boreholes demonstrated that AR-RC

drilling significantly disturbs the PSD of drill cuttings from in situ conditions in saturated alluvium, and that these cuttings are not representative of drive core, or in situ conditions.

Further evidence of significant disturbance of saturated alluvium drill cuttings PSD values from in situ conditions is shown on Figure 5.2-7, where Phase IV PSD data from 19PB sonic core grab samples are compared with Phase III drill cuttings data from 19IM2A. These boreholes are located less than 100 feet from each other and would be expected to penetrate alluvium with reasonably similar PSD depth profiles. This figure shows that AR-RC drilling produces greatly decreased gravel and increased sand and fines percentages in comparison with data obtained from sonic core samples, which in turn are considered representative of in situ conditions.

5.2.2 Electrical Conductivity Data from Unsaturated Alluvium

EC measurements made on unsaturated alluvial drill cuttings are presented for Flat Tire Flat RC boreholes on Figures 5.2-8 and 5.2-9, and for Fortymile Wash boreholes on Figure 5.2-10. EC depth profiles for all RC boreholes show peaks in EC values in the upper 15 feet of each borehole, indicating salt accumulation in the near surface. However, at depths below the near-surface peaks, the EC profiles differ noticeably between Fortymile Wash and Flat Tire Flat boreholes. Flat Tire Flat boreholes exhibit a second major broad peak or series of peaks at depth, whereas the peaks at depth in Fortymile Wash boreholes are narrower or nonexistent. The reason for these differences are unknown. However, the same factors that may affect PSD values may also play a role; that is, differences in source rock and the size of the drainage basins may be in part responsible.

It is important to note that EC depth profiles for Fortymile Wash boreholes 24P and 29P (Figure 5.2-10) differ significantly from those for Fortymile Wash Phase III boreholes (NWRPO, 2003). Figure 5.2-11 illustrates the differences between Phase III borehole 19IM2A and Phase IV borehole 29P, which are approximately 1 mile apart in Fortymile Wash. This figure shows numerous sharp peaks in EC throughout the unsaturated alluvium for 19IM2A, but not for 29P. Preliminary retesting of duplicate archived samples from 19IM2A could not duplicate the data peaks shown in Figure 5.2-11. Additional testing is in progress to attempt to identify the reason for and scope of the potential problem(s) with EC data from 19IM2A and other Phase III RC boreholes, which show sharp peaks in EC data in unsaturated zone alluvial samples. When this work is complete, all problem EC data from Phase III will be censored and the revised data will be made available.

5.2.3 Gravimetric Water Content Data in Unsaturated Alluvium

Figures 5.2-12 and 5.2-13 compare GWC values from drill cuttings with drive core from unsaturated alluvium in RC boreholes 24P and 29P, respectively. Assuming that drive core samples exhibit GWC values that approximate in situ conditions, these plots clearly show that AR-RC drilling significantly dries the drill cuttings from in situ conditions. This drying process was previously observed in unsaturated alluvium in all Phase III RC boreholes (NWRPO, 2003).

GWC profiles from drill cuttings are useful, however, to identify relative differences between boreholes and identify depth intervals where excess drilling fluids were used to condition the borehole. Figure 5.2-13 shows that the unsaturated alluvium in 27P was drier than that in 16P,

which is consistent with the observation made previously that 27P is not located close to any surface water drainages, while 16P is. The peaks in water content in 27P at approximately 150 and 410 feet likely reflect the use of excess drilling fluids in these intervals to condition the borehole.

5.3 Constant Head Saturated Hydraulic Conductivity Tests in 19PB

5.3.1 Constant Head Data

Ksat data from constant head tests conducted in 19PB shallow and deep piezometer strings are summarized in Table 5.3-1; test methods are described in detail in Section 3.3. Table 5.3-1 shows that the average Ksat value determined in the shallow piezometer string is more than an order of magnitude less than that observed in the deep piezometer string. This difference in value was unexpected, because flow-related data collected from the sonic core from depth intervals corresponding to the sandpacks of the shallow and deep piezometer are very similar. For example, average PSD data from the two sandpack intervals are nearly identical. (Table 5.3-2). Moreover, coring methods were also nearly identical; the only difference was the diameter of the core barrel and drill casing used in the two piezometer sandpack intervals. Finally, constant head testing methods were identical, including factors such as temperature and chemical composition of the injected water. It is possible, and even likely, that the differences in Ksat values are due to the preferential accumulation of fines on borehole walls and/or the smearing of these fines in the shallow piezometer string. However, a reason for such preferential disturbance is not readily apparent.

Following these initial constant head tests in 19PB, an attempt was made to more aggressively develop both the shallow and deep strings and remove fines from the borehole walls in screened intervals using swabbing and air lifting. Unfortunately, this approach resulted in cracking the PVC casing of the deep piezometer string in the vicinity of the shallow piezometer screen, the same region that collapsed (i.e., caved) on the deep string during well completion. It is hypothesized that this caving caused a relatively sharp bend in the blank PVC casing and the tight-fitting development swab cracked the casing as it moved through this bend. Regardless of the mechanism of failure, the cracking resulted in hydraulic communication between piezometer strings and invalidated additional constant head Ksat testing. In the future, greater care will be taken in both the completion and development of PVC piezometer strings to avoid similar problems. Consideration will also be given to the use of stainless-steel piezometer casing and screen in place of PVC, especially in deeper boreholes. Finally, both piezometer strings in 19PB will be replaced as part of EWDP Phase V activities.

5.3.2 Comparison of Saturated Hydraulic Conductivity Tests

Table 5.3-3 presents average Ksat and related parameter values obtained from the 19PB piezometer strings, together with average values determined from small-scale measurements made in the laboratory and large-scale measurements made during a 48-hour constant pump rate aquifer test in a well near 19PB. The laboratory tests have been presented and discussed in previous sections. The methods and results of the 48-hour aquifer pump test are described in NWRPO (2001b).

A comparison of the measurement scale (i.e., volume tested) data with Ksat data in Table 5.3-3 suggests a direct relationship between these parameters. That is, Ksat appears to increase with the scale of measurement. This relationship between measurement scale and Ksat in geologic material has been observed by numerous workers, including Schulze-Makuch and others (1999), who observed nearly straight-line relationships between measurement scale and Ksat values for differing aquifer geologic material plotted on log-log coordinates.

Figure 5.3-1 presents a graph of measurement scale and Ksat data from Table 5.3-3 on log-log coordinates. This graph illustrates clearly the direct correlation between parameters. The only major outlier on Figure 5.3-1 appears to be data collected from 19PB sonic grab core samples repacked at air-dried water content to approximately 1.7 g/cm^3 . Figure 5.3-2 shows a much better linear relationship when these outlier data are removed from the data set. In addition, it is likely that an even better correlation could be achieved if 19PB were developed successfully and a more representative Ksat value in the upper piezometer screen measured. Additional Ksat data, especially field test data, would be useful to increase the level of confidence in the trend line shown on Figure 5.3-2.

Figures 5.3-1 and 5.3-2 also provide further evidence that sonic core samples repacked at air-dried water contents are not representative of in situ conditions. Moreover, they emphasize that measurement scale must be taken into account when evaluating the representativeness of Ksat data.

As mentioned previously in Section 5.1.3.2, drive core samples were collected in the vertical direction perpendicular to alluvial textural layers and laboratory Ksat measurements reflect this core orientation. In contrast, Ksat field measurements were primarily oriented in the horizontal direction. Since Ksat measurements made in the horizontal direction in alluvium are often one or more orders of magnitude larger than those made in the vertical direction (Bear et al., 1968), the differences between drive core and field measurements shown on Figures 5.3-1 and 5.3-2 are likely in part due to measurement orientation rather than scale.

6.0 BOREHOLE LITHOLOGY

Summary lithologic and borehole geophysical logs are presented and discussed in this section.

6.1 Summary Lithologic Logs

Summary lithologic logs from Phase IV boreholes are presented in Appendix I. The alluvial section of each RC borehole is subdivided into major coarse-grained textural groups using the USCS group name classification system based on the particle size percentage criteria specified in ASTM D-2487 and percentages of gravel, sand, and fines determined from laboratory wet sieve analyses of drill cuttings samples. However, because laboratory hydrometer data and field estimates of plasticity suggested that roughly equal parts of silt and clay exist in most drill cuttings samples, the borderline symbol of "SM/CL," defined in ASTM D-2488, is used to describe the fine fractions in the alluvium lithologic logs described in the following. The remaining portion of the alluvium lithologic logs summarize much of the data for texture group depth intervals listed on the Alluvium Drill Cuttings Logging Form (Figure 2.3-1).

The underlying volcanic and sedimentary rocks are subdivided, based first on lithology and second on recognized formation and member unit. Rocks are described using the parameters recorded on the Non-Alluvium Drill Cuttings Logging Form (Figure 2.3-2). In general, Phase IV RC boreholes intersect a more complete and representative section of volcanic stratigraphy typical of the Yucca Mountain area than earlier EWDP boreholes, which focused on the Highway 95 and Fortymile Wash areas.

As in the case of RC boreholes, the major textural groups in the summary lithologic log for sonic corehole 19PB are determined from laboratory PSD data for core rather than drill cuttings. Additional geologic data for each textural group are based on data in the Alluvium Core Logging Forms presented in Appendix D.

This section will briefly describe the location of each RC borehole with respect to gravity and/or magnetic gradients, known faults, and nearby surface outcrops, followed by a narrative description of the summary lithologic logs and correlations, if any, with other wells in the area, including those within the main block of Yucca Mountain.

Since 19PB penetrated only the upper portion of the saturated alluvium, the focus of its discussion will be limited to combining USCS units into hydrogeologic units suitable for modeling and comparing the summary log based on core samples with logs developed for Phase III boreholes based on drill cuttings.

6.1.1 Borehole 27P

Borehole 27P is in the northwest section of Flat Tire Flat, northwest of the large gravity gradient increase shown on Figure 1.3-3 and south of the large east-west magnetic lineament at the Stagecoach Road latitude shown on Figure 1.3-4. As previously mentioned, another Phase IV borehole had been planned north of this lineament; these two boreholes were designed to examine the geologic and hydrologic significance of this large magnetic feature. Ultimately, the second borehole was not drilled and this objective was not met.

Hills to the west of 27P, in the footwall of the Windy Wash Fault, consist of Tiva Canyon Tuff with local remnants of Ammonia Tanks Tuff (Figure 1.3-2). The summary lithologic log (Appendix I-1) indicates that the borehole started in alluvium consisting mainly of well-graded sand with silt, clay, and gravel to a depth of 45 feet bgs. From this depth to 182.5 feet bgs, the borehole penetrated primarily silty, clayey sand with gravel. Bedrock was encountered at 182.5 feet bgs, starting in ashy nonwelded tuff, interpreted to be part of the Rainier Mesa Tuff, a member of the Timber Mountain Group.

Underlying this tuff unit, from 202.5 to 1,180 feet bgs, are the Paintbrush Group tuff members, including the Tiva Canyon Tuff from 202.5 to 355 feet bgs, a pre-Tiva Canyon Tuff unit from 355 to 400 feet, the Topopah Spring Tuff from 400 to 1,180 feet bgs, and Pre-Topopah Spring bedded tuffs from 1,180 to 1,355 feet bgs. The water table was encountered at approximately 600 feet bgs, with the static water level rising to approximately 583 feet bgs.

Crater Flat Group units, including the Prow Pass Tuff, are penetrated from 1,355 to 1,765 feet bgs, and upper sections of the Bullfrog Tuff from 1,765 to 1,900 feet bgs. Drilling of this borehole was stopped at 1,900 feet bgs in the Bullfrog Tuff.

Overall, the stratigraphy penetrated by 27P is similar to that of other wells south of Yucca Mountain, including WT-11 and -12. The thickness and welding features of the Topopah Spring and Prow Pass Tuffs indicate that deposition of these units was unrestricted and comparable in thickness to the geologic section within the main block of Yucca Mountain (Day et al., 1998). The approximately 150-foot thickness of the uppermost welded unit encountered in the hole, the Tiva Canyon Tuff, indicates some thinning of this unit; elsewhere at Yucca Mountain, the Tiva Canyon Tuff is up to 500 feet thick (Day et al., 1998).

6.1.2 Borehole 16P

Borehole 16P is near the center of Flat Tire Flat, to the northwest of the large gravity gradient (Figure 1.3-3) and a prominent northeast-trending magnetic lineament (Figure 1.3-4). Borehole 28P is on the opposite side of these geophysical features to the southeast.

Previous workers have recognized geologic and geophysical problems in the region between 16P and 28P. For example, a geologic cross section constructed for a USGS map of northern Flat Tire Flat indicated the potential for uplifted Crater Flat-aged rocks in the footwall to north-south trending down-to-the-west faults concealed beneath thin alluvial cover. Based on gravity data, the north-south faults are truncated against an inferred northeast trending down-to-the-southeast fault (Potter et al., 2002). The cross section implies that Paleozoic rocks are found within 2,000 feet of the surface along the footwall side of a buried growth fault affecting rocks as young as Pre-Crater Flat Group volcanic rocks approximately 13.5 million years old (Ma). This very complicated construction of inferred faults beneath the cover and strong geophysical trends prompted the siting of 16P and 28P, discussed further in Section 6.1.4., to better understand the complex geology and hydrologic significance.

The summary lithologic log for 16P (Appendix I-2) shows that its thickness and lithology of alluvium are similar to those of 27P. That is, the alluvium is predominantly silty, clayey sand with gravel. Bedrock, encountered at 166 feet bgs, consists of weathered nonwelded tuff

interpreted as the Pre-Ammonia Tanks member of the Timber Mountain Group. Underlying this unit is the Rainier Mesa member from 395 to 720 feet bgs. The water table was encountered at approximately 535 feet bgs, with the static water level rising to approximately 496 feet bgs. The base of the Rainier Mesa Tuff is represented by a series of three nonwelded and locally deeply weathered tuffs from 720 to 876 feet bgs.

The Tiva Canyon Tuff of the Paintbrush Group was encountered between 876 to 1,065 feet bgs, with five distinguishable subzones. A nonwelded ash-fall tuff separates the Tiva Canyon from Topopah Spring Tuff from 1,065 to 1,080 feet bgs. The Topopah Spring Tuff was encountered from 1,080 to 1,810 feet bgs, with nine distinguishable subzones. The base of the Paintbrush Group includes a thin ash-fall tuff from 1,810 to 1,820 feet bgs.

An intermediate-composition ash-flow tuff, from 1,820 to 1,905 feet bgs, interpreted as Wahmonie Formation separates the Paintbrush Group from the underlying Prow Pass Tuff of the Crater Flat Group. The Prow Pass Tuff is penetrated from 1,905 to 2,278 feet bgs, and consists of predominantly nonwelded tuff with local vapor phase alteration and an oxidized and foliated base. The Bullfrog Tuff is encountered from 2,278 to 2,815 feet bgs in 16P. This tuff is mostly moderate to densely welded, with a basal sandstone from 2,805 to 2,815 feet bgs. A non to weakly welded tuff occurring from 2,815 feet bgs to the bottom of the borehole at 2,900 feet was interpreted as the top section of the Tram Tuff.

Every major tuff interval is represented in 16P, which penetrates the Miocene volcanic section from the bottom of the Ammonia Tanks Tuff through the top of the Tram Tuff. The thickness of major pyroclastic flow deposits are consistent with like units within the main block of Yucca Mountain (Day et al., 1998). The thickness of the volcanic aquifer, although not fully penetrated, likely approaches 2,500 to 3,000 feet (i.e., from the top of the water table to the top of the Pre-Tram sedimentary rocks).

6.1.3 Borehole 28P

Borehole 28P is in the southeast section of Flat Tire Flat, to the southeast of the large gravity gradient (Figure 1.3-3) and northeast-trending magnetic lineament (Figure 1.3-4). As stated, its location was chosen to complement that of 16P.

The summary lithologic log for 28P (Appendix I-3) shows an upper section from 0 to 45 feet bgs consisting mainly of layers of well-graded sand with silt, clay, and gravel interbedded with more finely textured layers of silty, clayey sand with gravel. From 45 to 70 feet bgs, the sediments are predominantly well-graded sand with silt, clay, and gravel; from 70 to 240 feet, the alluvium consists mainly of silty, clayey sand with gravel. Bedrock, encountered at 240 feet bgs, consists of weathered, nonwelded to weakly welded tuff interpreted as the Ammonia Tanks member of the Timber Mountain Group. Underlying this unit is the Rainier Mesa Tuff member from 405 to 660 feet bgs, consisting of nonwelded Post-Rainier Mesa Tuff from 405 to 660 feet bgs and nonwelded Rainier Mesa Tuff from 660 to 765 feet bgs. The water table was encountered at approximately 405 feet bgs, with the static water level rising to approximately 374 feet bgs.

The Timber Mountain Group is separated from the Tiva Canyon Tuff member of the Paintbrush Group by a nonwelded tuff from 765 to 920 feet bgs that includes a 10-foot-thick, deeply

weathered top. The Tiva Canyon Tuff was encountered between 920 to 1,035 feet bgs; however, no easily distinguishable subzones were logged. A nonwelded ash-fall tuff separates Tiva Canyon from Topopah Springs Tuff from 1,035 to 1,065 feet bgs. The Topopah Spring Tuff was encountered from 1,065 to 1,145 feet, with no distinguishable subzones except a very poorly developed vitric zone from 1,120 to 1,130 feet bgs.

The Paintbrush Group lies in sharp contact with a weathered and altered pumiceous, weakly to nonwelded tuff from 1,145 to 1,342 feet bgs. Initially this tuff unit was interpreted as Tram Tuff, however preliminary age dating (i.e., the $^{39}\text{Ar}/^{40}\text{Ar}$ age dating technique) indicates that the tuff is approximately 14.5 Ma and thus the age of a Pre-Tram Tuff. This deeply weathered tuff is underlain by calcareous mudstone of lacustrine origin from 1,342 to 1,400 feet bgs that also suggests a deeper, older, stratigraphic position for the overlying tuff. The mudstone is finely laminated and locally contains cherty siltstone with fine pyrite. Below the mudstone unit is a sequence of calcareous sandstone from 1,400 to 1,445 feet bgs. The base of the sandstone in this interval contains layers of clay, possibly representing altered ash beds. A lacustrine-deposited ash-fall tuff from 1,445 to 1,795 feet bgs occurs below the sedimentary rocks. Within this ash fall are bedded horizons similar to the overlying siltstone and mudstone units. The tuff is generally weakly calcareous. Below this tuff is a distinctive ash-flow tuff unit with brilliant green glass shards from 1,795 to 1,943 feet bgs. The top of the tuff from 1,795 to 1,810 feet bgs contains beds of chert with finely disseminated pyrite. Locally, the tuff is weathered, bleached white and zeolitized. Again, this ash flow is interpreted to have been deposited in a lacustrine environment. Finally, underlying these tuffs, is a highly plastic clay from 1,943 to 1,974 feet bgs interpreted as an argillized ash. The tuff has scattered lithic clasts near the base and probably represents the early eruptive phase of the overlying tuff that was deposited in a lacustrine environment and altered in place. This altered ash overlies interbedded claystone and siltstone from 1,974 to 2,080 feet bgs, where the borehole was terminated. This sedimentary unit consists of cherty and silty claystone grading downward into homogeneous claystone and thinly laminated mudstones with gypsum and pyrite.

Borehole 28P penetrates an upper Miocene volcanic section very similar to that of 16P. Both boreholes have a section from the bottom of the Ammonia Tanks through the bottom of the Topopah Springs Tuffs. The thickness of Paintbrush Group members are, however, greatly diminished, indicating some restriction in the basin, which is especially evident in the thickness of the Topopah Spring Tuff in 28P, where this unit, which is usually more than 500-foot-thick unit is less than 100 feet thick. Below 1,145 feet bgs in 28P, the stratigraphy differs greatly from that of 16P. A series of weathered, nonwelded tuffs, interlayered with lacustrine sedimentary rock, is encountered that likely correlates with units normally mapped as older volcanic rocks (Tvo) and older sedimentary rocks (Ts). The sedimentary rocks are similar to those encountered in the deeper section of Phase I and II boreholes 1DX, 3D, 2DB and 19D. The thickness of the volcanic aquifer is greatly diminished compared to that of 16P, to the north. The aquifer at this location is less than 1,000 feet thick (i.e., from the top of the water table to the top of the Pre-Tram Tuff sedimentary rocks) compared to the thickness of more than 2,500 feet at 16P.

6.1.4 Borehole 24P

Borehole 24P is on the southwest side of the lower reaches of Fortymile Wash along the western side of the NTS. 24P and 29P were sited to produce basic hydrogeologic data in this area of

extensive alluvial cover, near the transition of saturated flow from the volcanic to the alluvial aquifers. The boreholes were also sited to serve as control points for future surface geophysical studies of the contact between saturated alluvial and volcanic rocks along the western margin of Fortymile Wash. In addition, 24P is located to the southeast of a series of north-northeast-striking magnetic lineations believed to represent the Stagecoach Road and Paintbrush Canyon Faults (Figure 1.3-4). Another lineation occurs just west of the borehole and probably represents an eastern splay to the Paintbrush Canyon Fault buried beneath alluvial cover. It was hoped that the geologic data obtained from 24P and 29P would also help explain the relationship between the unusual tuff unit underlying the alluvium in boreholes at Site 19, due south of 24P and 29P.

Hills to the north of 24P, in the footwall of the Paintbrush Canyon Fault, consist of lower sections of the Paintbrush Group and uppermost sections of Crater Flat Group (Figure 1.3-2). Exposures on these hills provide evidence of an up-thrown and eroded footwall block that is broken up by a series of sympathetic faults projected to strike to the west side of 24P. These faults preserve more stratigraphy, suggesting that, beneath the alluvium, the borehole is expected to intersect units of Paintbrush Group age or younger. In addition, a small outcrop to the south of the borehole site has exposures of the top of the Topopah Spring Tuff.

The summary lithologic log for 24P (Appendix I-4) indicates that the borehole started in alluvium consisting of layers of well-graded sand with silt, clay, and gravel interbedded with more finely textured layers of silty, clayey sand with gravel. From 60 to 245 feet bgs, the alluvium is composed primarily of coarse-textured layers of well-graded sand with silt, clay, and gravel. This section is underlain primarily by fine textured layers of silty, clayey sand with gravel to a depth of 400 feet bgs. Bedrock was encountered at 400 feet bgs, well below an anticipated depth of 150 to 200 feet bgs.

The first bedrock unit, from 400 to 890 feet bgs, consists of moderately to densely welded tuff containing 1 to 5 percent quartz phenocrysts. The water table was encountered at approximately 420 feet bgs, with the static water level rising to approximately 404 feet bgs. Initially, while drilling this tuff unit, the unit was interpreted as Rainier Mesa Tuff. Careful examination of tuff features, its stratigraphic position, and its thickness indicated that it is the Bullfrog Tuff member of the Crater Flat Group instead. The Bullfrog Tuff is underlain by a conglomeratic sandstone unit from 890 to 933 feet bgs. This sandstone is slightly coarser and thicker than a similar unit observed at the base of the Bullfrog Tuff in 16P from 2,805 to 2,815 feet bgs.

Below the sandstone is a weakly to nonwelded tuff from 933 to 1,356 feet bgs, interpreted as Tram Tuff, that is similar to the unit in borehole 16P from 2,815 to 2,900 feet bgs. Below the weakly welded Tram Tuff is a short sequence of volcaniclastic rocks from 1,356 to 1,400 feet bgs, including fine sandstone, siltstone, and claystone, probably of lacustrine origin. Below these sedimentary rocks is a reworked tuff unit from 1,400 to 1,480 feet bgs, which has a gradational contact with a thicker underlying ash-flow tuff unit from 1,480 to 1,722 feet bgs. Both units are quartz porphyritic. These tuff units are preliminarily identified as Pre-Tram Tuff until further $^{39}\text{Ar}/^{40}\text{Ar}$ geochronologic data are available. The tuff is underlain by a sequence of lacustrine sedimentary rocks, including claystone, siltstone, and sandstone from 1,722 to 1,860 feet bgs, where the borehole was terminated. The sequence consists of an upper interval from 1,722 to 1,760 feet bgs of interbedded sandstone and lesser claystone grading into predominantly laminated siltstone below 1,760 feet bgs.

Borehole 24P cut an unexpectedly thick sequence of alluvium, with a section of silty, clayey sand with gravel from 245 to 400 feet bgs. Other boreholes within the modern-day axis of Fortymile Wash (e.g., 10S, 22S and 19IM2) generally have a sequence of well-graded sand with silt and gravel to depths of approximately 300 to 400 feet bgs before transitioning to silty sands. In general, relatively shallow silty and clayey sand sequences are observed only in boreholes on the east side of the wash (i.e., 23P and 5S) and in the lower reaches of the wash at depth in 2DB. This observation may support the theory that Fortymile Wash has been drastically downcut along its axis or that finer alluvial facies (i.e., clayey units) were deposited only distally from the main axis in an overbank setting.

The first bedrock unit encountered in 24P is Bullfrog Tuff. Based on the structural setting in this area, the rather shallow intersection of Bullfrog Tuff is anomalous. Two explanations are possible. The first is that an odd striking down-to-the-west late (i.e., younger) fault west of 24P uplifted the footwall block at 24P. This fault would allow deeper erosion of Crater Flat Group units, exposing Bullfrog Tuff prior to the deposition of alluvium.

A second explanation, consistent with the apparent unconformity in the volcanic sequence in 28P, is that lower tuff units of the Crater Flat Group were structurally uplifted and possibly eroded relative to Paintbrush Group tuffs before the eruption of the Topopah Spring Tuff (i.e., before 12.8 Ma). In this scenario, a growth fault would cause uplift in the Crater Flat-aged rocks to form a structural high and associated basin trending southward from the east side of Yucca Mountain to the northwest side of Busted Butte and southwestward to the west side of the Lathrop Wells Cone. This growth fault can be traced by a steep gravity gradient that is reflected in the abrupt change in thickness of Cenozoic rocks (Figure 1.3-3) and by roughly coincident aeromagnetic lineaments (Figure 1.3-4). The structural footwall high is subsequently buried by a veneer of Paintbrush Tuffs. On the structural hanging wall within the basin, west and northwest of the growth fault, Paintbrush Tuffs are deposited within unrestricted basins to a total thickness approaching 2,000 feet. On the footwall side, Paintbrush Tuffs are thinner, as the deposition of the pyroclastic flows was restricted by this buttress-like feature. It is also likely that the Highway 95 Fault is a similar structure, of similar age.

6.1.5 Borehole 29P

Borehole 29P is also located on the southwest side of the lower reaches of Fortymile Wash along the western side of the NTS. As stated, this borehole, like 24P, was sited to produce basic hydrogeologic data for this area.

The summary lithologic log for 29P (Appendix I-5) indicates that the borehole started in alluvium consisting of well-graded sand with silt, clay, and gravel from the surface to 125 feet bgs. From 125 to 265 feet bgs, the well-graded sand is interbedded with silty, clayey sand with gravel. The lower section of alluvium, from 265 to 320 feet bgs, is mostly silty, clayey sand with gravel.

Bedrock was encountered at 320 feet bgs, consisting of densely welded tuff interpreted as Tiva Canyon Tuff of the Paintbrush Group. Underlying this tuff unit, from 378 to 410 feet bgs is nonwelded Pre-Tiva Canyon and Topopah Spring Tuffs from 410 to 640 feet bgs with five recognized subzones. The Topopah Spring Tuff overlies bedded, nonwelded ash falls of the Pre-

Topopah and Pre-Wahmonie Formation units. Below 700 feet bgs, a well-sorted, poorly cemented sandstone interpreted as a Pre-Wahmonie unit was encountered. This sandstone unit produced unstable conditions in the open borehole, including flowing sand intervals. The borehole was terminated at a depth of 790.7 feet bgs, after two attempts to grout the flowing sand intervals and continue drilling.

Borehole 29P cut a thin section of Paintbrush Group tuffs from the base of the Tiva Canyon Tuff through a relatively thin section of Topopah Spring and Pre-Topopah Spring Tuff units. The thickness of the Topopah Spring Tuff, elsewhere up to 1,000 feet thick, indicates some restriction in the basin. Alternatively, it can be argued that the ash-flow sheet is near its terminus at 29P. It is likely that the Paintbrush Group tuff units are drastically thinned across the paleotopographic high discussed previously. The area of this high is poorly constrained but probably exists to the southeast of the large gravity gradient, and likely diminishes in stratigraphic offset to the northeast. 29P was terminated due to drilling conditions and never intersected the stratigraphy beneath the Paintbrush Group to provide information about the structural orientation and possible erosional level of the footwall block.

6.1.6 Corehole 19PB

The summary lithologic log for 19PB (Appendix I-6) is based on laboratory PSD measurements made on sonic grab core samples, including wet sieve tests made on each sonic grab core sample and hydrometer and Atterberg limits tests on random subsets of the total samples (Table 2.2-3).

USCS group symbols were assigned to each grab sample. Wet sieve tests were used to determine grading as well as percentages of gravel, sand, and fine fractions. Hydrometer and Atterberg limits tests were used to determine whether silt or clay predominated in the fines fraction of the samples tested. For samples where both hydrometer and Atterberg limits tests were conducted, Atterberg limits results were used to classify the fines fraction as silt, clay, or silt and clay according to ASTM D-2487 (ASTM, 2000a). In samples where neither hydrometer nor Atterberg limits tests were done, clay was assumed to predominate over silt, based on the data trends illustrated on Figures 5.1-3 and 5.1-4. The final step in USCS classification consisted of using grab sample data to assign group symbols to each sample interval.

Figure 6.1-1A shows the distribution of the 14 USCS groups in the lower approximately 20 feet of the unsaturated zone and the upper approximately 260 feet of the saturated zone. Also shown are lost core and drive core depth intervals for which grab sample data are not available. This figure and the associated raw data served as the basis for developing the formal summary lithology log for 19PB (Appendix I-6).

The log shows that the upper 130 feet of the saturated zone portion of aquifer are primarily composed of numerous, relatively thin alternating intervals of gravels with clay and clayey gravels. Below 500 feet bgs, relatively thick intervals of clayey sands predominate, and are divided primarily by thinner intervals of clayey gravels. These trends of decreasing gravel content and increasing sand and fines content with depth are, and should be, consistent with the PSD depth profile (Figure 5.1-2).

Figure 6.1-1 also shows two simplified combinations of USCS groups in 19PB (i.e., Logs B and C on Figure 6.1-1). Even the log with two USCS group combinations (i.e., Log C on Figure 6.1-1) is far too complicated for flow and transport modeling in the upper saturated zone in the vicinity of 19PB. However, taken together, the logs on this figure suggest a further simplification that divides the upper saturated zone into two hydrogeologic units that could be useful in flow and transport modeling. For example, gravels with clay, silt, and sand predominate in the interval between the water table and approximately 500 feet bgs and clayey sands with gravel predominate below 500 feet bgs. The upper interval consists mainly of textural layers with less than 12 percent fines and the lower interval consists mostly of layers with 12 percent or more fines. Figure 5.1-7 suggests that layers with differing fines percentages in these two intervals would exhibit very different average Ksat values, at least for small-scale core samples repacked from these layers.

Ideally, large-scale Ksat field values should be used to obtain representative average field-scale values for these two hydrogeologic units. If using these values is not feasible, it may be possible to use relations such as those presented on Figure 5.3-2 to “scale-up” laboratory core measurements from these units to larger field-scale estimates. Regardless of the approach taken, additional data are needed to determine representative Ksat values for these hydrogeologic units before using the units in flow and transport models.

It should be noted that simplifications, such as dividing the saturated zone into two hydrogeologic units, may not capture the variability in Ksat that is observed in laboratory and field test data and suggested in the variability of the textural groups shown on Figure 6.1-1. Alternative modeling approaches may be required to encompass the effects of this variability, which may include preferential or fast pathways.

Both the highly detailed 19PB log presented in Appendix I and the simplified log shown on Figure 6.1-1 for the interval from approximately 350 to 630 feet bgs are significantly different from the log for this interval in nearby Phase III RC borehole 19IM2A (NWRPO, 2003). The more recent logs, based on core samples, contain significantly more layers of gravel with clay and layers of clayey gravel than the earlier log, based on drill cuttings samples. This observation is consistent with PSD depth profiles presented for both boreholes in Section 5.2.1; and illustrates the difference in logs obtained from drill cuttings (i.e., 19IM2A) and logs obtained from core samples (i.e., 19PB).

6.2 Borehole Geophysical Logs

Geophysical logs run in Phase IV boreholes are classified as one of three logging suites: drill-string, open-hole, and well completion (Table 2.5-2). Selected logs from the drill-string suite, run by Century, and the open-hole suite, run by GLS, are presented on Plates 1 through 6. More specifically, selected logs from the GLS suite run in boreholes 16P, 27P, and 28P are presented on Plates 1 through 3, respectively; selected logs from the Century drill-string and GLS open-hole suites run in 29P and 24P are shown on Plates 4 and 5, respectively; and logs from the Century drill-string suite in 19PB are shown on Plate 6. In addition, geologic logging data, including lithologic unit and degree of tuff welding, are presented on each of these plates. Borehole diameters are also schematically illustrated in well completion diagrams on each plate. Correlations between these lithologic log and other borehole data and the responses of the

borehole geophysical logs will be described for each borehole in the following sections. The discussion of these correlations will be limited to non-alluvium in the exploratory RC boreholes, since alluvium in these boreholes showed little, if any, borehole geophysical log response, and the lithologic log data showed only minor variations with depth.

Several logging tools produced no consistent or reasonable results. These logs were not used in interpretations and are considered censored logs (Table 6.2-1).

Drill-string and open-hole logs were run in exploratory boreholes drilled primarily with air; only very small amounts of bentonite, bentonite with polymer, and several synthetic-based drilling fluids were used to maintain stable borehole conditions during drilling, geophysical logging, and subsequent well completion activities (Appendix A). The exception is 29P, where large amounts of cement and bentonite were used in an attempt to stabilize a flowing sand unit in the lower portion of the borehole.

Several geophysical logs are considered to have meaningful responses only while run beneath the water table. These included resistivity, spontaneous potential, sonic, fluid temperature, and fluid resistivity logs.

Responses of both drill-string and open-hole logs to changes in formation conditions are likely affected only to a small degree by the relatively small amounts of bentonite and other drilling fluids used to condition the boreholes. For example, the use of these drilling fluids to condition the boreholes did not prevent the GLS open-hole suite from providing useful information regarding the water table, water production zones, and confirmation of the depth of the alluvium/tuff and volcanic/volcanic contacts, where present.

In addition to impacts from drilling fluids, responses of the Century drill-string suite are likely dampened to some extent by the steel drill casing. In spite of this dampening, logs in the drill-string suite clearly show the location of the water table and zones that may be producing or taking water, changes in water-filled porosity immediately above and below the water table, changes in formation density, and, where present, contacts between alluvium and tuff units.

Although the well-completion suite helps to confirm the location and integrity of sandpacks and bentonite seals, it shows few, if any, trends related to formation lithology and/or water production. As a result, these logs will not be discussed in this report, but may be viewed on the NWRPO website (NWRPO, 2005a) or at the QARC.

6.2.1 Geophysical Log Signatures and Interpretations for 27P

Geophysical logs and lithologic log data from 27P are displayed on Plate 1.

Topopah Spring and Pre-Topopah Spring Tuffs

The open-hole pre-completion water table occurs within the upper lithophysal zone of the Topopah Spring Tuff. A decrease in natural gamma log values is observed at the water table.

The saturated portion of the Topopah Spring Tuff consists mostly of devitrified, densely welded tuff. Just below the water table, the middle non-lithophysal zone is very resistive, indicating low water-filled porosity, which is consistent with a densely welded tuff. The sonic log shows

increasing velocity toward the base of this subzone, which is also consistent with the signature expected for a densely welded tuff.

The spontaneous potential log mimics the formation resistivity log. However, because there are no clay layers for use in establishing a shale line, or sharp local variations in lithologies, variations in the spontaneous potential curve are difficult to interpret.

A sharp drop in formation resistivity at 740 feet bgs corresponds to the lithologic change from the middle non-lithophysal zone to the underlying middle lithophysal zone containing numerous densely welded cavities. The continuously decreasing resistivities and sonic velocities toward the middle of this zone suggest that the cavities are water-filled and that there is probably some connectivity of cavities through the matrix or fractures. Near the middle of this zone, resistivities and velocities increase, suggesting a decrease in cavities and secondary fracturing.

The basal vitrophyre of the middle lithophysal zone is glassy at the top, showing moderate formation resistivity, decreasing to low resistivity and lower sonic velocity in the moderately welded and nonwelded, devitrified base. The devitrified basal vitrophyre also exhibits lower natural gamma values than the overlying part of the Topopah Spring Tuff.

At approximately 1,170 feet bgs, in the basal vitrophyre, there are sharp deflections in the fluid resistivity log trace and the water temperature log, which suggest a water inflow zone, most likely along a fracture. The borehole televiwer was run in this borehole. The image of the depth interval of 1,160 to 1,165 feet bgs is shown on Figure 6.2-1. A clearly defined, open and steeply dipping fracture is visible near the water inflow zone.

The Pre-Topopah Spring bedded tuffs include reworked ash-flow tuffs and underlying volcanoclastic rocks. The caliper log indicates that the base of the unit from approximately 1,315 to 1,350 feet bgs was washed out during drilling operations, leaving an enlarged hole and resulting in lower natural gamma values.

Prow Pass Tuff

The underlying Prow Pass Tuff ash-flow units are moderately resistive. Slight increases in formation resistivity correlate with an increased degree of welding. The lower ash-flow unit exhibits markedly lower natural gamma values.

Bullfrog Tuff

The Bullfrog Ashflow Tuff shows increased welding with depth. The sonic velocity log shows increasing values with depth and likely reflects an increase in rock density associated with increased welding. Formation resistivity values show a slight increase in the lower portion of the weakly welded zone and the upper portion of the underlying moderately welded zone.

6.2.2 Geophysical Log Signatures and Interpretations for 16P

Geophysical logs and lithologic log data from 16P are displayed on Plate 2.

Rainier Mesa Tuff

The open-hole pre-completion water table occurs within the Rainier Mesa Tuff. A decrease in natural gamma log values is observed at the water table.

The lower part of the Rainier Mesa Tuff from 720 to 876 bgs has a weathered, porous appearance, is nonwelded, and shows very low formation resistivity. This weathered zone has noticeably lower natural gamma values than the overlying ash-fall tuff. Slow sonic velocity values throughout this unit are consistent with its porous appearance.

Deflections of both the fluid resistivity and temperature logs occur over this lower weathered interval and the underlying upper portion of the densely welded Tiva Canyon Tuff between approximately 800 to 1,000 feet bgs. The largest change in slope in these logs occurs at approximately 800 feet bgs, which likely indicates that a significant amount of water enters the borehole at that point.

Tiva Canyon Tuff

The densely-welded Tiva Canyon Tuff displays markedly high formation resistivity values, particularly the basal vitrophyre. There is an excellent degree of correspondence between the formation resistivity log and the degree of welding described in the drill cuttings.

Topopah Spring Tuff

The Topopah Spring Tuff, from 1,080 to 1,810 feet bgs, is weakly to densely welded. Again, there is a correspondence between welding and formation resistivity. The basal vitrophyre, at 1,723 to 1,773 feet bgs, is very resistive, indicating that the unit is essentially non-porous.

Pre-Topopah Spring, Wahmonie Formation, and Prow Pass Tuffs

Pre-Topopah Spring ash-fall tuff, Wahmonie Formation ash-flow tuff, and Prow Pass Tuff are mostly nonwelded ash. Formation resistivity values are characteristically low. None of the other geophysical logs offer any diagnostic rock or aquifer properties for this interval.

Bullfrog Tuff

The unit consist of non to densely welded tuffs. The higher degree of welding recorded in the field from drill cuttings descriptions corresponds well with the higher formation resistivity values.

Within the Bullfrog Tuff, at approximately 2,560 feet bgs, a relatively thin (i.e., 20 feet) densely welded zone exhibits high formation resistivity. Both the fluid resistivity and temperature logs record slight deflections just below this zone. It is interpreted that this densely welded zone is fractured and that there is some water movement in the wellbore because of fracturing. Similarly, at approximately 2,800 feet bgs, a thin, resistive zone occurs with deflections in temperature and fluid resistivity logs, again suggesting water movement between the formation and borehole. This lower zone of water movement may be within the strongly cemented basal sandstone.

Geophysical logs suggest that water production zones in 16P occur at discrete intervals, primarily in the Rainier Mesa and Bullfrog Tuffs. Water production occurs in Rainier Mesa Tuff in a weathered zone and likely in fractures in the Bullfrog Tuff.

6.2.3 Geophysical Log Signatures and Interpretations for 28P

Geophysical logs and lithologic log data from 28P are displayed on Plate 3.

Rainier Mesa and Post-Rainier Mesa Tuffs

The open-hole, pre-completion water table occurs near the base of the Ammonia Tanks Tuff, which overlies the Rainier Mesa Tuff. A decrease in natural gamma log values is observed at the water table.

The Rainier Mesa and Post-Rainier Mesa Tuffs are nonwelded, relatively soft rocks; the caliper log shows that the borehole interval from the water table to the bottom of these tuffs is highly eroded. The enlarged hole conditions likely affected the natural gamma, formation resistivity, and sonic logs through this interval. However, it is difficult to determine the degree to which these logs were impacted by wellbore washout conditions.

Post-Tiva Canyon Tuff

The caliper log indicates that the deeply weathered paleosol that occurs at the top of the Post-Tiva Canyon Tuff is severely washed out. The underlying rock is nonwelded and devitrified, with an open, porous matrix, and exhibits a distinctly lower natural gamma value than the overlying Rainier Mesa Tuff. It is not known why the Rainier Mesa and Post-Tiva Canyon Tuffs, both with open and porous matrices, exhibit moderately high formation resistivity values. Possible reasons include porosity that is not connected to the wellbore and/or the presence of lower total dissolved solids in the water.

Tiva Canyon and Pre-Tiva Canyon Tuffs

The Tiva Canyon Tuff is densely welded and shows high formation resistivity throughout the unit. Natural gamma values from this unit are slightly higher than those observed in the overlying Post-Tiva Canyon Tuff.

The Pre-Tiva Canyon Tuff is a nonwelded ash-fall tuff with a paleosol at the top. The caliper log shows that the paleosol has washed out. As observed in the overlying Post-Tiva Canyon Tuff, the Pre-Tiva Canyon Tuff exhibits moderate formation resistivity values, which are generally uncharacteristic of Phase IV nonwelded tuffs.

Topopah Spring Tuff

The Topopah Spring Tuff is a relatively thin section of moderately to densely welded tuffs. The unit shows relatively low formation resistivity values that are uncharacteristic of most moderately and densely welded tuff units encountered in Phase IV.

Pre-Tram Tuff

The rocks from the base of the Topopah Spring Tuff to total depth, interpreted as Pre-Tram Tuff, consist of ash-flow tuffs and clastic sedimentary rocks that display low formation resistivity values. The clastic sedimentary rocks, including mudstone and sandstone, have very low formation resistivity because they contain clays.

The pronounced spike in the natural gamma log at a depth of approximately 1,395 to 1,400 feet bgs coincides with the lowermost portion of the calcareous mudstone in contact with underlying calcareous sandstone. A geochemical investigation of a similar spike in an earlier EWDP well (i.e., 3D) suggests that the spike was likely related to low-grade uranium mineralization. In this earlier case, it was hypothesized that mineralized fluids migrated upward through the underlying volcanic and volcanoclastic units until the first reactive bed was encountered and chemical

reduction and uranium precipitation occurred. This process may also have occurred in 28P, with the reactive bed in this case the calcareous mudstone unit.

Below approximately 1,350 feet bgs, the fluid temperature log exhibited a marked change in slope, suggesting a change in water movement from and/or to the formation. The change in slope of the fluid resistivity log at the same depth was not nearly as large as that observed in the temperature log.

6.2.4 Geophysical Log Signatures and Interpretations for 24P

Geophysical logs and lithologic log data from 24P are displayed on Plate 4.

Alluvium/Bullfrog Tuff Contact

The open-hole, pre-completion water table occurs at approximately 404 feet bgs near the contact of the alluvium and underlying Bullfrog Tuff. A decrease in natural gamma log values is observed at the water table.

A marked decrease in counts per second in both the near and far neutron logs occurs near this contact, indicating an increase in water-filled porosity. An increase in both formation resistivity and spontaneous potential also occurs near this contact.

Bullfrog and Pre-Bullfrog Tuffs

The Bullfrog Tuff intercepted in the borehole is a relatively nonporous, moderately to densely welded volcanic unit. Washout zones shown in the caliper log at approximately 720 and 775 feet bgs correlate with relatively sharp decreases in natural gamma, density, and neutron log values. Note that decreases in neutron log values equate to increases in water filled porosity. A formation resistivity high characterized by two peaks occurs in the lower densely welded portion of this unit from approximately 740 to 820 feet bgs. Relatively high natural gamma, density, and neutron log values appear to correlate with the two peaks of the resistivity high, suggesting that the resistivity highs correspond with the highest density or lowest porosity (i.e. most densely welded) zone in the Bullfrog Tuff. Each of these logs generally decreases slightly toward the base of the unit, where the degree of welding decreases to moderate.

The optical televiewer log was run in this borehole. In most regions of the borehole it was not useful, due to cloudy water conditions caused by drilling. However, in the lower Bullfrog Tuff, at 790 to 890 feet bgs, dark, planar features, interpreted to be fractures, are visible. Obvious, open fractures are not recognized.

The underlying Pre-Bullfrog Tuff sandstone has been logged as argillized and possibly zeolitized. The unit displays an increase in natural gamma values relative to the overlying basal portion of the Bullfrog Tuff.

Tram and Pre-Tram Tuffs

The Tram Tuff at this location is a weakly to moderately welded unit. An increase in both formation resistivity and neutron log values occurs in the central portion of the tuff and appears to correlate with a slight increase in welding and expected decrease in water filled porosity. The underlying Pre-Tram Tuff volcaniclastic sedimentary rocks are characterized by a decrease in

formation resistivity, natural gamma, density, and neutron log values relative to the overlying tuff.

Lithic Ridge Tuff and Pre-Lithic Ridge Sedimentary Rocks

The Lithic Ridge Tuff is a nonwelded, devitrified, and weathered tuff with a porous matrix. Both formation resistivity and natural gamma logs display a slight increase relative to the overlying volcanoclastic sedimentary rocks. The caliper log indicates a washout near 1,480 feet bgs in a moderately weathered portion of the tuff near the contact between the upper reworked and lower ash-flow tuff units. Natural gamma and neutron log values increase toward the base of the unit and the uppermost portion of the underlying sedimentary units (i.e., claystone, siltstone, and sandstone) before being terminated.

6.2.5 Geophysical Log Signatures and Interpretations for 29P

Geophysical logs and lithologic log data from 29P are displayed on Plate 5.

Tiva Canyon and Pre-Tiva Canyon Tuffs

The open-hole, pre-completion water table occurs within the Tiva Canyon Tuff. A decrease in natural gamma log values is observed at the water table.

The Tiva Canyon Tuff is composed primarily of slightly weathered, densely welded ash-flow tuff. The contact with the overlying alluvium corresponds to an increase on the Century natural gamma log. An increase in the density log values corresponds with an increase in cementation observed in the alluvium near the bedrock contact. Natural gamma and neutron log values decrease sharply at the water table. Finally, natural gamma log values decrease significantly in the lower portion of the Tiva Canyon Tuff.

The Pre-Tiva Canyon Tuff is a nonwelded, devitrified ash-fall tuff. Lower density, neutron, and formation resistivity log values relative to the overlying Tiva Canyon Tuff suggest that this unit has increased water filled porosity. This unit also exhibits lower values on the natural gamma log.

Topopah Spring and Pre-Topopah Spring Tuffs

The Topopah Spring Tuff consists of five subzones, with welding varying from moderate to dense. Natural gamma, density, and neutron log values throughout the unit appear to be relatively constant, with the exception of the uppermost weakly to moderately welded subzone.

The upper subzone is described as having an open, porous matrix, with an increase in welding with depth. Gradual increases indicated by the natural gamma, density, and neutron logs through this unit indicate the transition into the next subzone (i.e., the upper vitrophyre).

The upper vitrophyre subzone exhibits high sonic velocity, increased density and decreased porosity, and elevated formation resistivity log values. These trends reflect the densely welded, glassy character of this subzone. The interval near the middle of the subzone, with a low sonic velocity, may be due to a washout, which is shown on the caliper log.

In the upper vitrophyre zone, the optical televiewer shows zones of numerous fractures and breccia. The fractures are interpreted to be filled with a light-colored mineral against the black rock matrix (Figure 6.2-2).

The middle non-lithophysal subzone is also generally densely welded, except for the moderately welded top of the subzone. This subzone exhibits higher resistivity values than the overlying densely-welded upper vitrophyre, possibly due to less fracturing. Density and neutron log values remain high and similar to the overlying vitrophyre subzone.

In the optical televiewer analysis, a steeply dipping open fracture was noted between 518 and 522 feet bgs in the middle non-lithophysal zone (Figure 6.2-3).

Borehole erosion shown in the caliper log near the bottom of this subzone appears to have affected the density, neutron, and natural gamma log values. Problems also occurred with the formation resistivity tool; details can be viewed at the QARC.

Additional significant borehole washout intervals in the lower non-lithophysal subzone also likely created artifacts in the density, neutron, and natural gamma logs.

Volcaniclastic Sandstone

Because of borehole stability problems, drilling was terminated in the volcaniclastic sandstone and logging with geophysical tools was not possible.

6.2.6 Geophysical Log Signatures and Interpretations for 19PB

Geophysical logs and lithologic log data from the lower approximately 20 feet of the unsaturated zone and the upper approximately 260 feet of the saturated zone of 19PB are displayed on Plate 6. This borehole penetrated only alluvium. The major portion of the unsaturated zone of this borehole was not sampled or logged and will not be discussed herein.

As in other boreholes, natural gamma log values decrease in the vicinity of the water table. Far neutron logs show decreasing values at the water table, indicating increasing water filled porosity. Decreases in density log values near the water table may indicate that hole erosion is a problem in the vicinity of the water table. The reason for the spike in the near neutron log at the water table is unknown and is likely an artifact.

In the remainder of the borehole, near neutron and density logs generally show increases with depth, indicating increased formation density and decreased water filled porosity. These trends are consistent with increased overburden pressure with depth.

Increases shown on the natural gamma log correspond directly to decreases in the number of steel casings down which the natural gamma tool was run. For example, approximately two telescoping steel casings were present from 350 to 470 feet bgs, one casing from 470 to 620 feet bgs, and none below 620 feet bgs.

An slight change in slope of the temperature near 615 feet bgs likely reflects the influx of formation water into the drill string from the open-hole interval from 620 feet bgs to the bottom of the corehole.

Formation bulk density values were measured in sonic core recovered from 19PB, as described previously. Dry bulk density values were measured for sonic core repacked at both air-dried and optimum water contents, sonic core runs, and drive core. These calculated dry bulk density values are compared with downhole wireline compensated density geophysical log values on Figure 6.2-4. Note that the density tool was not calibrated to the specific hole conditions in 19PB.

Calculated and measured dry bulk density values compare reasonably well with the geophysical log data, except for some notable discrepancies. In general, much more variability exists in the trends of density from the geophysical log than from the laboratory samples. The geophysical log also shows a number of unrealistically low and high values. From the depth of 360 to approximately 410 feet bgs, there is reasonable correlation between the various methods, although there is considerable variability in the density values measured by the geophysical log. The unrealistically low log values in this interval may in part be due to borehole wall erosion resulting from coring gravelly layers present in the upper portion of the borehole. The unrealistically high values may be related to the effects of logging through two steel casings, as well as logging cobbles present on the formation wall.

From 410 to approximately 459 feet bgs, the log measured higher density values than did the laboratory. It is possible that the log is responding to actual higher density values (i.e., those of cobbles) coupled with the fact that it was run through two steel casings between the depths of 360 and 470 feet bgs. Below 470 feet bgs, there is a general correlation in trend of laboratory data with the geophysical log; however, in general, the laboratory data tends to show somewhat lower values than those of the log.

6.3 Geologic Cross Sections

Three geologic cross sections were constructed using 1) summary lithologic logs from Phase IV drilling data, 2) data from previous EWDP drilling phases, and 3) published geologic information. The locations of the three cross sections are shown on Figure 1.3-2.

Geologic Cross Section A-A' is drawn through the Flat Tire Flat area and includes 27P, 16P, and 28P (Figure 6.3-1). This cross section is based on relatively close-spaced boreholes and detailed stratigraphic identifications.

Cross Sections B-B' and C-C' are presented on Figures 6.3-2 and 6.3-3. While all cross sections are interpretive in the projection of geologic features and correlations at depth, these cross sections, drawn at a larger scale in order to project to greater depths, are considered more interpretive, or conceptual, than Geologic Cross Section A-A' and are referred to herein as conceptual cross sections.

Conceptual Cross Section B-B' is drawn from 27P on the west side to 22S on the east side. Conceptual Cross Section C-C' is drawn from 24P on the north side to 2DB on the south. The two cross sections intersect at 24P.

The cross sections include data from boreholes drilled in EWDP Phases II and III. Lithologic logs from Phase III boreholes 2DB and 22SA are presented in NWRPO (2003). Geologic data projected in the cross section for 19D is a composite of data from two closely spaced boreholes

drilled from the same pad at Site 19 but to different depths. These two boreholes are 19IM2A, whose summary lithologic log is included in NWRPO (2003), and 19D, with a less detailed lithology report that can be viewed on the NWRPO website (NWRPO, 2005a). 19IM2A was not as deep as 19D; data from 19D has been used only to extend lithologic data and interpretations below the total depth of 19IM2A.

Geologic interpretations of basins and fault structures in the cross sections were aided by a gravity-based interpretation of the thickness of Cenozoic deposits (Figure 1.3-3) and interpretations of aeromagnetic survey data (Figure 1.3-4).

Neither geologic nor conceptual cross sections identify textural groups within the alluvium. Stratigraphic units are identified by formal group name and, if practical, divided into tuff members. Contacts between groups are shown with darker lines to emphasize large-scale trends.

6.3.1 Cross Section A-A'

Geologic Cross Section A-A' is constructed in two panels with a bend at 16P (Figure 6.3-1). The alluvial units are generalized at the scale of the cross section and labeled as Quaternary alluvium. Volcanic units are divided into the major tuff units described in the summary lithologic logs.

The water table occurs primarily within the Timber Mountain tuffs in this cross section and shows a very gentle slope.

The stratigraphy in these three closely-spaced boreholes (i.e., 27P, 16P, and 28P) shows remarkable differences. Because of these differences, other geological and geophysical data are used to infer structures between the boreholes.

Two faults are shown. The fault to the southeast, between 16P and 28P, represents a buried growth, or syn-volcanic, fault. Borehole evidence indicates that the fault was active until buried by the Topopah Springs Tuff. On the footwall of this fault, Pre-Crater Flat units are uplifted, possibly rotated and eroded, and form a paleotopographic high. The gravity and magnetic signatures of this feature (Figures 1.3-3 and 1.3-4) are consistent with a northeast-striking normal fault with a throw of approximately 1,640 feet. The fault to the northwest is a younger fault in comparison, offsetting all the volcanic units. This normal fault preserves the Ammonia Tanks Tuff in the hanging wall and exposes Rainier Mesa Tuff in the footwall.

6.3.2 Conceptual Cross Section B-B'

Conceptual Cross Section B-B' is a west-east cross section (Figure 6.3-2). To help with interpretation, nearby boreholes are projected into the plane of the cross section.

The alluvial units are lumped together and labeled as Quaternary/Tertiary alluvium. The volcanic units are divided by group name; individual tuff units are not shown at this scale. A darker and wider line of color, similar to that of the individual volcanic group, represents the approximate interpreted top of that group. The top of the Paleozoic-aged rocks is based on the thickness of Cenozoic deposits (Figure 1.3-3).

The water table measured in wells is also drawn on this cross section. At this scale, the water table is fairly flat across several fault blocks and rock units.

The interpretation of the Paleozoic surface is based mostly on gravity data shown on Figure 1.3-3. The most prominent feature in this cross section is the structure high of Paleozoic-age units underlying the high fault block between 28P and 24P. This high block is expressed at the surface by a ridge of outcropping Paintbrush Group.

The west side of the section shows a graben-like feature of upper Tertiary volcanic units having been dropped down into the structure that defines Flat Tire Flat basin. This graben, which preserves Timber Mountain Group volcanic rocks, is expressed only in the younger Tertiary rocks. Gravity data suggests that the Paleozoic and older rocks are deep under the west end of the section toward eastern Crater Flat. If these rocks are very deep and the Paintbrush and Crater Flat Group volcanic units are at the surface or very shallow, the Pre-Crater Flat Group units must thicken toward Crater Flat basin.

On the east side of Conceptual Cross Section B-B', all units dip into Jackass Flat basin. The dip slope is broken by several normal faults, the largest of which is the Paintbrush Canyon Fault.

6.3.3 Conceptual Cross Section C-C'

Conceptual Cross Section C-C' projects from south of U.S. Highway 95 to a location north of 24P (Figure 6.3-3). The water table crosses several units in this cross section due to structural relief. In 24P, the water table occurs at the alluvium/Crater Flat Group contact, in 29P it occurs in the Paintbrush Group tuffs, and in 19D1 and 2DB it occurs in the alluvium.

The interpretation of the Paleozoic surface is based mostly on gravity data shown on Figure 1.3-3. Prominent features include a fault-bounded basin north of Phase II borehole 19D1, with structural highs to the south, beneath 2DB, and to the north beneath 24P. Immediately north of 19D1 is a conceptualization of the Highway 95 Fault.

Between 2DB and 19D1, the southern edge of the basin is interpreted to step down to the north along growth faults active during deposition of the Crater Flat and Paintbrush Groups. An unidentified ash-flow tuff occurs in 19D1 but not 2DB, shown as a hatched pattern on Figure 6.3-3. Positive identification of this tuff is problematic, as it is unusually yellow and does not resemble typical Paintbrush Group tuff. Whether this tuff is Paintbrush Group or possibly some younger tuff, the basin edge is thought to be the southern extent of the Paintbrush Group or an equivalent ash-flow tuff. The Paintbrush Group is exposed in outcrop between 29P and the northern end of the cross section. It has been eroded off the structural high penetrated by 24P.

An eastern splay of the Paintbrush Canyon Fault is intersected obliquely by this cross section north of 24P. It therefore has an apparent low dip angle. Along the fault, the Paintbrush Group is juxtaposed against the Crater Flat Group.

6.3.4 Cross Section Interpretation

Cross Section A-A' defines an important relationship in the evolution of the Crater Flat basin. Previous workers speculated that the thickening of Cenozoic deposits across the gravity gradient

illustrated on this cross section was a result of thickening of deposits of T_{vo} and T_s (Potter et al., 2002). Drilling data illustrated on this cross section suggest that the thickening likely involves rocks as young as Crater Flat and Paintbrush Groups. Due to the uncertainty of the age of the units penetrated on the footwall block, the apparent throw of approximately 1,640 feet may be greater if the footwall block is deeply eroded. No well-defined stratigraphy or chronostratigraphy has been defined for the older rocks (i.e., T_{vo} and T_s), which limits the interpretative value of an intercept of older rocks in 16P and other EWDP boreholes.

Work by Murray and others (2003) in mapping the older sequences in the region provides a stratigraphic framework for the older rocks, but more detailed definition will be required to interpret stratigraphic location within the sequence. The scale of the total thickness of these older rocks can be misleading. Three boreholes in the Yucca Mountain region have been drilled through the section (i.e., Felderhoff Federal 25-1, UE 25p#1 and 2DB), all at locations chosen because of a lack of thick section of these deposits. In the thickest section of the basins, such as in Crater Flat, shown on Conceptual Cross Section B-B' (Figure 6.3-2), these deposits may be more than several miles thick. The Crater Flat basin may be better described as a Late Oligocene and Early Miocene sedimentary basin capped by middle Miocene volcanic deposits.

This stratigraphic uncertainty becomes more acute where sections of the more familiar volcanic section are missing, or where the volcanic rocks interface with the older sequence along fault boundaries such as the Highway 95 area. For example, in 2DB, the volcanic stratigraphy consists of a single thin tuff unit identified as Tram Tuff by YMP workers. This thin tuff unit is overlain by a short sequence of fine-grained sedimentary and volcanoclastic units, possibly representing eruptive events to the north. The Tram Tuff in 2DB is underlain by a thick sequence of fine-grained sedimentary units without defined marker beds or detailed stratigraphy. It is therefore very difficult to understand the exact stratigraphic position of an isolated borehole or borehole intersection.

Moreover, stratigraphic correlations of similarly textured T_s can be made only at a very large scale with much uncertainty.

7.0 FINDINGS AND RECOMMENDATIONS

7.1 Findings

This section summarizes major findings from Phase IV drilling, logging, and testing of geologic deposits in Flat Tire Flat and along the western margin of lower Fortymile Wash.

7.1.1 Drilling, Coring, and Well Construction

AR-RC drilling methods used in Phase IV RC boreholes proved to be relatively rapid and inexpensive, produced drill cuttings from both above and below the water table that were reasonably representative of in situ formation rock, minimized the disturbance of the formation rock and groundwater chemistry, and produced boreholes suitable for completing piezometer screens across the water table.

Borehole conditioning methods using small amounts of bentonite-based drilling mud in RC boreholes drilled with AR-RC methods successfully stabilized borehole walls both above and below the water table. The only exception was 29P, where these methods, as well as the use of cement grout, failed to prevent caving of the borehole below approximately 700 feet bgs and prevented advancing the borehole below approximately 790 feet bgs.

APH-RC drilling methods, used in selected 20-foot intervals of unsaturated alluvium in 24P and 29P, proved to be problematic due to bit plugging, plugging of the cuttings return crossover to the dual-wall drill pipe, and caving of loose, unsaturated sediments. Caving occurred because it was not possible to condition the borehole by pumping bentonite mud through the air percussion hammer assembly to the bit.

It was demonstrated that it is feasible to obtain minimally disturbed drive core samples from unsaturated alluvium in uncased RC boreholes 24P and 29P; however, the coring process was time consuming and the core barrel, in nearly all cases, contained some fill in addition to in situ formation material.

Sonic coring in 19PB was an unqualified success and produced nearly continuous core from the upper approximately 260 feet of saturated alluvium suitable for logging (e.g., geologic, digital photographic, and video logs) and laboratory testing of parameters independent of porosity, as well as coring-related data to permit calculation of in situ dry bulk density values and porosity values.

The sonic coring process resulted in some disturbance of the core samples from in situ conditions, including the following:

- Core expansion, resulting in higher core porosity and lower density values, although textural layers remained intact.
- Some migration of silt and clay from the interior of the core to the outside surface of the core; however, there was no evidence of migration of fines along the length of the core.

- Some migration of water from core in the lower region of the core barrel to core in the upper region, due to heat produced primarily at the core bit.

Borehole drilling and well installation resulted in the emplacement of piezometer screens, sandpacks, and grout seals at or near target depths for all boreholes except 19PB, where caving precluded placement of the upper piezometer at target depths. The development of piezometer screens, primarily by low-flow-rate pumping of at least several hundred gallons of water, removed most suspended sediment from the produced water. Aggressive development of the lower piezometer in 19PB, using swabbing and air-lifting, caused the collapse of this screen. This well will be redrilled and recompleted as part of Phase V.

7.1.2 Geologic Logging

Geologic logs indicate that alluvium penetrated during Phase IV was composed solely of volcanic rocks; non-alluvium was composed primarily of volcanic rocks or sediment derived from these rocks. Field logging estimates of the PSD of sand and fines fractions of both drill cuttings and core differ significantly from laboratory measurements and were not used in quantitative analyses.

Alluvial Drill Cuttings

The observed water contents of unsaturated zone alluvial drill cuttings from RC boreholes were significantly decreased by the drilling process. Drill cuttings collected below the water table show evidence of drying for distances ranging from 5 to 50 feet into the saturated zone.

Little or no cementation was observed in unsaturated zone alluvial drill cuttings from boreholes in Flat Tire Flat; however, more intervals of weak and moderate cementation were noted in similar samples from boreholes in Fortymile Wash. The fact that little or no strong cementation was observed in unsaturated alluvial drill cuttings from all RC boreholes suggests that little soil development is present in unsaturated alluvium in both Flat Tire Flat and western lower Fortymile Wash.

HCl reaction on drill cuttings shows no apparent trend with depth, nor does there appear to be a correlation between HCl reaction and observed cementation in alluvium. This lack of correlation indicates that calcium carbonate does not play a major role in the observed cementation in the alluvium penetrated in RC boreholes, and cementing agents other than calcium carbonate likely exist in the alluvium.

The highest drilling rates (i.e., 1 foot per minute or greater) were recorded in alluvium, clastic sedimentary rocks (e.g., siltstone or claystone), volcanoclastic sedimentary rocks, and nonwelded intervals in volcanic tuffs. The lowest drilling rates (i.e., less than 1 foot per minute) were recorded in the welded portions of most tuff units. The inverse relationship between drilling rate and degree of welding in tuffs is most clearly illustrated in 27P and 29P.

Typically, water production increased with depth, especially in zones of moderately or densely welded tuff that are presumably highly fractured. Moreover, nonwelded tuff generally appeared to slow water production to a nearly constant rate as it was penetrated. The use of bentonite mud

containing polymer to condition and stabilize the walls of several of the RC boreholes below the water table likely reduced water production rates in the conditioned intervals.

Alluvial Drive Core

In 19PB, 24P, and 29P, drive core drying occurred in the downhole end of core barrels, due to heat generated at the core bit.

A significant amount of disturbed fill material was observed in nearly every APH-DC and S-DC core run, due to the caving or sloughing in uncased RC boreholes and the difficulty in cleaning out slough from the bottom of both RC boreholes and the cased sonic corehole.

Continuous Sonic Core

As with drive core, drying of 19PB sonic core often occurred in the downhole end of core barrels due to heat generated at the core bit.

Numerous weakly cemented zones were observed in the upper approximately 260 feet of the saturated zone in 19PB. These zones were not observed in alluvial drill cuttings collected in Phase III boreholes drilled at the same location. The differences are due to the difficulty of detecting cementation in drill cuttings samples significantly disturbed by drilling. No evidence of strong cementation was observed in sonic core samples from saturated alluvium in 19PB.

The colors of sonic core from the upper approximately 260 feet of saturated alluvium indicated oxidizing conditions throughout this depth interval.

7.1.3 Dry Bulk Density Tests on Core Runs

Field measurements were made to determine the mass and volume of each core run for both drive and sonic core. These measurements, together with laboratory measurements of GWC, were used to determine the dry bulk density of each core run.

On the average, dry bulk density values calculated for drive-core runs in 24P (e.g., 1.92 g/cm³) and 29P (e.g., 1.97 g/cm³) are slightly greater than for those in 19PB (e.g., 1.81 g/cm³), which may be due to the method of advancing the core barrel and/or the fact that core runs in 24P and 29P were in unsaturated alluvium and those in 19PB in saturated alluvium.

The average 19PB dry bulk density values calculated for 5 drive core runs agrees closely with the average dry bulk density values calculated for 22 sonic core runs (i.e., both 1.81 g/cm³). This agreement may be coincidental, since there are numerous sources of error in both types of measurements.

7.1.4 Laboratory Tests on Core

In general, core samples are considered to exhibit flow- and transport-related properties more representative of in situ conditions than those of drill cuttings.

Drive Core Samples from 19PB, 24P, and 29P

PSD data from a limited number of drive core segments indicate that alluvial sediments consist of coarse-grained sands and gravels, with fines ranging from approximately 5 to 25 percent by

weight. Significant differences in PSD data were obtained from drive core samples collected from the same core run, especially in 19PB, which shows that on the relatively small scale of a drive core run, fluvial sedimentary processes create, in some cases, a highly layered flow system with contrasting properties.

Average dry bulk density values of 6-inch-long by 3.9-inch-diameter drive core samples for 24P (e.g., 1.94 g/cm³) and 29P (e.g., 1.96 g/cm³) are similar to average density values calculated for entire core barrels. The average dry bulk density values for drive core samples from 19PB (e.g., 1.89 g/cm³) are significantly higher than the average dry bulk density values determined for entire core runs for both drive and sonic core (e.g., approximately 1.81 g/cm³). It is believed that the higher average value is more representative of in situ conditions.

Evidence was found for a linear correlation between the natural logarithm of Ksat and percentage of fines in drive core samples from 24P. Similar trends of decreasing Ksat with increasing fines percentages have been found in numerous other studies for a variety of sediments (Todd, 1980). The smaller sample population size for drive core samples from 29P and 19PB may in part be responsible for this lack of linear correlation in samples from these boreholes. The arithmetic and geometric mean values of Ksat differ in 24P, suggesting that these values are log-normally distributed.

Sonic Core Samples from 19PB

Results from wet sieve PSD data from sonic grab core samples include the following:

- All samples are coarse-grained and, on the average, contain approximately 14 percent fines, 46 percent sand, and 40 percent gravel. The USCS group name for the average PSD composition is a silty or clayey sand with gravel.
- Both hydrometer PSD and Atterberg limits data indicate that clay predominates slightly over silt in the fines fraction for most sonic core samples tested.

EC data from the lower part of the unsaturated zone immediately above the present water table shows several EC spikes and valleys. It is possible that paleo-water tables may be in part responsible for these variations in EC values.

Repacking of 15 representative sonic core segments in 12-inch-long by 6-inch-diameter PVC tubes at air-dried water contents produced core samples with an average dry bulk density value of 1.72 g/cm³ and an average porosity value of 0.33 cm³/cm³. Repacking 7 of the original 15 representative sonic core segments at optimum water contents produced core samples with an average dry bulk density value of 1.90 g/cm³ and an average porosity value of 0.25 cm³/cm³. Drive core and geophysical logging data indicate that an average dry bulk density value of 1.90 g/cm³ and an average porosity value of 0.25 cm³/cm³ are more representative of in situ conditions than values of 1.72 g/cm³ and 0.33 cm³/cm³, respectively.

Linear correlations between the natural logarithm of Ksat and percentage of fines were found for sonic core segments repacked at air-dried and optimum water contents. As expected, the geometric and arithmetic mean Ksat values for sonic core samples repacked at optimum water contents are significantly lower than those of the same core material repacked at air-dried water contents. Also as expected, mean Ksat values for sonic core samples repacked at optimum water

contents were significantly higher than those for drive core samples. Numerous workers have found that, on the average, the smaller the volume of the sample being tested, the lower the resulting Ksat value. Presumably, smaller samples are expected to contain fewer porosity-related heterogeneities and preferential flowpaths.

7.1.5 Laboratory Tests on Drill Cuttings

Results from wet sieve and hydrometer PSD tests for alluvial drill cuttings from RC boreholes include the following:

- PSD depth profiles are similar for Flat Tire Flat boreholes (i.e., 16P, 27P, and 28P), which differ significantly from those of Fortymile Wash (i.e., 24P and 29P).
- The average fines fraction in Flat Tire Flat boreholes equals or exceeds 20 percent compared to 14 percent or less in Fortymile Wash; gravel content is generally greater in Fortymile Wash boreholes.
- Summary statistics for 24P and 29P PSD data are similar to those of previously drilled Fortymile Wash boreholes.
- The significant differences in PSD between Flat Tire Flat and Fortymile Wash may be due to differences in source rock and/or drainage basin size.
- A comparison of PSD depth profile data for drill cuttings and drive core from 24P and 29P indicates good agreement in fines content and less agreement in sand and gravel, especially for 29P.
- Significantly more gravel is found in drive core than in drill cuttings from 29P, suggesting that grinding during drilling may reduce large gravel-sized particles into smaller sand-sized ones, which is consistent with findings from Phase III boreholes.
- In general, unsaturated alluvial drill cuttings from Phase III and IV RC boreholes yield PSD roughly approximate to those from drive core, and therefore roughly approximate to in situ conditions. In contrast, data from Phase III boreholes demonstrated that AR-RC drilling significantly disturbs the PSD of drill cuttings from saturated alluvium and that these cuttings are representative of neither drive core nor in situ conditions.

EC tests on a one-to-one by weight ratio of water to drill cuttings extracts show the following :

- EC depth profiles for all RC boreholes show peaks in EC values in the upper 15 feet of each borehole, indicating salt accumulation in the near surface. However, at depths below the near-surface peaks, the EC profiles differ noticeably between Fortymile Wash and Flat Tire Flat boreholes. The reason for these differences in EC profiles may be in part due to differences in source rock and the size of the drainage basins.
- EC depth profiles for Phase IV borehole 29P and Phase III borehole 19IM2A (NWRPO, 2003) are very dissimilar, even though the boreholes are only approximately one mile apart. Recent retesting of archived samples from 19IM2A could not duplicate sharp EC peaks shown for this borehole in NWRPO (2003). Additional testing is in progress to identify the scope of problems with EC data

presented for Phase III boreholes. When this work is complete, inaccurate and non-reproducible EC data will be censored and replaced.

GWC tests on drill cuttings show the following trends:

- Water contents of drill cuttings are much lower than those of drive core samples taken from adjacent depths.
- Assuming that drive core samples exhibit water contents that approximate in situ conditions, these data show that AR-RC drilling significantly dries the drill cuttings from in situ conditions.
- Drill cuttings water content profiles are, however, useful in identifying relative differences between RC boreholes and depth intervals where excess drilling fluids were used to condition the borehole.

7.1.6 Field Saturated Hydraulic Conductivity Tests at Site 19

Constant head injection tests conducted in 19PB produced Ksat values more than 10 times lower for the shallow piezometer screen than for the deep one. This difference was not expected and may be related to the preferential accumulation of fines or smearing of fines on borehole walls of the shallow piezometer by a yet-to-be-defined mechanism. An attempt to remove fines from the corehole walls in the vicinity of the piezometer screens by aggressively swabbing and air lifting damaged the blank casing of the deep piezometer in the vicinity of the upper piezometer screen and created direct hydraulic communication between piezometers. Both piezometers will be replaced as part of Phase V activities.

Comparing average Ksat values from constant head tests in 19PB with values from both smaller scale laboratory tests on core samples and a larger scale constant-rate 48-hour pump test in an immediately adjacent borehole suggests a direct relationship between measurement scale and Ksat value. However, the differences between drive core and field Ksat measurements are likely in part due to the orientation of the measurement (i.e., vertical versus horizontal) rather than due simply to scale.

7.1.7 Summary Lithology Logs

Borehole 27P

Overall, 27P stratigraphy is similar to that of other, older boreholes south of Yucca Mountain, including WT-11 and -12. The thickness and welding features of the Topopah Spring and Prow Pass Tuffs indicate that deposition of these units was unrestricted and comparable in thickness to the geologic section within the main block of Yucca Mountain. The 150-foot thickness of the Tiva Canyon Tuff, the uppermost welded unit encountered in the hole, indicates some thinning of this unit compared to the main block of Yucca Mountain, where the thickness is up to 500 feet. The water table occurs within the upper lithophysal zone of the Topopah Spring Tuff.

Borehole 16P

16P penetrated the Miocene volcanic section from the bottom of the Ammonia Tanks Tuff through the top of the Tram Tuff. Every major tuff interval is represented. The thickness of major pyroclastic flow deposits is consistent with like units within the main block of Yucca

Mountain. The water table occurs within the Rainier Mesa Tuff. The thickness of the volcanic aquifer, although not fully penetrated, likely approaches 2,500 to 3,000 feet from the top of the water table to the top of the Pre-Tram sedimentary rocks.

Borehole 28P

28P penetrated the upper portion of the Miocene volcanic section from the Ammonia Tanks through the Topopah Spring Tuffs. The thickness of Paintbrush Group members is greatly diminished, indicating some restriction in the basin. Below the Topopah Spring Tuff, at 1,145 feet bgs, the stratigraphy is much different from that of 16P. A series of weathered, nonwelded tuffs interlayered with lacustrine sedimentary rocks are encountered that are likely similar to sedimentary rock units found in deeper sections of Phase I and II boreholes 1DX, 3D, 2DB and 19D. Crater Flat Group tuff members are missing (i.e., an unconformity exists). The water table occurs near the base of the Ammonia Tanks Tuff. The approximately 1,000 foot thickness of the volcanic aquifer in 28P is greatly diminished in comparison to 16P to the north.

Borehole 24P

The first bedrock unit encountered by 24P is Bullfrog Tuff of the Crater Flat Group at approximately 400 feet bgs. The younger volcanic units are either eroded away or not deposited at this location. The water table occurs near the contact of the alluvium and underlying Bullfrog Tuff. Below the Crater Flat Group units, the borehole penetrated Pre-Lithic Ridge sedimentary rocks (i.e., claystone, siltstone, and sandstone).

Borehole 29P

29P penetrated a relatively thin section of Paintbrush Group from the base of the Tiva Canyon Tuff, approximately 360 feet bgs, through a relatively thin section of Topopah Spring and Pre-Topopah Spring Tuffs, before termination at 790 feet bgs due to flowing sands. The thinness of the Topopah Spring Tuff, elsewhere up to 1,000 feet thick, is a marked difference from that of Yucca Mountain. The water table occurs within the Tiva Canyon Tuff.

Corehole 19PB

19PB penetrated the upper 260 feet of the saturated alluvial aquifer. USCS group symbols are used to show the following trends in textural layering:

- The upper 130 feet (i.e., approximately 370 to 500 feet bgs) of the saturated zone portion of the aquifer are composed primarily of numerous relatively thin alternating intervals of gravels with clay and clayey gravels. Below 500 feet, relatively thick intervals of clayey sands predominate, and are divided primarily by thinner intervals of clayey gravels. This division into two major USCS groups suggests that the upper saturated zone in 19PB could be divided into two hydrogeologic units, which could be useful in flow and transport modeling. However, this division may be an oversimplification, and modeling approaches that do a better job of capturing the variability in flow related parameters may be more suitable.
- The upper interval consists mainly of textural layers with less than 12 percent fines and the lower consists mainly of 12 percent or more fines. Layers that occur in these two intervals would be expected to exhibit very different average Ksat values based on laboratory tests conducted on small-scale core samples repacked from these

intervals. For example, a layer with 10 percent fines would be expected to exhibit a significantly higher Ksat value than a layer containing 14 percent fines.

7.1.8 Borehole Geophysical Logging

Borehole geophysical logs were used for lithologic characterization and stratigraphic correlations. For the most part, only qualitative interpretations of rock properties were made from the logs. Significant findings include the following.

- In Tertiary volcanic units, formation resistivity logs are useful for identifying the degree of welding within ash-flow tuffs, and therefore useful for stratigraphic correlation. Higher resistivity values correlate well with welded rocks identified in the geological cuttings described at the site and low resistivity values correlate with nonwelded rocks.
- In some boreholes, fluid resistivity and fluid temperature logs could be used to identify discrete intervals where groundwater flows into the wellbore.
- Optical televiewer logs, though not always of usable quality, show that, in some places, these discrete flow zones are open fractures. Discrete inflow zones were identified in 16P and 27P.

7.1.9 Gravity and Magnetic Features

Previous surface-based gravity and aeromagnetic studies identified the following linear features that were helpful in locating boreholes and interpreting drilling results:

- A large east-west-trending magnetic gradient coincides roughly with the path of Stagecoach Road as it passes from Fortymile Wash, across Flat Tire Flat, and into Crater Flat. Borehole 27P was drilled on the south side of this feature and future plans include drilling borehole 26P on the north side of this feature.
- A large gravity gradient trends northeast from west of the Lathrop Wells Cone to south of Busted Butte on the western boundary of the NTS and runs between 27P and 16P. This gravity feature played a role in locating 28P, 16P, and 27P.
- A northeast-trending magnetic feature between 28P and 16P helped to locate these boreholes. Drilling data indicate that this feature likely results from a buried fault.

These linear geophysical gradients, whether they represent a fault or some other type of steep contact between the basin fill and Paleozoic rocks, could have significant control on groundwater flowpaths in this area south of Yucca Mountain.

7.1.10 Geologic Interpretations from Drilling and Geophysical Data

Three cross sections were constructed to help interpret the stratigraphy penetrated by Phase IV boreholes. The cross sections were based on drilling data and geophysical information. The cross sections differ significantly from recent USGS map interpretations.

Cenozoic deposits thicken across an interpreted fault between 16P and 28P. Displacement on the fault likely involves rocks as young as those of the Crater Flat and Paintbrush Groups, but

probably older than Tiva Canyon Tuff. The age of the interpreted faulting between 16P and 28P is pre-Basin and Range. The stratigraphic offset across the fault is, conservatively, approximately 1,500 feet. The maximum extent of the offset may be larger; however, the stratigraphy and/or ages of the older rocks penetrated in the footwall block have not been determined.

24P, 28P and 29P are located on a structurally high block where Paleozoic rocks are relatively shallow. Pre-Crater Flat Group stratigraphic units are interpreted to thicken markedly into the Crater Flat structural basin under 27P. The water table transitions from Tertiary volcanic rocks to the north, in 29P, to alluvium to the south, in 19PB.

The Highway 95 Fault is interpreted to mark the southern depositional boundary of the Tertiary volcanic aquifers as characterized within Yucca Mountain. Juxtaposition of volcanic aquifers north of the fault against less permeable Ts on the south side of the fault probably forces southward groundwater flow up into the alluvial aquifer system in lower Fortymile Wash and into Amargosa Valley. In Phase II borehole 19D1, rocks identified as possibly Paintbrush Group or equivalent have yet to be identified.

7.2 Recommendations

The recommendations in this section focus primarily on future drilling, sampling, and well construction activities.

1. It is recommended that APH-RC methods not be used to drill unconsolidated sediments in future small-diameter exploratory RC boreholes, as problems with plugging of various airways and hole conditioning will likely be encountered.
2. Collecting drive core from unsaturated alluvium in uncased RC boreholes is not recommended. It is very difficult, if not impossible, to completely remove fill material from the borehole before coring, which results in collecting a significant amount of fill together with in situ formation material in the core barrel.
3. It is recommended that the realistic Phase IV sonic core density data be used to help assign accurate depths to future sonic core that has expanded during coring.
4. To avoid preferentially sampling the fines-rich outer surface or the fines-poor center of sonic core when collecting the grab samples in the field, it is recommended to split the core horizontally in half or collect pie-shaped samples with their apex terminating in the center of the core.
5. To minimize the effects of caving during well-completion activities in sonic coreholes, it is recommended that the drill casing be pulled back and completion material emplaced in short intervals (i.e., 20 to 40 feet), rather than longer ones.
6. To facilitate more aggressive development of small-diameter piezometer strings, the use of stainless steel blank casing and screen rather than PVC is recommended.
7. It is recommended that another exploratory borehole be drilled at the location of 29P, using casing-advance methods to penetrate and seal off flowing sands between approximately 700 and 790 feet bgs. Penetrating and characterizing the stratigraphy beneath the Paintbrush Group will help assess the structural orientation and possible erosional level of the footwall block in the area of 29P and 24P.

8. It is recommended that the optical televiewer or another borehole imaging tool be included in conjunction with temperature and fluid resistivity logs to help identify fracture flow zones.
9. Modeling approaches that capture the variability of Ksat and PSD parameters in the highly layered alluvial sediments described in this study should be considered in addition to approaches that rely on average parameter values for thick intervals.
10. Finally, it is recommended that additional drilling and coring investigations be conducted in Fortymile Wash alluvium in conjunction with crosshole tracer tests to better characterize the continuity or extent of coarse-grained textural layers with high Ksat values that could potentially act as preferential pathways for water and solutes.

8.0 REFERENCES

- API (American Petroleum Institute). 1997. *Recommended Practice 31A, Standard Form for Hardcopy Presentation of Downhole Well Log Data*, First Edition, American Petroleum Institute. Readily available.
- ASTM (American Society for Testing and Materials). 1993. *ASTM D-2488-93. Standard Practice for the Description and Identification of Soils (Visual Manual Procedure)*. Philadelphia, Pennsylvania: American Society for Testing and Materials. Readily available.
- ASTM (American Society for Testing and Materials). 1995. *ASTM D-5753-95. Standard Guide for Planning and Conducting Borehole Geophysical Logging*. Philadelphia, Pennsylvania: American Society for Testing and Materials. Withdrawn.
- ASTM (American Society for Testing and Materials). 2000a. *ASTM D-2487, Practice for Classification of Soils for Engineering Purposes (Unified Soil Classification System)*. Philadelphia, Pennsylvania: American Society for Testing and Materials. Readily available.
- ASTM (American Society for Testing and Materials). 2000b. *ASTM D-1557, Standard Test Methods for Calibration of Laboratory Mechanical-Rammer Soil Compactors*. Philadelphia, Pennsylvania: American Society for Testing and Materials. Readily available.
- Bear, J., D. Zaslavsky, and S. Irmay. 1968. *Physical Properties of Water Percolation and Seepage*. UNESCO, Paris.
- Blakely, R.J.; V.E. Langenheim, D.A. Ponce; and G.L. Dixon. 2000. *Aeromagnetic Survey of the Amargosa Desert, Nevada and California: A Tool for Understanding Near-Surface Geology and Hydrology*. Open-File Report 00-188. Denver, Colorado: U.S. Geological Survey. 25 pp.
- Blakely, R.J. and D.A. Ponce. 2001, Map Showing Depth to Pre-Cenozoic Basement in the Death Valley Ground-Water Model Area, Nevada and California: U.S. Geological Survey Miscellaneous Field Studies Map MF-2381-E, U.S. Geological Survey, Denver, Colorado.
- Davis, J. C. 1986. *Statistics and Data Analysis in Geology*. 2nd Edition. John Wiley & Sons, Inc.
- Day, W.C., C.J. Potter, D.S. Sweetkind, R.P. Dickerson, and C.A. San Juan. 1998. Bedrock Geologic Map of the Central Block Area, Yucca Mountain, Nye County, Nevada: U.S. Geological Survey Miscellaneous Investigations Series Map I-2601. U.S. Geological Survey. Denver, Colorado.
- DOE (U.S. Department of Energy), 2003. Technical Basis Document No. 11: *Saturated Zone Flow and Transport*, Revision 2, Las Vegas, Nevada; Prepared for the U. S. Department of Energy.
- Heizler, M.T., F.V. Perry, B.M. Crowe, L. Peters, and R.Appelt. 1999, "The age of Lathrop Wells volcanic center —an $^{40}\text{Ar}/^{39}\text{Ar}$ dating investigation: " *Journal of Geophysical Research. B: Solid Earth*, v. 104, pp. 767–804.

- Keys, W. S. 1990. "Techniques of Water-Resource Investigations of the United States Geological Survey," *Borehole Geophysics Applied to Ground-Water Investigations*, Book 2, Chapter E2. Denver, Colorado: U.S. Geological Survey.
- Murray, D.A., K.D. Ridgway, and J.A. Stamatakos. 2003, *Stratigraphy of Oligocene and Lower Miocene strata - Yucca Mountain Region*: Proceedings of the 10th International High-Level Radioactive Waste Management Conference, La Grange Park, IL, American Nuclear Society (CD-ROM publication)
- NWRPO (Nuclear Waste Repository Project Office). 2001a. *NWRPO Independent Scientific Investigations Program Final Report, Fiscal Years 1996–2001*. Technical Report No. NWRPO-2001-04. Pahrump, Nevada: Nuclear Waste Repository Project Office.
- NWRPO (Nuclear Waste Repository Project Office). 2001b. *Analysis of Pump-Spinner Tests and 48-Hour Pump Test in Well NC-EWDP-19D, Near Yucca Mountain, Nevada*. Technical Report No. NWRPO-2001-03. Pahrump, Nevada: Nuclear Waste Repository Project Office. 43 p.
- NWRPO (Nuclear Waste Repository Project Office). 2003. *Nye County Drilling, Geologic Sampling and Testing, Logging, and Well Completion Report for the Early Warning Drilling Program Phase III Boreholes*. Technical Report No. NWRPO-2002-04. Pahrump, Nevada: Nuclear Waste Repository Project Office.
- NWRPO (Nuclear Waste Repository Project Office). 2005a. Drilling data files. Nye County, Nevada website. Accessed 2005. <http://www.nyecounty.com>.
- NWRPO (Nuclear Waste Repository Project Office). 2005b. *Groundwater Chemistry Analysis Annual Report for April 2004 through March 2005*. Technical Report No. NWRPO-2005-01. Pahrump, Nevada: Nuclear Waste Repository Project Office.
- Ponce, D.A., and Blakely, R.J. 2001. Aeromagnetic Map of the Death Valley Ground-Water Model Area, Nevada and California: U.S. Geological Survey Miscellaneous Field Studies Map MF-2381-D. U.S. Geological Survey. Denver, Colorado.
- Potter, C. J., R. P. Dickerson, D. S. Sweetkind, R. M. Drake II, E. M. Taylor, C. J. Fridrich, C. A. San Juan, and W. C. Day. 2002. Geologic Map of the Yucca Mountain Region, Nye County, Nevada. Geologic Investigations Series I-2755. Denver, Colorado: U.S. Geological Survey.
- Reamer, C.W. 1999. "Review of Nye County Quality Assurance Program for the Early Warning Drilling Program." Letter from C.W. Reamer (U.S. Nuclear Regulatory Commission) to L. Bradshaw (NWRPO), April 12, 1999, with enclosures, "Acceptance Evaluation of NWRPO Quality Assurance Program Plan."
- Sawyer, D.A., R.J. Fleck, M.A. Lanphere, R.G. Warren, D.E. Broxton, and M.R. Hudson. 1994. *Episodic caldera volcanism in the Miocene southwestern Nevada volcanic field—Revised stratigraphic framework, $^{40}\text{Ar}/^{39}\text{Ar}$ geochronology, and implications for magmatism and extension*: Geological Society of America Bulletin, v. 106, p. 1304-1318.

- Schulze-Makuch, D., D. A. Carlson, D. S. Cherkauer, and P. Malik. 1999. "Scale Dependence of Hydraulic Conductivity in Heterogeneous Media." *Ground Water*, Vol. 37, No. 6, pp. 904-919.
- Telford, L.P. Geldart, and R.E. Sheriff. 1990 *Applied Geophysics, Second Edition*. Cambridge University Press, New York.
- Todd, D. K. 1980. *Groundwater Hydrology*. New York: Wiley. pp. 69-71.
- USBR (U.S. Bureau of Reclamation). 1989, "Procedure for Constant-Head Hydraulic Conductivity Tests in Single Drill Holes (USBR 7310-89)," in *Earth Manual, Part 2, A Water Resources Technical Publication*, 3rd edition, U.S. Department of the Interior, Bureau of Reclamation, Denver, Colorado.
- Walvoord, M.A., and R.G. Strieg, D.E. Prudic, and D.A. Stonestrom. 2005. *CO₂ dynamics in the Amargosa Desert: Fluxes and isotopic speciation in a deep unsaturated zone*. *Water Resources Research*, Vol. 41, W02006, 15 pp.
- Winograd, I.J. and W. Thordarson. 1975. *Hydrogeologic and Hydrochemical Framework, South-Central Great Basin, Nevada-California, with Special Reference to the Nevada Test Site*. Professional Paper 712-C. Washington, D.C.: U.S. Geological Survey.
- Winterle, J. 2004. "Modeling of Site-Scale Saturated Zone Flow at Yucca Mountain." Presentation given by Center for Nuclear Waste Regulatory Analyses at the Nuclear Waste Technical Review Board Meeting, March 10, 2004, Las Vegas, Nevada.

TABLES

Table 1.3-1
Survey Coordinates and Well Completion Information

Well Name	Drilling Duration		Total Depth (feet bgs) ^a	Yucca Mountain Project Survey Coordinates		Ground Elevation ^b (feet amsl) ^c	Approximate Open-Hole Water Level at End of Drilling (feet bgs)	Screened Interval (feet bgs)		Sandpack Interval (feet bgs)		Lithology at Sandpack Interval	Well Casing Total Depth ^d (feet bgs)
	Start	Completion		North Latitude	West Longitude			To	From	To	From		
16P	12/13/02	1/27/03	2900.0	36° 43' 29.089"	116° 29' 22.219"	2888.9	496	489.4	549.4	474.8	555.3	Tertiary Tuff	559.9
24P	7/16/03	8/19/03	1860.0	36° 42' 16.775"	116° 26' 52.756"	2789.8	404	400.0	440.0	393.2	446.8	Tertiary Tuff	450.0
27P	11/20/02	12/12/02	1900.0	36° 44' 02.072"	116° 29' 51.436"	2973.4	583	580.7	620.6	563.0	626.7	Tertiary Tuff	631.0
28P	10/21/02	11/20/02	2080.0	36° 42' 28.386"	116° 29' 19.390"	2767.2	374	370.0	449.0	365.6	451.5	Tertiary Tuff	459.3
29P	6/25/03	7/15/03	790.7	36° 40' 57.297"	116° 26' 52.884"	2724.3	349	340.0	390.0	333.8	404.8	Tertiary Tuff	395.0
19PB	12/2/03	12/18/03	634.0	36° 40' 15.440"	116° 26' 55.593"	2688.4	368	375.5	395.0	350.0	401.9	Alluvium	405.3
								514.7	534.7	505.1	545.2	Alluvium	545.0

^a Below ground surface.

^b Ground elevations provided by the Yucca Mountain Project and based on a Global Positioning System. The elevations are not known to be precise to one-tenth of a meter.

^c Above mean sea level.

^d PVC blank well casing and screen with 2 3/8-inch outside diameter.

Table 1.6-1
Phase IV Quality Assurance Documents

Type	Number	Revision	Title	Date
Work Plan	WP-5	3	Early Warning Drilling Program Phase IV Drilling and Well Construction Work Plan	7/31/02
	WP-6	1	Early Warning Drilling Program Geophysical Logging Work Plan	5/31/01
	WP-8	3	Sample Management Plan	7/30/02
Technical Procedure	TP-7.0	3	Drill Site Management	9/30/02
	TP-8.0	4	Field Logging and Handling of Borehole Samples	10/28/02
		5		11/15/03
Test Plan	TPN-5.1	0	Construction of Sonic Corehole NC-EWDP-19PB	11/15/03
	TPN-8.1	0	Constant Head Saturated Hydraulic Conductivity Measurements on Repacked Core Samples	4/1/04

Table 2.1-1
Summary of Drilling Equipment Used in Reverse-Circulation Boreholes

Well Name	Drilling Method			Dual-Wall Pipe Specifications			Drill Bit Assembly			
	Type	Depth Interval (feet)		Diameter (inches)	Depth Interval (feet)		Type	Diameter (inches)	Depth Interval (feet)	
		From	To		From	To			From	To
29P	AR-RC ^a	0	180	4.5	0	708	Tricone center return	6.25	0	180
	APH-RC ^b	180	203	4.75	708	788	Hammer bit reverse circulation	6.25	180	203
	AR-RC	203	280				Tricone center return	6.25	203	280
	APH-RC	280	303				Hammer bit reverse circulation	6.25	280	303
	AR-RC	303	791				Tricone center return	6.25	303	791
24P	AR-RC	0	80				4.5	0	1778	Tricone center return
24P	APH-RC	80	100	4.75	1778	1858	Hammer bit reverse circulation	6.25	80	100
	AR-RC	100	1860				Tricone center return	6.25	100	1200
								6.125	1200	1860
16P	AR-RC	0	2900	4.5	0	2858	Tricone center return	6.5	0	1720
				4.75	2858	2898		6	1720	2122
								5.75	2122	2662
								5.625	2662	2900
27P	AR-RC	0	1900	4.5	0	1858	Tricone center return	6.5	0	760
				4.75	1858	1898		6	760	1900
28P	AR-RC	0	2080	4.5	0	2038	Tricone center return	6.5	0	1270
				4.75	2038	2078		6.125	1270	1283
								5.625	1283	2080

^aAir-rotary dual-wall reverse circulation.

^bAir-percussion-hammer dual-wall reverse circulation.

Table 2.2-1
Summary of Drill Cuttings Sampling, Splitting, and Testing

Borehole Name	Geologic Material	Drilling Method	Drill Cuttings Sample Interval (feet)	Total Number of Drill Cuttings Samples	Number of Drill Cuttings Samples ^a						
					Split (5-lb bag)		Nuclear Waste Repository Project Office (NWRPO) Laboratory Analysis				
					NWRPO/SMF ^b Split	DOE YMP ^c SMF Split	NWRPO Laboratory Split	Gravimetric Water Content ^d	Soil Water Extract Electrical Conductivity ^d	Wet Sieve	Hydrometer
16P	Alluvium ^e	AR-RC ^f	2.5	66	66	66	33	33	33	33	6
	Non-alluvium		5	547	547	37	0	0	0	0	0
24P	Alluvium	AR-RC	2.5	151	151	151	78	78	78	78	6
	Alluvium	APH-RC ^g	2.5	8	8	8	4	4	4	4	0
	Non-alluvium	AR-RC	5	292	292	292	0	0	0	0	0
27P	Alluvium	AR-RC	2.5	73	73	73	36	36	36	36	6
	Non-alluvium		5	344	344	42	42	0	0	0	0
28P	Alluvium	AR-RC	2.5	96	96	96	48	48	48	48	6
	Non-alluvium		5	377	377	16	16	0	0	0	0
29P	Alluvium	AR-RC	2.5	110	110	110	56	56	56	56	4
	Alluvium	APH-RC	2.5	18	18	18	6	8	8	8	2
	Non-alluvium	AR-RC	5	94	94	94	4	4	0	0	0
TOTAL				2,176	2,176	2,176	362	362	263	263	30

^a Density-related field measurements made on selected samples. Measurements not made on samples below the water table, or where water was used as a drilling fluid.

^b Sample Management Facility.

^c U.S. Department of Energy Yucca Mountain Project.

^d Not conducted on samples below the water table.

^e All unconsolidated sediments.

^f Air-rotary dual-wall reverse circulation.

^g Air-percussion-hammer dual-wall reverse circulation.

Table 2.2-2
Summary of Drive Core Sampling, Splitting, and Testing

Borehole Name	Geologic Material	Coring Method	Number of Core Runs per Borehole	Number of Density-Related Field Measurements	Number of Drive Core Samples							
					Split (6- and 3-inch liners and drive shoe)			Nuclear Waste Repository Project Office (NWRPO) Laboratory Analysis				
					NWRPO SMF ^a Subsamples	DOE YMP ^b SMF Subsamples	NWRPO Laboratory Subsamples	Volumetric Water Content	Grain and Bulk Density	Wet Sieve	Hydrometer	Saturated Hydraulic Conductivity
24P	Alluvium - unsaturated zone	APH-DC ^c	8	8	16	4	22	14	14	22	22	14
29P	Alluvium - unsaturated zone	APH-DC	3	3	2	4	9	6	6	9	9	6
19PB	Alluvium - saturated zone	SC-DC ^d	5	5	3	6	10	10	10	10	10	10
TOTAL			16	16	21	14	41	30	30	41	41	30

^a Sample Management Facility.
^b U.S. Department of Energy Yucca Mountain Project.
^c Air-percussion-hammer drive core.
^d Sonic drive core.

Table 2.2-3
Summary of Sonic Core Sampling, Splitting, and Testing

Sample Type	Total Number of Samples	Density-Related Field Measurements	Number of Assigned Samples			Number of Nuclear Waste Repository Project Office (NWRPO) Laboratory Analyses										
			DOE YMP SMF ^a	NWRPO Laboratory	Outside Researchers ^b	Gravimetric Water Content	Soil Water Extract EC ^c	Wet Sieve	Saturated Volumetric Water Content	Saturated Hydraulic Conductivity	Hydrometer	Atterberg Limits	Specific Gravity	Dry Bulk Density		
Grab sample (water content split)	219	NA ^d	0	199	0	199	19	0	0	0	0	0	0	0	0	0
Grab sample	199	NA	0	199	55	0	0	199	0	75	45	75	0	0	0	0
Sonic core segment ^e	180	180	180	35 ^f	0	35	0	14	22	15	15	22	15	15	15	35
TOTAL	598	NA	180	433	55	234	19	213	22	90	60	22	90	90	90	35

^a U.S. Department of Energy Yucca Mountain Project Sample Management Facility.

^b Samples provided as a split of NWRPO laboratory grab samples when sufficient sample was available to U.S. Geological Survey and Center for Nuclear Waste Regulatory Analyses.

^c Electrical conductivity analyses, not conducted on samples below the water table.

^d Not applicable.

^e Samples were repacked to target densities for saturated volumetric water content and hydraulic conductivity analyses.

^f Selected core segments were transferred to the NWRPO laboratory from DOE/YMP sonic core segments.

Table 2.4-1
Summary of Laboratory Tests on Geologic Samples

Type	Drilling/Coring Method	Sample Type	Number of Samples Tested										
			Saturated Hydraulic Conductivity	Saturated Volumetric Water Content	Volumetric Water Content	Gravimetric Water Content	Specific Gravity (Grain Density)	Dry Bulk Density	Soil Water Extract Electrical Conductivity	Wet Sieve	Hydrometer	Atterberg Limits	
Reverse-circulation (RC) borehole	AR-RC ^a	Drill cuttings	0	0	0	350	0	0	0	251	251	28	0
	APH-RC ^b		0	0	12	0	0	12	12	12	2	0	
	APH-DC ^c	Drive core	20	20	20	20	20	20	0	0	31	31	0
Sonic (SC) borehole	SC ^d	Textural layer grab samples	0	0	0	199	75	0	19	199	199	75	45
	SC	Sonic core segment ^e	22	22	0	35	15	35	0	14	15	15	15
	SC-DC ^f	Drive core	10	10	10	10	10	10	0	10	10	10	10
TOTAL			52	52	30	626	120	65	282	517	161	70	

^a Air-rotary dual-wall reverse circulation.

^b Air-percussion-hammer dual-wall reverse circulation.

^c Air-percussion-hammer dual-wall drive core.

^d Sonic core.

^e Samples were repacked to target densities for saturated volumetric water content and hydraulic conductivity analyses.

^f Sonic drive core.

Table 2.4-2
Laboratory Test Methods

Laboratory Test	Laboratory Method	
	Nevada Geotech, Inc. ^a	Nuclear Waste Repository Project Office Testing Laboratory
Volumetric Water Content	ASTM D-2216-92. Method for laboratory determination of water (moisture content) of soil, rock, and soil-aggregate mixtures. In: 1996 <i>Annual Book of ASTM Standards</i> , Vol. 04.08, American Society for Testing and Materials.	Gardner, W.H. 1986, "Water Content." In: Klute, A. (ed), <i>Methods of Soil Analysis</i> , Part 1, Physical and Mineralogical Methods (2nd ed.), American Society of Agronomy, Chapter 21, pp. 493-507 (specifically page 506). ^b
Dry Bulk Density	Blake, G.R. and K.H. Hartge. 1986. "Bulk Density." In: Klute, A. (ed), <i>Methods of Soil Analysis</i> , Part 1, Physical and Mineralogical Methods (2nd ed.), American Society of Agronomy, Chapter 13, pp. 363-367.	Blake, G.R. and K.H. Hartge. 1986. "Bulk Density." In: Klute, A. (ed), <i>Methods of Soil Analysis</i> , Part 1, Physical and Mineralogical Methods (2nd ed.), American Society of Agronomy, Chapter 13, pp. 363-367. ^b
Specific Gravity (grain density)	ASTM D-854-92. Standard test method for specific gravity of soils. In: 1996 <i>Annual Book of ASTM Standards</i> , Vol. 04.08, American Society for Testing and Materials.	ASTM D-854-02. Standard Test Methods for Specific Gravity of Soil Solids by Water Pycnometer. In: 2003 <i>Annual Book of ASTM Standards</i> , Vol. 04.08, American Society for Testing and Materials.
Saturated Hydraulic Conductivity (constant head method)	Klute, A., and C. Dirksen, 1986. "Hydraulic Conductivity and Diffusivity: Laboratory Methods." In: Klute, A. (ed), <i>Methods of Soil Analysis</i> , Part 1, Physical and Mineralogical Methods (2nd ed.), American Society of Agronomy, Chapter 28, pp. 694-700.	Klute, A., and C. Dirksen, 1986. "Hydraulic Conductivity Diffusivity: Laboratory Methods." In: Klute, A. (ed), <i>Methods of Soil Analysis</i> , Part 1, Physical and Mineralogical Methods (2nd ed.), American Society of Agronomy, Chapter 28, pp. 687-700. ^b
Atterberg Limits	Not applicable.	ASTM D-4318-00. Standard Test Methods for Liquid Limit, Plastic Limit, and Plasticity Index of Soils. In: 2003 <i>Annual Book of ASTM Standards</i> , Vol. 04.08, American Society for Testing and Materials.
Soil Extract Electrical Conductivity	Rhoades, J.D. 1986. Soluble salts—Electrical conductivity of saturation extract. In: Page, A.L. (ed), <i>Methods of Soil Analysis</i> , Part 2, Chemical and Microbiological Properties (2nd ed.), American Society of Agronomy, pp. 172-173.	Rhoades, J.D. 1982. Soluble Salts—Extracts at Soil/Water Ratios of 1:1 and 1:5, Electrical conductivity of saturation extract. In: Page, A.L. (ed), <i>Methods of Soil Analysis</i> , Part 2, Chemical and Microbiological Properties (2nd ed.), American Society of Agronomy, Chapter 10, pp. 169-170 and 172-173.
Gravimetric Water Content	ASTM D-2216-92. Method for laboratory determination of water (moisture content) of soil, rock, and soil-aggregate mixtures. In: 1996 <i>Annual Book of ASTM Standards</i> , Vol. 04.08, American Society for Testing and Materials.	ASTM D-2216-98. Standard Test Methods for Laboratory Determination of Water (Moisture) Content of Soil and Rock by Mass. In: 2003 <i>Annual Book of ASTM Standards</i> , Vol. 04.08, American Society for Testing and Materials.
Wet Sieve Analysis	ASTM D-1140-97. Standard test method for amount of material in soil finer than the No. 200 (75 μ m) sieve (Method B for wet sieve analysis). In: 1997 <i>Annual Book of ASTM Standards</i> , Vol. 04.08, American Society for Testing and Materials.	ASTM D-1140-00. Standard Test Methods for Amount of Material in Soil Finer Than the No. 200 (75 μ m) Sieve (Method B for wet sieve analysis). In: 2003 <i>Annual Book of ASTM Standards</i> , Vol. 04.08, American Society for Testing and Materials.
Hydrometer Analysis (silt/clay break)	ASTM D-422. Standard method for Particle Size Analysis of Soils. In: 1996 <i>Annual Book of ASTM Standards</i> , Vol. 04.08, American Society for Testing and Materials.	ASTM D-422-63 (Re-approved 1998). Standard Test Method for Particle Size Analysis of Soils. In: 2003 <i>Annual Book of ASTM Standards</i> , Vol. 04.08, American Society for Testing and Materials.

^aContract testing laboratory.

^bFor repacked sonic core samples, detailed methods to repack samples and to measure saturated volumetric water content, saturated hydraulic conductivity, and dry bulk density are given in TPN-8.1, *Constant Head Saturated Hydraulic Conductivity Measurements on Repacked Samples*.

Table 2.5-1
Description of Types and Applications of Geophysical Logs

Log Name	Suite	Description	Application
Caliper	Open-hole	Borehole diameter	Provides borehole correction (e.g., wash-out zones) for other logs, borehole volume for well completions, and possible identification of fractures and contacts.
Density	Drill-string, open-hole, and well completion	Tool output altered by formation materials ^a	Yields density information on adjacent borehole wall formation material; identifies washout zones.
Deviation	Drill-string, open-hole, and well completion	Deviation of borehole from vertical	Permits calculation of true elevations for lithologic contacts, well screens, water levels, and other borehole depth measurements.
Fluid Resistivity	Open-hole	Borehole fluid resistivity and conductivity	Estimates relative amount of dissolved salts in borehole fluid and may provide an indication of inflow in open boreholes.
Fluid Temperature (Temperature)	Drill-string, open-hole, and well completion	Borehole fluid temperature	Helps identify locations of inflow/outflow in open boreholes, and geothermal gradient in cased boreholes.
Gamma (Natural Gamma)	Drill-string, open-hole, and well completion	Gamma radiation from natural sources in formation and in borehole drilling fluids	Helps identify lithology and stratigraphic unit correlation; may respond to differences in clay content.
Magnetic Susceptibility	Open-hole and well completion	Ferromagnetism and conductivity in rocks	Indicates presence of magnetic minerals; may indicate deposition of magnetic minerals within porous media.
Neutron (Moisture)	Drill-string, open-hole, and well completion	Tool output altered by water in formation and borehole ^b	Identifies moisture content changes in the unsaturated zone and/or indicates porosity changes in the saturated zone.
Optical Televiwer	Open-hole	360° image of reflection of borehole wall via prism mirror and camera	May help detect fractures, thin beds, and bedding dip; provides caliper and deviation data.
Resistivity (Formation) (R8, R16, R32, or R64)	Open-hole	Apparent formation resistivities at different distances from the borehole	Helps identify lithology and stratigraphic unit correlation; indicates relative changes in water quality.
Single-Point Resistivity (SPR)	Open-hole	Resistivity of borehole fluids and adjacent formation	Helps identify lithology and changes in borehole fluid composition.
Sonic (Acoustic Velocity)	Open-hole	Compressional wave velocity through fluids and formations	Helps define changes in porosity and lithology; indicates of fractures.
Spectral Gamma	Drill-string, open-hole, and well completion	Radiation emitted by uranium, thorium and potassium	Can help identify minerals containing uranium, thorium and potassium.
Spontaneous Potential	Open-hole	Electrical potential between fluids in borehole and adjacent formation	Helps identify lithology, clay, and shale content and relative changes in formation water quality.

Source: Modified from Keys (1990) and Telford and others (1990).

^aGeophysical Logging Services density tool contains no radioactive source; Century Geophysical tool uses a cesium-137 source.

^bGeophysical Logging Services moisture tool contains no radioactive source; Century Geophysical tool uses a directed americium beryllium source

Table 2.5-2
Summary of Phase IV Geophysical Logs

Well Name	Date	Suite	Interval Logged (feet)	Log Name												Record Identification Designation (RID) Number	Company Name	Comments
				Gamma (Natural Gamma)	Density	Spectral Gamma	Neutron (Moisture)	Fluid Temperature	Resistivity (SPR, R8-R64)	Fluid Resistivity	Spontaneous Potential	Caliper	Acoustic Velocity (Sonic)	Magnetic Susceptibility	Optical Televiwer			
16P	1/20/03	Open-hole	1,980	X	X	X	X	X	X	X	X	X	X	X	X	Geophysical Logging Services (GLS)	Run in 6.5- to 5.625-inch borehole with 61.5 feet of 12-inch surface casing.	
	1/20/03	Drill-string	0	X	X	X	X	X	X	X	X	X	X	X	GLS	Run in 4.5-inch dual-wall drill pipe in 6.5- to 5.625-inch borehole with 61.5 feet of 12-inch surface casing.		
	1/8/04	Well-completion	0	X	X	X	X	X	X	X	X	X	X	X	GLS	Run in 2-inch Schedule 80 PVC well casing with 61.5 feet of 12-inch surface casing.		
	3/4/04		0	X	X	X	X	X	X	X	X	X	X	X	GLS	Run in 2-inch Schedule 80 PVC well casing with 61.5 feet of 12-inch surface casing.		
28P	1/10/03 to 11/03	Open-hole	0	X	X	X	X	X	X	X	X	X	X	X	GLS	Run in 6.5- to 5.75-inch borehole with 61.5 feet of 12-inch surface casing.		
	11/2/02	Open-hole	0	X	X	X	X	X	X	X	X	X	X	X	GLS	Run in 6.5- to 6.125-inch borehole.		
	11/2/02		0	X	X	X	X	X	X	X	X	X	X	GLS	Run in 6.5- to 6.125-inch borehole.			
	11/13/02		1,120	X	X	X	X	X	X	X	X	X	X	GLS	Run in 6.5- to 5.625-inch borehole.			
	11/13/02	Drill-string	1,120	X	X	X	X	X	X	X	X	X	X	GLS	Run in 4.5-inch dual-wall drill pipe in 6.5- to 5.625-inch borehole.			
	1/8/04	Well-completion	0	X	X	X	X	X	X	X	X	X	X	GLS	Run in 2-inch Schedule 80 PVC well casing.			
	3/4/04		0	X	X	X	X	X	X	X	X	X	X	GLS	Run in 2-inch Schedule 80 PVC well casing.			

Table 2.5-2
Summary of Phase IV Geophysical Logs

Well Name	Date	Suite	Interval Logged (feet)	Log Name												Record Identification Designation (RID) Number	Company Name	Comments
				Gamma (Natural Gamma)	Density	Spectral Gamma	Neutron (Moisture)	Fluid Temperature	Resistivity (SPR, R8-R64)	Fluid Resistivity	Spontaneous Potential	Caliper	Acoustic Velocity (Sonic)	Magnetic Susceptibility	Optical Televiwer			
27P	1/8/04	Well-completion	0	X	X	X	X	X						X	6036	GLS	Run in 2-inch Schedule 80 PVC well casing with 60.4 feet of 12-inch surface casing.	
	3/4/04		0			X									6212	GLS	Run in 2-inch Schedule 80 PVC well casing with 60.4 feet of 12-inch surface casing.	
	12/7/02 to 1/8/02	Open-hole	0	X	X	X	X	X	X	X	X	X	X		5536	GLS	Run in 6.5- to 6-inch borehole with 60.4 feet of 12-inch surface casing.	
	12/7/02 to 12/8/02		0										X		5484	GLS	Run in 6.5- to 6-inch borehole with 60.4 feet of 12-inch surface casing.	
29P	7/9/03	Open-hole	0	X	X	X	X	X	X	X	X	X	X		5746	GLS	Run in 5-inch steel casing inside 6.25-inch borehole to total depth with 61.5 feet of 12-inch surface casing. Inductive resistivity and inductive conductivity logs run as a test in the unsaturated zone.	
	7/9/03		0										X		5745	GLS	Run in 6.25-inch borehole with 61.5 feet of 12-inch surface casing.	
	7/10/03	Drill-string	0	X	X	X	X	X	X	X	X	X	X		5767	Century Geophysical (Century)	Run in 5-inch steel casing inside 6.25-inch borehole with 61.5 feet of 12-inch surface casing.	
	7/10/03		0												5766	Century	Run in 5-inch steel casing inside 6.25-inch borehole with 61.5 feet of 12-inch surface casing.	
	1/8/04	Well-completion	0	X	X	X	X	X	X	X	X	X	X		6032	GLS	Run in 2-inch Schedule 80 PVC well casing with 61.5 feet of 12-inch surface casing.	
	3/4/04		0											X	6214	GLS	Run in 2-inch Schedule 80 PVC well casing with 61.5 feet of 12-inch surface casing.	

Table 2.5-2
Summary of Phase IV Geophysical Logs

Well Name	Date	Suite	Interval Logged (feet)	Log Name												Record Identification Designation (RID) Number	Company Name	Comments
				Gamma (Natural Gamma)	Density	Spectral Gamma	Neutron (Moisture)	Fluid Temperature	Resistivity (SPR, R8-R64)	Fluid Resistivity	Spontaneous Potential	Caliper	Acoustic Velocity (Sonic)	Magnetic Susceptibility	Optical Televiwer			
24P	8/8/03	Drill-string	0	X	X	X	X	X	X	X					X	GLS	Run in 4.5-inch dual-wall drill pipe inside 6.25- to 6.125-inch borehole with 61.5 feet of 12-inch surface casing.	
	8/9/03		0	X	X	X	X	X	X	X						Century	Run in 5-inch steel casing inside 6.25- to 6.125-inch borehole with 61.5 feet of 12-inch surface casing.	
	8/9/03		0	X	X	X	X	X	X	X						Century	Run in 5-inch steel casing inside 6.25- to 6.125-inch borehole with 61.5 feet of 12-inch surface casing.	
24P	8/10/03	Open-hole	0	X	X	X	X	X	X	X				X	GLS	Run in 6.25- to 6.125-inch borehole with 61.5 feet of 12-inch surface casing.		
	8/10/03		728	1,550									X	X	GLS	Run in 6.25- to 6.125-inch borehole with 61.5 feet of 12-inch surface casing.		
19PB	1/9/04	Well-completion	0	X	X	X	X	X	X	X				X	GLS	Run in 2-inch Schedule 80 PVC well casing with 61.5 feet of 12-inch surface casing.		
	3/4/04		0	450											GLS	Run in 2-inch Schedule 80 PVC well casing with 61.5 feet of 12-inch surface casing.		
19PB	11/22/03	Open-hole	0	X	X	X	X	X	X	X				X	GLS	Run in 10.625-inch borehole with 18 feet of 17.5-inch surface casing above the water table.		
	12/18/03		0	634	X	X	X	X	X	X				X	GLS	Run in sonic coring casings within multiple telescoping casings and 18 feet of 17.5-inch surface casing.		
	12/19/03		0	619.6	X	X	X	X	X	X	X				Century	Run in 5.5-inch steel casing within multiple telescoping casings and 18 feet of 17.5-inch surface casing.		
19PB (deep)	1/9/04	Well-completion	0	X	X	X	X	X	X	X				X	GLS	Run in 2-inch Schedule 80 PVC within multiple telescoping casings and 18 feet of 17.5-inch surface casing.		
	3/4/04		0	545	X	X	X	X	X	X	X				GLS	Run in 2-inch Schedule 80 PVC within multiple telescoping casings and 18 feet of 17.5-inch surface casing.		

Table 3.1-1
Summary of Well Elevations and Water Levels

Well Name	Top of Casing Elevation ^a (feet amsl ^b)	Original Ground Surface Elevation ^c (feet amsl)	Water Level Measurement Date	Groundwater Elevation ^d (feet amsl)	Depth to Water ^d (feet)
16P	2891.6	2888.9	7/23/04	2393.0	498.6
24P	2792.2	2789.8	7/23/04	2385.6	406.7
27P	2976.1	2973.4	7/23/04	2390.5	585.6
28P	2770.1	2767.2	7/23/04	2392.9	377.2
29P	2726.2	2724.3	7/23/04	2378.0	348.1
19PB Shallow	2690.3	2688.4	7/23/04	2321.0	369.4
19PB Deep	2690.3	2688.4	7/23/04	2323.0	367.3

^aElevations provided by the Yucca Mountain Project and based on a Global Positioning System. The elevations are not known to be precise to one-tenth of a meter.

^bAbove mean sea level.

^cBased on GPS survey elevation at top of casing, minus casing stickup.

^dGroundwater elevation and depth-to-water data have not been corrected for borehole deviation.

Table 4.1-1
Summary of Censored Geologic Data

Well Name	Sample Type	Field Logging Data Depth Interval (feet below ground surface [bgs])		Laboratory Test Data Depth Interval (feet bgs)						
		PSD and USCS Group Symbol ^a	Sample Bulk-Density-Related ^b	EC ^c	GWC ^c	Wet Sieve PSD ^d	Hydrometer PSD ^e	Dry Bulk Density	Porosity ^f	Saturated Hydraulic Conductivity
16P	Drill Cuttings	0-165	0-165				32.5-35			
							57.5-60			
19PB	Sonic Core Grab Sample	350.8-633.8				378.1-378.4				
						416.8-418.4				
					522.1-522.7					
										449.10-449.40
24P	Drive Core Run	0-400	0-400	405-410	405-410	405-410 ^g				
				415-420	415-420	415-420 ^g				
27P	Drill Cuttings	0-182.5	0-182.5				157.5-160			
							147.5-150			
28P	Drill Cuttings	0-240	0-240				172.5-175			
							162.5-165			
29P	Drill Cuttings						182.5-185			
							232.5-235			
29P	Drive Core Run	100.00-102.27								
		180.00-181.13								
		279.98-282.11								
	Drive Core Segment						180.00-180.36	180.00-180.36	180.00-180.36	180.00-180.36

^a Field estimates of particle size distribution (PSD) and Unified Soil Classification System (USCS) group symbol data differ significantly from laboratory measurements.
^b A significant amount of sample was not collected and weighed over drill run intervals.
^c Electrical conductivity (EC) of soil-water extract and gravimetric water content (GWC) data obtained from alluvium drill cuttings are applicable to regions above the water table only.
^d Data included a negative percent value for one or more of the smallest size fractions, likely from using separate sample splits to obtain air dry water contents.
^e Hydrometer silt plus clay percent differed significantly from wet sieve fines percent.
^f Core samples tested were observed to be loosely packed in their liners and obviously disturbed from in situ conditions.
^g Wet sieve measurements not applicable to bedrock units beginning at approximately 400 feet bgs.

Table 4.2-1
Drive Core Recovery and Density Data

Well Name	Coring Method	Core Run Number	Depth (feet)		Recovery (feet)			Core Diameter (inches)	Sample Weight ^a (kilograms)	Average Sample Gravimetric Water Content (grams/gram [g/g])	Calculated Oven Dry Sample Weight (g)	Sample Volume (cubic centimeter [cm ³])	Dry Bulk Density ^b (g/cm ³)
			From	To	Core	Fill	Total Length						
24P	APH-DC ^c	1	80.18	81.69	1.51	0.76	2.27	3.9	11.1	0.056	10510	5330	1.97
		2	120.13	121.34	1.21	1.06	2.27	3.9	10.85	0.072	10130	5330	1.90
		3	160.00	162.13	2.13	0.56	2.69	3.9	11.25	0.185	9490	6320	1.50 ^d
		4	200.31	200.87	0.56	1.71	2.27	3.9	11.25	0.078	10440	5330	1.96
		5	240.00	241.75	1.75	0.52	2.27	3.9	11.2	0.062	10550	5330	1.98
		6	280.40	281.00	0.60	1.67	2.27	3.9	11.6	0.141	10170	5330	1.91
		7	322.50	323.44	0.94	1.75	2.69	3.9	13.3	0.083	12290	6320	1.94
		8	360.00	360.71	0.71	1.98	2.69	3.9	12.35	0.096	11270	6320	1.78
											Average	1.92	
29P	APH-DC	1	100.00	102.27	2.27	0	2.27	3.9	11.3	0.108	10200	5330	1.91
		2	180.00	181.13	1.13	1.14	2.27	3.9	11.2	0.108	10110	5330	1.90
		3	279.98	282.11	2.13	0	2.13	3.9	11.55	0.107	10440	5000	2.09
											Average	1.97	
19PB	SC-DC ^e	9	380.00	381.00	1.00	0.70	1.70	3.9	ND ^f	NA ^g	NA	NA	NA
		19	449.09	449.66	0.57	1.49	2.06	3.9	9.25	0.130	8190	4860	1.69
		32	527.05	528.80	1.75	0.94	2.69	3.9	13.0	0.148	11320	6320	1.79
		41	561.74	563.34	1.60	0.68	2.28	3.9	11.45	0.173	9760	5360	1.82
		53	619.99	622.02	2.03	0.14	2.17	3.9	11.25	0.152	9770	5100	1.92
											Average	1.81	

^a Sample weight includes core and fill.

^b Density of core plus fill assuming average water content of core equals that of fill.

^c Air-percussion hammer drive core.

^d Sample composed primarily of coring-related crushed gravel and cobbles. Density value not considered representative and not used in average calculation.

^e Sonic drive core.

^f Not determined.

^g Not applicable.

Table 4.2-2
Saturated Formation Dry Bulk Density Data for 19PB Sonic Core Runs

Core Barrel Diameter (inches)	Core Run Number	Depth Interval (feet below ground surface)		Average Dry Bulk Density (grams per cubic centimeter [g/cm ³])		Lost Core (feet)
		From	To	All Core Runs	Core Runs with Less than 0.2 Feet of Lost Core ^a	
6.16	7	371.0	375.4	1.78		0.3
	8	375.7	378.4	1.98		0.6
	10	381.3	386.1	1.85	1.85	0.0
	11	386.1	396.1	1.85	1.85	0.0
	12	396.3	406.1	1.74	1.74	0.2
	13	406.3	416.1	1.84	1.84	0.0
	14	416.2	424.4	1.80	1.80	0.1
	15	424.6	429.3	1.78	1.78	0.2
	16	429.3	434.1	1.81		1.1
	17	435.5	445.1	1.76		1.9
	18	445.3	447.9	1.77		0.5
	20	450.6	460.7	1.85	1.85	0.0
	21	460.7	466.3	1.66	1.66	0.2
	22	466.5	476.2	1.93	1.93	0.2
	23	476.4	478.0	2.11	2.11	0.2
	24	478.2	481.9	1.78		1.0
	25	481.9	489.4	1.57	1.57	0.2
	26	489.6	494.6	1.85		1.6
	27	495.2	499.0	1.72		0.7
	28	500.1	510.0	1.67		0.4
29	510.0	519.4	1.57	1.57	0.0	
30	519.4	522.7	1.75		1.7	
Average Dry Bulk Density				1.79	1.80	
4.5	31	524.4	527.1	1.75	1.75	0.0
	33	528.8	531.1	2.24		0.9
	34	533.0	534.1	2.34		1.3
	35	534.4	543.1	1.85	1.85	0.2
	36	543.3	545.7	2.23		1.0
	37	545.9	549.6	1.83		1.9
	38	550.7	553.3	1.79		1.0
	39	553.7	557.8	2.17		2.0
	40	559.6	560.4	2.95		0.5
	42	563.3	565.9	1.60	1.60	0.0
	43	565.9	567.1	2.04		1.3
	44	568.4	570.9	2.39		0.8
	45 ^b	571.7	578.3	1.78	1.78	0.0
	46	578.3	581.8	2.15	2.15	0.1
	47	581.9	587.4	1.71		0.9
	48	588.3	591.7	1.86	1.86	0.2
	49	591.9	601.0	1.88		0.9
	50	601.9	605.2	1.86	1.86	0.0
	51	605.2	615.3	1.85	1.85	0.0
	52	615.3	619.9	1.64	1.64	0.0
54	622.0	627.9	1.72		0.5	
55	628.4	633.8	1.81	1.81	0.2	
Average Dry Bulk Density				1.97	1.82	

^aShading indicates excluded core run.

^bLast core segment deleted from density calculation due to field error in mass.

Table 5.1.1-1
 Laboratory Analysis Data for 19PB, 24P, and 29P Drive Core Samples
 (Blanks indicate unmeasured parameters)

Well Name	Sample Number	Sample Type	Volumetric Water Content (cm ³ /cm ³)		Calculated Porosity (cm ³ /cm ³)	Density (g/cm ³)		Wet Sieve (%)			Hydrometer (%)		Saturated Hydraulic Conductivity (cm/sec)
			Field Sample	Saturated Sample		Specific Gravity	Dry Bulk Density	Gravel	Sand	Fines	Silt	Clay	
19PB	19PB-380.00-380.50-C	Core	0.33	0.38	0.27	2.59	1.95	70	23	7		4	4.2E-06
19PB	19PB-380.50-381.00-C	Core	0.38	0.48	0.33	2.53	1.74	21	63	16		9	2.3E-06
19PB	19PB-449.10-449.40-C	Core	0.21	0.28	0.30	2.58	1.82	53	40	7		3	Censored
19PB	19PB-449.40-449.70-C	Core	0.25	0.29	0.22	2.53	1.97	65	28	7		5	
19PB	19PB-527.61-528.11-C	Core	0.29	0.31	0.25	2.53	1.94	46	38	16		9	1.4E-05
19PB	19PB-528.11-528.61-C	Core	0.29	0.32	0.26	2.55	1.97	43	41	16		9	7.0E-07
19PB	19PB-562.07-562.57-C	Core	0.32	0.34	0.28	2.51	1.86	43	47	10		4	7.6E-06
19PB	19PB-562.57-563.07-C	Core	0.31	0.33	0.27	2.54	1.93	23	64	13		5	1.1E-06
19PB	19PB-620.75-621.25-C	Core	0.38	0.45	0.31	2.56	1.85	37	50	13		8	1.7E-05
19PB	19PB-621.25-621.75-C	Core	0.35	0.37	0.31	2.56	1.84	34	53	13		7	5.3E-07
24P	24P-120.13-120.58-C	Core	0.13	0.26	0.27	2.59	1.88	31	58	11	6	6	2.8E-03
24P	24P-120.58-121.08-C	Core	0.14	0.25	0.29	2.59	1.85	30	60	10	4	6	2.6E-03
24P	24P-121.08-121.34-C	Shoe Core						24	60	16	9	6	
24P	24P-160.87-161.37-C	Core	0.46	0.51	0.37	2.56	1.62	39	55	6	3	3	1.8E-03
24P	24P-161.37-161.87-C	Core	0.16	0.28	0.26	2.56	1.89	28	53	9	5	5	2.4E-03
24P	24P-161.87-162.13-C	Shoe Core						34	52	14	4	9	

Table 5.1-1
 Laboratory Analysis Data for 19PB, 24P, and 29P Drive Core Samples
 (Blanks indicate unmeasured parameters)

Well Name	Sample Number	Sample Type	Volumetric Water Content (cm ³ /cm ³)		Calculated Porosity (cm ³ /cm ³)	Density (g/cm ³)		Wet Sieve (%)			Hydrometer (%)		Saturated Hydraulic Conductivity (cm/sec)
			Field Sample	Saturated Sample		Specific Gravity	Dry Bulk Density	Gravel	Sand	Fines	Silt	Clay	
24P	24P-200.31-200.61-C	Core	0.18	0.28	0.11	2.58	2.30	28	59	13	7	6	6.5E-06
24P	24P-200.61-200.87-C	Shoe Core						28	62	10	6	5	
24P	24P-240.48-240.98-C	Core	0.13	0.16	0.24	2.59	1.98	32	64	4	1	2	3.0E-02
24P	24P-240.98-241.48-C	Core	0.11	0.26	0.27	2.59	1.90	24	64	12	6	6	3.2E-03
24P	24P-241.48-241.75-C	Shoe Core						21	66	13	6	7	
24P	24P-280.40-280.73-C	Core	0.27	0.31	0.26	2.60	1.92	25	56	19	8	10	1.7E-05
24P	24P-280.73-281.00-C	Shoe Core						19	56	25	12	14	
24P	24P-322.50-322.75-C	Core	0.19	0.23	0.18	2.63	2.16	32	49	19	10	9	1.7E-05
24P	24P-322.75-323.25-C	Core	0.16	0.21	0.22	2.63	2.05	29	50	21	9	13	1.2E-04
24P	24P-323.25-323.44-C	Shoe Core						25	40	35	15	19	
24P	24P-360.00-360.02-C	Core				2.54		33	47	20	10	10	
24P	24P-360.02-360.52-C	Core	0.15	0.27	0.32	2.54	1.74	35	49	16	9	7	5.1E-03
24P	24P-360.52-360.71-C	Shoe Core						49	33	18	9	8	
24P	24P-80.43-80.93-C	Core	0.10	0.19	0.22	2.54	1.97	29	61	10	6	4	4.9E-04
24P	24P-80.93-81.43-C	Core	0.12	0.21	0.24	2.54	1.93	29	60	11	6	6	2.2E-03
24P	24P-81.43-81.69-C	Shoe Core						24	62	14	6	8	

Table 5.1-1
 Laboratory Analysis Data for 19PB, 24P, and 29P Drive Core Samples
 (Blanks indicate unmeasured parameters)

Well Name	Sample Number	Sample Type	Volumetric Water Content (cm ³ /cm ³)		Calculated Porosity (cm ³ /cm ³)	Density (g/cm ³)		Wet Sieve (%)			Hydrometer (%)		Saturated Hydraulic Conductivity (cm/sec)
			Field Sample	Saturated Sample		Specific Gravity	Dry Bulk Density	Gravel	Sand	Fines	Silt	Clay	
29P	29P-100.50-101.00-C	Core	0.23	0.26	0.25	2.52	1.90	36	48	16	8	8	8.4E-06
29P	29P-101.00-101.50-C	Core	0.19	0.21	0.19	2.52	2.03	54	34	12	6	6	9.6E-06
29P	29P-102.00-102.27-C	Shoe Core						50	36	14	6	8	
29P	29P-180.00-180.36-C	Core	0.23	0.25	Censored	2.58	Censored	47	39	14	Censored	Censored	1.8E-05
29P	29P-180.36-180.86-C	Core	0.13	0.22	0.21	2.58	2.04	54	34	12	6	6	5.0E-05
29P	29P-180.86-181.13-C	Shoe Core						48	38	14	4	10	
29P	29P-280.84-281.34-C	Core	0.22	0.27	0.27	2.56	1.88	43	42	15	5	10	4.4E-05
29P	29P-281.34-281.84-C	Core	0.18	0.32	0.24	2.56	1.94	55	31	14	6	8	1.4E-05
29P	29P-281.84-282.11-C	Shoe Core						41	39	20	7	13	

Table 5.1-2
 Mean Dry Bulk Density and Saturated Hydraulic Conductivity Data for Drive Core Samples

Well Name	Sample Number	Dry Bulk Density Arithmetic Mean (g/cm ³)	Saturated Hydraulic Conductivity (cm/sec)		
			Core Value	Geometric Mean	Arithmetic Mean
19PB	19PB-380.00-380.50-C	1.89	4.2E-06	3.0E-06	5.9E-06
	19PB-380.50-381.00-C		2.3E-06		
	19PB-527.61-528.11-C		1.4E-05		
	19PB-528.11-528.61-C		7.0E-07		
	19PB-562.07-562.57-C		7.6E-06		
	19PB-562.57-563.07-C		1.1E-06		
	19PB-620.75-621.25-C		1.7E-05		
	19PB-621.25-621.75-C		5.3E-07		
24P	24P-80.43-80.93	1.94	4.9E-04	6.50E-04	3.90E-03
	24P-80.93-81.43		2.2E-03		
	24P-120.13-120.58		2.8E-03		
	24P-120.58-121.08		2.6E-03		
	24P-160.87-161.37		1.8E-03		
	24P-161.37-161.87		2.4E-03		
	24P-200.31-200.61		6.5E-06		
	24P-240.48-240.98		3.0E-02		
	24P-240.98-241.48		3.2E-03		
	24P-280.40-280.73		1.7E-05		
	24P-322.50-322.75		1.7E-05		
	24P-322.75-323.25		1.2E-04		
	24P-360.02-360.52		5.1E-03		
29P	29P-100.50-101.00	1.96	8.4E-06	1.9E-05	2.4E-05
	29P-101.00-101.50		9.6E-06		
	29P-180.36-180.86		1.8E-05		
	29P-180.00-180.36		5.0E-05		
	29P-280.84-281.34		4.4E-05		
	29P-281.34-281.84		1.4E-05		

Table 5.1-3
 Laboratory Particle Size Distribution Data,
 Summary Statistics for 24P and 29P Drive Core Samples

Well Name	Depth Interval Containing Data (feet)		Number of Samples in Depth Interval	Wet Sieve Parameter	Minimum (%)	Maximum (%)	Average (%)	Standard Deviation	Coefficient of Variation
24P	80.43	360.71	22	Gravel	19	49	30	6	22
				Sand	33	66	55	8	15
				Fines	4	35	15	7	46
29P	100.5	282.11	9	Gravel	36	55	48	7	14
				Sand	31	48	38	5	13
				Fines	12	20	15	2	17

Table 5.1-4
Laboratory Particle Size Distribution Data,
Summary Statistics for 19PB Sonic Grab Core Samples

Parameter	Depth Interval Containing Data (feet)		Number of Samples in Depth Interval	Minimum	Maximum	Average	Standard Deviation	Coefficient of Variation
Wet Sieve Gravel (%)	352.4	631.1	199	3.4	83.4	40.0	18.0	45
Wet Sieve Sand (%)	352.4	631.1	199	14.8	75.6	45.6	14.2	31
Wet Sieve Fines (%)	352.4	631.1	197	0.6	41.3	14.6	6.9	47

Table 5.1-5
 Summary of Laboratory Analyses of 19PB Sonic Core Grab Samples
 Repacked to Target Densities at Air-Dried and Optimum Water Contents
 (Blanks indicate unmeasured parameters)

Sample Number	Density (g/cm ³)		Calculated Porosity (cm ³ /cm ³)	Saturated Volumetric Water Content (cm ³ /cm ³)	Saturated Hydraulic Conductivity (cm/sec)	Atterberg Limits Fines Classification	Particle Size Analysis (Percent)				
	Dry Bulk Density	Specific Gravity					Wet Sieve			Hydrometer	
							Cobbles	Gravel	Sand		Fines
19PB-388.9-394.1-SCR	1.76	2.57	0.315	0.310	8.8E-04	ML	37	27	33	3	5
19PB-401.1-405.0-SCR	1.74	2.54	0.315	0.317	3.1E-03	ML	0	43	47	10	7
19PB-406.3-408.5-SCR	1.76	2.58	0.318	0.309	4.4E-03	CL	0	47	45	8	5
19PB-437.8-441.2-SCR	1.75	2.53	0.308	0.317	8.8E-04		0	19	72	9	5
19PB-450.3-455.1-SCR	1.73	2.55	0.322	0.317	3.9E-03	ML	0	41	46	13	9
19PB-457.2-460.7-SCR	1.79	2.55	0.298	0.295	3.0E-04	ML	0	45	42	13	6
19PB-478.2-481.9-SCR	1.69	2.54	0.335	0.331	7.3E-04	ML	0	39	44	17	12
19PB-481.9-484.4-SCR	1.65	2.53	0.348	0.342	2.1E-03	ML	0	45	42	13	11
19PB-512.1-514.2-SCR	1.74	2.59	0.328	0.324	9.8E-04						
19PB-517.3-519.4-SCR	1.69	2.54	0.335	0.336	2.1E-03	ML	0	38	52	10	6
19PB-519.4-522.1-SCR	1.68	2.53	0.336	0.346	5.4E-03	CL	0	48	40	12	7
19PB-547.6-553.3-SCR	1.73	2.58	0.329	0.329	3.0E-04	CL-ML	0	38	43	19	11
19PB-553.7-557.8-SCR	1.73	2.56	0.324	0.313	1.2E-04	ML	0	23	57	20	11
19PB-598.7-602.9-SCR	1.67	2.52	0.337	0.326	1.8E-04	ML	0	24	60	16	8
19PB-618.9-624.9-SCR	1.70	2.55	0.333	0.336	2.3E-04	ML	0	26	56	18	10
19PB-618.9-624.9-SCR	1.90		0.264	0.251	6.9E-05						
19PB-406.3-408.5-SCRM	1.90		0.255	0.262	4.0E-05						
19PB-457.2-460.7-SCRM	1.90		0.252	0.253	7.9E-06						
19PB-478.2-481.9-SCRM	1.90		0.252	0.244	1.6E-05						
19PB-481.9-484.4-SCRM	1.90		0.249	0.261	7.6E-05						
19PB-519.4-522.1-SCRM	1.90		0.258	0.265	1.0E-05						
19PB-553.7-557.8-SCRM	1.90		0.255	0.237	5.2E-07						
19PB-618.9-624.9-SCRM	1.90		0.255								

Table 5.1-6
 Mean Saturated Hydraulic Conductivity Data
 for 19PB Drive Core Samples and Repacked Laboratory Samples

Sample Number	Core Type	Saturated Hydraulic Conductivity (cm/sec)		
		Core Value	Geometric Mean	Arithmetic Mean
19PB-380.00-380.50-C	Drive Core	4.20E-06	3.0E-06	5.9E-06
19PB-380.50-381.00-C		2.30E-06		
19PB-527.61-528.11-C		1.40E-05		
19PB-528.11-528.61-C		7.00E-07		
19PB-562.07-562.57-C		7.60E-06		
19PB-562.57-563.07-C		1.10E-06		
19PB-620.75-621.25-C		1.70E-05		
19PB-621.25-621.75-C		5.30E-07		
19PB-406.3-408.5-SCR	Repacked Core at Air-Dried Water Content	4.4E-03	8.4E-04	1.9E-03
19PB-457.2-460.7-SCR		3.0E-04		
19PB-478.2-481.9-SCR		7.3E-04		
19PB-481.9-484.4-SCR		2.1E-03		
19PB-519.4-522.1-SCR		5.4E-03		
19PB-553.7-557.8-SCR		1.2E-04		
19PB-618.9-624.9-SCR		2.3E-04		
19PB-406.3-408.5-SCRM	Repacked Core at Optimum Water Content	6.90E-05	1.7E-05	3.9E-05
19PB-457.2-460.7-SCRM		4.00E-05		
19PB-478.2-481.9-SCRM		7.90E-06		
19PB-481.9-484.4-SCRM		1.60E-05		
19PB-519.4-522.1-SCRM		7.60E-05		
19PB-553.7-557.8-SCRM		1.00E-05		
19PB-618.9-624.9-SCRM		5.20E-07		

Table 5.1-7
Comparison of Particle Size Distribution Data for 19PB Sonic Grab Core Samples
and Repacked Laboratory Sample Splits

Grab Sample							Repacked Laboratory Sample Split			
Sample Number	Field Split			Weighted Average of Field Split			Sample Number	Gravel (%)	Sand (%)	Fines (%)
	Gravel (%)	Sand (%)	Fines (%)	Gravel (%)	Sand (%)	Fines (%)				
19PB-388.9-394.1-SC	42	41	17	NA	NA	NA	19PB-388.9-394.1-SCR	27	33	3
19PB-401.1-406.1-SC	68	25	7	NA	NA	NA	19PB-401.1-405.0-SCR	43	47	10
19PB-406.3-407.5-SC	72	25	3	69	28	3	19PB-406.3-408.5-SCR	47	45	8
19PB-407.5-407.9-SC	54	42	4							
19PB-407.9-408.5-SC	75	24	1							
19PB-437.2-441.2-SC	21	69	10	NA	NA	NA	19PB-437.8-441.2-SCR	19	72	9
19PB-450.0-455.1-SC	71	25	4	NA	NA	NA	19PB-450.3-455.1-SCR	41	46	13
19PB-457.2-460.7-SC	50	37	11	NA	NA	NA	19PB-457.2-460.7-SCR	45	42	13
19PB-478.2-481.9-SC	44	41	15	NA	NA	NA	19PB-478.2-481.9-SCR	39	44	17
19PB-481.9-484.4-SC	49	38	13	NA	NA	NA	19PB-481.9-484.4-SCR	45	42	13
19PB-512.1-514.2-SC	38	49	13	NA	NA	NA	19PB-512.1-514.2-SCR			
19PB-517.3-519.4-SC	28	57	15	NA	NA	NA	19PB-517.3-519.4-SCR	38	52	10
19PB-519.4-519.7-SC	52	43	6	67	28	5	19PB-519.4-522.1-SCR	48	40	12
19PB-519.7-522.1-SC	69	26	5							
19PB-547.6-549.6-SC	26	49	25	22	52	26	19PB-547.6-553.3-SCR	38	43	19
19PB-550.7-553.3-SC	19	55	26							
19PB-553.7-554.8-SC	31	50	18	27	53	21	19PB-553.7-557.8-SCR	23	57	20
19OB-554.8-555.2-SC	26	53	20							
19PB-555.2-557.8-SC	25	54	22							
19PB-598.7-601.0-SC	26	59	15	25	59	16	19PB-598.7-602.9-SCR	24	60	16
19PB-601.9-602.9-SC	25	57	18							
19PB-618.9-619.9-SC	16	46	39	22	47	30	19PB-618.9-624.9-SCR	26	56	18
19PB-622.0-622.5-SC	28	56	16							
19PB-622.5-624.0-SC	19	53	27							
19PB-624.0-624.9-SC	32	34	35							

**Table 5.2-1
Laboratory Particle Size Distribution Data,
Summary Statistics for 16P, 27P, and 28P Drill Cuttings Samples**

Well Name	Depth Interval Containing Data (feet)		Number of Samples in Depth Interval	Wet Sieve Parameter	Summary Statistics				
	From	To			Minimum (%)	Maximum (%)	Average (%)	Standard Deviation (%)	Coefficient of Variation
16P	2.5	165	33	Gravel	5	38	21.8	8.3	38
				Sand	40	61	52.3	4.5	9
				Fines	11	55	25.8	11.2	43
27P	2.5	180	36	Gravel	9	42	20.9	7.6	36
				Sand	35	76	57.7	8.8	15
				Fines	6	50	21.4	11.1	52
28P	2.5	240	48	Gravel	8	39	23	8.7	38
				Sand	42	72	57.4	6.6	11
				Fines	5	48	19.6	10.6	54

Table 5.2-2
Laboratory Particle Size Distribution Data,
Summary Statistics for 24P and 29P Drill Cuttings Samples

Well Name	Number of Samples in Depth Interval	Depth Interval Containing Data (feet)		Wet Sieve Parameter	Summary Statistics				
		From	To		Minimum (%)	Maximum (%)	Average (%)	Standard Deviation (%)	Coefficient of Variation
24P	82	2.5	420	Gravel	6.0	47.0	26.6	9.7	36
				Sand	43.0	78.0	59.3	6.3	11
				Fines	3.0	36.0	14.1	7.4	53
29P	64	2.5	320	Gravel	5.0	47.0	31.2	7.6	24
				Sand	42.0	88.0	57.5	8.7	15
				Fines	4.0	19.0	11.3	3.7	33

Table 5.3-1
Hydraulic Conductivity Data from Constant Head Tests in 19PB Piezometers

19PB Piezometer	Test (Sandpack) Interval (feet below ground surface)		Test Number	Water Injection Rate (gallons/minute)	Test Interval Length (feet)	Head of Water Acting on Test Interval ^a (feet)	Radius of Borehole (feet)	Hydraulic Conductivity (centimeters/second)	Average Hydraulic Conductivity (centimeters/second)
	From	To							
Deep	505.1	545.2	1	12.8	40.1	43.6	0.34	3.9E-04	4.8E-04
			2	28.6	40.1	82.9	0.34	5.1E-04	
			3	35.3	40.1	110.8	0.34	5.0E-04	
			4	20.7	40.1	54.3	0.34	5.2E-04	
Shallow	350.0	401.9	1	2.3	51.9	155.6	0.25	2.0E-05	2.0E-05
			2	2.3	51.9	151.0	0.25	2.0E-05	

^aHead is calculated as the applied head above the water table and assumes that the test interval is below the water table. However, the upper approximately 20 feet of the test interval in the shallow screen is above the water table. This fact was ignored in the calculation of applied head on the shallow screen test interval.

**Table 5.3-2
Laboratory Particle Size Distribution Data,
Summary Statistics for 19PB Sonic Core Grab Samples
from both Shallow and Deep Piezometer Sandpack Intervals**

19PB Piezometer	Number of Samples in Depth Interval	Depth Interval Containing Data (feet)		Wet Sieve Parameter	Summary Statistics				
		From	To		Minimum (%)	Maximum (%)	Average (%)	Standard Deviation (%)	Coefficient of Variation
Deep	27	506.0	544.7	Gravel	13.9	73.5	40.8	14.8	36
				Sand	22.5	72.2	45.8	12.5	27
				Fines	3.9	23.5	13.4	4.8	36
Shallow	42	352.4	401.1	Gravel	10.7	80.6	42.9	18.0	42
				Sand	14.8	75.6	44.7	15.5	35
				Fines	3.0	26.5	12.4	5.1	41

Table 5.3-3
 Summary of Average Saturated Hydraulic Conductivity vs. Measurement Scale Data for Site 19 Core and In Situ Tests

Type of Measurement	Well Name	Material Tested	Number of Samples/ Tests	Depth Interval Covered by Tests (feet bgs)		Average Density (g/cm ³)	Average Porosity (cm ³ /cm ³)	Average Volume (Scale Volume) (m ³)	Relative Measurement Scale	Average Saturated Hydraulic Conductivity (m/sec)	
				From	To					Arithmetic Mean	Geometric Mean
Laboratory constant head test on drive core samples	19PB	Alluvium drive core (4 inches in diameter by 6 inches long)	6	389.00	563.07	1.9	0.28	1.1E-03	Smallest	5.0E-08	3.0E-08
Laboratory constant head test on repacked core with an average density of 1.7 g/cm ³	19PB	Alluvium repacked at air dry water content (6 inches in diameter by 12 inches long)	13	388.9	557.8	1.7	0.32	5.6E-03	Small	1.9E-05	1.2E-05
Laboratory constant head test on repacked core with an average density of 1.9 g/cm ³	19PB	Alluvium repacked at optimum water content (6 inches in diameter by 12 inches long)	6	406.3	557.8	1.9	0.26	5.6E-03	Small	3.7E-07	2.5E-07
Field piezometer constant head injection test in shallow and deep screens	19PB	Alluvium formation with volume equal to injected water divided by porosity	2	350.0	545.2	1.9 ^a	0.26	5.6E+00	Intermediate	2.5E-06	9.8E-07
Field 48-hour aquifer constant rate pump test with all screens open (analysis done on upper two screens)	19D	Alluvium formation with volume equal to pumped water divided by porosity	1	408.5	519.0	1.9 ^a	0.26	5.2E+02	Large	2.7E-05	2.7E-05

^a Estimated from borehole geophysical logs.

Table 6.2-1
Summary of Censored Geophysical Logs

Well Name	Record Index Designator (RID) Number	Log Type	Interval (feet)		Reason for Censoring
			From	To	
16P	5482	Acoustic Velocity (Sonic)	880	2898	Tool does not seem to respond properly, or data are over-filtered.
		Moisture	1980	2898	Moisture data are suspect; tool is possibly not functioning properly.
	5485	Density	0	2121	Density data are suspect; tool is possibly not functioning properly.
		Caliper	1300	2121	Tool is not responding properly - possibly dragging on the borehole wall.
28P	5341	Moisture	0	1196.5	Moisture data are suspect; tool is possibly not functioning properly or data are over-filtered.
	5337	Moisture	1120	2050	Moisture data are suspect; tool is possibly not functioning properly or data are over-filtered.
		Density	1120	2050	Density data are suspect; tool is possibly not functioning properly or data are over-filtered.
27P	5536	Moisture	0	1897.7	Moisture data are suspect; tool is possibly not functioning properly or data are over-filtered.
		Density	0	1897.7	Density data are suspect; tool is possibly not functioning properly or data are over-filtered.
		Acoustic Velocity (Sonic)	607	612	Negative travel times are not possible - tool was not functioning properly over this interval.
			622	626	Negative travel times are not possible - tool was not functioning properly over this interval.
29P	5746	Conductivity	345	702	Data unreliable below the water table, as tool was calibrated for the 0 - 15 ohm*m scale.
		Inductive Resistivity	345	702	Data unreliable below the water table, as tool was calibrated for the 0 - 15 ohm*m scale.
		Resistivity (SPR, R8 - R64)	0	702	Data are unreliable.
		Resistivity (R32) - repeat	380	585	Negative resistivity values occur due to tool being run on the "high" scale.
		Resistivity (R64) - repeat	380	585	Negative resistivity values occur due to tool being run on the "high" scale.
		Acoustic Velocity (Sonic)	378	400	Negative travel times are not possible - tool was not functioning properly over this interval.
24P	6031	Acoustic Velocity (Sonic)	465	1595	Sonic data are suspect; tool is possibly not functioning properly.

FIGURES

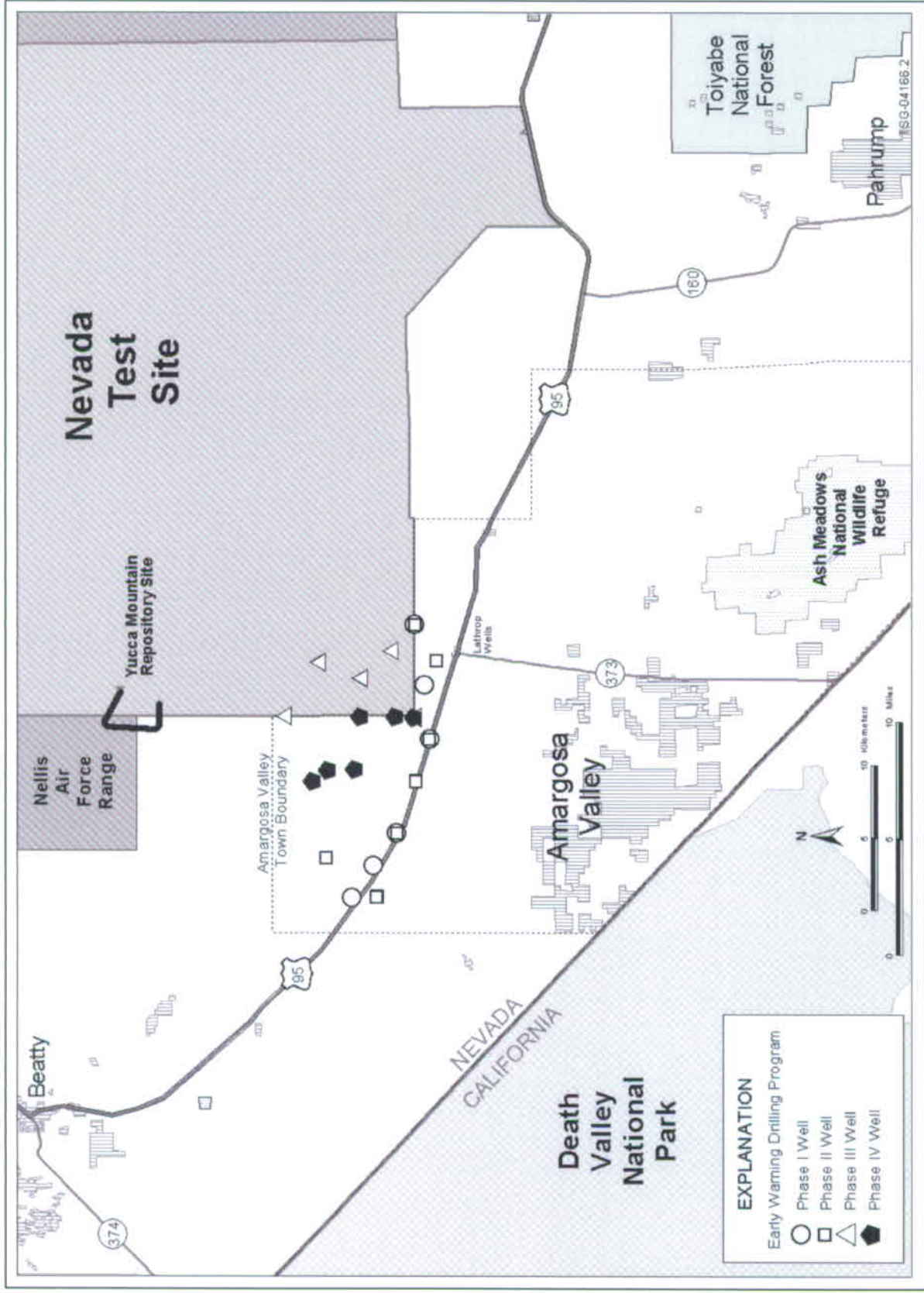
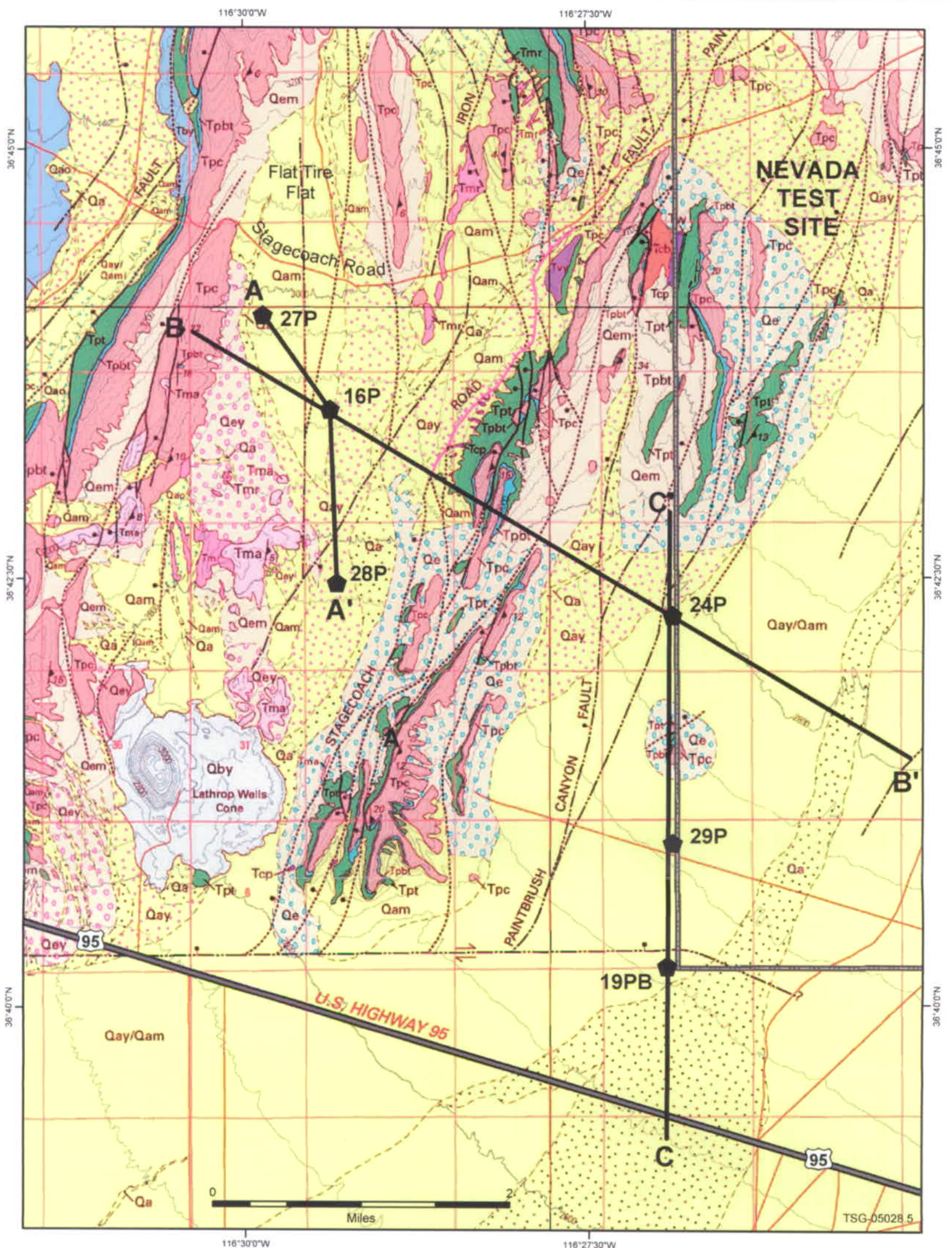

Figure 1.1-1
Early Warning Drilling Program Region



EXPLANATION

Early Warning Drilling Program Well by Drilling Phase



Phase IV

Cross Section Transect



- Bedrock contact - Solid where exposed, dashed where approximately located, dotted where concealed beneath Quaternary cover
- Contact between Quaternary surficial deposits
- Fault scarp in surficial deposits - Hachures on downthrown side
- Fault - Solid where exposed or tightly constrained; dashed where approximately located; dotted where concealed beneath Quaternary cover. Ball and bar on downthrown side. Opposed arrows indicate relative movement where known.
- Fault located from geophysical methods - Ball and bar on downthrown side. Opposed arrows indicate relative movement where known.
- Strike and dip of bedding - Inclined - measured in field
- Strike and dip of compaction foliation in welded tuff

Source: Potter and others, 1992

	Alluvium (Holocene)
	Younger alluvium (Holocene and late Pleistocene)
	Alluvium (late and middle Pleistocene)
	Older alluvium (middle and early Pleistocene)
	Eolian sand and fragments (Holocene and late Pleistocene)
	Eolian-colluvial ramp deposits (Holocene to middle Pleistocene)
	Younger Quaternary basalt (late Pleistocene)
	Older Quaternary basalt (early Pleistocene)
	Younger Tertiary basalt of Crater Flat (Pliocene)
	Younger volcanic rocks (Pliocene to Miocene)
Timber Mountain Group (Miocene)	
	Ammonia Tanks Tuff
	Rainier Mesa Tuff—includes rhyolite of Fluorspar Canyon
Paintbrush Group (Miocene)	
	Intracaldera and caldera margin megabreccia and mesobreccia
	Rhyolite of Comb Peak
	Rhyolite of Vent Pass
	Tuff of Pinyon Pass
	Tiva Canyon Tuff
	Bedded tuff
	Topopah Spring Tuff
	Wahmonie Formation (Miocene)
Crater Flat Group (Miocene)	
	Prow Pass Tuff
	Bullfrog Tuff
	Pre-Bullfrog Tuff bedded tuff

Figure 1.3-2
Geologic Map of the Yucca Mountain Area with Cross Section Locations

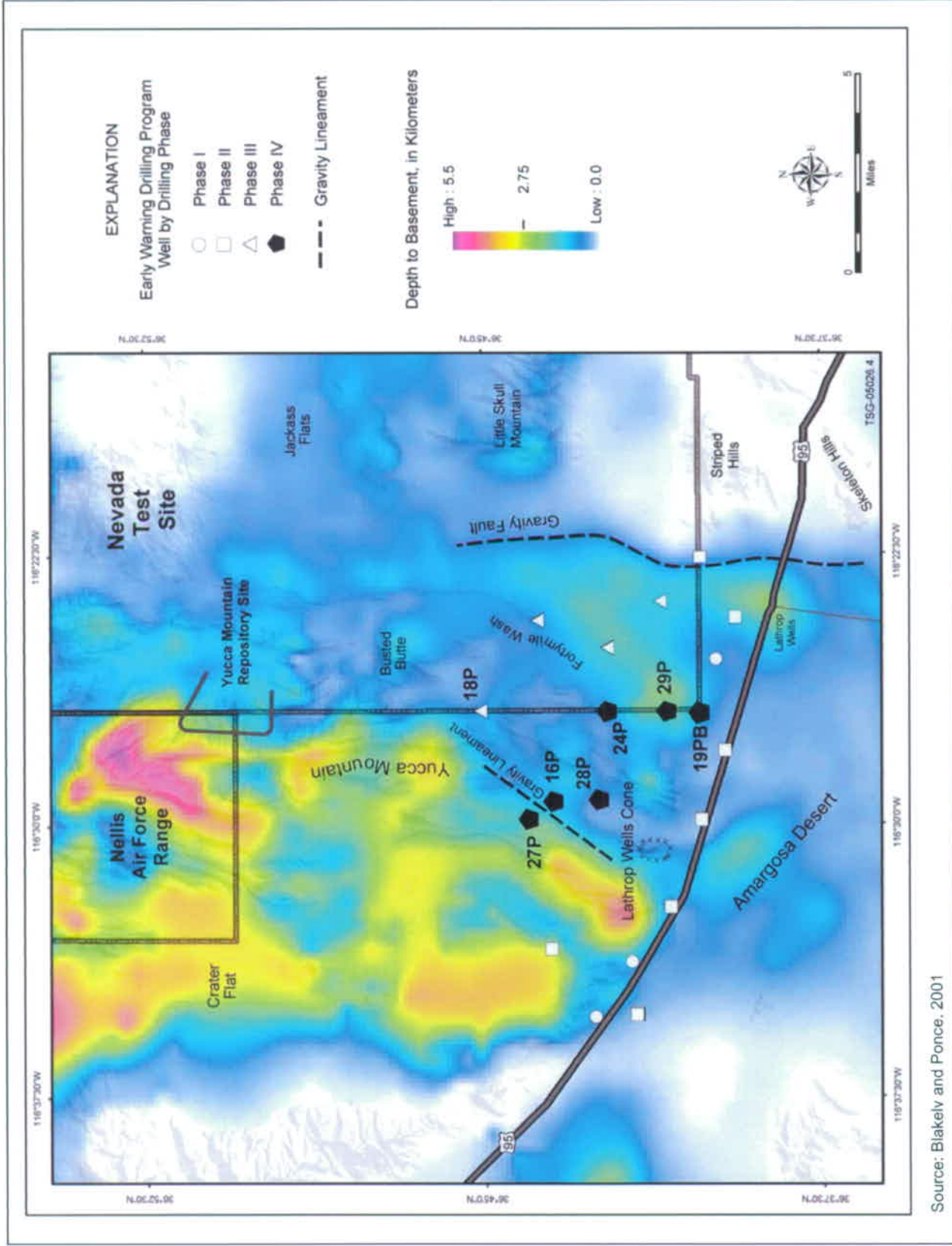

Source: Blakely and Ponce, 2001

Figure 1.3-3
Depth to Paleozoic-Age Basement Rocks

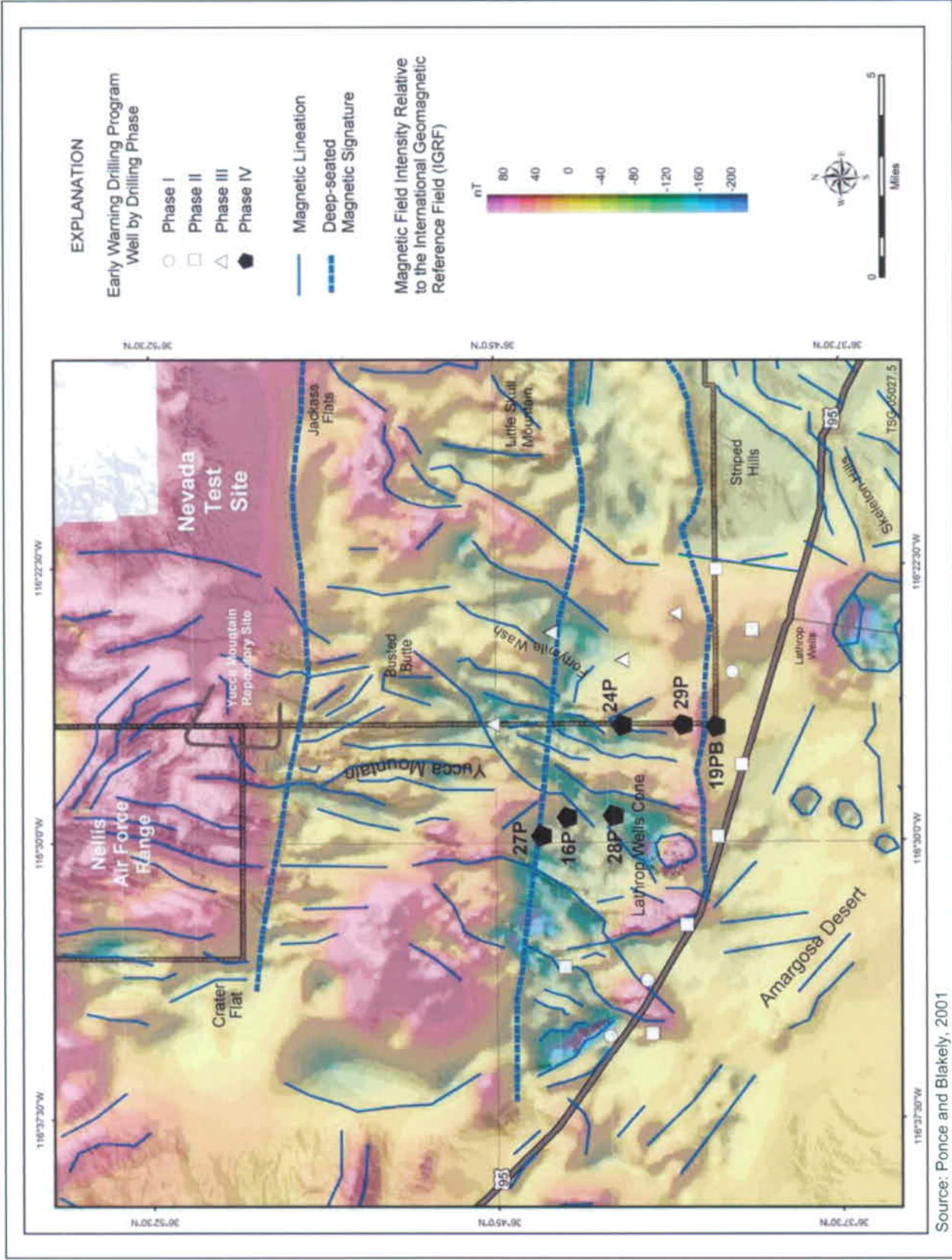

Source: Ponce and Blakely, 2001

Figure 1.3-4
Aeromagnetic Survey Map

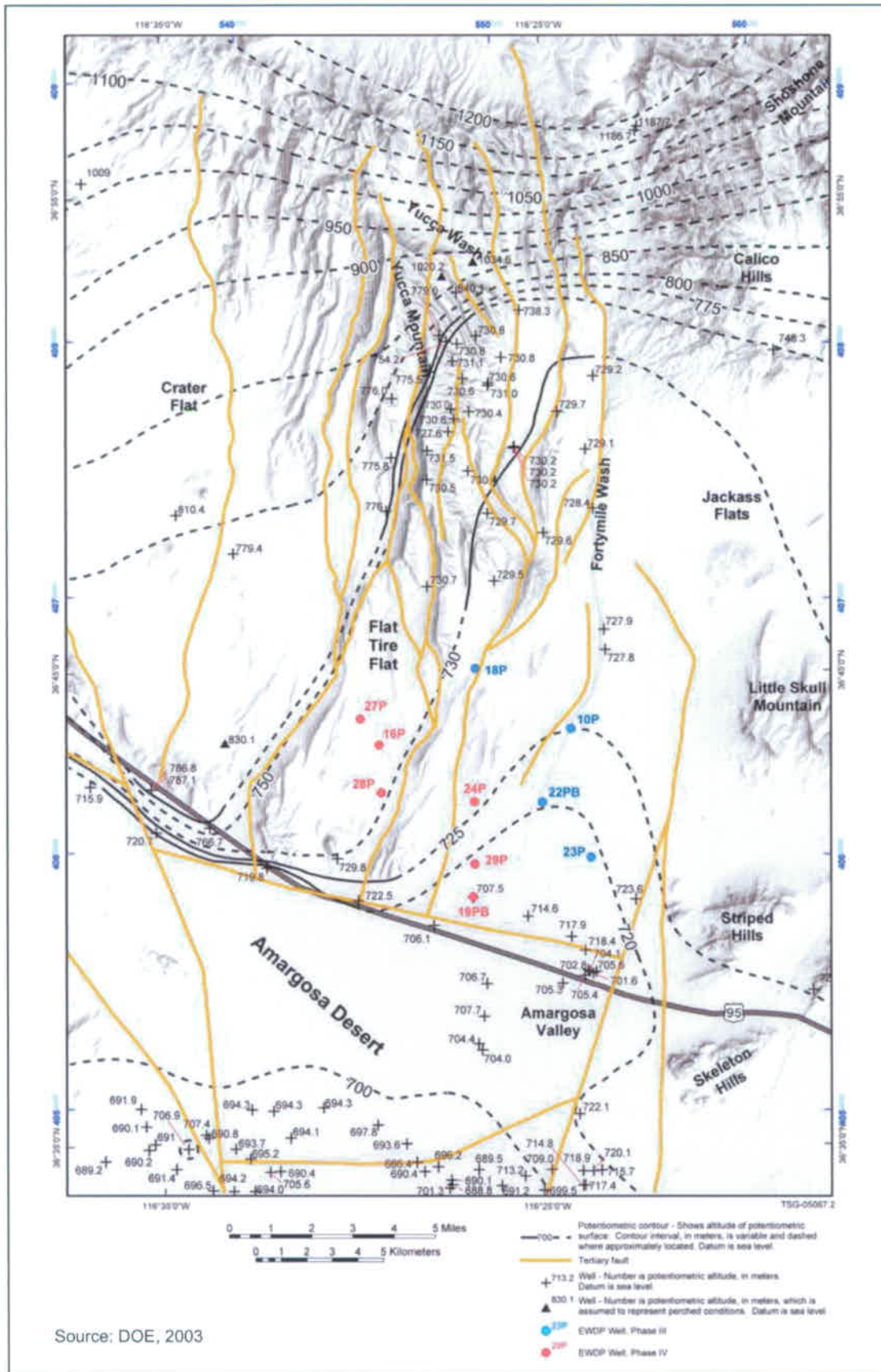
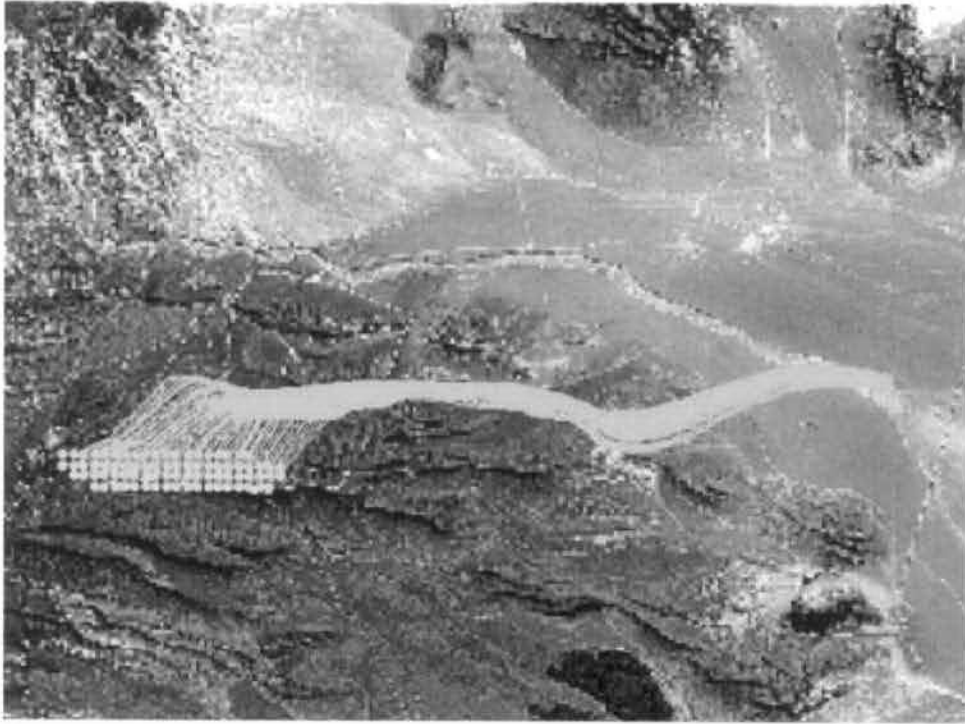

Figure 1.3-5
Potentiometric Surface Map of the Yucca Mountain/Amargosa Desert Area



Modeled flowpaths for original model with Case 2 recharge rates

Source: (Winterle, CNWIRA)



Modeled flowpaths for potential climate change scenario

Figure 1.3-6
Modeled Potential Groundwater Flowpaths from the Yucca Mountain Repository

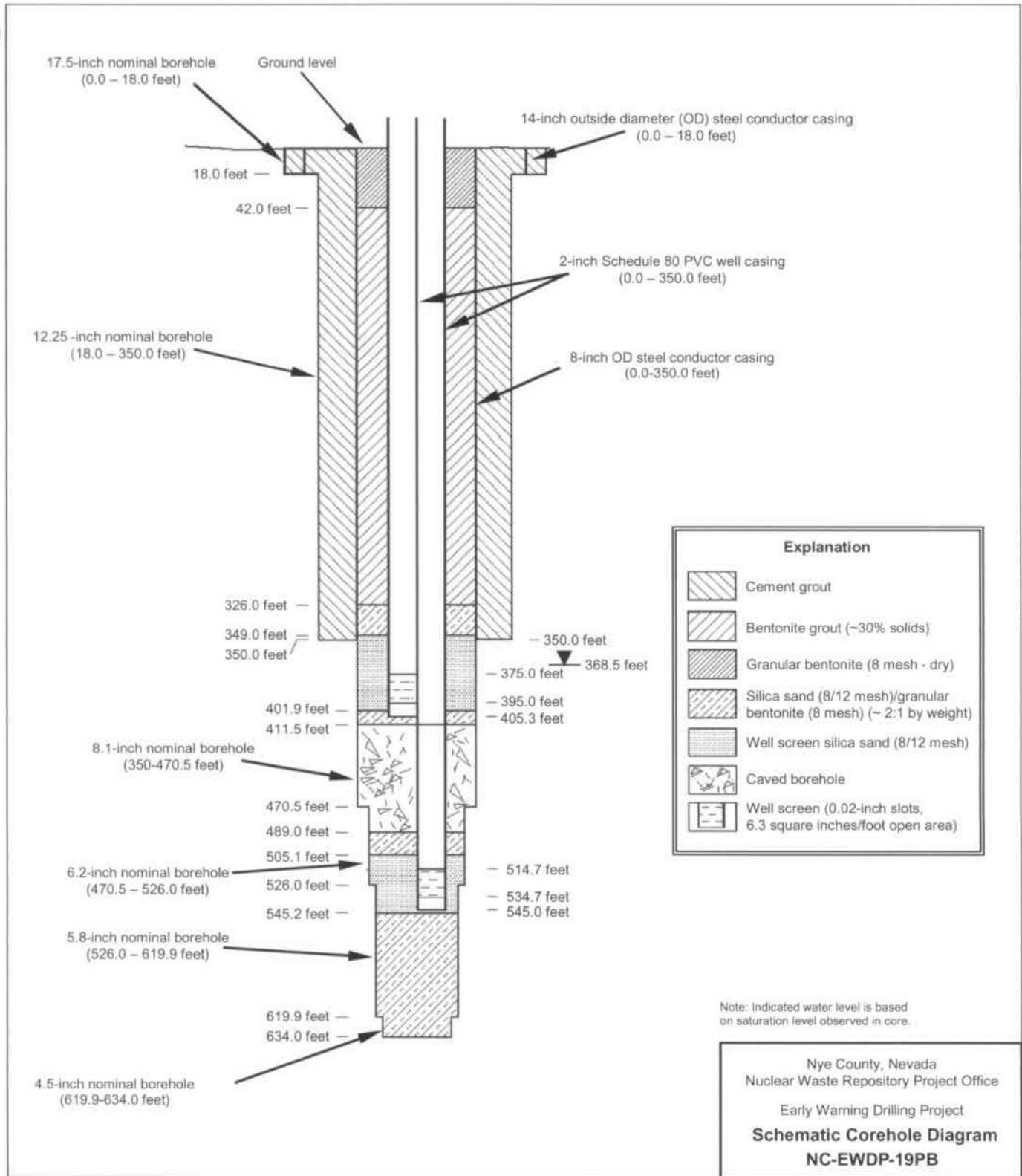

Figure 3.1-1
 Schematic Dual-String Piezometer Completion Diagram for 19PB

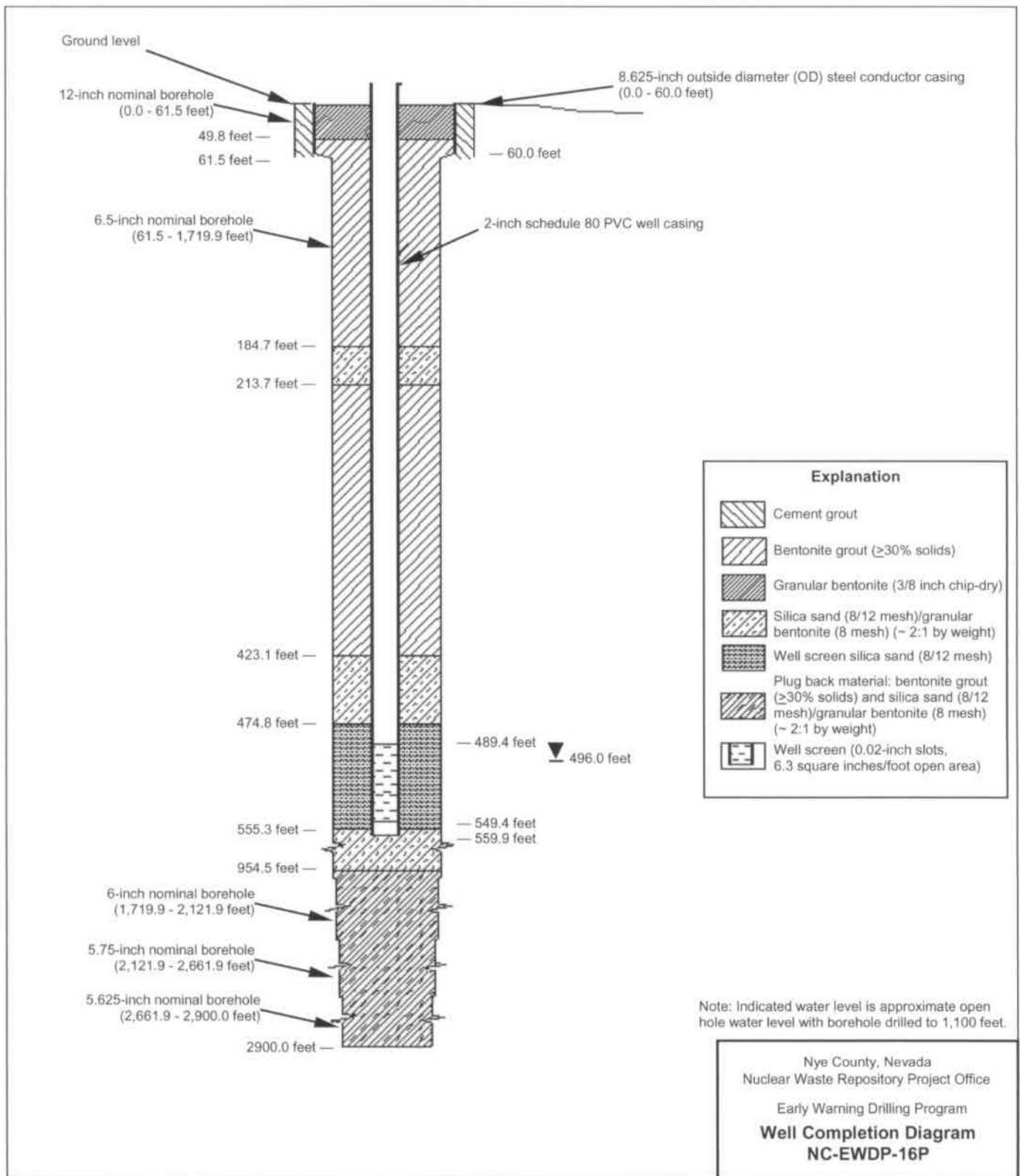

Figure 3.1-2
Schematic Single-String Piezometer Completion Diagram for 16P

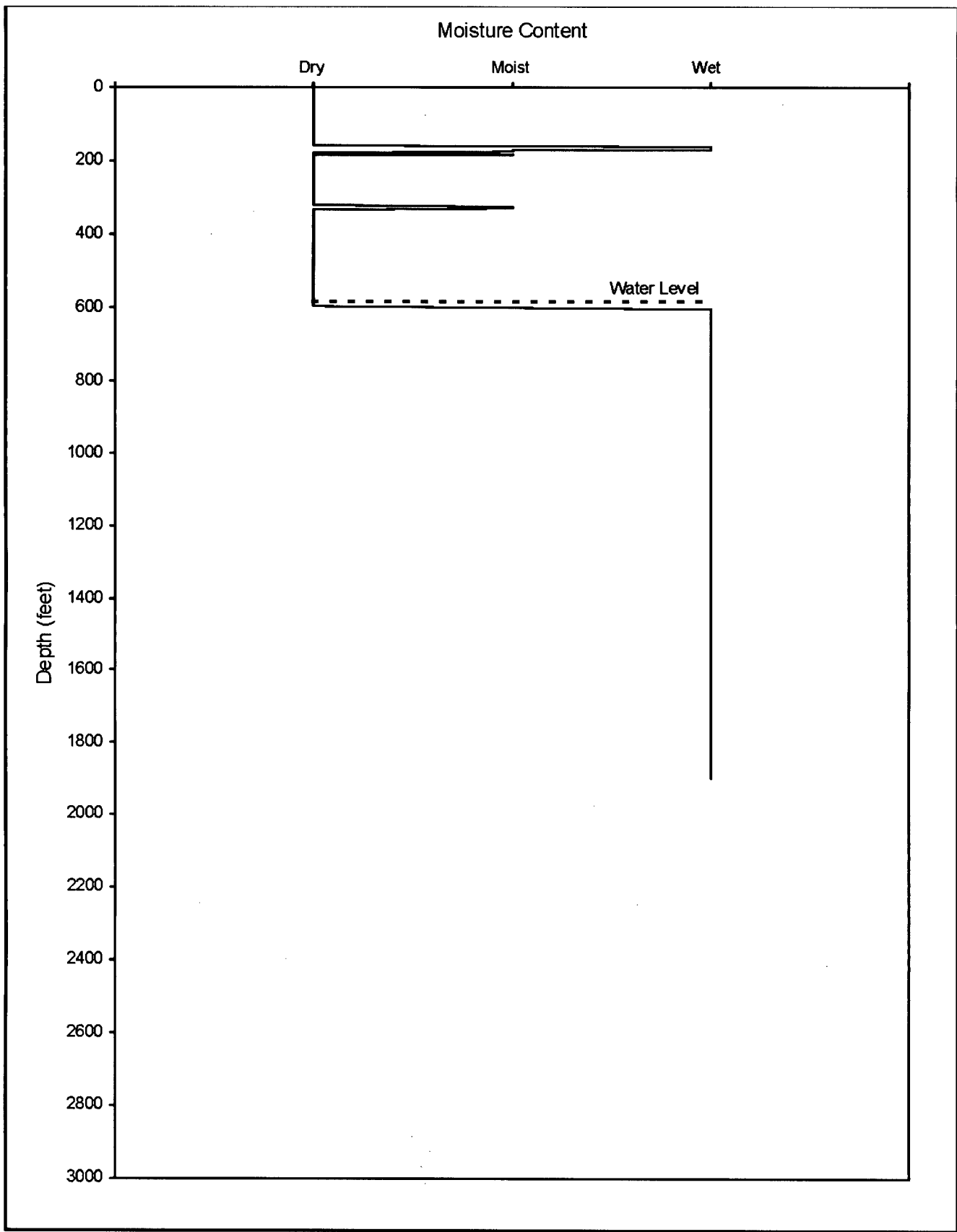

Figure 4.1-1
Moisture Content vs. Depth for 27P Drill Cuttings Samples

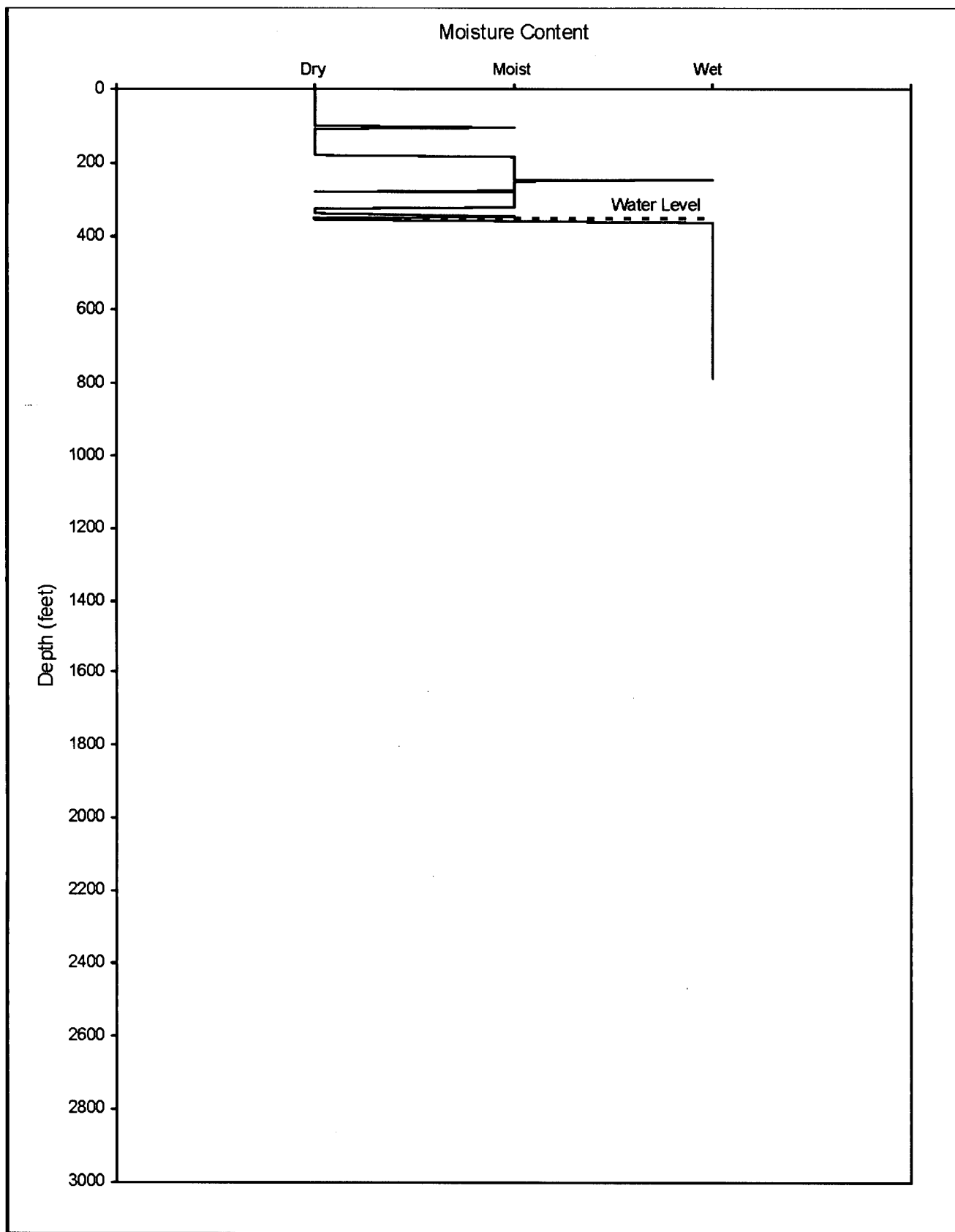

Figure 4.1-2
Moisture Content vs. Depth for 29P Drill Cuttings Samples

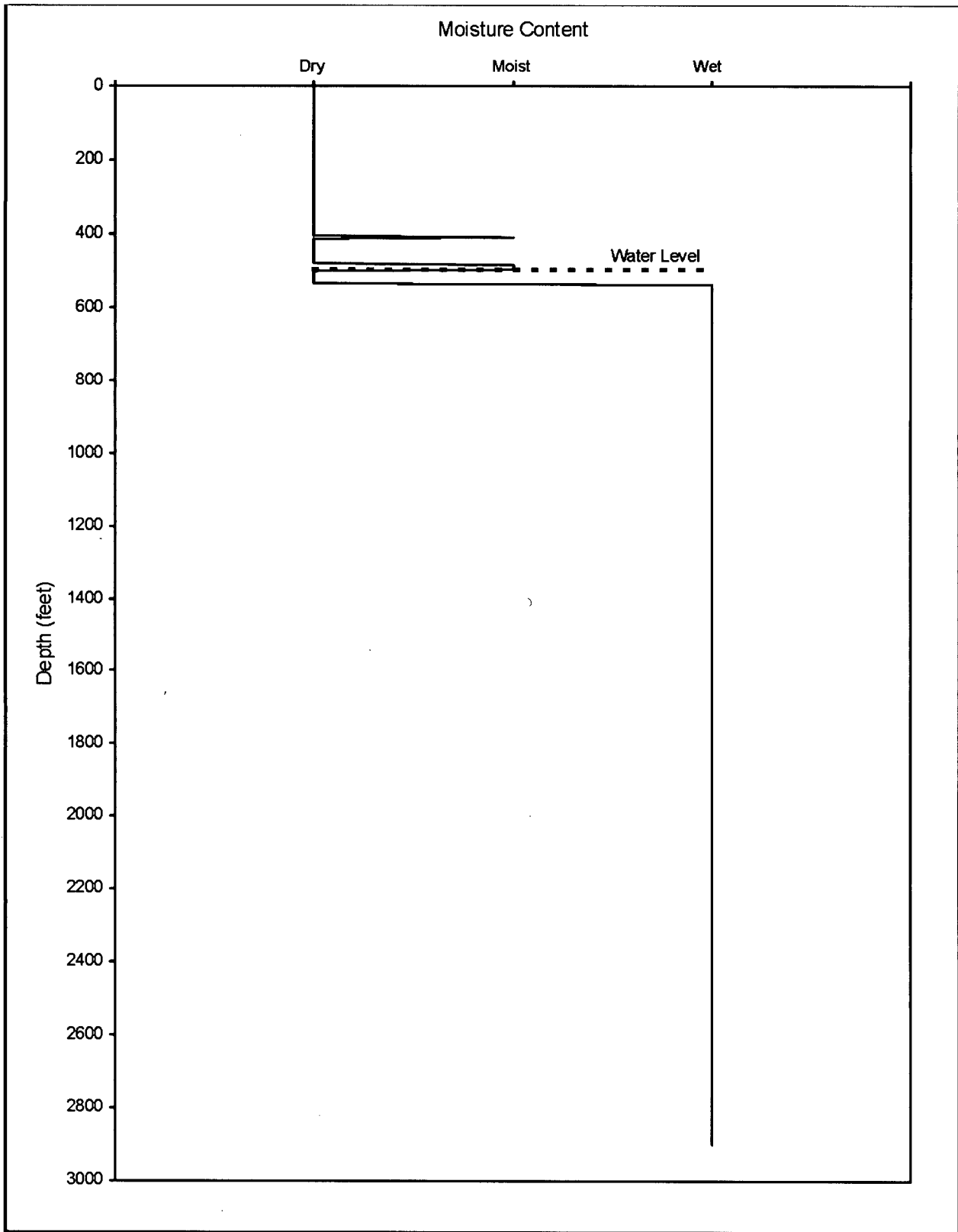

Figure 4.1-3
Moisture Content vs. Depth for 16P Drill Cuttings Samples

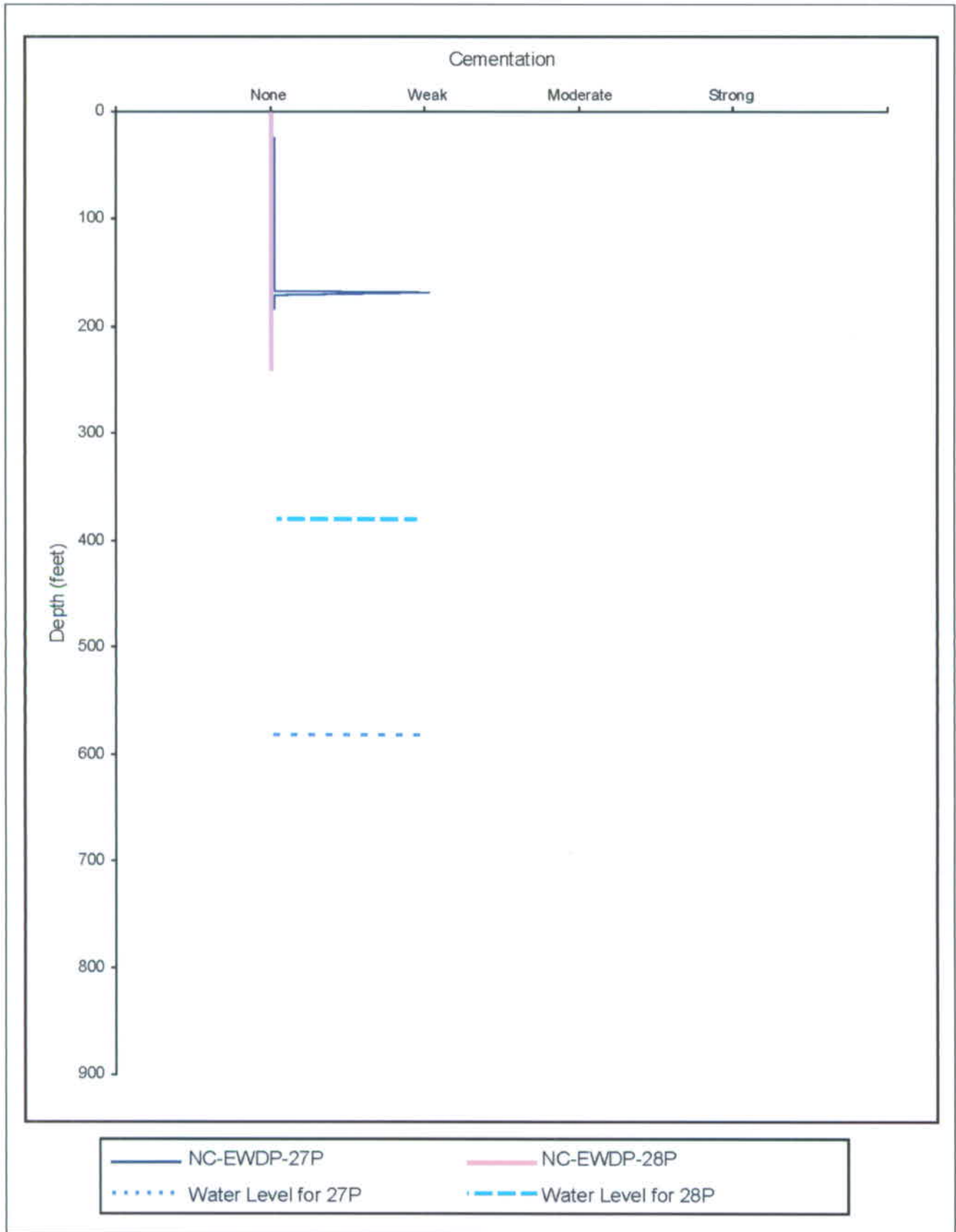

Figure 4.1-4
Cementation vs. Depth for 27P and 28P Alluvial Drill Cuttings Samples

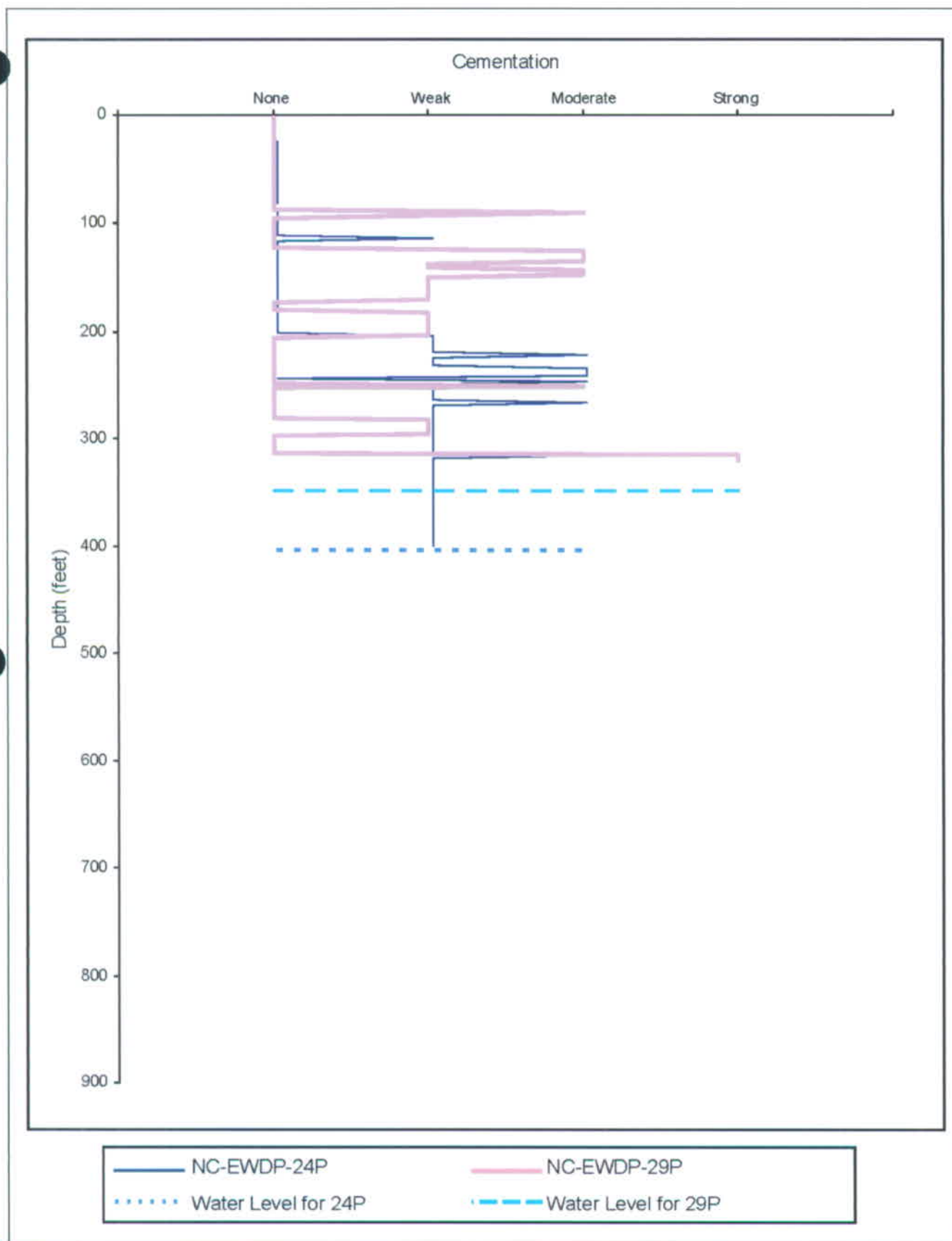

Figure 4.1-5
Cementation vs. Depth for 24P and 29P Alluvial Drill Cuttings Samples

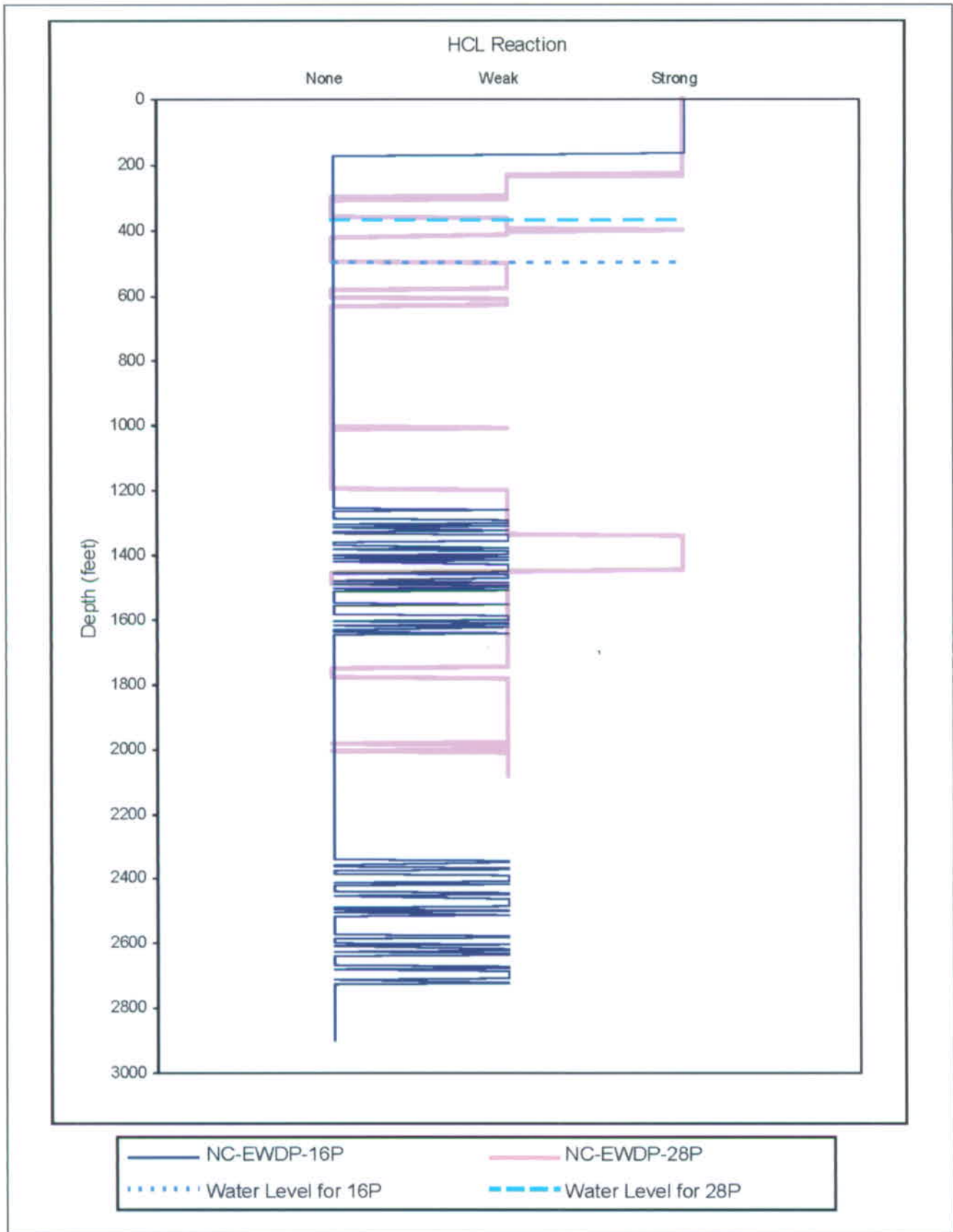

Figure 4.1-6
Hydrochloric Acid Reaction vs. Depth for 16P and 28P Drill Cuttings Samples

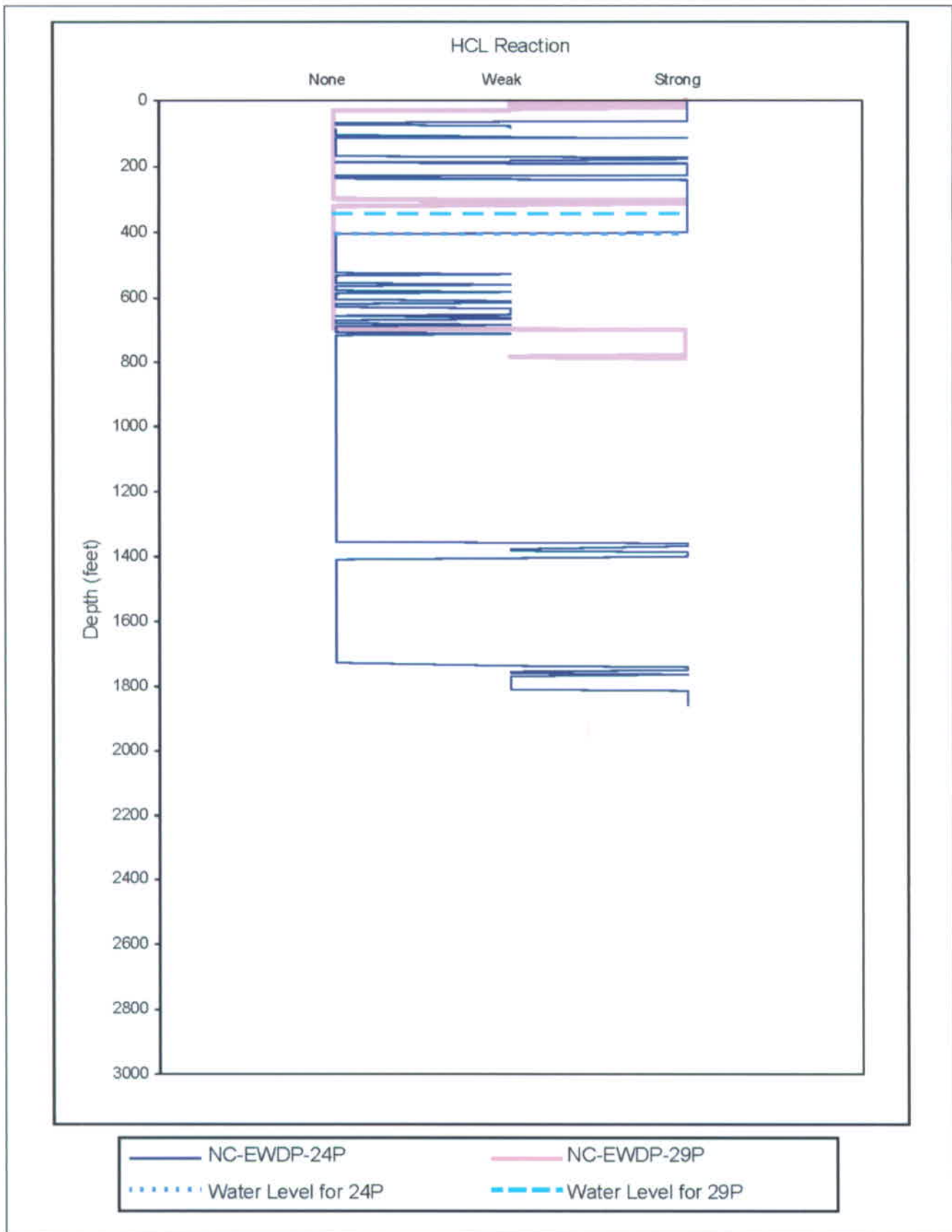

Figure 4.1-7
Hydrochloric Acid Reaction vs. Depth for 24P and 29P Drill Cuttings Samples

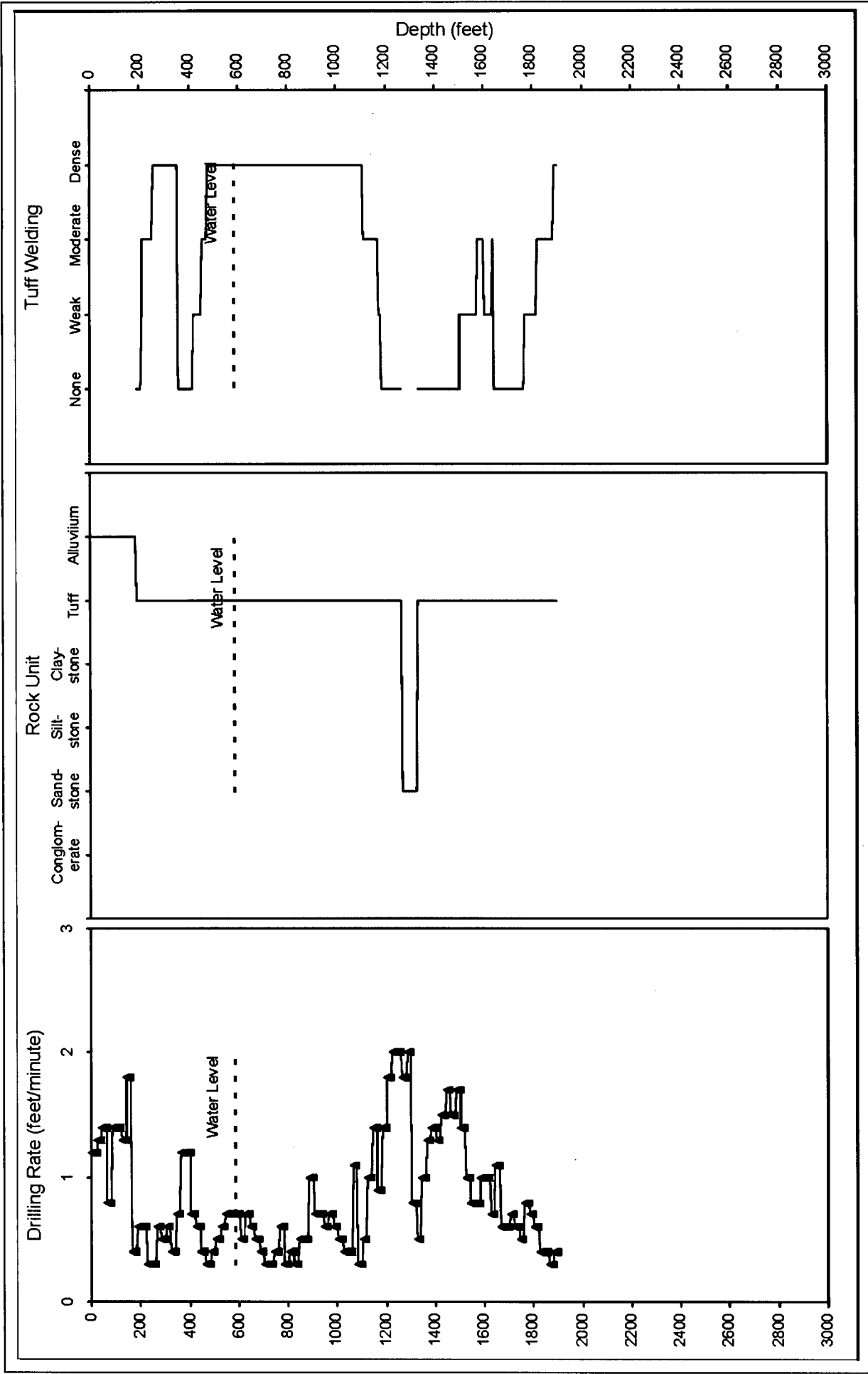

Figure 4.1-8
Drilling Rate, Rock Unit, and Tuff Welding vs. Depth for 27P

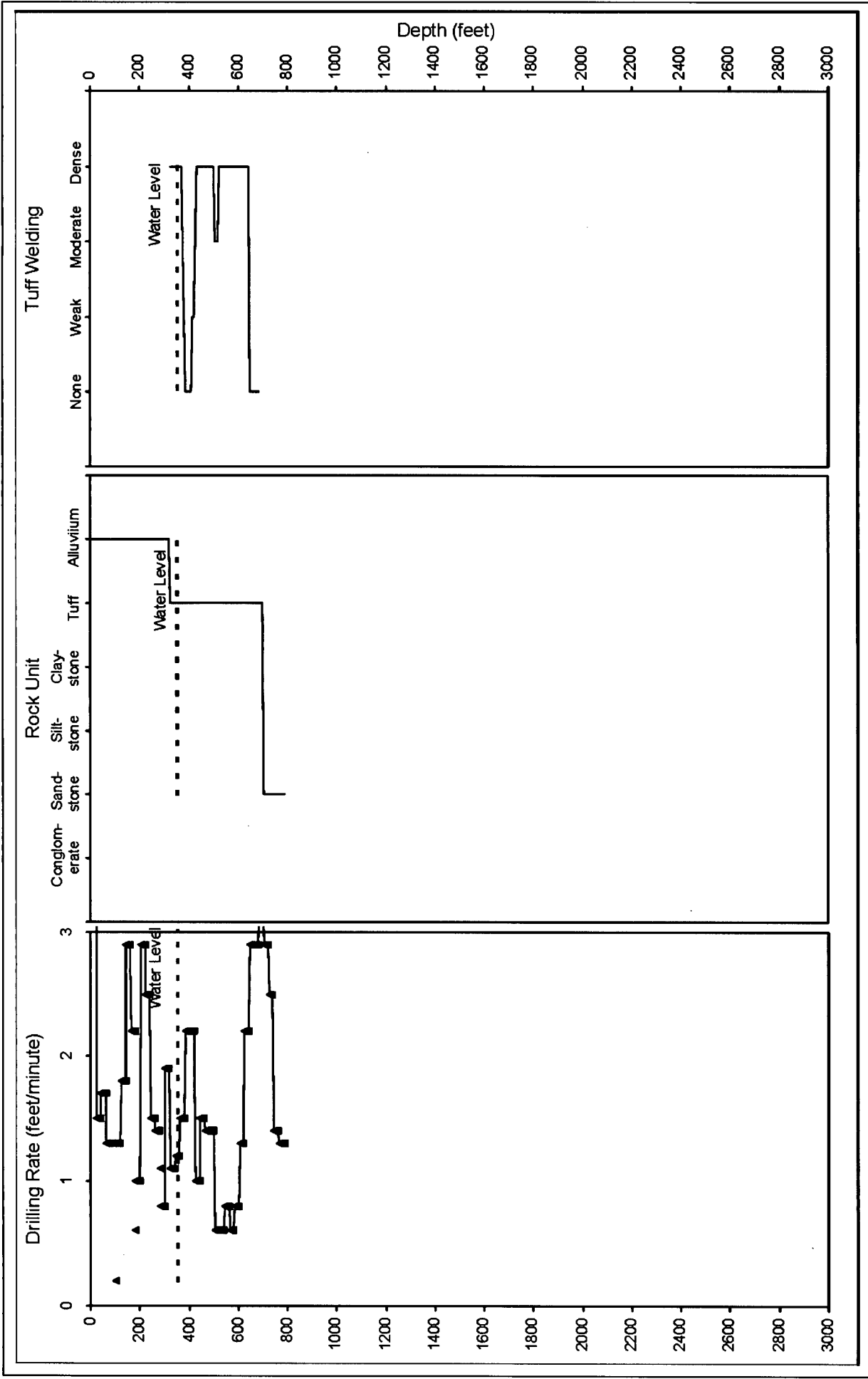

Figure 4.1-9
Drilling Rate, Rock Unit, and Tuff Welding vs. Depth for 29P

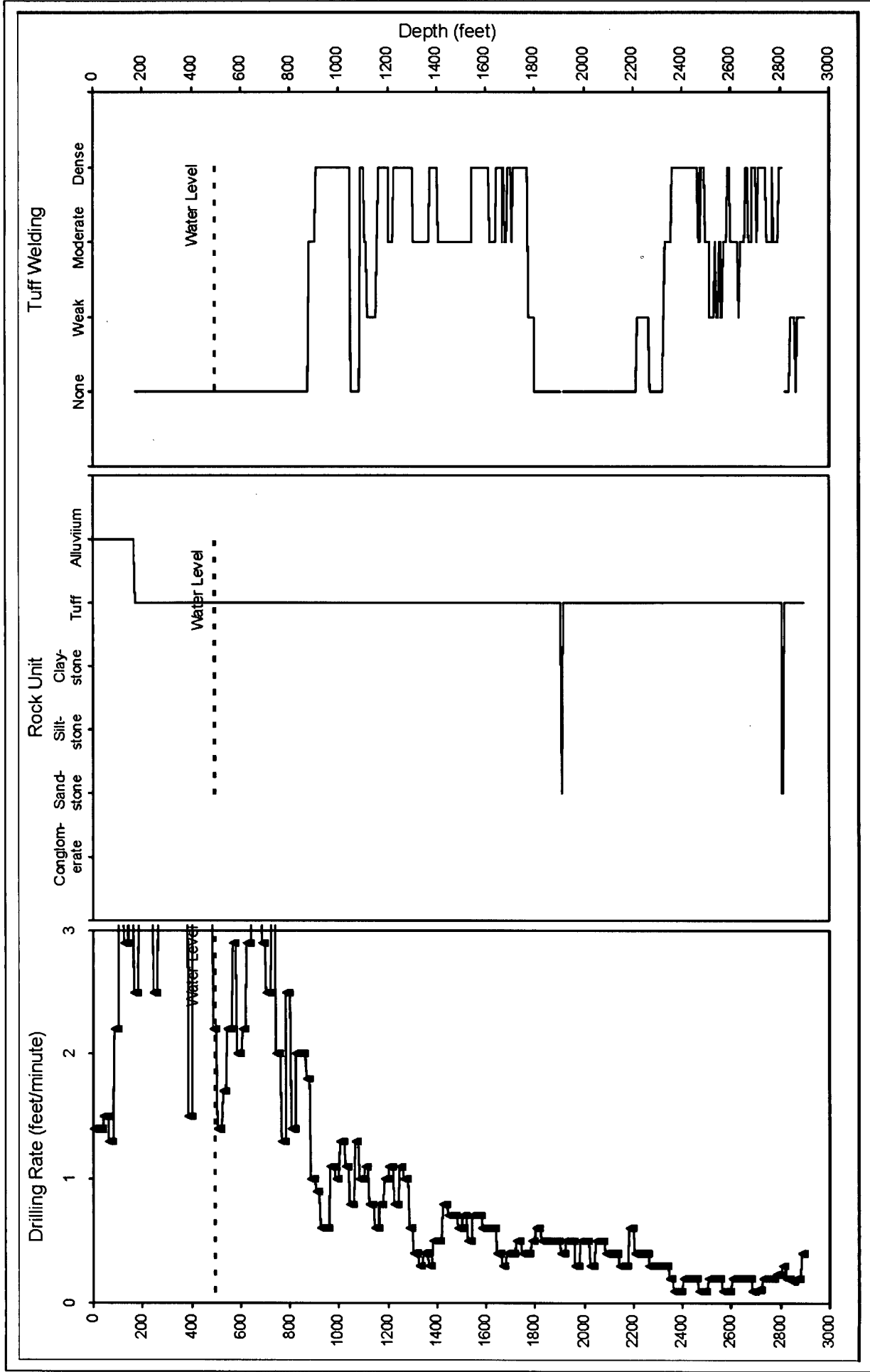

Figure 4.1-10
Drilling Rate, Rock Unit, and Tuff Welding vs. Depth for 16P

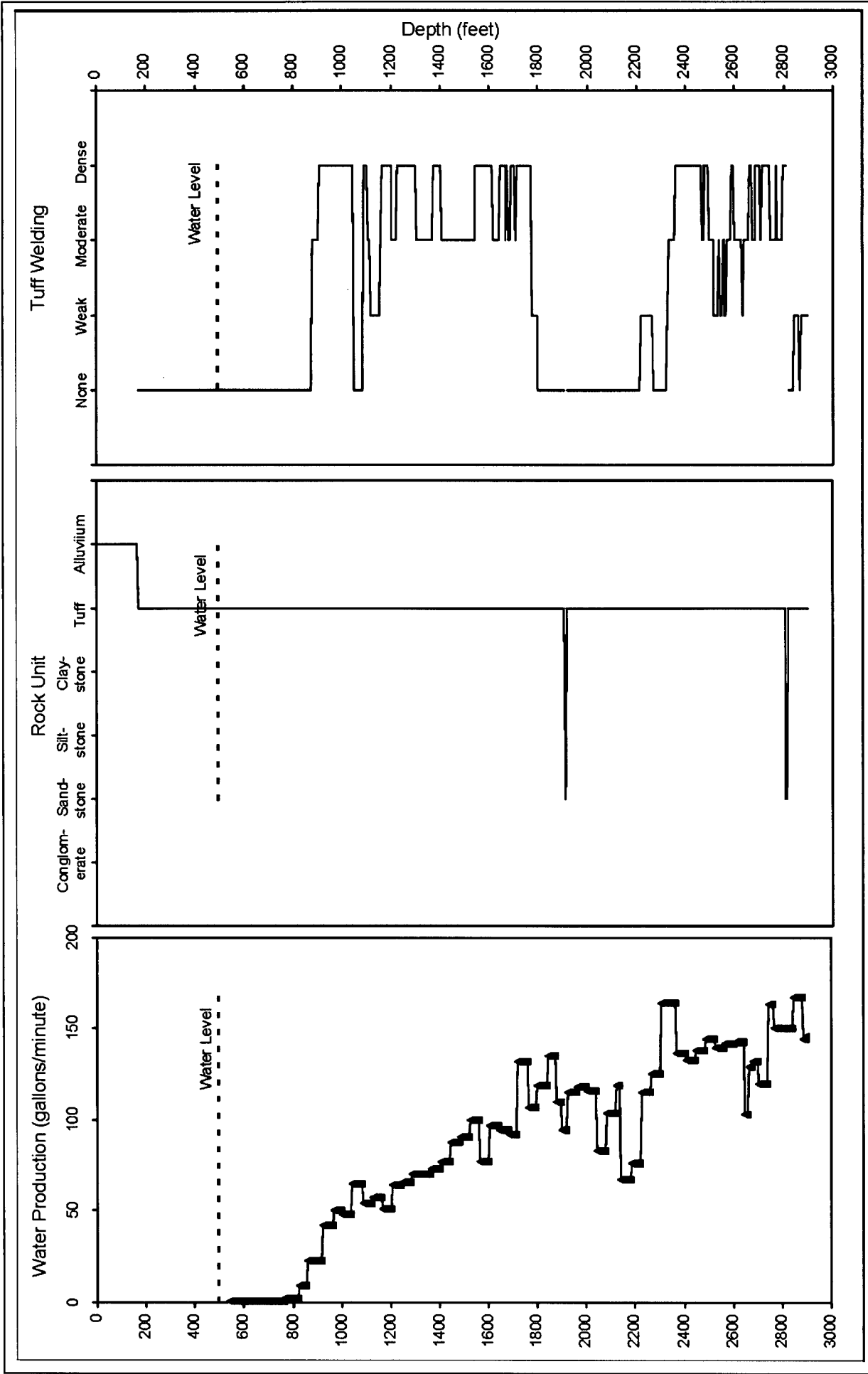

Figure 4.1-11
Water Production, Rock Unit, and Tuff Welding vs. Depth for 16P

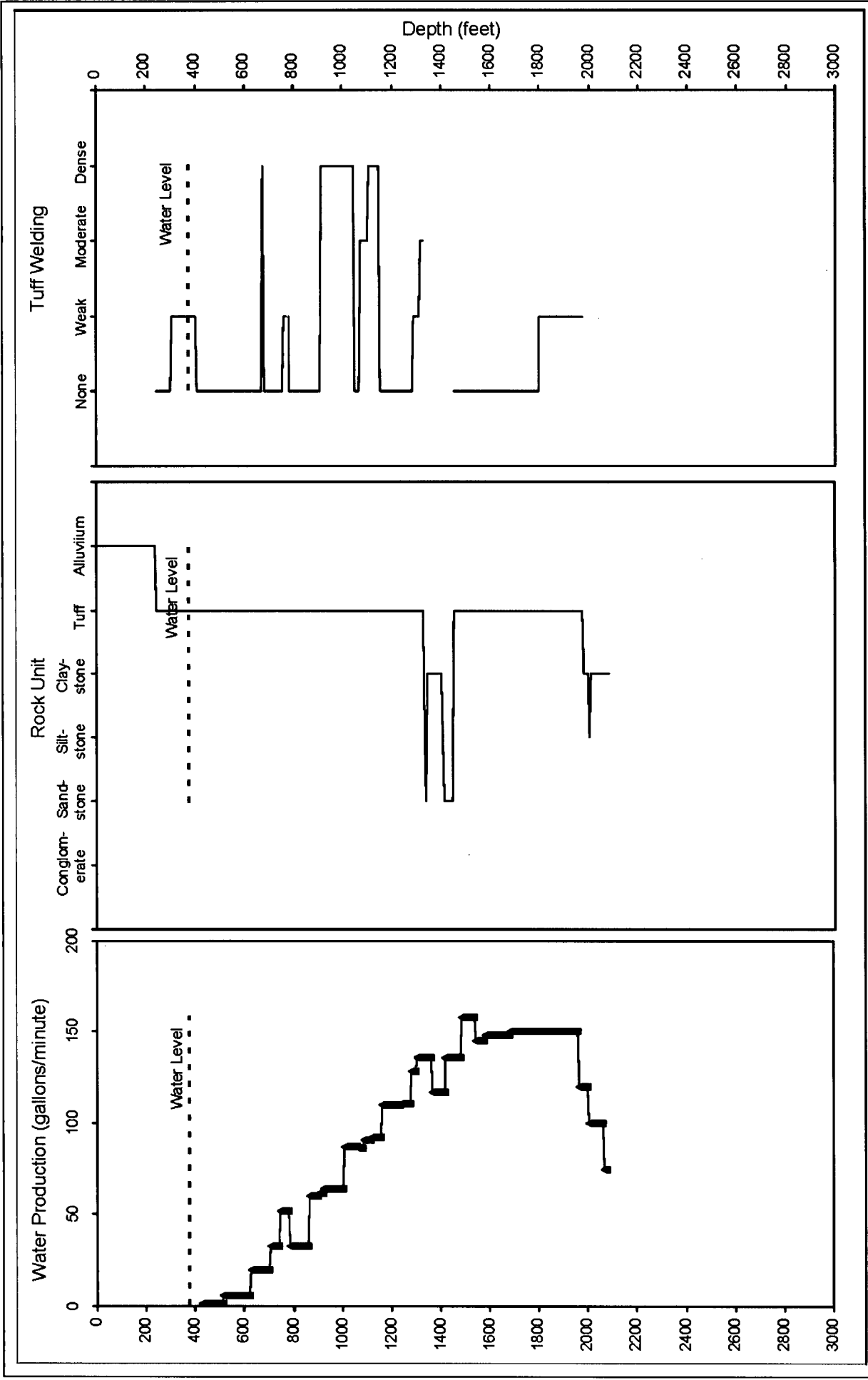

Figure 4.1-12
Water Production, Rock Unit, and Tuff Welding vs. Depth for 28P

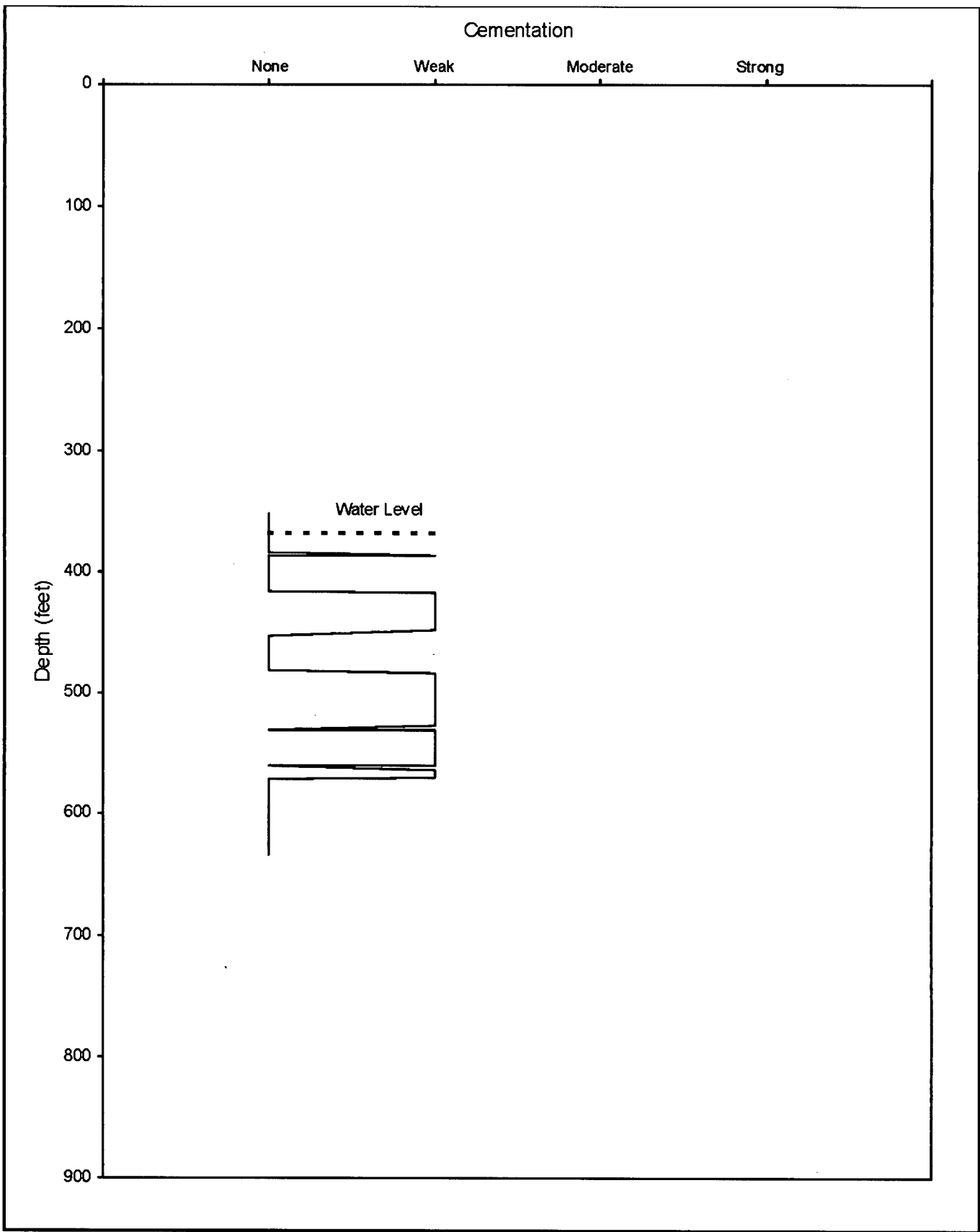

Figure 4.2-1
Cementation vs. Depth for 19PB Alluvial Sonic Grab Core Samples

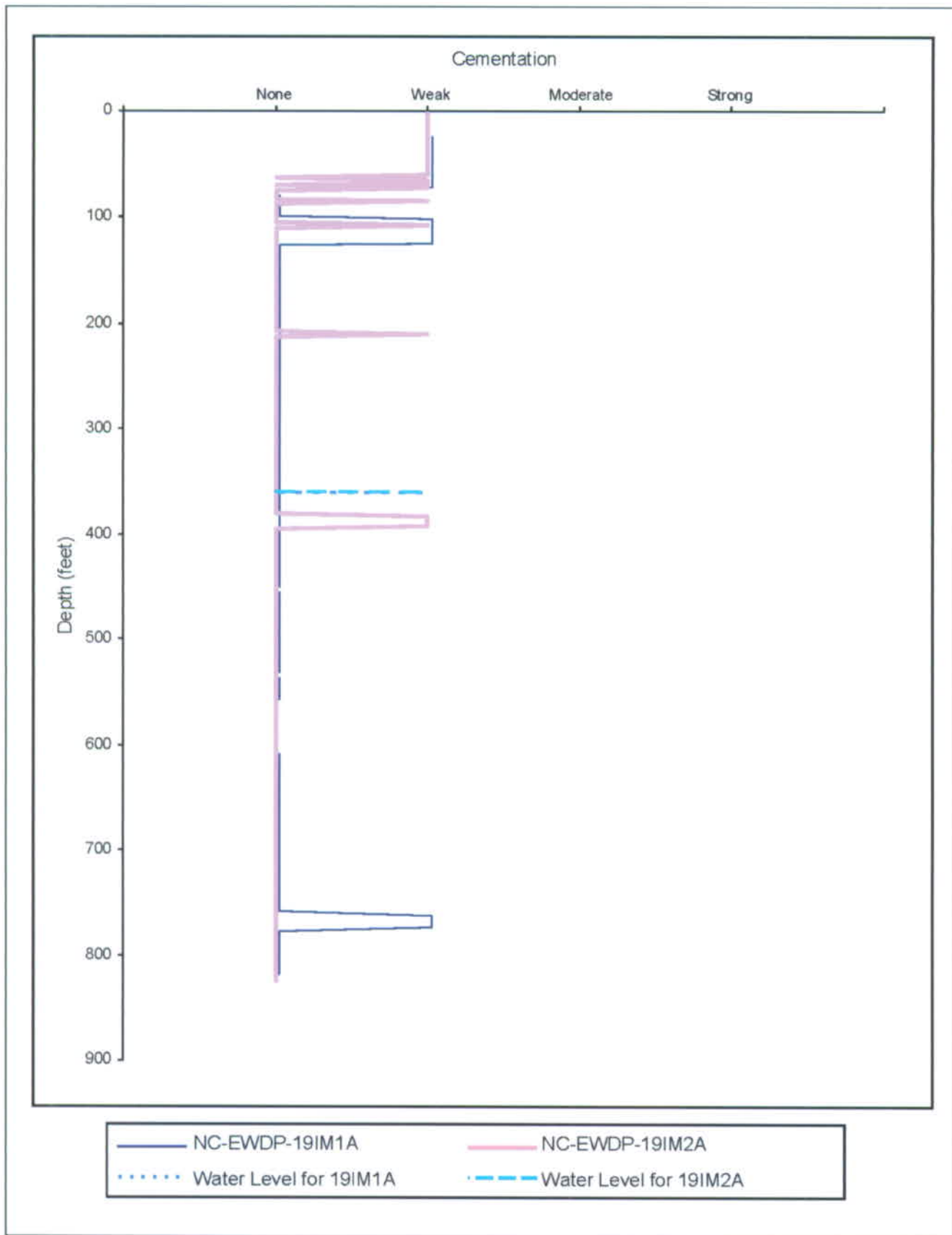

Figure 4.2-2
Cementation vs. Depth for 19IM1A and 19IM2A Alluvial Drill Cuttings Samples

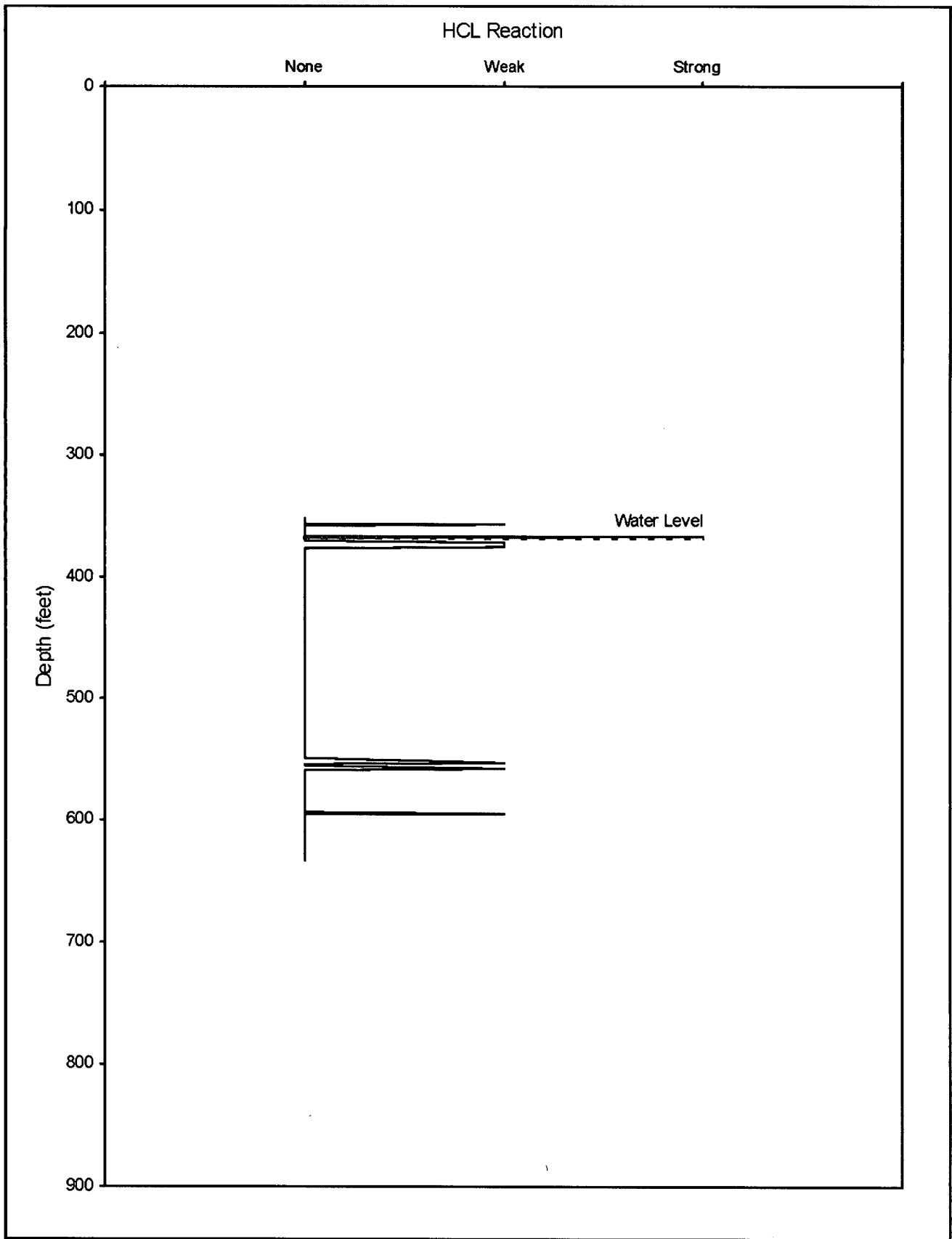

Figure 4.2-3
Hydrochloric Acid Reaction vs. Depth for 19PB Alluvial Sonic Grab Core Samples

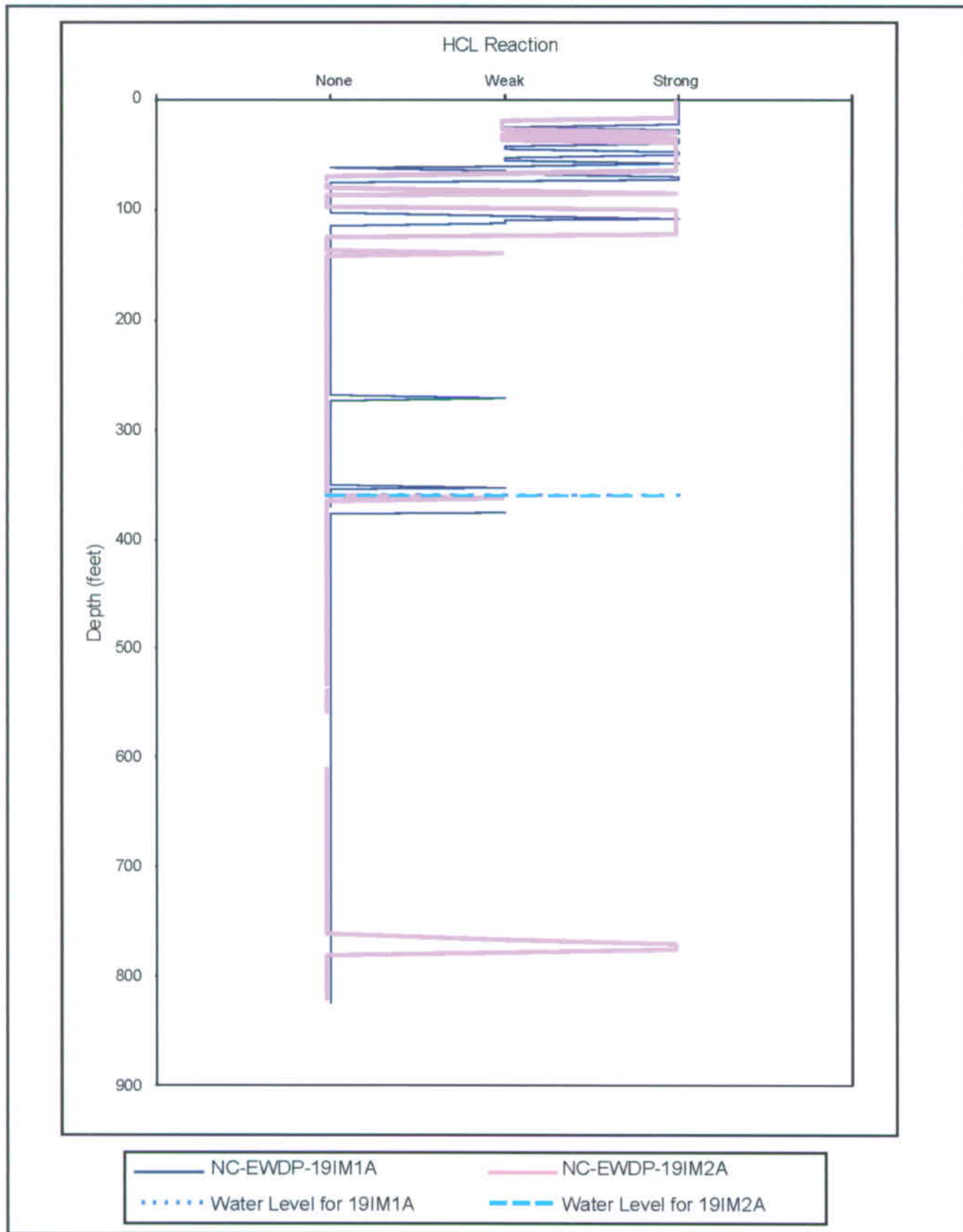

Figure 4.2-4
Hydrochloric Acid Reaction vs. Depth for 19IM1A and 19IM2A Alluvial Drill Cuttings Samples

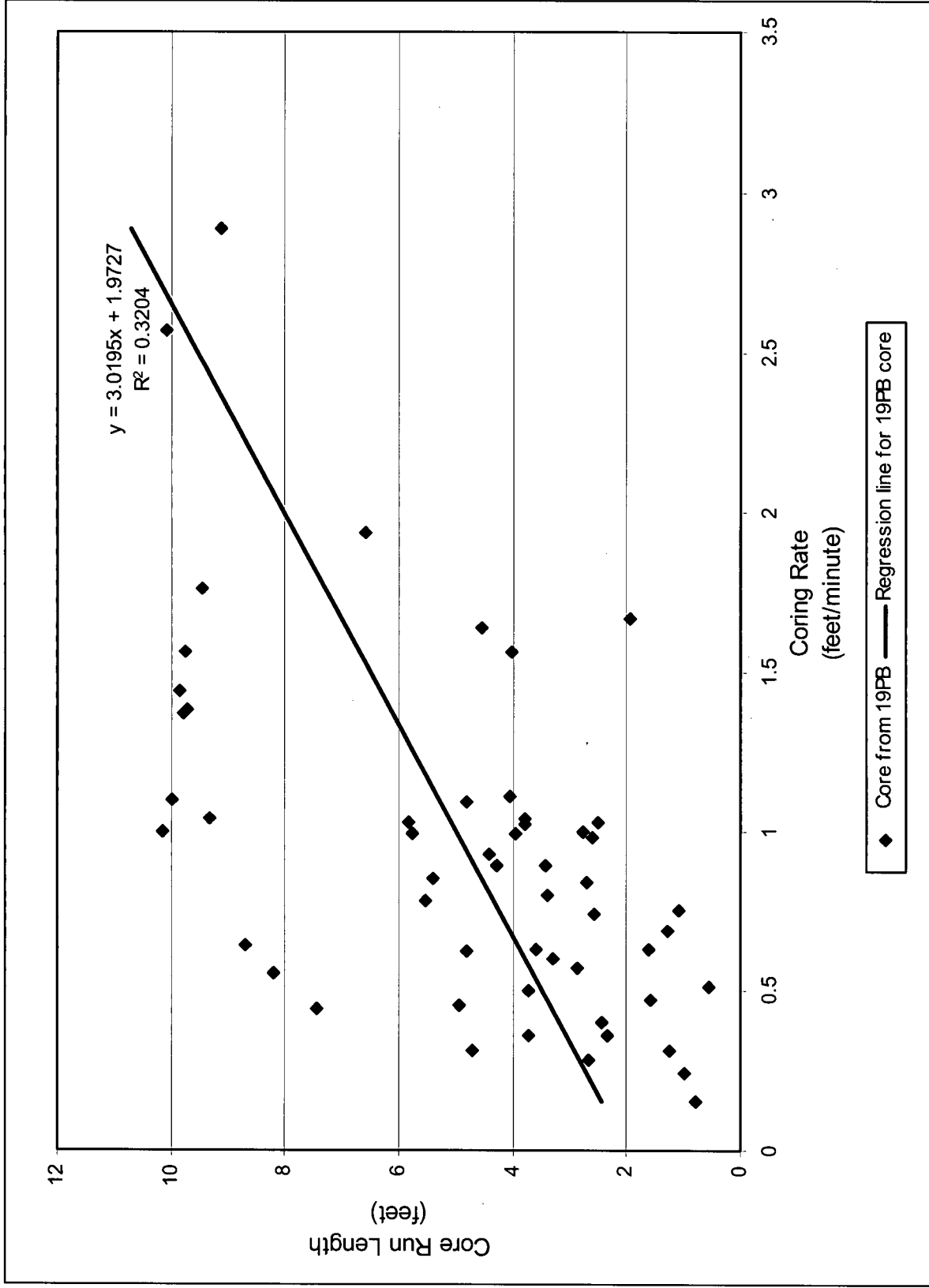

Figure 4.2-5
Coring Rate vs. Run Length for 19PB



Figure 4.2-6
Example of Sample Disturbance in 19PB Sonic Core Segments

Cobbles and coarser gravel to finer gravel at 456.6 feet.



Increase in fines at 581.1 feet.



Cobbles and gravel from 570.5 to 570.9 feet.



Figure 4.2-7
Examples of Textural Layers in 19PB Sonic Core Segments

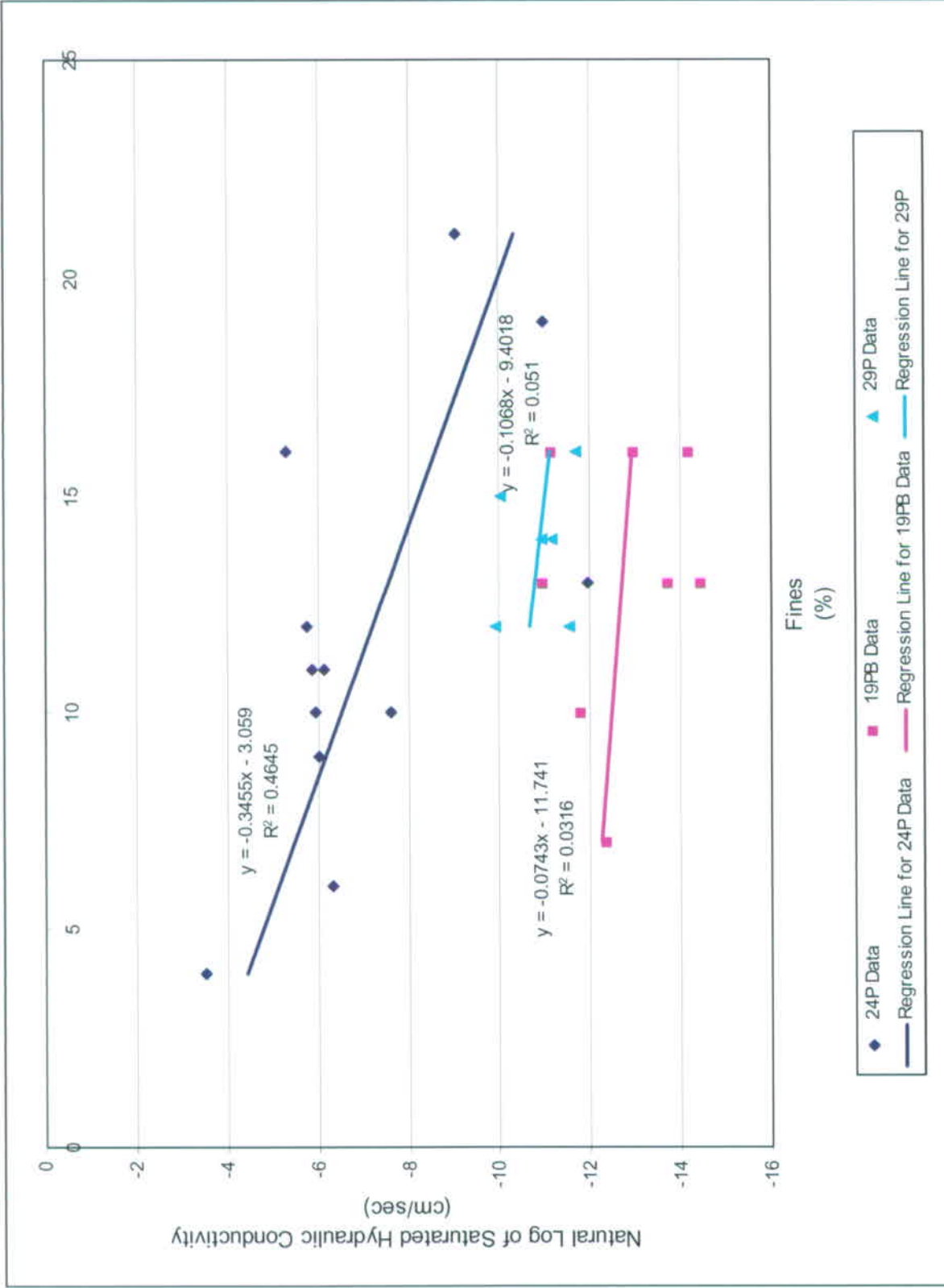

Figure 5.1-1 Saturated Hydraulic Conductivity vs. Percentage of Fines for 24P, 29P, and 19PB Drive Core Samples

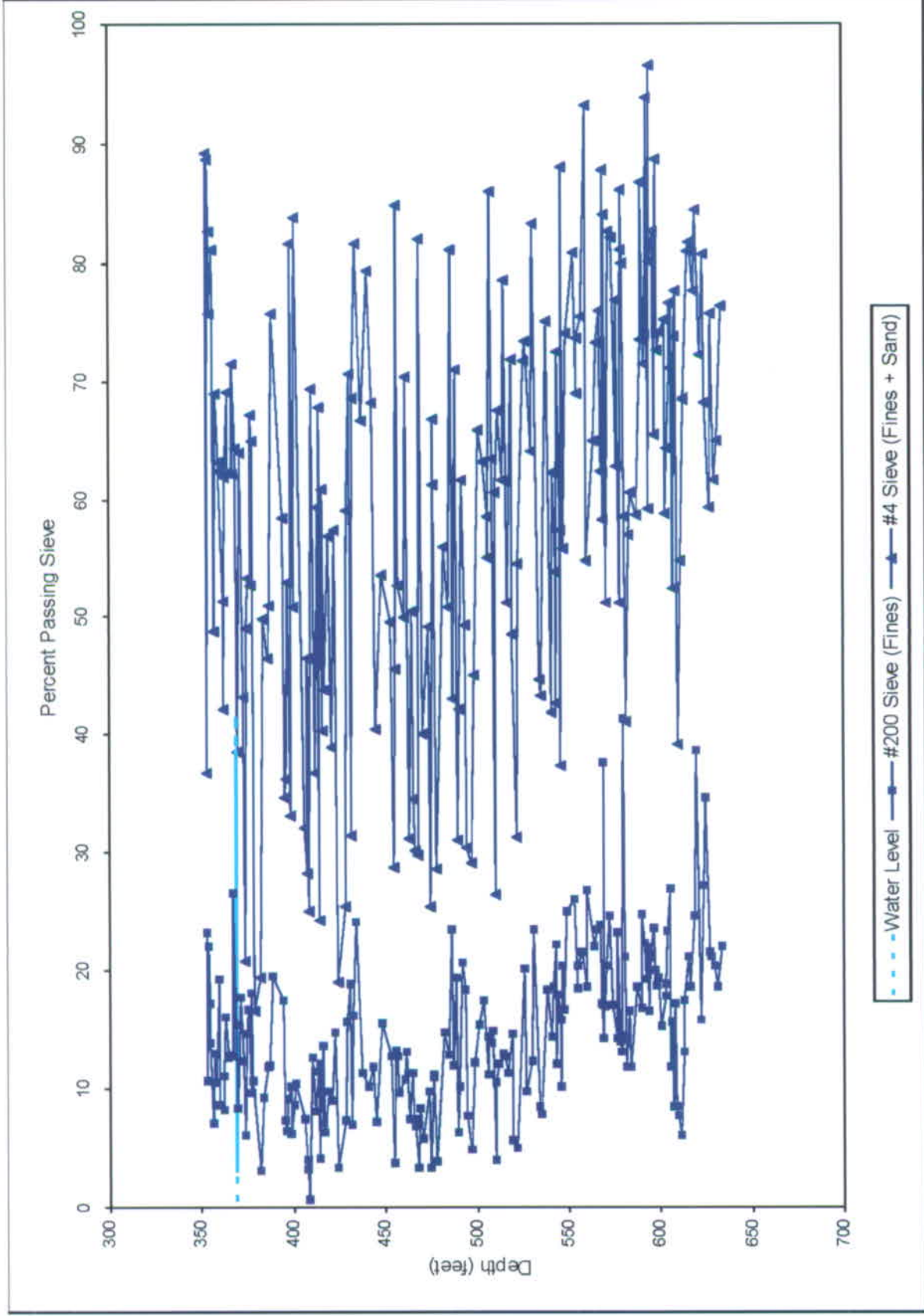

Figure 5.1-2
Laboratory Particle Size Distribution vs. Depth for 19PB Alluvial Sonic Grab Core Samples

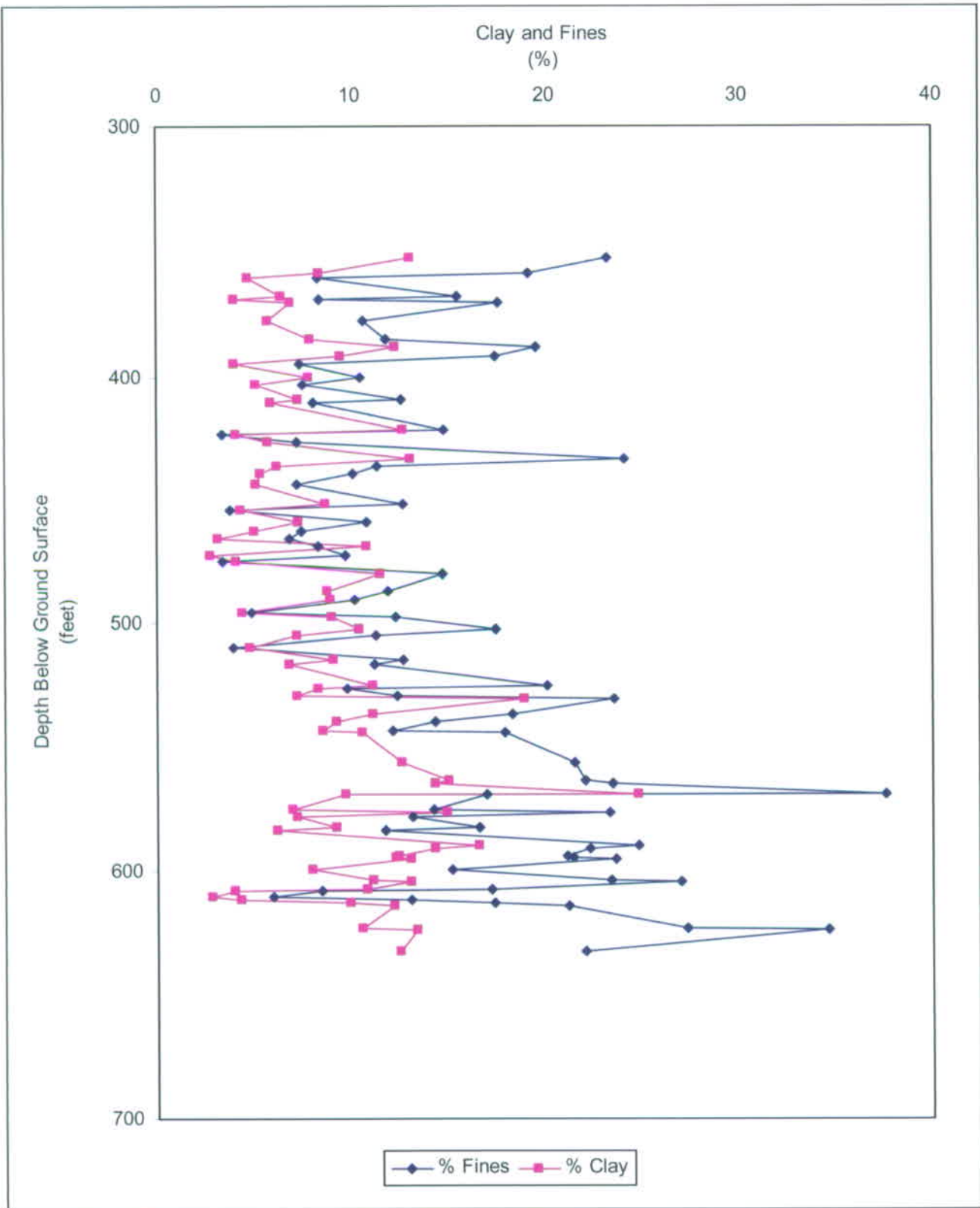

Figure 5.1-3
Clay and Fines Fractions for 19PB Sonic Grab Core Samples,
based on Hydrometer and Wet Sieve Particle Size Distribution Data, Respectively

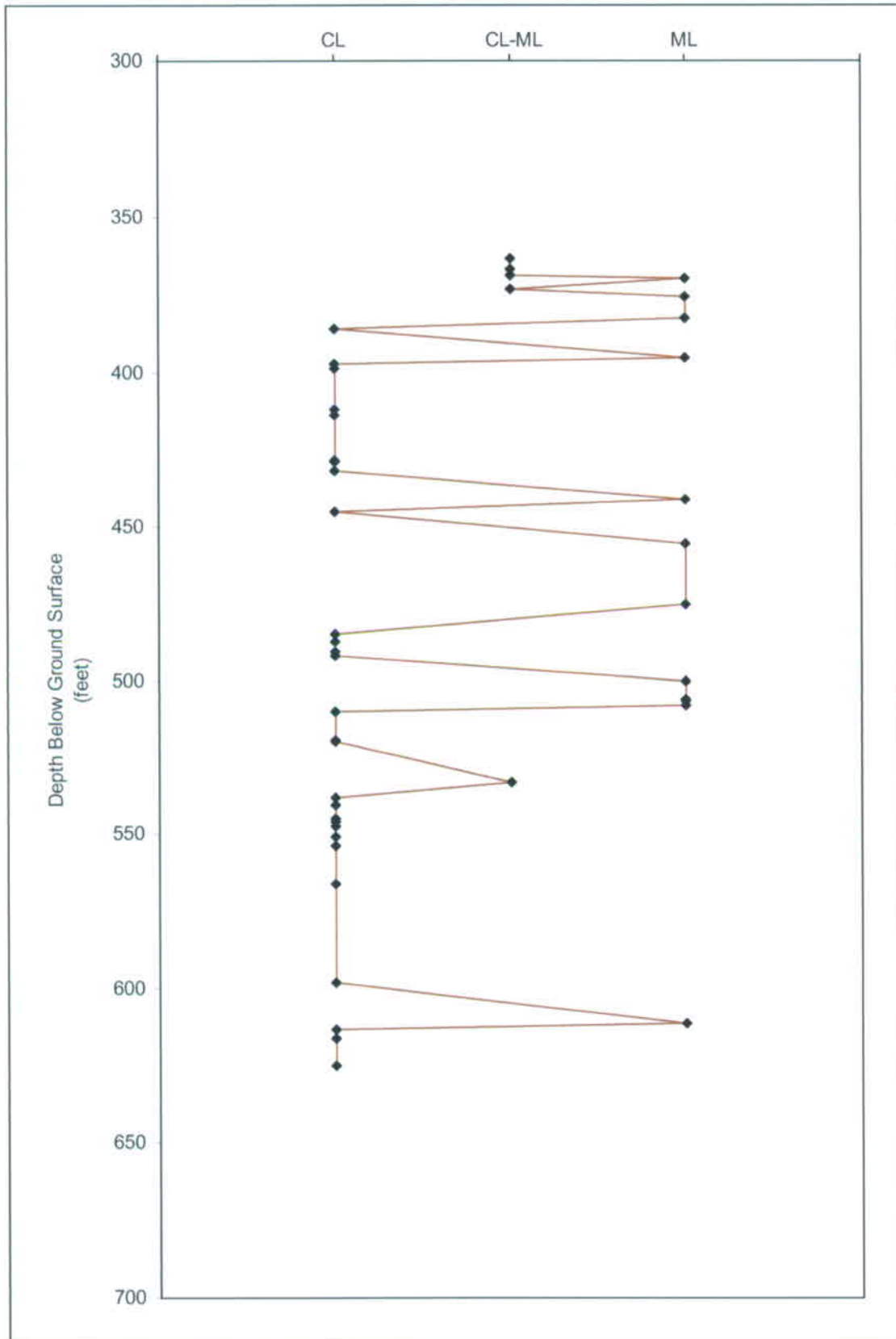

Figure 5.1-4
 Atterberg Limits-based Classification of Fines Fraction for 19PB Sonic Grab Core Samples

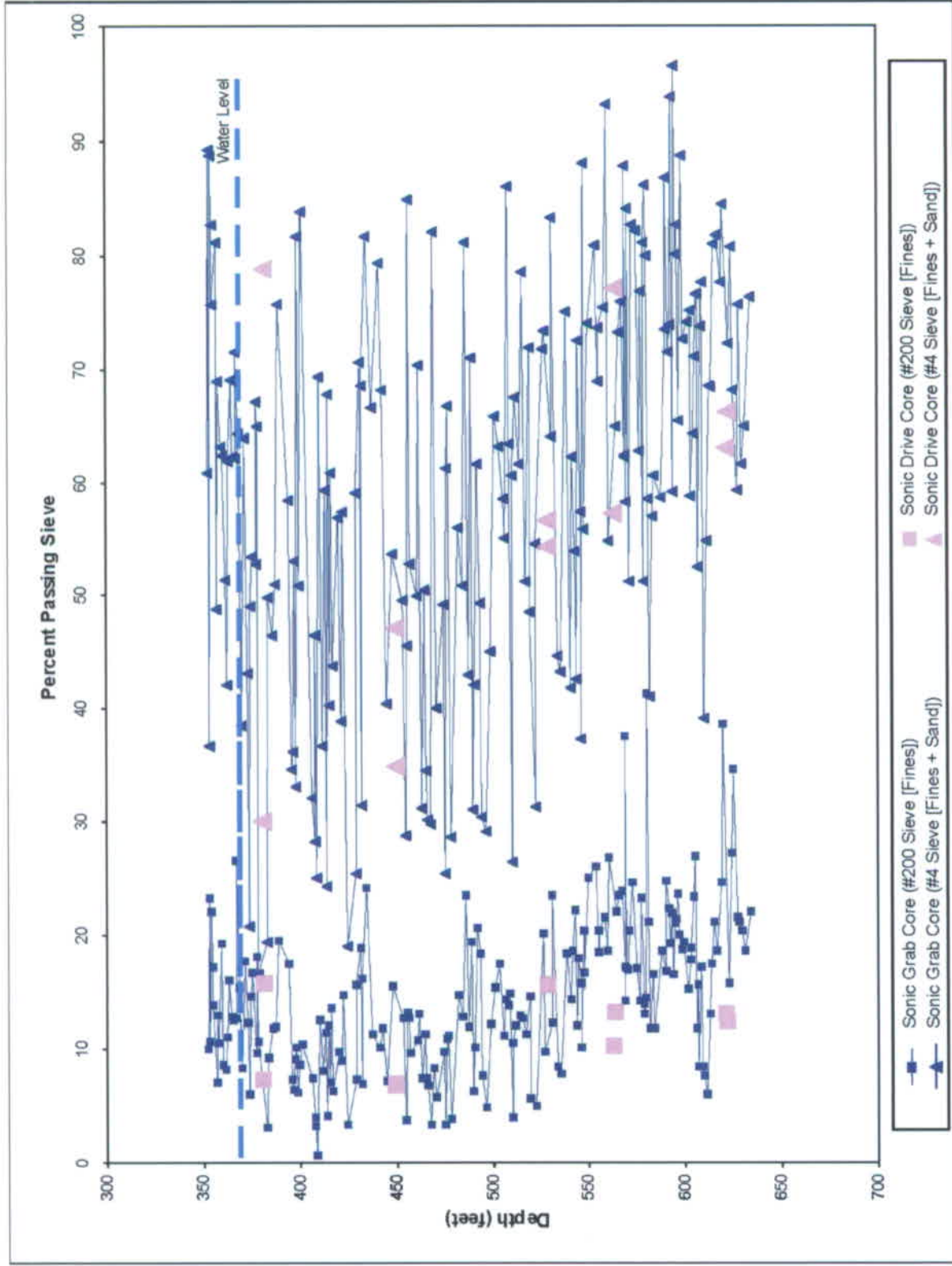

Figure 5.1-5 Laboratory Particle Size Distribution vs. Depth for 19PB Alluvial Sonic Grab and Drive Core Samples

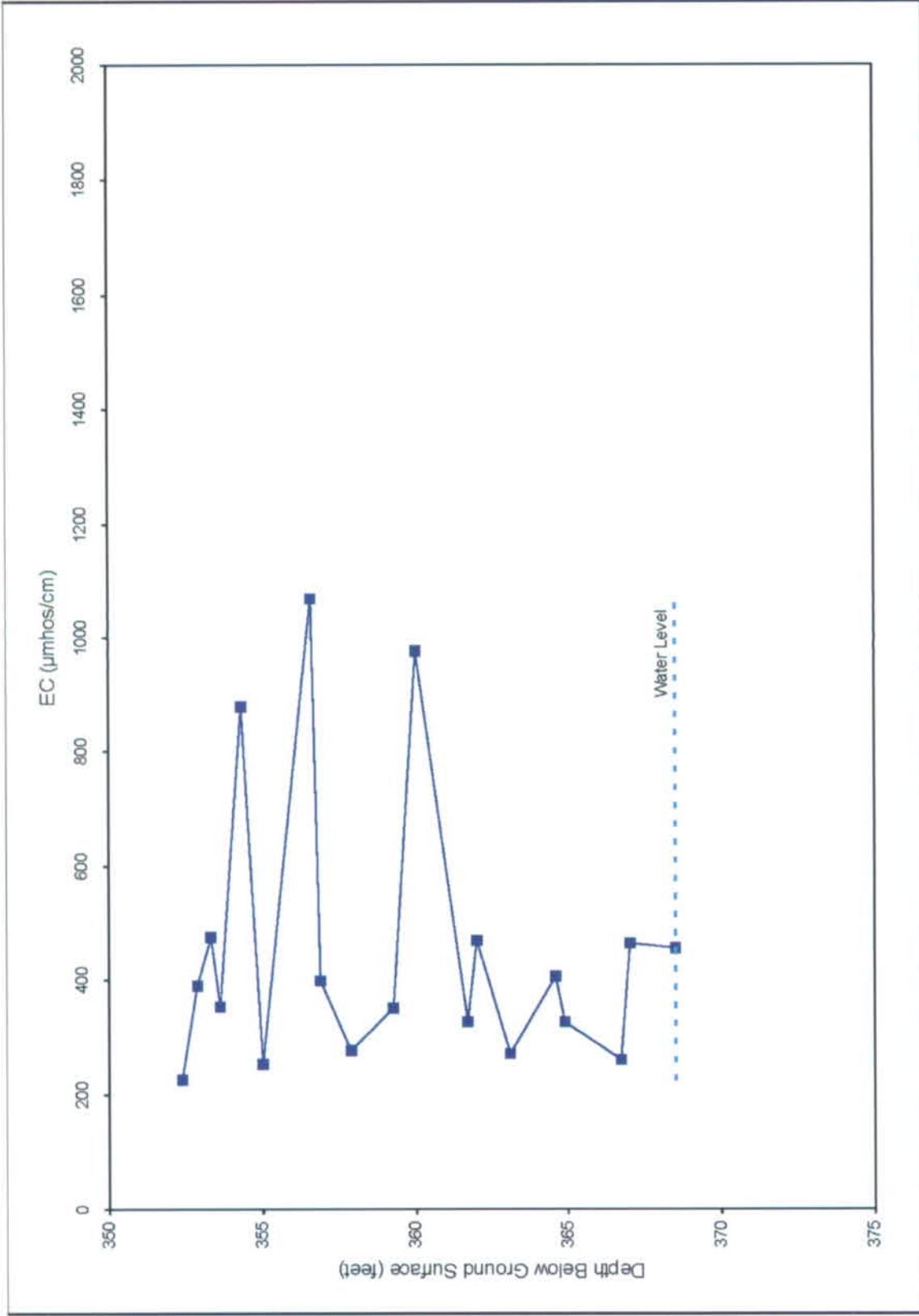

Figure 5.1-6
Electrical Conductivity vs. Depth for 19PB Alluvial Sonic Grab Core Samples

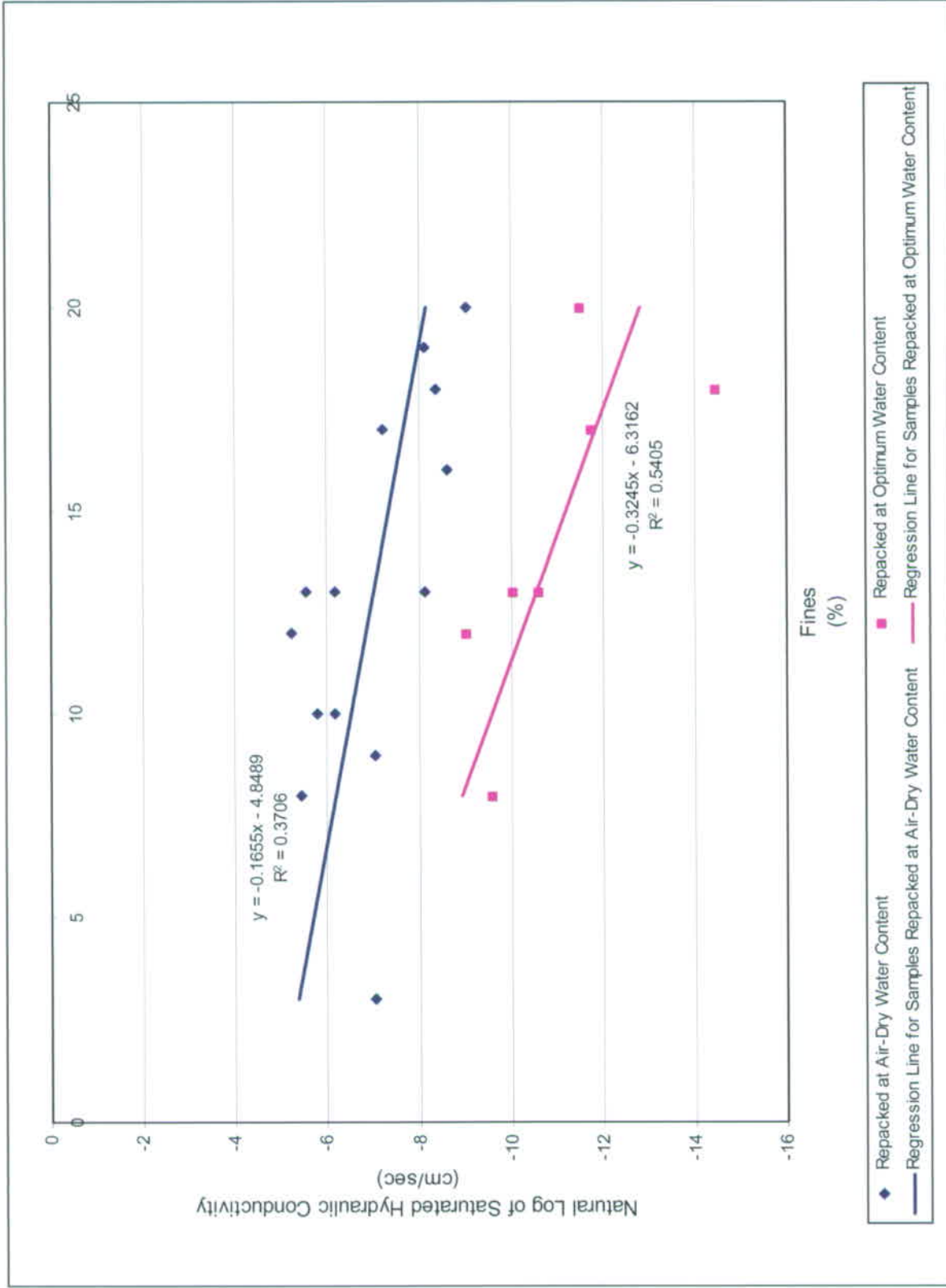

Figure 5.1-7 Saturated Hydraulic Conductivity vs. Fines Fraction for Repacked Sonic Core Samples

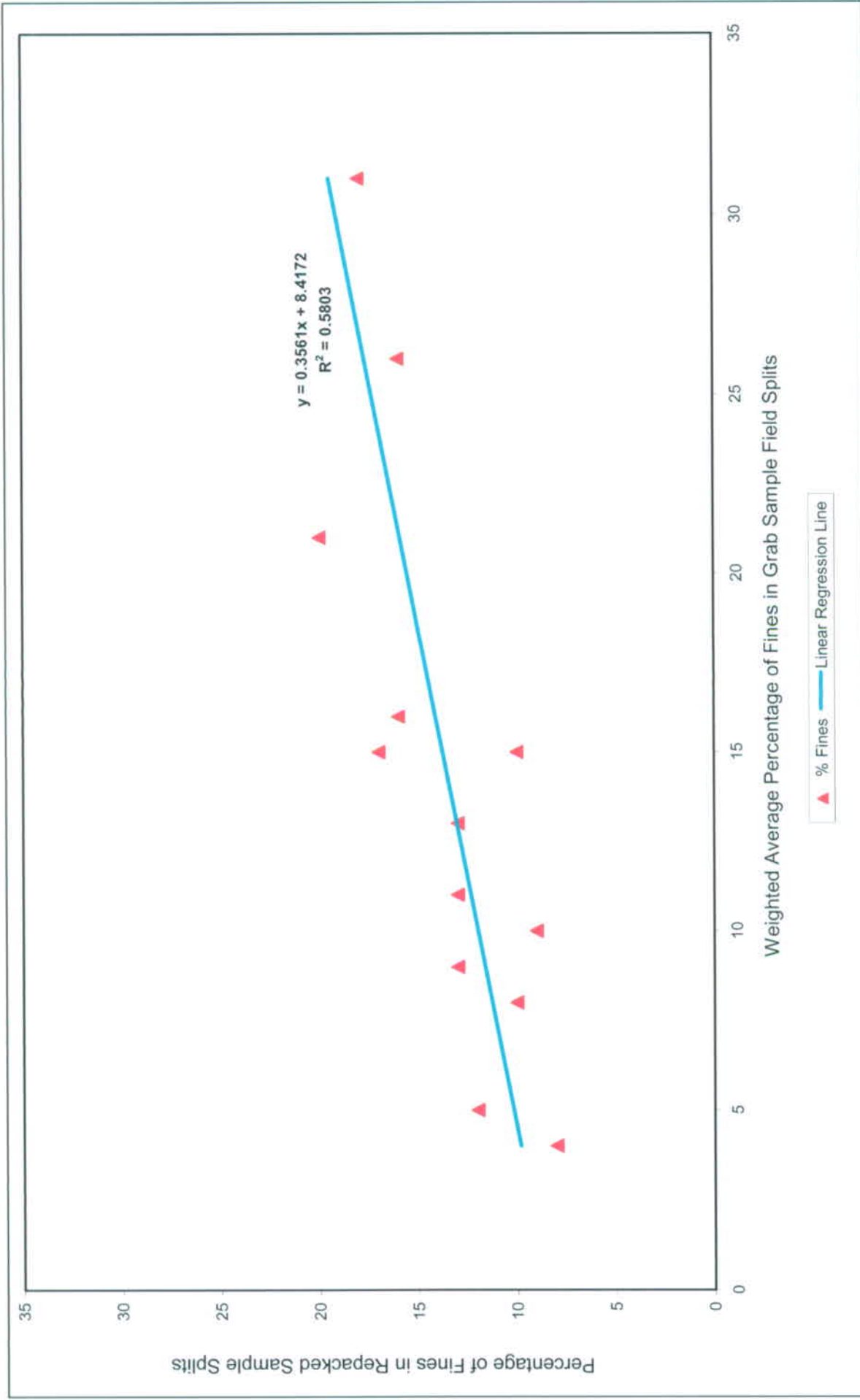

Figure 5.1-8
Percentage of Fines in Sample Splits from Identical Depth Intervals

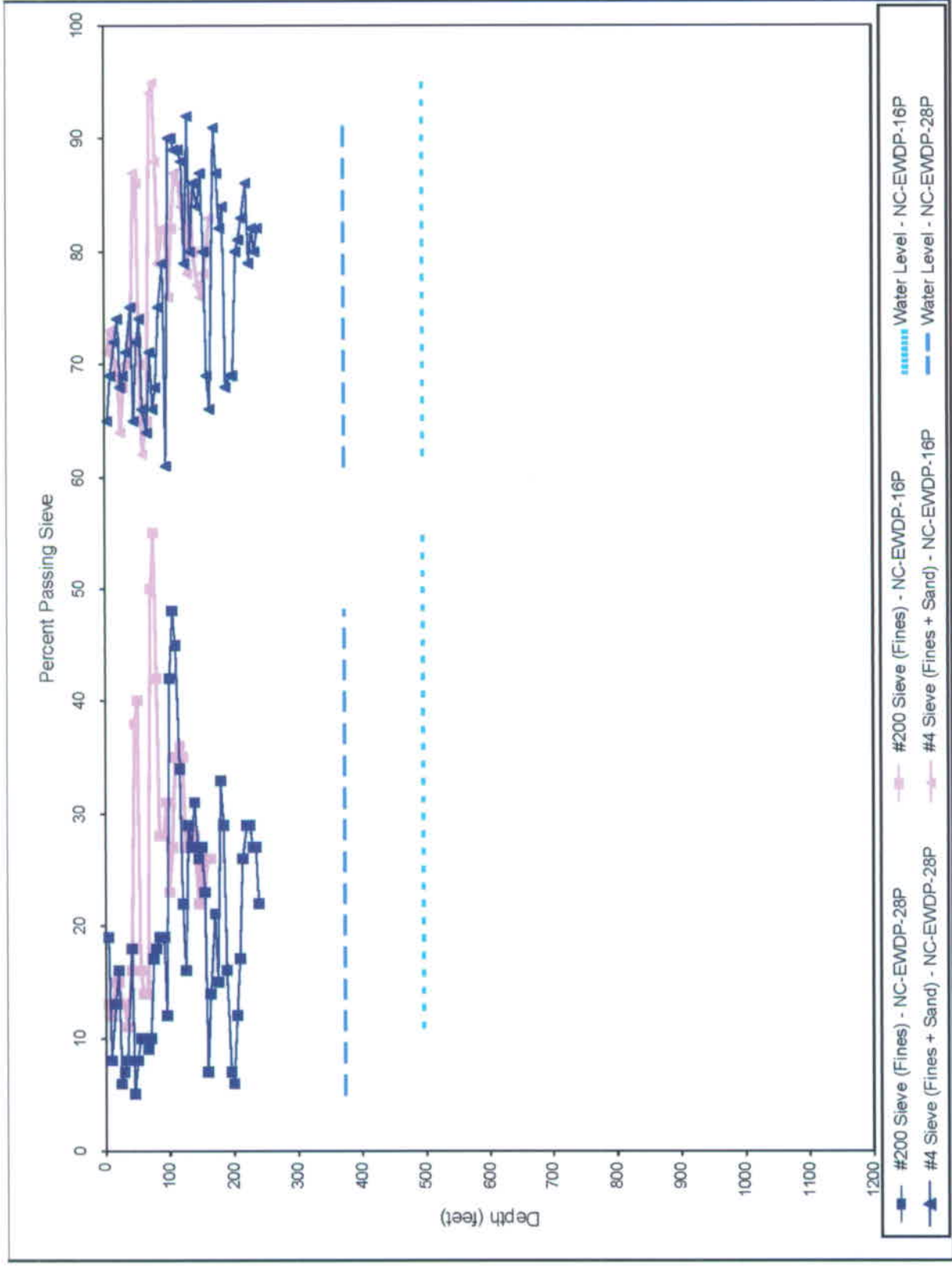

Figure 5.2-1
Laboratory Particle Size Distribution vs. Depth for 28P and 16P Alluvial Drill Cuttings Samples

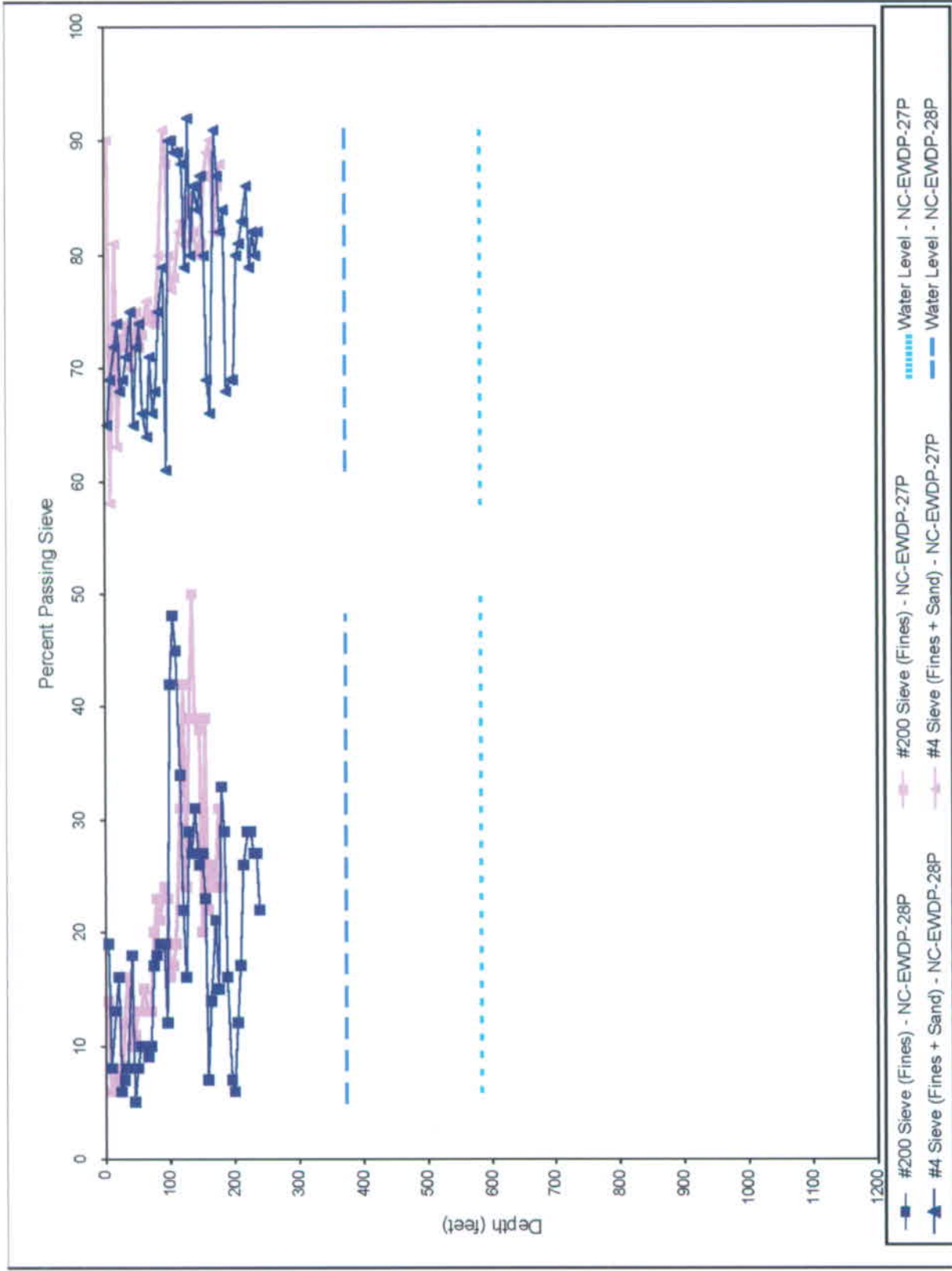

Figure 5.2-2 Laboratory Particle Size Distribution vs. Depth for 28P and 27P Alluvial Drill Cuttings Samples

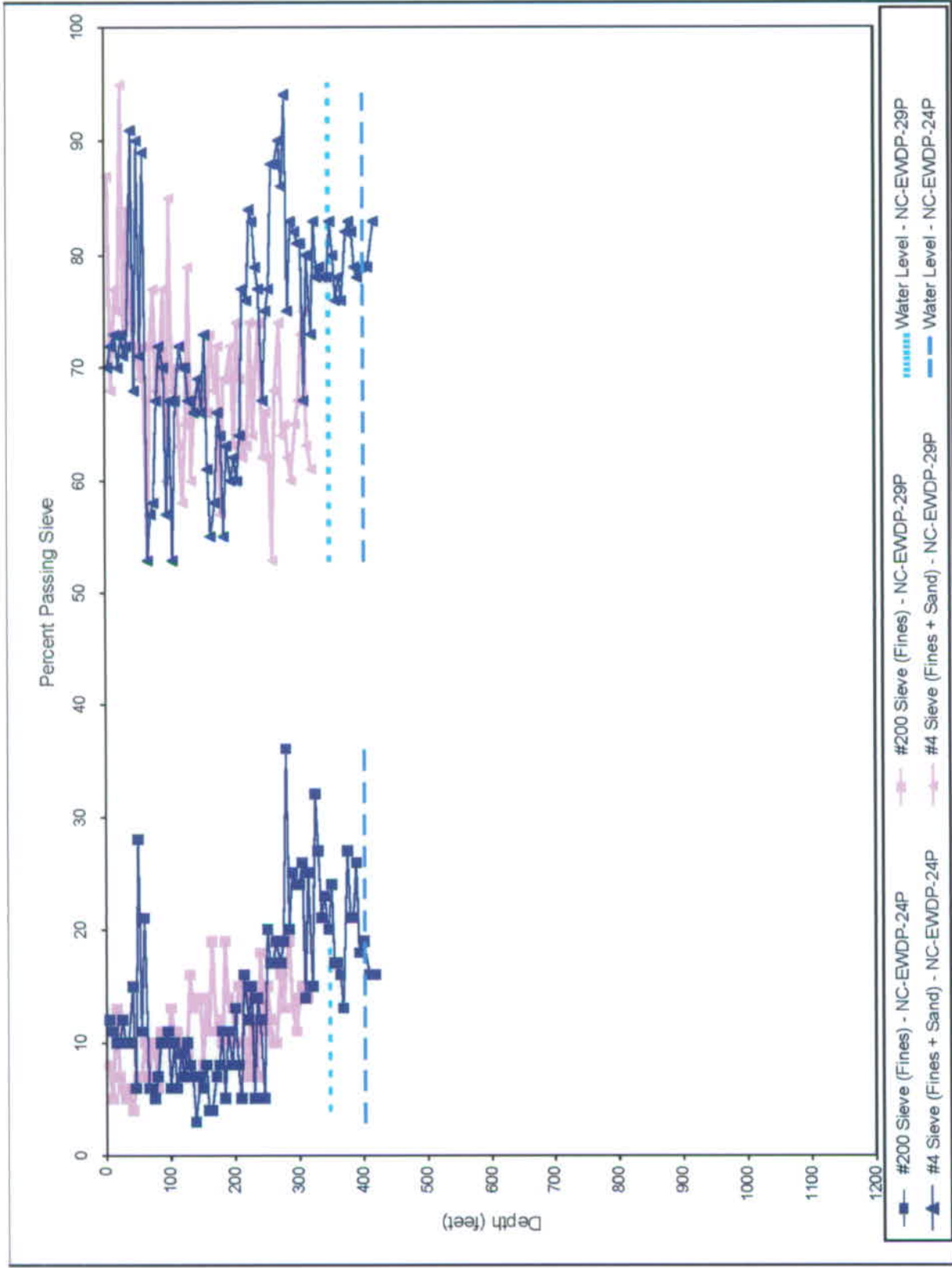

Figure 5.2-3 Laboratory Particle Size Distribution vs. Depth for 24P and 29P Alluvial Drill Cuttings Samples

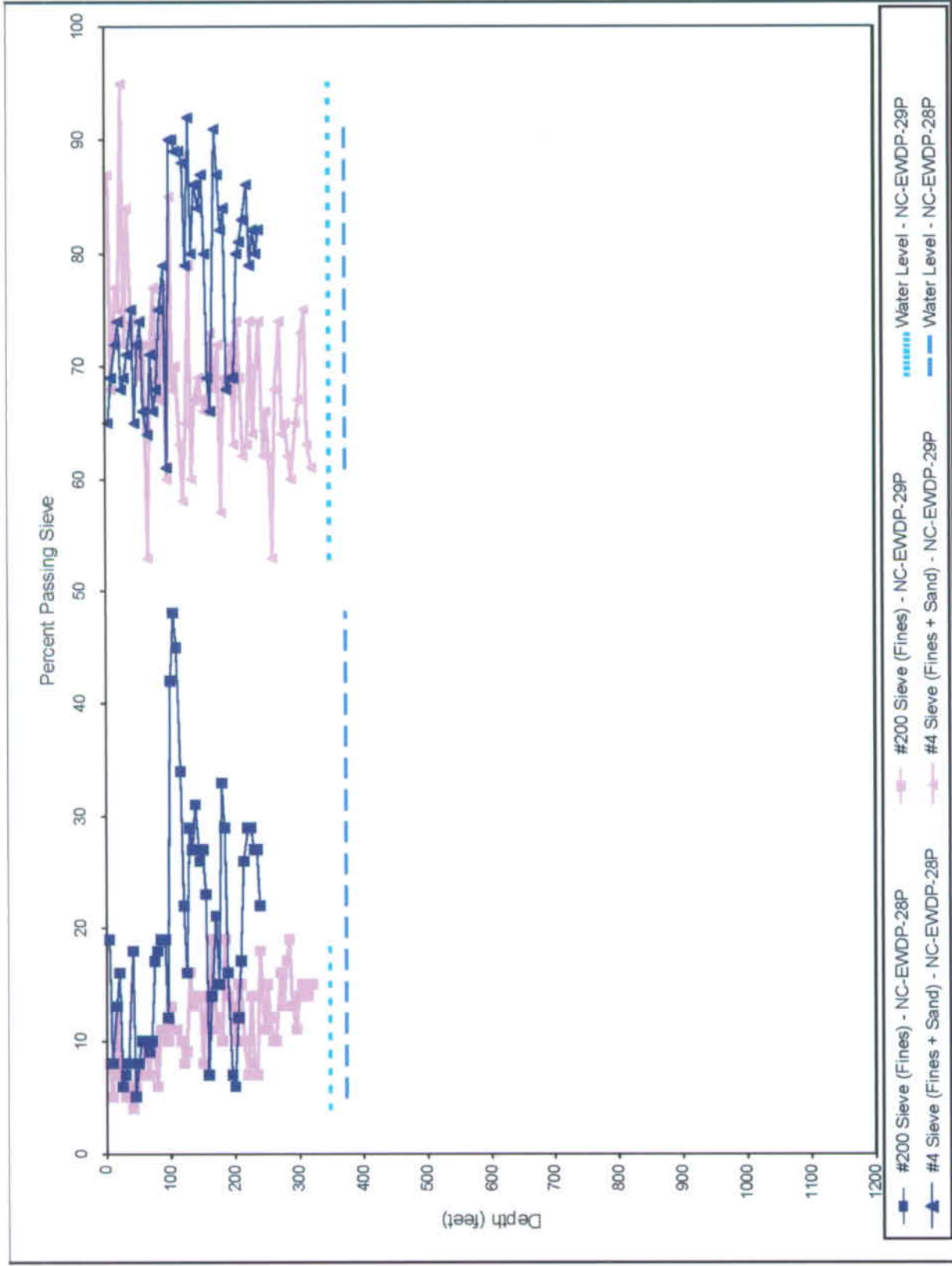

Figure 5.2-4 Laboratory Particle Size Distribution vs. Depth for 28P and 29P Alluvial Drill Cuttings Samples

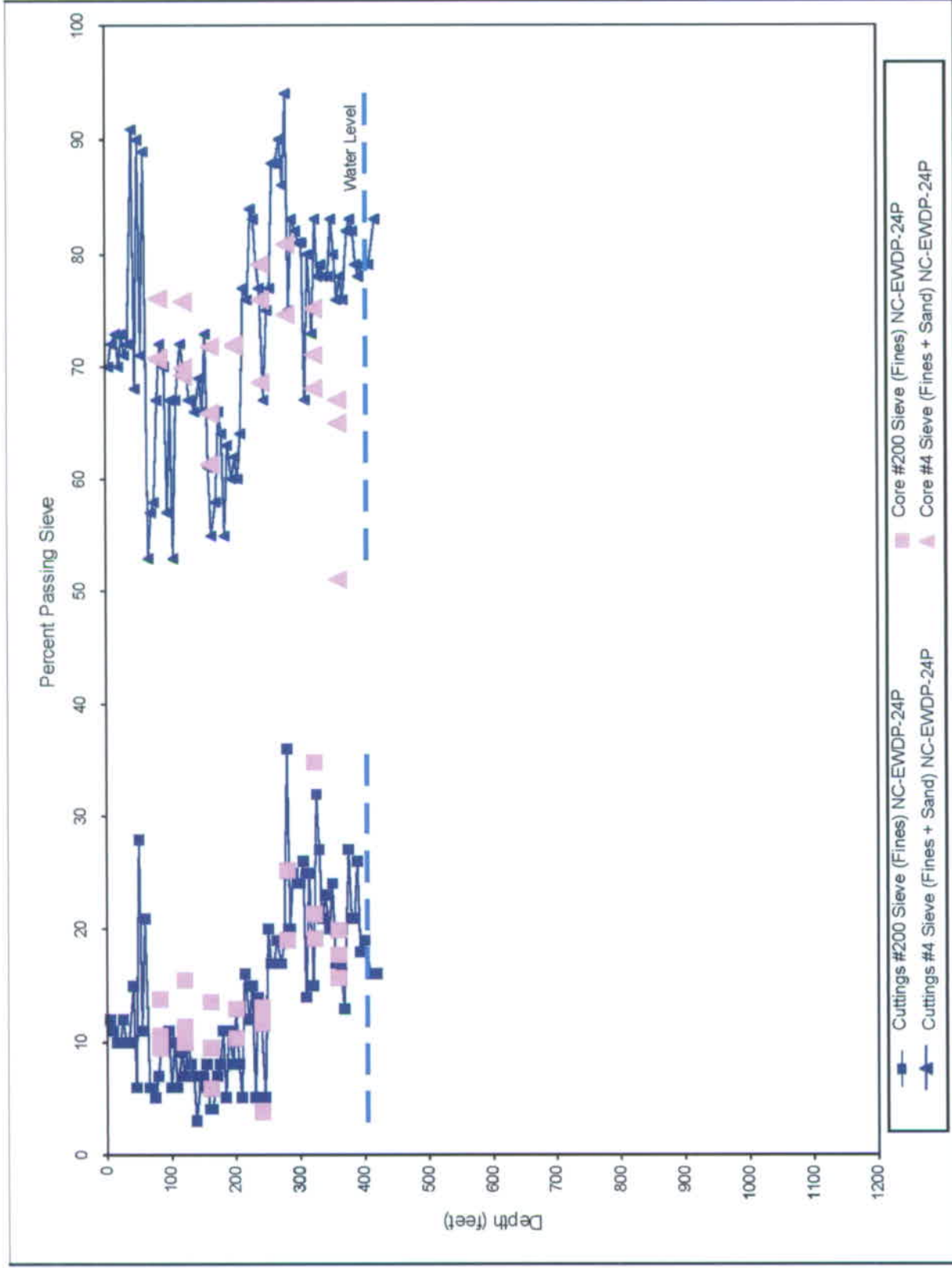

Figure 5.2-5

Laboratory Particle Size Distribution vs. Depth for 24P Alluvial Drill Cuttings and Drive Core Samples, including Shoe Core Samples

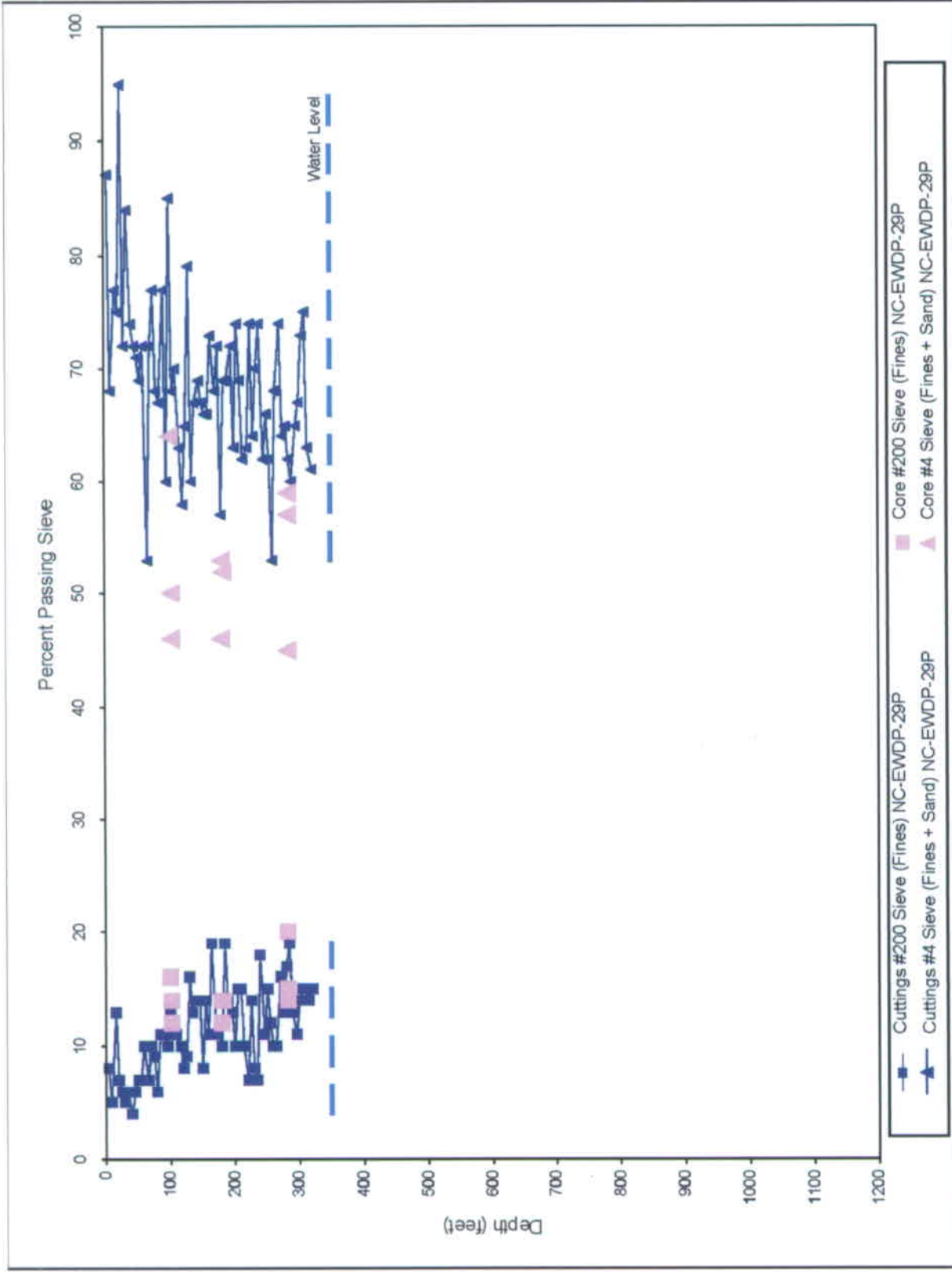

Figure 5.2-6

Laboratory Particle Size Distribution vs. Depth for 29P Alluvial Drill Cuttings and Drive Core Samples, including Shoe Core Samples

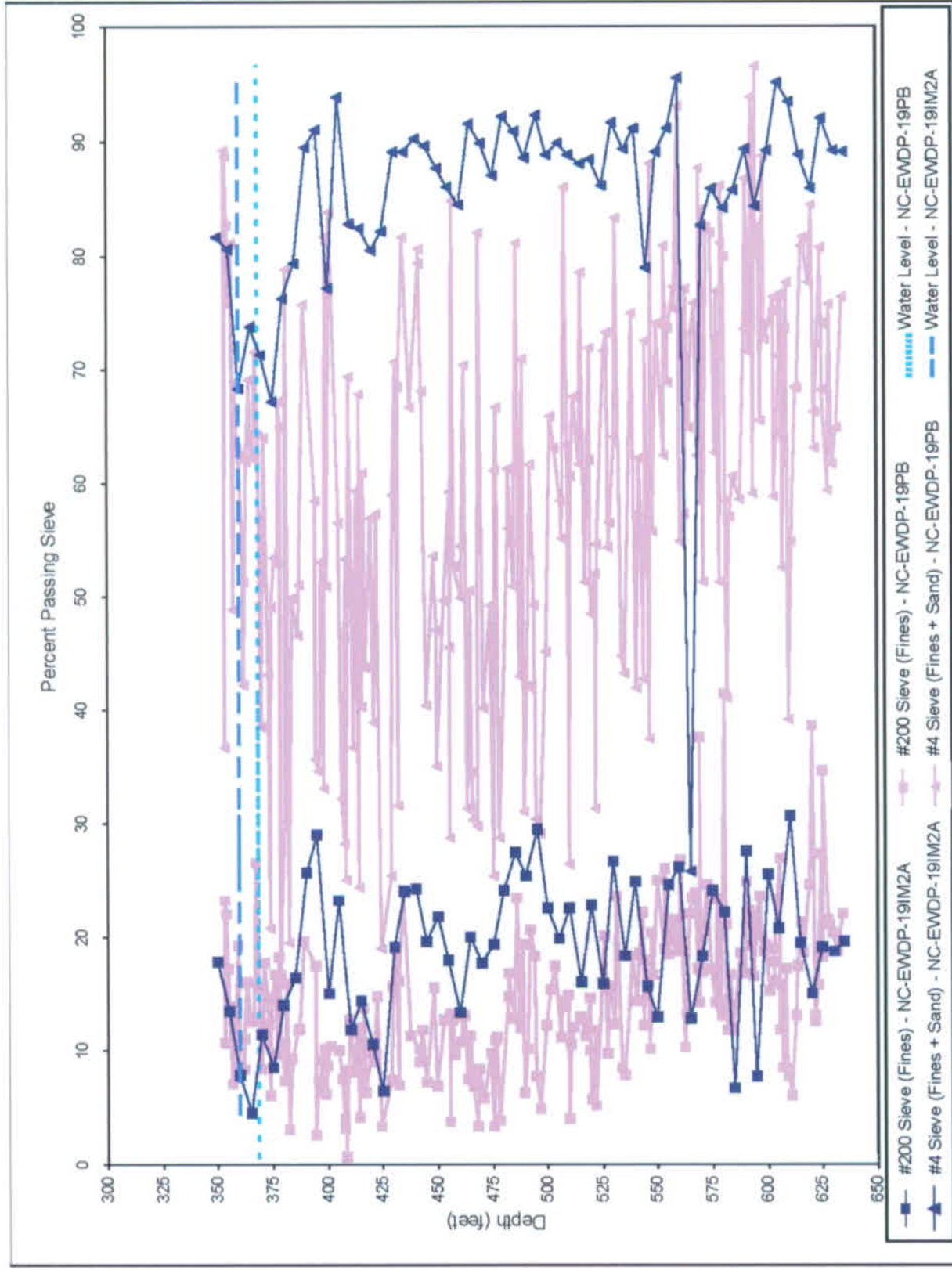

Figure 5.2-7

Laboratory Particle Size Distribution vs. Depth for 19IM2A Alluvial Drill Cuttings and 19PB Sonic Grab Core Samples

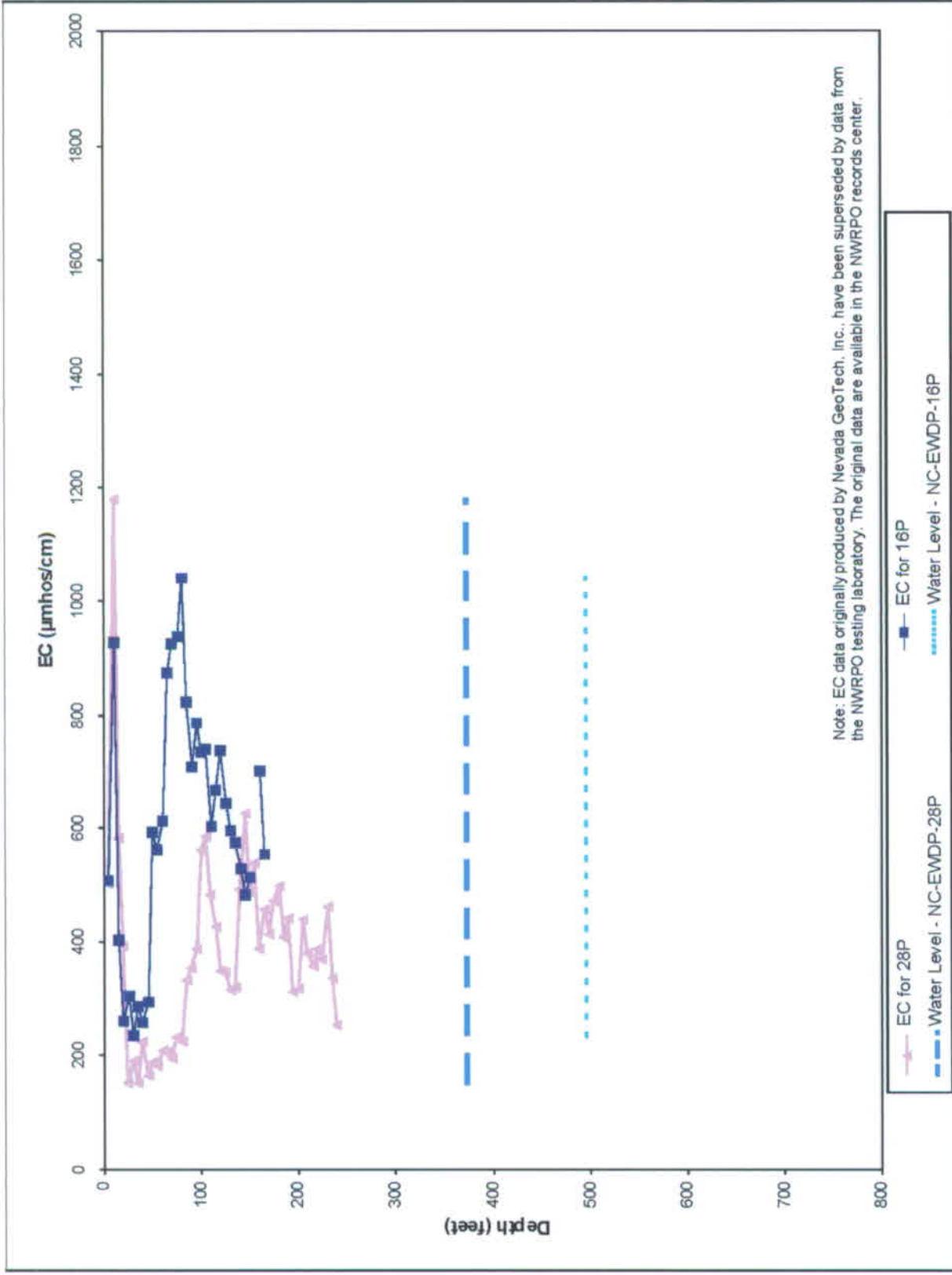

Figure 5.2-8
Electrical Conductivity vs. Depth for 28P and 16P Alluvial Drill Cuttings Samples

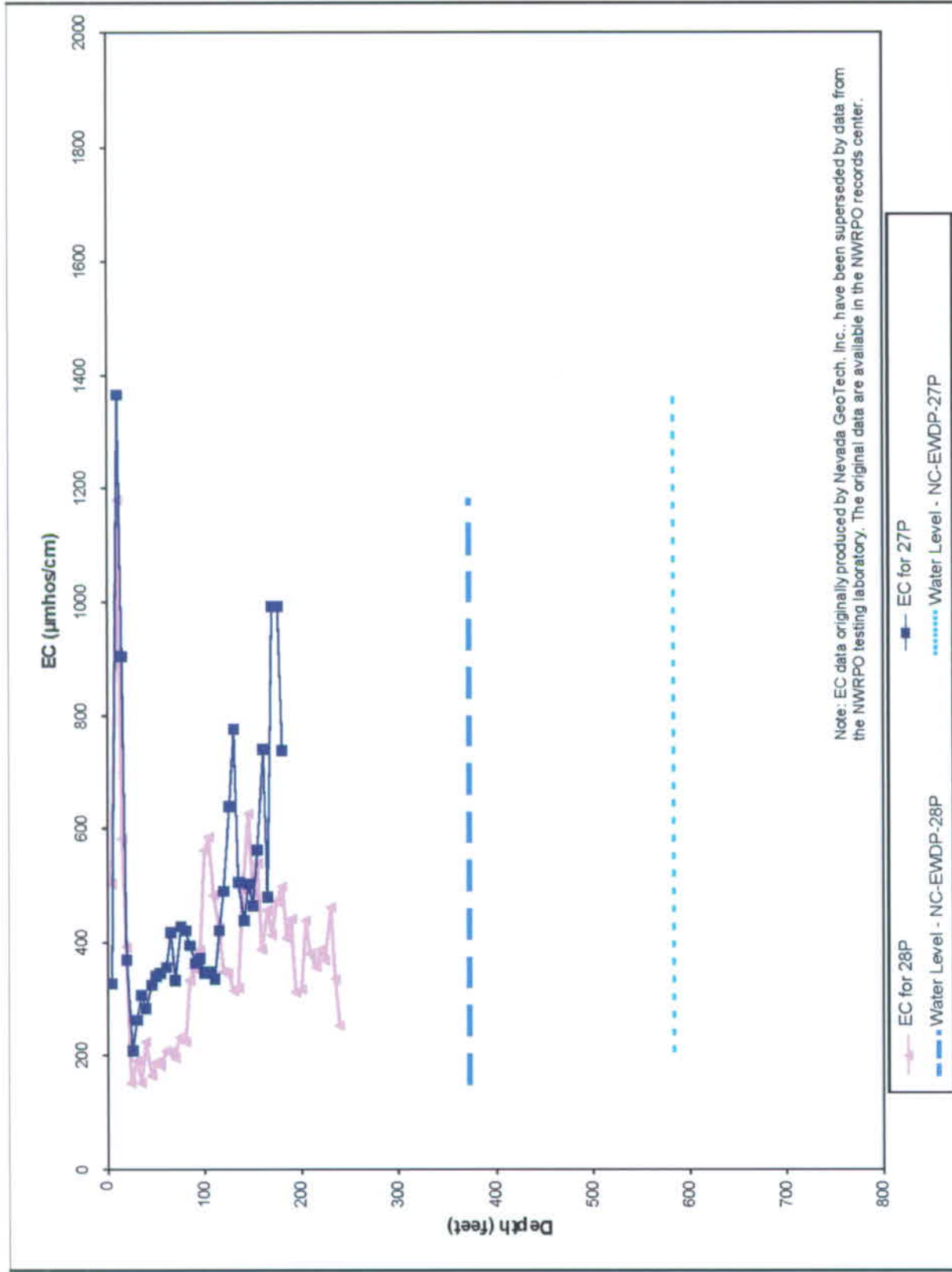

Figure 5.2-9
Electrical Conductivity vs. Depth for 28P and 27P Alluvial Drill Cuttings Samples

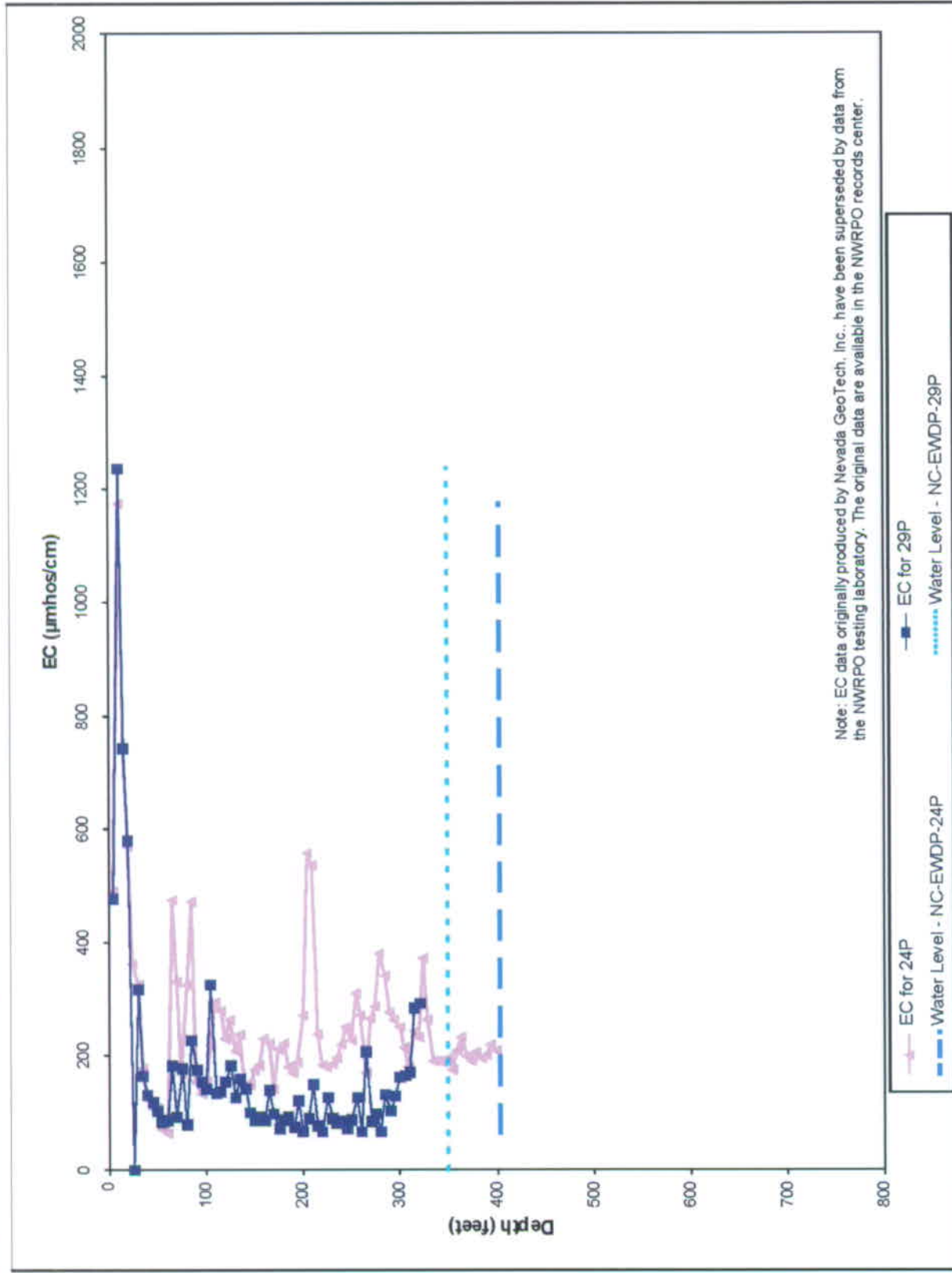

Figure 5.2-10 Electrical Conductivity vs. Depth for 24P and 29P Alluvial Drill Cuttings Samples

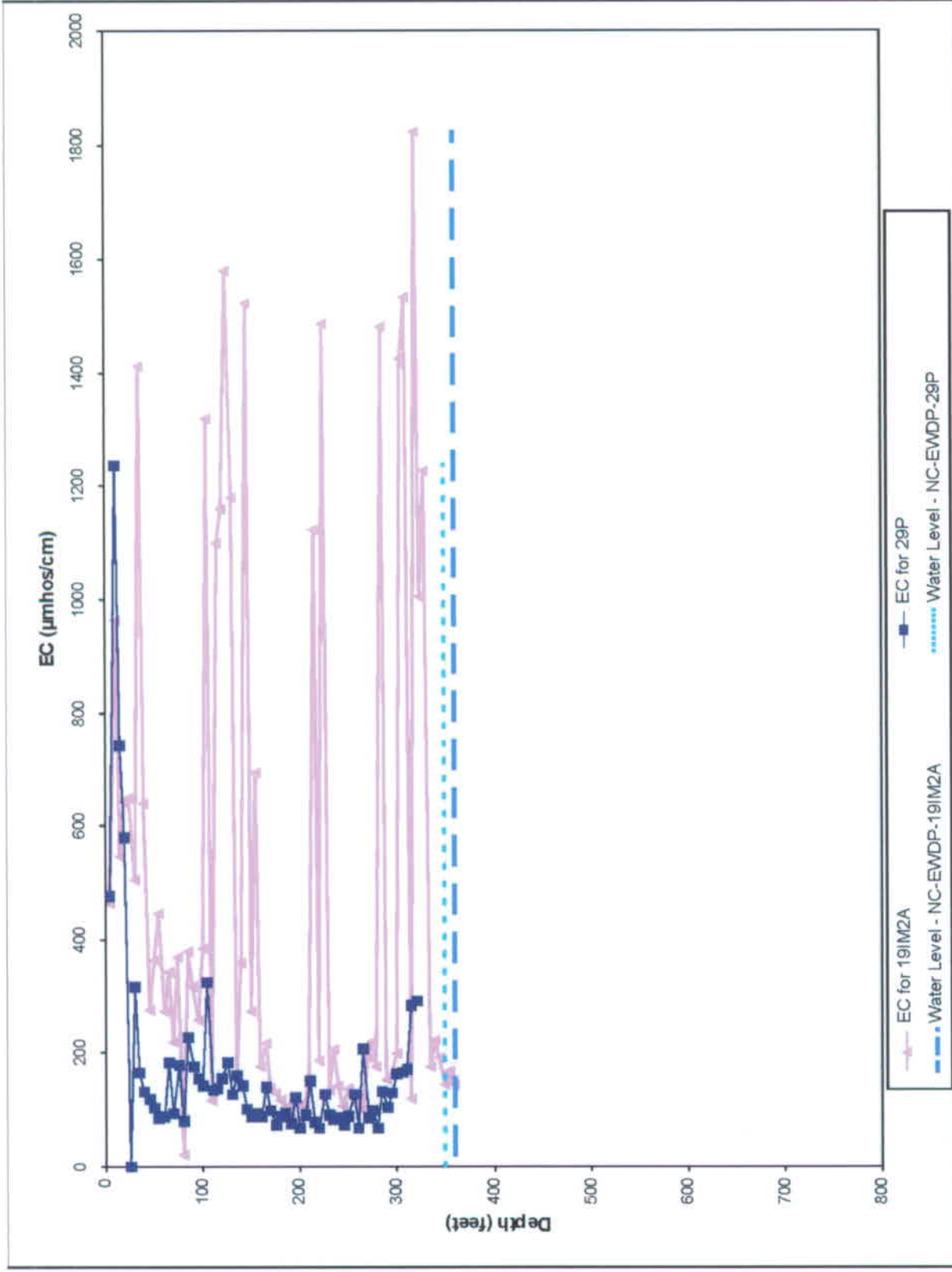

Figure 5.2-11
Electrical Conductivity vs. Depth for 19IM2A and 29P Alluvial Drill Cuttings Samples

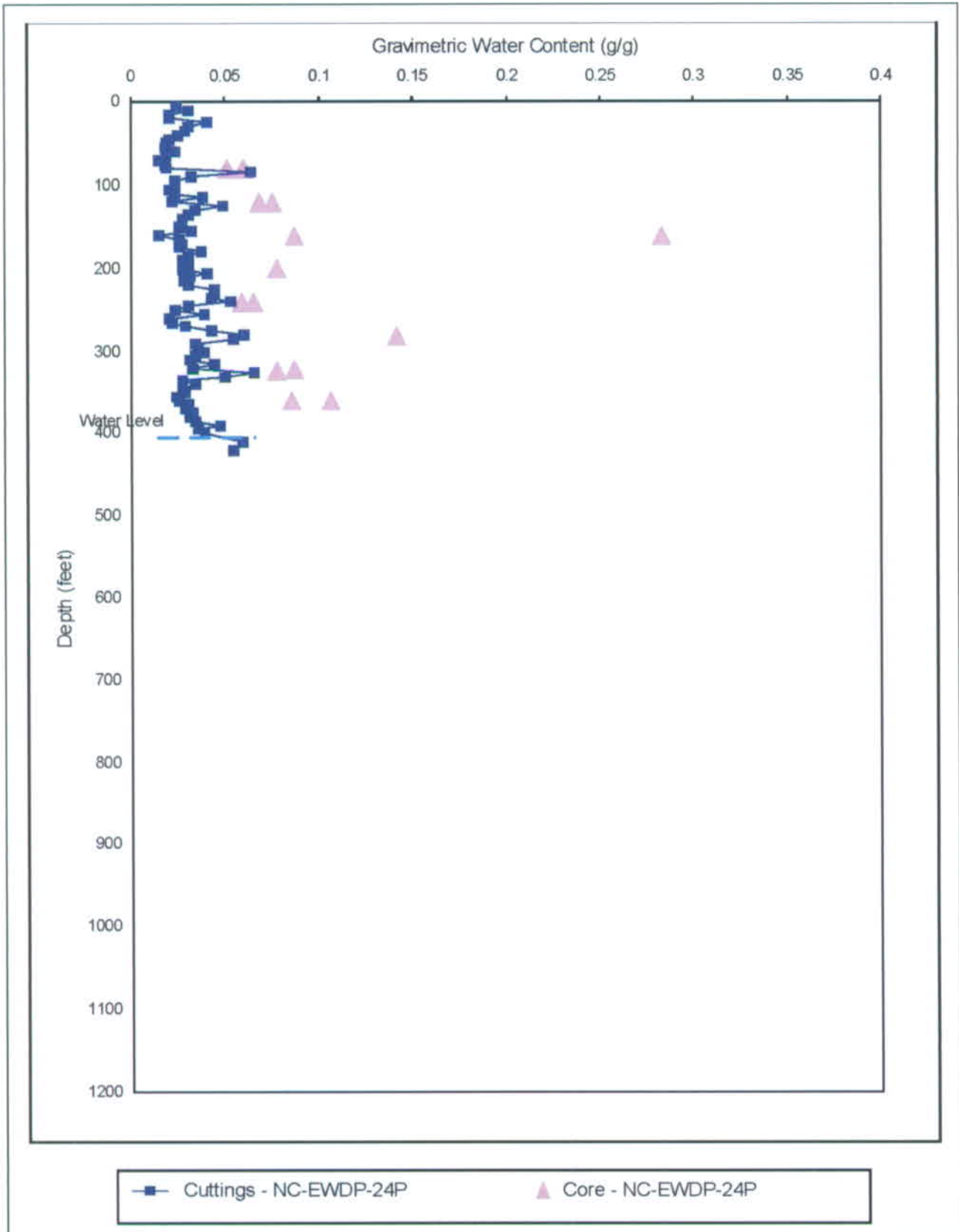

Figure 5.2-12
Gravimetric Water Content vs. Depth for 24P Alluvial Drill Cuttings and Drive Core Samples

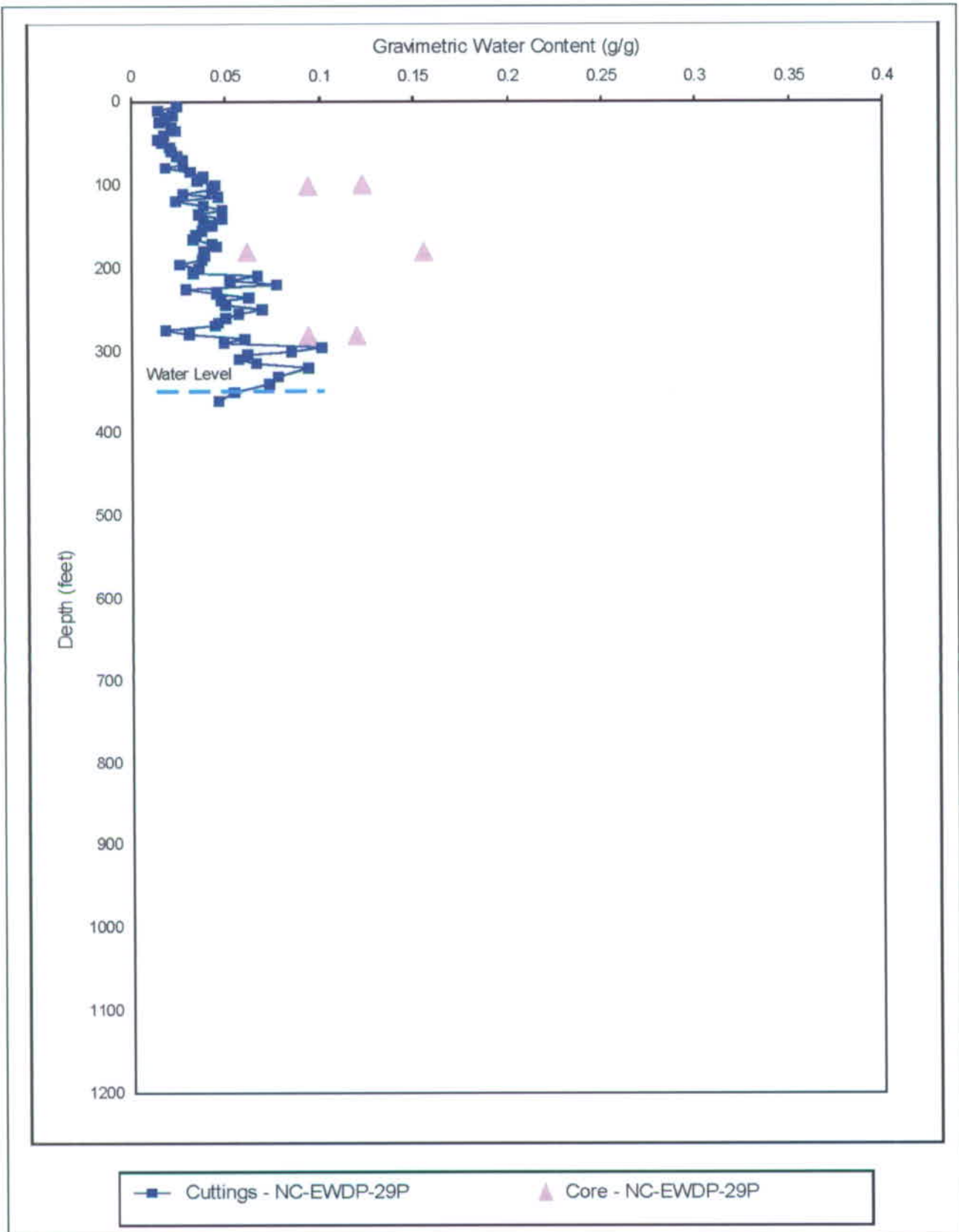

Figure 5.2-13
Gravimetric Water Content vs. Depth for 29P Alluvial Drill Cuttings and Drive Core Samples

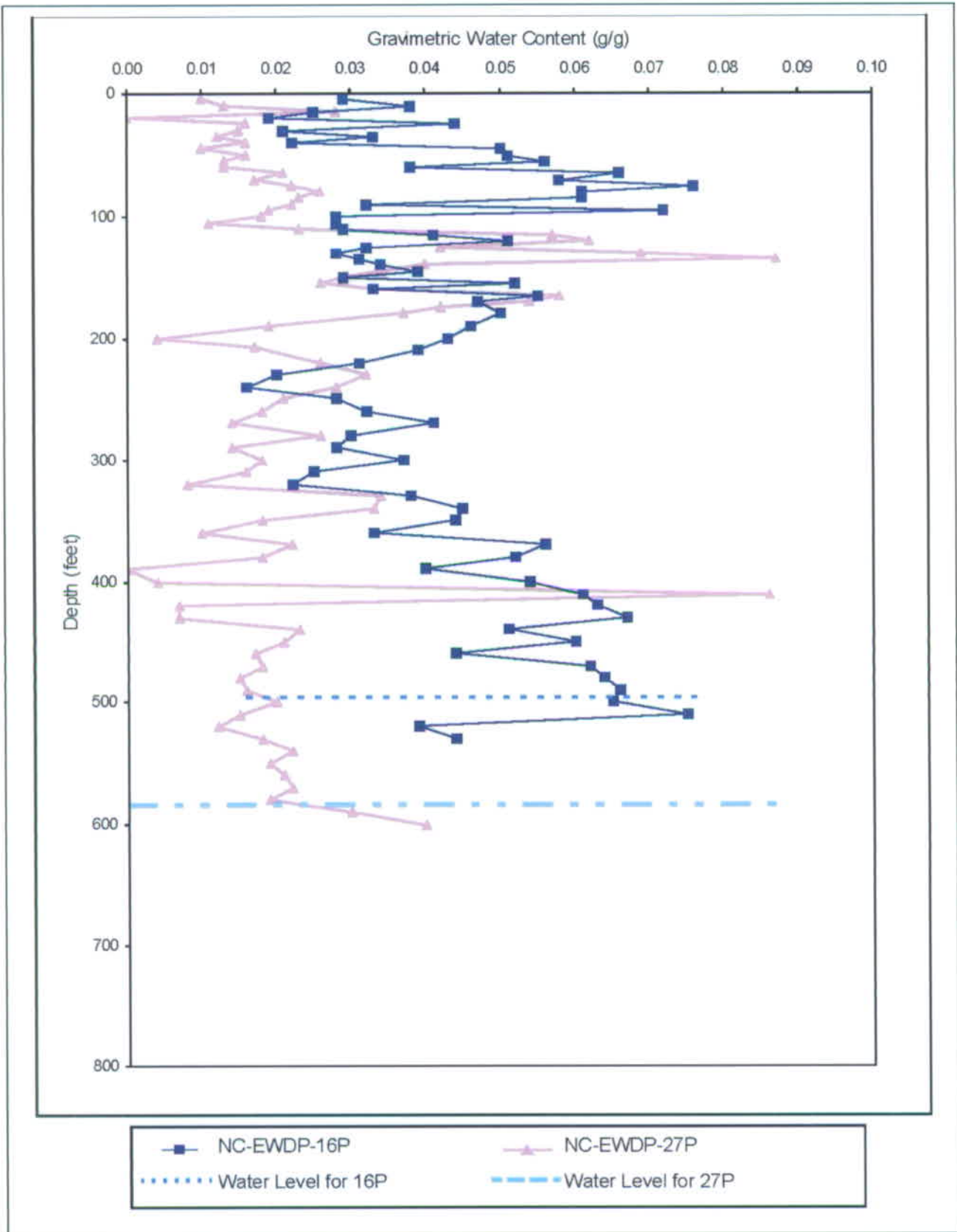

Figure 5.2-14
Gravimetric Water Content vs. Depth in Alluvium and Non-Alluvium for 16P and 27P

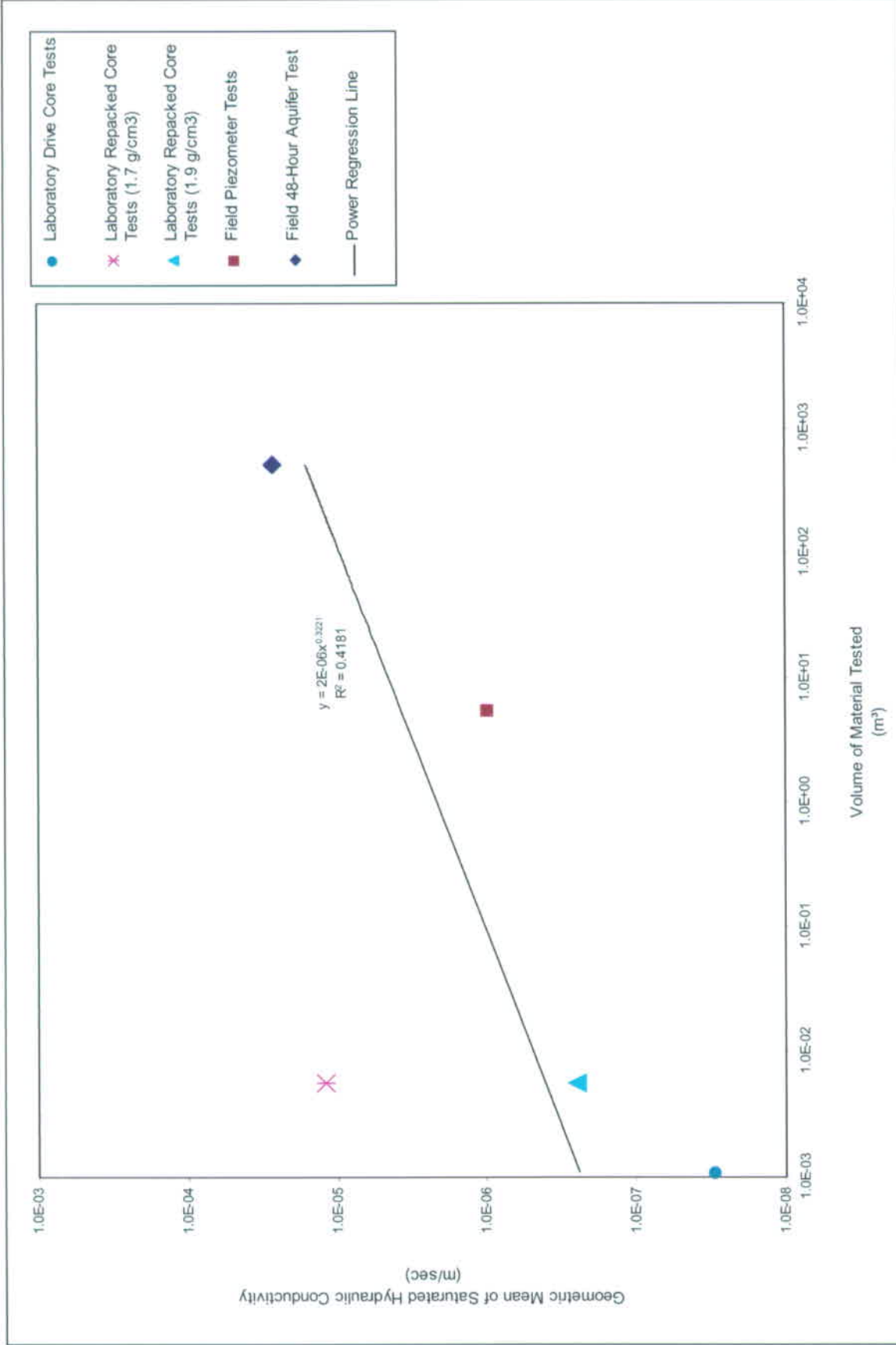

Figure 5.3-1 Geometric Mean of Saturated Hydraulic Conductivity vs. Measurement Scale for Site 19 Core and In Situ Tests

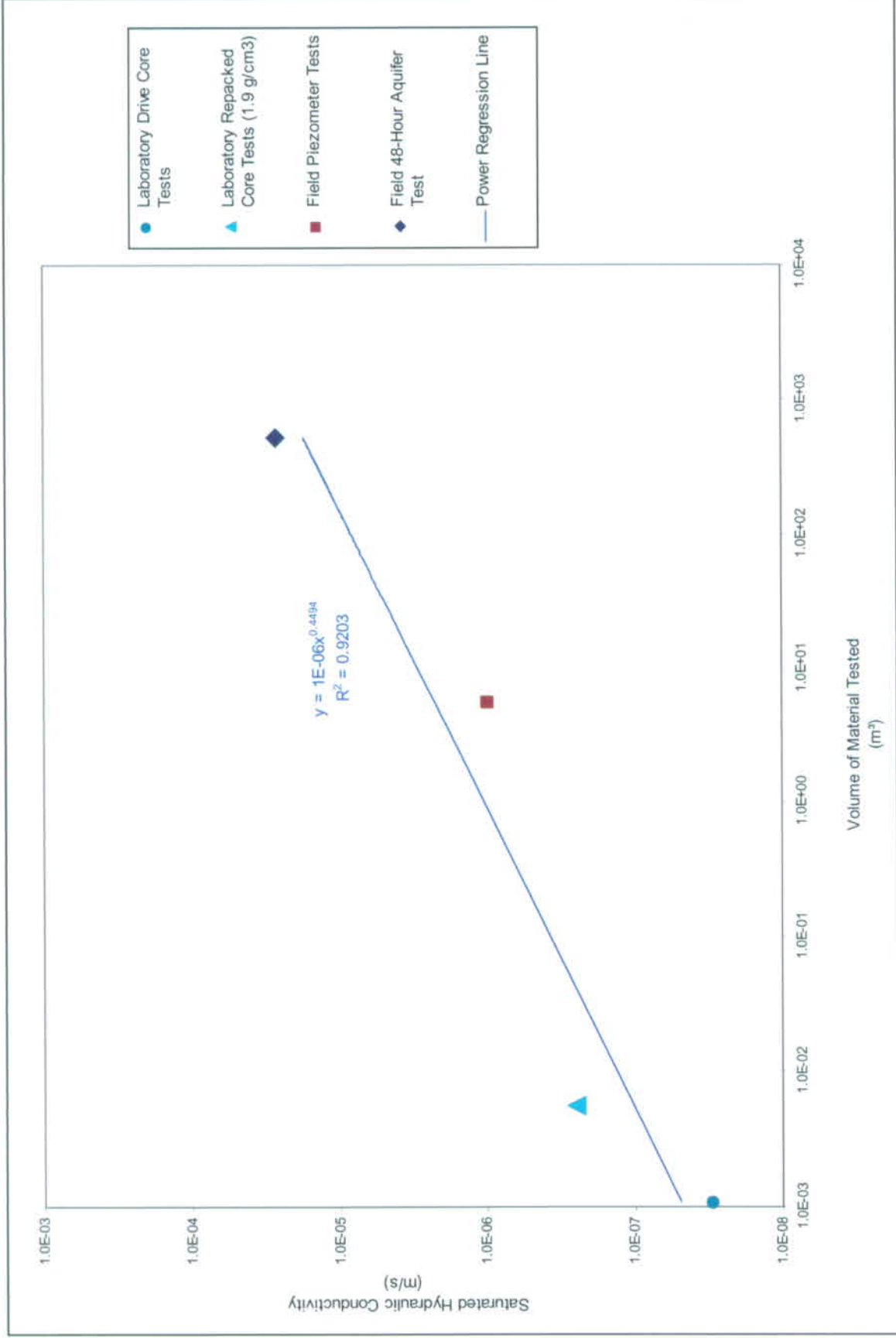

Figure 5.3-2 Geometric Mean of Saturated Hydraulic Conductivity vs. Measurement Scale for Site 19 Core and In Situ Tests, excluding Data from Core Repacked at Air-Dried Water Content

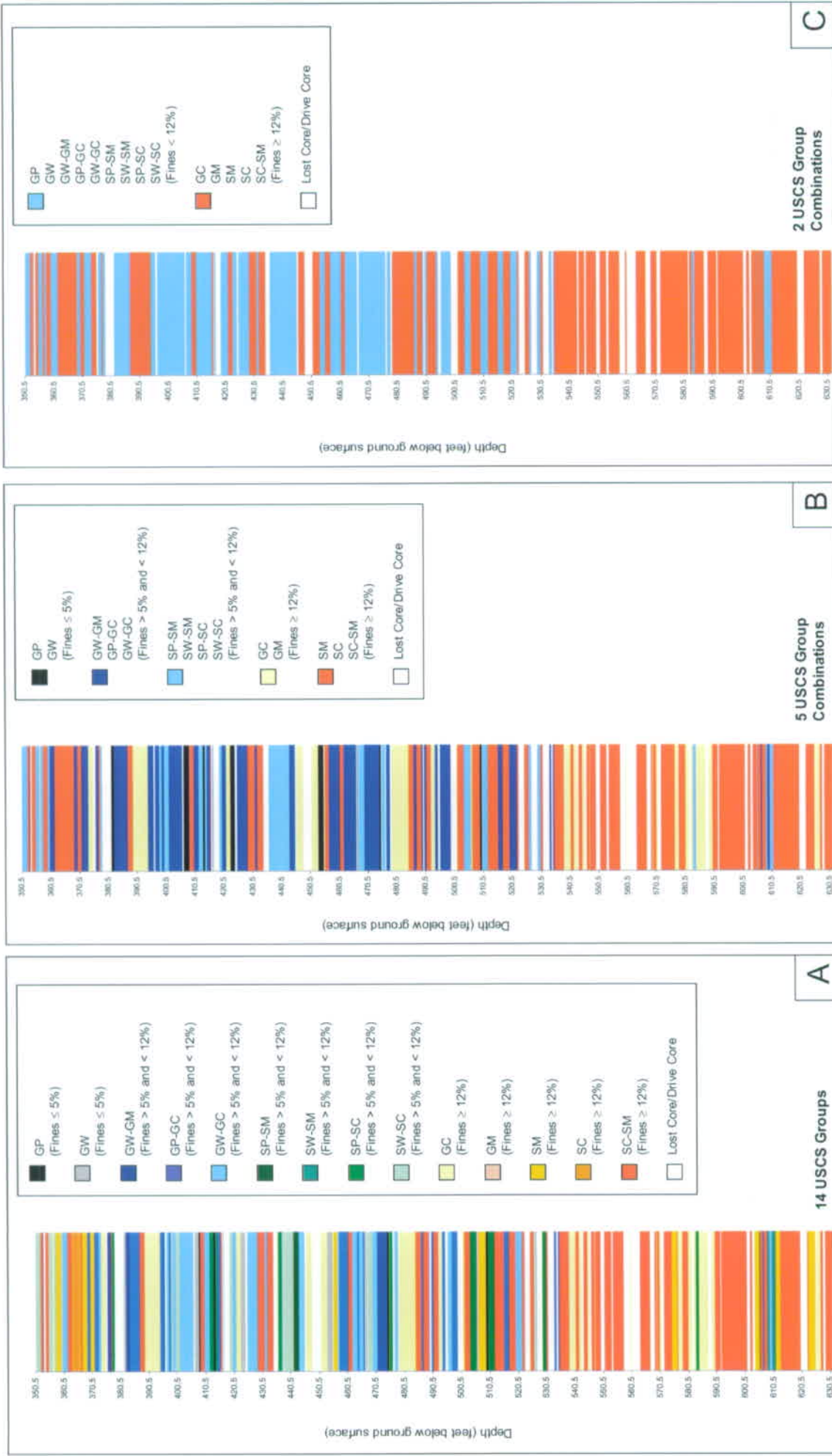

Figure 6.1-1
Preliminary Summary Lithologic Logs for 19PB

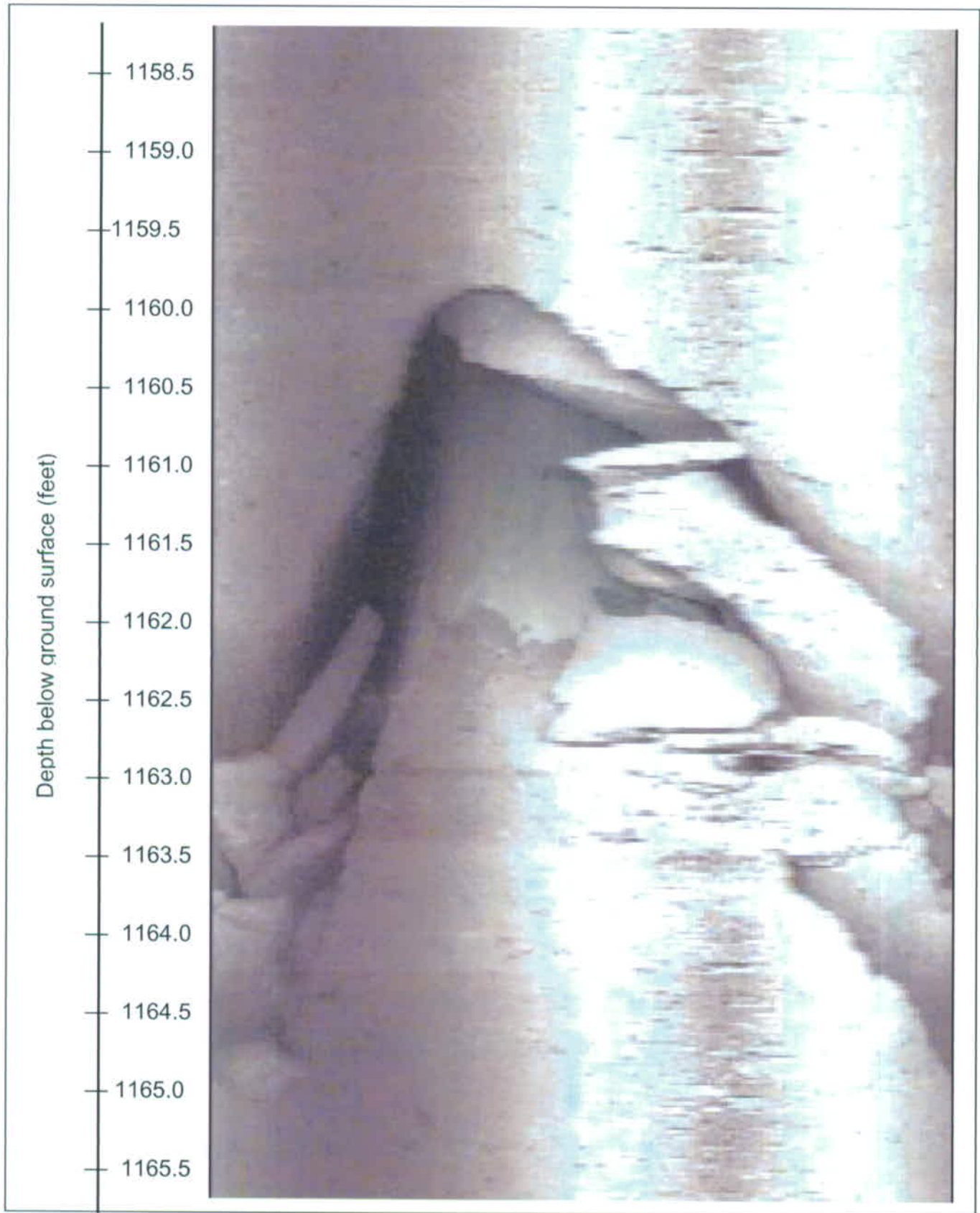

Figure 6.2-1
Optical Televiewer Image for 27P from 1158.5 to 1165.5 Feet Below Ground Surface

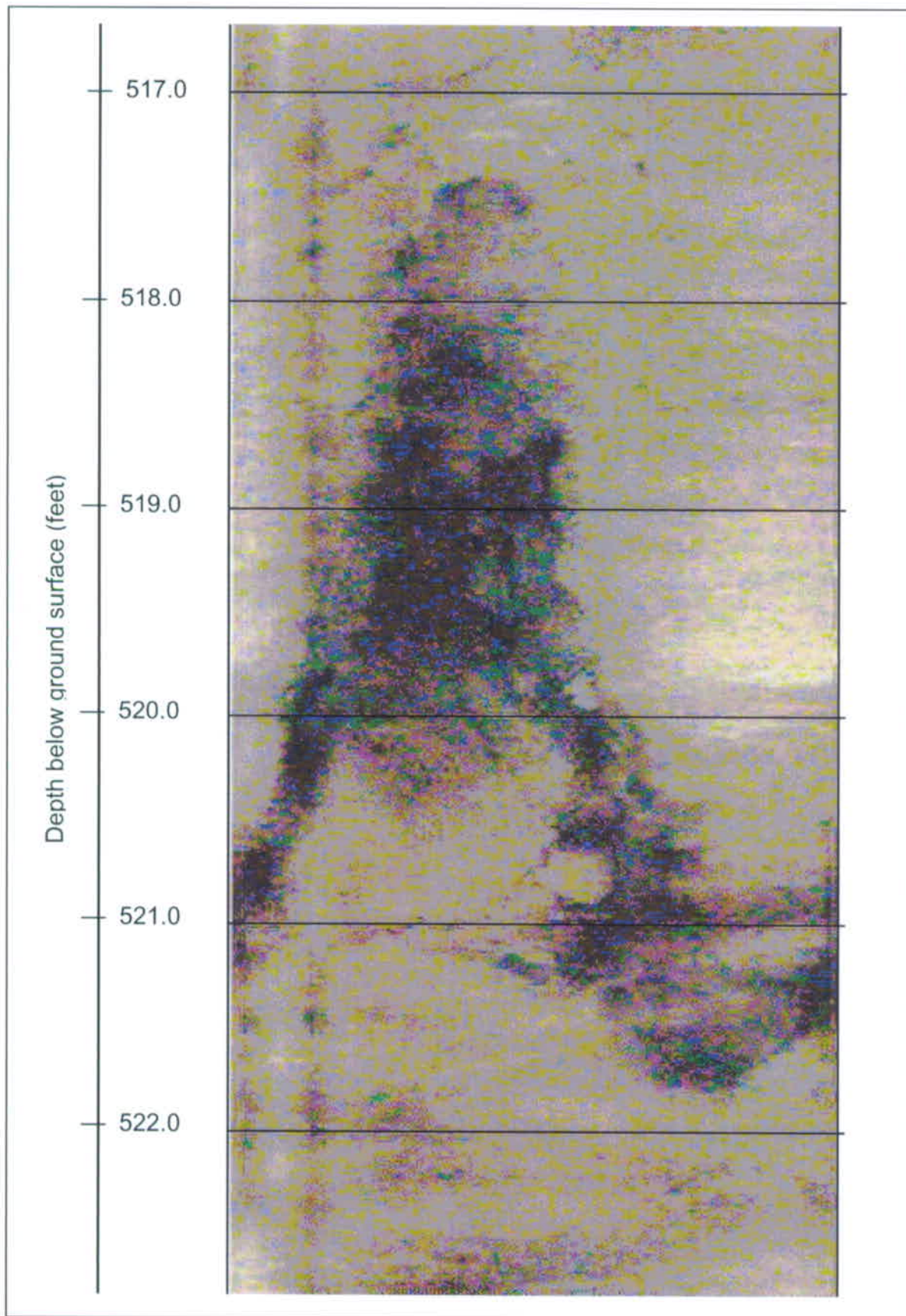

Figure 6.2-2
Optical Televiewer Image for 29P from 517 to 522 Feet Below Ground Surface

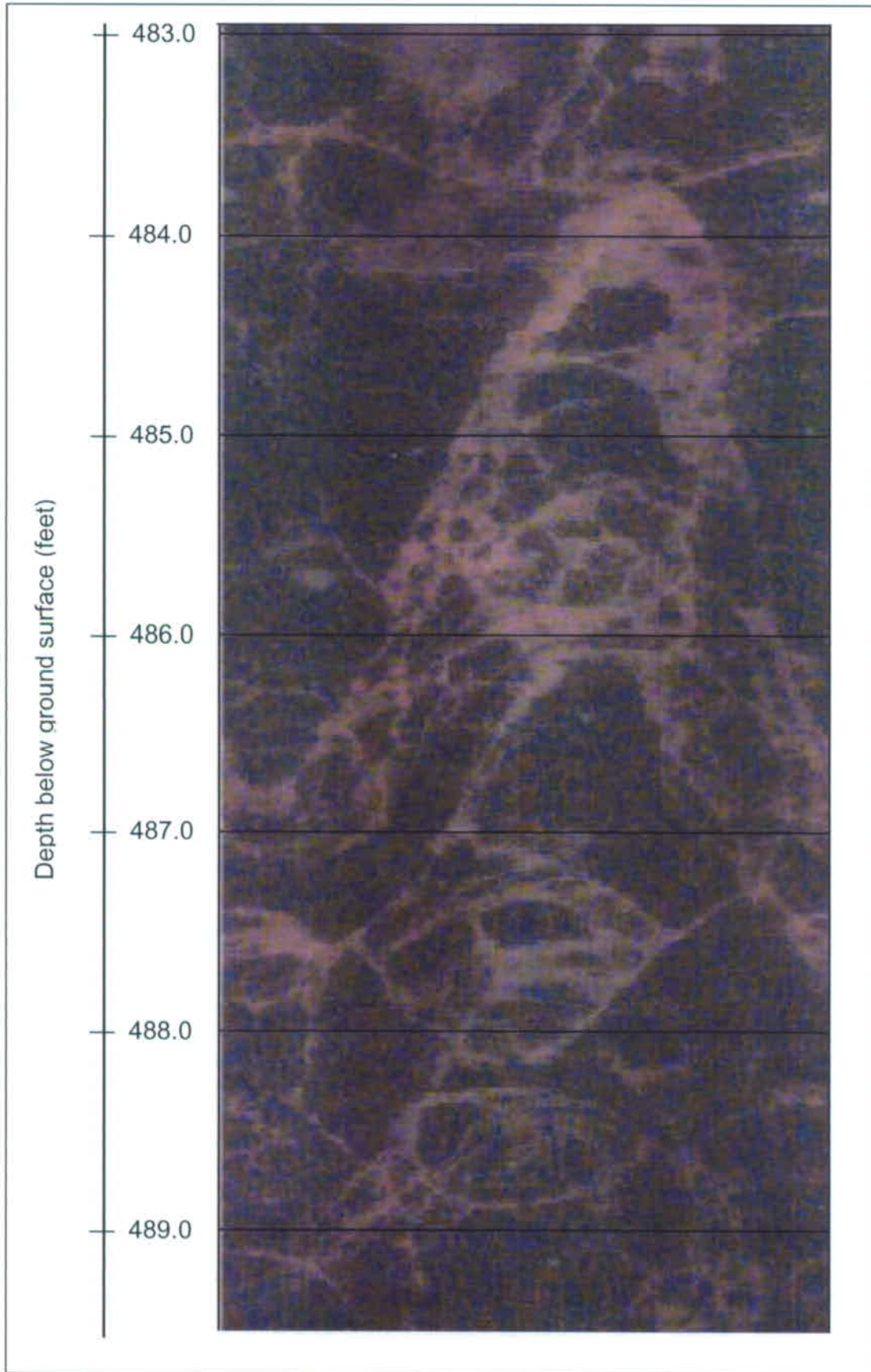

Figure 6.2-3
Optical Televiewer Image for 29P from 483.0 to 489.5 Feet Below Ground Surface

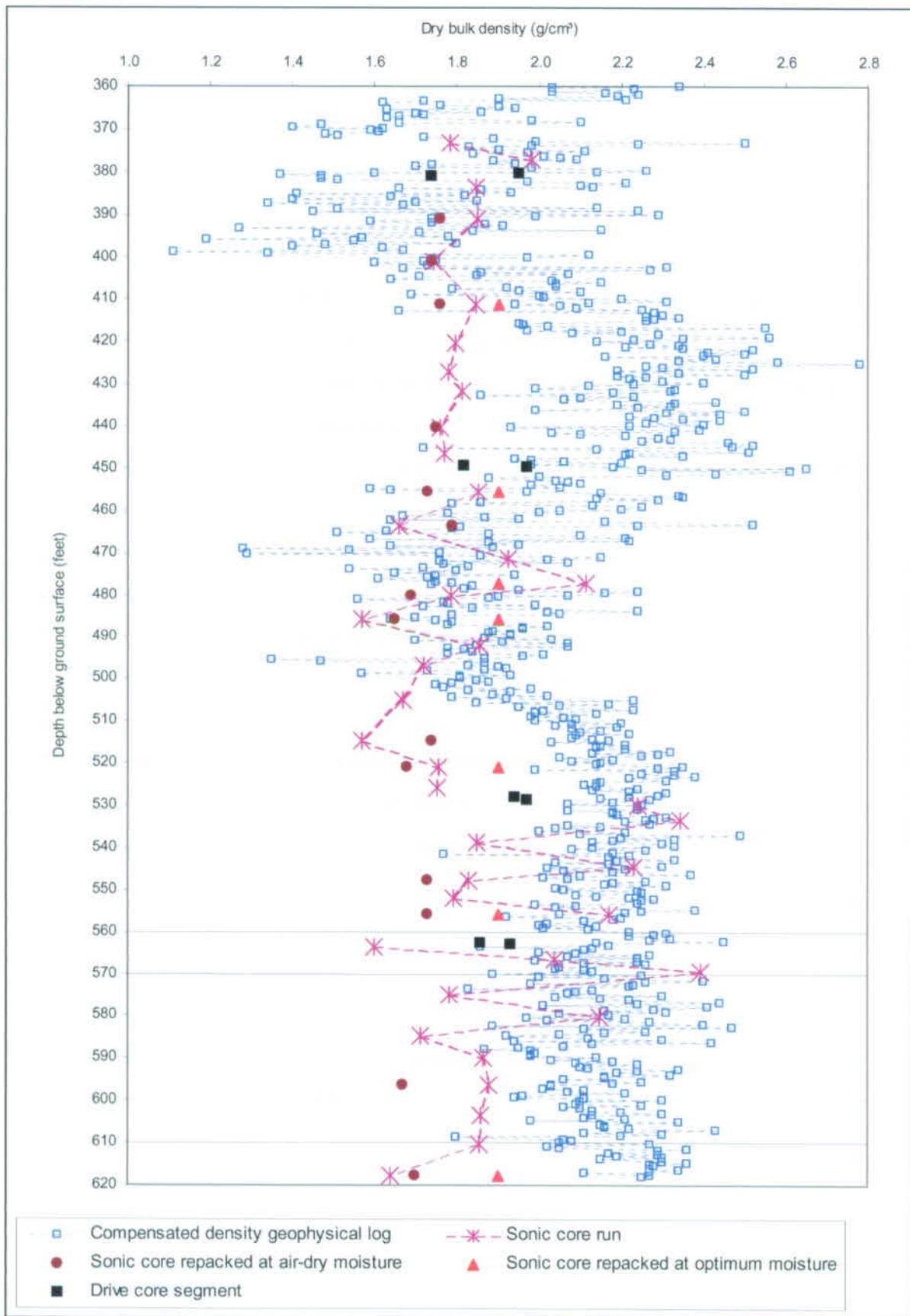

Figure 6.2-4
Dry Bulk Density Depth Profiles from 19PB using Different Measurement Methods

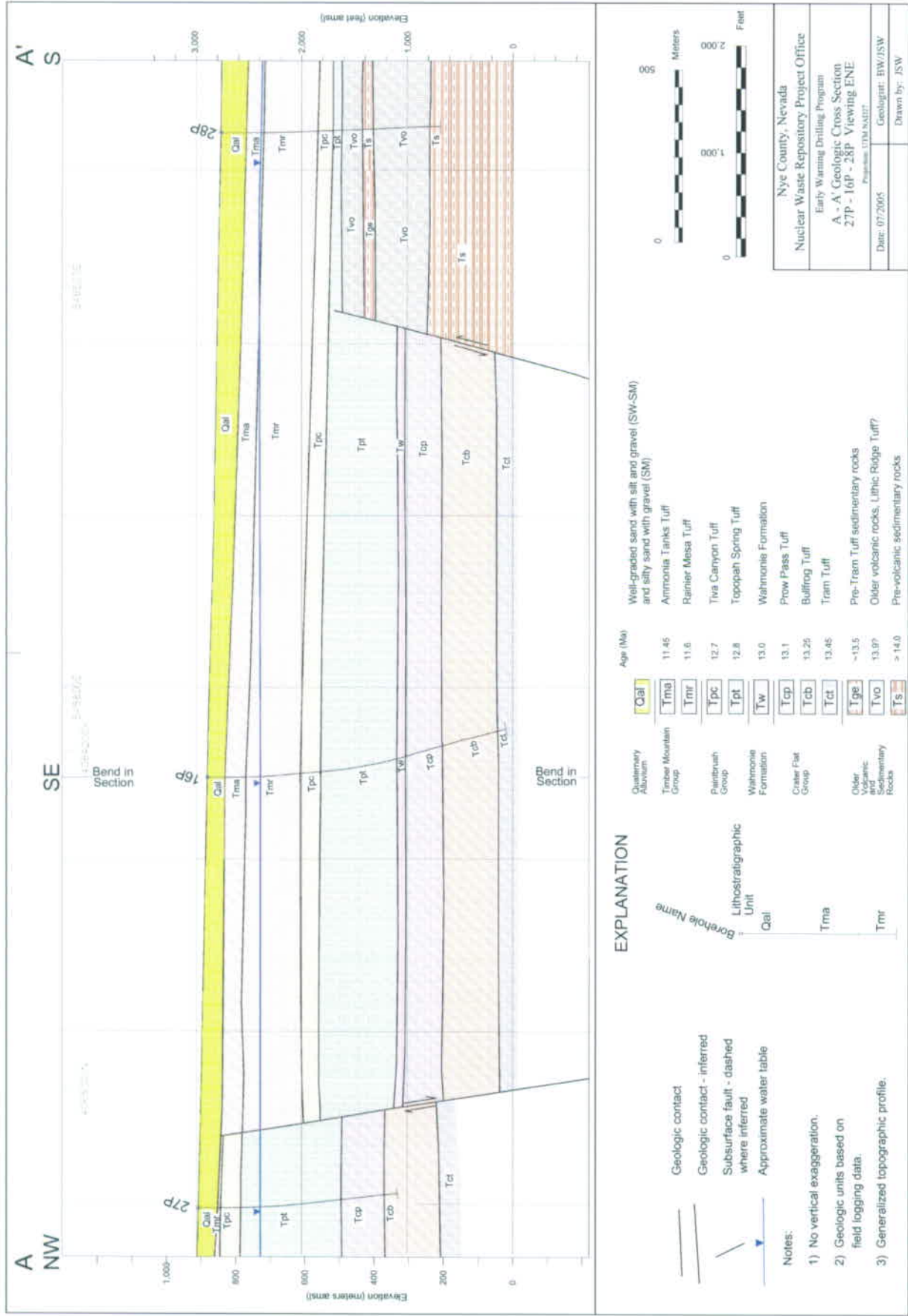

Figure 6.3-1
Cross Section A-A'

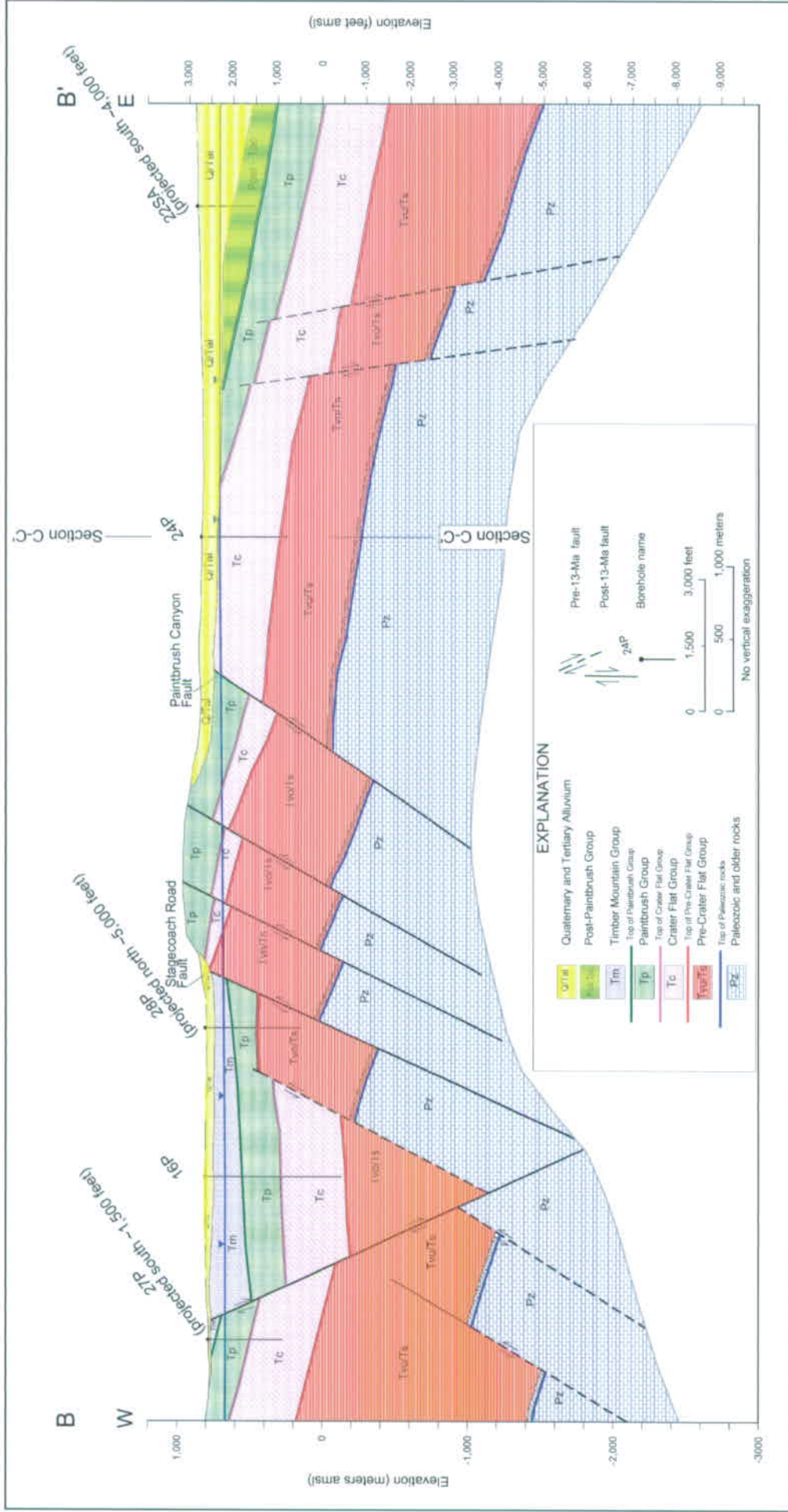

Figure 6.3-2
Conceptual Cross Section B-B'

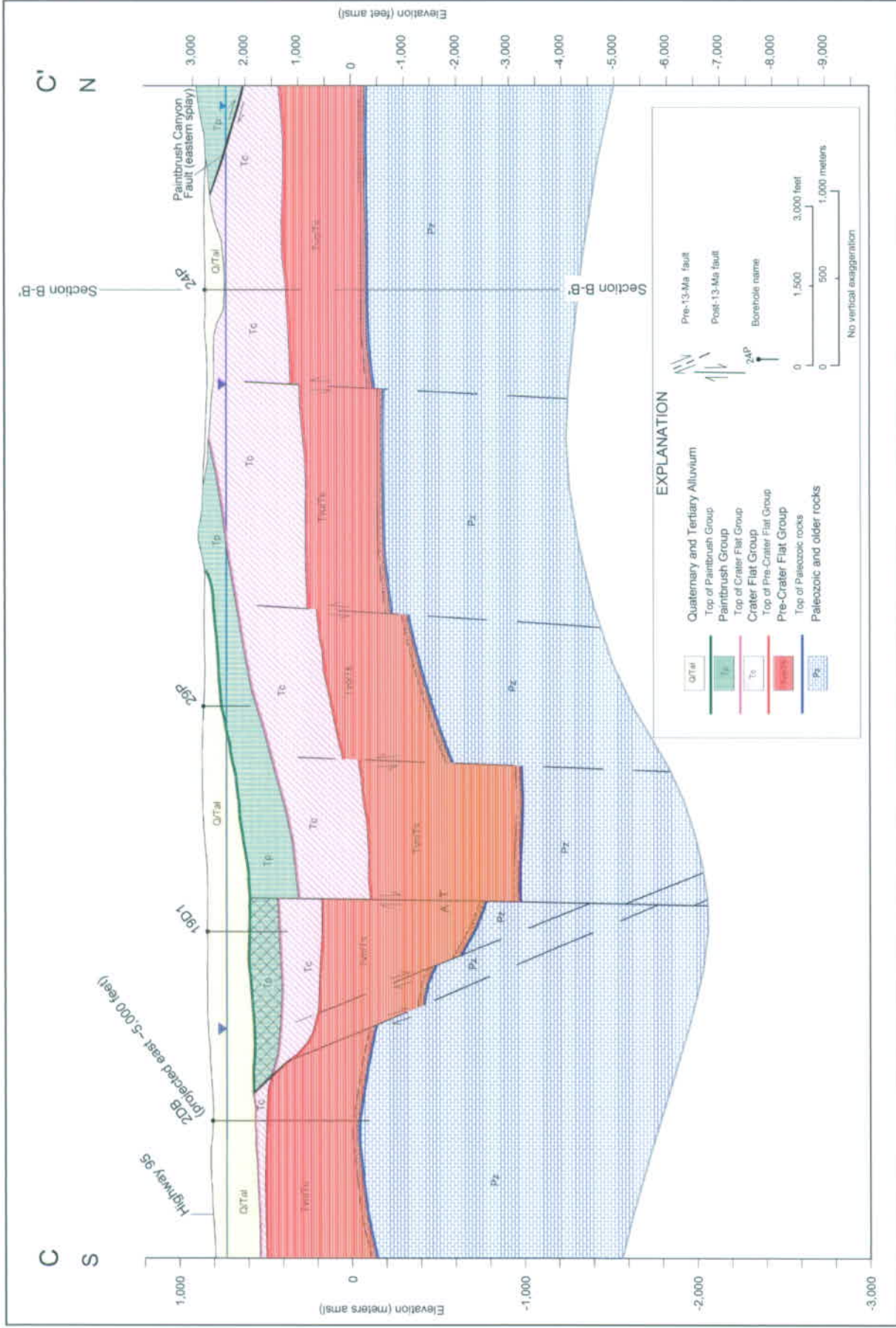

Figure 6.3-3
Conceptual Cross Section C-C'

APPENDIX A

**APPENDIX A
SUMMARY OF DRILLING ADDITIVES**

Appendix A
 Drilling Additives Used in Boreholes 16P, 24P, 27P, 28P, and 29P

Well Name	Activity	Date	Depth (feet below ground surface)	Material	Quantity ^a	Comments
16P	Drilling	12/14/02	550-1140	Max Gel ^{® b}	3 bags (mixed)	Two to five "shots" injected at each joint to stabilize hole.
		12/16/02	1140-1735		3 bags (mixed)	
		1/8/03	1735-1840		3 bags (mixed)	
		1/9/03	1840-2900		3 bags (mixed)	
24P	Drilling	7/17/03	80	Max Gel (dry)	4 bags	Used to condition borehole.
				FSF Super Foam Plus ^{® c}	10 gallons	
		7/22/03	100	Max Gel	13 gallons	
				FSF Super Foam Plus	5 gallons	
				Pac R ^{® d}	1 cup	
				Kwik Plug ^{® e}	1 bag	
		7/22/03	115	Max Gel	13 gallons	
			155		19.5 gallons	
			160	Max Gel (dry)	1 bag	
		7/23/03	197.5	Max Gel	13 gallons	
					13 gallons	
			200	Max Gel (dry)	1 bag	
			220	Max Gel	26 gallons	
				FSF Super Foam Plus	2 gallons	
			240	Max Gel	4 gallons	
				FSF Super Foam Plus	1 cup	
				Kwik Plug	1 gallon	
		260	Max Gel	26 gallons		
			FSF Super Foam Plus	1 cup		
		7/24/03	280	Max Gel	52 gallons	
				FSF Super Foam Plus	3 gallons	
				Kwik Plug	4 gallons	
				Pac R	32 oz	
		7/25/03	320	Max Gel	400 gallons	
Super Plug ^{® f}	200 gallons					
FSF Super Foam Plus	1 gallon					
357.5	FSF Super Foam Plus		3 gallons			
400			2 gallons			
400	Super Plug (dry)		5 bags			

Appendix A
Drilling Additives Used in Boreholes 16P, 24P, 27P, 28P, and 29P

Well Name	Activity	Date	Depth (feet below ground surface)	Material	Quantity ^a	Comments	
27P	Drilling	11/21/02	160	Max Gel	108 gallons	Used to condition borehole.	
		11/22/02	215		242 gallons		
			245		400 gallons		
			320		400 gallons		
		11/23/02	320		400 gallons		
			335	Max Gel (dry)	1 bag		
		11/25/02	625	Max Gel	300 gallons		Two to five "shots" injected at each joint to stabilize hole.
			645		15 gallons		
		12/2/02	700		96 gallons		
		12/3/02	1010-1100		2 bags (mixed)		
		12/4/02	1100-1340		3 bags (mixed)		
		12/5/02	1340-1660		3 bags (mixed)		
		12/6/02	1660-1900		3 bags (mixed)		
28P	Drilling	10/22/02	101.44		Max Gel	96 gallons	Used to condition borehole.
		10/23/02	380.7			48 gallons	
		10/31/02	1270			400 gallons	
		11/3/02	1225-1270	Polyplus 2000 ^{®g}	2800 gallons	Used to drill through borehole collapse.	
			1281.97-1460		100.5 gallons		
		11/4/02	1460	Max Gel	800 gallons	Injected to keep borehole stabilized.	
					Polyplus 2000		3 gallons
					Max Gel		400 gallons
		11/5/02	1540	Max Gel	1.5 gallons		
					1540-1620		200 gallons
					1660		200 gallons
			1710	Polyplus 2000	1 gallon		
				Max Gel	200 gallons		
				Polyplus 2000	1 gallon		
				1715	Max Gel	400 gallons	
		11/6/02	1760	Polyplus 2000	1 gallon		
				Max Gel	100 gallons		
1860	Polyplus 2000		0.25 gallons				
	Max Gel		300 gallons				
	Polyplus 2000		0.75 gallons				
1870	Max Gel	300 gallons					
		Polyplus 2000	1 gallon	Used to condition borehole.			

Appendix A
Drilling Additives Used in Boreholes 16P, 24P, 27P, 28P, and 29P

Well Name	Activity	Date	Depth (feet below ground surface)	Material	Quantity ^a	Comments	
28P	Drilling	11/7/02	1950	Max Gel	400 gallons	Used to condition borehole.	
				Polyplus 2000	1 gallon		
			1960	Max Gel	400 gallons		
				Polyplus 2000	0.25 gallons		
		11/12/02	1960	Max Gel	400 gallons		
				Polyplus 2000	0.25 gallons		
			1960-2040	Max Gel	400 gallons		
				Polyplus 2000	0.25 gallons		
		2040-2060	Max Gel	400 gallons			
			Polyplus 2000	0.25 gallons			
11/13/02	2060-2080	Max Gel	400 gallons				
		Polyplus 2000	0.25 gallons				
29P	Drilling	6/26/03	80	Max Gel	117 gallons	Used to condition borehole	
		6/27/03	120		26 gallons		
			157.5		26 gallons		
			180		13 gallons		
			220		13 gallons		
		6/28/03	247.5		26 gallons		
			280		26 gallons		
			85 gallons				
		6/29/03	340		Polyplus 2000		10 gallons
					FSF Super Foam Plus		1 gallon
	Pac R			32 ounces			
	Plugging	7/1/03	790	Cement plus Bentonite	250 gallons	Used to control heaving sand.	
		7/10/03	717		240 gallons		
			700.81		150 gallons		
			697.19		350 gallons		
		7/11/04	695.85		350 gallons		
695.11			350 gallons				

^a Material mixed with variable volume of water.

^b Max Gel: Sodium bentonite coated with polymer.

^c FSF Super Foam Plus: Oil well drilling fluid additive containing surfactant, water, and isopropyl alcohol.

^d Pac R: Oil well drilling fluid additive consisting of carboxymethylcellulose and sodium salt.

^e Kwik Plug: Untreated ground sodium bentonite chips.

^f Super Plug: Bentonite formulated for plugging holes, as opposed to conditioning a hole during borehole advance.

^g Polyplus 2000: Synthetic copolymer.

APPENDIX B

**APPENDIX B
WELL COMPLETION AND
WELLHEAD PROTECTION DIAGRAMS**

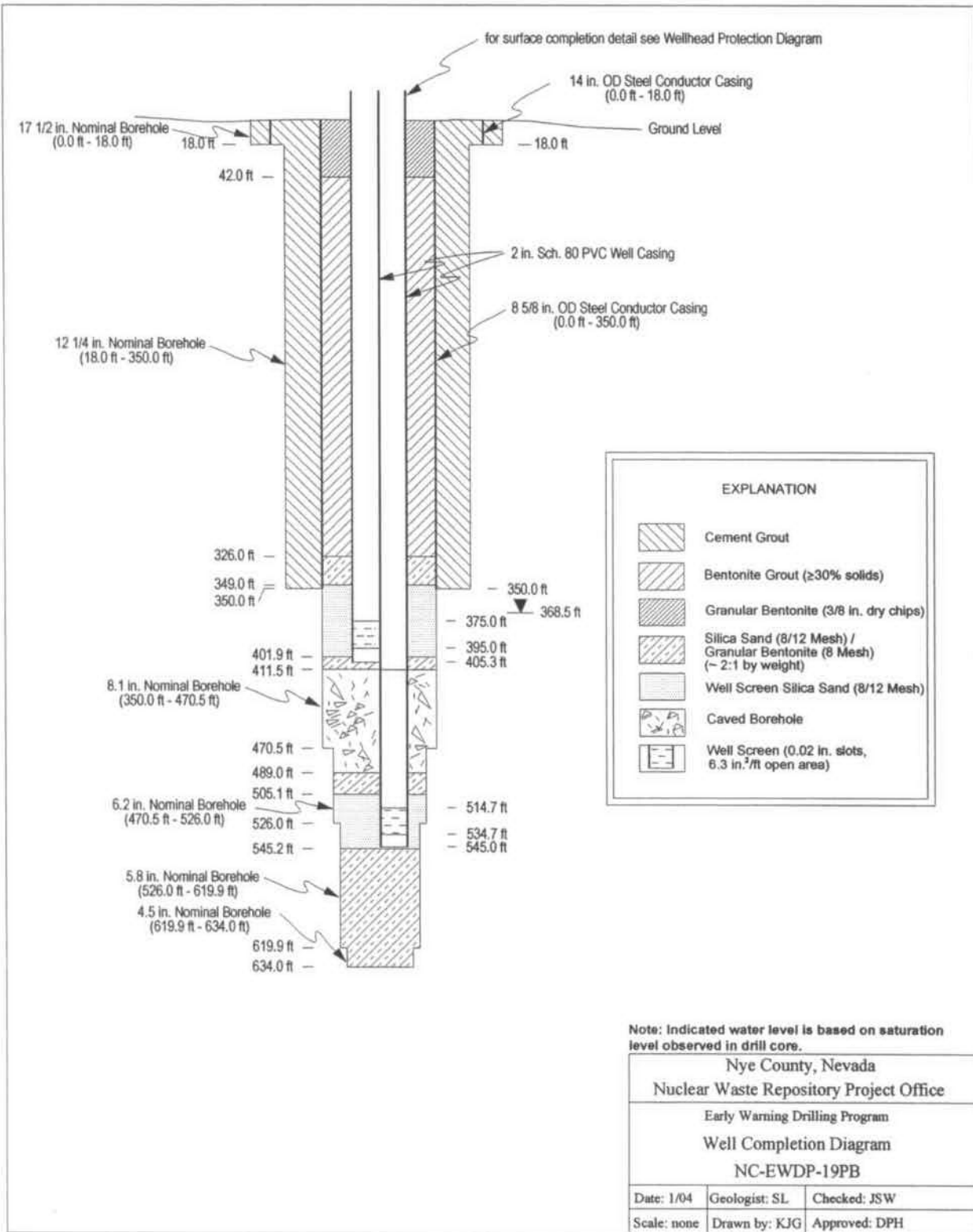

Well Completion Diagram for 19PB

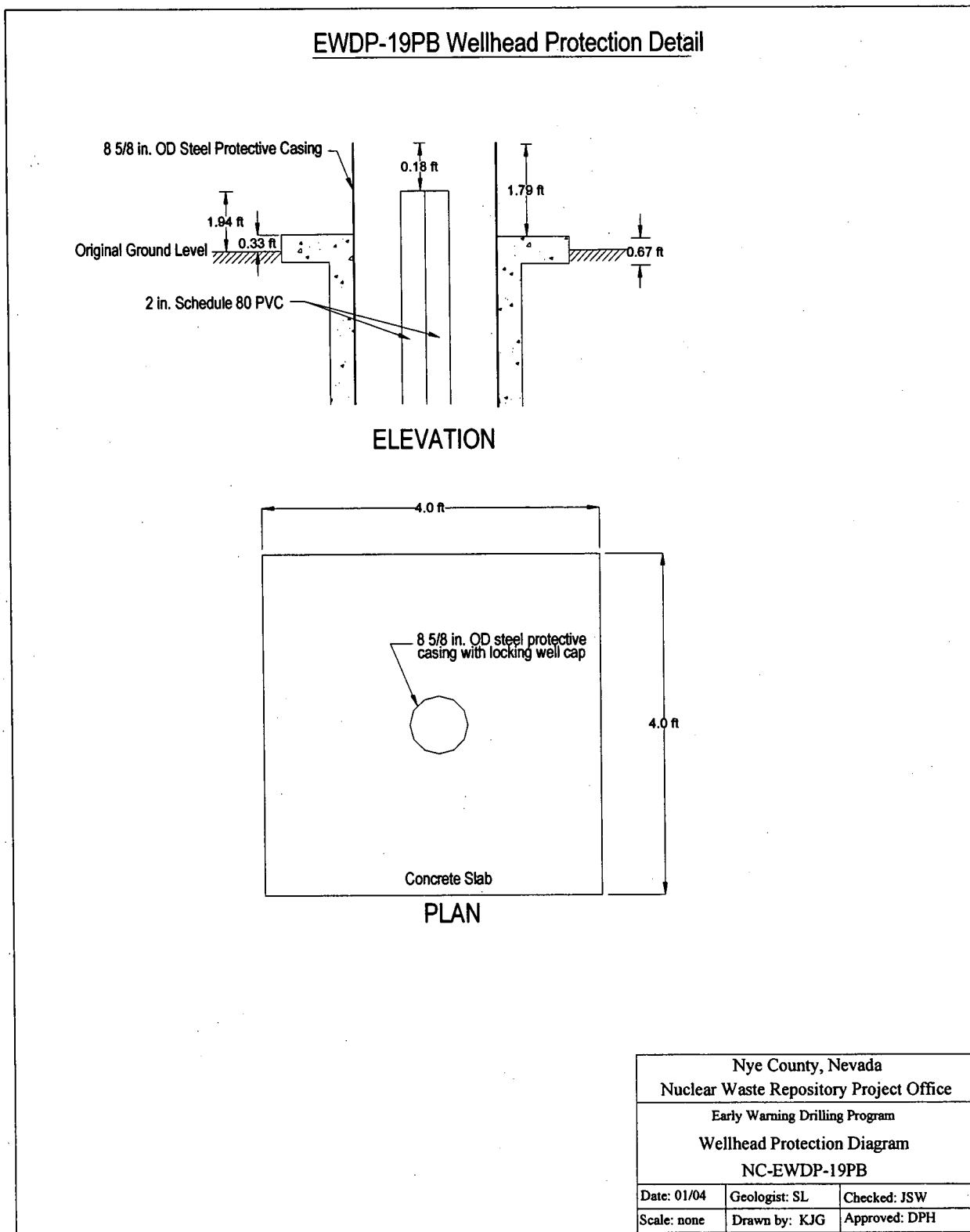

Wellhead Protection Diagram for 19PB

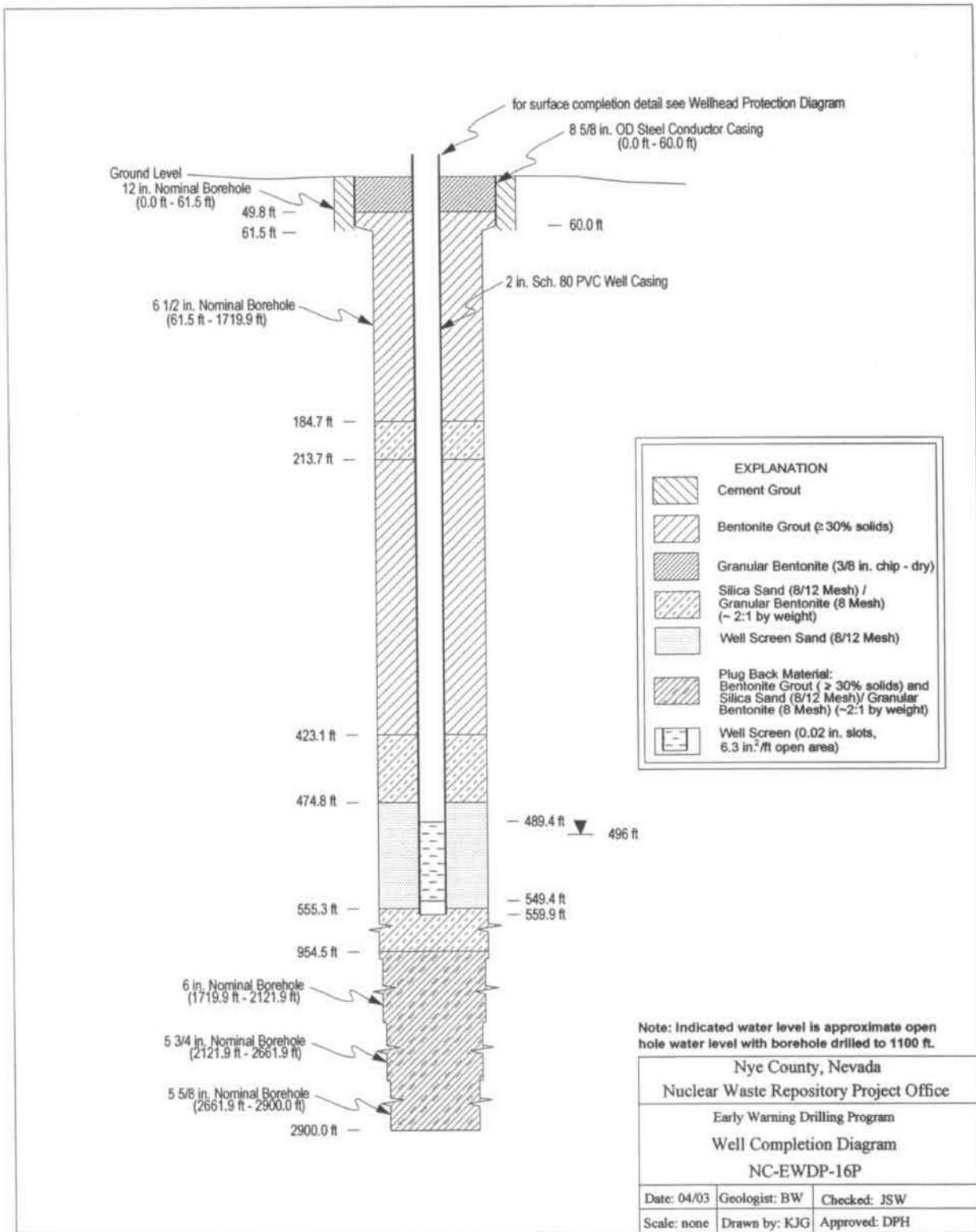

Well Completion Diagram for 16P

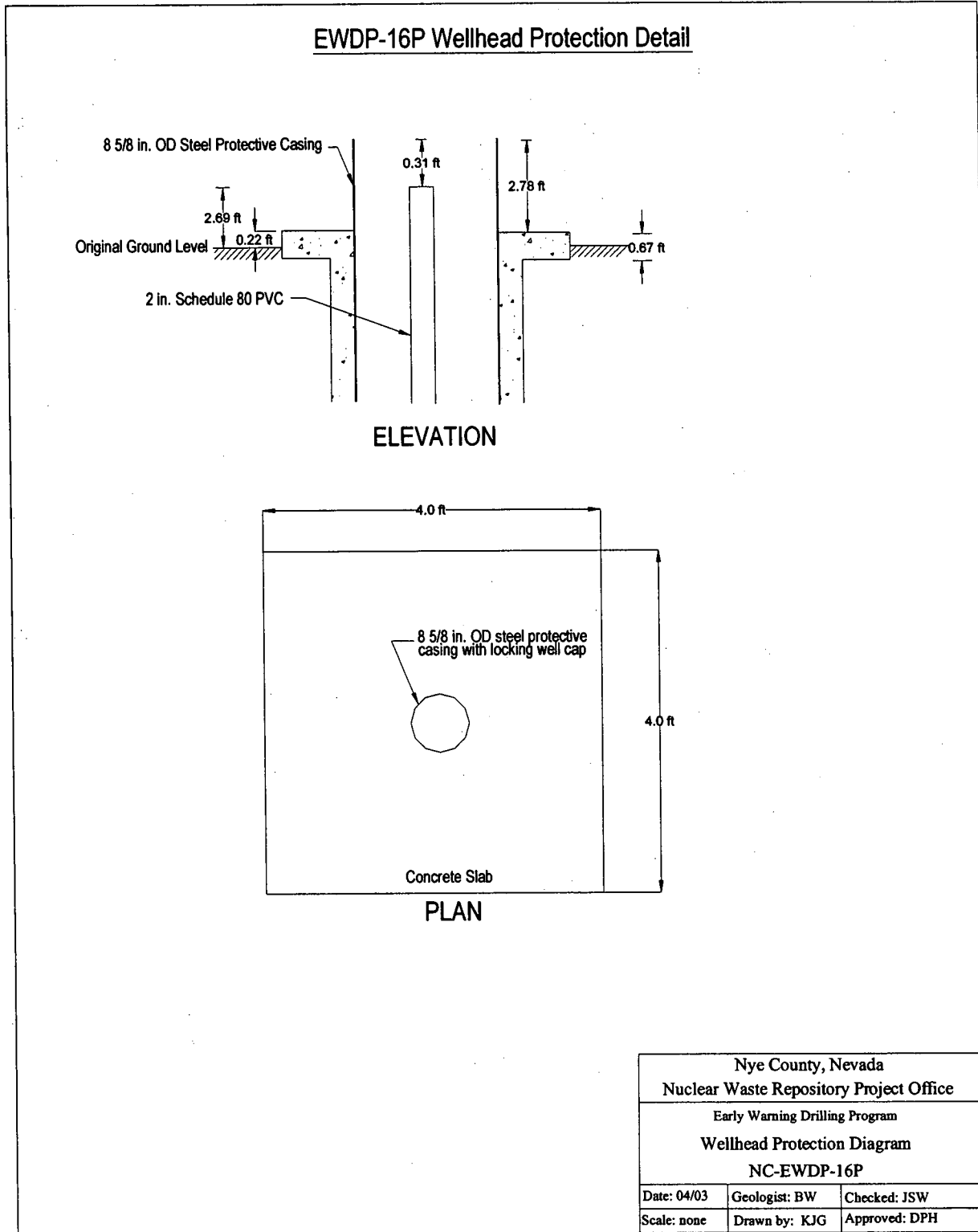

Wellhead Protection Diagram for 16P

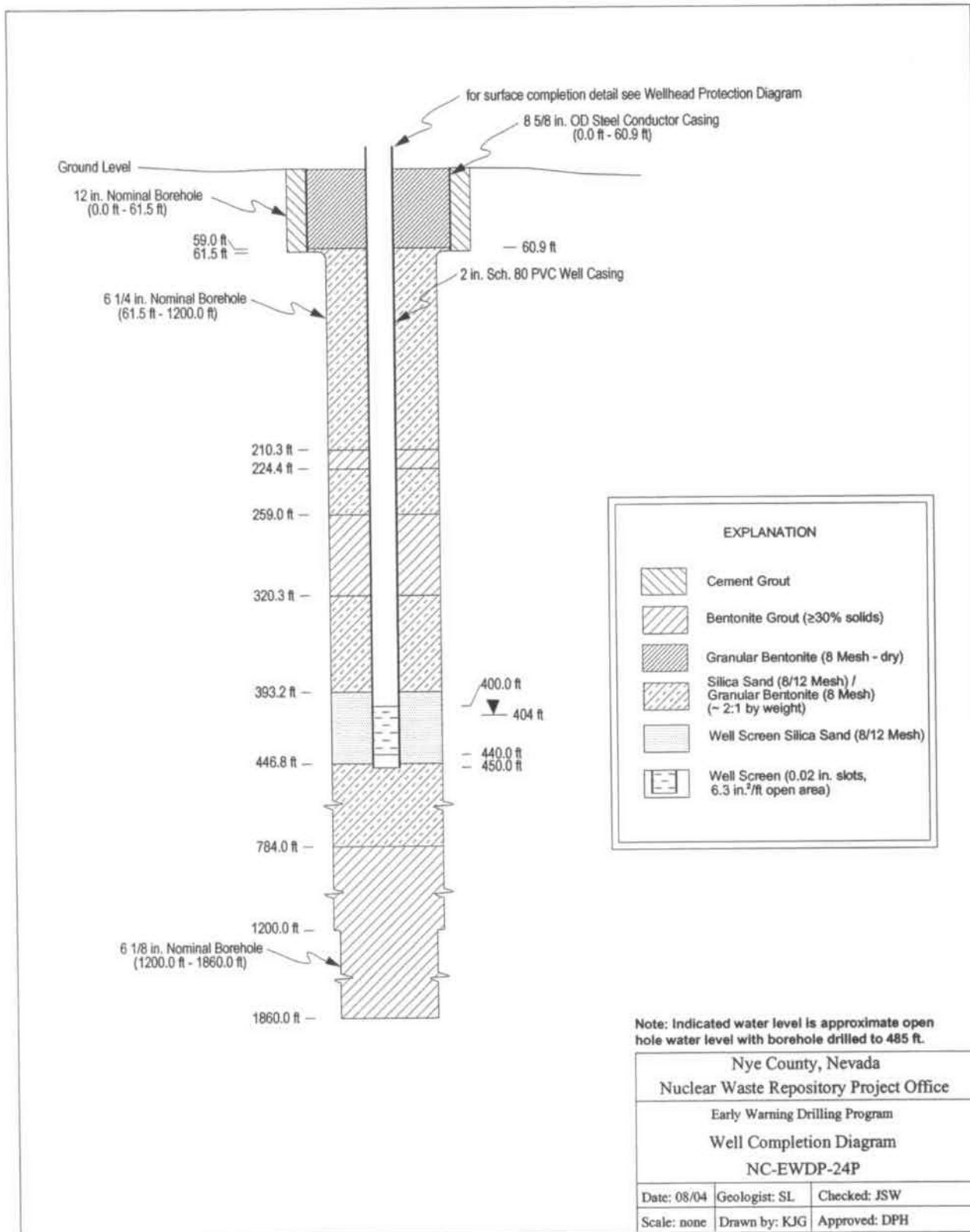

Well Completion Diagram for 24P

EWDP-24P Wellhead Protection Detail

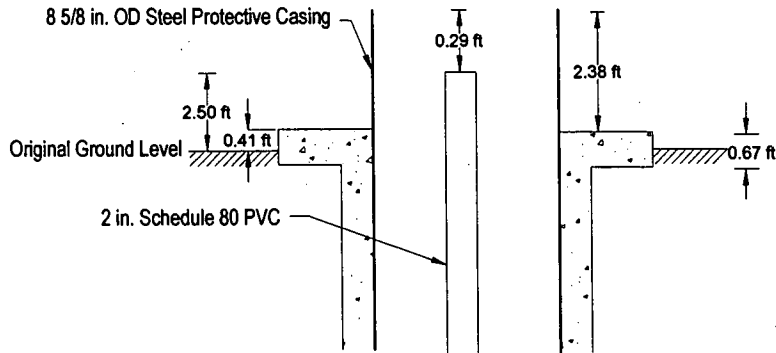

ELEVATION

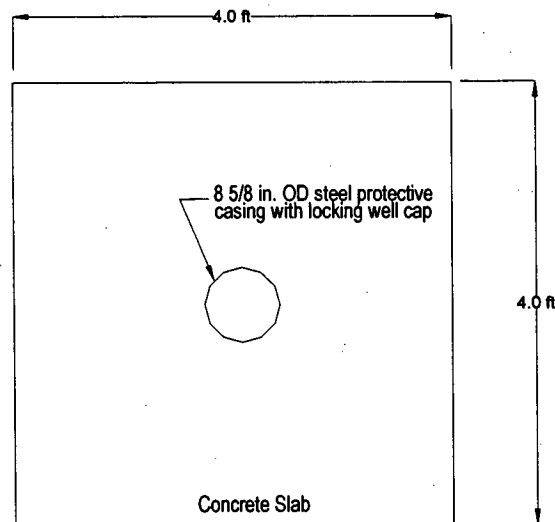

PLAN

Nye County, Nevada Nuclear Waste Repository Project Office		
Early Warning Drilling Program Wellhead Protection Diagram NC-EWDP-24P		
Date: 11/03	Geologist: SL	Checked: JSW
Scale: none	Drawn by: KJG	Approved: DPH

Wellhead Protection Diagram for 24P

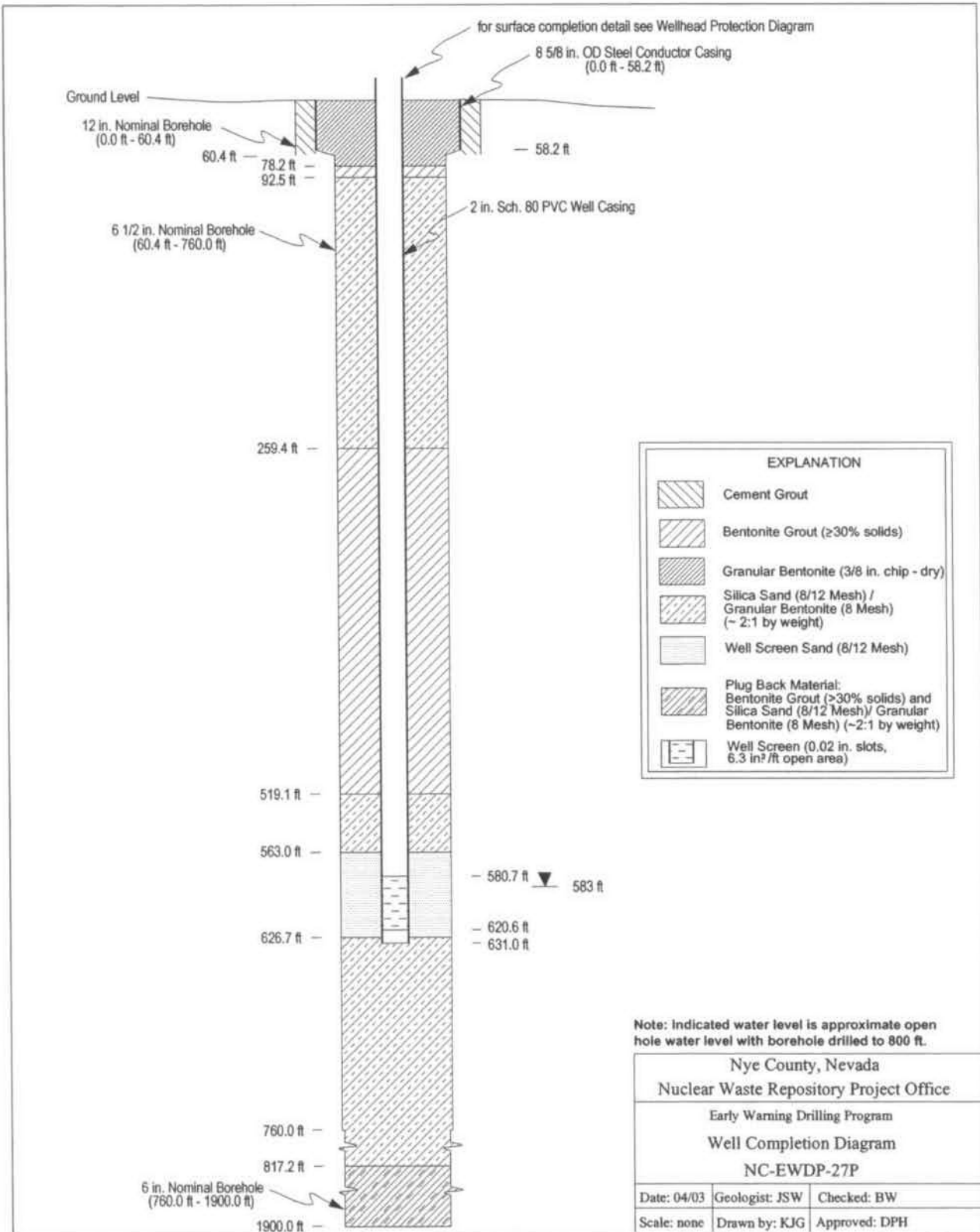

Well Completion Diagram for 27P

EWDP-27P Wellhead Protection Detail

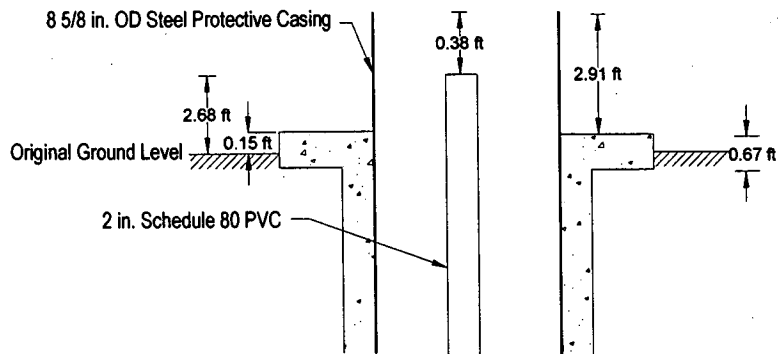

ELEVATION

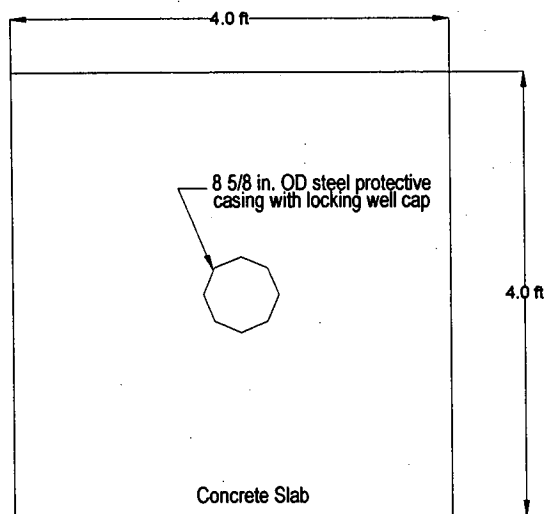

PLAN

Nye County, Nevada Nuclear Waste Repository Project Office		
Early Warning Drilling Program Wellhead Protection Diagram NC-EWDP-27P		
Date: 04/03	Geologist: JSW	Checked: BW
Scale: none	Drawn by: KJG	Approved: DPH

Wellhead Protection Diagram for 27P

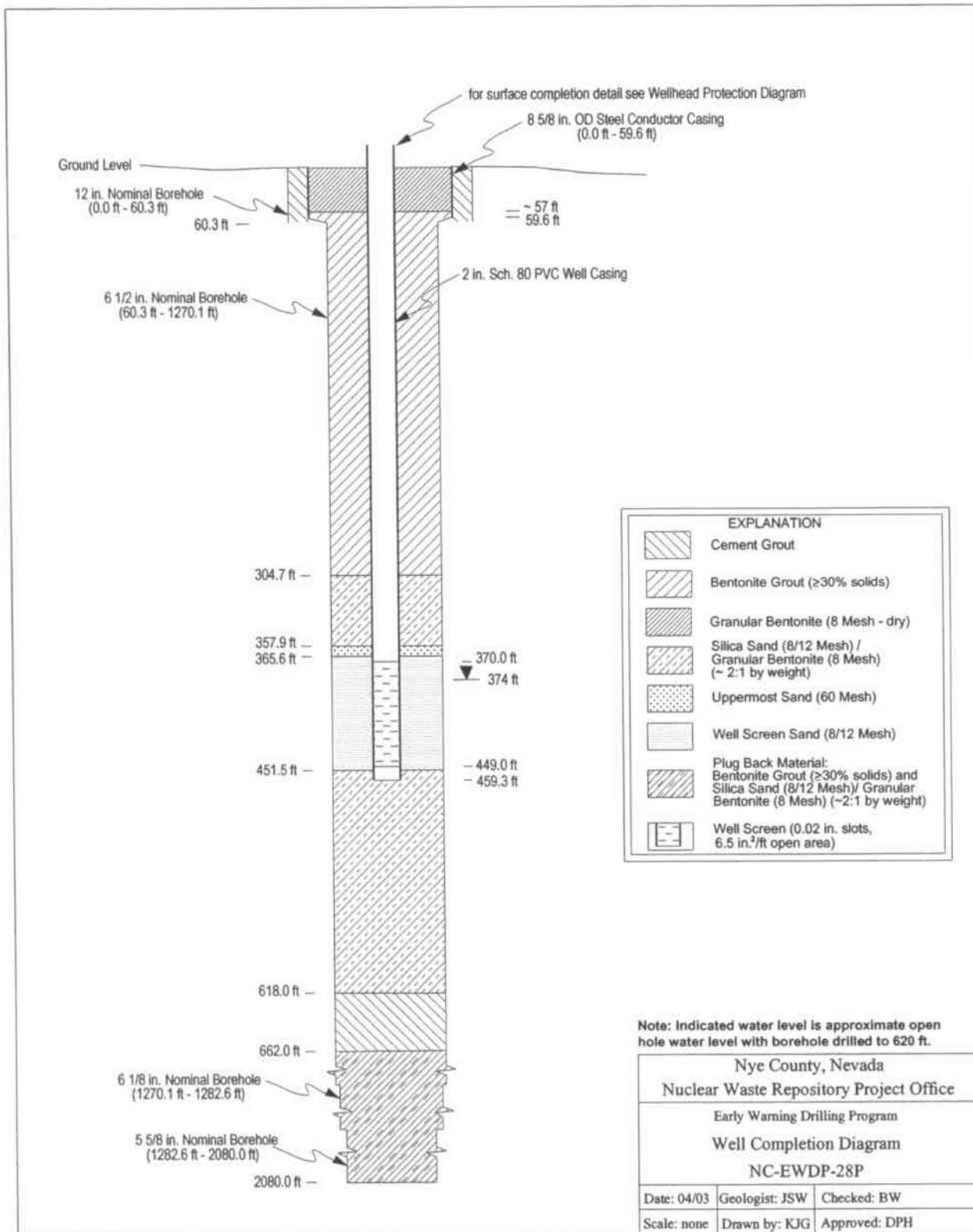

Well Completion Diagram for 28P

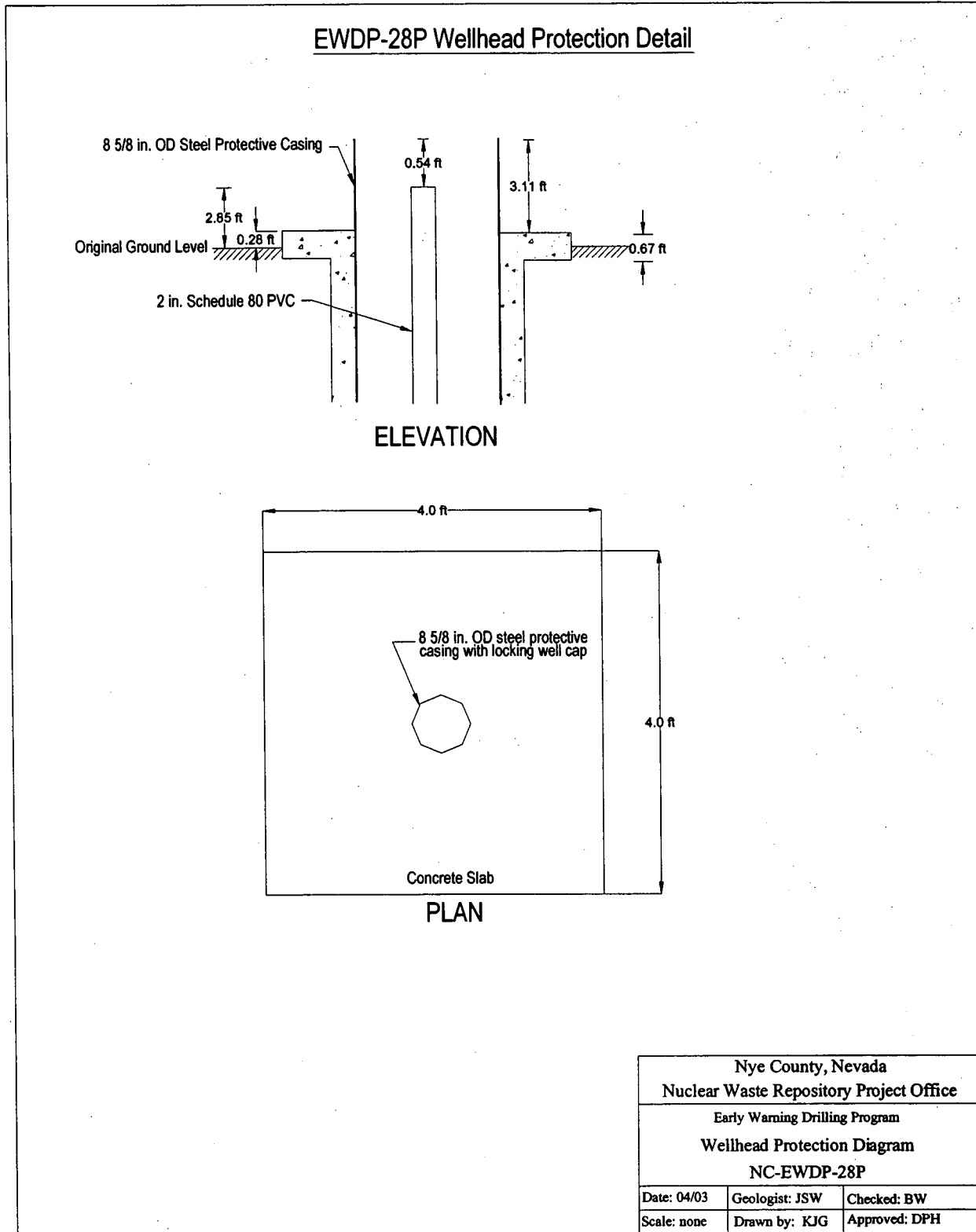

Wellhead Protection Diagram for 28P

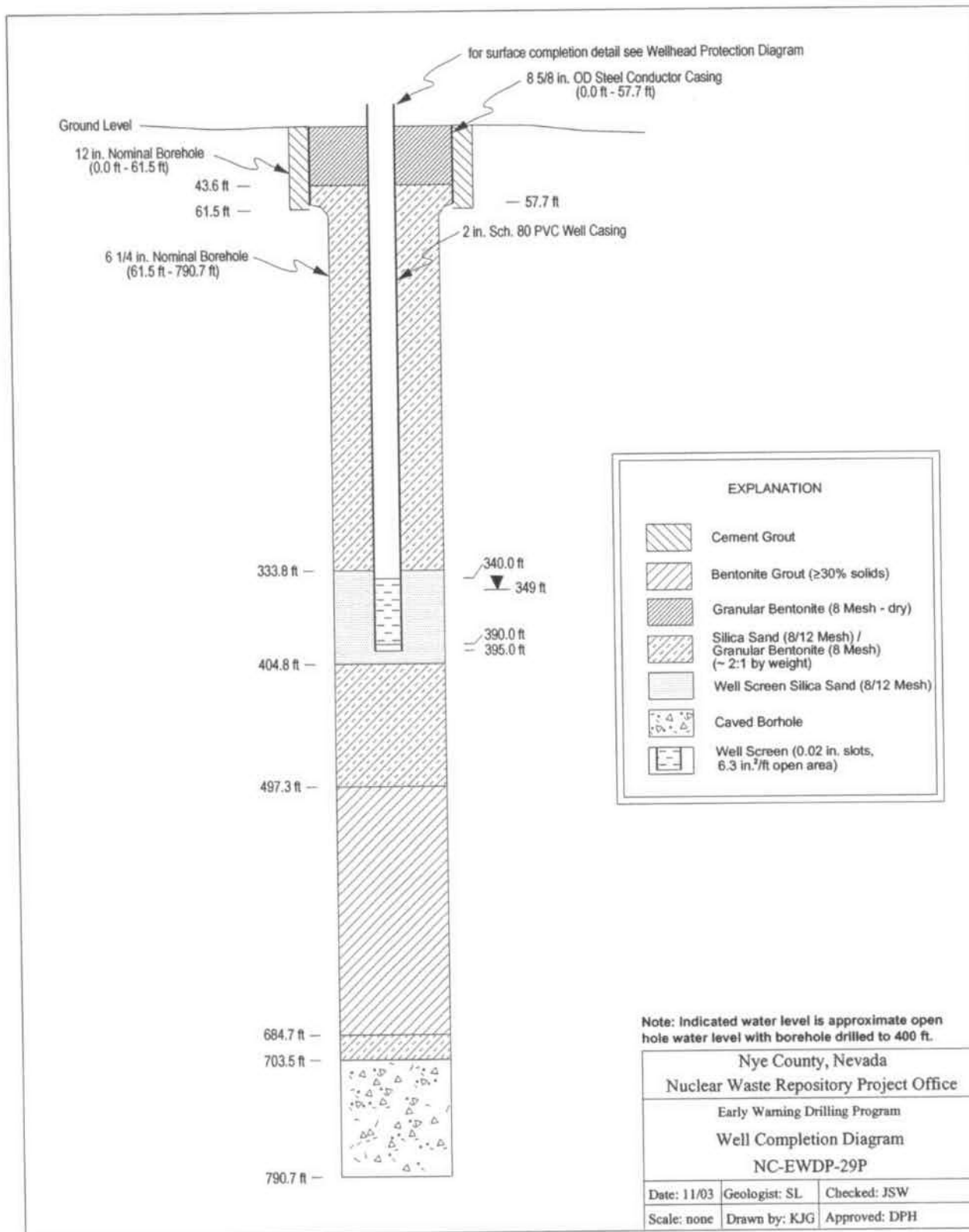

Well Completion Diagram for 29P

EWDP-29P Wellhead Protection Detail

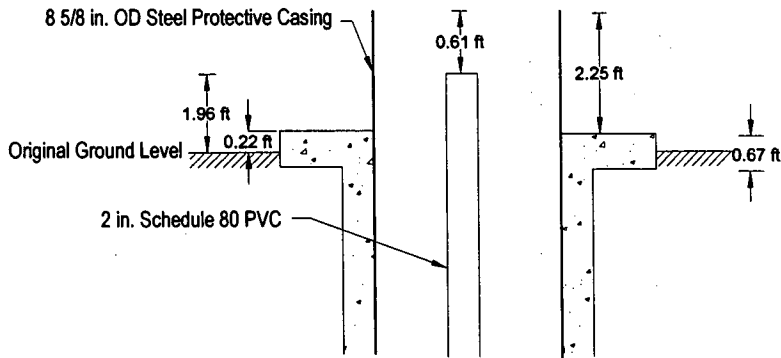

ELEVATION

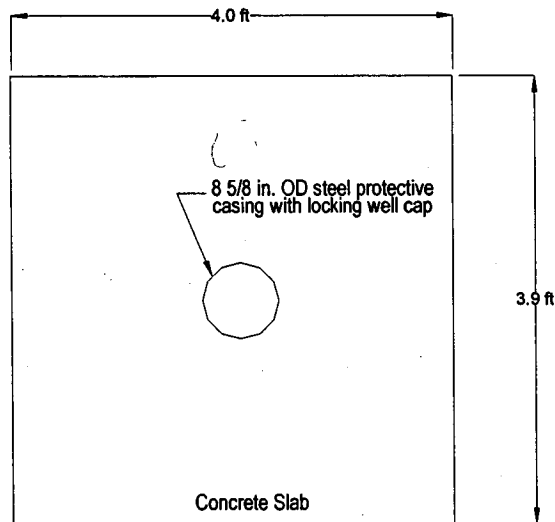

PLAN

Nye County, Nevada		
Nuclear Waste Repository Project Office		
Early Warning Drilling Program		
Wellhead Protection Diagram		
NC-EWDP-29P		
Date: 11/03	Geologist: JSW	Checked: JSW
Scale: none	Drawn by: KJG	Approved: DPH

Wellhead Protection Diagram for 29P

APPENDIX C

**APPENDIX C
GEOLOGIC LOGGING PARAMETERS
FOR DRILL CUTTINGS**

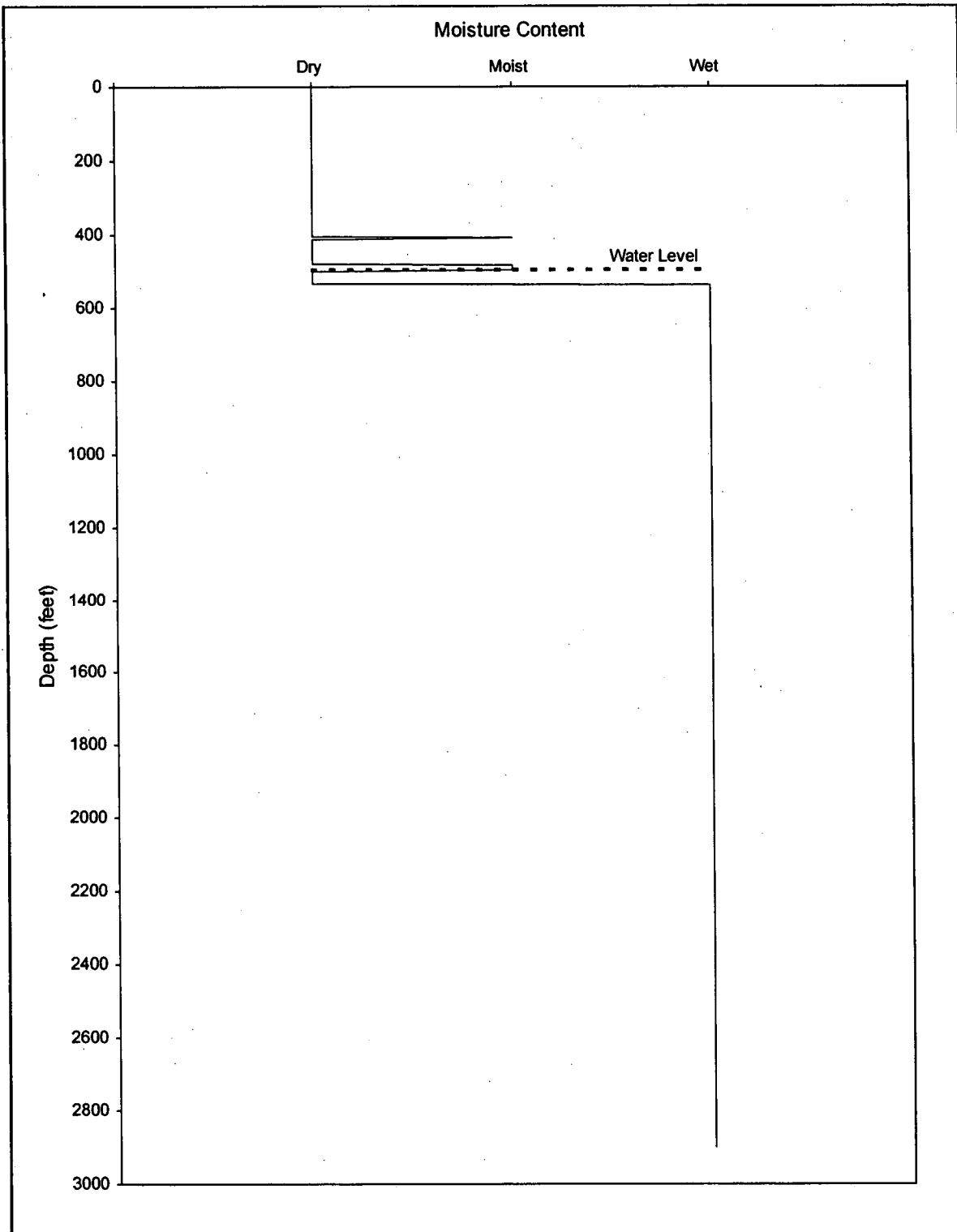

Appendix C-1
Moisture Content vs. Depth of Drill Cuttings in Alluvium and Non-Alluvium for 16P

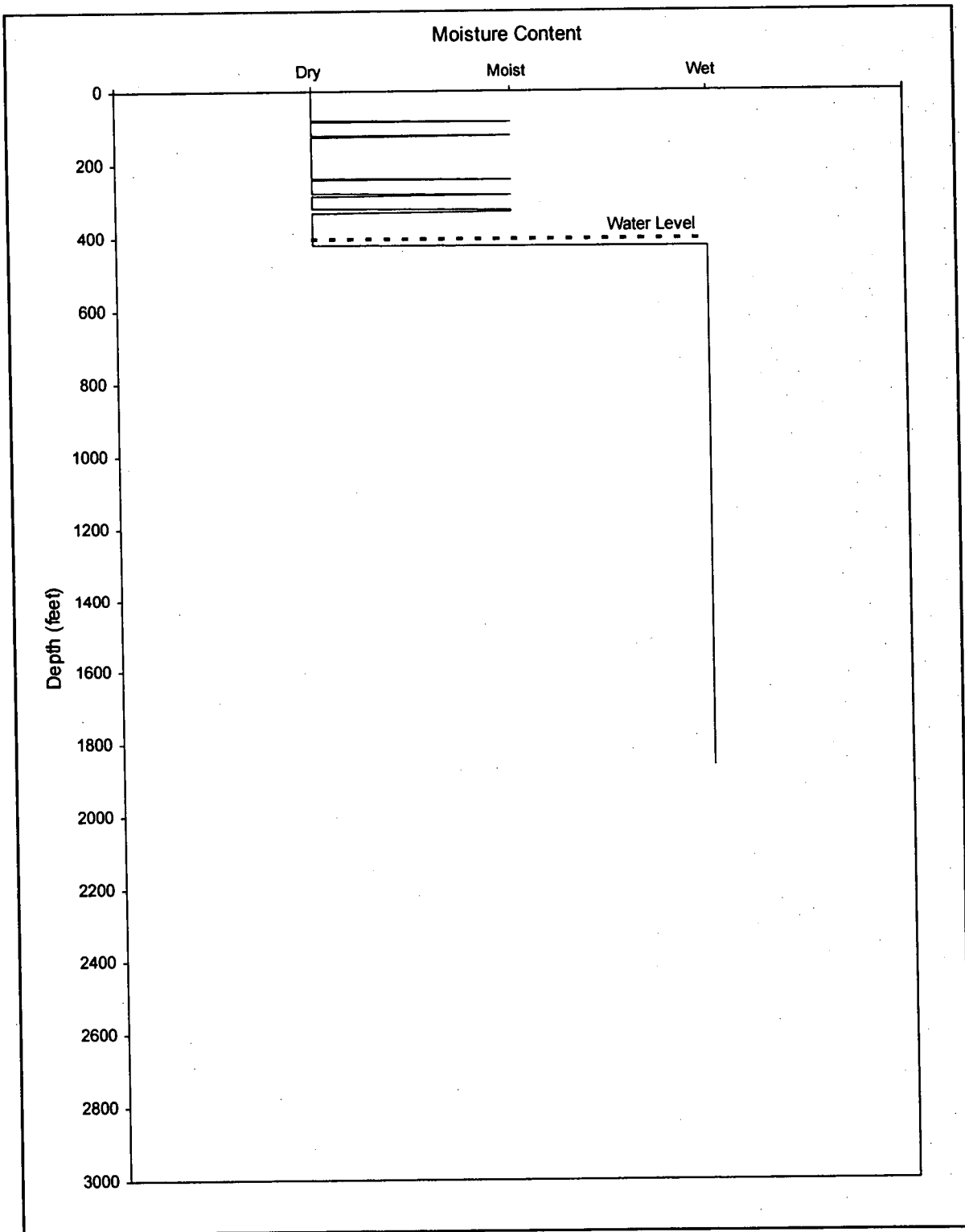

Appendix C-2
Moisture Content vs. Depth of Drill Cuttings in Alluvium and Non-Alluvium for 24P

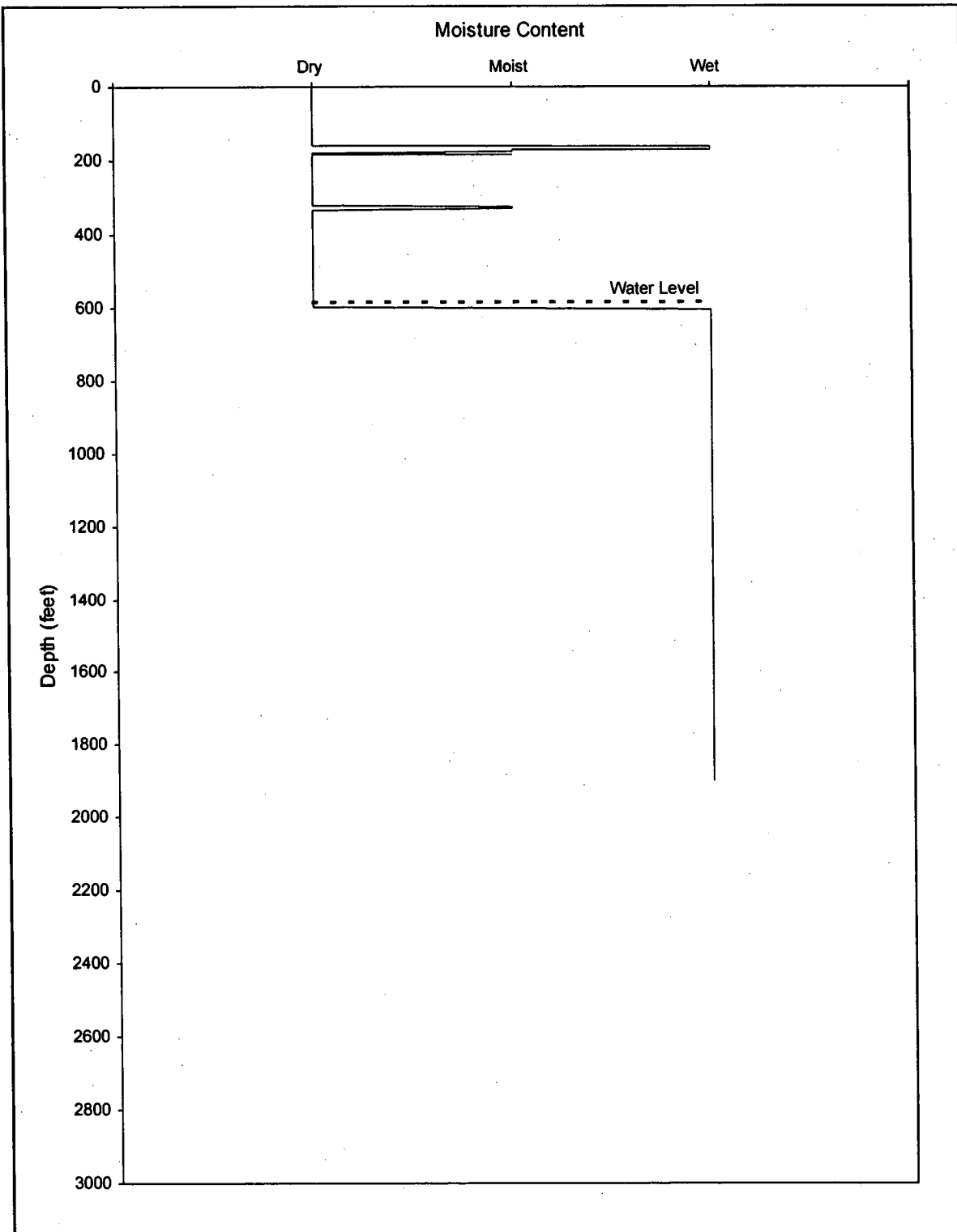

Appendix C-3
Moisture Content vs. Depth of Drill Cuttings in Alluvium and Non-Alluvium for 27P

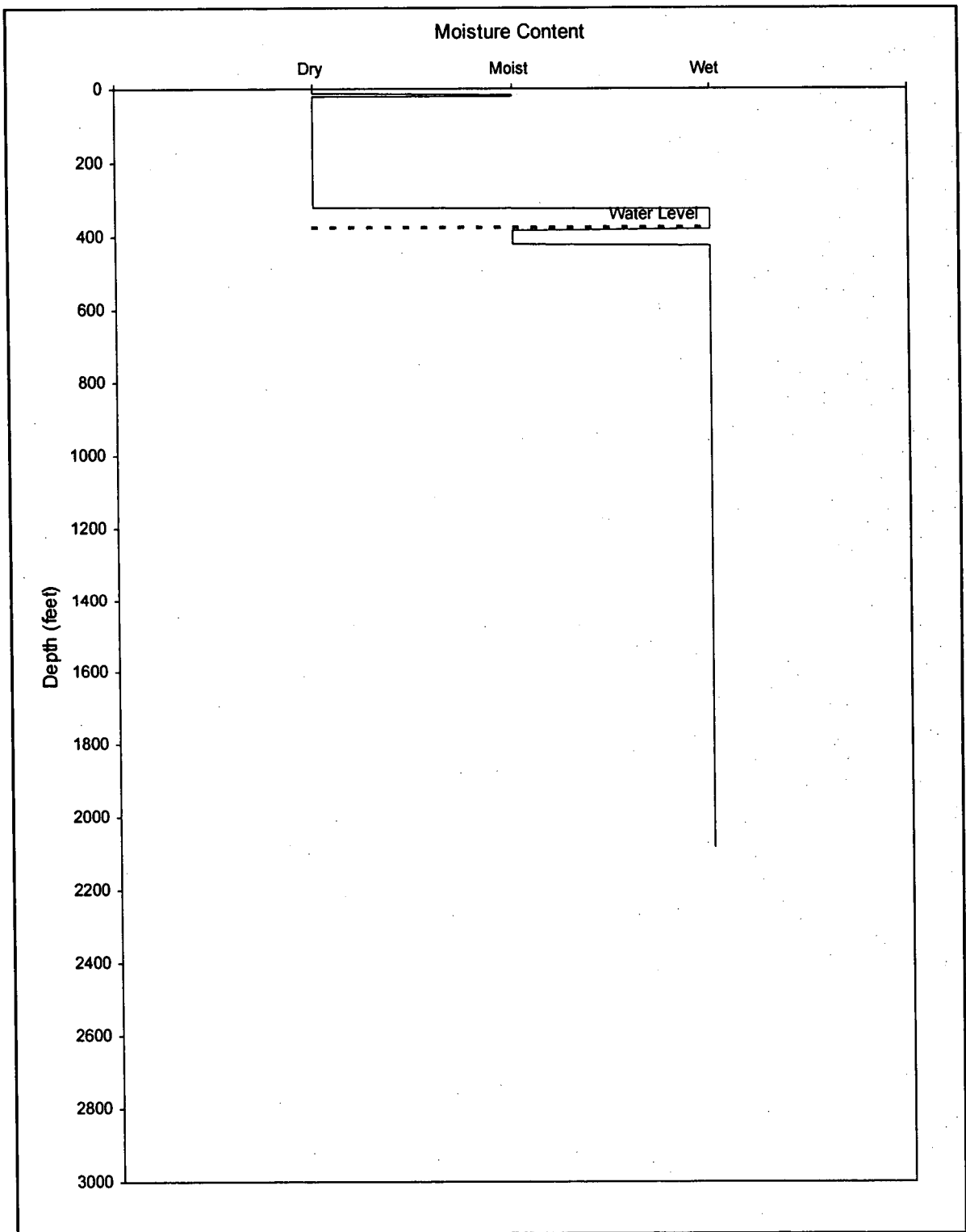

Appendix C-4
Moisture Content vs. Depth of Drill Cuttings in Alluvium and Non-Alluvium for 28P

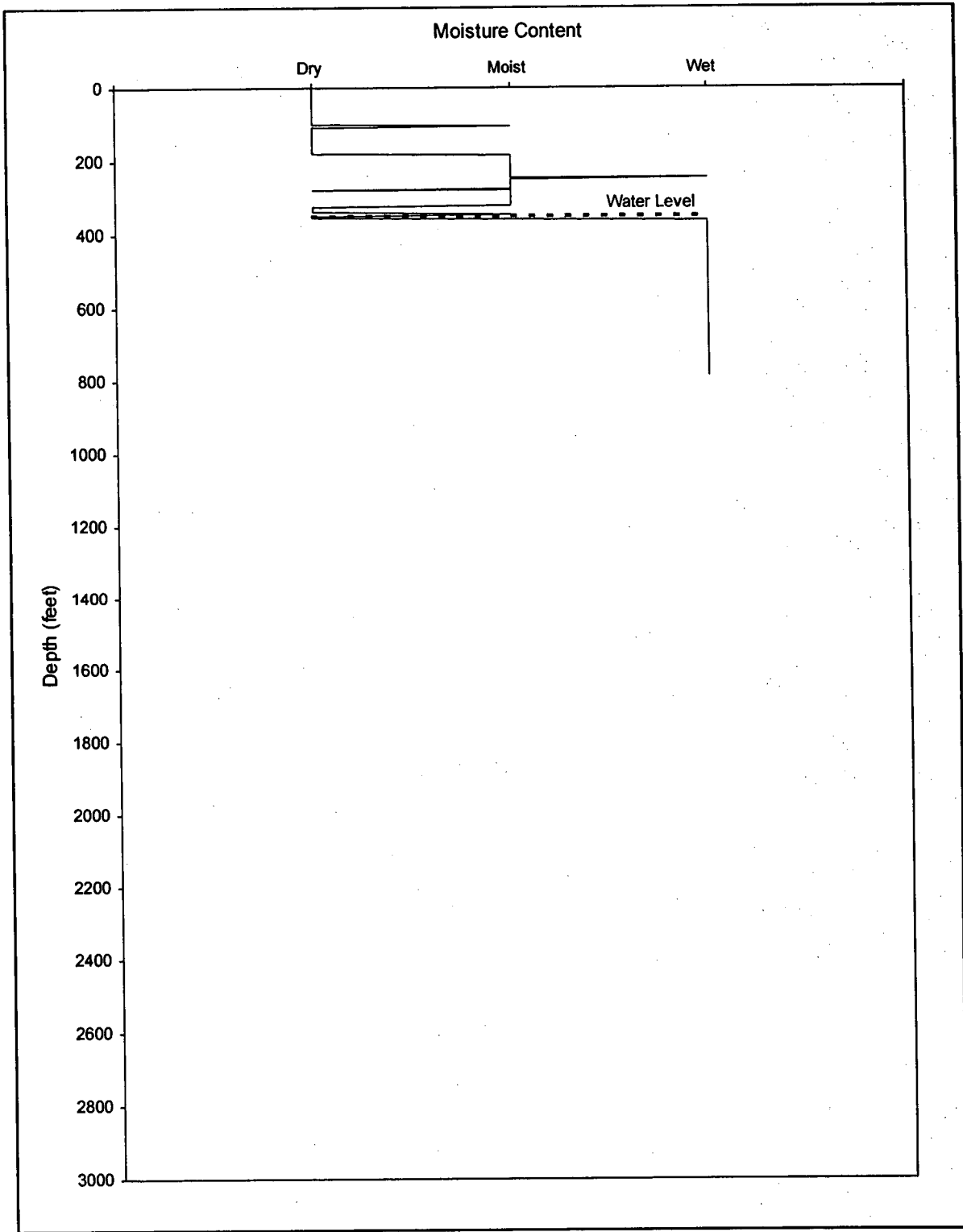

Appendix C-5
Moisture Content vs. Depth of Drill Cuttings in Alluvium and Non-Alluvium for 29P

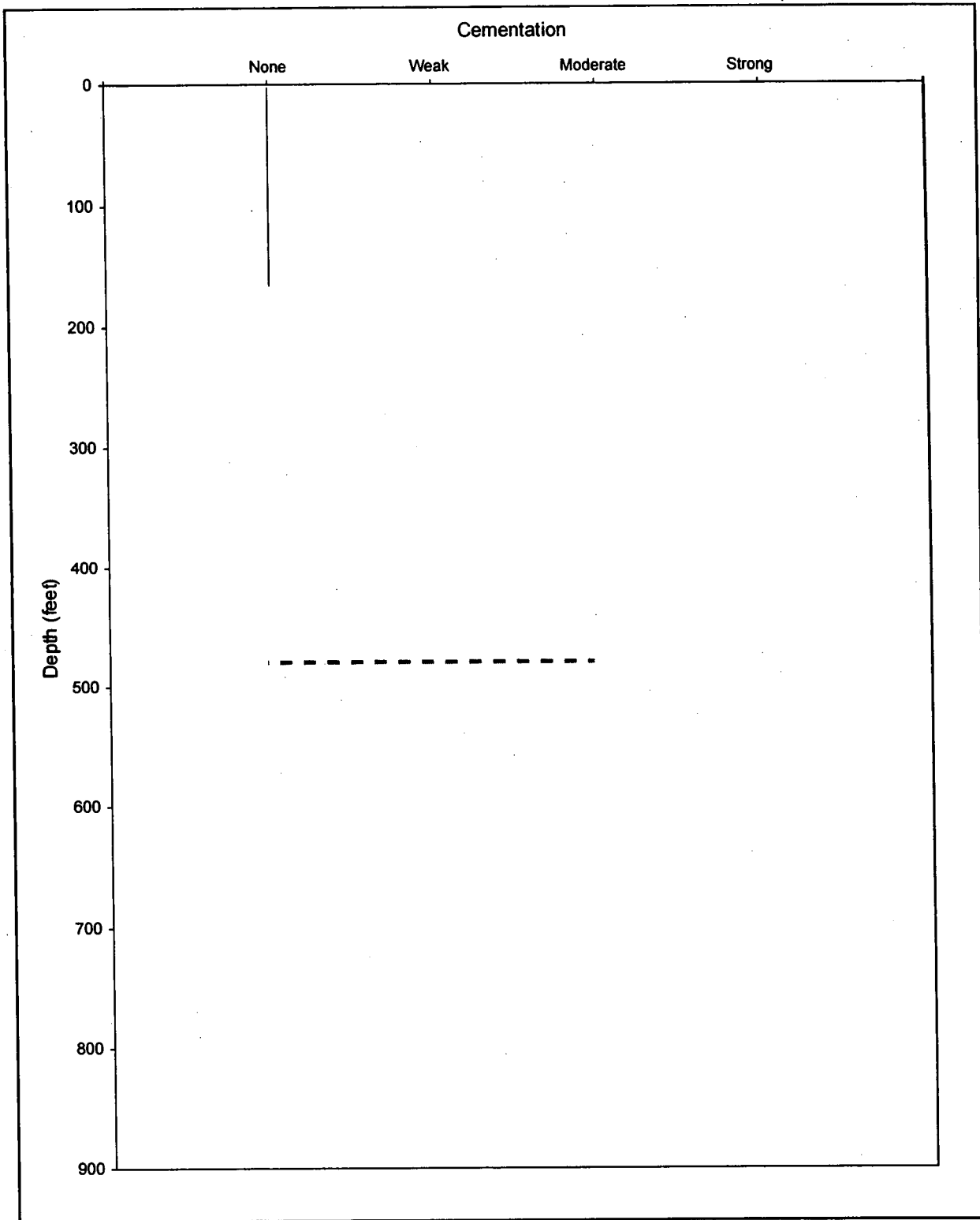

Appendix C-6
Cementation vs. Depth of Drill Cuttings in Alluvium for 16P

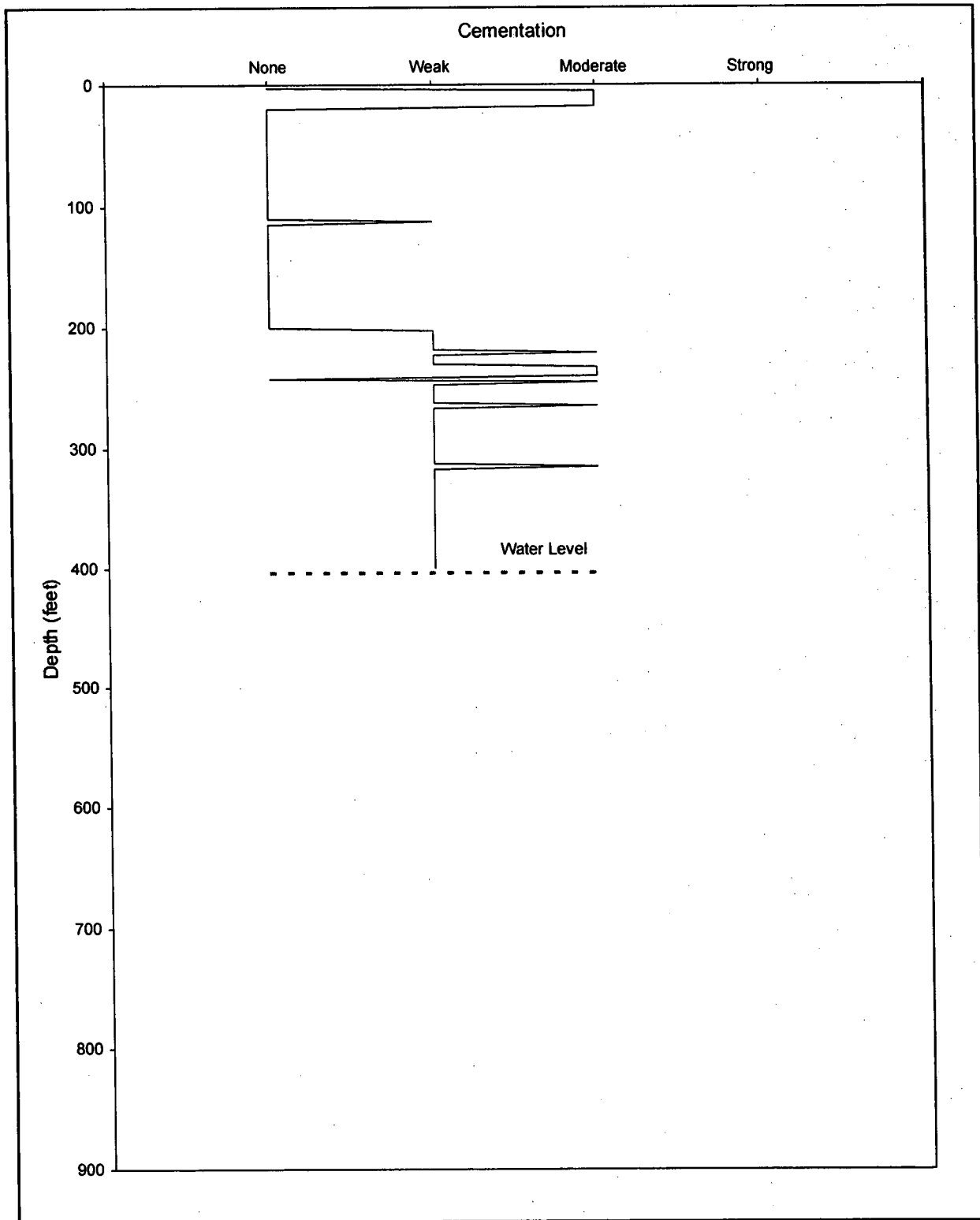

Appendix C-7
Cementation vs. Depth of Drill Cuttings in Alluvium for 24P

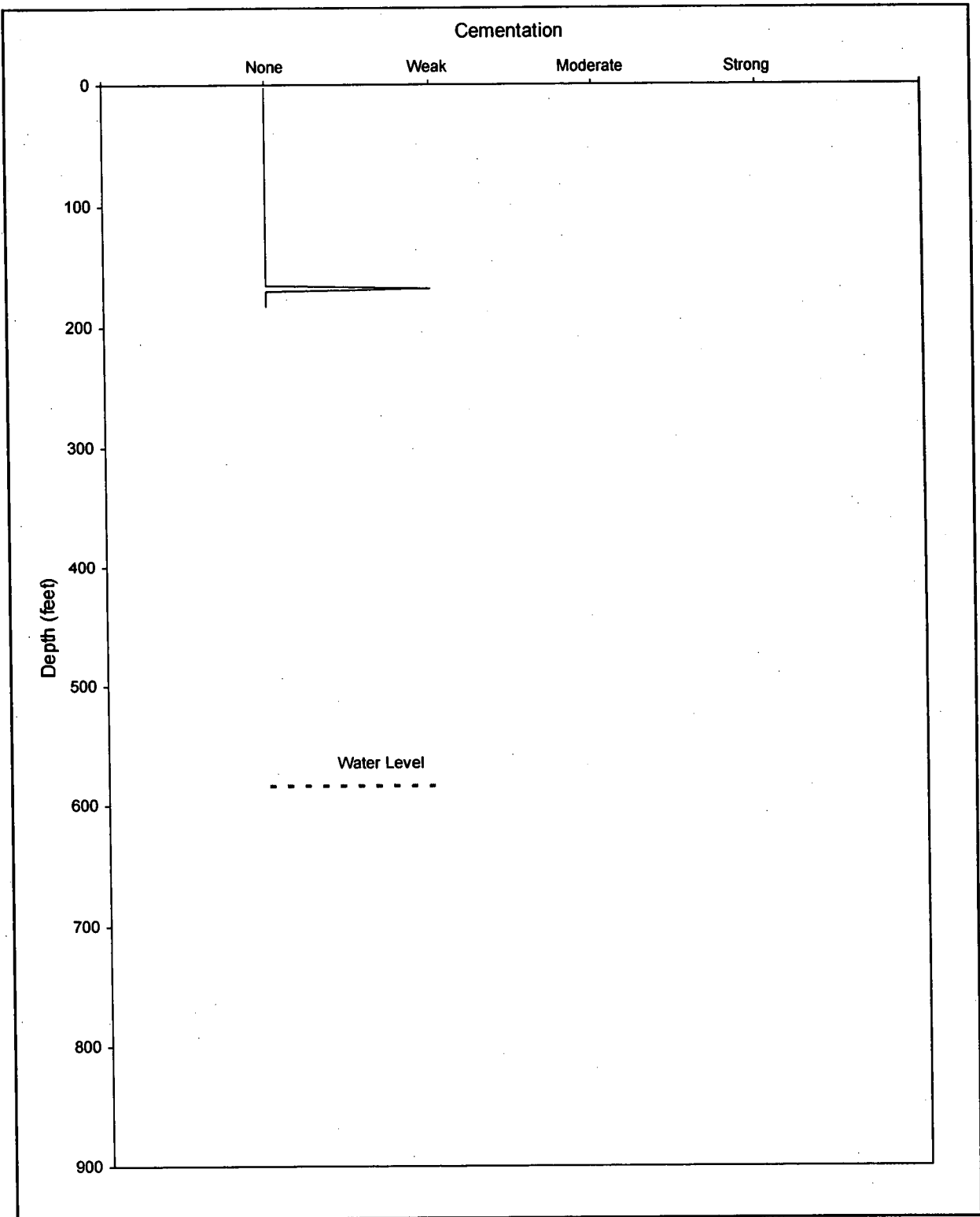

Appendix C-8
Cementation vs. Depth of Drill Cuttings in Alluvium for 27P

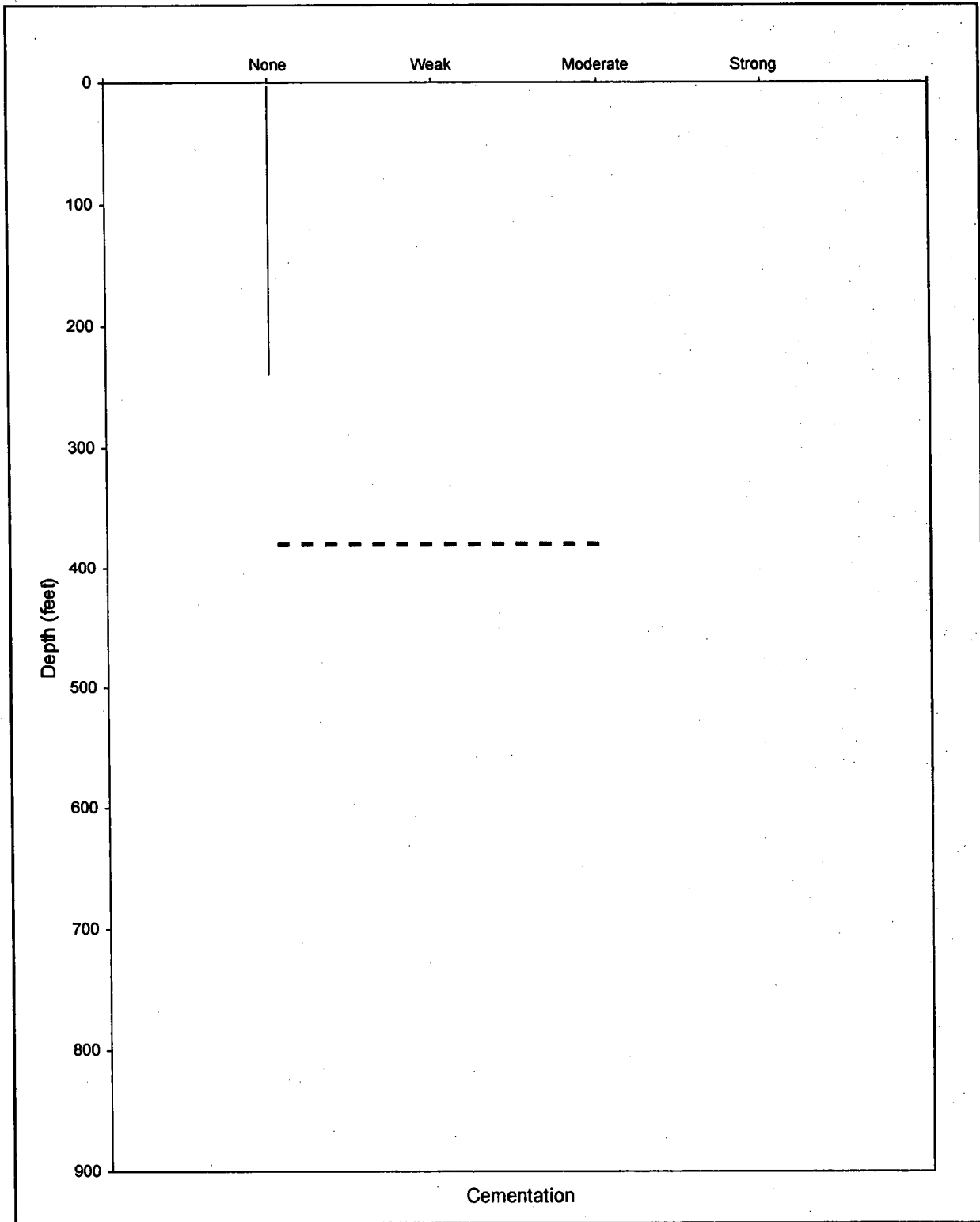

Appendix C-9
Cementation vs. Depth of Drill Cuttings in Alluvium for 28P

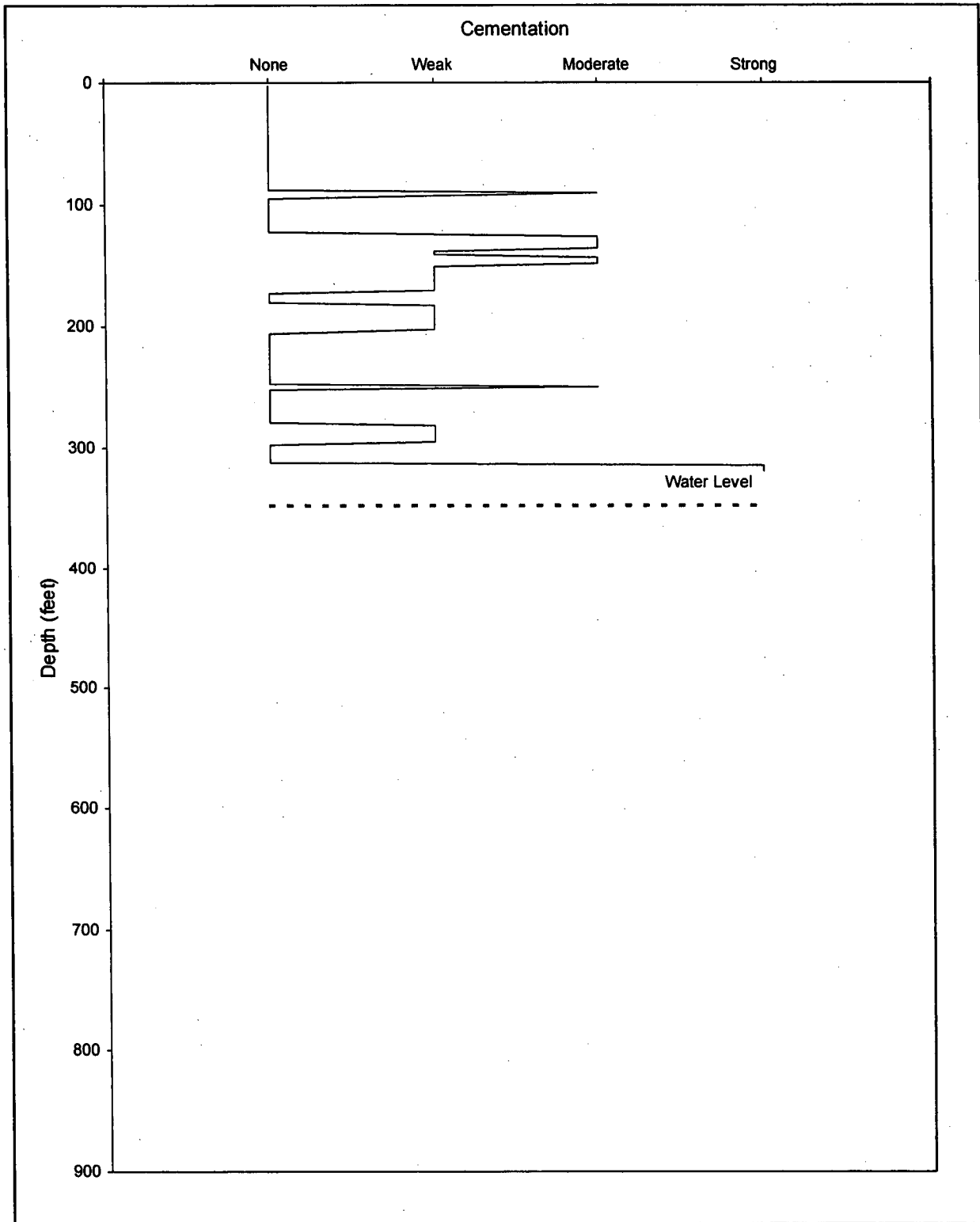

Appendix C-10
Cementation vs. Depth of Drill Cuttings in Alluvium for 29P

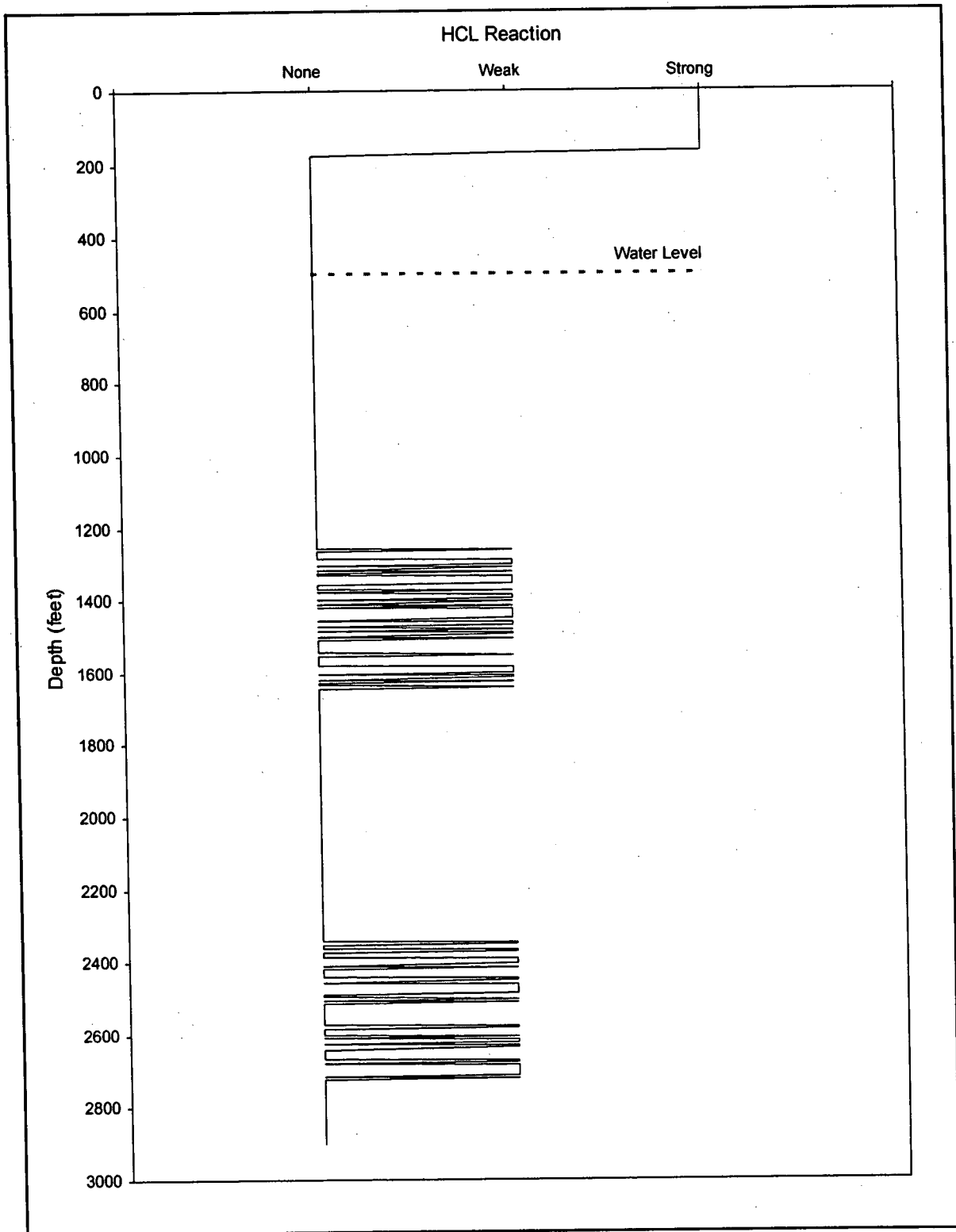

Appendix C-11
HCL Reaction vs. Depth for Drill Cuttings in Alluvium and Non-Alluvium for 16P

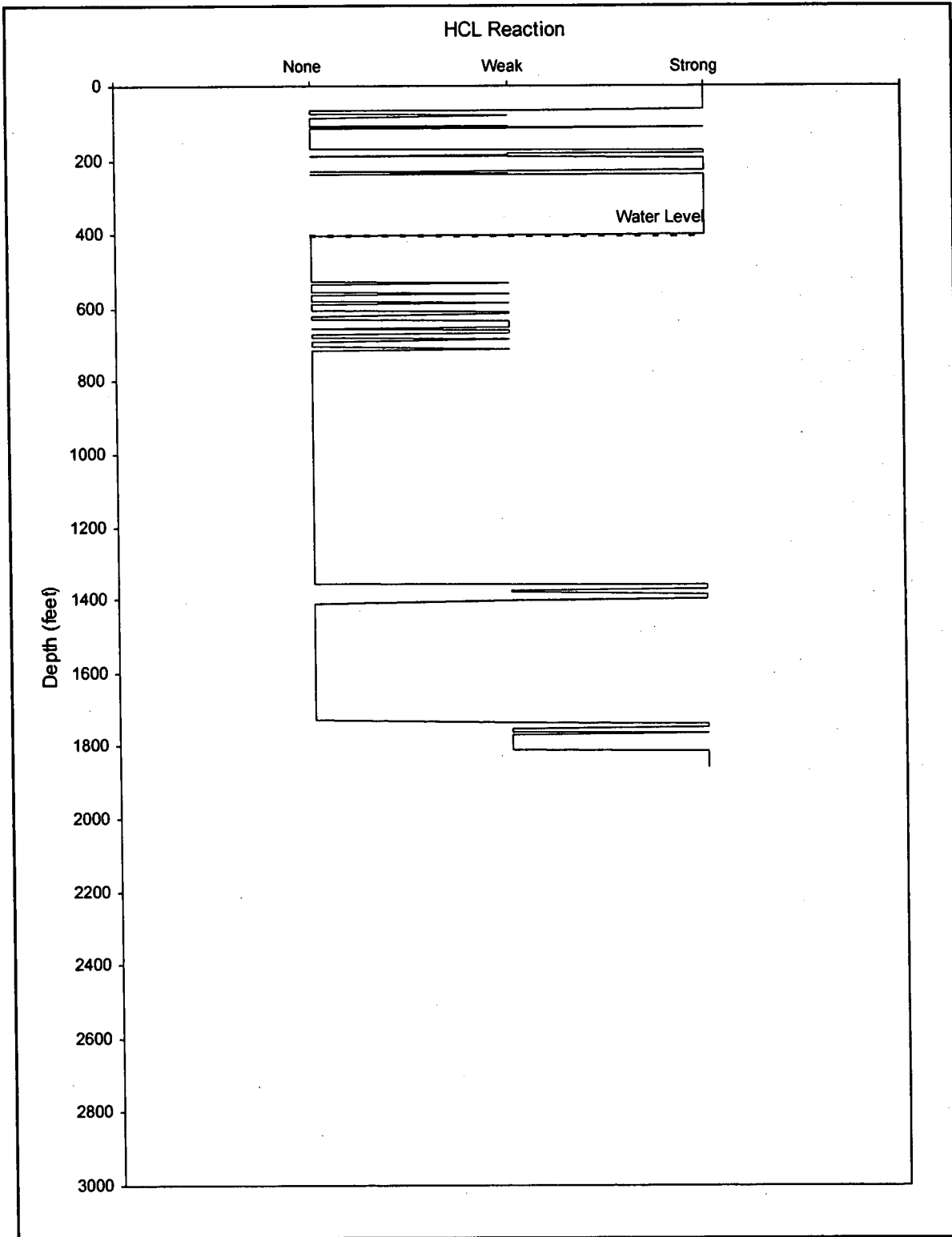

Appendix C-12
HCL Reaction vs. Depth for Drill Cuttings in Alluvium and Non-Alluvium for 24P

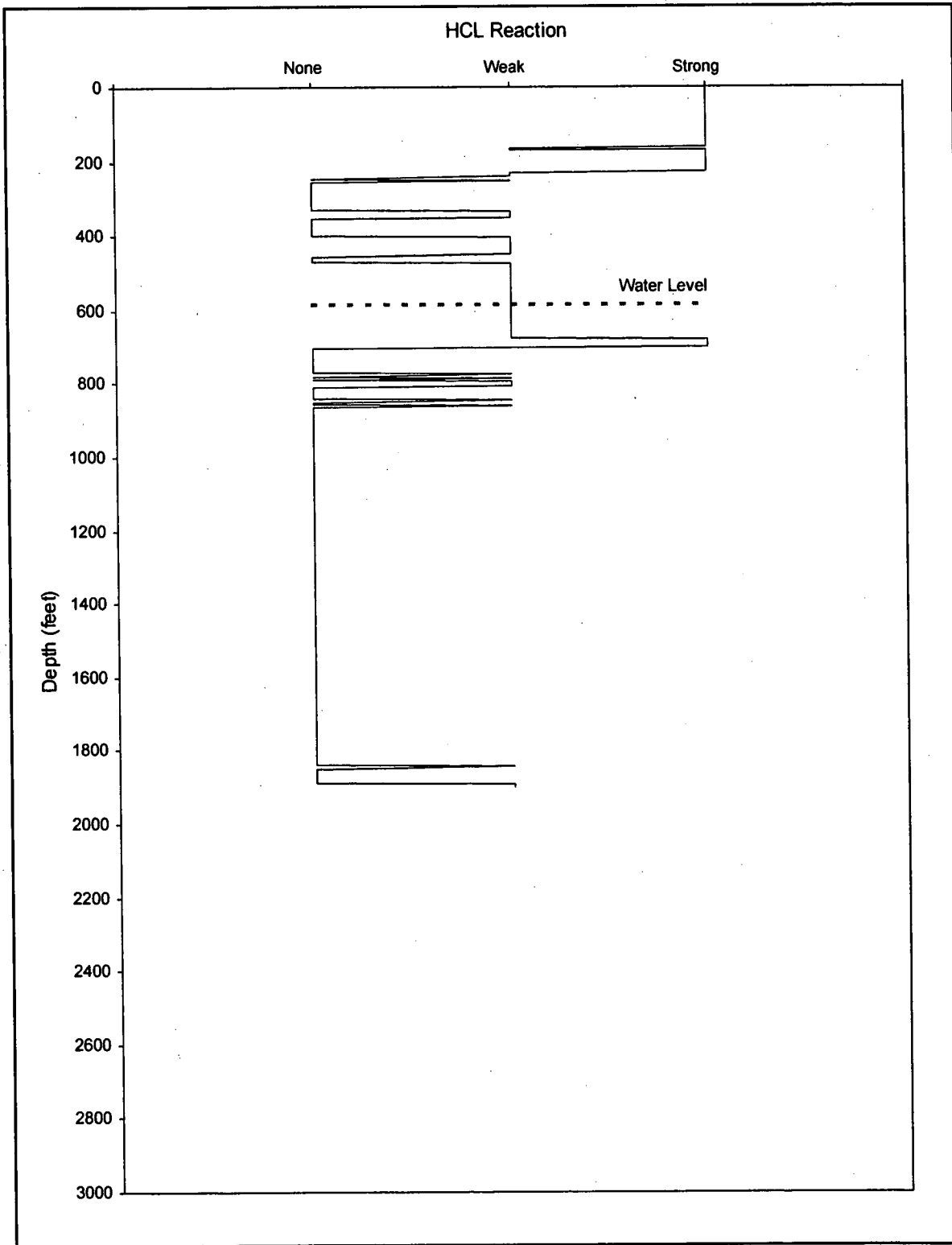

Appendix C-13
HCL Reaction vs. Depth for Drill Cuttings in Alluvium and Non-Alluvium for 27P

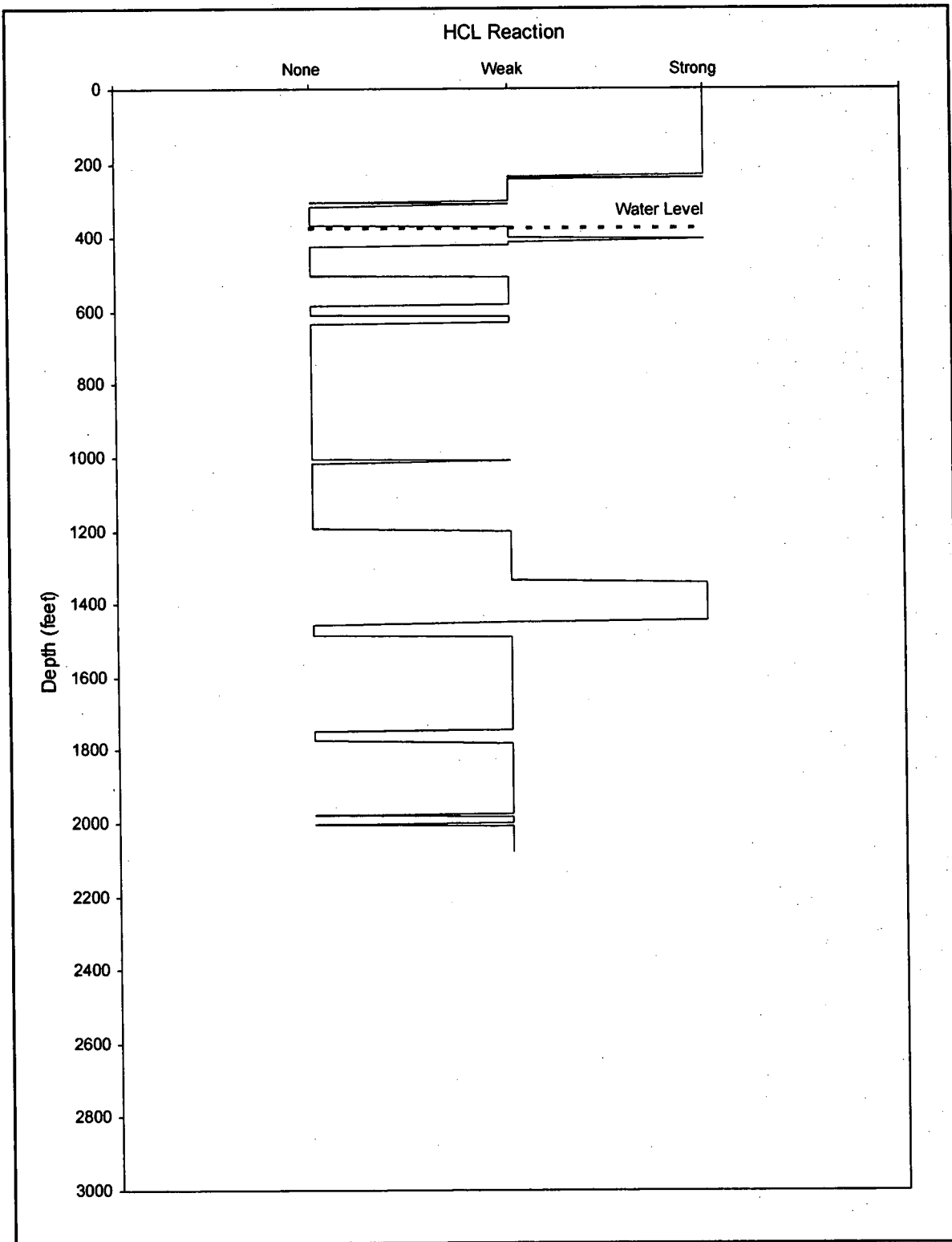

Appendix C-14
 HCL Reaction vs. Depth for Drill Cuttings in Alluvium and Non-Alluvium for 28P

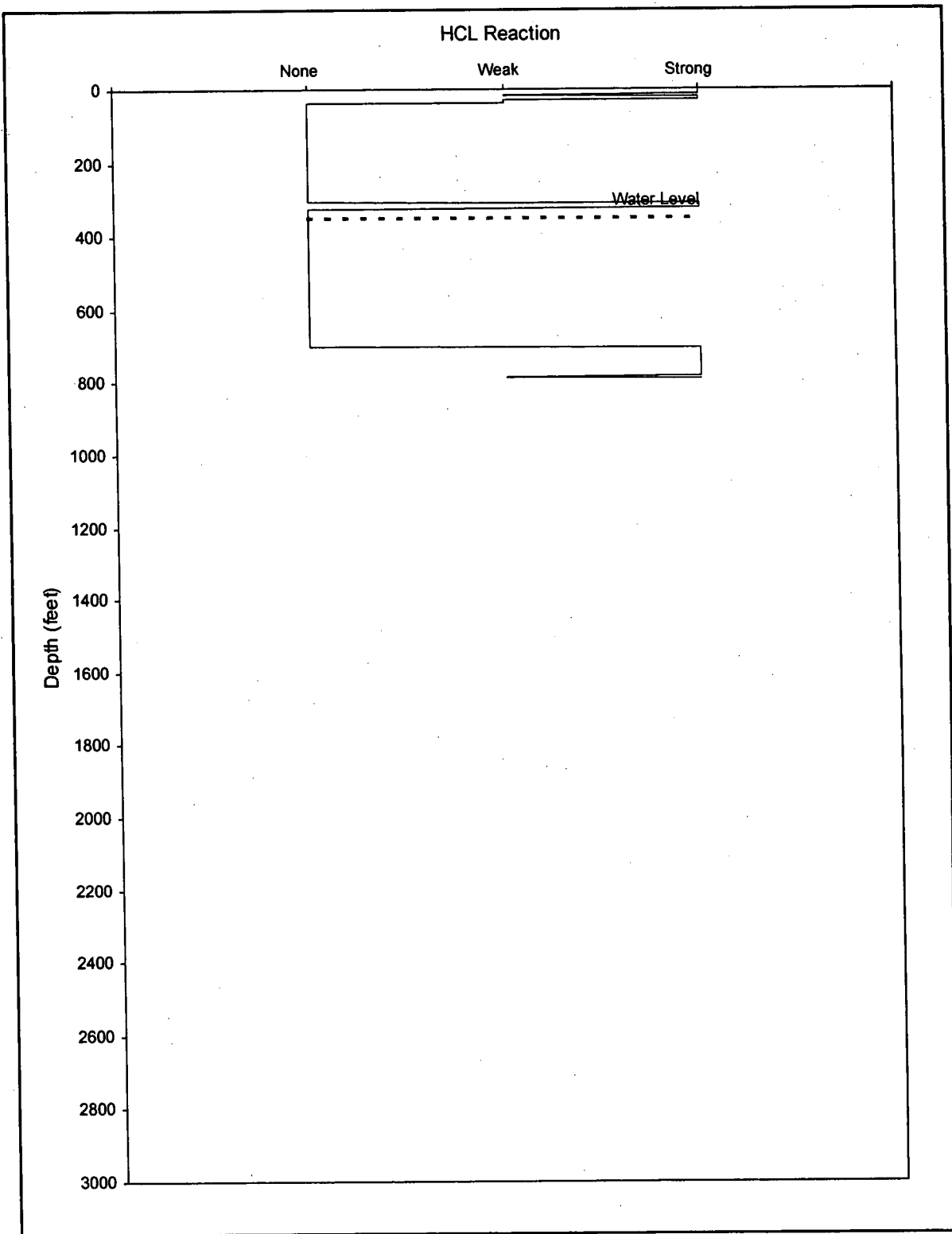

Appendix C-15
HCL Reaction vs. Depth for Drill Cuttings in Alluvium and Non-Alluvium for 29P

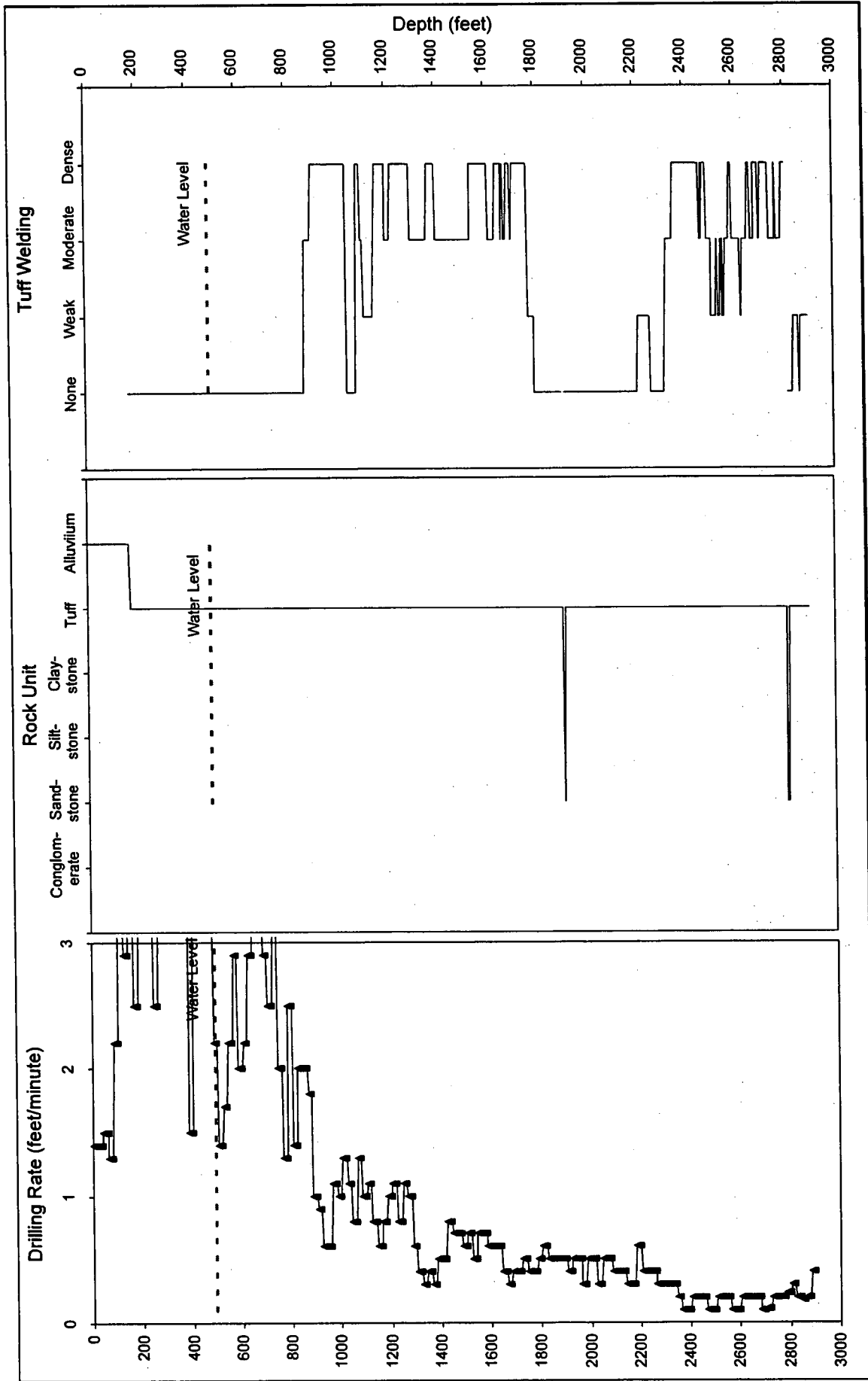

Appendix C-16
 Drilling Rate, Rock Unit, and Tuff Welding vs. Depth in Alluvium and Non-Alluvium for 16P

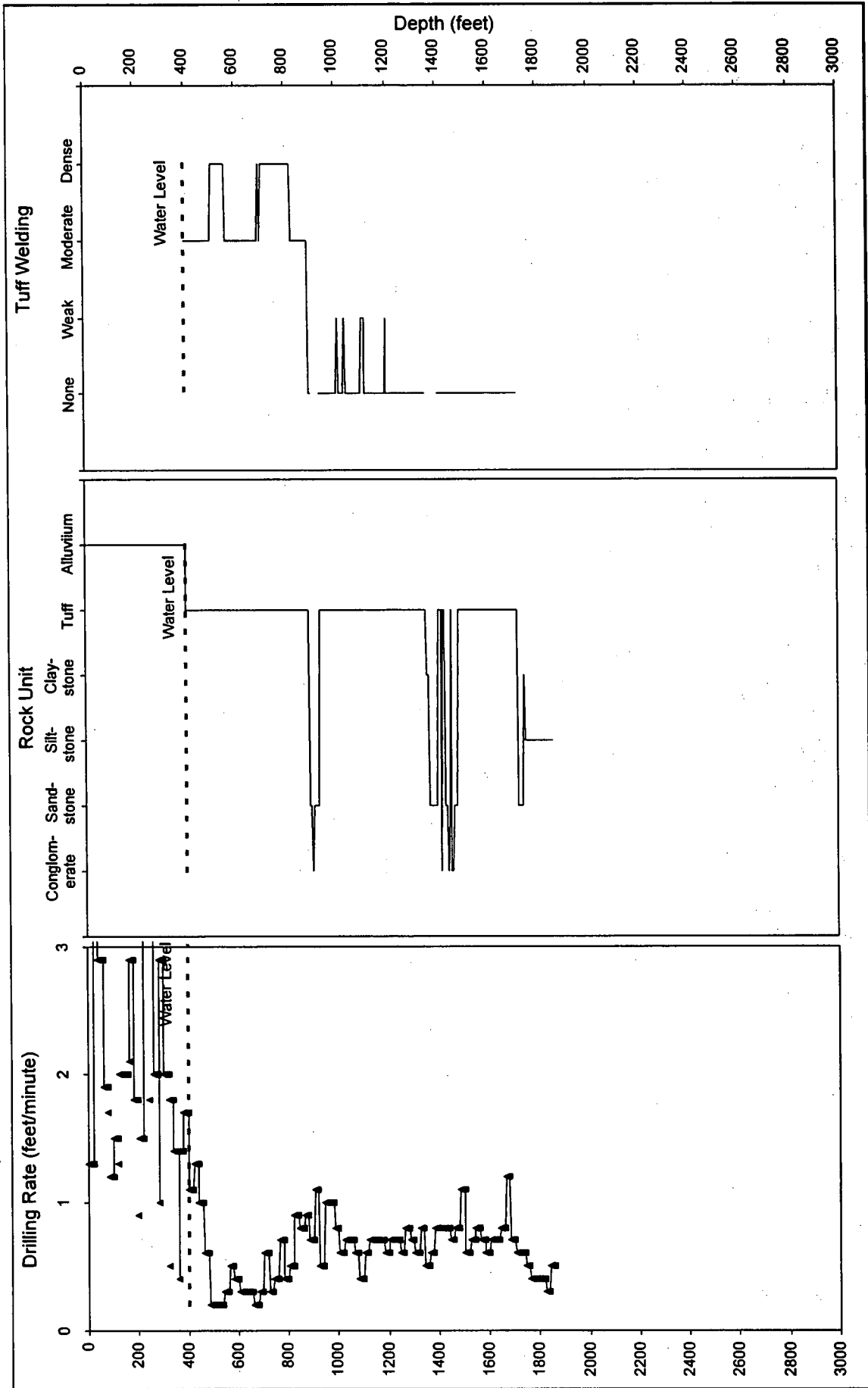

Appendix C-17
Drilling Rate, Rock Unit, and Tuff Welding vs. Depth in Alluvium and Non-Alluvium for 24P

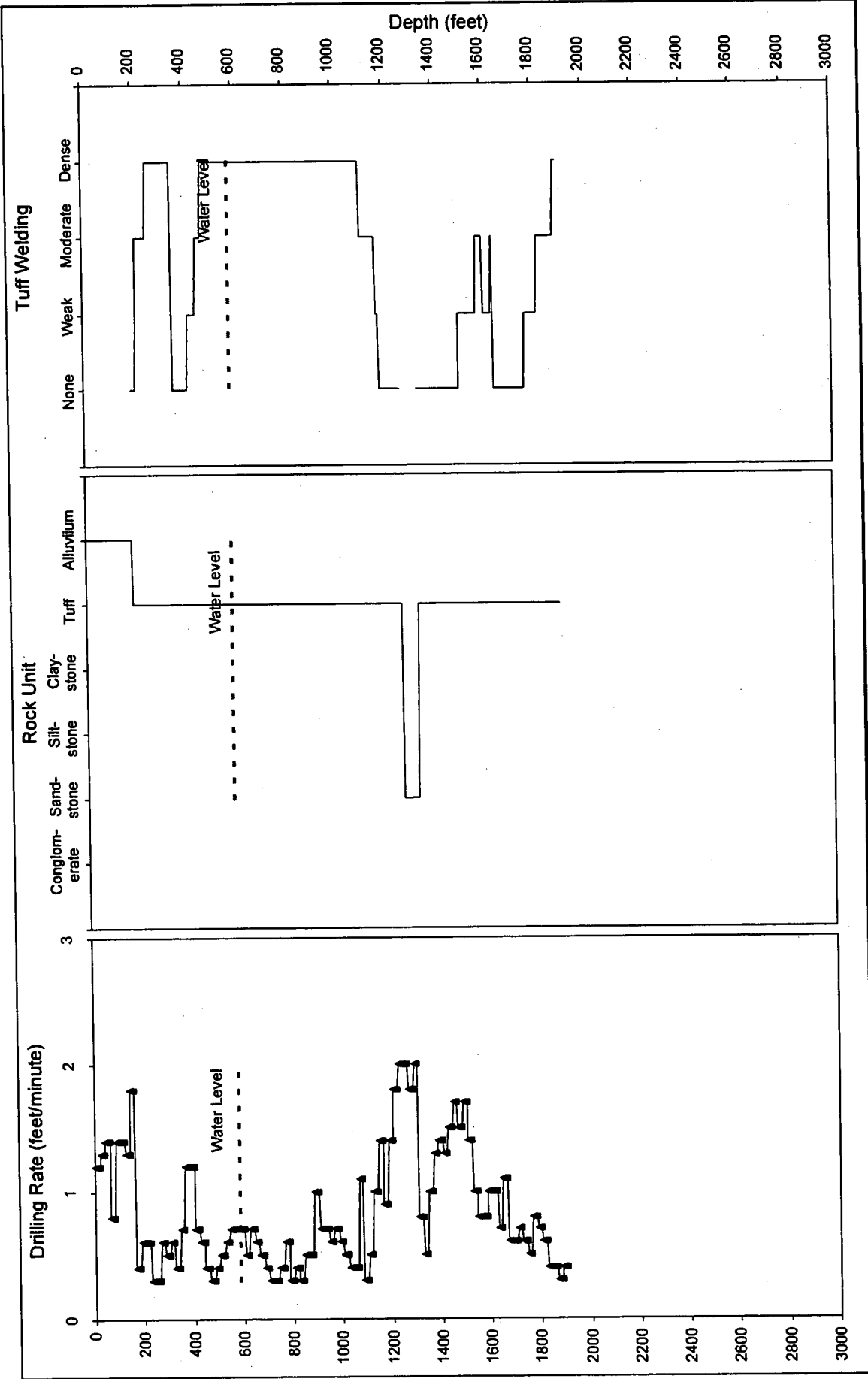

Appendix C-18
Drilling Rate, Rock Unit, and Tuff Welding vs. Depth in Alluvium and Non-Alluvium for 27P

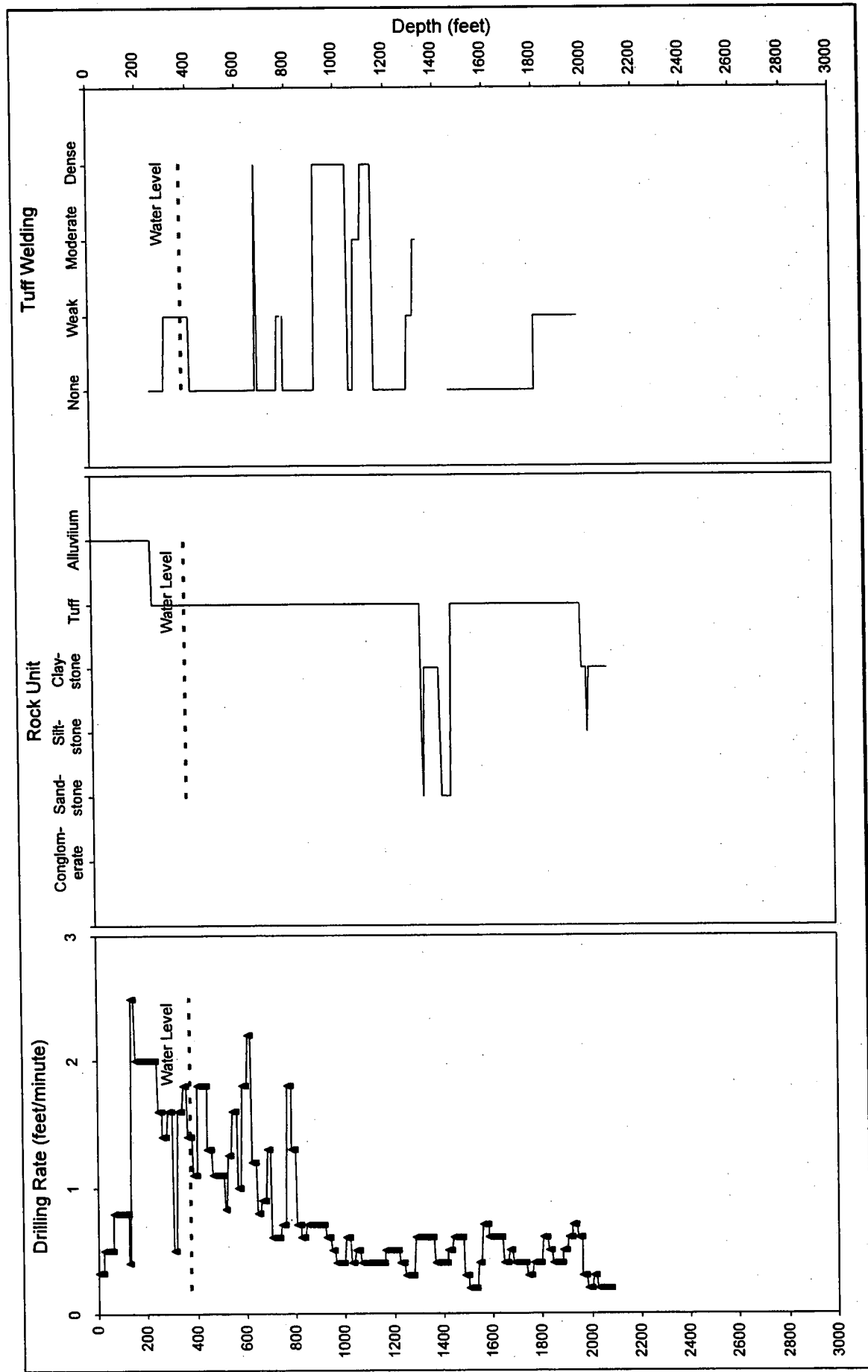

Appendix C-19
 Drilling Rate, Rock Unit, and Tuff Welding vs. Depth in Alluvium and Non-Alluvium for 28P

Nye County Early Warning Drilling Program Phase IV Drilling Report

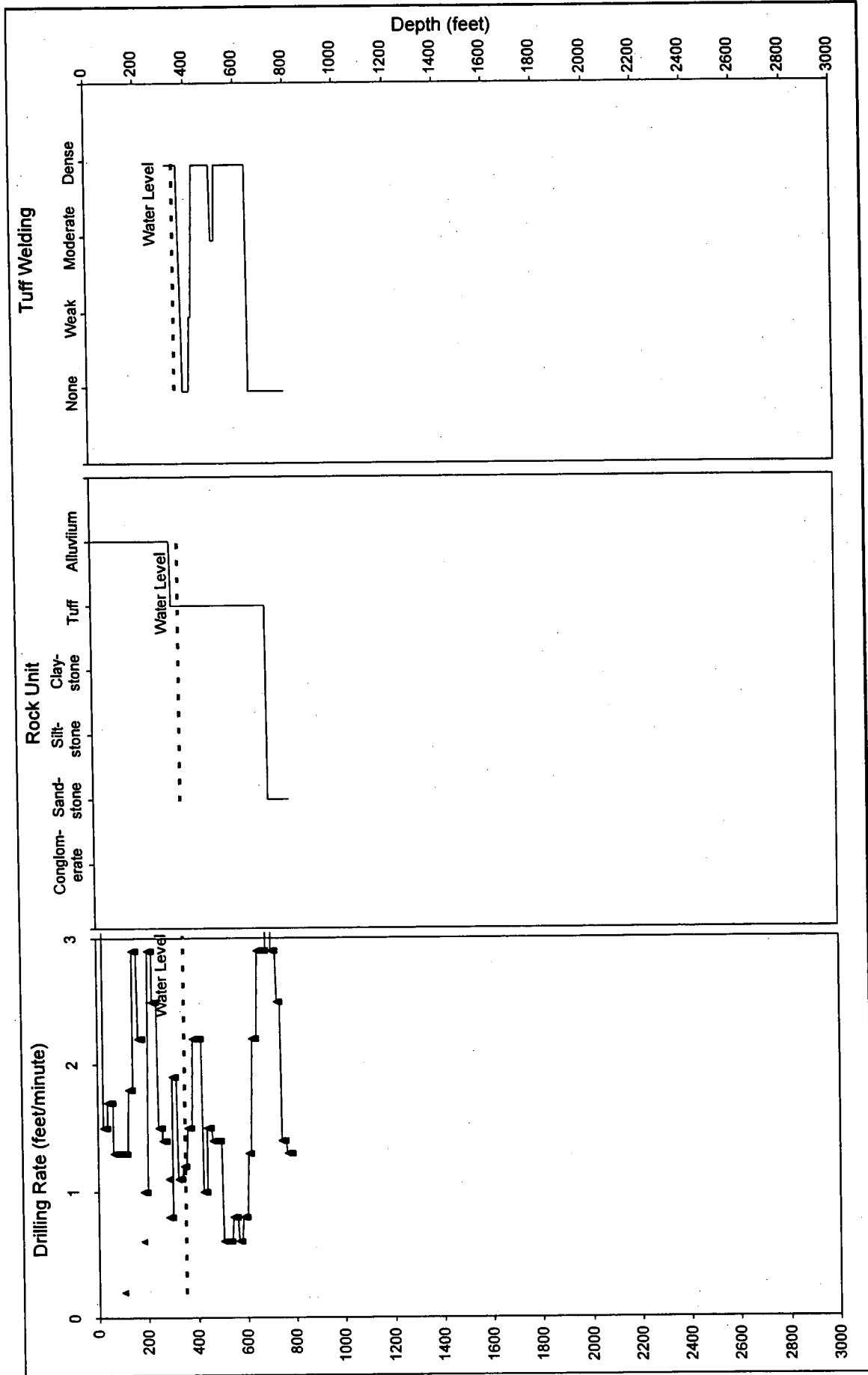

Appendix C-20
 Drilling Rate, Rock Unit, and Tuff Welding vs. Depth in Alluvium and Non-Alluvium for 29P

Nye County Early Warning Drilling Program Phase IV Drilling Report

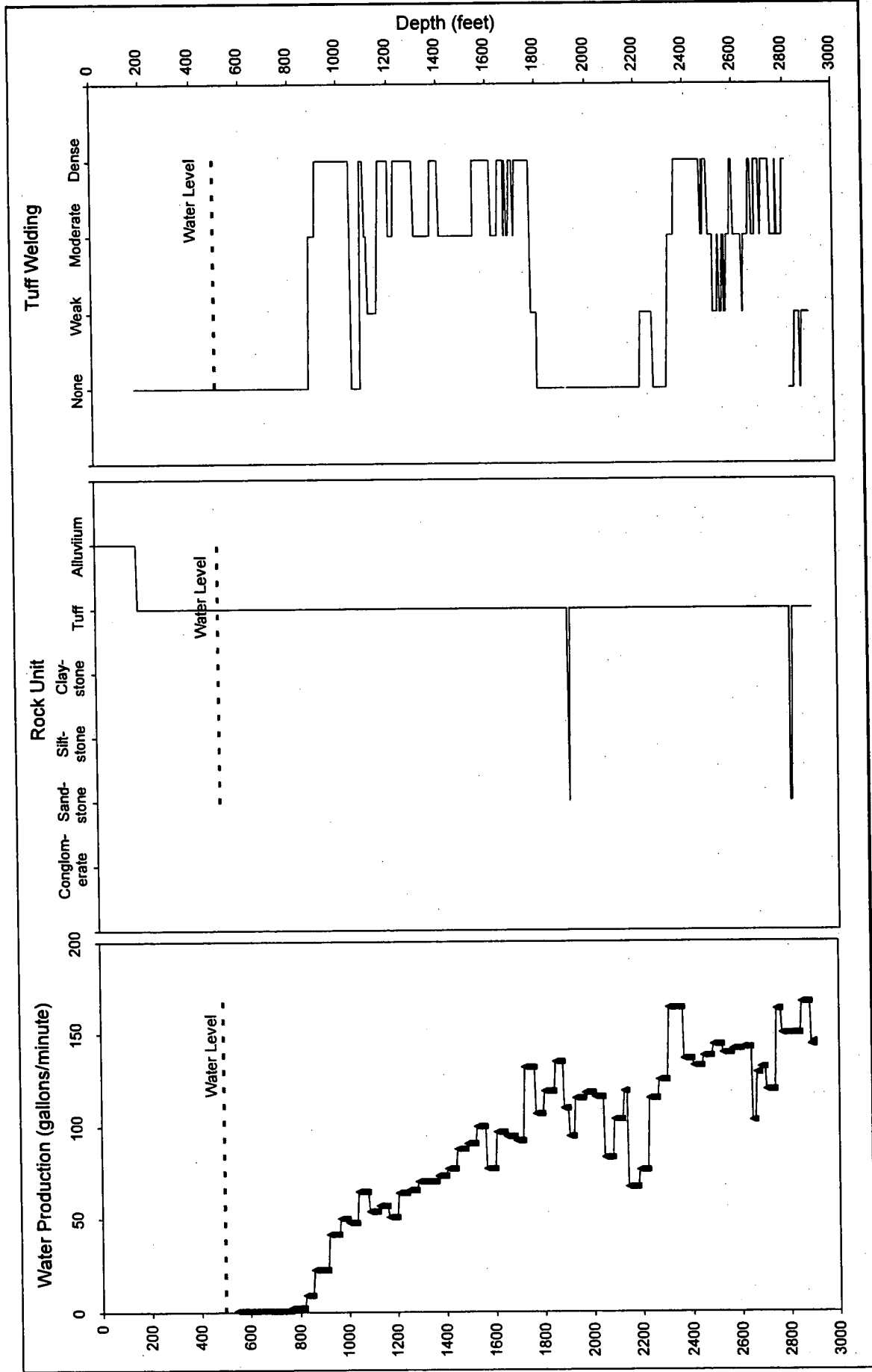

Appendix C-21
Water Production, Rock Unit, and Tuff Welding vs. Depth in Alluvium and Non-Alluvium for 16P

Nye County Early Warning Drilling Program Phase IV Drilling Report

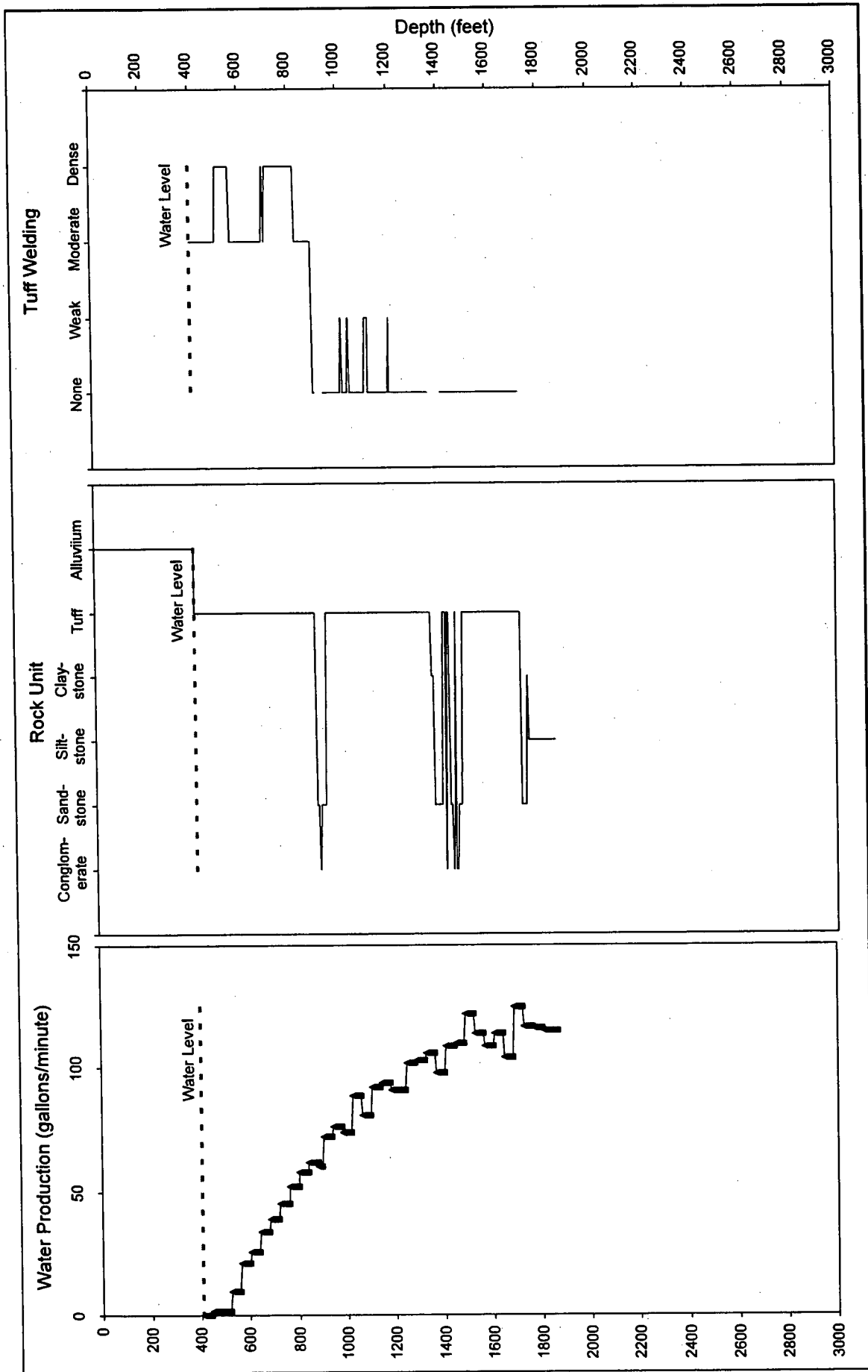

Appendix C-22
 Water Production, Rock Unit, and Tuff Welding vs. Depth in Alluvium and Non-Alluvium for 24P

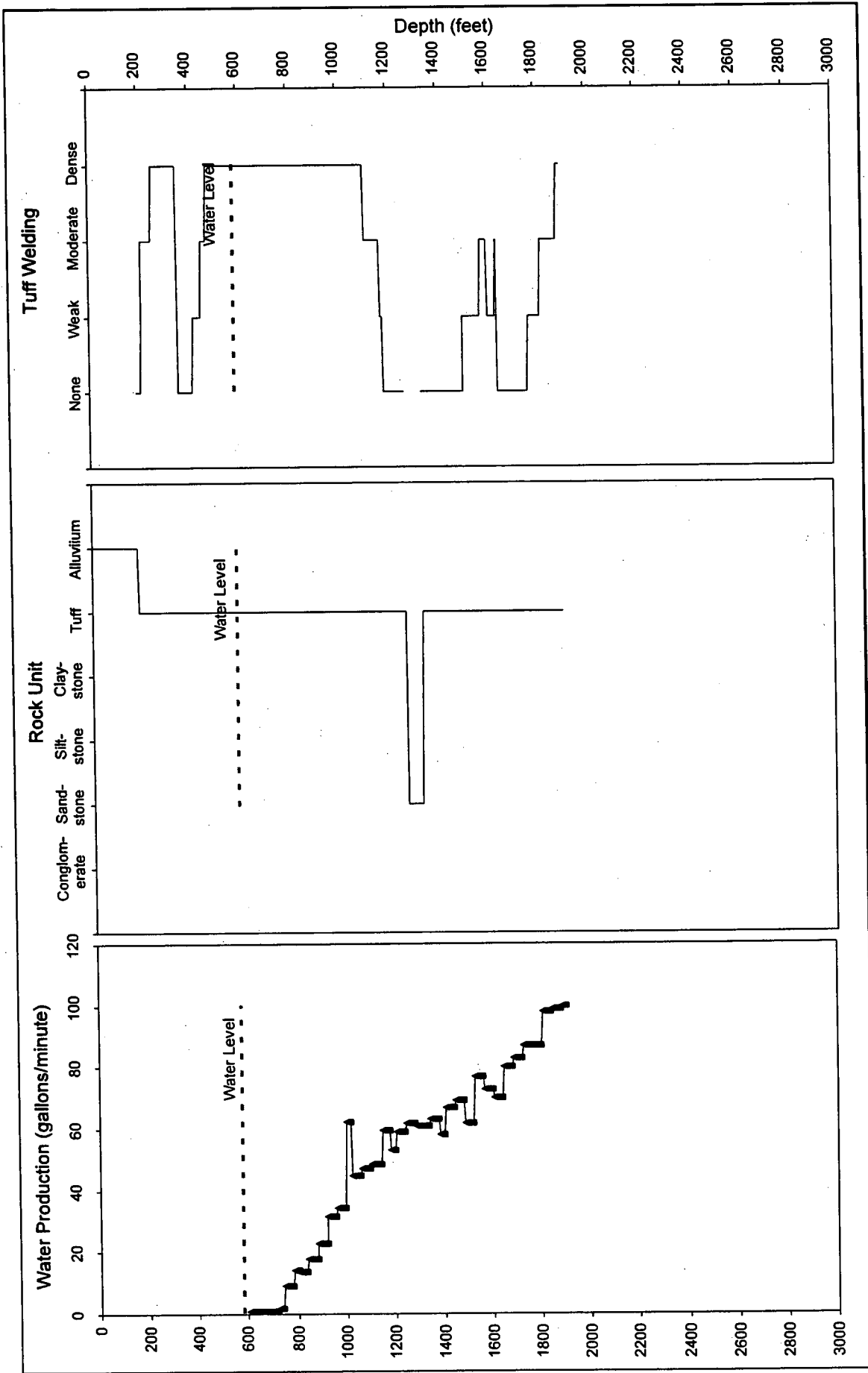

Appendix C-23
 Water Production, Rock Unit, and Tuff Welding vs. Depth in Alluvium and Non-Alluvium for 27P

Nye County Early Warning Drilling Program Phase IV Drilling Report

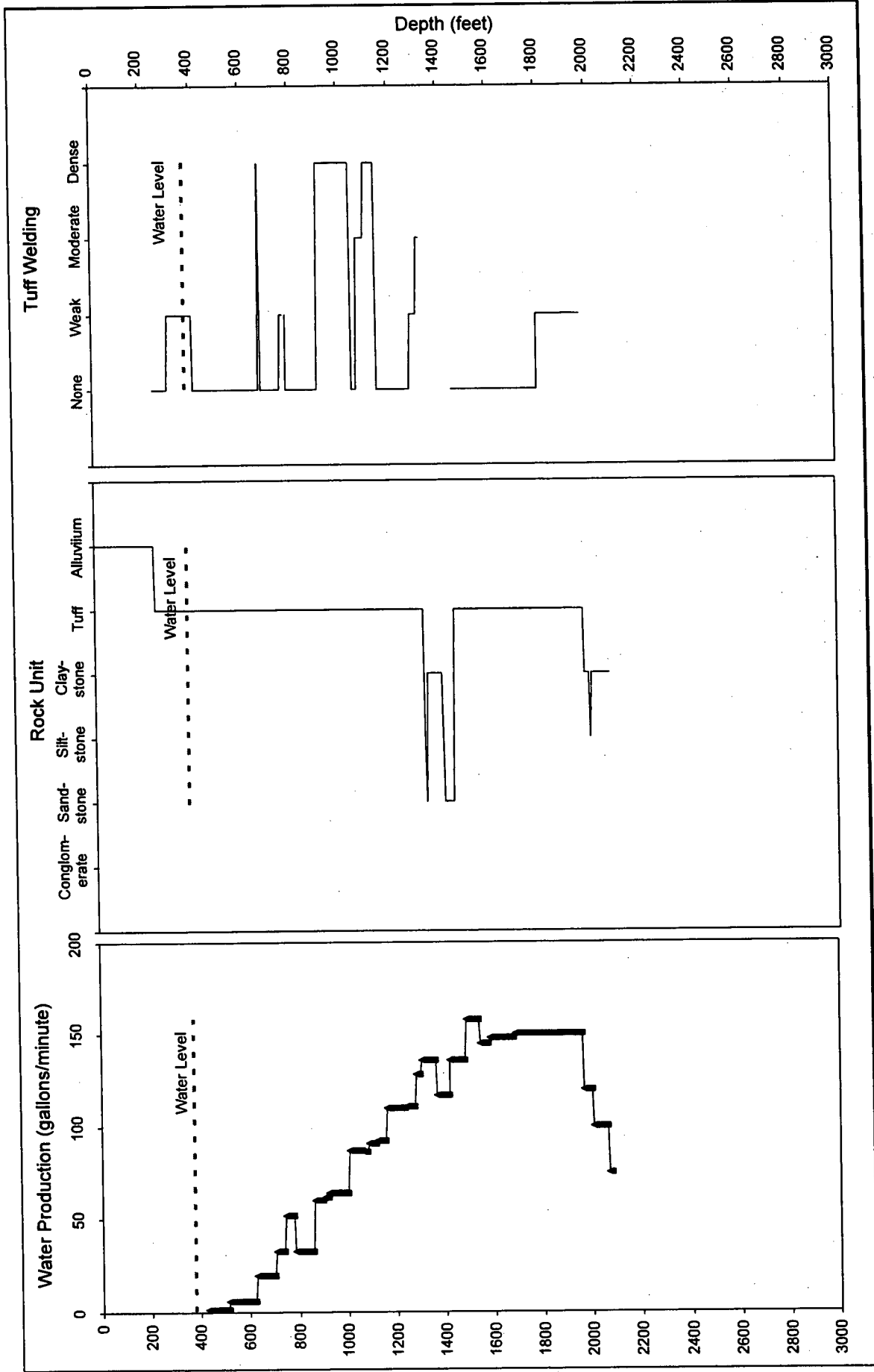

Appendix C-24
 Water Production, Rock Unit, and Tuff Welding vs. Depth in Alluvium and Non-Alluvium for 28P

Nye County Early Warning Drilling Program Phase IV Drilling Report

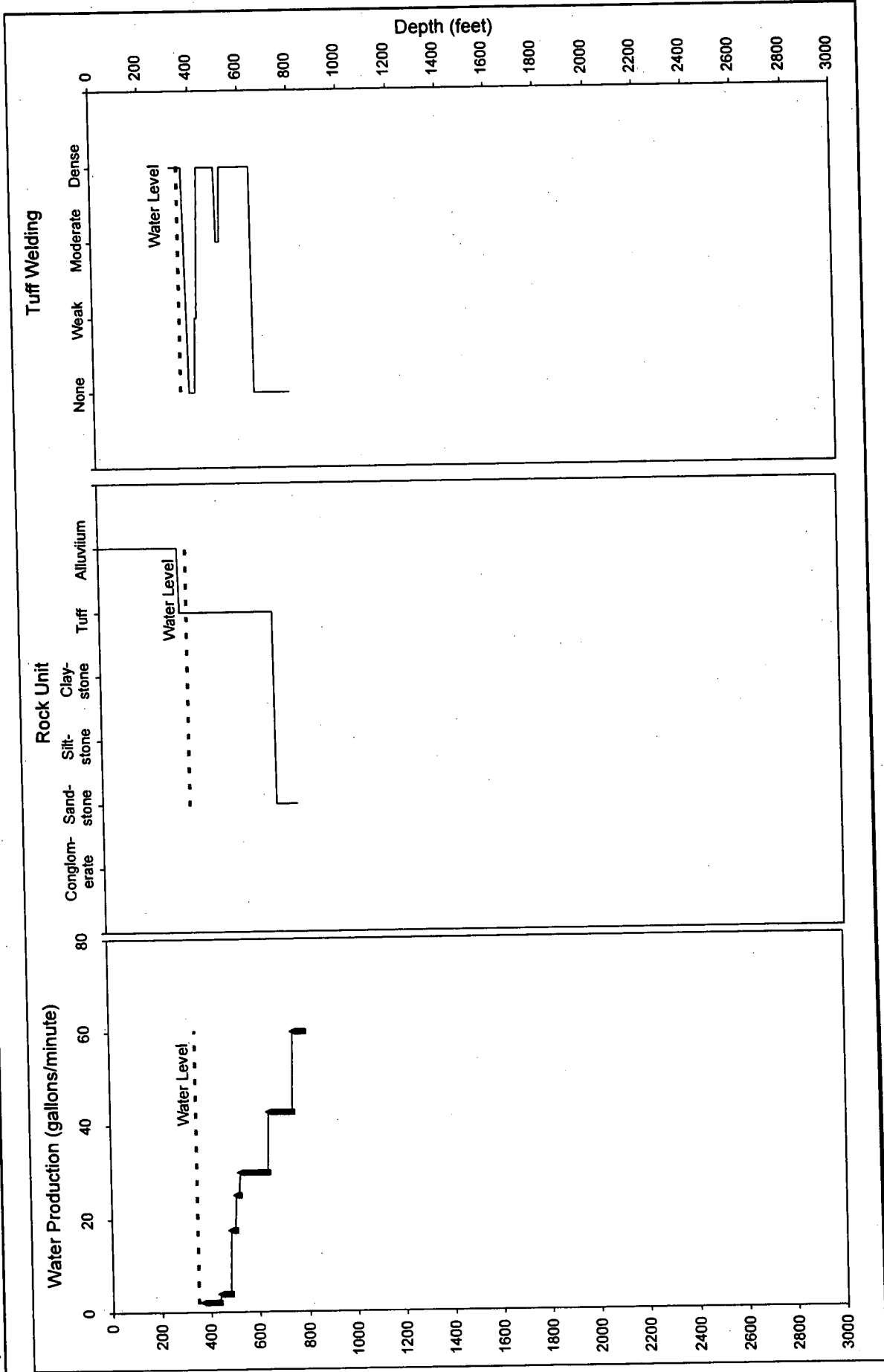

Appendix C-25
 Water Production, Rock Unit, and Tuff Welding vs. Depth in Alluvium and Non-Alluvium for 29P

APPENDIX D

**APPENDIX D
ALLUVIUM CORE LOGGING FORMS**

Alluvium Core Logging Form - Nye County Nuclear Waste Repository Project Office

Key for Sample Number: SG = Sonic core, C = Drive core, Key for Sample Type: L = Logging, D = Density, F = FR, LC = Lost core, B = Entire run, X = End of run (overlays with next run).

Borehole ID: NC-EMDP-34P (Phase 4) Driller/Drilling Company: Grog Sackels/Eland Drilling Co. Drilling Method: Reverse Circulation Air Rotary & Sealed Drive Core Alluvium Depth (ft bgs): 0 to 400 Start Date: 7/16/2003 End Date: 7/25/2003 Page 1 of 2

Table with columns: Date Logged, Logged By (Initials), Date Checked, Checked By (Initials), Core Run Number, Sample Type, Sample Number, Depth Interval (feet bgs), Coring Data, Sample Density Data, Moisture Content, Particle Size Distribution (%), Grading, Estimated Plasticity, USCS Group Symbol, Gravels/Sand Grain Shape, Cementation, HCL Reaction, Major Rock Type, Other.

Appendix D
Alluvium Core Logging Form - Nye County Nuclear Waste Repository Project Office

Key for Sample Number: BC = Sonic core, C = Drive core, Key for Sample Type: L = Logging, D = Density, F = FR, LC = Lost core, B = Enter core, X = End of run (overlaps with next run)

Borehole ID: **NC-EWDP-24P** (Phase 4) Driller/Drilling Company: **Gregg Secessi/Etland Drilling Co.**

Start Date: 7/16/2003 End Date: 7/25/2003 Page 2 of 2

Drilling Method: **Reversa Circulation Air Rotary & Select Drive Core** Alluvium Depth (ft bgs): 0 to 400

Date Logged	Logged By (Initials)	Draw Checked	Checked By (Initials)	Core Run Number	Sample Type	Sample Number	Depth Interval (feet bgs)		Drilling/Coring Rate (feet/min)	Sample Recovery (feet)	Core Diameter (inches)	Sample Density Data			Moisture Content			Particle Size Distribution (%)					Grading	Estimated Plasticity				USCS Group Symbol	HCL Reaction			Major Rock Type (%)										
							From	To				Tare Weight (kg)	Sample Plus Tare Weight (kg)	Sample Weight (kg)	Mossel Color Symbol	Wet	Moist	Dry	Gravel	Sand	Silt	Clay		Fines (Sil plus Clay)	Well Graded	Poorly Graded	None		Low	Moderate	High		None	Weak	Strong	Volcanics	Carbonates	Other				
7/23/2003	BW	2/17/2004	JRW	5	L	24P-240.48-240.88-C	240.48	240.88																											100							
7/23/2003	BW	2/17/2004	JRW	5	L	24P-240.88-241.48-C	240.88	241.48																												100						
7/23/2003	BW	2/17/2004	JRW	5	L	24P-241.48-241.75-C	241.48	241.75																												100						
7/24/2003	BW	2/17/2004	JRW	6	F	24P-278.73-286.49-F	278.73	286.40																													100					
7/24/2003	BW	2/17/2004	JRW	6	L	24P-286.40-286.73-C	286.40	286.73																													100					
7/24/2003	BW	2/17/2004	JRW	6	RD	24P-286.40-281.09-C	286.40	281.09	1.0	0.6	4.0	38.80	41.50	11.00																							100					
7/24/2003	BW	2/17/2004	JRW	6	L	24P-280.73-281.09-C	280.73	281.09																														100				
7/25/2003	BW	2/17/2004	JRW	7	F	24P-320.75-322.50-F	320.75	322.50																														100				
7/25/2003	BW	2/17/2004	JRW	7	L	24P-322.50-322.75-C	322.50	322.75																															100			
7/25/2003	BW	2/17/2004	JRW	7	RD	24P-322.50-322.44-C	322.50	322.44	0.5	0.9	4.0	32.25	45.55	13.30																								100				
7/25/2003	BW	2/17/2004	JRW	7	L	24P-322.75-323.25-C	322.75	323.25																															100			
7/25/2003	BW	2/17/2004	JRW	7	L	24P-323.25-323.44-C	323.25	323.44																															100			
7/25/2003	BW	2/17/2004	JRW	8	F	24P-358.02-360.09-F	358.02	360.09																															100			
7/25/2003	BW	2/17/2004	JRW	8	L	24P-360.09-360.02-C	360.09	360.02																															100			
7/25/2003	BW	2/17/2004	JRW	8	RD	24P-360.09-360.71-C	360.09	360.71	0.4	0.7	4.0	32.35	44.70	12.35																								100				
7/25/2003	BW	2/17/2004	JRW	8	L	24P-360.02-360.52-C	360.02	360.52																															100			
7/25/2003	BW	2/17/2004	JRW	8	L	24P-360.52-360.71-C	360.52	360.71																																100		

Nye County Early Warning Drilling Program Phase IV Drilling Report

Appendix D

Alluvium Core Logging Form - Nye County Nuclear Waste Repository Project Office

Key for Sample Number: SC = Sonic Core, C = Drive Core, Key for Sample Type: L = Logging, D = Density, F = FR, LC = Lost Core, R = Entire run, X = End of run (surface with next run). Borehole ID: NC-EWDR-199B Driller/Drilling Company: Stawm Construction Logyear: (Phase 4) Start Date: 12/2/2003 End Date: 12/19/2003 Page 1 of 18

Main data table with columns: Date Logged, Logged By, Date Checked, Checked By, Core Run Number, Sample Type, Sample Number, Depth Interval (feet high), Coring Data (Drilling/Coring Rate, Sample Recovery, Core Diameter, Tare Weight, Sample Plus Tare Weight, Sample Weight, Moisture Content, Particle Size Distribution, Grain Size, Estimated Plasticity, USCS Group Symbol, Grain Shape, Cementation, HCL Reaction, Major Rock Type). Rows 1-50 contain detailed logging data for various samples.

Appendix D

Alluvium Core Logging Form - Nye County Nuclear Waste Repository Project Office

Key for Sample Number: SC = Soils core, C = Drive core, Key for Sample Type: L = Logging, D = Density, F = Fill, LC = Lead core, R = Enrichment, X = End of run (overlaps with next run). Start Date: 12/22/2003 End Date: 12/18/2003 Page 6 of 18

Table with columns: Date Logged, Logged By, Checked By, Core Run Number, Sample Type, Sample Number, Depth Interval (feet type), Coring Data, Sample Density Data, Moisture Content, Particle Size Distribution (%), Grain Size, Estimated Plasticity, USCS Group Symbol, Gravifield Characteristics, Cementation, NCL Reaction, Major Risk Type, Other. Rows correspond to core samples 16-19.

Drilling Method: Sonic Coring. Drilling/Drilling Company: Shawn Cain/Boart Longyear. Alluvium Depth (ft type): 350.8 to 633.8. Printed: 11/28/2004.

Nye County Early Warning Drilling Program Phase IV Drilling Report

Appendix D
Alluvium Core Logging Form - Nye County Nuclear Waste Repository Project Office

Key for Sample Number: SC = Sonic core, C = Drive core, M = Hand core, L = Logging, D = Density, F = Fill, LC = Lead core, R = Enble run, X = End of run (inches with next run),
Borehole ID: NC-EWDP-19PB (Phase 4) Driller/Drilling Company: Shawn Cain/Boart Longyear Drilling Method: Sonic Coring Alluvium Depth (ft top): 350.8 to 833.8 Start Date: 12/2/2003 End Date: 12/18/2003 Page 7 of 18

Date Logged	Logged By (Initials)	Date Checked	Checked By (Initials)	Core Run Number	Sample Type	Sample Number	Depth Interval (feet top)		Drilling/Logging Rate (feet/min)	Sample Recovery (feet)	Core Diameter (inches)	Sample Density Data			Moisture Content	Particle Size Distribution (%)				Drainage	Estimated Plasticity	USCS Group Symbol	Gravel/Sand Grain Shape			Cementation			HCL Reaction			Major Rock Type (%)									
							From	To				Tare Weight (kg)	Sample Plus Tare Weight (kg)	Sample Weight (kg)		Wet	Moist	Dry	Gravel				Sand	Silt	Clay	Fines (Silt plus Clay)	Well Graded	Poorly Graded	None	Low	Moderate	High	Angular	Subangular	Subrounded	Rounded	None	Weak	Strong	None	Weak
12/8/2003	BW			20	D	19PB-450.6-452.4-5C	450.80	452.40			6.2	0.20	20.00	20.00	20.00																	100									
12/8/2003	BW			26	LX	19PB-450.6-453.5-5C	450.80	453.00																																	
12/8/2003	BW			20	R	19PB-450.6-460.7-5C	450.80	460.70	1.0	10.2	6.2	0.20	20.35	20.15																											
12/8/2003	BW			20	D	19PB-452.4-453.9-5C	452.40	453.90																																	
12/8/2003	BW			20	L	19PB-453.0-455.1-5C	453.00	455.10																																	
12/8/2003	BW			20	D	19PB-453.8-455.5-5C	453.90	455.50																																	
12/8/2003	BW			20	L	19PB-455.1-455.5-5C	455.10	455.50																																	
12/8/2003	BW			20	L	19PB-455.5-456.6-5C	455.50	456.60																																	
12/8/2003	BW			20	D	19PB-455.5-457.4-5C	455.50	457.40																																	
12/8/2003	BW			20	L	19PB-456.6-457.2-5C	456.60	457.20																																	
12/8/2003	BW			20	LX	19PB-457.2-460.7-5C	457.20	460.70																																	
12/8/2003	BW			20	D	19PB-457.4-459.1-5C	457.40	459.10																																	
12/8/2003	BW			20	D	19PB-459.1-460.7-5C	459.10	460.70																																	
12/8/2003	BW			21	LX	19PB-460.7-461.8-5C	460.70	461.80																																	
12/8/2003	BW			21	D	19PB-460.7-462.7-5C	460.70	462.70																																	
12/8/2003	BW			21	R	19PB-460.7-466.5-5C	460.70	466.50	1.0	5.8	6.2	0.20	21.45	21.25																											
12/8/2003	BW			21	L	19PB-461.8-463.4-5C	461.80	463.40																																	
12/8/2003	BW			21	D	19PB-462.7-464.5-5C	462.70	464.50																																	
12/8/2003	BW			21	L	19PB-463.4-464.5-5C	463.40	464.50																																	
12/8/2003	BW			21	L	19PB-464.5-465.5-5C	464.50	465.50																																	
12/8/2003	BW			21	D	19PB-464.5-466.5-5C	464.50	466.50																																	
12/8/2003	BW			21	LX	19PB-465.5-466.5-5C	465.50	466.50																																	
12/8/2003	BW			21	LC	19PB-466.5-466.5-5C	466.50	466.50																																	
12/8/2003	BW			22	D	19PB-466.5-467.7-5C	466.50	467.70																																	
12/8/2003	BW			22	LX	19PB-466.5-468.1-5C	466.50	468.10																																	
12/8/2003	BW			22	R	19PB-466.5-478.4-5C	466.50	478.40	1.4	9.7	6.2	0.20	15.80	15.80																											
12/8/2003	BW			22	D	19PB-467.7-469.4-5C	467.70	469.40																																	
12/8/2003	BW			22	L	19PB-468.1-469.5-5C	468.10	469.50																																	

Nye County Early Warning Drilling Program Phase IV Drilling Report

Appendix D Alluvium Core Logging Form - Nye County Nuclear Waste Repository Project Office

Key for Sample Number: BC = Sonic core, C = Drive core, Key for Sample Type: L = Logging, F = FHL, LC = Last core, R = Enrichment, X = End of run (overlaps with next run).

Borehole ID: NC-EWDP-19PB (Phase 4) Driller/Drilling Company: Shawm Cain/Boart Longyear Drilling Method: Sonic Coring Alluvium Depth (ft log): 350.8 to 833.8 Start Date: 12/22/2003 End Date: 12/18/2003 Page 8 of 18

Main data table with columns: Date Logged, Logged By, Checked By, Core Run Number, Sample Type, Sample Number, Depth Interval, Coring Data, Sample Density Data, Moisture Content, Particle Size Distribution, Grading, Estimated Plasticity, USCS Group Symbol, Gravels and Grain Shape, Cementation, HCL Reaction, Major Root Type, Other.

Nye County Early Warning Drilling Program Phase IV Drilling Report

Appendix D

Alluvium Core Logging Form - Nye County Nuclear Waste Repository Project Office

Key for Sample Number: SC = Sinter core, C = Drive core, Key for Sample Type: L = Logging, D = Densify, F = FB, LC = Lead core, R = Entire run, X = End of run (includes with next run).

Start Date: 12/22/2003 End Date: 12/15/2003 Page 9 of 18
Alluvium Depth (ft bgs): 350.8 to 833.8
Drilling Method: Sonic Coring

Table with columns: Date Logged, Logged By (Initials), Checked By (Initials), Core Run Number, Sample Type, Sample Number, Depth Interval (feet bgs), Coring Data, Sample Density Data, Moisture Content, Particle Size Distribution, Grading, Estimated Plasticity, USCS Classification Symbol, Major Rock Type, and Other. The table contains 28 rows of data for samples 19PB-486 through 19PB-501.

Appendix D

Alluvium Core Logging Form - Nye County Nuclear Waste Repository Project Office

Key for Sample Number: BC = Sand core, C = Drive core, L = Logging, D = Density, F = FR, LC = Last core, R = Entire run, X = End of run (overfills with next run).

Borehole ID: NC-EWDP-19PB (Phase 4) Driller/Drilling Company: Shawm Calm/Rowt Longyear Drilling Method: Bottle Coring Alluvium Depth (ft top): 350.8 to 633.8 Start Date: 12/22/2003 End Date: 12/16/2003 Page 13 of 18

Table with columns: Date Logged, Logged By (Initials), Date Checked, Checked By (Initials), Core Run Number, Sample Type, Sample Number, Depth Interval (feet top), Core Data (Drilling/Coring Rate, Sample Recovery, Core Diameter), Sample Density Data (Tare Weight, Sample Plus Tare Weight, Sample Weight), Moisture Content, Particle Size Distribution (Gravel, Sand, Silt, Clay), Grain- ing (Well Graded, Poorly Graded), Estimated Plasticity (High, Moderate, Low, None), USCS Color Symbol, Conventional Grainshape (Angular, Subangular, Subrounded, Rounded), Cementation (None, Weak, Moderate, Strong), HCL Reaction (None, Weak, Strong), Major Rock Type (Volcanics, Carbonates, Other).

Nye County Early Warning Drilling Program Phase IV Drilling Report

Appendix D

Alluvium Core Logging Form - Nye County Nuclear Waste Repository Project Office

Key for Sample Number: SC = Sonic core, C = Drive core, K = Key for Sample Type, L = Logging, D = Density, F = FB, LC = Last core, R = Entire run, X = End of run (overlaid with next run). Start Date: 12/22/2003 End Date: 12/18/2003 Page 15 of 18

Table with columns: Date Logged, Logged By (Initials), Date Checked, Checked By (Initials), Core Run Number, Sample Type, Sample Number, Depth Interval (ft/bgl), Coring Data (Drilling/Coring Rate, Sample Recovery, Core Diameter), Sample Density Data (Tare Weight, Sample Plus Tare Weight, Sample Weight, Moisture Content), Particle Size Distribution (Gravel, Sand, Silt, Clay, Fines), Estimated Plasticity (High, Moderate, Low, None), USCS Group Symbol, Gravel/Sand Grain Shape, Cementation, HCL Reaction, Major Rock Type (Volcanics, Carbonates, Other).

APPENDIX E

**APPENDIX E
LABORATORY ANALYSES
OF DRIVE CORE SAMPLES**

Appendix E-1
Results of Analyses by the NWRPO Testing Laboratory on Drive Core from Phase IV Well 19PB
 (Blanks indicate unmeasured parameters.)

Sample Number	Dry Bulk Density (g/cm ³)	Volumetric Water Content (cm ³ /cm ³)		Specific Gravity (g/cm ³)	Saturated Hydraulic Conductivity (cm/s)	Wet Sieve Particle Size Analysis (Percent Passing)								Hydrometer Particle Size Analysis										
		Field	Saturated			3- inch Sieve	1 1/2- inch Sieve	3/4- inch Sieve	1/4- inch Sieve	No. 4 Sieve	No. 10 Sieve	No. 40 Sieve	No. 100 Sieve	No. 200 Sieve	2 Minutes		5 Minutes		15 Minutes		45 Minutes		120 Minutes	
															Largest Particle Passing (mm)	Per- cent Pass- ing	Largest Particle Passing (mm)	Per- cent Pass- ing	Largest Particle Passing (mm)	Per- cent Pass- ing	Largest Particle Passing (mm)	Per- cent Pass- ing	Largest Particle Passing (mm)	Per- cent Pass- ing
19PB-380.00-380.50-C	1.95	0.258	0.307	2.59	4.2E-06	100	51	42	36	30	22	12	9	7	7.0	0.0207	6.2	0.0122	5.5	0.0073	4.7	0.0046	3.8	
19PB-380.50-381.00-C	1.74	0.328	0.424	2.53	2.3E-06	100	100	95	89	79	64	32	20	16	0.0346	0.0219	13.8	0.0129	12.5	0.0075	11.2	0.0047	9.2	
19PB-449.10-449.40-C	1.82	0.208	0.276	2.58	Censored	100	70	58	53	47	36	17	9	7	0.0355	0.0226	5.9	0.0132	5.1	0.0077	4.3	0.0048	3.0	
19PB-449.40-449.70-C	1.97	0.252	0.290	2.53		100	63	54	43	35	28	18	11	7	0.0326	0.0213	8.1	0.0125	7.0	0.0074	6.0	0.0046	4.9	
19PB-527.61-528.11-C	1.94	0.238	0.257	2.53	1.4E-05	100	90	76	65	54	42	28	18	16	0.0316	0.0204	13.6	0.0122	11.9	0.0071	10.6	0.0045	8.8	
19PB-528.11-528.61-C	1.97	0.218	0.247	2.55	7.0E-07	100	94	78	68	57	42	27	18	16	0.0300	0.0201	13.5	0.0119	11.9	0.0071	10.2	0.0045	8.6	
19PB-562.07-562.57-C	1.86	0.252	0.276	2.51	7.6E-06	100	100	83	69	57	42	22	13	10	0.0349	0.0223	8.5	0.0131	7.2	0.0077	6.0	0.0048	4.3	
19PB-562.57-563.07-C	1.93	0.235	0.257	2.54	1.1E-06	100	100	97	91	77	52	26	17	13	0.0349	0.0223	10.4	0.0131	8.9	0.0077	6.8	0.0048	5.3	
19PB-620.75-621.25-C	1.85	0.305	0.380	2.56	1.7E-05	100	93	83	74	63	47	27	17	13	0.0338	0.0219	11.4	0.0129	10.4	0.0076	9.0	0.0047	7.6	
19PB-621.25-621.75-C	1.84	0.280	0.302	2.56	5.3E-07	100	100	87	77	66	51	29	17	13	0.0353	0.0224	10.8	0.0131	9.8	0.0077	8.3	0.0048	6.7	

Appendix E-2
Results of Analyses by Nevada GeoTech, Inc., on Drive Core from Phase IV Wells 24P and 29P
 (Blanks indicate unmeasured parameters.)

Well Name	Sample Number	Core	Depth Interval (feet bgs)		Gravimetric Water Content (g/g)	Volumetric Water Content (cm ³ /cm ³)		Specific Gravity (g/cm ³)	Dry Bulk Density (g/cm ³)	Wet Sieve (%)				Hydrometer (%)			Saturated Hydraulic Conductivity (cm/sec)
			From	To		Field Sample	Saturated Sample			Gravel	Sand	Fines	Silt	Clay	Total Sand		
24P	24P-120.13-120.58-C	Core	120.13	120.58	0.068	0.129	0.255	2.59	1.88	31	58	11	6	6	58	2.8E-03	
	24P-120.58-121.08-C	Core	120.58	121.08	0.075	0.140	0.252	2.59	1.85	30	60	10	4	6	60	2.6E-03	
	24P-121.08-121.34-C	Shoe Core	121.08	121.34						24	60	16	9	6	60		
	24P-160.87-161.37-C	Core	160.87	161.37	0.283	0.458	0.505	2.56	1.62	39	55	6	3	3	55	1.8E-03	
	24P-161.37-161.87-C	Core	161.37	161.87	0.087	0.164	0.278	2.56	1.89	28	53	9	5	5	53	2.4E-03	
	24P-161.87-162.13-C	Shoe Core	161.87	162.13						34	52	14	4	9	52		
	24P-200.31-200.61-C	Core	200.31	200.61	0.078	0.179	0.278	2.58	2.30	28	59	13	7	6	59	6.5E-06	
	24P-200.61-200.87-C	Shoe Core	200.61	200.87						28	62	10	6	5	62		
	24P-240.48-240.98-C	Core	240.48	240.98	0.065	0.129	0.156	2.59	1.98	32	64	4	1	2	64	3.0E-02	
	24P-240.98-241.48-C	Core	240.98	241.48	0.059	0.112	0.262	2.59	1.90	24	64	12	6	6	64	3.2E-03	
	24P-241.48-241.75-C	Shoe Core	241.48	241.75						21	66	13	6	7	66		
	24P-280.40-280.73-C	Core	280.40	280.73	0.141	0.271	0.312	2.6	1.92	25	56	19	8	10	56	1.7E-05	
	24P-280.73-281.00-C	Shoe Core	280.73	281.00						19	56	25	12	14	56		
	24P-322.50-322.75-C	Core	322.50	322.75	0.087	0.189	0.228	2.63	2.16	32	49	19	10	9	49	1.7E-05	
	24P-322.75-323.25-C	Core	322.75	323.25	0.078	0.160	0.208	2.63	2.05	29	50	21	9	13	50	1.2E-04	
	24P-323.25-323.44-C	Shoe Core	323.25	323.44						25	40	35	15	19	40		
	24P-360.00-360.02-C	Core	360.00	360.02	0.106	0.000	0.000	2.54	0.00	33	47	20	10	10	47	0.0E+00	
	24P-360.02-360.52-C	Core	360.02	360.52	0.086	0.149	0.266	2.54	1.74	35	49	16	9	7	49	5.1E-03	
24P-360.52-360.71-C	Shoe Core	360.52	360.71						49	33	18	9	8	33			
29P	24P-80.43-80.93-C	Core	80.43	80.93	0.052	0.102	0.193	2.54	1.97	29	61	10	6	4	61	4.9E-04	
	24P-80.93-81.43-C	Core	80.93	81.43	0.060	0.116	0.212	2.54	1.93	29	60	11	6	6	60	2.2E-03	
	24P-81.43-81.69-C	Shoe Core	81.43	81.69						24	62	14	6	8	62		
	29P-100.50-101.00-C	Core	100.50	101.00	0.122	0.232	0.259	2.52	1.90	36	48	16	8	8	48	8.4E-06	
	29P-101.00-101.50-C	Core	101.00	101.50	0.094	0.192	0.212	2.52	2.03	54	34	12	6	6	34	9.6E-06	
	29P-102.00-102.27-C	Core Shoe	102.00	102.27						50	36	14	6	8	36		
	29P-180.00-180.36-C	Core	180.00	180.36	0.155	0.225	0.253	2.58	1.45	47	39	14	Censored	Censored	39	1.8E-05	
	29P-180.36-180.86-C	Core	180.36	180.86	0.061	0.125	0.216	2.58	2.04	54	34	12	6	6	34	5.0E-05	
	29P-180.86-181.13-C	Core Shoe	180.86	181.13						48	38	14	4	10	39		
	29P-280.84-281.34-C	Core	280.84	281.34	0.119	0.224	0.269	2.56	1.88	43	42	15	5	10	42	4.4E-05	
	29P-281.34-281.84-C	Core	281.34	281.84	0.094	0.183	0.319	2.56	1.94	55	31	14	6	8	31	1.4E-05	
	29P-281.84-282.11-C	Core Shoe	281.84	282.11						41	39	20	7	13	39		

APPENDIX F

**APPENDIX F
LABORATORY ANALYSES OF SONIC
REPACKED AND GRAB CORE SAMPLES**

Appendix F-1 Results of NWRPO Laboratory Analyses of Sonic Core from 19PB Repacked to Target Density at Air-Dried and Optimum Water Contents (Blanks indicate unmeasured parameters)

Sample Number	Dry Bulk Density (g/cm ³)	Saturated Volumetric Water Content (cm ³ /cm ³)	Saturated Hydraulic Conductivity (cm/s)	Specific Gravity (g/cm ³)	Atterberg Limits			Wet Sieve Particle Size Analysis (Percent Passing)										Hydrometer Particle Size Analysis																																				
					Liquid Limit	Plastic Limit	Plasticity Index	3-inch Sieve	1/2-inch Sieve	3/4-inch Sieve	3/8-inch Sieve	No. 4 Sieve	No. 10 Sieve	No. 40 Sieve	No. 100 Sieve	No. 200 Sieve	2 Minutes	5 Minutes	15 Minutes	45 Minutes	120 Minutes	Largest Particle Passing (mm)	Per-cent Passing	Largest Particle Passing (mm)	Per-cent Passing	Largest Particle Passing (mm)	Per-cent Passing	Largest Particle Passing (mm)	Per-cent Passing																									
19PB-388.9-394.1-SCR	1.76	0.310	8.8E-04	2.57	32	26	6	63	63	46	36	25	12	5	3	0.0311	8.0	0.0203	7.3	0.0120	6.5	0.0072	5.5	0.0045	4.5	0.0045	5.5	0.0072	8.2	0.0045	6.5	0.0045	5.1	0.0046	5.1	0.0048	5.0	0.0044	8.3	0.0045	6.1	0.0044	11.4	0.0044	10.3	0.0044	10.3							
19PB-401.1-405.0-SCR	1.74	0.317	3.1E-03	2.54	32	26	6	100	88	81	57	42	21	13	10	0.0322	11.6	0.0207	10.8	0.0123	9.1	0.0072	8.2	0.0045	6.5	0.0045	6.5	0.0072	8.2	0.0045	6.5	0.0045	5.1	0.0046	5.1	0.0048	5.0	0.0044	8.3	0.0045	6.1	0.0044	11.4	0.0044	10.3	0.0044	10.3							
19PB-406.3-408.5-SCR	1.76	0.309	4.4E-03	2.58	33	18	15	100	98	86	69	53	36	18	8	0.0322	10.1	0.0208	8.7	0.0124	7.3	0.0073	6.2	0.0046	5.1	0.0046	5.1	0.0073	6.2	0.0046	5.1	0.0046	5.1	0.0046	5.1	0.0048	5.0	0.0044	8.3	0.0045	6.1	0.0044	11.4	0.0044	10.3	0.0044	10.3							
19PB-437.8-441.2-SCR	1.75	0.317	8.8E-04	2.53				100	100	96	90	81	60	25	12	0.0355	9.8	0.0226	8.6	0.0132	7.4	0.0077	6.2	0.0048	5.0	0.0048	5.0	0.0077	6.2	0.0048	5.0	0.0048	5.0	0.0048	5.0	0.0048	5.0	0.0044	8.3	0.0045	6.1	0.0044	11.4	0.0044	10.3	0.0044	10.3							
19PB-450.3-455.1-SCR	1.73	0.317	3.9E-03	2.55	35	25	10	100	100	85	72	59	44	24	15	0.0306	13.5	0.0202	12.2	0.0119	10.9	0.0070	9.6	0.0048	5.0	0.0048	5.0	0.0070	9.6	0.0048	5.0	0.0048	5.0	0.0048	5.0	0.0048	5.0	0.0044	8.3	0.0045	6.1	0.0044	11.4	0.0044	10.3	0.0044	10.3							
19PB-457.2-460.7-SCR	1.79	0.295	3.0E-04	2.55	29	24	5	100	91	78	65	55	40	24	16	0.0321	11.8	0.0207	10.2	0.0122	8.6	0.0072	7.4	0.0045	6.1	0.0045	6.1	0.0072	7.4	0.0045	6.1	0.0045	6.1	0.0045	6.1	0.0048	5.0	0.0044	8.3	0.0045	6.1	0.0044	11.4	0.0044	10.3	0.0044	10.3							
19PB-478.2-481.9-SCR	1.69	0.331	7.3E-04	2.54	31	26	5	100	100	82	72	61	48	30	20	0.0300	18.8	0.0199	16.9	0.0118	15.4	0.0070	9.6	0.0048	5.0	0.0048	5.0	0.0070	9.6	0.0048	5.0	0.0048	5.0	0.0048	5.0	0.0048	5.0	0.0044	8.3	0.0045	6.1	0.0044	11.4	0.0044	10.3	0.0044	10.3							
19PB-481.9-484.4-SCR	1.65	0.342	2.1E-03	2.53	44	32	12	100	86	74	66	55	42	22	15	0.0316	15.3	0.0201	14.1	0.0119	12.8	0.0070	9.6	0.0048	5.0	0.0048	5.0	0.0070	9.6	0.0048	5.0	0.0048	5.0	0.0048	5.0	0.0048	5.0	0.0044	8.3	0.0045	6.1	0.0044	11.4	0.0044	10.3	0.0044	10.3							
19PB-512.1-514.2-SCR	1.74	0.324	9.8E-04	2.59																																																		
19PB-517.3-519.4-SCR	1.69	0.336	2.1E-03	2.54	40	33	7	100	95	88	75	62	44	20	13	0.0341	9.4	0.0220	8.0	0.0128	7.6	0.0075	6.7	0.0046	6.3	0.0046	6.3	0.0075	6.7	0.0046	6.3	0.0046	6.3	0.0046	6.3	0.0046	6.3	0.0046	6.3	0.0046	6.3	0.0046	6.3	0.0046	6.3	0.0046	6.3							
19PB-519.4-522.1-SCR	1.68	0.346	5.4E-03	2.53	30	20	10	100	92	78	63	52	37	21	14	0.0326	11.3	0.0207	10.2	0.0121	9.5	0.0072	8.3	0.0045	6.8	0.0045	6.8	0.0072	8.3	0.0045	6.8	0.0045	6.8	0.0045	6.8	0.0045	6.8	0.0045	6.8	0.0045	6.8	0.0045	6.8	0.0045	6.8	0.0045	6.8							
19PB-547.6-553.3-SCR	1.73	0.329	3.0E-04	2.58	29	22	7	100	88	79	71	62	50	33	23	0.0319	16.9	0.0206	15.9	0.0121	14.3	0.0072	12.3	0.0045	10.7	0.0045	10.7	0.0072	12.3	0.0045	10.7	0.0045	10.7	0.0045	10.7	0.0045	10.7	0.0045	10.7	0.0045	10.7	0.0045	10.7	0.0045	10.7	0.0045	10.7							
19PB-553.7-557.8-SCR	1.73	0.313	1.2E-04	2.56	30	23	7	100	100	97	89	77	63	36	24	0.0334	16.8	0.0216	15.5	0.0127	14.2	0.0075	12.3	0.0045	10.4	0.0045	10.4	0.0075	12.3	0.0045	10.4	0.0045	10.4	0.0045	10.4	0.0045	10.4	0.0045	10.4	0.0045	10.4	0.0045	10.4	0.0045	10.4	0.0045	10.4							
19PB-598.7-602.9-SCR	1.67	0.326	1.8E-04	2.52	31	29	2	100	100	96	88	76	59	30	20	0.0345	13.1	0.0220	11.4	0.0129	10.3	0.0076	8.6	0.0047	8.0	0.0047	8.0	0.0076	8.6	0.0047	8.0	0.0047	8.0	0.0047	8.0	0.0047	8.0	0.0047	8.0	0.0047	8.0	0.0047	8.0	0.0047	8.0	0.0047	8.0							
19PB-618.9-624.9-SCR	1.70	0.336	2.3E-04	2.55	34	25	9	100	100	94	86	74	57	32	22	0.0338	15.8	0.0218	14.7	0.0127	13.5	0.0075	11.7	0.0047	8.0	0.0047	8.0	0.0075	11.7	0.0047	8.0	0.0047	8.0	0.0047	8.0	0.0047	8.0	0.0047	8.0	0.0047	8.0	0.0047	8.0	0.0047	8.0	0.0047	8.0							
19PB-406.3-408.5-SCRM	1.90	0.251	6.9E-05																																																			
19PB-457.2-460.7-SCRM	1.90	0.262	4.3E-05																																																			
19PB-478.2-481.9-SCRM	1.90	0.253	7.9E-06																																																			
19PB-481.9-484.4-SCRM	1.90	0.244	2.5E-05																																																			
19PB-519.4-522.1-SCRM	1.90	0.261	1.2E-04																																																			
19PB-553.7-557.8-SCRM	1.90	0.265	1.0E-05																																																			
19PB-618.9-624.9-SCRM	1.90	0.237	5.2E-07																																																			

Appendix F-2 Results of NWRPO Laboratory Analyses of Sonic Core Grab Samples from 19PB (Blanks indicate unmeasured parameters)

Sample Number	Gravimetric Water Content (g/g)	Electrical Conductivity of Soil/Water Extract (µmhos/cm)	Specific Gravity (g/cm³)	Atterberg Limits			Wet Sieve Particle Size Analysis (Percent Passing)							Hydrometer Particle Size Analysis											
				Liquid Limit	Plasticity Index	3-inch Sieve	1½-inch Sieve	¾-inch Sieve	¾-inch Sieve	No. 4 Sieve	No. 10 Sieve	No. 40 Sieve	No. 100 Sieve	No. 200 Sieve	2 Minutes		5 Minutes		15 Minutes		45 Minutes		120 Minutes		
															Largest Particle Passing (mm)	Percent Passing	Largest Particle Passing (mm)	Percent Passing	Largest Particle Passing (mm)	Percent Passing	Largest Particle Passing (mm)	Percent Passing	Largest Particle Passing (mm)	Percent Passing	Largest Particle Passing (mm)
19PB-413.9-414.4-SC	0.151			38	24	14	100	100	94	86	68	57	27	16	12										
19PB-414.4-415.7-SC	0.088						100	65	57	49	40	32	18	9	7										
19PB-415.7-416.1-SC	0.150						100	82	80	69	61	47	27	17	14										
19PB-416.2-416.8-SC	0.122						100	84	82	59	44	32	18	8	6										
19PB-416.8-418.4-SC	0.084						Cen-sored	Cen-sored	Cen-sored	Cen-sored	Cen-sored	Cen-sored	Cen-sored	Cen-sored	Cen-sored										
19PB-418.4-419.6-SC	0.092						100	100	86	71	57	40	23	12	10										
19PB-419.6-421.2-SC	0.081						100	67	47	44	39	30	16	11	9										
19PB-421.2-422.5-SC	0.098	2.56					100	100	78	70	57	45	26	17	15	0.0307	18.4	0.0195	16.9	0.0116	15.4	0.0068	13.9	0.0043	12.3
19PB-422.5-424.4-SC	0.077	2.57					50	32	28	23	19	14	8	5	3	0.0307	6.8	0.0198	6.2	0.0117	5.6	0.0069	5.0	0.0043	4.4
19PB-424.6-428.7-SC	0.059	2.55					55	36	33	29	25	20	13	9	7	0.0275	9.3	0.0185	8.4	0.0110	7.6	0.0066	6.7	0.0041	6.1
19PB-428.7-429.3-SC	0.116			36	19	17	100	100	78	70	59	44	27	19	16										
19PB-429.3-431.0-SC	0.134			42	20	22	100	100	89	80	71	54	32	22	19										
19PB-431.0-431.9-SC	0.146						100	51	48	38	31	24	13	8	7										
19PB-431.9-432.4-SC	0.142			37	20	17	100	100	92	82	69	49	28	19	16										
19PB-432.4-434.1-SC	0.197	2.57					100	100	95	90	82	66	42	29	24	0.0307	22.4	0.0196	19.9	0.0118	16.8	0.0070	14.3	0.0044	12.4
19PB-435.5-437.2-SC	0.147	2.54					100	100	88	76	67	53	29	15	11	0.0350	14.5	0.0227	11.4	0.0133	9.3	0.0077	7.1	0.0048	6.1
19PB-437.2-441.2-SC	0.148	2.54					100	100	96	89	79	62	26	14	10	0.0341	10.7	0.0223	9.0	0.0130	7.9	0.0076	6.7	0.0048	5.0
19PB-441.2-442.9-SC	0.138			30	23	7	100	100	89	78	68	53	26	15	12										
19PB-442.9-445.1-SC	0.061	2.55					100	70	56	48	40	30	15	9	7	0.0311	9.1	0.0203	8.2	0.0121	7.1	0.0072	5.9	0.0045	5.1
19PB-445.3-447.9-SC	0.130			30	22	8	100	85	71	62	54	43	27	19	16										
19PB-450.6-453.0-SC	0.141	2.54					100	82	67	58	50	39	23	15	13	0.0290	13.3	0.0193	12.2	0.0115	10.8	0.0068	9.3	0.0042	8.6
19PB-453.0-455.1-SC	0.118	2.53					100	63	45	35	29	20	11	5	4	0.0306	7.8	0.0200	6.9	0.0119	5.9	0.0070	5.2	0.0044	4.5
19PB-455.1-455.5-SC	0.122						100	63	56	51	46	37	23	16	13										
19PB-455.5-456.6-SC	0.150			36	26	10	100	100	100	94	85	62	26	15	13										
19PB-456.6-457.2-SC	0.131						100	87	72	67	53	38	19	12	10										

**Appendix F-2
Results of NWRPO Laboratory Analyses of Sonic Core Grab Samples from 19PB
(Blanks indicate unmeasured parameters)**

Sample Number	Gravimetric Water Content (g/g)	Electrical Conductivity of Soil/Water Extract (µmhos/cm)	Specific Gravity (g/cm ³)	Atterberg Limits				Wet Sieve Particle Size Analysis (Percent Passing)										Hydrometer Particle Size Analysis							
				Liquid Limit	Plasticity Index	3-inch Sieve	1 1/2-inch Sieve	3/4-inch Sieve	3/8-inch Sieve	No. 4 Sieve	No. 10 Sieve	No. 40 Sieve	No. 100 Sieve	No. 200 Sieve	2 Minutes		5 Minutes		15 Minutes		45 Minutes		120 Minutes		
															Largest Particle Passing (mm)	Percent Passing	Largest Particle Passing (mm)	Percent Passing	Largest Particle Passing (mm)	Percent Passing	Largest Particle Passing (mm)	Percent Passing	Largest Particle Passing (mm)	Percent Passing	Largest Particle Passing (mm)
19PB-457.2-460.7-SC	0.134		2.54			100	83	69	60	50	37	21	13	11	0.0290	12.6	0.0193	11.2	0.0116	9.6	0.0069	8.3	0.0043	6.9	
19PB-460.7-461.8-SC	0.161					100	100	94	86	70	52	27	17	13											
19PB-461.8-463.4-SC	0.127		2.55			100	47	42	37	31	24	15	9	7	0.0305	8.9	0.0200	7.8	0.0121	6.7	0.0072	5.6	0.0045	4.9	
19PB-463.4-464.5-SC	0.114					100	100	84	65	50	38	22	14	11											
19PB-464.5-465.6-SC	0.122					100	60	47	39	34	27	16	9	7											
19PB-465.6-466.3-SC	0.118					100	50	45	35	30	24	15	9	7											
19PB-466.5-468.1-SC	0.143		2.53			100	59	50	39	30	21	11	5	3	0.0337	6.2	0.0215	5.5	0.0128	4.7	0.0076	3.8	0.0047	3.2	
19PB-468.1-469.0-SC	0.154		2.55			100	100	100	92	82	61	24	12	8	0.0322	18.5	0.0210	16.2	0.0125	14.0	0.0074	11.8	0.0046	10.6	
19PB-469.0-470.5-SC	0.110					100	70	60	49	40	28	13	8	6											
19PB-470.5-474.3-SC	0.115		2.54			100	82	72	60	49	36	19	12	10	0.0367	5.9	0.0232	5.2	0.0135	4.5	0.0080	3.5	0.0049	2.8	
19PB-474.3-475.1-SC	0.118		2.59			100	75	50	33	25	17	9	4	3	0.0367	8.3	0.0234	7.3	0.0136	6.2	0.0080	5.2	0.0049	4.1	
19PB-475.1-476.2-SC	0.126				32	24	8																		
19PB-476.4-476.6-SC	0.083																								
19PB-476.6-478.0-SC	0.109					100	61	40	34	29	21	10	5	4											
19PB-478.2-481.9-SC	0.112		2.53			100	90	72	64	56	45	27	17	15	0.0283	18.4	0.0191	16.3	0.0114	14.7	0.0068	13.0	0.0043	10.9	
19PB-481.9-484.4-SC	0.170					100	76	69	60	51	39	21	15	13											
19PB-484.4-486.0-SC	0.138				44	23	21																		
19PB-486.0-487.2-SC	0.069		2.56																						
19PB-487.2-488.8-SC	0.131				42	23	19																		
19PB-488.8-489.4-SC	0.067																								
19PB-489.6-490.6-SC	0.089		2.56																						
19PB-490.6-492.0-SC	0.119				39	21	18																		
19PB-492.0-493.6-SC	0.111				34	20	14																		
19PB-493.6-494.6-SC	0.105																								
19PB-495.2-496.7-SC	0.149		2.53																						

Appendix F-2
Results of NWRPO Laboratory Analyses of Sonic Core Grab Samples from 19PB
(Blanks indicate unmeasured parameters)

Sample Number	Gravimetric Water Content (g/g)	Electrical Conductivity of Soil/Water Extract ($\mu\text{mhos/cm}$)	Specific Gravity (g/cm^3)	Atterberg Limits			Wet Sieve Particle Size Analysis (Percent Passing)								Hydrometer Particle Size Analysis										
				Liquid Limit	Plasticity Index	3-inch Sieve	1/2-inch Sieve	3/4-inch Sieve	No. 4 Sieve	No. 10 Sieve	No. 40 Sieve	No. 100 Sieve	No. 200 Sieve	2 Minutes		5 Minutes		15 Minutes		45 Minutes		120 Minutes			
														Largest Particle Passing (mm)	Percent Passing	Largest Particle Passing (mm)	Percent Passing	Largest Particle Passing (mm)	Percent Passing	Largest Particle Passing (mm)	Percent Passing	Largest Particle Passing (mm)	Percent Passing	Largest Particle Passing (mm)	Percent Passing
19PB-496.7-499.0-SC	0.084		2.54			100	76	63	53	45	35	21	15	12	0.0302	13.1	0.0195	12.1	0.0117	10.8	0.0069	9.8	0.0043	8.9	
19PB-500.1-501.5-SC	0.157			36	25	11	100	100	85	77	66	48	26	18	15										
19PB-501.5-503.4-SC	0.121		2.53			100	100	82	73	63	48	30	21	17	0.0319	15.3	0.0204	14.0	0.0120	12.7	0.0071	11.4	0.0044	10.1	
19PB-503.4-506.0-SC	0.122		2.52			100	88	77	69	59	43	22	14	11	0.0334	11.3	0.0212	10.5	0.0125	9.3	0.0074	8.2	0.0046	7.0	
19PB-506.0-506.6-SC	0.178			37	25	12	100	73	66	60	55	44	25	17	14										
19PB-506.6-508.1-SC	0.205			43	30	13	100	100	98	96	86	61	25	17	14										
19PB-508.1-509.1-SC	0.139			45	27	18	100	100	92	78	63	46	25	17	15										
19PB-509.1-510.0-SC	0.142		2.53			100	56	43	33	26	20	10	5	4	0.0319	7.4	0.0201	7.0	0.0120	6.2	0.0071	5.6	0.0044	4.9	
19PB-510.0-510.3-SC	0.118					100	100	85	74	61	44	21	13	11											
19PB-510.3-512.1-SC	0.166			41	25	16	100	100	85	77	68	51	25	15	12										
19PB-512.1-514.2-SC	0.159					100	100	93	78	62	44	24	16	13											
19PB-514.2-515.3-SC	0.187		2.52			100	100	97	90	79	61	28	16	13	0.0326	13.9	0.0213	12.8	0.0125	11.1	0.0074	9.5	0.0046	8.9	
19PB-515.3-517.3-SC	0.185		2.55			100	81	67	59	51	38	21	14	11	0.0311	10.9	0.0205	9.8	0.0121	8.8	0.0072	7.4	0.0045	6.7	
19PB-517.3-519.4-SC	0.198					100	100	93	84	72	53	26	18	15											
19PB-519.4-519.7-SC	0.131			35	22	13	100	100	77	63	48	30	12	7	6										
19PB-519.7-522.1-SC	0.137			30	19	11	100	57	43	37	31	22	11	7	5										
19PB-522.1-522.7-SC	0.145					100	100	97	83	72	56	35	25	20	0.0316	18.3	0.0204	16.2	0.0122	14.1	0.0071	12.6	0.0045	10.5	
19PB-524.4-526.1-SC	0.086		2.51			100	100	91	85	73	50	23	12	10	0.0332	13.2	0.0214	11.8	0.0126	10.0	0.0074	9.0	0.0046	8.1	
19PB-526.1-527.1-SC	0.092		2.52			100	100	87	78	64	48	27	15	12	0.0316	14.8	0.0206	13.0	0.0126	9.6	0.0074	8.3	0.0046	7.0	
19PB-528.8-530.4-SC	0.148		2.52			100	100	100	94	83	72	47	28	24	0.0274	28.5	0.0183	25.9	0.0110	22.7	0.0066	19.5	0.0042	17.5	
19PB-530.4-531.1-SC	0.112		2.51			100	100	100	97	83	72	47	28	24											
19PB-533.0-534.1-SC	0.116			25	19	6	100	65	58	54	45	34	18	10	8										
19PB-534.4-535.2-SC	0.114					100	100	65	55	49	43	32	18	10	8										
19PB-535.2-538.2-SC	0.144		2.54			100	100	100	88	75	54	31	22	18	0.0306	17.5	0.0196	16.0	0.0117	14.0	0.0069	12.1	0.0043	10.6	
19PB-538.2-540.7-SC	0.132		2.54			100	64	57	48	42	35	24	17	14	0.0274	14.7	0.0182	13.4	0.0110	11.8	0.0066	10.1	0.0042	8.8	

APPENDIX G

**APPENDIX G
REPACKING AND WATER CONTENT/DENSITY
DATA FOR 19PB SONIC CORE**

Appendix G-1
Core Repacking Specifications and Data Sheet for 19PB

Lab ID	Sample Number	Core Input Data				Calculated Data						Lift Weight (g)				Repacked Core Data		
		Target Density	Gravimetric Water Content (g/g)	Target Core Diameter (cm)	Target Core Length (cm)	Lift Height (cm)	Core Volume (cm ³)	Total Oven-dried Sample Weight (g)	Total Moist Sample Weight (g)	Moist Sample Weight per Lift (g)	1	2	3	4	Total Moist Sample Weight (g)	Total Oven-dried Weight (g)	Dry Bulk Density (g/cm ³)	
1	19PB-406.3-408.5-SCR	1.85	0.027	15.30	30.48	7.62	5,604	10,367	10,645	2,661	2,520	2,480	2,560	10,140	9,875	1.76		
2	19PB-450.3-455.1-SCR	1.85	0.011	15.30	30.48	7.62	5,604	10,367	10,480	2,620	2,434	2,502	2,358	9,823	9,717	1.73		
3	19PB-519.4-522.1-SCR	1.85	0.016	15.30	30.48	7.62	5,604	10,367	10,534	2,633	2,464	2,432	2,052	9,592	9,440	1.68		
4	19PB-401.1-405.0-SCR	1.83	0.015	15.30	30.48	7.62	5,604	10,227	10,379	2,595	2,442	2,515	2,633	9,907	9,762	1.74		
5	19PB-437.8-441.2-SCR	1.83	0.010	15.30	30.48	7.62	5,604	10,227	10,328	2,582	2,562	2,522	2,454	9,927	9,830	1.75		
6	19PB-457.2-460.7-SCR	1.83	0.008	15.30	30.48	7.62	5,604	10,227	10,314	2,578	2,468	2,505	2,607	10,139	10,054	1.79		
7	19PB-481.9-484.4-SCR	1.83	0.013	15.30	30.48	7.62	5,604	10,255	10,388	2,597	2,256	2,219	2,456	9,371	9,251	1.65		
8	19PB-512.1-514.2-SCR	1.83	0.013	15.30	30.48	7.62	5,604	10,255	10,388	2,597	2,515	2,447	2,453	9,879	9,752	1.74		
9	19PB-478.2-481.9-SCR	1.83	0.015	15.30	30.48	7.62	5,604	10,255	10,413	2,603	2,330	2,382	2,349	9,638	9,492	1.69		
10	19PB-517.3-519.4-SCR	1.83	0.010	15.30	30.48	7.62	5,604	10,255	10,357	2,589	2,300	2,406	2,425	9,570	9,475	1.69		
11	19PB-388.9-394.1-SCR	1.80	0.009	15.30	30.48	7.62	5,604	10,087	10,179	2,545	2,363	2,676	2,396	9,946	9,856	1.76		
12	19PB-598.7-602.9-SCR	1.80	0.009	15.30	30.48	7.62	5,604	10,087	10,173	2,543	2,480	2,351	2,280	9,460	9,380	1.67		
13	19PB-553.7-557.8-SCR	1.80	0.013	15.30	30.48	7.62	5,604	10,087	10,218	2,555	2,463	2,410	2,526	9,835	9,709	1.73		
14	19PB-547.6-553.3-SCR	1.80	0.010	15.30	30.48	7.62	5,604	10,087	10,184	2,546	2,457	2,332	2,540	9,768	9,675	1.73		
15	19PB-618.9-624.9-SCR	1.80	0.008	15.30	30.48	7.62	5,604	10,087	10,163	2,541	2,375	2,268	2,376	9,598	9,526	1.70		
101	19PB-406.3-408.5- SCR	1.90	0.110	15.31	30.48	7.62	5,611	10,661	11,834	2,959	2,956	2,954	2,956	11,820	10,649	1.90		
103	19PB-519.4-522.1- SCR	1.90	0.110	15.31	30.48	7.62	5,611	10,661	11,834	2,959	2,956	2,956	2,952	11,820	10,649	1.90		
106	19PB-457.2-460.7- SCR	1.90	0.110	15.31	30.48	7.62	5,611	10,661	11,834	2,959	2,955	2,955	2,955	11,820	10,649	1.90		
107	19PB-481.9-484.4- = SCR	1.90	0.125	15.31	30.48	7.62	5,611	10,661	11,994	2,998	2,997	2,999	2,995	11,984	10,652	1.90		
109	19PB-478.2-481.9- SCR	1.90	0.125	15.31	30.48	7.62	5,611	10,661	11,994	2,998	2,997	2,995	2,999	11,984	10,652	1.90		
113	19PB-553.7-557.8- SCR	1.90	0.120	15.31	30.48	7.62	5,611	10,661	11,941	2,985	2,980	2,981	2,983	11,928	10,650	1.90		
115	19PB-618.9-624.9- SCR	1.90	0.110	15.31	30.48	7.62	5,611	10,661	11,834	2,959	2,955	2,955	2,955	11,820	10,649	1.90		

Appendix G-2
Results of Water Content vs. Density Compaction Tests for Selected 19PB Sonic Core Samples

Lab ID	Sample Number	Target Gravimetric Water Content (g/g)	Pre-Repacking Air-Dry Sample Weight (g)	Weight of Empty Liner Plus Add-Ons (g)	Weight of Repacked Liner Plus Add-Ons (g)	Weight of Repacked Sample (g)	Inside Diameter of Liner (cm)	Length of Repacked Sample (cm)	Volume of Repacked Sample (cm ³)	Post-Repacking Air-Dry Sample Weight	Calculated Oven Dry Weight	Gravimetric Water Content of Repacked Sample (g/g)	Dry Bulk Density (g/cm ³)
1	19PB-406.3-407.5-SCR1	0.070	9,919	1,832	12,280	10,448	15.3	31.2	5,727	9,925	9,807	0.065	1.712
7	19PB-481.9-484.4-SCR1	0.070	9,252	1,824	11,600	9,776	15.3	29.6	5,433	9,242	9,132	0.070	1.681
15	19PB-618.9-624.9-SCR1	0.070	9,623	1,818	11,980	10,162	15.3	30.0	5,510	9,582	9,468	0.073	1.718
1	19PB-406.3-407.5-SCR2	0.100	9,925	1,832	12,580	10,748	15.3	27.9	5,128	9,901	9,784	0.099	1.908
7	19PB-481.9-484.4-SCR2	0.100	9,242	1,823	11,820	9,997	15.3	27.8	5,107	9,213	9,104	0.098	1.782
15	19PB-618.9-624.9-SCR2	0.100	9,582	1,834	12,220	10,386	15.3	27.1	4,988	9,551	9,438	0.100	1.892
1	19PB-406.3-407.5-SCR3	0.130	9,901	1,831	12,780	10,949	15.3	28.0	5,155	9,839	9,722	0.126	1.886
7	19PB-481.9-484.4-SCR3	0.130	9,213	1,822	12,060	10,238	15.3	26.4	4,856	9,196	9,087	0.127	1.871
15	19PB-618.9-624.9-SCR3	0.130	9,551	1,818	12,420	10,602	15.3	28.0	5,148	9,510	9,397	0.128	1.825
1	19PB-406.3-407.5-SCR4	0.110	11,087	1,832	13,903	12,071	15.3	30.5	5,604	11,087	10,956	0.102	1.955
7	19PB-481.9-484.4-SCR4	0.125	10,593	1,824	13,520	11,696	15.3	30.5	5,604	10,593	10,467	0.117	1.868
15	19PB-618.9-624.9-SCR4	0.110	10,648	1,819	13,536	11,717	15.3	30.5	5,604	10,648	10,522	0.114	1.878
7	19PB-481.9-484.4-SCR5	0.160	9,196	1,823	12,280	10,457	15.3	27.9	5,133	9,180	9,071	0.153	1.767

APPENDIX H

**APPENDIX H
LABORATORY ANALYSES
OF DRILL CUTTINGS SAMPLES**

Appendix H
 Results of Analyses by Nevada GeoTech, Inc., on Drill Cuttings
 (Blanks indicate unmeasured parameters)

Well Name	Sample Number	Depth Interval (feet bgs)		Gravimetric Water Content (g/g)	Volumetric Water Content (cm ³ /cm ³)		Specific Gravity (g/cm ³)	Dry Bulk Density (g/cm ³)	Electrical Conductivity of Soil-Water Extract (µmhos/cm)	Wet Sieve (%)			Hydrometer (%)			Saturated Hydraulic Conductivity (cm/sec)
		From	To		Field Sample	Saturated Sample				Gravel	Sand	Fines	Silt	Clay	Total Sand	
16P	BCS00042502	2.5	5	0.029					509	29	57	13				
16P	BCS00042504	7.5	10	0.038					929	27	61	12				
16P	BCS00042506	12.5	15	0.025					403	30	56	15				
16P	BCS00042508	17.5	20	0.019					261	31	54	15				
16P	BCS00042510	22.5	25	0.044					304	36	51	13				
16P	BCS00042512	27.5	30	0.021					234	32	55	13				
16P	BCS00042514	32.5	35	0.033					285	30	59	11	Censored	Censored	Censored	
16P	BCS00042516	37.5	40	0.022					257	28	56	16				
16P	BCS00042518	42.5	45	0.05					294	13	50	38				
16P	BCS00042520	47.5	50	0.051					592	14	46	40				
16P	BCS00042522	52.5	55	0.056					563	30	54	16				
16P	BCS00042524	57.5	60	0.038					614	38	48	14	Censored	Censored	Censored	
16P	BCS00042526	62.5	65	0.066					874	35	51	14				
16P	BCS00042528	67.5	70	0.058					926	6	43	50				
16P	BCS00042530	72.5	75	0.076					937	5	40	55	25	27	39	
16P	BCS00042532	77.5	80	0.061					1040	12	45	42				
16P	BCS00042534	82.5	85	0.061					821	21	51	28	Censored	Censored	Censored	
16P	BCS00042536	87.5	90	0.032					709	18	54	28				
16P	BCS00042538	92.5	95	0.072					787	18	51	31				
16P	BCS00042540	97.5	100	0.028					735	24	53	23				
16P	BCS00042542	102.5	105	0.028					739	18	55	27				
16P	BCS00042544	107.5	110	0.029					602	13	52	35				
16P	BCS00042546	112.5	115	0.041					668	14	49	36	16	15	52	
16P	BCS00042548	117.5	120	0.051					738	16	49	35				
16P	BCS00042550	122.5	125	0.032					645	18	54	27				

Nye County Early Warning Drilling Program Phase IV Drilling Report

Appendix H
 Results of Analyses by Nevada GeoTech, Inc., on Drill Cuttings
 (Blanks indicate unmeasured parameters)

Well Name	Sample Number	Depth Interval (feet bgs)		Gravimetric Water Content (g/g)	Volumetric Water Content (cm ³ /cm ³)		Specific Gravity (g/cm ³)	Dry Bulk Density (g/cm ³)	Electrical Conductivity of Soil-Water Extract (µmhos/cm)	Wet Sieve (%)			Hydrometer (%)			Saturated Hydraulic Conductivity (cm/sec)
		From	To		Field Sample	Saturated Sample				Gravel	Sand	Fines	Silt	Clay	Total Sand	
16P	BCS00042552	127.5	130	0.028					596	22	52	27				
16P	BCS00042554	132.5	135	0.031					575	15	56	29				
16P	BCS00042556	137.5	140	0.034					529	20	52	28				
16P	BCS00042558	142.5	145	0.039					483	23	55	22	13	10	Censored	
16P	BCS00042560	147.5	150	0.029					514	24	51	25				
16P	BCS00042562	152.5	155	0.052						22	55	23				
16P	BCS00042564	157.5	160	0.033					701	20	54	26				
16P	BCS00042566	162.5	165	0.055					553	17	57	26				
16P	BCS00042567	165	170	0.047												
16P	BCS00042569	175	180	0.05												
16P	BCS00042571	185	190	0.046												
16P	BCS00042573	195	200	0.043												
16P	BCS00042575	205	210	0.039												
16P	BCS00042577	215	220	0.031												
16P	BCS00042579	225	230	0.02												
16P	BCS00042581	235	240	0.016												
16P	BCS00042583	245	250	0.028												
16P	BCS00042585	255	260	0.032												
16P	BCS00042587	265	270	0.041												
16P	BCS00042589	275	280	0.03												
16P	BCS00042591	285	290	0.028												
16P	BCS00042593	295	300	0.037												
16P	BCS00042595	305	310	0.025												
16P	BCS00042597	315	320	0.022												
16P	BCS00042599	325	330	0.038												

Appendix H
 Results of Analyses by Nevada GeoTech, Inc., on Drill Cuttings
 (Blanks indicate unmeasured parameters)

Well Name	Sample Number	Depth Interval (feet bgs)		Gravimetric Water Content (g/g)	Volumetric Water Content (cm ³ /cm ³)		Specific Gravity (g/cm ³)	Dry Bulk Density (g/cm ³)	Electrical Conductivity of Soil-Water Extract (µmhos/cm)	Wet Sieve (%)			Hydrometer (%)			Saturated Hydraulic Conductivity (cm/sec)
		From	To		Field Sample	Saturated Sample				Gravel	Sand	Fines	Silt	Clay	Total Sand	
16P	BCS00042601	335	340	0.045												
16P	BCS00042603	345	350	0.044												
16P	BCS00042605	355	360	0.033												
16P	BCS00042607	365	370	0.056												
16P	BCS00042609	375	380	0.052												
16P	BCS00042611	385	390	0.04												
16P	BCS00042613	395	400	0.054												
16P	BCS00042615	405	410	0.061												
16P	BCS00042617	415	420	0.063												
16P	BCS00042619	425	430	0.067												
16P	BCS00042621	435	440	0.051												
16P	BCS00042623	445	450	0.06												
16P	BCS00042625	455	460	0.044												
16P	BCS00042627	465	470	0.062												
16P	BCS00042629	475	480	0.064												
16P	BCS00042631	485	490	0.066												
16P	BCS00042633	495	500	0.065												
16P	BCS00042635	505	510	0.075												
16P	BCS00042637	515	520	0.039												
16P	BCS00042639	525	530	0.044												
24P	24P-2.5-5	2.5	5	0.024					489	30	58	12				
24P	24P-7.5-10	7.5	10	0.03					1176	28	61	11				
24P	24P-12.5-15	12.5	15	0.02					741	27	63	10				
24P	24P-17.5-20	17.5	20	0.02					569	30	60	10				
24P	24P-22.5-25	22.5	25	0.04					360	27	61	12				

Appendix H
 Results of Analyses by Nevada GeoTech, Inc., on Drill Cuttings
 (Blanks indicate unmeasured parameters)

Well Name	Sample Number	Depth Interval (feet bgs)		Gravimetric Water Content (g/g)	Volumetric Water Content (cm ³ /cm ³)		Specific Gravity (g/cm ³)	Dry Bulk Density (g/cm ³)	Electrical Conductivity of Soil-Water Extract (µmhos/cm)	Wet Sieve (%)			Hydrometer (%)			Saturated Hydraulic Conductivity (cm/sec)
		From	To		Field Sample	Saturated Sample				Gravel	Sand	Fines	Silt	Clay	Total Sand	
24P	24P-27.5-30	27.5	30	0.03					325	29	61	10				
24P	24P-32.5-35	32.5	35	0.029					179	28	62	10				
24P	24P-37.5-40	37.5	40	0.025					123	9	76	15				
24P	24P-42.5-45	42.5	45	0.02					109	32	62	6				
24P	24P-47.5-50	47.5	50	0.019					108	10	62	28	14	12	60	
24P	24P-52.5-55	52.5	55	0.018					73	29	60	11				
24P	24P-57.5-60	57.5	60	0.023					65	11	68	21				
24P	24P-62.5-65	62.5	65	0.019					475	47	47	6				
24P	24P-67.5-70	67.5	70	0.015					329	43	51	6				
24P	24P-72.5-75	72.5	75	0.018					171	42	53	5				
24P	24P-77.5-80	77.5	80	0.019					326	33	60	7				
24P	24P-82.5-85	82.5	85	0.064					472	28	62	10				
24P	24P-87.5-90	87.5	90	0.032					155	30	60	10				
24P	24P-92.5-95	92.5	95	0.023					135	43	46	11				
24P	24P-97.5-100	97.5	100	0.023					155	33	61	6				
24P	24P-102.5-105	102.5	105	0.02					219	47	43	10				
24P	24P-107.5-110	107.5	110	0.023					295	33	61	6				
24P	24P-112.5-115	112.5	115	0.038					278	28	63	9				
24P	24P-117.5-120	117.5	120	0.022					229	30	63	7				
24P	24P-122.5-125	122.5	125	0.049					262	30	60	10				
24P	24P-127.5-130	127.5	130	0.034					209	33	59	8				
24P	24P-132.5-135	132.5	135	0.03					237	33	60	7				
24P	24P-137.5-140	137.5	140	0.027					147	34	63	3				
24P	24P-142.5-145	142.5	145	0.027					149	31	62	7	6	5	61	
24P	24P-147.5-150	147.5	150	0.026					174	34	60	6				

Appendix H
 Results of Analyses by Nevada GeoTech, Inc., on Drill Cuttings
 (Blanks indicate unmeasured parameters)

Well Name	Sample Number	Depth Interval (feet bgs)		Gravimetric Water Content (g/g)	Volumetric Water Content (cm ³ /cm ³)		Specific Gravity (g/cm ³)	Dry Bulk Density (g/cm ³)	Electrical Conductivity of Soil-Water Extract (µmhos/cm)	Wet Sieve (%)				Hydrometer (%)			Saturated Hydraulic Conductivity (cm/sec)
		From	To		Field Sample	Saturated Sample				Gravel	Sand	Fines	Silt	Clay	Total Sand		
24P	24P-152.5-155	152.5	155	0.032					183	27	65	8					
24P	24P-157.5-160	157.5	160	0.015					230	39	57	4					
24P	24P-162.5-165	162.5	165	0.026					221	45	51	4					
24P	24P-167.5-170	167.5	170	0.027					142	42	51	7					
24P	24P-172.5-175	172.5	175	0.026					211	34	58	8					
24P	24P-177.5-180	177.5	180	0.037					222	36	53	11					
24P	24P-182.5-185	182.5	185	0.03					181	45	50	5					
24P	24P-187.5-190	187.5	190	0.027					169	37	52	11					
24P	24P-192.5-195	192.5	195	0.03					189	40	52	8					
24P	24P-197.5-200	197.5	200	0.027					271	38	49	13					
24P	24P-202.5-205	202.5	205	0.04					557	40	52	8					
24P	24P-207.5-210	207.5	210	0.031					535	36	59	5					
24P	24P-212.5-215	212.5	215	0.028					236	23	61	16	9	8	59		
24P	24P-217.5-220	217.5	220	0.03					184	24	64	12					
24P	24P-222.5-225	222.5	225	0.044					180	16	69	15					
24P	24P-227.5-230	227.5	230	0.044					186	17	78	5					
24P	24P-232.5-235	232.5	235	0.043					195	21	65	14					
24P	24P-237.5-240	237.5	240	0.053					220	23	65	12					
24P	24P-242.5-245	242.5	245	0.03					249	33	62	5					
24P	24P-247.5-250	247.5	250	0.023					226	25	55	20					
24P	24P-252.5-255	252.5	255	0.039					309	23	60	17					
24P	24P-257.5-260	257.5	260	0.02					270	12	71	17					
24P	24P-262.5-265	262.5	265	0.022					171	12	69	19					
24P	24P-267.5-270	267.5	270	0.029					266	10	73	17					
24P	24P-272.5-275	272.5	275	0.043					285	14	67	19					

Appendix H
Results of Analyses by Nevada GeoTech, Inc., on Drill Cuttings
(Blanks indicate unmeasured parameters)

Well Name	Sample Number	Depth Interval (feet bgs)		Gravimetric Water Content (g/g)	Volumetric Water Content (cm ³ /cm ³)		Specific Gravity (g/cm ³)	Dry Bulk Density (g/cm ³)	Electrical Conductivity of Soil-Water Extract (µmhos/cm)	Wet Sieve (%)			Hydrometer (%)			Saturated Hydraulic Conductivity (cm/sec)
		From	To		Field Sample	Saturated Sample				Gravel	Sand	Fines	Silt	Clay	Total Sand	
24P	24P-277.5-280	277.5	280	0.06					379	6	58	36				
24P	24P-282.5-285	282.5	285	0.054					339	25	55	20				
24P	24P-287.5-290	287.5	290	0.034					275	17	58	25				
24P	24P-292.5-295	292.5	295	0.036					262	18	58	24				
24P	24P-297.5-300	297.5	300	0.039					249	19	57	24				
24P	24P-302.5-305	302.5	305	0.034					214	19	55	26				
24P	24P-307.5-310	307.5	310	0.031					180	33	53	14	7	10	55	
24P	24P-312.5-315	312.5	315	0.044					243	20	55	25				
24P	24P-317.5-320	317.5	320	0.033					231	27	58	15				
24P	24P-322.5-325	322.5	325	0.065					370	17	51	32	13	19	52	
24P	24P-327.5-330	327.5	330	0.05					262	22	51	27				
24P	24P-332.5-335	332.5	335	0.027					192	21	58	21				
24P	24P-337.5-340	337.5	340	0.034					190	22	55	23				
24P	24P-342.5-345	342.5	345	0.027					188	22	58	20				
24P	24P-347.5-350	347.5	350	0.029					196	17	59	24				
24P	24P-352.5-355	352.5	355	0.024					176	20	63	17				
24P	24P-357.5-360	357.5	360	0.026					209	24	59	17				
24P	24P-362.5-365	362.5	365	0.03					231	22	62	16				
24P	24P-367.5-370	367.5	370	0.029					198	24	63	13				
24P	24P-372.5-375	372.5	375	0.033					191	18	55	27				
24P	24P-377.5-380	377.5	380	0.031					205	17	62	21				
24P	24P-382.5-385	382.5	385	0.034					196	18	61	21				
24P	24P-387.5-390	387.5	390	0.047					201	21	53	26	14	11	51	
24P	24P-392.5-395	392.5	395	0.036					218	22	60	18				
24P	24P-397.5-400	397.5	400	0.039					208	21	60	19				

Appendix H
Results of Analyses by Nevada GeoTech, Inc., on Drill Cuttings
(Blanks indicate unmeasured parameters)

Well Name	Sample Number	Depth Interval (feet bgs)		Gravimetric Water Content (g/g)	Volumetric Water Content (cm ³ /cm ³)		Specific Gravity (g/cm ³)	Dry Bulk Density (g/cm ³)	Electrical Conductivity of Soil-Water Extract (µmhos/cm)	Wet Sieve (%)			Hydrometer (%)			Saturated Hydraulic Conductivity (cm/sec)
		From	To		Field Sample	Saturated Sample				Gravel	Sand	Fines	Silt	Clay	Total Sand	
24P	24P-405-410	405	410	0.059						Censored	Censored	Censored				
24P	24P-415-420	415	420	0.054						Censored	Censored	Censored				
27P	BCS00040451	2.5	5	0.01					328	10	76	14				
27P	BCS00040453	7.5	10	0.013					1365	42	52	6				
27P	BCS00040455	12.5	15	0.028					904	19	73	8				
27P	BCS00040457	17.5	20						369	37	56	7				
27P	BCS00040459	22.5	25	0.016					209	28	66	6	2	3	65	
27P	BCS00040461	27.5	30	0.015					262	27	61	12				
27P	BCS00040463	32.5	35	0.012					306	26	58	16				
27P	BCS00040465	37.5	40	0.016					283	30	60	10				
27P	BCS00040467	42.5	45	0.01					324	28	61	11				
27P	BCS00040469	47.5	50	0.016					341	25	62	13				
27P	BCS00040471	52.5	55	0.013					346	28	59	13				
27P	BCS00040473	57.5	60	0.013					356	27	58	15				
27P	BCS00040475	62.5	65	0.021					418	24	63	13				
27P	BCS00040477	67.5	70	0.017					332	26	61	13	5	3	55	
27P	BCS00040479	72.5	75	0.022					428	25	55	20				
27P	BCS00040481	77.5	80	0.026					419	26	51	23				
27P	BCS00040483	82.5	85	0.023					394	20	59	21	10	10	57	
27P	BCS00040485	87.5	90	0.022					363	9	67	24				
27P	BCS00040487	92.5	95	0.019					371	12	65	23				
27P	BCS00040489	97.5	100	0.018					345	20	64	16				
27P	BCS00040491	102.5	105	0.011					347	23	60	17				
27P	BCS00040493	107.5	110	0.023					334	22	59	19				
27P	BCS00040495	112.5	115	0.057					419	18	51	31				

Appendix H
 Results of Analyses by Nevada GeoTech, Inc., on Drill Cuttings
 (Blanks indicate unmeasured parameters)

Well Name	Sample Number	Depth Interval (feet bgs)		Gravimetric Water Content (g/g)	Volumetric Water Content (cm ³ /cm ³)		Specific Gravity (g/cm ³)	Dry Bulk Density (g/cm ³)	Electrical Conductivity of Soil-Water Extract (µmhos/cm)	Wet Sieve (%)			Hydrometer (%)			Saturated Hydraulic Conductivity (cm/sec)
		From	To		Field Sample	Saturated Sample				Gravel	Sand	Fines	Silt	Clay	Total Sand	
27P	BCS00040497	117.5	120	0.062					489	17	41	42	26	15	43	
27P	BCS00040499	122.5	125	0.042					640	19	57	24				
27P	BCS00040501	127.5	130	0.069					777	15	46	39				
27P	BCS00040503	132.5	135	0.087					505	15	35	50	15	24	43	
27P	BCS00040505	137.5	140	0.04					438	18	43	39				
27P	BCS00040507	142.5	145	0.034					502	20	42	38				
27P	BCS00040509	147.5	150	0.029					465	19	61	20				
27P	BCS00040511	152.5	155	0.026					561	13	48	39				
27P	BCS00040513	157.5	160	0.033					739	11	67	22	Censored	Censored		
27P	BCS00040515	162.5	165	0.058					479	10	64	26				
27P	BCS00040517	167.5	170	0.054					991	18	58	24				
27P	BCS00040519	172.5	175	0.042					992	14	55	31				
27P	BCS00040521	177.5	180	0.037					736	12	64	24				
27P	BCS00040524	185	190	0.019												
27P	BCS00040526	195	200	0.004												
27P	BCS00040528	202.5	207.5	0.017												
27P	BCS00040530	212.5	220	0.026												
27P	BCS00040532	225	230	0.032												
27P	BCS00040534	235	240	0.028												
27P	BCS00040536	245	250	0.021												
27P	BCS00040538	255	260	0.018												
27P	BCS00040540	265	270	0.014												
27P	BCS00040542	275	280	0.026												
27P	BCS00040544	285	290	0.014												
27P	BCS00040546	295	300	0.018												

**Appendix H
Results of Analyses by Nevada GeoTech, Inc., on Drill Cuttings
(Blanks indicate unmeasured parameters)**

Well Name	Sample Number	Depth Interval (feet bgs)		Gravimetric Water Content (g/g)	Volumetric Water Content (cm ³ /cm ³)		Specific Gravity (g/cm ³)	Dry Bulk Density (g/cm ³)	Electrical Conductivity of Soil-Water Extract (µmhos/cm)	Wet Sieve (%)			Hydrometer (%)			Saturated Hydraulic Conductivity (cm/sec)
		From	To		Field Sample	Saturated Sample				Gravel	Sand	Fines	Silt	Clay	Total Sand	
27P	BCS00040548	305	310	0.016												
27P	BCS00040550	315	320	0.008												
27P	BCS00040552	325	330	0.034												
27P	BCS00040554	335	340	0.033												
27P	BCS00040556	345	350	0.018												
27P	BCS00040558	355	360	0.01												
27P	BCS00040560	365	370	0.022												
27P	BCS00040562	375	380	0.018												
27P	BCS00040564	385	390													
27P	BCS00040566	395	400	0.004												
27P	BCS00040568	405	410	0.086												
27P	BCS00040570	415	420	0.007												
27P	BCS00040572	425	430	0.007												
27P	BCS00040574	435	440	0.023												
27P	BCS00040576	445	450	0.021												
27P	BCS00040578	455	460	0.017												
27P	BCS00040580	465	470	0.018												
27P	BCS00040582	475	480	0.015												
27P	BCS00040584	485	490	0.016												
27P	BCS00040586	495	500	0.02												
27P	BCS00040588	505	510	0.015												
27P	BCS00040590	515	520	0.012												
27P	BCS00040592	525	530	0.018												
27P	BCS00040594	535	540	0.022												
27P	BCS00040596	545	550	0.019												

Appendix H
 Results of Analyses by Nevada GeoTech, Inc., on Drill Cuttings
 (Blanks indicate unmeasured parameters)

Well Name	Sample Number	Depth Interval (feet bgs)		Gravimetric Water Content (g/g)	Volumetric Water Content (cm ³ /cm ³)		Specific Gravity (g/cm ³)	Dry Bulk Density (g/cm ³)	Electrical Conductivity of Soil-Water Extract (µmhos/cm)	Wet Sieve (%)			Hydrometer (%)			Saturated Hydraulic Conductivity (cm/sec)
		From	To		Field Sample	Saturated Sample				Gravel	Sand	Fines	Silt	Clay	Total Sand	
27P	BCS00040598	555	560	0.021												
27P	BCS00040600	565	570	0.022												
27P	BCS00040602	575	580	0.019												
27P	BCS00040604	585	590	0.03												
27P	BCS00040606	595	600	0.04												
28P	BCS00040901	2.5	5	0.021				502		35	46	19				
28P	BCS00040903	7.5	10	0.022				1181		31	61	8				
28P	BCS00040905	12.5	15	0.033				582		28	59	13				
28P	BCS00040907	17.5	20	0.056				392		26	58	16				
28P	BCS00040909	22.5	25	0.028				152		32	62	6				
28P	BCS00040911	27.5	30	0.031				190		31	62	7				
28P	BCS00040913	32.5	35	0.027				153		29	63	8				
28P	BCS00040915	37.5	40	0.037				225		25	57	18				
28P	BCS00040917	42.5	45	0.018				165		35	60	5				
28P	BCS00040919	47.5	50	0.029				187		28	64	8				
28P	BCS00040921	52.5	55	0.02				183		26	64	10	6	7	61	
28P	BCS00040923	57.5	60	0.026				208		34	56	10				
28P	BCS00040925	62.5	65	0.019				206		36	55	9				
28P	BCS00040927	67.5	70	0.021				196		29	61	10				
28P	BCS00040929	72.5	75	0.018				233		34	49	17				
28P	BCS00040931	77.5	80	0.036				223		32	50	18				
28P	BCS00040933	82.5	85	0.055				333		25	56	19				
28P	BCS00040935	87.5	90	0.042				353		21	60	19				
28P	BCS00040937	92.5	95	0.038				386		39	49	12				
28P	BCS00040939	97.5	100	0.036				562		10	48	42				

Appendix H
Results of Analyses by Nevada GeoTech, Inc., on Drill Cuttings
(Blanks indicate unmeasured parameters)

Well Name	Sample Number	Depth Interval (feet bgs)		Gravimetric Water Content (g/g)	Volumetric Water Content (cm ³ /cm ³)		Specific Gravity (g/cm ³)	Dry Bulk Density (g/cm ³)	Electrical Conductivity of Soil-Water Extract (µmhos/cm)	Wet Sieve (%)			Hydrometer (%)			Saturated Hydraulic Conductivity (cm/sec)
		From	To		Field Sample	Saturated Sample				Gravel	Sand	Fines	Silt	Clay	Total Sand	
28P	BCS00040941	102.5	105	0.039					584	10	42	48	26	27	39	
28P	BCS00040943	107.5	110	0.022					483	11	44	45				
28P	BCS00040945	112.5	115	0.059					424	11	55	34				
28P	BCS00040947	117.5	120	0.041					349	12	66	22	11	13	64	
28P	BCS00040949	122.5	125	0.034					345	21	63	16				
28P	BCS00040951	127.5	130	0.045					314	8	63	29				
28P	BCS00040953	132.5	135	0.041					319	20	53	27				
28P	BCS00040955	137.5	140	0.044					493	14	55	31				
28P	BCS00040957	142.5	145	0.044					626	16	58	26				
28P	BCS00040959	147.5	150	0.034					486	13	60	27	Censored	Censored	Censored	
28P	BCS00040961	152.5	155	0.035					539	20	57	23				
28P	BCS00040963	157.5	160	0.044					386	31	62	7				
28P	BCS00040965	162.5	165	0.04					456	34	52	14				
28P	BCS00040967	167.5	170	0.043					412	9	70	21				
28P	BCS00040969	172.5	175	0.054					471	13	72	15	Censored	Censored	Censored	
28P	BCS00040971	177.5	180	0.037					498	18	49	33				
28P	BCS00040973	182.5	185	0.045					406	16	55	29				
28P	BCS00040975	187.5	190	0.034					441	32	52	16				
28P	BCS00040977	192.5	195	0.035					313	31	62	7				
28P	BCS00040979	197.5	200	0.028					317	31	63	6				
28P	BCS00040981	202.5	205	0.036					437	20	68	12	9	6	68	
28P	BCS00040983	207.5	210	0.035					378	19	64	17				
28P	BCS00040985	212.5	215	0.031					355	17	57	26				
28P	BCS00040987	217.5	220	0.03					386	14	57	29				
28P	BCS00040989	222.5	225	0.032					368	21	50	29				

Appendix H
 Results of Analyses by Nevada GeoTech, Inc., on Drill Cuttings
 (Blanks indicate unmeasured parameters)

Well Name	Sample Number	Depth Interval (feet bgs)		Gravimetric Water Content (g/g)	Volumetric Water Content (cm ³ /cm ³)		Specific Gravity (g/cm ³)	Dry Bulk Density (g/cm ³)	Electrical Conductivity of Soil-Water Extract (µmhos/cm)	Wet Sieve (%)			Hydrometer (%)			Saturated Hydraulic Conductivity (cm/sec)
		From	To		Field Sample	Saturated Sample				Gravel	Sand	Fines	Silt	Clay	Total Sand	
28P	BCS00040991	227.5	230	0.045					461	18	55	27				
28P	BCS00040993	232.5	235	0.052					335	20	53	27				
28P	BCS00040995	237.5	240	0.037					253	18	60	22				
28P	BCS00040997	242.5	245	0.03												
28P	BCS00040999	247.5	250	0.025												
28P	BCS00041001	252.5	255	0.026												
28P	BCS00041003	257.5	260	0.031												
28P	BCS00041005	262.5	265	0.025												
28P	BCS00041007	267.5	270	0.024												
28P	BCS00041009	272.5	275	0.023												
28P	BCS00041011	277.5	280	0.029												
28P	BCS00041013	282.5	285	0.035												
28P	BCS00041014	285	290	0.041												
28P	BCS00041016	295	300	0.036												
28P	BCS00041018	305	310	0.023												
28P	BCS00041034	385	390	0.039												
28P	BCS00041036	395	400	0.025												
28P	BCS00041038	405	410	0.026												
28P	BCS00041020	315 ^a	320	0.022												
29P	29P-2.5-5	2.5	5	0.024					477	13	79	8				
29P	29P-7.5-10	7.5	10	0.014					1238	32	64	5				
29P	29P-12.5-15	12.5	15	0.022					742	23	64	13				
29P	29P-17.5-20	17.5	20	0.018					580	25	68	7				
29P	29P-22.5-25	22.5	25	0.015					0	5	88	6				
29P	29P-27.5-30	27.5	30	0.021					318	28	67	5				

Appendix H
Results of Analyses by Nevada GeoTech, Inc., on Drill Cuttings
(Blanks indicate unmeasured parameters)

Well Name	Sample Number	Depth Interval (feet bgs)		Gravimetric Water Content (g/g)	Volumetric Water Content (cm ³ /cm ³)		Specific Gravity (g/cm ³)	Dry Bulk Density (g/cm ³)	Electrical Conductivity of Soil-Water Extract (µmhos/cm)	Wet Sieve (%)			Hydrometer (%)			Saturated Hydraulic Conductivity (cm/sec)
		From	To		Field Sample	Saturated Sample				Gravel	Sand	Fines	Silt	Clay	Total Sand	
29P	29P-32.5-35	32.5	35	0.023					166	16	78	6				
29P	29P-37.5-40	37.5	40	0.017					131	26	70	4				
29P	29P-42.5-45	42.5	45	0.014					118	28	67	6				
29P	29P-47.5-50	47.5	50	0.016					104	29	65	7				
29P	29P-52.5-55	52.5	55	0.02					84	31	62	7				
29P	29P-57.5-60	57.5	60	0.021					88	28	62	10				
29P	29P-62.5-65	62.5	65	0.024					182	47	46	7				
29P	29P-67.5-70	67.5	70	0.027					93	28	62	10	2	6	61	
29P	29P-72.5-75	72.5	75	0.027					179	23	68	9				
29P	29P-77.5-80	77.5	80	0.018					81	32	62	6				
29P	29P-82.5-85	82.5	85	0.031					226	33	55	11				
29P	29P-87.5-90	87.5	90	0.038					174	23	66	11				
29P	29P-92.5-95	92.5	95	0.035					155	40	50	10				
29P	29P-97.5-100	97.5	100	0.044					141	15	72	13				
29P	29P-102.5-105	102.5	105	0.043					324	32	57	11				
29P	29P-107.5-110	107.5	110	0.027					134	30	59	11				
29P	29P-112.5-115	112.5	115	0.046					137	37	53	10				
29P	29P-117.5-120	117.5	120	0.023					155	42	50	8				
29P	29P-122.5-125	122.5	125	0.038					182	35	56	9				
29P	29P-127.5-130	127.5	130	0.048					125	21	63	16	4	8	66	
29P	29P-132.5-135	132.5	135	0.036					159	40	46	13				
29P	29P-137.5-140	137.5	140	0.048					142	33	53	14				
29P	29P-142.5-145	142.5	145	0.038					100	31	55	14				
29P	29P-147.5-150	147.5	150	0.043					88	33	59	8				
29P	29P-152.5-155	152.5	155	0.037					92	34	51	14				

Appendix H
Results of Analyses by Nevada GeoTech, Inc., on Drill Cuttings
(Blanks indicate unmeasured parameters)

Well Name	Sample Number	Depth Interval (feet bgs)		Gravimetric Water Content (g/g)	Volumetric Water Content (cm ³ /cm ³)		Specific Gravity (g/cm ³)	Dry Bulk Density (g/cm ³)	Electrical Conductivity of Soil-Water Extract (µmhos/cm)	Wet Sieve (%)			Hydrometer (%)			Saturated Hydraulic Conductivity (cm/sec)
		From	To		Field Sample	Saturated Sample				Gravel	Sand	Fines	Silt	Clay	Total Sand	
29P	29P-157.5-160	157.5	160	0.034					87	34	55	11				
29P	29P-162.5-165	162.5	165	0.033					138	27	54	19	Censored	Censored		
29P	29P-167.5-170	167.5	170	0.043					99	32	57	11				
29P	29P-172.5-175	172.5	175	0.045					73	28	60	12				
29P	29P-177.5-180	177.5	180	0.038					87	43	47	10				
29P	29P-182.5-185	182.5	185	0.039					92	31	50	19	Censored	Censored		
29P	29P-187.5-190	187.5	190	0.037					76	31	55	14				
29P	29P-192.5-195	192.5	195	0.026					120	28	59	13				
29P	29P-197.5-200	197.5	200	0.036					68	37	52	10				
29P	29P-202.5-205	202.5	205	0.033					91	26	59	15				
29P	29P-207.5-210	207.5	210	0.067					150	31	54	15				
29P	29P-212.5-215	212.5	215	0.052					77	38	52	10				
29P	29P-217.5-220	217.5	220	0.077					66	37	56	7				
29P	29P-222.5-225	222.5	225	0.029					125	26	59	14				
29P	29P-227.5-230	227.5	230	0.045					91	36	56	8				
29P	29P-232.5-235	232.5	235	0.062					83	30	62	7	Censored	Censored		
29P	29P-237.5-240	237.5	240	0.047					86	26	56	18				
29P	29P-242.5-245	242.5	245	0.05					73	38	51	11				
29P	29P-247.5-250	247.5	250	0.069					87	34	51	15				
29P	29P-252.5-255	252.5	255	0.057					126	38	50	12				
29P	29P-257.5-260	257.5	260	0.05					66	47	43	10				
29P	29P-262.5-265	262.5	265	0.046					207	32	58	10				
29P	29P-267.5-270	267.5	270	0.044					86	26	57	16				
29P	29P-272.5-275	272.5	275	0.018					98	36	51	13				
29P	29P-277.5-280	277.5	280	0.03					68	35	48	17				

Appendix H
 Results of Analyses by Nevada GeoTech, Inc., on Drill Cuttings
 (Blanks indicate unmeasured parameters)

Well Name	Sample Number	Depth Interval (feet bgs)		Gravimetric Water Content (g/g)	Volumetric Water Content (cm ³ /cm ³)		Specific Gravity (g/cm ³)	Dry Bulk Density (g/cm ³)	Electrical Conductivity of Soil-Water Extract (µmhos/cm)	Wet Sieve (%)				Hydrometer (%)			Saturated Hydraulic Conductivity (cm/sec)
		From	To		Field Sample	Saturated Sample				Gravel	Sand	Fines	Silt	Clay	Total Sand		
29P	29P-282.5-285	282.5	285	0.06					132	38	42	19	7	8	62		
29P	29P-287.5-290	287.5	290	0.049					103	40	47	13					
29P	29P-292.5-295	292.5	295	0.101					128	35	54	11					
29P	29P-297.5-300	297.5	300	0.085					162	33	53	14					
29P	29P-302.5-305	302.5	305	0.061					166	27	59	15					
29P	29P-307.5-310	307.5	310	0.057					171	25	60	15					
29P	29P-312.5-315	312.5	315	0.066					284	37	50	14					
29P	29P-317.5-320	317.5	320	0.094					291	39	46	15					
29P	29P-325-330	325	330	0.078													
29P	29P-335-340	335	340	0.073													
29P	29P-345-350	345	350	0.054													
29P	29P-355-360	355	360	0.046													

^aWet sample - 320 - 380 feet due to injection water.

APPENDIX I

**APPENDIX I
SUMMARY LITHOLOGIC LOGS**

Summary Lithologic Log for Borehole 27P

NWRPPO-2004-04

Nye County Early Warning Drilling Program Phase IV Drilling Report

Depth	LITHOLOGY	DESCRIPTION
0		(0 to 45 feet [ft]) WELL-GRADED SAND WITH SILT, CLAY AND GRAVEL (SW-SM/SC) The interval consists almost totally of layers of well-graded sand with silt, clay and gravel (SW-SM/SC). Fines display no plasticity. Gravel clasts are volcanic in origin, with grain shape predominantly subrounded and locally subangular. Sediment colors range from predominantly reddish gray (5YR 5/2) to yellowish brown (10YR 5/4). No cementation is observed. Sediments react strongly to 10 percent (%) hydrochloric acid (HCl). All samples are dry.
100		(45 to 182.5 ft) SILTY, CLAYEY SAND WITH GRAVEL (SM/SC) The interval consists primarily of layers of silty, clayey sand with gravel (SM/SC). A layer of sandy clay with gravel (CL) occurs from 132.5 to 135 ft. Fines display no plasticity from 45 to 170 ft, and no to moderate plasticity from 170 to 182.5 ft. Gravel clasts are volcanic in origin and predominantly rounded. A zone of subrounded to subangular gravel clasts is observed from 50 to 57.5 ft. Sediment colors range from predominantly yellowish red (5YR 5/6) to reddish brown (5YR 5/4), reddish gray (5YR 5/2), dark grayish brown (10YR 4/2), and yellowish brown (10YR 5/4). No cementation is observed. Sediments react strongly to 10% HCl. Samples are dry from 45 to 160 and 175 to 180 ft, moist from 170 to 175 and 180 to 182.5 ft, and wet from 160 to 170 ft.
200		(182.5 to 202.5 ft) ASH-FALL TUFF (RAINIER MESA TUFF) The tuff is moderate orange pink (5YR 8/4), nonwelded, and vitric with an open/porous matrix. The unit appears slightly weathered throughout the interval. The upper section from 182.5 to 195 ft may be intercalated with alluvium. The tuff contains 40 to 50% light brown (5YR 5/6) glassy pumice clasts up to 12 millimeters (mm) in diameter, 2% grayish brown (5YR 3/2) lithic clasts up to 3 mm in diameter, 5% very light gray (N8) quartz phenocrysts up to 3 mm in long, 5% pale greenish yellow (5Y 8/1) feldspar phenocrysts up to 3 mm long, and 2 to 4% black (N1) biotite phenocrysts up to 2 mm long. The tuff unit is an unconsolidated, ash-rich air fall that may be a pre-Rainier Mesa tuff unit. The base lies in sharp contact with the underlying ash-flow tuff.
300		(202.5 to 355 ft) ASH-FLOW TUFF (TIVA CANYON TUFF) Tuff colors range from grayish brown (5YR 3/2) to medium gray (N5) to dark yellowish orange (10YR 6/6). The tuff is nonwelded to densely welded and devitrified. The tuff is slightly weathered from 202.5 to 212.5 ft. The matrix is dense/nonporous, except for the nonwelded base from 350 to 355 ft, which has an open/porous matrix. Three zones are distinguished and defined by the degree of welding and devitrification. The color changes correspond closely with the zones, which are as follows: 202.5 to 339 ft (LOWER NONLITHOPHYSAL ZONE): The zone is grayish brown (5YR 3/2), weakly to moderately welded, and devitrified. The zone contains 0 to 1% light gray (N7) pumice clasts up to 2 mm in diameter, up to 5% light gray (N7) lithic clasts up to 2 mm in diameter, up to 2% colorless quartz phenocrysts up to 2 mm in diameter, decreasing with depth, up to 3% colorless and light gray (N3) feldspar phenocrysts, predominantly sanidine, and 1 to 3% mafic minerals, mostly altered bronze biotite. The base of the zone from 325 to 339 ft is spherulitic and grades into the underlying densely welded vitrophyre. 339 to 349 ft (BASAL VITROPHYRE): The zone is medium gray (N5), densely welded, vitric, and displays perlitic textures. The unit contains 1% medium light gray (N6) feldspar. No pumice or lithic fragments are observed. A thin, blackish-brown clay zone is present from 348.5 to 349 ft. 349 to 355 ft (NONWELDED BASAL ZONE): The zone is dark yellowish orange (10YR 6/6), nonwelded, and devitrified. The unit is crystal- and fragment-poor, has a devitrified, ashy matrix, and contains "root beer bottle" glass shards. This zone lies in sharp contact with the underlying ash-fall tuff.
400		(355 to 400 ft) ASH-FALL TUFF (PRE-TIVA CANYON TUFF) The tuff is dark yellowish orange (10YR 6/6) from 355 to 375 ft and dusky yellow (5Y 6/4) from 375 to 400 ft. The unit is nonwelded and vitric with an open/porous matrix. The upper section from 355 to 375 ft is pumice-rich and contains 50% light yellowish gray (5Y 8/1) pumice clasts up to 20 mm in diameter. At 375 ft, pumice content and size decrease to 10% and 3 mm in diameter, respectively. The unit contains 1 to 3% light gray (N6) lithic clasts in the upper pumiceous section, up to 2% quartz phenocrysts up to 2 mm in diameter, some opalescent, 1 to 3% greenish gray (5GY 5/1) mafic minerals, and up to 2% colorless feldspar phenocrysts. Lithics become highly variable in color below 375 ft. This unit lies in sharp contact with the underlying ash-flow tuff.
500		(400 to 1,180 ft) ASH-FLOW TUFF (TOPOPAH SPRING TUFF) Six zones are identified in this unit and defined primarily by degree of vapor-phase alteration, degree of devitrification, and presence or absence of lithophysae. The matrix is dense/nonporous, except for the interval from 400 to 415 ft, which has an open/porous matrix. Samples are wet beyond 600 ft. Individual zones and colors are described below. 400 to 600 ft (UPPER NONLITHOPHYSAL ZONE): The zone color is variable and appears to be related to the degree of welding in the rock. Colors vary from light brownish gray (5YR 6/1) in the nonwelded top from 400 to 415 ft, to brownish gray (5YR 4/1) in the weakly and moderately welded section from 415 to 470 ft, to moderate brown (5YR 4/4) in the densely welded section from 470 to 600 ft. The zone is devitrified, except at 470 and 495 ft, where minor vapor-phase alteration is present. At 465 ft, calcite coatings appear on cooling joint faces. Pumice is largely absent except at 465 ft, where a few clasts appear that also contain trace biotite. There are 1 to 2% black (N1) and grayish black (N2) lithics from 400 to 500 ft. At 465 ft, pink reaction halos surround the lithic clasts. No lithic clasts are observed below 500 ft. The zone is crystal-poor, with 1% feldspar phenocrysts, trace quartz phenocrysts, and 1% mafics from 470 to 535 ft. 600 to 665 ft (UPPER LITHOPHYSAL ZONE): The zone colors range from moderate brown (5YR 4/4) to grayish red (10R 4/2) to pale brown (5YR 5/2) and contain 15 to 20% light gray (N8) to pinkish gray (10R 8/2) vapor-phase alteration as spots and rims on lithophysae. Lithophysae content varies from 10 to 15% throughout most the interval and decreases to 5% near the base, and are typically less than 10 mm long in drill cuttings. The zone is densely welded, contains no pumice or lithics, and is crystal-poor, with 1% quartz, 1% sanidine feldspar, and no mafics. A few sanidine phenocrysts are enveloped by vapor-phase mineralization. The lower contact is gradational with the underlying nonlithophysal zone. 665 to 740 ft (MIDDLE NONLITHOPHYSAL ZONE): The zone is pale brown (5YR 5/2), densely welded, and devitrified. Some clasts display spherulitic texture. Vapor-phase alteration and lithophysae are rare to absent. The zone contains no pumice, no lithics, and is crystal-poor, with 1% quartz, 1% mafics, and 1% feldspar. Fractures are typically smooth and planar and a few have a thin, 1-mm calcite coating. The lower contact is sharp with the underlying lithophysal zone. 740 to 1,015 ft (LOWER LITHOPHYSAL ZONE): The zone is mottled moderate brown (5YR 3/4), yellowish brown (10YR 5/2) and densely welded. Vapor-phase alteration comprises 20% of the zone and is present as very light gray (N7) to pale grayish red (10R 6/1) spots, streaks, veinlets, fracture surfaces, and lithophysal cavity coatings. Lithophysae comprise less than 5% of the zone and are elongate, with major axes typically less than 10 mm in drill cuttings. During borehole advancement in this zone, the driller reported numerous cavities up to 2 ft wide. Pumice is absent and small lithic clasts less than 5 mm long comprise less than 1% of the rock and have black (N1), glassy textures. Very light gray (N7) reaction rims surround a few lithic clasts and extend into the matrix 3 to 5 mm. The zone is crystal-poor with 1% anhedral quartz, rare biotite, and 1% feldspar. Euhedral sanidine is the predominant feldspar and is less than 3 mm long. Fractures are smooth and planar. The lower contact of the zone is gradational with the underlying nonlithophysal zone. 1,015 to 1,062 ft (LOWER NONLITHOPHYSAL ZONE): The zone grades downward from moderate brown (5YR 3/4) to a mottled light brown (5YR 5/6) and grayish brown (5YR 3/2) below 1,045 ft. The tuff is densely welded and devitrified. A remnant shard texture occurs throughout and is best preserved in the upper section where mottling has not obscured it. Vapor-phase mineralization is present in minor amounts and occurs as very thin, less than 1 mm veinlets and small, diffuse blebs. The rock tends to break along the veinlets. Pumice and lithic clasts are absent. Phenocrysts comprise 1% of the rock and consist of sanidine feldspar and quartz. Fractures are rough and irregular. The lower contact is sharp with the underlying zone. 1,062 to 1,180 ft (BASAL VITROPHYRE): Three subunits are distinguished in this zone and defined by degree of welding and devitrification. From 1,062 to 1,082 ft, the rock is composed of densely welded, dark gray (N3) and black (N1) glass. From 1,082 to 1,142 ft the rock is devitrified, moderate brown (5YR 3/4), and moderately welded. Devitrified, moderate orange pink (10R 7/4) pumice clasts begin appearing in this middle subunit, which contains up to 10% lithics composed of devitrified, crystal-poor volcanic clasts that are medium dark gray (N4) from 1,082 to 1,100 ft and varied in color from 1,100 to 1,142 ft. From 1,142 to 1,180 ft, the rock is devitrified, light brown (5YR 6/4), and nonwelded. Pumice clasts are undeformed in this lower subunit. Phenocrysts were observed only from 1,075 to 1,080 ft, where trace sanidine and rare biotite phenocrysts occur. The rock breaks along smooth irregular fractures, a few of which have thin coatings of pale-blue vapor-phase mineralization. The lower contact is sharp with the underlying ash-flow tuff.
1200		(1,180 to 1,355 ft) REWORKED ASH-FLOW TUFF, VOLCANICLASTIC SANDSTONE, AND ASH-FLOW TUFF (PRE-TOPOPAH SPRING BEDDED TUFF) The formation is light brown (5YR 6/4, 5/6) and becomes orange pink (5YR 8/4) and pale orange (10YR 8/3) below 1,315 ft. Volcanic units are nonwelded, with an open/porous matrix. The formation is comprised of three units: an upper, reworked ash-flow sequence from 1,180 to 1,265 ft; a middle, immature volcaniclastic conglomeratic sandstone from 1,265 to 1,315 ft that grades downward into volcaniclastic sandstone from 1,315 to 1,325 ft; and an altered, basal, reworked ash-flow tuff from 1,325 to 1,355 ft. The formation is highly weathered and the ashy matrix material is argillic and poorly recovered. The upper units from 1,180 to 1,325 ft are compositionally related and represent volcaniclastic reworking of a felsic pumice- and

Summary Lithologic Log for Borehole 27P
Appendix I-1

July 2005

Appendix I

Summary Lithologic Log for Borehole 27P

NWRPO-2004-04



Summary Lithologic Log for Borehole 16P

NWRPPO-2004-04

Nye County Early Warning Drilling Program Phase IV Drilling Report

Depth ft. 1000'	LITHOLOGY	DESCRIPTION
0		(0-166 feet [ft]) SILTY, CLAYEY SAND WITH GRAVEL (SM/SC). The interval consists primarily of layers of silty, clayey sand with gravel (SM/SC) with a layer of sandy clay (CL) from 67.5 to 75 ft. Fines typically display no plasticity. Gravel clasts are volcanic in origin and subangular to angular from 0 to 5 ft, and rounded to subrounded from 5 to 166 ft. Sediment color is predominantly yellowish brown (10YR 5/4) to reddish brown (5YR 4/4), very dark gray (N3), dark gray (N4), and dark grayish brown (10YR 4/2). No cementation is observed. Sediments react strongly with 10 percent (%) hydrochloric acid (HCl). All samples are dry.
200		(166 to 395 ft) ASH-FLOW TUFF (PRE-AMMONIA TANKS TUFF). The tuff is light brown (5YR 5/6) from 166 to 240 ft, dark yellowish orange (10YR 6/6) from 240 to 360 ft, and moderate orange pink (5YR 8/4) from 360 to 395 ft. The tuff is nonwelded, devitrified, and has an open/porous matrix. The unit is moderately weathered from 166 to 200 ft, slightly weathered from 200 to 240 ft, unweathered from 240 to 300 ft, and slightly weathered from 300 ft to 395 ft. The tuff contains 0 to 3% white (N9), orange pink (5YR 8/4), and pale orange (10YR 8/2) pumice clasts up to 20 millimeters (mm) in diameter with a pumice-rich (i.e., up to 50% pumice) zone from 360 to 370 ft and 1 to 5% reddish brown (10R 3/4) and dusky yellowish brown (10YR 2/2) lithic clasts up to 12 mm in diameter from 165 to 300 ft. The tuff is lithic-rich from 300 to 360 ft, with 5 to 20% variably colored clasts, mostly dusky yellowish brown (10YR 2/2), probably Paintbrush Tuff, up to 20 mm in diameter and up to 3% variably colored lithic clasts up to 10 mm in diameter from 360 to 395 ft. The tuff is phenocryst-poor with up to 1% colorless sanidine, including chatoyant sanidine, up to 3 mm long, up to 1% colorless quartz up to 3 mm in diameter. The interval from 200 to 300 ft contains 1% black and bronze biotite up to 3 mm long. A weak reaction to 10% HCl is observed in the first 5 feet of the unit. All samples are dry. The lower contact is gradational with the underlying ash-flow tuff.
400		(395 to 720 ft) ASH-FLOW TUFF (RAINIER MESA TUFF). The tuff is light brownish gray (5YR 6/1) from 395 to 535 ft and medium light gray to very light gray (N6 to N8) below 535 ft. The tuff is nonwelded, devitrified, and has an open/porous matrix. The upper 5 ft from 395 to 400 ft is argillic and highly weathered, otherwise, the tuff is unweathered. The tuff contains up to 10% light brownish gray (5YR 6/1) to very pale orange (10YR 8/2) to medium light gray (N6) and very light gray (N8) angular and partially vitric pumice up to 12 mm in diameter, and 1 to 5% predominantly moderate brown (5YR 3/4) to grayish black (N2) lithic clasts up to 20 mm long. The unit is phenocryst-poor and has less than 2% feldspar, 1% quartz, and rare biotite. Samples show no reaction to 10% HCl. Moisture is noted from 405 to 410 and 480 to 495 ft. All samples are wet after 535 ft. The base of the unit is in sharp contact with the underlying ash-flow tuff.
800		(720 to 876 ft) ASH-FLOW TUFF (RAINIER MESA TUFF). The tuff unit is composed of 3 subunits. Overall, the tuff is moderately weathered from 720 to 760 ft, highly weathered from 760 to 780 ft, moderately to slightly weathered from 780 to 795 ft, and fresh below 795 ft. The upper subunit from 720 to 762 ft is dark yellowish brown (10YR 2/2) to light brown (5YR 5/6) and nonwelded with an open/porous, altered matrix. Pumice clasts are replaced by cryptocrystalline silica. The upper subunit also contains 20% light brownish gray (5YR 6/1) pumice up to 20 mm in diameter, up to 5% variably colored lithic clasts up to 3 mm in diameter, 1% feldspar phenocrysts up to 2 mm long, 1% quartz phenocrysts up to 3 mm in diameter, and no mafic minerals. The middle subunit from 762 to 780 ft is pale reddish brown (10R 5/4) and consists of a clayey, matrix-supported, crystal ash tuff with no observed pumice or lithic clasts. It contains 15 to 20% feldspar phenocrysts up to 5 mm long and 15 to 20% quartz phenocrysts up to 2 mm in diameter. The matrix is intensely clay altered or argillized, and this subunit may represent a paleosol horizon. The lower subunit from 780 to 876 ft is a pale yellowish brown (10YR 6/2), homogeneous, nonwelded, devitrified, pumiceous tuff, with most of the pumice and lithic clasts completely to partially weathered out, imparting the tuff with a distinctive porous texture. This subunit also has an open, porous matrix. The lower section is phenocryst-poor, with no observed feldspar, 1% quartz phenocrysts, and rare mafics. Samples show no reaction to 10% HCl. The lower contact is sharp with the underlying ash-flow tuff.
900		(876 to 1,065 ft) ASH-FLOW TUFF (TIVA CANYON TUFF). The tuff color ranges from grayish brown (5YR 3/2) to moderate brown (5YR 3/4). Color changes correspond approximately with changes in the degree of welding and the presence or absence of vapor-phase alteration. The tuff unit has a dense/non-porous matrix and a generally fresh and unweathered appearance. The zones are as follows: 876 to 900 ft (UPPER LITHOPHYCAL ZONE): The zone is grayish brown (5YR 3/2), moderately welded, vapor-phase altered, and crystal-poor. The zone contains 1% predominantly sanidine feldspar phenocrysts, rare quartz phenocrysts, 1% bronze biotite, and rare very pale orange (10YR 8/2) pumice clasts up to 4 mm in diameter. Vapor-phase mineralization fills lithophysal cavities and coats grain surfaces. 900 to 1,000 ft (MIDDLE NONLITHOPHYCAL ZONE): The zone is olive gray (5Y 4/1) to moderate brown (5YR 3/4), densely welded, devitrified, and crystal-poor. The zone contains 1% feldspar phenocrysts, rare quartz phenocrysts, and trace mafic minerals, rare medium light gray (N6) lithic clasts that are less than 4 mm in diameter, and no observed pumice clasts. 1,000 to 1,020 ft (LOWER LITHOPHYCAL ZONE): The zone is moderate brown (5YR 3/4), densely welded, vapor-phase altered, and crystal-poor. The zone contains 1% feldspar phenocrysts, rare medium light gray (N6) pumice clasts up to 20 mm in diameter, no observed quartz phenocrysts or mafic minerals, and no observed lithic clasts. Vapor-phase alteration occurs as thick grain coatings. Lithophysae are poorly developed. 1,020 to 1,045 ft (BASAL VITROPHYRE): The zone is moderate brown (5YR 3/4), densely welded, and vitric with spherulitic texture below 1,026 ft. Phenocrysts are rare and pumice clasts are vitric. The contact between the overlying devitrified zone and this vitric zone is gradational with the matrix becoming more vitric with depth. This lower vitric zone is poorly developed. The dark translucent glass typical of vitrophyres is altered and appears to be incipiently devitrified.
1100		1,045 to 1,065 ft (NONWELDED BASAL ZONE): The zone is moderate brown (5YR 3/4), nonwelded, devitrified, and crystal-poor, with rare feldspar phenocrysts, no observed quartz phenocrysts, and no mafic minerals. The lower interval in this zone is similar in texture and color to the nonwelded basal zone at 27P from 349 to 355 ft, but lacks the well-developed glass shards. The lower contact is sharp with the underlying ash-fall tuff.
1200		(1,065 to 1,080 ft) ASH-FALL TUFF (PRE-TIVA CANYON TUFF). The tuff is moderate yellowish brown (10YR 5/4), nonwelded, vitric, weathered, and has an open/porous matrix. The tuff contains up to 30% yellowish gray (5Y 7/2) to moderate orange pink (5YR 8/4) pumice clasts less than 3 mm in diameter, 1% dusky brown (5YR 2/2) angular lithic clasts 5 to 10 mm long, and 1% sanidine feldspar. Quartz phenocrysts and mafic minerals are not observed. The rock is in sharp contact with the underlying ash-flow tuff.
1300		(1,080 to 1,810 ft) ASH-FLOW TUFF (TOPOPAH SPRING TUFF). The tuff color is variable and related to changes in the degree of welding and presence or absence of vapor-phase alteration. The degree of welding and vapor-phase alteration defines each subzone. The unit is predominantly devitrified, with zones of intense vapor-phase alteration. The matrix is dense, and nonporous except in the nonwelded zones. The zones are as follows: 1,080 to 1,085 ft (UPPER NONWELDED ZONE): The zone is moderate yellowish brown (10YR 5/4), nonwelded, pumice-rich with 10% altered, white (N9) pumice clasts, and lithic-poor with 1% multi-colored lithic clasts. 1,085 to 1,115 ft (CAPROCK ZONE): The zone is composed of dark reddish brown (10R 3/4), densely welded, and devitrified glass and contains 30% white (N9) to moderate orange pink (10R 7/4) pumice clasts less than 3 mm long, 15 to 20% feldspar phenocrysts up to 2 mm long, 15 to 20% quartz phenocrysts, and sparse biotite. 1,115 to 1,175 ft (UPPER NONLITHOPHYCAL ZONE): The zone is pale brown (5YR 5/2) in the upper section and grades downward to light brown (5YR 5/6) below 1,150 ft. Welding increases with depth from weak to moderate at 1,150 ft to dense at 1,155 ft. The upper section from 1,115 to 1,150 ft is crystal- and pumice-poor, the lower section from 1,150 to 1,175 ft is crystal-rich with 5% feldspar phenocrysts up to 2 mm long and 2% quartz phenocrysts up to 2 mm in diameter. 1,175 to 1,330 ft (UPPER LITHOPHYCAL ZONE): The zone is light brown (5YR 5/6), moderate to densely welded, and devitrified. Lithics and pumice are absent, except in the lower part of the interval from 1,300 to 1,330 ft, which contains 1% moderate brown (5YR 3/4) lithic clasts up to 5 mm in diameter. The zone is crystal-poor, with less than 2% combined feldspar and quartz phenocrysts. The zone is intensely vapor-phase altered. Vapor-phase mineralization coats cavities, alters pumice clasts, and extends outward into the groundmass. Lithophysae are not observed in drill cuttings. 1,330 to 1,400 ft (MIDDLE NONLITHOPHYCAL ZONE): The zone is grayish orange pink (5YR 7/2), moderately to densely welded, and crystal-poor. There is little to no pumice present and vapor-phase alteration is absent to minor (i.e., less than 1%). 1,400 to 1,595 ft (LOWER LITHOPHYCAL ZONE): The zone is mottled moderate brown (5YR 4/4) and medium gray (N5), moderately to densely welded, and crystal-poor. The interval is intensely vapor-phase altered. The tuff contains rare altered pumice the same color as the matrix, rare medium gray (N5) angular lithic clasts up to 4 mm long, a few of which are glassy, 1% feldspar phenocrysts with sanidine predominating, and 1% quartz phenocrysts from 1,400 to 1,440 ft. Quartz phenocryst are absent below 1,440 ft. Lithophysae are absent; the zone is defined by the presence of intense vapor-phase alteration similar to that noted in the upper lithophysal zone. 1,595 to 1,723 ft (LOWER NONLITHOPHYCAL ZONE): The zone is mottled moderate brown (5YR 4/4) and light brown (5YR 4/6), moderate to densely welded, and crystal-poor. The zone contains rare grayish black (N2) to brownish black (5YR 2/1) lithic clasts up to 6 mm long, less than 1% feldspar phenocrysts, rare quartz phenocrysts, and no observed pumice or mafic minerals. Vapor-phase alteration is present as grain coatings, but lithophysae are not observed. The contact between the lower lithophysal and lower nonlithophysal zones is gradational and based principally on the style of alteration of the groundmass. Below the contact, the matrix appears to be finer grained or massive. 1,723 to 1,773 ft (BASAL VITROPHYRE): The zone alternates between black (N1) and moderate brown (5YR 5/6) and is densely welded and predominantly vitric, with subordinate incipient devitrified zones. The zone is aphanitic, with no observed pumice fragments, phenocrysts, or lithic fragments. Devitrified zones are partially argillically altered and possibly zeolitized. The highest degree of vitrification occurs in the middle of the zone from 1,755 to 1,760 ft.

Summary Lithologic Log for Borehole 16P
Appendix I-2

July 2005

Appendix I

Summary Lithologic Log for Borehole 16P

NWRPO-2004-04

Nye County Early Warning Drilling Program Phase IV Drilling Report

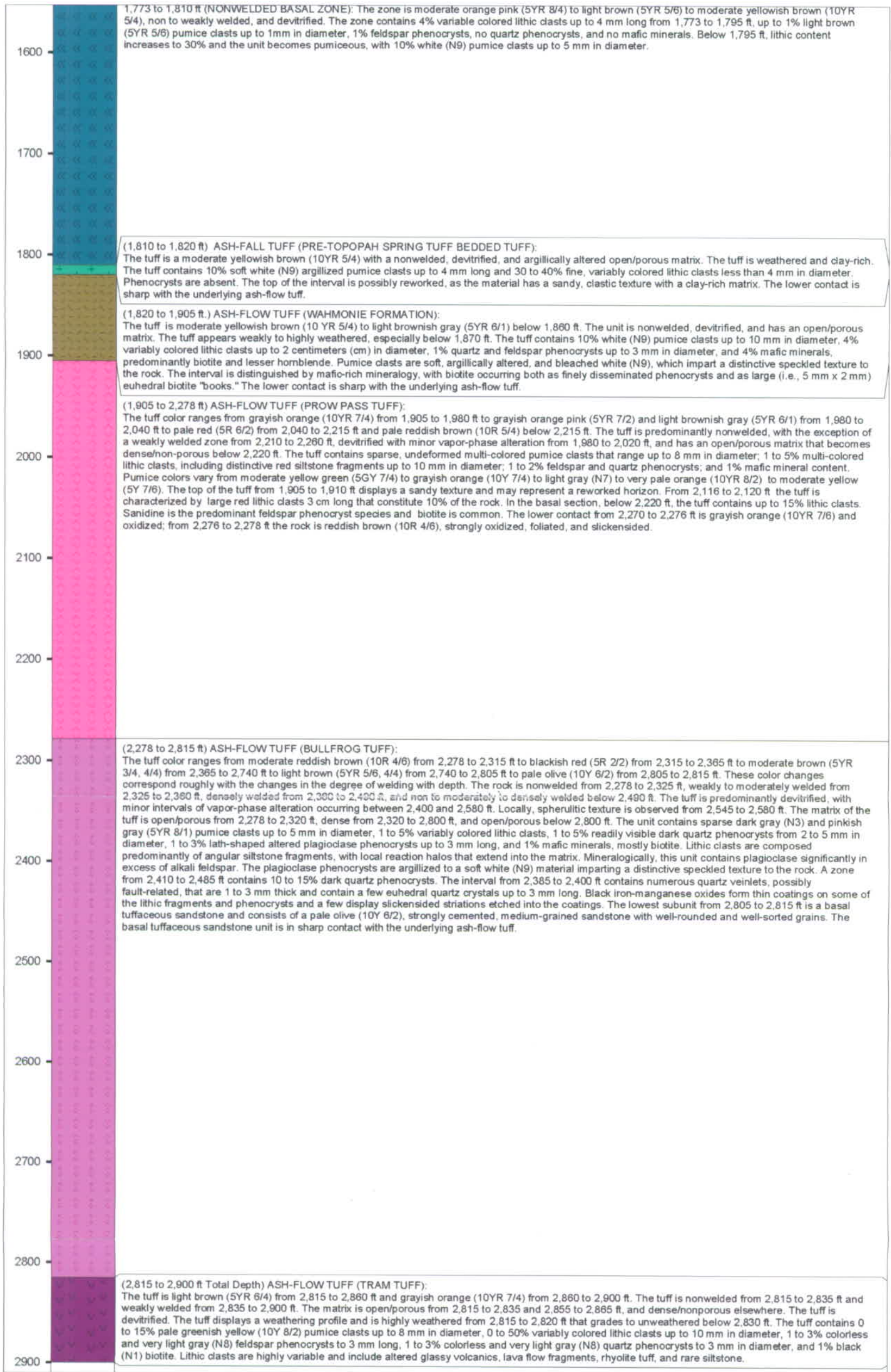

Summary Lithologic Log for Borehole 16P
Appendix I-2

July 2005

Appendix I

Summary Lithologic Log for Borehole 28P

NWR/PC-2004-04

Nye County Early Warning Drilling Program Phase IV Drilling Report

Depth in feet	LITHOLOGY	DESCRIPTION
0		<p>(0 to 45 feet [ft]) INTERBEDDED WELL-GRADED SAND WITH SILT, CLAY AND GRAVEL (SW-SM/SC) AND SILTY, CLAYEY SAND WITH GRAVEL (SM/SC) The interval consists of layers of well-graded sand with silt, clay and gravel (SW-SM/SC) up to 12.5 ft thick interbedded with layers of silty, clayey sand with gravel (SM/SC) up to 7.5 ft thick. A thin layer of well-graded sand with gravel (SW) occurs from 42.5 to 45 ft. Fines display no plasticity. Gravel clasts are volcanic in origin, subangular from 0 to 17.5 ft, and subrounded from 17.5 to 45 ft. Sediment color is reddish brown (5YR 4/4). No cementation is observed. Sediments react strongly to 10 percent (%) hydrochloric acid (HCl). Samples are dry from 0 to 12.5 and 20 to 45 ft, and moist from 12.5 to 20 ft.</p>
100		<p>(45 to 70 ft) WELL-GRADED SAND WITH SILT, CLAY AND GRAVEL (SW-SM/SC): The interval consists primarily of layers of well-graded sand with silt, clay and gravel (SW-SM/SC). Fines display no plasticity. Gravel clasts are volcanic in origin and subrounded to subangular. Sediment color is reddish brown (5YR 4/4). No cementation is observed. Sediments react strongly with 10% HCl. All samples are dry.</p> <p>(70 to 240 ft) SILTY, CLAYEY SAND WITH GRAVEL (SM/SC): The interval consists primarily of silty, clayey sand with gravel (SM/SC). A uniform layer of silty, clayey sand without gravel (SM/SC) occurs from 97.5 to 117.5 ft. Fines display no to high plasticity. Gravel clasts are volcanic in origin and typically rounded to subangular. Sediment colors range from predominantly reddish brown (5YR 4/4) to yellowish red (5YR 5/6), light reddish brown (5YR 6/4), yellowish brown (10YR 5/4), dark grayish brown (10YR 4/2), very pale brown (10YR 7/4), and light brownish gray (10YR 6/2). No cementation is observed. Sediments typically react strongly to 10% HCl; however, a zone of weak reaction to 10% HCl is observed from 232.5 to 237.5 ft. All samples are dry.</p>
200		
300		<p>(240 to 405 ft) ASH-FLOW TUFF (AMMONIA TANKS TUFF) The tuff colors are highly variable and range from pale yellowish brown (10YR 6/2) to grayish orange (10YR 7/4), very pale orange (10YR 8/2), light gray (N7), light brownish gray (5YR 6/1), pinkish gray (5YR 8/1), and pale yellowish brown (10YR 6/2). The tuff is non to weakly welded, displays vitric textures from 240 to 300 ft, and is devitrified from 300 to 405 ft. The tuff has an open/porous matrix and contains 5 to 10% pinkish gray (5YR 8/1) and light gray (N8) pumice clasts up to 1 centimeter (cm) in diameter, 1% dark grayish red (10R 3/4) lithic clasts up to 1 cm in diameter from 240 to 300 ft, and no observed lithic clasts from 300 to 405 ft. The unit also contains 15 to 20% feldspar phenocrysts up to 0.5 millimeter (mm) long, with sanidine predominating, including chatoyant sanidine, 5% quartz phenocrysts up to 0.5 mm in diameter, a few displaying bipyramidal crystal habits, and up to 1% mafic minerals up to 1 mm long. Most samples display a weak reaction to 10% HCl. Samples are wet from 320 to 380 ft, due to injection water, and moist from 380 to 405 ft. Below 405 ft, all samples are wet. The unit lies in sharp contact with a possible paleosol developed on the underlying tuff.</p>
400		
500		<p>(405 to 660 ft) ASH-FLOW TUFF (POST-RAINIER MESA TUFF) The tuff is predominantly light brown (5YR 6/4) to moderate reddish orange (10R 6/6), displays nonwelded textures, is vitric from 405 to 500 ft, and is devitrified from 500 to 660 ft. The tuff has an open/porous matrix and contains 20 to 30% grayish orange pink (10R 8/2) and yellowish gray (5Y 8/1) pumice clasts 2 to 5 mm in diameter, 15% moderate brown (5YR 3/4) to moderate reddish brown (10R 4/6) to dark reddish brown (10R 3/4) lithic fragments 2 to 5 mm in diameter, 15 to 20% feldspar phenocrysts, predominantly sanidine, up to 0.5 mm long, less than 5% quartz phenocrysts up to 0.5 mm in diameter, and 1% mafic minerals up to 0.5 mm long. Samples display a weak reaction to 10% HCl from 405 to 420, 500 to 580, and 610 to 630 ft. Several dark yellowish orange (10YR 6/6) and moderate reddish orange (10R 6/6) horizons are present at 405 to 415, 575 to 590, and 630 to 645 ft, which appear weathered and oxidized, display well-sorted clasts, have some clay alteration especially from 575 to 590 ft, and could represent paleosols. The unit contains large, grayish black (N2) lithic clasts up to 2 cm in diameter from 600 to 625 ft. The unit lies in sharp contact with a possible paleosol developed in the underlying tuff.</p>
600		
700		<p>(660 to 765 ft) ASH-FLOW TUFF (RAINIER MESA TUFF) The tuff is grayish red (10R 4/2) to grayish orange pink (5YR 7/2), and light brownish gray (5YR 6/1), and is nonwelded and devitrified. The tuff has an open/porous matrix and contains 1% yellowish gray (5Y 8/1) pumice clasts up to 2 mm in diameter, less than 2% grayish black (N2) lithic fragments up to 2 mm in diameter, 15 to 30% feldspar phenocrysts, predominantly sanidine, up to 2 mm long that decrease to 3% at the base from 720 to 765 ft, 5% quartz up to 1 mm in diameter that includes bipyramidal quartz, and 1% mafic minerals. No reaction to 10% HCl is observed. The top of the unit from 660 to 665 ft contains a possible paleosol that is clayey and grayish red (10R 4/2). A well-sorted pumice fallout is present from 690 to 700 ft, with 50 to 60% pumice. The unit lies in sharp contact with a possible paleosol in the underlying ash-flow tuff.</p>
800		
900		<p>(765 to 920 ft) ASH-FLOW TUFF (POST-TIVA CANYON TUFF) The tuff is very pale orange (10YR 8/2), nonwelded, and devitrified. The tuff has an open/porous matrix and contains 1% moderate orange pink (10R 7/4) to moderate reddish orange (10R 6/6) pumice clasts up to 2 mm in diameter, 1% grayish black (N2) and dark reddish brown (10R 3/4) lithic clasts up to 1 cm in diameter from 765 to 835 ft that increase to 5% from 835 ft to the base of the unit at 920 ft, 1 to 3% feldspar phenocrysts generally 1 mm long, 5% quartz phenocrysts less than 1 mm in diameter, and 1% mafic minerals. No reaction to 10% HCl is observed. The upper 10 ft of the unit contains a deeply weathered pale reddish purple (5RP 6/2) clay-rich zone that is possibly a paleosol. The unit lies in sharp contact with the underlying tuff.</p>
1000		<p>(920 to 1,035 ft) ASH-FLOW TUFF (TIVA CANYON TUFF) The tuff is moderate brown (5YR 3/4) to a slightly lighter moderate brown (5YR 4/4), light brown (5YR 5/6), moderate yellowish brown (10YR 5/4), and grayish red (5R 4/2). The unit is densely welded and devitrified, has a dense/nonporous matrix, and contains 1 to 2% very light gray (N8) to white (N9) pumice clasts up to 1 mm in diameter. The unit is lithic-poor and contains 1 to 2% feldspar phenocrysts 1 to 3 mm long, less than 1% mafic minerals, and no quartz phenocrysts. No reaction to 10% HCl is observed. From 985 to 1,000 ft there are silica coatings (i.e., drusy quartz) on smooth planar fractures imparting a sparkling texture to the rock. The unit lies in sharp contact with the underlying tuff.</p>
1100		<p>(1,035 to 1,065 ft) ASH-FALL TUFF (PRE-TIVA CANYON TUFF) The tuff is moderate yellowish brown (10YR 5/4), nonwelded, and devitrified. It has an open/porous matrix and contains 10% grayish yellow (5Y 8/4) to light greenish gray (5GY 8/1) pumice up to 8 mm in diameter and 15% light brown (5YR 5/6) lithic clasts up to 3 mm in diameter. The unit is generally phenocryst-poor and contains 1 to 2% feldspar phenocrysts up to 0.5 mm long, no quartz phenocrysts, and no mafic minerals. No reaction to 10% HCl is observed. The top of the unit from 1,035 to 1,040 ft is orange (10R 6/6), oxidized and weathered, and possibly represents a paleosol. The tuff unit is weakly oxidized and possibly reworked. The base of the unit is in sharp contact with the underlying tuff.</p> <p>(1,065 to 1,145 ft) ASH-FLOW TUFF (TOPOPAH SPRING TUFF) The tuff is moderate yellowish brown (10YR 5/4) to light brown (5YR 5/6) to grayish red (5R 4/2). The unit is moderately welded from 1,065 to 1,100 ft, densely welded from 1,100 to 1,145 ft, devitrified throughout, and weakly argillitic and weathered below 1,115 ft. The tuff is pumice- and lithic-poor and contains 1 to 2% feldspar phenocrysts up to 0.5 mm long, no observed quartz phenocrysts, and 1% mafic minerals. No reaction to 10% HCl is observed. A poorly developed vitric zone is present from 1,120 to 1,130 ft and contains black feldspar-porphyratic glass. The unit is in unconformable contact with the underlying weathered tuff.</p>
1200		<p>(1,145 to 1,342 ft) ASH-FLOW TUFF (PRE-TRAM TUFF) The tuff colors range from grayish orange (10YR 7/4) to grayish orange pink (10R 8/2), pale greenish yellow (10Y 8/2), light brown (5YR 6/4), pinkish gray (5YR 8/1), dusky red (5R 3/4) and grayish yellow (5Y 8/4). The unit is non to weakly welded, devitrified, and moderately to highly weathered to clay. Zeolitic alteration is also present locally. The unit contains 30 to 50% white (N9) to pinkish gray (5YR 8/1) pumice clasts that range in size from 5 to 10 mm, 1 to 15% reddish brown (10R 4/6) and light brown (5YR 5/6) lithic clasts up to 1 cm in diameter, 1 to 2% feldspar phenocrysts up to 0.5 mm long, no quartz, and a trace of mafic minerals. Samples react weakly to 10% HCl below 1,195 ft. The base of the unit lies in sharp contact with the underlying sedimentary rock.</p>

Summary Lithologic Log for Borehole 28P
Appendix I-3

July 2005

Appendix I

Summary Lithologic Log for Borehole 28P

NWRRPO-2004-04

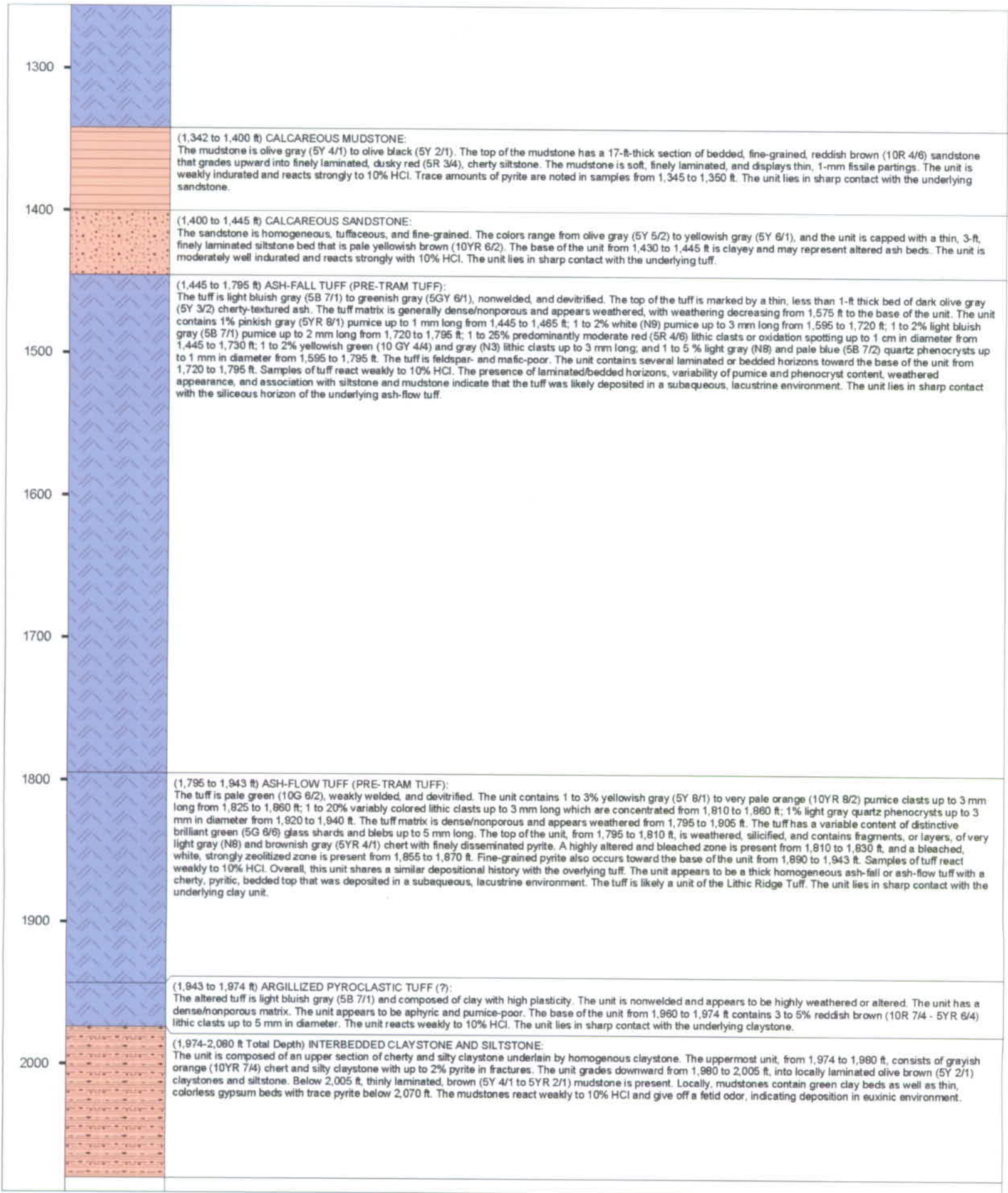

Summary Lithologic Log for Borehole 24P

NWRRPO-2004-04

Depth in Feet	LITHOLOGY	DESCRIPTION
0	(0 to 60 feet [ft]) INTERBEDDED WELL-GRADED SAND WITH SILT, CLAY AND GRAVEL (SW-SM/SC) AND SILTY, CLAYEY SAND WITH GRAVEL (SM/SC)	The interval consists of layers of well-graded sand with silt, clay and gravel (SW-SM/SC) up to 12.5 feet thick interbedded with thinner layers of silty, clayey sand with gravel (SM/SC). Fines in the SW-SM/SC layers typically display no to low plasticity, and fines in the SM/SC layers typically display no to low plasticity. Gravel clasts are volcanic in origin and subangular. Sediment colors range from predominantly yellowish brown (10YR 5/4) to brown (7.5YR 4/4, 5/2), gray (5YR 5/1) and light reddish brown (5YR 6/3). Cementation is observed to be moderate from 0 to 17.5 ft. No cementation is observed from 17.5 to 60 ft. Sediments reacted strongly to 10 percent (%) hydrochloric acid (HCl). All samples are dry.
100	(60 to 245 ft) WELL-GRADED SAND WITH SILT, CLAY AND GRAVEL (SW-SM/SC)	The interval consists primarily of layers of well-graded sand with silt, clay and gravel (SW-SM/SC) up to 17.5 ft thick. Lesser layers of well-graded sand with gravel (SW) and silty, clayey sand with gravel (SM/SC) are present, with the proportion of the latter increasing toward the base of the interval. Fines typically display no to low plasticity, with a zone of moderate plasticity from 200 to 210 ft. Gravel clasts are volcanic in origin and subrounded to subangular. Sediment colors range from predominantly reddish brown (5YR 4/3, 5/4) to light reddish brown (5YR 6/3), dark reddish brown (5YR 4/2), yellowish brown (10YR 5/6, 5/4), yellowish red (5YR 5/6), dark yellowish brown (10YR 4/4), brown (10YR 4/3), and grayish brown (10YR 5/2). No cementation is observed. Typically, sediments do not react to 10% HCl from 60 to 170 ft, and react strongly from 170 to 245 ft. Samples of drill cuttings are dry. Moisture is observed in drive core samples from 80, 120, 160, 200 and 240 ft.
200	(245 to 400 ft) SILTY, CLAYEY SAND WITH GRAVEL (SM/SC)	The interval consists primarily of layers of silty, clayey sand with gravel (SM/SC). Fines typically display low plasticity from 245 to 272.5 feet, and moderate to high plasticity from 272.5 to 400 ft. Gravel clasts are volcanic in origin and typically subangular to angular. Sediment colors range from predominantly light brown (7.5YR 6/4) to grayish brown (10YR 5/2), reddish brown (5YR 5/3, 5/4), and brown (7.5YR 5/4). Weak cementation is observed. Sediments react strongly to 10% HCl. Samples of drill cuttings are dry. Moisture is observed in drive core samples from 280, 320, and 360 ft.
300	(400 to 890 ft) ASH-FLOW TUFF (BULLFROG TUFF)	The tuff is moderate brown (5YR 3/4) to light brown (5YR 5/6), devitrified, and variably welded, with moderate welding from 400 to 505 ft, dense welding from 505 to 560 ft, moderate welding from 560 to 690 ft and 825 to 890 ft, and dense welding from 690 to 825 ft. A weak zone of spherulitic development occurs from 535 to 540 ft. The tuff matrix is open and porous from 400 to 440 ft and dense/nonporous from 440 to 890 ft. The tuff contains 10-20% very pale orange (10YR 8/2) pumice clasts up to 5 millimeters (mm) in diameter from 695 to 730 ft, and 1% pale yellowish orange (10YR 8/6) pumice clasts from 870 to 885 ft, 1 to 5% grayish brown (5YR 3/2) to black (N1) lithic clasts from 2 to 10 mm in diameter from 400 to 545 ft. Locally, from 545 to 890 ft, the tuff contains 2 to 10% light grey (N3-N8) lithic clasts from 3 to 15 mm in diameter. The tuff also contains 1 to 3% colorless feldspars up to 2 mm long, 2 to 5% light grey (N7) to colorless quartz phenocrysts up to 2 mm in diameter from 400 to 830 ft, 1% light grey (N7) to colorless quartz phenocrysts from 830 to 890 ft, and 1 to 5% greenish black (5GY 2/1) and black (N1) biotite up to 3 mm long and trace hornblende from 480 to 890 ft. Reaction with 10% HCl is observed where white calcite fills open fractures in samples from 525 to 530, 555 to 560, 580 to 585, 605 to 615, 655 to 665, 680 to 685, and 705 to 710 ft. The lower contact is sharp with the underlying sedimentary rock.
400	(890 to 933 ft) SANDSTONE (PRE-BULLFROG TUFF SEDIMENTARY ROCKS)	The interval consists of dark reddish brown (5YR 3/2 to 5YR 5/6) conglomeratic sandstone from 890 to 915 ft, grading into light brown (10YR 5/4) fine volcaniclastic sandstone from 915 to 933 ft. The conglomeratic section contains 15 to 85% gray (N4) and reddish brown (5YR 3/2) rounded volcanic pebbles and rare reddish brown (5YR 3/4) siltstone fragments. The sandstone is argillic, or zeolitic, and weathered. The lower contact is gradational with the underlying ash-flow tuff.
500	(933 to 1,356 ft) ASH-FLOW TUFF (TRAM TUFF)	The tuff is variable in color and ranges from pale orange (10YR 8/2) from 933 to 1,035 ft, reddish brown (10R 6/4) from 1,035 to 1,135 ft, light brown (5YR 5/6) from 1,135 to 1,200 ft, and grayish orange (5YR 7/2) from 1,200 to 1,356 ft. The tuff is devitrified, has an open/porous matrix, and is generally nonwelded, except for zones of weak welding at 1,005 to 1,010 ft, 1,030 to 1,040 ft and 1,100 to 1,115 ft. From 933 to 985 ft, the tuff is locally weakly to moderately weathered. From 985 to 1,356 ft, the tuff is unweathered. The tuff contains 10 to 20% moderate orange pink (5YR 8/4) to greenish gray (5GY 6/4) pumice clasts from 5 to 8 mm in diameter from 940 to 1,190 ft, 1 to 2% orange pink (5YR 8/4) to light brown (5YR 8/2) pumice clasts from 1 to 5 mm in diameter from 1,190 to 1,356 ft, 2 to 20% reddish brown (5YR 3/4) to gray (N5) lithic clasts from 2 to 10 mm in diameter from 933 to 1,190 ft, and 2 to 25% reddish brown (10R 4/6) to black (N1) lithic clasts from 2 to 10 mm in diameter from 1,190 to 1,356 ft. From 940 to 955, 1,120 to 1,190, and 1,220 to 1,240 ft, lithic clasts can comprise up to 25% of the tuff. The tuff also contains 1 to 2% colorless feldspars up to 2 mm long from 935 to 1,065 ft and 1,190 to 1,355 ft, 1 to 2% light gray (N5 to N8) to colorless quartz phenocrysts up to 3 mm in diameter, 1 to 3% greenish black (5GY 2/1) to black (N1) biotite up to 2 mm long from 933 to 1,140 ft, and 1% black (N1) biotite up to 1 mm long from 1,140 to 1,356 ft. No reaction to 10% HCl is observed. The lower contact is sharp with the underlying sedimentary rocks.
600	(1,356 to 1,400 ft) VOLCANICLASTIC SEDIMENTARY ROCK (PRE-TRAM TUFF SEDIMENTARY ROCKS)	The interval consists of variably colored calcareous volcaniclastic siltstone, claystone, and fine sandstones. The colors range from red (10R 4/6) from 1,356 to 1,366 ft to pale olive (10Y 6/2 to 5/4) from 1,366 to 1,400 ft. The sequence consists of an upper section of red siltstones and claystones from 1,356 to 1,359 ft overlying olive-colored, fine sandstones with siltstone beds from 1,366 to 1,400 ft. Typically, the sequence reacts strongly to 10% HCl.
700	(1,400 to 1,480 ft) REWORKED TUFF (LITHIC RIDGE TUFF)	The tuff is light olive (10Y 5/4) to olive gray (5T 3/2) from 1,400 to 1,425 ft, greenish yellow (10Y 7/4) from 1,425 to 1,430 ft, olive brown (5Y 4/4) from 1,430 to 1,455 ft, and dark yellowish orange (10YR 6/6) from 1,455 to 1,480 ft. The tuff is devitrified, nonwelded, has an open/porous matrix, and is moderately weathered from 1,400 to 1,430 ft. The tuff contains 1 to 3% yellowish green (10Y 6/6) pumice clasts up to 3 mm in diameter from 1,400 to 1,420 ft, 8 to 10% greenish yellow (5Y 8/4) pumice clasts up to 3 mm in diameter from 1,450 to 1,480 ft, 2 to 10% pale brown (5YR 5/2) to gray (N5) lithic clasts from 2 to 20 mm in diameter from 1,400 to 1,455 ft, and 10 to 50% gray (N5) to brownish black (5YR 2/1) lithic clasts from 6 to 20 mm in diameter from 1,455 to 1,480 ft. The tuff also contains up to 1% colorless feldspar phenocrysts up to 2 mm long from 1,400 to 1,455 ft, up to 10% light gray (N8) quartz phenocrysts up to 2 mm in diameter from 1,400 to 1,420 ft, and 1 to 2% black (N1) mafic minerals up to 1 mm long from 1,400 to 1,480 ft. The rock has no reaction to 10% HCl. The lower contact is gradational with the underlying ash-flow tuff, suggesting that the unit is a reworked tuff derived from the underlying unit.
800	(1,480 to 1,722 ft) ASH-FLOW TUFF (LITHIC RIDGE TUFF)	The tuff is highly variable in color, from dark yellowish orange (10YR 6/6) from 1,480 to 1,540 ft, moderate red (5R 5/4) from 1,540 to 1,600 ft, greyish orange (10YR 7/4) to moderate red (5R 5/4) from 1,600 to 1,655 ft, and moderate orange pink (10YR 7/4) from 1,655 to 1,722 ft. The tuff is devitrified, nonwelded, with an open/porous matrix. The tuff is moderately weathered from 1,480 to 1,500 ft, slightly weathered from 1,480 to 1,505 ft, and fresh from 1,505 to 1,722 ft. The tuff contains 10 to 20% pale brown (5Y 3/4) to pale orange (10Y 8/2) pumice clasts from 2 to 5 mm in diameter from 1,480 to 1,540 ft, 1 to 5% greenish yellow (10Y 8/2-7/4) pumice clasts to 4 mm in diameter from 1,540 to 1,722 ft decreasing in size and content with depth, and 5 to 10% moderate brown (5YR 4/4) to gray (N4, N5) lithic clasts up to 10 mm in diameter throughout the interval, with concentrations of 10 to 20% from 1,520 to 1,550 ft and 20 to 50% from 1,600 to 1,722 ft. The tuff also contains 1% and, locally, up to 5% light gray (N7) to colorless quartz phenocrysts up to 2 mm in diameter, 1% colorless feldspar phenocrysts from 1,510 to 1,710 ft, and 1 to 4% black (N1) mafic minerals up to 2 mm long from 1,480 to 1,722 ft. No reaction to 10% HCl is observed. The lower contact is gradational with the underlying weathered, clayey, sedimentary rocks.
900	(1,722 to 1860 ft Total Depth) CLAYSTONE, SILTSTONE, AND SANDSTONE (PRE-LITHIC RIDGE TUFF SEDIMENTARY ROCKS)	The interval consists of a variably colored sequence of claystone, siltstone, and sandstone. The rocks are brown (5YR 6/4, 3/2 and 10YR 5/4, 3/4) from 1,722 to 1,795 ft and moderate brown (5YR 3/4) from 1,795 to 1,860 ft. From 1,722 to 1,760 ft, the interval consists predominantly of fine-grained volcaniclastic sandstone and layers of claystone, grading downward into predominantly finely laminated siltstones at 1,760 ft. Reaction to 10% HCl is variable with no reaction from 1,722 to 1,730 ft, weak reaction from 1,730 to 1,735 ft, strong reaction from 1,735 to 1,750 ft, weak reaction from 1,750 to 1,810 ft and strong reaction from 1,810 to 1,860 ft at the total depth. Trace amounts of gypsum are observed with the cuttings from 1,800 to 1,805 ft and 1,830 to 1,835 ft.

Nye County Early Warning Drilling Program Phase IV Drilling Report

Appendix I

Summary Lithologic Log for Borehole 29P

NWRPPO-2004-04

Nye County Early Warning Drilling Program Phase IV Drilling Report

Depth in feet	LITHOLOGY	DESCRIPTION
0		(0 to 125 feet (ft)) WELL-GRADED SAND WITH SILT, CLAY AND GRAVEL (SW-SM/SC) The interval consists primarily of layers of well-graded sand with silt, clay and gravel (SW-SM/SC) up to 52.5 feet thick. Thin layers of well-graded sand with gravel (SW) occur from 7.5 to 10, 27.5 to 30, and 37.5 to 40 ft. Fines display low to moderate plasticity. Gravel clasts are volcanic in origin, rounded from 0 to 47.5 ft, and subrounded from 47.5 to 125 ft. Sediment colors range from predominantly reddish gray (5YR 5/2) to yellowish red (5YR 5/6), reddish brown (5YR 4/4, 5/3), and dark reddish gray (5YR 4/2). Cementation ranges from none to moderate. Sediments react strongly to 10 percent (%) hydrochloric acid (HCl) from 0 to 35 ft, and display no reaction from 35 to 125 ft. All drill cuttings samples are dry. Moisture is observed in a drive core sample from 100 ft.
100		(125 to 265 ft) INTERBEDDED SILTY, CLAYEY SAND WITH GRAVEL (SM/SC) AND WELL-GRADED SAND WITH SILT, CLAY AND GRAVEL (SW-SM/SC) The interval consists of layers of silty, clayey sand with gravel (SM/SC) up to 17.5 ft thick interbedded with layers of well-graded sand with silt, clay and gravel (SW-SM/SC) up to 7.5 ft thick. Fines display low to moderate plasticity. Gravel clasts are volcanic in origin, subangular from 125 to 180 ft, and subrounded from 180 to 265 ft. Sediment colors range from predominantly reddish gray (5YR 5/2) to yellowish red (5YR 5/6), and brown (7.5YR 5/3). Cementation ranges from none to moderate. Sediments display no reaction to 10% HCl. Samples of drill cuttings are dry from 125 to 180 ft, and moist from 180 to 265 ft. Moisture is observed in a drive core sample from 180 ft.
200		(265 to 320 ft) SILTY, CLAYEY SAND WITH GRAVEL (SM/SC) The interval consists of a uniform sequence of silty, clayey sand with gravel (SM/SC). Fines display low to high plasticity. Gravel clasts are volcanic in origin, subangular from 265 to 312.5 ft, and angular from 312.5 to 320 ft. Sediment colors range from predominantly reddish gray (5YR 5/2) to yellowish red (5YR 5/6), reddish brown (5YR 5/3), and light brown (7.5YR 6/4). Strong cementation is observed from 312.5 to 320 ft, with the remainder of the interval exhibiting no to weak cementation. Sediments display no reaction to 10% HCl from 265 to 305 ft, and display a weak to strong reaction from 305 to 320 ft. All samples are moist.
300		(320 to 378 ft) ASH-FLOW TUFF (TIVA CANYON TUFF) The tuff is dark brown (10YR 4/2), devitrified and densely welded from 320 to 370 ft, and moderately welded from 370 to 378 ft. The tuff is slightly weathered from 320 to 325 ft, unweathered from 325 to 375 ft, and moderately weathered from 375 to 378 ft. The tuff matrix is dense/nonporous from 325 to 365 ft and open/porous from 365 to 378 ft. The tuff contains 1% gray brown (10YR 6/2) pumice clasts up to 4 millimeters (mm) in diameter from 320 to 355 ft and 2 to 5% brown (5YR 3/4) pumice clasts 2 to 4 mm in diameter from 355 to 380 ft. The tuff is generally lithic-poor, except from 335 to 345 ft, where there are 1% gray brown (10YR 6/4) lithic fragments up to 3 mm in diameter. The tuff also contains 1% colorless feldspar up to 3 mm long, 1 to 2% colorless to white (N9) quartz phenocrysts up to 3 mm in diameter from 340 to 360 and 370 to 378 ft, and 1 to 2% dark green (5GY 3/2) euhedral biotite phenocrysts up to 3 mm in diameter from 320 to 360 ft. Samples are dry to 355 ft, moist from 355 to 360 ft, and wet beyond 360 ft. The lower contact is sharp with the underlying ash-fall tuff.
400		(378 to 410 ft) ASH-FALL TUFF (PRE-TIVA CANYON TUFF) The tuff is light brown (10YR 5/4) from 378 to 400 ft and reddish brown (10R 5/4) from 400 to 410 ft. The tuff is nonwelded, devitrified, slightly weathered, and displays an open/porous matrix. The tuff is probably poorly consolidated. The tuff is pumiceous, with 5 to 20% light to dark brown (10YR 5/4-4/2) pumice clasts up to 12 mm in diameter and 2% olive gray (10Y 6/2) and dark brown (5YR 3/4) pumice clasts up to 4 mm in diameter. The tuff contains 2 to 5% colorless and chatoyant feldspar phenocrysts up to 4 mm long, 1% colorless quartz phenocrysts up to 3 mm long, and 1% dark brown (10YR 2/2) biotite crystals. The lower contact appears to be gradational with the underlying ash-flow tuff from 408 to 412 ft.
500		(410 to 640 ft) ASH-FLOW TUFF (TOPOPAH SPRING TUFF) The tuff ranges from reddish brown (10R 4/6) to black (N1) to moderate brown (5YR 3/4, 4/4). The tuff is generally densely welded, devitrified and has widely spaced zones of weak vapor-phase alteration that may correspond to lithophysal zones. The upper and lower vitrophyre zones are well represented. The zones are as follows: 410 to 425 ft (UPPER MODERATELY WELDED ZONE): The zone is reddish brown (10R 4/6), vitric, and weakly to moderately welded with an open/porous matrix. The zone contains 1 to 3% colorless feldspar phenocrysts up to 4 mm long, up to 1% colorless to very light gray (N8) quartz phenocrysts, and up to 2% olive green (10Y 5/4) biotite up to 3 mm long. Welding increases toward the sharp contact with the underlying vitrophyre. 425 to 503 ft (UPPER VITROPHYRE): The zone is comprised of a black (N1), densely welded, glassy tuff with a dense/nonporous matrix. The zone contains 3 to 8% colorless feldspar up to 4 mm long and 1% black (N1) biotite from 460 to 465 ft. Locally, feldspars are chatoyant or opalescent. The vitrophyre is interlayered with soft, zeolitized material from 465 to 495 ft. The lower contact is gradational with the underlying welded tuff. 503 to 600 ft (MIDDLE NONLITHOPHYSAL ZONE): The zone is moderate brown (10YR 3/4) from 503 to 595 ft and dark brown (10YR 2/2) from 595 to 600 ft. The tuff is moderately welded from 503 to 515 ft, densely welded from 515 to 600 ft, devitrified, and displays a dense/nonporous matrix. Traces of vapor-phase alteration occur at 520 to 525, 550 to 555, 565 to 570, and 585 to 595 ft. Weak spherulitic development is observed from 570 to 575 ft. The tuff contains 2 to 3% colorless feldspar phenocrysts up to 3 mm long, 1% very light gray (N8, N9) to colorless quartz phenocrysts to 3 mm in diameter from 500 to 560 and 585 to 595 ft, and 1% bronze biotite up to 1 mm long from 505 to 525, 535 to 540, and 575 to 595 ft. The tuff also contains 1 to 2% medium gray (N5) lithic clasts up to 8 mm in diameter from 505 to 555 and 565 to 595 ft. Welding increases beyond 585 ft toward the gradational contact with the underlying basal vitrophyre. 600 to 611 ft (BASAL VITROPHYRE): The zone is comprised of a black (N1), densely welded, glassy tuff with a dense/nonporous matrix. No phenocrysts or lithic clasts are observed. The rock is granular due to grinding from the drill bit. The lower contact is sharp with the underlying vitroclastic tuff. 611 to 640 ft (LOWER MODERATELY WELDED ZONE): The zone is light brown (5YR 4/4) and densely to moderately welded with a dense/nonporous matrix. A distinctive vitroclastic texture is evident, with stretched shards of "root beer bottle" glass up to 4 mm long. The tuff contains 1% colorless feldspar up to 3 mm long and 1 to 2% greenish yellow (5Y 8/4) to grayish pink (5YR 7/2) pumice clasts up to 10 mm in diameter. The contact with the underlying ash-fall tuff is sharp.
600		(640 to 700 ft) ASH-FALL TUFF (PRE-TOPOPAH SPRING TUFF AND PRE-WAHMONIE FORMATION BEDDED TUFF) The tuff is brown (5YR 3/4) to grayish orange brown (10YR 7/4), nonwelded, devitrified, and has an open/porous matrix. The tuff appears slightly weathered throughout. The tuff contains 1 to 2% brown (5YR 7/2) pumice clasts up to 4 mm in diameter from 640 to 655 ft, 1% colorless feldspar phenocrysts up to 2 mm long, 1 to 10% very light gray (N7, N9) quartz phenocrysts 2 to 4 mm in diameter that are concentrated toward the base of the unit from 680 to 695 ft, and 2 to 5% black biotite up to 4 mm long. Bedding is inferred in the unit based on the variation in colors observed. The lower contact is sharp with the underlying volcanoclastic sandstone.
700		(700 to 790.7 ft Total Depth) VOLCANICLASTIC SANDSTONE (PRE-WAHMONIE FORMATION BEDDED TUFF) The sandstone is dark to light brown (10YR 4/2 - 5YR 5/6) and consists of well-sorted and well-rounded grains of fine quartz, feldspar, volcanic glass, and biotite that represent epiclastic/volcanoclastic reworking of unwelded tuffs. The sandstone is cemented with coarse, greater than 2 centimeter, sparry calcite throughout much of the interval, however, sections are uncemented and the borehole produces abundant sand, especially in the interval from 700 to 720 ft. It is also likely that seams of uncemented sand occur within the sandstone below 720 ft. The borehole was stopped in this unit due to drilling problems as a result of flowing sand.







Summary Lithologic Log for Borehole 29P
Appendix I-5

July 2005

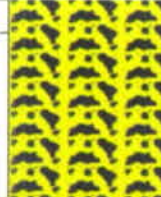
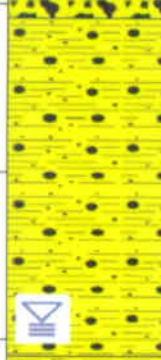
Appendix I

Summary Lithologic Log for Corehole 19PB

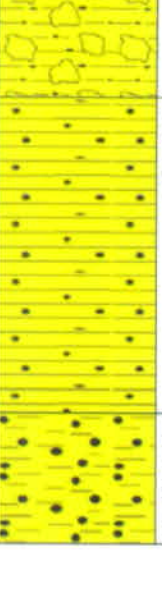
NWRPO-2004-04

Depth (ft)	LITHOLOGY	DESCRIPTION
340		(0 to 350.8 feet (ft)) UNDIFFERENTIATED ALLUVIUM This interval consists of unsaturated zone alluvium, unlogged and not sampled. Sonic coring begins at 350.8 feet, and continues to the end of the borehole.
350		(350.8 to 371.0 ft) WELL-GRADED SAND WITH CLAY (SW-SC) AND POORLY GRADED SAND WITH CLAY (SP-SC) In this interval, layers of SW-SC up to 3.3 ft thick and SP-SC up to 3.6 ft thick predominate. Lesser amounts of silty sand with gravel (SM), clayey sand with gravel (SC), well-graded gravel with clay and sand (GW-GC), and poorly graded gravel with clay and sand (GP-GC) occur in roughly equal proportions. Fines in SM and SC layers range from no to moderate plasticity. Gravel clasts are volcanic in origin and subangular to subrounded. Colors range from predominantly yellowish red (5YR 5/6) to reddish brown (5YR 4/4). No cementation or reaction with 10 percent (%) hydrochloric acid (HCl) is observed. All samples are moist.
370		(371.0 to 408.5 ft) POORLY GRADED GRAVEL WITH CLAY (GP-GC) AND WELL-GRADED GRAVEL WITH SILT (GW-GM) In this interval, layers of poorly graded gravel with clay (GP-GC) up to 2.4 ft thick and well-graded gravel with silt (GW-GM) up to 5.0 ft thick predominate. Lesser amounts of well-graded gravel (GW), poorly graded gravel (GP), well-graded gravel with clay (GW-GC), clayey gravel (GC), clayey sand (SC), poorly graded sand with clay (SP-SC), and well-graded sand with clay (SW-SC) occur in roughly equal proportions. Fines range from low to moderate plasticity. Gravel clasts are volcanic in origin and subrounded. Colors range from predominantly reddish gray (5YR 5/2) to light reddish brown (5YR 6/4) and dark yellowish orange (10YR 6/6). No cementation is observed. Typically no reaction with 10% HCl is observed, but weak reaction is observed from 371 to 375 ft. All samples are wet.
380		
390		
400		
410		(408.5 to 428.7 ft) WELL-GRADED GRAVEL WITH CLAY (GW-GC) AND POORLY GRADED SAND WITH CLAY (SP-SC) In this interval, layers of well-graded gravel with clay (GW-GC) up to 4.1 ft thick and poorly graded sand with clay (SP-SC) up to 1.4 ft thick predominate. Lesser well-graded gravel (GW), poorly graded gravel (GP), poorly graded gravel with clay (GP-GC), and well-graded sand with clay (SW-SC) occur in roughly equal proportions. Fines range from low to moderate plasticity. Gravel clasts are volcanic in origin and subrounded. Colors range from predominantly light reddish brown (5YR 6/4) to yellowish red (5YR 5/6), reddish yellow (5YR 6/6), and reddish brown (5YR 4/4). No cementation is observed from 408.5 to 416.1 ft. Weak cementation is observed from 416.1 to 428.7 ft. No reaction to 10% HCl is observed. All samples are wet.
420		
430		(428.7 to 442.9 feet) CLAYEY SAND (SC) AND WELL-GRADED SAND WITH CLAY (SW-SC) In this interval, layers of clayey sand (SC) up to 1.7 ft thick and well-graded sand with clay (SW-SC) up to 4.0 ft thick predominate. Lesser well-graded gravel with clay (GW-GC) also occurs within this interval. Fines range from low to moderate plasticity. Gravel clasts are volcanic in origin and subrounded. Colors range from predominantly reddish yellow (5YR 6/6) to yellowish red (5YR 5/6). Weak cementation is observed throughout the interval, however, no reaction to 10% HCl is observed. All samples are wet.
440		
450		(442.9 to 484.4 ft) POORLY GRADED GRAVEL WITH SILT (GP-GM) AND WELL-GRADED GRAVEL WITH CLAY (GW-GC) In this interval, layers of poorly graded gravel with silt (GP-GM) up to 3.5 ft thick and well-graded gravel with clay (GW-GC) up to 2.2 ft thick predominate. Lesser well-graded gravel with silt (GW-GM), clayey gravel (GC), well-graded gravel (GW), poorly graded gravel (GP), poorly graded gravel with clay (GP-GC), poorly graded sand with clay (SP-SC), poorly graded sand with silt (SP-SM), and well-graded sand with clay (SW-SC) occur in roughly equal proportions. Fines have low plasticity. Clasts are volcanic in origin and subrounded. Colors range from predominantly yellowish red (5YR 5/6) to reddish yellow (5YR 6/6), reddish brown (5YR 5/4), and brown (7.5YR 5/4). Weak cementation is observed from 442.9 to 449.7 ft. No cementation is observed from 449.7 to 484.4 ft. No reaction to 10% HCl is observed. All samples are wet.
460		
470		
480		
490		(484.4 to 503.4 ft) CLAYEY SAND (SC) AND POORLY GRADED GRAVEL WITH CLAY (GP-GC) In this interval, layers of clayey sand (SC) up to 1.9 ft thick and poorly graded gravel with clay (GP-GC) up to 2.3 ft thick predominate. Lesser well-graded gravel with clay (GW-GC), clayey gravel (GC), well-graded gravel (GW) and silty sand (SM) occur in roughly proportional amounts. Fines have low plasticity. Gravel clasts are volcanic in origin and subrounded. Colors range from predominantly reddish yellow (5YR 6/6) to reddish brown (5YR 5/4), strong brown (7.5YR 5/6), and reddish yellow (7.5YR 5/6). Weak cementation is observed throughout the interval. No reaction to 10% HCl is observed. All samples are wet.
500		
510		(503.4 to 530.4 ft) POORLY GRADED SAND WITH CLAY (SP-SC) AND POORLY GRADED SAND WITH SILT (SP-SM) In this interval, layers of poorly graded sand with clay (SP-SC) up to 2.6 ft thick and poorly graded sand with silt (SP-SM) up to 2.1 ft thick predominate. Lesser poorly graded gravel with silt (GP-GM), poorly graded gravel with clay (GP-GC), poorly graded gravel (GP), well-graded gravel with clay (GW-GC), well-graded sand with clay (SW-SC) and clayey sand (SC) occur in roughly proportional amounts. Fines have low plasticity. Gravel clasts are volcanic in origin and subrounded to subangular, with the percentage of subangular clasts increasing toward the base of the interval. Colors range from predominantly strong brown (7.5YR 5/6) to reddish yellow (7.5YR 6/6). Weak cementation is observed throughout the interval. No reaction with 10% HCl is observed. All samples are wet.

Appendix I-6
Summary Lithologic Log for Corehole 19PB

July 2005

Summary Lithologic Log for Corehole 19PB

NWRPO-2004-04



PLATES

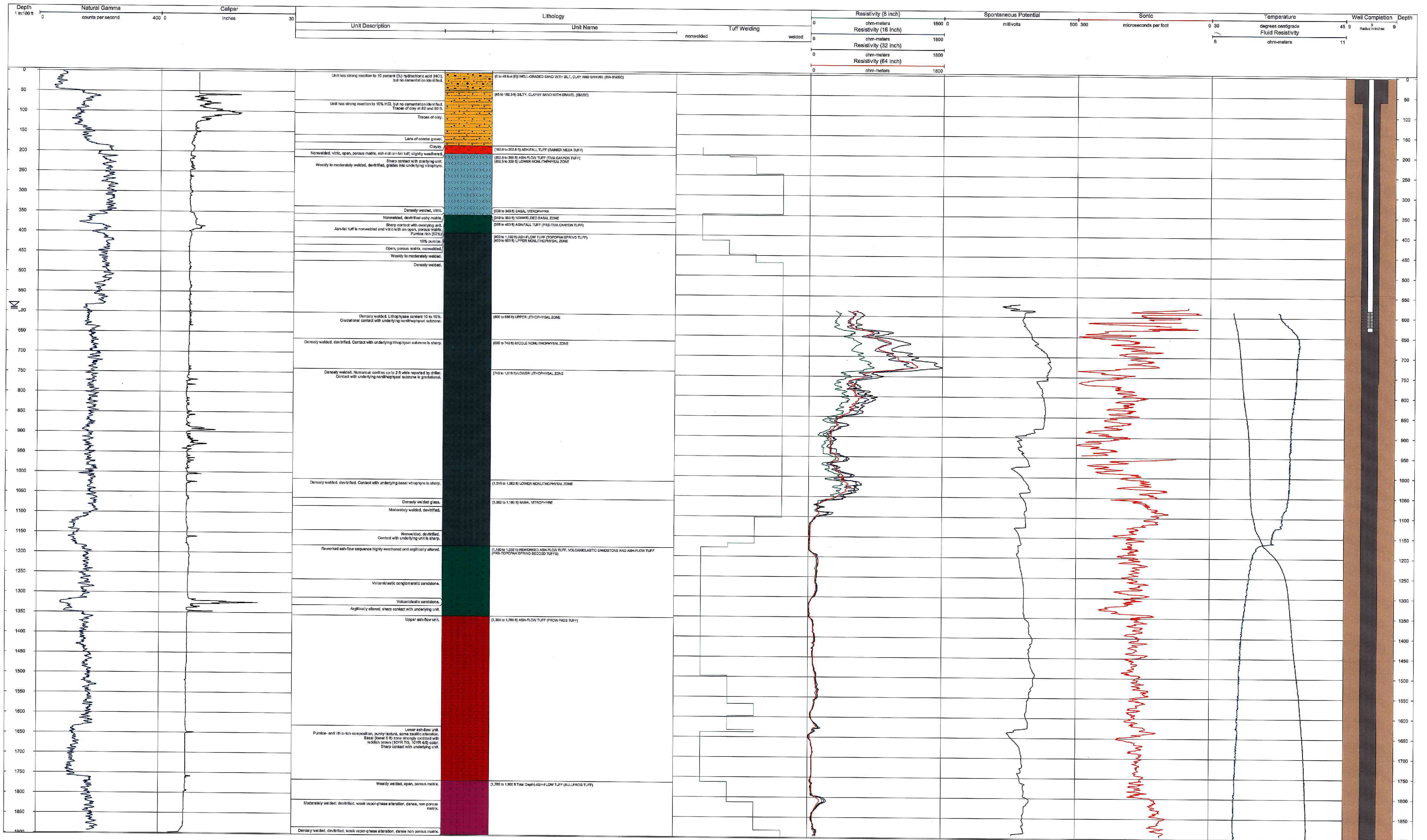

Drilled By: DSD, LAK Checked By: DPH, LAK, DSD Approved By: EHP

Data Sources: Geophysical logs run by Century Geophysical Corporation and Geophysical Logging Services Inc. Some geophysical logs may have been corrected for this report. Refer to Table E-2-1 for details. Geologic logging and interpretations performed by Nye County staff and contract geologists.

August 26, 2005

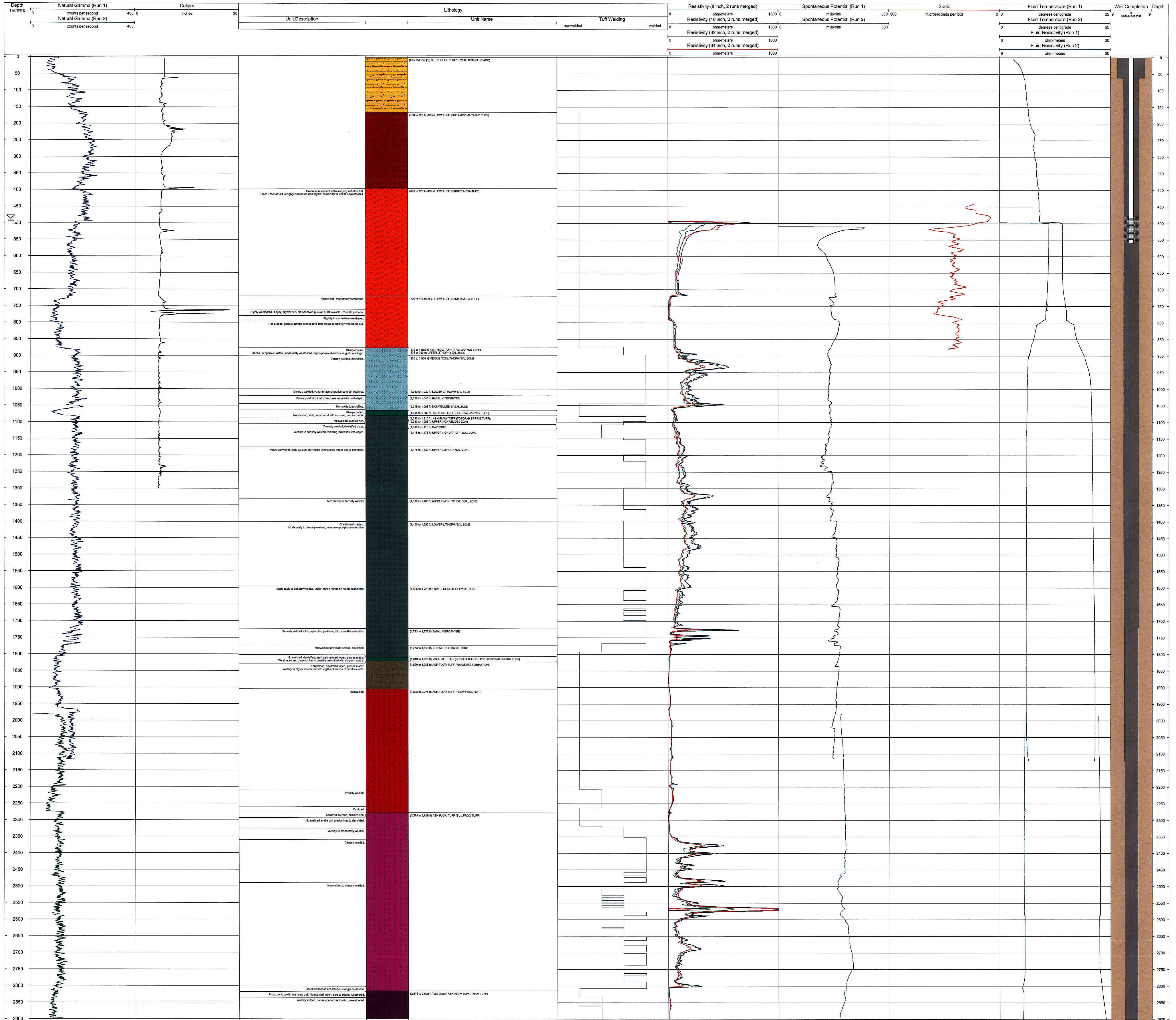

Drafted By: DSD, LAK Checked By: JPH, LAK, DSD Approved By: BIP

Data Sources: Geophysical logs run by Century Geophysical Corporation and Geophysical Logging Services, Inc. Some geophysical logs may have been corrected for this report. Refer to Table B.5-1 for details. Geologic logs and interpretations performed by Nye County and contract geologists.

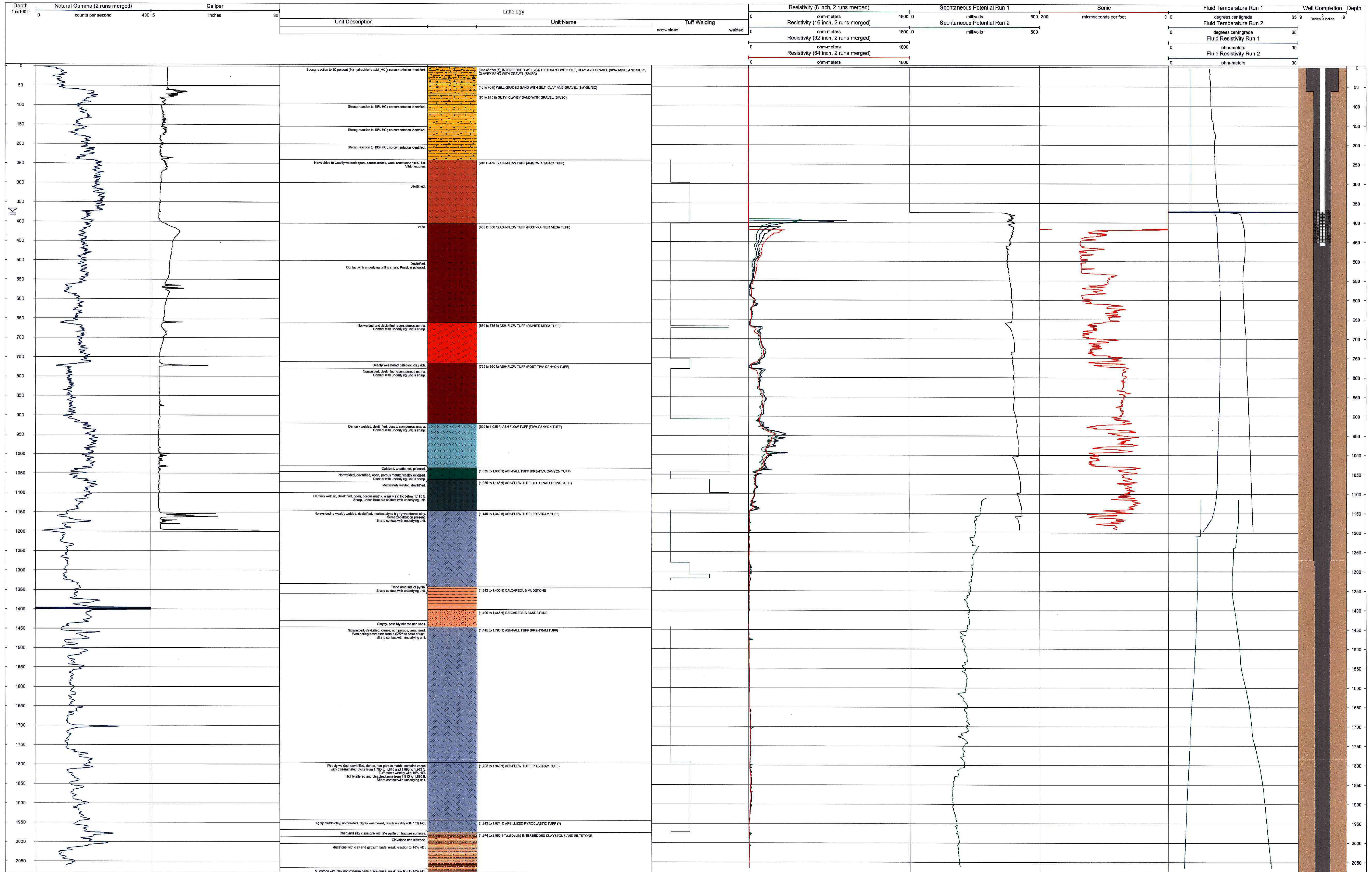

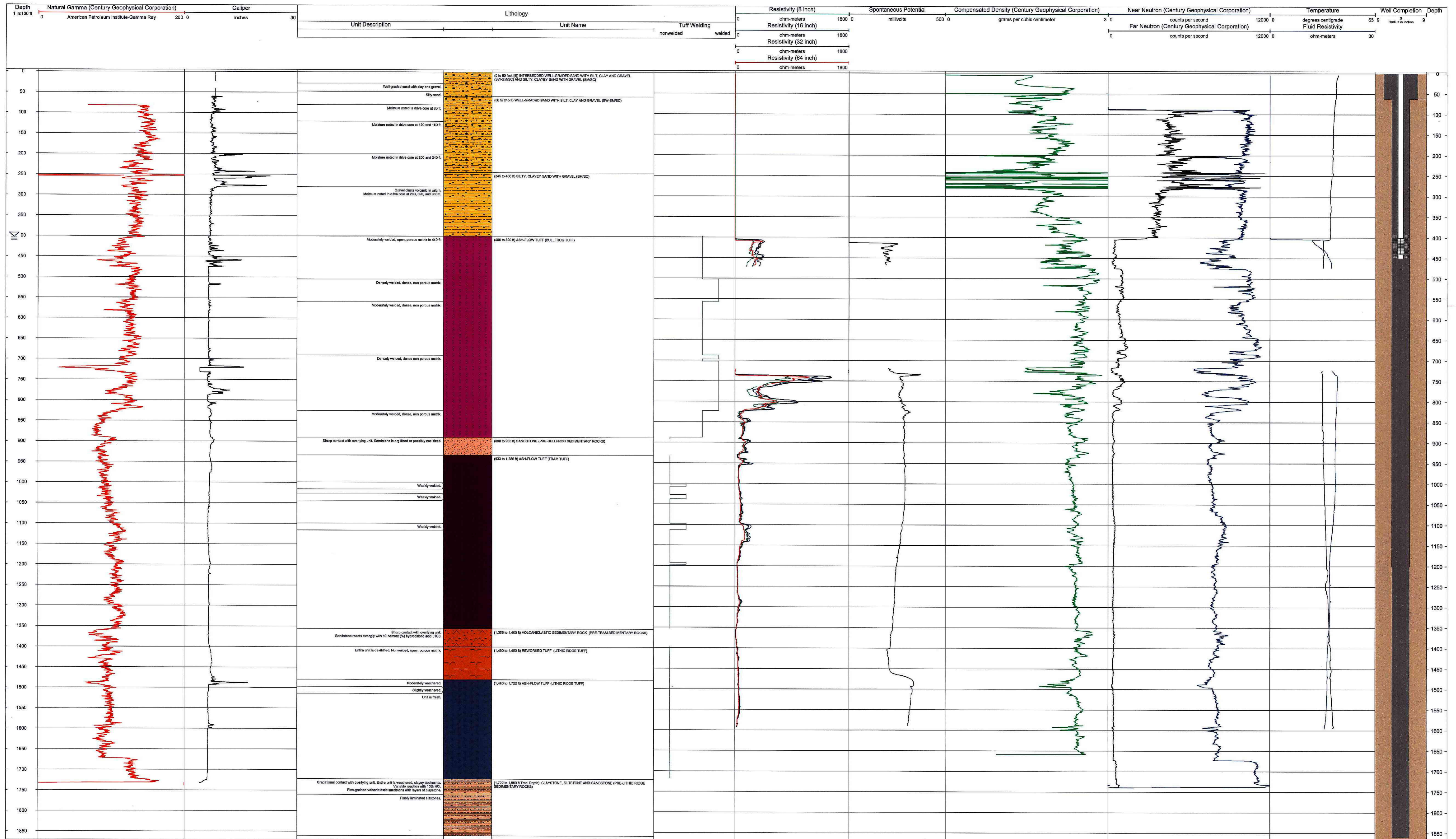

Drafted By: DSD, LAK Checked By: DPH, LAK, DSD Approved By: EHP

Date Sources: Geophysical logs run by Century Geophysical Corporation and Geophysical Logging Services Inc. Some geophysical logs may have been corrected for this report. Refer to Table B.2-1 for details. Corrigible logging and interpretations performed by Nye County staff and contract geologists.

August 26, 2008

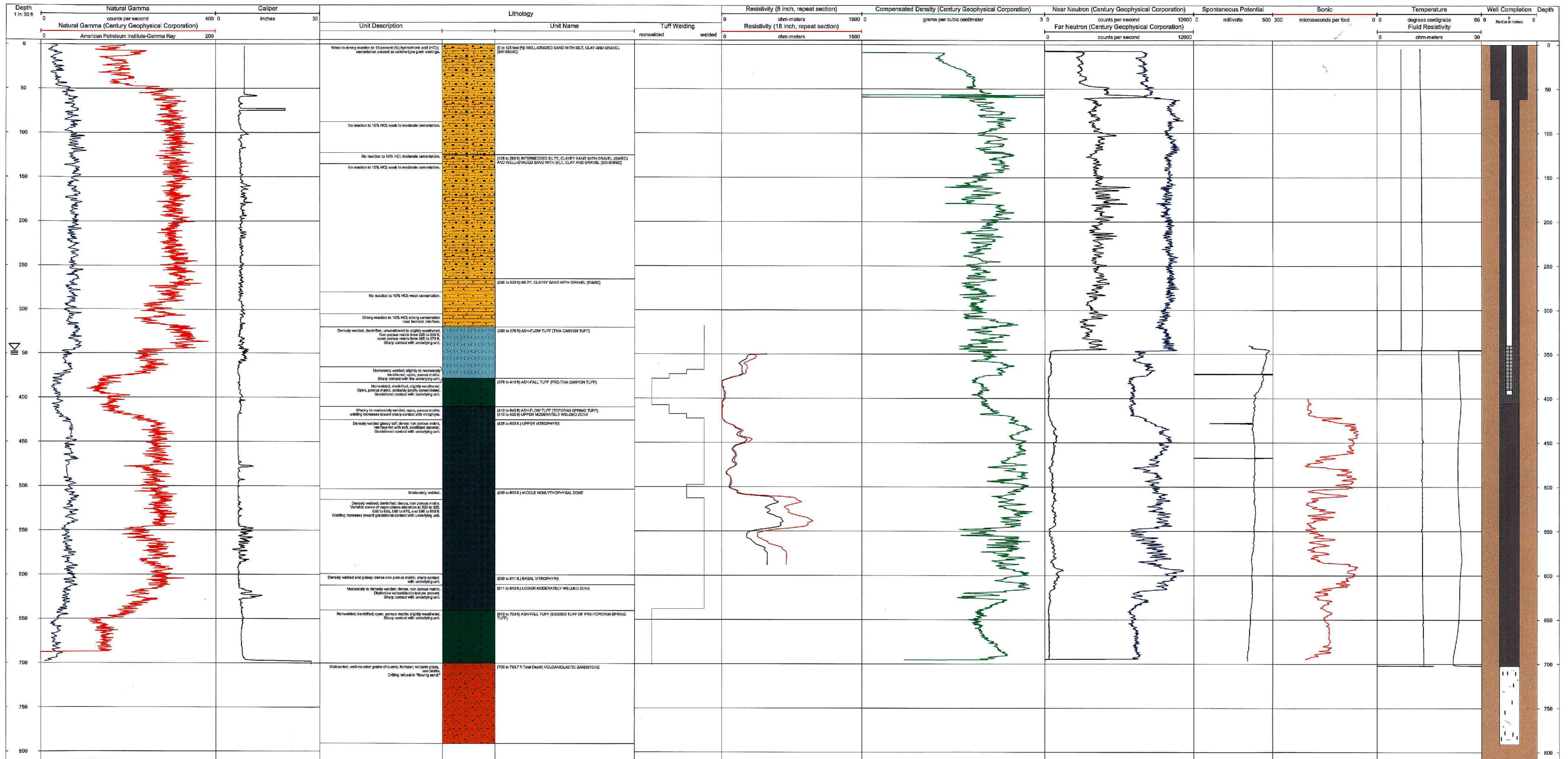

Drafted By: DSD, LAK Checked By: DPH, LAK, DSD Approved By: BHP

Date Sources: Geophysical logs run by Century Geophysical Corporation and Geophysical Logging Services Inc. Some geophysical logs may have been corrected for this report. Refer to Table 6.2.1 for details. Geologic logging and interpretations performed by Nye County staff and contract geologists. August 26, 2005

