

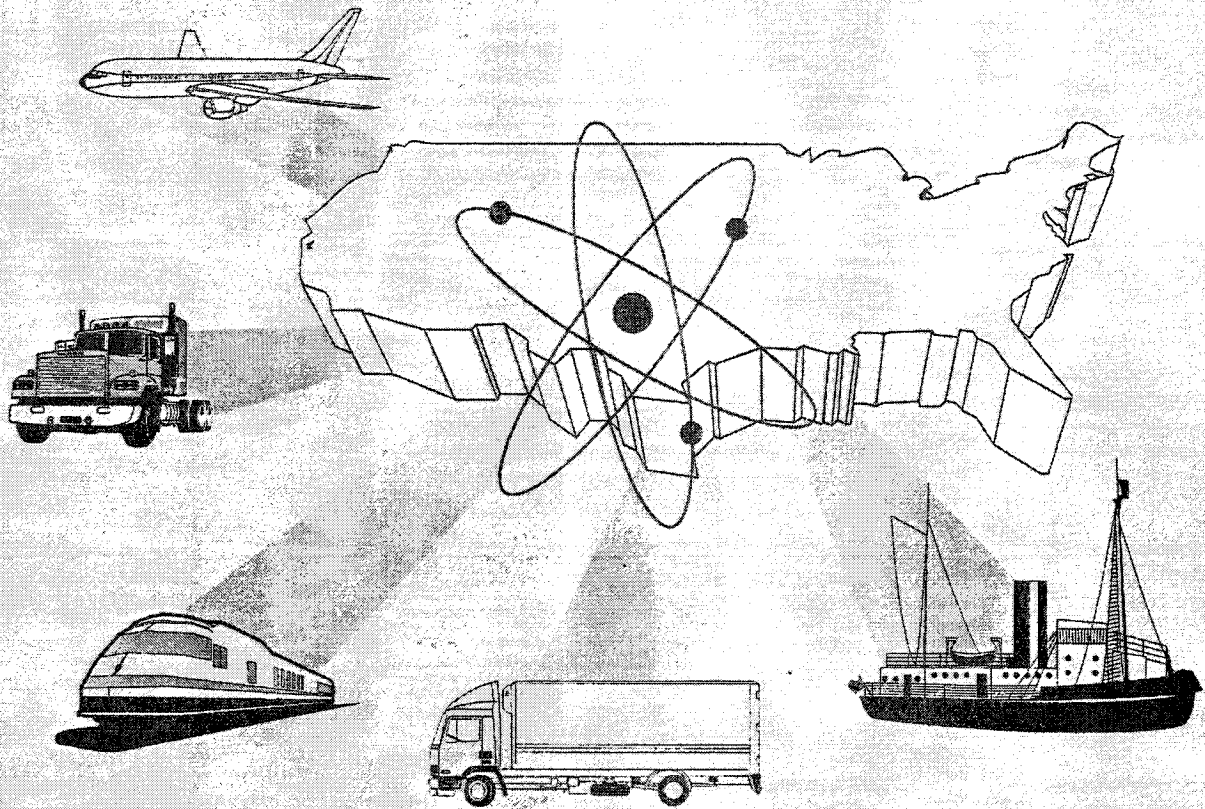

Guidance for Developing State, Tribal, and Local Radiological Emergency Response Planning and Preparedness for Transportation Accidents



Prepared by

*The Transportation Accidents Subcommittee
Federal Radiological Preparedness Coordination Committee*

NOTICE

This document, *Guidance for Developing State, Tribal, and Local Radiological Emergency Response Planning and Preparedness for Transportation Accidents*, was prepared by the Transportation Accidents Subcommittee of the Federal Radiological Preparedness Coordinating Committee (FRPCC). The document, commonly referred to as FEMA-REP-5, Revision 2, is intended for use by State, Tribal, and local officials responsible for radiological emergency planning and preparedness in responding to transportation accidents. The purpose of the FRPCC, a Federal interagency organization, as described in 44 Code of Federal Regulations (CFR) 351, is "to establish Federal agency roles and assign tasks regarding Federal assistance to State and local governments in their radiological emergency planning and preparedness activities." The regulation states that assignments "are applicable to radiological accidents at fixed nuclear facilities and transportation accidents involving radioactive materials." This document supersedes the 1992 FEMA-REP-5, Revision 1 document and all previous editions.

All comments received to date have been considered during the development of this document. Although this is the final edition of FEMA-REP-5, comments for consideration by the FRPCC Subcommittee on Transportation Accidents are encouraged. This document will be reviewed and revised, as warranted, by significant changes impacting radiological planning and preparedness for transportation accidents. Comments should be addressed to Rules Docket Clerk, Federal Emergency Management Agency, Room 840, 500 C Street, SW, Washington, DC 20472. Please reference the publication number, FEMA-REP-5, Revision 2, as well as the title, in your correspondence.

This page is intentionally left blank.

PREFACE

FEMA-REP-5, Revision 2, is published by FEMA on behalf of the FRPCC's Subcommittee on Transportation Accidents. It provides a basis for State, Tribal, and local governments to develop emergency plans and improve emergency preparedness for all transportation accidents involving radioactive materials and inherently impacts Federal agency planning.

Use of the guidance contained in this document is voluntary; compliance with the guidelines is not a Federal regulatory requirement. Because this guidance is relevant to transportation accidents involving all types of hazardous materials, it is recommended that the emergency response planning addressed by this guidance be closely integrated into comprehensive (i.e., all hazard) emergency planning and preparedness [see Appendix O, Bibliography item 27].

The Subcommittee on Transportation Accidents comprises representatives of the following agencies and organizations:

- Conference of Radiation Control Program Directors (CRCPD)
- Defense Threat Reduction Agency (DTRA)
- Federal Emergency Management Agency (FEMA)
- National Congress of American Indians (NCAI)
- Sandia National Laboratories (SNL)
- Southern States Energy Board (SSEB)
- U.S. Department of Agriculture (USDA)
- U.S. Department of Energy (DOE)
- U.S. Department of Health and Human Services (DHHS)
- U.S. Department of Transportation (DOT)
- U.S. Environmental Protection Agency (EPA)
- U.S. Nuclear Regulatory Commission (NRC)
- Western Interstate Energy Board (WIEB)

This page is intentionally left blank

CONTENT AND REVISIONS

Section I provides an introduction that addresses the purpose and scope of this guidance document and provides some general information to acquaint the reader with the subject matter. Information about accident consequences that appeared in Section I in the 1992 edition has been moved to Section III, Part C, entitled "Probable Accident Consequences." The text included in Section II.D in Revision 1 is now in Section II, Organizational Responsibilities; subsequent sections have been renumbered. Section III has been updated to include the latest Federal regulations governing packaging. The 14 planning elements found in Section IV have also been brought up to date. For example, since the 1992 edition was issued, the Emergency Broadcast System (EBS) has been replaced by the Emergency Alert System (EAS), which is adaptable to all electronic means of communication, but places a limit on the length of the automated alert message.

The List of Abbreviations and Acronyms and the Glossary have been expanded to accommodate new terms.

Appendix A is a database of radioactive material transportation accidents during the 27-year period from 1971 through 1997; the database has been revised from the 1992 version of FEMA-REP-5 to provide better interpretation of the accident statistics. The Federal contact addresses, along with telephone and facsimile numbers, that appear in Appendix C, Section C.2, have been updated, and the section now includes private-sector organization contacts.

We have provided descriptions and points of contact for the training courses listed in Appendix D to allow users to obtain information about specific courses and admission procedures. Emergency planners and responders should consider taking the courses on the Incident Command System (ICS) offered by FEMA. The adoption of the ICS as an on-site management procedure would solve most of the response problems long associated with hazardous material transportation accidents.

Appendix E has been revised to include a larger indemnification figure (i.e., \$8.9 billion) under the Price-Anderson Act and information regarding liabilities under the National Contingency Plan (NCP)/Superfund.

Appendix K was added to provide a brief description of the requirements for mutual-aid agreements. The information provided in Appendix K was formerly located in Section IV.C, "State, Tribal, and Local Coordination" in the 1992 FEMA-REP-5 document; it has been moved to improve the readability of the document.

Several States requested descriptive information about the different types of radiological instruments; Appendix J was added to this version of FEMA-REP-5 to provide that information. Detailed information on packaging categories was also moved from the main text (in the 1992 FEMA-REP-5 version) to Appendix L in this version.

Appendix M was added to illustrate, with photographs and drawings, the many kinds of packaging that responders might encounter at the scene of an accident. This appendix provides an overview of the packaging configurations for Type A and B, fissile, and radioactive wastes in the transportation realm. Requirements for package labeling, vehicle placarding, and shipping papers are covered in Appendix N in order to provide emergency personnel with relevant information concerning radioactive material shipments.

The Bibliography was moved to Appendix O, and additional entries were included; we also provided another list, called Useful References, of sources that the users can consult for additional details on the topics covered in this document. A final appendix, Appendix P, provides a list of sources for obtaining copies of some of the documents used in preparing FEMA-REP-5 and addresses for some useful Internet websites.

William B. Wark, Jr.

Russell Salter, Chair
Federal Radiological Preparedness
Coordinating Committee

11/29/00

Date

ABSTRACT

FEMA-REP-5, Revision 2, contains planning and preparedness guidance for transportation accidents involving radioactive materials. The document provides information for State, Tribal, and local governments to use in developing and enhancing their emergency capabilities for responding to transportation accidents involving radioactive materials. The guidance contained in this document does not represent a Federal regulatory requirement. Its use is voluntary, but we do recommend that users consider integrating the principles described in the document into comprehensive emergency response planning and preparedness measures at all levels of government.

The document is structured into four main sections:

- Section I, Introduction, describes the need for, purpose of, and scope of the document.
- Section II, Organizational Responsibilities, describes the roles and responsibilities of governmental authorities and agencies, and addresses the issue of Federal assistance.
- Section III, Planning Basis, describes transportation systems, packaging methods and materials, and probable accident sequences.
- Section IV, Guidance for Preparing a Plan, consists of 14 planning elements (A–N) covering all aspects of preparedness from pre-accident coordination and assignment of responsibilities to post-accident operations, cleanup, and site restoration. Specific guidance is presented for each planning element to illustrate how the planning element may be implemented.

In addition to these four main sections, the document contains a list of Abbreviations and Acronyms, a Glossary, 16 Appendices (A–P) that include the Bibliography and Useful References in Appendix O and Document Sources and Internet Websites in Appendix P.

This page is intentionally left blank.

FRPCC SUBCOMMITTEE ON TRANSPORTATION ACCIDENTS

Committee Members

William F. McNutt	Federal Emergency Management Agency Subcommittee Co-Chairman	Washington, D.C.
A. Wendell Carriker	U.S. Department of Transportation, Subcommittee Co-Chairman	Washington, D.C.
Richard G. Katz (retired)	Federal Emergency Management Agency	Washington, D.C.
Charles Blue	U.S. Environmental Protection Agency	Washington, D.C.
James Cruickshank	U.S. Department of Energy	Germantown, MD
Elizabeth Fulmer	Southern States Energy Board	Atlanta, GA
James C. Hardeman, Jr.	Conference of Radiation Control Program Director	Atlanta, GA
Robert Holden	National Congress of American Indians	Washington, D.C.
Stanley Keel	Defense Threat Reduction Agency	Alexandria, VA
Tammy Ottmer	Western Interstate Energy Board	Denver, CO
Ronald Graham	U.S. Department of Agriculture	Washington, D.C.
Corinne Macaluso	U.S. Department of Energy	Washington, D.C.
Mary Jane Ross-Lee	U.S. Nuclear Regulatory Commission	Washington, D.C.
Edward Tupin	U.S. Department of Health and Human Services	Atlanta, GA

Alternate Members

Robert Conley	U.S. Department of Agriculture	Washington, D.C.
Edward Langston	U.S. Department of Energy	Germantown, MD
Douglas Larson	Western Interstate Energy Board	Denver, CO
Lisa Ratcliff	U.S. Environmental Protection Agency	Washington, D.C.
Stacey Rosenberg	U.S. Nuclear Regulatory Commission	Washington, D.C.
J. Marty Simonin	Argonne National Laboratory	Argonne, IL

This page is intentionally left blank.

CONTENTS

NOTICE	i
PREFACE	iii
CONTENT AND REVISIONS	v
ABSTRACT	vii
FRPCC SUBCOMMITTEE ON TRANSPORTATION ACCIDENTS	ix
ABBREVIATIONS AND ACRONYMS	xix
GLOSSARY	xxiii
I. INTRODUCTION	1
A. Purpose	1
B. Scope	3
C. General Information	3
1. Federal Involvement	3
2. Nuclear Weapons: A Special Case	3
3. Federal Policy Toward Indian Tribes and Nations	4
4. General Statements About Planning	4
5. Overview of Laws and Regulations	5
II. ORGANIZATIONAL RESPONSIBILITIES	7
A. State, Tribal, and Local Governments	7
1. State and Tribal Officials	8
2. Local Government Officials	8
B. Federal Government	9
1. Obtaining Federal Assistance	10
2. Radiological Monitoring and Assessment Assistance	11
3. Federal Interagency Coordination	11
4. Superfund	11
5. Presidential Emergency Declarations	12
6. Nuclear Weapons-Related and Special Nuclear Materials-Related Transportation Accidents	12
7. Transportation Emergency Preparedness Programs	13
8. DOE Shipping Programs that Impact State, Tribal, and Local Authorities	14
C. Shipper Responsibilities	14
D. Carrier Responsibilities	15
III. PLANNING BASIS	18
A. Transportation Systems	18
1. Introduction	18
2. Highway and Rail Modes	18
3. Air and Water Modes	19
B. Materials and Packaging in Transportation	19

C.	Probable Accident Consequences	20
D.	Shipments of Uranium Hexafluoride	22
IV. OBJECTIVES AND GUIDANCE FOR PLAN DEVELOPMENT		23
A.	Assignment of Responsibilities	23
1.	Planning Objective	23
2.	Guidance	23
B.	Analysis of Radioactive Materials Transportation	25
1.	Planning Objective	25
2.	Guidance	25
C.	State, Tribal, and Local Coordination	26
1.	Planning Objective	26
2.	Guidance	26
D.	Emergency Equipment, Facilities, Expertise, and Resources	27
1.	Planning Objective	27
2.	Guidance	27
E.	Notification Methods and Procedures for Activating Emergency Response Personnel	29
1.	Planning Objective	29
2.	Guidance	29
F.	Emergency Communications	30
1.	Planning Objective	30
2.	Guidance	30
G.	Public Information	32
1.	Planning Objective	32
2.	Guidance	33
H.	Accident Assessment	34
1.	Planning Objective	34
2.	Guidance	34
I.	Protective Actions	36
1.	Planning Objective	36
2.	Guidance	36
J.	Radiation Exposure Control	37
1.	Planning Objective	37
2.	Guidance	37
K.	Medical Support	38
1.	Planning Objective	38
2.	Guidance	38
L.	Post-Accident Operations	39
1.	Planning Objective	39
2.	Guidance	39
M.	Radiological Emergency Response Training and Exercises	40
1.	Planning Objective	40
2.	Guidance	40

N.	Periodic Review and Update.....	41
1.	Planning Objective	41
2.	Guidance	41
APPENDIX A: TRANSPORTATION ACCIDENTS/INCIDENTS INVOLVING RADIOACTIVE MATERIALS (1971-1997)		A-1
A.1	Introduction.....	A-1
A.2	Reporting Requirements for Transportation Accidents/Incidents Involving Radioactive Materials	A-1
A.3	Analysis of U.S. Radioactive Materials Transportation Accident/Incident Data	A-2
A.3.1	Historical Overview.....	A-2
A.3.2	Accidents Involving Type B Packages.....	A-5
A.3.3	Accident Involving Type A Packages	A-6
A.4	Summary and Conclusions	A-7
APPENDIX B: FEDERAL REGULATORY RELATIONSHIPS FOR COMMERCIAL TRANSPORTATION OF RADIOACTIVE MATERIALS		B-1
APPENDIX C: FEDERAL AND PRIVATE-SECTOR AGENCY EMERGENCY ROLES AND CONTACTS		C-1
C.1	Roles and Responsibilities	C-1
C.1.1	Federal Agencies	C-1
C.1.2	Private-Sector Organizations	C-5
C.2	Contact Information.....	C-5
C.2.1	Federal Agencies	C-5
C.2.2	Private-Sector Organizations	C-23
APPENDIX D: TRAINING RESOURCES.....		D-1
D.1	U.S. Department of Agriculture	D-1
D.2	U.S. Department of Defense	D-1
D.3	U.S. Department of Energy.....	D-2
D.4	U.S. Department of Transportation	D-2
D.5	U.S. Environmental Protection Agency.....	D-3
D.6	Federal Emergency Management Agency	D-3
D.7	U.S. Nuclear Regulatory Commission	D-4
APPENDIX E: PUBLIC LIABILITY COVERAGE FOR TRANSPORTATION OF RADIOACTIVE MATERIALS		E-1
E.1	Price-Anderson Act: Nuclear Incidents	E-1
E.2	Incidents Not Covered by Price-Anderson Indemnification.....	E-7
E.3	National Contingency Plan/Superfund	E-8
E.3.1	Superfund Response Liability	E-8

E.3.2 Statutory Provision E-8
E.3.3 Cost Recovery E-9

APPENDIX F: INTERNATIONAL SYSTEM OF UNITS
FOR RADIOACTIVE MATERIALS F-1

F.1 Introduction F-1
F.2 Definitions and Abbreviations F-1
F.3 Conversions F-2
F.3.1 Quantity (Activity) F-3
F.3.2 Radiation Level (Dose Equivalent Rate) F-3
F.4 Use of Conversion Factors F-3

APPENDIX G: TRANSPORTATION ACCIDENT CASE STUDIES G-1

G.1 Case No. 1: Radiopharmaceuticals G-1
G.1.1 Accident Description and Response G-1
G.1.2 Related Notes G-1
G.2 Case No. 2: Industrial Sources G-2
G.2.1 Accident Description and Response G-2
G.2.2 Related Notes G-2
G.3 Case No. 3: Fuel-Cycle Shipments G-2
G.3.1 Accident Description and Response G-2
G.3.2 Related Notes G-3
G.4 Case No. 4: Nuclear Reactor Components G-3
G.4.1 Accident Description and Response G-3
G.4.2 Related Notes G-3
G.5 Case No. 5: Nuclear Spent Fuel G-3
G.5.1 Accident Description and Response G-3
G.5.2 Related Notes G-4
G.6 Case No. 6: Industrial Sources for Exempt Devices G-4
G.6.1 Accident Description and Response G-4
G.6.2 Related Notes G-4
G.7 Case No. 7: Type B Packages — Radiography Devices G-4
G.7.1 Accident Description and Response G-4
G.7.2 Related Notes G-5

APPENDIX H: MODAL STUDY OF SPENT FUEL TRANSPORTATION H-1

H.1 Definition and Results of Study H-1
H.2 Shipping Casks and Standards H-1
H.3 Level of Protection Results H-2

APPENDIX I:	USE AND RESPONSE OF CIVIL DEFENSE INSTRUMENTS.....	I-1
I.1	Introduction.....	I-1
I.2	Instrument Use.....	I-1
I.3	Response Capabilities.....	I-2
I.3.1	CD V-700.....	I-2
I.3.2	CD V-715.....	I-3
APPENDIX J:	RADIATION DETECTION EQUIPMENT.....	J-1
J.1	Scintillation Counters.....	J-1
J.2	GM and Ionization Chamber Survey Instruments.....	J-2
J.3	Gas Proportional Detectors.....	J-3
J.4	Pressurized Ionization Chambers.....	J-4
J.5	Neutron Sources and Detectors.....	J-4
J.6	Pocket Ionization Chambers and Dosimeters.....	J-5
J.7	Digital Electronic Dosimeters.....	J-6
APPENDIX K:	REQUIREMENTS FOR MUTUAL-AID AGREEMENTS.....	K-1
APPENDIX L:	PACKAGING CATEGORIES.....	L-1
L.1	Excepted Packaging for Limited-Quantity Materials.....	L-1
L.2	Low-Specific-Activity and Surface-Contaminated Objects Packaging.....	L-2
L.3	Type A Packaging.....	L-3
L.4	Type B Packaging.....	L-4
L.5	Fissile Radioactive Materials Packaging.....	L-4
L.6	Summary.....	L-5
APPENDIX M:	PACKAGING ILLUSTRATIONS.....	M-1
M.1	Typical Type A Packaging Configurations.....	M-1
M.2	Typical Type B Packages.....	M-4
M.3	Fissile Radioactive Material Packaging.....	M-6
M.4	Typical Packages for Radioactive Waste.....	M-9
APPENDIX N:	SHIPMENT IDENTIFICATION FOR TRANSPORTATION OF RADIOACTIVE MATERIALS.....	N-1
N.1	Introduction.....	N-1
N.2	Shipping Paper Requirements.....	N-2
N.2.1	Basic Requirements.....	N-2
N.2.2	Additional Requirements.....	N-2
N.2.3	Other Information and Examples of Shipping Paper Entries.....	N-3
N.2.4	Documentation for Excepted Packages.....	N-5

N.2.5	Shipper's Certification Statements	N-5
N.2.6	Proper Shipping Names for Fissile Materials	N-6
N.3	Marking Requirements	N-6
N.3.1	Basic Requirements	N-6
N.3.2	Liquid Marking Requirements	N-7
N.3.3	Radioactive Materials	N-7
N.3.4	Bulk Radioactive Material Packages	N-7
N.4	Labeling Requirements	N-8
N.5	Placarding Requirements	N-10
N.5.1	Placarding by Carrier	N-10
N.5.2	Placarding for Exclusive-Use Shipments of LSA and SCO by Shipper	N-10
N.6	Emergency Response Information Requirements	N-10
N.6.1	Applicability	N-10
N.6.2	Specific Requirements	N-11
N.6.3	2000 Emergency Response Guidebook	N-11
APPENDIX O: BIBLIOGRAPHY AND USEFUL REFERENCES		O-1
O.1	Bibliography	O-1
O.2	Useful References	O-8
O.2.1	Statutes	O-8
O.2.2	Regulations	O-8
O.2.3	Guidelines and Safety Standards	O-9
O.2.4	Reports and Publications	O-17
O.2.5	Videos	O-18
O.2.6	Miscellaneous References	O-19
APPENDIX P: DOCUMENT SOURCES AND INTERNET WEBSITES		P-1
P.1	Document Sources	P-1
P.1.1	International Agencies	P-1
P.1.2	Federal/State Agencies	P-2
P.1.3	Private Organizations	P-6
P.2	Internet Websites	P-8
P.2.1	Federal, State, and International Sites	P-9
P.2.2	Private-Sector Hazardous Materials Emergency Resource Sites	P-11

Figures

Figure N-1: Package Labels	N-8
Figure N-2: Vehicle Placard.....	N-10

Tables

Table A-1: U.S. Radioactive Materials Transportation Events (1971–1997).....	A-3
Table A-2: Search Code Classification for Incident Reports (1991–1997).....	A-3
Table A-3: Transport Mode Classification for Incident Reports (1991–1997)	A-4
Table A-4: Package Classification for Incident Reports (1991–1997)	A-4
Table A-5: Package Response for Reported Accidents (1971–1997).....	A-4
Table A-6: Summary of 60 Accidents Involving Type B Packages (1971–1997)	A-5
Table B-1: Current Federal Regulations Covering Radioactive Materials Transportation and Transportation Safety	B-2
Table F-1: Multiplication Factors, Numerical Prefixes, and Symbols for Radiological Units.....	F-2
Table I-1: Some Common Radionuclides and Detection Capabilities of Two CD V Radiation Survey Instruments	I-4
Table J-1: Radiation Survey Instruments	J-6
Table N-1: Most Commonly Used Proper Shipping Names for Radioactive Material.....	N-1
Table N-2: Less Frequently Encountered Proper Shipping Names for Radioactive Materials that Present a Subsidiary Hazard	N-1
Table N-3: Label Category Based on TI and Surface Radiation Level.....	N-9
Table N-4: ERG2000 Guide Numbers and Corresponding UN Identification Numbers.....	N-13

This page is intentionally left blank

ABBREVIATIONS AND ACRONYMS¹

AEA	Atomic Energy Act
AFB	Air Force Base
ALARA	as low as reasonably achievable
ANSI	American National Standards Institute
BF ₃	boron trifluoride
CERCLA	Comprehensive Environmental Response, Compensation, and Liability Act
CFR	Code of Federal Regulations
CH-TRU	contact-handled transuranic
CRWM	Civilian Radioactive Waste Management
CRCPD	Conference of Radiation Control Program Directors
DHHS	U.S. Department of Health and Human Services
DOD	U.S. Department of Defense
DOE	U.S. Department of Energy
DOT	U.S. Department of Transportation
DPH	Department of Public Health
DRD	direct-reading dosimeter
DTRA	Defense Threat Reduction Agency
EAS	Emergency Alert System
EBS	Emergency Broadcast System
EMS	emergency medical services
ENO	extraordinary nuclear occurrences
EOC	emergency operations center
EOP	emergency operations plan
EPA	U.S. Environmental Protection Agency
ERG2000	<i>2000 Emergency Response Guidebook</i>
FAA	Federal Aviation Administration
FEMA	Federal Emergency Management Agency
FHWA	Federal Highway Administration
Fiedler	field instrument for the detection of low-energy radiation
FMCSA	Federal Motor Carrier Safety Administration
FR	Federal Register
FRERP	Federal Radiological Emergency Response Plan
FRMAC	Federal Radiological Monitoring and Assessment Center
FRPCC	Federal Radiological Preparedness Coordinating Committee
FRA	Federal Railroad Administration

¹ The Glossary (see page xxiii) provides definitions and descriptions of many of the abbreviations and acronyms found in this publication.

GM	Geiger-Mueller
HLW	High-Level Waste (Radioactive)
HMIR	Hazardous Material Incident Report
HRCQ	Highway Route Controlled Quantity
IAEA	International Atomic Energy Agency
IATA	International Air Transport Association
IC	Incident Commander
ICAO	International Civil Aviation Organization
ICS	Incident Command System
IMO	International Maritime Organization
IP	Industrial Package
IRF	Initial Response Force
JIC	Joint Information Center
JIS	Joint Information System
JNACC	Joint Nuclear Accident Coordinating Center
LED	light-emitting diode
LFA	Lead Federal Agency
LLW	Low-Level Waste (Radioactive)
LQ	Limited Quantity
LSA	Low Specific Activity
NARP	Nuclear Weapon Accident Response Procedures
NCAI	National Congress of American Indians
NCP	National Contingency Plan
NDA	National Defense Area
NETC	National Emergency Training Center
n.o.s.	not otherwise specified
NRC ²	U.S. Nuclear Regulatory Commission
NRT	National Response Team
NSA	National Security Area
OCRWM	Office of Civilian Radioactive Waste Management
OD	outside diameter
OSHA	Occupational Safety and Health Administration
PAG	Protective action guide
PL	public law

² In this publication, the initials NRC will be used exclusively for the U.S. Nuclear Regulatory Commission. Other entities having the same initials will be spelled out.

RAP	Radiological Assistance Program
RCO	Regional Coordinating Office
RCRA	Resource Conservation and Recovery Act
REAC/TS	Radiation Emergency Assistance Center/Training Site
REP	Radiological Emergency Preparedness
RF	radio frequency
RMIR	Radioactive Material Incident Report
RQ	reportable quantity
SARA	Superfund Amendments and Reauthorization Act
SCO	Surface Contaminated Object
SECOM	Security Command
SI	International System of Units
SLG	State and Local Guide
SNF	Spent Nuclear Fuel
SNL	Sandia National Laboratory
SNM	Special Nuclear Material
SSEB	Southern States Energy Board
TEPP	Transportation Emergency Preparedness Program (DOE)
TI	transport index
TLD	thermoluminescent dosimeter
TRU	transuranic
UF ₆	uranium hexafluoride
UN	United Nations
U ₃ O ₈	uranium oxide
USC	United States Code
USCG	U.S. Coast Guard
USDA	U.S. Department of Agriculture
USPS	U.S. Postal Service
WIPP	Waste Isolation Pilot Plant
WIEB	Western Interstate Energy Board

Units of Measure

Bq	Becquerel
Ci	Curie
cm ²	square centimeter
cpm	counts per minute
d	day

eV	electron-volt
ft	foot
ft ³	cubic foot
g	gram
GBq	GigaBequerel
Gy	Gray
h	hour
in.	inch
J	joule
keV	kiloelectron-volt
kg	kilogram
kR	kiloRoentgen
L	liter
lb	pound
m	meter
m ³	cubic meter
mCi	millicuries
mg	milligram
mi	mile
min	minute
mR	milliRoentgen
mrem	millirem
mSv	milliSievert
μR	microRoentgen
ηCi	nanocuries
R	Roentgen
rad	Radiation Absorbed Dose
r	rem
Sv	Sievert
TBq	teraBecquerel
yr	year

GLOSSARY

A₁ and A₂ — Values for the radioactivity assigned for each of the more than 300 radionuclides listed in DOT and NRC regulations that indicate the maximum amount, in curies (trillion Bq), of the radionuclide that may be transported in a Type A package. A₁ is the number of curies (Ci) when the radioactive material is in Special Form; A₂ is the amount that may be transported when the radioactive material is in Normal Form (non-Special Form).

Agreement State — A State that has entered into an agreement under the Atomic Energy Act (AEA) of 1954, as amended, in which the NRC has relinquished to such State the majority of its regulatory authority over source material, byproduct, and special nuclear material (SNM) in quantities not sufficient to form a critical mass. See Appendix C, Section C.2.1, for a display of the Agreement States.

Alpha (α) Radiation — Energetic particles emitted from radionuclides that travel up to 2 centimeters (cm) in air before being absorbed. Alpha particles are easily shielded with materials such as paper and skin and pose no health threat from external exposure. However, alpha particles may pose an internal hazard and could cause tissue damage when they are absorbed into the body through inhalation or ingestion.

As Low As Reasonably Achievable (ALARA) — The process of maintaining safety procedures that limit worker exposure to radiation at levels below the applicable dose limits — as far below as reasonably attainable.

Becquerel (Bq) — A unit used to measure radioactivity. One Bq is that quantity of a radioactive material that will have one transformation in one second. Often radioactivity is expressed in larger units like thousands (kiloBequerels [kBq]), millions (megaBequerels [MBq]), billions (gigaBequerels [GBq]), or even trillions (teraBequerels [TBq]). There are 3.7×10^{10} Bq in one Ci (see Appendix O, Bibliography item 72, for more information).

Beta (β) Radiation — Energetic particles emitted from radionuclides that usually travel up to 2 meters (m) in air before their energy is absorbed. Beta particles present both external and internal hazards. At high intensities they can cause burns on the exposed surfaces of the skin and the eye; and if absorbed into the body through inhalation or ingestion, they can cause serious tissue damage. Beta particles may be easily shielded with such common materials as wood or aluminum.

Byproduct Material — Any radioactive material (except special nuclear material) resulting from or made radioactive by exposure to the radiation that results from the process of producing or utilizing special nuclear material.

Contact-Handled Transuranic Waste (CH-TRU) — Transuranic waste materials that emit primarily alpha radiation that does not result in high radiation levels outside unshielded inner packages. Radiation levels are low enough that these wastes can be handled without remote equipment.

Curie (Ci) — A measure of the radioactivity of 1.0 gram (g) of radium, equal to 37 billion disintegrations per second (i.e., 1 curie equals 3.7×10^{10} Bq). Appendix F provides International System of Units (SI) unit conversions.

Decay — The decrease in activity of any radionuclide over time caused by the spontaneous emission of alpha particles, beta particles, or gamma rays from the nuclei of the atoms. The rate of decay for a radionuclide is related to its half-life.

Drill — An event involving organizational responses to a simulated accident in order to develop, test, and maintain specialized emergency skills that constitute one or more components of an emergency plan and procedures.

Exempted Package — A package containing quantities of radioactive material that are so limited in activity that they are exempt from most requirements specified in the Federal regulations. Package limits are listed in 49 CFR §173.425.

Exclusive-Use — Shipments made with special written arrangements between the shippers, carriers, and receivers to control conditions and activities while the shipment is in transport. These arrangements may provide relief from some regulatory requirements (see 49 CFR §173.403). Exclusive-use provisions made to the carrier (in writing) specify the initial, intermediate, and final loading and unloading arrangements.

Exercise — An event involving organizational responses to a simulated accident with radiological and other hazardous consequences. The purpose of an exercise is to test the integrated capabilities of involved organizations to implement emergency functions described in emergency plans and procedures.

Fissile — Radioactive materials capable of undergoing nuclear fission and sustaining a chain reaction when in a particular geometric configuration, and thus require controls to ensure nuclear criticality safety during transportation. Fissile materials include plutonium-238, plutonium-239, plutonium-241, uranium-233, and uranium-235.

Gamma (γ) Radiation — Electromagnetic radiation (i.e., photons of energy) of short wavelength and high energy emitted from the nucleus of radionuclides. Gamma radiation travels a greater distance in air than either alpha or beta particles before being absorbed. Gamma radiation is very penetrating and is best stopped or shielded by dense materials such as lead or depleted uranium. Gamma radiation and x-rays are considered “whole body” external radiation hazards.

Half-Life — The time required for the activity of a radionuclide to decrease to half of its initial radioactivity due to radioactive decay.

High-Level Radioactive Waste (HLW) — Radioactive waste that includes (1) irradiated reactor fuel; (2) liquid wastes resulting from the operation of a first-cycle solvent extraction system, or equivalent, in a facility for reprocessing irradiated reactor fuel; and (3) solids derived from such liquid wastes (see 10 CFR 60.2).

Highway Route Controlled Quantity (HRCQ) — A Type B quantity package that has additional constraints imposed during its transportation. The HRCQ quantity is 3,000 times the Type A quantity or 27,000 Ci (1,000 [TBq]), whichever is less. Routing and other carrier requirements are described in the Federal Motor Carrier Safety regulations of 49 CFR §397.

Industrial Package (IP) — Three types of industrial packages (IP-1, IP-2, and IP-3) and their performance requirements are described in 49 CFR §173.411. Each must meet specific packaging tests, and records of these tests must be retained. As the radiological hazards associated with the contents of the low-level radioactive material package increase from LSA-I to LSA-III or SCO-I to SCO-II, the package durability should increase from IP-1 to IP-3.

Ingestion Pathway — The presence of radionuclides on crops, vegetation, bodies of water, and ground surfaces resulting from a radioactive materials release that poses a potential health risk through exposure or intake of contaminated food (such as milk, fresh fruits, and vegetables) and/or water.

Labels — The 100-mm (4-inch) square-on-point warning, placed on hazardous material packages that identifies the categories of hazardous material contained in the package. A characteristic name, symbol and/or number identify the hazard category for the material in the package. Radioactive material packages require a label on opposite sides (unless excepted). Each of the three radioactive label categories (White – I, Yellow – II, or Yellow – III) bears the unique trefoil symbol for radiation as prescribed in 49 CFR §172. See Appendix N for more details on labeling.

Low-Level Radioactive Waste (LLW) — Waste material generated in almost all activities involving radioactive materials, from the production, use, cleanup, and decontamination activities. LLW typically pose a low-level of radiological risk, a limited health hazard, and is usually disposed of by shallow land burial. See Appendix L under Section L.2 for more details on LLW.

Low Specific Activity (LSA) Material — Material in which the radioactivity is essentially distributed uniformly and in which the estimated concentration per gram of content does not exceed the specifications of 49 CFR §173.403. Radiological hazards are limited because of the low amount of activity per unit weight of the material. Depending on radiological hazards, these materials may be shipped either packaged or unpackaged.

National Defense Area (NDA) — A designated geographic area surrounding the site of a nuclear weapon accident when DOD has custody of the weapons and controls access to the area. Specially trained and equipped DOD or DOD-designated personnel are in charge of eliminating any hazard and correcting the situation within the NDA.

National Security Area (NSA) — A designated geographic area surrounding the site of a nuclear weapon accident when DOE has custody of the weapons and controls access to the area.

Normal Form — Materials that, because of their physical form, might present some possibility of contamination or direct radiation if released from a package. These materials may be in a liquid or powder form in glass receptacles that are not special form encapsulations and are more likely to be dispersible. All materials are normal form if not classified special form.

Package — Radioactive material or components as presented for transportation, including the material's packaging.

Packaging — For radioactive materials, the assembly of components necessary to ensure compliance with the packaging requirements of 49 CFR §173. In particular, packaging may consist of one or more receptacles, absorbent materials, spacing structures, thermal insulation, radiation shielding, and/or devices for cooling or absorbing mechanical shocks. The transporting vehicle, tie-down system, and auxiliary equipment may sometimes be designated as part of the packaging (49 CFR §173.403).

Placard — A 273-mm square-on-point hazard warning posted on transport vehicles or freight containers. The category of hazardous materials inside is characterized by symbols, colors, names and numbers. For radioactive material the upper half of the placard is yellow with the characteristic black trefoil that symbolizes radiation. The hazard class number "7" appears in the lowest corner. For some international shipments the placard may be in the same format as a radioactive material label. For more information, see Appendix N.

Protective Action Guide (PAG) — The projected dose to reference man (or other defined individual), resulting from an unplanned release of radioactive material, at which radiation professionals recommend a specific protective action to reduce or void that dose. The PAG values should reflect a balance of risks and costs to onsite personnel, public health and safety, and the environment weighed against the benefits obtained from specific protective actions.

Quality Factor — The modifying factor (listed in Tables 1004[b].1 and 1004 [b].2 of 10 CFR §20.1004 that is used to derive dose equivalent from absorbed dose.

Rad — A measure of the radiation dose absorbed by a material or recipient. One rad is equal to an absorbed dose of 100 ergs/g or 0.01 joules per kilogram (J/kg) (0.01 Gray [Gy]). The rad is being replaced by Gy, which is the equivalent of 100 rad.

Radiation Authority — An official designated either by a Federal, State/provincial agency or state/province. The responsibilities of this authority include evaluating radiological hazards during normal operations and during emergencies. In planning for and responding to most transportation incidents, the radiation authority a State official (see Section II.A.1.)

Radioactive Material — In transportation, any material having a specific activity greater than 70 Bq/g or 2 nanocuries (η Ci) (see the definition of "specific activity").

Radionuclides/Radioisotopes — For purposes of this document, these terms are synonymous and identify specific isotopes of chemical elements that have radioactive properties. A radionuclide is an unstable isotope that spontaneously disintegrates, emitting ionizing radiation.

Rem — A rem is a specific unit of any of the quantities expressed as dose equivalent, which is equal to the absorbed dose (in rads) multiplied by the quality factor (1 rem equals 0.01 Sv).

Roentgen (R) — A unit of radiation exposure equal to the quantity of x-ray or gamma ionizing radiation that will produce one electrostatic unit of electricity in 1 cubic centimeter (cm^3) of dry air at 0°C and standard atmospheric pressure.

Sievert (Sv) — A unit of radiation dose. The Sievert is the SI unit of any of the quantities expressed as dose equivalent. The dose equivalent (in Sv) is equal to the absorbed dose (in Gy) multiplied by the quality factor (1 Sv = 100 rem).

Special Form - Materials that satisfy the following conditions: (1) either a single solid piece or contained in a sealed capsule that may be opened only by destroying the capsule; (2) piece or capsule has at least one dimension not less than 5 millimeters; and (3) satisfies the test requirements of 49 CFR §173.469. These materials present little or no possibility of contamination, but present a probable external radiation hazard if they come out of their shielded packaging.

Special Nuclear Material (SNM) — Plutonium 239, uranium enriched in isotopes 233 or 235, any material artificially enriched by any of these elements, or any other material that NRC, pursuant to the provisions of Section 51 of the AEA, determines to be special nuclear material, not including source material.

Specific Activity – The activity of the radionuclide per unit mass of that nuclide. The specific activity of a material in which the radionuclide is essentially uniformly distributed is the activity per unit mass of the material.

Spent Fuel — Nuclear reactor fuel that has been used in a nuclear reactor and that contains large amounts of highly radioactive fission products and is no longer producing power via the fission process.

Surface Contaminated Object (SCO) – A solid object that is not itself radioactive but that has radioactive material distributed on any of its surfaces. See 49 CFR §173.403 for a more detailed definition.

Transport Index — A number placed by the shipper on Yellow – II or Yellow – III labels on a package to denote the degree of control to be exercised by the carrier (i.e., to determine the number of yellow-labeled packages that may be placed in a single vehicle or storage location, whereas in most cases, the limit is a total of 50 TI). The TI is either the highest measured dose rate of radiation (1 mrem/h or $10 \mu\text{Sv/h}$) at 1 m from the surface of the package or a number assigned for criticality control.

Transuranic Elements — Elements above uranium in the periodic table; that is, with an atomic number greater than 92. All 13 known transuranic elements are radioactive. They are generally more hazardous if inhaled or ingested because they are primarily alpha emitters. The most frequently transported transuranic elements are californium, plutonium, curium, and americium.

Transuranic Waste — Any waste with measured or assumed concentrations of transuranic radionuclides exceeding 3.7 kBq/g (0.1 μ Ci/g). Most TRU waste is generated from the manufacture of plutonium for nuclear weapons.

Type A Packaging — Packaging that is designed in accordance with the performance requirements in 49 CFR §173.412. These criteria are adequate to prevent the loss or dispersal of radioactive contents and to retain the shielding efficiency if the package is subjected to the prescribed tests (49 CFR §173.412 and §173.465) that represent normal, rough handling conditions of transport.

Type A Quantity — The maximum quantity (A_1 or A_2) of radioactive material that may be transported in a Type A packaging (49 CFR §173.431). The A_1 and A_2 values in the regulations have been computed for each radionuclide to limit the dose to workers or responders to non-life endangering doses in the event of a Type A package failure during transport.

Type B Packaging — Packaging that meets the standards for Type A packaging and the standards for the hypothetical transport accident conditions prescribed in 10 CFR 71. Type B package design and testing simulate very severe transport accidents and demonstrates that life-endangering quantities of radioactive materials are not expected to be released in an accident.

Type B Quantity — Any quantity of radioactive material that exceeds Type A quantity and must be transported in Type B packaging.

United Nations (UN) Identification Number — An identification number assigned to hazardous materials listed in 49 CFR §172.101. UN identification numbers are used to identify hazardous materials for domestic and/or international shipments and are marked on the outside of all radioactive materials packages.

Uranium Hexafluoride (UF_6) — A corrosive chemical that is shipped in large amounts in heavy cylinders as part of the nuclear fuel cycle. The greater hazard is that UF_6 reacts with water or water vapor to form toxic and corrosive hydrogen fluoride gas, which can be fatal when inhaled.

Yellowcake — A uranium ore concentrate known as uranium diuranate, consisting mostly of U_3O_8 . It is usually yellow-green in color and is produced by processing uranium ores. It is transported as LSA to facilities where it is commonly converted to uranium hexafluoride.

I. INTRODUCTION

A. Purpose

The purpose of FEMA-REP-5, Revision 2, is to provide guidance to State, Tribal, and local governments in developing emergency response plans and procedures along with preparedness measures for transportation accidents involving radioactive materials. Use of this guidance is voluntary. It is intended to:

- Provide a basis for incorporating responses to transportation accidents involving radioactive materials into State, Tribal, and local Emergency Operations Plans (EOPs).
- Identify the principal elements involved in preparedness for and response to transportation accidents involving radioactive materials.
- Provide a common reference for the review and evaluation of emergency response plans and preparedness measures.

Jurisdictional planners are encouraged to use this document to integrate plans for transportation incidents involving radioactive materials into their all-hazards plan as an annex. FEMA's *Guide for All-Hazard Emergency Operations Planning*, State and Local Guide (SLG) 101 is a useful planning guide (see Appendix O, Bibliography item 31).

About 300 million domestic materials shipments per year are categorized as hazardous.³ Of the hundreds of millions of packages sent in these shipments, only about 5 to 10 million contain radioactive materials, mostly of radioisotopes for medical, research, and industrial applications. Some packages contain small amounts of radioactive material incorporated into such consumer products as smoke detectors, luminous watches, and electrical devices. This packaging is simple in design and can usually be shipped without markings and labels.

DOE is now conducting major shipping campaigns of radioactive material and many more are anticipated, including the shipment of transuranic (TRU) waste to the Waste Isolation Pilot Plant (WIPP). Over the next 35 years, a maximum of 6.2 million cubic feet (ft³) of TRU waste will be disposed at WIPP from 23 (10 major) generator and storage sites throughout the United States. DOE estimates that nearly 38,000 shipments of TRU waste in Type B packages will travel from these sites. This number represents only a small fraction of the total number of radioactive materials shipments in the United States.

During the more than 50 years that radioactive materials have been shipped domestically, there have been relatively few accidents. Appendix A contains a report of the incidents that occurred from 1971–1997. In the reported 1,906 transportation accidents and incidents — of which only

³ This information is from NRC's *Final Environmental Statement of the Transportation of Radioactive Material by Air and Other Modes* (see Appendix O, Bibliography item 49)

400 were actual transportation accidents — there have been no deaths or injuries that can be attributed to the radioactive nature of the cargo. In the one instance of damage to a spent fuel cask (December 8, 1971), no release occurred. For reviews and assessments of three transportation emergency response operations, see Appendix O, Bibliography items 42, 46, and 47.

State, Tribal, and local authorities should anticipate a possible increase in the number of vehicle accidents that might occur with any increase in traffic. Health physics professionals who respond to accidents involving radioactive materials have an advantage in gauging the degree of risk or exposure posed by an accident. These responders, trained in radiological monitoring, can use portable instruments to obtain real-time measurements of radiological exposure or contamination. Although no one instrument can detect all types of radionuclides, a responder who knows what radionuclide may be present and whether that radionuclide emits gamma, beta, alpha, or neutron radiation can select the proper monitoring instrument and take measures to prevent exposure or to minimize the further spread of contamination (see Appendices I and J).

However, the enforcement by Federal, State, Tribal, and local agencies of packaging regulations and safety measures during shipment and handling of hazardous materials promises to keep the accident risk at a low level. State, Tribal, and local government agencies are encouraged to prepare and maintain emergency plans, and to exercise plans, equipment, and personnel regularly.

The paramount concern of regulators, planners, and shippers is the health and safety of freight handlers and the populations through which radioactive materials are transported. An excellent safety record has been compiled over the years. However, a few persistent emergency response problems are encountered when transportation accidents involve hazardous materials, such as radioactive materials:

- Lack of coordination among responsible agencies;
- Failure to appoint a predesignated official to serve as the local incident commander (IC) or on-scene coordinator;
- Lack of involvement by shipper and carrier organizations in the State, Tribal, and local emergency response planning and preparedness programs;
- Inadequate communication between persons at the accident scene and persons representing emergency response agencies not at the accident scene; and
- Overreaction by the public because of failure of Federal, State, Tribal, and local government response organizations to develop accurate and timely communications with the news media.

Adoption of the ICS can solve most of these problems (Appendix K provides a brief description of ICS and see Appendix O, Bibliography items 73 and 74).

B. Scope

FEMA-REP-5, Revision 2 provides general information on the types of radioactive materials transported, how they are transported, and the likely consequences in the event of an accident. The document also provides general guidance for State, Tribal, and local agencies on the content of emergency plans and preparedness measures for responding to such accidents. It does not provide guidance for transportation emergencies relating to the physical protection of nuclear weapons and weapon materials.

C. General Information

1. Federal Involvement

Federal agencies become involved in responding to an emergency when specifically requested to do so by State, Tribal, or local government officials who are faced with a situation beyond their capability to protect life and property. The Federal Radiological Emergency Response Plan (FRERP) establishes "...an organized and integrated capability for timely, coordinated response by Federal agencies to peacetime radiological emergencies." DOE is the primary agency for providing radiological monitoring and assessment assistance in most instances. However, if the radioactive source involved in the transportation accident is unknown, unidentified, or from a foreign country (e.g., reentry of a foreign-owned space object such as a communications satellite), EPA will be responsible for coordinating the Federal response. In most cases, EPA will respond under the NCP consistent with its statutory authorities. The NRC, FEMA, and many other agencies also provide assistance as part of the FRERP. There is a possibility that the NCP may become the dominant plan for a Federal response to radiological incidents.

It should be noted that §104(a)(4) of the Comprehensive Environmental Response, Compensation, and Liability Act (CERCLA) of 1980, allows the President to "...respond to any release or threat of release, if in the President's discretion, it constitutes a public health or environmental emergency and no other person with the authority and capability to respond to the emergency will do so in a timely manner."

The support to State, Tribal, and local governments that DOE can bring to the scene of an accident ranges from giving technical advice over the telephone to sending highly trained personnel and state-of-the-art equipment to the accident site to help identify and minimize the radiological hazard. Plans developed at all levels of government for responding to a transportation emergency involving radioactive material should address these Federal resources (see Section II.B).

2. Nuclear Weapons: A Special Case

While State, Tribal, and local governments have the primary role in handling transportation accidents, the U.S. Department of Defense (DOD) and/or DOE have the primary role in responding to nuclear weapons transportation accidents within designated areas because of inherent national security concerns. These areas are designated as National Defense Areas

(NDAs) if DOD has custody of the weapons and as National Security Areas (NSAs) if DOE has custody of the weapons. State, Tribal, and local governments retain the primary role for releases and consequences impacting areas outside of either NSAs or NDAs. The State, Tribal, and local governments should be involved and concerned about on-site recovery within an NSA or NDA in instances where these areas will be returned to their control. EPA may be called to the scene to address off-site contamination if the responsible party (public or private) fails to address the spread of contamination that poses a possible imminent and substantial danger to public health and the environment. (For further explanations of NDAs and NSAs, see Section II.B.6.)

The extent to which State, Tribal, and local governments should incorporate planning and preparedness activities for nuclear weapons into their transportation plans can be guided by two documents: (1) *Guidance and Information on Nuclear Weapons Accident Hazards, Precautions and Emergency Procedures*, and (2) *Nuclear Weapon Accident Response Procedures (NARP) Manual* (see Appendix O, Bibliography items 7 and 8). Appendix C, Section C.2., provides information for contacting DOE's Albuquerque Operations Office or DOD's Joint Nuclear Accident Coordinating Center (JNACC) for incidents involving nuclear weapons.

3. Federal Policy Toward Indian Tribes and Nations

Every U.S. President since Richard Nixon has issued a policy statement to Federal agencies regarding the "unique legal relationship with Native American Tribal governments" in order to ensure that the sovereignty of Tribal governments is respected. A memorandum by President Clinton dated April 29, 1994, which appeared in the FR (Volume 59, Number 85, May 4, 1994, page 22951) contains a similar statement. FEMA and other Federal agencies are committed to working with Indian Tribes to develop radiological emergency response plans and preparedness measures for transportation accidents to ensure that public health and safety are protected. An example of one agency's commitment is the draft policy document prepared by FEMA (see Appendix O, Bibliography item 25.) Full support is given for the government-to-government relationship with all Federally recognized Tribes. Among other things, these efforts are intended to enhance the spirit of cooperation and partnership not only between FEMA and Tribal governments, but also among the governments of "neighboring Tribes, States, local governments, and nations."

4. General Statements About Planning

FEMA-REP-5 contains 14 planning elements and related guidance considerations. In order to expedite internal review and evaluation of emergency plans developed in accordance with this guidance, it is recommended that either each plan's format reflect the order of the 14 planning elements or that a convenient cross-reference guide be incorporated into the plan.

A more detailed explanation of the roles of State, Tribal, local, and Federal governments (as well as shippers and carriers) in handling transportation accidents is provided in Section II. In addition, Appendix A includes a brief discussion of the statistics for transportation

accidents. In order for State, Tribal, and local governments to identify potential sources of Federal assistance, Section II.B also includes a brief discussion of such assistance for inclusion in emergency response plans.

Because of the broad coverage of this document, users should adapt the guidance to their specific needs. Preparedness activities and plans developed with the help of this document should be integrated into other emergency management functions and responsibilities, especially those for radiological emergencies and hazardous materials accidents. This guidance is intended to complement or supplement other planning guidance, such as the *Guide for All-Hazard Emergency Operations Planning*, SLG 101.

Because of the regulated nature of radioactive materials shipments (e.g., limited levels of radioactivity per package, limited quantities per shipment, and protective packaging), in nearly all cases, any release would be limited to a very small area. Although some types of incidents are highly unlikely, governmental authorities are obligated to plan a response because of legal and humanitarian considerations to protect life and property. Thus, planning should include the protection of animal and human food supplies in the event of radioactive contamination of crops and livestock. Public perception is another important factor for governmental planners to consider when planning a response to potential releases.

5. Overview of Laws and Regulations

Under Title III of the Superfund Amendments and Reauthorization Act (SARA) of 1986, voluntary planning is encouraged by State, Tribal, and local governments and involved private organizations for hazardous materials contingencies at fixed facilities and in transportation. However, emergency planning for contingencies involving extremely hazardous substances is required of local communities where such substances are used or transported. Because EPA has not designated radioactive materials as extremely hazardous substances, there is no requirement under SARA for State, Tribal, and local governments to plan for transportation accidents involving radioactive materials. If technical assistance from Federal agencies is desired for developing or evaluating State, Tribal, and local government planning and preparedness, requests for such assistance may be made to specific agencies or to FEMA. Appendix C, Section C.2 provides contact information for several Federal agencies.

Regulations established by the Occupational Safety and Health Administration (OSHA), U.S. Department of Labor, govern the development of plans and specify training requirements for agencies responsible for responding to hazardous materials incidents. The regulations are found in 29 CFR §1910.120, Hazardous Waste Operations and Emergency Response.

Title 49 of the United States Code (USC) has undergone an extensive recodification effort in the last few years. The Hazardous Materials Transportation Safety Act and various amending statutes previously codified at 49 USC §1801 et seq. are now included with the Hazardous Materials Transportation Authorization Act of 1994 at 49 USC §5101 et seq. DOT has responsibilities for regulating the safe transportation of hazardous materials and is

involved in emergency response training and planning. The Act requires extensive coordination with other Federal agencies to develop planning and training programs to assist non-Federal agencies in emergency response preparedness. A registration and fee program for shippers and carriers of certain hazardous materials has been developed to fund a grant program. The grant funds are distributed primarily to grantees appointed by the Governor of each State, who then distribute funds to local emergency planning committees and responders for planning and training for response to hazardous materials emergencies. Officials should inquire about such grants at their DOT Regional Offices (see Appendix C, Section C.2). Programs and activities developed as a result of this Act have a significant bearing on emergency response to transportation accidents involving radioactive materials.

II. ORGANIZATIONAL RESPONSIBILITIES

A. State, Tribal, and Local Governments

Although shippers and carriers are responsible for safety in the packaging and transport of radioactive and other hazardous materials, State, Tribal, and/or local governments are responsible for the initial response to emergencies resulting from transportation accidents and man-made or natural disasters. The appropriate agencies should be prepared to respond to a transportation accident involving radioactive materials. It is imperative that State, Tribal, and local governments identify the organizations within their jurisdiction that will be responsible from the earliest through the final phases at the scene of an accident. They must designate the respective lead agencies and title(s) of person(s) to be responsible for coordinating and implementing emergency planning, preparedness, and response functions. The ICS, as described in 29 CFR §1910.120, provides the framework for the organization at the accident scene (Appendix K provides a brief description of ICS and see Appendix O, Bibliography items 73 and 74). At minimum, first responders at a radioactive accident/incident must be trained as mandated by paragraph q. of 29 CFR §1910.120 as it applies to the duties assigned and the ability to understand and implement the actions identified in the DOT 2000 *Emergency Response Guidebook* (ERG2000) (see Appendix O, Bibliography item 17).

Federal, State, and local authorities who plan for and respond to emergencies must be aware that the Indian Tribes and Nations are autonomous; their planning and response activities must respect this autonomy. The Tribal roles and responsibilities range across the levels normally considered for Federal, State, and local governments. Therefore, all officials must recognize that effective planning and response depend on timely cooperation and communication with other officials who have similar interests and responsibilities.

One consideration that cannot be overstressed in planning and preparing to respond to emergencies is the provision for personnel training and the exercising of plans, personnel, and equipment. Preparation is inadequate without periodic testing using realistic scenarios. This testing helps ensure that the plans are adequate, equipment is usable, and that trained personnel can use the equipment and follow the plans to successfully respond to an emergency (see Section IV.M). These expectations are illustrated in two training videotapes:⁴ (1) *Using the North American Emergency Response Guide: A First Response to Incidents Involving Radioactive Materials* (by DOT), and (2) *First Response to Transportation Accidents Involving Radioactive Materials* (by CRCPD). Additional training videotapes are listed in Appendix O, Section O.2.8.

The use of FEMA's *Guide for All-Hazard Emergency Operations Planning*, SLG 101 is recommended for the preparation of EOPs at all levels of government. Plans for specific types of emergencies, such as transportation radiological incidents, should be included as annexes to the larger, comprehensive document.

⁴ Available from Copy Master Video, Inc., Villa Park, Illinois (see Appendix P).

1. State and Tribal Officials

State and Tribal officials are responsible for protecting persons within the State or Tribal jurisdiction from unwarranted radiation exposure. Their specific responsibilities should include the following:

- a. Develop and distribute to appropriate persons a radiological emergency response plan addressing Federal, State, Tribal, local, and private organizations and resources for planning, preparedness, and response;
- b. Designate one or more State and Tribal emergency radiological response team(s) and team leader(s) who have radiological response expertise;
- c. Ensure the establishment and operability of a State and Tribal communications system to communicate with Federal and local agencies involved in emergency response;
- d. Negotiate agreements with neighboring States and Tribal governments addressing responses to incidents that occur near a common border; and
- e. Prepare, or assist in preparing, and distribute implementing instructions and operational procedures to be used by State, Tribal, local, and private organizations' response forces in carrying out their respective responsibilities.
- f. Ensure that advance notification of MRC-licensed material and spent fuel shipments that are received from NRC licensees are protected as Safeguards information in accordance with 10 CFR §73.21.

2. Local Government Officials

Local government officials have the responsibility to ensure that any local emergency response plan is compatible with the State response plan. Priorities for rescue, life saving, first aid, and control of fire and other hazards are higher than the priority for measuring radiation levels. It is expected that the first responders will carry out functions for which they are trained or have the capability to perform. The local government officials should:

- a. Specify the respective roles and responsibilities of Federal, State, Tribal, local, and private organizations in their locality.
- b. Provide training to law enforcement or fire service personnel who are likely to be the first governmental responders to an accident involving radioactive materials and other hazardous material. These individuals should be trained to the level of emergency response required by 29 CFR §1910.120(q). See Appendix O, Bibliography items 41 and 42 for more details on training.

- c. Ensure that these responders are prepared to take the actions required to respond to hazardous material accidents as identified in DOT's ERG2000. These actions include the following:
- (1) Administering emergency measures to save lives and attend to the injured;
 - (2) Determining whether radioactive or other hazardous materials are present in the transportation incident and obtaining information about these materials;
 - (3) Notifying appropriate authorities to obtain radiological expertise if radioactive materials are involved;
 - (4) Determining the action required to prevent further damage to life or property; and
 - (5) Reporting the incident to proper authorities.

B. Federal Government

The role of the Federal government in responding to transportation accidents is usually one of supporting the lead role of State, Tribal, and local governments. Federal agencies generally do not become involved unless specifically requested to do so by State, Tribal, or local government officials. When a Federal agency is the shipper, that agency will provide technical information regarding the shipment through its 24-hour emergency response contact (see Appendix C, Section C.2). The agency will also perform all other shipper emergency response activities as if it was a shipper in the private-sector (see Section B.6). The response support activities that may be provided by Federal agencies are described in the FRERP (see Appendix O, Bibliography item 29). The one exception to this general rule is situations involving nuclear weapons or related devices. In such cases, DOD or DOE would have the lead response role within specially designated geographical areas (see Section I.C.2), while State, Tribal, and local government organizations would have the lead response role outside of these designated areas. These areas are isolated by Federal officials primarily to protect classified materials that may be involved in the accident.

Although the State and Tribal governments have primary responsibility for protecting public health and safety, some Federal agencies have statutory or other authority for responding to certain situations affecting public health and safety without a State's request. Section II of the FRERP, entitled "Concept of Operations," details the Lead Federal Agency (LFA) and its responsibilities and describes these authorities and situations.

FEMA coordinated the development of the FRERP through the FRPCC Subcommittee on Federal Response. The FRERP is the Federal response plan for all types of radiological emergencies, including radioactive materials transportation accidents. A copy of the FRERP, which was published May 1, 1996, can be obtained from FEMA (see Appendix P).

The following paragraphs provide information on obtaining Federal response assistance and resources for commercial transportation accidents, response concerns related specifically to radiological monitoring and assessment assistance, Federal interagency coordination, EPA's Superfund program, and military-related transportation accidents.

1. Obtaining Federal Assistance

Under the Concept of Operations described in the FRERP, the Federal agencies that would most likely be involved in responding to requests for assistance to transportation accidents involving radioactive materials are DOE, DOD, EPA, and NRC. Depending on the type of assistance and resources requested from the Federal government, other agencies could be involved in the Federal response effort (see Appendix C, Section C.1). For example, when food crops and livestock are involved in a radiological incident, USDA will assess the damage and provide other assistance as outlined in the FRERP. Contact information for these agencies (e.g., location of field offices and current telephone numbers) is provided in Appendix C, Section C.2.

Although State and Tribal governments and private-sector organizations may contact any of the Federal agencies identified (or others) to obtain Federal assistance, the DOT *North American Emergency Response Guidebook* recommends that initial requests for assistance be made through one of several private-sector organizations such as CHEMTREC; CHEMTEL, Inc.; INFOTRAC; or 3E Company (Appendix C, Section C.2 provides contact information for these organizations). Although these organizations have little radiological response capability, when they receive a report of a radiological incident, they routinely contact the appropriate State radiation authority and the appropriate DOE Regional Coordinating Office (RCO).

Technical assistance — in the form of information, advice, and evaluation — is also available upon request from the National Response Center, a joint venture between DOT and EPA. The National Response Center is the 24-hour communications center of the National Response Team (NRT), located at the U.S. Coast Guard (USCG) Headquarters. The NRT receives telephone reports of oil spills and chemical releases (see Appendix C, Section C.2 [under DOT] for contact information). The Center is involved primarily with responses to non-radioactive hazardous materials spills, but when a report of a radioactive material incident comes in to the Center, the report is immediately relayed to proper authorities for appropriate action.

Please note that contacting DOE in an emergency situation does not absolve shippers and carriers from their regulatory responsibilities to contact DOT, NRC, or the NRC Agreement State (see glossary definition of Agreement State) to report accident-related information under prescribed circumstances. Carriers are required under 49 CFR §171.15 and §171.16 to contact DOT for most incidents involving radioactive materials. Licensees are required (under 10 CFR §20.2201, §20.2202, §20.2203, and 10 CFR §71.95 or similar State regulatory requirements) to contact NRC or the appropriate NRC Agreement State when control of the licensed material is jeopardized by an accident.

2. Radiological Monitoring and Assessment Assistance

Each State has its own protocol for addressing radiological emergencies. It is important for local, Tribal, and State agencies to first establish contact with the appropriate State or Tribal radiological authority, which may be, for example, the State Department of Public Health (DPH). Such authorities can provide technical guidance and can coordinate additional resources, including DOE Radiological Assistance Program (RAP) resources. In accordance with the FRERP, for major accidents, DOE has the lead Federal role in coordinating radiological monitoring and assessment until emergency conditions have subsided, at which time the management role for long-term monitoring and assessment is transferred to EPA. If the situation requires more assistance than a RAP team can provide, DOE will alert or activate additional Federal resources. These resources may include the establishment of a Federal Radiological Monitoring and Assessment Center (FRMAC) to be used as an on-scene coordination center for Federal radiological assessment activities. Response teams consisting of Federal and contract personnel are located at most DOE laboratories and at some laboratories and offices of other Federal agencies across the country.

Any State, Tribal, local, or private-sector organization or individual who needs assistance with a radiological matter may call the nearest DOE RCO to obtain information, advice, or assistance. Telephone numbers for contacting RCOs on a 24-hour basis are provided in Appendix C, Section C.2. The DOE Radiological Response Coordinator decides what action is needed on the basis of the request. When contacted by local government officials or private parties, DOE's Radiological Response Coordinators will involve the appropriate State or Tribal personnel and help obtain the required resources as well as inform DOE Headquarters Emergency Operations Center. If necessary, the Radiological Response Coordinator will arrange for a Federal team to respond to the incident to help or advise the authorities in charge.

3. Federal Interagency Coordination

Under the FRERP, provisions are made for interagency coordination when two or more Federal agencies are responding to a radiological accident. The coordination will be provided by the LFA. Procedures are established in the FRERP for Federal interagency coordination, whenever needed, without a specific State request. In addition, State and Tribal Nation governments may request such assistance directly from FEMA, DOE, or EPA. Specific requests for assistance from FEMA may be made on a 24-hour basis to FEMA's Emergency Information and Coordination Center in Washington, D.C. or to any of FEMA's Regional Offices (see Appendix C, Section C.2). Normally, requests are made through the State's Office of Emergency Management or equivalent agency.

4. Superfund

CERCLA (Superfund) and Executive Order 12316 together require EPA to write a plan to ensure coordination of Federal responses to oil and hazardous materials discharges to the environment. The Plan, found in 40 CFR §300, is called the "National Oil and Hazardous Substances Contingency Plan." The Plan was signed by EPA's Administrator on March 8,

1990, published in the FR (Volume 59, No. 178) as a final rule on September 15, 1994, and subsequently incorporated into 40 CFR §9 and §300. In §300.130(f), the Plan states, "Where appropriate, when a discharge or a release involves radioactive materials, the lead or support Federal agency shall act consistent with the notification and assistance procedures described in the appropriate Federal Radiological Emergency Response Plan." Most radiological releases do not result in FRERP activation and should be handled in accordance with the NCP. Releases from nuclear accidents that are subject to the requirements for financial protection established by NRC under the Price-Anderson amendments (§170) of the Atomic Energy Act (AEA) are specifically excluded from CERCLA and NCP requirements. Appendix E provides additional information concerning liability for CERCLA responses and cost recovery for Federal responses.

5. Presidential Emergency Declarations

Federal assistance may be provided for peacetime radiological emergencies when presidential emergency declarations are made under the Robert T. Stafford Disaster Relief and Emergency Relief Act, as amended (42 USC §5121 et seq.). Such assistance may be provided to the general public; private-sector; and State, Tribal and local governments to support emergency actions intended to save lives and protect property. Because this Federal assistance may only be provided to supplement existing and available resources, the availability of assistance from private-sector organizations (e.g., shippers and carriers) and provisions of the Price-Anderson Act (see Appendix E) must be explored before such presidential emergency declarations are invoked. While a presidential emergency declaration could be made for transportation accidents involving radioactive materials, it is highly unlikely.

6. Nuclear Weapons-Related and Special Nuclear Materials-Related Transportation Accidents

Both DOD and DOE transport nuclear weapons and special nuclear materials (SNMs). These classified shipments are often made in a convoy under high levels of safety and security, although not all shipments will require a convoy. In case of an accident involving a convoy shipment, the Convoy Commander will establish contact with the local jurisdiction and the State. The Convoy Commander will be the initial Federal On-Scene Commander with whom State, Tribal, and local authorities will interact. If a Convoy Commander is not available for any reason, the following agencies need to be contacted, depending on what agency is responsible for the shipment:

- **DOD Shipments.** DOD's JNACC, Headquarters — DTRA (see Appendix C, Section C.2, for contact information).
- **DOE Shipments.** Headquarters DOE Watch Office or Security Command (SECOM) Control Center (see Appendix C, Section C.2, for contact information).

Convoy Commanders have the authority, under the AEA, to take whatever measures are necessary to ensure the safety and security of the convoy's shipment. They will provide

information about potential hazards, protective action recommendations, security, and response requirements.

Convoy personnel are authorized to use whatever force is necessary to maintain custody and security of shipments and protect them from hostile forces. An on-going liaison program between Federal authorities and State, Tribal, and local law enforcement agencies help ensure close cooperation between all of the security forces during an accident.

Convoy Commanders may activate an NDA or an NSA to create a Federal safe zone in which to secure the classified elements of the shipment. These areas will not preclude or hinder the lifesaving operations of the local emergency responders.

Federal responders have jurisdiction only within the NDA/NSA area. The local IC retains full authority outside of these areas and the responsibility to protect the public and the environment. The Federal responders will provide technical advice and assistance to the local IC.

Upon notification of an accident, both DOD and DOE will activate their respective response forces and specialized teams. Normally, the nearest military installation will provide the next level of Federal response, called the Initial Response Force (IRF). Usually, the first military team to respond to the accident scene will include a number of specialists: medical, security, fire suppression, logistics, explosives ordnance disposal, safety, and photography personnel. However, it is also possible that a DOE RAP team, consisting of radiation technical experts, will be the first Federal support to arrive to help on-scene convoy personnel. Both teams will assist the Convoy Commander to ensure the safety of the shipment and provide technical advice to the local IC.

Additional information to help State, Tribal, and local emergency planners and responders prepare for these types of shipment can be obtained by:

- Reviewing DOD's *Nuclear Accident Response Procedures Manual*;
- Contacting the DOD Defense Nuclear Weapons School at Kirtland Air Force Base (AFB) (see contact information in Appendix C, Section C.2); and
- Contacting DOE's Transportation Safeguards Division (see contact information in Appendix C, Section C.2).

7. Transportation Emergency Preparedness Programs

DOE has developed the Transportation Emergency Preparedness Program (TEPP) to provide Federal, State, Tribal, and local emergency responders with access to the plans, training, and technical assistance necessary to safely, efficiently, and effectively respond to transportation accidents and incidents involving DOE shipments of unclassified radioactive materials. The TEPP is implemented and managed at the regional level as an overlay of the RCO structure, which supports the RAP teams (see contact information in Appendix C,

Section C.2). The TEPP and RCOs are two elements of DOE's Emergency Management System, which maintains working relationships with communities and emergency responders.

8. DOE Shipping Programs that Impact State, Tribal, and Local Authorities

- a. **WIPP Shipments.** As part of DOE's national clean-up strategy, the WIPP is designed to permanently dispose of TRU radioactive waste remaining from research and production of nuclear weapons. The waste will be shipped from ten major generator/storage sites and approximately 30 small-quantity sites to a facility in southeastern New Mexico, 26 miles east of Carlsbad. Initially, the waste will be transported by truck using a dedicated carrier with dedicated drivers. Routes have been established, and emergency response training is being conducted along the initial transportation corridors. Emergency response is addressed in the DOE's Carlsbad Area Office document entitled, *Emergency Planning, Response, and Recovery Roles and Responsibilities for TRU-Waste Transportation Incidents* (DOE/CAO-94-1039). Several training exercises have been conducted to demonstrate the guidance in this document.

Emergency response planning and preparedness for transportation accidents along the WIPP routes (including training for corridor states) has been developed by DOE. State, Tribal, and local officials confronted with an incident involving a WIPP shipment must observe the protocol agreed upon and signed with the DOE.

- b. **Civilian Radioactive Waste Management (CRWM) Shipments.** Section 180(c) of the Nuclear Waste Policy Act of 1982, as amended (42 USC §10101 et seq.) requires DOE "to provide technical assistance and funds to States and Tribes through which Spent Nuclear Fuel (SNF) and High-Level Radioactive Waste (HLW)" will be transported to a Federal repository or Federal interim storage facility. This requirement includes funds for training local public safety officials and for emergency response and safe routine transportation procedures. The CRWM shipments will contain large quantities of radioactive material; the total number of these shipments will be greater than the number of similar shipments made during the 1990s. However, when these shipments are made, some time after the turn of the century, they will represent only a very small increase in the 5 to 10 million radioactive materials packages presently being transported each year.

C. Shipper Responsibilities

It is the responsibility of each shipper to know and comply with all applicable Federal, State, Tribal, and local regulations pertaining to the shipment of radioactive materials. These responsibilities include the following:

- a. Transfer packages of radioactive materials to the carrier in full compliance with applicable DOT and NRC packaging requirements because packaging is the primary means of protecting public health and safety.

- b. Supply shipping papers with the shipment that provide the basic information necessary to describe the material, its hazards, and the appropriate response actions to be taken in the event of a transportation accident. Sometimes excerpts from the ERG2000 are included with shipments of hazardous materials.
- c. Provide information to the carrier when a shipment requires special precautions to ensure safe transportation.
- d. Provide on the shipping papers a 24-hour emergency response telephone number for persons knowledgeable about the hazards of the material (e.g., specific handling and accident mitigation information), as required for all hazardous materials.
- e. Be prepared to supply any additional information to assist in planning for and responding to an accident.
- f. Provide advance notification to required officials of NRC-licensed material and spent fuel shipments in accordance with 10 CFR §73.37 or 10 CFR §71.97.

D. Carrier Responsibilities

It is the responsibility of each carrier to know and comply with all applicable Federal, State, Tribal, and local regulations and other appropriate non-regulatory standards — established by such organizations as the American National Standards Institute (ANSI) — that pertain to the transportation of radioactive materials. Table B-1 in Appendix B is a matrix showing the relationship of Federal regulations to different carriers. Carrier responsibilities include the following:

- a. Ensure that emergency response information is available at in-transit storage facilities.
- b. Ensure that a prompt and proper response is initiated, including preventing individuals at the scene from contacting packages and spilled radioactive materials; that the vehicles, area, or equipment in which radioactive materials may have spilled are not used; and that vehicles and equipment are not placed in service again until they have been surveyed and decontaminated. Equipment and vehicles should be decontaminated in accordance with applicable DOT, State, or Tribal regulatory requirements.
- c. Notify local authorities, DOT, the shipper, and the driver's own management at the earliest feasible time after an accident.
- d. Notify DOT by telephone as soon as possible after an accident and by written report within 30 days, in accordance with 49 CFR §171.15 and §171.16. This notification applies to all hazardous materials, primarily for data collection and incident reporting; it is not intended for emergency mitigation.
- e. Maintain working contact with the responsible governmental authorities until these agencies have declared that the incident has been satisfactorily resolved and closed.

- f. Provide appropriate resources for the resolution of the incident, including cleanup functions on its own or by contracting with others (such as the shipper or consignee) that have the necessary expertise. Although the resolution of conditions and cleanup may not be clearly defined in the regulations, carriers are responsible for remediation activities associated with an accident, even when consequences involve spillage of non-hazardous materials. In accidents in which radioactive materials have been released, the radioactive materials spilled plus any resulting contaminated materials will need to be recovered and prepared for transport to an appropriate facility. A representative designated by the carrier must have appropriate radiological expertise to handle such situations and should be familiar with applicable Federal, State, and Tribal regulations. An organization's competency for conducting cleanups, could be indicated by having a radioactive material license issued by the NRC or an Agreement State (see Glossary for definition of Agreement State) for handling the types of materials involved in the accident.

The DOT Motor Carrier Safety Regulations in 49 CFR §387, identify carrier responsibilities related to bodily injury, property damage, and damage to the environment. The responsibilities relate to transport of non-hazardous and hazardous materials, including radioactive materials. The regulations specify requirements for liability insurance coverage that may range up to five million dollars for carriers of "highway route controlled quantities" of radioactive materials.

- g. Reimburse public and private emergency response organizations, as appropriate, according to State, Tribal, and local laws, or as determined by the courts.
- h. Provide 24-hour telephone contacts for HRCQ shipments (see Glossary for definition of HRCQ).
- i. Maintain liability insurance of \$1 million for handling any hazardous materials in interstate commerce. Carriers of Type B HRCQ and certain other types and quantities of hazardous materials must have liability insurance of \$5 million (see Appendix E for more details on liability).
- j. Comply with standards to protect human health and the environment, as required for shippers and handlers of hazardous waste under §3003 of the Solid Waste Disposal Act. Such standards include, but are not limited to, those addressing the following topics:
- (1) Maintenance of records of hazardous wastes transported, their sources, and delivery points;
 - (2) Transportation of such waste only if properly labeled;
 - (3) Compliance with the manifest system referred to in §3002(5) of the Solid Waste Disposal Act; and

- (4) Transportation of all such hazardous waste only to the hazardous waste treatment, storage, or disposal facilities that the shipper designates on the manifest form that hold a permit issued under the Solid Waste Disposal Act or pursuant to Title I of the Marine Protection, Research, and Sanctuaries Act (86 Statute 1052).

III. PLANNING BASIS

A. Transportation Systems

1. Introduction

A State, Tribal, or local emergency response plan should be applicable to any type of transportation accident, but plans should generally emphasize the dominant transport mode in a particular locale. State, Tribal, and local governments are encouraged to obtain available information about the transportation of radioactive materials within and through their jurisdictions. They should determine what types of shipments are made by mode, routes, and frequency; identify the terminals where these shipments are processed; and determine when the shipments occur.

Radioactive materials may be transported by land, water, or air; by common carriers, contract carriers, and private carriers; and through or near major cities, towns, villages, and rural areas. Because most radioactive materials are transported by highway, a response plan for transportation accidents involving radioactive materials should address the variables involved in highway transportation.

After the turn of the century, DOE expects to transport commercial SNF and defense HLW to a national repository. This responsibility was assigned to DOE in the Nuclear Waste Policy Act of 1982. The transportation system that will be used is currently under development. Modal options include rail, highway, and water. Routes will be selected within the regulatory controls imposed by DOT on HRCQ shipments. The number of shipments will depend on a variety of factors, including location of the repository and other system facilities, design of the transport cask, and transport modes.

2. Highway and Rail Modes

Facilities that use radioactive materials may ship the materials by rail, if railroad service is available. In an accident or incident, the railroad may be able to supply information on radioactive cargoes. Shipments must be made in accordance with Federal Railroad Administration (FRA) guidelines.

Not all materials are permitted to move through all the areas cited or by all the conveyances listed above. For example, spent (used) reactor fuel, which is highly radioactive, is limited to movement on certain routes. Relatively small quantities of radioactive materials may be shipped from anywhere that medical, industrial, or research activities are performed. Radioactive materials that require vehicle placarding must be shipped along routes that will minimize potential radiological risk to the public (49 CFR §397.101). This requirement means that carriers must use the interstate highway system to the extent possible and travel along only Federally approved routes. The shipment must also be transported in heavily shielded containers that are constructed to exacting specifications and designs approved by NRC. Trained personnel (drivers and escorts) must accompany such shipments for physical

protection (see Appendix O, Bibliography item 5). Radioactive materials exceeding certain large quantities of activity are designated as HRCQ shipments. The number of spent fuel and other HRCQ shipments represents only a small fraction of all radioactive materials shipments.

Routes for HRCQ shipments are generally limited to interstate highway systems, State-designated alternative routes, or both. (The States or Tribes may designate alternative routes for HRCQ shipments.) Although not required by statute, DOE has voluntarily agreed to ship contact-handled (CH)-TRU waste destined for WIPP on HRCQ-designated routes.

NRC participates in the designation and approval of routes for spent fuel shipments. NRC and DOT have data on authorized routes and the number and type of HRCQ shipments that have traveled these routes. These data are available to State, Tribal, and local planners and other interested parties upon request. Requests may be made by writing or calling DOT's, Federal Highway Administration (FHWA) (see Appendix C, Section C.2).

The vast majority of radioactive materials shipments are not strictly route controlled by NRC or DOT. As with other hazardous materials, no route data collection programs are currently in place to provide emergency planners with complete information on all routes and all shipments.

3. Air and Water Modes

The movement of radioactive materials by air or water, except in a few special cases, is limited. Except for radiopharmaceuticals, few shipments of radioactive materials are carried on commercial passenger flights, although cargo flights may carry almost any type of radioactive materials. DOD sometimes carries radioactive materials related to nuclear weapons on military aircraft.

Most shipments of radioactive materials by water are international shipments of reactor fuel cycle materials. Thus, the accident potential is primarily at seaport locations. Transport of other radioactive materials on inland and coastal waterways is limited.

B. Materials and Packaging in Transportation

The amount of radioactive material allowed in different types of packaging is regulated on the basis of the radiological toxicity and other properties of the radioactive materials. The transportation regulations for radioactive materials address hundreds of different species of radioactive materials known as radionuclides. Each radionuclide is assigned an A_1 or A_2 value that indicates the amounts of radioactivity in either normal or special form that are allowed in non-accident-resistant packaging ("Type A" packaging; see Glossary definition). For radionuclides that present a significant hazard, the A_1 and A_2 values are low, and the radioactivity allowed in Type A packaging is correspondingly low. The amount of activity in a package may be limited because of the maximum allowable radiation levels outside the packaging. The International System of Units (SI) for radiological measurements is being used more frequently on shipping papers and package labels. State, Tribal, and local

officials should become familiar with these units. They appear throughout this document together with the customary units for radiological measurements (see Appendix F).

Packaging for radioactive materials varies widely. Some packages are simple in concept and appearance; others are elaborate and massive. Packaging requirements for specific radioactive materials shipments are based on a number of factors, including type of radioactive material, quantity, form (normal or special), specific activity, fissile properties, and other characteristics (physical, chemical, and nuclear properties). Appendix L provides detailed information about the various kinds of packages (e.g., excepted, low-specific activity [LSA], Type A, and Type B). Appendix M provides illustrations of several kinds of packages.

Labels help identify the level of hazard presented by undamaged packages (see Appendix N). For example, a package with a radioactive White-I label indicates a very low radiation level outside the package (i.e., less than 0.005 milliSievert per hour [mSv/h] or 0.5 millirem per hour [mrem/h]; see Glossary for definitions). Radioactive Yellow – II and Yellow – III labels indicate that the package contains radiation at higher levels. The transport index (TI) on the label identifies the maximum radiation level (in mrem/h or 0.01 times mSv/h) at 1 m from the package.

C. Probable Accident Consequences

Current estimates indicate that 5 to 10 million packages of radioactive materials are transported annually in the United States. Most of these packages are for medical and industrial uses. It is reasonable to expect that some of these shipments may be involved in accidents with consequences ranging from trivial for most to severe for a few (see Appendix A). The potential consequences associated with these accidents depend on various factors, including:

- Severity of accident forces (crushing, fire, and impact);
- Accident location, local demographics, and environmental, agricultural, and industrial conditions;
- Quantity and type of material being transported (e.g., radionuclides, chemical and physical characteristics);
- Type of packaging used in the shipment, including non-specification, Type A, and Type B;
- Material release status and portion of material released from the packaging;
- Meteorological conditions at the scene of the accident;
- Time of day that the accident occurs;

- Time required for emergency response personnel who are capable of minimizing the accident consequences to reach the accident;
- Level of training and capability (including equipment) of emergency response teams;
- Presence of dispersing mechanisms such as fire, explosion, or a water course (e.g., rain or stream); and
- Presence of other hazardous materials and other factors of importance that might influence accident conditions.

Transportation accidents may be generally classified into two broad categories: those involving non-accident-resistant packaging (e.g., excepted quantities, "strong, tight" IP, and Type A) and those involving accident-resistant (Type B) packages. The non-accident-resistant packages are likely to withstand minor accidents without releasing their contents, but if involved in a serious accident, they may release some or all of their contents. The limited radioactivity allowed in each package limits the hazard posed by a serious accident involving these package types. Accident-resistant (Type B) packages are designed to withstand even serious accidents with no release of their contents.

Because of the limits on package contents, the consequences of releases from different types of packaging would be affected by both the activity of the radioactive materials contained in the packaging and the accident-resistant design characteristics of the packaging.

For example, if a Type A package were involved in an accident severe enough to cause a release of its radioactive contents, the affected area would likely be limited to the immediate vicinity unless such dispersing forces as fire or runoff are involved. The radiological consequences for public's health and safety would be limited by the amount of radioactive materials in the package. If a Type B package were involved in a similar accident, its design characteristics would limit any significant release. If a Type B package were involved in a more severe accident, its design characteristics should prevent content loss from exceeding activity limits established for a Type A package. Therefore, the expected radiological release for most accidents involving either package type should not be severe.

However, even radioactive materials that present a low risk and are released in small amounts may be tracked from the scene in lower, but still detectable levels. The contamination may be controlled by limiting access to and egress from the accident scene. Although the contamination released may be of insignificant radiological consequence to professional personnel who understand and administer radiation control activities in State, Tribal, and local government agencies, any detectable amount of contamination tends to cause great concern among the public and media (see Section IV.G, Public Information).

Very severe accidents involving HRCQ shipments are highly improbable (see the modal study description provided in Appendix H), but not impossible. The guidance in this document addresses the kinds of radioactive materials transportation accidents that are most likely to occur, but the guidance also applies to severe accidents involving HRCQ shipments

of radioactive materials. Such an accident might require an extensive response effort, if the packages were damaged to the point that a significant loss of contents occurred. Although this is highly unlikely — because of the stringent requirements of packaging design and construction — response plans for such events should be available, even if only to verify that the accident presents no significant hazards. Because many of the nation's transportation systems pass through agricultural areas, EOPs should include ingestion protective action guides (PAGs). For more information on the consequences of actual radioactive materials transportation accidents, see Appendices A and G.

D. Shipments of Uranium Hexafluoride

Uranium hexafluoride (UF_6) is a unique material with respect to transportation requirements. This compound of hexavalent uranium and fluorine is used as a process gas in gaseous diffusion plants to increase the concentration of the fissile isotope Uranium-235 in the mixture of uranium isotopes found in naturally occurring uranium. UF_6 is transported as a crystalline solid in special metal cylinders at slightly reduced atmospheric pressure. (The cylinders are constructed to withstand the high pressures and temperature involved in producing the UF_6 in a gaseous state.) Because of its radioactivity and corrosivity, the material presents special hazards. Reaction of solid UF_6 with moisture in the air produces a highly corrosive, moderately radioactive gaseous cloud. Solid UF_6 is packaged and shipped essentially as either a non-fissile (LSA) or fissile material, depending on its enrichment in the Uranium-235 isotope. When the material is enriched beyond 1%, it is shipped as and subject to the additional requirements for a fissile radioactive material.

Packaging requirements for UF_6 , both fissile and LSA, are outlined in 49 CFR §173.420, which details the physical requirements for the pressure cylinders used to process and package UF_6 . This section contains references to ANSI Standard N14.1 and United States Enrichment Corporation Report USEC-651 (see Appendix O, Bibliography items 75 and 77). These documents are extremely important sources of information relative to the processing, packaging, and transport of UF_6 .

Quantity limits for shipment of enriched (fissile) UF_6 in the form of residual "heels" of material in "empty" cylinders are listed in 49 CFR §173.417(a)(7). Quantity limits for fissile UF_6 in metal cylinders contained within DOT Specification 20PF and 21PF (Protective Overpacks) are provided in 49 CFR §173.417(b)(5) or in the certificates for NRC-certified UF_6 packages. The specifications for the DOT overpacks are listed in 49 CFR §178.356 and §178.358.

Several NRC Certificates of Compliance for transport have been issued for packages that are used for shipment of fissile UF_6 . These include certificate numbers USA/4909/AF, USA/9196/AF, USA/9234/AF, and USA/6553/AF. Other useful sources of information on packaging and shipment of UF_6 (in addition to the ANSI N 14-1 standard and USEC-651 document) include NRC and NUREG-0383 Information Notice 90-27 (see Appendix O, Bibliography items 75 and 76). Essentially all fissile UF_6 is transported in NRC certified packages. Illustration M-3d displays one UF_6 transport cylinder next to its protective overpack.

IV. OBJECTIVES AND GUIDANCE FOR PLAN DEVELOPMENT

Planning elements A through N in this section provide an outline for State, Tribal, and local governments' radiological emergency response plans for transportation accidents⁵ involving radioactive materials. As stated in the Preface, this guidance does not constitute a regulatory requirement. Use of this guidance is voluntary; when it is used, it should be tailored to the transportation activities, the organizational structures, and the available resources of State, Tribal, and local governments. The guidance provides an extensive list of options for the development and review of plans and preparedness measures at all levels of government.

Although this guidance is for transportation accidents, it is also relevant to other types of natural and technological emergencies. Use of this guidance should therefore be closely integrated into comprehensive emergency planning and preparedness measures.

A. Assignment of Responsibilities

1. Planning Objective

The planning objective is to ensure that primary responsibilities for emergency response to transportation accidents have been assigned, that the emergency responsibilities of the various supporting organizations have been specifically established and documented in writing, and that appropriate organizations are able to respond to transportation accidents on a 24-hour basis.

2. Guidance

- a. The plan should identify the government organizations (i.e., Federal, State, Tribal, and local) and private-sector organizations (i.e., shippers; carriers; industrial, technical, and educational organizations) that are intended to be part of the overall planning and response for transportation accidents. (See also Planning Element C: State, Tribal, and Local Coordination.)
- b. The plan should ensure, to the maximum extent possible, that personnel and other resources employed for other types of emergencies may be used for transportation accidents.
- c. Legal authority for lead and support responsibilities should be assigned by the Governor of the State, Tribal leader, head of the local government, or by legislation to agencies capable of planning for and responding to transportation accidents. Such assignments of authority and responsibilities should be expressed in writing. For most local governments, these responsibilities are not assigned for transportation accidents specifically, but for emergencies in general.

⁵ In Section IV, the term "transportation accidents" refers to those involving radioactive materials.

- d. During the plan development phase, each organization having an operational role should specify its concept of operations and its relationship to the overall plan. These inputs should be reviewed, coordinated, and integrated into the overall plan by the organization that has been given lead responsibility for developing the emergency response plan.
- e. Each plan should graphically illustrate the interrelationships described in items c and d above in a matrix format, such as a diagram or table (see Appendix O, Bibliography item 31).
- f. Each organization should identify, in writing, a specific individual (by title) to be in charge of the organization's overall emergency response functions.
- g. Authority and responsibility should be assigned and documented in writing for major functions, such as command and control, warning, communications, provision of equipment and materials, fire, rescue, law enforcement, traffic control, public information, emergency medical services (EMS), emergency transportation services, social services, accident assessment, protective response, radiological exposure control, decontamination, cleanup, and recordkeeping. The documentation should include a statement regarding who has the authority to request Federal assistance and to initiate necessary protective actions.
- h. The plan should identify and contain copies of any written inter-jurisdictional agreements (e.g., mutual assistance agreement, letter of agreement) among State, Tribal, local, and Federal agencies and other support organizations that have an emergency response role. These agreements should identify the emergency measures to be provided and the mutually acceptable criteria for their implementation (see Appendix K). If written agreements are not available, a statement to this effect should be made in the plan along with an explanation of the basis and nature of any unwritten agreements.
- i. Emergency organizations should be capable of maintaining 24-hour per day operations for a protracted period. A list or roster of qualified personnel for two shifts should be maintained as an attachment or appendix to the plan. The individuals in the emergency organizations who will be responsible for assuring continuity of resources (technical, administrative, and material) should be specified by title.
- j. The plan should provide for establishment of a command post at the accident scene, if and when needed, for major accidents. The ICS is recommended as the standard response management system (Appendix K provides a brief description of ICS and see Appendix O, Bibliography items 73 and 74).
- k. The plan should designate on-scene coordinators who will direct emergency response and recovery operations during an accident by level of government (State, Tribal, or local) and lead organization(s), although it may be necessary to transfer lead roles depending on the magnitude and phase of the emergency.

1. The State or Tribal plan should address shipper, carrier, and government responsibilities and liabilities for decontamination, reclamation, and waste disposal, and should cite appropriate legal references (see Appendix E).
- m. State, Tribal, and local agencies should be prepared to assume initial costs for such activities as providing temporary shelter (as they would in other emergencies in which protection of public health and safety is involved).

B. Analysis of Radioactive Materials Transportation

1. Planning Objective

The planning objective is to determine the type and quantity of material being transported, identify the most likely places for accidents to occur, and identify the types of problems that might be encountered during an accident.

2. Guidance

State, Tribal, and local government agencies should obtain available information concerning the transportation of radioactive materials within their geographical boundaries to assess geographic-specific transport patterns and related risks.

- a. The plan should include the following specific information on transportation accidents in the United States, some of which is available from DOE, DOT, and NRC (see Appendix C, Section C.2):
 - (1) Various modes of transportation likely to be encountered.
 - (2) Names and locations of major shippers and receivers. Carriers who make frequent use of existing transportation routes, terminals, and in-transit storage facilities within the community should also be identified.
 - (3) Primary routes for shipments of large numbers of packages and HRCQ shipments of radioactive materials either within or through the jurisdiction. Routes used for HRCQ shipments minimize the probability of accidents in transit. Information on routes for, and volume of, HRCQ shipments is available from DOT. Information on spent fuel shipment routes is available from either NRC or DOT (see Appendix C, Section C.2). The data collected may also indicate local areas where accident frequency is unusually high; these areas will probably not be authorized as HRCQ shipment routes.
 - (4) Routes used for scheduled or frequent shipments of all radioactive materials. Planners might investigate when materials are received at pharmacies and delivered to hospitals, or they might determine typical schedules for radiographers and well-logging companies.

- (5) The specific types, quantities, and forms of materials involved in routine shipments within the jurisdiction and the typical packaging and vehicles used.
 - (6) Transportation hubs, such as airports, truck terminals, seaports, and railroad yards that handle large volumes of radioactive materials and other hazardous materials shipments.
 - (7) Special factors that may influence transportation accidents, including sections of highways where accidents occur frequently, topography or geography, periodic shipping patterns, and weather. Weather conditions and natural forces that may impact the severity of accidents and impede the emergency response should be considered.
- b. Information developed from these analyses should be listed in an appendix to the EOP for easy reference and updating and should be used to determine the following:
- (1) Where to place particular emphasis on the need for emergency response capability, on the basis of the frequency, size, and type of materials shipped; and
 - (2) The types of equipment and personnel that may be needed for an adequate response.

C. State, Tribal, and Local Coordination

1. Planning Objective

The planning objective is to ensure that State, Tribal, and local political jurisdictions can adequately coordinate their responses to a radioactive materials transportation accident. Cooperating jurisdictions may border one another or may be more distant neighbors; for example, a community beyond the adjacent one may have the needed equipment or expertise.

2. Guidance

- a. State, Tribal, and local emergency response plans should recognize that, by their very nature, transportation accidents might occur along any border with neighboring jurisdictions.
- b. The emergency response plan should identify potential resources that may be called upon in the event of an inter-jurisdictional transportation accident (e.g., health departments from neighboring States, Tribes, or counties; sheriff and fire departments from adjacent counties). Joint training and exercising of emergency personnel will help ensure that common terms and procedures are used to allow efficient interactions.
- c. Formal mutual-aid agreements should be made between neighboring States and Tribal governments and between nearby local jurisdictions within a State. Interstate and intrastate (between local jurisdictions within each State and Tribe that are located on State and Tribal borders) agreements should also be established. Such cooperative agreements enable the parties to cross jurisdictional lines and to more effectively use their expertise, equipment,

and funding during a radiological emergency. Contacting State and local organizations near manufacturing plants may help agencies to identify potential mutual-aid partners (see Appendix K for details regarding mutual-aid agreements).

- d. Once inter-jurisdictional agreements have been made, joint exercises should be conducted so that all parties will be able to easily cross over jurisdictional boundaries and function together in an emergency
- e. As an outgrowth of a mutual-aid agreement, letters, memoranda, or agreements of understanding should be signed by counterpart agencies (e.g., the State health department and the county sheriff's department). Such agreements would help ensure that the sub-units of a State, Tribe, or local government are fully aware of mutual-aid agreements and their respective responsibilities under such agreements.
- f. Neighboring Tribal, State, and local jurisdictions should share information about highway and/or rail routes that are heavily traveled by transporters of radioactive materials.

D. Emergency Equipment, Facilities, Expertise, and Resources

1. Planning Objective

The planning objective is to ensure that arrangements for requesting and effectively using resources have been made and that adequate emergency facilities and equipment⁶ to support the response are provided. Resources normally available for natural and technological disasters should be adapted, as much as possible, to accommodate radiological consequences.

2. Guidance

- a. The plan should describe resources (e.g., emergency equipment, facilities, trained personnel) available from individuals and organizations. Any contracts or written agreements for accessing these resources should be referenced. Descriptions of available resources may be found in, or are available from:
 - (1) State, Tribal, and local government agencies;
 - (2) Federal government agencies, as designated in the FRERP;
 - (3) State compacts;
 - (4) Hospitals and local health departments and EMS;
 - (5) Universities;
 - (6) Other organizations or companies having radiological expertise;

⁶ National Fire Protection Association Series 70 for HAZMAT equipment.

- (7) Professional societies (e.g., Health Physics Society);
 - (8) Private industry;
 - (9) Volunteer agencies (e.g., Red Cross);
 - (10) Consultants;
 - (11) Individuals or groups such as shippers and carriers that work professionally with radioactive materials;
 - (12) World Wide Web (a few resource websites are listed in Appendix P); and
 - (13) Warning systems (EAS) broadcast outlets.
- b. The plan should describe existing emergency equipment, its location, availability, and the method of gaining access to the equipment during an emergency. Type of equipment needs will vary depending on the type of accident. Planners are encouraged to research and establish an inventory of equipment sources so that equipment suited to specific needs may be found quickly. (Examples of State capabilities for providing accident equipment are noted in NUREG/CR-5399, Appendix O, Bibliography item 34.) These resources could include equipment borrowed or leased from commercial interests, such as:
- (1) Radiation detection and monitoring instruments⁷ available for 24-hour emergency use. The method for obtaining this equipment during an emergency and for ensuring periodic maintenance and calibration, as appropriate, should be described. More information on the selection and capabilities of radiation detection and monitoring instruments is provided in Appendix J.
 - (2) Personal protective equipment.
 - (3) Ground vehicles, aircraft, and watercraft capable of transporting emergency teams and their equipment to the accident scene.
 - (4) Mobile emergency operations and communications equipment.
 - (5) Traffic control equipment.
 - (6) Portable emergency lighting equipment.
 - (7) Emergency barriers (e.g., snow fencing and warning signs).
 - (8) Earthmoving and construction equipment.

⁷ The relative responses of civil defense monitoring instruments to specific radionuclides are listed in Table I-1 of Appendix I.

- (9) Environmental sampling equipment. This equipment should include air, soil, water, milk, food, and vegetation sampling equipment.

E. Notification Methods and Procedures for Activating Emergency Response Personnel

1. Planning Objective

The planning objective is to ensure that State, Tribal, and local organizations have established procedures for contacting the proper emergency response personnel; that the carrier and shipper are notified; that accident information has been secured; and that procedures have been established for the timely activation and deployment of emergency personnel. Existing procedures for other hazardous materials incidents should be adapted, as much as possible, to apply to radiological transportation accidents.

2. Guidance

- a. The plan should establish procedures to address the following notification and activation functions.
 - (1) Communication methods (e.g., telephone, pager, radio, facsimile, computer network, and teletype) to be used for notifying and activating emergency personnel.
 - (2) A call-down list for notifying appropriate emergency personnel and authorities. The list should include trigger levels for emergency notification and deployment of personnel (e.g., non-technical first responders or radiological/technical responders to address radioactive material packages damaged, involved in a fire, or missing.)
 - (3) Notification of appropriate State, Tribal, and local organizations, as well as other resources such as shipper and carrier organizations and emergency resource contacts such as CHEMTREC; CHEM-TEL, Inc.; INFOTRAC; or 3E Company (see Appendix C, Section C.2). If radioactive materials are present at an accident scene, the appropriate State radiation control programs (only Wyoming has no radiation control program) should be notified in accordance with the plan and procedures. The State communications center may also provide communication links (conference calling) with all necessary organizations, including local hazardous materials groups.
 - (4) Provision of a conference hookup (through emergency resource contacts such as CHEMTREC; CHEM-TEL, Inc.; INFOTRAC; or 3E Company) for contacting identified responsible personnel in shipper and carrier organizations and in Federal, State, and Tribal agencies.
 - (5) Documentation of whether other applicable regulations may have additional reporting requirements.

- b. The plan should specify an emergency contact(s) for Federal, State, Tribal, and/or local agencies to receive information about an accident on a 24-hour basis (see Planning Element A.2.i and Appendix C, Section C.2).
- c. State, Tribal, and local government organizations should establish a system for disseminating the information contained in the initial and follow-up messages received from the accident scene. This system should include procedures that specify the following:
 - (1) Identification of specific individual(s) in organizations who will be responsible for contacting emergency response teams and Federal organizations;
 - (2) Identification of primary and alternate communication methods to be used;
 - (3) Verification procedures to determine the authenticity of the information; and
 - (4) Communication with private-sector organizations that can provide emergency contacts (see Appendix C, Section C.2).
- d. State, Tribal, and local plans should identify specific carrier notification responsibilities (see Section II.D).

F. Emergency Communications

1. Planning Objective

The planning objective is to ensure that agencies have made provisions for prompt and effective communications between emergency personnel and their supervisors at the principal response organizations during an emergency.

2. Guidance

- a. Planning for emergency communications should address the following:
 - (1) Reliable primary and backup means of communication;
 - (2) Names and titles of individuals within organizations, and also alternates for each organization (these persons should be the same as those named on the notification lists under Planning Element E.2.a.);
 - (3) Compatible communication systems among organizations, including pre-identification of emergency radio frequencies;
 - (4) The capability, during emergency situations, to operate communication systems on a 24-hour basis (see Planning Element A.2.i);

- (5) Communications with neighboring State, Tribal, and local governments, field assessment teams, carriers, shippers, and appropriate Federal agencies; and
 - (6) Inventory of emergency communications equipment.
- b. Communication systems should be periodically tested to ensure effectiveness. The use of both primary and backup communications systems during actual emergencies should familiarize personnel with the operation of the systems and help to identify communications shortfalls.
 - c. Communication links between organizations should correlate with the matrix described in Planning Element A.2.e.
 - d. Call lists of responsible authorities within contiguous jurisdictions should be developed in order to notify the appropriate persons in the event of an accident. The plan should identify the person(s) who will determine the emergency contacts to be notified in the jurisdictions affected by the accident.
 - e. Response organizations should designate officials to obtain appropriate accident information. Relevant information concerning the radioactive shipment will usually be available from shipping papers and communications with the carrier and shipper. The "reporter" of this information may be a first on-the-scene responder, vehicle operator, or member of the public in the vicinity of the accident. The following are guidelines for appropriate accident information to be obtained from the "reporter" during notifications:
 - (1) Injured persons requiring lifesaving assistance and other priority medical care.
 - (2) Names of callers, organizational affiliations, location of accident, and telephone number or any other communication identifier.
 - (3) Description of the vehicle (type of vehicle and placards); number and type of packages and markings (labels and DOT/NRC certification numbers); and indicators, if any, of possible releases, such as wet areas or the presence of fire or smoke.
 - (4) Description or identification of radioactive materials in the shipment. These should be available from the shipping papers, labels and package markings, and hazardous materials information sheets, and should include the following:
 - (a) Radionuclide activity in millicuries (mCi), Ci, MBq, or GBq;
 - (b) Reportable quantities (RQs), shipping names, and United Nations (UN) identification numbers;
 - (c) Emergency response telephone number(s);

- (d) Emergency response information may be on separate papers that accompany the shipping papers (e.g., immediate health hazards, risks of fire or explosion, immediate precautions and methods for handling fires, initial methods for handling spills, preliminary first-aid instructions, Material Safety Data Sheets for each hazardous material onboard, or DOT's ERG2000 with appropriate page numbers);
 - (e) Physical and chemical forms of the material; and
 - (f) Other hazardous properties and characteristics (e.g., corrosive).
- (5) Description or identification of the presence and status of non-radioactive, hazardous materials involved in the accident.
 - (6) Description of significant environmental characteristics that could impact accident conditions as well as emergency response. Conditions such as weather, wind speed and direction, terrain, accessibility, and surrounding population characteristics influence the overall emergency response capabilities and requirements.
 - (7) Emergency response procedures and actions underway.
 - (8) Identification of organizations already at the scene of the accident and requests already made for additional on-scene support from other organizations.
 - (9) Prognosis of worsening situation or termination of event based on current information.
 - (10) Identification of involved shipper and carrier, if possible.
- f. Procedures should be established for verifying the authenticity of emergency notifications.
 - g. Following the initial notification, provisions should be made for updating emergency information (the progress and control of the accident and associated environmental conditions) at specified intervals.

G. Public Information

1. Planning Objective

The planning objective is to establish methods and systems for timely notification of the public through mass communications media; to provide current, accurate information to protect lives, public health, and property; and to minimize public concern.

2. Guidance

- a. A complete review should be undertaken of all methods and systems used within the area to disseminate emergency information on incidents, such as tornadoes, hurricanes, fires, floods, earthquakes, explosions, nuclear power plant accidents, and hazardous materials incidents.
- b. Wherever possible, plans for disseminating emergency information on these types of incidents should be consolidated into one comprehensive plan, so that one source and one system is used for all types of emergency information activities. An all-hazards approach to planning is recommended (see Appendix O, Bibliography item 31).
- c. Management representatives of the communications media, especially radio and television, should participate in the planning process.
- d. State, Tribal, and local officials should consider conducting a study of the communities' perceptions of risks associated with transportation of hazardous materials. Identification of key issues such as perceived risk, trust, protection of the public's interests, and environmental impacts would be valuable in developing a customized public information approach.
- e. Special attention should be given to planning and testing methods of disseminating emergency information from responsible authorities to the news media, using a variety of redundant systems that provide both voice and written messages. Communications links with the media should be established through such means as commercial telephones, radio networks, and the EAS (see Appendix O, Bibliography items 27 and 28) that has replaced the longstanding EBS methodology (1964-1996). Some of the features of the new system are:
 - (1) It is a digital system and interfaces well with computers;
 - (2) Any transmission means can be used to send and receive alerts and tests (e.g., satellite communications, telephone, radio, pagers);
 - (3) EAS equipment can be programmed for unique events and specific areas;
 - (4) Visual and audio messages can be sent automatically on broadcast stations and cable systems; and
 - (5) The system can use any AM, FM, or TV stations to transmit EAS messages.
- f. The primary local agency responsible for response and control should designate a spokesperson or public information officer, plus alternates, who has access to all pertinent information and all key emergency response personnel, and who is kept fully informed of all pertinent developments in an actual emergency. Assignment of public information officers to response teams should be considered.

- g. The identity of the local spokesperson (and alternates) should be known by the media in order to verify and authenticate emergency messages. The media should know how to reach the spokesperson at any time and should have immediate access to that spokesperson during an emergency.
- h. For significant emergencies requiring more than local personnel and resources, methods and procedures should be established for coordinating public information activities with other organizations (i.e., Federal, State, Tribal, local, shipper, and carrier) to control rumors and to avoid erroneous or conflicting information. This is best accomplished by centralizing the emergency information activities of all organizations in a Joint Information Center (JIC) or Joint Information System (JIS). Provisions should be made for notifying and establishing communications with Governors, Tribal Leaders, mayors, and other elected officials.
- i. Plans and training should stress the dissemination of concise messages that are easily understood by people who are unfamiliar with the technical aspects of an accident.
- j. Standard news release forms/formats should be developed for use in releasing information to the public concerning emergencies. The use of these forms will help to ensure that information needed by the public is provided through the media in a timely manner.

H. Accident Assessment

1. Planning Objective

The planning objective is to identify, establish, and ensure the adequacy of methods, systems, and equipment for determining whether radioactive materials have been released and for assessing the actual or potential consequences.

2. Guidance

- a. State and Tribal radiological response teams should be established and trained. Provisions should be made for rapid notification and deployment of these teams on a 24-hour basis. Some local governments have established radiological response teams.
- b. Because specialists with the expertise to assess the degree of the radiological hazards in an accident will seldom be at the accident scene during the initial response phase, provisions should be made for rapid and reliable communication between emergency first responders and radiological authorities not at the scene.
- c. The chain of command at the accident scene should be stated explicitly. There should be one person in control at the scene who will ensure that technically competent personnel complete the radiological assessment. This could also involve evaluation of information by individuals away from the scene.
- d. Provisions should be made for record keeping and documentation of key data obtained or developed during the initial accident assessment phase. This information should include

when, how close, and how long an individual stood near the radioactive materials. This information is particularly important for those individuals involved close in to the rescue operations and fighting fires.

- e. Adequately trained teams from appropriate jurisdictions (e.g., State, Tribal, or local) should have responsibility for the following functions:
- (1) Assess the need for first aid and lifesaving efforts, as appropriate;
 - (2) Assess the scene for the presence of hazardous materials and possible interactions and evaluate prevailing conditions;
 - (3) Determine whether radioactive materials and other hazardous materials, such as flammables and corrosives, are involved and, if so, which of these materials present separate hazards and which might interact with radioactive materials or their packaging;
 - (4) Develop procedures for controlling access to and egress from the accident scene;
 - (5) Develop and adopt safety measures for response team members to prevent injury from environmental factors not related to radioactive or other hazardous materials, such as avoiding electric shock, falls, and fire;
 - (6) Develop methods for obtaining all possible information regarding the type of packaging; the information from marking, labeling, and placarding; the type, quantity, and chemical form of the radioactive materials involved; and the observable indicators of release of radioactive materials from packaging;
 - (7) Obtain relevant information on the accident, including location, condition of radioactive materials packages, fire potential, weather conditions, and agricultural concerns (in accidents involving the transport of hazardous material, the EPA transportation manifest and/or chain-of-custody forms should be collected);
 - (8) Determine the capabilities of available radiological survey instruments and their applicability (see Appendices I and J);
 - (9) Measure radiation levels, as appropriate, if the monitoring equipment is available;
 - (10) Collect information about proximity of individuals to packages and possible airborne radioactive materials to facilitate performance of dose projections by radiological experts for all pathways (e.g., dermal contact, inhalation, and ingestion, if needed) on the basis of observation, measurements, and actual or potential radioactive releases (State and Tribal radiation control personnel or DOE RAP personnel could perform this assessment [see Appendix C, Section C.1]); and

- (11) Develop criteria for determining the need and methods for collecting environmental samples.

I. Protective Actions

1. Planning Objective

The planning objective is to ensure that State, Tribal, and local jurisdictions establish methods, procedures, and proper authorities for recommending protective actions under a variety of accident conditions.

2. Guidance

- a. First responders should follow the appropriate "Action Guides" for radioactive and other hazardous materials described in DOT's ERG2000. These Action Guides conservatively assume minimal specialized training by first responders; response actions beyond those indicated in this Guide would depend on the particular accident contingencies and the expertise of the responders.
- b. Response plans should identify sources for rapidly obtaining information about current local conditions (e.g., large gatherings at entertainment events, hospitals, or schools; agricultural activities; demographics; road network; and surface water supplies) in order to identify human and environmental resources that need to be protected or used to resolve the emergency.
- c. Protective action guides developed by EPA to protect human populations and establish exposure limits for emergency workers should be identified and listed. The protective action for a specific incident will be determined at the scene, possibly by the first responder using DOT's ERG2000, or shortly thereafter by a radiation authority or designee with instrumentation and greater knowledge. Although specific guidance has not been developed for applying PAGs to transportation accidents involving radioactive materials, PAGs developed by EPA and others for nuclear incidents can apply to transportation incidents and are recommended for such use (see Appendix O, Bibliography items 21 and 33).
- d. Plans should include guidance on proper implementation of protective actions, considering possible constraints such as weather, accident injuries, and other competing emergencies.
- e. The benefits of protective actions, such as shelter, respiratory protection, ingestion pathway protection, and evacuation, should be evaluated, and plans should be prepared for appropriate use of these measures.
- f. Procedures should be developed to control access to and egress from accident-affected areas if known or suspected releases have occurred [see Planning Element H.2.e(4)].
- g. A procedure should be established to account for persons involved in the accident or evacuated from the accident scene.

- h. Concepts, procedures, and mechanisms for containing spilled radioactive materials and for limiting the spread of contamination should be developed and documented (see Appendix O, Bibliography item 40).
- i. Procedures for reducing radiation exposure by external and internal exposure pathways should be developed and documented (see Appendix O, Bibliography item 40).

J. Radiation Exposure Control

1. Planning Objective

The planning objective is to ensure that the radiation authority has established guidance for monitoring, assessing, and limiting radiation exposures to response personnel. Although for nearly a half-century emergency responders to transportation accidents involving radioactive materials have not received a radiation dose of any consequence, plans still need to be made for assessing radiation doses if observations indicate there has been a major release and/or if the contacted radiation authority advises responders that consequences of a reported accident may be substantial. The radiation program staff (e.g., Bureau of Radiation Protection, Radiological Health Division) of affected States or appropriate Federal agencies (e.g., DOE, EPA, NRC, OSHA) have established general guidelines for dose assessment and projections of radiation exposure to individuals who provide assistance at accident scenes with substantial radiological releases. These guidelines should stipulate the method that should be used and the data required for assessment of the radiation exposure that could be received by response personnel at the scene of severe accidents.

2. Guidance

- a. Information should be assembled, on the basis of Federal guidance, concerning the criteria for protecting emergency personnel from excessive exposure to radiation during accident assessment, rescue of endangered or injured persons, lifesaving activities, evacuation of affected populations, and protection against or prevention of property damage or loss. A governing principle is to keep exposure as low as reasonably achievable (ALARA) (see Glossary and Appendix O, Bibliography item 21).
- b. Standard operating procedures for emergency response personnel should be developed for different phases and provided to each emergency response person.
- c. The plans should indicate what is contained in a dosimetry kit (e.g., type of dosimeters, instructions for use of dosimeters, where the kits are stored, who calibrates the dosimeters, where to go for dosimetry instructions and information). Instruments could be combined into a single kit with the dosimeters.
- d. The plan should indicate the contents of the instrument kits (e.g., radiation survey instrument[s], instructions for use of instruments, where the kits are stored, who calibrates the instruments, where to go for instrument instructions and information). Dosimeters could be combined into a single kit with the instruments.

- e. Procedures and equipment for proper personnel and equipment decontamination should be identified. Criteria should be established for release of personnel and equipment from controlled areas (see Planning Elements L.2.c and L.2.d).
- f. Procedures should be identified for monitoring and assessing doses for persons who may have been exposed to radiation — by dermal contact, ingestion, or inhalation — at the accident scene.
- g. Provisions should be made for monitoring, recording, and documenting exposures of all persons present at or near the scene, including emergency workers and evacuees. These provisions should include at least the following information:
 - (1) Monitored person's name and address;
 - (2) Locations, times, and date(s) of monitoring;
 - (3) Instrument used, model and serial number, and date of last calibration;
 - (4) Radiation exposure measured, computed, or estimated;
 - (5) Efforts taken to decontaminate;
 - (6) Advice given to persons and identification of source(s) of advice;
 - (7) Measurements made after decontamination; and
 - (8) Names of the individual(s) conducting monitoring. Most of the monitoring and remediation activities will be conducted or directed by radiological specialists who are not among the first responders at an accident scene.

K. Medical Support

1. Planning Objective

The planning objective is to ensure that arrangements for medical services are made for injured persons who may be contaminated. Guidance for treating contaminated individuals emphasizes that timely treatment of persons suffering from non-radiological urgent injuries should take precedence over concern about contamination. In other words, serious injuries should be treated before dealing with possible radioactive contamination.

2. Guidance

- a. Because medical and EMS personnel along transportation routes are an integral component of a comprehensive emergency response system, an assessment of emergency medical preparedness should be completed prior to anticipated shipping campaigns such as those conducted under DOE's authority. The number of vehicles that annually transport

radioactive materials under these campaigns will be smaller than the number of vehicles that routinely transport medical and industrial shipments of radioactive materials on most major highways. Four principle areas to be addressed in such an assessment are: hospital readiness for radiological response to fixed facility and transportation incidents; training frequency for hospital personnel; equipment availability and needs; and frequently raised questions and concerns of assessed hospitals. A similar assessment should be completed for ambulance/transport companies.

- b. Key results of the emergency medical preparedness assessment should include a breakdown (by hospital) of the status of: (1) each hospital's radiological plan, (2) training and exercise/drill programs, (3) types of radiological equipment and supplies, (4) nuclear medicine department resources, (5) decontamination facilities, (6) worker protection measures, (7) monitoring capabilities for patients, emergency workers, vehicles, and equipment, (8) number of hospital beds at the facility, and (9) willingness to accept potentially contaminated patients. Hospitals with long-term radiological monitoring and treatment protocols (including those with whole body counting facilities, the ability to conduct bioassays, and the capability to administer chelation medication and/or decontamination solutions) should be identified.
- c. Following the assessment, State, Tribal, and local agencies should work with hospital and EMS organizations to develop a plan to address unmet needs and strategies to maintain these services at a desired level of preparedness.
- d. Technical guidance and medical advice, including information regarding investigational new drugs, can be obtained from the DOE Radiation Emergency Assistance Center/Training Site (see Appendix D). Personnel at this facility can provide information regarding both short- and long-term medical, chemical, physical, biological, social, and psychological implications of exposure, contamination, and/or injury resulting from an accident involving radioactive materials.

L. Post-Accident Operations

1. Planning Objective

The planning objective is to ensure that general planning is undertaken for post-accident operations, including cleanup and decontamination of property (real and personal), vehicles, equipment, and the release of contaminated roads. Appropriate State, Tribal, and Federal authorities should be consulted. The question of compensating the public for damages and local governments for the response and cleanup operations is discussed in Appendix E.

2. Guidance

- a. The State and Tribal radiation authority, emergency management directors, and their legal counsel should establish a policy of how, and under what circumstances, their organization will perform cleanup operations. The question of who is responsible for cleanup and other

- related liability concerns will vary widely from one government body to another, but should be addressed in the policy (see Appendix E).
- b. The multi-agency radiological authorities that will plan, direct, and evaluate cleanup, decontamination, and restoration operations should be identified (see Appendix O, Bibliography item 78). To establish criteria for the decontamination and recovery phase, it is recommended to use the U.S. Atomic Energy Commission's Regulatory Guide 1.86 and Chapter 7 of EPA's *Manual of Protective Action Guides and Protective Actions for Nuclear Incidents* (see Appendix O, Bibliography items 1 and 21).
 - c. Criteria should be established for unrestricted access to an area that has been contaminated and subsequently decontaminated should be allowed only after the criteria for decontamination and other related tasks have been met (these criteria should be established in accordance with the directions contained in the references listed in Planning Element L.2.b).
 - d. Release of vehicles and equipment for unrestricted use should be permitted only after the criteria for decontamination and other related tasks have been met (these criteria should be established in accordance with the references listed in Planning Element L.2.b).
 - e. Provisions should be made for necessary radiological surveillance and monitoring around the area of the accident during cleanup. If the effort is too large for State resources, assistance is available from the Federal government (see Section II.B.2, Radiological Monitoring and Assessment Assistance).

M. Radiological Emergency Response Training and Exercises

1. Planning Objective

The planning objective is to ensure that training is provided for emergency response personnel who may be called upon to assist in a transportation accident involving radioactive materials. Regularly scheduled exercises and drills — tabletop and full-scale — should be included in the plan to ensure the proper functioning of plans, personnel and equipment. (A tabletop exercise involves only discussion of the implementation of plans; a full-scale exercise involves actual demonstration of emergency operations procedures.)

2. Guidance

- a. Programs should be established to provide for initial and periodic training of personnel who have primary responsibilities for responding to hazardous materials accidents, including transportation accidents involving radioactive materials (see Appendix D). Listings of Federal agency training courses are often found at agency websites (see Appendix P, Section P.2).
- b. Training should be provided for State, Tribal, and local personnel to address specific problems that may be encountered relative to the items listed in Planning Element B, *Analysis of Radioactive Materials Transportation*, (e.g., major shipper and receiver

locations; major routes; types and quantities of radioactive materials typically transported; transportation hubs; and special factors that may influence transportation such as geographical features of the route, time of day when the majority of shipments are made on city streets or at various terminals, or meteorological conditions).

- c. Provisions should be made for supplementing State, Tribal, and local government training programs with applicable shipper and carrier training.
- d. Each State, Tribal, and local response organization should participate in and receive training. Training requirements for hazardous materials handling are found in 29 CFR §1910. Financial assistance for training is described in 49 CFR §110, "Hazardous Materials Public Sector Training and Planning Grants," dated August 24, 1992. Where mutual-aid agreements exist, the training should be offered to all organizations that are part of the agreement(s).
- e. Specific training should be provided to individuals with specific response roles, such as first aid and rescue, fire fighting, security and traffic control, and radiation monitoring and assessment. Not all persons responding to a radiological transportation accident need to have expertise and training in radiation monitoring and assessment.
- f. Periodic exercises should be conducted to evaluate major portions of emergency response capabilities. Periodic drills should be conducted to develop and maintain key skills. Evaluation of exercises and drills should define problem areas and identify corrective measures. The plans should indicate the frequency and participation of groups and agencies needed in the exercises and drills.

N. Periodic Review and Update

1. Planning Objective

The planning objective is to ensure that plans are revised and kept current.

2. Guidance

- a. Provisions should be made for periodic review and updating of emergency plans. The organization and position responsible for ensuring periodic review and updating of the plans should be identified. The plans should be reviewed annually and updated more often if major changes are necessary. Telephone numbers and names of emergency response personnel should be verified and included in the periodic updating of plans. It is recommended that the plans indicate a central location (e.g., county emergency operations center [EOC] or law enforcement communications center) where these lists will be maintained.
- b. Changes in emergency procedures that are based on actual emergency responses or problem areas identified through exercises and drills should be incorporated into plans.
- c. A distribution list of all persons holding copies of the plan should be maintained and kept current. Plan holders should be notified of the review of, and changes to, the plan. If no

changes are made, this fact should be communicated to plan holders. The lead agency should receive written confirmation that each plan holder has received the plan and that changes have been recorded.

- d. Each plan should contain a listing of supporting plans and procedures and their sources. The plans should be cross-referenced to the planning objectives.
- e. The date of publication (month and year) should be prominently shown on the cover page of the original plan and on any subsequent revisions. It is also recommended that each page of the plan be dated and a revision number placed on each page under the date so that subsequent page revisions may be identified by date.

APPENDIX A

Transportation Accidents/Incidents Involving Radioactive Materials (1971-1997)

A.1 Introduction

This appendix addresses the following topics: (1) the Federal regulations for reporting a hazardous/radioactive materials transportation incident, (2) an analysis of radioactive material accident/incident data, and (3) information on package performance under transportation accident conditions. The DOT reports are from the Hazardous Material Incident Report (HMIR) database. The HMIR database contains a secondary database, called the Radioactive Material Incident Report (RMIR) database after the parent DOT database, HMIR. Sandia National Laboratories in Albuquerque, New Mexico is responsible for maintaining the RMIR database (see contact information in Appendix C, Section C.2 [under DOE]).

A.2 Reporting Requirements for Transportation Accidents/Incidents Involving Radioactive Materials

The two Federal agencies with primary responsibility for developing and promulgating regulations for the transport of radioactive materials in the United States are DOT and NRC. The reporting requirements for these two agencies differ. The DOT regulations for reporting a hazardous materials incident (of which radioactive material is a subset) are specified in 49 CFR §171.15. The Department requires that a report be filed after each incident that occurs during the course of radioactive materials transportation (including loading, unloading, handling, and temporary storage) in which one of the following directly results:

1. A death;
2. An injury that requires hospitalization;
3. Estimated carrier or other property damage exceeding \$50,000;
4. Fire, breakage, spillage, or suspected contamination involving radioactive materials; or
5. A situation that the carrier believes should be reported.

The NRC regulations, found in 10 CFR §20.2201, §20.2202, §20.2203, and 10 CFR §71.95, require that the theft or loss of radioactive materials, exposure to radiation, or release of radioactive materials be reported. Reporting is required also for Type B or fissile packages when (1) a defect that is significant in terms of the safety of the shipment is detected, (2) a significant reduction in the package effectiveness occurs during use, or (3) a violation of the certificate of compliance occurs during use.

In addition to the reports received from the DOT and NRC, the RMIR database contains data obtained from State radiation control offices, the DOE Unusual Occurrence Report database, and media coverage of radioactive materials transportation incidents.

A.3 Analysis of U.S. Radioactive Materials Transportation Accident/Incident Data

A.3.1 Historical Overview

To evaluate the safety of transporting radioactive materials, it is helpful to examine the record of hazardous materials shipments in the United States over the years. The *Final Environmental Statement on the Transportation of Radioactive Material by Air and Other Modes* (see Appendix O, Bibliography item 49) estimates that, during a given year, approximately 500 billion packages of all commodities are transported by all modes throughout the United States. Of those 500 billion packages, several hundred million are classified as hazardous materials (e.g., flammables, explosives, poisons, and radioactive materials). The number of packages containing radioactive materials is estimated to be in the range of 5–10 million per year, which is 1–2% (or less) of hazardous materials packages being transported.

The RMIR database was developed in 1981 primarily to accommodate the information on DOT Form 5800 (*Hazardous Materials Incident Report*) for transportation accidents and incidents. In order to give users a better understanding of the type of reported transportation incidents, the RMIR database makes a definite distinction between an accident and other reported incidents. The three classifications of reported transportation incidents are defined as follows:

- **Transportation Accident:** Any accident that involves the vehicle that is transporting radioactive material.
- **Handling Accident:** Damage to a package during loading, handling, or unloading operations (e.g., a forklift puncturing a package at an air terminal).
- **Reported Incident:** Transportation event in which an actual or suspected release or surface contamination (exceeding regulatory requirements) of radioactive materials from either the package or the transport vehicle occurs, but accident conditions are not present. (In the database structure and query programs, a new category — “Missing or Stolen” — has been added to accommodate the requests of other Federal agencies using the RMIR data.) In this summary, the categories of missing and stolen will be considered a sub-heading under Reported Incidents.

From 1971 through 1990, approximately 180,000 hazardous material incident reports were submitted to DOT — an average of approximately 9,000 hazardous material reports sent to the DOT per year. From 1971 through 1997, if the reporting level to DOT remained at past levels, approximately 243,000 hazardous material reports would have been made to DOT. Table A-1 shows that, from 1971 through 1997, only 1,906 of these reports involved radioactive materials. So, of the part of the hazardous materials population for which incidents have been reported to

DOT, radioactive materials occupy only about 0.8 percent (1,906/243,000) of the reported incidents.

Table A-1 tabulates the transportation accidents, handling accidents, and incidents that have occurred for the 27-year timeframe of 1971–1997. Transportation accidents represent 21% of the 1,906 reported incidents. Handling accidents represent 15% of the reported incidents. The remaining 1,221 reported incidents did not involve transportation or handling accident conditions. Reported transportation incidents comprise 64% of all reported incidents listed in Table A-1.

Table A-1: U.S. Radioactive Materials Transportation Events (1971–1997)

Type of Accident/Incident	Number of Accidents/Incidents	Percent of Total
Transportation accidents	399	21
Handling accidents	286	15
Reported incidents	1,221	64
Total	1,906	100

Most radioactive materials are transported on the highway. These highway shipments generally include industrial gauges, radioactive material used in or as a result of the nuclear fuel cycle, low-level radioactive materials or waste, and teletherapy sources. Air shipments of radioactive materials generally contain isotopes with short half-lives being shipped over 500 miles from the shipper's location; most of these are diagnostic nuclear medicine materials. Upon arrival at an airport, these radioisotopes are generally delivered to their consignees by a courier service. Radioactive materials transported by modes other than aircraft usually do not require immediate delivery.

Tables A-2 through A-4 provide descriptions of the characteristics of 472 incidents that were reported in the RMIR database for the 7-year period of 1991–1997. During this period, a total of 93 transportation accidents and 43 handling accidents were reported.

Table A-2: Search Code Classification for Incident Reports (1991–1997)

Search Code	Number	Percent of Reports
Medical	157	33
Industrial	222	47
Fire	6	1
Nuclear Fuel Cycle	51	11
LLW	16	3
Unknown	20	5
Total	472	100

Table A-3: Transport Mode Classification for Incident Reports (1991–1997)

Transport Mode	Number	Percent of Reports
Highway	334	71
Rail	25	5
Air	67	14
Water (Marine)	6	1
Freight Forwarder/Courier	5	1
Warehouse	2	<1
Unknown/Other	33	7
Total	472	100

Table A-4: Package Classification for Incident Reports (1991–1997)

Package Type in Reported Incidents	Number	Percent of Reports
“Strong, Tight” (S)	21	4
Type A (A)	198	42
Type B (B)	36	8
Unknown	217	46
Total	472	100

During the 27 years from 1971 through 1997, 2,379 Type A packages were exposed to transportation accident conditions (see Table A-5). Although Type A packages are not designed to resist accident conditions, only 219 of the packages were damaged to the extent that their contents were released. However, because the limit of radioactive contents in a Type A package is A₁ or A₂, no significant health effects resulted from these Type A package releases.

During the period from 1971 through 1997, a total of 400 transportation accidents involving radioactive materials occurred. Of these, 60 involved Type B accident-resistant packages. The percent of these Type B packages from which a release occurred is reported in Tables A-5 and A-6.

Table A-5: Package Response for Reported Accidents (1971–1997)

Package Type in Reported Accidents	Number of Packages in Accidents	Estimated Number of Packages with Release of Radioactive Contents
“Strong, Tight” (S)	1,255	236
Type A (A)	2,379	219
Type B (B)	95	0
Total	3,729	455

A.3.2 Accidents Involving Type B Packages

Table A-6 provides a list of the 60 accidents involving Type B packages that occurred from 1971 through 1997. These accidents involved 95 Type B packages; no release of their radioactive contents occurred as a result of accident conditions. Of these 60 accidents, 7 involved SNF (3 occurred during rail transport and 4 occurred on the highway). Only one SNF accident has resulted in more than trivial damage to the cask. This accident occurred on December 8, 1971, on U.S. Highway 25 in Tennessee. The accident rollover caused the cask to come off of the trailer. The radiation surveys taken at the accident scene indicated that the structural integrity of the cask was intact and there was no release of radioactive contents. The driver of the truck transporting the cask was killed in the accident, but his death was not related to the radioactive nature of the cargo.

Table A-6: Summary of 60 Accidents Involving Type B Packages (1971-1997)

Date of Accident	Mode	Package Description	Radioactive Material Involved	Packages Shipped/Damaged
07/10/71	Highway	Lead container	Co-60	1/0
12/05/71	Highway	Radiography camera	Ir-192	1/0
12/08/71	Highway	Cask, spent fuel	Spent fuel	1/1
03/10/74	Highway	Container	Ir-192	1/0
03/29/74	Rail	Cask, spent fuel	Empty cask	1/0
08/09/75	Highway	Cask	U-235, U-238, Pu-239	1/0
05/06/77	Highway	Radiography camera	Ir-192	1/0
08/11/77	Highway	Radiography camera	Ir-192	1/0
08/25/77	Rail	Cylinders	UF ₆	4/0
10/03/77	Highway	Radiography source	Ir-192	1/0
02/09/78	Highway	Cask, spent fuel	Spent fuel	1/0
04/10/78	Highway	Radiography camera	Ir-192	1/0
07/07/78	Highway	Cask	Mixed fission	1/0
07/26/78	Highway	Steel cask, lead	Cs-137	2/0
08/13/78	Highway	Cask, spent fuel	Empty cask	1/0
08/27/78	Highway	Radiography camera	Ir-192	1/0
09/11/78	Highway	Radiography camera	Ir-192	1/0
09/15/78	Highway	Radiography camera	Ir-192	1/0
11/28/78	Highway	Radiography camera	Ir-192	1/0
01/10/79	Highway	Cylinder	Ir-192	5/0
08/12/79	Highway	Cask	Empty cask	2/0
12/11/79	Highway	Cylinder	UF ₆	5/0
01/14/80	Highway	Cask, teletherapy	Co-60	1/0
01/31/80	Highway	Cask	LLW	2/0
07/21/80	Highway	Source	Ir-192	1/0
08/22/80	Highway	Cylinder, 30B	UF ₆	5/0
09/06/80	Rail	Cylinder, 30B	UF ₆	8/0
09/29/80	Rail	Radiography source	Sr-90, Y-90	3/0

Date of Accident	Mode	Package Description	Radioactive Material Involved	Packages Shipped/Damaged
06/09/81	Highway	Source, shielded	Am-241/Be	1/0
09/02/81	Highway	Source	Ir-192	1/0
10/26/81	Highway	Radiography camera	Ir-192	1/0
11/03/82	Highway	Cask LLW	Empty cask	2/0
03/11/83	Highway	Cask	LLW	1/0
05/10/83	Highway	Radiography source	Ir-192	1/0
07/14/83	Air	Cask	Y-90, Ir-192	2/0
12/09/83	Highway	Cask, spent fuel	Spent fuel	1/0
07/16/84	Air	Container	Ir-192	1/0
08/08/84	Highway	Container	Reactor waste	1/0
02/11/85	Highway	Steel drum	Ir-192	1/0
02/13/85	Highway	Steel drum	Ir-192	1/1
12/04/85	Highway	Radiography camera	Ir-192	1/0
01/10/86	Highway	Source	Cs-137	1/0
08/15/86	Highway	Cylinder, 30B	UF ₆	3/0
03/24/87	Rail	Cask, spent fuel	Spent fuel	2/0
10/26/87	Highway	Radiography source	Ir-192	1/0
01/09/88	Rail	Cask, spent fuel	Empty cask	1/0
01/23/88	Highway	Radiography camera	Ir-192	1/0
09/23/88	Highway	Radiography camera	Ir-192	1/0
03/27/89	Highway	Radiography camera	Ir-192	1/0
05/19/89	Highway	Cask	LLW	1/0
06/08/91	Highway	Radiography camera	Ir-192	1/0
09/15/91	Highway	Radiography camera	Ir-192	1/0
11/03/91	Highway	Radiography camera	Ir-192	1/0
02/07/92	Highway	Radiography camera	Ir-192	1/0
03/04/93	Highway	LLW cask	LLW	1/0
12/23/94	Rail	Cylinder (14 ton)	UF ₆	1/0
12/14/95	Highway	Cask, spent fuel	Empty cask	1/0
09/06/96	Air	Packages (no details)	Ir-192	1/0
12/06/96	Air	Packages (no details)	Ir-192	1/0
01/24/97	Highway	Cylinder	UF ₆	4/0
Total				95/2

A.3.3 Accident Involving Type A Packages

One of the most notable transportation accidents that has occurred in the United States in recent years involved the shipment of 12 packages, each containing two unirradiated nuclear fuel assemblies, destined for Vermont Yankee Nuclear Power Plant (see Appendix O, Bibliography item 2). The accident occurred on December 16, 1991, at 3:15 a.m. on Interstate 91 in downtown Springfield, Massachusetts. A car was traveling on the wrong side of the interstate, and although the truck driver swerved to avoid a collision, the car struck the tractor-trailer on the right side near the right fuel tank. The truck continued northbound and hit the center guardrail on the

opposite side of the road. After striking the outside guardrail, the truck skidded across the highway and came to rest against the center guardrail.

A fire started in the engine compartment of the tractor, spread to the entire tractor, and then to the trailer. NRC's report on the accident (see Appendix O, Bibliography item 2) indicated that the fire burned for at least three-quarters of an hour before the cargo was affected. At that time, the entire cargo was entirely intact. Because the fire was not extinguished, the flatbed trailer and the radioactive cargo also burned. The fire lasted approximately 3 hours. The tractor-trailer was completely destroyed by the fire and there was significant damage to several Type A packages and their contents. Eight containers fell off the trailer and sustained minor damage from the impact. Although the wooden outer containers were burned and the inner metal containers sustained damage ranging from minor to severe, there was no release of radioactive contents from the unirradiated fuel assemblies.

A.4 Summary and Conclusions

Only a small fraction of all hazardous materials incidents reported in the RMIR database involve radioactive materials. Accident occurrences in which radioactive materials have been released from the packages have involved packages of the industrial type ("strong, tight") or Type A packages not designed to withstand accident conditions. The regulatory limit on the activity that can be transported in a Type A package (A_1 or A_2 magnitude) provides a high level of environmental safety when releases from Type A packages (or IP) occur. No Type B accident-resistant packages have released their contents during transportation accidents.

The accident summary described in this appendix is usually completed on an annual basis. Update information on transportation accidents from the RMIR database can be obtained by contacting DOE's TRANSNET system (see Appendix C, Section C.2).

This page is intentionally left blank

APPENDIX B

Federal Regulatory Relationships for Commercial Transportation of Radioactive Materials

Packaging and transportation of radioactive materials are regulated at the Federal level by both DOT and NRC, with some overlapping jurisdiction. Under the Hazardous Materials Transportation Authorization Act of 1994 (PL 103-311; 49 USC §5101 et seq.) and other statutes that now constitute the Hazardous Materials Transportation Law, the DOT regulates the transportation of all hazardous materials, including radioactive materials. This authority extends to shippers and carriers. Pursuant to the Energy Reorganization Act of 1974 (PL 93-438; 42 USC §5801 et seq.), NRC licenses and regulates the receipt, possession, use, and transfer of most kinds of radioactive materials and enforces DOT regulations pertaining to licensees as shippers.

DOT and NRC operate under a Memorandum of Understanding revised on June 8, 1979 (see FR dated July 2, 1979). Under this memorandum, DOT's role includes development of the overall safety standards governing all radioactive materials packages, their classification, marking, and labeling. Generally, DOT is responsible for Type A and LSA packaging requirements, and NRC is responsible for reviewing and approving designs for Type B and fissile packaging. DOT also develops safety standards covering the mechanical conditions of carrier equipment, qualifications of carrier personnel, carrier loading and unloading, handling, storage, and vehicle placarding.

Requirements have also been established for notification and reporting of transportation incidents, including suspected radioactive contamination. DOT acts as the national authority for administrative requirements of the International Atomic Energy Agency (IAEA) transportation regulations.

In general, the regulatory standards for packaging and transportation of radioactive materials are designed to achieve the following four primary objectives:

1. To protect persons and property from radiation emitted from packages during transportation by specifically limiting the allowable radiation levels.
2. To provide proper containment of the radioactive materials in the package under the normal rigors of transportation (for the less hazardous Type A quantities) or under normal and accident conditions (for the more significant Type B quantities). Package design requirements for containment are based on performance-oriented package damage tests and environmental criteria.
3. To prevent, during transit or storage, the possibility of reaching nuclear criticality (i.e., a nuclear chain reaction) for fissile radioactive materials.

4. To provide physical protection procedures and methods to prevent theft and sabotage during transit of strategic quantities and types of fissile radioactive materials.

Table B-1 lists the Federal regulations that apply to the transportation of radioactive materials, which are included as hazardous materials in the CFR. Titles have different effective dates, and the most recent issue of the regulations should be used. The references listed in Table B-1 provide a detailed summary of DOT packaging regulations.

Table B-1: Current Federal Regulations Covering Radioactive Materials Transportation and Transportation Safety

Transportation Group Regulated	Agency ^a	CFR Title	CFR Parts
Shippers and carriers for all modes	DOT	49	101-178
Highway carriers	DOT/FMCSA	49	177 & 382-399
Air carriers	DOT/FAA	14; 49	60-139; 175
Rail carriers	DOT/FRA	49	174 & 209-236
Water carriers	DOT/USCG	46; 49	146-148; 176
Postal shippers and carriers ^b	USPS	39	123
NRC licensees who prepare radioactive materials for transportation	NRC	10	71 & 73

^a For domestic mail, refer to USPS Publication 52 (see Appendix O, Bibliography item 79); for international mail shipments, refer to the International Mail Manual, Section 135.6; see Appendix P for the USPS address.

^b See the Abbreviation and Acronym list for definitions of FMCSA, FHWA, FAA, and USPS.

APPENDIX C

Federal and Private-Sector Agency Emergency Roles and Contacts

This appendix describes the emergency roles of Federal and private-sector organizations and provides the points of contact that State, Tribal, and local emergency response planners may use in requesting Federal assistance for planning and/or response. Contact information is provided for USDA, DOD, DOE, EPA, FEMA, DHHS, NRC, and DOT (including USCG) and several private-sector emergency response organizations. Descriptions of the roles of the Federal agencies are taken from the FRERP, dated May 1, 1996 (available from FEMA upon request); see Appendix P, Section P.1.2.

C.1 Roles and Responsibilities

C.1.1 Federal Agencies

U.S. Department of Agriculture

USDA is prepared to provide the following assistance in response to a transportation emergency, if requested.

Resource Assistance

1. Provide emergency food coupon assistance in officially designated disaster areas, if needed and if the commercial food system is sufficient to accommodate the use of food coupons.
2. Provide for the availability of USDA-donated food supplies from warehouses, local schools, and other outlets to emergency care centers. These food supplies are donated to various outlets through the USDA food programs.
3. Provide lists of the locations of alternate sources of food and livestock feed.
4. Assist in providing temporary housing for evacuees.
5. Provide emergency communications assistance to the agricultural community through the Cooperative State Research, Education, and Extension Service electronic mail system.

Technical Assistance

1. Assess damage to crops, soil, livestock, poultry, and processing facilities and incorporate findings in a damage assessment report.
2. Inspect meat, poultry, and egg products identified for interstate and foreign commerce to ensure that they are safe for human consumption.

3. Assist, in conjunction with DHHS, in monitoring the production, processing, storage, and distribution of food through the wholesale level to eliminate contaminated product or to reduce the contamination in the product to a safe level.
4. Collect agricultural samples within the Ingestion Exposure Pathway Emergency Planning Zone.
5. Provide advice on the disposition of exposed livestock and poultry.

U.S. Department of Defense

DOD has the following role under the FRERP.

1. Provide radiological resources, including trained response personnel, specialized radiation instruments, mobile instrument calibration, repair capabilities, and expertise in site restoration.
2. Perform special sampling of airborne contamination on request.

U.S. Department of Energy

DOE's responsibilities are in initial and transitional response coordination, as described below.

Initial Response Coordination

1. Coordinate Federal offsite radiological environmental monitoring and assessment activities.
2. Maintain technical liaison with State and local agencies that have monitoring and assessment responsibilities.
3. Maintain a common set of all offsite radiological monitoring data in an accountable, secure, and retrievable form and ensure the technical integrity of the FRMAC data.
4. Provide monitoring data and interpretations, including exposure rate contours, dose projections, and any other requested radiological assessments, to the LFA and to the States.
5. Provide, in cooperation with other Federal agencies, the personnel and equipment needed to perform radiological monitoring and assessment activities.
6. Request supplemental assistance and technical support from other Federal agencies as needed.
7. Arrange consultation and support services through appropriate Federal agencies to all other entities (e.g., private contractors) with radiological monitoring functions and capabilities and arrange technical and medical advice for handling radiological contamination and population monitoring.

Transition of Coordination Responsibility

The DOE FRMAC Director works closely with the Senior EPA representative to facilitate a smooth transition of the Federal radiological monitoring and assessment coordination responsibility to EPA at a mutually agreeable time and after consultation with the States and LFA.

U.S. Environmental Protection Agency

The EPA is the LFA for an emergency that involves radiological material not licensed or owned by a Federal agency or an Agreement State. EPA has the following responsibilities under the FRERP.

1. Prior to assuming responsibility from DOE for the FRMAC, provide resources, including personnel, equipment, and laboratory support (e.g., mobile laboratories), to assist DOE in monitoring radioactivity levels in the environment.
2. Assume coordination of Federal radiological monitoring and assessment responsibilities from DOE after the transition.
3. Assist in the development and implementation of a long-term monitoring plan.
4. Provide nationwide environmental monitoring data for assessing the national impact of the accident.

Federal Emergency Management Agency

FEMA coordinates the provision of non-radiological Federal resources and assistance to affected State and local governments. These functions are performed at the Disaster Field Office or other appropriate location established by FEMA. FEMA's role is to:

1. Monitor the status of the Federal response to requests for non-radiological assistance from the States and provide this information to the States.
2. Keep the LFA informed of requests for assistance from the State(s) and the status of the Federal response.
3. Identify and inform Federal agencies of actual or apparent omissions, redundancies, or conflicts in response activities.
4. Establish and maintain a source of integrated, coordinated information about the status of all non-radiological resource support activities.
5. Provide other non-radiological support to Federal agencies responding to the emergency.

U.S. Department of Health and Human Services

DHHS has the following role under the FRERP.

1. In conjunction with USDA, inspect production, processing, storage, and distribution facilities for human food and animal feeds that may be used in interstate commerce to ensure protection of the public health.
2. Collect samples of agricultural products to monitor and assess the extent of contamination as a basis for recommending or implementing protective actions.
3. Provide guidance to State and local health officials on disease control measures and epidemiological surveillance and study of exposed populations.
4. Provide advice on proper medical treatment of personnel exposed to or contaminated by radioactive materials.
5. Provide advice and guidance in assessing the impact of the effects of radiological incidents on the health of persons in the affected area.

U.S. Nuclear Regulatory Commission

NRC provides assistance in the Federal radiological monitoring and assessment activities during incidents. The NRC is the LFA for an emergency that involves radiological material licensed by the NRC or an Agreement State. The NRC has the following role under the FRERP.

1. Provide assistance in Federal radiological monitoring and assessment activities during incidents.
2. Provide, where available, continuous measurement of ambient radiation levels around NRC licensed facilities, primarily power reactors using thermoluminescent dosimeters (TLD).

U.S. Department of Transportation

DOT's Regional Emergency Transportation Coordinators and Regional Emergency Transportation Representatives do not provide radiological expertise or monitoring for resolution of emergencies. The agency is responsible for the following tasks under the FRERP.

1. Support State and local governments by identifying sources of civil transportation on request and when consistent with statutory responsibilities.
2. Coordinate the Federal civil transportation response in support of emergency transportation plans and actions with State and local governments. (This task may include provision of Federally controlled transportation assets and the controlling of airspace or transportation routes to protect commercial transportation and to facilitate the movement of response resources to the scene.)

3. Provide Regional Emergency Transportation Coordinators and staff for assisting State and local authorities in emergency planning and response.
4. Provide technical advice and assistance on the transportation of radioactive materials and the impact of the incident on the transportation system.

One of the agencies under DOT is the USCG; in addition to operating the National Response Center, the USCG is the lead Federal agency for resolving all hazardous materials spills in navigable waters. All such actions are addressed under the NCP, which incorporates the FRERP as the framework for actions if the hazardous materials are radioactive. In contrast to its role in addressing oil spills, the USCG is heavily dependent on technical support from other NCP agencies for spills of many other hazardous materials (including radioactive materials).

C.1.2 Private-Sector Organizations

CHEMTREC and several other private-sector organizations — such as CHEM-TEL, Inc.; INFOTRAC; or 3E Company — are national public service resources. Although all of these organizations provide 24-hour information and communications coordination with shippers primarily for chemical emergencies, they also work closely with Federal, State, and Tribal organizations that have responsibilities and capabilities for providing technical assistance for radiological emergencies.

When requested, these private-sector organizations will provide a hookup to the National Response Center for the carrier-required notification of a release of a RQ of hazardous material, in accordance with 40 CFR §302. This regulation provides criteria for notification of certain hazardous materials releases that may include radioactive materials (e.g., mixed waste where radioactive materials are mixed in with other hazardous wastes, which may compel EPA involvement, potentially under Superfund and/or Resource Conservation and Recovery Act [RCRA] authorities). If radioactive materials are present in an accident, one of these private-sector organizations and/or the National Response Center will also immediately notify DOE. They or DOE will immediately notify NRC if the materials are NRC-licensed. These organizations are also capable of establishing conference-call links for many parties during an emergency.

C.2 Contact Information

C.2.1 Federal Agencies

U.S. Department of Agriculture

24-hour pager emergency phone number: 1-800-sky-page; pin 74939

Emergency Programs Office

Emergency Programs Office
USDA, Food Safety Inspection Service (FSIS),
Office of Management (OM),
Emergency Planning Staff (EPS)
5601 Sunnyside Avenue, Suite 1-2260-C
Beltsville, MD 20705
Phone: (301) 504-2160
Fax: (301) 504-2141

Emergency Points of Contact

Lori Thomas
E-mail: lori.thomas2@usda.gov
Ronald Graham
E-mail: ron.graham@usda.gov

U.S. Department of Defense

DOD Headquarters JNACC, DTRA
6801 Telegraph Road
Alexandria, VA 22310-3398
Phone: (703) 325-2102/2103.

DOD Defense Nuclear Weapons School
Kirtland AFB
1900 Wyoming Blvd., SE
Albuquerque, NM 87116
Phone: (505) 846-5666

U.S. Department of Energy

DOE JNACC
Kirtland AFB
Pennsylvania and H Street
Albuquerque, NM 87116
Phone: (505) 844-4667

Headquarters DOE Watch Office, Forrestal Building
1000 Independence Avenue, SW
Washington, D.C. 20585
Phone: (202) 586-8100

Security Command (SECOM) Control Center
Albuquerque Operations Office,
Pennsylvania and H Street
Albuquerque, NM 87116
Phone: (800) 424-0167 or (505) 845-5291

DOE's Transportation Safeguards Division
Kirtland AFB
Pennsylvania and H Street
Albuquerque, NM 87116
Phone: (505) 845-5214

RMIR database information on transportation accidents can be obtained by contacting the TRANSNET system at SNL.

Transportation Systems Analysis, Department 6341
Sandia National Laboratories
1515 Eubank Blvd. SE
Albuquerque, NM 87123
Phone: (505) 844-1121; (505) 845-8181; or (505) 845-8753

U.S. DEPARTMENT OF ENERGY - RADIOLOGICAL ASSISTANCE PROGRAM

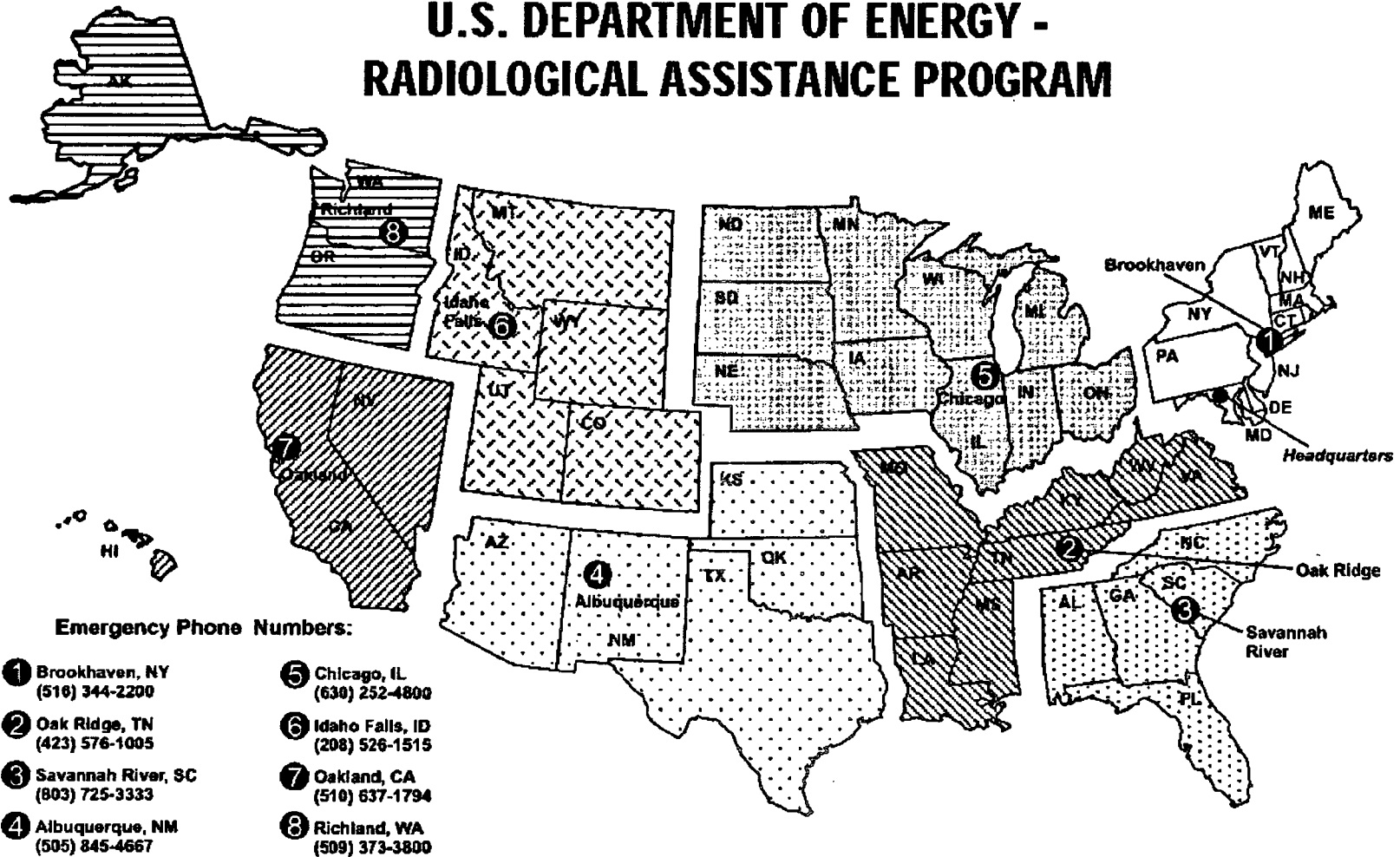

For transportation emergency response assistance, please call:

**Headquarters Emergency Operations Center
Phone: (202) 586-8100**

U.S. Environmental Protection Agency

National Response Center

Phone: 1-800-424-8802 (24-hour emergency number)

Office of Radiation and Indoor Air — Headquarters

Center for Risk Modeling and Emergency Response
Phone: (202) 564-9360

EPA Response Team

National Air & Radiation Environmental Laboratory
Montgomery, Alabama
Phone: (334) 270-3400

Office of Radiation and Indoor Air Radiation Laboratory
Las Vegas, Nevada
Phone: (702) 798-2476

EPA Radiation Representatives

Region	Address	Phone Number
Region I CT, ME MA, NH, RI, VT	Boston, Massachusetts 24-hour emergency number	Phone: (617) 565-3234 Phone: (617) 223-7265
Region II NJ, NY, PR, VI	New York, New York 24-hour emergency number	Phone: (212) 637-4010 Phone: (908) 548-8730
Region III DE, DC, MD, PA, VA, WV	Philadelphia, Pennsylvania 24-hour emergency number	Phone: (215) 597-4084 Phone: (215) 566-3255
Region IV AL, FL, GA, KY, MS, NC, SC, TN	Atlanta, Georgia 24-hour emergency number	Phone: (404) 562-9100 Phone: (404) 562-8700
Region V IL, IN, MI, MN, OH, WI	Chicago, Illinois 24-hour emergency number	Phone: (312) 886-6175 Phone: (312) 353-2316

Region	Address	Phone Number
Region VI AR, LA, NM, OK, TX	Dallas, Texas 24-hour emergency number	Phone: (214) 665-7297 Phone: (214) 665-2222
Region VII IA, KS, MO, NE	Kansas City, Missouri 24-hour emergency number	Phone: (913) 551-7605 Phone: (913) 281-0991
Region VIII CO, MT, ND, SD, UT, WY	Denver, Colorado 24-hour emergency number	Phone: (303) 312-6147 Phone: (303) 293-1788
Region IX AS, AZ, CA, GU, HI, NV	San Francisco, California 24-hour emergency number	Phone: (415) 744-1048 Phone: (415) 744-2000
Region X AK, ID, OR, WA	Seattle, Washington 24-hour emergency number	Phone: (206) 553-7660 Phone: (206) 553-1263

EPA REGIONAL OFFICES AND STATE BREAKDOWN

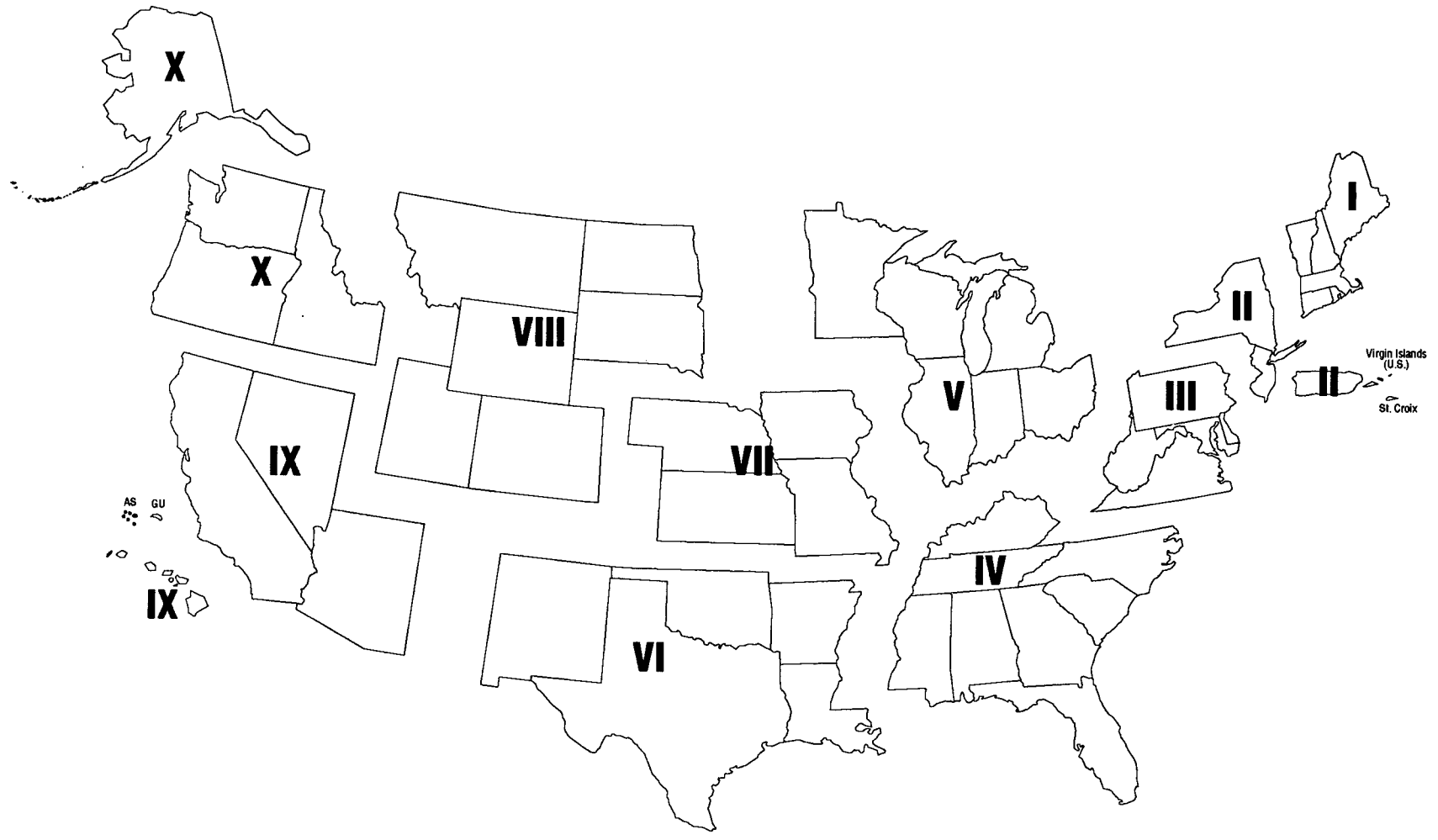

Federal Emergency Management Agency

Emergency Information & Coordination Center

Phone: (202) 646-2400 (24-hour emergency number)

Region	Address	Phone and Fax
Region I CT, ME MA, NH, RI, VT	Regional Director FEMA Region I J.W. McCormack Post Office & Courthouse Boston, MA 02109-4595	Phone: (617) 223-9540 Fax: (617) 223-9519
Region II NJ, NY, PR, VI	Regional Director FEMA Region II 26 Federal Plaza, Room 1338 New York, NY 10278-0002	Phone: (212) 225-7209 Fax: (212) 225-7281
Region III DE, DC, MD, PA, VA, WV	Regional Director FEMA Region III One Independence Mall, 6th Floor 615 Chestnut Street Philadelphia, PA 19106-4404	Phone: (215) 931-5608 Fax: (215) 931-5608
Region IV AL, FL, GA, KY, MS, NC, SC, TN	Regional Director FEMA Region IV 3003 Chamblee Tucker Road Atlanta, GA 30341	Phone: (770) 220-5200 Fax: (770) 220-5233
Region V IL, IN, MI, MN, OH, WI	Regional Director FEMA Region V 536 S. Clark Street Chicago, IL 60605	Phone: (312) 408-5502 Fax: (312) 408-5234
Region VI AR, LA, NM, OK, TX	Regional Director FEMA Region VI 800 N. Loop 288, Rm. 206 Denton, TX 76201-3698	Phone: (940) 898-5104 Fax: (940) 898-5235

Region	Address	Phone and Fax
Region VII IA, KS, MO, NE	Regional Director FEMA Region VII 2323 Grand Blvd., Suite 900 Kansas City, MO 64108-2670	Phone: (816) 283-7061 Fax: (816) 283-7582
Region VIII CO, MT, ND, SD, UT, WY	Regional Director FEMA Region VIII Denver Federal Center, Bldg. 710 Denver, CO 80225-0267	Phone: (303) 235-4813 Fax: (303) 235-4800
Region IX AS, AZ, CA, GU, HI, MC ^a , MH, MP, NV, PW	Regional Director FEMA Region IX Building 105 Presidio of San Francisco San Francisco, CA 94129-1250	Phone: (415) 923-7100 Fax: (415) 923-7112
Region X AK, ID, OR, WA	Regional Director FEMA Region X Federal Regional Center 130 228th Street, SW Bothell, WA 98021-9796	Phone: (425) 487-4607 Fax: (425) 487-4622

^a MC – Federated States of Micronesia

FEDERAL EMERGENCY MANAGEMENT AGENCY REGIONAL BOUNDARIES

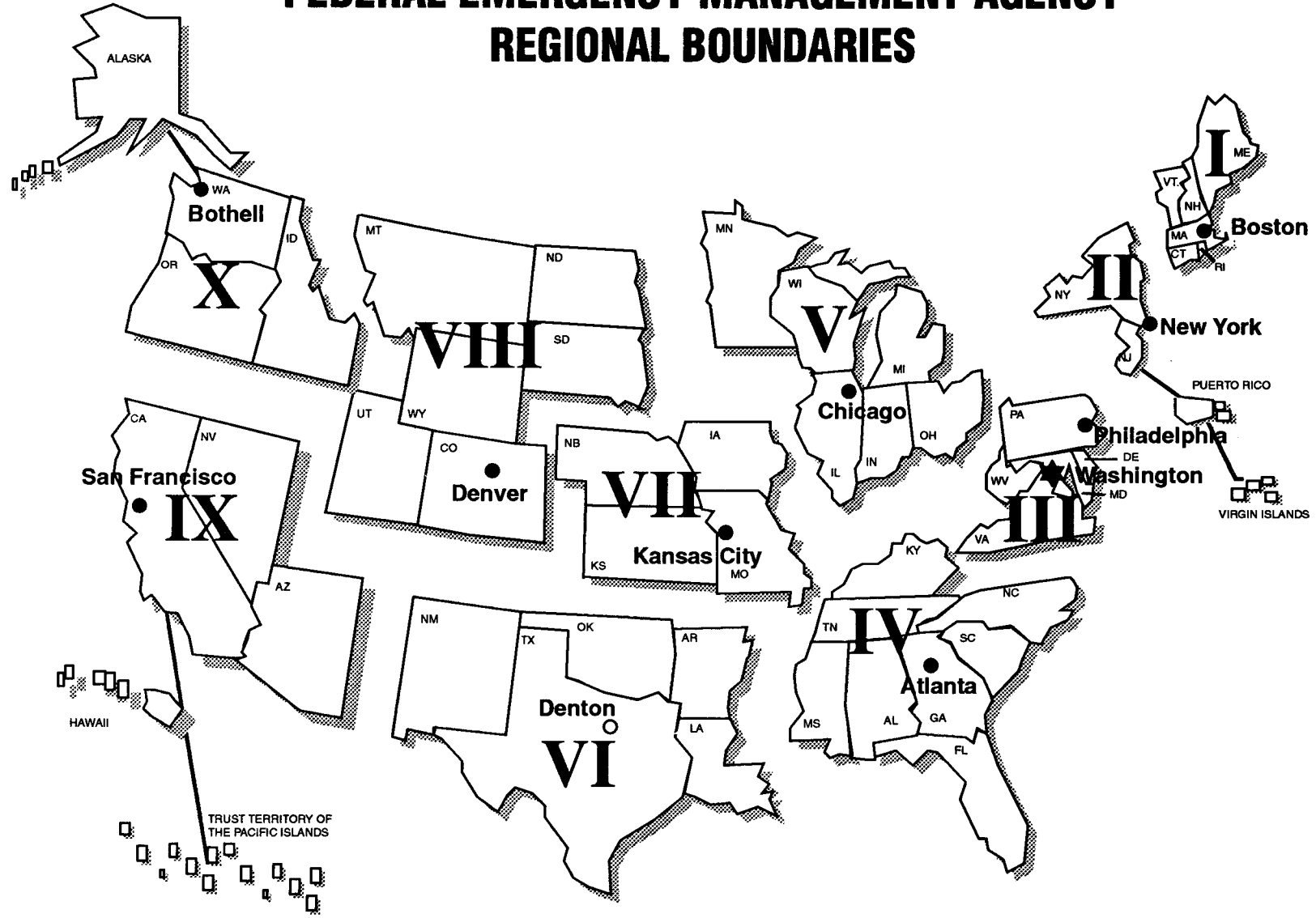

U.S. Department of Health and Human Services

Emergency Response Coordination Centers for Disease Control
1600 Clifton Road (E32)
Atlanta, GA 30333
Phone: (770)-488-7100 (24-hour emergency number)

Food and Drug Administration – Regional Radiological Health Representatives

Region	Regional Representatives	Region	Regional Representatives
<i>Northeast</i>		<i>Midwest</i>	
CT, ME, MA, NH, NY, PR, RI, VT	DHHS, FDA 830 Third Avenue Brooklyn, NY 11232 Phone: (718) 965-5052	IL, IN, MI, MN, ND, SD, WI	DHHS, FDA 20 N. Michigan Ave., Rm. 550 Chicago, IL 60602-4888 Phone: (312) 353-9408
<i>Mid-Atlantic</i>		<i>Southwest</i>	
DE, DC, MD, KY, OH, PA, NJ, VA, WV	DHHS, FDA 900 Madison Avenue Baltimore, MD 21201 Phone: (410) 922-3461	AR, CO, IA, KS, MO, NE, NM, OK, TX	DHHS, FDA 7920 Elmbrook Drive, Suite 102 Dallas, TX 75247 Phone: (214) 655-8100
<i>Southeast</i>		<i>Pacific</i>	
AL, FL, GA, LA, MS, NC, SC, TN, VI	DHHS, FDA 297 Plus Park Blvd. Nashville, TN 37217 Phone: (615) 781-5385	AK, AZ, CA, HI, ID, MT, NV, OR, WA	DHHS, FDA 22201 23rd Drive, SE P.O. Box 3012 Bothell, WA 98041-3012 Phone: (206) 483-4954

U.S. DEPARTMENT OF HEALTH & HUMAN SERVICES, FOOD AND DRUG ADMINISTRATION REGIONS

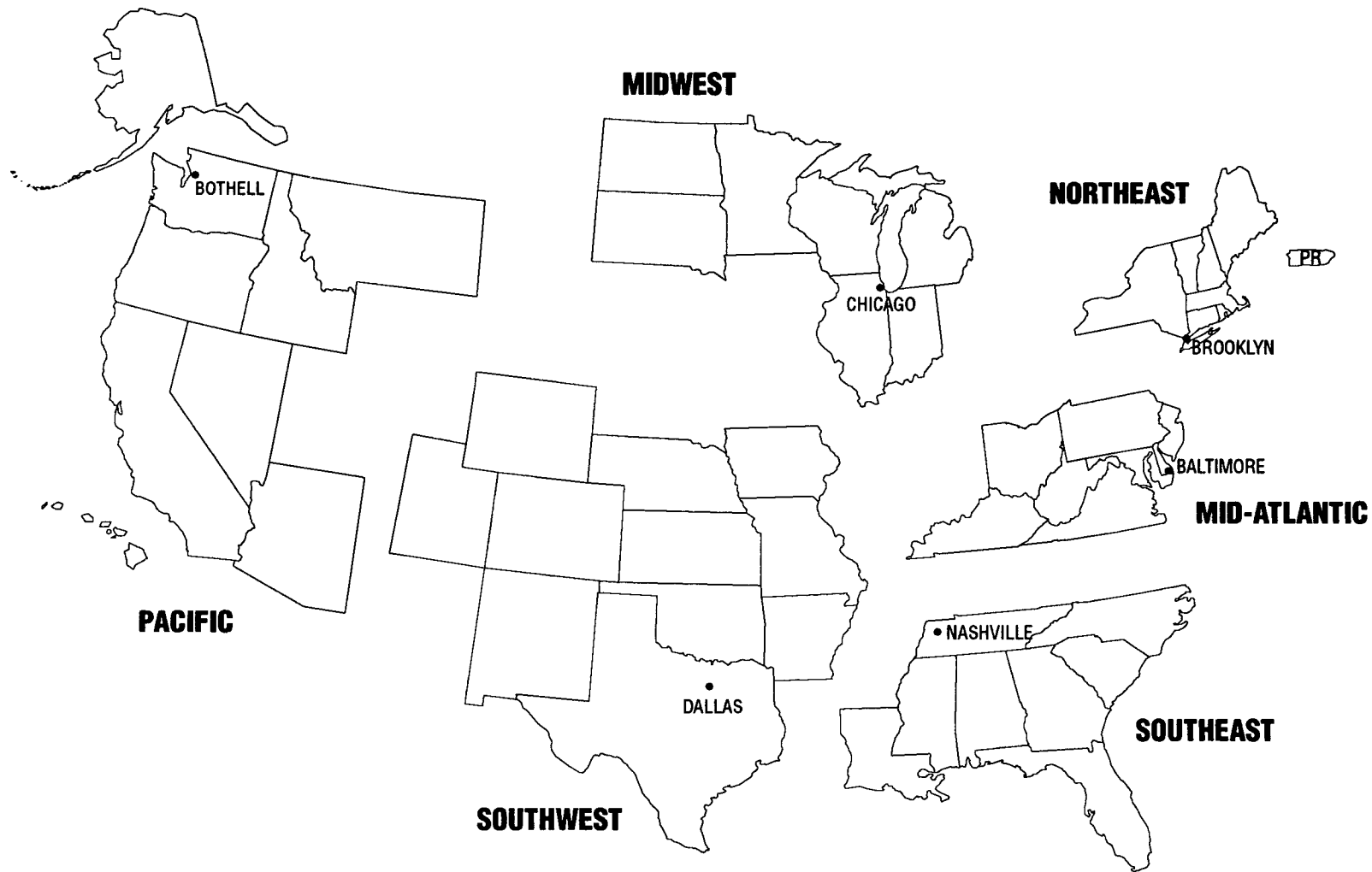

U.S. Nuclear Regulatory Commission

Emergency Operations Center

Phone: (301) 816-5100 (24-hour emergency number)

Building/Location	Address	Abbreviations
Headquarters		
Gelman Building (Public Document Room)	2120 L St., N.W. Washington, DC 20037-1527	L-ST
One White Flint North	11555 Rockville Pike Rockville, MD 20852-2738 Phone: (301) 415-7000	OWFN
Two White Flint North	11545 Rockville Pike Rockville, MD 20852-2738 Phone: (301) 415-7000	TWFN
Warehouse	5008 Bolling Brook Pkwy. Rockville, MD 20852-2738	WHSE
Regions		
Region I		
CT, D.C., DE, MA, ME, MD, NH, NJ, NY, PA, RI, VT	475 Allendale Road King of Prussia, PA 19408-1415 Phone: (610) 337-5000	RGN-I
Region II		
AL, FL, GA, KY, MS, NC, PR, SC, TN, WV, VA, VI	Sam Nunn Atlanta Federal Center, 23 T85 61 Forsyth Street S.W. Atlanta, GA 30303-3415 Phone: (404) 331-4503	RGN-II
Region III		
IA, IL, IN, MI, MN, MO, OH, WI	801 Warrenville Road Lisle, IL 60532-4351 Phone: (630) 829-9500	RGN-III
Region IV		
AK, AR, AZ, CA, CO, HI, ID, LA, KS, MP, MT, ND, NE, NM, NV, OK, OR, SD, TX, UT, WA, WY	611 Ryan Plaza Drive, Suite 400 Arlington, TX 76011-8064 Phone: (817) 860-8100	RGN-IV

Building/Location	Address	Abbreviations
Other		
High-Level Waste Management Office	1551 Hillshire Drive, Suite A Las Vegas, NV 89134-1048	NV
Paducah Resident Inspector Office	P.O. Box 487 West Paducah, KY 42088-4087	PADUCAH
NRC Portsmouth Resident Inspector Office	P.O. Box 860 Piketon, OH 45661-0700	PORTSMOUTH
NRC Technical Training Center	5746 Marlin Road, Suite 200 Chattanooga, TN 37411-5077	C-TN
NMSS/Tank Waste Remediation System Office	A4-70/484 825 Jadwin Avenue Richland, WA 99352	WA

Official Headquarters Mail

The following mailing address is applicable to all NRC organizational locations at NRC Headquarters:

U.S. Nuclear Regulatory Commission
ATTN: (recipient's name and organization)
Mail Stop (recipient's mail stop)
Washington, DC 20555-0001

This is the only acceptable mailing address and is required on all mail sent via the U.S. Postal Service. Do not use any other NRC Headquarters address for Headquarters mail. Include the mail stop and organizational identifier on all communications to NRC: these are available by dialing (301) 415-7000.

All incoming communications that are hand-carried to any NRC Headquarters building by a private delivery carrier should be addressed to the building location and must include the mail stop and unique organizational identifier, where applicable.

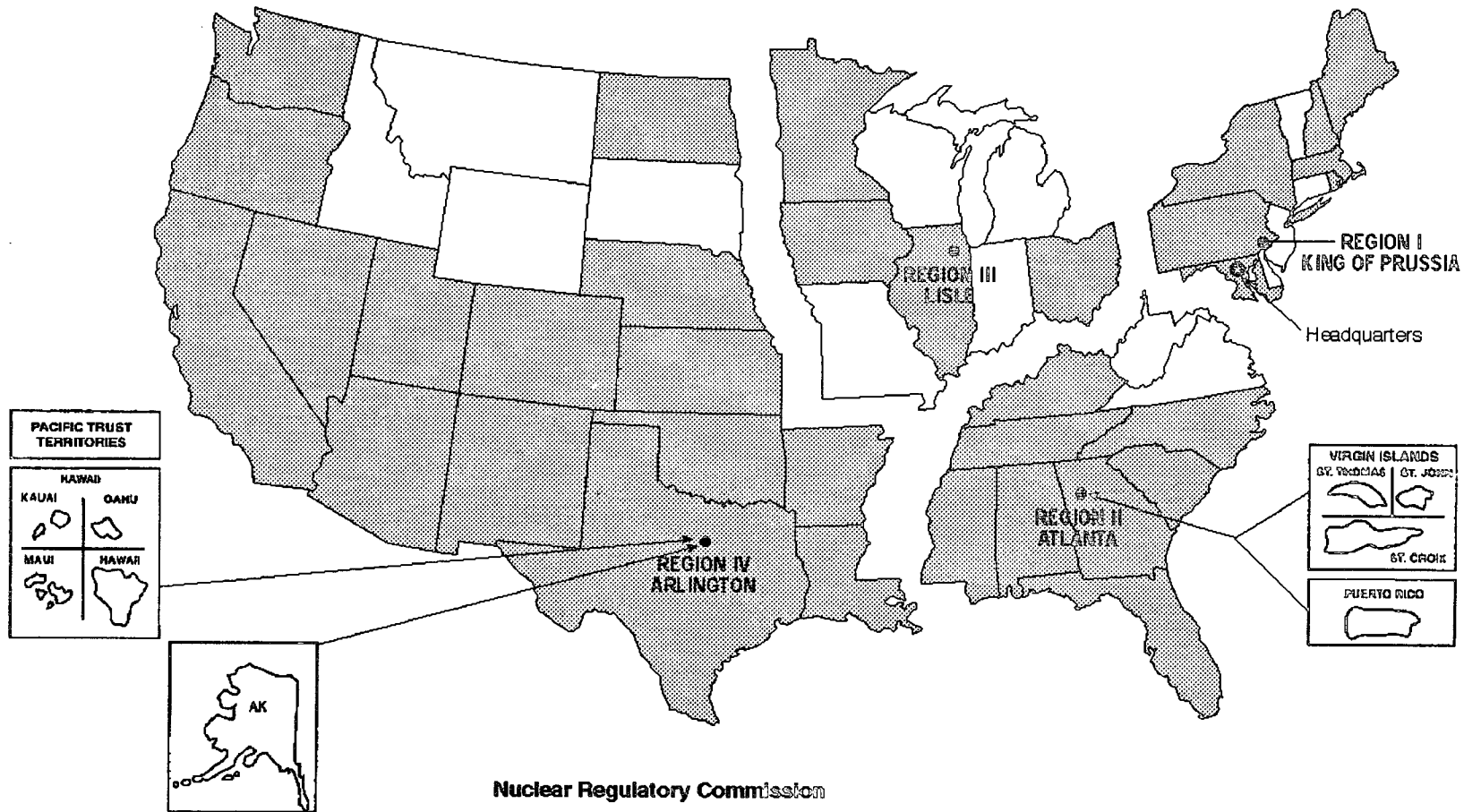

For example, incoming mail or packages to be hand-carried to one of the White Flint locations should be addressed: U.S. Nuclear Regulatory Commission; ATTN: (recipient's name and organization); Mail Stop (recipient's mail stop).

NUCLEAR REGULATORY COMMISSION AND AGREEMENT STATES



Nuclear Regulatory Commission

Headquarters	301-415-7000	800-368-5642
Regions		
I King of Prussia, Pennsylvania	610-337-5000	800-432-1156
II Atlanta, Georgia	404-331-4503	800-577-8510
III Lisle, Illinois	630-829-9500	800-522-3025
IV Arlington, Texas	817-860-8100	800-952-9677

 34 Agreement States
 (Approximately 17,800 licenses)
 16 Non-Agreement States
 (Approximately 4,000 licenses)

U.S. Department of Transportation

National Response Center/Team

USCG Headquarters
Washington, D.C.
Phone: (800) 424-8802 or
(202) 267-2675 (commercial number)

OET ^a /DOT Region	Regional Emergency Transportation Coordinators	Regional Emergency Transportation Representatives
1&2 ME, NY, VT, NJ, NH, MA, CT, RI	Commander, 1st USCG District 408 Atlantic Avenue Boston, MA 02110-3350 Phone: (617) 223-8480 Fax: (617) 223-8401	1st USCG District 408 Atlantic Avenue Boston, MA 02110-3350 Phone: (617) 223-8451
3 PA, MD, VA, WV, DE	Regional FHWA Administrator 10 South Howard Street Suite 400 Baltimore, MD 21201 Phone: (410) 962-0093 Fax: (410) 962-4586	Federal Highway Administration 10 South Howard Street Suite 400 Baltimore, MD 21201 Phone: (410) 962-0077, ext. 3058
4 KY, TN, MS, GA, NC, SC, AL, FL, PR	Regional Administrator FAA Southern Region (ASO-1) P.O. Box 20636 Atlanta, GA 30320 Phone: (404) 305-5000 Fax: (404) 305-5821	Manager, Operations Center FAA Southern Region (ASO-50E) P.O. Box 20636 Atlanta, GA 30320 Phone: (404) 305-5734
5 MN, MI, IN, WI, IL, OH	Regional FHWA Administrator 19900 Governors Drive, Suite 301 Olympia Fields, IL 60461 Phone: (708) 283-3510 Fax: (708) 283-3501	Federal Highway Administration 19900 Governors Drive, Suite 301 Olympia Fields, IL 60461 Phone: (708) 283-3503

^a Office of Emergency Transportation

OET/DOT Region	Regional Emergency Transportation Coordinators	Regional Emergency Transportation Representatives
6 NM, OK, LA, TX, AR	Regional Administrator FAA Southwest Region 2601 Meacham Blvd. Ft. Worth, TX 76193-0001 Phone: (817) 222-5001 Fax: (817) 222-5943/4	Manager, Operations Center FAA Southwest Region, ASW-1B 2601 Meacham Blvd. Ft. Worth, TX 76193-0001 Phone: (817) 2224-5806
7 NE, IA, KS, MO	Regional FHWA Administrator P.O. Box 419715 Kansas City, MO 64141-6715 Phone: (816) 276-2700 Fax: (816) 363-3347	Federal Highway Administration P.O. Box 419715 Kansas City, MO 64141-6715 Phone: (816) 276-2700
8 MT, WY, UT, CO, ND, SD	Regional FHWA Administrator 555 Zang Street, Room 400 Lakewood, CO 80228 Phone: (303) 969-6722 Fax: (303) 969-6727	Federal Highway Administration 555 Zang Street, Room 400 Lakewood, CO 80228 Phone: (303) 969-6722, ext. 331
9 CA, NV, AZ, HI, GU	Commander, Pacific Area, USCG Coast Guard Island Alameda, CA 94501 Phone: (510) 437-3196 Fax: (510) 437-5700	Pacific Area, USCG (PE) Coast Guard Island Alameda, CA 94501-5100 Phone: (415) 437-5841
10 ID, OR, WA	Commander, 13th CG District Federal Building, Rm. 3590 915 Second Avenue Seattle, WA 98174 Phone: (206) 220-7090 Fax: (206) 220-7265/7342	United States Coast Guard Federal Building, Rm. 3408 915 Second Avenue Seattle, WA 98174 Phone: (206) 220-7095
AK	Regional Administrator FAA Alaskan Region, AAL-1 222 W. 7th Avenue #14 Anchorage, AK 99513 Phone: (907) 271-5645	Federal Aviation Administration Alaskan Region, AAL-6 222 W. 7th Avenue #14 Anchorage, AK 99513 Phone: (907) 271-5936 Fax: (907) 276-7261

DOT REGIONAL EMERGENCY TRANSPORTATION COORDINATOR LOCATIONS

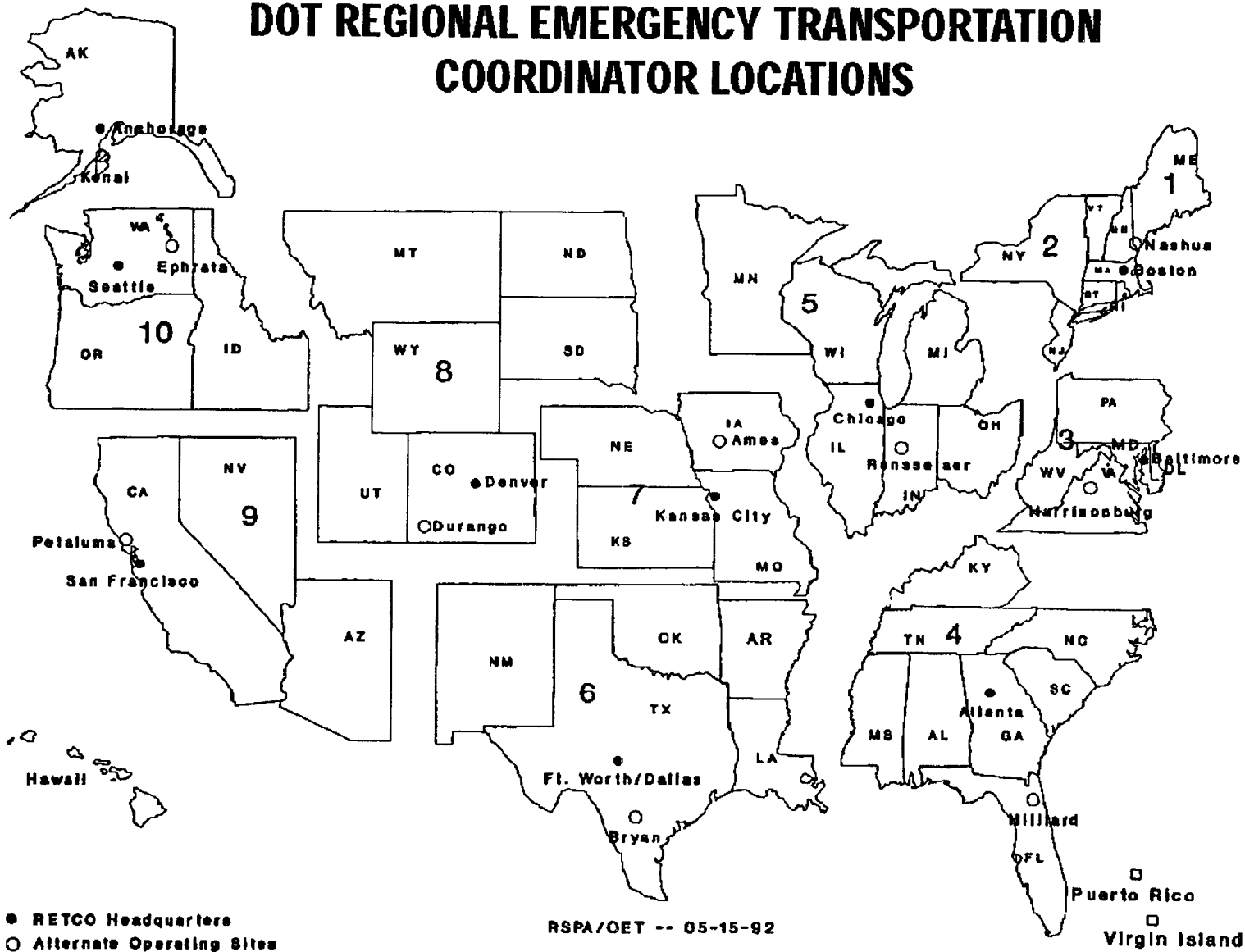

C.2.2 Private-Sector Organizations

CHEMTREC

For emergencies and non-emergencies, call (800) 424-9300 or (703) 527-3887

CHEM-TEL Inc.

For emergencies and non-emergencies, call (800) 255-3924 or (813)-248-0585

INFOTRAC

For emergencies and non-emergencies, call (800) 535-5053 or (352) 323-3500

3E Company

For emergencies and non-emergencies, call (800) 360-3220 or (760) 602-8703

This page is intentionally left blank.

APPENDIX D

Training Resources

This appendix outlines the status and availability of Federally sponsored training programs for responding to accidents involving radioactive materials, as well as some training resources that apply to the full spectrum of hazardous materials. The regional offices of most agencies (see Appendix C, Section C.2) can provide answers to most questions about the training offered. In most instances, lists of current curricula can be obtained from the contacts shown for each agency below. A few agencies have posted on-line catalogs on their Internet websites (see Appendix P).

D.1 U.S. Department of Agriculture

Description: The USDA provides guidance and assistance to State, Tribal, and local governments in preparing emergency plans that address food safety and other agricultural issues and training in protecting the food supply in the event of a radiological emergency.

Audience: Emergency management, agriculture, and public health agency representatives.

Contact: Emergency Programs Office
USDA, Food Safety and Inspection Service, Office Management, Emergency
Programs Branch
5601 Sunnyside Avenue, Ste. 1-2260-C
Beltsville, MD 20705
Phone: (301) 504-2160
Fax: (301) 504-2141

D.2 U.S. Department of Defense

Description: DOD provides five courses on nuclear weapons orientation, accident command and control, radiological team operations, weapons effects, and radiological hazards. The number of classes per year and the size of the classes vary. Students learn about nuclear weapons — what they are, their effects, responses to a nuclear accident, emergency team operations, decontamination, site restoration, stockpile and waste management, safety and security, key issues related to nuclear accidents, Federal response plans and capabilities, and the medical aspects of radiation.

Audience: Depending on the course, students may be military (grades E-5 and above); civilians (GS-7 and above); medical and allied health personnel; military, civilian, or contractor personnel who must be familiar with nuclear weapons effects; or military and civilian personnel currently filling an Explosives Disposal, Disaster Preparedness, or other emergency response force position.

Contact: Defense Nuclear Weapons School
Registrar's Office
1900 Wyoming Blvd., SE
Kirtland AFB, NM 87117-5669
Phone: (505) 846-5666
Fax: (505) 846-9168

D.3 U.S. Department of Energy

Description: The objective of DOE's Transportation Emergency Preparedness Program (TEPP) training is to make flexible, low-cost, high-quality training materials available to the jurisdictions affected by DOE shipments. Developed and managed by DOE-Richland (RL)/Hazardous Material Management and Emergency Response (HAMMER), TEPP provides training materials for emergency responders at all levels of government. The training materials address the skills and knowledge emergency responders need to safely respond to incidents involving shipments of radioactive materials.

The objectives of DOE's Radiation Emergency Assistance Center/Training Site (REAC/TS) are to: (1) provide courses in the handling of radiation accident cases; (2) maintain a research program on human radiation exposure; and (3) provide 24-hour direct or consulting assistance regarding medical and health physics problems associated with radiation accidents at local and national levels.

Audience: The intended audience varies according to the course. Courses are intended for fire service responders, emergency medical personnel, emergency management representatives, and law enforcement responders.

At REAC/TS, courses provide training for physicians, nurses, physician assistants, and health physics personnel on handling of radiologically contaminated and injured individuals and in the medical planning and care provided at radiation accidents.

Contact:

U.S. Department of Energy
Office of Environmental Management
Office of Transportation and Emergency
Management
Washington, D.C. 20545
Ella McNeil (301) 903-7284 or
June Ollero (509) 373-6722

REACT/TS, MS-39
Oak Ridge Institute for Science and Education
P.O. Box 117
Oak Ridge, TN 37831-0117
Attn: L.G. Mack, Registrar
Phone: (815) 576-3132
E-mail: mackg@ornl.gov

D.4 U.S. Department of Transportation

Description: DOT provides guidance and assistance on hazardous materials transportation regulations and emergency response to hazardous materials incidents. The Transportation Safety

Institute in Oklahoma City, Oklahoma, offers several courses addressing regulations for hazardous materials, including radioactive materials. DOT offers seven training modules on compliance and enforcement, including the hazardous materials table, shipping papers, packaging, marking, labeling, placarding, and carrier requirements. In addition, the agency offers a 27-minute videocassette training course entitled *Using the North American Emergency Response Guidebook: A First Response to Incidents Involving Radioactive Materials*, that is designed to instruct first responders in the use of the guidebook.

Audience: All levels of government and the regulated industry (e.g., shippers, carriers, and enforcement and response personnel).

Contact: U.S. Department of Transportation
Office of Hazardous Materials Initiatives and Training
DHM-50
Washington, D.C. 20590
Phone: (202) 366-2301

D.5 U.S. Environmental Protection Agency

Description: EPA administers a one-week course that teaches students how to implement and use EPA's PAGs.

Audience: All levels of government officials who must be familiar with the PAGs as part of their responsibilities.

Contact: Richey Lyman
U.S. Environmental Protection Agency
401 M Street, SW, 660 2J
Washington, D.C. 20460
Phone: (202) 564-9363
Fax: (202) 565-2037

D.6 Federal Emergency Management Agency

Description: Many courses relevant to radiological transportation accidents are available at either FEMA's National Emergency Training Center (NETC) in Emmitsburg, Maryland, or the Mt. Weather facility in Bluemont, Virginia. Co-located at the NETC are the Emergency Management Institute and the National Fire Academy. Another major resource for students and faculty is FEMA's Learning Resource Center. The websites listed in Appendix P provide additional information on these facilities. A catalog of activities is also available upon request from FEMA's Publications Office (see Appendix P for the address and fax number). Several courses are given only at the State level, and others are independent (i.e., home) study courses. FEMA offers a radiological series that includes planning, management, response, monitoring, assessment, and advanced operations courses. The agency also offers several hazardous materials and ICS courses. In addition, the National Fire Academy offers courses on command and control for qualified personnel.

Audience: The intended audience varies according to the course. Courses are intended for emergency planners, trainers, responders, health physicists, emergency medical personnel, public works personnel, law enforcement officers, fire command or company officers, and public officials in general. Write or fax for a copy of the catalog.

Contact: Requests for enrollment in the courses described should be directed to your State Training Officer, State Department of Emergency Services (Emergency Management) or your State Department of Health (Radiological Health Division). For further information about the courses, contact:

FEMA
Emergency Management Institute
Emmitsburg, MD 21727
Phone: (301) 447-1233 or
(301) 447-1360

FEMA
National Fire Academy
Office of Admissions
Emmitsburg, MD 21727
Phone: (301) 447-1035
Fax: (301) 447-1441

D.7 U.S. Nuclear Regulatory Commission

Description: A one-week course on the "Transportation of Radioactive Material" covering NRC and DOT regulations is administered by ChemNuclear Systems, Inc. NRC also offers a five-week program to train about 20 State health physicists a year.

Audience: State, Tribal, and local officials who must know the DOT and NRC regulations for transporting radioactive materials as a function of their responsibilities, and State and Tribal health physicists.

Contact: U.S. Nuclear Regulatory Commission
Technical Training Center
5746 Marlin Road, Suite 200
Chattanooga, TN 37411-5677
Phone: (423) 855-6500
Fax: (423) 855-6543

APPENDIX E

Public Liability Coverage for Transportation of Radioactive Materials

E.1 Price-Anderson Act: Nuclear Incidents

In 1957, Congress enacted the Price-Anderson Act (Act)⁸ as an amendment to the Atomic Energy Act (AEA) of 1954 to encourage the development of the nuclear industry and to ensure prompt and equitable compensation in the event of a nuclear incident. Specifically, the Price-Anderson Act established a system of financial protection and indemnification for persons who may be liable for a nuclear incident and assures that funds are available to compensate persons who suffer harm from the nuclear incident. The original two-fold purpose of the Act was as follows: (1) to encourage growth and development of the nuclear industry through the increased participation of private industry; and (2) to protect the public by assuring that funds were available to compensate victims for damages and injuries sustained in the event of a nuclear incident. The indemnification covers all DOE activities and certain NRC-licensed activities, including transportation of nuclear material. Congress renewed and amended the Price-Anderson Act in 1966, 1969, 1975, and 1988.⁹ The Price Anderson Amendments Act¹⁰ extended the Act for fourteen years until August 1, 2002. Covered facilities (which includes transportation of nuclear materials to and from them) and activities are as follows:

1. Nuclear power plants.
2. Nuclear facilities operated by contractors for DOE (e.g., Hanford Reservation in Washington, Savannah River Plant in South Carolina).
3. Plutonium processing and nuclear fuel fabrication plants.
4. Other nuclear reactors (such as those operated by nonprofit educational institutions).
5. DOE activities (including transportation) involving SNF, HLW, and TRU waste.

Radiopharmaceuticals are not covered under the NRC Price-Anderson indemnification system. In May 1989, the NRC concluded that it would be impractical to cover radiopharmaceutical companies under the Price-Anderson system. Radioactive materials transportation incidents not involving the above facilities or activities are also not covered by the Price-Anderson indemnification system and are discussed briefly later on.

The Price-Anderson Act establishes a system of private insurance, industry pooling, and Federal indemnification that generally ensures that certain amounts are available to compensate for

⁸ Price-Anderson Act amended the AEA, 42 USC §§ 2011 *et seq.* (1994) & Supplement III (1997).

⁹ For a comprehensive discussion of the issues and legislative history, see Appendix O, Bibliography items 80-82, 83, and 84.

¹⁰ The Price-Anderson Amendments Act of 1988, see Appendix O, Bibliography item 85.

damage or injuries suffered by the public in incidents involving DOE activities and NRC-licensed power reactors and other NRC-licensed activities, regardless of who causes the damages. The current amount of \$9.43 billion¹¹ reflects a threshold level beyond which Congress would review the need for additional payment of claims in the case of a nuclear incident with catastrophic damage. In other covered incidents relating to NRC licensees, the sum is limited to the sum exceeds \$500 million.

The liability of all indemnified persons is limited to the amount of coverage provided by the Price-Anderson system. If a State incurs liability for a covered nuclear accident (e.g., through negligent highway maintenance) or a local emergency responder increases the severity of the accident (e.g., through inadequate response), Price-Anderson funds will be available to compensate the States to pay the public for their damages up to the limit of liability. All State, local and Tribal governments are indemnified persons who will be reimbursed for any liability incurred in a covered nuclear accident and cannot be required to provide any additional compensation.

In the unlikely event that the damage from a nuclear incident were to exceed \$9.43 billion, the Price-Anderson Act contains a Congressional commitment to thoroughly review the particular incident and take whatever action is determined necessary to provide full and prompt compensation to the public [AEA §170.i.(1)]. In support of this commitment, the Act requires the President to submit a plan for full and prompt compensation for all valid claims to Congress not later than 90 days after a determination by a court that damage may exceed the indemnification [AEA §170.i.(2)]. The limit for incidents occurring outside the United States is \$100 million.¹²

The Act authorizes two Federal agencies to extend Price-Anderson Act indemnification. The DOE indemnifies its contractors (including subcontractors and suppliers) and other persons for contractual activities conducted for the agency. The NRC indemnifies some, but not all entities licensed by the agency. These agencies fully describe their schemes of indemnification in recent reports filed with Congress. Both agencies recommended renewal of the Act in substantially the same form (see Appendix O, Useful References items 80-82, 83, and 84).

With respect to activities conducted for DOE, the Price-Anderson Act requires DOE to include an agreement of indemnification in each contract that involves the risk of a nuclear incident. This DOE indemnification: (1) provides omnibus coverage of all persons who might be legally liable; (2) indemnifies fully all legal liability up to the statutory limit on such liability (currently \$9.43 billion for a nuclear incident in the United States); (3) covers all DOE contractual activity that might result in a nuclear incident in the United States; (4) is not subject to the usual limitation on the availability of appropriated funds; and, (5) is mandatory and exclusive.

The NRC indemnifies any nuclear incident in the course of transportation of nuclear fuel to or from a reactor site, the storage of nuclear fuel at a site, the operation of a reactor including discharges of radioactive emissions or effluents, the storage of nuclear wastes at a reactor site,

¹¹ This was the amount as of December 31, 1999. This figure will increase as new nuclear power plants are built and decrease as existing plants are decommissioned.

¹² Those harmed by accidents within the U.S., but causing damage beyond its borders, are entitled to compensation up to the full amounts allowable for accidents in the U.S. under the Act.

and the transportation of radioactive material from a reactor. The NRC is required to indemnify production and utilization facilities. The NRC is also given discretionary authority to apply the provisions to other types of licensees not involved in the operation of production or utilization facilities, such as those possessing radioactive materials. The NRC indemnification currently applies to the following categories of licensees: large commercial reactors (nuclear power plants); reactors under 100 megawatts, including Federal licensee and nonprofit educational institutions; plutonium processing and fuel fabrication facilities and other materials licensees. The amount of indemnification provided by the NRC is a combination of the maximum available level of primary and secondary insurance coverage and/or government indemnification and varies depending on a number of factors including the category of licensee.

The Act defines “public liability” as any legal liability arising out of or resulting from a nuclear incident or precautionary evacuation including all reasonable additional costs incurred by a State or a political subdivision of a State, in the course of responding to a nuclear incident or a precautionary evacuation. Liability excludes: (1) claims under State or Federal workmen's compensation acts of employees of persons indemnified who are employed at the site of and in connection with the activity where the nuclear incident occurs; (2) claims arising out of an act of war; and, (3) claims involving certain property located on site [AEA §11.w.; see also AEA §170.n(1)(B), §170.n(1)(E), and §170.n(1)(F)].

The Price-Anderson Act establishes the system that pays for the damages, but refers to the tort law¹³ of the State in which an accident occurs to determine whether there is liability and what the damages are. (The exception is that for certain large incidents where NRC or DOE finds that a radioactivity caused substantial offsite damage — extraordinary nuclear occurrences (ENO) — Federal law waivers result, in effect, in strict liability (proof of fault is not required and a Federal statute of limitations will be used). Therefore, the law of the State where the accident occurs will have a significant impact on how injured persons will be compensated for their losses. The relevant principles governed by State laws are as follows.

- **Statute of Limitations** — the length of time an injured person has to file a claim. Under a typical three-year personal injury statute of limitations, the filing time could run out before the health effects of radiation exposure are evident. The Price-Anderson Act addressed this problem by saying that the time does not begin to run in an ENO until the injured person discovers (or reasonably should have discovered) the harm and realizes that the accident caused the harm. The Price-Anderson Act has a three-year discovery rule for ENO. Some States have adopted a like provision with broader application.
- **Standard of Liability** — degree of fault or lack of care required to hold a person liable for harm to others. It may be difficult for an injured person to prove that an accident was caused by someone's negligence or intentional fault. Under the Price-Anderson Act for ENO and some States' laws, people causing a nuclear incident are strictly liable, regardless of whether they exercised reasonable care.

¹³ The law governing the liabilities that may arise when someone has been harmed, regardless of whether the harm was caused intentionally or through negligence.

- **Proof of Causation** — proving that a nuclear incident caused the person's injuries. It may be difficult to prove that a particular person's disease was caused by the incident because radiation exposure can cause diseases that also have other causes (unrelated to radiation). Under traditional tort law, even if the number of cases of a particular disease increased dramatically after an accident, it is possible that no one would receive compensation because it would be impossible to determine which people would not have developed the disease if the accident had not occurred. At least one State has eliminated this problem by allowing the courts to consider statistical information and other evidence often considered persuasive in the medical field.
- **Liability Ceiling** — Price Anderson sets a limit or ceiling on liability for any covered accident. That limit is the maximum amount of money available under its financial protection and indemnification system. The limit governs the aggregate of damages that can be awarded to all claimants. In response to rising insurance costs, some States have placed a cap on the amount of compensation that any injured person can receive for certain types of injuries, even if a person's actual losses exceed this cap. These caps could limit the amount of compensation a person is eligible to receive from the Price-Anderson system.
- **Sovereign Immunity** — the legal principle that prevents governments from being sued without their consent. If State and local governments do not waive their sovereign immunity, it is possible that injured persons will not be compensated fully for any damages caused by these governments. Careful drafting of a waiver of sovereign immunity may avoid this problem, making Price-Anderson coverage available without placing State and local treasuries at risk. Under Price-Anderson, all State and local governments are indemnified for any liability they incur.

The 1988 amendments to the Act also added indemnification for a precautionary evacuation resulting from an event that is not a nuclear incident but poses an imminent danger of injury or damage from radiological properties of source material, specific nuclear materials, byproduct material, HLW, SNF, or TRU waste, and causes an evacuation. The evacuation must be initiated by an official of a State or a political subdivision of a State, who is authorized by State law to initiate such an evacuation and who reasonably determined that such an evacuation was necessary to protect the public health and safety. The evacuation of the public must be within a specified area near a nuclear facility, or the transportation route in the case of an accident involving transportation of these materials (AEA §11. gg.).

The Price-Anderson Act indemnification covers any legal liability arising out of, or resulting from, a nuclear incident or precautionary evacuation that occurs during transportation of radioactive material, as set forth below.

With respect to DOE activities, DOE indemnifies any nuclear incident arising in the course of any transportation activities conducted in connection with a DOE contractual activity, including transportation of nuclear materials to and from DOE facilities. The indemnification specifically includes nuclear waste activities that DOE undertakes involving the storage, handling, transportation, treatment, or disposal of, or research and development on, SNF, HLW, or TRU

waste (AEA §11. ff.). Covered transportation activities also include activities authorized to be carried out under the WIPP under §213 of PL 96-164 (93 Statute 1265) and AEA §11. gg.). For a nuclear incident that arises from DOE transportation activities outside the United States, the incident must result from contractual activity for the account of DOE that involves nuclear material owned by the United States.

With respect to the NRC indemnification, the NRC indemnifies any nuclear incident in the course of transportation of nuclear fuel to a reactor site and the transportation of radioactive material from a reactor. Outside the United States, coverage extends only to a nuclear incident arising from transportation activities between two NRC licensees.

Moreover, if an authorized State or local official reasonably orders a precautionary evacuation of the public within the transportation route in the case of an accident involving transportation of nuclear material but no nuclear incident actually occurs, liability resulting from the evacuation would be covered (AEA §11. gg.).

Liability for accidents that occur while SNF and HLW is in transit from the nuclear power plants to the proposed repository at Yucca Mountain, at a storage facility, or at the repository would be determined in accordance with applicable State tort law. In applying State tort law, a court normally would attribute liability to the person responsible for causing damage. If a DOE contractor was liable for the nuclear incident or a precautionary evacuation resulting from its contractual activities, DOE, under the Act, normally would indemnify the contractor

DOE's own tort liability would be determined in accordance with State tort law and the Federal Tort Claims Act. Under current plans, however, DOE intends to use contractors to transport spent fuel and waste and to construct and operate the repository and a storage facility, if one is authorized. Therefore, DOE indemnification would apply to liability claims arising from these activities.

State, Tribal, and local governments are included in the Price-Anderson Act among the "persons" who may be indemnified if they incur legal liability. A "person," according to AEA §11. s, includes: "(1) any individual, corporation, partnership, firm, association, trust, estate, public or private institution, group, Government agency other than [DOE or NRC], any State or any political subdivision of, or any political entity within a State, any foreign government or nation or any political subdivision of any such government or nation, or other entity; and, (2) any legal successor, representative, agent, or agency of the foregoing."

A State or a political subdivision of a State may be entitled to be indemnified for legal liability including all reasonable additional costs incurred in the course of responding to a nuclear incident or an authorized precautionary evacuation (AEA §11. w.).

The Act contains numerous provisions to ensure the prompt availability and equitable distribution of compensation, including emergency assistance payments, consolidation and prioritization of claims in one Federal court, channeling liability to one source of funds, and waiver of certain defenses in the event of a large accident. It explicitly provides authority to make payments for the purpose of providing immediate assistance following a nuclear incident.

In addition, it provides for the establishment of coordinated procedures for the prompt handling, investigation and settlement of claims resulting from a nuclear incident (AEA §170.m.).

The Act, according to AEA §170.n.(2), provides that the U.S. District Court for the district in which a nuclear incident occurs shall have original jurisdiction "with respect to any [suit asserting] public liability ... without regard to the citizenship of any party or the amount in controversy." It also provides for special procedures to expedite the legal proceedings and the distribution of compensation (AEA §170.n.(3) and AEA §170.o.) If a case is brought in another court, it must be removed to the Federal district court with jurisdiction upon motion of a defendant, NRC or DOE [AEA §170.n.(2)].

In addition to providing a single Federal court with jurisdiction over all claims, the Price-Anderson Act provides for the establishment of a special caseload management panel to consolidate claims, establish priorities, and implement other measures that will encourage the equitable, prompt and efficient resolution of claims [AEA §170.n.(3)(A) and §170.n.(3)(B)]. It also provides for the development of a plan for the distribution of funds where such a plan is appropriate (AEA §170.o.).

The Price-Anderson Act channels to one source of funds (that is, the operator's or contractor's indemnification and insurance, if applicable) the payment of all claims arising from the legal liability of any person for a nuclear incident. This "economic channeling" eliminates the need to sue all potential defendants or to allocate legal liability among multiple potential defendants. Economic channeling, according to AEA §11.t. and §170.d.(2), results from the broad definition of "persons indemnified" to include any person that may be legally liable for a nuclear incident. Thus, regardless of who is found legally liable for a nuclear incident resulting from a DOE contractual activity or NRC-licensed activity, the claim will be paid under the indemnification system.¹⁴

Legal liability is not defined in the Act, but the legislative history indicates clearly that State tort law determines what legal liabilities are covered (see Appendix O, Bibliography item 86). The 1988 amendments confirmed the substantive role of State tort law. The 1988 amendments added AEA §11.hh., which defines "public liability action" as "any suit asserting public liability." The definition contains an explicit statement that "the substantive rules for decision in such action shall be derived from the law of the State in which the nuclear incident involved occurs, unless such law is inconsistent with the provisions of [§170]." The legislative history indicates that the purpose of this language was to reemphasize that the substantive law of the State in which a nuclear incident occurs would apply unless inconsistent with the provisions of the Act (see Appendix O, Bibliography item 87).

The Price-Anderson Act contains numerous provisions to minimize protracted litigation and, in particular, eliminates the need to prove the fault of or to allocate legal liability among various

¹⁴ In the hearings on the original Act, "the question of protecting the public was raised where some unusual incident, such as negligence in maintaining an airplane motor, should cause an airplane to crash into a reactor and thereby cause damage to the public. Under this bill, the public is protected and the airplane company can also take advantage of the indemnification and other proceedings." Senate Report No. 296, 85th Congress, 1st. Session (1957), U.S. Code Congressional and Administrative News, 1803 and 1818.

potential defendants. In a limited number of situations, the Act provides that certain provisions of State law may be superseded by uniform rules prescribed by the Act such as the limitation on the awarding of punitive damages.¹⁵ Specifically, in the case of an ENO (that is, any nuclear incident that causes substantial off-site damage), the Price-Anderson Act imposes strict liability by requiring the waiver of any defenses related to conduct of the claimant or fault of any person indemnified (AEA §170.o.). Such waivers would result, in effect, in strict liability,¹⁶ the elimination of charitable and governmental immunities,¹⁷ and the substitution of a three-year discovery rule in place of statutes of limitations that would normally bar all suits after a specified number of years.¹⁸

E.2 Incidents Not Covered by Price-Anderson Indemnification

As discussed above, not all nuclear incidents involving transportation of radioactive materials, are covered under the Price-Anderson system. There is no NRC indemnification unless an indemnification agreement has been executed. The NRC has not extended indemnification to cover most materials licensees. For example, it does not indemnify shipments of industrial radiography and radiopharmaceuticals and might not indemnify transportation of low-level radioactive wastes other than those from nuclear reactors.

The DOE indemnification, however, covers any damage from DOE transportation activities to the extent they are related to DOE contractual activities. DOE is required to insert the indemnity in all contracts in which the contractor is under risk of public liability for a nuclear incident or precautionary evacuation arising out of or in connection with the contract work, including such events caused by a product delivered to a DOE-owned facility for use by DOE or its contractors.

If the Price-Anderson Act indemnification does not apply, liability is determined under State law, as it would for any other type of transportation accident.¹⁹

The Federal Motor Carrier Act of 1980 (PL 96-298) requires carriers of highway route controlled quantities of radioactive materials to carry \$5 million in conventional liability insurance; carriers of certain other radioactive materials must carry \$1 million in insurance. These DOT motor carrier safety requirements for liability insurance are prescribed in 49 CFR §387. As with any underinsured motorist, however, the carrier may be required to pay additional damages. This insurance does not provide coverage for any damage caused by State or local officials (e.g., through negligent emergency response), nor does it explicitly cover State and local government

¹⁵ §170.s. prohibits a court from awarding "punitive damages "... against a person on behalf of whom the United States is obligated to make payments under an agreement of indemnification ...". See also §170.q. (limitation on the awarding of precautionary evacuation costs as defined in §11.gg.) and §170.r. (limitation on liability of lessors).

¹⁶ §170.n.(1) waives "(I) any issue or defense as to the conduct of the claimant or fault of the persons indemnified."

¹⁷ §170.n.(1) waives "(ii) any issue or defense as to charitable or governmental immunity." See also §170.d.(1)(B)(I)(II) that permits DOE to require a similar waiver with respect to "any nuclear incident arising out of nuclear waste activities subject to" a DOE contract.

¹⁸ §170.n.(1) waives "(iii) any issue or defense based on any statute of limitations if suit is instituted within three years from the date on which the claimant first knew, or reasonably could have known, of his injury or damage and the cause thereof."

¹⁹ Some carriers choose to purchase a \$160 million suppliers and transporters insurance policy which may not include reimbursements of State and local emergency response costs.

emergency response costs. However, State and local governments could adopt laws to hold carriers responsible for emergency response costs. Such a law might be more likely to withstand legal challenges if it applied to all hazardous materials and not just radioactive materials, and limited the carrier's responsibility to those emergency response costs unique to hazardous materials.

Federal law does not require rail, barge, or air carriers of radioactive materials to maintain liability insurance, although these carriers often voluntarily carry such insurance. Regardless of whether these carriers have purchased insurance, a radioactive materials incident involving these carriers would be subject to State law applicability for any other type of accident.

E.3 National Contingency Plan/Superfund

E.3.1 Superfund Response Liability

Under CERCLA (1980), as amended, governmental response authority, release notification requirements, and liability are largely tied to a release of a "hazardous substance." Section 104 authorizes government response to releases or threatened releases of hazardous substances including radionuclides or "pollutants or contaminants." Similarly, liability for response costs and damages under §107 attaches to persons who generate, transport, treat, or dispose of hazardous substances at a site from which there is a release or threatened release of such substances. Under §103 of CERCLA, a release of a reportable quantity of a hazardous substance triggers notification to the National Response Center.

E.3.2 Statutory Provision

Four categories of persons (parties) may be found liable under CERCLA §107(a) for response costs incurred as a result of a release or threat of release of a hazardous substance. These are:

- The current owner and operator of a vessel or a facility;
- The owner or operator at the time of disposal;
- Generators of hazardous substances treated or disposed of at the site; and
- Transporters who selected the disposal facility.

The Federal government is subject to liability under CERCLA to the same extent as non-governmental entities (CERCLA §120[a][1]). Under CERCLA §107(a)(4), the responsible parties are liable for persons are liable for:

- All costs of removal or remedial action incurred by the United States or a State, not inconsistent with the National Contingency Plan (NCP);
- Any other necessary costs of response incurred by private parties consistent with the NCP;

- Damages for injury to natural resources; and
- The costs of any health assessment or health effects study carried out under CERCLA §104(I).

The Act further establishes liability for such amounts to be "strict" in the sense that no showing of actual fault is required. Three statutory defenses are allowed, however, where the damage resulted solely from:

- An act of God;
- An act of war; or
- An act or omission of a third party (other than an agent, employee or one having a contractual relationship with the defendant) if the defendant establishes that he exercised due care and the acts or omissions of the third party were unforeseeable (see CERCLA §107[b]).

Maximum liability under this provision is as follows:

- For any vessel, other than an incineration vessel, that carries hazardous substance as cargo, \$300 per gross ton or \$5,000,000, whichever is greater;
- For any other vessel, other than an incineration vessel, \$300 per gross ton or \$5,000,000, whichever is greater;
- For any motor vehicle, aircraft, pipeline, or rolling stock, \$50,000,000 or such lesser amount as established by regulation (but the ceiling may not be less than \$5,000,000 or, for release of hazardous substance to the navigable waters, \$8,000,000); and
- For any incineration vessel or any other facility, all response costs plus \$50,000,000 for natural resource damages (CERCLA §107[c]).

These liability ceilings do not apply when the violation resulted from willful misconduct, or the responsible party failed to cooperate in the cleanup.

E.3.3 Cost Recovery

Liability for Superfund response costs, natural resource damages, and any health assessment or health effects study may be imposed on the present or past owner or operator of a vessel or a facility from which there is a release or threat of release of hazardous substances, on any person who arranged for disposal or treatment of hazardous substances at a site from which a release or threat of release occurred, and on any transporter who selected the site. The United States, a State, or any other party that has incurred response costs consistent with the NCP can collect these funds in a "cost recovery" suit under CERCLA §107. The amount recoverable shall include

interest accrued from the later date of (1) the date payment of a specified amount is demanded in writing, or (2) the date of the expenditure concerned.

If a responsible party who is liable for a release (or threat of a release) of a hazardous substance fails to take an ordered action in accordance with CERCLA §104 or §106, such party may be liable to the United States for punitive damages. The damages would be an amount equal to, but not more than three times, the amount of any costs incurred by the CERCLA fund as a result of failure to take proper action.

APPENDIX F

International System of Units for Radioactive Materials

F.1 Introduction

This appendix addresses the relationships between the SI and the traditional units for radiological measurements most instruments measure. It is designed to help in converting values shown in one system (e.g., curies [Ci]) to values in the other system (e.g., Becquerels [Bq]). It is recommended that planners and first responders become familiar with these units (except Sv) because both types of units may be found on shipping papers and package labels for hazardous materials. (see Appendix O, Bibliography items 4 and 62).

In the United States, the transition to SI units is continuing. Domestic regulations for radioactive materials transportation have been revised to accommodate both traditional and SI units. The unit of measurement for radiation levels traditionally has been the rem per hour (r/h) (or a fraction of the r). The new SI unit is Sv/h.

Because very large numbers are involved in radioactive materials, numerical abbreviations are used to write the measured values in a practical way. Following are commonly used definitions and abbreviations for numerical factors and for the traditional units and the SI units. Examples of conversions from traditional radiological units to SI radiological units and from SI to traditional are also provided.

F.2 Definitions and Abbreviations

The Ci and Bq are units of measure of the quantity or activity of radioactive materials; these measures indicate the rate that atoms in the material are giving off radiation or disintegrating. The Ci is equal to 37 billion disintegrations per second; the Bq is equal to only one disintegration per second. The Sv and the rem are measurements of absorbed radiation that are related to health effects. Table F-1 lists multiplication factors, numerical prefixes, and symbols for the various units.

Table F-1: Multiplication Factors, Numerical Prefixes, and Symbols for Radiological Units

Multiplication Factors	Numerical Prefix	Symbol
1 000 000 000 000 000 000 = 10^{18}	exa	E
1 000 000 000 000 000 = 10^{15}	peta	P
1 000 000 000 000 = 10^{12}	tera	T
1 000 000 000 = 10^9	giga	G
1 000 000 = 10^6	mega	M
1 000 = 10^3	kilo	k
100 = 10^2	hecto	h
10 = 10^1	deka	da
0.1 = 10^{-1}	deci	d
0.01 = 10^{-2}	centi	c
0.001 = 10^{-3}	milli	m
0.000 001 = 10^{-6}	micro	μ
0.000 000 001 = 10^{-9}	nano	η
0.000 000 000 001 = 10^{-12}	pico	p
0.000 000 000 000 001 = 10^{-15}	femto	f
0.000 000 000 000 000 001 = 10^{-18}	atto	a

F.3 Conversions

The following are examples of terms (units) commonly converted from one measurement system to another or different numerical values within the same system.

F.3.1 Quantity (Activity)

$$1 \text{ TBq} = 27 \text{ Ci} = 27,000 \text{ mCi}$$

$$1 \text{ GBq} = 0.027 \text{ Ci} = 27 \text{ mCi} = 27,000 \text{ } \mu\text{Ci}$$

$$1 \text{ MBq} = 0.000027 \text{ Ci} = 0.027 \text{ mCi} = 27 \text{ } \mu\text{Ci}$$

$$1 \text{ Ci} = 0.037 \text{ TBq} = 37 \text{ GBq} = 37,000 \text{ MBq}$$

$$1 \text{ mCi} = 0.000037 \text{ TBq} = 37 \text{ MBq}$$

$$1 \text{ } \mu\text{Ci} = 0.037 \text{ MBq} = 37,000 \text{ Bq}$$

$$1 \text{ nCi} = 0.000037 \text{ MBq} = 37 \text{ Bq}$$

$$1 \text{ pCi} = 0.037 \text{ Bq} = 37 \text{ mBq}$$

F.3.2 Radiation Level (Dose Equivalent Rate)

$$1 \text{ Sv/h} = 100 \text{ rem/h} = 100,000 \text{ mrem/h}$$

$$1 \text{ mSv/h} = 0.1 \text{ rem/h} = 100 \text{ mrem/h}$$

$$1 \text{ } \mu\text{Sv/h} = 0.0001 \text{ rem/hr} = 0.1 \text{ mrem/h}$$

$$1 \text{ R/h} = 0.01 \text{ Sv/h} = 10 \text{ mSv/h} = 10,000 \text{ } \mu\text{Sv/h}$$

$$1 \text{ mR/h} = 0.00001 \text{ Sv/h} = 0.01 \text{ mSv/h} = 10 \text{ } \mu\text{Sv/h}$$

F.4 Use of Conversion Factors

To convert a value from one system of units to the other, use the following procedure. First, in the left column, find the unit you wish to convert *from*. Second, find the factor in that line for the unit you wish to convert *to*. Third, multiply the original value by the factor; the result will be the measure in the desired units.

Examples

1. Problem: A radioactive material label shows 14 TBq. How many Ci is it?

Solution: $14 \text{ TBq} \times 27 \text{ Ci per TBq} = 378 \text{ Ci}$

2. Problem: We have 50 MBq of radioactive materials in a package. How many mCi is it?

Solution: $50 \text{ MBq} \times 0.027 \text{ mCi per MBq} = 1.35 \text{ mCi}$

3. Problem: The regulations state that, for a material to be considered radioactive for transport, the specific activity must be greater than 0.002 $\mu\text{Ci/g}$. What is this lower limit in Bq?

Solution: $0.002 \mu\text{Ci/g} \times 37,000 \text{ Bq}/\mu\text{Ci} = 74 \text{ Bq/g}$

4. Problem: How many TBq are equal to 500 Ci?

Solution: $500 \text{ Ci} \times 0.037 \text{ TBq per Ci} = 18.5 \text{ TBq}$

5. Problem: The EPA standards require that public drinking water systems limit the natural radium concentration to less than 5 pCi per liter (L). What is this upper limit in Bq?

Solution: $5 \text{ pCi/L} \times 0.037 \text{ Bq/pCi} = 0.185 \text{ Bq/L}$

6. Problem: Earlier domestic regulations define the TI of a package as the number equal to the maximum radiation level in millirem per hour at a distance of 1 m from the package. A TI of 1.0 was equal to 1 mrem/h at 1 m. What is a TI of 2.5 equal to in $\mu\text{Sv/h}$?

Solution: $2.5 \text{ TI} \times 1.0 \text{ mrem/h/TI} \times 10 \mu\text{Sv/mrem/h} = 25 \mu\text{Sv/h}$

7. Problem: The maximum surface radiation level for a package with a Radioactive Yellow – II label is 50 mrem/h. Would a measured radiation level of 380 $\mu\text{Sv/h}$ be acceptable for a Radioactive Yellow – II label?

Solution: $380 \mu\text{Sv/h} \times 0.1 \text{ mrem/h}/\mu\text{Sv/h} = 38 \text{ mrem/h}$

Answer: Yes, because 38 mrem/h is less than 50 mrem/h.

APPENDIX G

Transportation Accident Case Studies

The following are actual cases of accidents involving radioactive material and the responses by State and local officials. These cases reflect the type of transportation accidents/incidents that State, Tribal, and local responders are likely to encounter.

G.1 Case No. I: Radiopharmaceuticals

G.1.1 Accident Description and Response

At 4:00 p.m. on December 3, 1983, a luggage trailer towed by a truck and containing 76 packages of radiopharmaceuticals with a total inventory of 203.5 GBq (55 Ci) was rear-ended by a passenger car moving at a high speed. The trailer was destroyed in the collision and the packages were dispersed to both sides of the highway over a distance of 250 yards (228.6 m). The outer packaging materials of 30 of the packages were destroyed. The containment vessels of two of the packages were ejected from their shielding and broken. One package contained 185 MBq (5 mCi) of Gallium-67, a beta-gamma emitter with a half-life of 78 hours, and the other contained 74 MBq (2 mCi) of Iodine-131, a beta-gamma emitter with a half-life of 8 days. The State Highway Patrol arrived in about ten minutes, along with the County Emergency Management Director. The local fire department arrived a few minutes later.

The State Division of Radiological Health arrived at the accident scene within two hours of the accident and surveyed the area, which had already been cordoned off by the highway patrol. People and vehicles at the scene were monitored but showed no evidence of radioactive contamination. The shipping papers were adequate to determine the limited extent of the problem. Shipper and carrier representatives arrived at the scene between 2:30 a.m. and 3:30 a.m. on the following morning and within three hours completed cleanup of the packages and contaminated soil. A re-survey by the State Division of Radiological Health confirmed that the cleanup was complete. The highway was opened for public use 16 hours after the accident occurred.

G.1.2 Related Notes

Accidents involving a limited quantity (LQ) of radiopharmaceutical packages represent the majority of all transportation accidents involving radioactive materials. Most accidents of this type are less violent than the one described and some simply involve dropping of packages from improperly closed vehicle doors. The packages usually survive the accidents with damage to only the outer packaging and without allowing external contamination or increased radiation levels. In very violent accidents or crushing incidents, radiopharmaceutical packages have failed, but the small volume and low radioactivity of the contents typically make the response activity one of identifying the problem and cleaning it up; generally, no more than basic precautions associated with protection from radiation exposure are required. Frequently, the manufacturer or

someone from the manufacturer's delivery system is available to take possession of packages involved in an accident and either complete the delivery or return the packages to the shipper.

G.2 Case No. 2: Industrial Sources

G.2.1 Accident Description and Response

On March 4, 1986, a load of pipe being off-loaded from a ship was dropped back into the ship's holding area, damaging a container marked "Radioactive Materials." The State Bureau of Radiation Control responded and found that three pipe gauges, two containing 111 GBq (3 Ci), and one containing 185 GBq (5 Ci of Cesium-137) were in the damaged container. Direct radiation and contamination surveys confirmed that the sealed sources of radioactive materials in the gauges were undamaged. The gauges were returned to their owner.

G.2.2 Related Notes

In other accidents involving industrial sources of radioactive materials, the typically higher radioactivity involved is compensated for by the sturdy-walled, sealed capsules and by the industrial equipment within which the radioactive materials are typically placed for transportation and use. Industrial packages of radioactive materials generally do not lose their integrity in transportation accidents. Many types of gauges containing radioactive materials for measuring levels, thickness, and density are transported on a daily basis. Industrial radiographers frequently transport devices containing up to 3.7 TBq (100 Ci) of Iridium-192.

Neutron radiation sources are also commonly used in the construction industry and the oil and gas exploration industry in the form of moisture density gauges and well logging tools. Loss of a neutron radiation source during transport between job locations or resulting from a traffic accident is a potential transportation-related radiation incident. While vehicles carrying neutron sources may be properly placarded and be accompanied by appropriate shipping papers, the actual hazard posed by the neutron component may be masked because the radioactive materials in the neutron sources appear to emit other forms of radiation (e.g., alpha, beta, or gamma).

G.3 Case No. 3: Fuel-Cycle Shipments

G.3.1 Accident Description and Response

On August 27, 1985, a tractor-trailer carrying 53 drums of natural uranium concentrates, averaging 850 pounds (lb) each, collided with a slow-moving train, killing the driver. Damage to the truck was extensive, and approximately 30 of the drums were damaged; 10 to 15 were nearly emptied. The area of contamination was limited by a natural depression in the terrain measuring about 100 by 200 ft (30.5 by 61 m). The State EOC coordinated response activities; two NRC health physicists participated. The shipper sent a response team and a contractor with a 20-person cleanup crew. Bioassays and nasal smears were used for airborne exposure monitoring of the cleanup workers. This portion of the highway remained closed throughout the cleanup period, until September 13, 1985, because a convenient detour was available. The truck, trailer, parts of the train, and 37 truckloads of recovered material were returned to the shipper.

G.3.2 Related Notes

The uranium concentrate involved in this accident is only mildly hazardous from a radiological standpoint, but it is chemically toxic. Because uranium concentrate is quite valuable, the shipper was anxious to recover the spilled material. In recent similar accidents, the piles of uranium concentrate were covered to prevent airborne contamination, and dikes were constructed to capture contaminated rain runoff. In all such incidents, a large amount of material with limited radioactivity was released, and several days were required for cleanup. Although this type of accident is limited to the routes over which fuel-cycle shipments are transported, a large number of States can potentially be involved.

G.4 Case No. 4: Nuclear Reactor Components

G.4.1 Accident Description and Response

On March 24, 1987, a train carrying two shipping casks (Type B packaging) containing core debris from the Three Mile Island nuclear reactor accident struck an automobile. The train was traveling at 25–30 mi/h. The automobile driver sustained minor injuries. The train's engine received minor damage. There was no evident damage to the shipping casks. The City Department of Health performed radiation surveys on the shipping casks and determined that no release of radioactive materials had occurred. The carrier inspected the train's engine and determined that it could remain in service. The train got underway approximately 45 minutes after the accident. The State was notified.

G.4.2 Related Notes

Similar accidents involving shipping casks transporting nuclear reactor wastes can occur in virtually any area of the country. When the casks contain SNF or other HLW, advance notification is provided to the Governor of each State through which the shipment passes. Even when the casks are not required to be designed to withstand severe transportation accidents, as when the contained wastes are relatively low-level, the casks are still very accident resistant because of their enormous weight and associated steel structural design.

In the past, some cask shipments have been delayed and radiologically surveyed because of liquids apparently leaking from the casks. In most cases, experts concluded that the liquid was rainwater.

G.5 Case No. 5: Nuclear Spent Fuel

G.5.1 Accident Description and Response

On December 8, 1970, a tractor-trailer carrying a cask of spent nuclear fuel overturned along the side of a major highway. The cask assembly separated from the tractor-trailer and traveled more than 100 ft (30.5 m) before coming to rest in a ditch. The driver was killed in the accident. By sampling the water in the ditch, the State Highway Patrol and DOE officials confirmed that no leakage of radioactive materials to the environment had occurred. Exterior radiation levels were

very low (in the normal range). There was minor damage to the outer thermal insulation of the cask. Shipping papers examined at the scene were helpful in designating the origin and destination of the shipment, the weight of the cask assembly, and the potential hazard from radioactivity. The cask was recovered, repaired, and subsequently returned to service.

G.5.2 Related Notes

Because nuclear spent fuel shipping casks are designed to withstand the stresses of being stopped immediately from a speed of 44 ft/sec, this accident scenario with a 100-foot (ft) stopping distance was not a real threat to the structural integrity of the cask.

G.6 Case No. 6: Industrial Sources for Exempt Devices

G.6.1 Accident Description and Response

On January 11, 1983, a cargo aircraft crashed shortly after takeoff. The aircraft's lower rear cargo pit held a Type A package containing 10,000 Americium-241 Special Form sources, each with a radioactive material content of 55.5 kBq (1.5 μ Ci); the sources were used as alpha-particle emitters in smoke detectors. When the package was recovered, the outer fiber-board packaging was completely burned away, the inner metal can was badly dented and scorched (but intact), and the 20 polystyrene jars inside the one-gallon can were melted enough to allow the radioactive materials to be released to the inside of the can. The State Police notified the State DPH that a package of radioactive materials was aboard the plane that crashed. DPH staff responded in 1.7 hours and found the package by using a "micro R meter." After confirming that there was no leakage from the can, DPH placed the can in a heavy plastic bag for further examination.

G.6.2 Related Notes

This type of package, weighing just 14 pounds, is similar to many radiopharmaceutical packages in that, under normal transportation conditions, it is not highly susceptible to damage from impact, but in accident conditions it can be readily crushed or burned. As noted under the radiopharmaceutical scenario (Case No. 1), this type of package usually survives accidents with damage to the outer packaging, but without allowing external contamination or increased radiation levels.

G.7 Case No. 7: Type B Packages — Radiography Devices

G.7.1 Accident Description and Response

On January 27, 1988, a radiography device fell from the back of a camper-type pickup truck onto the highway and was struck by an automobile. The device became wedged under the car and was dragged along the roadway for about two blocks. The quick-disconnect end-cap and lock mechanisms separated from the device. The handle was torn loose and a welded seam on the metal container cracked. The source, 1.3 TBq (48 Ci) of Iridium-192 attached to a short cable,

separated from the device near the point of impact. A tow truck operator called for emergency assistance after noting a radioactive label on the device. Police, fire, and a hazardous materials team responded and removed the jammed container from beneath the car. The responders were unaware that the radioactive source was in the roadway. They did not know that the low-level radiation readings, obtained from the depleted uranium shielding and the contamination resulting from the uranium corrosion products coming through the crack in the weld, were well below the expected readings for a loaded radiography device. Meanwhile, the owner noted that his camper door was open and the device was missing. After inquiry, he located the device at the fire station. He took additional radiation measurements from the device and immediately returned to the incident scene, where he located and retrieved the source from the roadway.

The damaged device was confiscated by the State regulatory agency for investigation, but was later returned to the owner for disposal. The undamaged source was permitted by the State to be used in another device.

G.7.2 Related Notes

Although this is the only known case of a source coming out of a radiography device or a Type B package during a transportation accident, sources have, on numerous occasions, been released from industrial radiography devices at the location of use because of user errors and/or equipment failures. Devices similar to the one involved in this accident have survived a variety of highway accidents. One example involves a device being thrown through the wall of the camper shell and landing in a ditch when the pickup truck hit a bridge abutment. In other cases, similar devices have not released their sources or sustained shielding damage when run over by construction equipment or by passing vehicles at highway and other construction sites. Clearly, a source came out of its packaging, but the exact causes, regulatory responsibilities, and needed changes are not clear.

This page is intentionally left blank.

APPENDIX H

Modal Study of Spent Fuel Transportation

H.1 Definition and Results of Study

In 1987, the Office of Nuclear Material Safety and Safeguards of the NRC prepared a modal study as a synopsis of NRC's *Transporting Spent Fuel* report (see Appendix O, Bibliography items 59 and 60). The term "modal study" refers to a research program conducted for the NRC regarding the level of protection provided by NRC-certified packages during the shipment of SNF from U.S. power reactors. The objective of the study was to examine the response of the packages to actual highway and railway accident conditions.

The modal study results show that NRC-certified spent fuel casks adequately perform their safety functions under severe accident conditions. The study also explains how NRC's cask design conditions, which are expressed in engineering terms, relate to actual accident conditions, with which the public is more familiar. The modal study, along with other transportation studies, the physical testing of casks, and the spent fuel shipment safety record, confirm that the casks provide a high level of public safety during spent fuel transport.

H.2 Shipping Casks and Standards

Spent fuel casks are cylindrical in shape, measure over 3 ft in diameter and 20 ft in length, and weigh approximately 50,000 lb for a truck cask and 200,000 lb for a rail cask. The spent fuel cask is the primary safety component in spent fuel transport. NRC evaluates and certifies the cask designs used in the shipment of spent fuel. DOT has requirements for transport vehicles, routing, and drivers. NRC's regulations require an assessment of cask safety functions under hypothetical accident conditions. The assessment includes the sequential application of tests for free drop, puncture, thermal conditions, and immersion to the same package. Cask safety functions must be shown by test or analysis to satisfy the following performance standards:

1. Containment of the spent fuel so that there is no escape of nuclear materials exceeding a specified limit;
2. Shielding against radiation emitted by the spent fuel so that external radiation dose rates do not exceed a specified level; and
3. Prevention of nuclear criticality (i.e., ensure the fuel does not undergo a self-sustaining reaction). NRC cask standards are similar to those used internationally and are based on recommendations of the IAEA.

H.3 Level of Protection Results

The modal study included a review of hundreds of thousands of non-nuclear accidents to provide information regarding crash forces and fire conditions that spent fuel casks could experience in actual highway and railway accidents. Computers were used to evaluate the response of a cask — comparing NRC's hypothetical accident conditions to actual conditions. The results indicate that minor functional cask damage might occur in one accident for every 40 million-shipment miles. (DOE data indicate that approximately 40 million shipment miles would be required to transport all of the spent fuel currently in storage at U.S. power reactors to a HLW repository.) One accident in every 80 million-shipment miles would cause cask damage that might result in a radiological hazard slightly exceeding NRC limits. Only one accident in approximately 2 billion shipment miles would be expected to result in a hazard exceeding NRC limits by a factor of about 10.

The results also include an evaluation of probable cask response to four actual accidents that were considered particularly severe, including the Caldecott Tunnel fire in California and the Livingston train derailment in Louisiana. In three of the accidents evaluated, casks would be expected to perform their safety functions. In the Livingston train derailment, the cask, depending on its location in the ensuing 3–4 day fire, could lose its shielding effectiveness, resulting in a localized increase in radiation levels.

As a final perspective, an estimate of spent fuel shipment risk was compared with the risk from the previous assessment used by NRC that concluded that existing transport regulations provide adequate public safety. The new results indicate that the risk is less than a third of the previous estimates.

APPENDIX I

Use and Response of Civil Defense Instruments

I.1 Introduction

The more than 350 radionuclides listed in transportation regulations differ greatly from one another in terms of the types of emitted radiation (alpha [α], beta [β] or gamma [γ]) and the energy of the radiation. These differences influence the capabilities of the instruments to detect or measure the radiation from radioactive materials that may be inside or outside a package.

In order to determine whether radiation has been released from a package during a transportation accident, responders need instruments that are capable of detecting the type of radiation emitted. The Civil Defense-type instruments (CD V-700 and CD V-715) that have been commonly available in the past to emergency responders have good detection capabilities for some radionuclides, but poor response for others. This appendix provides information about the capabilities of the CD V-700 and CD V-715 for detecting a small quantity of 72 different radionuclides that are commonly transported within the United States.

Evaluating the radiological hazards of possibly released radioactive materials at the scene of a transportation accident or at a fixed facility (e.g., hospital, laboratory, construction site) depends on many factors other than the capability of an instrument to detect a particular radionuclide. This is especially true if the released material is in a powder, liquid, or vapor form that could be ingested or inhaled or could contaminate skin.

I.2 Instrument Use

The CD V-700 is a low-range survey instrument designed for measuring gamma radiation and detecting beta-gamma radiation at low exposure rates. It uses a Geiger-Mueller (GM) detector, and has a maximum range for gamma radiation of 0-50 mR/h and for beta-gamma radiation of 0-30,000 counts per minute (cpm). It can detect high-energy beta particles and low- or high-energy gamma radiation when the shield on the detector probe is open. When the shield is closed, all but the weakest gamma radiation is detected. The wall density thickness of the GM detector (expressed in milligrams per square centimeter [mg/cm^2]) is the principal factor contributing to the energy dependence of the CD V-700's response to beta radiation. The wall of the GM detector for the CD V-700s evaluated in this appendix had a density thickness of 30 mg/cm^2 ; thus, beta particles with energies less than about 150 kiloelectron-volts (keV) cannot be detected because they cannot penetrate the detector wall. Detection efficiency for plutonium and americium radionuclides that have gamma energies of less than 60 keV is poor. Some commercially available low-range instruments, with 30 mg/cm^2 GM detectors, may be expected to have "shield open" and "shield closed" capabilities similar to those of the CD V-700s listed in Table I-1.

Commercially available low-range survey instruments may use GM detectors with wall thicknesses greater than or less than the 30 mg/cm² listed for the CD V-700 in Table I-1. The “shield open” responses of the instruments with detectors that have wall thicknesses greater than 30 mg/cm² (only a fraction of available CD V-700s) are expected to be poorer for some radionuclides than the responses shown in Table I-1. The “shield open” responses of the instruments with detectors that have wall thicknesses less than 30 mg/cm² may be better for some radionuclides than the responses listed in Table I-1. The “shield closed” responses of all low-range instruments, regardless of the wall thickness of the detector, should be similar to those listed in Table I-1 if the instruments have been properly calibrated for gamma radiation.

The CD V-715 uses an ionization chamber (wall thickness of 1,250 mg/cm²) to measure gamma radiation at rates ranging from 0–500 mR/h to 0–500 R/h. The wall thickness of the CD V-715 prevents detection of alpha and beta radiation. It is the instrument of choice for measuring most gamma radiation at moderate to high exposure rates and in circumstances in which the CD V-700 instrument indicates an off-scale reading (greater than 50 mR/h). For practical purposes the radiological measurement units of mR/h or R/h will be considered equivalent to mrem/h or rem/h.

I.3 Response Capabilities

The response capabilities of CD V-700 and CD V-715 were evaluated (mostly by computation) for more than 350 radionuclides listed in the transportation regulations (see Appendix O, Bibliography item 20). The response capabilities for 72 of the most commonly used and transported radionuclides are listed in Table I-1. The capabilities were computed for a common radiological risk amount (0.1% of the A₂ value) for each of these radionuclides. This amount ranges from μCi to Ci quantities for the different radionuclides. The A₁ and A₂ values (see Glossary) for each radionuclide in the transportation regulations reflect a similar range — about one million times— because of the radiological risk differences.

I.3.1 CD V-700

For purposes of this tabulation, the relative response capabilities of the CD V-700 (probe shield open and shield closed) were based on the following definitions:

- **Good (G):** The CD V-700 will indicate a reading of a least 0.1 mR/h (60 cpm) when the probe is 1 m from 0.1% of the A₂ value of the radionuclide. This response is approximately twice the meter fluctuations caused by normal background radiation and is 20% of full-scale on the lowest (×1) range, with readings of 0–0.5 mR/h or 0–300 cpm.
- **Some (S):** The CD V-700 will respond to the radiation emitted by the radionuclide, but a reading of at least 0.1 mR/h (60 cpm) can be observed if the probe is placed at a distance of 30 cm from 0.1% of the A₂ value of the radionuclide.
- **None (N):** Either the radiation emitted by the radionuclide cannot be detected by the CD V-700 probe under any conditions or the probe must be placed at a distance less than 30 cm from 0.1% of the A₂ value to obtain any response.

I.3.2 CD V-715

For purposes of this tabulation, the relative response capabilities of the CD V-715 were based on the following definitions:

- **Good (G):** A reading of at least 10 mR/h will be obtained when the instrument is 1 m from 0.1% of the A_2 value of the radionuclide. This response must be cautiously recognized as less than the possible "zero drift" because of the instrument's electronics; it is only 2% of full-scale on the most sensitive ($\times 0.1$) range, with readings of 0–500 mR/h.
- **Some (S):** The CD V-715 will respond to the radiation emitted by the radionuclide, but a reading of at least 10 mR/h may be observed only if the instrument is placed at a distance of 30 cm from 0.1% of the A_2 value of the radionuclide.
- **None (N):** Either the radiation emitted by the radionuclide cannot be detected by the CD V-715 under any conditions or the instrument must be placed at a distance less than 30 cm from 0.1% of the A_2 value to obtain any response.

The G, S, and N factors were computed using best available nuclear data, but the calculations required making some realistic assumptions about radiation detectors, sources, decay, and/or in-growth of the decay product (daughter) radionuclides involved. More details about the calculations and complex assumptions made can be found in Appendix O, Bibliography item 20, which lists the G, S, and N factors for all of the 350 radionuclides in the transportation regulations. The reference also provides the basic information for computing similar response capability factors for other instruments (e.g., Geiger counter instruments with tube wall thicknesses other than 30 mg/cm²).

Those who respond to radiological transportation incidents can usually identify the radionuclides present at the scene from the shipping papers for the packages or, in most cases, from the labels on the packages. For fixed facilities, the radionuclides may be identified by tags, labels, or signs on or near the material or by facility personnel familiar with plant operations.

Those who evaluate radiological hazards must consider more information than the indicated responses of their instruments and the data in Table I-1. In most locations, a State, Tribal, and/or local government agency with technically trained personnel is responsible for evaluating radiological hazards. Responsible technical personnel consider instrument measurements along with such other important information as the physical and chemical properties of the radioactive materials, the conditions at the incident scene, and whether the material is highly concentrated or dispersed in or on large amounts of non-radioactive materials. The radionuclide uptake or rejection by individuals is based on many biological and chemical factors. Mixtures of radionuclides in a material and interfering radiation from nearby materials or packages can produce erroneous measurements. Available emergency assistance, resources, and non-radiological hazards at the scene will impact incident evaluation and actions.

Table I-1 lists the radionuclides in alphabetical order of the chemical elements they contain. The half-lives of radionuclides are listed in minutes (m), hours (h), days (d), years (yr), kilo (1×10^3)

years (kyr), mega (1×10^6) years (Myr), and giga (1×10^9) years (Gyr). The emitted radiation for each radionuclide is listed as α , β , or γ , with γ including x-rays. The A_1 and A_2 values for each radionuclide are given in units of TBq and Ci. The response capabilities for the CD V-700 (probe shield open and shield closed) and CD V-715 are shown in the three right columns.

Table I-1: Some Common Radionuclides and Detection Capabilities of Two CD V Radiation Survey Instruments

Nuclide	Half-life	Radiation	Values in Regulations ¹				CD V-700 Shield		CD V-715
			A_1 TBq (Ci)	A_2 TBq (Ci)	Open	Closed			
Americium									
Am-241	432.2 yr	$\alpha \beta \gamma$	2	(50)	0.0002	(0.005)	N	N	N
Antimony									
Sb-125	2.77 yr	$\beta \gamma$	2	(50)	0.9	(20)	G	G	S
Argon									
Ar-41	1.83 h	$\beta \gamma$	0.6	(10)	0.6	(10)	G	G	S
Barium									
Ba-133	10.74 yr	$\beta \gamma$	3	(80)	3	(80)	G	G	G
Bismuth									
Bi-206	6.24 d	$\beta \gamma$	0.3	(8)	0.3	(8)	G	G	G
Bi-207	38.0 yr	$\beta \gamma$	0.7	(10)	0.7	(10)	G	G	G
Cadmium									
Cd-109	464.0 d	$\beta \gamma$	40	(1,000)	1	(20)	G	G	S
Calcium									
Ca-45	163.0 d	$\beta \gamma$	40	(1,000)	0.9	(20)	G	N	N
Californium									
Cf-252	2.64 yr	$\alpha \beta \gamma \eta$	0.1	(2)	0.001	(0.02)	N	N	N
Carbon									
C-11	20.4 m	$\beta \gamma$	1	(20)	0.5	(8)	G	S	N
C-14	5,730 yr	β	40	(1,000)	2	(50)	N	N	N
Cesium									
Cs-137	30.0 yr	$\beta \gamma$	2	(50)	0.5	(10)	G	G	S
Chromium									
Cr-51	27.7 d	$\beta \gamma$	30	(800)	30	(800)	G	G	G
Cobalt									
Co-57	270.9 d	$\beta \gamma$	8	(200)	8	(200)	G	G	G
Co-60	5.27 yr	$\beta \gamma$	0.4	(10)	0.4	(10)	G	G	G
Copper									
Cu-64	12.7 h	$\beta \gamma$	5	(100)	0.9	(20)	G	G	S
Curium									
Cm-244	18.11 yr	$\alpha \beta \gamma$	4	(100)	0.0004	(0.01)	N	N	N
Fluorine									
F-18	109.8 m	$\beta \gamma$	1	(20)	0.5	(10)	G	G	S

Nuclide	Half-life	Radiation	Values in Regulations ^a				CD V-700 Shield		
			A ₁ TBq (Ci)	A ₂ TBq (Ci)	Open	Closed	CD V-715		
Gadolinium									
Gd-153	242.0 d	β γ	10	(200)	5	(100)	G	G	G
Gallium									
Ga-67	78.3 h	β γ	6	(100)	6	(100)	G	G	G
Hydrogen									
H-3	12.35 yr	β	40	(1,000)	40	(1,000)	N	N	N
Indium									
In-111	2.83 d	β γ	2	(50)	2	(50)	G	G	G
Iodine									
I-123	13.2 h	β γ	6	(100)	6	(100)	G	G	G
I-125	60.14 d	β γ	20	(500)	2	(50)	G	S	S
I-131	8.04 d	β γ	3	(80)	0.5	(10)	G	G	S
Iridium									
Ir-192	74.02 d	β γ	1	(20)	0.5	(10)	G	G	S
Iron									
Fe-55	2.7 y	β γ	40	(1,000)	40	(1,000)	N	N	N
Fe-59	44.53 d	β γ	0.8	(20)	0.8	(20)	G	G	G
Krypton									
Kr-85	10.72 yr	β γ	20	(500)	10	(200)	G	G	N
Lead									
Pb-203	52.1 h	β γ	3	(80)	3	(80)	G	G	G
Pb-210	22.3 yr	α β γ	0.6	(10)	0.009	(0.2)	G	N	N
Pb-212	10.64 h	β γ	0.3	(8)	0.3	(8)	G	G	S
Manganese									
Mn-54	312.5 d	β γ	1	(20)	1	(20)	G	G	G
Mn-56	2.58 h	β γ	0.2	(5)	0.2	(5)	G	G	S
Mercury									
Hg-203	46.6 d	β γ	4	(100)	0.9	(20)	G	G	S
Mixed Fission Products									
MFP ^b		β γ	0.2	(5)	0.2	(5)	G	G	S
Molybdenum									
Mo-99	66.0 h	β γ	0.6	(10)	0.5	(10)	G	G	S
Nickel									
Ni-63	96.0 yr	β	40	(1,000)	30	(800)	N	N	N
Phosphorus									
P-32	14.3 d	β	0.3	(8)	0.3	(8)	G	N	N
P-33	25.4 d	β	40	(1,000)	0.9	(20)	G	N	N
Plutonium									
Pu-238	87.74 yr	α β γ	2	(50)	0.0002	(0.005)	N	N	N
Pu-239	24,065 yr	α β γ	2	(50)	0.0002	(0.005)	N	N	N
Pu-241	14.4 yr	α β γ	40	(1,000)	0.01	(0.2)	N	N	N

Nuclide	Half-life	Radiation	Values in Regulations ^a				CD V-700 Shield		
			TBq	A ₁ (Ci)	TBq	A ₂ (Ci)	Open	Closed	CD V-715
Polonium									
Po-210	138.38 d	α β γ	40	(1,000)	0.02	(0.5)	N	N	N
Potassium									
K-43	22.6 h	β γ	1	(20)	0.5	(10)	G	G	S
Radium									
Ra-224	3.66 d	α β γ	0.3	(8)	0.06	(1)	G	G	N
Ra-226	1,600 yr	α β γ	0.3	(8)	0.02	(0.5)	G	G	N
Ra-228	5.75 yr	β γ	0.6	(10)	0.04	(1)	G	G	N
Radon									
Rn-222	3.82 d	α β γ	0.2	(5)	0.004	(0.08)	G	S	N
Ruthenium									
Ru-103	39.28 d	β γ	2	(50)	0.9	(20)	G	G	S
Selenium									
Se-75	119.8 d	β γ	3	(80)	3	(80)	G	G	G
Sodium									
Na-22	2.6 yr	β γ	0.5	(10)	0.5	(10)	G	G	G
Na-24	15.0 h	β γ	0.2	(5)	0.2	(5)	G	G	S
Strontium									
Sr-82	25.0 d	β γ	0.2	(5)	0.2	(5)	G	G	S
Sr-89	50.5 d	β γ	0.6	(10)	0.5	(10)	G	N	N
Sr-90	29.12 yr	β γ	0.2	(5)	0.1	(2)	G	N	N
Sulfur									
S-35	87.44 d	β	40	(1,000)	2	(50)	N	N	N
Technetium									
Tc-99	0.21 Myr	β γ	40	(1,000)	0.9	(20)	G	N	N
Tc-99m	6.02 h	β γ	8	(200)	8	(200)	G	G	G
Thallium									
Tl-201	3.04 d	α β γ	10	(200)	10	(200)	G	G	G
Thorium									
Th-230	77 kyr	α β γ	2	(50)	0.0002	(0.005)	N	N	N
Th-232	14.0 Gyr	α β γ	Unlimited ^c		Unlimited		N	N	N
Tungsten									
W-181	121.2 d	α β γ	30	(800)	30	(800)	G	G	G
Uranium									
U-234	0.24 Myr	α β γ	10	(200)	0.001	(0.02)	N	N	N
U-235	0.7 Gyr	α β γ	Unlimited		Unlimited		G	G	S
U-238	4.51 Gyr	α β γ	Unlimited		Unlimited		G	N	N
Depleted ^d		α β γ	Unlimited		Unlimited		S	N	N
Natural ^e		α β γ	Unlimited		Unlimited		G	S	N
Natural ^f		α β γ	Unlimited		Unlimited		G	N	N

Nuclide	Half-life	Radiation	Values in Regulations ^a				CD V-700 Shield		CD V-715
			A ₁ TBq	(Ci)	A ₂ TBq	(Ci)	Open	Closed	
Xenon									
Xe-133	5.25 d	β γ	20	(500)	20	(500)	G	G	G
Yttrium									
Y-88	106.64 d	β γ	0.4	(10)	0.4	(10)	G	G	G
Y-90	64.0 h	β γ	0.2	(5)	0.2	(5)	G	N	N
Zinc									
Zn-65	243.9 d	β γ	2	(50)	2	(50)	G	G	G

^a The A₁ and A₂ values are from the 1985–86 IAEA transportation regulations. Both the Ci and TBq quantities are rounded-off to one significant digit.

^b Mixed Fission Products (MFP) is not an entry in the regulations, but the A₁ and A₂ values and the response factors were computed for a mixture described in Appendix O, Bibliography item 20.

^c For radionuclides with unlimited A₁ and A₂ values, the quantity evaluated was 1 kg.

^d Response measured from a 1-kg cube of depleted uranium metal.

^e Response was computed.

^f Response measured from a 1-kg, compact pile of yellowcake, a uranium ore concentrate consisting mostly of U₃O₈.

This page is intentionally left blank.

APPENDIX J

Radiation Detection Equipment²⁰

This appendix provides information for State, Tribal, and local emergency management officials who are seeking to acquire radiological instruments for responding to transportation accidents and incidents. Instruments should be selected by a health physicist or other professional with training and experience in the use of survey instruments used to detect and measure ionizing radiation.

Several types of radiation detection equipment are available; each has specific capabilities. For example, radiation survey meters are used to identify contaminated areas and radiation exposure rates, while direct-reading dosimeters (DRDs) record the total amount of an individual's exposure to x-rays or gamma radiation. More than one instrument type will probably be required at the scene of an accident. Not all are useful to first responders. These instruments are described below; their characteristics are summarized in Table K-1.

J.1 Scintillation Counters

Instruments that measure alpha, beta, and gamma radiation may employ scintillation detectors that use chemical scintillators, such as zinc sulfide, sodium iodide, cesium iodide, plastic, or organic materials as the detection media. A counter employing silver-activated zinc sulfide can detect alpha radiation; one that uses thallium-activated sodium iodide or cesium iodide can detect gamma radiation. In one zinc sulfide model, alpha particles enter through a thin, aluminized Mylar[®] window that prevents ambient light from activating a photomultiplier while allowing alpha radiation to penetrate without significant energy degradation. Alpha particles cause the zinc sulfide to emit light pulses. The photomultiplier electronic tube amplifies the light pulses and converts them to voltage pulses. Pulses above a pre-set threshold value are counted on a digital scaler/ratemeter. Because of the short range of alpha particles in air, the detector must be held 1 inch (in.) (2.5 cm) or less from the surface being monitored to detect the alpha particle radiation. Environmental conditions can also impair the use of alpha detection instruments. For example, any moisture on the surface that is being surveyed absorbs the alpha radiation, which can result in a false conclusion that no alpha contamination is present. Therefore, alpha detection instruments should be used only in dry conditions, not after a rain or heavy dew.

The sodium iodide, cesium iodide, and plastic scintillators are commonly used for detecting beta and gamma radiation. Light signals and electrical pulses are produced and registered in a manner similar to the zinc sulfide process for detecting alpha radiation. These probes do not need to be held close to the surfaces being monitored because most beta particles have a range in air much greater than the range of alpha particles. While the scintillators for detecting betas are relatively thin, the sodium-iodide detectors used to detect low levels of gamma radiation are commonly 2 in. (5 cm) in diameter by 2 in. (5 cm) thick. Some organic scintillators used for detecting

²⁰ The information provided in this appendix is derived from Appendix O, Bibliography items 53 and 71.

extremely low levels of gamma radiation have volumes greater than several gallons and can detect very small variations in natural background radiation. These large-volume scintillation detectors are more useful for monitoring when mounted at fixed locations (e.g., weigh stations, ports of entry, and entrances to junk yards, recycling facilities, landfills) for screening transportation vehicles rather than incident response detectors at the scene of a transportation accident.

Instruments with scintillation detectors are more expensive than GM counters. Also, the thin Mylar window on scintillation detectors is somewhat fragile. Normally, these instruments are used by trained health physicists, perhaps from the State radiation protection unit, who are called to the scene of an accident following the initial detection of radiation by first responders.

A fairly recently developed detector, call the "radiation pager," uses a cesium iodide scintillator. The outer case of this detection device is thick enough to prevent the detection of beta radiation, so the cesium iodide scintillator is constrained by the device case to detect gamma or x-rays above a lower energy cutoff of 45 keV. Radiation pagers indicate the presence of gamma radiation or x-rays by a single-digit light-emitting diode (LED) display and either an audio tone or a vibration. The LED display, along with the audio tone and the vibration, provides an indication of the intensity of the radiation field. The LED display is not related to radiation dose or an exposure rate. However, the maximum single LED reading of 9 does indicate that the radiation field may be greater than 12 mR/h. The lower sensitivity of this detection device, depending on the manufacturer's specified range, can be in the $\mu\text{R}/\text{h}$ range. The background exposure rate at the location where the device is turned on is stored as the reference level. The background level must be acquired in an area that is not influenced by any outside source of gamma or x-ray radiation. If a gamma or x-ray radiation field exceeds the background level by a significant amount, the device will alarm and display a numeric value.

Several specialty types of scintillation detectors, such as the (Fidler) field instrument for the detection of low-energy radiation and the Phoswich, may be useful for certain types of contamination surveys. For example, if Americium-241 is present as a component of the contamination, the Fidler-type detector may be of some use because of its capability to detect low-energy gamma radiation in the presence of higher-energy gamma radiation. The Phoswich-type detectors are also useful for low-background counting of x-rays and beta particles.

J.2 GM and Ionization Chamber Survey Instruments

Two models of this commonly used type of instrument are described in Appendix I: the CD V-700 and the CD V-715. These older models are being phased out and, to a limited extent, replaced by the CD V-718 model. The CD V-718 has two GM detectors: a thin ($1.5 \text{ mg}/\text{cm}^2$) end window GM detector for low-level radiation or contamination surveys and a smaller GM detector, with $30 \text{ mg}/\text{cm}^2$ detector walls, for high-range gamma radiation surveys. The newer models are smaller, have digital readout displays, and automatically provide measurements in units ranging from microRoentgen ($\mu\text{R}/\text{h}$) to kiloRoentgen (kR/h). For practical purposes, the radiological measurement units of $\mu\text{R}/\text{h}$ or kR/h will be considered equivalent to $\mu\text{rem}/\text{h}$ or krem/h .

The low-range instruments allow the use of a "radioactive check source" to ensure that they respond to ionizing radiation; if the detector is properly directed, users should obtain the same reading they did for that source immediately after its calibration. The ability to use a check source is an extremely valuable feature. The manufacturer's instructions should be consulted as to the appropriate source to use for each instrument and each type of radiation being measured, as well as the energy levels of radionuclides (especially those used for compliance) in order to ensure that the instruments are properly responding.

The CD V-700 can detect gamma and beta (e.g., Phosphorus-32) radiation but is usually calibrated to measure only gamma radiation dose rates. This low-range survey meter utilizes a probe with a closable shield to permit discrimination between gamma and beta radiation. With the shield open, both beta and gamma radiation are detected. With the shield closed, beta radiation is blocked, and only gamma radiation reaches the GM tube. A decrease in readings with the probe shield closed indicates the presence of beta radiation. A radiation field may be indicated by an audio tone (through a speaker or headphones) and on the instrument's meter. The headphone or speaker permits rapid surface monitoring without the need to constantly watch the meter face. On some models, a check source is provided on the side of the instrument to test operability and response. These survey meters need to be calibrated at the frequency suggested by the manufacturer against a gamma radiation source (e.g., known energy spectrum and radioactivity); the resultant calibration curve or response range of values should be taped to the side of the meter. Instruments used for compliance should be calibrated at least annually to ensure that the instrument is properly responding.

The CD V-715 uses an ionization chamber as the detector. Periodic checks of the meter's operation are essential (approximately annually) if it is to be used with assurance in an emergency. Because of its high range and immediate response, the CD V-715 is the instrument most often carried by first responders (e.g., hazardous materials response team, radiological response team). Proper training in the use of these instruments is required, and practice sessions during the year are encouraged.

The CD V-718 uses two GM detector tubes filled with an ionizable inert gas, usually a mixture of argon, helium, neon, and a halogen quenching gas. Incident radiation reaches the tube through a mica or plastic window and a metal end cap (beta shield); the density/thickness of the window affects the detection sensitivity. Output pulses are registered on a digital scaler/ratemeter with a set threshold value. Another commonly used GM detector is the pancake type, which has a larger-diameter thin (1.5 to 2.0 mg/cm²) mica window that is sometimes covered with a plastic cap for protection. In general, the end window GM detector is about a factor of three less sensitive than the pancake-style GM detector used for contamination surveys.

J.3 Gas Proportional Detectors

Gas proportional detectors are used for detecting both alpha and beta radiation. The detector cavity in these instruments is filled with a mixture of argon and methane, so a leak will change the instrument's response. Radiation enters the detector cavity through an aluminized Mylar window; the density thickness of the window is one factor that can affect the detector's efficiency. The instrument can be used to detect (1) only alpha radiation by using a low operating

voltage, (2) alpha and beta radiation by using a higher operating voltage, or (3) only beta radiation by using a Mylar shield to block the alpha particles in a mixed alpha/beta-gamma field. Gas proportional counters are difficult to use outside of a laboratory setting. There are field use instruments with gas proportional detectors; however, some of the older field-type gas proportional counters were subject to operational difficulties in the environmental extremes of field operations.

J.4 Pressurized Ionization Chambers

The pressurized ionization chamber can be used to monitor direct gamma radiation levels in "real time" and record exposure rates. Ions are collected within a cavity chamber filled with pressurized argon gas. The current generated is proportional to the amount of ionization produced in the chamber. Quantitative measurements of exposure rate are made and may be recorded in $\mu\text{R/h}$ to R/h .

J.5 Neutron Sources and Detectors

Because of their long half-lives, the following neutron radiation sources are used most commonly: Americium-241, beryllium (AmBe), Radium-226 Beryllium (RaBe), Plutonium-239 Beryllium (PuBe), and Californium-252. The AmBe, RaBe and PuBe sources generate neutrons by alpha bombardment of a beryllium target, which transforms a beryllium target nucleus to a stable carbon atom with the associated release of a neutron. Californium-252 undergoes alpha decay, but approximately 10% of the time, spontaneous fission occurs, which results in the release of neutrons. Americium-241, Californium-252, and Radium-226 also emit some gamma radiation.

Conventional radiation surveys with alpha detectors or beta-gamma detectors will not detect the presence of neutrons, which may lead to an underestimate of the potential dose related to exposure from these sources. The AmBe, RaBe, and PuBe neutron source readings should be multiplied by a safety factor of three for any survey measurements made with conventional alpha and beta-gamma survey instruments. For Californium-252 sources, the conventional readings should be multiplied by a safety factor of ten.

Neutrons, as the name implies, are a particulate form of radiation originating in the nucleus and having a neutral charge. Like gamma rays, neutrons are not directly ionizing; they must react with another medium to produce a primary ionizing particle, such as an alpha particle, a recoil proton, or a recoil nucleus. This characteristic of neutrons has resulted in the development of several detector types, but the most commonly used are scintillation detectors and gas proportional detectors that have special fill gases or scintillating materials. Activation foil devices are used to determine the neutron energy spectrum.

One of the most commonly used detectors is a proportional counter that employs boron trifluoride (BF_3) gas. For increased sensitivity, the boron is usually highly enriched in the B-10 isotope above the 19.8% that occurs in nature. The BF_3 proportional counter can shield against gamma rays that may be present with neutrons. In other counter designs, a boron counter can be loaded into zinc sulfide scintillators for neutron detection. Scintillators made from crystals of

lithium iodide (europium doped) can also be used to detect neutrons, but the gamma discrimination is poorer than in detectors using BF_3 gas. One of the drawbacks of neutron detectors is their large size and weight. Detector weights can range from a few ounces for a single BF_3 tube proportional detector to upwards of 100 lb for detector arrays that are used for more complex neutron measurements.

The neutron measurements should be left to the radiation health professionals, who have appropriate instrumentation. It is very important, however, that the initial response teams be aware of the potential additional hazard associated with the AmBe, RaBe, PuBe and Californium-252 neutron sources. Other sources for neutron exposure could be shipments of SNF, but the neutron hazard component from spontaneous fission of the spent fuel will be very low compared with the radiation hazard associated with the mixed fission products inside the shipping casks. An intact spent fuel shipping cask poses little or no radiation hazard.

J.6 Pocket Ionization Chambers and Dosimeters

The most commonly used DRD, sometimes called a self-reading dosimeter, works on the principle of electrostatics. A quartz or carbon fiber in a sealed ionization chamber is electrostatically charged, usually to the zero point on the scale. Gamma radiation discharges the electrostatic charge on the fiber, which then moves a certain distance, depending upon the amount of radiation received. To read the exposure received, the user places a light source at the open end of the instrument, casting a shadow of the fiber onto a scale viewed at the other end of the instrument. Care should be taken in reading these dosimeters to ensure that the numbers on the scale are upright. If the dosimeter is tilted (rotated slightly), the indicated exposure will change because of the pull of gravity on the fiber. These instruments are used when personnel are required to enter fields of high radiation or remain in low radiation fields for long periods. They are useful only for x-ray or gamma radiation.

Users should test DRDs for accuracy and calibrate these instruments at the frequency suggested by the manufacturer. Those that read in mR should be tested for electrical leakage on a quarterly basis and, if the drift is over 20% in 48 hours, they should be recharged and checked again; if still defective, they should be replaced. Those that read in R should be tested for electrical leakage in the same manner as the mR dosimeters, but on an annual (rather than a quarterly) basis. Records should be maintained of the electrical leakage test results.

(Although first responders may use thermoluminescent dosimeters (TLDs) and film badges [as workers do in the fields of medicine and industry], they are not described in this document because they do not read out directly. The TLD and film badge dosimeters are used to determine and document, after the fact, the amount of external gamma exposure received [depending on the type of holding device they are placed in and the film used, beta and neutron exposure can also be detected]. They can detect the presence of radiation, but they cannot provide an instant readout.)

J.7 Digital Electronic Dosimeters

Another type of pocket dosimeter, these devices provide a digital display of accumulated radiation exposure. There are several different manufacturers and models of these electronic dosimeters and almost as many different types of detectors (e.g., GM, surface barrier) within them. This type of dosimeter is primarily used to monitor gamma radiation or x-rays. All of the digital electronic dosimeters are potentially subject to interference from radio frequency (RF) signals. The sensitivity to RF interference depends on the shielding built into the dosimeter and the frequency and proximity of the RF signal. Users should be careful about using hand-held radios and telephones in the areas where the digital dosimeters are being used.

Table J-1: Radiation Survey Instruments

Detector	Types of Radiation Measured	Typical Full Scale Readings	Use	Minimum Energy Measured	Directional Dependence	Advantages	Possible Disadvantages
Scintillation Counter	α or β or γ and x-rays	0.02 mR/h to 20 mR/h or 100 to 10,000 cpm	Survey	20 keV for γ and x-rays; variable for α and β	Low for γ and x-rays; High for α	1. High sensitivity 2. Rapid response	1. Fragile 2. Relatively expensive
Geiger-Mueller Counter	γ and x-rays; detects β	0.2 to 20 mR/h or 800 to 80,000 cpm	Survey	20 keV for γ and x-rays; 150 keV for β	Low for γ and x-rays	Rapid response	1. Strong energy dependence 2. Possible response paralysis at high count or exposure rates 3. Limited range
Gas Proportional Detector	α or β	500,000 cpm	Survey for α contamination	Depends on window thickness	High	1. Special probes for α or β detection 2. Can count α without interference from β or γ	1. Slow response 2. Fragile window 3. Sensitive to changing environmental conditions
Pressurized Ionization Chamber	γ and x-rays	3 mR/h to 500 R/h	Survey	20 keV for γ and x-rays; variable for β	Low for γ and x-rays	1. Low energy dependence 2. Accurate measurements	1. Relatively low sensitivity 2. May be slow to respond
Pocket Ionization Chamber and Dosimeter	γ and x-rays	200 mR to 600 R	Monitoring and survey	50 keV	Low	1. Relatively inexpensive 2. Gives estimate of integrated dose 3. Small size	1. Subject to accidental discharge when dropped

APPENDIX K

Requirements for Mutual-Aid Agreements

Formal interstate and intrastate mutual-aid agreements should be made between contiguous States and Tribal governments for responding to radiological transportation accidents/incidents. A number of interstate mutual-aid compacts are currently in force; they provide for mutual assistance in managing any emergency/disaster that overextends the ability of local and state governments to reduce, counteract, or remove the danger. Examples of these compacts include:

- Interstate Civil Defense and Disaster Compact;
- Southern States Energy Board's Agreement for Mutual State Radiological Assistance;
- Southern Caucus Supplemental Agreement to Interstate Civil Defense Compact; and
- Southern Regional Emergency Management Compact.

A copy of each interstate emergency preparedness compact should be transmitted promptly to the U.S. Senate and House of Representatives. The consent of Congress is granted to each compact upon the expiration of the 60-day period beginning on the date on which the compact was submitted to Congress (Robert T. Stafford Disaster Relief and Emergency Relief Act, as amended).

Mutual-aid agreements should accomplish the following:

1. Identify authority and responsibility for emergency planning and response for accidents occurring on or near the boundaries of States and localities.
2. Identify each agency and available resources of the signatory parties available for implementing action under the agreement, including the role to be played by each agency.
3. Establish appropriate mechanisms (e.g., legal agreements, plans, and procedures) for administering the agreement.
4. Identify the scope of the radiological emergency assistance that will be provided under the agreement, both geographically and functionally.
5. Identify uniform PAGs for use in the contiguous region.
6. Identify existing Federal emergency response support and/or assistance agreements related to specific transportation programs for movement of radioactive materials by Federal agencies.

7. Clarify the legal and financial liability of the parties to the agreement and provide a mechanism to limit liability for all personnel who may be called upon to provide assistance during any emergency within the scope of the agreement.
8. Establish a system of communications between the signatory parties to provide for rapid and consistent alerts and responses.
9. Clarify the circumstances under which these coordination procedures would be called into action, perhaps by specifying the following: a minimum distance to a border; distance combined with meteorological, geological, and hydrological conditions; special resources needed or available; or other emergency response-triggering circumstances.
10. Provide a system for coordinated decision-making and implementation of protective actions. The ICS is being adopted nationwide by fire, police, and other emergency service providers for use in any type or size of emergency, ranging from a minor incident involving a single response unit to a major event involving several agencies (see Appendix O, Bibliography items 73 and 74). ICS allows agencies to communicate using common terminology and operating procedures and to efficiently combine their resources during an emergency. The IC can be an engine company captain or the chief of a department, depending on the situation. The structure of the ICS can be established and expanded in response to the changing conditions of the incident. The system is intended to be staffed and operated by qualified personnel from a variety of emergency services agencies. ICS includes procedures for controlling personnel, facilities, equipment, and communications and has five major functional areas: Command, Operations, Planning, Logistics, and Finance. The system has several components that work interactively to provide effective command and control:
 - Common terminology;
 - Modular organization;
 - Integrated communications;
 - Unified command structure;
 - Consolidated action plans;
 - Manageable span-of-control;
 - Predesignated incident facilities; and
 - Comprehensive resource management.

A mutual-aid agreement that is not based exclusively on inter-border transportation accidents should clarify the circumstances under which such agreements would be activated. A triggering mechanism would depend on the following factors, which should be agreed upon in advance:

- Type of problem;
- Type of resources needed;
- Where resources should be delivered; and
- What equipment would be available for transfer between governments.

The mutual assistance agreement may call for joint training and exercises between or among neighboring Tribal, State, and/or local jurisdictions.

This page is intentionally left blank.

APPENDIX L

Packaging Categories

Safe transportation of radioactive materials depends primarily upon the use of proper packaging for the type, quantity, and form of radioactive materials being transported. It is also important to ensure that the packaging has been performance tested and is appropriate for the potential hazards associated with the radioactive materials it contains.

There are essentially five categories of radioactive materials packaging. Development of the technical criteria for each packaging category correlates to certain general and performance requirements. The five general packaging categories are:

1. Excepted packaging for LQ materials (49 CFR §173.421, §173.424, §173.426, §173.428);
2. Packaging for LSA materials and surface-contaminated objects (SCOs) (49 CFR §173.427);
3. Type A packaging (49 CFR §173.403, §173.412, §173.415, and §173.465);
4. Type B packaging (49 CFR §173.403, §173.413, §173.416, and §173.417); and
5. Fissile radioactive materials packaging (49 CFR §173.420).

Each type is described in the following sections.

L.1 Excepted Packaging for Limited-Quantity Materials

A threshold of 74 Bq (0.002 μ Ci)/g of radioactive material is the lowest concentration requiring regulation for transport. Materials with concentrations lower than 74 Bq (0.002 μ Ci)/g are presently not regulated for transportation; however, they may be regulated and controlled for possession, use, transfer, and disposal. Neither outside warning labels nor specification markings are required for Excepted Packages, including LQ, instruments and articles, items made of uranium or thorium metal, and empty packages. However, the word "Radioactive" and other prescribed statements may appear on the outside of the inner package or on the outer package. The quantity of radioactivity per package and the surface radiation levels of these packages are extremely low. Typically, the quantity limits for LQ shipments range from a few Bq (fractions of a μ Ci) for shipment of some electron tubes to 0.74 TBq (about 20 Ci) for shipments of tritium and luminous devices. The packaging requirements are basically the same as those that apply to any hazardous materials: use of "strong, tight," good-quality IP that ensures no loss of contents under normal transportation conditions. Radioactive materials shipments with LQ packaging are made routinely by common carriers. The U.S. Postal Service also transports LQ packages, although the amount of radioactivity per package is one-tenth the amount allowed for transportation by commercial carriers.

The potential radiation hazard from any such shipment is very low. If LQ packages were destroyed in an accident, measurable amounts of radioactive contamination might be found in the debris. However, the amounts of radioactivity released would pose no significant threat to public health and safety. Typical examples of radioactive materials shipped in LQ packaging include some types of medical diagnostic kits; research and industrial samples or test materials and wastes from these operations; radioactive devices, such as smoke detectors, luminous dials and indicators; and special electronic tubes and instruments.

L.2 Low-Specific-Activity and Surface-Contaminated Objects Packaging

In LSA materials, radioactivity is uniformly distributed throughout the volume of large amounts of non-radioactive materials. SCOs are non-radioactive items on which accessible and non-accessible surfaces are contaminated with radioactive materials. In either case, the low levels of radioactivity would pose minimal risk if the material were dispersed in an accident. The following regulations apply to LSA and SCO shipments.

Materials with concentrations higher than 74 Bq (0.002 μ Ci)/g are regulated during transport. Materials transported as LSA may have specific activities ranging from 74 Bq (0.002 μ Ci)/g for most radionuclides to 740 MBq (0.02 Ci)/g for tritium (Hydrogen-3) in water.

When LSA packages are transported with other commodities by common carrier, they must be essentially Type A packages. However, when LSA materials totaling less than Type B quantities per package are transported under exclusive-use conditions (i.e., arrangements between shipper, carrier, and consignee to control conditions during transportation), the packaging needs to meet only "strong, tight" criteria. These criteria help ensure that the packages will not allow loss of contents under anticipated normal transportation conditions expected by the shipper under exclusive-use controls during shipment. Many nuclear fuel cycle wastes (e.g., uranium ore concentrate) and LLWs are shipped in LSA packaging. Many institutional waste generators, such as licensed hospitals, universities, and industrial laboratories, also ship LLW in LSA packaging.

Significant changes in the regulations for transportation of LSA and SCO materials became effective in 1996. These changes resulted in three categories of LSA (LSA-I, LSA-II, and LSA-III) and two categories of SCOs (SCO-I and SCO-II). The activity per gram increases from LSA-I to LSA-III, as does the activity per cm^2 from SCO-I to SCO-II.

The 1996 changes in the regulations also added three new categories of IPs: IP-I, IP-II, and IP-III. IP-1 packages must meet the general design requirements of §173.410. The IP-I package has very limited performance standards and is very similar to the "strong, tight" package that has been authorized for transport under exclusive-use conditions for many years. The IP-II and IP-III packages are required to satisfy performance standards similar to those for Type A packages. IP-2 packages must meet IP-1 requirements and also not show loss, dispersal, or have a significant increase in radiation levels at the external surface when tested as specified in §173.465(c) and (d) or evaluated against these tests by any methods authorized by §173.461(a). IP-3 (essentially Type A) packages must meet the requirements for IP-1 and IP-2 plus those specified in §173.412(a)-(j) concerning package and device security systems and must also be resistant to specified temperature and pressure changes. IP-1, IP-2, and IP-3 packages are used

for transporting low-level radioactive materials classified as LSA or SCO. The increase in the number of categories of packages that can be used for the transport of LSA and SCO materials adds complexity, but the changes provide shippers with more flexibility for making shipments safely and cost effective.

Another category of materials commonly transported is LLWs scheduled for disposal at shallow land burial sites. LLW is defined as radioactive waste that is: (1) neither high-level waste, transuranic waste, spent nuclear fuel, nor by-product material, as defined in Section 11e(2) of the AEA of 1954, as amended; and (2) classified by the Federal Government as low-level waste consistent with existing law. LLW does not include waste generated as a result of Atomic Energy Defense activities of the Federal Government, as defined in Public Law (PL) 96-573, as amended, or Federal research and development activities. With the increasing costs for land disposal of radioactive LLWs — which have very low activity — in the 1990s, an increasing number of shipments of such wastes (e.g., contaminated wiping rags, protective clothing, hand tools, vials, needles, test tubes, other medical research materials) are sent to waste processing facilities that compact, incinerate, otherwise reduce the volume of the LLWs, and then repackage them for shipment to disposal sites. Another category of high-bulk, very low-activity shipments are ores and materials used in the processing of ores for extraction of uranium and other materials. Many of the shipments are transported in freight containers and closed vans as “unpacked bulk LSA material,” although the material may sometimes be in bags or cardboard boxes for convenience in handling.

L.3 Type A Packaging

The most common shipments of radioactive materials are for medical, industrial, and research purposes; they are not in the LSA or SCO category, although their activity is often above the limits for LSA or SCO. The packaging requirements for these materials are related to the total quantity in the package. LSA and SCO requirements, on the other hand, are based on activity per gram, which means less restriction on the quantity.

Type A packaging is designed to withstand the stress of transit under non-accident conditions (which includes rough handling); Type B packaging must withstand stress associated with severe accident conditions. The A_1 and A_2 values assigned to each radionuclide in the regulations are the maximum quantity of that radionuclide that may be transported in a Type A package. (See Glossary for definitions of A_1 and A_2 and of Type A packaging; see Appendix O, Bibliography item 88 for regulatory treatment of Special Form, Normal Form, and Type A packaging.)

Although Type A packaging is not designed to prevent the loss of its contents under accident conditions, many accidents have involved Type A and LSA packaging that maintained their integrity with no loss of contents. Even in those accidents where a loss of contents occurred, there were no significant adverse effects to persons or the environment because of the limited radioactive material allowed in the packaging. (See Appendices A and G for discussions of accidents involving Type A packaging.)

The majority of radioactive materials shipped are transported in Type A packaging. Examples include radiopharmaceuticals, research and industrial sources, and some nuclear fuel-cycle

materials. The amount of activity in nearly all Type A packaging is a small fraction of the amount permitted by the A_1 and A_2 value limits in regulations. The amount of material in such packaging is generally limited by the receiver's needs.

The activity limits for Type A packages typically range from MBq (a fraction of a mCi) for some radiopharmaceutical shipments to 3.7 TBq (100 Ci) of tritium (Hydrogen-3) for some industrial procedures. Quantity limits for Type A packages (which never exceed 37 TBq [1,000 Ci]) are greater than the limits for LQ packages but lower than those for Type B packages. Thus, accidents that may cause damage to Type A packaging would not likely result in life-endangering radiation hazards. Therefore, Type A packaging must withstand only the moderate degrees of stress associated with non-accident rough handling during transport. Conditions include heat, cold, reduced air pressure, vibration, water spray, 4-ft drop, puncture, and compression.

L.4 Type B Packaging

If the amount of radioactive materials to be shipped exceeds A_1 or A_2 value limits, the material must be shipped in Type B packaging. The quantity of radioactive materials transported in Type B packaging ranges from GBq (several μ Ci) to PBq (million Ci). Because the potential hazard resulting from releases of Type B quantities would be greater than for Type A quantities, structural design requirements for Type B packaging are more stringent. In addition to meeting Type A packaging standards, Type B packaging must withstand the more severe puncture, drop, thermal, and water immersion stresses that might be experienced under actual or hypothetical transportation accident conditions (see Appendix B, Table B-1). Examples of materials transported in Type B packages include industrial radiography devices, sources used in some industrial logging and gauging operations, and some sources for therapeutic medical procedures.

Prior to 1988, no reports were forwarded to DOT or NRC indicating the loss of containment of a Type B package caused by severe forces during vehicular accidents. However, human errors in preparing packages for transport have resulted in a few cases of content release and radiation exposures above regulatory limits. These occurrences have not resulted in adverse health effects (see Appendix G, Section G.7).

When a Type B quantity is greater than a certain value (generally 3,000 times the Type A packaging limit), that quantity is designated as an HRCQ and is subject to additional restrictions during transport by highway. Examples of HRCQ shipments include sources for sterilizing medical supplies, SNF, and other HLW.

L.5 Fissile Radioactive Materials Packaging

Radioactive materials may be classified as fissile if they contain quantities of radionuclides that, in certain configurations, can disintegrate by a process known as fission and sustain a chain reaction. The fissile radionuclides are Uranium-233, Uranium-235, Plutonium-238, Plutonium-239, and Plutonium-241. The transportation regulations for fissile materials are designed to avoid accidentally reaching criticality (causing a sustained chain reaction). Such events could occur if the quantity of fissile radionuclides was sufficiently large, and other

conditions are present. Fissile materials are shipped in Type A and Type B packaging that is designed and constructed on the basis of activity (Bq or Ci) and the fissile nature of the radionuclides in the package. Fresh nuclear fuel, SNF, and TRU waste are examples of the types of shipments that contain fissile material.

L.6 Summary

Packaging requirements reflect the degree of hazard associated with the type, quantity, and other characteristics of the radioactive materials shipped. For Type B radioactive materials, which pose significant potential hazards, the packages are designed to prevent the release of the radioactive contents or damage to the radiation shielding following accidents of all but the most improbable severity. Type A and other packages authorized for transporting other radioactive materials that present limited radiological hazard have been involved in accidents that have resulted in some release of the radioactive contents. However, radiological risks to workers, the public, and the environment have been very low because of the limited hazard of the radioactive material. Some Type A packages involved in very severe accidents have performed far beyond their expected design capabilities. In several accidents of moderate severity, materials with the lowest regulated concentrations allowed in bulk packaging have been released but, as expected, the consequences have not been significant because of the extremely low hazard of the material. Following these accidents, the released material was put into new containers for transport to the original destination.

This page is intentionally left blank.

APPENDIX M

Packaging Illustrations

M.1 Typical Type A Packaging Configurations

The following are descriptions for the Figure M-1 illustrations of several typical Type A packaging configurations. The package measurements and activities shown are representative of those that may be encountered.

- M-1a: Molybdenum 99 Generator** — Cutaway shows outer carton, foam spacer, shielding, ion column, and tubing for saline solution; Dimensions: 35 cm³; Weight: 18 kg (39.7 lb); Contents: Mo-99 and Tc-99m; Activity: 0.15 TBq (4 Ci).

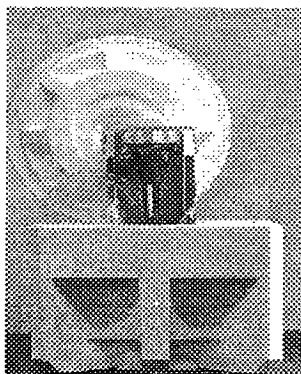

- M-1b: Moisture Density Gauge and Carrying Case** — Dimensions: 20 cm by 13 cm by 10 cm (handle is 30 cm in length, case is 30 cm by 20 cm by 15 cm); Weight: 11 kg (24.3 lb); Contents: special form Am-241/Be and Cs-137; Activity: 2 GBq (50 mCi) and 0.4 GBq (10 mCi).



M-1c: Steel Drum — Capacity: 55 gal; Dimensions: 60 cm by 90 cm; Weight: 200 kg (441 lb); Contents: inside packaging configurations and radioactive material contents may vary widely; Activity: 0.1 GBq to 40 TBq (3 mCi to 1,000 Ci).

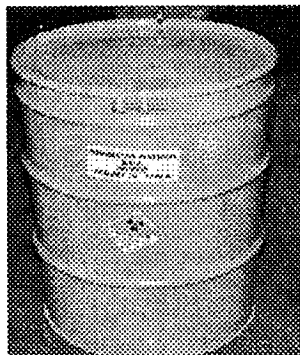

M-1d: Wooden Box — Dimensions: rectangular/0.2 to 4 m; Weight: 2–1,000 kg (4.4–2,205 lb); Contents: many radionuclides (special and normal form); inner packaging varies widely depending on weight and form of content; Activity: 0.1 GBq to 40 TBq (3 mCi to 1,000 Ci).

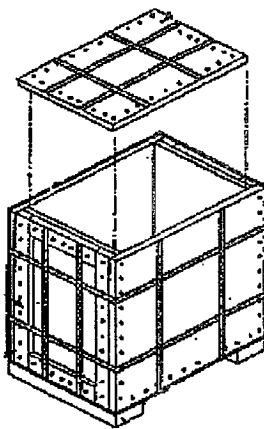

M-1e: Nuclear Pharmacy Unit Dose(s) Package (Ammo Box) — Dimensions: 30 cm by 23 cm by 15 cm; Weight: 8 kg (17.6 lb); Contents: Tc-99m, Ga-67, Tl-201, I-131; Activity: 0.1 to 10 GBq (3 to 270 mCi).

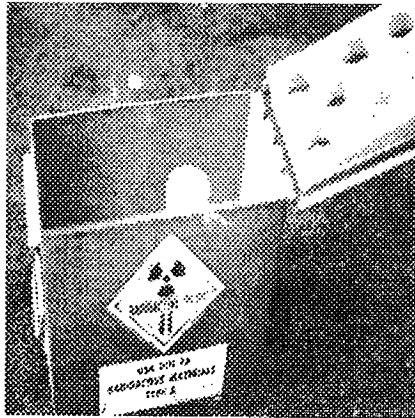

M-1f: Carton for Medical/Research Radionuclide (in Liquid Form) — Drawing Shows: carton, foam spacer, shielding, secondary container, absorbent and primary container. Dimensions: 20–50 cm³; Weight: 2–25 kg (4.4–55.1 lb); Contents: many radionuclides; Activity: 10 MBq to 40 TBq (0.3mCi to 1,000 Ci).

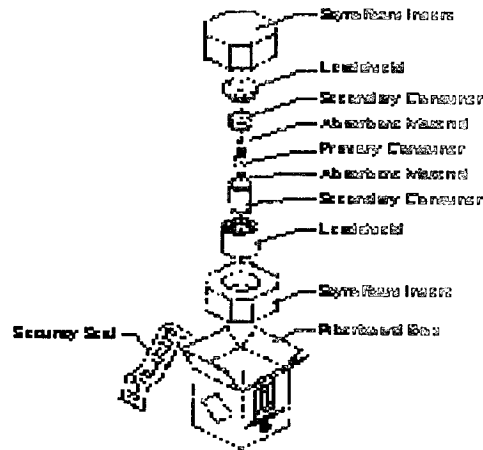

M.2 Typical Type B Packages

The following are descriptions of several typical Type B packages. Type B packages cover a wide range of physical size, from small radiographic devices to large waste casks and SNF casks.

M-2a: BUSS Cask (with Impact Limiters) — Dimensions: 2.2 m outside diameter (OD) by 2.7 m; Weight: 13,600 kg (29,983 lb); Contents: Cs-137 (special form); Activity: 31 PBq (0.85×10^6 Ci).

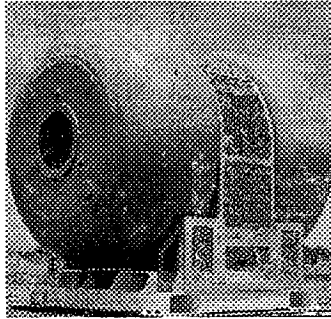

M-2b: Industrial Radiography Exposure Device — Cutaway Shows: “S” tube for source in the shielding material. Dimensions: 33 cm by 20 cm by 13 cm; Weight: 21 kg (46.3 lb); Contents: Ir-192 (special form); Activity: 4 TBq (100 Ci).

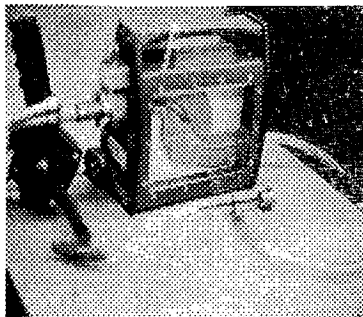

M-2c: Normal-Form Material (20WC-2) — Dimensions: 0.6 m OD by 0.7 m; Weight: 200 kg (441 lb); Contents: Mo-99, I-131; Activity: 40 TBq (1,000 Ci), 7 TBq (200 Ci).

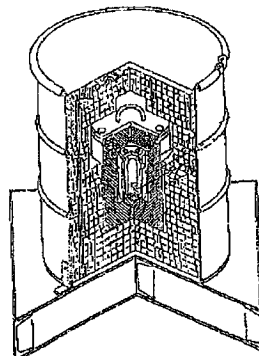

M-2d: Multiple Special-Form Sources — Drawing Shows: cutaway of metal cage for thermal protection of personnel and shielded container with cooling fins, Dimensions: cage – 50 cm³, cask (without cooling fins) – 20 cm OD by 28 cm; Weight: 186 kg (410 lb); Contents: Ir-192; Activity: 400 TBq (10,000 Ci).

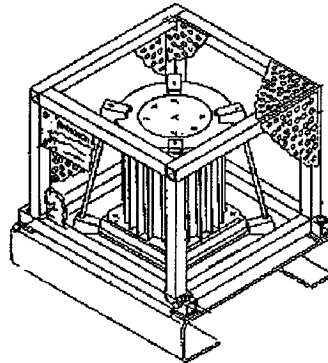

M-2e: DOT Specification 6 M (with Flanged, Leak-Testable 2R Inner Container) — Dimensions: 60 cm OD by 90 cm; Weight: 290 kg (639.5 lb); Contents: many solid non-fissile radionuclides (special or normal form); Activity: GBq to TBq quantities (10 mCi to 1,000 Ci); Thermal Output: less than 10 watts.

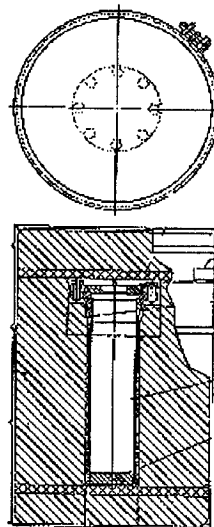

M-2f: Liquid-Form Package (Details of Inner Multiple Containment and Shielding Not Shown) — Dimensions: outer steel drum – 49 cm OD by 52 cm; Weight: 140 kg (308.7 lb); Contents: Mo-99, I-131, Y-90 or Sr-90; Activity: 20 TBq to 55 TBq (500–1,500 Ci).

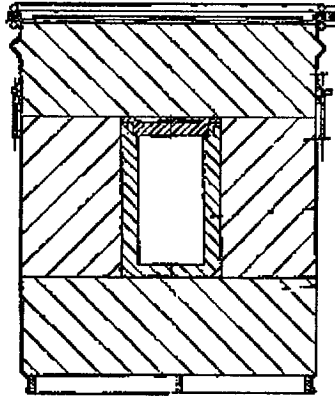

M.3 Fissile Radioactive Material Packaging

The following are descriptions for some typical packages used in the transportation of fissile radioactive materials. The dimensions, weight, and contents of the packages are approximate.

M-3a: Type A Drum for UO₂ — Illustration Shows: outer drum, solid insulation, sealed container, and inner receptacles for powder or pellets. Dimensions: 0.6 m OD by 0.7 m; Weight: 210 kg (463 lb); Contents: 30 kg UO₂ enriched up to 5% U-235; Activity: 3 GBq (0.08 Ci).

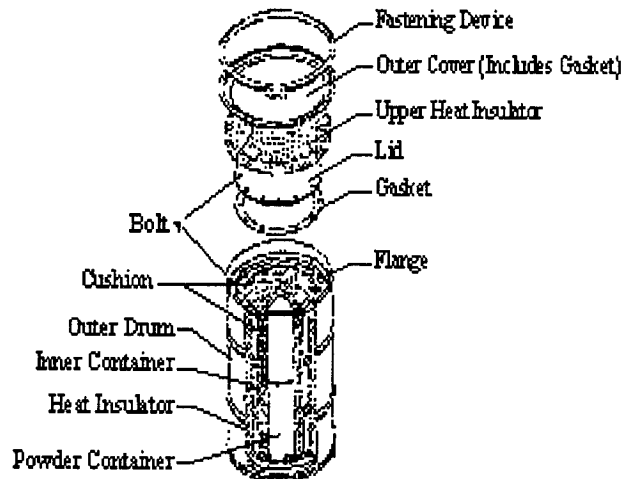

M-3b: Power Reactor Fresh Fuel — Dimensions: 1.1 m OD by 5.5 m; Weight: 1,400 kg (3,087 lb); Contents: two power reactor fuel assemblies (2% of assemblies in a power reactor), total 750 kg uranium as oxide (enriched to 4% U-235); Activity: 0.7 TBq (20 Ci).

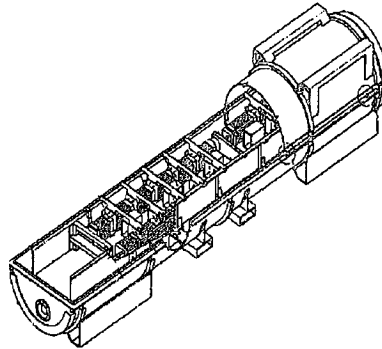

M-3c: Power Reactor Spent Fuel (Shown with Personnel Barrier, on Rail Car) — Dimensions: 1.6 m OD by 5.3 m; Weight: 64,000 kg (141,200 lb/70.6 tons); Contents: 7 power reactor assemblies (minimum cool time 120 days; maximum thermal output 1,700 watts), fission products, and other nuclides; Activity: 120 PBq (3.1×10^6 Ci).

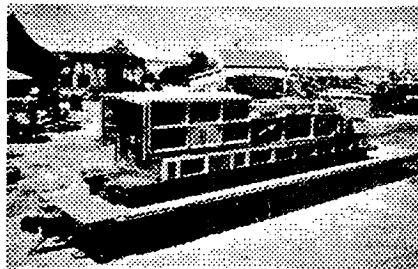

M-3d: UF₆ Overpack (Bare 30-in. Cylinder for UF₆ Beside Overpack) — Dimensions: 1.1 m OD by 2.3 m; Weight: 3,700 kg (8,200 lb/4.1 tons); Contents: 2,200 kg UF₆ enriched to 5% U-235; Activity: 0.2 TBq (6 Ci).

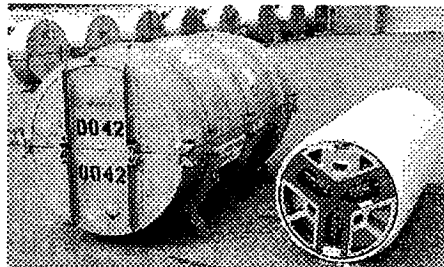

M-3e: Research Reactor Spent Fuel (with Impact Limiters) — Dimensions: 1.8 m OD by 3.3 m; Weight: 15,200 kg (33,600 lb/16.8 tons); Contents: 7 kg U-235 (pre-irradiation), mixed fission products; Activity: 600 TBq (16,000 Ci).

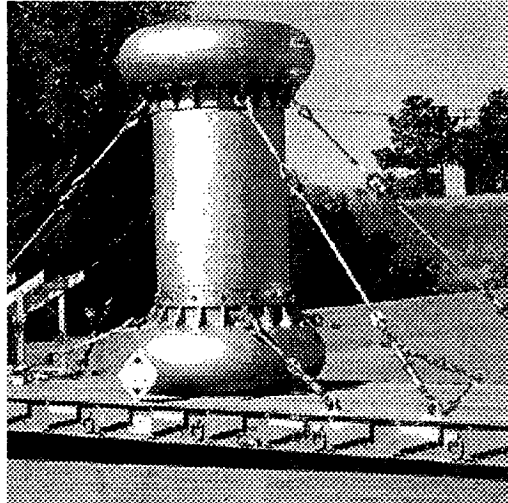

M-3f: Research Reactor Fresh Fuel — Dimensions: 0.8 m OD by 1.2 m; Weight: 480 kg (1,058.4 lb); Contents: one fuel element, uranium enriched to 95% U-235, 6.9 kg of U-235; Activity: 0.02 TBq (0.6 Ci).

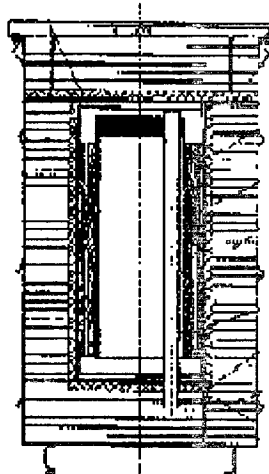

M.4 Typical Packages for Radioactive Wastes

The following are descriptions for typical packaging for radioactive wastes. Some of these are appropriate for wastes classified as LSA or SCO. Others are for wastes that may be classified as Type B and/or fissile radioactive material. The dimensions and activities indicated are approximate.

M-4a: Intermodal Container — Depending on contents or other packaging, may be a conveyance, bulk packaging, “strong, tight” or IP packaging, Dimensions: 2.4 m by 2.6 m by 6 m or 12 m; Weight: 18,000 kg (39,600 lb/19.8 tons); Contents: Type B or Type A packages, IP or “strong, tight” packages, unpackaged LSA-1 or LSA-2 materials, SCOs unpackaged or in intermediate packaging; Radionuclides: non-fissile, fissile excepted, or fissile materials in quantities from LQ through HRCQ.

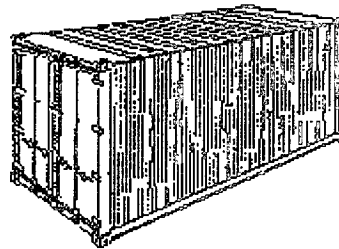

M-4b: TRUPACT-II — Dimensions: 1.9 m OD by 1.9 m; Weight: 8,740 kg (19,200 lb/ 9.6 tons); Contents: non-fissile and fissile TRU radionuclides dispersed in processed solid waste inside drums or other containers. Activity and fissile contents are restricted for both inner container and total package, typically in the GBq to TBq range.

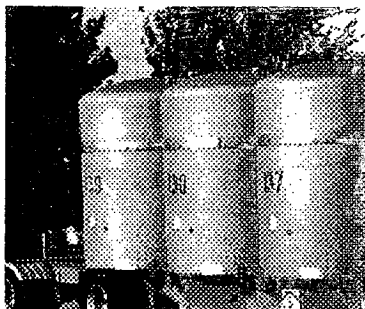

M-4c: Shielded LSA Cask (Type A, IP-II, and IP-III) — Dimensions: 1.9 m OD by 2.2 m; Weight: 26,500 kg (58,400 lb/29.2 tons); Contents: Irradiated solids, dewatered resins, and other solids meeting LSA and SCO definition. Non-fissile or fissile excepted radionuclides in quantities less than or greater than A_2 that meet the 10 mSv/h (1 R/h) at 1-m limit.

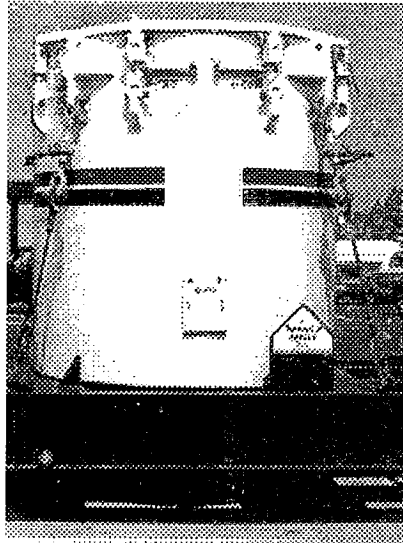

M-4d: Steel Drum — Depending on content and inner packaging, may be “strong, tight,” Type A, Type B, or IP-I, II, or III. Dimensions: 0.7 m OD by 0.9 m; Weight: 290 kg (639.5 lb); Contents: may range from LQ, LSA-I, LSA-II, LSA-III, SCO I, SCO II, to Type B quantities. Radionuclides may be non-fissile, fissile excepted, or occasionally fissile in quantities from MBq to TBq (mCi to 1,000 Ci).

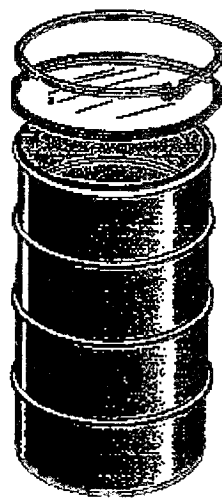

M-4e: Metal Box — “Strong, tight,” Type A or IP. Dimensions: 0.9 m by 1.2 m by 2.4 m; Weight: 3,600 kg (8,000 lb/4 tons); Content: LSA-I, II, or III, SCOs, or radioactive material not otherwise specified (n.o.s.). Radionuclides may be non-fissile or fissile excepted in quantities ranging from MBq to TBq (mCi to 1,000 Ci).

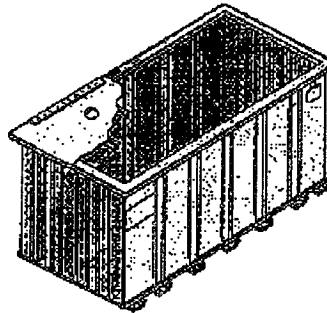

M-4f: Wooden Box — “Strong, tight,” Type A, or IP. Dimensions: vary widely; Weight: range of 10–225 kg (22–496 lb); Contents: solid LSAs and SCOs, radionuclides, usually non-fissile, in quantities ranging from MBq to TBq (mCi to 10 Ci).

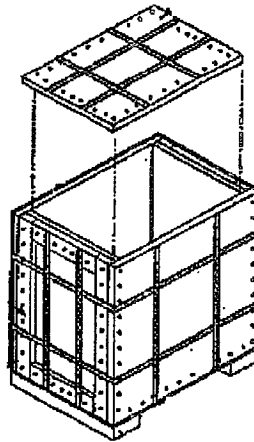

This page is intentionally left blank.

APPENDIX N

Shipment Identification for Transportation of Radioactive Materials

N.1 Introduction

Table N-1 lists the most commonly used proper shipping names for radioactive materials. Table N-2 lists the proper shipping names (49 CFR §172.101) for less frequently encountered radioactive materials, all of which have a comparatively low order of radioactivity but present a secondary hazard. The proper shipping names that should be used for some radioactive materials are not always obvious. Guidelines for selecting the most appropriate name are provided in 49 CFR §172.101(c)(11).

Table N-1: Most Commonly Used Proper Shipping Names for Radioactive Materials

UN Number	Proper Shipping Name (49 CFR §172.101)
UN 2910	Radioactive material, excepted package-articles manufactured from natural uranium <i>or</i> depleted uranium <i>or</i> natural thorium
	Radioactive material, excepted package-empty package <i>or</i> empty packaging
	Radioactive material, excepted package-instruments <i>or</i> articles
	Radioactive material, excepted package-LQ of material
UN 2912	Radioactive material, LSA, n.o.s., <i>or</i> radioactive material, LSA, n.o.s.
UN 2913	Radioactive material, surface-contaminated object, n.o.s. <i>or</i> radioactive material, SCO, n.o.s.
UN 2918	Radioactive material, fissile, n.o.s.
UN 2974	Radioactive material, special form, n.o.s.
UN 2982	Radioactive material, n.o.s.

Table N-2: Less Frequently Used Proper Shipping Names for Radioactive Materials That Present a Subsidiary Hazard^a

UN Number	Proper Shipping Name (49 CFR §172.101)
UN 2975	Thorium metal, pyrophoric
UN 2976	Thorium nitrate, solid
UN 2977	Uranium hexafluoride, fissile (containing more than 1% U-235)
UN 2978	Uranium hexafluoride, fissile excepted <i>or</i> non-fissile
UN 2979	Uranium metal, pyrophoric
UN 2980	Uranyl nitrate hexahydrate solution
UN 2981	Uranyl nitrate, solid

^a All present a low hazard from radioactivity but pose a serious secondary hazard.

N.2 Shipping Paper Requirements

As with other hazardous materials shipments, certain essential elements of information *must* be included on shipping papers (49 CFR, Subpart C, §172.200 through §172.205). The availability of a complete and correct shipping paper description for a hazardous material shipment is vital not only to the carrier and the consignee, but also to emergency response personnel in the event of an incident or accident.

N.2.1. Basic Requirements

The shipping paper description must include the following basic information:

1. The proper shipping name (from 49 CFR, §172.101);
2. The UN hazard class or division (radioactive material is hazard class 7);
3. The UN identification number;
4. The net quantity of material by weight or volume;²¹
5. The letters "RQ," if the shipment is a "hazardous substance" (see 49 CFR, §172.101, Appendix A, Table 2 for RQ values of radionuclides); and
6. Emergency response telephone number, as prescribed in 49 CFR §172.600, Subpart G.

A shipping paper may contain additional information concerning the material, provided it is not inconsistent with, and does not cause confusion with, the basic description. Unless otherwise specified, the additional information must be placed after the required basic description.

N.2.2. Additional Requirements

The shipping paper description for radioactive material must also include the following (49 CFR §172.203[d]) (this information follows items 1, 2, and 3 in Section N.2.1):

1. The words "Radioactive Material," unless these words are contained in the proper shipping name.
2. The name of each radionuclide in the material as listed in 49 CFR §173.435. For mixtures of radionuclides, only the radionuclides that constitute 95% of the hazard of the mixture as described in 49 CFR §173.433(f) need to be listed on shipping papers and package labels.

²¹ For most radioactive material, the shipper is not required to list the weight or volume, because the additional requirements of 49 CFR §172.203(d) provide better information (i.e., the radioactivity content in Bq [Ci]). A listing of weight or volume is usually needed only for establishing freight charges.

3. A description of the physical and chemical form of the material, unless the material is "Special Form." A generic description of the material (e.g., protein, carbohydrate, enzyme) is acceptable if the exact chemical form is difficult to specify.
4. The activity contained in each package in the shipment in appropriate SI units (e.g., Bq, TBq) or in terms of appropriate SI units followed by customary units (e.g., Ci, mCi). Except for Plutonium-238, -239, and -241, the weight in grams or kilograms of fissile radionuclides may be inserted instead of activity units. For Plutonium-238, -239, and -241, the weight in grams or kilograms may be inserted in addition to the activity units. If the package contains an HRCQ, the words "Highway Route Controlled Quantity" must also be shown with the basic description.
5. The category of radioactive label applied to each package in the shipment, for example: "Radioactive White - I."
6. The TI assigned to each package in the shipment bearing a Radioactive Yellow - II or Radioactive Yellow - III label.
7. For a shipment of fissile material, the additional information required in 49 CFR §172.203(d)(7) (e.g., "Fissile Excepted," "Warning-Fissile Material, Controlled Shipment"), as appropriate.²²
8. For a shipment required to be consigned as exclusive use, an indication that the shipment is consigned as exclusive use, along with any appropriate special instructions to the carrier regarding maintenance of exclusive-use shipment controls.
9. For a shipment of LSA or SCO materials, the appropriate group notation (e.g., LSA-I, SCO-I).

The certificate identification marking required on the package must also be noted on the shipping papers if the package is (1) approved and certified by NRC or DOE, or (2) of foreign origin and revalidated by DOT.

N.2.3 Other Information and Examples of Shipping Paper Entries

As indicated above, a great deal of specific information is required on shipping papers for radioactive materials. While there is no precise prescription for the shipping paper format,²³ the first three entries must be in a specific order (see Section N.2.1, items 1-3).

Descriptive information other than that provided above is allowed, such as the functional description of the product or the applicable regulatory citation under which the shipment is

²² For a package containing a fissile nuclide with an activity content less than the definition of "Radioactive Material" (70 Bq/g or 0.002 μ Ci/g), the term "Fissile Excepted" need not be added, because these materials are not subject to transportation regulations.

²³ Regulations of international transportation organizations such as the International Civil Aviation Organization (ICAO) and International Maritime Organization (IMO) specify only the content of shipping papers. However, the International Air Transport Association (IATA) tariff specifies both content and format.

offered. This additional information must not confuse or detract from the required information. The following are examples of different ways shipments can be described on shipping papers.

Example 1: One box, radioactive material, special form, n.o.s., Class 7, UN 2974, RQ, radiographic camera, Ir-192, 2.2 TBq (60 Ci), Radioactive Yellow – II, TI of 0.6, USA/9033/B(U), cargo aircraft only. In an emergency, contact 1-800-000-0000. (Note: Physical and chemical form is not listed because material is “Special Form.”)

Example 2: One carton, radioactive material, n.o.s., Class 7, UN 2982, Co-60, 1.1 GBq (30 mCi), liquid, cobalt in 50 ml 5% hydrochloric acid solution, TI of 1.8, Radioactive Yellow – III and “Corrosive” labels applied. In an emergency, contact 1-800-000-0000.

Example 3: One box, thorium nitrate, solid, radioactive material, Class 7, UN 2976, 10 kg, thorium natural, as powdered solid thorium nitrate, 48 MBq (1.3 mCi), Radioactive Yellow – II and “Oxidizer” labels applied, TI of 0.1, cargo aircraft only. In an emergency, contact 1-800-000-0000. (Note: Because the material is specifically listed in 49 CFR §172.101, there is no “n.o.s.” in the proper shipping name. Although this material is also an LSA-I, it must be packaged and described on shipping papers in accordance with the specific packaging requirements of 49 CFR §173.419, with air shipment limited to no more than 15 kg by cargo aircraft only.)

Example 4: Three drums, radioactive material, LSA, n.o.s., Class 7, UN 2912, LSA-II, non-compacted solid debris and waste; Cs-137, Co-60, and Sr-90 solids as inorganic salts or elemental; 1.5, 0.57, and 0.18 MBq (0.04, 0.015, and 0.005 mCi), respectively. Drum n.o.s. 731, 680, and 541 are IP-1 packages, Radioactive White – I labels (see attached Radwaste Manifest [NRC Form 540]). Exclusive-use shipment instructions attached for more details. In an emergency, contact (24-hour) 1-800-000-0000. (Note: This is an example of a shipment prepared in accordance with 49 CFR §173.427[b](1)).

Example 5: Three cartons, radioactive material, n.o.s., Class 7, UN 2982, material to be used in physical chemistry research project at University Z. **Carton No. 1:** catalytic specimen, S-35, 70 mCi, solid, powdered metal oxide matrix, Radioactive White – I label, 27.2 kg, 60 lb. **Carton No. 2:** tagged solvent, Cl-30, 3 mCi, liquid, nonflammable organic, Radioactive White – I label, 22.7 kg, 50 lb. **Carton No. 3:** converter element, Fe-59 and Fe-55, 30 mCi and 20 mCi, solid, steel part, TI of 1.6, Radioactive Yellow – III label, 36.3 kg, 80 lb.

(Note: This is an example of how one basic entry on the shipping paper can be used to accompany three different packages. Detailed information regarding the content, labels, and TI is provided on each package.)

Example 6: Four packages, UF₆, fissile, Class 7, UN 2977, radioactive material, total gross weight 18,795 kg (41,350 lb). Solid UF₆ contained in four Model 30B steel cylinders, each enclosed in a Model UX-30 protective overpack; NRC certificate USA/9196/AF, Type A. Each cylinder contains 2,277 kg (5,020 lb) of UF₆ at 5% U-235 enrichment or 63 kg U-235 (629 MBq); Radioactive Yellow – III labels, TI of 5.1 per package; “Radioactive” and “Corrosive” placards and orange “2977” UN panel applied. In an emergency, contact (24-hour) 1-800-000-0000.

N.2.4 Documentation for Excepted Packages

Packages shipped according to the exceptions provided in 49 CFR §173.421, §173.424, §173.426, and §173.428 (i.e., for LQ, instruments or articles, articles manufactured from natural or depleted uranium or natural thorium, and empty radioactive material packaging) are not subject to the detailed shipping paper description requirements outlined above.

However, excepted packages must have a certification statement or notice “in” or “on” the package or forwarded with the package that includes the name of the consignor or consignee and a specific statement selected on the basis of the proper shipping name for the package (see Section N.2.5). Packages shipped internationally will have a 4-digit number. The following is an example of a notice on a shipping paper for an excepted package containing an instrument or article pursuant to 49 CFR §173.424:

Example: One carton, Ajax Model 123 monitor, *This package conforms to the conditions and limitations specified in 49 CFR §173.424 for radioactive material, excepted package — instruments or articles, UN 2910, 45 lb. (Note: Although shipping papers are not required for these excepted packages, they are not forbidden. In accordance with 49 CFR §173.422(b)(3), a shipping paper is required if the radioactive material in the excepted package is also (or is part of) a hazardous substance or hazardous waste (as defined in §171.8). When air shipment of excepted packages is involved, shippers should be aware that a certification statement, similar to those provided in Section N.2.5, is required on the airbill by ICAO and IMO regulations.*

N.2.5 Shipper's Certification Statements

Unless excepted, a shipping paper must include a certification statement signed by the person offering the package for transport. The certification must appear on the paper that contains the required shipping description.

The following statement, from 49 CFR §172.204(a)(1) (or an alternate statement listed in §172.204[a][2]) must be used for all hazardous materials shipments except those by air. *This is to certify that the above-named (or herein named) materials are properly classified, described, packaged, marked, and labeled, and are in proper condition for transportation according to the applicable regulations of the Department of Transportation.*

For air transportation, the following language may be included on shipping papers instead of the above statement. *I hereby certify that the contents of this consignment are fully and accurately described above by proper shipping name and are classified, packed, marked, and labeled, and in proper condition for carriage by air according to applicable national governmental regulations.*

The requirements and limitations for transport of radioactive materials onboard aircraft are prescribed in 49 CFR §175.75(a)(3) and §175.700 through §175.705. The following statement is required for all hazardous material (including radioactive material) shipments by air. *This shipment is within the limitations for passenger carrying/cargo aircraft only (delete non-applicable).*

N.2.6 Proper Shipping Names for Fissile Materials

Shippers of fissile radionuclides are subject to the specific requirements in 49 CFR §172.203(d)(7)(i). That section requires the addition of the words "Fissile Excepted" if the package contains a fissile radionuclide in a quantity or form that it is excepted from the specific requirements for fissile materials (49 CFR §173.453). The following guidelines should be considered in selecting the correct shipping name for fissile radionuclides:

1. If the radioactive material is not fissile excepted and does not satisfy the conditions for shipment in an excepted package, use the phrase: "Radioactive Material, Fissile n.o.s., UN 2918"; or
2. If the package contains a fissile excepted quantity that can be shipped in an excepted package, use the phrase: "Radioactive Material, Excepted Package — LQ of Material, UN 2910" and add the words "Fissile Excepted"; or
3. If the radioactive content does not satisfy the conditions for shipment in an excepted package, but the fissile content is excepted, use one of the following phrases, as appropriate: "Radioactive Material, n.o.s., UN 2982" and add the words "Fissile Excepted"; "Radioactive Material LSA; n.o.s., UN 2912"; "Radioactive Material, SCO, n.o.s., UN 2913"; or "Radioactive Material, Special Form, n.o.s., UN 2974."

N.3 Marking Requirements

N.3.1 Basic Requirements

Certain basic elements of information (other than the required *labels* discussed below) are required as "marking." When marking is required, it is sometimes referred to as "specification" marking, although this term is usually used with reference to "specification packaging." The required markings on non-bulk radioactive material packages are prescribed in 49 CFR §172.301 and include the following:

1. The proper shipping name and UN identification number for the materials, as described in 49 CFR §172.101;
2. For exemption packages, "DOT-E" followed by the applicable DOT exemption number assigned;
3. The name and address of the consignor or consignee; and
4. "RQ" if the package contains a "hazardous substance" (see 49 CFR §172.324[b] and 49 CFR §172.101, Appendix A, Table 2).

N.3.2 Liquid Marking Requirements

Each non-bulk package containing a liquid (as defined in 49 CFR §172.312) within its inner containment vessel must be packed so that the vessel closure is facing upward. The package must also be legibly marked with package orientation markings that conform to International Standards Organization (ISO) Standard 780-1985. Such markings must be on two opposite sides of the package with the double arrows in the symbol pointing in the correct upright direction. Arrows for any other purposes may not be displayed on a package containing a liquid hazardous material.

N.3.3 Radioactive Materials

Except for "excepted" packages (49 CFR §172.310), all radioactive material packages must also be marked with:

1. Gross weight, if it exceeds 50 kg (110 lb);
2. "Type A" or "Type B," as applicable. This relates to the packaging design, not the radioactive content;
3. Applicable DOT specification number and NRC or DOE package certificate identification number, as specified in the DOT specification or relevant certificate (e.g., "USA-DOT-7A," USA/9166/B(U)-85).
4. For certain Type B packages, the trefoil radiation symbol (which conforms to the standard provided in 49 CFR, Appendix B, §172);
5. "IP-1," "IP-2," or "IP-3," as applicable, when such packages contain LSA or SCO materials. (This marking is recommended, but not presently required nor prohibited by 49 CFR §172.303.)

N.3.4 Bulk Radioactive Material Packages

Bulk packaging for a hazardous material is defined in 49 CFR §171.8. The concept of "bulk" packaging reflected in that definition is that the packaging may involve the vehicle itself or a freight container or other large closed receptacle in which the hazardous material is loaded with no intermediate form of containment. Bulk radioactive material packaging is therefore most likely to involve conveyances such as closed tight truck/vans or rail cars. The packaging may contain contaminated soils and debris, LLW to be consolidated, or objects that have internal and/or external contamination; large bins or freight containers for solids; or tanks containing slurries or other liquid wastes. For such shipments, the exterior of the bulk packaging must be marked with the applicable UN hazard identification number as specified in 49 CFR §172.101. When required for radioactive material, this identification number must be placed on an orange rectangular panel adjacent to the required "Radioactive" placard [see 49 CFR §172.332]. It may not be placed on the "Radioactive" placard in lieu of the word "Radioactive" for domestic shipments, according to 49 CFR §172.334(a). This prohibition is not included in IAEA and IMO regulations.

N.4 Labeling Requirements

Each package of Class 7 (radioactive material), unless excepted, must be labeled on two opposite sides, with a distinctive warning label. The three classes of labels prescribed in 49 CFR §172, Appendix B (§172.403 and §172.436–440) are: (1) Radioactive White I has an all-white background and one vertical red bar, indicating that the external radiation level is low and no special handling is required (49 CFR §172.436); (2) Radioactive Yellow – II has an upper yellow background and two vertical red bars, indicating that there are external radiation levels and/or fissile properties that require consideration (49 CFR §172.438) (this label must bear a transport index [TI]); and, (3) Radioactive Yellow – III has an upper yellow background and three vertical red bars, indicating that external radiation levels and/or fissile properties are higher than those allowed for the Yellow – II label and that the label must bear a TI. The radionuclides contained (content) and the quantity (activity) of radioactive material in the package is written on lines on the lower half of the label.

The “Radioactive” labels alert persons, particularly package handlers, that the package contains radioactive material and *may* require special handling and stowage distance/separation control. As illustrated in Figure N.1, a label with an all-white background indicates that the external radiation level is low, and no special stowage controls or handling are required. If the upper half of the label is yellow, the package will have an external radiation level or fissile (nuclear safety criticality) characteristic that requires consideration during stowage in transportation. If the package bears a yellow label with three red stripes, the carrier must placard the transport vehicle as “Radioactive” when the packages are accepted from a shipper. Placarding is discussed in more detail later on.



Figure N-1: Package Labels

The vertical bars on each label are red. Each label is diamond-shaped, 4 in. (10 cm) on each side, and has a black solid-line border 1/4 in. from the edge. The background color of the upper half (within the black line) is white for the “I” label and yellow for the “II” and “III” labels. The regulatory provisions of 49 CFR §172.403(f) and (g) that apply to the use of these labels are outlined below.

The following applicable information items must be entered in the blank spaces of each label in legible printing (manual or mechanical) using a durable, weather-resistant means of marking:

- **Contents** — The name of the radionuclides, as listed in 49 CFR §173.435 (established radiation protection symbols are authorized). For mixtures of radionuclides (in consideration of the amount of space on the labels), a list of the radionuclides that represent 95% of the hazard present as determined by 49 CFR §173.433(f).
- **Activity** — Rates of disintegration (transformation) or decay of radioactive material. Activity must be expressed in appropriate SI units (e.g., Bq, TBq), followed by appropriate traditional units (e.g., Ci, mCi, μ Ci) in brackets (optional).
- **Transport Index** — The term used for the highest measured dose rate of radiation in mrem/h or 10 μ Sv/h at 1 m from the package surface or a number assigned for criticality control purposes. This number is placed on all Yellow – II and Yellow – III labels on packages (see 49 CFR §172.403).

The principal criteria that the shipper must consider in choosing the appropriate category of label are the dose rate at the surface of the package and the TI (see Table N.3 below).

Table N-3: Label Category Based on TI and Surface Radiation Level

Transport Index	Maximum Radiation Level at Any Point on the External Surface	Label Category ^a
0 ^b	Not more than 0.005 mSv/h (0.5 mrem/h)	White – I
More than 0 but not more than 1.0	More than 0.005 mSv/h (0.5 mrem/h) but not more than 0.5 mSv/h (50 mrem/h)	Yellow – II
More than 1 but not more than 10	More than 0.5 mSv/h (50 mrem/h) but not more than 2 mSv/h (200 mrem/h)	Yellow – III
More than 10	More than 2 mSv/h (200 mrem/h) but not more than 10 mSv/h (1 rem/h)	Yellow – III (must be shipped under exclusive-use provisions (see 49 CFR §173.441[b]))

^a Any package containing an “HRCQ” (§173.403) must be labeled as Radioactive Yellow – III.

^b If the measured TI is not greater than 0.05, the value may be considered zero.

N.5 Placarding Requirements

N.5.1. Placarding by Carrier

A carrier is required to place a placard on the transport vehicle (rail or highway) if any radioactive material package (1) bears the "Radioactive Yellow - III" label (49 CFR §172.440), or (2) if the shipment includes LSA or SCO material required by 49 CFR §173.427 to be consigned as exclusive use in accordance with 49 CFR §172.504. The "Radioactive" placard (49 CFR §172.556) is illustrated in Figure N-2.



Figure N-2: Vehicle Placard

The background color for the black trefoil symbol in the upper half of this 12-in. by 12-in. placard is yellow. (*Note:* In the case of foreign shipments coming into the United States, the placard may take the form of a large "Radioactive" label.)

N.5.2 Placarding for Exclusive-Use Shipments of LSA and SCO by Shipper

Pursuant to the shipper requirements of 49 CFR §173.427(a)(6)(v), except for shipments of unconcentrated uranium or thorium ores, the shipper must placard the transport vehicle with the "Radioactive" placard. This requirement differs from the customary placarding requirement (the carrier must placard on the basis of any Radioactive Yellow - III packages in the shipment). LSA or SCO packages consigned as exclusive use (domestic shipment only) are *excepted* from labeling requirements, so basing the requirements for placarding these materials on the presence of Radioactive Yellow - III labels would be illogical.

N.6 Emergency Response Information Requirements

N.6.1 Applicability

According to 49 CFR, §172.600, Subpart G (see Appendix O, Bibliography item 89), the shippers are required to provide emergency response information for hazardous materials shipments. The regulation applies to any shipment of a hazardous material for which shipping papers are required. Shipments of *excepted* radioactive materials packages (packages containing limited quantities, instruments or articles, or "empty" packages) are not subject to shipping paper requirements or emergency response information requirements.

N.6.2 Specific Requirements

The emergency response information accompanying a hazardous material shipment must minimally provide (49 CFR §172.602): (1) the basic description and technical name of the hazardous material(s); (2) immediate hazards to health; (3) immediate precautions to be taken in the event of an accident or incident; (4) immediate methods for handling fires; (5) immediate methods for handling spills or leaks in the absence of fire; and (6) preliminary first aid measures.

This information must be on a shipping paper or an associated document that is maintained in the vehicle and at all locations where the shipment is handled. The required information is very similar to the information provided in the guide pages of DOT's ERG2000 (see Appendix O, Bibliography item 17). In many cases, shippers satisfy this requirement by attaching an appropriate guide page from the ERG2000 to their shipping papers.

A wide range of potential hazards is associated with many types of radioactive material that can be shipped under a given shipping name and guide number. If the product being shipped has properties that are either less hazardous or more hazardous than the description in the applicable guide in the ERG2000, the emergency actions required to respond to a material release could be more specific than those in the guide. In such cases, the shipper may wish to satisfy the technical information requirements from 49 CFR §172.602 (a)(1-7) by preparing statements that are appropriate to the product being shipped.

In accordance with 49 CFR §172.604, shippers are required to provide an emergency response telephone number that must be monitored on a 24-hour basis while the shipment is in transport. The number must belong to someone who is knowledgeable about mitigation or who has immediate access to such a person. The number may be of an agency that is capable of providing the information and agrees to do so.

N.6.3 2000 Emergency Response Guidebook

DOT, in partnership with Canada and Mexico, has developed and distributed the *2000 Emergency Response Guidebook — A Guidebook for First Responders during the Initial Phase of a Dangerous Goods/Hazardous Materials Incident* (see Appendix O, Bibliography item 17) with the intent that a copy of DOT's ERG2000 be in every emergency services vehicle in North America. The ERG2000 is used by first responders to hazardous materials accidents/incidents as a means of obtaining initial information to help identify and respond to the hazards of the specific materials and decide on appropriate actions.

The ERG2000 provides a cross reference of the four-digit UN hazard identification number assigned to each DOT proper shipping name to a three-digit guide number. For class 7 radioactive material, the ERG2000 contains guide numbers that correlate to all DOT proper shipping names for radioactive material. Although there are changes in the proper shipping names and UN identification numbers with the adoption of Safety Series Number ST-1 (see Appendix O, Bibliography item 90) in the edition of ERG2000, the guide numbers and corresponding UN identification numbers are as presented in Table N-4.

The UN identification numbers and proper shipping names for radioactive materials that are covered in guides 161 - 166 of ERG2000 and from the 1996 IAEA regulations (ST-1) are listed below. At the time this edition of FEMA-REP-5 was being prepared, the U.S. Department of Transportation regulations did not list the shipping names and UN identification numbers that were in the 1996 IAEA regulations. Those proper shipping names and UN identification numbers were included in ERG2000 because, beginning in 2001, the international transportation regulations for transport by air and by vessel are expected to include the ST-1 entries. Starting in 2001, emergency responders may encounter the names and numbers in ST-1 on radioactive material packages being imported or exported.

The following is a very general description of the types of radioactive materials covered by Guides 161 - 166. Guide 161 is for very small quantities in excepted packages. Guide 162 is for materials with a low activity per gram of material or surface area. Guide 163 ranges from low to high amounts of activity dispersed in solid, liquid or gas materials. Guide 164 is for low to high amounts of activity in durable capsules, not expected to release activity if the capsule is released from the packaging. Guide 165 is for small to large amounts of fissile radioactive materials that emit alpha particles and are capable of fission if very special conditions exist. Guide 166 is for uranium hexafluoride (both fissile and non-fissile) where there is a relatively low-radiation hazard material with substantial corrosive and toxic properties, that is associated with processing uranium before it is suitable for use in reactors.

The UN identification numbers and proper shipping names for radioactive materials that are covered in guides 161 - 166 of ERG2000 and from the 1996 IAEA regulations (ST-1) are listed below. At the time this edition of FEMA-REP-5 was being prepared, the U.S. Department of Transportation regulations did not list the shipping names and UN identification numbers that were in the 1996 IAEA regulations. Those proper shipping names and UN identification numbers were included in ERG2000 because, beginning in 2001, the international transportation regulations for transport by air and by vessel are expected to include the ST-1 entries. Starting in 2001, emergency responders may encounter the names and numbers in ST-1 on radioactive material packages being imported or exported.

The following is a very general description of the types of radioactive materials covered by Guides 161 - 166. Guide 161 is for very small quantities in excepted packages. Guide 162 is for materials with a low activity per gram of material or surface area. Guide 163 ranges from low to high amounts of activity dispersed in solid, liquid or gas materials. Guide 164 is for low to high amounts of activity in durable capsules, not expected to release activity if the capsule is released from the packaging. Guide 165 is for small to large amounts of fissile radioactive materials that emit alpha particles and are capable of fission if very special conditions exist. Guide 166 is for uranium hexafluoride (both fissile and non-fissile) where there is a relatively low-radiation hazard material with substantial corrosive and toxic properties, that is associated with processing uranium before it is suitable for use in reactors.

Table N-4: ERG2000 Guide Numbers and Corresponding UN Identification Numbers

ERG2000 Guide Number (Radiation Levels)	UN Identification
161 (low-level radiation)	UN 2908 Radioactive material, empty packages
	UN 2908 Radioactive material, excepted package, empty packaging
	UN 2909 Radioactive material, articles manufactured from depleted Uranium
	UN 2909 Radioactive material, articles manufactured from natural Thorium
	UN 2909 Radioactive material, articles manufactured from natural Uranium
	UN 2910 (excepted packages), excepted package, articles manufactured from depleted Uranium
	UN 2910 (excepted packages), excepted package, articles manufactured from natural Thorium
	UN 2910 (excepted packages), excepted package, articles manufactured from natural Uranium
	UN 2910 Radioactive material, excepted package, empty package
	UN 2910 Radioactive material, excepted package, instruments
162 (low-to-moderate-level radiation)	UN 2910 Radioactive material, excepted package, articles
	UN 2910 Radioactive material, excepted package, limited quantity of material
	UN 2911 Radioactive material, instruments and articles
	UN 2911 Radioactive material, excepted package, instruments and articles
	UN 2912 Radioactive material, LSA, n.o.s.
	UN 2912 Radioactive material, LSA, non-fissile or fissile-excepted
	UN 2913 Radioactive material, SCO
	UN 2913 Radioactive material, SCO-I, non-fissile excepted
	UN 2913 Radioactive material, SCO-II, non-fissile excepted
	UN 2975 Thorium metal, pyrophoric
163 (low- to high-level radiation)	UN 2976 Thorium metal, solid
	UN 2979 Uranium metal, pyrophoric
	UN 2980 Uranyl nitrate, hexahydrate solution
	UN 2981 Uranyl nitrate, solid
	UN 3321 Radioactive material, LSA-II, non fissile or fissile excepted
	UN 3322 Radioactive material, LSA-III, non fissile or fissile excepted
	UN 2982 Radioactive material, n.o.s.
	UN 2915 Radioactive material, Type A package, non-special form, non fissile or fissile excepted
	UN 2916 Radioactive material, Type B (U) package, non fissile or fissile excepted
	UN 2917 Radioactive material, Type B (M) package, non fissile or fissile excepted
164 (special form/low-to-high-level radiation)	UN 2919 Radioactive material, transported under special arrangement, non fissile or fissile excepted
	UN 3323 Radioactive material, Type C package, non fissile or fissile excepted
165 (fissile/low-to-high-level radiation)	UN 2974 Radioactive material, special form
	UN 3332 Radioactive material, Type A package, special form, non fissile or fissile excepted
	UN 2918 Radioactive material, fissile, n.o.s.
	UN 3324 Radioactive material, LSA-II, fissile
	UN 3325 Radioactive material, LSA-III, fissile
	UN 3326 Radioactive material, SCO-I, fissile
	UN 3326 Radioactive material, SCO-II, fissile
	UN 3327 Radioactive material, Type A package, fissile, non-special form
	UN 3328 Radioactive material, Type B (U) package, fissile
	UN 3329 Radioactive material, Type B (M) package, fissile
166 (low-level radiation/water sensitive with corrosive/toxic properties)	UN 3330 Radioactive material, Type C package, fissile
	UN 3331 Radioactive material, transported under special arrangement, fissile
	UN 3333 Radioactive material, Type A package, Special Form, fissile
	UN 2977 Radioactive material, Uranium hexafluoride, fissile
	UN 2977 Uranium hexafluoride, fissile containing more than 1% Uranium-235
166 (low-level radiation/water sensitive with corrosive/toxic properties)	UN 2978 Radioactive material, Uranium hexafluoride, non-fissile or fissile excepted
	UN 2978 Radioactive material, Uranium hexafluoride, fissile excepted
	UN 2978 Radioactive material, Uranium hexafluoride, LSA
	UN 2978 Radioactive material, Uranium hexafluoride, non-fissile

This page is intentionally left blank.

APPENDIX O

Bibliography and Useful References

Appendix O contains both a Bibliography for the sources used in preparing this document and a list of additional Useful References. The Bibliography and Useful References lists are numbered separately. Users of the sources of statutes, regulations, textbooks, and pamphlets included in the Useful References list should be aware that the list is not all inclusive, although we have attempted to provide a comprehensive list of sources relevant to radioactive materials transportation. Users should also ensure that they use the most current edition of each reference listed.

O.1 Bibliography

1. U.S. Atomic Energy Commission (now U.S. Nuclear Regulatory Commission), 1974, *Termination of Operating Licenses for Nuclear Reactors*, Regulatory Guide 1.86, Washington, D.C., June.
2. Carlson, R.W., and L.E. Fischer, 1992, *A Highway Accident Involving Unirradiated Nuclear Fuel in Springfield, Massachusetts, on December 16, 1991*, NUREG/CR-5892, U.S. Nuclear Regulatory Commission, Washington, D.C.
3. Conference of Radiation Control Program Directors, Inc., 1997, *Directory of State Agencies Involved with the Transportation of Radioactive Material* (includes notes on their statutory authority and regulations), CRCPD Publication 97-2, published by the U.S. Department of Energy, Washington, D.C., October.
4. National Council on Radiation Protection and Measurements, 1985, *SI Units in Radiation Protection and Measurements*, NCRP Report Number 82, Bethesda, Md., August 13.
5. Defense Special Weapons Agency (now Defense Threat Reduction Agency), 1997, *Nuclear Accident Response Capability Listing*, DSWA 5100.52.1L, Alexandria, Va., April.
6. Joint Chiefs of Staff, 1996, *JP for Mortuary Affairs in Joint Operations*, JP 4-06, U.S. Department of Defense, Washington, D.C., August 28.
7. U.S. Department of Defense and U.S. Atomic Energy Commission, 1973, *Guidance and Information on Nuclear Weapons Accident Hazards, Precautions and Emergency Procedures*, WASH 1274, Alexandria, Va., revised October.
8. U.S. Department of Defense, 1990, *Nuclear Weapon Accident Response Procedures (NARP) Manual*, Washington, D.C., September.

9. U.S. Department of Defense, U.S. Department of Energy, and Federal Emergency Management Agency, 1981, *Agreement for Response to Nuclear Weapon Accidents and Nuclear Weapon Significant Incidents*, 46 FR 8724, Washington, D.C., January 27.
10. U.S. Department of Energy, Carlsbad Area Office, 1996, *Emergency Planning, Response, and Recovery Roles and Responsibilities for TRU-Waste Transportation Incidents*, DOE/CAO-94-1039, Washington, D.C.
11. Science Applications International Corporation, 1990, *Emergency Preparedness for Transportation Accidents Involving Radioactive Materials*, SAIC-89/1354, prepared for U.S. Department of Energy, Washington, D.C., May.
12. U.S. Department of Energy, 1994, *Multi-Purpose Canister System*, DOE/RW-0426, Office of Civilian Radioactive Waste Management (OCRWM) Information Center, Washington, D.C., October.
13. U.S. Department of Energy, 1993, *Safety of Shipments of Plutonium by Sea*, DOE/EM-0103, and *Implementation Plan for the Recommendations in the Safety of Shipments of Plutonium by Sea Study*, DOE/EM-0170, Washington, D.C., September.
14. U.S. Department of Energy, 1992, *Transportation of Spent Nuclear Fuel*, DOE/RW-0356, OCRWM Information Center, Washington, D.C.
15. U.S. Department of Energy, 1989, *Transporting Radioactive Material...Answers to Your Questions*, DOE/DP-0064, Washington, D.C., August.
16. U.S. Department of Transportation, 1998, *Guidelines for Public Sector Hazardous Materials Training*, Hazardous Materials Emergency Preparedness Grant Program, Washington, D.C., March.
17. U.S. Department of Transportation, 2000, *2000 Emergency Response Guidebook — A Guidebook for First Responders during the Initial Phase of a Dangerous Goods/Hazardous Materials Incident*, RSPA P 5800.8, triennial publication, Research and Special Programs Administration, Washington, D.C.
18. U.S. Department of Transportation, 1983, *A Review of the Department of Transportation Regulations for Transportation of Radioactive Materials*, Washington, D.C.
19. U.S. Department of Transportation, 1998, *Radioactive Material Regulations Review*, RAMREG-001-98, Research and Special Programs Administration, Washington, D.C.
20. Eckerman, K.F. and A.W. Carriker, 1992, *Response of Radiation Monitoring Instruments to Normalized Risk Quantities of Radionuclides*, SNL 89-7057, Sandia National Laboratories, Albuquerque, N.M.

21. U.S. Environmental Protection Agency, 1992, *Manual of Protective Action Guides and Protective Actions for Nuclear Incidents*, EPA 400-R-92-001, Office of Radiation Programs, Washington, D.C., May.
22. U.S. Environmental Protection Agency, *Comprehensive Environmental Response, Compensation, and Liability Act of 1980 (Superfund)*, as amended by the *Superfund Amendments and Reauthorization Act of 1986*, PL 99-499, Washington, D.C.
23. U.S. Environmental Protection Agency, 1986, *Title III (Emergency Planning and Community Right-To-Know) of the Superfund Amendments and Reauthorization Act (SARA) of 1986*, PL 99-499, Washington, D.C., October 17.
24. Executive Office of the President, 1994, *Government-to-Government Relations with Native American Tribal Governments*, memorandum for the Heads of Executive Departments and Agencies, issued April 29; published in FR, Volume 39, Number 85, page 22951, May 4.
25. Federal Emergency Management Agency, 1998, *American Indian and Alaska Native Policy of the Federal Emergency Management Agency*, Washington, D.C., September.
26. Federal Emergency Management Agency, *Catalog of Activities*, annual publication of the Emergency Management Institute, Washington, D.C.
27. Federal Emergency Management Agency, 1996, *Emergency Alert System*, Interim Use, CPG 1-40, Washington, D.C., June.
28. Federal Emergency Management Agency, 1996, *Emergency Alert System: A Program Guide for State and Local Jurisdictions*, Interim Use, CPG 1-41, Washington, D.C., June.
29. Federal Emergency Management Agency, 1996, *Federal Radiological Emergency Response Plan*, Washington, D.C., May 1.
30. Federal Emergency Management Agency, 1992, *The Federal Response Plan*, PL 93-288 (as amended), Washington, D.C., April.
31. Federal Emergency Management Agency, 1996, *Guide for All-Hazard Emergency Operations Planning*, State and Local Guide (SLG) 101, Washington, D.C., September.
32. U.S. Department of Transportation, 1994, *Federal Hazardous Material Transportation Law*, 49 USC 5101 et seq., Washington, D.C., October.
33. U.S. Department of Health and Human Services, Food and Drug Administration, 1998, *Accidental Radioactive Contamination of Human Food and Animal Feeds: Recommendations for State and Local Agencies*, Washington, D.C., August.
34. Indiana University, 1990, *Survey of State and Tribal Emergency Response Capabilities for Radiological Transportation Incidents*, NUREG/CR-5399, Bloomington, Ind., prepared for the U.S. Nuclear Regulatory Commission, Washington, D.C., February 6.

35. International Atomic Energy Agency, 1988, *Emergency Response Planning and Preparedness for Transportation Accidents Involving Radioactive Materials*, Safety Series Number 87, STI/PUB/773, Vienna, Austria.
36. International Atomic Energy Agency, 1990, *Regulations for the Safe Transport of Radioactive Material*, Safety Series Number 6, STI/PUB/866, 1985 Edition (amended 1990), Vienna, Austria.
37. National Conference of State Legislatures, 1980, *Radioactive Materials Transport*, TR/HM/RA, Issue Brief, Office of Science and Natural Resources, Denver, Colo., August.
38. National Council on Radiation Protection and Measurements, 1994, *Advising the Public About Radiation Emergencies*, NCRP Commentary Number 10, Bethesda, Md.
39. National Council on Radiation Protection and Measurements, 1980, *Management of Persons Accidentally Contaminated with Radionuclides*, NCRP Report Number 65, Washington, D.C.
40. National Fire Protection Association, 1997, *Recommended Practice for Responding to Hazardous Materials Incidents*, NFPA 471, Quincy, Mass. June.
41. National Fire Protection Association, 1992, *Standard for Competencies for EMS Responders to Hazardous Materials Incidents*, NFPA 473, Quincy, Mass. April.
42. National Fire Protection Association, 1994, *Standard for Professional Competence of Responders to Hazardous Materials Incidents*, NFPA 472, Quincy, Mass. June.
43. National Response Team, 1988, *Criteria for Review of Hazardous Materials Emergency Plans*, NRT-1A (available from the Federal Emergency Management Agency), Washington, D.C., May.
44. National Response Team, 1990, *Developing a Hazardous Materials Exercise Program — A Handbook for State and Local Officials*, NRT-2 (available from the U.S. Environmental Protection Agency), Washington, D.C., September.
45. National Response Team, 1987, *Hazardous Materials Emergency Planning Guide*, NRT-1 (available from the U.S. Environmental Protection Agency), March.
46. National Response Team, 1998, *Integrated Contingency Plan (ICP) Guidance* (available from the U.S. Environmental Protection Agency), Washington, D.C. April.
47. National Transportation Safety Board, 1979, *Special Investigation Report: On-Scene Coordination Among Agencies at Hazardous Materials Accidents*, NTSB-HZM-79-3, Washington, D.C.

48. U.S. Nuclear Regulatory Commission, 1992, *Emergency Response to a Highway Accident in Springfield, Massachusetts on December 16, 1991*, NUREG-1458, Washington, D.C., June.
49. U.S. Nuclear Regulatory Commission, 1977, *Final Environmental Statement on the Transportation of Radioactive Material by Air and Other Modes*, NUREG-0170, Volumes 1 and 2, Washington, D.C.
50. U.S. Nuclear Regulatory Commission, 1974, *Guide and Checklist for Development and Evaluation of State and Local Government Radiological Emergency Response Plans in Support of Fixed Nuclear Facilities*, NUREG-75/111, Revision 1, Washington, D.C., December.
51. U.S. Nuclear Regulatory Commission, 1985, *A Highway Accident Involving Radiopharmaceuticals Near Brookhaven, Mississippi, on December, 3, 1983*, NUREG/CR-4035, UCRL-53587, Washington, D.C.
52. U.S. Nuclear Regulatory Commission, 1992, *A Highway Accident Involving Unirradiated Nuclear Fuel in Springfield, Massachusetts, on December 16, 1991*, NUREG/CR-5892, UCRL-ID-110638, Washington, D.C., June.
53. E.W. Belquist et al., 1998, *Minimum Detectable Concentrations with Typical Radiation Survey Instruments for Various Contaminants and Field Conditions*, NUREG-1507, prepared for U.S. Nuclear Regulatory Commission, Washington, D.C., June.
54. U.S. Nuclear Regulatory Commission, Annual Update, *Public Information Circular for Shipments of Irradiated Reactor Fuel*, NUREG/0725, Revision 11, Washington, D.C.
55. U.S. Nuclear Regulatory Commission, 1977, *Regulatory and Other Responsibilities as Related to Transportation Accidents*, NUREG-0179, Washington, D.C., June.
56. U.S. Nuclear Regulatory Commission, 1996, *Response Coordination Manual (RCM-96)*, NUREG/BR-0230, Washington, D.C., September.
57. U.S. Nuclear Regulatory Commission, 1996, *Response Technical Manual (RTM-96)*, NUREG/BR-0150, Volume 1, Revision 4, Washington, D.C., March.
58. U.S. Nuclear Regulatory Commission, 1979, *Review and Assessment of Package Requirements (Yellowcake) and Emergency Response to Transportation Accidents*, NUREG-0535, Washington, D.C., March.
59. U.S. Nuclear Regulatory Commission, 1987, *Shipping Container Response to Severe Highway and Railway Accidents*, NUREG/CR-4829, Washington, D.C., February. (Known as the "NRC Modal Study").

60. U.S. Nuclear Regulatory Commission, 1987, *Transporting Spent Fuel, Protection Provided Against Severe Highway and Railroad Accidents*, NUREG/BR-0111, Washington, D.C., March.
61. Oak Ridge Associated Universities, 1992, *Transport of Radioactive Materials — Q & A About Incident Response*, Oak Ridge, Tenn.
62. Office of Science and Technology Policy, 1986, *SI Metric Radiation Units, Report of the CIRRPC Policy Subpanel*, Executive Office of the President, Washington, D.C., December.
63. Sandia National Laboratories, 1980, *Transportation of Radionuclides in Urban Environs: Draft Environmental Assessment*, NUREG/CR-0743, SAND79-0369, Albuquerque, N.M., prepared for the U.S. Nuclear Regulatory Commission, Washington, D.C.
64. Southern States Energy Board, 1999, *Southern Mutual Radiation Assistance Plan*, Norcross, Ga., November.
65. Southern States Energy Board, 1999, *Transportation Planning Guide for U.S. Department of Energy's Shipments of Transuranic Waste*, Norcross, Ga., October.
66. State Planning Council on Radioactive Waste Management, 1981, *Report to the State Planning Council on Radioactive Waste Management*, Washington, D.C.
67. U.S. Fire Administration, biennial publication, *Catalog of Courses National Fire Academy*, available from Federal Emergency Management Agency, Washington, D.C.
68. U.S. Fire Administration, annual publication, *Off-Campus Delivery Schedule for Training Courses of the National Fire Academy*, available from Federal Emergency Management Agency, Washington, D.C.
69. Western Governors' Association, 1998, *WIPP Transportation Safety Program Implementation Guide*, Denver, Colo., May.
70. Western Interstate Nuclear Board and Regional Training Committee, 1975, *Guide and Example Plan for Development of State Emergency Response Plans and Systems for Transportation-Related Radiation Incidents*, Region VIII, Denver, Colo.
71. Shleien, B., 1983, *Preparedness and Response in Radiation Accidents*, FDA 83-8211, U.S. Department of Health and Human Services, Food and Drug Administration, HFZ-25, Rockville, Md., August.
72. International Commission on Radiation Units and Measurements, 1980, Report Number 33, *Radiation Quantities and Units*, Bethesda, Md. April 15.
73. Fire School of California, 1999, *Fire Service Field Operation Guide*, ICS420-1, Fairfield, Ca, April.

74. Federal Emergency Management Agency, 1999, *Incident Command System Self-Study Unit*, FEMA/US Fire Administration/National Fire Academy/ICS:SS, Washington, D.C., January.
75. American National Standards Institute, 1995, *Uranium Hexafluoride — Packaging For Transport*, N14.1-1995, New York, N.Y.
76. U.S. Nuclear Regulatory Commission, 1990, Information Notice 90-27, *Clarification of Recent Revisions to the Regulatory Requirements for Packaging of Uranium Hexafluoride (UF₆) for Transportation*, Washington, D.C., April 30.
77. United States Enrichment Corporation, 1997, *Uranium Hexafluoride — A Manual of Good Handling Practices*, Revision 8, USEC-651, Bethesda, Md.
78. U.S. Nuclear Regulatory Commission, 1997, NUREG-1575, *Multi-Agency Radiation Site Survey and Investigational Manual (MARSSIM)*, Washington D.C., December.
79. U.S. Postal Service, 1999, Publication Number 52, *Acceptance of Hazardous, Restricted, and Perishable Mail*, Washington D.C., July.
80. Berkovitz, D.M., 1989, *Price-Anderson Act: Model Compensation Legislation? — The Sixty-Three Million Dollar Question*, Harvard Environmental Law Review, Volume 13 (Number 1), page 1.
81. McNett, J.F. 1989, *Nuclear Indemnity for Government Contractors under the Price-Anderson Act: 1988 Amendments*, Government Contracts Law Journal, Volume 1, page 1, Winter.
82. McNett, J.F., 1983, *Nuclear Indemnity for Government Contractors under the Price-Anderson Act*, Public Contracts Law Journal, Volume 14, page 40.
83. U.S. Department of Energy, 1999, *Price-Anderson Act Report to Congress*, March (available at www.gc.doe.gov).
84. U.S. Nuclear Regulatory Commission, 1998, *The Price-Anderson Act — Crossing the Bridge to the Next Century: A Report to Congress*, NUREG/CR-6617 (available at <http://www.nrc.gov/NRC/NUREGS/indexnum.html>).
85. The Price-Anderson Amendments Act, 1988, PL 100-408, 102 Statute 1066, amending Atomic Energy Act, 42 USC §2011 *et seq.*
86. U.S. Code Congressional & Administrative News, 1966, Senate Report No. 1605, 89th Congress, 2d Session, 3201 and 3206
87. U.S. Code Congressional & Administrative News, 1987, House of Representatives, Report No. 104, 100th Congress, 1st Session, Part I at 29.

88. Monsanto Research Corporation, 1975, 1976, 1977, *Certification of ERDA Contractor' Packaging With Respect to Compliance with DOT Specification 7A Performance Requirements*, MLM-2228, Mound Laboratory, Miamisburg, Ohio, prepared for U.S. Department of Energy, Washington, D.C.
89. U.S. Department of Transportation, 1989/1990, *Emergency Response Information Requirements*, Docket HM-126C, Final Rule, 54 FR 27138 (June 27, 1989), 55 FR 870 (January 10, 1990), Research and Special Programs Administration, Washington, D.C.
90. International Atomic Energy Agency, 1996, Safety Series Number ST-1, *Regulations for the Safe Transport of Radioactive Material*, STI/PUB/998, Vienna, Austria.

O.2 Useful References

O.2.1 Statutes

91. U.S. Department of Transportation, 1975, PL 96-633, Title I, *Hazardous Materials Transportation Act*, 49 USC 1801-1812, January 3.
92. U.S. Department of Transportation, 1990, PL 101-615, *Hazardous Materials Transportation Uniform Safety Act of 1990*, 49 USC 1801-1819, December.
93. U.S. Department of Transportation, 1994, PL 103-311, *Hazardous Materials Transportation Authorization Act of 1994*, August 26.
94. Atomic Energy Commission, 1954, Atomic Energy Act (as amended), 42 USC Chapter 23 and Energy Reorganization Act of 1974 (as amended), 42 USC 5841, Section 301.

O.2.2 Regulations

95. U.S. Department of Transportation, 1999, *Hazardous Materials Regulations*, 49 CFR, Subchapter C, §171-178.
96. U.S. Nuclear Regulatory Commission, *Packaging and Transportation of Radioactive Material*, 10 CFR, Part 71.
97. U.S. Department of Transportation, Office of Motor Carrier Safety, Federal Motor Carrier Safety Regulations, 1999, 49 CFR, §383 and §390-397.
98. U.S. Department of Transportation and U.S. Nuclear Regulatory Commission, 1979, *Transportation of Radioactive Materials; Memorandum of Understanding*, 44 FR 38690, July 2.
99. U.S. Postal Service, 1990, Publication Number 6, Washington D.C., March.

100. International Civil Aviation Organization, *Technical Instructions for the Safe Transport of Dangerous Goods by Air*, 1999–2000 Edition, Montreal, Quebec, Canada.
101. International Maritime Organization, 1994, *International Maritime Dangerous Goods (IMDG) Code*, IMO Secretariat, London, England.
102. International Air Transport Association, 1999, *Dangerous Goods Regulations*, 40th Edition, Montreal, Quebec, Canada.
103. Airline Publishing Company, *Official Air Transport Restricted Articles Tariff Number 6-D and Air Transport Restricted Articles Circular 6-D*, Washington, D.C.
104. Association of American Railroads and Bureau of Explosives, *Hazardous Materials Regulations of the Department of Transportation, Including Specifications for Shipping Containers*, Sewickley, Penn.
105. American Trucking Association, *Hazmat Transport Regulations, Department of Transportation Regulations for Governing Transportation of Hazardous Materials by Air, Motor, Rail, and Water, Including Specifications for Shipping Containers*, Alexandria, Va.
106. Bureau of National Affairs, monthly update service for: *Chemical Regulation Reporter and Hazardous Materials Transportation*, Rockville, Md.
107. U.S. Nuclear Regulatory Commission, 1995, *Policy and Procedure for Enforcement Actions; Removal*, 10 CFR §2, 60 FR 34380, Office of Enforcement, Washington, D.C., June 30.
108. U.S. Department of Transportation, 1995, *Hazardous Materials; Transportation Regulations; Compatibility with Regulations of the International Atomic Energy Agency; Final Rule*, 60 FR 50292, Docket HM-169A, Research and Special Programs Administration, September 28.

O.2.3 Guidelines and Safety Standards

American National Standards Institute

109. American National Standards Institute, 1972, ANSI N13.5, *Performance Specifications for Direct Reading and Indirect Reading Pocket Dosimeters for X- and Gamma Radiation*, New York, N.Y.
110. American National Standards Institute, 1983 (revised 1993), ANSI N13.11, *Personnel Dosimetry Performance — Criteria for Testing*, New York, N.Y.
111. American National Standards Institute, 1981, ANSI N13.27, *Performance Specifications for Pocket-Sized Alarming Dosimeters/Ratemeters*, New York, N.Y.

112. American National Standards Institute, 1977, ANSI N322, *Inspection and Test Specifications for Direct and Indirect Reading Quartz Fiber Pocket Dosimeters*, New York, N.Y.
113. American National Standards Institute, 1969, ANSI N13.2, *Administrative Practices in Radiation Monitoring (A Guide for Management)*, New York, N.Y.
114. American National Standards Institute, 1973, ANSI N14.10, *Administrative Guide for Packaging and Transporting Radioactive Materials*, New York, N.Y.
115. American National Standards Institute, 1987, ANSI N14.5, *Leakage Tests on Packages for Shipment of Radioactive Materials*, New York, N.Y.
116. American National Standards Institute, 1994, ANSI N42.12, *Calibration and Usage of Sodium Iodide Detector Systems*, New York, N.Y.
117. American National Standards Institute, 1989, ANSI N42.17A, *Performance Specifications for Health Physics Instrumentation — Portable Instrumentation for Use in Normal Environmental Conditions*, New York, N.Y.
118. American National Standards Institute, 1997, ANSI N323A, *Radiation Protection Instrumentation Test and Calibration, Portable Survey Instruments*, New York, N.Y.

International Atomic Energy Agency

International Atomic Energy Agency safety standards and guides on transport of radioactive material, published by IAEA, Vienna, Austria:

119. International Atomic Energy Agency, 1985/1990, Safety Series Number 7, *Explanatory Material for the IAEA Regulations for the Safe Transport of Radioactive Material*, 1985 Edition and Second Edition (amended 1990), STI/PUB/867, Vienna, Austria.
120. International Atomic Energy Agency, 1985/1990, Safety Series Number 37, *Advisory Material for the IAEA Regulations for the Safe Transport of Radioactive Material*, 1985 Edition and Third Edition (amended 1990). STI/PUB/868, Vienna, Austria.
121. International Atomic Energy Agency, 1990, Safety Series Number 80, *Schedule of Requirements for the Transport of Specified Types of Radioactive Material Consignments* (amended 1990), STI/PUB/869, Vienna, Austria.
122. International Atomic Energy Agency, 1996, Safety Series Number 115, *International Basic Standards For Protection Against Ionizing Radiation and for the Safety of Radiation*, STI/PUB/996, Vienna, Austria.
123. International Atomic Energy Agency, 1994, Safety Series Number 112, *Compliance Assurance for the Safe Transport of Radioactive Material*, STI/PUB/953, Vienna, Austria.

124. International Atomic Energy Agency, 1994, Safety Series Number 113, *Quality Assurance for the Safe Transport of Radioactive Material*, STI/PUB/958.
125. International Atomic Energy Agency, 1990, Safety Series Number 104, *Extension of the Principles of Radiation Protection to Sources of Potential Exposure*, STI/PUB/834, Vienna, Austria.
126. International Atomic Energy Agency, 1996, Safety Series Number 115, *International Basic Safety Standards for Protection Against Ionizing Radiation and for the Safety of Radiation Sources: A Safety Standard*, STI/PUB/996, Vienna, Austria.
127. International Atomic Energy Agency, 1986, Safety Series Number 81, *Derived Intervention Levels for Application in Controlling Radiation Doses to the Public in the Event of a Nuclear Accident or Radiological Emergency: Principles, Procedures and Data*, STI/PUB/751, Vienna, Austria.
128. International Atomic Energy Agency, 1989, Safety Series Number 91, *Emergency Planning and Preparedness for Accidents Involving Radioactive Materials Used in Medicine, Industry, Research and Teaching*, STI/PUB/804, Vienna, Austria.
129. International Atomic Energy Agency, 1985, Safety Series Number 73, *Emergency Preparedness Exercises for Nuclear Facilities: Preparation, Conduct and Evaluation*, STI/PUB/709, Vienna, Austria.
130. International Atomic Energy Agency, 1988, Safety Series Number 88, *Medical Handling of Accidentally Exposed Individuals*, STI/PUB/771, Vienna, Austria.
131. International Atomic Energy Agency, 1996, Safety Series Number 114, *Direct Methods for Measuring Radionuclides in the Human Body: A Safety Practice*, STI/PUB/993, Vienna, Austria.
132. International Atomic Energy Agency, 1998, Safety Report Series Number 2, *Diagnosis and Treatment of Radiation Injuries*, STI/PUB/1040, Vienna, Austria.
133. International Atomic Energy Agency, 1998, Safety Report Series Number 4, *Planning the Medical Response to Radiological Accidents*, STI/PUB/1055, Vienna, Austria.
134. International Atomic Energy Agency, 1998, Safety Report Series Number 5, *Health Surveillance of Persons Occupationally Exposed to Ionizing Radiation: Guidance for Occupational Physicians*, STI/PUB/1056, Vienna, Austria.
135. International Atomic Energy Agency, 1994, Technical Reports Series Number 363, *Guidelines for Agricultural Countermeasures Following an Accidental Release of Radionuclides*, STI/DOC/010/363, Vienna, Austria.

136. International Atomic Energy Agency, 1989, Technical Report Series Number 295, *Measurement of Radionuclides in Food and the Environment: A Guidebook*, STI/DOC/10/295, Vienna, Austria.
137. International Atomic Energy Agency, 1997, Technical Reports Series Number 383. *Characterization of Radioactive Waste Forms and Packages*, STI/DOC/010/383, Vienna, Austria.
138. International Atomic Energy Agency, 1982, IAEA-TECDOC-262, *Emergency Response Planning for Transport Accidents Involving Radioactive Material*, Vienna, Austria.
139. International Atomic Energy Agency, 1989, *Recovery Operations in the Event of a Nuclear Accident or Radiological Emergency Proceedings Series*, STI/PUB/826, Vienna, Austria.
140. International Atomic Energy Agency, 1990, Training Course Series Number 1, *Safe Transport of Radioactive Material*, IAEA-TCS-1, Vienna, Austria.
141. International Atomic Energy Agency, 1994, Safety Series Nos. 6, 7, 37, and 80, *HYPERTRANS! A Hypertext Guide to the IAEA Transport Regulations*, STI/PUB/DAT/1, Vienna, Austria.

U.S. Department of Transportation

142. U.S. Department of Transportation, 1983, *A Review of the Department of Transportation Regulations for Transportation of Radioactive Material* (Revised), Research and Special Programs Administration, Washington, D.C.
143. U.S. Department of Transportation, 1991, *Hazardous Materials Transportation Guides*, Research and Special Programs Administration, Washington, D.C., Revised February.
144. U.S. Department of Transportation, 1988, *A Guide for the Inspection of Radioactive Materials Shipments by Motor Vehicle or at Freight Facilities*, Research and Special Programs Administration, Washington, D.C., November.
145. U.S. Department of Transportation, 1988, *A Guide for the Inspection of Spent Nuclear Fuel Shipments by Motor Vehicle*, Research and Special Programs Administration, Washington, D.C., November.
146. U.S. Department of Transportation, 1993, *Hazardous Materials Training Modules: Compliance and Enforcement, How To Use the Hazardous Materials Regulations*, Research and Special Programs Administration, Washington, D.C.
147. U.S. Department of Transportation, 1994, *Regulatory Guidance for the Federal Motor Carrier Safety Regulations; Questions and Answers*, FHWA-MC-94-009, Federal Highway Administration (elaborates on guidance and interpretations published on November 17, 1993, in 58 FR 60734, Number 220.)

148. U.S. Department of Transportation, 1992, *Training — It's The Law*, RSPA/OHMIT/92-06, Research and Special Programs Administration, Office of Hazardous Materials Initiatives and Training, Washington, D.C., October.
149. U.S. Department of Transportation, 1992/1993, *Training for Safe Transportation of Hazardous Materials*, Docket HM-126F, Final Rule, 57 FR 20994 (May 15, 1993), 57 FR 22181, (May 27, 1992), 59 FR 20994 (January 22, 1993), Research and Special Programs Administration, Washington, D.C.
150. U.S. Department of Transportation, 1992, *Hazardous Materials Transportation; Registration and Fee Assessment Program*, Docket HM-208, Final Rule, 57 FR 30620, Washington, D.C., July 9.
151. U.S. Department of Transportation, 1995, *Hazardous Materials Regulations; Penalty Guidelines*, Docket HM-207D, Final Rule, 60 FR 12139, Research and Special Programs Administration, Washington, D.C., March 6.

U.S. Environmental Protection Agency

152. U.S. Environmental Protection Agency, 1987, *Radiation Protection Guidance to Federal Agencies for Occupational Exposure: Recommendations Approved By the President*, 52 FR 2822, Washington, D.C., January 27.
153. U.S. Environmental Protection Agency, 1988, *Limiting Values of Radionuclide Intake and Air Concentration and Dose Conversion Factors for Inhalation, Submersion, and Ingestion*, Report Number 11, 520/1-88-020, Washington, D.C., September.
154. U.S. Environmental Protection Agency, 1993, *Radiation: Risk and Realities*, 402-K-92-004, Washington, D.C., August.
155. U.S. Environmental Protection Agency, 1993, *External Exposure to Radionuclides in Air, Water, and Soil*, Report Number 12, 402-R-93-081, Washington, D.C., September.
156. U.S. Environmental Protection Agency, 1996, *Technology Screening Guide for Radioactively Contaminated Sites*, 402-R-96-017, November.
157. U.S. Environmental Protection Agency, 1999, *Cancer Risk Coefficient for Environmental Exposure to Radionuclides*, 402-R-99-001, Federal Guidance Report Number 13, Washington, D.C., September.

U.S. Nuclear Regulatory Commission — Regulatory Guides

U.S. Nuclear Regulatory Commission regulatory guides on transport of radioactive material, published by NRC, Division 7, Transportation, Washington D.C.:

158. U.S. Nuclear Regulatory Commission, *Directory of Certificates of Compliance for Radioactive Materials Packages*, NUREG-0383, Issued each year in October as three volumes:
 - Volume 1: *Report of NRC-Approved Packages*
 - Volume 2: *Certificates of Compliance*
 - Volume 3: *Report of NRC-Approved Quality Assurance Programs for Radioactive Materials Packages*
159. U.S. Nuclear Regulatory Commission and U.S. Department of Transportation, 1998, *Categorizing and Transporting Low-Specific-Activity Materials and Surface Contaminated Objects*, NUREG-1608, NRC Office of Nuclear Material Safety and Safeguards, DOT Research and Special Programs Administration, Washington, D.C. July.
160. U.S. Nuclear Regulatory Commission, 1974, Regulatory Guide 7.1, *Administrative Guide for Packaging and Transporting Radioactive Material*, Washington D.C., June.
161. U.S. Nuclear Regulatory Commission, 1972, Regulatory Guide 7.2, *Packaging and Transportation of Radioactively Contaminated Biological Materials*, Washington D.C., June.
162. U.S. Nuclear Regulatory Commission, 1975, Regulatory Guide 7.3, *Procedures for Picking Up and Receiving Packages of Radioactive Material*, Washington D.C., May.
163. U.S. Nuclear Regulatory Commission, 1977, Regulatory Guide 7.4, *Leakage Tests on Packages for Shipment of Radioactive Material*, Washington D.C., May.
164. U.S. Nuclear Regulatory Commission, 1978, Regulatory Guide 7.6, *Design Criteria for Structural Analysis of Shipping Cask Containment Systems*, Washington D.C., March.
165. U.S. Nuclear Regulatory Commission, 1977, Regulatory Guide 7.7, *Administrative Guide for Verifying Compliance with Packaging Requirements for Shipments of Radioactive Materials*, Washington D.C., August (for comment).
166. U.S. Nuclear Regulatory Commission, 1989, Regulatory Guide 7.8, *Load Combinations for the Structural Analysis of Shipping Casks*, Washington D.C., March.
167. U.S. Nuclear Regulatory Commission, 1980, Regulatory Guide 7.9, *Standard Format and Content of § 71 Applications for Approval of Packaging of Type B and Large Quantity, and Fissile Radioactive Material*, Washington D.C., January.

168. U.S. Nuclear Regulatory Commission, 1986, Regulatory Guide 7.10, *Revision 2, Establishing Quality Assurance Programs for Packaging Used in the Transport of Radioactive Material*, Washington D.C., June.
169. U.S. Nuclear Regulatory Commission, 1991, Regulatory Guide 7.11, *Fracture Toughness Criteria of Base Material for Ferritic Steel Shipping Cask Containment Vessels with a Maximum Wall Thickness of 4 Inches (0.1 m)*, Washington D.C., June.
170. U.S. Nuclear Regulatory Commission, 1991, Regulatory Guide 7.12, *Fracture Toughness Criteria of Base Material for Ferritic Steel Shipping Cask Containment Vessels with a Wall Thickness Greater Than 4 Inches (0.1 m), but Not Exceeding 12 Inches (0.3 m)*, Washington D.C., June.
171. U.S. Nuclear Regulatory Commission, 1981, Regulatory Guide 8.28, *Audible-Alarm Dosimeters*, Washington D.C.
172. U.S. Nuclear Regulatory Commission, 1973, Regulatory Guide 8.4, *Direct-Reading and Indirect-Reading Pocket Dosimeters*, Washington D.C.

U.S. Nuclear Regulatory Commission — Information Notices and Bulletins

173. U.S. Nuclear Regulatory Commission, 1995, Bulletin 95-01, *Quality Assurance Program for Transportation of Radioactive Material*, Washington, D.C., January 13.
174. U.S. Nuclear Regulatory Commission, 1993, Information Notice 93-07, *Classification of Transportation Emergencies*, Washington, D.C., February 1.
175. U.S. Nuclear Regulatory Commission, 1993, Information Notice 93-05, *Locking of Radiography Devices*, Washington, D.C., January 14.
176. U.S. Nuclear Regulatory Commission, 1992, Information Notice 92-71, *Employee Training and Shipper Registration Requirements for Transporting Radioactive Materials*, Washington, D.C., October 28.
177. U.S. Nuclear Regulatory Commission, 1991, Information Notice 91-35, *Labeling Requirements For Transporting Multi-Hazard Radioactive Materials*, Washington, D.C., June 7.
178. U.S. Nuclear Regulatory Commission, 1990, Information Notice 90-82, *Requirements For Use of Nuclear Regulatory Commission (NRC) Approved Transport Packages For Shipment of Type A Quantities of Radioactive Material*, Washington, D.C., December 31.
179. U.S. Nuclear Regulatory Commission, 1990, Information Notice 90-66, *Incomplete Draining and Drying of Shipping Casks*, Washington, D.C., October 25.

180. U.S. Nuclear Regulatory Commission, 1990, Information Notice 90-56, *Inadvertent Shipment of a Radioactive Source In A Container Thought To Be Empty*, Washington, D.C., September 4.
181. U.S. Nuclear Regulatory Commission, 1990, Information Notice 90-35, *Transportation of Type A Quantities of Nonfissile Radioactive Materials*, Washington, D.C., May 24.
182. U.S. Nuclear Regulatory Commission, 1989, Information Notice 89-74, *Clarification of Transportation Requirements Applicable To Return of Spent Radiopharmacy Dosages From Users To Suppliers*, Washington, D.C., November 7.
183. U.S. Nuclear Regulatory Commission, 1988, Information Notice 88-101, *Shipment of Contaminated Equipment Between Nuclear Power Stations*, Washington, D.C., December 28.
184. U.S. Nuclear Regulatory Commission, 1988, Information Notice 88-33, *Recent Problems Involving The Model Spec 2-T Radiographic Exposure Device*, Washington, D.C., May 27.
185. U.S. Nuclear Regulatory Commission, 1987, Information Notice 87-47, *Transportation of Radiographic Devices*, Washington, D.C., October 5.
186. U.S. Nuclear Regulatory Commission, 1987, Information Notice 87-31, *Blocking, Bracing and Securing of Radioactive Material Packages In Transportation*, Washington, D.C., July 18.
187. U.S. Nuclear Regulatory Commission, 1986, Information Notice 86-67, *Portable Moisture/Density Gauges: Recent Incidents and Common Violations of Requirements for Use, Transportation and Storage*, Washington, D.C., August 15.
188. U.S. Nuclear Regulatory Commission, 1985, Information Notice 85-46, *Clarification of Several Aspects of Removable Radioactive Surface Contamination Limits For Transport Packages*, Washington, D.C., June 18.
189. U.S. Nuclear Regulatory Commission, 1984, Information Notice 84-14, *Highlights of Recent Transport Regulatory Revisions By DOT and NRC*, Washington, D.C., March 2.
190. U.S. Nuclear Regulatory Commission, 1982, Information Notice 80-32 (Revision 1), *Clarification of Certain Requirements For Exclusive Use Shipments of Radioactive Materials*, Washington, D.C., February 12.
191. U.S. Nuclear Regulatory Commission, 1980, Information Notice 80-32, *Clarification of Certain Requirements For Exclusive-Use Shipments of Radioactive Material*, Washington, D.C., August 29.

192. U.S. Nuclear Regulatory Commission, 1988, Bulletin 88-06, *Actions To Be Taken For The Transportation of Model Spec 2-T Radiographic Exposure Device*, Washington, D.C., June 14.
193. U.S. Nuclear Regulatory Commission, 1979, Bulletin 79-19, *Packaging of Low-Level Waste for Transport*, Washington, D.C., August 10.
194. U.S. Nuclear Regulatory Commission, 1994, Bulletin 94-02, *Corrosion Problems in Certain Stainless Steel Packagings Used To Transport Uranium Hexafluoride*, Washington, D.C., November 14.
195. U.S. Nuclear Regulatory Commission, Office of Enforcement, 1995, 10 CFR §2, *Policy and Procedure for Enforcement Actions: Removal*, 60 FR 34380, June 30.

O.2.4 Reports and Publications

Conference of Radiation Control Program Directors

196. Conference of Radiation Control Program Directors, 1985, Publication 85-4, *Ionizing Radiation Measurement Criteria for Regulatory Purposes*, Second Edition, prepared by the Committee on Radiation Measurements, Frankfort, Ky., December.
197. Conference of Radiation Control Program Directors, 1999, Publication 99-3, *Directory of State and Federal Agencies Involved with the Transportation of Radioactive Material with Notes on Their Statutory Authority and Regulations*, Frankfort, Ky., October.
198. Conference of Radiation Control Program Directors, 1998, Publication 98-6, *Radiological Health Risks from Transportation of Radioactive Materials*, Frankfort, Ky., November.
199. Conference of Radiation Control Program Directors, 1998, Publication 98-3, *Detection and Prevention of Radioactive Contamination in Solid Waste Facilities*, developed by the Committee on Resource Recovery and Radioactivity (E-23), Frankfort, Ky., March.

National Bureau of Standards

200. National Bureau of Standards and Conference of Radiation Control Program Directors, 1988, GCR 88-539, *Directory of Calibration Services for Ionizing Radiation Survey Instruments*, prepared for U.S. Department of Commerce, January.
201. National Bureau of Standards, 1979, GCR 79-174, *Ionizing Radiation Measurement Criteria for Regulatory Purposes*, U.S. Department of Commerce, November.

National Council on Radiation Protection and Measurements

202. National Council on Radiation Protection and Measurements, 1976, Report Number 50, *Environmental Radiation Measurements*, Bethesda, Md.

203. National Council on Radiation Protection and Measurements, 1980, Report Number 65, *Management of Persons Accidentally Contaminated with Radionuclides*, Washington, D.C.
204. National Council on Radiation Protection and Measurements, 1978, Report Number 59, *Operational Radiation Safety Program*, Washington, D.C.
205. National Council on Radiation Protection and Measurements, 1980, Report Number 33, *Radiation Quantities and Units*, Washington, D.C.
206. National Council on Radiation Protection and Measurements, 1978, Report Number 57, *Instrumentation and Monitoring Methods for Radiation Protection*, Washington, D.C.
207. National Council on Radiation Protection and Measurements, 1985, Report Number 58, *A Handbook of Radioactivity Measurement Procedures*, Washington, D.C., Second Edition.

U.S. Department of Energy

208. U.S. Department of Energy, 1989, *Transporting Radioactive Material...Answers To Your Questions*, Transportation Management Division, Washington, D.C., August.
209. U.S. Department of Energy, 1989, *Emergency Preparedness for Transportation Incidents Involving Radioactive Material*, SAIC-89/135, Transportation Management Division, Washington, D.C., May.
210. U.S. Department of Energy, 1993, DOE Order 5400.5, *Radiation Protection of the Public and the Environment*, Washington, D.C., January 7.
211. U.S. Department of Energy, 1988, DOE/EH-0071, *Internal Dose Conversion Factors for Calculation of Dose to the Public*, Washington, D.C., July.
212. U.S. Department of Energy, 1988, DOE/EH-0070, *External Dose Conversion Factors for Calculation of Dose to the Public*, Washington, D.C., July.

O.2.5 Videos

213. Conference of Radiation Control Program Directors, 1998, Publication 98-4, *Dealing with Stray Radioactive Material*, June. (Video providing guidance to operators of municipal waste or scrap recycling facilities on the detection of radioactivity in shipments of waste and scrap and to those who assess and dispose of discovered radioactive material.)
214. Conference of Radiation Control Program Directors, 1995, Publication 95-5, *First Response to Transportation Accidents Involving Radioactive Materials*, guidance video prepared by the Committee on Emergency Response Planning, December.

215. Conference of Radiation Control Program Directors, 1994, Publication 94-7, *Radiological Safety Inspection of Highway Vehicles Transporting LLRW [Radioactive Materials]*, video of the procedure recommended by the Committee on Radioactive Waste Management, February.

O.2.6 Miscellaneous References

216. Knoll, G. F., 1979, *Radiation Detection and Measurement*, John Wiley and Sons, New York, N.Y.
217. Wade, J.E., and G. E. Cunningham, 1967, *Radiation Monitoring: A Programmed Instruction Book*, Division of Technical Information, Oak Ridge National Laboratory, Oak Ridge, Tenn.
218. Westinghouse Hanford Company, 1990, *Test and Evaluation Document for DOT Specification 7A Type A Packaging*, DOE/WHC-EP-0558, Richland, Washington, prepared for the U.S. Department of Energy, Washington, D.C. (two revisions issued).
219. Monsanto Research Corporation, 1987, *DOE Evaluation Document for DOT-7A Type A Packaging*, MLM-3245, Mound Laboratory, Miamisburg, Ohio, prepared for the U.S. Department of Energy, Washington, D.C., March
220. Electric Power Research Institute, 1993, *Guidance on New DOT Training Requirements for Hazardous Materials Employees*, EPRI TR-102662, Palo Alto, Calif., July.
221. International Commission on Radiological Protection, 1984, Publication Number 40, *Protection of the Public in the Event of Major Radiation Accidents: Principles for Planning*, Pergamon Press, Oxford, England.
222. Moghissi, et al., 1986, *Radioactive Waste Technology*, Chapter 10, "Regulation of Nuclear Waste Transportation," published by American Society of Mechanical Engineers, New York, N.Y.
223. Schleien, B., et al., 1997, *The Health Physics and Radiological Health Handbook*, 3rd Edition, Chapter 14, "Nuclear Transportation Including Shipment of Low-Level Waste," published by Lippincott Williams and Wilkins, Hagerstown, Md. September.
224. Willis, C.A., 1989, *Health Physics Annotated Bibliography*, Chapter 16, "Transportation," published by the Baltimore-Washington Chapter of the Health Physics Society, Silver Spring, Md.
225. Gibson, R., 1966, *The Safe Transport of Radioactive Materials*, Pergamon Press, Oxford, England.

226. United Nations, *United Nations Recommendations on the Transport of Dangerous Goods*, 9th Revised Edition (1995), and *UN Recommendations on the Transport of Dangerous Goods, Tests and Criteria*, 2nd Edition (1995).
227. Association of American Railroads and Bureau of Explosives, 1997, *Emergency Action Guides*, Sewickley, Penn.
228. Association of American Railroads and Bureau of Explosives, 1998, *Emergency Handling of Hazardous Materials in Surface Transportation*, Sewickley, Penn.
229. Atomic Energy Act, 1997, Supplement III, 42 USC §§ 2011 *et seq.*
230. U.S. Code Congressional & Administrative News, 1957, Senate Report No. 296, 85th Congress, 1st Session, 1803 and 1818.
231. U.S. Nuclear Regulatory Commission, 1992, *Resources Available for Nuclear Power Plant Emergencies Under the Price-Anderson Act and the Robert T. Stafford Disaster Relief and Emergency Assistance Act*, NUREG-1457, Washington D.C., July.
232. Federal Emergency Management Agency, 1999, *Computer Assisted Instruction for Incident Command System, Self-Study Course*, CD ROM disk, Fire Academy, Washington, D.C.
233. National Fire Protection Association, 1999, *Emergency Services Incident Management System*, NFPA 1581, Quincy, Mass.
234. National Fire Protection Association, 1999, *Disaster Emergency Management*, NFPA 1600, Quincy, Mass.
235. International Fire Service Training Association, 1990, *Dispatcher's Medical Desk Reference Manual*, 2nd Edition, Stillwater, Ok.
236. International Fire Service Training Association, 1994, *Hazardous Materials for First Responders*, 2nd Edition, Stillwater, Ok.
237. International Fire Service Training Association, 1995, *Hazardous Materials Emergencies Involving Intermodal Containers: Guidelines and Procedures*, Stillwater, Ok.
238. International Fire Service Training Association, 1995, *Hazardous Materials: Managing the Incident*, 2nd Edition, Stillwater, Ok.
239. International Journal of Radioactive Materials Transport Volume, 8, Nos. 3-4, 1997, *Transport for the Nuclear Industry*, ISBN 1 870965 48 5, published by Nuclear Technology Publishing, Kent, England, October/November.
240. International Journal of Radioactive Materials Transport Volume, 2, Nos. 4-5, 1991, *Directory of Test Facilities for Radioactive Materials Transport Packages*, ISBN 1 870965 27 2, published by Nuclear Technology Publishing, Kent, England, March 1992.

241. International Journal of Radioactive Materials Transport, Volume 4, No. 2, 1993, *Nuclear Transport Systems*, ISBN 1 870965 34 5, published by Nuclear Technology Publishing, Kent, England, February 1994.
242. International Journal of Radioactive Materials Transport, Volume 2, Nos. 4-5, 1991, *Directory of Test Facilities for Radioactive Materials Transport Packages*, ISBN 1 870965 27 2, published by Nuclear Technology Publishing, Kent, England, March 1992.
243. International Journal of Radioactive Materials Transport, Volume 7, Nos. 2-3, 1996, *Radioactive Waste Packaging and Transport*, ISBN 1 870965 48 5, published by Nuclear Technology Publishing, Kent, England, August 1996.
244. International Journal of Radioactive Materials Transport, Volume 9, No. 2, 1998, *Sea Transport of Radioactive Materials*, ISBN 1 870965 50 7, published by Nuclear Technology Publishing, Kent, England, April 1998.
245. International Journal of Radioactive Materials Transport Volume 10, No. 2, 1999, *Radioactive Materials Transport Databases*, ISBN 1 870965 60 4, published by Nuclear Technology Publishing, Kent, England, April 1999.

Please let us know if there are other pertinent documents
for inclusion in either the Bibliography or Useful
References lists. Submit your contribution through:

Rules Docket Clerk

**FEMA, Room 840
500 C Street, SW
Washington, D.C. 20472**

This page is intentionally left blank.

APPENDIX P

Document Sources and Internet Websites

Section P.1 of this appendix provides contact information for agencies and private organizations that can provide guidance documents or other information related to transportation incidents/accidents involving radioactive and hazardous materials. Section P.2 contains the URLs of websites that provide additional information.

P.1 Document Sources

P.1.1 International Agencies

International Air Transport Association

IATA
800 Place Victoria
P.O. Box 113
Montréal, Québec H4Z 1M1 Canada
Phone: (514) 874-0202
Fax: (514) 874-9632

International Atomic Energy Agency publications are available for purchase from:

International Atomic Energy Agency
Vienna International Centre
Sales and Promotion Unit
Wagramerstrasse 5, Postfach 100
A-1400 Vienna, Austria
Phone: +43 (1) 2060 22529
Fax: +43 (1) 2060 29302

Bernan Associates
4611-F Assembly Drive
Lanham, MD 20706-1391
Phone: (800) 274-4447
Fax: (800) 865-3450

The Stationary Office Books
P.O. Box 276
London, SW8 5DT United Kingdom
Phone: +44 (0) 171 873 9090
Fax: +44 (0) 171 873 8200

International Civil Aviation Organization

International Civil Aviation Organization
Document Sales Unit, ICAO
999 University Street,
Montreal, Quebec H3C 5H7, Canada
Phone: (514) 954-8022
Fax: (514) 954-6769
E-mail: sales_unit@icao.org

International Maritime Organization

IMO Secretariat, Publication Section
4 Albert Embankment
London, England SE1 7SR
Phone: +44 (0)20 7735 7611
Fax: +44 (0)20 7587 3210
E-mail: info@imo.org

United Nations

United Nations Publications, Sales Section
2 United Nations Plaza, Room DC2-853, Department 1001
New York, NY 10017
Phone: (212) 963-8302
Fax: (212) 963-3489
E-mail: publications@un.org

P.1.2 Federal/State Agencies

Bureau of Explosives and Association of American Railroads

Bureau of Explosives Publications
P.O. Box 1020
Sewickley, PA 15143
Phone: (412) 741-1096
Fax: (412) 741-0609

Conference of Radiation Control Program Directors

CRCPD
Attn: Bettye Merriman
205 Capital Avenue
Frankfort, KY 40601
Phone: (502) 227-4543
Fax: (502) 227-7862
E-mail: cariganline@aol.com

Council of State Governments

Midwest High-Level Radioactive Waste Committee

P.O. Box 981
Sheboygan, WI 53082-0981
Phone: (920) 803-9976
Fax: (920) 803-9978
E-mail: isattler@csg.org

Eastern Regional Conference

Phillip Paull
P.O. Box 1028
Montpelier, VT 05601-1028
Phone: (802) 223-4841
Fax: (802) 229-2157
E-mail: paull@csg.org

Federal Emergency Management Agency

FEMA
P.O. Box 2012
Jessup, MD 20794-2012
Phone: (800) 480-2520
Fax: (301) 497-6378

Please include the title and quantity of each publication, along with your name, address, zip code, and daytime phone number.

Hazardous Materials Advisory Council

1101 Vermont Ave. NW, Suite 301
Washington, DC 20006
Phone: (202) 289-4550
Fax: (202) 289-4074

National Council on Radiation Protection and Measurements

NCRP
7910 Woodmont Ave., Suite 800
Bethesda, MD 20814-3095
Phone: (301) 657-2652
Fax: (301) 907-8768

National Technical Information Service

National Technical Information Service
Technology Administration
U.S. Department of Commerce
5285 Port Royal Rd
Springfield, VA 22161
Phone: (800) 553-NTIS (6847) or (703) 605-6050
Fax: (703) 605-6900

Southern States Energy Board

Southern States Energy Board
6325 Amherst Court
Norcross, GA 30092-3174
Phone: (770) 242-7712
Fax: (770) 242-0421

U.S. Department of Defense

Document Automation and Production Services

P.O. Box 3, Building 721
Naval Air Station
Jacksonville, FL 32212
Phone: (904) 542-3446

Defense Technical Information Center

8725 John J. Kingman Road, Suite 0944
Ft. Belvoir, VA 22060-6218
Phone: (800) 225-3842
E-mail: bcporder@dtic.mil

U.S. Department of Energy

U.S. Department of Energy, Forrestal Building, IE-206
1000 Independence Ave., SW
Washington, D.C. 20585
Phone: (202) 586-5575

U.S. Department of Transportation

Department of Transportation, Training Resources Department
400 7th Street, SW
Washington, D.C. 20590
Phone: (202) 366-4900 or
Phone: (202) 366-4425 (DOT library)

U.S. Environmental Protection Agency

U.S. Environmental Protection Agency
National Center for Environmental Publications and Information
P.O. Box 42419
Cincinnati, OH 45242
Phone: (800) 490-9198
Fax: (513) 489-8695

U.S. Government Printing Office

Superintendent of Documents
P.O. Box 37082
Washington, D.C. 20402-9328
Phone: 202-512-1800
Fax: 202-512-2250

U.S. Nuclear Regulatory Commission

NRC Public Document Room
GPO Sales Program
Division of Information and Document Control
2120 L Street, NW
Washington, D.C. 20037
Phone: (202) 634-3273 or (800) 397-4209
Fax: (202) 634-3343
E-mail: pdr@nrc.gov

U.S. Postal Service

U.S. Postal Service
Attn: Business Mail Acceptance
475 L'Enfant Plaza, SW
Washington D.C. 20260
Phone: (202) 268-2900

Western Governors' Association

Western Governors' Association
600 17th Street, Suite 1705 South Tower
Denver, CO 80202-5442
Phone: (303) 623-9378
Fax: (303) 534-7309

Western Interstate Energy Board

Western Interstate Energy Board
600 17th Street, Suite 1704
Denver, CO 80202
Phone: (303) 573-8910
Fax: (303) 573-9107

P.1.3 Private Organizations

American Trucking Association

Customer Service Section
2200 Mill Road
Alexandria, VA 22314
Phone: (703) 838-1770

Bureau of National Affairs

BNA Books, a division of
Bureau of National Affairs, Inc.
P.O. Box 7814
Edison, NJ 08818-7814
Phone: (800) 960-1220
Outside US and Canada: (732) 346-0089
Fax: (732) 346-1624

Conference on Safe Transportation of Hazardous Articles (COSTHA)

7812 Carrisigh Parkway
Springfield, VA 22152
Phone: (703) 451-4031
Fax: (703) 451-4207

CopyMaster Video, Inc.

711 Fairfield Ave.
Villa Park, IL 60181
Phone: (630) 279-1276

International Fire Service Training Association

IFSTA/Fire Service Programs
930 North Willis
Stillwater, OK 74078-8045
Phone: (800) 654-4055 or (405) 744-5723
Fax: (405) 744-8204

National Fire Protection Association Headquarters

National Fire Protection Association
1 Batterymarch Park
PO Box 9101
Quincy, MA 02269-9101
Phone: (800) 344-3555

New York Nautical

140 West Broadway
New York, NY 10013
Phone: (212) 962-4522
Fax: (212) 406-8420

Nuclear Technology Publishing

P.O. Box No. 7 Ashford
Kent TN23 1YW, England
Phone: (01233) 64-1683
Fax: (01233) 61-0021
E-mail: Sales@ntp.org.uk

Safe Navigation

454 Pacific Avenue
Long Beach, CA 90802
Phone: (562) 590-8744
Fax: (562) 481-0073

Vessel Operators Hazardous Materials Association (VOHMA)

1118 Bay Road
Lake George, NY 12845-4618
Phone: (518) 761-0263
Fax: (518) 792-7781

Hazardous materials regulations, including radioactive materials (49 CFR), ERG2000, and hazardous materials marking, labeling, and placarding guide (Chart 11) are available from the following sources.

Carlton Industry, Inc.
P.O. Box 280
LaGrange, TX 78945
Phone: (800) 231-5934
Fax: (409) 242-5069

Compliance Discount Center
1038 North Ashland Ave.
Chicago, IL 60622
Phone: (773) 292-9100
Fax: (773) 292-9288

Currie Associates, Inc.
1118 Bay Road
Lake George, NY 12845-4618
Phone: (518) 761-0668
Fax: (518) 792-7781

Danatec Educ. Services, Inc.
900 6th Ave., SW Suite 1410
Calgary, AB, Canada T2P 3G3
Phone: (800) 465-3388
Fax: (403) 232-6962

DG Supplies, Inc.
28C Industrial Drive
Hamilton, NJ 08619
Phone: (800) 347-7879
Fax: (609) 584-5744

Hazardous Materials Compliance
200 North Palmetto Street
Leesburg, FL 34748
Phone: (800) 468-1263
Fax: (362) 323-1991

HAZMAT Publishing Co.
243 West Main Street
Kutztown, PA 19530
Phone: (610) 693-6721
Fax: (610) 693-3171

Industrial Hygiene Services, Inc.
11760 Westline Industrial Drive
St. Louis, MO 63141
Phone: (800) 732-3015
Fax: (314) 993-3193

INFOTRAC
200 North Palmetto Street
Leesburg, FL 34748
Phone: (800) 535-5063
Fax: (362) 323-0005

ICC The Compliance Center, Inc.
2160 Liberty Drive, #1 & #2
Niagara Falls, NY 14304
Phone: (800) 732-3015
Fax: (314) 993-3193

J.J. Keller
3003 W. Breezewood Lane
Neenah, WI 54957-0368
Phone: (800) 327-6858
Fax: (920) 722-2848

Lab Safety Supply
P.O. Box 1368
Janesville, WI 63547-1368
Phone: (800) 356-0783
Fax: (800) 543-9910

Labelmaster, IRQ Marketing Dept.
5724 North Pulaski Road
Chicago, IL 60646-6797
Phone: (800) 621-5808
Fax: (800) 723-4327

LPS Industries, Inc.
10 Caesar Place
Moonachie, NJ 0707
Phone: (800) 242-7628
Fax: (201) 438-0040

Power Engineering Books Ltd.
7 Perron Street
St. Albert, AB, Canada TBN 1K3
Phone: (800) 867-3155

Silvi & Associates
9564 Greystone Lane
Mentor, OH 44060
Phone: (440) 354-2425
Fax: (440) 354-6765

Test Depth Software
364 Spyglass Circle
Idaho Falls, ID 83401
Phone: (208) 524-8261

Text-Trieve-American Labelmark
1931 2nd Ave., Suite 300
Seattle, WA 98101
Phone: (800) 678-4955
Fax: (206) 443-0529

UNZ & Co.
700 Central Avenue
New Providence, NJ 07974
Phone: (800) 631-3098
Fax: (908) 665-7866

P.2 Internet Websites

Each of the identified websites contains information related to radiological emergency planning and preparedness for transportation accidents. Users of these sources should be aware that the list is not all-inclusive, although we have attempted to provide a comprehensive list of sources relevant to radioactive material transportation. Additional information may be acquired through

use of usual search engines (e.g., Yahoo, Lycos, Infoseek, Dogpile, Mamma, HotBot). State government websites can be accessed via FEMA's website. What you find may depend as much on your perseverance as on your search strategy. Remember to try any useful links that might be offered. For example, the National Response Team site lists several "links" to interesting sources such as the Hazmat Emergency Preparedness Home Page that describes the hazardous material emergency preparedness grant program. (The purpose of this program is to distribute fees collected from shippers and carriers to emergency responders for hazardous material training and to local emergency planning committees for hazardous material planning.) Training courses, publications, regulations, and activities besides program descriptions are often listed on these websites.

P.2.1 Federal, State, and International Sites

Argonne National Laboratory	http://www.anl.gov
Energy Technology	http://www.et.anl.gov
Environmental Assessment Division	http://www.ead.anl.gov
Decision and Information Sciences Division	http://www.dis.anl.gov
Association of American Railroads	http://www.aarstore.org
Bureau of Explosives	http://www.portcitypress.com/boe-pubs
Council of State Governments – Midwestern Office	http://www.csgmidwest.org
Conference of Radiation Control Program Directors	http://www.crcpd.org
Federal Emergency Management Agency	http://www.fema.gov
Emergency Management Institute	http://www.fema.gov/emi
Fire Administration	http://www.usfa.fema.gov
Learning Resource Center	http://www.lrc.fema.gov/
Rapid Response Information System	http://www.fema.gov/rris
International Air Transport Association	http://www.iata.org
International Atomic Energy Agency (IAEA)	http://www.iaea.or.at/worlatom
International Civil Aviation Organization	http://www.icao.int
International Maritime Organization (IMO)	http://www.imo.org/imo/pubs/pubdetr.htm
National Academy of Sciences Transportation Research Board	http://www.nationalacademies.org/trb/tris.nsf

National Fire Protection Association	http://www.nfpa.org
National Response Team	http://www.nrt.org
National Technical Information Service (U.S. Department of Commerce)	http://www.ntis.gov/ordering.htm
Nuclear Energy Institute	http://www.nei.org
Oak Ridge National Laboratories	http://www.ornl.gov
Sandia National Laboratories	http://www.sandia.gov
Southern States Energy Board	http://www.sseb.org
U.S. Department of Agriculture	http://www.usda.gov
Food Safety and Inspection Service (FSIS)	http://www.fsis.usda.gov
U.S. Department of Defense	http://www.defenselink.mil/ or http://www.dtic.mil/
U.S. Department of Energy	http://www.doe.gov
U.S. Environmental Protection Agency	http://www.epa.gov
Publications	http://www.epa.gov/ncepihom/orderpub
U.S. Department of Health and Human Services	http://www.hhs.gov
U.S. Department of Transportation	http://www.dot.gov
U.S. Coast Guard	http://www.dot.gov/dotinfo/uscg
Office of Hazardous Materials	http://hazmat.dot.gov
DOT Library	http://www.access.gpo.gov/index.html
ERG2000	http://hazmat.dot.gov/gydebook.htm
U.S. Government Printing Office	http://www.access.gpo.gov/su_docs
U.S. Nuclear Regulatory Commission	http://www.nrc.gov
United Nations Publications	http://www.un.org/publications
Western Governors' Association	http://www.westgov.org/wga
Western Interstate Energy Board	http://www.westgov.org/wieb

P.2.2 Private-Sector Hazardous Materials Emergency Resource Sites

Bernan Associates	http://www.bernan.com
Bureau of National Affairs (BNA)	http://www.bna.com
CHEMTREC	http://www.chemtrec.org
CHEM-TEL, Inc.	http://www.chemtelinc.com
Conference on Safe Transportation of Hazardous Articles (COSTHA)	http://www.costha.com
Currie Associates, Inc.	http://www.currieassociates.com
Danatec Educ. Services Inc.	http://www.danatec.com
DG Supplies, Inc.	http://www.dgsupplies.com
Hazardous Materials Compliance	http://www.infotrac.net
HAZMAT Publishing Co.	http://www.hazmat.tsp.com
ICC The Compliance Center, Inc.	http://thecompliancecenter.com
INFOTRAC	http://www.infotrac.net
International Fire Service Training Assoc.	http://www.ifsta.org
Industrial Hygiene Services, Inc.	http://ourworld.compuserve.com
J.J. Keller	http://www.jjkeller.com
Lab Safety Supply	http://www.labsafety.com
Labelmaster	http://www.labelmaster.com
National Fire Protection Association	http://www.nfpa.org
New York Nautical	http://www.newyorknautical.com
Power Engineering Books, Ltd.	http://www.powerbooks.com
Safe Navigation	http://www.safenavigation.com
Test Depth Software	http://www.testdepth.com
Text-Trieve-American Labelmark	http://www.text-trieve.com
The Stationary Office Books	http://www.the-stationary-office.co.uk
3E Company	http://www.3ecompany.com
UNZ & Co.	http://www.unzexport.com
Vessel Operators Hazardous Materials Association (VOHMA)	http://www.vohma.com