



National Science and Technology Council (NSTC)
Committee on Technology
The Interagency Working Group on NanoScience, Engineering and Technology (IWGN)

Nanostructure Science and Technology

A Worldwide Study

Prepared under the guidance of the IWGN, NSTC

Edited by R.W. Siegel, E. Hu, M.C. Roco

WTEC, Loyola College in Maryland

About the National Science and Technology Council

President Clinton established the National Science and Technology Council (NSTC) by Executive Order on November 23, 1993. This cabinet-level council is the principal means for the President to coordinate science, space and technology policies across the Federal Government. NSTC acts as a "virtual" agency for science and technology (S&T) to coordinate the diverse parts of the Federal research and development (R&D) enterprise. The NSTC is chaired by the President. Membership consists of the Vice President, Assistant to the President for Science and Technology, Cabinet Secretaries and Agency Heads with significant S&T responsibilities, and other White House officials.

An important objective of the NSTC is the establishment of clear national goals for Federal S&T investments in areas ranging from information technologies and health research, to improving transportation systems and strengthening fundamental research. The Council prepares R&D strategies that are coordinated across Federal agencies to form an investment package that is aimed at accomplishing multiple national goals.

To obtain additional information regarding the NSTC, contact 202-456-6102 or see the NSTC web site at <http://www.whitehouse.gov/WH/EOP/OSTP/NSTC/>

Interagency Working Group on Nano Science, Engineering and Technology (IWGN)

Chairman : Dr. M.C. Roco, Directorate for Engineering, NSF

White House IWGN Co-chairman: T.A. Kalil , Senior Director, National Economic Council, WH

Vice-chairman: Dr. R. Trew, Director of Research, DOD

Executive Secretary: Dr. J.S. Murday, Chemistry Division, NRL

Members:

White House: T.A. Kalil

OSTP: Dr. K. Kirkpatrick

OMB: E.L. Macris, D. Radzanowski

DOC: Dr. P. Genter-Yoshida, Dr. M.P. Casassa (NIST), Dr. R.D. Shull (NIST)

DOD: Dr. R. Trew, Dr. J.S. Murday (NRL), Dr. G.S. Pomrenke (AFOSR)

DOE: Dr. I.L. Thomas, Dr. R.Price, Dr. B.G. Volintine

DOT: Dr. R.R. John, Dr. G. Kovatch, A. Lacombe (all Volpe Center)

DoTREAS: E. Murphy

NASA: Dr. S. Venneri, G.H. Mucklow, Dr. M. Meyyappan (NASA Ames)

NIH: Dr. J. Schloss, Dr. E. Kousvelari, Dr. A. Levy

NSF: Dr. M.C. Roco, Dr. T. A. Weber, M. P. Henkart.

International Technology Research Institute, World Technology (WTEC) Division, Loyola College

R.D. Shelton, ITRI Director

G.M. Holdridge, WTEC Division Director and ITRI Series Editor

WTEC Panel on

NANOSTRUCTURE SCIENCE AND TECHNOLOGY

R&D Status and Trends in Nanoparticles, Nanostructured Materials, and Nanodevices

FINAL REPORT

September 1999

Richard W. Siegel, Panel Chair

Evelyn Hu, Panel Co-Chair

Donald M. Cox

Herb Goronkin

Lynn Jelinski

Carl C. Koch

John Mendel

M. C. Roco

David T. Shaw

This document was prepared by the above authors under the guidance of the Committee on Technology of the National Science and Technology Council, Interagency Working Group on NanoScience, Engineering, and Technology, with contributions from the Departments of Commerce, Defense, Energy and Transportation; and the National Institutes of Health, National Aeronautics and Space Administration, and the National Science Foundation of the United States government.

**International Technology Research Institute
World Technology (WTEC) Division
Loyola College in Maryland**

This document is available on the World Wide Web at <http://itri.loyola.edu/nano/final/>.

WTEC PANEL ON NANOPARTICLES, NANOSTRUCTURED MATERIALS, AND NANODEVICES

Sponsored by the National Science Foundation, the Air Force Office of Scientific Research, the Office of Naval Research, the Department of Commerce, the Department of Energy, the National Institutes of Health, and the National Aeronautics and Space Administration of the United States Government.

Richard W. Siegel (Panel Chair)
Materials Science and Engineering Dept.
Rensselaer Polytechnic Institute
110 Eighth Street
Troy, New York 12180-3590

Evelyn Hu (Panel Co-Chair)
Center for Quantized Electronic Structures
University of California
Santa Barbara, CA 93106

Donald M. Cox
Exxon Research & Engineering
Clinton Township, Rt. 22E
Annandale, NJ 08801

Herb Goronkin
Motorola EL 508
2100 East Elliott Road
Tempe, AZ 85284

Lynn Jelinski
Center for Advanced Technology
in Biotechnology
130 Biotechnology Bldg.
Cornell University
Ithaca, NY 14853-2703

Carl Koch
Materials Science & Engineering Dept.
North Carolina State University
233 Riddick, Box 7907
Raleigh, NC 27695-7907

John Mendel
Eastman Kodak
1669 Lake Avenue
Rochester, N.Y. 14652-3701

David T. Shaw
Electrical & Computer Eng. Dept.
330b Bonner Hall, North Campus
SUNY Buffalo
Buffalo, NY 14260

NSF Coordinator:

M.C. Roco
National Science Foundation
4201 Wilson Blvd., Suite 525
Arlington, VA 22230

INTERNATIONAL TECHNOLOGY RESEARCH INSTITUTE World Technology (WTEC) Division

WTEC at Loyola College (previously known as the Japanese Technology Evaluation Center, JTEC) provides assessments of foreign research and development in selected technologies under a cooperative agreement with the National Science Foundation (NSF). Loyola's International Technology Research Institute (ITRI), R.D. Shelton, Director, is the umbrella organization for WTEC. Paul Herer, Senior Advisor for Planning and Technology Evaluation at NSF's Engineering Directorate, is NSF Program Director for WTEC. Several other U.S. government agencies provide support for the program through NSF.

WTEC's mission is to inform U.S. scientists, engineers, and policymakers of global trends in science and technology in a manner that is timely, credible, relevant, efficient, and useful. WTEC's role is central to the government's effort to measure its performance in science and technology. WTEC assessments cover basic research, advanced development, and applications. Panels of typically six technical experts conduct WTEC assessments. Panelists are leading authorities in their field, technically active, and knowledgeable about U.S. and foreign research programs. As part of the assessment process, panels visit and carry out extensive discussions with foreign scientists and engineers in their labs.

The ITRI staff at Loyola College help select topics, recruit expert panelists, arrange study visits to foreign laboratories, organize workshop presentations, and finally, edit and disseminate the final reports.

Dr. R.D. Shelton
ITRI Director
Loyola College
Baltimore, MD 21210

Mr. Geoff Holdridge
WTEC Division Director
Loyola College
Baltimore, MD 21210

Dr. George Gamota
ITRI Associate Director
17 Solomon Pierce Road
Lexington, MA 02173

ABSTRACT

This report reviews the status of research and development in nanoparticles, nanostructured materials, and nanodevices worldwide, with particular focus on comparisons between the United States and other leading industrialized countries. Topics covered include particle synthesis and assembly, dispersions and coatings of nanoparticles, high surface area materials, functional nanoscale devices, bulk behavior of nanostructured materials, and biological methods and applications. The final chapter is a review of related government funding programs around the world. The report also includes site reports for visits conducted by the panel to leading research laboratories in Japan and Europe. The panel held workshops in the United States, Germany, Sweden, and Russia to gather additional information for this report on activities in those countries. The proceedings of the U.S. and Russia workshops are being published separately by WTEC. The panel's conclusions include the following: (1) In the synthesis and assembly area (Chapter 2), the U.S. appears to be ahead with Europe following and then Japan; (2) In the area of biological approaches and applications (Chapter 7), the U.S. and Europe appear to be rather on a par with Japan following; (3) In nanoscale dispersions and coatings (Chapter 3), the U.S. and Europe are again similar with Japan following; (4) For high surface area materials (Chapter 4), the U.S. is clearly ahead of Europe and then Japan; (5) In the nanodevices area (Chapter 5), Japan seems to be leading quite strongly with Europe and the U.S. following; In the area of consolidated materials (Chapter 6), Japan is a clear leader with the U.S. and Europe following. These and other conclusions are reviewed in detail in the panel's executive summary.

ACKNOWLEDGEMENTS

I would like to thank the U.S. government sponsors of this study: the National Science Foundation, the Air Force Office of Scientific Research, the Office of Naval Research, the Department of Commerce (both the National Institute of Standards and Technology and the Office of Technology Policy), the Department of Energy, the National Institutes of Health, and the National Aeronautics and Space Administration (Ames Research Center). We are very much indebted to our panel chair, Richard Siegel, and to our co-chair, Evelyn Hu, for their dedication and leadership over the course of the study. All of the panelists are due great credit for their invaluable contributions of time and intellect to the project. It was both an honor and a pleasure to work with such an illustrious and affable group. Finally, we are extremely grateful to all of our hosts and correspondents around the world who took the time to share their work with us, as well as their insights and vision of the future of this exciting field.

Sincerely,

Geoffrey M. Holdridge
WTEC Division Director and ITRI Series Editor

International Technology Research Institute (ITRI)

R.D. Shelton, Principal Investigator, ITRI Director
George Mackiw, Deputy ITRI Director
George Gamota, Associate ITRI Director
J. Brad Mooney, TTEC Division Director
Robert Margenthaler, BID Division Director

World Technology (WTEC) Division

Geoffrey M. Holdridge, WTEC Division Director
Bobby A. Williams, Financial Officer
Aminah Batta, Editorial Assistant, Europe trip advance work
Catrina M. Foley, Administrative Assistant
Christopher McClintick, Head of Publications Section
Roan E. Horning, Professional Assistant, Web Administrator
Rob Capellini, Student Assistant
Jason Corso, Student Assistant
Michael Stone, Linux Systems Administrator
Rob Tamburello, Student Assistant
Xinye Zhang, Student Assistant

Cecil Uyehara, Senior Advisor for Japan Operations
Hiroshi Morishita, WTEC Japan Representative
Patricia M.H. Johnson, Editor

This document was sponsored by the National Science Foundation (NSF) and other agencies of the U.S. government under NSF Cooperative Agreement ENG-9707092, awarded to the International Technology Research Institute at Loyola College in Maryland. The U.S. government has certain rights in this material. Any opinions, findings, and conclusions or recommendations expressed in this material are those of the authors and do not necessarily reflect the views of the United States government, the authors' parent institutions, or Loyola College.

Copyright 1999 by Kluwer Academic Publishers. Copyright to electronic versions reserved by Loyola College in Maryland. This work relates to NSF Cooperative Agreement ENG-9707092. The U.S. government retains a nonexclusive and nontransferable license to exercise all exclusive rights provided by copyright. This copy reproduced for U.S. government use under license. A list of available JTEC/WTEC reports and information on ordering them is available at <http://itri.loyola.edu/>.

Foreword

Timely information on scientific and engineering developments occurring in laboratories around the world provides critical input to maintaining the economic and technological strength of the United States. Moreover, sharing this information quickly with other countries can greatly enhance the productivity of scientists and engineers. These are some of the reasons why the National Science Foundation (NSF) has been involved in funding science and technology assessments comparing the United States and foreign countries since the early 1980s. A substantial number of these studies have been conducted by the World Technology Evaluation Center (WTEC) managed by Loyola College through a cooperative agreement with NSF. The National Science and Technology Council (NSTC), Committee on Technology's Interagency Working Group on NanoScience, Engineering and Technology (CT/IWGN) worked with WTEC to develop the scope of this Nanostucture Science and Technology report in an effort to develop a baseline of understanding for how to strategically make Federal nanoscale R&D investments in the coming years.

The purpose of the NSTC/WTEC activity is to assess R&D efforts in other countries in specific areas of technology, to compare these efforts and their results to U.S. research in the same areas, and to identify opportunities for international collaboration in precompetitive research.

Many U.S. organizations support substantial data gathering and analysis efforts focusing on nations such as Japan. But often the results of these studies are not widely available. At the same time, government and privately sponsored studies that are in the public domain tend to be "input" studies. They enumerate inputs to the research and development process, such as monetary expenditures, personnel data, and facilities, but do not provide an

assessment of the quality or quantity of the outputs obtained. Studies of the outputs of the research and development process are more difficult to perform because they require a subjective analysis performed by individuals who are experts in the relevant scientific and technical fields. The NSF staff includes professionals with expertise in a wide range of disciplines. These individuals provide the expertise needed to assemble panels of experts who can perform competent, unbiased reviews of research and development activities. Specific technologies such as telecommunications, biotechnology, and nanotechnology are selected for study by government agencies that have an interest in obtaining the results of an assessment and are able to contribute to its funding. A typical WTEC assessment is sponsored by several agencies.

In the first few years of this activity, most of the studies focused on Japan, reflecting interest in that nation's growing economic prowess. Then, the program was called JTEC (Japanese Technology Evaluation Center). Beginning in 1990, we began to broaden the geographic focus of the studies. As interest in the European Community (now the European Union) grew, we added Europe as an area of study. With the breakup of the former Soviet Union, we began organizing visits to previously restricted research sites opening up there. Most recently, studies have begun to focus also on emerging science and technology capabilities in Asian countries such as the People's Republic of China.

In the past several years, we also have begun to substantially expand our efforts to disseminate information. Attendance at WTEC workshops (in which panels present preliminary findings) has increased, especially industry participation. Representatives of U.S. industry now routinely number 50% or more of the total attendance, with a broad cross-section of government and academic representatives making up the remainder. Publications by WTEC panel members based on our studies have increased, as have the number of presentations by panelists at professional society meetings.

The WTEC program will continue to evolve in response to changing conditions. New global information networks and electronic information management systems provide opportunities to improve both the content and timeliness of WTEC reports. We are now disseminating the results of WTEC studies via the Internet. Over 25 of the most recent WTEC final reports are now available on the World Wide Web (<http://itri.loyola.edu>) or via anonymous FTP ([ftp.wtec.loyola.edu/pub/](ftp:wtec.loyola.edu/pub/)).

As we seek to refine the WTEC activity, improving the methodology and enhancing the impact, program organizers and participants will continue to operate from the same basic premise that has been behind the program from its inception, i.e., improved awareness of international developments can significantly enhance the scope and effectiveness of international

collaboration and thus benefit the United States and all its international partners in collaborative research and development efforts.

Paul J. Herer
Directorate for Engineering
National Science Foundation
Arlington, VA

Contents

Foreword	i
Table of Contents	v
Executive Summary	xiii
1. Introduction and Overview <i>RICHARD W. SIEGEL</i>	1
2. Synthesis and Assembly <i>EVELYN L. HU AND DAVID T. SHAW</i>	15
3. Dispersions and Coatings <i>JOHN MENDEL</i>	35
4. High Surface Area Materials <i>DONALD M. COX</i>	49
5. Functional Nanoscale Devices <i>HERB GORONKIN, PAUL VON ALLMEN, RAYMOND K. TSUI, AND THEODORE X. ZHU</i>	67
6. Bulk Behavior of Nanostructured Materials <i>CARL KOCH</i>	93

7. Biologically Related Aspects of Nanoparticles, Nanostructured Materials, and Nanodevices <i>LYNN JELINSKI</i>	113
8. Research Programs on Nanotechnology in the World <i>M.C. ROCO</i>	131
Appendix A. Biographies of Panelists and Other Team Members	151
Appendix B. Site Reports—Europe	159
Appendix C. European Roundtable Discussions	221
Appendix D. Site Reports—Japan	243
Appendix E. Site Reports—Taiwan	313
Appendix F. Glossary	327

List of Figures

1.1	Organization of nanostructure science and technology and the WTEC study.	5
2.1	Schematic of variety of nanostructure synthesis and assembly approaches.	16
2.2	Interactive cycle of characterization, understanding and enhanced control in the synthesis and assembly of nanostructures.	18
2.3	TEM images of (a) the lamellar morphology, (b) the cubic phase with Ia3d symmetry viewed along its [111] zone axis, and (c) the hexagonal phase viewed along its [001] zone axis of the silica/surfactant nanostructured composites by co-assembly (McGehee et al. 1994) (bars = 30 nm).	26
2.4	TEM image of unlinked cluster array of 3.7 nm Au clusters encapsulated by dodecanethiol (Andres et al. 1998).	27
2.5	Array of InAs quantum dot structures grown on GaAs substrates (Mirin et al. 1996).	27
2.6	Variation of optical transparency with diameter of chemically synthesized CdSe nanocrystals (Alivisatos 1996).	27
2.7	A sequence of 670 nm by 670 nm AFM images taken during the manipulation of a 50 nm Au particle into the gap between two Au/Ti electrodes (Junno et al. 1998).	30
3.1	Transparency as a function of particle size (courtesy, Nanophase).	42

4.1	Schematic drawing of the experimental setup used in Göteborg for studies of chemical reactivity and/or sticking probability of various molecules with the clusters. The production of clusters is via laser vaporization of metal substrates and detection via photo-ionization time-of-flight mass spectrometry. (A. Rosen, University of Göteborg, Sweden.)	53
4.2	Effect of moisture on conversion profiles for CO oxidation over Co_3O_4 and $\text{Au}/\text{Co}_3\text{O}_4$.	54
4.3	Hydrodesulfurization reaction. Selective catalysis is controlled by either the edge or rim of MoS_2 . (Chianelli 1998).	56
4.4	Hydrogen absorption-desorption characteristics for mixture of Mg and Mg_2Ni prepared by mechanical alloying.	57
4.5	Typical zeolite structures together depicting the positions of the O atoms (vertices in upper figure) and two different zeolitic structures one (a) with a three dimensional structure and (b) a zeolite with a two dimensional channel structure.	58
4.6	Examples of carbon nanotube structures, including multiwalled and metal-atom-filled nanotubes.	61
5.1	Functional device scales.	68
5.2	Metal colloids, self-assembled monolayer (SAM) coatings, polysilicon, quantum dots embedded in SiO_2 (Hitachi, IBM, RIKEN, NTT, ETL, University of Lund).	71
5.3	Sidewall extensions of MOSFET gate (Toshiba).	71
5.4	Oxidation of metal or semiconductor with scanning tunneling microscope (STM) tip (ETL).	71
5.5	STM probe oxidation of metal on vicinal substrate steps (ETL).	71
5.6	Double barrier tunnel diode structure (Max-Planck-Institut, Stuttgart; NTT).	72
5.7	Gated double barrier tunnel diode structure (Max-Planck-Institut, Stuttgart; NTT; Purdue University).	72
5.8	Depletion layer control of 2DEG area (Hitachi, University of Glasgow, University of Tokyo).	72
5.9	Tetrahedral shaped recess, TSR (Fujitsu).	73
5.10	Double barrier metallic SET patterned by e-beam (NEC).	73
5.11	A single molecule connecting metallic contacts (Yale University, University of South Carolina, Delft University, Karlsruhe University).	74

5.12	Granular GMR—Co, Fe (Nagoya University, Tohoku University, CNRS-Thomson, UCSB, UCSD).	78
5.13	Current in plane (Matsushita, Fujitsu, Mitsubishi, Toshiba, Hitachi, Thomson, Philips, Siemens, IBM, Univ. Regensburg, IMEC, Nagoya University, Tohoku University, NIST).	78
5.14	Magnetic tunnel junction (IBM, MIT, HP, Tohoku University).	78
5.15	Ferromagnetic/metal/ferromagnetic: 3 - 60 periods free-standing (NRL, CNRS-Thomson, Philips, Michigan State, Lawrence Livermore Labs); plated into pores (L'École Polytechnique Fédérale de Lausanne, Johns Hopkins University, Université Catholique Louven).	79
5.16	Schematic of a semiconductor laser.	83
5.17	Density of electronic states as a function of structure size.	83
6.1	Ratio of the Young's (E) and shear (G) moduli of nanocrystalline materials to those of conventional grain size materials as a function of grain size. The dashed and solid curves correspond to a grain boundary thickness of 0.5 and 1 nm, respectively (Shen et al. 1995).	96
6.2	Elongation to failure in tension vs. grain size for some nanocrystalline metals and alloys.	98
6.3	Effective permeability, μ_e , vs. saturation magnetic flux density, B_s , for soft ferromagnetic materials (after A. Inoue 1997).	105
7.1	Organization of the WTEC study; sections with large biological content are indicated.	114
7.2	Top: a 36-mer protein polymer with the repeat sequence (alanine-glycine) ₃ – glutamic acid – glycine. Bottom: idealized folding of this protein polymer, where the glutamic acid sidechains (+) are on the surface of the folds.	115
7.3	Idealized truncated octahedron assembled from DNA. This view is down the four-fold axis of the squares. Each edge of the octahedron contains two double-helical turns of DNA.	117
7.4	An elastomeric stamp (top left) is made from an original master (bottom left). The stamp is dipped into the biological material (top right) and the pattern is transferred to the substrate (bottom right).	119
7.5	Mushroom-shaped clusters formed from self-assembly of rod-coil molecules; these clusters can undergo further packing to form sheets.	119

- 7.6 Novel combinations of DNA, metal ligands, DNA templating, and proteins are being investigated for molecular wires, inductors, and switches (photo courtesy of Shionoya and coworkers, Inst. for Molecular Science). 123

List of Tables

ES.1	Technological Impact: Present and Potential	xvi
ES.2	Comparison of Activities in Nanostructure Science and Technology in Europe, Japan, and the United States	xvii
3.1	Nanoparticle Preparation for Dispersions/Coatings	40
3.2	Particle Properties	42
3.3	Dispersions and Coatings—Nanotechnology Comparisons Between the United States, Europe, and Japan	46
4.1	Zeolite Channel “Window” Dimension for Number of Oxygens in Ring	59
5.1	SET Architectures	75
5.2	Quantum Dot Flash Memory	75
5.3	Giant Magnetoresistance Activities	77
5.4	Summary of Quantum Dot Laser Results	85
5.5	Nanotube Fabrication Methods	87
5.6	Electrical and Field Emission Properties of Nanotubes	88
7.1	Comparisons between Japan, Europe, and the United States in Biologically Related Aspects of Nanotechnology	127
8.1	Support for Nanotechnology Research from U.S. Federal Agencies in 1997	133
8.2	Government Expenditures on Nanotechnology Research in 1997, Based on the WTEC Site Interviews	147

Executive Summary

Richard W. Siegel ¹
Rensselaer Polytechnic Institute
Panel Chair

INTRODUCTION

Nanostructure science and technology is a broad and interdisciplinary area of research and development activity that has been growing explosively worldwide in the past few years. It has the potential for revolutionizing the ways in which materials and products are created and the range and nature of functionalities that can be accessed. It is already having a significant commercial impact, which will assuredly increase in the future.

A worldwide study of research and development status and trends in nanoparticles, nanostructured materials, and nanodevices (or more concisely, nanostructure science and technology) was carried out during the period 1996-98 by an eight-person panel under the auspices of the World Technology (WTEC) Division of Loyola College. Led by the National Science Foundation, a wide range of U.S. government agencies commissioned and funded this study: the Air Force Office of Scientific Research, the Office of Naval Research, the Department of Commerce (including the National Institute of Standards and Technology and the Technology Administration), the Department of Energy, the National Institutes of Health, and the National Aeronautics and Space Administration. Their support indicates the breadth of interest in and the far-reaching potential of this burgeoning new field. The purpose of the study was to assess the current status and future trends internationally in research and development in the broad and rapidly growing area of nanostructure science and technology. The goals were fourfold:

1. provide the worldwide science and engineering community with a broadly inclusive and critical view of this field

¹ Although written by the panel chair, this summary includes contributions from the full panel and represents the consensus views of the panel as a whole.

2. identify promising areas for future research and commercial development
3. help stimulate development of an interdisciplinary international community of nanostructure researchers
4. encourage and identify opportunities for international collaboration

This report is the principal volume in a three-part publication of the activities and findings of the WTEC panel; it is an overview of the panel's observations and conclusions regarding nanostructure science and technology worldwide. It includes reviews of panel workshops held in Germany and Sweden, as well as site reports of panel visits to university, government, and industry laboratories in Europe, Japan, and Taiwan. An earlier volume, published in January 1998, reported the proceedings of a WTEC workshop on R&D Status and Trends in Nanoparticles, Nanostructured Materials, and Nanodevices in the United States (Baltimore: Loyola College, International Technology Research Institute, NTIS #PB98-117914). A third volume to be published by WTEC reports the proceedings of a workshop held in St. Petersburg, Russia on related work.

FINDINGS

There are two overarching findings from this WTEC study:

First, it is abundantly clear that we are now able to nanostructure materials for novel performance. That is the essential theme of this field: novel performance through nanostructuring. It represents the beginning of a revolutionary new age in our ability to manipulate materials for the good of humanity. The synthesis and control of materials in nanometer dimensions can access new material properties and device characteristics in unprecedented ways, and work is rapidly expanding worldwide in exploiting the opportunities offered through nanostructuring. Each year sees an ever increasing number of researchers from a wide variety of disciplines enter the field, and each year sees an ever increasing breadth of novel ideas and exciting new opportunities explode on the international nanostructure scene.

Second, there is a very wide range of disciplines contributing to the developments in nanostructure science and technology worldwide. The rapidly increasing level of interdisciplinary activity in nanostructuring is exciting and growing in importance, and the intersections between the various disciplines are where much of the novel activity resides.

The field of nanostructure science and technology has been growing very rapidly in the past few years, since the realization that creating new materials and devices from nanoscale building blocks could access new and improved properties and functionalities. While many aspects of the field existed well before nanostructure science and technology became a definable entity in the

past decade, it has only become a coherent field of endeavor through the confluence of three important technological streams:

1. new and improved control of the size and manipulation of nanoscale building blocks
2. new and improved characterization (spatial resolution, chemical sensitivity, etc.) of materials at the nanoscale
3. new and improved understanding of the relationships between nanostructure and properties and how these can be engineered

As a result of these developments, a wide range of new opportunities for research and applications in the field of nanotechnology now present themselves. Table ES.1 indicates some examples of present and potential applications with significant technological impact that were identified in the course of this study. Considerable resources are being expended around the world for research and development aimed at realizing these and a variety of other promising applications. Government funding alone approached half a billion dollars per year in FY 1997: \$128 million in Western Europe; \$120 million in Japan; \$116 million in the United States; and \$70 million altogether in other countries such as China, Canada, Australia, Korea, Taiwan, Singapore, and the countries of the former Soviet Union (see Chapter 8).

Table ES.2 presents an overall comparison of the current levels of activity among the major regions assessed (Europe, Japan, and the United States) in the various areas of the WTEC study. These broad areas—synthesis and assembly, biological approaches and applications, dispersions and coatings, high surface area materials, nanodevices, and consolidated materials—constitute the field of nanostructure science and technology. These are the areas around which the study was crafted.

In the synthesis and assembly area (Chapter 2), the United States appears to be ahead, with Europe following and then Japan. In the area of biological approaches and applications (Chapter 7), the United States and Europe appear to be rather on a par, with Japan following. In nanoscale dispersions and coatings (Chapter 3), the United States and Europe are again at a similar level, with Japan following. For high surface area materials (Chapter 4), the United States is clearly ahead of Europe, followed by Japan. On the other hand, in the nanodevices area (Chapter 5), Japan seems to be leading quite strongly, with Europe and the United States following. And finally, in the area of consolidated materials (Chapter 6), Japan is a clear leader, with the United States and Europe following. These comparisons are, of course, integrals over rather large areas of a huge field and therefore possess all of the inevitable faults of such an integration. At best, they represent only a snapshot of the present, and the picture is admittedly incomplete.

TABLE ES.1. Technological Impact: Present and Potential

Technology	Present Impact	Potential Impact
Dispersions and Coatings	Thermal barriers	Targeted drug delivery/gene therapy
	Optical (visible and UV) barriers	Multifunctional nanocoatings
	Imaging enhancement	
	Ink-jet materials	
	Coated abrasive slurries	
	Information-recording layers	
High Surface Area Materials	Molecular sieves	Molecule-specific sensors
	Drug delivery	Large hydrocarbon or bacterial filters
	Tailored catalysts	Energy storage
	Absorption/desorption materials	Grätzel-type solar cells
Consolidated Materials	Low-loss soft magnetic materials	Superplastic forming of ceramics
	High hardness, tough WC/Co cutting tools	Ultrahigh-strength, tough structural materials
	Nanocomposite cements	Magnetic refrigerants
		Nanofilled polymer composites
		Ductile cements
Nanodevices	GMR read heads	Terabit memory and microprocessing
		Single molecule DNA sizing and sequencing
		Biomedical sensors
		Low noise, low threshold lasers
		Nanotubes for high brightness displays
Additional Biological Aspects	Biocatalysis	Bioelectronics
		Bioinspired prostheses
		Single-molecule-sensitive biosensors
		Designer molecules

TABLE ES.2. Comparison of Activities in Nanostructure Science and Technology in Europe, Japan, and the United States

Synthesis & Assembly	U.S.	Europe	Japan
	U.S./Eur	Japan	
	U.S./Eur	Japan	
	U.S.	Europe	Japan
	Japan	Europe	U.S.
	Japan	U.S./Eur	
Biological Approaches & Applications			
Dispersions and Coatings			
High Surface Area Materials			
Nanodevices			
Consolidated Materials			
Level	1	2	3
	Highest		

More detailed findings in each of these major areas are included in the individual chapters of this report, along with additional general findings and observations in Chapter 1. Chapter 8 compares the scope and funding levels for the relevant nanostructure science and technology R&D programs around the world. The appendices give details on the site visits and workshops of the panel: B contains the Europe site reports, C contains notes on workshops held in Germany and Sweden, D contains the Japan site reports, and E contains the Taiwan site reports. Appendix A lists the professional experience of panelists and other members of the traveling team.

CHALLENGES

We are now at the threshold of a revolution in the ways in which materials and products are created. How this revolution will develop, how great will be the opportunities that nanostructuring can yield, and how rapidly we progress, will depend upon the ways in which a number of challenges are met.

Among the challenges facing us are those concerned with making the necessary advances in enabling technologies in order for rapid progress to continue in this field. We must increase characterization capabilities in visualization and chemical analysis at ever finer size scales. We must be able to manipulate matter at ever finer size scales, and we must eventually

use computational approaches in directing this, if we are really going to take full advantage of the available opportunities. Experiment simply cannot do it alone. Theory and modeling are essential. Fortunately, this is an area in which the sizes of the building blocks and their assemblies are small enough that one can, with the ever increasing capabilities in computational sciences, now start doing very serious controlled modeling experiments to guide us in the nanostructuring of matter. Hence, multiscale modeling of nanostructuring and the resulting materials properties across the hierarchy of length scales from atomic, to mesoscopic, to macroscopic is an absolute necessity as we go down the road in the next decades to realizing the tremendous potential of nanostructure science and technology.

Furthermore, we need to understand the critical roles that surfaces and interfaces play in nanostructured materials. Nanoparticles have very high specific surface areas, and thus in their assembled forms there are large areas of interfaces. We need to know in detail not only the structures of these interfaces, but also their local chemistries and the effects of segregation and interaction between the nanoscale building blocks and their surroundings. We need to learn more about the control of nanostructure size and size distribution, composition, and assembly. For some applications, there are very stringent conditions on these parameters; in other applications less so. We must therefore understand the relationships between this stringency and the desired material or device properties.

We also need to be concerned with the thermal, chemical, and structural stability of nanostructured materials and the devices made therefrom, in the face of both the temperature and changing chemistries of the environments in which these nanostructures are asked to function. A nanostructure that is only a nanostructure at the beginning of a process is not of much use to anybody, unless the process is over in a very short time or the process itself is the actual nanostructure advantage. So for many applications, stability is an important consideration, and we must investigate whether natural stability is sufficient or whether we must additionally stabilize against changes that we cannot afford.

To effectively commercialize and utilize the nanostructuring of matter we also need enhancements in statistically driven process control. Achieving reproducibility and scalability of nanoparticle synthesis and consolidation processes in nanostructuring are paramount if successful scale-up is to be effected and if what we do in the laboratory is to contribute to the society that pays for this research. Given a commercial need, the viability of nanostructure production and utilization is wrapped up in the costs of precursors or raw materials, processing costs, and also the costs of dealing with effluent. It is the total integrated cost, in terms of raw materials, synthesis of the building blocks, manufacture of parts from those building

blocks, and effluent clean-up costs, that is important and that will ultimately determine commercial viability.

Finally, in order for the field of nanostructure science and technology to truly reach fruition, it is an absolute necessity to create a new breed of researchers who can work across traditional disciplines and think “outside the box.” Educating this new breed of researchers, who will either work across disciplines or know how to work with others in the interfaces between disciplines, is vital to the future of nanostructure science and technology. People must start thinking in unconventional ways if we are to take full advantage of the opportunities in this new and revolutionary field.

Chapter 1

Introduction and Overview

Richard W. Siegel
Rensselaer Polytechnic Institute

BACKGROUND

The field of nanostructure science and technology is a broad and interdisciplinary area of worldwide research and development activity that has been growing explosively in the past few years. While an understanding of the range and nature of functionalities that can be accessed through nanostructuring is just beginning to unfold, its tremendous potential for revolutionizing the ways in which materials and products are created is already clear. It is already having a significant commercial impact, and it will very certainly have a much greater impact in the future.

During the years 1996-98, an eight-person panel under the auspices of the World Technology Evaluation Center (WTEC) conducted a worldwide study of the research and development status and trends in nanoparticles, nanostructured materials, and nanodevices, or more concisely, nanostructure science and technology. The study was commissioned and sponsored by a wide range of U.S. government agencies led by the National Science Foundation (NSF), which included the Air Force Office of Scientific Research, Office of Naval Research, Department of Commerce (including the National Institute of Standards and Technology and the Technology Administration), Department of Energy, National Institutes of Health, and National Aeronautics and Space Administration. Additional participating U.S. government agencies for the study were the Army Research Office, Army Research Laboratory, Defense Advanced Research Projects Agency, and the Ballistic Missile Defense Organization. The uniquely broad sponsor

list for this WTEC study mirrors the broadly based interests in and, in fact, the reality of the field of nanostructure science and technology.

The panel study began in 1996, when panel co-chair Prof. Evelyn L. Hu (University of California at Santa Barbara) and I came to Washington to present our thoughts to WTEC and the sponsors on how the study could best be configured and carried out, given the available resources (time, people, and money). After an extensive discussion with sponsors and potential sponsors of the study, we assembled a team of experts for the panel from industry and university, including Dr. Donald M. Cox (Exxon Research and Engineering Company), Dr. Herb Goronkin (Motorola), Prof. Lynn Jelinski (Cornell University during most of this study, now at Louisiana State University), Prof. Carl Koch (North Carolina State University), John Mendel (Eastman Kodak Company), and Prof. David T. Shaw (State University of New York at Buffalo). Two of us on the panel, Prof. Koch and I, although presently in universities, had spent large fractions of our careers at Oak Ridge and Argonne National Laboratories, respectively, lending national laboratory perspectives to the study, as well. Biographical sketches of the panel members and other study participants are included in Appendix A of the present volume.

The purposes of this study, which the panel determined in conjunction with its sponsors, were to assess the current status and future trends internationally in research and development in the broad and rapidly growing area of nanostructure science and technology. The study had the following four goals:

1. to provide the worldwide science and engineering community with a broadly inclusive and critical view of this field
2. to identify promising areas for future research and commercial development
3. to help stimulate development of an interdisciplinary international community of nanostructure researchers
4. to encourage and identify opportunities for international collaboration

Based on these goals, the panel formulated a number of questions, for which we sought answers during our study:

- What are the scientific drivers (new properties and phenomena, instruments, theory, and simulation methods) and advantages (applications) to be gained from control at the nanostructure level?
- What are the critical parameters to control in nanostructured material synthesis and device manufacturing?
- What are the likelihood of and the time scale for bringing these new technologies to fruition?

- What are the underlying research and development and educational concepts and directions driving nanostructure science and technology development?
- What are the expected financial dimensions of this effort over the next five to ten years, and are there national programs in force or planned?
- Which areas of nanostructure science and technology would be most fruitful for international collaboration?

These questions were posed in advance to the various workshop participants and hosts of our panel visits so that answers could be considered and prepared. In every case, our hosts went to great lengths and considerable efforts to prepare for our visits and to make our study both effective and comfortable. The various activities of the WTEC panel, in addition to considerable reading, thinking, discussing, and writing, included the following:

- a U.S. workshop on 8-9 May 1997 with presentations by 26 invited expert participants from universities, industry, and national laboratories, and by 23 U.S. government agency sponsors
- visits by panel members to 42 universities, industrial companies, and national laboratories in Europe (France, Germany, Belgium, the Netherlands, Sweden, Switzerland, and the United Kingdom), Japan, and Taiwan
- three round-table workshops involving 27 additional institutions in Germany, Sweden, and Russia

These activities represent a rather broad base of information for the study from which the panel derived the findings and conclusions that appear in this volume. One must emphasize, however, that even though we visited many places, listened to many presentations, and read much material, there is no way that this study is, or could have been with the available resources, encyclopedic. The field of nanostructure science and technology is simply too large, too geographically dispersed, and changing too rapidly to cover exhaustively. What this volume presents are only examples, the best examples the panel could find, to describe what the field encompasses, its current breath and depth, and where it appears to be heading. The choices of the places that we visited, and even the types of visits, were made from lists and suggestions generated by all the panel members, with useful sponsor input. The final priorities were made according to where we felt the most exciting research and development activities in nanostructure science and technology were going on, overlaid with a realistic evaluation of which sites and how many of them could be logically visited in the time allotted. Unfortunately, this means that panel members on our limited schedule could not visit many interesting institutions and could not accommodate visits to entire countries that make significant contributions to nanostructure science

and technology—Australia, Canada, China, Finland, India, Israel, Italy, Mexico, Spain, and the Ukraine, to name just a few.

The initial public report of the findings of the WTEC study panel was presented in Arlington, Virginia (<http://itri.loyola.edu/nano/views/top.htm>) on 10 February 1998. Full site reports from the panel's visits in Europe, Japan, and Taiwan are included as Appendices B to E in this volume. A separate volume covering the U.S. workshop has already been published by WTEC under the title *R&D Status and Trends in Nanoparticles, Nanostructured Materials, and Nanodevices in the United States* (see bibliography at the end of this chapter). WTEC will soon publish a third volume of this study that consists of papers presented at its workshop in St. Petersburg, Russia.

An introduction to and overview of the study and its conclusions are presented in this chapter, including some of the technical highlights of nanostructure science and technology that the panel observed.

The WTEC panel would like to take this opportunity to thank all of the study participants around the world for their conscientious help and contributions and for their generous hospitality. We would also like to extend our thanks to Dr. Mike Roco of NSF for the wonderful support he has given us throughout the study and for his active participation in many of the visits that we made around the world. In addition, we would like to thank Mr. Geoff Holdridge (WTEC Director) and his staff for their excellent support, without which the study could not have been accomplished.

FINDINGS

There are two overarching findings from this WTEC study. First, it is now abundantly clear that we are able to nanostructure materials for novel performance. This is the essential theme of this field: novel performance through nanostructuring. Nanostructuring represents the beginning of a revolutionary new age in our ability to manipulate materials for the good of humanity. The synthesis and control of materials in nanometer dimensions can access new material properties and device characteristics in unprecedented ways. Panelists had seen the tip of the iceberg or the pinnacle of the pyramid before starting this study, but only since undertaking the study do we fully appreciate just how broad the field really is and begin to understand what its exciting potential and impact may really be. It is now clear that work is rapidly expanding worldwide in exploiting the opportunities offered through nanostructuring.

The second major finding is that there is a wide range of disciplines contributing to the developments in nanostructure science and technology

worldwide. Each year sees an ever increasing number of researchers from diverse disciplines enter the field and an increasing breadth of novel ideas and exciting new opportunities explode on the international nanostructure scene. The rapidly mounting level of interdisciplinary activity in nanostructuring is truly exciting. The intersections between the various disciplines are where much of the novel activity resides, and this activity is growing in importance.

If nothing else, these are the two basic findings that you need to carry away from this study.

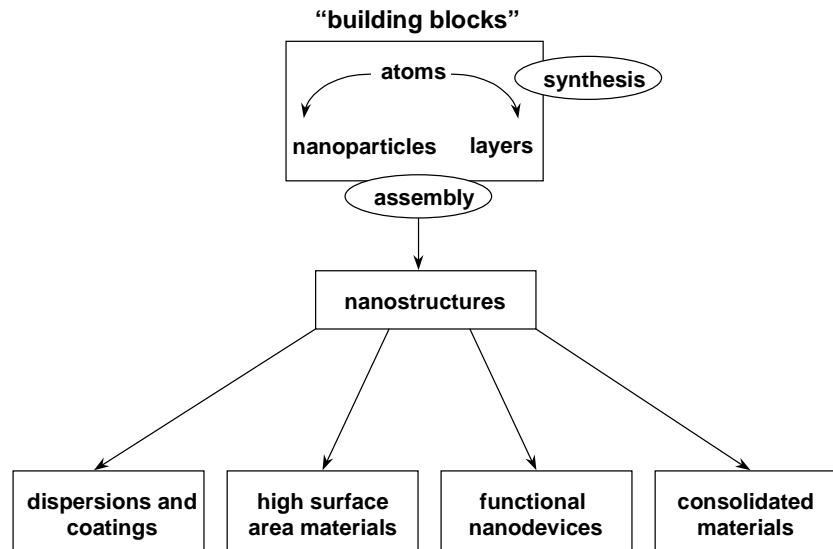

Figure 1.1. Organization of nanostructure science and technology and the WTEC study.

The broad field of nanostructure science and technology can be most conveniently organized according to the chart shown in Figure 1.1, which indicates its tremendous breadth and potential impact. The WTEC study was organized along the same lines as Figure 1.1, as is this final report, which has a separate chapter focused on each major area shown in the figure. The basis of the field is any type of material (metal, ceramic, polymer, semiconductor, glass, composite) created from nanoscale building blocks (clusters or nanoparticles, nanotubes, nanolayers, etc.) that are themselves synthesized from atoms and molecules. Thus, the controlled synthesis of those building blocks and their subsequent assembly into nanostructures is one fundamental theme of this field. This is the subject of Chapter 2 by Evelyn Hu and David Shaw. This theme draws upon all of the materials-related disciplines from physics to chemistry to biology and to essentially all

of the engineering disciplines as well. In fact, there is a very strong thread from all these disciplines running throughout the fabric of this study; the biological aspects are so pervasive that special attention is given to them in Chapter 7 by Lynn Jelinski.

The second and most fundamentally important theme of this field is that the nanoscale building blocks, because of their sizes below about 100 nm, impart to the nanostructures created from them new and improved properties and functionalities heretofore unavailable in conventional materials and devices. The reason for this is that materials in this size range can exhibit fundamentally new behavior when their sizes fall below the critical length scale associated with any given property. Thus, essentially any material property can be dramatically changed and engineered through the controlled size-selective synthesis and assembly of nanoscale building blocks. Four broadly defined and overlapping application areas that cover the tremendous range of challenges and opportunities for nanostructure science and technology are dispersions and coatings, high surface area materials, functional nanodevices, and consolidated materials.

In the synthesis and assembly area (Chapter 2) we see that atoms, molecules, clusters and nanoparticles can be used as building blocks for nanostructuring. However, the useful size of these building blocks depends upon the property to be engineered, since the critical length scales for which one is designing these building blocks depends upon the particular property of interest. For multifunctional applications, more than one property and one length scale must be considered. Every property has a critical length scale, and if a nanoscale building block is made smaller than that critical length scale, the fundamental physics of that property starts to change. By altering the sizes of those building blocks, controlling their internal and surface chemistry, and controlling their assembly, it is possible to engineer properties and functionalities in unprecedented ways.

The characteristics of the building blocks, such as their size and size distribution, composition, composition variation, and morphology, must be well controlled. Also, the interfaces between the building blocks and their surroundings can be critical to performance. It is not sufficient simply to make the building blocks; one must also worry about the structure and chemistry of their surfaces and how they will interact one with another or with a matrix in which they are embedded. There is a very wide range of diverse synthesis and assembly strategies being employed in nanostructuring, all the way from fundamental biological methods for self-assembling molecules to sophisticated chemical precipitation methods to a variety of physical and chemical aerosol techniques for making clusters or nanoparticles and then dispersing them or bringing them together in consolidated forms. All of these strategies contribute in essential ways to the

growth of this field. Each may have unique capabilities that will benefit a particular property, application, or process. The most generally applicable of them are likely to have significant technological impact and commercial potential.

In the area of dispersions and coatings, covered in Chapter 3 by John Mendel, a wide range of new and enhanced functionalities are now becoming available by means of nanostructuring. They cover the whole set of properties that are of interest in optical, thermal, and electrical applications. This is the most mature area of nanoscale science and technology. The many current commercial applications include printing, sunscreens, photography, and pharmaceuticals. Some examples of the present technological impact of nanostructuring are thermal and optical barriers, imaging enhancement, ink-jet materials, coated abrasive slurries, and information-recording layers. From our vantage point at present, there appears to be very strong potential impact in the areas of targeted drug delivery, gene therapy, and multifunctional coatings. Nevertheless, certain central issues must be addressed if work in this area is going to continue to affect society in meaningful new ways in the coming years. Successful nanoscale dispersions require freedom from agglomeration and surface control. Process controls are required to ensure reproducibility, reliability, and scalability. There is also a need to develop process models that lead to shorter cycle times in manufacturing, if commercialization is to be truly effective.

In the area of high surface area materials, reviewed by Donald Cox in Chapter 4, it is of primary importance to realize that nanostructured material building blocks have inherently high surface areas unless they are consolidated. For example, a nanoparticle 5 nm in diameter has about half of its atoms on its surface. If the nanoparticles are then brought together in a lightly assembled way, this surface area is available for a variety of useful applications. In fact, there is a wide range of new applications in high capacity uses for chemical and electrical energy storage, or in sensors and other applications that take copious advantage of this feature. Already there are numerous commercial applications in porous membranes or molecular sieves, drug delivery, tailored catalysts, and absorption/desorption materials. Clearly, what is required to optimize the impact of nanostructures to be really useful to society in high surface area material applications is to create materials that combine high selectivity, high product or function yield, and high stability. Thus, the major challenges in this area are critical dimensional control and long-term thermal and chemical stability. When these problems are solved, considerable future technological potential is seen in the areas of molecule-specific sensors, large hydrocarbon or bacterial filters, energy storage, and Grätzel-type solar cells.

The area of functional nanoscale devices, covered in Chapter 5 by Herb Goronkin and his Motorola colleagues, is largely driven by the need for ever smaller devices, which necessitate both new device and new circuit architectures. It is not very useful to make nanoscale devices if they cannot be assembled in a circuit with interconnects that are themselves nanoscale. Thus, a complete rethinking of this area is required. The major research and development effort worldwide in functional nanoscale devices is focused on the single electron transistor (SET) using a variety of nanostructuring approaches. However, there is also considerable worldwide activity on magnetic devices using giant magnetoresistance (GMR) of nanostructures with architectures of various modulation dimensionalities. In fact, it is the nanostructuring with various modulation dimensionalities that has created an expanding range of different functionalities that can be engineered into these GMR devices. There is also exciting carbon nanotube research being actively pursued in areas of high-field-emission displays and several other nanoscale electronic devices. This is an area still very early in its development, since nanotubes and their derivatives are a relatively recent discovery, but one with tremendous potential.

While there is little technological impact already present in the nanoscale device area other than GMR read heads, several potential areas of significant impact do appear on the horizon. These include terabit memory and microprocessing; single molecule DNA sizing and sequencing; biomedical sensors; low-noise, low-threshold lasers; and nanotubes for high brightness displays. Nevertheless, a major challenge looms in the efficient manipulation of these nanoscale building blocks and their eventual commercial scaleup, if any of this is really going to affect society as we know it. One shining example that indicates probable success in overcoming such obstacles in the future is the ability to now translate SET devices made by individual atomic manipulation into arrays of similarly functional devices created by the biological self-assembly of large molecular arrays. Such cross-disciplinary transfers of nanostructuring ideas and capabilities can be expected to increasingly impact the future successful implementation of nanostructure science and technology.

In the area of consolidated materials, reviewed by Carl Koch in Chapter 6, we have known for about a decade that the bulk behavior of materials can be dramatically altered when constituted of, or consolidated from, nanoscale building blocks. This can significantly and favorably affect the mechanical properties, magnetic properties, and optical properties of a range of engineering materials. We already know that the hardness and strength of nanophase metals can be greatly increased by nanostructuring, for example. On the other hand, the ductility and superplastic forming capabilities of nanophase ceramics have now become possible generically,

leading to new processing routes that will be more cost-effective than present methods. Nanoparticle fillers in metal, ceramic, or polymer matrices can yield a very wide range of nanocomposites with unique properties. This is an area that in some cases is just beginning to be researched seriously, but it could have huge technological impact in the future. Nanostructuring can also uniquely create both soft and hard magnetic materials with greatly improved performances. These materials are already having technological impact in the areas of low-loss magnets, high-hardness and tough cutting tools, and nanocomposite cements. Potential technological applications with high commercial impact can be expected in the areas of superplastic forming of ceramics, ultrahigh-strength and tough structural materials, magnetic refrigerants, a wide range of nanoparticle-filled polymer nanocomposites based on elastomers, thermoplastics and thermosets, and ductile cements.

In Chapter 7 Lynn Jelinski describes nanoparticles, nanostructured materials, and nanodevices from the point of view of biological applications and biological analogies. Current research directed toward biological synthesis and assembly is highlighted as it pertains to the building blocks of nanotechnology, and examples are presented of state-of-the-art research on the biological aspects of dispersions and coatings, high surface area materials, and functional nanostructures. A primary finding is that although biological applications of nanostructure science and technology may not be as well developed currently as non-biological ones, they nevertheless present a very promising research and development frontier that is likely to have tremendous future impact.

Funding and research programs in nanotechnology around the world are reviewed by Mike Roco in Chapter 8. It is noteworthy that these funding levels have been increasing very rapidly in recent years as the number of researchers worldwide who are excited about this field have multiplied and funding agencies have responded accordingly. The various ways in which nanostructure science and technology research is funded in the countries the panel surveyed had often appeared quite different from a distance, but are actually quite similar to one another at closer view. Some countries, most notably Japan, have tended to primarily fund their nanostructure research through large national programs, with a rather monolithic appearance from afar, centered at national laboratories or at major national universities. On the other hand, with some exceptions, most of the nanostructure research funding in the United States and Europe tends to be based upon competition among individual research groups for smaller amounts of support. In both types of nanostructure funding schemes, however, it seems that the individual researchers actually dominate how the work proceeds. In most cases, any significant interactions among researchers occur through normal personal and professional contacts; large-scale institutionalized cooperative

research efforts in this field have often not been particularly effective. A particularly impressive national funding effort in nanostructure science and technology occurs in France under the auspices of the Centre National de la Recherche Scientifique (CNRS). There, an extensive multidisciplinary network of laboratories in universities, industries, and national laboratories, funded partly by the CNRS and partly by industry, appear to interact successfully. It could be a very useful model to follow.

CONCLUSIONS

Table ES.2 (p. xvii) compares the current levels of activity of the major regions assessed in this WTEC study (Europe, Japan, and the United States), for the broad areas of synthesis and assembly, biological approaches and applications, dispersions and coatings, high surface area materials, nanodevices, and consolidated materials. These comparisons are, of course, integrals over rather large areas of a huge field and therefore possess all of the inevitable faults of such an integration. At best, they represent only a snapshot of the present. Nevertheless, the panel drew the following general conclusions. In the synthesis and assembly area, the United States appears to be somewhat ahead, with Europe and then Japan following. In the area of biological approaches and applications, the United States and Europe appear to be on a par, with Japan following. In nanoscale dispersions and coatings, the United States and Europe are again at a similar level, with Japan following. In the area of high surface area materials, the United States is clearly ahead of Europe, which is followed by Japan. On the other hand, in the nanodevices area, Japan seems to be leading quite strongly, with Europe and the United States following. Finally, in the area of consolidated nanomaterials, Japan appears to be a clear leader, with the United States and Europe following.

Nanostructure science and technology is clearly a very broad and interdisciplinary area of research and development activity worldwide. It has been growing explosively in the past few years, since the realization that creating new materials and devices from nanoscale building blocks could access new and improved properties and functionalities. While many aspects of the field existed well before nanostructure science and technology became a definable entity during the past decade, it has really only become a coherent field of endeavor through the confluence of three crucial technological streams:

1. new and improved control of the size and manipulation of nanoscale building blocks

2. new and improved characterization (e.g., spatial resolution, chemical sensitivity) of materials at the nanoscale
3. new and improved understanding of the relationships between nanostructure and properties and how these can be engineered

These developments have allowed for an accelerating rate of information transfer across disciplinary boundaries, with the realization that nanostructure scientists can and should borrow insights and techniques across disciplines, and for an increased access to common enabling tools and technologies. We are now at the threshold of a revolution in the ways in which materials and products are created. How this revolution will develop, and how great will be the opportunities that nanostructuring can yield in the future, will depend upon the ways in which a number of challenges are met.

Among the challenges facing nanostructure scientists and engineers in order for rapid progress to continue in this field are the necessary advances that must be made in several enabling technologies. We need to increase the capabilities in material characterization, be it in visualization or analytical chemistry, at ever finer size scales. We also need to be able to manipulate matter at finer and finer size scales, and we must eventually use computational approaches in directing this. Experiment simply cannot do it alone; theory and modeling are essential. Fortunately, this is an area in which the sizes of the building blocks and their assemblies are small enough that it is possible, with the ever increasing capabilities of computational sciences, to start doing very serious controlled modeling experiments to guide researchers in the nanostructuring of matter. Hence, multiscale modeling, across atomic, mesoscopic, and macroscopic length scales, of nanostructuring and the resulting hierarchical structures and material properties is an absolute necessity as we attempt in the coming decades to utilize the tremendous potential of nanostructure science and technology.

Another challenge is to fully understand the critical roles that surfaces and interfaces play in nanomaterials, owing to the very high specific surface areas of nanoparticles and the large areas of interfaces in the assembled nanophase forms. We need to know in detail not only the structures of these interfaces, but also their local chemistries and the effects of segregation and interaction between the nanoscale building blocks and their surroundings. We also need to learn more about the control parameters of nanostructure size and size distribution, composition, and assembly. For some applications of these building blocks, there are very stringent conditions on these parameters; in other applications considerably less so. We must therefore understand the relationships between the limits of this stringency and the desired material or device properties if efficient utilization of nanostructuring is to be achieved.

Since nanostructures are often inherently unstable owing to their small constituent sizes and high chemical activity, a further challenge is to increase the thermal, chemical, and structural stability of these materials and the devices made therefrom, in the various temperatures and chemistries of the environments in which the nanostructures are asked to function. A nanostructure that is only a nanostructure at the beginning of a process is not of much use unless the process is over in a very short time or unless the process itself is the actual nanostructure advantage. So, stability is a real concern in many applications. Researchers must determine whether natural stability or metastability is sufficient or if we must additionally stabilize against the changes that we cannot afford. Fortunately, it appears that many nanostructures possess either a deeply metastable structure or they can be readily stabilized or passivated using rather traditional strategies.

Reproducibility and scalability of nanoparticle synthesis and consolidation processes in nanostructuring are paramount for successful utilization of nanostructure research and development. What is accomplished in the laboratory must eventually benefit the society that pays the bills for the research, or the field will simply die. Also, significant enhancements in statistically driven process controls are required if we are to be able to effectively commercialize and utilize the nanostructuring of matter. New thinking is needed, not only about the materials, not only about the processing and assembly of these materials, but also about the manufacture of products from these materials and the economic impact of dealing with effluents. Given the commercial promise of net-shape forming of nanoscale ceramics, for example, the viability of such nanostructure production and utilization depends upon the total integrated costs of precursors or raw materials, synthesis of the building blocks, manufacturing of parts from those building blocks, and finally, disposition of the effluents. Higher than normal up-front costs for the nanoparticles or building blocks may be affordable if the processing steps save more than that. It is the total integrated costs, along with societal needs, that will determine commercial viability.

Education is also of tremendous importance to the future of the field of nanostructure science and technology. The creation of a new breed of researchers working across traditional disciplines and thinking "outside the box" is an absolute necessity for the field of nanostructure science and technology to truly reach fruition and to impact society with full force. The education of this new breed of researchers, who will either themselves work across disciplines or know how to work with others across disciplinary lines in the interfaces between disciplines, is necessary to make this happen in the future. People will need to start thinking in truly unconventional ways, if we are to take full advantage of this excitingly new and revolutionary field.

It appears that nanostructure science and technology at present resembles only the tip of a pyramid that has recently been uncovered from the sands of ignorance. As the new and expanding research community of nanostructure scholars worldwide digs away at these sands and uncovers more and more of the exciting field of nanostructure science and technology, we will eventually learn how truly important the field will have become and how great its impact will be on society. From our present vantage point, this future looks very exciting.

BIBLIOGRAPHY

1989

- Andres, R.P., R.S. Averback, W.L. Brown, L.E. Brus, W.A. Goddard, III, A. Kaldor, S.G. Louie, M. Moskovits, P.S. Peercy, S.J. Riley, R.W. Siegel, F. Spaepen, and Y. Wang. 1989. Research opportunities on clusters and cluster-assembled materials, a Dept. of Energy, Council on Materials Science, panel report. *Journal of Materials Research* 4:704-736.
- Gleiter, H. 1989. Nanocrystalline materials. *Progress in Materials Science* 33: 223-315.
- Kear, B.H., L.E. Cross, J.E. Keem, R.W. Siegel, F. Spaepen, K.C. Taylor, E.L. Thomas, and K.-N. Tu. 1989. *Research opportunities for materials with ultrafine microstructures*. Washington D.C.: National Academy, Vol. NMAB-454.

1990

- Rieke, P.C., P.D. Calvert, and M. Alper, eds. 1990. Materials synthesis utilizing biological processes. In *Mater. Res. Soc. Symp. Proc.* 174(1990).
- Stucky, G.D., and J.E. MacDougall. 1990. Quantum confinement and host/guest chemistry: Probing a new dimension. *Science* 247: 669-678.

1991

- Whitesides, G.M., J.P. Mathias, and C.T. Seto. 1991. Molecular self-assembly and nanochemistry: A chemical strategy for the synthesis of nanostructures. *Science* 254: 1312-1319.

1992

- Dagani, R. 1992. Nanostructured materials promise to advance range of technologies. *Chemical & Engineering News* (November 23): 18-24.
- Heuer, A.H., D.J. Fink, V.J. Laraia, J.L. Arias, P.D. Calvert, K. Kendall, G.L. Messing, J. Blackwell, P.C. Reike, D.H. Thompson, A.P. Wheeler, A. Veis, and A.I. Caplan. 1992. Innovative materials processing: A biomimetic approach. *Science* 255:1098-1105.

1993

- Siegel, R.W. 1993. Nanostructured materials—mind over matter. *Nanostructured Materials* 3: 1-18.

1994

- Hadjipanayis, G.C., and R.W. Siegel, eds. 1994. *Nanophase materials: Synthesis-properties-applications*. Dordrecht: Kluwer Press.
- Siegel, R.W. 1994. Nanophase materials. In *Encyclopedia of applied physics*, Vol. 11, G.L. Trigg, ed. Weinheim: VCH, pp. 1-27.

1995

Gleiter, H. 1995. Nanostructured materials: State of the art and perspectives.
Nanostructured Materials 6: 3-14.

1996

Edelstein, A.S., and R.C. Cammarata, eds. 1996. *Nanomaterials: Synthesis, properties and applications*. Bristol: IOP.

1998

Siegel, R.W., E. Hu, and M. C. Roco, eds. 1998. *R&D status and trends in nanoparticles, nanostructured materials, and nanodevices in the United States*. Baltimore: Loyola College, International Technology Research Institute. NTIS #PB98-117914.

Chapter 2

Synthesis and Assembly

Evelyn L. Hu

Univ. of California, Santa Barbara

David T. Shaw

State University of New York, Buffalo

INTRODUCTION

The common theme of this WTEC study is the engineering of materials with novel (i.e., improved) properties through the controlled synthesis and assembly of the material at the nanoscale level. The range of applications is extremely broad, and these will be described in further detail in subsequent chapters in this report. The corresponding means of synthesis and assembly are similarly wide-ranging. But however multifaceted the synthesis approaches and the ultimate applications, there are common issues and unique defining features of these nanostructured materials.

First, there is the recognition of critical scale lengths that define the material structure and organization, generally in the nanometer range, and that ultimately determine the fundamental macroscopic properties of the material. Research in nanostructured materials is motivated by the belief that ability to control the building blocks or nanostructure of the materials can result in enhanced properties at the macroscale: increased hardness, ductility, magnetic coupling, catalytic enhancement, selective absorption, or higher efficiency electronic or optical behavior.

Synthesis and assembly strategies accommodate precursors from liquid, solid, or gas phase; employ chemical or physical deposition approaches; and similarly rely on either chemical reactivity or physical compaction to integrate nanostructure building blocks within the final material structure. The variety of techniques is shown schematically in Figure 2.1.

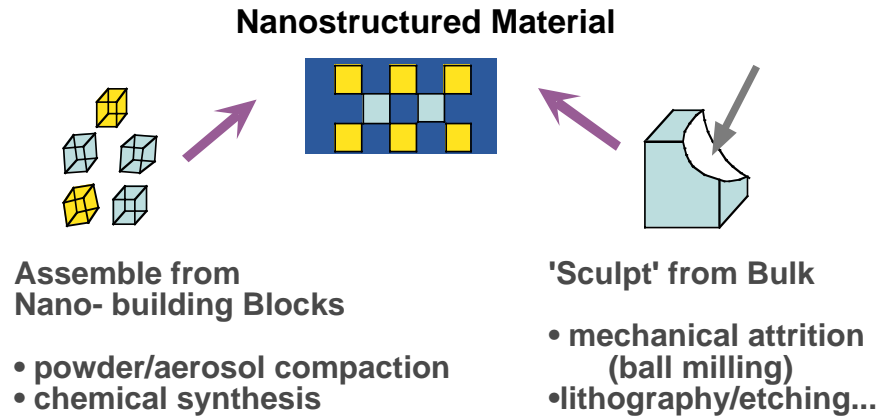

Figure 2.1. Schematic of variety of nanostructure synthesis and assembly approaches.

The “bottom-up” approach first forms the nanostructured building blocks and then assembles them into the final material. An example of this approach is the formation of powder components through aerosol techniques (Wu et al. 1993) and then the compaction of the components into the final material. These techniques have been used extensively in the formation of structural composite materials. One “top-down” approach begins with a suitable starting material and then “sculpts” the functionality from the material. This technique is similar to the approach used by the semiconductor industry in forming devices out of an electronic substrate (silicon), utilizing pattern formation (such as electron beam lithography) and pattern transfer processes (such as reactive ion etching) that have the requisite spatial resolution to achieve creation of structures at the nanoscale. This particular area of nanostructure formation has tremendous scope, warranting its own separate study, is a driving issue for the electronics industry, and will not be a principal theme of this study. Another top-down approach is “ball-milling,” the formation of nanostructure building blocks through controlled, mechanical attrition of the bulk starting material (Koch 1989). Those nano building blocks are then subsequently assembled into a new bulk material.

In fact, many current strategies for material synthesis integrate both synthesis and assembly into a single process, such as characterizes chemical synthesis of nanostructured materials (Murray et al. 1993; Katari et al. 1994). The degree of control required over the sizes of the nanostructure components, and the nature of their distribution and bonding within the fully formed material varies greatly, depending on the ultimate materials application. Achieving selective optical absorption in a material (e.g., UV-blocking dispersions) may allow a wide range of sizes of the component nanostructure building blocks, while quantum dot lasers or single electron

transistors require a far tighter distribution of size of the nanostructure components. Compaction methods may provide excellent adhesion for nanocomposite materials of improved structural performance (e.g., ductility), but such interfaces may be unsatisfactory for electronic materials.

The intention of this chapter of the report is not to recapitulate in detail the various synthesis and assembly techniques that have been and are being employed in the fabrication of nanostructured materials; that detail can be found in succeeding chapters as well as in excellent summary descriptions provided in the May 8-9, 1997 WTEC workshop proceedings (Siegel, Hu, and Roco 1998). Rather, in attempting to capture the salient features of a new impetus for and interest in a field of nanostructure science and technology, it is more useful to identify the emerging commonalities than the differences among synthesis and assembly approaches.

CRITICAL ISSUES FOR NANOSTRUCTURE SYNTHESIS AND ASSEMBLY

However broad the range of synthesis approaches, the critical control points fall into two categories:

1. control of the size and composition of the nanocluster components, whether they are aerosol particles, powders, semiconductor quantum dots, or other nanocomponents
2. control of the interfaces and distributions of the nanocomponents within the fully formed materials

These two aspects of nanostructure formation are inextricably linked; nevertheless, it is important to understand how to exercise separate control over the nucleation of the nanostructure building blocks and the growth (for example, minimizing coagulation or agglomeration) of those components throughout the synthesis and assembly process. This latter issue is related to the importance of the following:

- the chemical, thermal, and temporal stability of such formed nanostructures
- the ability to scale-up synthesis and assembly strategies for low-cost, large-scale production of nanostructured materials, while at the same time maintaining control of critical feature size and quality of interfaces (economic viability is a compelling issue for any nanostructure technology)

All researchers in this area are addressing these issues.

COMMON ENABLING TECHNOLOGIES

There has been steady technological progress in all fields of nanostructure synthesis and assembly, in no small part because of the more general availability of characterization tools having higher spatial, energy, and time resolution to clearly distinguish and trace the process of nanostructure formation. As transmission electron microscopy and X-ray diffraction techniques helped in an earlier period to relate the improved properties of “age-hardened” aluminum alloys to their nanostructure (Koch 1998), today’s technological advances in materials characterization are providing new insights into the role of the nanostructure in determining macroscopic properties. The tightly-coupled iteration between characterizing the nanostructure, understanding the relationship between nanostructure and macroscopic material properties (Figure 2.2), and improved sophistication and control in determining nanostructure size and placement have accelerated the rate of progress and helped to define the critical components of this “new” field of nanostructure science and technology. Tightly focused (1-2 μm), high brightness synchrotron X-ray sources provide detailed structural information on colloids, polymers, alloys, and other material structures, highlighting the inhomogeneities of the material with suitable spatial resolution (Hellemans 1998).

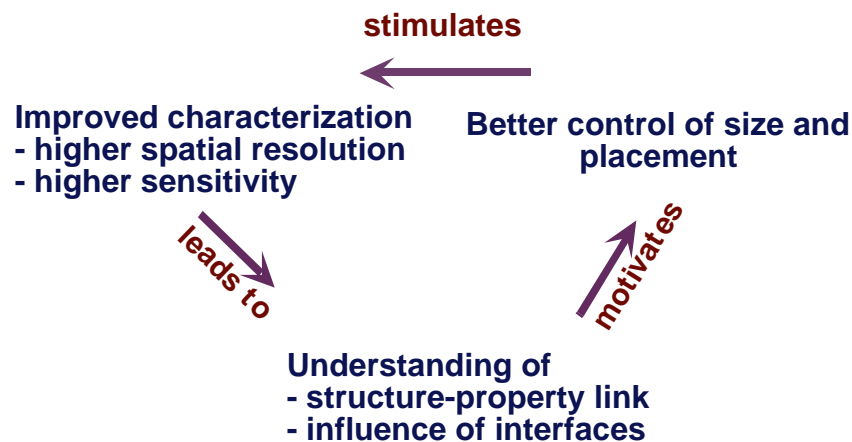

Figure 2.2. Interactive cycle of characterization, understanding and enhanced control in the synthesis and assembly of nanostructures.

Another important enabling technology has been the now widely available scanning probe technology, including scanning tunneling microscopy and atomic force microscopy. The power of these techniques has provided impetus for developing even higher performance scanning

probe tips, fabricated through microfabrication techniques. Development of different tip structures in various materials has given rise to an entire family of powerful scanning probe techniques that encompass such a wide range of characterization capabilities that one can envision “a laboratory on a tip” (Berger et al. 1996). The development of a tip technology also impacts the synthesis and assembly processes themselves: scanning probe technologies have been used as the basis of materials patterning and processing at nanometer scales (Held et al. 1997; Snow et al. 1997; and Wilder et al. 1997) and have provided information on the mechanical and thermal properties of materials at the nanoscale (Nakabeppu et al. 1995; Tighe et al. 1997; and Zhang et al. 1996).

More sophisticated in situ monitoring strategies have provided greater understanding and control in the synthesis of nanostructured building blocks, particularly those formed in vacuum environments. Molecular beam epitaxy (MBE) represents a physical vapor (gas phase) deposition technique where sub-monolayer control can be imposed on the formation of two-dimensional and, more recently, three-dimensional nanostructured materials (Leonard et al. 1993). A great deal of the understanding and control derives from the ability to carry out sensitive monitoring of the growth process in situ: reflection high energy electron diffraction (RHEED) details the nature of the surface and surface bonding, and oscillations of the RHEED intensity provide information on the growth rate (Neave et al. 1983).

The improvements brought about by these advances in technology have been substantial, but perhaps of greater importance for this nascent field of nanostructure science and technology has been the development of strategies and technologies that have been formed across the former disciplines. More reliable means of controlling nanostructure size and placement, with an end view of being able to scale up the production of such materials while maintaining the control over the nanostructure, have given impetus to a common search for novel synthesis and assembly strategies. In that search, it is apparent that the naturally occurring synthesis and assembly of biological materials can provide us with some critical insights.

NANOPARTICLE SYNTHESIS STRATEGIES

Gas Phase Synthesis and Sol-Gel Processing

Major efforts in nanoparticle synthesis can be grouped into two broad areas: gas phase synthesis and sol-gel processing. Nanoparticles with diameters ranging from 1 to 10 nm with consistent crystal structure, surface derivatization, and a high degree of monodispersity have been processed by

both gas-phase and sol-gel techniques. Typical size variances are about 20%; however, for measurable enhancement of the quantum effect, this must be reduced to less than 5% (Murray et al. 1993).

Initial development of new crystalline materials was based on nanoparticles generated by evaporation and condensation (nucleation and growth) in a subatmospheric inert-gas environment (Gleiter 1989; Siegel 1991, 1994). Various aerosol processing techniques have been reported to improve the production yield of nanoparticles (Uyeda 1991, Friedlander 1998). These include synthesis by combustion flame (Zachariah 1994, Calcote and Keil 1997, Axelbaum 1997, Pratsinis 1997); plasma (Rao et al. 1997); laser ablation (Becker et al. 1997); chemical vapor condensation (Kear et al. 1997); spray pyrolysis (Messing et al. 1994); electrospray (de la Mora et al. 1994); and plasma spray (Berndt et al. 1997).

Sol-gel processing is a wet chemical synthesis approach that can be used to generate nanoparticles by gelation, precipitation, and hydrothermal treatment (Kung and Ko 1996). Size distribution of semiconductor, metal, and metal oxide nanoparticles can be manipulated by either dopant introduction (Kyprianidou-Leodidou et al. 1994) or heat treatment (Wang et al. 1997). Better size and stability control of quantum-confined semiconductor nanoparticles can be achieved through the use of inverted micelles (Gacoin 1997), polymer matrix architecture based on block copolymers (Sankaran et al. 1993) or polymer blends (Yuan et al. 1992), porous glasses (Justus et al. 1992), and ex-situ particle-capping techniques (Majetich and Canter 1993; Olshavsky and Allcock 1997).

Other Strategies

Additional nanoparticle synthesis techniques include sonochemical processing, cavitation processing, microemulsion processing, and high-energy ball milling. In sonochemistry, an acoustic cavitation process can generate a transient localized hot zone with extremely high temperature gradient and pressure (Suslick et al. 1996). Such sudden changes in temperature and pressure assist the destruction of the sonochemical precursor (e.g., organometallic solution) and the formation of nanoparticles. The technique can be used to produce a large volume of material for industrial applications.

In hydrodynamic cavitation, nanoparticles are generated through creation and release of gas bubbles inside the sol-gel solution (Sunstrom et al. 1996). By rapidly pressurizing in a supercritical drying chamber and exposing to cavitation disturbance and high temperature heating, the sol-gel solution is mixed. The erupted hydrodynamic bubbles are responsible for nucleation, growth, and quenching of the nanoparticles. Particle size can be controlled

by adjusting the pressure and the solution retention time in the cavitation chamber.

Microemulsions have been used for synthesis of metallic (Kishida et al. 1995), semiconductor (Kortan et al. 1990; Pileni et al. 1992), silica (Arriagada and Osseo-Assave 1995), barium sulfate (Hopwood and Mann 1997), magnetic, and superconductor (Pillai et al. 1995) nanoparticles. By controlling the very low interfacial tension ($\sim 10^{-3}$ mN/m) through the addition of a cosurfactant (e.g., an alcohol of intermediate chain length), these microemulsions are produced spontaneously without the need for significant mechanical agitation. The technique is useful for large-scale production of nanoparticles using relatively simple and inexpensive hardware (Higgins 1997).

Finally, high energy ball milling, the only top-down approach for nanoparticle synthesis, has been used for the generation of magnetic (Leslie-Pelecky and Reike 1996), catalytic (Ying and Sun 1997), and structural (Koch 1989) nanoparticles. The technique, which is already a commercial technology, has been considered dirty because of contamination problems from ball-milling processes. However, the availability of tungsten carbide components and the use of inert atmosphere and/or high vacuum processes have reduced impurities to acceptable levels for many industrial applications. Common drawbacks include the low surface area, the highly polydisperse size distributions, and the partially amorphous state of the as-prepared powders.

Other Synthesis Issues

Means to Achieve Monodispersity

One of the most challenging problems in synthesis is the controlled generation of monodispersed nanoparticles with size variance so small that size selection by centrifugal precipitation or mobility classification is not necessary. Among all the synthesis techniques discussed above, gas-phase synthesis is one of the best techniques with respect to size monodispersity, typically achieved by using a combination of rigorous control of nucleation-condensation growth and avoidance of coagulation by diffusion and turbulence as well as by the effective collection of nanoparticles and their handling afterwards. The stability of the collected nanoparticle powders against agglomeration, sintering, and compositional changes can be ensured by collecting the nanoparticles in liquid suspension. For semiconducting particles, stabilization of the liquid suspension has been demonstrated by the addition of polar solvent (Murray et al. 1993); surfactant molecules have been used to stabilize the liquid suspension of metallic nanoparticles.

Alternatively, inert silica encapsulation of nanoparticles by gas-phase reaction and by oxidation in colloidal solution has been shown to be effective for metallic nanoparticles (Andres et al. 1998).

New approaches need to be developed for the generation of monodisperse nanoparticles that do not require the use of a size classification procedure. An example of this is a process developed in Japan where very monodispersed gold colloidal nanoparticles with diameters of about 1 nm have been prepared by reduction of metallic salt with UV irradiation in the presence of dendrimers (Esumi et al. 1998). Poly(amidoamine) dendrimers with surface amino groups of higher generations have spherical 3-D structures, which may have an effective protective action for the formation of gold nanoparticles. Although the specific role of dendrimers for the formation of monodispersed nanoparticles has yet to be defined, good monodispersity is thought to come from the complex reaction accompanying the decomposition of dendrimers, which eventually leads to the conversion of solution ions to gold nanoparticles.

Scaleup

Scaleup production is of great interest for nanoparticle synthesis. High energy ball milling, already a commercial high-volume process, as mentioned above, has been instrumental in generating nanoparticles for the preparation of magnetic, structural, and catalytic materials. However, the process produces polydispersed amorphous powder, which requires subsequent partial recrystallization before the powder is consolidated into nanostructured materials. Although gas-phase synthesis is generally a low production rate process (typically in the 100 milligrams per hour range) in research laboratories, higher rates of production (about 20 grams per hour) are being demonstrated at Ångström Laboratory at Uppsala University in Sweden (see Appendix C of this report). Even higher production rates (about 1 kg per hour) are now being achieved commercially. For sol-gel processing, the development of continuous processing techniques based on present knowledge of batch processing has yet to be addressed for economical scaleup production of nanoparticles. Other related sol-gel issues concern the cost of precursors and the recycling of solvent. Overall, sol-gel processing is attractive for commercial scale-up production.

Building Nanoparticle Chains or Wires

A recent paradigm shift envisioned for optoelectronics and computational devices involves the assembly of molecular or quantum wires (Chidsey and Murray 1986). Large polymeric molecules have been used as nano building

blocks for nanoporous molecular sieves, biocompatible materials, optical switching, data processing, and other nonlinear optical components. Chain aggregates of nanoparticles can be considered as polymer-like units with their primary particles composed of a few hundred to a few thousand molecules. Thus, these chain aggregates can be considered “heavy” quantum wires. In fact, nanoparticle chain aggregates have been studied extensively as magnetic materials (Zhang and Manthiram 1997), as reinforced elastomers (Pu et al. 1997), and as additives in concrete (Sabir 1997). These aggregates have been shown to have chemical and mechanical properties different from those of individual primary particles (Friedlander et al. 1998). Depending on the particle size and its compositional material, the bonding force responsible for holding the aggregates together varies from weak van der Waals force for micrometer particles to strong chemical bonds for nanometer particles to very strong magnetic dipolar bonds for nanosized magnetic particles. The mechanical, optical, and electronic transport properties can be varied by controlling the diameter and the monodispersity of the primary particles, the crystalline structure and morphology, aggregate length, interfacial properties, and material purity. These chain aggregates can be formed by allowing agglomeration of nanoparticles generated by any of the synthesis techniques discussed above, with the exception of high energy ball milling, which generates particles with low surface area and high anisotropic morphologies, both of which are detrimental for the formation of chain aggregates. Depending on the magnetic and electric charging properties of the nanoparticles, an external applied magnetic or electric field can be used to control the fractal dimension of aggregates. For optical applications of chain aggregates, lower fractal dimensions (i.e., relatively straight chain aggregates with few branches) are desirable.

Building Nanometer Fibers or Tubes

Recent advances in the fabrication of nanometer fibers or tubes offer another form of building blocks for nanostructured materials. An effective way to generate nanometer fibers (or tubes) is based on the use of membrane-template techniques (Martin 1994). Membranes, with nanochannels generated by fission-fragment tracks or by electrochemical etching of aluminum metal, are used as templates for either chemical or electrochemical deposition of conductive polymers (Pathasarathy and Martin 1994), metal (van de Zande et al. 1997), semiconductor (Klein et al. 1993), and other materials for the generation of nanofibers or tubes. Since the nanochannels on membranes are very uniform in size, the diameter and the aspect ratio of the nanofibers (or tubes) synthesized by the membrane-template technique can be precisely controlled. This greatly facilitates the

interpretation of optical data and the processing of these fibers (or tubes) into 2-D nanostructured materials (de Heer et al. 1995). Single-crystal semiconductor nanofibers can also be grown catalytically by metalorganic vapor phase epitaxy and laser ablation vapor-liquid-solid techniques (Hiruma et al. 1995; Morales and Lieber 1998). The synthesis of these one-dimensional structures with diameters in the range of 3 to 15 nm holds considerable technological promise for optoelectronic device applications, such as the p-n junctions for light emission at Hitachi Central Research Laboratory in Japan (see Appendix D of this report).

The advent of carbon-based nanotubes has created yet another way to fabricate nanometer fibers and tubes. These nanotubes have been used as templates for the fabrication of carbide and oxide nanotubes (Dai et al. 1995; Kasuga et al. 1998). Synthesis of nanotubes based on BN, BC₃ and BC₂N have also been reported (Chopra et al. 1995; Miyamoto et al. 1994). These nanotubes potentially possess large third-order optical non-linearity and other unusual properties (Xie and Jiang 1998). Metallic nanofibers synthesized by carbon-nanotube-template techniques are useful in the design of infrared absorption materials. The carbon nanotubes can now be catalytically produced in large quantities and have been used for reinforcement of nanostructural composite materials and concrete (Peigney et al. 1997).

BIOGENIC STRATEGIES

The elegant complexity of biological materials represents the achievement of structural order over many length scales, with the full structure developed from the “nested levels of structural hierarchy” (Aksay et al. 1992), in which self-assembled organic materials can form templates or scaffolding for inorganic components. These notions of a multilevel material structure with strong interactions among levels and an interplay of perfection and imperfection forming the final material was discussed earlier by Cyril Stanley Smith (1981). Along with characteristic length scales, there are characteristic relaxation times of the material, bringing in the consideration of the temporal stability of the structured materials (Zener 1948).

A more detailed discussion of the role of biological materials as both paradigm and tool for the fabrication of nanostructured materials is given in Chapter 7 of this report. It is interesting how many of the synthesis and assembly approaches seek out and adapt two key features of biogenic fabrication: that of “self-assembly,” and the use of natural nanoscaled templates.

Self-Assembly as a Deliberate Strategy

“Self-assembly” is a term that by now figures prominently in the literature of nanostructured materials and nanofabrication. The term therefore carries a variety of implicit or explicit meanings, and we cite the definition given by Kuhn and Ulman: “Self-assembly is a process in which supermolecular hierarchical organization is established in a complex system of interlocking components.” The mechanisms that produce the hierarchical organization are determined by competing molecular interactions (e.g., interactions between hydrophobic versus hydrophilic components, van der Waals, Coulombic, or hydrogen bonding), resulting in particular microphase separation or surface segregation of the component materials. Thus, the use of a hierarchy of bond strengths and/or chemical specificity can produce a hierarchy of lengths in the final nanostructured material (Muthukumar et al. 1998; Stupp and Braun 1998).

As one example of such self-assembled or self-organized materials, McGehee et al. (1994) have mixed silica precursors with surfactants that have self-ordered to form various surfactant-water liquid crystals, producing various structures built from walls of amorphous silica, organized about a repetitive arrangement of pores up to a hundred angstroms in diameter. A range of such structures is shown in Figure 2.3. In the “natural” formation of inorganic nanostructures, the addition of organic molecules can strongly influence the resulting structure of inorganic components. Such strategies have been adopted in synthetic formation of nanostructures, such as in the formation of networks of gold clusters (Andres et al. 1998).

Gold clusters 3.7 nm in diameter, formed in the vapor phase, are encapsulated in organic surfactants, such as dodecanethiol, forming a colloidal suspension. The surfactants prevent the agglomeration of the gold clusters. Addition of small amount of dithiol precipitates out a 3-D cluster network, which can in turn be deposited onto another solid substrate. Figure 2.4 shows a transmission electron microscope (TEM) image of a cluster array spin-cast onto MoS₂.

The methodology of self-assembly has even been extended to physical vapor deposition processes where it would seem more difficult to control the nucleation and growth of three-dimensional nanostructures. Utilizing the strain inherent in the epitaxial growth of lattice-mismatched materials, and the expected strain-induced transition from two-dimensional (layered) to three-dimensional (islanded) growth, together with careful monitoring of the growth process through RHEED analysis, researchers have been able to form arrays of semiconductor quantum dots, ~200-300 Å in diameter, ~10¹¹ cm⁻² in density, and with a size variation of about ±7% (Leonard et al. 1993). An example of such “self-assembled” semiconductor quantum dots is shown in

Figure 2.5. The achievement of arrays of several billions of quantum dots of these dimensions with such a size variation is beyond the capability of standard high resolution lithographic and pattern transfer processes. Moreover, the controlled formation of critical surfaces and interfaces without the intercession of ion-assisted processing that can introduce potential defects into the materials has produced a rich source of optically and electronically efficient quantum structures. A number of researchers have already incorporated such self-assembled dots into laser structures (Bimberg et al. 1998).

Chemical specificity may provide the most robust means of ensuring control of size and placement of nanostructured building blocks, and recent work in the synthesis of compound semiconductor quantum dots from chemical precursors have provided even tighter distributions of size variation ($\pm 5\%$) than those shown in the strain-induced self-assembled dots (Katari et al. 1994; Murray et al. 1993). The size-dependent and energy-selective optical absorption properties of such chemically synthesized quantum dots are shown in Figure 2.6.

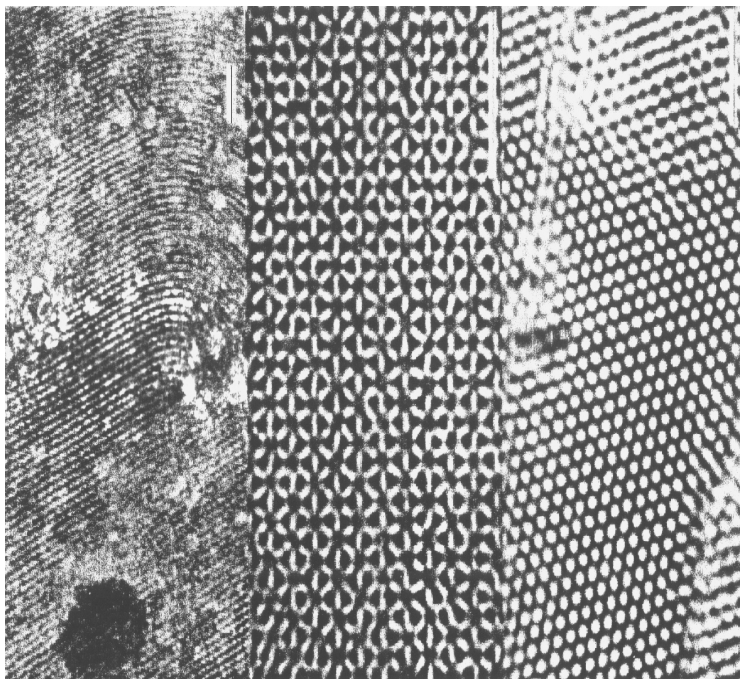

Figure 2.3. TEM images of (a) the lamellar morphology, (b) the cubic phase with Ia3d symmetry viewed along its [111] zone axis, and (c) the hexagonal phase viewed along its [001] zone axis of the silica/surfactant nanostructured composites by co-assembly (McGehee et al. 1994) (bars = 30 nm).

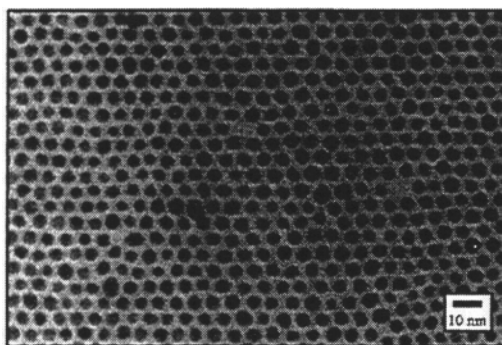

Figure 2.4. TEM image of unlinked cluster array of 3.7 nm Au clusters encapsulated by dodecanethiol (Andres et al. 1998).

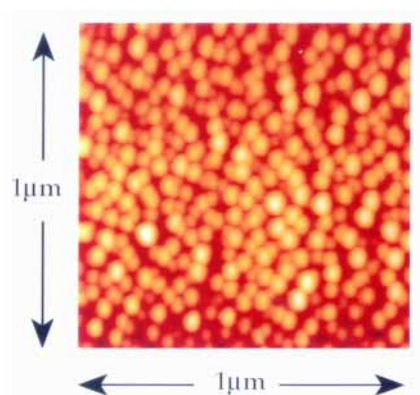

Figure 2.5. Array of InAs quantum dot structures grown on GaAs substrates (Mirin et al. 1996).

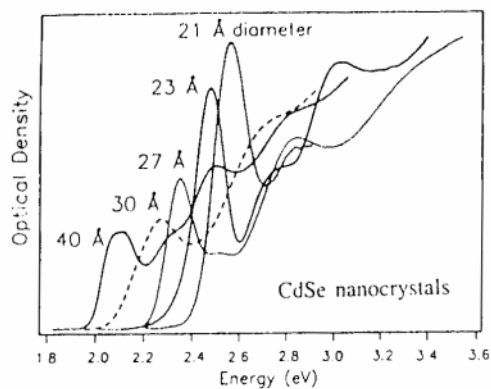

Figure 2.6. Variation of optical transparency with diameter of chemically synthesized CdSe nanocrystals (Alivisatos 1996).

Natural Templates or “Scaffolds”

Biogenic systems employ natural templates or scaffolding in the construction of nanoscaled materials, where the templates and scaffolding can help set the proper, critical dimensions that are characteristic of the final material. The templates can be formed “artificially,” through the use of lithographically defined patterning and processing of the substrate material in order to achieve selective nucleation and growth of the nanostructured materials. However, there are also a host of “natural” templating materials that researchers can avail themselves of. The zeolites have for a long time been utilized as the basis of high surface area materials that enable catalysis. Recent work has taken these natural cage structures and formed large cage structures with varying pore sizes (Estermann et al. 1991; Ying and Sun 1997; Bu et al. 1998). When zeolite cages are “loaded” with various materials, the controlled proximity enforced by the cage structure can result in various magnetically active or nonlinear optical materials. More recently, the C-based fullerenes and C-nanotubes have provided a tremendously rich basis for nanostructure research; the impact of such materials is further described in Chapters 4 and 5. The by now “easy” formation of such structures and ready availability of such materials provide a rich source of nanostructures with nearly immediate applications for electronic devices, storage, and enhancement of structural materials. Further, these materials can serve as the nanostructured precursors of nanostructure synthesis approaches (such as the starting material for cluster or aerosol deposition), or can provide an avenue for the synthesis of templates of varying sizes. Such templates can be electronically “doped” and filled with other materials. Recent work reported the synthesis of “nanorods” of GaN through confined reactions in carbon nanotubes (Han et al. 1998).

OUTSTANDING ISSUES: OPPORTUNITIES AND CHALLENGES

The broad explorations of this WTEC study have shown a great diversity of impressive work on nanostructured materials. One could argue that many aspects of the work on nanostructured materials have been long-established efforts, with well-developed techniques that have been brought forth into the manufacturing arena. How do we then explain the current excitement and interest in nanostructured materials as a promising new endeavor? Part of the answer lies in the recognition of common scientific issues and common enabling technologies that link this group of researchers together. Ready availability of ever more sophisticated characterization methods that allow

us to visualize and probe materials at the nanoscale has accelerated the pace of activities in this field; at the same time, recognition of the common critical issues of control over nanostructure size and placement motivates sharing of solutions over the boundaries of conventional disciplines. Thus, some of the most exciting findings of this study manifest the cross-fertilization of techniques and ideas; for example, aerosol particles are being integrated with more traditionally fabricated electronic nanostructures, with placement achieved through the manipulation of STM tips, in order to explore ideas of electronic device enhancement at the nanostructure level (Junno et al. 1998). A sample structure is shown in Figure 2.7. The ordered assembly of diblock copolymers define three-dimensional nanostructures, and those structures are transferred into electronic (semiconductor) substrates through high resolution pattern transfer processes (Möller 1998).

Recognizing the need for effective utilization of ideas across disciplines brings the responsibility of establishing the educational infrastructure that will adequately train young scientists to more fully develop the concepts and applications of nanostructured materials in the future. Such an infrastructure will require researchers and educators who are familiar with the properties of a broad range of materials, including polymers, biomolecular materials, metals, ceramics, and semiconductors. It will benefit from an informed perspective on critical applications, and must provide access to a wide range of synthesis and assembly techniques and characterization methods that currently reside separately in the disciplines of physics, chemistry, electrical engineering, biology, etc. Finally, a critical enabler for the future of this field and for its educational infrastructure is further development of computational tools that encompass the full range of atomistic calculations to macroscopic materials properties. This will require a “systems approach” (Olson 1997) that will span a variety of different computational models, addressing the different critical length scales, starting with solutions of the Schrodinger and Poisson equations, solving interatomic forces, and scaling all the way up to simulations of macroscopic properties and behavior (Goddard 1998).

Increased appreciation of and access to the diverse means of nanoparticle synthesis and assembly that have been developed within many different disciplines, and a common development of enabling tools and technologies, will enhance the pace of accomplishments in this new area of nanoscale synthesis and assembly.

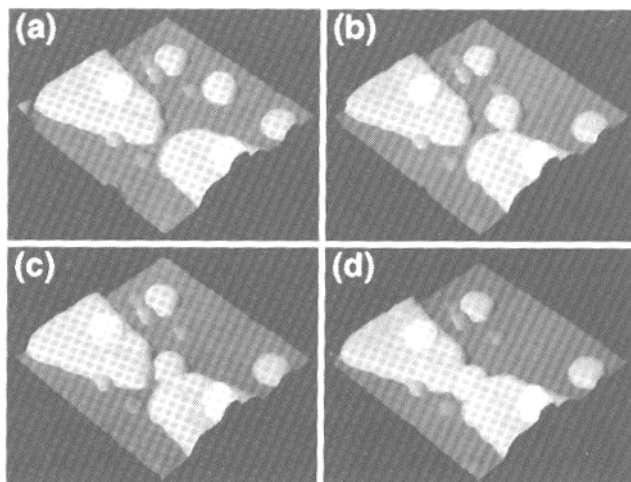

Figure 2.7. A sequence of 670 nm by 670 nm AFM images taken during the manipulation of a 50 nm Au particle into the gap between two Au/Ti electrodes (Junno et al. 1998).

REFERENCES

- Aksay, I.A., et al., eds. 1992. Hierarchically structured materials. *MRS Proceeding 255*.
- Alivisatos, A.P. 1996. Perspectives on the physical chemistry of semiconductor nanocrystals. *Journal of Physical Chemistry* 100:13226-13239.
- Andres, R.P., S. Datta, D.B. Janes, C.P. Kubiak, and R. Reifenberger. 1998. The design, fabrication and electronic properties of self-assembled molecular nanostructures. In *The handbook of nanostructured materials and nanotechnology*, ed. H.S. Nalwa. San Diego: Academic Press.
- Arriagada, F.J., and K. Osseo-Asave. 1995. *J. Colloid Interface Sci.* 170:8.
- Axelbaum, R.L. 1997. Developments in sodium/halide flame technology for the synthesis of unagglomerated non-oxide nanoparticles. In *Proc. of the Joint NSF-NIST Conference on Nanoparticles: Synthesis, Processing into Functional Nanostructures and Characterization* (May 12-13, Arlington, VA).
- Becker, M.F., J.R. Brock, H. Cai, N. Chaudhary, D. Henneke, L. Hilsz, J.W. Keto, J. Lee, W.T. Nichols, and H.D. Glicksman. 1997. Nanoparticles generated by laser ablation. In *Proc. of the Joint NSF-NIST Conf. on Nanoparticles*.
- Berger, R., C. Gerber, H.P. Lang, and J.K. Gimzewski. 1996. Micromechanics: a toolbox for femtoscale science: "Towards a laboratory on a tip." *Microelectronic Engineering*, 35:373-9. (International Conference on Micro- and Nanofabrication, Glasgow, U.K., 22-25 Sept. 1996). Elsevier.
- Berndt, C.C., J. Karthikeyan, T. Chraska, and A.H. King. 1997. Plasma spray synthesis of nanozirconia powder. In *Proc. of the Joint NSF-NIST Conf. on Nanoparticles*.
- Bimberg, D., N. Kirstaedter, N.N. Ledentsov, Zh.I. Alferov, P.S. Kopev, and V.M. Ustinov. 1998. InGaAs-GaAs quantum-dot lasers. *IEEE J. of Selected Topics in Quant. Electronics* 3:196-205.

- Brotzman, R. 1998. Nanoparticle Dispersions. In *R&D status and trends*, ed. Siegel et al.
- Bu, X., P. Feng, and G.D. Stucky. 1998. Large-cage zeolite structures with multidimensional 12-ring channels. *Science* 278:2080-2085.
- Calcote, H.F., and D.G. Keil. 1997. Combustion synthesis of silicon carbide powder. In *Proc. of the Joint NSF-NIST Conf. on Nanoparticles*.
- Chidsey, E.E.D., and R.W. Murray. 1986. *Science*, 231: 25.
- Chopra, N.G., R.J. Luyken, K. Cherrey, H. Crespi, M.L. Cohen, S.G. Louie, and A. Zettl. 1995. *Science* 269:966.
- Dai, H., E.W. Wong, Y.Z. Lu, S. Fan, and C.M. Leiber. 1995. *Nature* 375:769.
- deHeer, W.A., W.S. Bacsá, A. Chatelain, T. Gerfin, R. Humphrey-Baker, L. Forro, and D. Ugarte. 1995. *Science* 268:845.
- de la Mora, J.F., I.G. Loscertales, J. Rosell-Llompart, K. Serageldin, and S. Brown. 1994. Electro spray atomizers and ultrafine particles. In *Proc. Joint NSF-NIST Conf. on UltraFine Particle Engineering* (May 25-27, 1994, Arlington, VA).
- Estermann, M., L.B. McCusker, C. Baerlocher, A. Merrouche, and H. Kessler. 1991. *Nature* 331:698.
- Esumi, A., A. Suzuki, N. Aihara, K. Usui, and K. Torigoe. 1998. *Langmuir*, 14:3157.
- Friedlander, S.K. 1998. Synthesis of nanoparticles and their agglomerates: aerosol reactors. In *R&D status and trends*, ed. Siegel et al.
- Friedlander, S.K., H.D. Jang, and K.H. Ryu. 1998. *Appl. Phys. Lett.* 72(2):173.
- Gacoin, T., L. Malier, and J.P. Boilot. 1997. *Chem. Mater.* 9:1502.
- Gleiter, H. 1989. *Prog. Mater. Sci.* 33:223.
- Goddard, W.A. 1998. Nanoscale theory and simulation. In *R&D status and trends*, ed. Siegel et al.
- Han, W., S. Fam, O. Li, and Y. Hu. 1998. Synthesis of gallium nitride nanorods through a carbon nanotube-confined reaction. *Science* 277:1287-1289.
- Held, R., T. Heinzel, A.P. Studerus, K. Ensslin, and M. Holland. 1997. Semiconductor quantum point contact fabricated by lithography with an atomic force microscope. *Appl. Phys. Lett.* 71:2689-91.
- Hellemans, A. 1998. X-rays find new ways to shine. *Science* 277:1214-15.
- Higgins, R.J. 1997. An economical process for manufacturing of nano-sized powders based on microemulsion-mediated synthesis. In *Proc. of the Joint NSF-NIST Conf. on Nanoparticles*.
- Hiruma, K., M. Yazawa, T. Katsoyama, K. Ogawa, K. Haraguchi, M. Koguchi, and H. Kakibayashi. 1995. *J. Appl. Phys.* 77(2):476.
- Hopwood, J., and S. Mann. 1997. *Chem. Mater.* 9:1819.
- Junno, T., S.-B. Carlsson, H. Xu, L. Montelius, and L. Samuelson. 1998. Fabrication of quantum devices by angstrom-level manipulation of nanoparticles with an atomic force microscope. *Appl. Phys. Lett.* 72:548-550.
- Justus, B.L., R.J. Tonucci, and A.D. Berry. 1992. *Appl. Phys. Lett.* 61:3151.
- Kasuga, T., M. Hiramatsu, A. Hoson, T. Sekino, and K. Niihara. 1998. *Langmuir* 14:3160.
- Katari, J.E.B., V.L. Colvin, and A.P. Alivisatos. 1994. *J. Phys. Chem.* 98:4109.
- Kear, B.H., R.K. Sadangi, and S.C. Liao. 1997. Synthesis of WC/Co/diamond nanocomposites. In *Proc. of the Joint NSF-NIST Conf. on Nanoparticles*.
- Kishida, M., T. Fujita, K. Umakoshi, J. Ishiyama, H. Nagata, and K. Wakabayashi. 1995. *Chem. Commun.* 763.
- Klein, J.D., et al. 1993. *Chem. Mater.* 5:902.
- Koch, C.C. 1989. Materials synthesis by mechanical alloying. *Annual Review of Mater. Sci.* 19:121-143.
- Koch, C.C. 1998. Bulk behavior. In *R&D status and trends*, ed. Siegel et al.

- Kortan, A.R., R. Hull, R.L. Opila, M.G. Bawendi, M.L. Steigerwald, P.J. Carroll, and L.E. Brus. 1990. *J. Am. Chem. Soc.* 112:1327.
- Kyprianidou-Leodidou, T., W. Caseri, and V. Suter. 1994. *J. Phys. Chem.* 98:8992.
- Kung, H.H., and E.I. Ko, 1996. *Chem. Eng. J.* 64:203.
- Leonard, D., M. Krishnamurthy, C.M. Reaves, S.P. Denbaars, and P.M. Petroff. 1993. Direct formation of quantum-sized dots from uniform coherent islands of InGaAs on GaAs surfaces. *Appl. Phys. Lett.* 63:3203-5.
- Leslie-Pelecky, D.L., and R.D. Reike. 1996. *Chem. Mater.* 8:1770.
- Majetich, S.A. and A.C. Canter. 1993. *J. Phys. Chem.* 97:8727.
- Martin, C.R. 1994. *Science*, 266:1961.
- McGehee, M.D., S.M. Gruner, N. Yao, C.M. Chun, A. Navrotsky, and I.A. Aksay. 1994. Synthesis of mesoscopic structures by co-assembly. In *Proc. 52nd Annual Mtg. MSA*, ed. G.W. Bailey and A.J. Garret-Reed. San Francisco: San Francisco Press.
- Messing, G.L., S. Zhang, U. Selvaraj, R.J. Santoro, and T. Ni. 1994. Synthesis of composite particles by spray pyrolysis. In *Proc. of the Joint NSF-NIST Conf. on Ultrafine Particle Engineering* (May 25-27, Arlington, VA).
- Möller, M. 1998. Ultrathin and micellar block copolymer films for nanopatterning. *Bull. of the Amer. Phys. Soc.* 43:143.
- Mirin, R., A. Gossard, and J. Bowers. 1996. Room temperature lasing from InGaAs quantum dots. *Elect. Lett.* 32:1732-34.
- Miyamoto, Y., A. Rubio, S.G. Louie, and M.L. Cohen. 1994. *Phys. Rev. B.*, 50:18360.
- Morales, A.M., and C.M. Lieber. 1998. *Science* 279:208.
- Murray, C.B., D.J. Norris, and M.G. Bawendi. 1993. *J. Am. Chem. Soc.* 115:8706.
- Muthukumar, M., C.K. Ober, and E.L. Thomas. 1998. Competing interactions and levels of ordering in self-organizing polymeric materials. *Science* 277:1225-1232.
- Nakabeppu, O., M. Chandrachood, Y. Wu, J. Lai, and A. Majumdar. 1995. Scanning thermal imaging microscopy using composite cantilever probes. *Appl. Phys. Lett.* 66:694-6.
- Neave, J.H., B.A. Joyce, P.J. Dobson, and N. Norton. 1983. *Appl. Phys.* A31:1.
- Olshavsky, M.A., Allcock, H.R. 1997. *Chem. Mater.* 9:1367.
- Olson, G.B. 1997. Computational design of hierarchically structured materials. *Science* 277: 1237-1242.
- Pathasarathy, R., and C.R. Martin. 1994. *Nature* 369:298.
- Peigney, A., C.H. Laurent, and A. Rousset. 1997. *Key Eng. Mater.*, 132-136:743.
- Pileni, M.P., L. Motte, and C. Petit. 1992. *Chem. Mater.* 4:338.
- Pillai, V., P. Kumar, M.J. Hou, P. Ayyub, and D.O. Shah. 1995. *Adv. in Colloid and Interface Sci.* 55:241.
- Pratsinis, S.E. 1997. Precision synthesis of nanostructured particles. In *Proc. of the Joint NSF-NIST Conf. on Nanoparticles*.
- Pu, Z., J.E. Mark, J.M. Jethonalani, and W.T. Ford. 1997. *Chem. Mater.* 9:2442.
- Rao, N.P., N. Tymiak, J. Blum, A. Neuman, H.J. Lee, S.L. Girshick, P.H. McMurry, and J. Heberlein. 1997. Nanostructured materials production by hypersonic plasma particle deposition. In *Proc. of the Joint NSF-NIST Conf. on Nanoparticles*.
- Sabir, B.B. 1997. *Mag. of Concrete Research* 49(179):139.
- Sankaran, V., J. Yue, R.E. Cahen, R.R. Schrock, and R.J. Silbey. 1993. *Chem. Mater.* 5:1133.
- Siegel, R.W. 1991. *Ann. Rev. Mater. Sci.* 21:559.
- Siegel, R.W. 1994. *Physics of new materials*. F.E. Fujita (ed.), Springer Series in Materials Science, Vol. 27, Berlin: Springer.

- Siegel, R.W., E. Hu, and M.C. Roco, eds. 1998. *R&D status and trends in nanoparticles, nanostructured materials, and nanodevices in the United States*. Baltimore: Loyola College, International Technology Research Institute. NTIS #PB98-117914.
- Smith, C.S. 1981. *A search for structure*. Cambridge, Mass.: MIT Press.
- Snow, E.S., P.M. Campbell, and F.K. Perkins. 1997. Nanofabrication with proximal probes. *Proceedings of the IEEE* 85:601-11.
- Stupp, S., and P.V. Braun. 1997. Molecular manipulation of microstructures: biomaterials, ceramics, and semiconductors. *Science* 277:1242-1248.
- Sunstrom, J.E., IV, W.R. Moser, and B. Marshik-Guerts. 1996. *Chem. Mater.* 8:2061.
- Suslick, K.S., T. Hyeon, and F. Fang. 1996. *Chem. Mater.* 8:2172.
- Tighe, T.S., J.M. Worlock, and M.L. Roukes. 1997. Direct thermal conductance measurements on suspended monocrystalline nanostructures. *Appl. Phys. Lett.* 70:2687-9.
- Uyeda, R. 1991. *Prog. in Mater. Sci.* 35:1.
- Van de Zande, B.M.I., M.R. Bohmer, L.G.J. Fokkink, and C. Shonenberger. 1997. *J. Phys. Chem.* 101:852.
- Wang, C.C., Z. Zhang, and J.Y. Ying. 1997. *Nanostructured Mater.* 9:583.
- Wilder, K., H.T. Soh, T. Soh, A. Atalar, and C.F. Quate. 1997. Hybrid atomic force/scanning tunneling lithography. *J. of Vacuum Science & Technol. B.* 15:1811-17.
- Wu, M.K., R.S. Windeler, C.K. Steiner, T. Bors, and S.K. Friedlander. 1993. Controlled synthesis of nanosized particles by aerosol processes. *Aerosol Sci. Technol.* 19: 527.
- Xie, R.H., and J. Jiang. 1998. *J. Appl. Phys.* 83(6):3001.
- Ying, J.Y., and T. Sun. 1997. Research needs assessment on nanostructured catalysts. *J. of Electroceramics* 1:219-238.
- Yuan, Y., J. Fendler, and I. Cabasso. 1992. *Chem. Mater.* 4:312.
- Zachariah, M.R. 1994. Flame processing, in-situ characterization, and atomistic modeling of nanoparticles in the reacting flow group at NIST. In *Proc. of the Joint NSF-NIST Conf. on Ultrafine Particle Engineering* (May 25-27, Arlington, VA).
- Zener, C. 1948. *Elasticity and anelasticity of metals*. Chicago: University of Chicago Press.
- Zhang, Z., M.L. Roukes, and P.C. Hammel. 1996. Sensitivity and spatial resolution for electron-spin-resonance detection by magnetic resonance force microscopy. *J. of Appl. Phys.* 80:6931-8.
- Zhang, L., and A. Manthiram. 1997. *Appl. Phys. Lett.* 70(18):2469.

Chapter 3

Dispersions and Coatings

John Mendel
Eastman Kodak

INTRODUCTION

The object of the controlled assembly of nanoparticulates is to make materials with new properties and assemble them with practical applications. A unique value of nanoparticulates is their extremely high particle surface area; having many more sites for achieving property enhancements makes them ideal for a wide variety of applications as dispersions and coatings. Dispersive and coating applications of nanoparticles include optical, thermal, and diffusion barriers. Significant work on nanoscale dispersions and coatings is underway worldwide in the areas of ceramics, cosmetics, biosensors, colorants, and abrasion-resistant polymers. Other applications include imaging ink jet materials, electrophotography, pharmaceuticals, flavor enhancers, pesticides, lubricants, and other proprietary applications specific to industry. Still another application is in a new, post-silicon generation of electronic devices that includes nanotubes and fullerenes as constituent units of carbon nanoelectronic devices; here, dispersion takes on a more quantum consideration in which the number of atoms in a cluster is compared to the number of surface atoms to determine its dispersion function. Also in the semiconductor industry, a monolayer or thin film coating of atoms or molecules is deposited on foils, metal sheets, or glass to enhance storage capacity and accelerate responses from the electronic component.

All these applications deal with dispersions or coatings of particles that enhance specific features. Also, ability to manufacture smaller functional systems enhances performance, cost, and efficiency. These considerations power the drive towards miniaturization and precision finishing.

PROPERTY AMPLIFICATION

What's particularly exciting in the study of nanoparticles, nanostructured materials, and nanodevices is their ability to also add value to materials and products through enhancement of specific properties, such as the following:

- Mechanical strength. Nanostructured powders have been produced by plasma processing where the reactor vaporizes coarse metal particles (Froes 1998, 105-6); by combustion synthesis where redox reactions take place at elevated temperatures, followed by quenching; and by mechanical alloying with gas atomization. When nanocrystalline powders achieved by these means are compacted and applied as a coating, they lend significant strength and ductility to a variety of conventional materials such as ceramic, composites, and metal alloys.
- Superconductivity. Brus (1996) describes the nature of the superconductivity effect in detail. It involves a deposition of nanocrystals on substrates, leading to improved optical and electrical properties.
- Covering power. Because nanostructuring increases the number of active sites—there are many more atoms per grain boundary—the enhanced surface area leads to a reduced material requirement, which in turn can lower cost (Solomaon and Hawthorne 1983).
- Ability to incorporate high cost materials. Expensive materials such as colorants and drugs may be effectively dispersed in small and controlled quantities through nanostructuring (Schnur 1994).
- Environmental value. Improvements in environmental impact are achieved by utilizing nanostructure particulates in coatings and thus eliminating the requirement for toxic solvents. By eliminating hazardous wastes, nanocoatings can both reduce a company's disposal costs and improve its environmental position.

Thus, nanostructured dispersions and coatings can significantly reduce material costs and improve performance and functionality in a large variety of applications. In all of the sites the WTEC panel visited in Europe, Russia, and Japan, research groups were interested in achieving one or more of the properties listed above.

ENABLERS

For nanoparticulate dispersions and coatings, certain enablers must be present to achieve success: (1) effective particle preparation, (2) stabilization of the dispersed phase, (3) scaleup and control of the process, and (4) the

existence of excellent analytical capabilities. The main methods or issues for each are described below.

1. Particle preparation. Wet chemical methods such as liquid phase precipitation or sol-gel methods are of high interest in particle preparation (Friedlander 1993). In the area of hybrid methods, both spray pyrolysis and flame hydrolysis are utilized. Numerous physical methods such as mechanical size reduction are also often employed.

2. Stabilization of the dispersed phase. For stabilization of the dispersed phase, it is necessary to understand how particles can be kept as distinct entities. Either a charged stabilized system or a sterically stabilized approach is required. A successful preparation for use as a dispersion should be free from agglomeration in the liquid state so as to maintain particle integrity. The dry-coated format of nanoparticles should also minimize any presence of particle aggregation

3. Scaleup and control of the process. The scaleup and control of nanoparticle processing is well described by Kear (1998). Here, the issue in achieving a high rate of production of powder is the effective pyrolysis of the gas stream containing the precursor. Issues such as scaling and reproducibility from one run of nanoparticle material or dispersions to another are all inherent in the concept of precision engineering or invariant process control.

4. Analytical capabilities. Analytical capabilities are absolutely essential for characterizing dispersions and coatings (Angstrom 1995). Particle size determinations, assay analysis, and interfacial properties are all important. Transmission electron microscopes, atomic force microscopy, nuclear magnetic resonance, and scanning tunneling microscopy are just some of the tools utilized in characterizing nanoparticle dispersions and coatings, particularly at the very small end of the nanoscale.

APPLICATIONS

Below are some general examples of the vast array of applications of nanoparticulate dispersions and coatings. There are a number of applications in all of the categories below that are already in the public domain; however, most are still highly proprietary, especially drug delivery applications.

Cosmetics. An area of nanoparticle technology that has incredible commercial potential is the cosmetic industry (Crandall 1996, 251-267). Here there is a great demonstrated demand, and the technology can be made simple, since properties of color and light fastness are achieved by component mixing in the cosmetic preparation. A survey in 1990 indicated a worldwide gross volume of \$14-18 billion for toiletries (Crandall 1996, 61),

i.e., traditional hygiene products such as powders, sprays, perfumes, and deodorants. The large markets for sunscreens and skin rejuvenation preparations promise additional revenues.

The diet industry is said to gross \$33 billion annually (Crandall 1996, 61). One way that nanoparticle technology is addressing this market is through introducing nanoparticulate taste enhancers into low-calorie substrates.

Medicine/Pharmacology. In the area of medical applications, finely dispersed pharmaceuticals offer rapid drug delivery and reduced dosages for patients (POST 1995). Dispersions of strong and resilient biocompatible materials suggest opportunities for artificial joints. These generally are ceramic materials containing nanoparticulates.

Overall, much of the demand for nanoparticulate dispersions and coatings comes from the cosmetic and pharmaceutical industries; in particular, liquid dispersion preparations will be widely used to apply topical coatings to the human epidermis because they can be absorbed faster and more completely than conventional coatings.

Microelectromechanical systems (MEMS). Although MEMS technologies will support the semiconductor industry in particular, there are many other applications being explored, such as in medicine, ceramics, thin films, metal alloys, and other proprietary applications. In the United States a particular focus is applying sputtering coatings to achieve MEMS technology in concert with these applications.

Printing. In the areas of image capture/image output addressed by ink jet technology, nanoscience can help control the properties of the inks themselves. The production and use of nanoengineered ink products benefits from such complimentary technology as laser-assist delivery of the ink jet droplet to maintain an accurate deposit of the ink on its target (POST 1996). Another application in this field is using nanoscale properties to tailor the inks to achieve ideal absorption and drying times for desired color properties and permanency.

Semiconductors. One form of “bottom up” technology that is receiving considerable attention is thin films for the semiconductor industry (POST 1996). Here single atoms or molecules are deposited by physical vapor deposition, which could be achieved through sputtering, molecular beam epitaxy, or chemical vapor deposition. Sputtering is used on a large scale to coat metal sheets, glass, polymer substrates and other receptive materials in order to produce enhanced electronic properties for information storage and processing speed.

Sensors. Chemical or physical sensors often use nanoparticles because they provide high surface area for detecting the state of chemical reactions, because the quality of detection signals is improved, and because earlier and

more accurate determination of leakage reduces waste. Some commercial sensors and actuators composed of thin films are already used for environmental vapor monitoring in reactors, for example.

Other likely applications of nanotechnology involving dispersions and coatings include nanofabricated surface coatings for keeping windows and surfaces clean (POST 1996). Here, the transparent nanocoating on a surface prevents fog and dirt particles from depositing on the substrate. Commercial products (achieved through gas phase condensation) also include aluminum oxide/epoxy dispersions yielding 19 times more wear resistance than conventional products.

ONGOING R&D / PREPARATION ISSUES

During the course of this study, the WTEC panelists were privileged to hear of and to observe a wide variety of current work on nanostructured dispersions and coatings in various laboratories around the world. Descriptions follow of a number of research projects and the preparation issues being addressed in the United States and in some of the foreign laboratories that panelists visited. Table 3.1 outlines some of the nanoparticle preparation techniques that are currently in use, many of which will be discussed in the paragraphs that follow.

Work in the United States

Significant work on coatings of dispersions is underway in the United States, as described in the proceedings of the 1997 WTEC workshop report, *R&D status and Trends in Nanoparticles, Nanostructured Materials, and Nanodevices in the United States* (Siegel et al. 1998). Some of the highlights of that volume are summarized below. Similar work is ongoing in other countries.

TABLE 3.1. Nanoparticle Preparation for Dispersions/Coatings

Liquid Chemical Methods	Physical Methods	Elevated Temperature Methods
Sol-Gel *	Size reduction by mechanical means (low energy)	Aerosol
Chemical Precipitation Ag-X (Eastman Kodak) †		Flame
Colloidal Micelles *		Vapor phase condensation

* Wiltzius 1998; † Trivelli and Smith 1930.

I.A. Aksay describes a ceramic thin film structure that would mirror-image a self-assembly process in many materials (Aksay et al. 1992). Here silica precursors when mixed with surfactants yield polymerized templates having structures similar to surfactant-water liquid crystals; what results are highly controlled pores on the 10 to 100 Å scale. Controlling the pore structure and synthesizing the building blocks are two technical challenges facing future work in this area. However, Aksay has shown that he can grow silicate films onto a wide variety of substrates. The layer structure of the bound surfactant molecules is key. Atomic force microscopy can reveal some details on the morphology of these films. The nanostructural patterns obtained in processing ceramics that contain organic/inorganic composites allow self-assembly to take place at lower temperatures.

Another example of thin films or coating is the work of Gell (1998, 124-130), focused on improving both the physical and the mechanical properties of materials. Nanostructured coating can lead to high diffusivity, improved toughness and strength, and better thermal expansion coefficients, with lower density, elastic modulus, and thermal conductivity. In comparisons of nanostructures and conventional materials, use of nanostructured WC/cobalt composites have resulted in as much as a two-fold increase in abrasion resistance and hardness. Deposition is often accomplished by utilizing a sputtering chamber where the nanomaterial is coated on substrates. This can lead to such benefits as resistance to oxidation and cracks in addition to resistance to wear and erosion.

An area that offers exciting possibilities in the area of dispersions is the sol-gel process described by P. Wiltzius (1998, 119-121). Here, a concentrated dispersion of colloids is chemically converted into a gel body. Drying followed by sintering produces a ceramic or glass product. This process can create nanoparticles, fibers, film, plates, or tubes. All processing is at low temperatures. Lucent Technologies has developed a silica casting process that is reproducible for making tubes of pure silica of one meter in length for use in manufacturing optical fibers. Technical challenges include obtaining pure starting materials, removing refractory particles that lead to breakage in the fiber drawing process, and achieving very tight dimensional tolerances. Colloidal dispersions of this type play a critical role in chemical mechanical polishing. To obtain good yield and high quality, it is necessary to achieve very tight process control.

R. Brotzman at Nanophase Technologies Corporation describes the gas phase condensation process for synthesizing inorganic and metallic powders (Brotzman 1998, 122-123). Such a process was invented by R. Siegel and his colleagues at Rensselaer Polytechnic Institute in New York (Siegel et al. 1994). The process involves production of physical vapor from elemental or reacted material followed by sudden condensation and reaction of the vapor

into small nanometer particles. The condensation process is rapid and involves dilution to prevent the formation of hard agglomerates and coalescence.

Nanophase Technologies has developed a production system where forced convection flow controls the particle/gas stream and enhances particle transport from the particle growth region so as to generate more metal vapor (Parker et al. 1995). The convection flow helps in forming oxides and nitrides from metal crystallites. This process produces commercial quantities of nanosized inorganic powders that have a spherical shape with narrow size distributions. Table 3.2 shows some properties of these particles, and Figure 3.1 shows their transparency as a function of particle size.

Nanophase Technologies Corporation has developed a coating process that encapsulates nanoparticles with a surface treatment that ensures individual integrity of the particles in subsequent coating steps. Applications span their use in low dielectric media all the way to water and, if needed, steric stabilizers.

Nanophase also has directed efforts in the electronics and industrial catalyst areas. Friedlander (1998, 83-8) describes in good detail aerosol reaction engineering where attention is paid to design of the process and the importance of material properties and process conditions. Key process parameters include time, temperature, and volume concentration. Most commercially produced particles have polydispersity. Important full-scale processes are flame reactors for preparing pigments and powdered materials for optical fibers. Pyrolysis reactors have long been used to prepare carbon blacks.

Kear and Skandan (1998, 102-4) have discussed two divergent approaches toward fabrication of bulk materials. The first is a powder processing route involving preparations by physical or chemical means followed by condensation and sintering. Materials for cutting tools such as tungsten carbide/cobalt powders were prepared in a controllable way to about 50 nm. Liquid phase sintering completes the formation of the solid dispersion phase. However, a gap in fabrication technology remains that of controlling grain growth during liquid phase sintering.

A second approach to fabrication of bulk materials is spray forming. This procedure avoids contamination and coarsening of the dispersion and its particles when the process has a controlled atmosphere of inert gas at low pressure. In this approach there is need to establish process/product co-design where we understand cause-effect relationships between processing parameters and properties of nanophase spray/deposited materials.

TABLE 3.2. Particle Properties

Particle Properties	TiO ₂	ZnO	Fe ₂ O ₃
Refractive Index	2.40	2.01	3.01
Density (gm/cc)	3.95	5.61	5.30
Molecular Weight (μ)	80	81	160

Particle Sizes (see Figure 3.1 below)

Optical Density (D) = Absorbance (A) = $\log_{10} (I_0/I) = \epsilon Cl$
 C = concentration
 l = optical path length
 ϵ = molar absorption coefficient/2.303

Source: R. Brotzman, Nanophase Technologies

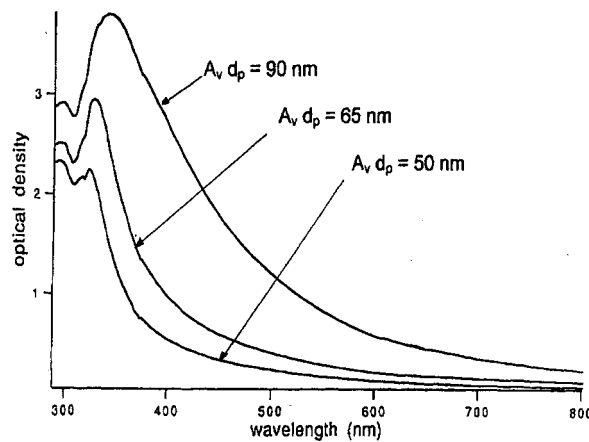

Figure 3.1. Transparency as a function of particle size (Nanophase).

In summary, particle preparation in the United States utilizes a wide variety of methods—both chemical and physical, at both high and low temperatures—all having unique considerations for scale-up and process control. Researchers in other countries are tackling many of these same issues.

Work in Europe and Japan

Due to time constraints, the WTEC panel was able to visit only a few labs in Europe and Japan that deal with issues associated with dispersions and coatings. Cited below are a visit to the Institute for New Materials at Saarbrücken in Germany and a visit to Japan's Industrial Research Institute

of Nagoya, both of which are exploring direct applications of nanostructured dispersions and coatings.

Drs. Rudiger Nass and Rolf Clasen at the Institute for New Materials at Saarbrücken make specific use of the sol-gel process in which liquid starting materials are utilized at low temperatures for nanoscale metal, ceramic, glass, and semiconductor nanoparticles (Clasen 1990). The advantages, besides temperature, include the isolation of high purity powders. The institute has focused on four basic areas for spin-off and adaptation towards commercialization:

1. New functional surfaces with nanomers. Properties such as corrosion protection, wettability, coloration, micropatterned surfaces, porosity, and the ability for selective absorption of molecules produce multifunctionality.
2. New materials for optical applications. This area combines properties of lasers and ceramics with polymers. Such features as optical filters, transparent conducting layers, materials for optical telecommunications, photochromic layers, and holographic image storage are under investigation.
3. Ceramic technologies. In this area, a simple precipitation process such as sol-gel provides for pilot-scale production of agglomerate-free powder.
4. Glass technologies. Chemical incorporation of metal colloids with intelligent properties into glasslike structures is clearly possible.

During the WTEC team's site visits to the Industrial Research Institute of Nagoya, S. Kanzaki and M. Sando described methods for preparing synergy ceramics using nanoporous silica particles that are used to fabricate thin films with one-dimensional throughput channels (Kanzaki et al. 1994). The channels had 10-20 nm sizes. High temperature Fe_2SiO_4 oxides were prepared as both molecular sieves and particulate fibers. Japan plans to pursue the preparation of nanoporous materials for absorbing oil and identified particulates.

ALTERNATIVE PREPARATION METHODS

The quest for low temperature nanoparticle preparation methods has spanned a wide range of systems. One that has been in existence for decades but has not been put into use in other industries is the method of preparing silver halide particles. Eastman Kodak in France, England, and the United States has utilized solution precipitation technology with well-controlled mixing and nucleation control to produce a wide range of grain sizes. "Lippmann"-type grains have a size of about 50 nm. Some of the properties of these fine-grain systems are discussed by Trivelli and Smith (1939).

There are other methods of creating nanoparticles of organic materials such as filter dye applications in photographic films and spectral sensitizing dyes for use in silver halide grains. Ultrafine grinding media are used to almost sandpaper organic crystals to nanoparticle ranges of 20-80 nm (Czekai et al. 1994). Similar technology by Bishop has been utilized in both pharmaceutical preparations and ink jet applications with good success (Bishop et al. 1990).

One other exciting area is in polymer science, where dendrimer molecules, often 10 nanometers in diameter, are prepared synthetically. These molecules have been studied in gene therapy, as aids in helping to detect chemical or biological agents in the air, and as a means to deliver therapeutic genes in cancer cells (Henderson 1996). The preparation of dendritic starburst molecules is described by Salamone (1996, 1814). One can imagine applications for coatings in which these molecules with their highly reactive surfaces participate in either classical (sub-nanosopic chemistry) or novel nanoscopic conversions.

OPPORTUNITIES AND CHALLENGES

There are some outstanding opportunities and challenges that face the nanoscience community. For dispersions and coatings these include four areas:

1. The foremost area of opportunity is controlling the particle preparation process so that size is reproducible and scaleable. This requires creation of narrow size range particles that can be prepared by processes mentioned in the study such as vapor phase condensation, physical size reduction, or flame and pyrolysis aerosol generators. These same processes must respond to good reproducibility and scaling. In most studies to date, the size of primary particles depends on material properties and the temperature/time history. Two processes, collision and coalescence, occur together, and the processes need to be controlled in order to favorably influence final particle size distribution (Wu et al. 1993).

2. The second area of opportunity is process control (Henderson 1996). In the concept of a process control methodology, the nature of chemical processes makes it imperative to have means of effectively monitoring and initiating change in the process variables of interest. Accordingly, those involved with production of nanoparticles would monitor outputs, make decisions about how to manipulate outputs in order to obtain desired behaviors, and then implement these decisions on the process. Control system configuration will necessarily have a feeding process from the output such that information can be fed back to the controller. It may also have an

opportunity to base controller decision-making on information that is being fed forward; decisions could be made before the process is affected by incoming disturbances. Such would apply to process parameters like temperature, flow rate, and pressure.

In many chemical setups, product quality variables must be considered, and such measurements often take place in the laboratory. An objective analysis is needed of any observed deviation of a process variable from its aim, and an objective decision must be made as to what must be done to minimize any deviation. Here process understanding leads to well behaved reactors in manufacturing that allow for true process verification with data feedback and analysis. This concept of process control requires the application of statistical methodologies for product and process improvements. Current interest in statistical process control (SPC) is due to several factors, in particular, interest in realizing consistent high quality so as to sustain the business and obtain greater market share. Most manufacturing zones are moving toward inline/online sensor technologies coupled with process software and user-friendly computer hardware for factory operators.

The benefits of process control are many. They include achieving reduced variability and higher quality, safety enhancement, reduction of process upsets, and in many cases, environmental improvements due to achieving mass balance in processes with material in/product out. Poor process design can be inherently overcome through SPC. Reduction in sampling and inspection costs results.

3. A third area of opportunity is the process/product relationship that leads to continuous uniformity—that is, the specification setting by product users that must be available to relate to process control in manufacturing. Here, nanoparticle formulation and the process used to prepare the particles must be linked and interactive.

4. A fourth technical opportunity is to develop process models for various dispersions and coatings that lead to shorter cycle time in manufacturing. Table 3.3 shows a comparison of enablers and opportunities in Europe, Japan, and the United States.

These four areas of opportunity, then, represent what lies ahead for advancement in nanotechnology with respect to dispersions and coatings. Achieving implementation in the industrial market will require close attention to resolving the challenges in the four areas summarized above. In addition, there remains a large gap between the cost of preparing conventional materials and the cost of preparing nanoparticles. This will remain a challenge for the future if nanomaterials are to be competitive.

TABLE 3.3. Dispersions and Coatings—Nanotechnology Comparisons
Between the United States, Europe, and Japan

LEVEL	1 (Highest)	2	3	4
Enablers				
Particle Preparation	U.S./Europe	Japan		
Stabilization	U.S./Europe	Japan		
Scaleup				
Characterization	U.S./Europe	Japan		
Coating	U.S./Japan/ Europe			
Opportunities				
Process Control			U.S.	Japan/Europe
Process/Product Co-Design			U.S.	
Modeling		U.S./Japan		

REFERENCES

- Aksay, I.A., et al., eds. 1992. Hierarchical structured materials. *MRS Proc.* 255.
- Angstrom Technology Partnership. 1995. *Challenging the angstrom*. Tokyo.
- Bishop, J. et al. 1990. *Surface modified drug nanoparticles*. U.S. Patent application. Docket 61894 Filed 9/17/90.
- Blackman, M. 1994. *An evaluation of the Link Nanotechnology Program and the National Initiative on Nanotechnology*. Cambridge.
- Brotzman, R. 1998. Nanoparticle dispersions. In *R&D status and trends*, ed. Siegel et al.
- Brus, L.E. 1996. Theoretical metastability of semiconductor crystallites in high pressure phases with applications to beta tin structures of silicon. *J. Am. Chem. Soc.* 118:4834-38.
- Clasen, R. 1990. *Int. Journal of Glass and Science Technology* 63: 291.
- Crandall, B.C. and J. Lewis, (eds.). 1992. *Nanotechnology: Research and perspectives*. Cambridge: MIT Press.
- Czekai, D., et al. 1994. *Use of smaller milling media to prepare nanoparticulate dispersions*. U.S. Patent application. Docket 69802(02) Filed 2/25/94.
- Friedlander, S.K. 1993. Controlled synthesis of nanosized particles by aerosol processes. *Aerosol Sci. Technol.* 19:527.
- Friedlander, S.K. 1998. Synthesis of nanoparticles and their agglomerates: Aerosol reactors. In *R&D status and trends*, ed. Siegel et al.
- Froes, F.H. 1998. Cost-affordable nanostructured materials. In *R&D status and trends*, ed. Siegel et al.
- Gell, M. 1998. Nanostructured coatings. In *R&D status and trends*, ed. Siegel et al.
- Henderson, T. 1996. Spheres of influence. *Corporate Detroit* (September): 23.

- Kanzaki, S. et al. 1994. New and developing research on advanced ceramics. *Bull Ceram. Soc. Japan*. 29: 124-30.
- Kear, B., and G. Skandan. 1998. Nanostructural bulk materials: Synthesis, processing, properties and performance. In *R&D status and trends*, ed. Siegel et al.
- Ogunnaike, B and W. Ray. 1994. *Process dynamics, modeling and control*. Oxford University Press, pp 5-21; 1033-48.
- Parker, J.C., et al. 1995. U.S. Patent 5,460,701.
- POST (Parliamentary Office of Science and Technology). 1995. *Vaccines and their future role in public health*. POST Report 66. London: Parliamentary Office of Science and Technology.
- _____. 1996. *Making it in miniature*. London: Parliamentary Office of Science and Technology. October.
- Rosen, A. 1996. *Surface Review and Letters* 3(1): 683-686.
- Salamone, J.C. 1996. *Polymeric Materials Encyclopedia*, Vol. 3, D-E. New York: CRC Press.
- Schnur, J.M. 1994. *J. Controlled Release* 28:3.
- Siegel, R.W., et al. 1994. U.S. Patents 5,128,081 and 5,320,800.
- Siegel, R.W., E. Hu, and M.C. Roco, eds. 1998. *R&D status and trends in nanoparticles, nanostructured materials, and nanodevices in the United States*. Baltimore: Loyola College, International Technology Research Institute. NTIS #PB98-117914.
- Solomaon, D.H. and D.G. Hawthorne. 1983. *Chemistry of pigments and fillers*. John Wiley and Sons.
- Trivelli, A., and W.F. Smith. 1939. *Photog. J.* 79:330,463,609. As referred to in T.H. James. 1977. *The theory of the Photographic process*. New York: MacMillan (p. 100).
- Williams, R.S. 1998. Functional nanostructures. In *R&D status and trends*, ed. Siegel et al.
- Wiltzius, P. 1998. Dispersions and coatings. In *R&D status and trends*, ed. Siegel et al.
- Wu, M., et al., 1993. Controlled syntheses of nanosized particles by aerosol processes. *Aerosol Sci. Technol.* 19:527.

Chapter 4

High Surface Area Materials

Donald M. Cox
Exxon Research and Engineering

INTRODUCTION

The trend to smaller and smaller structures, that is, miniaturization, is well known in the manufacturing and microelectronics industries, as evidenced by the rapid increase in computing power through reduction on chips of the area and volume needed per transistor (Roher 1993). In the materials area this same trend towards miniaturization also is occurring, but for different reasons. Smallness in itself is not the goal. Instead, it is the realization, or now possibly even the expectation, that new properties intrinsic to novel structures will enable breakthroughs in a multitude of technologically important areas (Siegel 1991; Gleiter 1989).

Of particular interest to materials scientists is the fact that nanostructures have higher surface areas than do conventional materials. The impact of nanostructure on the properties of high surface area materials is an area of increasing importance to understanding, creating, and improving materials for diverse applications. High surface areas can be attained either by fabricating small particles or clusters where the surface-to-volume ratio of each particle is high, or by creating materials where the void surface area (pores) is high compared to the amount of bulk support material. Materials such as highly dispersed supported metal catalysts and gas phase clusters fall into the former category, and microporous (nanometer-pored) materials such as zeolites, high surface area inorganic oxides, porous carbons, and amorphous silicas fall into the latter category.

There are many areas of current academic and industrial activity where the use of the nanostructure approach to high surface area materials may have significant impact:

- microporous materials for energy storage and separations technologies, including nanostructured materials for highly selective adsorption/separation processes such as H₂O, H₂S, or CO₂ removal; high capacity, low volume gas storage of H₂ and CH₄ for fuel cell applications and high selectivity; high permeance gas separations such as O₂ enrichment; and H₂ separation and recovery
- thermal barrier materials for use in high temperature engines
- understanding certain atmospheric reactions
- incorporation into construction industry materials for improved strength or for fault diagnostics
- battery or capacitor elements for new or improved operation
- biochemical and pharmaceutical separations
- product-specific catalysts for almost every petrochemical process

In catalysis the key goal is to promote reactions that have high selectivity with high yield. It is anticipated that this goal will be more closely approached through tailoring a catalyst particle via nanoparticle synthesis and assembly so that it performs only specific chemical conversions, performs these at high yield, and does so with greater energy efficiency. In the electronics area one may anticipate manufacture of single electron devices on a grand scale. Manufacture of materials with greatly improved properties in one or more areas such as strength, toughness, or ductility may become commonplace. In separations science new materials with well defined pore sizes and high surface areas are already being fabricated and tested in the laboratory for potential use in energy storage and separations technologies. In addition, many laboratories around the world are actively pursuing the potential to create novel thermal barrier materials, highly selective sensors, and novel construction materials whose bonding and strength depend upon the surface area and morphology of the nanoscale constituents. Many are also engaged in developing molecular replication technologies for rapid scaleup and manufacturing.

The nanoscale revolution in high surface area materials comes about for several reasons. First, since the late 1970s the scientific community has experienced enormous progress in the synthesis, characterization, and basic theoretical and experimental understanding of materials with nanoscale dimensions, i.e., small particles and clusters and their very high surface-to-volume ratios. Second, the properties of such materials have opened a third dimension to the periodic table, that is, the number of atoms, N (for a recent example see Rosen 1998). N now becomes a critical parameter by which the properties for “small” systems are defined. As a simple example, for metals

we have known for decades that the atomic ionization potential (IP) is typically about twice the value of the bulk work function (Lide 1993). It is only relatively recently that experiments have shown that the IP (and electron affinity) for clusters containing a specific number N of (metal) atoms varies dramatically and non-monotonically with N for clusters containing less than 100-200 atoms. (For examples see Taylor et al. 1992; Rademann et al. 1987; and Rohlfing et al. 1984.) Other properties such as chemical reactivity, magnetic moment, polarizability, and geometric structure, where they have been investigated, are also found to exhibit a strong dependence on N . Expectations for new materials with properties different from the atom or the bulk material have been realized (e.g., see Jena 1996 and reports therein). The opportunity is now open to precisely tailor new materials through atom-by-atom control of the composition (controlling the types as well as the numbers of atoms) in order to generate the clusters or particles of precision design for use in their own right or as building blocks of larger-scale materials or devices—that is, nanotechnology and fabrication at its ultimate.

Such precision engineering or tailoring of materials is the goal of much of the effort driving nanoscale technology. Scientists and engineers typically have approached the synthesis and fabrication of high surface area nanostructures from one of two directions:

1. The “bottom up” approach in which the nanostructures are built up from individual atoms or molecules. This is the basis of most “cluster science” as well as crystal materials synthesis, usually via chemical means. Both high surface area particles and micro- and mesoporous crystalline materials with high void volume (pore volume) are included in this “bottom up” approach.
2. The “top down” approach in which nanostructures are generated from breaking up bulk materials. This is the basis for techniques such as mechanical milling, lithography, precision engineering, and similar techniques that are commonly used to fabricate nanoscale materials (see Chapter 6), which in turn can be used directly or as building blocks for macroscopic structures.

A fundamental driving force towards efforts to exploit the nanoscale or nanostructure is based upon two concepts or realizations: (1) that the macroscopic bulk behavior with which we are most familiar is significantly different from quantum behavior, and (2) that materials with some aspect of quantum behavior can now be synthesized and studied in the laboratory. Obviously, quantum behavior becomes increasingly important as the controlling parameter gets smaller and smaller. There are numerous examples of quantum behavior showing up in high surface materials: the fact introduced above that clusters are found to exhibit novel (compared to the

bulk) electronic, magnetic, chemical, and structural properties; the fact that the diffusivity of molecules through molecular sieving materials cannot be predicted or modeled by hard sphere molecule properties or fixed wall apertures; and the fact that catalysts with one, two, or three spatial dimensions in the nanometer size range exhibit unique (compared to the bulk) catalytic or chemical activity.

OPPORTUNITIES FOR CLUSTERS AND NANOCRYSTALLINE MATERIALS¹

Clusters are groups of atoms or molecules that display properties different from both the smaller atoms or molecules and the larger bulk materials. Many techniques have been developed to produce clusters, beams of clusters, and clusters in a bottle (see Chapter 2) for use in many different applications including thin film manufacture for advanced electronic or optical devices (see Chapters 3 and 5), production of nanoporous structures as thermal barrier coatings (Chapter 3), and fabrication of thin membranes of nanoporous materials for filtration and separation (see Chapters 3 and 7). Figure 4.1 depicts an apparatus developed at the University of Göteborg to measure cluster reactivity and sticking probability as a function of the number of metal atoms in the cluster.

The unique properties of nanoparticles make them of interest. For example, nanocrystalline materials composed of crystallites in the 1-10 nm size range possess very high surface to volume ratios because of the fine grain size. These materials are characterized by a very high number of low coordination number atoms at edge and corner sites which can provide a large number of catalytically active sites. Such materials exhibit chemical and physical properties characteristic of neither the isolated atoms nor of the bulk material. One of the key issues in applying such materials to industrial problems involves discovery of techniques to stabilize these small crystallites in the shape and size desired. This is an area of active fundamental research, and if successful on industrially interesting scales, is expected to lead to materials with novel properties, specific to the size or number of atoms in the crystallite.

¹ For examples see conference proceedings such as: ISSPIC 1, *J. Phys.* **38** (1977); ISSPIC 2, *Surf. Sci.* **106** (1981); ISSPIC 3, *Surf. Sci.* **156**, (1985); ISSPIC 4, *Z. Phys. D.* **12**, (1989); ISSPIC 5, *Z. Phys. D.* **19**, (1991); ISSPIC 6, *Z. Phys. D* **26**, (1993); ISSPIC 7, *Surf. Rev. and Lett.* **3**, (1996); ISSPIC 8, *Z. Phys. D.*, (1997). For background information, see Prigogine and Rice 1998; Averbach et al. 1991; Jena et al. 1996; and Chapter 2 of this report.

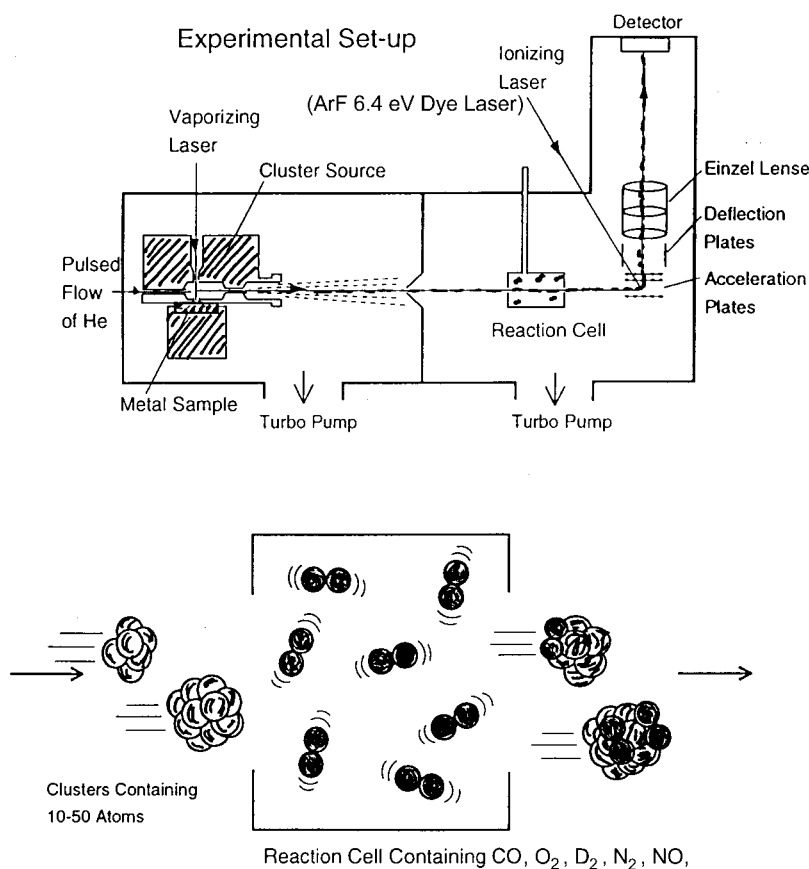

Figure 4.1. Schematic drawing of the experimental setup used in Göteborg for studies of chemical reactivity and/or sticking probability of various molecules with the clusters. The production of clusters is via laser vaporization of metal substrates and detection via photoionization time-of-flight mass spectrometry (A. Rosen, University of Göteborg, Sweden).

A typical objective of nanoscale catalyst research is to produce a material with exceedingly high selectivity at high yield in the reaction product or product state, i.e., chemicals by design, with the option of altering the product or product state simply by changing the surface functionality, elemental composition, or number of atoms in the catalyst particle. For instance, new catalysts with increasing specificity are now being fabricated in which the stoichiometry may be altered due to size restrictions or in which only one or two spatial dimensions are of nanometer size.

Five recent examples where nanocrystalline metallic and ceramic materials have been successfully investigated for catalytic applications are discussed below (Trudeau and Ying 1996).

Novel Catalytic Properties of Nanostructured Gold Catalysts

In the study of transition metal catalytic reactions the group at Osaka National Research Institute has discovered that nanoscale gold particles display novel catalytic properties (Haruta 1997). Highly selective low temperature catalytic activity is observed to switch on for gold particles smaller than about 3-5 nanometers in diameter. Accompanying this turn on in catalytic activity is the discovery that these nanoscale gold particles (crystals) also have icosahedral structure and not the bulk fcc structure, again a nanoscale phenomena not available with bulk samples.

In fabricating these novel catalytic materials several issues appear to be crucial. For instance, the Osaka group has shown that (a) the preparation method plays a crucial role for generating materials with high catalytic activity and selectivity; that (b) the catalytic activity, selectivity and temperature of operation is critically dependent on the choice of catalyst support, and that (c) water (moisture) even in parts per million (ppm) levels dramatically alters the catalytic properties. Figure 4.2 shows the effect of moisture on the conversion profiles for CO oxidation for nanoscale gold catalysts supported on cobalt oxide.

Examples of novel catalytic behavior of nanoscale gold particles include the following:

- CO oxidation at temperatures as low as -70°C , as illustrated in Figure 4.2
- very high selectivity in partial oxidation reactions, such as 100% selectivity at 50°C for oxidation of propylene to propylene oxide as well as near room temperature reduction of nitric oxide with H_2 using alumina-supported gold nanoparticles

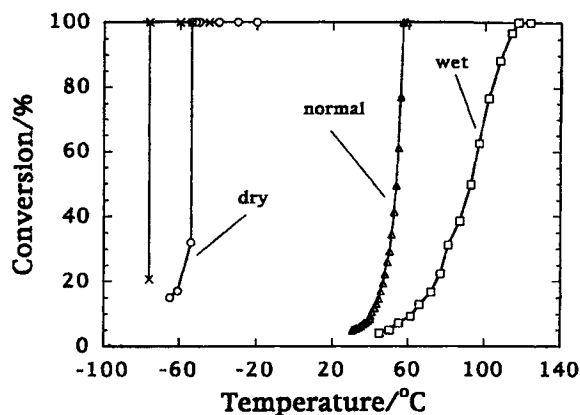

Figure 4.2. Effect of moisture on conversion profiles for CO oxidation over Co_3O_4 and $\text{Au}/\text{Co}_3\text{O}_4$.

The fundamental work on gold catalysts has led to “odor eaters” for the bathroom, based on nanoscale gold catalysts supported on $\alpha\text{-Fe}_2\text{O}_3$, a recent commercialization from Osaka National Research Institute in Japan.

Demonstration of the Importance of Controlling at Least One Dimension in the Nanoscale Size Range for the Industrially Important HDS Reaction²

For catalysts based on the layered compound MoS_2 , maximum hydrodesulfurization (HDS) activity is obtained only on well-crystallized nanosized materials, while HDS selectivity is determined by the number of layers or “stack height” of the nanocrystalline MoS_2 . In the hydrodesulfurization reaction, illustrated in Figure 4.3, cyclohexylbenzene occurs only on the MoS_2 “rim sites,” or those around the edges of the stack, whereas the pathway to biphenyl requires both “rim” and “edge” sites. Thus, the reaction selectivity can be controlled by controlling the aspect ratio of the nanoparticles of MoS_2 . Such control of one- and two-dimensional nanostructures for selective chemical advantage is an exciting new area of research. Of course, a major industrial challenge will be to fabricate such nanocrystals in a commercializable form (Chianelli 1998).

Generation of Nanocrystalline, Non-Stoichiometric CeO_{2-x} by Controlled Post-Oxidation of Cerium Nanoclusters Produced Via Inert Gas Condensation Synthesis³

The cerium oxide (CeO_{2-x}) materials have been found to possess a significant concentration of Ce^{3+} and oxygen vacancies, even after high temperature (500°C) calcination. Such nanoclusters give rise to a substantial reduction in the temperature of selective SO_2 reduction by CO and exhibit excellent poisoning resistance against H_2O and CO_2 in the feed stream compared to that for conventional high surface area cerium oxide.

Electrochemical Reduction of Metal Salts⁴

Electrochemical reduction of metal salts is yet another option available to control the size of nanoscale catalyst particles. This has been successfully used to prepare highly dispersed metal colloids and fix the metal clusters to the substrate. Control of the current density during the electrochemical

² Chianelli et al. 1994

³ Tschope and Ying 1994; Tschope et al. 1995

⁴ Reetz et al. 1995

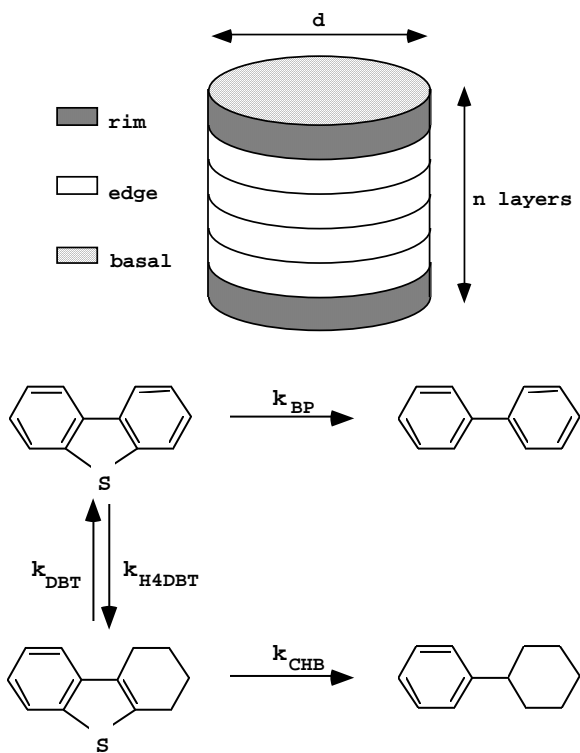

Figure 4.3. Hydrodesulfurization reaction. Selective catalysis is controlled by either the edge or rim of MoS₂ (Chianelli 1998).

synthesis process allows one to control the size of nanoscale transition metal particles. A combination of scanning tunneling microscopy (STM) and high-resolution transmission electron microscopy (TEM) has allowed surfactant molecules to be visualized on nanostructured palladium clusters.

Energy Storage Enhanced by Catalytic Dissociation of H₂

Materials with higher hydrogen storage per unit volume and weight are considered by many to be an enabling technology for vehicular fuel cell applications. Scientists at Los Alamos National Laboratories have developed an approach that enables materials such as Mg to be used for hydrogen storage (Schwartz 1998). Magnesium is of interest because it can store about 7.7 wt % hydrogen, but its adsorption/desorption kinetics are slow, i.e., the rate of charge (hydrogen dissociation and hydride formation) is much slower than in metal hydrides. At Los Alamos, high surface area mixtures of nanoscale Mg and Mg₂Ni particles are produced by mechanical means, ball milling. The addition of Mg₂Ni catalyzes the H₂ dissociation

such that the rate of hydrogen adsorption increases to a rate comparable to that of LaNi_5 . Once a hydride is formed, the hydrogen “spillover” leads to magnesium hydride formation.

Figure 4.4 illustrates the hydrogen adsorption/desorption characteristics of the mixture of Mg with 23 atomic % Ni. As can be seen, a low pressure plateau at about 1500 torr is obtained for this particular sample. Experiments show that the pressure plateau can be tailored through such alloying. Studies with other nanoscale materials, including other catalysts such as FeTi and LaNi_5 , are presently ongoing to further improve both the capacity and the rate of hydrogen storage.

OPPORTUNITIES IN SELF-ASSEMBLY

In self-assembly large molecular structures are obtained from the organization of a large number of molecules or atoms into a given shape, typically through specific interactions of the molecules among themselves and with a template. The interaction of the different bonding mechanisms is an area of strong fundamental research interest. Only two areas will be highlighted here: zeolites and carbon materials. Both of these materials exhibit characteristics of self-assembly, namely novel and reproducible structures that can be fabricated in industrially significant quantities.

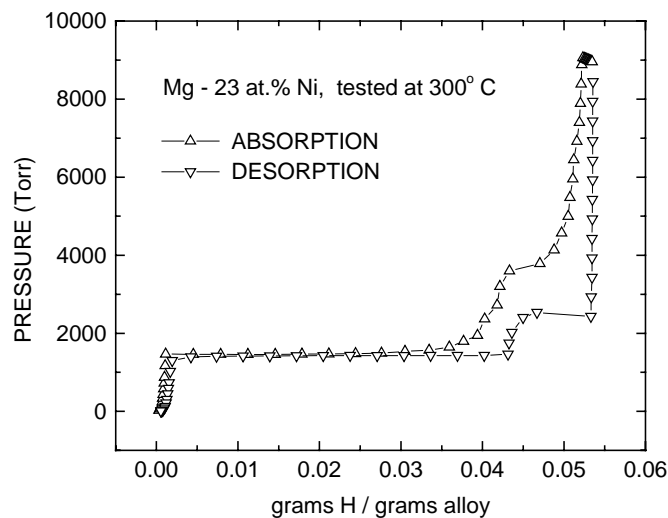

Figure 4.4. Hydrogen absorption-desorption characteristics for mixture of Mg and Mg_2Ni prepared by mechanical alloying.

Zeolitic Materials

Aluminosilicates (e.g., zeolites) are crystalline porous nanostructures with long range crystalline order with pore sizes which can be varied from about 4 Å to 15 Å in conventional zeolites. Figure 4.5 shows a 3-dimensional (e.g., MFI) zeolite cage structure together with a depiction of the straight and ziz-zag channels and a 2-dimensional zeolite with channels only in 2 directions. The vertices in the stick drawing denote position of the O atoms in the crystalline lattice. This particular zeolite has 10 atoms in the zeolite “window.” The size of the window is determined by the number of oxygens in the ring. Table 4.1 gives approximate window dimensions for zeolites as a function of the number of oxygens in the ring.

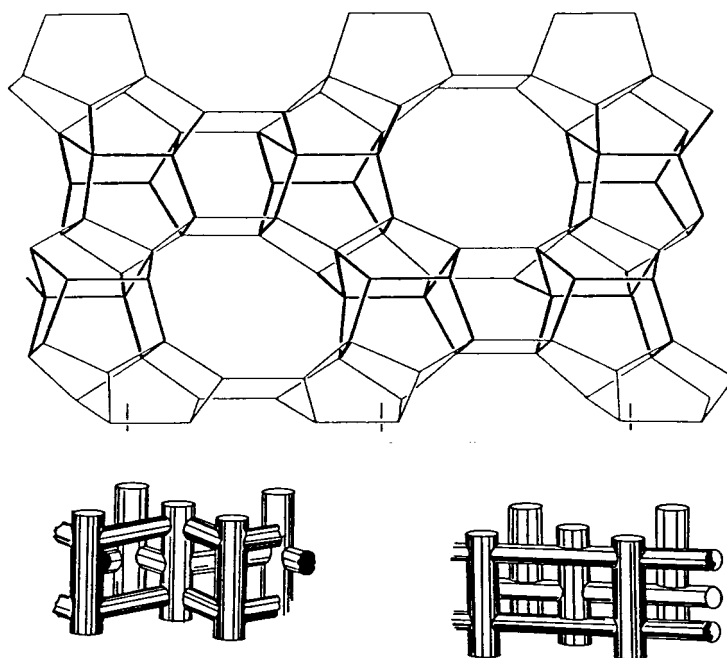

Figure 4.5. Typical zeolite structures together depicting the positions of the O atoms (vertices in upper figure) and two different zeolitic structures one (lower left) with a three dimensional structure and (lower right) a zeolite with a two dimensional channel structure.

TABLE 4.1. Zeolite Channel "Window" Dimension for Number of Oxygens in Ring

Number of Oxygens in Ring	Ring Diameter (Å)
4	1.2
5	2.0
6	2.8
8	4.5
10	6.3
12	8.0

As can be seen by examination of Table 4.1, molecules can pass through or be blocked from transport through or into the zeolite depending on the zeolite. For example normal hexane with a kinetic molecular diameter of about 5.1 Å can pass through a 10 ring or larger, whereas cyclohexane with a kinetic molecular diameter of 6.9 Å would be hard pressed to pass through a 10 ring. Thus all other things being equal, a 10-ring zeolite could be used to separate mixtures of normal hexane and cyclohexane. It is this property together with the ability to chemically modify the acidity of zeolitic materials that makes them extremely valuable as selective sorbants, as membranes and for use in selective catalytic reactions.

In 1992, a new family of aluminosilicates (M41S) with pores sizes between 20 and 100 Å in diameter were reported by Mobil researchers (Beck et al. 1992; Kresge et al. 1992). One of particular interest is MCM-41, which consists of hexagonal arrays of uniform 2 to 10 nanometer-sized cylindrical pores. Not only can such materials be synthesized, but novel structures such as "tubules-within-a-tubule" have been fabricated as mesoporous molecular sieves in MCM-41 (Lin and Mou 1996). Of particular interest is the possibility of expanding the so-called "liquid crystal templating" mechanism (Chen et al. 1993) to non-aluminum dopants within the silicate MCM-41 framework (Tanev et al. 1994) and to derive non-siliceous MCM-41 type of materials (Braun et al. 1996).

Another approach to synthesizing large pore and large single crystals of zeolytic materials is being pioneered by Geoffrey Ozin and his group at the University of Toronto, who have demonstrated that crystals as large as 5 mm can be synthesized (Kupperman et al. 1993). The ability to synthesize such large crystals has important implications for discovery of new sensors (selective chemical adsorbants) and membrane devices (selective transport of molecular species), since large single crystals can now be available to the laboratory researcher to carry out fundamental studies of adsorption and diffusion properties with such materials. These materials are expected to create new opportunities for applications in the fields of separations science, for use directly as molecular sieves or as new molecular sieving sorbant materials; in catalysis, as heterogeneous catalysts; and as supports for other

catalytic materials as well as other novel applications (Bowes et al. 1996; Brinker 1996; Sayari 1996). The ability to synthesize zeolitic materials of precise pore size in the range between 4 and 100 Å continues to expand the possibilities for research and technological innovation in the catalytic, separations, and sorption technologies (Ruthven et al. 1994; Karger and Ruthven 1992).

Carbon Materials

The carbon-based materials of interest from a molecular self-assembly point of view include fullerenes and their relatives, including endohedral fullerenes and metal-coated fullerenes, carbon nanotubes, carbon nanoparticles, and porous carbons. Since 1990 with the discovery of techniques to produce soluble carbon in a bottle (for examples, see Krätschmer et al. 1990 and references therein), research on and with carbon materials has skyrocketed (Dresselhaus et al. 1996; Dresselhaus and Dresselhaus 1995). Not only can the molecular forms of carbon (the fullerenes and their derivatives) be synthesized, characterized, and studied for applications, but many other new carbon materials such as multi- and single-walled carbon nanotubes can now be produced in macroscopic quantities. Figure 4.6 illustrates the broad variety of carbon nanotube structures whose properties are now being examined both theoretically and experimentally. A rich literature on these new carbon materials now exists. This report will only attempt to highlight a few important recent examples in the area of high surface area materials.

Of particular interest for future catalytic applications is the recent report that not only can C_{60} be coated with metal atoms, but that the metal coating can consist of a precise number of metal atoms. For example, $C_{60}Li_{12}$ and $C_{60}Ca_{32}$ have been identified mass spectroscopically (Martin, Malinowski, et al. 1993; Martin, Naher, et al. 1993; Zimmerman et al. 1995). C_{60} has been coated with a variety of different metals, including Li, Ca, Sr, Ba, V, Ta and other transition metals. Interestingly, addition of more than 3 Ta atoms to C_{60} breaks the C_{60} cage. Replacement of one carbon atom in C_{60} by a transition metal atom such as Co or Ir is being studied for possible catalytic applications. The future technological challenge will be to discover techniques to fabricate large quantities of such materials, so that such catalyst materials can be put in a bottle and not just in molecular beams.

means to power fuel cells for ultralow-emission vehicles or for electric power generation. Microporous hollow carbon fibers have exhibited high permeance and high selectivity as hydrogen selective membranes, and development is now underway to scale up these membranes to commercial levels (Soffer et al. 1987; Jones and Koros 1994; Rao and Sircar 1993). Carbon fiber materials produced via catalytic decomposition of hydrocarbon vapors have also recently been reported to exhibit exceptionally high hydrogen adsorption capacity (Baker 1998). More mundane uses of nanotubes are as nanometer reinforcing rods in polymers or even in concrete. Incorporation of conducting carbon nanotubes in construction materials such as concrete or structural plastics opens opportunities for real time monitoring of material integrity and quality.

Microporous and Dense Ultrathin Films

Research and development of microporous thin films for use as molecular sieving membranes using inorganic crystalline materials such as zeolites or porous silica is another area of active research around the world. For molecular sieving membranes, one critical challenge rests on discovering ways to create large scale, thin, nearly defect-free membranes. One recent example is the fabrication of mesoporous conducting thin films grown from liquid crystal mixtures (Attard et al. 1997). Transmission electron microscopy (TEM) reveals an ordered array of 2.5 nm diameter cylindrical holes in a 300 nm thick Pt film. The hole diameter can be varied either by changing the chain length of the surfactant molecule or by adding an alkane to the plating solution. It is interesting that this technique produces a continuous thin film with nanoscale porosity in an electrically conducting material.

Dense ultrathin films such as single monolayer films would be of significant importance in the semiconductor industry (see Chapter 3). Thin films of specialized coatings for corrosion, thermal, and/or chemical stability should be valuable for the chemical and aerospace industries. Novel chemical sensors may be anticipated through use of ultrathin films composed of specialized clusters. Typical techniques for production of thin films are physical vapor deposition, chemical vapor deposition, and Langmuir-Blodgett processes.

OPPORTUNITIES IN CHARACTERIZATION AND MANIPULATION AT THE NANOSCALE

Over the last two decades, the development and improvement of new techniques to fabricate and characterize nanoscale materials have fueled

much of the enormous growth in nanoscale science and technology, not only by making nanoscale materials relatively easily available for scientific study and characterization, but also in some instances, opening the door for large scale industrial use. For example, atomic force microscopy and scanning tunneling microscopy are two techniques that have become major workhorses for characterization of nanoscale materials. The strong upsurge in interest and funding in nanoscale materials must to some (large) degree be credited to the recent development of these two techniques. Combining X-ray structure, high resolution TEM and low energy, high resolution scanning electron microscopy (SEM), researchers now have the means to physically characterize even the smallest structures in ways impossible just a few years ago. Not only can a nanostructure be precisely examined, but its electronic character can also be mapped out.

Using the scanning probe devices, scientists can both image individual atoms and molecules and also manipulate and arrange them one at a time. This atomic manipulation to build structures is just in its infancy, but it does allow one to imagine a route to the ultimate goal of atomically tailored materials, built up atom-by-atom by a robotic synthesizer. The “abacus” of C₆₀ molecules produced at the IBM laboratories in 1997 is an excellent example of possibilities that may lie ahead for manipulation at the atomic scale. The Atom Technology project in Japan is now in its second five-year program to push the frontiers of atom manipulation closer to the commercial sector (see NAIR site report in Appendix D).

Of all fundamental properties controlling the stability of atoms, clusters, and particles on a surface or support, knowledge of the adsorption and adhesive energies of the metal atom or particle on the solid metal or oxide surface is critical to fundamental understanding of the stability of high surface area materials for materials applications that include oxide-supported metal catalysts, bimetallic catalysts, and metal-ceramic interfaces used in microelectronics. Knowledge of such parameters allows researchers to predict the relative strengths of the metal-metal and metal atom-support interaction energies, and to infer relative stabilities as a function of the composition and size of the metal cluster. Recently it has become possible to experimentally measure the metal atom-surface bond strength on a per-atom basis using adsorption micro-calorimetry on ultrathin single crystal metal or metal oxide surfaces (Stuckless et al. 1997). The direct calorimetric measurement of metal adsorption energies developed at the University of Washington is based in part on earlier work first developed by D.A. King and colleagues at Cambridge University (Yeo et al. 1995). A technique such as this capable of probing interactions on an atom-by-atom or molecule-by-molecule basis can be thought of as another “atomic probe” that can be expected to substantially advance our database and understanding at the ultimate nanoscale for materials, that is, single atom binding energies to surfaces.

Similarly, new techniques are being developed to allow chemical and catalytic reactions to be followed in situ in real time. As an example, an infrared and nuclear magnetic resonance spectroscopic technique is being developed at the Max Planck Institute in Mülheim (see the MPI Mülheim site report in Appendix B) to monitor kinetics of CO adsorption on 1-3 nm diameter metal colloid particles (typically Pt, Rh, or Pd) in liquids and to follow in real time the way CO organizes itself on the particles while in liquid suspension. Such techniques will allow one to begin to understand the metal particle properties in solution and thus infer what might occur in real reaction mixtures. Extension of such techniques to real catalytic reactions in solution for catalyst particles of various sizes and composition is likely in the not too distant future.

SUMMARY

The areas where nanoscale high surface area materials may have the greatest future impact are difficult to predict, but some signs point to the possibility of substantial advancement in the areas of adsorption/separations, particularly in gas sorption and separations and in novel chemical catalysis using nanoscale catalyst particles.

At least two major challenges must be faced before utilization and generation of high surface area nanoscale materials becomes a commonplace reality. First is critical dimensional control of the nanoscale structure over long times and varying conditions. In nanoscale catalyst materials the critical chemical selectivity is likely to be intimately associated with the local environment around what is termed the “active” site. This suggests that the size, type, and geometry of the atoms making up the active site will play a critical role in defining the conditions under which this active site will be able to carry out its designed function. Ability to fabricate materials with “exactly” the same structure and composition at each active site has been and will continue to be a major challenge to materials and catalytic scientists.

A second challenge involves thermal and chemical stability control of the fabricated nanostructure. It is generally accepted that the smaller the nanostructure (active site) the more likely it is that the structure may move, aggregate, be poisoned, decompose, or change its shape, composition or morphology upon exposure to thermal and/or chemical cycling. Identifying windows of stable operation in which the specific structure or material will be able to retain the desired (and designed) behavior is critical for commercial applications. On the other hand, the driving force is the fact that nanostructured materials typically exhibit unique properties that are expected to open windows of opportunity previously inaccessible with existing materials.

It is important to recognize that nanoscale science and technology is not a “stand alone” field of endeavor, but rather is more of a “generic” area that is expected to have a critical impact and overlap in many areas of science and technology. The breadth of issues covered in this report can be taken as proof of this principle. The fields that fall under the “nanoscale” umbrella are many and diverse, illustrating that nanoscale science and technology is a collection of many different disciplines and areas of expertise. Such science and technology offers both an opportunity and a challenge to the scientific and technological community. Researchers in some areas of science included under the broad umbrella of nanoscale science and technology in this report do not normally consider (or in some cases, want) their scientific efforts to be labeled as “nanoscale.” For this chapter, nanoscale science and technology broadly encompasses the science and technology that falls between that involving individual atoms or molecules at the one extreme and that involving “bulk” materials at the other extreme.

In summary, it is important to recognize that the use of nanostructuring or nanostructures to generate, fabricate or assemble high surface area materials is at an embryonic stage. The effect of the nanostructure and our ability to measure it will be increasingly important for future progress and development of materials for the marketplace. That said, it is apparent that so-called “mature” technologies such as catalysis, coatings, separations, etc., are already being impacted. Thus, one may eagerly anticipate exciting new advances in many diverse technological areas growing from our increasing understanding of nanostructuring and nanostructured materials.

REFERENCES

- Attard, G.S., et al. 1997. *Science* 278:838.
- Averback, R.S., J. Bernholc, and D.L. Nelson. 1991. *MRS Symposium Proceedings* Vol. 206.
- Baker, R.T.K. Synthesis, properties and applications of graphite nanofibers. In *R&D status and trends*, ed. Siegel et al.
- Beck, J.S., J.C. Vartuli, W.J. Roth, M.E. Leonowicz, C.T. Kresge, K.D. Schmitt, C.T.-W. Chu, D.H. Olsen, E.W. Shepard, S.B. McCullen, J.B. Higgins, and J.L. Schlenker. 1992. *J. Am. Chem. Soc.* 114:10834.
- Bowes, C.L., A. Malek, and G.A. Ozin. 1996. *Chem. Vap. Deposition* 2:97.
- Braun, P.V., P. Osenar, and S.I. Stupp. 1996. *Nature*. 368: 2.
- Brinker, C.J. 1996. *Curr. Opin. Solid State Mater. Sci.* 1:798.
- Chen, C-Y., S.L. Burkett, H.-X. Li, and M.E. Davis. 1993. *Microporous Mater.* 2:27.
- Chianelli, R.R. 1998. Synthesis, fundamental properties and applications of nanocrystals, sheets, and fullerenes based on layered transition metal chalcogenides. In *R&D status and trends*, ed. Siegel et al.
- Chianelli, R.R., M. Daage, and M.J. Ledoux. 1994. *Advances in Catalysis* 40:177.
- Dresselhaus, M., and G. Dresselhaus. 1995. *Ann. Rev. Mat. Sci.* 25:487.
- Dresselhaus, M.S. 1998. Carbon-based nanostructures. In *R&D status and trends*, ed. Siegel et al.

- Dresselhaus, M.S., G. Dresselhaus, and P. Eklund. 1996. *Science of fullerenes and carbon nanotubes*. San Diego: Academic Press.
- Gleiter, H. 1989. *Prog. Mater. Sci.* 33:223.
- Haruta, M. 1997. *Catalyst surveys of Japan* 1:61 and references therein.
- _____. 1997. *Catalysis Today*. 36:153.
- Huo, Q., D.I. Margolese, U. Ciesla, P. Feng, T.E. Gier, P. Sieger, R. Leon, P.M. Petroff, F. Schuth, and G.D. Stucky. 1994. *Nature* 368:317.
- Jena, P., S.N. Khanna, and B.K. Rao. 1996. In *Science and technology of atomically engineered materials*, ed. P. Jena. River Edge, NJ: World Scientific.
- Jones, C.W., and W.J. Koros. 1994. *Carbon* 32:1419.
- Jounet, C., W.K. Maser, P. Bernier, A. Loiseau, M. Lamy de la Chapelle, S. Lefrant, P. Deniard, R. Lee, and J.E. Fischer. 1997. *Nature* 388:756.
- Karger, J., and D.M. Ruthven. 1992. *Diffusion in zeolites*. New York: J. Wiley.
- Krätschmer, W., L.D. Lamb, K. Fostiropoulos, and D.R. Huffman. 1990. *Nature* 347:354.
- Kresge, C.T., M.E. Leonowicz, W.J. Roth, J.C. Vartuli, and J.S. Beck. 1992. *Nature* 359:710.
- Kupperman, A., S. Nadimi, S. Oliver, G. Ozin, J. Garcés, and M. Olken. 1993. *Nature* 365:239.
- Lide, D.R., ed. 1993-1994. *CRC Handbook of Chemistry and Physics*, 74th ed.
- Lin, H.-P., and C.-Y. Mou. 1996. *Science* 273:765.
- Martin, T.P., N. Malinowski, U. Zimmerman, U. Naher, and H. Schaber. 1993. *J. Chem. Phys.* 99:4210.
- Martin, T.P., U. Naher, H. Schaber, U. Zimmerman. 1993. *Phys. Rev. Lett.* 70:3079.
- Prigogine, I., and S. Rice. 1988. *Advances in chemical physics*, Vol. 70, Parts 1 & 2. New York: J. Wiley.
- Rademann, K., B. Kaiser, U. Even, F. Hensel. 1987. *Phys. Rev. Lett.* 59:2319.
- Rao, C.N.R., B.C. Satishkumar, and A. Govindaraj. 1997. *Chem. Commun.* 1581.
- Rao, M.B., and S. Sircar. 1993. *Gas Separation and Purification* 7:279.
- Reetz, M.T., et al. 1995. *Science* 267:367.
- Roher, H. 1993. *Jpn. J. Appl. Phys.* 32:1335.
- Rohlfing, E.A., D.M. Cox, and A. Kaldor. 1984. *J. Chem. Phys.* 81:3846.
- Rosen, A. 1998. A periodic table in three dimensions: A sightseeing tour in the nanometer world. In *Advances in quantum chemistry*. In press.
- Ruthven, D.M., S. Farooq, K.S. Knaebel. 1994. *Pressure swing adsorption*. New York: VCH Publishers.
- Sayari, A. 1996. *Chem. Mater.* 8:1840.
- Schwarz, R.B. 1998. Storage of hydrogen in powders with nanosized crystalline domains. In *R&D status and trends*, ed. Siegel et al.
- Siegel, R.W. 1991. *Ann. Rev. Mater. Sci.* 21:559.
- Siegel, R.W., E. Hu, and M.C. Roco, eds. 1998. *R&D status and trends in nanoparticles, nanostructured materials, and nanodevices in the United States*. Baltimore: Loyola College, International Technology Research Institute. NTIS #PB98-117914.
- Soffer, A., J.E. Koresh, S. Saggy. 1987. United States Patent 4,685,940.
- Stuckless, J.T, D.E. Starr, D.J. Bald, C.T. Campbell. 1997. *J. Chem. Phys.* 107:5547.
- Tanev, P.T., M. Chibwe, and T.J. Pinnavaia. 1994. *Nature* 368:321.
- Taylor, K.J., C.L. Pettiette-Hall, O. Cheshnovsky, and R.J. Smalley. 1992. *J. Chem. Phys.* 96:3319.
- Trudeau, M.L., and J.Y. Ying. 1996. *Nanostructured Materials* 7:245.
- Tschope, A.S., W. Liu, M. Flyzani-Stephanopoulos, and J.Y. Ying. 1995. *J. Catal.* 157:42.
- Tschope, A.S., and J.Y. Ying. 1994. *Nanostructured Materials* 4:617.
- Yeo, Y.Y., C.E. Wartnaby, and D.A. King. 1995. *Science* 268:1731.
- Zimmermann, U., N. Malinowski, A. Burkhardt, and T.P. Martin. 1995. *Carbon* 33:995.

Chapter 5

Functional Nanoscale Devices

Herb Goronkin, Paul von Allmen, Raymond K. Tsui, and Theodore X. Zhu
Motorola

INTRODUCTION

The recent emergence of fabrication tools and techniques capable of constructing structures with dimensions ranging from 0.1 to 50 nm (see Fig. 5.1) has opened up numerous possibilities for investigating new devices in a size domain heretofore inaccessible to experimental researchers. The WTEC nanotechnology panel reviewed research in the United States, Japan, Taiwan, and Europe to find that there is considerable nanoscience and technology activity in university, industrial, and government laboratories around the world. The insight gained from this survey suggests areas of strength and areas of possible improvement in the field.

There is intense study around the world to determine the exact point in dimensional scaling where it becomes either physically unfeasible or financially impractical to continue the trend towards reducing the size while increasing the complexity of silicon chips. In some of the same laboratories where research activities on Si are decreasing, research activities on single-electron devices (SEDs) are increasing. Although there are myriad questions involving electrical contacts, interconnections, reliability, and the like, one of the fundamental issues in the miniaturization/complexity debate concerns the Si MOSFET itself when the gate length is reduced to less than 50 nm. Does it behave like a long gate device or does the output conductance increase to impractical levels due to short-channel effects? Based on the WTEC panel's survey, most of the activities examining these questions are taking place in Japanese industrial laboratories.

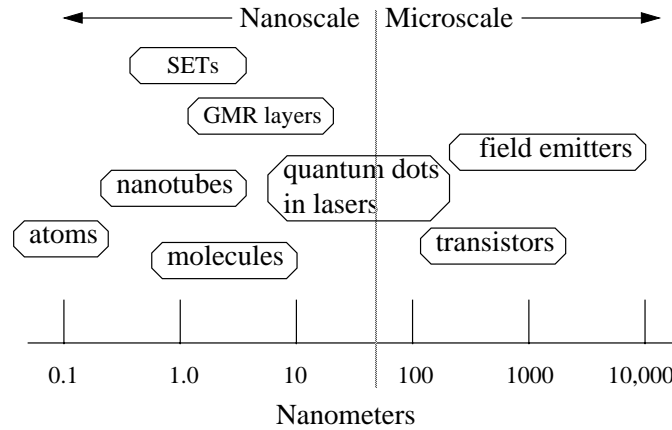

Figure 5.1. Functional device scales.

While the signature current-voltage (I-V) characteristics provide a common basis for comparison of device performance, there are significant variations in the fabrication methods and device structures being considered by the different labs in the countries the panel surveyed that have significant SED activity. The range of research in the surveyed laboratories spans electrical measurements from millikelvin to room temperature and from discrete electronic elements to integrated single-electron transistors (SETs). Materials that are used to form the active single-electron element range from charge clusters that are shaped by electric fields in a two-dimensional electron gas to metallic colloids to single oligomers. Progress in the field is hindered by architectures based on conventional circuit approaches that fail to take sufficient advantage of the unique properties of single-charge electronics to achieve significant impact in future high density applications. Most research in SED technology is fundamental and is distributed among universities funded by government agencies. A smaller body of application-directed research exists in industrial laboratories; these are mostly in Japan.

The field of magnetics has experienced increasing attention since giant magnetoresistance (GMR) in multilayered structures was discovered in 1988. In these structures ferromagnetic layers are quantum mechanically coupled across a 1-3 nm nonmagnetic metallic layer. GMR structures are under intense study for applications in hard disk heads, random access memory (RAM), and sensors. Several laboratories are investigating the physics of the transition of these layers, which are quantum mechanically confined in one dimension, to layered filaments in which there are one- and two-dimensional confinements. There are numerous experimental process approaches under consideration in fabricating GMR structures, including the following:

- magnetron or ion beam sputter deposition
- epitaxy for layered structures
- rubber stamping of nanoscale wire-like patterns
- electroplating into nanoscale pores in polymer membranes

In RAM applications, a high ratio of magnetoresistance combined with a small coercive switching field is key to density, speed, and low power. These features are also achieved in magnetic tunnel junctions in which the ferromagnetic layers are quantum mechanically coupled through a thin dielectric layer. Although research in nanoscale magnetics is underway internationally, most of the activities on the practical applications mentioned above are in the United States.

Optical devices have already benefited from incorporation of nanostructured materials: commercially available semiconductor lasers incorporate active regions comprised of quantum wells, the presence of which modifies the electronic density of states and the localization of electrons and holes, resulting in more efficient laser operation. Extrapolating from those results, even greater improvements are predicted for lasers utilizing either quantum wire or quantum dot active layers. Recent advances in the “self-assembled” formation of quantum dot structures have stimulated progress in the fabrication and characterization of quantum dot lasers in Japan, Europe, and the United States.

In late 1991, the first synthesis and characterization of carbon nanotubes were reported. The novel material contained a wide variety of multiwalled nanotubes (MWNT) containing 2 to 50 concentric cylindrical graphene sheets with a diameter of a few nm and a length of up to 1 μm . The material was produced at the negative electrode of an arc discharge and appeared to be mixed with a large amount of other forms of carbon. This initial work led many groups throughout the world to produce and purify nanotubes. The theoretical study of their electronic structure followed in the next year. Soon it became clear that nanotubes have unique electronic and mechanical properties that are expected to lead to ground-breaking industrial applications. Some of the progress made in this respect over recent years is summarized later in this chapter.

SINGLE-CHARGE ELECTRONICS

Even though the study of single-electron charging effects with granular metallic systems dates back to the 1950s, it was the research of Likharev and coworkers almost 10 years ago that laid much of the groundwork for understanding single-charge transport in nanoscale tunnel junctions (Likharev 1988; Averin and Likharev 1991, Chap. 6). The concept was developed of a Coulomb gap that can be exploited to control the transfer of

single charges. Since then, many research groups have made use of the Coulomb blockade effect to develop SED technology. Figures 5.2 through 5.11 show some of the myriad approaches to developing SEDs and representative laboratories pursuing the various SED concepts. Some of the more recent results are discussed below.

The group at Hitachi Europe uses a side-gated constriction in a delta-doped GaAs structure to fabricate a magnetic tunnel junction device in which a series of small islands separated by tunnel barriers are formed (Nakazato et al. 1992) (see, for example, Fig. 5.2). At ~ 2 K, the Coulomb gap voltage oscillates as a function of the side-gate voltage. Using the MTJ device as a building block, both memory and logic (inverter, NOR) functions have been demonstrated (Nakazato 1996, 65). The fabrication procedure makes use of standard semiconductor processing techniques and does not rely on lithography to define the nanoscale islands, since these are created by disorder in the delta-doped layer.

Other groups have utilized fine-line lithography to fabricate SEDs. At IBM, a flash memory SED was demonstrated by fabricating a sub-50 nm Si quantum dot (QD) on top of a MOSFET channel using a silicon-on-insulator (SOI) substrate, with the QD acting as a floating gate (Wesler et al. 1997). Single-electron charging was observed up to 90 K, while large threshold voltage shifts of up to 0.75 V were measured at 290 K. The University of Minnesota and Fujitsu have also reported similar structures (Guo et al. 1977; Nakajima et al. 1997). To overcome the lithography limitation on the QD size, the Toshiba group used a Si edge quantum wire approach (Ohata and Toriumi 1996). An inversion layer was formed at the 15 nm high Si sidewall of a SOI structure by growing a gate oxide and depositing a poly-Si gate there. Conductance oscillations were clearly seen at 4.2 K in this edge-channel MOSFET (Fig. 5.3). More recently, the Toshiba group has reverted back to a more planar device configuration, with a 50 nm wide Si quantum wire defined by e-beam lithography and oxidation of the surrounding SiO_2 (Koga et al. 1997, 79).

One method to form semiconductor QDs without depending on fine-line lithography is to make use of the self-organizing nature inherent in the Stranski-Krastanow thin film growth mode. In the initial stages of the heteroepitaxial growth of lattice-mismatched materials, strain-induced coherent relaxation occurs and dislocation-free islands are formed that are in the tens of nanometers range in size. There has been considerable research in these self-organized quantum dots (SOQDs) in the past few years, though much of the work has been of a fundamental nature (see, for example, Petroff and Demmester 1995; Nötzel 1996). More recently, the University of Tokyo has proposed the embedding of InAs SOQDs in AlGaAs/GaAs heterojunction field effect transistors (HFETs) to form a flash-memory SED (Sakaki et al. 1995).

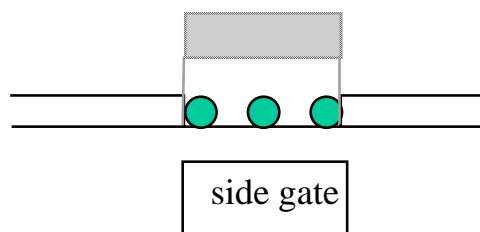

Figure 5.2. Metal colloids, self-assembled monolayer (SAM) coatings, polysilicon, quantum dots embedded in SiO_2 (Hitachi, IBM, RIKEN, NTT, ETL, University of Lund).

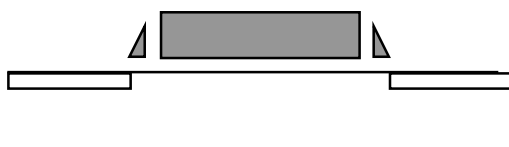

Figure 5.3. Sidewall extensions of MOSFET gate (Toshiba).

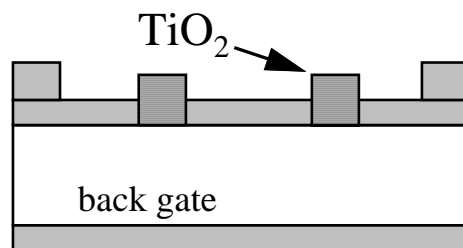

Figure 5.4. Oxidation of metal or semiconductor with scanning tunneling microscope (STM) tip (ETL).

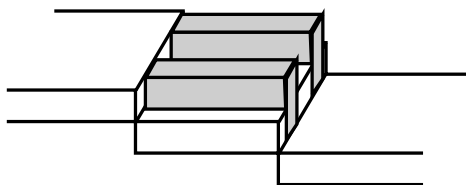

Figure 5.5. STM probe oxidation of metal on vicinal substrate steps (ETL).

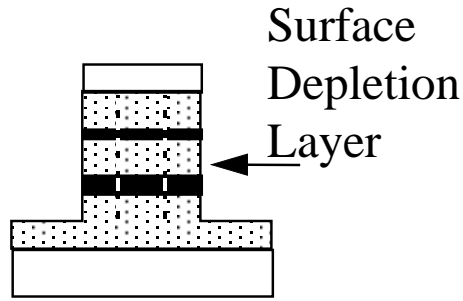

Figure 5.6. Double barrier tunnel diode structure (Max-Planck-Institut, Stuttgart; NTT).

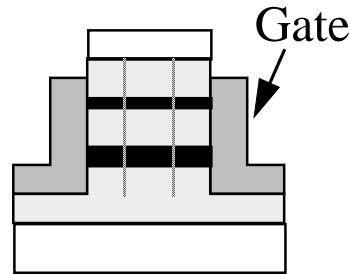

Figure 5.7. Gated double barrier tunnel diode structure (Max-Planck-Institut, Stuttgart; NTT; Purdue University).

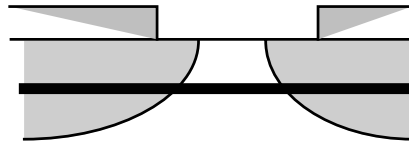

Figure 5.8. Depletion layer control of 2DEG area (Hitachi, University of Glasgow, University of Tokyo).

This concept was further demonstrated by the Sony group, which reported observing threshold voltage shifts at 300 K (Taira et al. 1997, 53). Fujitsu has also proposed the use of InGaAs QDs in a similar manner (Futatsugi et al. 1997, 46). The one difference in this case is that the QDs are formed at the bottom of tetrahedral-shaped recesses formed by substrate patterning. Since SOQDs form in a somewhat random manner on a planar surface, this approach provides positioning control.

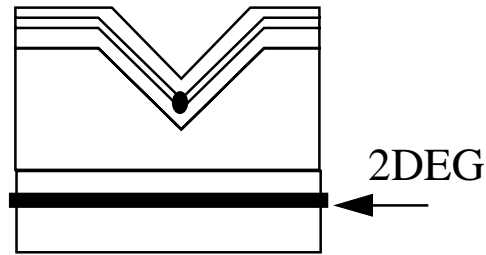

Figure 5.9. Tetrahedral shaped recess, TSR (Fujitsu).

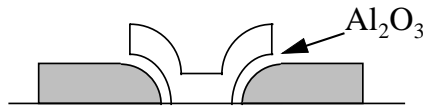

Figure 5.10. Double barrier metallic SET patterned by e-beam (NEC).

Of course, QDs can be formed with materials other than semiconductors. In fact, some of the earliest work in single-electron charging was done with metallic tunnel junctions. With modern fabrication tools and techniques, some groups have investigated the formation of nanoscale Au particles between metallic contacts. The University of Cambridge group used focused ion beam deposition to place Au dots between electrodes spaced 30 - 40 nm apart (Woodham and Ahmed 1997, 73). At Lund University in Sweden, atomic force microscopy (AFM) is utilized to move a 50 nm Au particle in between contacts formed by e-beam lithography (Carlsson et al. 1997, 128). Researchers observed conductance plateaus stable for several minutes at 300 K. The group at Cambridge University/Hitachi Europe used a colloidal process to form a chain of insulated Au particles between source, drain, and gate electrodes (Tsukagoshi et al. 1997, 67). At 4.2 K, the chain exhibited a Coulomb staircase and periodic conduction oscillations in I-V measurements.

For a very different approach, a molecular embodiment of a QD-based system can be realized by connecting a single molecule between metallic contacts. At Yale University a single molecule of benzene-1,4-dithiol was self-assembled from solution onto two electrodes of a mechanically controllable break junction (Fig. 5.11, left) (Reed et al. 1997). The spacing between the electrodes is ~ 0.8 nm, and I-V measurements at room temperature showed a gap ~ 0.7 V wide, which is attributed to a Coulomb gap. The Delft University of Technology in the Netherlands is also working on transport through oligomers (Fig. 5.11, right).

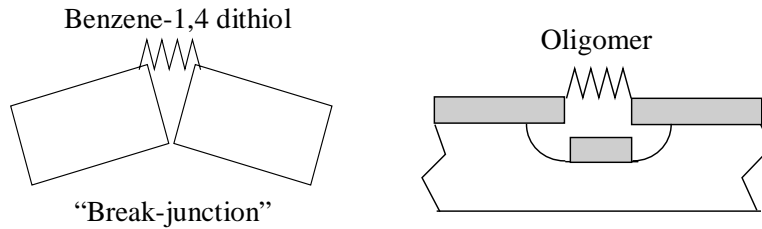

Figure 5.11. A single molecule connecting metallic contacts (Yale University, University of South Carolina, Delft University, Karlsruhe University).

Concerning the architecture in which SEDs are utilized, a number of approaches have been proposed. One of the more novel ideas is that of quantum cellular automata (QCA), based on some earlier work at Texas Instruments and developed at the University of Notre Dame (Lent et al. 1993; Tougaw and Lent 1994). The basic QCA cell is made up of a group of capacitively coupled QDs. Each cell holds two electrons, resulting in two polarization configurations that can represent the logic “0” and “1” states, and each cell interacts via Coulombic forces with neighboring cells. An array of cells can then be used to transmit binary information, which eliminates the need for physical interconnects between devices and represents a paradigm shift for ultralarge-scale integration (ULSI). Basic Boolean operations (AND, OR, etc.) can be implemented using QCA, and more complex functions have been simulated. Most recently, the Notre Dame group has demonstrated a nonlinear, bistable response of a QCA cell, albeit at a very low temperature of less than 20 mK (Snider et al. 1997, 233).

The QCA approach is not without its challenges (and critics). Circuit fabrication will be difficult because stringent control in QD positioning is required. Others have pointed out that bistability is only a necessary but not sufficient condition for the operation of Boolean logic circuits, because isolation is needed between the input and output, while background charge fluctuations will hamper logic implementation (Roychowdhury et al. 1966; Barker et al. 1997, 233). Thus, there is also considerable research in the use of SEDs with more conventional architectures. The group at Hitachi Europe uses its MTJ devices in binary decision diagram logic that is commonly used in large-scale integrated (LSI) circuits (Tsukagoshi et al. 1997, 67). The Toshiba group is combining its SED with a MOSFET to compensate for the lack of gain in the former, as are, presumably, other groups working on QD-based flash memory SEDs (Koga et al. 1997, 79). Tables 5.1 and 5.2 summarize some of these approaches.

TABLE 5.1. SET Architectures

Flash Memory	Digital Logic	Cellular Automata	Neural Networks
Hitachi	Hitachi (binary decision diagram logic)	Notre Dame Hitachi	Delft U. Technology
IBM	Hokkaido University		
Toshiba			

TABLE 5.2. Quantum Dot Flash Memory

	Hitachi	Minnesota	Fujitsu	IBM	Sony
Material	Poly-Si	SOI	SOI	SOI	GaAs
QD Material	Poly-Si	Poly-Si	Poly-Si	Poly-Si	InAs
QD Fab Method	E-beam / etch	E-beam / etch	E-beam / etch	E-beam / etch	Epitaxial self-assembly
QD Size (nm)	10 (estim.)	7 x 7 x 2 h	30 x 20 x 25 h	30 x 20 x 8 h	25 x 4 h
$2V_{th}$ (V)	0.5 - 1.0	0.055	0.1	0.75	0.45
Write/Erase	15 V / 10 V	> 4 V	4 V	3 V	> 1 V
Retention	1 - 24 h	10 sec.		> 1 wk	10 sec.
Circuits	128 Mb LSI				

In summary, while significant progress has been made in nanofabrication techniques, the field of single-charge electronics is still limited in scope by the lack of a suitable architecture that fully utilizes the unique aspects of single-electron charging. Current approaches require many SED elements to achieve conventional functions such as adders, exclusive NORs, etc. Simulations of such circuits predict slow operating speed. The field seems to be stuck on applying conventional electronics to SEDs. Either a new architecture will be discovered or SEDs may find a niche home in those applications where measurements of single charges are needed.

For the fabrication of nanoscale electronic devices, the self-organizing technique appears to be the most promising. The field of self-organized semiconductor QDs is quite active, but aside from optical emitters, very few practical electronic functions have been proposed. Of those, the single-electron flash memory is attracting attention, but there has been no serious proposal as to how the device could operate under normal integrated circuit performance conditions and reliability specifications. Using the SED as a floating gate to a MOSFET has the same kinds of problems as applying conventional approaches to SED architectures; until someone comes up with a better idea, the future of these approaches remains to be determined.

NANOMAGNETICS

The discovery in 1988 of GMR in structures of alternating magnetic and nonmagnetic thin layers (Baibich et al. 1988) was the accumulation of several decades of intensive research in thin film magnetism (Shinjo and Takada 1987) and improvements in epitaxial growth techniques developed mainly in semiconductor materials. Not surprisingly, the first GMR structure was fabricated using molecular beam epitaxy (Baibich et al. 1988). The high quality magnetic and nonmagnetic metallic films provide electrons with a mean free path exceeding 100 \AA ; on the other hand, the epitaxial growth allows for each constituent layer of the structure to be as thin as a few atomic layers. The greatly enhanced spin-dependent scattering in these multilayered structures provides magnetoresistance changes as high as 50%. Table 5.3 shows some of the institutions involved in GMR research and development, based on various publications, patents, and WTEC visits.

Two subsequent major developments from IBM enabled the application of GMR materials to hard disk heads, RAM, and sensors. The first development was the demonstration of equally good or better GMR materials using high throughput and production-worthy magnetron sputtering systems (Parkin et al. 1990). The other development was the invention of magnetically soft spin-valve structures, which allow low field and low power operation (Dieny et al. 1991a; Dieny et al. 1991b).

TABLE 5.3. Giant Magnetoresistance Activities

Memory:	MRAM	HD Heads	Structures / Physics / Materials
• Fujitsu	■	■	• IMEC
• Hitachi	■	■	• L'Ecole Polytechnique Lausanne
• Honeywell	■		• IBM Zurich
• IBM	■	■	• Tohoku University
• Motorola	■		• Nagoya University
• Matsushita	■	■	• NIST
• Mitsubishi	■	■	• UC Santa Barbara
• Philips		■	• UC San Diego
• Samsung	■		• Carnegie Mellon
• Toshiba	■	■	• Princeton
• Seagate		■	
• Siemens	■		
• Sony		■	

*Based on publications, patents or visit:

Industrial R&D efforts on GMR materials initially focused on high density read heads. The major U.S. players are IBM, Seagate, Quantum, ReadRite, and Applied Magnetics. In Japan, all the semiconductor companies are involved, in addition to strong magnetic media powerhouses such as TDK and Yamaha. Korea's Samsung is also actively involved in the GMR race. In Europe, Thomson CSF, Philips, and Siemens seem to have fallen behind. All in all, IBM is in a commanding position to reap the benefits of the GMR phenomenon. In November 1997, it announced the volume production of the first generation of GMR read heads.

In 1995, a different class of high magnetoresistive materials was discovered in which the nonmagnetic layer separating the two ferromagnetic layers is made with an ultrathin insulating material, such as an aluminum oxide layer $< 20 \text{ \AA}$ thick (Miyazaki and Tezuka 1995; Moodera et al. 1995). With the switching of magnetization of the two magnetic layers between parallel and antiparallel states, the differences in the tunneling coefficient of the junction and thus the magnetoresistance ratio have been demonstrated to be more than 25%. A distinctive feature of this MTJ class of materials is its high impedance ($> 100 \text{ k}\Omega\text{-}\mu\text{m}^2$), which allows for large signal outputs.

The gradual improvement of GMR and MTJ materials have made them attractive for nonvolatile magnetic random access memory (MRAM) applications. The potential to make MRAM a high density, high speed, and low power, general purpose memory prompted the Defense Advanced Research Projects Agency to fund three MRAM consortia beginning in 1995, led by IBM, Motorola, and Honeywell, respectively. Other companies engaged in MRAM research are Hewlett-Packard, Matsushita, NEC, Fujitsu, Toshiba, Hitachi, and Siemens.

The key for a competitive MRAM technology is the fabrication of deep submicron-dimension magnetic cells. The further development of lithography tools utilizing e-beam and deep ultraviolet radiation is essential. Magnetic storage elements as small as $0.25\ \mu\text{m}$ have been demonstrated by both Motorola and IBM (Tehrani et al. 1996; Chen et al. 1997; Gallagher et al. 1997). Among the steps of MRAM fabrication that are not yet compatible with semiconductor processing is the ion milling of the magnetic cells. The possibility of dry etching the magnetic materials has, nevertheless, been demonstrated (Jung et al. 1997). Figures 5.12 through 5.15 summarize the major directions in memory R&D. Arrows denote ferromagnetic layers.

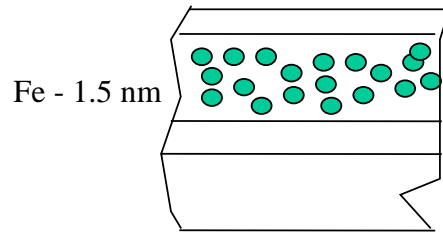

Figure 5.12. Granular GMR—Co, Fe (Nagoya University, Tohoku University, CNRS-Thomson, UCSB, UCSD).

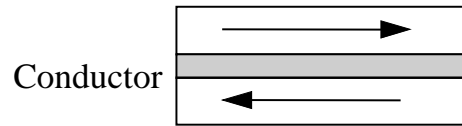

Figure 5.13. Current in plane (Matsushita, Fujitsu, Mitsubishi, Toshiba, Hitachi, Thomson, Philips, Siemens, IBM, Univ. Regensburg, IMEC, Nagoya University, Tohoku University, NIST).

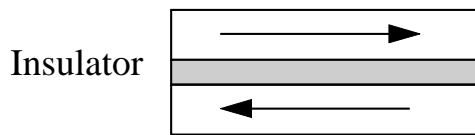

Figure 5.14. Magnetic tunnel junction (IBM, MIT, HP, Tohoku University).

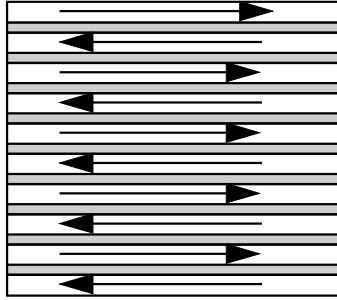

Figure 5.15. Ferromagnetic/metal/ferromagnetic: 3 - 60 periods free-standing (NRL, CNRS-Thomson, Philips, Michigan State, Lawrence Livermore Labs); plated into pores (L'École Polytechnique Fédérale de Lausanne, Johns Hopkins University, Université Catholique Louven).

The ability to fabricate submicron magnetic elements has opened a very rich and fascinating area of micromagnetics research. Characterization techniques having nanoscale resolution have been utilized and improved to measure and image the complex magnetization patterns in order to understand the magnetization switching characteristics. Examples of such techniques include the following:

- superconducting quantum interference device (SQUID) magnetometry (Zhu et al. 1997)
- magnetic force microscopy (MFM) (Ohkubo et al. 1991)
- scanning electron microscopy with polarization analysis (SEMPA) (Scheinfein et al. 1990)
- magnetic near-field microscopy (Betzig and Trautmann 1992)
- electron holography (Mankos et al. 1995)

Another essential tool is micromagnetics modeling, which is used to predict complex magnetic domain configurations in patterned magnetic elements and to generate transient pictures that demonstrate the process of forming complex domain configurations (Zheng and Zhu 1997).

By combining MFM, SQUID magnetometry, SEMPA, and micromagnetics modeling, researchers at Motorola have conducted a systematic study of the switching characteristics of single-layer and multilayer submicron magnetic structures. Three different phases of the magnetization phase diagram have been identified with regards to material composition, dimension, shape, thickness, and other structural parameters: (1) the quasi-single domain phase can be well described by the coherent rotation model (Sakaki et al. 1995); (2) the end-domain phase is dominated by the nonuniform regions of magnetization at the two ends of the element—the magnetization switching process can either be rotational or through domain wall nucleation and propagation (Shi et al. 1998); and (3) the trapped magnetization vortice (TMV) phase, which is characterized by the presence

of magnetization vortices. Nucleation from TMV sites requires lower reversal fields than coherent rotation, but a high field is needed to drive out TMVs in the element. When the driving field is not high enough, TMVs can cause unusually large fluctuations in the switching field (Shi et al. n.d.).

As the size of magnetic elements scales below 20 nm, a superparamagnetic phase emerges in which the room temperature thermal energy overcomes the magnetostatic energy well of the element, resulting in zero hysteresis (Hylton 1993). In other words, although the element itself is a single-domain ferromagnet, the ability of an individual magnetic “dot” to store magnetization orientation information is lost when its dimension is below a threshold. On the other hand, suitably prepared alloys of immiscible ferromagnetic and nonmagnetic metals that contain single-domain ferromagnetic grains in a nonmagnetic matrix have been shown to exhibit GMR characteristics. The moments of the magnetic grains are aligned at high fields and random at the coercive field, leading to GMR characteristics. In such “granular” metals, GMR has been reported for sputtered alloy films of CoCu (Berkowitz et al. 1992; Xiao et al. 1992), FeCu (Xiao et al. 1992), NiFe/Ag (Jiang et al. 1992), and CoAg (Carey et al. 1992; Tsoukatos et al. 1992). GMR values as high as 55% at 4.2 K and 20% at room temperature have been observed. The granular films require magnetic fields of the order of 10 kOe to achieve such a change in electrical resistance.

A very exciting consequence of ultrascaled magnetic particles is quantum tunneling of the magnetization direction of a collection of spins. There is no simple Schrödinger equation that describes this process, since it is not an elementary particle that is tunneling but a collective coordinate. Below its “blocking temperature,” at which thermally assisted hopping between magnetic orientations becomes frozen out, magnetic particles of TbCeFe at sizes around 15 nm have been observed to behave independent of temperature and with no freeze-out magnetic relaxation (Barbara et al. 1993). Because of the coherent tunneling of the magnetization orientation between the symmetric double-well potential, a resonance line in the magnetic susceptibility and noise spectra has been observed at temperatures below 200 mK in zero applied magnetic field (Awschalom et al. 1992). This work has stimulated a number of theoretical investigations into the effects of dissipation and the feasibility of producing quantum effects in larger magnetic structures (Prokofev and Stamp 1993; Gaarg 1994; Braun and Loss 1994).

Another interesting type of nanomagnetic structure is nanometer ferromagnetic wires fabricated using conventional nanolithography (Adeyeye et al. 1997; Chou 1997), nanoimprint lithography (Chou et al. 1995), AFM/MFM direct writing (Kong et al. 1997), groove deposition (Hong and Giordano 1995), and electrodeposition into pores of template polymer membranes (Piroux et al. 1994; Blondel et al. 1994). Such nanowires of either single layer or multilayers may provide new approaches

to very small magnetoresistive sensors, ultrahigh-density hard disks (Chou et al. 1994), and other extensions of conventional applications. Another intriguing possibility is the suggestion to use heterostructure nanowires to investigate single electron tunneling (Cavicchi and Silsbee 1984; Kumzerov and Poborchii 1994).

Recently, molecular magnetism has received much attention with the development of a variety of synthesis techniques largely adapted from biology and chemistry (Kahn 1993). Natural and artificial ferritin proteins are examples of systems obtained using these methods (Gatteschi et al. 1994). The ability to add one magnetic ion at a time has resulted in nanoscale magnets precisely defined by atomic weight. Ferritin consists of a segmented protein shell in the shape of a hollow sphere, with an outer diameter of 12.5 nm and an inner diameter of 7.5 nm. In vivo, the inner space is normally filled with a crystal of an iron oxide that is antiferromagnetic below 240 K. The empty protein shells can also serve as vessels for the synthesis of ferrimagnetic magnetite and maghemite. Thus, there exists a system in which its size as well as the nature of its magnetic interactions can be varied.

Another example of molecular magnetism is a cobalt-iron-cyanide-based Prussian blue analog (Sato et al. 1996a). In the ground state the Fe^{+2} and Co^{+3} ions are low-spin and diamagnetic, and there is no interaction between them. Red light excitation transfers one electron from an iron site to a cobalt site, resulting in high-spin Fe^{+3} and Co^{+2} ions and magnetic interactions between them. The application of a blue light causes a transition back to the initial state and switches off the Fe^{+3} - Co^{+2} interactions. In addition to this kind of photochemically controllable magnets, electrochemically controllable magnets have also been reported (Sato et al. 1996b).

QUANTUM DOT LASERS

Semiconductor lasers are key components in a host of widely used technological products, including compact disk players and laser printers, and they will play critical roles in optical communication schemes. The basis of laser operation depends on the creation of nonequilibrium populations of electrons and holes, and coupling of electrons and holes to an optical field, which will stimulate radiative emission. Calculations carried out in the early 1970s by C. Henry (Dingle and Henry 1976) predicted the advantages of using quantum wells as the active layer in such lasers: the carrier confinement and nature of the electronic density of states should result in more efficient devices operating at lower threshold currents than lasers with “bulk” active layers. In addition, the use of a quantum well, with discrete transition energy levels dependent on the quantum well dimensions

(thickness), provides a means of “tuning” the resulting wavelength of the material. The critical feature size—in this case, the thickness of the quantum well—depends on the desired spacing between energy levels. For energy levels of greater than a few tens of millielectron volts (meV, to be compared with room temperature thermal energy of 25 meV), the critical dimension is approximately a few hundred angstroms. Although the first quantum well laser, demonstrated in 1975, was many times less efficient than a conventional laser (van der Ziel et al. 1975), the situation was reversed by 1981 through the use of new materials growth capabilities (molecular beam epitaxy), and optimization of the heterostructure laser design (Tsang 1982).

Even greater benefits have been predicted for lasers with quantum dot active layers. Arakawa and Sakaki (1982) predicted in the early 1980s that quantum dot lasers should exhibit performance that is less temperature-dependent than existing semiconductor lasers, and that will in particular not degrade at elevated temperatures. Other benefits of quantum dot active layers include further reduction in threshold currents and an increase in differential gain—that is, more efficient laser operation (Asada et al. 1986). Figures 5.16 and 5.17 illustrate some of the key concepts in the laser operation. Stimulated recombination of electron-hole pairs takes place in the GaAs quantum well region, where the confinement of carriers and of the optical mode enhance the interaction between carriers and radiation (Fig. 5.16). In particular, note the change in the electronic density of states, as a function of the “dimensionality” of the active layer, shown in Figure 5.17. The population inversion (creation of electrons and holes) necessary for lasing occurs more efficiently as the active layer material is scaled down from bulk (3-dimensional) to quantum dots (0-dimensional). However, the advantages in operation depend not only on the absolute size of the nanostructures in the active region, but also on the uniformity of size. A broad distribution of sizes “smears” the density of states, producing behavior similar to that of bulk material.

Thus, the challenge in realizing quantum dot lasers with operation superior to that shown by quantum well lasers is that of forming high quality, uniform quantum dots in the active layer. Initially, the most widely followed approach to forming quantum dots was through electron beam lithography of suitably small featured patterns (~ 300 Å) and subsequent dry-etch transfer of dots into the substrate material. The problem that plagued these quantum dot arrays was their exceedingly low optical efficiency: high surface-to-volume ratios of these nanostructures and associated high surface recombination rates, together with damage introduced during the fabrication itself, precluded the successful formation of a quantum dot laser.

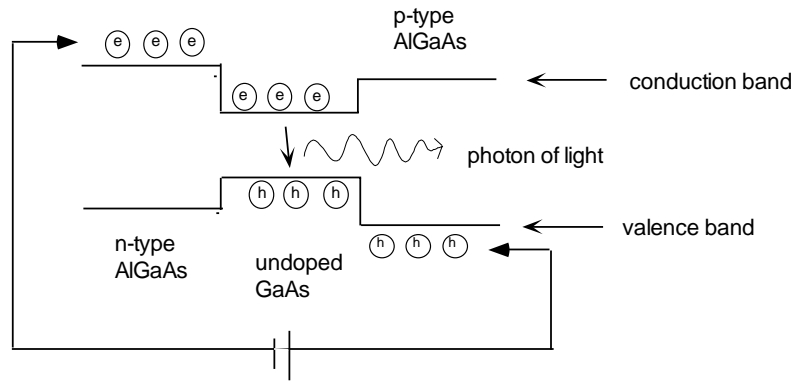

Figure 5.16. Schematic of a semiconductor laser.

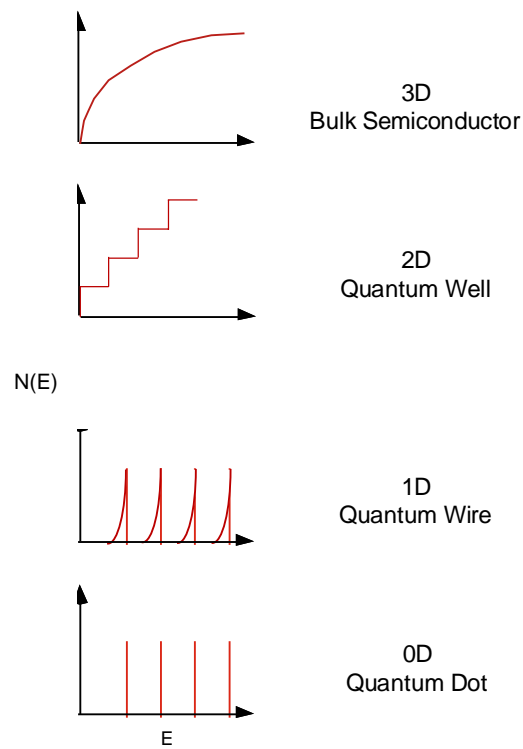

Figure 5.17. Density of electronic states as a function of structure size.

With the demonstration of the high optical efficiency self-assembled formation of quantum dots (see Chapter 2), formed without need of external processing and having the natural overgrowth of cladding material (which addressed issues of surface recombination), there ensued a marked increase

in quantum dot laser research. The first demonstration of a quantum dot laser with high threshold density was reported by Ledentsov and colleagues in 1994. Bimberg et al. (1996) achieved improved operation by increasing the density of the quantum dot structures, stacking successive, strain-aligned rows of quantum dots and therefore achieving vertical as well as lateral coupling of the quantum dots. In addition to utilizing their quantum size effects in edge-emitting lasers, self-assembled quantum dots have also been incorporated within vertical cavity surface-emitting lasers. Table 5.4 gives a partial summary of the work and achievements in quantum dot lasers.

As with the demonstration of the advantages of the quantum well laser that preceded it, the full promise of the quantum dot laser must await advances in the understanding of the materials growth and optimization of the laser structure. Although the self-assembled dots have provided an enormous stimulus to work in this field, there remain a number of critical issues involving their growth and formation: greater uniformity of size, controllable achievement of higher quantum dot density, and closer dot-to-dot interaction range will further improve laser performance. Better understanding of carrier confinement dynamics and capture times, and better evaluation of loss mechanisms, will further improve device characteristics. It should be noted that the spatial localization of carriers brought about by the quantum dot confinement may play a role in the “anomalous” optical efficiency of the GaN-based materials, which is exceptional in light of the high concentration of threading dislocations ($\sim 10^8 - 10^{10} \text{ cm}^{-2}$) that currently plague this material system. The localization imposed by the perhaps natural nanostructure of the GaN materials may make the dislocation largely irrelevant to the purely optical (but not to the electrical) behavior of the material.

CARBON NANOTUBES

The first synthesis and characterization of carbon nanotubes were reported by Iijima from NEC in late 1991. The initial theoretical study of their electronic structure was soon followed with the work by Dresselhaus and coworkers at MIT (Dresselhaus et al. 1992; Saito et al. 1992a; Saito et al. 1992b). Since then, the fabrication of nanotubes has been improved by several groups, and methods other than arc discharge have been explored. The main issues are to separate the nanotubes from other forms of carbon also produced in the fabrication process and to increase the yield of single-walled nanotubes (SWNT) for potential applications. Following Iijima’s work, macroscopic quantities of MWNT were produced with an improved arc discharge method by Ebbesen and coworkers at NEC (Tsukuba) (Ebbesen and Ajayan 1992).

TABLE 5.4. Summary of Quantum Dot Laser Results

Year	QD composition & size	Threshold (kA/cm ²)	Operating T (K)	Wavelength (μm)	Reference
1994	InAs	1	300	0.9	(Kirstaedter et al. 1994) Europe/Russia
	7 nm	0.1	77	0.95	
1994	InGaAs 30 nm	7.6	77	1.26	(Hirayama et al. 1994) Japan
1995	In _{0.5} Ga _{0.5} As 20 nm	0.8	85	0.92	(Shoji et al. 1995) Japan
1996	InP 25 nm	25	300	0.7	(Moritz et al. 1996) Europe
1996	In _{0.3} Ga _{0.7} As	0.5	300	1.2	(Mirin et al. 1996) United States
		1.2		1	
1996	In _{0.4} Ga _{0.6} As 12 nm	0.65	300	1	(Kamath et al. 1996) United States
1996	In _{0.5} Ga _{0.5} As 10 layers	0.06	300	1	(Ledentsov et al. 1996) Russia/Europe

Source: Bimberg et al. 1997

It was not until 1995 that Smalley and colleagues at Rice University showed that SWNT can be efficiently produced by laser ablation of a graphite rod (Guo et al. 1995). In the following year, that same group produced what is considered to be among the best SWNT material generated so far; over 70% of the volume of material was nanotubes bundled together into crystalline ropes of metallic character (Thess et al. 1996). Also in 1996, a group from the Chinese Academy of Science used chemical vapor deposition to produce a 50 mm thick film of nanotubes that were highly aligned perpendicular to the surface (Li et al. 1996). Progress in recent years leads one to predict that it will indeed be possible to produce high quality carbon nanotubes in macroscopic quantities needed for many of the applications outlined below.

Nanotube bundles form a low density material and are expected to have high stiffness and axial strength as a result of their seamless cylindrical graphitic structure. It is therefore predicted that they can be used to fabricate a material with better mechanical properties than the present carbon fiber materials. Information about the mechanical properties of nanotubes has been gathered recently by a study of the thermal vibrations of a single

SWNT attached to a substrate (Treacy et al. 1996). Ebbesen's group at the Princeton NEC Research Institute found that nanotubes have an exceptionally high Young's modulus ($\sim 2 \times 10^9$ Pa) (Treacy et al. 1996). In order to reach a better understanding of the mechanical properties and intrinsic limitations of nanotubes, Bernholc's group from North Carolina State University theoretically studied the behavior of nanotubes beyond the linear Hooke's law and the nature of the defects leading to dislocations and fractures (Yakobson et al. 1996; Nardelli et al. 1998).

Nanotubes are highly polarizable nanoscale straws, a property that confers on them the capacity to ingest inorganic elements by nanocapillarity (Pederson and Broughton 1992). As a result, it has been conjectured that they could be used as minute molds to shape nanometer-sized quantum wires and as miniature test tubes. Ajayan and coworkers at NEC (Tsukuba) have first shown that lead can be introduced into carbon nanotubes (Ajayan and Iijima 1993). The efficiency of their process is low, and prior removal of the caps from the ends of the nanotubes is expected to improve the situation (Tsang et al. 1993). More information about the mechanism of NT filling was obtained by Pascard and coworkers from the École Polytechnique in France by studying the propensity to form nanowires for 15 encapsulated metal elements (Guerret-Plécourt et al. 1994). Finally, external decoration of nanotubes with metal atoms has been demonstrated and is predicted to have applications in catalysis (Satishkumar et al. 1996). Table 5.5 summarizes the primary methods of nanotube fabrication and the institutions engaged in specific methods of nanotube fabrication.

Early theoretical studies already showed that the electronic properties of nanotubes strongly depend on their diameter and their chirality leading to metallic or semiconducting structures (Saito et al. 1992c). It was conjectured that these properties can be used to construct nanoscale electronic devices. While theoretical studies were promptly published, it was only in 1996 that Ebbesen and coworkers (1996) at the Princeton NEC Research Institute presented reliable four-point probe conductivity measurements on MWNT, confirming the theoretical predictions. In 1997, two groups, one at Lawrence Berkeley National Laboratory (Bockrath et al. 1997) and the second at Delft University (Tans et al. 1997) in the Netherlands showed that conductivity through nanotubes is controlled by low dimensional effects such as resonant tunneling and single-electron charging effects. Hall effect measurements at the École Polytechnique Fédérale de Lausanne (EPFL) in Switzerland have shown that hole transport is predominant in electronic conductance (Baumgartner et al. 1997). Despite these and other very recent and encouraging efforts such as those studying the mean free path of carriers in nanotubes, the conduction mechanism is still only partially understood (Petit et al. 1997).

TABLE 5.5. Nanotube Fabrication Methods

Method	Institution
Laser ablation – SWNT	Rice University
Arc discharge – SWNT	University of Montpellier
	University of Kentucky
Arc discharge - MWNT	NEC
Chemical vapor deposition - aligned MWNT	Beijing

Metallic nanotubes are strongly polarizable in an electric field and thereby lead to field enhancement at their extremity, the strength of which depends on the ratio of the diameter to the length and can be extremely large for routinely produced nanotubes. For this reason and possibly others related to quantum confinement effects, nanotubes are expected to form outstanding field-emitting materials. In 1995, the Rice University group showed that nanotubes emit electrons very efficiently when immersed in an electric field and irradiated by a laser to remove their cap (Rinzler et al. 1995). They attribute their observation to the unraveling of an atomic wire of carbon atoms. Efficient field emission was also obtained from carefully aligned nanotubes by de Heer and coworkers (1995) at EPFL, whereas Collins and coworkers from the University of California at Berkeley (Collins and Zettl 1996, 1997), have used randomly oriented nanotubes with similar results. Efficient field-emitting material is highly desirable for the production of field-emission displays and microwave tubes.

Recently, a group from Mie University in Japan has built a cathode ray tube (CRT) using nanotube field emitters (Saito et al. n.d.). In this work, the layers of nanotubes were cut out from the soot produced in an arc discharge chamber. This fabrication method is presently not compatible with industrial production requirements, and more progress must be made before this effort can be translated into an industrial product. Table 5.6 summarizes the electrical and field emission properties of nanotubes, with the representative institutions pursuing these studies.

In summary, macroscopic amounts of good quality nanotubes can presently be fabricated by several groups around the world, and the theoretical understanding of the electronic structure and related properties of nanotubes has reached a very good level. However, despite the fact that many potential applications are mentioned in the literature over and over again, only the outstanding field emission properties of nanotubes have achieved realization in practical devices. One of the main obstacles simply remains the controlled manipulation of nanoscale objects. In this respect it seems that the generation of self-aligned structures is a path to explore further, especially after the encouraging successes reported in the literature in 1997-98.

TABLE 5.6. Electrical and Field Emission Properties of Nanotubes

Results	Institution
Theory and experiment: nanotubes can be metallic or semiconducting	MIT, NEC
Conductivity shows low dimensional signature	LBNL Delft University
Field emission from unraveled carbon chains at the end of nanotubes	Rice University
Field emission from aligned nanotubes attached to scanning probe tip	EPFL
CRTs fabricated with nanotubes as field emitters	Mie University

REFERENCES

- Adeyeye, A., G. Lauhoff, J. Bland, C. Daboo, D. Hasko, and H. Ahmed. 1997. *Appl. Phys. Lett.* 70:1046.
- Ajayan, P.M., and S. Iijima. 1993. *Nature.* 361:333.
- Arakawa, Y., H. Sakaki. 1982. *Appl. Phys. Lett.* 40: 939.
- Asada, M., Y. Mayamoto, and Y. Suematsu. 1986. *IEEE Journ. Quantum Electronics* QE-22(9): 1915-1921.
- Averin, D.V., and K.K. Likharev. 1991. Chapter 6 in *Mesoscopic phenomena in solids*, ed. B.L. Altshuler, P.A. Lee, and R.A. Webb. Amsterdam: Elsevier.
- Awschalom, D., D. DiVincenzo, and J. Smyth. 1992. *Science* 258:414.
- Baibich, M.N., J.M. Broto, A. Fert, F. Nguyen Van Dau, F. Petroff, P. Etienne, G. Creuzet, A. Friederich, and J. Chazelas. 1988. *Phys. Rev. Lett.* 61:2472.
- Barbara, B., L.C. Sampaio, J.E. Wegrowe, B.A. Ratnam, A. Marchand, C. Paulsen, M.A. Novak, J.L. Tholence, M. Uehara, and D. Fruchart. 1993. *J. Appl. Phys.* 73:6703.
- Barker, J. R., S. Roy, S. Babiker, and A. Asenov. 1997. *Proceedings of the International Conference on Quantum Devices and Circuits.* Singapore: World Scientific.
- Baumgartner, G., M. Carrard, L. Zuppiroli, W. Bacsa, W.A. de Heer, and L. Forró. 1997. *Phys. Rev. B.* 55:6704.
- Berkowitz, A.E., J.R. Mitchell, M.J. Carey, A.P. Young, S. Zhang, F.E. Spada, F.T. Parker, A. Hutten, and G. Thomas. 1992. *Phys. Rev. Lett.* 68:3745.
- Betzig, E., and J. Trautmann. 1992. *Science* 257:189.
- Bimberg, D., N. Ledentsov, M. Grundmann, N. Kirstaedter, O. Schmidt, M. Mao, V. Ustinov, A. Egorov, P. Kop'ev, Zh. Alferov, S. Ruvimov, U. Gösele, and J. Heydenreich. 1996. *Jap. Journal. Appl. Phys.* 35 1311-1219.
- Bimberg, D., N. Kirstaedter, N.N. Ledentsov, Zh. Alferov, P.S. Kop'ev, and V.M. Ustinov. 1997. *IEEE Selected Topics in Quantum Electronics* 3:196-205.
- Blondel, A., J. Meier, B. Doudin, and J. Ansermet. 1994. *Appl. Phys. Lett.* 65:3019.
- Bockrath, M., D.H. Cobden, P.L. McEuen, N.G. Chopra, A. Zettl, A. Thess, and R.E. Smalley. 1997. *Science* 275:1922.
- Braun, H., and D. Loss. 1994. *J. Appl. Phys.* 73:6177.
- Nardelli, M.B., B.I. Yakobson, and J. Bernholc. 1998. *Phys. Rev. B* 57:R4277.
- Carey, M.J., A.P. Young, A. Starr, D. Rao, A.E. Berkowitz, and J.S. Jiang. 1992. *Appl. Phys. Lett.* 61:2935.

- Carlsson, S.-B., T. Junno, H. Xu, L. Montelius, and L. Samelson. 1997. *Extended abstracts of the 3rd International Workshop on Quantum Functional Devices*. Tokyo: R&D Association for FED.
- Cavicchi, R., and R. Silsbee. 1984. *Phys. Rev. Lett.* 52:1453.
- Chen, E., S. Tehrani, T. Zhu, M. Durlam, and H. Goronkin. 1997. *J. Appl. Phys.* 81:3992.
- Chou, S. 1997. *Proceedings of the IEEE* 85:652.
- Chou, S., P. Krauss, and P.R. Enstrom. 1995. *Science* 272:8.
- Chou, S., M. Wei, P. Krauss, and P. Fischer. 1994. *J. Appl. Phys.* 76:6673.
- Collins, P., and A. Zettl. 1996. *Appl. Phys. Lett.* 69:1969.
- Collins, P., and A. Zettl. 1997. *Phys. Rev. B.* 55:9391.
- de Heer, W.A., A. Chatelain, and D. Ugarte. 1995. *Science* 270:1179.
- Dingle, R., and C.H. Henry. 1976. Quantum effects in heterostructure lasers. U.S. Patent 3982207 (Sept. 21).
- Dieny, B., V.S. Speriosu, B.A. Gurney, S.S.P. Parkin, D.R. Wilhoit, K.P. Roche, S. Metin, D.T. Peterson, and S. Nadimi. 1991a. *J. Mag. Magn. Mater.* 93:101.
- Dieny, B., V.S. Speriosu, S. Metin, S.S.P. Parkin, B.A. Gurney, P. Baumgart, and D.R. Wilhoit. 1991b. *J. Appl. Phys.* 69:4774.
- Dresselhaus, M.S., G. Dresselhaus, and R. Saito. 1992. *Phys. Rev. B.* 45:6234.
- Ebbesen, T.W., and P.M. Ajayan. 1992. *Nature* 358: 220.
- Ebbesen, T. W., H. J. Lezec, H. Hiura, J. W. Bennett, H. F. Ghaemi, and T. Thio. 1996. *Nature.* 382:54.
- Eberl, K., P.M. Petroff, and P. Demmester, eds. 1995. *Low dimensional structures prepared by epitaxial growth or regrowth on patterned substrates*. Dordrecht: Kluwer.
- Futatsugi, T., Y. Awano, Y. Sakuma, M. Shima, Y. Sugiyama, H. Nakao, T. Strutz, M. Takatsu, and N. Yokoyama. 1997. *Extended abstracts of the 16th Symposium on Future Electron Devices*. Tokyo: R&D Association for FED.
- Gaarg, A. 1994. *J. Appl. Phys.* 76:6168.
- Gallagher, W.J., S.S.P. Parkin, X. Bian, A. Marley, K. Roche, R. Altman, S. Rishton, C. Jahnke, T. Shaw, and G. Xiao. 1997. *J. Appl. Phys.* 81:3741.
- Gatteschi, D., A. Caneschi, L. Paedi, and R. Sessoli. 1994. *Science* 265:1054.
- Guerret-Plécourt, C., Y. Le Bouar, A. Loiseau, and H. Pascard. 1994. *Nature* 372:76.
- Guo, L., E. Leobandung, and S.Y. Chou. 1977. *Science* 275:649.
- Guo, T., P. Nikolaev, A. Thess, D.T. Colbert, and R.E. Smalley. 1995. *Chem. Phys. Lett.* 243:49.
- Hirayama, H., K. Matsunaga, M. Asada, and Y. Suematsu. 1994. *Electronics Letters* 30:142-3.
- Hong, K., and N. Giordano. 1995. *J. Mag. Magn. Mater.* 151:396.
- Hylton, T. 1993. *Appl. Phys. Lett.* 62:2431.
- Iijima, S. 1991. *Nature* 354:56.
- Jiang, J.S., J.Q. Xiao, and C.L. Chien. 1992. *Appl. Phys. Lett.* 61:362.
- Jung, K., J. Shi, K. Nordquist, S. Tehrani, M. Durlam, E. Chen, and H. Goronkin. 1997. *IEEE Trans. Mag.* 33:3601.
- Kahn, O. 1993. In *Molecular magnetism*. New York: VCH.
- Kamath, K., P. Bhattacharya, T. Sosnowski, T. Norris, and J. Phillips. 1996. *Electronics Letters* 32:1374-75.
- Kirstaedter, N., N. Ledentsov, M. Grundmann, D. Bimberg, V. Ustinov, S. Ruvimov, M. Maximov, P. Kop'ev, and Zh. Alferov. 1994. *Electronics Letters* 30:1416-7.
- Koga, J.K., K. Uchida, and A. Toriumi. 1997. *Extended abstracts of the 16th Symposium on Future Electron Devices*. Tokyo: R&D Association for FED.
- Kong, L., L. Zhuang, and S. Chou. 1997. *IEEE Trans. Mag.* 33:3019.
- Kumzerov, Y., and V. Poborchii. 1994. *Phantoms* 4:2.
- Ledentsov, N.N., M. Grundmann, N. Kirstaedter, J. Christen, R. Heitz, J. Börher, F. Heinrichsdorff, D. Bimberg, S.S. Ruvimov, P. Werner, U. Richter, U. Gösele, J.

- Heydenreich, V.M. Ustinov, A.Yu. Egorov, M.V. Maximov, P.S. Kop'ev, and Zh.I. Alferov. 1994. *Proc. ICPS-22*, Vancouver 3:1855. Singapore: World Scientific.
- Ledentsov, N.N., V.A. Shchukin, M. Grundmann, N. Kirstaedter, J. Börher, O.G. Schmidt, D. Bimberg, V.M. Ustinov, A. Yu. Egorov, A.E. Zhukov, P.S. Kop'ev, S.V. Zaitsev, N.Yu. Gordeev, and Zh.I. Alferov. 1996. *Physical Review B* 54:8743-50.
- Lent, C.S., P.D. Tougaw, W. Porod, and G.H. Bernstein. 1993. *Nanotechnology* 4:49.
- Li, W.Z., S.S. Xie, L.X. Qian, B.H. Chang, B.S. Zou, W.Y. Zhou, R.A. Zhao, and G. Wang. 1996. *Science* 274:1701.
- Likharev, K.K. 1998. *IBM J. Res. Dev.* 32:144.
- Mankos, M., P. de Haan, V. Kambersky, G. Matteucci, M. McCartney, Z. Yang, M. Scheinfein, and J. Cowley. 1995. In *Electron holography*, ed. A. Tonomura. Elsevier.
- Mirin, R., A. Gossard, and J. Bowers. 1996. *Proceedings, Int. Conf. Quantum Devices and Circuits*, ed. K. Ismail, S. Bandyopadhyay, and J.P. Leburton. Singapore: World Scientific.
- Miyazaki, T., and N. Tezuka. 1995. *J. Mag. Magn. Mater.* 139:L231.
- Moopera, J.S., L.R. Kinder, T.M. Wong, and R. Merservey. 1995. *Phys. Rev. Lett.* 74:3273.
- Moritz, A., R. Wirth, A. Hangleiter, A. Kurtenback, and K. Eberl. 1996. *Appl. Phys. Lett.* 69:212-214.
- Nakajima, A., T. Futatsugi, K. Kosemura, T. Fukano, and N. Yokoyama. 1997. *Appl. Phys. Lett.* 70:1742.
- Nakazato, K. 1996. *Extended abstracts of 15th Symposium on Future Electron Devices*. Tokyo: R&D Association for FED.
- Nakazato, K., T. J. Thornton, J. White, and H. Ahmed. 1992. *Appl. Phys. Lett.* 61:3145.
- Nötzl, R. 1996. *Semicond. Sci. Technol.* 11:1365, and references therein.
- Ohata, A., and A. Toriumi. 1996. *IEICE Trans. Electron.* E79-C:1586.
- Ohkubo, T., J. Kishigami, K. Yanagisawa, and R. Kaneko. 1991. *IEEE Trans. Magn.* 6:5286.
- Parkin, S.S.P., N. More, and K.P. Roche. 1990. *Phys. Rev. Lett.* 64:2304.
- Pederson, M.R. and J.Q. Broughton. 1992. *Phys. Rev. Lett.* 69:2689.
- Petit, P., E. Jougelet, J.E. Fischer, A.G. Rinzler, and R.E. Smalley. 1997. *Phys. Rev. B.* 56:9275.
- Petroff and Demmester. 1995. In *Low dimensional structures*, ed. Eberl et al.
- Piroux, L., J. George, J. Despres, C. Leroy, E. Ferain, R. Legres, K. Ounadjela, and A. Fert. 1994. *Appl. Phys. Lett.* 65:2484.
- Prokofev, N., and P. Stamp. 1993. *J. Phys. Condensed Mater.* 5:L663.
- Reed, M.A., C. Zhou, C.J. Muller, T.P. Burgin, and J. M. Tour. 1997. *Science* 278:252.
- Rinzler, A.G., J.H. Hafner, P. Nikolaev, L. Lou, S.G. Kim, D. Tománek, P. Nordlander, D.T. Colbert, and R.E. Smalley. 1995. *Science* 269:1550.
- Roychowdhury, V.P., D.B. Janes, S. Bandyopadhyay, and X. Wang. 1966. *IEEE Trans. Electron Devices* 43:1688.
- Saito, R., G. Dresselhaus, and M.S. Dresselhaus. 1992a. *Appl. Phys. Lett.* 60:2204.
- Saito, R., M. Fujita, G. Dresselhaus, and M.S. Dresselhaus. 1992b. *Phys. Rev. B.* 46:1804.
- _____. 1992c. *Appl. Phys. Lett.* 60:2204.
- Saito, Y., S. Uemura, and K. Hamaguchi. 1998. *Jap. J. Appl. Phys.* 37:L346.
- Sakaki, H., G. Yusa, T. Someya, Y. Ohno, T. Noda, H. Akiyama, Y. Kadoya, and H. Noge. 1995. *Appl. Phys. Lett.* 67:3444.
- Satishkumar, B.C., E.M. Vogl, A. Govindaraj, and C.N.R. Rao. 1996. *J. Phys. D.* 29:3173.
- Sato, O., T. Iyoda, A. Fujishima, and K. Hashimoto. 1996a. *Science* 272:704.
- Sato, O., T. Iyoda, A. Fujishima, and K. Hashimoto. 1996b. *Science* 271:49.
- Scheinfein, M., J. Unguris, M. Kelley, D. Pierce, and R. Celotta. 1990. *Rev. Sci. Instrum.* 61:2501.
- Shi, J., T. Zhu, M. Durlam, E. Chen, and S. Tehrani. 1998. *J. Appl. Phys.* (In press.)
- Shi, J., T. Zhu, S. Tehrani, Y. Zheng, and J.G. Zhu. N.d. submitted to *Phys. Rev. Lett.*

- Shinjo, T. and T. Takada. 1987. Metallic superlattices. In *Ferromagnetic Materials*, Vol. 3, ed. E.P. Worhlfarth.4 Amsterdam: Elsevier.
- Shoji, H., K. Mukai, N. Ohtsuka, M. Sugawara, T. Uchida, and H. Ishikawa. 1995. *IEEE Photonic Technology Letters* 7:1385-87.
- Snider, G.L., A.O. Orlov, I. Amlani, G.H. Bernstein, C.S. Lent, J.L. Merz, and W. Porod. 1997. *Extended abstracts of the 3rd International Workshop on Quantum Functional Devices*. Tokyo: R&D Association for FED.
- Taira, K., T. Suzuki, H. Ono, K. Nomoto, and I. Hase. 1997. *Extended abstracts of the 3rd International Workshop on Quantum Functional Devices*. Tokyo: R&D Assn. for FED.
- Tans, S.F., M.H. Devoret, H. Dai, A. Thess, R.E. Smalley, L.J. Geerligs, and C. Dekker. 1997. *Nature* 386:474.
- Tehrani, S., E. Chen, M. Durlam, T. Zhu, and H. Goronkin. 1996. *IEDM Digest* 96:193.
- Thess, A., R. Lee, P. Nikolaev, H. Dai, P. Petit, J. Robert, C. Xu, Y.H. Lee, S.G. Kim, A.G. Rinzler, D.T. Colbert, G.E. Scuseria, D. Tománek, J.E. Fischer, and R.E. Smalley. 1996. *Science* 273:483.
- Tougaw, P.D., and C.S. Lent. 1994. *J. Appl. Phys.* 75:1818.
- Treacy, M.M.J., T.W. Ebbesen, and J.M. Gibson. 1996. *Nature* 38:678.
- Tsang, S.C., P.J.F. Harris, and M.L.H. Green. 1993. *Nature* 362:520.
- Tsang, W.T. 1982. *Appl. Phys. Lett.* 40:217-219.
- Tsoukatos, A., H. Wan, G.C. Hadjipanayis, and Z.G. Li. 1992. *Appl. Phys. Lett.* 61:2059.
- Tsukagoshi, K., K. Nakazato, and T. Sato. 1997. *Extended abstracts of 16th Symposium on Future Electron Devices*. Tokyo: R&D Association for FED.
- van der Ziel, J.P., R. Dingle, R.C. Miller, W. Wiegmann, and W.A. Nordland, Jr. 1975. *Appl. Phys. Lett.* 26:463-465.
- Wesler, J.J., S. Tiwari, S. Rishton, K.Y. Lee, and Y. Lee. 1997. *IEEE Electron Rev. Lett.* 18:278.
- Woodham, R.G. and H. Ahmed. 1997. *Extended abstracts of the 3rd International Workshop on Quantum Functional Devices*. Tokyo: R&D Association for FED.
- Xiao, J.Q., J.S. Jiang, and C.L. Chien. 1992. *Phys. Rev. Lett.* 68:3749.
- Yakobson, B.I., C.J. Brabec, and J. Bernholc. 1996. *Phys. Rev. Lett.* 76:2511.
- Zheng, Y., and J.G. Zhu. 1997. *J. Appl. Phys.* 81:5471.
- Zhu, T., J. Shi, K. Nordquist, S. Tehrani, M. Durlam, E. Chen, and H. Goronkin. 1997. *IEEE Trans. Mag.* 33:3601.

Chapter 6

Bulk Behavior of Nanostructured Materials

Carl Koch
North Carolina State University

INTRODUCTION

Bulk nanostructured materials are defined as bulk solids with nanoscale or partly nanoscale microstructures. This category of nanostructured materials has historical roots going back many decades but has a relatively recent focus due to new discoveries of unique properties of some nanoscale materials.

Early in the century, when “microstructures” were revealed primarily with the optical microscope, it was recognized that refined microstructures, for example, small grain sizes, often provided attractive properties such as increased strength and toughness in structural materials. A classic example of property enhancement due to a refined microstructure—with features too small to resolve with the optical microscope—was age hardening of aluminum alloys. The phenomenon, discovered by Alfred Wilm in 1906, was essentially explained by Merica, Waltenberg, and Scott in 1919 (Mehl and Cahn 1983, 18), and the microstructural features responsible were first inferred by the X-ray studies of Guinier and Preston in 1938. With the advent of transmission electron microscopy (TEM) and sophisticated X-ray diffraction methods it is now known that the fine precipitates responsible for age hardening, in Al-4% Cu alloys, for example, are clusters of Cu atoms—Guinier-Preston (GP) zones—and the metastable partially coherent θ' precipitate (Silcock et al. 1953-54; Cohen 1992). Maximum hardness is observed with a mixture of GPII (or θ'') (coarsened GP zones) and θ' with the dimensions of the θ' plates, typically about 10 nm in thickness by 100 nm in diameter. Therefore, the important microstructural feature of age-

hardened aluminum alloys is nanoscale. There are a number of other examples of nanoscale microstructures providing optimized properties. The critical current density J_C of commercial superconducting Nb_3Sn is controlled by grain size and is inversely proportional to grain size, with grain sizes of 50-80 nm providing high values of J_C (Scanlan et al. 1975).

The field of nanocrystalline (or nanostructured, or nanophase) materials as a major identifiable activity in modern materials science results to a large degree from the work in the 1980s of Gleiter and coworkers (Gleiter 1990), who synthesized ultrafine-grained materials by the in situ consolidation of nanoscale atomic clusters. The ultrasmall size (< 100 nm) of the grains in these nanocrystalline materials can result in dramatically improved—or different—properties from conventional grain-size (> 1 μm) polycrystalline or single crystal materials of the same chemical composition. This is the stimulus for the tremendous appeal of these materials.

While there are a number of bulk properties that may be dramatically changed when the microstructure is nanoscale, this chapter focuses on those for which the recent work with nanostructured materials has been most extensive. These are (1) the mechanical properties of nanostructured materials for a variety of potential structural applications, and (2) ferromagnetic materials with nanoscale microstructures for potential applications as soft magnetic materials and permanent magnet materials, and for other special applications such as information storage, magnetoresistance spin valves, and magnetic nanocomposite refrigerants. Other bulk applications such as hydrogen storage are discussed briefly.

MECHANICAL BEHAVIOR: STRUCTURAL NANOSTRUCTURED MATERIALS

The great interest in the mechanical behavior of nanostructured materials originates from the unique mechanical properties first observed and/or predicted for the materials prepared by the gas condensation method. Among these early observations/predictions were the following:

- lower elastic moduli than for conventional grain size materials—by as much as 30 - 50%
- very high hardness and strength—hardness values for nanocrystalline pure metals (~ 10 nm grain size) are 2 to 7 times higher than those of larger grained (> 1 μm) metals
- a negative Hall-Petch slope, i.e., decreasing hardness with decreasing grain size in the nanoscale grain size regime
- ductility—perhaps superplastic behavior—at low homologous temperatures in brittle ceramics or intermetallics with nanoscale grain sizes, believed due to diffusional deformation mechanisms

While some of these early observations have been verified by subsequent studies, some have been found to be due to high porosity in the early bulk samples or to other artifacts introduced by the processing procedures. The following summarizes the author's understanding of the state of the art of the mechanical behavior of nanostructured materials, as determined from the literature, presentations at the U.S. workshop (Siegel et al. 1998), and the WTEC panel's site visits in Japan and Europe.

Elastic Properties

Early measurements of the elastic constants on nanocrystalline (nc) materials prepared by the inert gas condensation method gave values, for example for Young's Modulus, E , that were significantly lower than values for conventional grain size materials. While various reasons were given for the lower values of E , it was suggested by Krstic and coworkers (1993) that the presence of extrinsic defects—pores and cracks, for example—was responsible for the low values of E in nc materials compacted from powders. This conclusion was based on the observation that nc NiP produced by electroplating with negligible porosity levels had an E value comparable to fully dense conventional grain size Ni (Wong et al. 1994, 85). Subsequent work on porosity-free materials has supported these conclusions, and it is now believed that the intrinsic elastic moduli of nanostructured materials are essentially the same as those for conventional grain size materials until the grain size becomes very small, e.g., < 5 nm, such that the number of atoms associated with the grain boundaries and triple junctions becomes very large. This is illustrated in Figure 6.1 for nanocrystalline Fe prepared by mechanical attrition and measured by a nano-indentation technique. Thus, for most nanostructured materials (grain size > 10 nm), the elastic moduli are not unique properties and not a “negative.”

Hardness and Strength

Hardness and strength of conventional grain size materials (grain diameter, $d > 1$ μm) is a function of grain size. For ductile polycrystalline materials the empirical Hall-Petch equation has been found to express the grain-size dependence of flow stress at any plastic strain out to ductile fracture. In terms of yield stress, this expression is $\sigma_o = \sigma_i + kd^{-1/2}$, where σ_o = yield stress, σ_i = friction stress opposing dislocation motion, k = constant, and d = grain diameter. Similar results are obtained for hardness, with $H_o = H_i + kd^{-1/2}$. To explain these empirical observations, several models have been proposed, which involve either dislocation pileups at grain boundaries or grain boundary dislocation networks as dislocation sources. In

all cases the Hall-Petch effect is due to dislocation motion/generation in materials that exhibit plastic deformation.

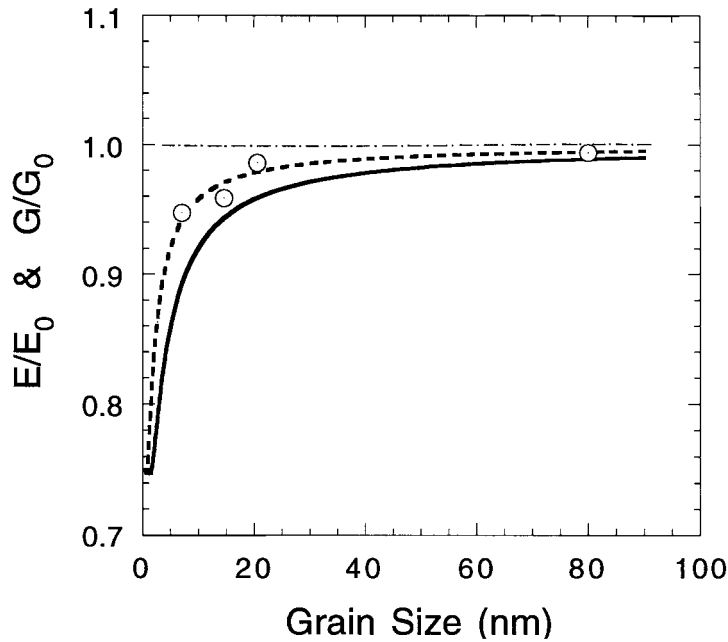

Figure 6.1. Ratio of the Young's (E) and shear (G) moduli of nanocrystalline materials to those of conventional grain size materials as a function of grain size. The dashed and solid curves correspond to a grain boundary thickness of 0.5 and 1 nm, respectively (Shen et al. 1995).

Most of the mechanical property data on nc materials have pertained to hardness, although some tensile test data are becoming available. Several recent reviews have summarized the mechanical behavior of these materials (Siegel and Fougere 1994, 233–261; Siegel 1997; Morris and Morris 1997; Weertman and Averback 1996, 323–345). It is clear that as grain size is reduced through the nanoscale regime (< 100 nm), hardness typically increases with decreasing grain size and can be factors of 2 to 7 times harder for pure nc metals (10 nm grain size) than for large-grained (> 1 μm) metals.

The experimental results of hardness measurements, summarized previously, show different behavior for dependence on grain size at the smallest nc grains (< 20 nm), including (a) a positive slope (“normal” Hall-Petch behavior), (b) essentially no dependence (\sim zero slope), and (c) in some cases, a negative slope (Siegel and Fougere 1994, 233–261; Siegel 1997; Morris and Morris 1997; Weertman and Averback 1996, 323–345). Most data that exhibit the negative Hall-Petch effect at the smallest grain sizes have resulted from nc samples that have been annealed to increase their

grain size. It is suggested that thermally treating nanophase samples in the as-produced condition may result in such changes in structure as densification, stress relief, phase transformations, or grain boundary structure, all of which may lead to the observed negative Hall-Petch behavior (Siegel and Fougere 1994, 233–261). Only a few cases of negative Hall-Petch behavior have been reported for as-produced nanocrystalline samples with a range of grain sizes. These include electrodeposited nc alloys and devitrified nc alloys (Erb et al 1996, 93-110; Alves et al. 1996). Nanocrystalline thin films with grain sizes ≤ 6 nm are also observed to exhibit a negative Hall-Petch effect (Veprék 1998). While it seems likely that in many cases the observed negative Hall-Petch slopes are due to artifacts of the specimen preparation methods, it is also likely that conventional dislocation-based deformation is not operable in nanocrystalline materials at the smallest grain sizes ($< \sim 30$ nm). At these grain sizes, theoretically, mobile dislocations are unlikely to occur; nor have they been observed in *in situ* TEM deformation experiments (Siegel and Fougere 1994, 233–261; Milligan et al 1993; Ke et al. 1995). Thus, the hardness, strength, and deformation behavior of nanocrystalline materials is unique and not yet well understood.

Ductility and Toughness

It is well known that grain size has a strong effect on the ductility and toughness of conventional grain size ($> 1 \mu\text{m}$) materials. For example, the ductile/brittle transition temperature in mild steel can be lowered about 40°C by reducing the grain size by a factor of 5. On a very basic level, mechanical failure, which limits ductility, is an interplay or competition between dislocations and cracks (Thomson 1996, 2208–2291). Nucleation and propagation of cracks can be used as the explanation for the fracture stress dependence on grain size (Nagpal and Baker 1990). Grain size refinement can make crack propagation more difficult and therefore, in conventional grain size materials, increase the apparent fracture toughness. However, the large increases in yield stress (hardness) observed in nc materials suggest that fracture stress can be lower than yield stress and therefore result in reduced ductility. The results of ductility measurements on nc metals are mixed and are sensitive to flaws and porosity, surface finish, and method of testing (e.g., tension or compression testing). In tension, for grain sizes < 30 nm, essentially brittle behavior has been observed for pure nanocrystalline metals that exhibit significant ductility when the grain size is conventional. This is illustrated in Figure 6.2.

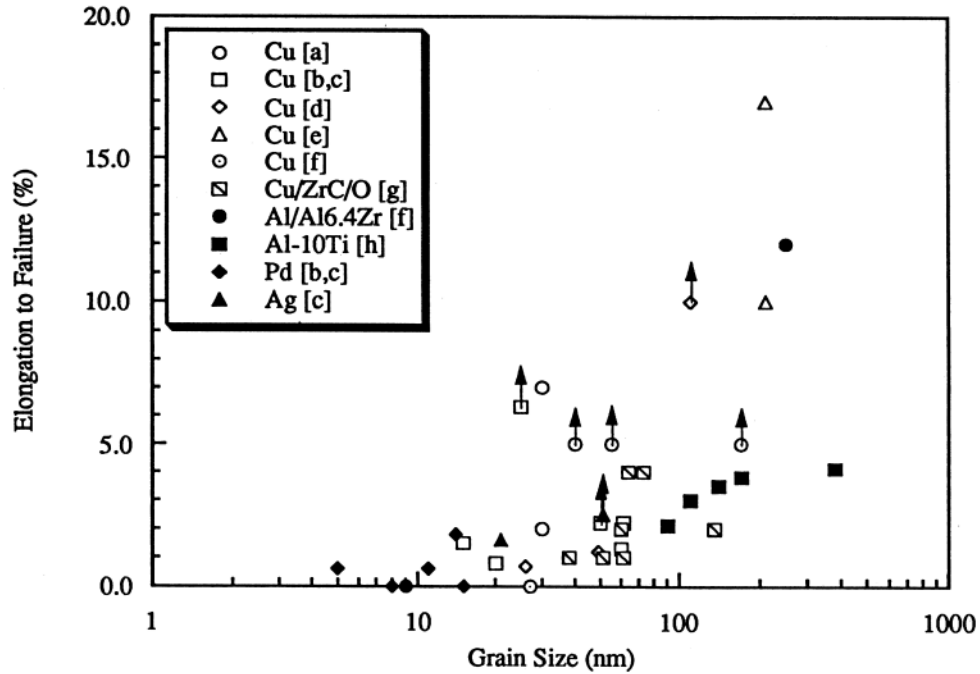

Key to Sources

a. Gunther et al. 1990	e. Gertsman et al. 1994
b. Nieman et al. 1991a	f. Eastman et al. 1997, 173-182
c. Nieman et al. 1991b	g. Morris and Morris 1991
d. Sanders et al. 1996, 379-386	h. Liang et al. 1996

Figure 6.2. Elongation to failure in tension vs. grain size for some nanocrystalline metals and alloys.

In some metals, Cu for example, ductile behavior is observed in compression, along with yield strengths about twice those observed in tension. While it is likely that the flaws and porosity present in many nc samples seriously affect the results of mechanical tests and may be partly responsible for the asymmetry of results in compression compared to tension tests, the nature of the deformation process in terms of shear banding (see below) may also be important. The above behavior is presumably due to the inability of usual dislocation generation and motion to occur at these smallest nc grain sizes.

An intriguing suggestion based on early observations of ductile behavior of brittle nc ceramics at low temperatures is that brittle ceramics or intermetallics might exhibit ductility with nc grain structures (Karch et al. 1987; Bohn et al. 1991). Karch and colleagues (1987) observed apparent

plastic behavior in compression in nc CaF₂ at 80°C and nc TiO₂ at 180°C. These observations were attributed to enhanced diffusional creep providing the plasticity at these temperatures, where conventional grain-size materials would fail in the elastic regime. It was assumed that diffusional creep was responsible for the plasticity; observations were rationalized, with boundary diffusion dominating the behavior such that the strain (creep) rate is defined as

$$\frac{d\varepsilon}{dt} = \frac{B\sigma\Omega\Delta D_b}{d^3kT} \quad (\text{Equation 1})$$

where σ is the applied stress, Ω the atomic volume, d the grain size, k the Boltzmann constant, T the temperature, B a constant, and D_b the grain boundary diffusion coefficients. Going from a grain size of 1 μm to 10 nm should increase $d\varepsilon/dt$ by 10^6 or more if D_b is significantly larger for nc materials. However, these results on nc CaF₂ and nc TiO₂ have not been reproduced, and it is believed that the porous nature of these samples was responsible for the apparent ductile behavior. In addition, the idea of unusually high creep rates at low temperatures has been refuted. Recent creep measurements of nc Cu, Pd, and Al-Zr at moderate temperatures by Sanders et al. (1997) find creep rates comparable to or lower than corresponding coarse-grain rates. The creep curves at low and moderate homologous temperatures (.24 – .48 T_M) could be fit by the equation for exhaustion (logarithmic) creep. One explanation is that the observed low creep rates are caused by the high fraction of low energy grain boundaries in conjunction with the limitation on dislocation activity by the small grain sizes.

In sum, the predicted ductility due to diffusional creep in nc brittle ceramics or intermetallics at temperatures significantly less than 0.5 T_M has not been realized.

Superplastic Behavior

Superplasticity is the capability of some polycrystalline materials to exhibit very large tensile deformations without necking or fracture. Typically, elongations of 100% to > 1000% are considered the defining features of this phenomenon. As grain size is decreased it is found that the temperature is lowered at which superplasticity occurs, and the strain rate for its occurrence is increased. As discussed previously, Equation 1 suggests that creep rates might be enhanced by many orders of magnitude and superplastic behavior might be observed in nc materials at temperatures much lower than 0.5 T_M . As mentioned above, actual creep experiments have not borne out this prediction, but instead have shown creep rates

comparable to or lower than those in coarse-grained samples of the same material. This is presumably why little enhancement in ductility or superplastic behavior has been observed for nc materials at temperatures $< 0.5 T_M$. However, there is evidence of enhancement of superplastic behavior in nc materials at temperatures $> 0.5 T_M$. Superplasticity has been observed at somewhat lower temperatures and at higher strain rates in nc materials. The evidence for tensile superplasticity is limited and observed typically at temperatures greater than $0.5 T_M$ and in materials that exhibit superplasticity in coarser grain sizes (1–10 μm). For example, Mishra et al. (1997) observed superplastic behavior in nc Pb-62%Sn at $0.64 T_M$ and nc Zn-22%Al at 0.52 to $0.60 T_M$. However, Salishekev et al (1994) observed superplastic behavior in submicron—200 nm—Ti and several Ti and Ni base alloys. Here, superplasticity (190% elongation, $m = 0.32$) was observed in Ti at $0.42 T_M$. This was at a temperature 50°C lower than for 10 μm grain size Ti. The flow stress for the 200 nm Ti at 550°C was 90 MPa, compared to 120 MPa for 10 μm Ti at 600°C .

Very recently, Mishra and Mukherjee (1997) have observed superplastic behavior in Ni_3Al with a 50 nm grain size at temperatures of 0.56 to $0.60 T_M$ to strains of 300 - 600%, but with unusual stress-strain behavior and significant apparent strain-hardening. These new results suggest very different mechanisms may be causing superplastic behavior in these nc materials.

Unique Mechanical Properties of Nanocrystalline Materials

While there are still only limited data on the mechanical behavior—especially tensile properties—of nc materials, some generalizations may be made regarding the deformation mechanisms. It is likely that for the larger end of the nanoscale grain sizes, about 50 - 100 nm, dislocation activity dominates for test temperatures $< 0.5 T_M$. As grain size decreases, dislocation activity apparently decreases. The essential lack of dislocations at grain sizes below 50 nm is presumably the result of the image forces that act on dislocations near surfaces or interfaces. The lack of dislocations in small, confined spaces such as single-crystal whiskers has been known for many years (Darken 1961). Creation of new dislocations is also made difficult as the grain size reaches the lower end of the nanoscale (< 10 nm). Stresses needed to activate dislocation sources, such as the Frank-Read source, are inversely proportional to the distance between dislocation pinning points. Since nanoscale grains will limit the distance between such pinning points, the stresses to activate dislocation sources can reach the theoretical shear stress of a dislocation-free crystal at the smallest grain sizes (~ 2 nm). Thus, at the smallest grain sizes we may have new phenomena controlling deformation behavior. It has been suggested that such

phenomena may involve grain boundary sliding and/or grain rotation accompanied by short-range diffusion-assisted healing events (Siegel 1997).

Several examples of deformation by shear banding have been reported for nc materials. Carsley et al (1997, 183-192) have studied nc Fe–10% Cu alloys with grain sizes ranging from 45 to 1,680 nm. In all cases, deformation in compression proceeds by intense localized shear banding. The stress-strain curves exhibited essentially elastic, perfectly plastic behavior; that is, no measurable strain hardening was observed. Shear banding is also the deformation mode observed in amorphous metallic alloys and amorphous polymers. The deformation shear banding in nc Fe–10% Cu was compared to that for metallic glasses, amorphous polymers, and coarse-grained polycrystalline metals after significant plasticity and work hardening had taken place. While this suggests a close similarity between deformation in nc materials and amorphous materials, not all tensile data on nc materials exhibit a lack of strain hardening. The Fe–10% Cu samples of Carsley et al. (1997, 183-192) showed shear bands even in their larger grained specimens (i.e., about 1,000 nm).

Theoretical Needs

Central to all of the above discussion is the lack of understanding of the microscopic deformation and fracture mechanisms in nc materials. Clearly, a stronger theoretical effort is needed to guide critical experiments and point the direction for optimizing properties. There has been limited work in this area, especially in Russia, in applying disclination theory to grain rotation (Romanov and Vladimirov 1992, 191), for example. However, a much larger theoretical effort is required. Another alternate deformation mechanism that may be important in nc materials is mechanical twinning (Huang et al. 1996). Little theoretical work has been carried out to address this possibility. Another important potential approach to understanding the deformation mechanisms in nc materials is to explore the rich older literature on shear banding—mechanical instabilities that have been observed in, for example, mild steels as grain size decreases; the approach to very low strain hardening (perfectly plastic behavior) is observed. Amorphous materials exhibit many of the phenomenological characteristics of deformation in nc materials, that is, shear banding, asymmetry between tensile and compressive behavior, and perfectly plastic behavior. However, deformation mechanisms are not well understood in amorphous materials either. Recent work on bulk metallic glasses may help clarify this.

Applications

Of the present or near-term applications for nc materials, the hard material WC/Co is an example of several important trends. Nanostructured WC/Co composites have been prepared that can have the following characteristics:

- nanoscale grain sizes after consolidation of powder
- hardness values about twice that of conventional micrograined WC/Co
- enhanced wear resistance and cutting performance

While this material has increased hardness and strength, preliminary reports from Stevens Institute of Technology in Hoboken, NJ, and the Royal Institute of Technology in Stockholm, Sweden, point to similar or increased fracture toughness values for nanostructured WC/Co. As noted earlier, single-phase nanostructured materials studied to date have exhibited high strength and hardness but brittle behavior at low homologous temperatures ($< 0.5 T_M$). The results of these studies of WC/Co two-phase nanostructured materials suggest that the combination of high hardness/strength and toughness/ductility may be possible in multiphase nanostructured materials.

Other examples that point to this possibility come from the work of Professor A. Inoue at Tohoku University in Japan, whose lab the WTEC panel visited (see Appendix D). Inoue and coworkers have synthesized a variety of multiphase Al, Mg, and Ni-base alloys with nanoscale microstructures. Many of these alloys consist of nanocrystallites in an amorphous matrix. Some Al-rich alloys contain nanoscale quasi-crystalline particles surrounded by crystalline face-centered cubic Al. The fascinating properties of these multiphase nanostructured alloys include extremely high strength coupled with some ductility. Ductility is high in compression, but uniform elongation in tension is limited. Again, this behavior is analogous to that exhibited by ductile amorphous alloys. These results again suggest the possibility for development of nanostructured multiphase composites that combine extremely high hardness and strength with toughness and ductility. Such materials could have many applications as unique structural materials.

Multiphase ceramic nanocomposites are the focus of several efforts. One significant effort is underway at the Research Center for Intermaterials of the Institute of Scientific and Industrial Research at Osaka University in Japan (see site report, Appendix D). Professor Koichi Niihara has a large effort studying micro-nano composites such as Al_2O_3/SiC that have enhanced toughness and also a variety of hard matrix/soft dispersion or soft matrix/hard dispersion nanocomposites. The enhanced toughness in some ceramic nanocomposites observed by Prof. Niihara has been verified by parallel studies of Dr. Steve Roberts at University of Oxford in England (see site report, Appendix B).

While “low temperature” superplasticity has not been realized in nanostructured materials, enhanced superplastic behavior has been observed at elevated temperatures in terms of a somewhat lower temperature range for superplasticity and, perhaps more significant, a higher strain rate regime. While much needs to be understood about superplastic behavior of nanostructured materials, the possibility for using more conventional strain rates for forming has major industrial implications. This is of particular interest for near net shape forming of ceramics.

Outstanding Issues: Opportunities and Challenges

Perhaps the overriding issue for defining the mechanical behavior of nanostructured materials is the lack of understanding of the mechanisms for plastic deformation and fracture in these materials. An extensive experimental and theoretical research effort should be applied to solve these questions. Only with such understanding can the intelligent design of nanostructured materials with optimum mechanical properties be realized.

Since many of the synthesis routes for nanostructured materials involve using powder or particulate products, compaction of such powders is needed to form bulk parts without coarsening the nanoscale microstructure. While there has been ongoing work on compaction and the thermal stability of nanocrystalline microstructures, more basic work is needed in this critical area. If some unique properties are limited to the finest grain sizes, methods must be found to stabilize the grain size while attaining theoretical density and complete particulate bonding. Furthermore, conventional processing methods are desirable if realistic scaleup and economy are to be realized.

Near-term opportunities for structural applications of nanostructured materials are in the form of coatings prepared by, for example, thermal spray deposition or electrodeposition. There is a significant effort in the United States on thermal spray deposition of nc materials. Several groups in Canada lead in deposition of nc materials by electrodeposition methods. A spin-off company, Nanometals, formed under the auspices of Parteq Research and Development Innovations, has adopted a commercial electrodeposition method to produce nanostructured metals.

Structural applications of nanostructured materials may be viewed as a focused approach to a long standing, well known design of materials with optimum mechanical properties. Use of nanoscale precipitates or dispersoids has been known for decades to improve mechanical behavior. The “new” emphasis on using nanostructured materials comes from 2 significant factors:

1. the special processing methods to push microstructures to the limits of the nanoscale
2. the unique properties and phenomena—as yet not well understood—when this limit is approached

FERROMAGNETIC NANOSTRUCTURED MATERIALS

Soft Magnetic Nanocrystalline Alloys

The discovery of nanocrystalline Fe-based soft magnetic materials is less than ten years old. The first class of such materials was the melt-spun Fe-Si-B alloys containing small amounts of Nb and Cu (Yoshizawa et al. 1988). The Fe-Si-B-Nb-Cu amorphous phase transforms to a body-centered cubic (bcc) Fe-Si solid solution with grain sizes of about 10 nm during annealing at temperatures above the crystallization temperature. The presence of small amounts of Cu helps increase the nucleation rate of the bcc phase while Nb retards the grain growth. These “Finemet” alloys provide low core losses (even lower than amorphous soft magnetic alloys such as Co-Fe-Si-B), exhibit saturation induction of about 1.2 T, and exhibit very good properties at high frequencies, comparable to the best Co-based amorphous alloys. These were first developed in Japan and have stimulated a large amount of research and development worldwide to optimize the magnetic properties. There has been relatively little work in the United States in this area, however.

While many of the soft magnetic properties of Finemet-type nanocrystalline alloys are superior, they exhibit lower saturation inductions than Fe-metalloid amorphous alloys, mainly because of the lower Fe content to attain amorphization and because of the addition of Nb and Cu (or other elements to control the nucleation and growth kinetics). In order to remedy this problem, another class of Fe-based nanocrystalline alloys was developed by Inoue and coworkers at Tohoku University (Makino et al. 1997), which is commercialized by Alps Electric Co., Ltd., of Nagaoka, Japan (see also the Tohoku University site report, Appendix D). These “Nanoperm” alloys are based on the Fe-Zr-B system; they contain larger concentrations of Fe (83-89 at.%) compared to the Finemet alloys (~ 74 at.% Fe) and have higher values of saturation induction (~ 1.6-1.7 T). The Nanoperm nc alloys have very low energy losses at power frequencies (60 Hz), making them potentially interesting for electrical power distribution transformers. The issues of composition modification, processing, and the brittle mechanical behavior of these nanocrystalline/amorphous alloys are discussed by V.R. Ramanan in the first volume of this WTEC study, the proceedings of the May 8-9, 1997 panel workshop on the status of nanostructure science and technology in the United States (Ramanan 1998, 113-116). Figure 6.3 compares the soft magnetic properties of Finemet, Nanoperm, and other materials.

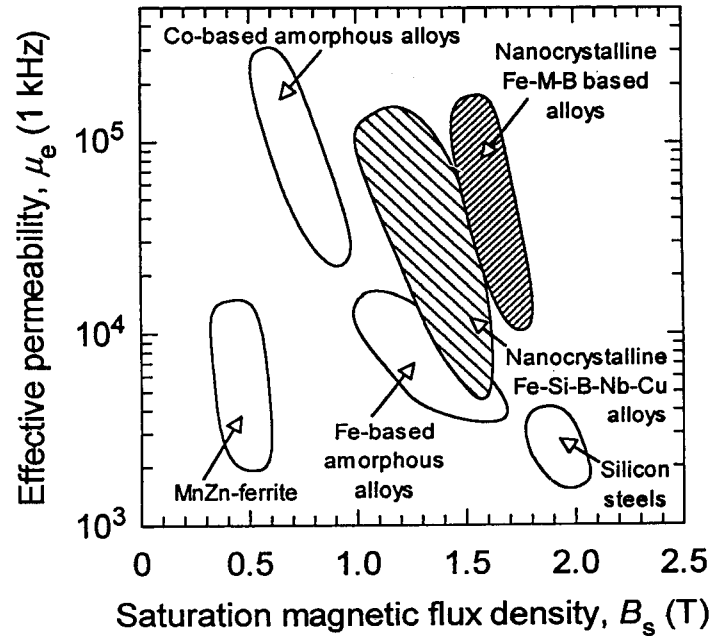

Figure 6.3. Effective permeability, μ_e , vs. saturation magnetic flux density, B_s , for soft ferromagnetic materials (after A. Inoue 1997).

While there has been extensive research on these alloys, particularly in Japan and Europe, most of the development has been carried out in Japan. The Finemet family of alloys is marketed by Hitachi Special Metals. Vacuumschmelze GmbH (Germany) and Impky (France) also market similar alloys. The Nanoperm alloys are being commercialized by Alps Electric Co. (Japan). No extensive research nor any commercialization of these materials has been carried out in the United States.

The small single-domain nanocrystalline Fe particles in the amorphous matrix gives these alloys their unique magnetic behavior, the most dramatic being the lowest energy losses (narrowest B/H hysteresis loop) of any known materials, along with very high permeabilities. These alloys can also exhibit nearly or exactly zero magnetostriction. To date, these materials have been made by crystallization of rapidly solidified amorphous ribbons. Other methods that might provide geometrically desirable products should be explored or developed. Electrodeposition is one such method that requires further work. Electrodeposited nc Fe-Ni soft magnetic alloys are being developed in Canada.

The brittle nature of these materials is a problem for scaleup and transformer manufacture. The brittleness problem must be solved by finding less brittle materials or applying the handling and processing knowledge that exists for embrittled (after annealing) metallic glasses.

Permanent Magnet Materials

The first attempts to produce nanoscale microstructures to enhance the magnetic properties of the Nb-Fe-B permanent magnetic materials used mechanical alloying of blended elemental powders followed by heat treatment (Schultz et al. 1987). Since the grain structure so obtained does not exhibit any crystallographic texture—and limits the energy product—special processing methods such as die-upsetting were used by Schultz and coworkers (1989) to provide the crystallographic anisotropy. While the coercivities of these nanocrystalline alloys are high, the remanent magnetization is decreased.

Recent approaches to increasing the magnetic induction have utilized exchange coupling in magnetically hard and soft phases. The Fe-rich compositions (e.g., $\text{Fe}_{90}\text{Nd}_7\text{B}_3$) result in a mixture of the hard $\text{Fe}_{14}\text{Nd}_2\text{B}$ phase and soft αFe phase. The nanoscale two-phase mixtures of a hard magnetic phase and a soft magnetic phase can exhibit values of remanent magnetization, M_r , significantly greater than the isotropic value of $0.5 M_s$. This “remanence enhancement” is associated with exchange coupling between the hard and soft phases, which forces the magnetization vector of the soft phase to be rotated to that of the hard phase (Smith et al. 1996). Two important requirements for alloys to exhibit remanence enhancement are a nanocrystalline grain size and a degree of coherence across interphase boundaries sufficient to enable adjacent phases to be exchange-coupled. The significant feature of the exchange coupling is that it allows crystallographically isotropic materials to exhibit remanence values approaching those achieved after full alignment. Such two-phase nanoscale ferromagnetic alloys have been prepared by nonequilibrium methods such as melt-spinning, mechanical alloying, and sputter deposition. Besides the high reduced remanence, the material cost is reduced by reduction in the content of the expensive hard rare earth-containing magnetic phase.

The theoretical understanding of remanence enhancement appears to be developed to a degree enabling prediction of magnet performance; however, this performance, while a significant improvement over single-phase isotropic magnets, does not reach predicted values. Work is required on optimizing the orientation relationships between the hard and soft phases and the interphase properties (coherency) between them.

Research on nanocrystalline hard magnetic alloys has received attention worldwide. The U.S. efforts are summarized in the article by G.C. Hadjipanayis (1998, 107-112). While less research seems to be carried out in the world on these materials compared to the nanocrystalline soft magnetic alloys, some efforts exist in most countries. Notable programs are those of L. Schultz and coworkers at the Institut für Festkörper und Werkstofforschung (IFW) in Dresden (see site report in Appendix B) and P.G. McCormick and coworkers at the University of Western Australia.

While the very low losses of the nc soft magnetic materials (Finemet or Nanoperm) are dependent on grain size for their properties, the hard magnetic nc alloys with remanence enhancement provide flexibility in processing, especially with powder materials. These remanence-enhanced nc hard magnetic alloys may find many applications as permanent magnet components.

Giant Magnetoresistance (GMR)

The phenomenon of giant magnetoresistance (GMR)—the decrease of electrical resistance of materials when exposed to a magnetic field—was first reported in a number of multilayer ferromagnetic/nonferromagnetic thin film systems (Baibich et al. 1988). More recently, GMR was observed in equiaxed granular nanocrystalline materials (Berkowitz et al. 1992). In particular, GMR systems with low saturation fields offer a wide area for application in magnetoresistive devices. GMR sensors have a higher output than conventional anisotropic magnetoresistive sensors or Hall effect sensors. They can operate at higher magnetic fields than conventional magnetoresistive sensors. In multilayer systems the antiferromagnetic alignment of the ferromagnetic layers in zero field becomes ferromagnetic as the field is applied and causes a decrease in resistance. Granular materials that show GMR consist of small ferromagnetic single-domain particles with randomly oriented magnetic axes in a nonmagnetic matrix. An external field rotates the magnetic axes of all magnetic particles. The rotation towards complete alignment of all magnetic axes again reduces the resistance in a similar way as for multilayers. The GMR in granular systems is isotropic. The explanation for the GMR is spin-dependent scattering of the conduction electrons at the ferromagnetic/nonmagnetic interfaces and, to a lesser extent, within the magnetic grains. The GMR scales inversely with the average particle diameter.

There is worldwide research on the GMR effect. U.S. programs are reviewed by R. Shull and G.C. Hadjipanayis in the proceedings of the WTEC U.S. nanotechnologies workshop (Shull 1998, 43-58; Hadjipanayis 1998, 107-112). The NIST work described by Shull has provided material with the largest GMR values for the smallest switching fields. Japanese research on GMR includes studies in Prof. Fujimori's group at Tohoku University (see site report in Appendix D).

While the theory for GMR of spin-dependent scattering referred to above has been used as an explanation, other explanations taking into account interaction between magnetic regions have been proposed (El-Hilo et al. 1994). Combined theoretical and experimental studies should help to clarify the mechanism for this effect.

Other Ferromagnetic Nanocrystalline Materials

Magnetic nanocomposite refrigerants, which have four times the magnetocaloric effects of the best low temperature magnetic refrigerant, were developed by NIST and described by R. Shull (1998, 43-58). The entropy change at a given (low) temperature for a system of magnetic spins is enhanced when the isolated spins are clustered. Shull et al. (1993) have shown that the nanocomposite $Gd_3Ga_{5-x}Fe_xO_{12}$ gives superior magnetocaloric effects, which increase with x up to $x = 2.5$ and can be extended to higher temperatures than conventional materials.

Magnetostrictive materials such as Terfonol-D ($Tb_{0.3}Dy_{0.7}Fe_2$) have been of scientific and technological interest in recent years. It is suggested by G.C. Hadjipanayis (1998, 107-112) that nanostructured magnetostrictive materials can have improved properties, such as lower saturation fields, with reduced anisotropy and in multilayers with alternate layers of magnetostrictive and soft magnetic materials that are exchange-coupled. Hadjipanayis states that most of the research in this area is carried out in Japan and Europe.

Opportunities and Challenges

Nanocrystalline magnetic materials offer perhaps the nearest-term prospect of significant applications of bulk nanostructured materials. The remanence enhancement in two-phase hard/soft magnetic materials can result in excellent energy products—comparable to those from rapid solidification processing routes—in powder composites. The flexibility in manufacturing this allows should provide many possible permanent magnet applications.

Nanocrystalline soft magnetic materials have the lowest energy losses of any material. While problems such as mechanical brittleness remain, these materials promise to replace existing transformer core materials for power applications. The U.S. research and industrial effort in these materials lags the efforts in Japan.

OTHER BULK APPLICATIONS OF NANOSTRUCTURED MATERIALS

Nanocrystalline Hydrogen Storage Materials

R.B. Schwarz (1998, 93-95) has pointed out that nanostructured materials offer several potential advantages for hydrogen storage materials. Rapid kinetics of absorption/desorption can be aided by refining the microstructure

to the nanoscale. For example, nanoscale inclusions of Mg₂Ni in Mg catalyze the decomposition of the molecular hydrogen, increasing the hydrogen absorption/desorption kinetics. Another advantage of the nanoscale microstructure is that the alloy powder does not comminute on repeated charging/discharging with hydrogen. This is not strictly a bulk material, since powder agglomerates or green compacts can be used, thus obviating the need for compaction to theoretical density.

Nanocrystalline Corrosion-Resistant Materials

The limited work to date on corrosion resistance of nanocrystalline materials indicates that no generalizations can be made. Superior localized corrosion resistance in HCl was observed for nanocrystalline 304 stainless steel (Fe–18%Cr–8%Ni) prepared by sputter deposition (Inturi and Szklavska-Smialowska 1991 and 1992). This was attributed to the fine grain size and homogeneity of the nc material. However, the average dissolution rate of nc Ni was found to be higher than that for coarse-grained material (Rofagha et al. 1991).

REFERENCES

- Alves, H., M. Ferreira, U. Koster, and B. Muller. 1996. *Materials Science Forum* 225–227: 769.
- Baibich, M.N., J.M. Broto, A. Fert, F. Nguyen Van Dau, F. Petroff, P. Etienne, G. Creuzet, A. Friederich, and J. Chazelas. 1998. *Phys. Rev. Lett.* 61:2472.
- Berkowitz, A.E., J.R. Mitchell, M.J. Carey, A.P. Young, S. Zhang, F.E. Spada, F.T. Parker, A. Hutten, and G. Thomas. 1992. *Phys. Rev. Lett.* 68:3745.
- Bohn, R., T. Haubold, R. Birringer, and H. Gleiter. 1991. *Scripta Metall. Mater.* 25:811.
- Carsley, J.E., R. Shaik, W.W. Milligan, and E.C. Aifantis. 1997. In *Chemistry and physics of nanostructures and related non-equilibrium materials*, ed. E. Ma, B. Fultz, R. Shull, J. Morral, and P. Nash. Warrendale, PA: TMS.
- Cohen, J.B. 1992. *Metall. Trans. A.* 23A:2685.
- Darken, L.S. 1961. *Trans. Am. Soc. Met.* 54:599.
- Eastman, J.A., M. Choudry, M.N. Rittner, C.J. Youngdahl, M. Dollar, J.R. Weertman, R.J. DiMelfi, and L.J. Thompson. 1997. In *Chemistry and physics of nanostructures*, ed. Ma et al.
- El-Hilo, M., K. O'Grady, and R.W. Chantrell. 1994. *J. Appl. Phys.* 76:6811.
- Erb, U., G. Palumbo, R. Zugic, and K.T. Aust. 1996. In *Processing and properties of nanocrystalline materials*, ed. C. Suryanarayana, J. Singh, and F.H. Froes. Warrendale, PA: TMS.
- Gertsman, V.Y., M. Hoffman, H. Gleiter and R. Birringer. 1994. *Acta Metall. Mater.* 42:3539-3544.
- Gleiter, H. 1990. *Progress in Materials Science* 33:4.
- Guinier, A. 1938. *Nature* 142:569; Preston, G.D. 1938. *Nature* 142:570.
- Günther, B., A. Baalman, and H. Weiss. 1990. *Mater. Res. Soc. Symp. Proc.* 195:611-615.
- Hadjipanayis, C.G. 1998. Nanostructured magnetic materials. In *R&D Status and Trends*, ed. Siegel et al.

- Huang, J.Y., Y.K. Wu, and H.Q. Ye. 1996. *Acta Mater.* 44:1211.
- Inoue, A. 1997. Private communication.
- Inturi, R.B., and Z. Szklavska-Smialowska. 1992. *Corrosion* 48:398.
- Karch, J., R. Birringer, and H. Gleiter. 1987. *Nature* 330:556.
- Ke, M., S.A. Hackney, W.W. Milligan, and E.C. Aifantis. 1995. *Nanostructured Mater.* 5:689.
- Krstic, V., U. Erb, and G. Palumbo. 1993. *Scripta Metall. et Mater.* 29:1501.
- Liang, G., Z. Li, and E. Wang. 1996. *J. Mater. Sci.*
- Makino, A., A. Inoue, T. Hatanai, and T. Bitoh. 1997. *Materials Science Forum* 235-238:723.
- Mehl, R.F., and R.W. Cahn. 1983. Historical development. In *Physical metallurgy*. North Holland.
- Milligan, W.W., S.A. Hackney, M. Ke, and E.C. Aifantis. 1993. *Nanostructured Materials* 2:267.
- Mishra, R.S., and A.K. Mukherjee. 1997. Oral presentation at TMS meeting, Indianapolis, Indiana, 16-18 September 1997, to be published in proceedings of Symp. "Mechanical Behavior of Bulk Nano-Materials."
- Mishra, R.S., R.Z. Valiev, and A.K. Mukherjee. 1997. *Nanostructured Materials* 9:473.
- Morris, D.G., and M.A. Morris. 1991. *Acta Metall. Mater.* 39:1763-1779.
- Morris, D.G., and M.A. Morris. 1997. *Materials Science Forum* 235-238:861.
- Nagpal, P., and I. Baker. 1990. *Scripta Metall. Mater.* 24:2381.
- Nieman, G.W., J.R. Weertman, and R.W. Siegel. 1991a. *Mater. Res. Soc. Symp. Proc.* 206:581-586.
- _____. 1991b. *J. Mater. Res.* 6:1012-1027.
- Ramanan, V.R. 1998. Nanocrystalline soft magnetic alloys for applications in electrical and electronic devices. In *R&D Status and Trends*, ed. Siegel et al.
- Rofagha, R., R. Langer, A.M. El-Sherik, U. Erb, G. Palumbo, and K.T. Aust. 1991. *Scr. Metall. Mater.* 25:2867.
- Romanov, A.E., V.I. Vladimirov. 1992. In *Dislocations in solids*, ed. F.R.N. Nabarro, Vol. 9. Amsterdam: North-Holland.
- Salishekev, G.A., O.R. Valiakhmetov, V.A. Valitov, and S.K. Mukhtarov. 1994. *Materials Science Forum.* 170-172:121.
- Sanders, P.G., M. Rittner, E. Kiedaisch, J.R. Weertman, H. Kung, and Y.C. Lu. 1997. *Nanostructured Mater.* 9:433.
- Sanders, P.G., J.A. Eastman, and J.R. Weertman. 1996. In *Processing and properties of nanocrystalline materials*, ed. Suryanarayana et al.
- Scanlan, R.M., W.A. Fietz, and E.F. Koch. 1975. *J. Appl. Phys.* 46:2244.
- Schultz, L., J. Wecker, and E. Hellstern. 1987. *J. Appl. Phys.* 61:3583.
- Schultz, L., K. Schnitzke, and J. Wecker. 1989. *J. Magn. Mater.* 80:115.
- Schwarz, R.B. 1998. Storage of hydrogen powders with nanosized crystalline domains. In *R&D Status and Trends*, ed. Siegel et al.
- Shen, T.D., C.C. Koch, T.Y. Tsui, and G.M. Pharr. 1995. *J. Mater. Res.* 10:2892.
- Shull, R.D., R.D. McMichael, and J.J. Ritter. 1993. *Nanostructured Mater.* 2:205.
- Shull, R.D. 1998. NIST activities in nanotechnology. In *R&D Status and Trends*, ed. Siegel et al.
- Siegel, R.W. 1997. *Materials Science Forum* 235-238:851.
- Siegel R.W. and G.E. Fougere. 1994. In *Nanophase materials*, ed. G.C. Hadjipanayis and R.W. Siegel. Netherlands: Kluwer Acad. Publ.
- Siegel, R.W., E. Hu, and M.C. Roco, eds. 1998. *R&D status and trends in nanoparticles, nanostructured materials, and nanodevices in the United States*. Baltimore: Loyola College, International Technology Research Institute. NTIS #PB98-117914.
- Silcock, J.M., T.J. Heal, and H.K. Hardy. 1953-54. *Journal of the Institute of Metals* 82:239.
- Smith, P.A.I., J. Ding, R. Street, and P.G. McCormick. 1996. *Scripta Materialia* 34:61.

- Thomson, R.M. 1996. In *Physical metallurgy*, 4th ed., ed. R.W. Cahn and P. Haasen. Elsevier Science BV.
- Veprek, S. 1998. Private conversation, February.
- Weertman, J.R., and R.S. Averback. 1996. In *Nanomaterials: Synthesis, properties, and applications*, ed. A.S. Edlestein and R.C. Cammarata. Bristol: Institute of Physics Publ.
- Wong, L., D. Ostrander, U. Erb, G. Palumbo, and K.T. Aust. 1994. In *Nanophases and nanocrystalline structures*, ed. R.D. Shull and J.M. Sanchez. Warrendale, PA: TMS.
- Yoshizawa, Y., S. Oguma, and K. Yamauchi. 1988. *J. Appl. Phys.* 64:6044.

Chapter 7

Biologically Related Aspects of Nanoparticles, Nanostructured Materials, and Nanodevices

Lynn Jelinski
Louisiana State University

INTRODUCTION

Biological molecules and systems have a number of attributes that make them highly suitable for nanotechnology applications. For example, proteins fold into precisely defined three-dimensional shapes, and nucleic acids assemble according to well-understood rules. Antibodies are highly specific in recognizing and binding their ligands, and biological assemblies such as molecular motors can perform transport operations. Because of these and other favorable properties, biomolecules, biophysics, and biology are themes that run through all of the topics of this report.

Although very promising, the bio-related aspects of nanoparticles, nanostructured materials, and nanodevices, are, for the most part, not as well developed as the nonbiological ones. However, a number of recent workshops (e.g., the U.S./EC Workshop on Nanobiotechnology), symposia (e.g., the Conference on Molecular Nanotechnology, and the Symposium on Bio-Nano Electronics), and books (e.g., *Nanofabrication and Biosystems*, Hoch et al. 1996) attest to the fact that many of the novel developments in this field are poised for rapid expansion.

This chapter is organized along the lines of the main report (Figure 7.1). It first puts into perspective current research directed toward biological synthesis and assembly as it pertains to the building blocks of nanotechnology. It then focuses on the current state of the art in biological aspects of dispersions and coatings, high surface area materials, and functional

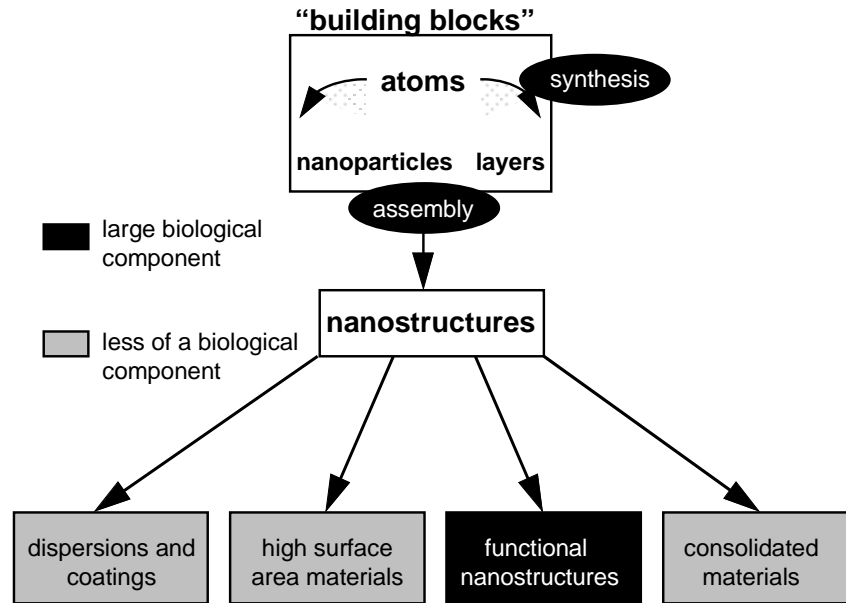

Figure 7.1. Organization of the WTEC study; sections with large biological content are indicated.

nanostructures. Finally, it ends with a section on the challenges and opportunities for the biological aspects of nanotechnology.

NANOTECHNOLOGY BUILDING BLOCKS

Synthesis

Although it seems at first that Nature has provided a limited number of basic building blocks—amino acids, lipids, and nucleic acids—the chemical diversity of these molecules and the different ways they can be polymerized or assembled provide an enormous range of possible structures. Furthermore, advances in chemical synthesis and biotechnology enable one to combine these building blocks, almost at will, to produce new materials and structures that have not yet been made in Nature. These self-assembled materials often have enhanced properties as well as unique applications.

The selected examples below show ways in which clever synthetic methodologies are being harnessed to provide novel biological building blocks for nanotechnology.

The protein polymers produced by Tirrell and coworkers (1994) are examples of this new methodology. In one set of experiments, proteins were

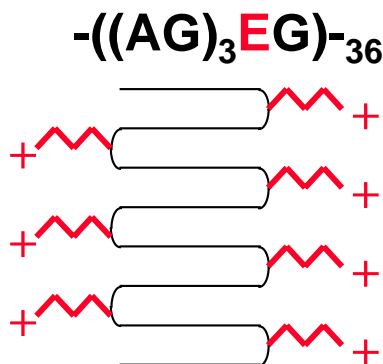

Figure 7.2. Top: a 36-mer protein polymer with the repeat sequence (alanine-glycine)₃ – glutamic acid – glycine. Bottom: idealized folding of this protein polymer, where the glutamic acid sidechains (+) are on the surface of the folds.

designed from first principles to have folds in specific locations and surface-reactive groups in other places (Figure 7.2) (Krejchi et al. 1994; 1997). One of the target sequences was $-((AG)_3EG)_{36}$. The hypothesis was that the AG regions would form hydrogen-bonded networks of beta sheets and that the glutamic acid would provide a functional group for surface modification. Synthetic DNAs coding for these proteins were produced, inserted into an *E. coli* expression system, and the desired proteins were produced and harvested. These biopolymers formed chain-folded lamellar crystals with the anticipated folds. In addition to serving as a source of totally new materials, this type of research also enables us to test our understanding of amino acid interactions and our ability to predict chain folding.

Biopolymers produced via biotechnology are monodisperse; that is, they have precisely defined and controlled chain lengths; on the other hand, it is virtually impossible to produce a monodisperse synthetic polymer. It has recently been shown that polymers with well-defined chain lengths can have unusual liquid crystalline properties. For example, Yu et al. (1997) have shown that bacterial methods for polymer synthesis can be used to produce poly(γ -benzyl α L-glutamate) that exhibits smectic ordering in solution and in films. The distribution in chain length normally found for synthetic polymers makes it unusual to find them in smectic phases. This work is important in that it suggests that we now have a route to new smectic phases whose layer spacings can be controlled on the scale of tens of nanometers.

The biotechnology-based synthetic approaches described above generally require that the final product be made from the natural, or L-amino acids. Progress is now being made so that biological machinery (e.g., *E. coli*), can be co-opted to incorporate non-natural amino acids such as β -alanine or

dehydroproline or fluorotyrosine, or ones with alkene or alkyne functionality (Deming et al. 1997). Research along these lines opens new avenues for producing controlled-length polymers with controllable surface properties, as well as biosynthetic polymers that demonstrate electrical phenomena like conductivity. Such molecules could be used in nanotechnology applications.

Novel chemical synthesis methods are also being developed to produce “chimeric” molecules that contain organic turn units and hydrogen-bonding networks of amino acids (Winningham and Sogah 1997). Another approach includes incorporating all tools of chemistry into the synthesis of proteins, making it possible to produce, for example, mirror-image proteins. These proteins, by virtue of their *D*-amino acid composition, resist biodegradation and could have important pharmaceutical applications (Muir et al. 1997).

Arnold and coworkers are using a totally different approach to produce proteins with enhanced properties such as catalytic activity or binding affinity. Called “directed evolution,” this method uses random mutagenesis and multiple generations to produce new proteins with enhanced properties. Directed evolution, which involves DNA shuffling, has been used to obtain esterases with five- to six-fold enhanced activity against *p*-nitrobenzyl esters (Moore et al. 1997).

Assembly

The ability of biological molecules to undergo highly controlled and hierarchical assembly makes them ideal for applications in nanotechnology. The self-assembly hierarchy of biological materials begins with monomer molecules (e.g., nucleotides and nucleosides, amino acids, lipids), which form polymers (e.g., DNA, RNA, proteins, polysaccharides), then assemblies (e.g., membranes, organelles), and finally cells, organs, organisms, and even populations (Rousseau and Jelinski 1991, 571-608). Consequently, biological materials assembly on a very broad range of organizational length scales, and in both hierarchical and nested manners (Aksay et al. 1996; Aksay 1998). Research frontiers that exploit the capacity of biomolecules and cellular systems to undergo self-assembly have been identified in two recent National Research Council reports (NRC 1994 and 1996). Examples of self-assembled systems include monolayers and multilayers, biocompatible layers, decorated membranes, organized structures such as microtubules and biomineralization, and the intracellular assembly of CdSe semiconductors and chains of magnetite.

A number of researchers have been exploiting the predictable base-pairing of DNA to build molecular-sized, complex, three-dimensional objects. For example, Seeman and coworkers (Seeman 1998) have been investigating these properties of DNA molecules with the goal of forming complex 2-D and 3-D periodic structures with defined topologies. DNA is

ideal for building molecular nanotechnology objects, as it offers synthetic control, predictability of interactions, and well-controlled “sticky ends” that assemble in highly specific fashion. Furthermore, the existence of stable branched DNA molecules permits complex and interlocking shapes to be formed. Using such technology, a number of topologies have been prepared, including cubes (Chen and Seeman 1991), truncated octahedra (Figure 7.3) (Zhang and Seeman 1994), and Borromean rings (Mao et al. 1997).

Other researchers are using the capacity of DNA to self-organize to develop photonic array devices and other molecular photonic components (Sosnowski et al. 1997). This approach uses DNA-derived structures and a microelectronic template device that produces controlled electric fields. The electric fields regulate transport, hybridization, and denaturation of oligonucleotides. Because these electric fields direct the assembly and transport of the devices on the template surface, this method offers a versatile way to control assembly.

There is a large body of literature on the self-assembly on monolayers of lipid and lipid-like molecules (Allara 1996, 97-102; Bishop and Nuzzo 1996). Devices using self-assembled monolayers are now available for analyzing the binding of biological molecules, as well as for spatially tailoring the

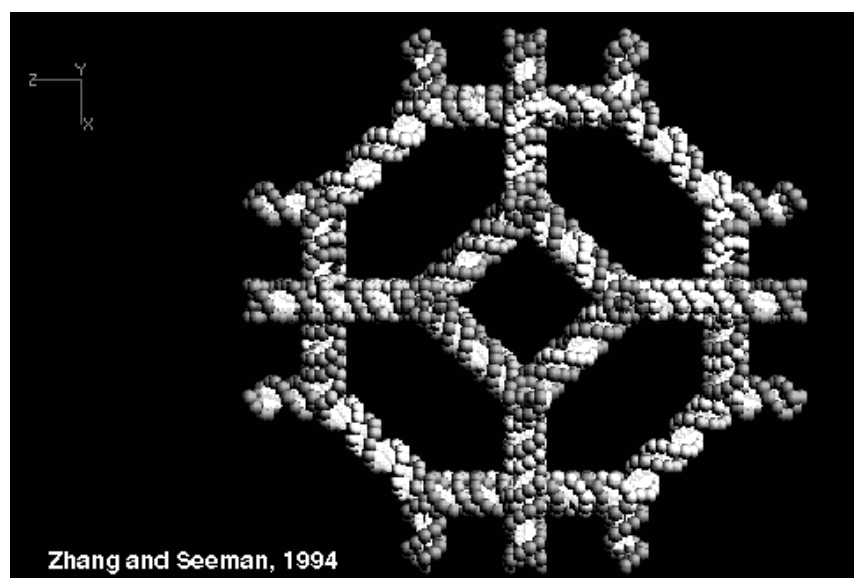

Figure 7.3. Idealized truncated octahedron assembled from DNA. This view is down the four-fold axis of the squares. Each edge of the octahedron contains two double-helical turns of DNA.

surface activity. The technology to make self-assembled monolayers (SAMs) is now so well developed that it should be possible to use them for complex electronic structures and molecular-scale devices.

Research stemming from the study of SAMs (e.g., alkylthiols and other biomembrane mimics on gold) led to the discovery of “stamping” (Figure 7.4) (Kumar and Whitesides 1993). This method, in which an elastomeric stamp is used for rapid pattern transfer, has now been driven to < 50 nanometer scales and extended to nonflat surfaces. It is also called “soft lithography” and offers exciting possibilities for producing devices with unusual shapes or geometries.

Self-assembled organic materials such as proteins and/or lipids can be used to form the scaffolding for the deposition of inorganic material to form ceramics such as hydroxyapatite, calcium carbonate, silicon dioxide, and iron oxide. Although the formation of special ceramics is bio-inspired, the organic material need not be of biological origin. An example is production of template-assisted nanostructured ceramic thin films (Aksay et al. 1996).

A particularly interesting example of bio-inspired self-assembly has been described in a recent article by Stupp and coworkers (Stupp et al. 1997). This work, in which organic “rod-coil” molecules were induced to self-assemble, is significant in that the molecules orient themselves and self-assemble over a wide range of length scales, including mushroom-shaped clusters (Figure 7.5); sheets of the clusters packed side-by-side; and thick films, where the sheets pack in a head-to-tail fashion. The interplay between hydrophobic and hydrophilic forces is thought to be partially responsible for the controlled assembly.

DISPERSIONS AND COATINGS

Drug Delivery Systems

Nanoparticles and nanospheres have considerable utility as controlled drug delivery systems (Hanes et al. 1997). When suitably encapsulated, a pharmaceutical can be delivered to the appropriate site, its concentration can be maintained at proper levels for long periods of time, and it can be prevented from undergoing premature degradation (see Chapter 3). Nanoparticles (as opposed to micron-sized particles) have the advantage that they are small enough that they can be injected into the circulatory system.

Highly porous materials are also ideal candidates for controlled drug delivery (Schnur et al. 1994) and for tissue engineering (Hubbell and Langer 1995). An example of a controlled drug delivery system comes from the area of microtubules. Phospholipid bilayers can self-assemble into long cylindrical tubes with diameters usually below a micron and lengths up to hundreds of microns (Schnur 1993). During synthesis, drugs can be entrained

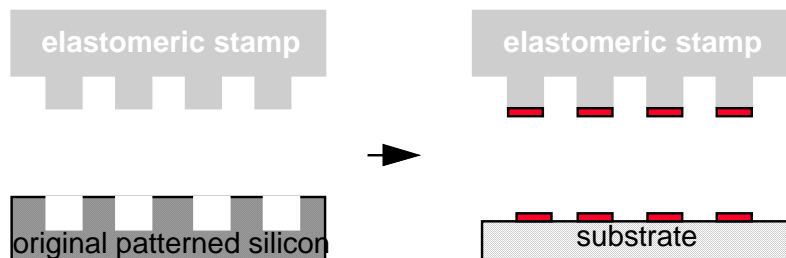

Figure 7.4. An elastomeric stamp (top left) is made from an original master (bottom left). The stamp is dipped into the biological material (top right) and the pattern is transferred to the substrate (bottom right).

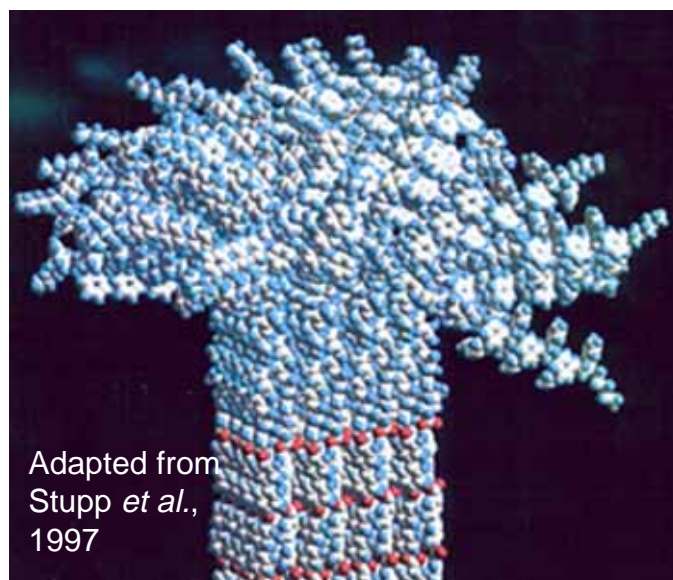

Figure 7.5. Mushroom-shaped clusters formed from self-assembly of rod-coil molecules; these clusters can undergo further packing to form sheets.

in these nanotubes, and the final product can be used as a controlled delivery system. Tubules prepared from phospholipid bilayers are ideal for such applications because they are biocompatible.

Dendrimers can be prepared so they are of discrete size and contain specific functional groups (Karak and Maiti 1997). They can be functionalized and used in biomedicine. Examples include gene transfer agents for gene therapy, made to carry and control the relaxivity of paramagnetic MRI (magnetic resonance imaging) contrast agents (Toth et al. 1996), and to deliver drugs on a controlled release basis.

Role of Nanoparticles in Health and Pollution

Although beyond the scope of this review, it is important to keep in mind the potential role of atmospheric nanoparticles in photocatalytic and thermal production of atmospheric pollutants. Atmospheric aerosols in heavily polluted areas have the potential to accelerate ozone formation reactions. Furthermore, because they are respirable, they could represent a health hazard. Two controversial studies (the Harvard University six-city study and the American Cancer Society study) have linked the presence of fine particular matter to premature mortality (*Chemical and Engineering News* 1997).

Atmospheric aerosols generally contain two major components: one is composed of amorphous carbon that has fullerene-like particles dispersed in it; the second is inorganic and consists of oxides and sulfides supported on clay minerals. In particular, the iron oxide, manganese oxide, and iron sulfide nanoparticles have band-gaps that could enhance the photocatalytic adsorption of solar radiation. In addition, these materials are acidic and may be coated with water, which would enhance their catalytic ability to crack hydrocarbons and create free radicals (Chianelli 1998). At present this is an underexplored area of research that bears scrutiny.

It is interesting to note that some microorganisms produce and sequester CdSe and CdS nanoparticles in response to high levels of toxic Cd^{++} in their environment (Brus 1996). A large number of organisms also have the ability to precipitate ferrimagnetic minerals Fe_3O_4 and Fe_3S_4 (see Consolidated Materials, below).

HIGH SURFACE AREA MATERIALS

Membranes for Biological Separations

Supported polymeric membranes can be used to remove low molecular weight organics from aqueous solution (Ho et al. 1996). They work by filling the pores of microfiltration or ultrafiltration membranes with functional, polymeric, or oligomeric liquids that have an affinity for the compound of interest. These ideas can be extended to microemulsions and used for separations of large biological molecules. For example, non-ionic microemulsions (i.e., oil-water systems) have been used for hemoglobin extraction. These results augur well for the separation of other biological materials (Qutubuddin et al. 1994). Molecular imprinting can also be used to produce high surface area adsorbents that are enantioselective for amino acids and other biological molecules (Vidyasankar et al. 1997).

Bacterial Cell Surface Layers as Patterning Elements

Crystalline bacterial cell surface layers (S-layers) are composed of repeating protein units. These layers self-assemble and have a high binding capacity. They have been explored as patterning elements for molecular nanotechnology. For example, they have been used to pattern cadmium sulfide superlattices (Shenton et al. 1997).

FUNCTIONAL NANOSTRUCTURES

Molecular Computation

The smallest possible computer would ideally be able to perform computations on a molecular scale. Even though the computation may be carried out on that scale, the issue becomes one of having enough molecules to obtain sufficient signal-to-noise ratio to read out the answer. Consequently, at least at present, these computations must be carried out in bulk or with extremes in temperature. There has been a recent development along this line. Adleman (1994) has shown how the rules of DNA self-assembly, coupled with polymerase chain reaction (PCR) amplification of DNA, can lead to a molecular computer of sorts. The system was used to solve the Hamiltonian path problem, a classic and difficult (NP complete) mathematical problem that involves finding a path between vertices of a graph. The starting and ending vertices of each edge of the graph were encoded as the first and second halves of a strand of DNA. A solution to the problem (what is the path between two specific vertices?) was obtained by using PCR primers for the two vertices. Others have extended these ideas and shown that it is possible to make DNA add (Guarnieri et al. 1996). Although these are exciting demonstrations, at present this technology has a number of drawbacks, including the labor and time it takes to analyze the results of the computation, and the uncertainties associated with wet chemistry.

Optoelectronic Devices

Biological molecules and assemblies, such as the photochemical reaction center, are capable of capturing light with good quantum efficiency and transforming it into chemical energy. If properly exploited, such assemblies have potential applications as biomolecule information processing units.

Bacteriorhodopsin, from the purple membrane bacterium *Halobacterium halobium*, is one such system that has been studied extensively and has been

commercialized into optical holographic memories (Birge 1995). In the bacterium, the protein bacteriorhodopsin self-assembles into ordered lipid patches. The protein absorbs light and undergoes a cycle involving a complex series of intermediates, resulting in a proton being pumped across the membrane. It was information developed from understanding the basic science behind the way that bacteriorhodopsin works that led to the use of bacteriorhodopsin as a biomolecule information processing unit. To be used for information storage, the protein is placed under nonbiological conditions. It is dispersed and immobilized into a matrix (e.g., collagen or another polymeric substance) and held at liquid nitrogen temperatures. At this low temperature, the protein acts as an optically-driven bistable switch. One form, the light-adapted form of bacteriorhodopsin, absorbs light at 570 nm. When irradiated with green light at 77 K, it switches to a different stable form that absorbs at 630 nm. Using light of different colors enables one to read and write images onto these memories. By subtracting one memory from the other, these memories are especially useful for realtime, rapid comparison of images.

Molecular Motors

The molecular motors found in biology provide for bacterial locomotion, as well as for the active transport and delivery of molecules. For example, the bacterial flagellar motor is about 20 nm in diameter, and is comprised of a complex assembly of more than 10 different proteins (Imae and Atsumi 1989). The role of the motor is to rotate the helical flagella of the bacterium so that it is able to swim. Chemical energy (in this case protons or sodium) is transduced into mechanical energy.

Other examples of molecular motors include RNA polymerase (Yin et al. 1995), F_1 -ATPase (Noji et al. 1997), myosin, and kinesin (Seventh Biophysical Discussions 1995). The fuel that powers these motors is ATP (adenosine triphosphate). A number of researchers have proposed schemes by which such motors could be used to deliver molecules, one at a time, for the purpose of the ground-up assembly of nanoscale devices (NRC 1996). It is envisioned that the highways could be actin or tubulin, which would need to be immobilized onto a surface. Myosin or kinesin, which naturally travel along these highways, could be used to deliver molecular “packages” to a specific assembly site.

Other Forms of Biological Transport Using Nanoparticles

In the human body, the function of the high density lipoproteins is to transport cholesterol. The ~ 7.5 nm discoidal lipoprotein assemblies are sandwiched between discs of phospholipids and stacked, poker-chip style.

The lipoproteins stabilize the cholesterol particles and assist in their transport. Current research involves manipulating and fusing the assemblies and particles with an atomic force microscope (ATM) tip (Sligar 1998).

Bioelectronics

There has been considerable research activity in molecular electronics and bioelectronics, particularly in Japan (Aizawa 1994). Although this area of nanotechnology is still not as well developed as others in this report, it bears watching. For example, Shionoya and coworkers at the Institute for Molecular Science of the Okazaki National Research Institutes in Japan (see site report, Appendix D) have proposed that novel combinations of DNA, metal ligands, DNA templating, and proteins could produce molecular wires; molecular hoops through which DNA could be threaded; and double-stranded peptides whose helix pitch could be controlled by an entrained metal (Figure 7.6). The active site containing the metal could be induced to go from $\text{Cu(I)}_{\text{tetrahedral}}$ to $\text{Cu(II)}_{\text{square planar}}$, perhaps by electrons delivered by a scanning tunneling microscope (STM) tip.

CONSOLIDATED MATERIALS

Ceramics

Biomolecule/inorganic interactions can be used to produce ceramics with increased toughness. Fundamental studies of biomineralization, in which an organic substance (usually protein or peptide or lipid) interacts with an inorganic phase (e.g., calcium carbonate or hydroxyapatite) have led to the bioinspired synthesis of composite materials.

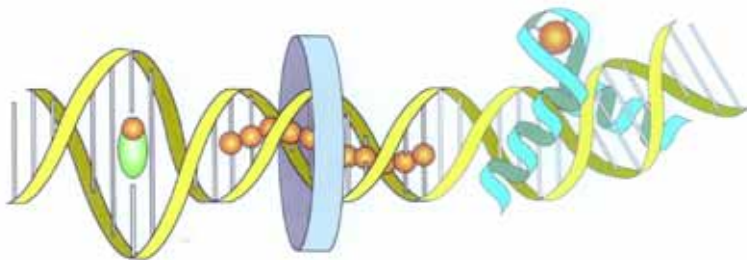

Figure 7.6. Novel combinations of DNA, metal ligands, DNA templating, and proteins are being investigated for molecular wires, inductors, and switches (photo courtesy of Shionoya and coworkers, Inst. for Molecular Science).

The structure and porosity of the inorganic phase can be controlled by templating with an organic surfactant, vesicular arrays, or liquid crystalline materials. Micelle-templated synthesis can produce ceramics with 20-100 Å pore dimensions (Ying 1998). These tailored pores can be used as catalysts and absorbents, and for gas/liquid separations and thermal and acoustic insulation. Their selectivity makes them very useful for biochemical and pharmaceutical separations. Bioceramics can also be made that are more compatible with teeth and bone.

An interesting example of an organic/inorganic composite is the new packaging material that has been developed to replace the polystyrene “clam-shell” for fast food products. Composed of potato starch and calcium carbonate, this foam combines the advantages of good thermal insulation properties and light weight with biodegradability (Stucky 1978).

Biological Bar Magnets

It has been well documented that a very large number of organisms have the ability to precipitate ferrimagnetic minerals such as Fe_3O_4 and Fe_3S_4 . In addition, linear chains of membrane-bound crystals of magnetite, called magnetosomes, have been found in microorganisms and fish (Kirschvink et al. 1992). For example, the Fe_3O_4 domain size in the organism *A. magnetotactum* is about 500 Å, and a chain of 22 of those domains has a magnetic moment of 1.3×10^{-15} . It is not immediately clear how these particles could be exploited for nonbiological applications.

OPPORTUNITIES AND CHALLENGES

This section of the review describes current limits on the biological aspects of nanotechnology. It outlines selected broad areas of research opportunity, and it sets forth challenges for the intermediate and long-term future.

Enabling Technologies

We owe much of the recent progress in the biological aspects of nanotechnology and nanoparticles to important enabling technologies. Many of these enabling technologies are described in other parts of this report. Those that have had a significant impact on biological measurements include techniques and instrumentation such as optical traps, laser tweezers, and “nano-pokers” to measure femtoNewton forces (Svoboda and Block 1994), and AFM and STM (Wildoer et al. 1998).

There is also a need to move detection away from the ensemble, to the single molecule scale. This includes driving instrumentation toward single-molecule spectroscopy; single-spin detection (Rugar et al. 1994); chemical analysis of nanoliter volumes (Hietpas et al. 1996, 139-158); nuclear magnetic resonance microcoils; nanoscale electrode arrays and chemical sensing and detecting technology (McConnell 1996, 97-102); separations technology; chemical analysis of single cells (Hietpas et al. 1996); new biological transformations; and chemical probes of nanostructures.

Enhanced computational infrastructure, both hardware and algorithm development, will also be required to investigate supramolecular assemblies and to understand interactions that occur over a wide variety of time and length scales. At present, we are fairly well equipped to handle quantum mechanical calculations. At the next level of computational complexity, the molecular dynamics force fields and atomic charges can presently handle up to about a million particles and still retain their accuracy. The next scale of complexity, mesoscale modeling, currently requires the use of pseudo atoms. Much more research is required to improve the accuracy of finite element calculations and the modeling of materials applications (Goddard 1998).

Surface Interactions and the Interface Between Biomolecules and Substrates

Much of the progress in the biological aspects of nanotechnology has come from research on surface interactions. It will be important to continue to develop a better understanding of the interface between biomolecules and surfaces. Of particular interest are questions about whether surfaces cause biomolecules to denature, the optimum length of linker groups, and ways to communicate from the biomolecule, through the linker, to the substrate. Another challenge is to produce nanometer ultrathin films that have stable order (Jaworek et al. 1998).

Robustness of Biomolecules and Their Interactions in Aqueous Solution

Although much progress has been made on ways to confer additional robustness on biomolecules, it will be necessary to continue to improve the stability and reliability of biomolecular assemblies. Such research may be along the lines of understanding the thermal stability of biomolecules, perhaps by examining extremophiles and molecules produced by directed evolution. It will also be necessary to produce molecules that can work in the absence of water, or to devise ways in which aqueous solutions can be used reliably.

Assemblers or Templating

The hierarchical self-assembly of biomolecules is often touted as one of their key attributes for nanotechnology applications. However, there remains much to be learned about how to make periodic arrays of biomolecular assemblies, how to use biological templating in an efficient manner, how to mimic biological self-assembly with nonbiological molecules, and how to exploit differences between biological and nonbiological self-assembly.

Combinatorial Approaches to Nanotechnology

Combinatorial chemistry has had an enormous impact on drug discovery and development in the past several years. Ability to develop molecularly sensitive screening techniques is one of the limiting factors of combinatorial chemistry. It would be intriguing to discover screening methods that are particularly sensitive for picking up new phenomena exhibited by biological nanoparticles.

Biomimetics and Polymer-Biopolymer Chimeras

The largest impact of biological sciences on nanotechnology may prove to be through the lessons one can learn from biology, rather than from directly employing the biological molecules themselves. To this end, it is important to support research on various aspects of biomimetics, including activities in which synthetic and biologically-based molecules are combined in chimeric fashion.

TECHNOLOGICAL COMPARISONS

Table 7.1 makes subjective comparisons, weighted by level of effort, impact of research, etc., between the state of biology-related nanotechnology work in Japan, Europe, and the United States.

TABLE 7.1. Comparisons Between Japan, Europe, and the United States in Biologically Related Aspects of Nanotechnology

Synthesis	US/Eur/Japan			
Assembly	US/Eur		Japan	
Dispersions and Coatings		US	Eur	Japan
High Surface Area Materials		Eur/Japan	US	
Functional Nanostructures		US/Japan		Eur
Bio-electronics		Japan		US/Eur
Level	1	2	3	4
	Highest			

REFERENCES

- Adleman, L.M. 1994. Molecular computation to solutions of combinatorial problems. *Science* 266:1021-1024.
- Aizawa, M. 1994. Molecular interfacing for protein molecular devices and neurodevices. *IEEE Engineering in Medicine and Biology* (Feb./March):94-102.
- Aksay, I.A., M. Trau, S. Manne, I. Honma, N. Yao, L. Zhou, P. Fenter, P.M. Eisenberger, and S.M. Gruner. 1996. Biomimetic pathways for assembling inorganic thin films. *Science* 273:892-898.
- Aksay, Ilhan. 1998. Nanostructured ceramics through self-assembly. In *R&D status and trends*, ed. Siegel et al.
- Allara, D.L. 1996. Nanoscale structures engineered by molecular self-assembly of functionalized monolayers. In *Nanofabrication and biosystems*, ed. Hoch et al.
- Birge, R.R. 1995. Protein based computers. *Sci. Am.* (Mar.):90-95.
- Bishop, A.R., and R.G. Nuzzo. 1996. Self-assembled monolayers: Recent developments and applications. *Current Opinion in Colloid & Interface Sci.* 1:127-136.
- Brus, L. 1996. Semiconductor colloids: Individual nanocrystals, opals and porous silicon. *Current Opinion in Colloid & Interface Science* 1:197-201.
- Chemical Engineering News.* 1997. Particulate matter health studies to be reanalyzed (August 18):33.
- Chen, J. and N.C. Seeman. 1991. The synthesis from DNA of a molecule with the connectivity of a cube. *Nature* 350:631-633.
- Chianelli, R.R. 1998. Synthesis, fundamental properties and applications of nanocrystals, sheets, and fullerenes based on layered transition metal chalcogenides. In *R&D status and trends*, ed. Siegel et al.

- Conference on Molecular Nanotechnology. 1997. 2nd Annual International Conference, December 8-9. La Jolla, CA.
- Deming, T.J., M.J. Fournier, T.L. Mason, and D.A. Tirrell. 1997. Biosynthetic incorporation and chemical modification of alkene functionality in genetically engineered polymers. *J. Macromol. Sci. Pure Appl. Chem. A* 34:2143-2150.
- Goddard, W.A. 1998. Nanoscale theory and simulation. In *R&D status and trends*, ed. R. Siegel et al.
- Guarnieri, F., M. Fliss, and C. Bancroft. 1996. Making DNA Add. *Science* 273:220-223.
- Hanes, J., J.L. Cleland, and R. Langer. 1997. New advances in microsphere-based single-dose vaccines. *Advanced Drug Delivery Reviews* 28:97-119.
- Hietpas, P.B., S.D. Gilman, R.A. Lee, M.R. Wood, N. Winograd, and A.G. Ewing. 1996. Development of voltammetric methods, capillary electrophoresis and tof sims imaging for constituent analysis of single cells. In *Nanofabrication and biosystems*, ed. Hoch et al.
- Ho, S.V., P.W. Sheridan, and E. Krupetsky. 1996. Supported polymeric liquid membranes for removing organics from aqueous solutions. 1. Transport characteristics of polyglycol liquid membranes. *J. Membrane Sci.* 112:13-27.
- Hoch, H.C., L.W. Jelinski, and H.G. Craighead, eds. 1996. *Nanofabrication and biosystems*. New York: Cambridge University Press.
- Hubbell, J.A., and R. Langer. 1995. Tissue engineering. *Chem. Eng. News* (March 13): 42-54.
- Imae, Y., and T. Atsumi. 1989. T. Na⁺-driven bacterial flagellar motors: A mini-review. *J. Bioenergetics and Biomembranes* 21:705-716.
- Jaworek, T., D. Deher, G. Wegner, R.H. Wieringa, and A.J. Schouten. 1998. Electromechanical properties of an ultrathin layer of directionally aligned helical polypeptides. *Science* 279:57-60.
- Karak, N., and S. Maiti. 1997. Dendritic polymers: A class of novel material. *J. Polym. Mater.* 14:105.
- Kirschvink, J.L., A. Koyayashi-Kirschvink, and B.J. Woodford. 1992. Magnetite biomineralization in the human brain. *Proc. Nat'l. Acad. Sci. USA* 89:7683-7687.
- Krejchi, M.T., E.D.T. Atkins, A.J. Waddon, M.J. Fournier, T.L. Mason, and D.A. Tirrell. 1994. Chemical sequence control of beta-sheet assembly in macromolecular crystals of periodic proteins. *Science* 265:1427-1432.
- Krejchi, M.T., S.J. Cooper, Y. Deguchi, E.D.T. Atkins, M.J. Fournier, T.L. Mason, and D.A. Tirrell. 1997. Crystal structures of chain-folded antiparallel beta-sheet assemblies from sequence-designed periodic polypeptides. *Macromolecules* 30:5012-5024.
- Kumar, A., and G.M. Whitesides. 1993. Features of gold having micrometer to centimeter dimensions can be formed through a combination of stamping with an elastomeric stamp and an alkanethiol ink followed by chemical etching. *App. Phys. Lett.* 63:2002-2004.
- Mao, C., W. Sun, and N.C. Seeman. 1997. Construction of Borromean rings from DNA. *Nature* 386:137-138.
- McConnell, H.M. 1996. Light-addressable potentiometric sensor: Applications to drug discovery. In *Nanofabrication and biosystems*, ed. Hoch et al.
- Moore, J.C., H.M. Jin, O. Kuchner, and F.H. Arnold. 1997. Strategies for the in vitro evolution of protein function: Enzyme evolution by random recombination of improved sequences. *J. Mol. Biol.* 272:336-347.
- Muir, T.W., P.E. Dawson, and S.B.H. Kent. 1997. Protein synthesis by chemical ligation of unprotected peptides in aqueous solution. *Meth. Enzymol.* 289:266-298.
- NRC (National Research Council). 1996. *Biomolecular self-assembling materials: Scientific and technological frontiers*. Washington, DC: National Academy Press.
- _____. 1994. *Hierarchical structures in biology as a guide for new materials technology*. Washington, DC: National Academy Press.
- Noji, H., R. Yasuda, M. Yoshida, and K. Kinosita, Jr. 1997. Direct observation of the rotation of F-1-ATPase. *Nature*. 386:299-302.

- Qutubuddin, S., J.M. Wiencek, A. Nabi, and J.Y. Boo. 1994. Hemoglobin extraction using cosurfactant-free nonionic microemulsions. *Sep. Sci. and Technology* 29:923-929.
- Rousseau, D.L., and L.W. Jelinski. 1991. Biophysics. In *Encyclopedia of Applied Physics* Vol. 2. New York: VCH Publishers.
- Rugar, D., O. Zuger, S. Hoen, C.S. Yannoni, H.M. Veith, and R.D. Kendrick. 1994. Force detection of nuclear magnetic resonance. *Science* 264:1560-1563.
- Schnur, J.M. 1993. Lipid tubules: A paradigm for molecularly engineering structures. *Science* 262:1669-1676.
- Schnur, J.M., R. Price and A.S. Rudolph. 1994. Biologically engineered microstructures—Controlled release applications. *J. Controlled Release* 28:3-13.
- Seeman, N.C. 1998. DNA nanotechnology. In *R&D status and trends*, ed. Siegel et al. Seventh Biophysical Discussions. 1995. Molecular motors: Structure, mechanics and energy transduction. *Biophys. J.* 68:Supplement S.
- Shenton, W., D. Pum, U.B. Sleytr, and S. Mann. 1997. S. synthesis of cadmium sulphide superlattices using self-assembled bacterial S-layers. *Nature* 389:585-587.
- Siegel, R.W., E. Hu, and M.C. Roco. 1998. *R&D status and trends in nanoparticles, nanostructured materials, and nanodevices in the United States*. Proceedings of the May 8-9, 1997 workshop. Baltimore: Loyola College, International Technology Research Institute. NTIS #PB98-117914.
- Sligar, S. 1998. Molecular and electronic nanostructures. In *R&D status and trends*, ed. Siegel et al.
- Sosnowski, R.G., E. Tu, W.F. Butler, J.P. O'Connell, and M.J. Heller. 1997. Rapid determination of single base mismatch mutations in DNA hybrids by direct electric field control. *P. Natl. Acad. Sci. USA* 94(4)(Feb. 18):1119-1123.
- Stuckey, G.D. 1998. High surface area materials. In *R&D status and trends*, ed. Siegel et al.
- Stupp, S.I., V. LeBonheur, K. Wlaker, L.S. Li, K.E. Huggins, M. Keser, and A. Armstutz. 1997. Supramolecular materials: Self-organized nanostructures. *Science* 276:384-389.
- Svoboda, K., and S.M. Block. 1994. Biological applications of optical forces. *Ann. Rev. Biophys. Biomol. Struct.* 23:247-285.
- Symposium on Bio-Nano Electronics. 1997. Proceedings. November 15, Toyo University, Japan.
- Tirrell, J.G., M.J. Fournier, T.L. Mason, and D.A. Tirrell. 1994. Niomolecular materials. *Chem. Eng. News* 72(January 30):40-51.
- Toth, E., D. Pubanz, S. Vauthey, L. Helm, and A.E. Merbach. 1996. The role of water exchange in attaining maximum relaxivities for dendrimeric mri contrast agents. *Chemistry—A European Journal* 2:1607-1615.
- US/EC Workshop on Nanobiotechnology. 1999. Workshop of September 23-24, 1997, Washington, D.C. (report available from the National Science Foundation, Washington, DC, in 1998).
- Vidyasankar, S., M. Ru, and F.H. Arnold. 1997. Molecularly imprinted ligand-exchange adsorbents for the chiral separation of underivatized amino acids. *J. Chromatography A* 775:51-63.
- Wildoer, J.W.G., L.C. Venema, A.G. Rinzler, R.E. Smalley, and C. Dekker. 1998. Electronic structure of atomically resolved carbon nanotubes. *Nature* 391:59-62.
- Winningham, M.J. and D.Y. Sogah. 1997. A modular approach to polymer architecture control via catenation of prefabricated biomolecular segments: Polymers containing parallel beta-sheets templated by a phenoxathiin-based reverse turn mimic. *Macromolecules* 30: 862 - 876.
- Yin, H., M.D. Wang, K. Svoboda, R. Landick, J. Gelles, and S.M. Block. 1995. Transcription against an applied force. *Science* 270:1653-1657.
- Ying, J.Y. 1998. Nanostructure processing of advanced catalytic materials. In *R&D status and trends*, ed. Siegel et al.

- Yu, S.J.M., V.P. Conticello, G.H. Zhang, C. Kayser, M.J. Fournier, T.L. Mason, and D.A. Tirrell. 1997. Smectic ordering in solutions and films of a rod-like polymer owing to monodispersity of chain length. *Nature* 389:167-170.
- Zhang, Y., and N.C. Seeman. 1994. The construction of a DNA truncated octahedron. *J. Am. Chem. Soc.* 116:1661-1669.

Chapter 8

Research Programs on Nanotechnology in the World *(Americas, Asia/Pacific, and Europe)*

M.C. Roco¹
National Science Foundation

INTRODUCTION

Scientific breakthroughs combined with recent research programs in the United States, Japan, and Europe, and various initiatives in Australia, Canada, China, Korea, Singapore, and Taiwan highlight the international interest in nanoscale science and technology. Definitions of nanotechnology vary somewhat from country to country. Nanotechnology as defined for the projects reviewed in this chapter arises from the exploitation of the novel and improved physical, chemical, mechanical, and biological properties, phenomena, and processes of systems that are intermediate in size between isolated atoms/molecules and bulk materials, where phenomena length and time scales become comparable to those of the structure. It implies the ability to generate and utilize structures, components, and devices with a size range from about 0.1 nm (atomic and molecular scale) to about 100 nm (or larger in some situations) by control at atomic, molecular, and macromolecular levels. Novel properties occur compared to bulk behavior because of the small structure size and short time scale of various processes. Nanotechnology's size range and particularly its new phenomena set it apart from the technologies referred to as microelectromechanical systems (MEMS) in the United States or microsystems technologies (MST) in Europe.

¹ Opinions expressed here are those of the author and do not necessarily reflect the position of the National Science Foundation.

It is estimated that nanotechnology is presently at a level of development similar to that of computer/information technology in the 1950s. As indicated in the preceding chapters and as evidenced by the WTEC panel's research and observations during the course of this study, the development of nanoscale science and technology is expected by most scientists working in the field to have a broad and fundamental effect on many other technologies. This helps to explain the phenomenal levels of R&D activity worldwide. This chapter presents an overview of most of the significant nanotechnology research programs in the world. Where possible, a general picture is given of the funding levels of the programs, based on site interviews and publications.

AMERICAS

Aspects of nanoscience are taught and researched in the physics, chemistry, and biology departments of research universities throughout the American continents. However, significant activities in nanotechnology, including production and application of nanostructures, have been limited essentially to the United States and Canada.

The United States²

Various U.S. public and private funding agencies; large companies in chemical, computer, pharmaceutical, and other areas; as well as small and medium-size enterprises provide support for precompetitive research programs on nanotechnology. Most of the supported programs are evolving out of disciplinary research programs, and only some are identified as primarily dealing with nanotechnology. U.S. government agencies sponsored basic research in this area at a level estimated at about \$116 million in 1997 (Siegel et al. 1998), as shown in Table 8.1. The National Science Foundation (NSF) has the largest share of the U.S. government investment, with an expenditure of about \$65 million per year, or about 2.4% of its overall research investment in 1997. In 1998 it expanded its research support to functional nanostructures with an initiative in excess of \$13 million.

² For a more in-depth look at the state of nanoscale science and engineering R&D in the United States, see Siegel et al. 1998.

TABLE 8.1. Support for Nanotechnology Research from U.S. Federal Agencies in 1997

Agency	Nanotechnology Research (\$M)
National Science Foundation (NSF)	65
Defense Advanced Research Projects Agency (DARPA)	10
Army Research Office (ARO)	15
Office of Naval Research (ONR)	3
Air Force Office of Scientific Research (AFOSR)	4
Department of Energy (DOE)	7
National Institutes of Health (NIH)	5
National Institute of Standards and Technology (NIST)	4
National Aeronautics and Space Administration (NASA)	3
Total	116

NSF activities in nanotechnology include research supported by the Advanced Materials and Processing Program; the Ultrafine Particle Engineering initiative dedicated to new concepts and fundamental research to generate nanoparticles at high rates; the National Nanofabrication User Network (NNUN); and Instrument Development for Nano-Science and Engineering (NANO-95) to advance atomic-scale measurements of molecules, clusters, nanoparticles, and nanostructured materials. A current activity is the initiative, Synthesis, Processing, and Utilization of Functional Nanostructures (NSF 98-20 1997).

In the United States, a number of large multinational corporations, small enterprises, and consortia are pursuing nanotechnology-related research and development activities. Dow, DuPont, Eastman Kodak, Hewlett-Packard (HP), Hughes Electronics, Lucent, Motorola, Texas Instruments, Xerox, and other multinationals have established specialized groups in their long-term research laboratories, where the total research expenditure for nanotechnology research is estimated to be comparable to the U.S. government funding. Computer and electronics companies allocate up to half of their long-term research resources to nanotechnology programs. HP spends 50% of long-term (over 5 years) research on nanotechnology (Williams 1998). Small business enterprises, such as Aerochem Research Laboratory, Nanodyne, Michigan Molecular Institute, and Particle Technology, Inc., have generated an innovative competitive environment in various technological areas, including dispersions, coatings, structural materials, filtration, nanoparticle manufacturing processes, and functional nanostructures (sensors, electronic devices, etc.). Small niches in the market as well as support from several U.S. government agencies through the Small Business for Innovative Research (SBIR) program have provided the nuclei

for high-tech enterprises. The university-small business technology transfer (STTR) program at NSF is dedicated to nanotechnology in fiscal year 1999. Two semiconductor processing consortia, the Semiconductor Manufacturing and Technology Institute (Sematech) and the Semiconductor Research Corporation (SRC), are developing significant research activities on functional nanostructures on inorganic surfaces.

A series of interdisciplinary centers with nanotechnology activities has been established in the last few years at many U.S. universities, creating a growing public research and education infrastructure for this field. Examples of such centers are

- Brown University, Material Research Science and Engineering Center
- Rice University, Richard Smalley's Center for Nanoscale Science and Technology (CNST)
- University of California–Berkeley, nanoelectronics facilities
- University of Illinois at Urbana, the Engineering Research Center on Microelectronics in collaboration with the Beckman Institute, a private foundation
- University of North Carolina
- University of Texas–Austin
- Rensselaer Polytechnic Institute
- University of Washington (focus on nanobiotechnology)
- University of Wisconsin at Madison (focus on nanostructured materials)

NNUN, mentioned above, is an interuniversity effort supported by NSF at five universities: Cornell, Stanford, University of California–Santa Barbara (UCSB), Penn State, and Howard. It has focused on nanoelectronics, optoelectronics, electromechanical systems, and biotechnology. The Center for Quantized Electronic Structures (QUEST) at UCSB is a national facility developing expertise on underlying physics and chemistry aspects. Hundreds of graduate students have completed their education in connection with these centers in the last few years.

Current interest in nanotechnology in the United States is broad-based and generally spread into small groups. The research themes receiving the most attention include

1. metallic and ceramic nanostructured materials with engineered properties
2. molecular manipulation of polymeric macromolecules
3. chemistry self-assembling techniques of “soft” nanostructures
4. thermal spray processing and chemistry-based techniques for nanostructured coatings
5. nanofabrication of electronic products and sensors
6. nanostructured materials for energy-related processes such as catalysts and soft magnets

7. nanomachining
8. miniaturization of spacecraft systems

In addition, neural communication and chip technologies are being investigated for biochemical applications; metrology has been developed for thermal and mechanical properties, magnetism, micromagnetic modeling, and thermodynamics of nanostructures; modeling at the atomistic level has been established as a computational tool; and nanoprobe have been constructed to study material structures and devices with nanometer length scale accuracy and picosecond time resolution. While generation of nanostructures under controlled conditions by building up from atoms and molecules is the most promising approach, materials restructuring and scaling-down approaches will continue. Exploratory research includes tools of quantum control and atom manipulation, computer design of hierarchically structured materials (e.g., Olson 1997), artificially structured molecules, combination of organic and inorganic nanostructures, biomimetics, nanoscale robotics, encoding and utilization of information by biological structures, DNA computing, interacting textiles, and chemical and bioagent detectors.

Commercially viable technologies are already in place in the United States for some ceramic, metallic, and polymeric nanoparticles, nanostructured alloys, colorants and cosmetics, electronic components such as those for media recording, and hard-disk reading, to name a few. The time interval from discovery to technological application varies greatly. For instance, it took several years from the basic research discovery of the giant magnetoresistance (GMR) phenomenon in nanocrystalline materials (Berkowitz et al. 1992) to industry domination by the corresponding technology by 1997. GMR technology has now completely replaced the old technologies for computer disk heads, the critical components in hard disk drives, for which there is a \$20+ billion market (Williams 1998). All disk heads currently manufactured by IBM and HP are based on this discovery. In another example, nanolayers with selective optical barriers are used at Kodak in more than 90% of graphics black and white film (Mendel 1997) and for various optical and infrared filters, which constitute a multibillion-dollar business. Other current applications of nanotechnology are hard coatings, chemical and biodetectors, drug delivery systems via nanoparticles, chemical-mechanical polishing with nanoparticle slurries in the electronics industry, and advanced laser technology. Several nanoparticle synthesis processes developed their scientific bases decades ago, but most processes are still developing their scientific bases (Roco 1998). Most of the technology base development for nanoparticle work is in an embryonic phase, and industry alone cannot sustain the research effort required for establishing the scientific and technological infrastructure. This is the role

of government (e.g., NSF and NIH) and private agency (e.g., Beckman Institute) support for fundamental research.

Nanotechnology research in the United States has been developed in open competition with other research topics within various disciplines. This is one of the reasons that the U.S. research efforts in nanotechnology are relatively fragmented and partially overlapping among disciplines, areas of relevance, and sources of funding. This situation has advantages in establishing competitive paths in the emerging nanotechnology field and in promoting innovative ideas; it also has some disadvantages for developing system applications. An interagency coordinating “Group on Nanotechnology” targets some improvement of the current situation. The group was established in 1997 with participants from twelve government funding/research agencies to enhance communication and develop partnerships among practicing nanoscience professionals.

Canada

Canada’s National Research Council supports nanotechnology through the Institute for Microstructural Science, which has the mission to interact with industry and universities to develop the infrastructure for information technology. The main project, the Semiconductor Nanostructure Project, was initiated in 1990. It provides support for fundamental research at a series of universities, including Queen’s, Carleton, and Ottawa Universities.

ASIA/PACIFIC

There are significant research programs on nanotechnology in Japan, as well as in China, Taiwan, South Korea, and Singapore.

Japan

The term “nanotechnology” is frequently used in Japan specifically to describe the construction of nanostructures on semiconductors/inorganic substrates for future electronic and computer technologies, and to describe the development of equipment for measurement at nanometer level (Sienko 1998). There are, however, Japanese programs in a number of other areas related to nanotechnology in the broader definition used in this report.

Government agencies and large corporations are the main sources of funding for nanotechnology in Japan; small and medium-size companies play only a minor role. Research activities are generally grouped in relatively large industrial, government, and academic laboratories. The three

main government organizations sponsoring nanotechnology in Japan are the Ministry of International Trade and Industry (MITI), the Science and Technology Agency (STA), and Monbusho (the Ministry of Education, Science, Sports, and Culture). Funding for nanotechnology research should be viewed in the context of an overall increased level of support for basic research in Japan since 1995 as a result of Japan's Science and Technology Basic Law No. 130 (effective November 15, 1995), even if the law has not been fully implemented. The data presented below are based on information received from Japanese colleagues during the WTEC visit in July 1997 (see site reports in Appendix D). All budgets are for the fiscal year 1996 (1 April 1996 to 31 March 1997) and assume an exchange rate of ¥115 = \$1, unless otherwise stated. The first five-year program on ultrafine particles started in 1981 under the Exploratory Research for Advanced Technologies (ERATO) program; an overview of the results of that program was published in 1991 (Uyeda 1991).

It is estimated that the Agency of Industrial Science and Technology (AIST) within MITI had a budget of approximately \$60 million per year for nanotechnology in 1996/97 (roughly 2.2% of the AIST budget). The National Institute for Advancement of Interdisciplinary Research (NAIR) hosts three AIST projects:

1. Joint Research Center for Atom Technology (JRCAT), with a ten-year budget of about \$220 million for 1992-2001 (\$25 million per year in 1996)
2. Research on Cluster Science program, with about \$10 million for the interval 1992-1997
3. Research on Bionic Design program, with \$10 million for 1992-1997, about half on nanotechnology

Other efforts supported to various degrees by MITI include the following:

- the Electrotechnical Laboratory in Tsukuba, which allocates about 17% (or \$17 million per year) of its efforts on advanced nanotechnology projects
- the Quantum Functional Devices Program, funded at about \$64 million for 1991-2001 (about \$6.4 million in 1996)
- the Osaka National Research Institute and the National Industrial Research Institute of Nagoya, which each spend in the range of \$2.5-3 million per year for nanotechnology
- the Association of Super-Advanced Electronics Technologies (ASET), a relatively new MITI-sponsored consortium with partial interest in nanotechnology; it has similarities with the U.S. Ultra Electronics program of DARPA

It is estimated that STA investment in nanotechnology research was about \$35 million in 1996, mainly within five organizations:

1. Institute of Physical and Chemical Research (RIKEN), where nanotechnology is included in the Frontier Materials Research initiative
2. National Research Institute for Metals (NRIM)
3. National Institute for Research in Inorganic Materials (NIRIM)
4. Japan Science and Technology Corporation (JST—formerly called JRDC), which manages the ERATO program, including four nanotechnology-related projects, each with total budgets of \$13-18 million for five years:
 - Quantum Wave Project (1988-1993)
 - Atomcraft Project (1989-1994)
 - Electron Wavefront Project (1989-1994)
 - Quantum Fluctuation Project (1993-1998)

Monbusho supports nanotechnology programs at universities and national research institutes, as well as via the Japan Society for Promotion of Science (JSPS). The most active programs are those at Tokyo University, Kyoto University, Tokyo Institute of Technology, Tohoku University, and Osaka University (see Appendix D). The Institute of Molecular Science and the Exploratory Research on Novel Artificial Materials and Substances program promote new research ideas for next-generation industries (5-year university-industry research projects). The “Research for the Future” initiative sponsored by JSPS has a program on “nanostructurally controlled spin-dependent quantum effects” (1996-2001) at Tohoku University. Monbusho’s funding contribution to nanotechnology programs is estimated at ~ \$25 million.

In total, MITI, STA, and Monbusho allocated ~ \$120 million for nanotechnology in 1996.

Large companies also drive nanotechnology research in Japan. Important research efforts are at six institutions: Hitachi (Central R&D Laboratories, where nanotechnology is ~ 25% of long-term research)—Hitachi has ~ \$70 billion per year in sales (see site report in Appendix D); NEC (Fundamental Research Laboratories, where nanotechnology is estimated to be ~ 50% of the precompetitive research)—NEC has ~ \$40 billion per year in sales (see site report in Appendix D); NTT (Atsugi Lab); Fujitsu (Quantum Electron Devices Lab); Sony; and Fuji Photo Film Co.

An allocation of 10% of sales for research and development is customary in these companies, with ~ 10% of this for long-term research. Some Japanese nanostructured products already have considerable market impact. Nihon Shinku Gijutsu (ULVAC) produces over \$4 million per year in sales of particles for electronics, optics, and arts. Also, there are in Japan, as in

the United States, private consortia making an increased contribution to nanotechnology R&D:

- The Semiconductor Industry Research Institute of Japan (SIRI), established in 1994, focuses on long-term research with partial government funding
- Semiconductor Leading Edge Technologies, Inc. (SELETE), established by ten large Japanese semiconductor companies in 1996, focuses on applied research and development with an estimated budget of \$60 million in 1997
- Semiconductor Technology Academic Research Center (STARC) promotes industry-university interactions

Strengthening of the nanotechnology research infrastructure in the last years has been fueled by both the overall increase of government funding for basic research and by larger numbers of academic and industry researchers choosing nanotechnology as their primary field of research. Potential industrial applications provide a strong stimulus. A systems approach has been adopted in most laboratory projects, including multiple characterization methods and processing techniques. A special Japanese research strength is instrumentation development. The university-industry interaction is stimulated by the new MITI projects awarded to universities in the last few years that encourage temporary hiring of research personnel from industry. Other issues currently being addressed are more extensive use of peer review, promoting personnel mobility and intellectual independence, rewarding researchers for patents, promoting interdisciplinary and international interactions, and better use of the physical infrastructure.

China

Nanoscience and nanotechnology have received increased attention in China since the mid-1980s. Approximately 3,000 researchers there now contribute to this field (Bai 1996). The ten-year “Climbing Project on Nanometer Science” (1990-1999) and a series of advanced materials research projects are the core activities. The Chinese Academy of Sciences sponsors relatively large groups, while the China National Science Foundation (CNSF) provides support mainly for individual research projects. Areas of strength are development of nanoprobes and manufacturing processes using nanotubes. The Chinese Physics Society and the Chinese Society of Particology are societies involved in the dissemination of nanotechnology research.

India

India's main research activities are on nanostructured materials and electronic devices (Sikka 1995). These involve a combination of research institutions (the Central Electronics Engineering Research Institute in Pilani, the Space Application Center in Ahmedabad, and others), funding organizations (the Centre for Development of Materials in Pune, the Indian Institute of Science in Bangalore, and others), and industry.

Taiwan

Taiwan's major nanotechnology research effort is conducted in the area of miniaturization of electronic circuits. The research is conducted in academic institutions and at the Industrial Technology Research Institute. Government funds for fundamental research are channeled via the National Science Council. (See site reports in Appendix E.)

South Korea

A national research focus on nanotechnology was established in Korea in 1995. The Electronics and Telecommunications Research Institute (ETRI) in Taejon, Korea's science city, targets advanced technologies for information and computer infrastructures, with a focus on nanotechnology (ATIP 1998). The emphasis is on nanoscale semiconductor devices and particularly on semiconductor quantum nanostructures and device applications (lasers, modulators, switches and logical devices, resonant tunneling devices, self-assembled nanosize dots, single-electron transistors, and quantum wires).

Singapore

Nanotechnology research received a considerable boost in Singapore by the initiation of a national program in this area in 1995.

Australia

The National Research Council (NRC) of Australia has sponsored R&D in nanotechnology since 1993 (ASTC 1993). Research groups work on synthesis of nanoparticles for membranes and catalysts (University of New South Wales), nanofiltration (UNESCO Center for Membrane Science and Technology), and use of nanoparticles in processing minerals for special products (the Advanced Mineral Products Research Center at the University

of Melbourne). AWA Electronics in Homebush has the largest industrial research facility for nanoelectronics in Australia.

EUROPE

European Community (EC)

The term “nanotechnology” is frequently defined in Europe as “the direct control of atoms and molecules” for materials and devices. A more specific definition from H. Rohrer (1997) is a “one-to-one relationship between a nano-object or nano-part of an object and another nano-, micro- or bulk object.” The nanotechnology field as defined in this WTEC report includes these aspects, with the clarification that only the specific, distinctive properties and phenomena manifesting at length scales between individual atoms/molecules and bulk behavior are considered.

There are a combination of national programs, collaborative European (mostly EC) networks, and large corporations that fund nanotechnology research in Europe. Multinational European programs include the following:

1. The ESPRIT Advanced Research Initiative in Microelectronics and the BRITE/EURAM projects on materials science in the EC are partially dedicated to nanotechnology.
2. The PHANTOMS (Physics and Technology of Mesoscale Systems) program is a network created in 1992 with about 40 members to stimulate nanoelectronics, nanofabrication, optoelectronics, and electronic switching. Its coordinating center is at the IMEC Center for Microelectronics in Leuven, Belgium (see site report in Appendix B).
3. The European Science Foundation has sponsored a network since 1995 for Vapor-phase Synthesis and Processing of Nanoparticle Materials (NANO) in order to promote bridges between the aerosol and materials science communities working on nanoparticles. The NANO network includes 18 research centers and is codirected by Duisburg University and Delft University of Technology.
4. The European Consortium on NanoMaterials (ECNM) was formed in 1996, with its coordinating center in Lausanne, Switzerland. This group aims at fundamental research to solve technological problems for nanomaterials and at improved communication between researchers and industry.
5. NEOME (Network for Excellence on Organic Materials for Electronics) has had some programs related to nanotechnology since 1992.

6. The European Society for Precision Engineering and Nanotechnology (EUSPEN) was designed in 1997 with participation from industry and universities from six EC countries.
7. The Joint Research Center Nanostructured Materials Network, established in 1996, has its center in Ispra, Italy.

It is expected that the European Framework V will introduce additional programs on nanotechnology, particularly by adding a new dimension in nanobiology in the next four-year plan.

Germany

The Federal Ministry of Education, Science, Research, and Technology (BMBF) in Germany provides substantial national support for nanotechnology. The Fraunhofer Institutes, Max Planck Institutes, and several universities have formed centers of excellence in the field. It is estimated that in 1997 BMBF supported programs on nanotechnology with a budget of approximately \$50 million per year. Two of the largest upcoming projects are "CESAR," a \$50 million science center in Bonn equally sponsored by the state and federal governments with about one-third of its research dedicated to nanoscience, and a new institute for carbon-reinforced materials near Karlsruhe (\$4 million over 3 years, 1998-2001). BMBF is establishing five "centers of competence in nanotechnology" in Germany starting in 1998, with topics ranging from molecular architecture to ultraprecision manufacturing.

U.K.

A network program (LINK Nanotechnology Programme) was launched in the United Kingdom in 1988 with an annual budget of about \$2 million per year. The Engineering and Physical Sciences Research Council (EPSRC) is funding materials science projects related to nanotechnology with a total value of about \$7 million for a five-year interval (1994-1999). About \$1 million is specifically earmarked for nanoparticle research. The National Physical Laboratory established a forum called the National Initiative on Nanotechnology (NION) for promoting nanotechnology in universities, industry, and government laboratories.

France

The Centre National de la Recherche Scientifique (CNRS) has developed research programs on nanoparticles and nanostructured materials at about 40 physics laboratories and 20 chemistry laboratories in France. Synthesis

methods include molecular beam and cluster deposition, lithography, electrochemistry, soft chemistry, and biosynthesis. Nanotechnology activity has grown within a wide variety of research groups, including ones focused on molecular electronics, large gap semiconductors and nanomagnetism, catalysts, nanofilters, therapy problems, agrochemistry, and even cements for ductile nanoconcretes. It is estimated that CNRS spends about 2% of its budget and dedicates 500 researchers in 60 laboratories (or about \$40 million per year) on projects related to nanoscience and nanotechnology. Companies collaborating to research and produce nanomaterials include Thompson, St. Gobain, Rhône Poulenc, Air Liquide, and IEMN. Also, there is the “French Club Nanotechnologie,” aimed at promoting interactions in this field in France.

Sweden

The estimated total expenditure for research on nanotechnology in Sweden is ~ \$10 million per year. There are four materials research consortia involved in this field:

1. Ångström Consortium in Uppsala, with a budget of ~ \$0.8 million per year in 1998 for surface nanocoatings
2. Nanometer Structures Consortium in Lund with a budget of ~ \$3.5 million per year partially supported by ESPRIT (~ \$1 million per year)
3. Cluster-based and Ultrafine Particle Materials in the University of Uppsala and Royal Institute of Technology with a budget of ~ \$0.4 million per year in 1998
4. Brinell Center at the Royal Institute of Technology

Switzerland

There is a Swiss national program on nanotechnology with a special strength in instrumentation. The most advanced research centers are focused on nanoprobe and molecule manipulation on surfaces (IBM Research Laboratory in Zürich), devices and sensors (Paul Scherrer Institute), nanoelectronics (ETH Zürich), and self-assembling on surfaces in patterns determined by the substrate or template (L'École Polytechnique Fédérale de Lausanne). See the site reports on all of these institutions in Appendix B.

The Netherlands

The most active research centers in the Netherlands are the DIMES institute at Delft University of Technology, which receives one-third support from industry, and the Philips Research Institute in Eindhoven, which

researches self-assembling monolayers and patterning on metallic and silicon surfaces. The SST Netherlands Study Center for Technology Trends is completing a study on nanotechnology and aims at promoting increased funding and research networking in the Netherlands (ten Wolte 1997).

Finland

The Academy of Finland and the Finnish Technology Development Center began a three-year nanotechnology program in 1997. The program involves sixteen projects with funding of \$9 million for a three-year period (1997-1999) for nanobiology, functional nanostructures, nanoelectronics, and other areas. Research on actuators and sensors is the Finnish area of strength.

Belgium and Spain

Since about 1993 both Belgium and Spain have established nanotechnology programs, centers of excellence, and university-industry interactions.

Multinational Efforts

Large multinational companies with significant nanotechnology research activities in Europe include IBM (Zürich), Philips, Siemens, Bayer, and Hitachi. Degussa Co., with headquarters in Germany, is a commercial supplier since 1940 of microparticles and, now, nanoparticles.

Western Europe has a variety of approaches to funding research on nanotechnology. These are discussed in detail in other studies. IPTS (the Science and Technology Forecast Institute) has conducted a study on nanotechnology research in the EC (Malsh 1997). Other European studies published recently include those by VDI (1996), UNIDO (1997), the U.K. Parliamentary Office of Science and Technology (1997), and NANO network (Fissan and Schoonman 1997). The overall expenditure for nanotechnology research within the EC was estimated in 1997 to be over \$128 million per year.

RUSSIA AND OTHER FSU COUNTRIES

Support for generation of nanoparticles and nanostructured materials has a tradition in Russia and other countries of the former Soviet Union (FSU) dating back to the mid-1970s; before 1990 an important part of this support

was connected to defense research. The first public paper concerning the special properties of nanostructures was published in Russia in 1976. In 1979 the Council of the Academy of Sciences created a section on "Ultra-Dispersed Systems." Research strengths are in the areas of preparation processes of nanostructured materials and in several basic scientific aspects. Metallurgical research for special metals, including those with nanocrystalline structures, has received particular attention; research for nanodevices has been relatively less developed. Due to funding limitations, characterization and utilization of nanoparticles and nanostructured materials requiring costly equipment are less advanced than processing.

Russian government funds are allocated mainly for research personnel and less for infrastructure (*Chem. Eng. News* 1997). Funding for nanotechnology is channeled via the Ministry of Science and Technology, the Russian Foundation for Fundamental Research, the Academy of Sciences, the Ministry of Higher Education, and other ministries with specific targets. The Ministry of Higher Education has relatively little research funding. Overall, 2.8% of the civilian budget in Russia in 1997 was planned for allocation to science. There is no centralized program on nanotechnology; however, there are components in specific institutional programs. Currently, about 20% of science research in Russia is funded via international organizations. The significant level of interest in the FSU can be identified by the relatively large participation at a series of Russian conferences on nanotechnology, the first in 1984 (First USSR Conference on Physics and Chemistry of Ultradispersed Systems), a second in 1989, and a third in 1993.

The Ministry of Science and Technology contributes to nanotechnology through several of its specific programs related to solid-state physics, surface science, fullerenes and nanostructures, and particularly "electronic and optical properties of nanostructures." This last program involves a network of scientific centers: the Ioffe Institute in St. Petersburg, Lebedev Institute in Moscow, Moscow State University, Novgograd Institute of Microstructures, Novosibirsk Institute of Semiconductor Physics, and others. This research network has an annual meeting on nanostructures, physics, and technology, and has developed interactions with the PHANTOMS network in the EC. The U.S. Civilian Research and Development Foundation has provided research funds in the FSU for several projects related to nanotechnology, including "Highly Non-Equilibrium States and Processes in Nanomaterials" at the Ioffe Institute (1996-1998).

Russian government and international organizations are the primary research sponsors for nanotechnology in Russia. However, laboratories and companies privatized in the last few years, such as the Delta Research Institute in Moscow, are under development. With a relatively lower base in

characterization and advanced computing, the research focus is on advanced processing and continuum modeling. Research strengths are in the fields of physico-chemistry, nanostructured materials, nanoparticle generation and processing methods, and applications for hard materials, purification, and the oil industry, and biologically active systems (Siegel et al. n.d.).

There are related programs in Ukraine, Belarus, and Georgia, mostly under the direction of the respective academies of sciences in these countries, that are dedicated to crystalline nanostructures and advanced structural and nanoelectronic materials. Several innovative processes, such as diamond powder production by detonation synthesis at SINTA in Belarus, are not well known abroad.

CLOSING REMARKS

Nanotechnology in the United States, Japan, and Western Europe is making progress in developing a suitable research infrastructure. The promise of nanotechnology is being realized through the confluence of advances in two fields: (1) scientific discovery that has enabled the atomic, molecular, and supramolecular control of material building blocks, and (2) manufacturing that provides the means to assemble and utilize these tailored building blocks for new processes and devices in a wide variety of applications. Technology programs cannot be developed without strong supporting science programs because of the scale and complexity of the nanosystems. The overlapping of discipline-oriented research with nanotechnology-targeted programs seems appropriate at this point in time. Highly interdisciplinary and multiapplication nanotechnology provides generic approaches that enable advances in other technologies, from dispersions, catalysts, and electronics to biomedicine. Essential trends include the following:

- learning from nature (including templating, self-assembly, multifunctionality)
- building up functional nanostructures from molecules
- convergence of miniaturization and assembly techniques
- novel materials by design
- use of hierarchical/adaptive simulations

A characteristic of discovery in nanotechnology is the potential for revolutionary steps. The question “what if?” is progressively replaced by “at what cost?” The road from basic research to applications may vary from a few months to decades. Research and development is expensive, and the field needs support from related areas. The R&D environment should favor multiapplication and international partnerships.

Based on the data for 1996 and 1997 collected during this WTEC study, 1997 government expenditures for nanotechnology research were at similar absolute levels in the United States, Japan, and Western Europe (Table 8.2). (Estimated OECD data for 1997 indicated GDPs of \$4.49 billion for Japan, \$7.76 billion for the United States, and \$7.00 billion for Western Europe.)

The largest funding opportunities for nanotechnology are provided by NSF in the United States (approximately \$65 million per year for fundamental research), by MITI in Japan (approximately \$50 million per year for fundamental research and development), and by BMBF in Germany (approximately \$50 million per year for fundamental and applied research).

Large companies in areas such as dispersions, electronics, multimedia, and bioengineering contribute to research to a larger extent in Japan and the United States than in Europe. While multinational companies are pursuing nanotechnology research activities in almost all developed countries, the presence of an active group of small and medium-size companies introducing new processes to the market is limited to the United States.

In the United States, individual and small-group researchers as well as industrial and national laboratories for specialized topics have established a strong position in synthesis and assembly of nanoscale building blocks and catalysts, and in polymeric and biological approaches to nanostructured materials. The Japanese large-group research institutes, and more recently academic laboratories, have made particular advances in nanodevices and nano-instrumentation. The European “mosaic” provides a diverse combination of university research, networks, and national laboratories with special performance in dispersion and coatings, nanobiotechnology, and nanoprobes. With a relatively lower base in characterization and computing infrastructure, the research focus in Russia is on physico-chemistry phenomena, advanced processing, and continuum modeling. Interest and economic support, particularly for device-related research, is growing in China, Australia, India, Taiwan, Korea, and Singapore.

TABLE 8.2. Government Expenditures on Nanotechnology Research in 1997,
Based on the WTEC Site Interviews

Geographical Area	Annual Budget, NTR* (\$ million)	Relative Annual Budget NTR/GDP* (ppm)
Japan	120	27
United States	116	15
Western Europe	128	18
Other countries (FSU, China, Canada, Australia, Korea, Taiwan, Singapore)	70	-
Total	432	-

* NTR – nanotechnology research; GDP – Gross Domestic Product

The pace of revolutionary discoveries that we are witnessing now in nanotechnology is expected to accelerate in the next decade worldwide. This will have a profound impact on existing and emerging technologies in almost all industry sectors, in conservation of materials and energy, in biomedicine, and in environmental sustainability.

REFERENCES

- ASTC (Australian Science and Technology Council). 1993. Small-things-big returns: The role of nanotechnology in Australia's future. *ASTC Report No. 26* (May).
- ATIP (Asian Technology Information Program). 1998. *Nanotechnology in Korea*. Report ATIP98.027.
- Bachmann, G. 1996. *Nanotechnology* (in German). Dusseldorf, Germany: Society of German Engineers (VDI) Technology Center.
- Bai, Chunli. 1996. Science and technology in China. In *Proc. Nanotechnology Forum*, München, Germany, Oct.
- Berkowitz, A.E., et al. 1992. *Phys. Rev. Lett.* 68:3745.
- Chem. Eng. News*. 1997. Science in Russia. *Chem. Eng. News* 75(7 April):45-47.
- European Commission. 1997. Fifth framework programme (1998-2002). Proposal EUR 17651, EC, Belgium.
- Fissan, H., and Schoonman, J. 1997. *Vapour-phase synthesis and processing of nanoparticle materials* (NANO). Mid-term report, ESF, Strasbourg, France, Oct.
- Malsh, I. 1997. *The importance of interdisciplinary approaches: The case of nanotechnology*. IPTS Report No. 13, Seville, Spain, April.
- Mendel, J. 1997. Private communication (Dec.).
- NSF. 1997. *Partnership in nanotechnology: Synthesis, processing and utilization of functional nanostructures*. Arlington, Virginia: National Science Foundation.
- Olson, G.B. 1997. Computational design of hierarchically structured materials. *Science* 277:1237-1242.
- POST (Parliamentary Office of Science and Technology, U.K.). 1996. *Making it in miniature – Nanotechnology, UK science and IT*. London: POST.
- Roco, M.C. 1998. Perspective on nanoparticle manufacturing research. In *Proc. NATO-ASI on nanostructured materials*. Amsterdam: Kluwer, pp. 71-92.
- Rohrer, H. 1997. *Nanotechnology—the Nature way*. Arlington, VA: NSF.
- Sheka, E.F. N.d. Some aspects of nanoparticle technology in Russia. In *Russian R&D on nanoparticles and nanostructured materials*, ed. Siegel et al.
- Siegel, R.W., E. Hu, and M.C. Roco. 1998. *R&D status and trends in nanoparticles, nanostructured materials, and nanodevices in the United States*. (Proceedings of the WTEC workshop 8-9 May 1997, Arlington, VA.) Baltimore: Loyola College, International Technology Research Institute (ITRI). NTIS #PB98-117914.
- Siegel, R.W., E. Hu, G.M Holdridge, I.A. Ovid'ko, and M.C. Roco, eds. N.d. *Russian research and development on nanoparticles and nanostructured materials* (Proceedings of the WTEC Workshop, 21 August 1997, St. Petersburg, Russia). To be published by Loyola College, ITRI, Baltimore, MD.
- Sienko, T. 1998. Present status of Japanese nanotechnology efforts. In *Proc., Fifth foresight conference on molecular nanotechnology*, Palo Alto, CA: Foresight Institute.

- ten Wolte, A. 1997. Nanotechnology think tank in the Netherlands. In *Proc., Fifth Foresight Conf.*
- UNIDO (United Nations Industrial Development Organization). 1997. Special issue on nanotechnology. In *New and advanced materials*, Emerging Technologies Series. Vienna, Austria: UNIDO.
- Uyeda, R. 1991. Studies of ultrafine particles in Japan. In *Progress in Materials Science* 35:1-73. Pergamon Press.
- Williams, S. 1998. Private communication.

APPENDICES

Appendix A. Biographies of Panelists and Other Team Members

PANELISTS

Dr. Richard W. Siegel (Panel Chair)

Robert W. Hunt Professor and Head, Materials Science and Engineering Dept.
Rensselaer Polytechnic Institute

Dr. Siegel holds an AB degree (Physics) from Williams College and MS (Physics) and PhD (Metallurgy) degrees from the University of Illinois in Urbana. He is the past Chairman of the International Committee on Nanostructured Materials and earlier served on the U.S. National Materials Advisory Board Committee on Materials with Submicron-Sized Microstructures and was the co-chairman of the Study Panel on Clusters and Cluster-Assembled Materials for the U.S. Department of Energy. He was on the faculty of the State University of New York at Stony Brook from 1966 to 1976 and at Argonne National Laboratory from 1974 to 1995.

He has authored more than 180 publications in the areas of defects in metals; diffusion; and nanophase metal, ceramic, and composite materials. In addition, he has presented more than 300 invited lectures around the world and has edited 9 books on these subjects. He was listed by *Science Watch* as the fourth most highly cited author in materials science during 1990-1994. Dr. Siegel is an associate editor of *Materials Letters* and a founding principal editor of *Nanostructured Materials*. He is a founder and director of Nanophase Technologies Corporation, and was recognized for this effort by a 1991 U.S. Federal Laboratory Consortium Award for Excellence in Technology Transfer. He is an honorary member of the Materials Research Societies of India and Japan, a 1994 recipient of an Alexander von Humboldt Foundation Senior Research Award in Germany, and he presented the 1996 MacDonald Lecture in Canada.

Dr. Evelyn Hu (Panel Co-chair)

Professor of Electrical and Computer Engineering and Director, Center for Quantized Electronic Structures
University of California Santa Barbara

Dr. Hu's research focus as Director of QUEST, the NSF-funded Science and Technology Center focusing on Quantized Electronic Structures, is high-resolution, low-damage fabrication of electronic and optoelectronic devices. She is also the Director of the University's node of the NSF-sponsored National Nanofabrication Users Network. Prior to joining UCSB, Dr. Hu was a member of technical staff and subsequently a supervisor in the Department of VLSI Patterning Processes at AT&T Bell Laboratories.

She received her BA in Physics (summa cum laude) from Barnard College and her MA and PhD in Physics from Columbia University. She currently serves on the Defense Advanced Research Projects Agency Defense Research Science Council. She is a Fellow of the IEEE, a Fellow of the American Physical Society (APS), and holds an honorary doctorate of engineering from the University of Glasgow.

Dr. Donald M. Cox

Exxon Research and Engineering Company

Dr. Cox is a physicist in the Corporate Research Laboratories of Exxon Research and Engineering Company. He received a BA in Physics and Mathematics from Indiana State College and his PhD degree in Atomic and Molecular Physics from the Joint Institute for Laboratory Astrophysics (JILA) at the University of Colorado. After postdoctoral research at New York University where he studied properties of thermal equilibrium alkali plasmas, he joined Exxon Research and Engineering Company in 1973.

At Exxon, Dr. Cox's research interests have encompassed a variety of areas, including laser isotope separation of molecules using infrared multiphoton excitation and dissociation; optoacoustic spectroscopy; studies of the electronic, magnetic, and chemical properties of size-selected transition metal clusters both in the gas phase and deposited on substrates; investigations probing the properties and uses of carbon clusters, fullerenes and carbon nanotubes; and most recently, studies of microporous materials useful in gas separations via membranes and sorption. He is a member of the APS and ACS and has two patents and over 100 publications.

Dr. Herb Goronkin

Director, Physical Research Laboratory
Phoenix Corporate Research Laboratories, Motorola Corp.

Dr. Goronkin received his BA, MA, and PhD in Physics from Temple University and began work on high-speed devices and compound semiconductor materials in 1963. He joined Motorola in 1977 to start the GaAs electronics program. This program developed Motorola's early versions of MESFETs, MMICs, and HFETs for low-power, low-noise applications, and the high-efficiency 3-volt power HFET for wireless applications. The Physical Research Lab is engaged in quantum devices for future ULSICs, giant magnetoresistance for nonvolatile memory, molecular self-assembly for future electronic and bioelectronic applications, and data mining using neural networks. The lab is the only non-Japanese organization working on MITI's 10-year program on quantum functional devices.

Dr. Goronkin is a fellow of the IEEE and member of the American Physical Society and Sigma Xi. He has served on many conference committees and organizations and given several conference short courses on III-V device physics. He has over 40 patents and numerous publications. Motorola presented him with the Distinguished Innovator Award (1992) and the Master Innovator Award (1995), and he is a member of Motorola's Science Advisory Board Associates. Also, the Phoenix Section of the IEEE selected him as Senior Engineer of the Year (1993). He is currently director of the Physical Research Lab in the Phoenix Corporate Research Laboratories and a Motorola Dan Noble Fellow.

Dr. Lynn Jelinski

At time of this study: Professor of Engineering and Director, Center for
Advanced Technology and Office of Economic Development,
Biotechnology Program, Cornell University
Presently: Vice Chancellor for Research and Graduate Studies, Louisiana
State University

Dr. Jelinski's research involves the use of magnetic resonance for studies of biomaterials, including spider silk. Prior to joining Cornell in 1991 and Louisiana State University in 1998, she was head of the Biophysics and Polymer Chemistry Departments at AT&T Bell Laboratories.

She graduated from Duke University (BS) and the University of Hawaii (PhD), both in chemistry. She is on a number of editorial boards and has served nationally in various capacities, including as a member of the Galvin Commission on the Future of the Department of Energy Laboratories. She currently serves on numerous panels and advisory boards, including the

Massachusetts Institute of Technology's Department of Nuclear Engineering and the National Science Foundation's Mathematics and Physical Sciences Division. She has published over 100 papers on her research.

Dr. Carl C. Koch

Professor, Associate Department Head, and Director of Graduate Programs
Materials Science and Engineering Department, North Carolina State Univ.

Dr. Koch's present research interests include non-equilibrium processing, metastable materials, and intermetallic compounds. Current projects are studies of ductility of nanocrystalline materials and metastable structures in polymer alloys.

Dr. Koch received his PhD in metallurgy from Case Western Reserve University (1964) and was an NSF postdoctoral fellow at Birmingham University, England (1964-65). In 1965 he joined Oak Ridge National Laboratory, where he became a group leader in 1970. In 1983 he was appointed professor at North Carolina State University. He is a fellow of the APS, ASM International, and AAAS. He is a member of TMS and MRS. He has received a Department of Energy Metallurgy and Ceramics Award. He was cited in Science Watch (October 1995) for the third highest number of citations per paper in the world for high impact papers in materials science for 1990-1994. Cofounder of three U.S. patents, he has coedited four books and authored or coauthored over 170 papers. He is editor of *Material Science and Engineering A* and associate editor of *Nanostructured Materials*.

Mr. John Mendel

Senior Unit Director, Dispersion Technology
Emulsion Process Division, Eastman Kodak Co.

Mr. Mendel's unit is a particle technology center involved with process research and development, scale-up, technology transfer, and manufacturing support. The unit's scientists and engineers address issues in particle size reduction, dispersion stabilization, process scale-up, process verification, and characterization, as well as resolving day-to-day manufacturing issues. This work involves interaction with Kodak plants worldwide on a variety of nanoparticle systems, including organic dyes and pigments, and important inorganic materials.

Mr. Mendel received his BS degree in Physical Chemistry from the University of Washington in Seattle and his MS degree also in Physical Chemistry from Boston College prior to entering industry at Hercules Development Center. For three years he worked on pigmented polymer systems before joining Kodak in Rochester, New York. He has been with

Kodak for 26 years. For the past nine years he has been the Unit Director for the Dispersion Technology Unit in Kodak's Emulsion Process Division.

Dr. David T. Shaw

Professor, Electrical and Computer Engineering
Executive Director, New York State Institute of Superconductivity
Director, Integrated Nanostructure Characterization Laboratory, State
University of New York, Buffalo

As founding president of the American Association for Aerosol Research (AAAR), Dr. Shaw has been actively involved with the development of nanoparticle technology. Together with Benjamin Liu and David Ensor, he was one of the founding editors-in-chief for the journal *Aerosol Science and Technology*, which is one of the major journals covering the generation, characterization, and applications of nanoparticles. He has published more than 230 journal papers and is the editor of seven monographs on aerosol science and technology. He has lectured extensively in Japan, Europe, and China and is well known for his work on the role of nanoparticles in the fundamental and the applied aspects of superconductivity, and for his work on magnetic and supermagnetic nanoparticles.

Dr. Shaw was a member of the US/USSR and US/OECD delegations on submicron particles, and led the U.S. delegation in a jointly sponsored effort to promote cooperation in the field of superconductivity between the United States and Japan. He is the recipient of the Association Award (1985) and the International Research Fellow Award (1994) from AAAR. Prof. Shaw received a bachelor's degree in Mechanical Engineering from the National Taiwan University and his MS and PhD degrees from Purdue University.

NSF COORDINATOR

Dr. M.C. Roco

Program Director, Directorate for Engineering
National Science Foundation (NSF)

Dr. Roco's area of responsibility at NSF includes chemical and mechanical engineering and the initiatives on functional nanostructures and nanoparticle manufacturing. He was a professor of mechanical engineering at the University of Kentucky (1981-1995) and has been a consultant to industry in the areas of two-phase flow equipment, surface phenomena, computer-aided design, toner-based copy machines, and chemical processing. Dr. Roco was honored as a recipient of the Carl Duisberg

Award in Germany, Gary Leach Award in the United States, special service awards from ASME and AIChE, the ASME Fluids Engineering Award, and as Outstanding Research Professor at the University of Kentucky. He served as associate technical editor for the *Journal of Fluids Engineering* and *Engineering Journal of Flow Visualization* and is currently editor of the *Journal of Nanoparticle Research*. He is credited with 13 inventions, has authored more than 100 archival articles, and has coauthored the books, *Slurry Flow: Theory and Practice* (1991) and *Particulate Two-Phase Flow* (1993). He is a fellow of ASME and is currently chair of the International Multiphase Award Committee (since 1995), chair of the Particle Technology Forum of AIChE (since 1996), and member of the executive committee of the Institute of Multiphase Science and Technology.

OTHER TEAM MEMBERS

Hiroshi Morishita

President, HMI Corporation

Mr. Morishita specializes in ultramicro manipulation technology for microelectromechanical systems. He founded HMI Corporation in 1991 to commercialize his ultramicro manipulator system. He extended his interest and business to the field of archaeological excavating machines and to the new robot manipulator system to help bed-ridden persons. In 1994, he became a consultant to WTEC panel members concerning their study tours in Japan. He graduated from the University of Tokyo (BA, MA in mechanical engineering) and is in the final stages of preparing his doctoral thesis. He was a visiting researcher in the Mechanical Engineering Department (1992 and 1993) and in the Research Center for Advanced Science and Technology (in 1994 and 1995) of the University of Tokyo.

Cecil H. Uyehara

Senior Advisor to WTEC for Japan Operations

President, Uyehara International Associates

Cecil H. Uyehara, president of Uyehara International Associates, is a consultant on U.S.-Japanese relations in the fields of science and technology. He served in the U.S. government for almost 25 years, with the U.S. Air Force (weapons systems planning), the Office of Management and Budget (military assistance), and the Agency for International Development (AID). He has published on Japanese politics, scientific advice and public policy, and Japanese calligraphy. He organized the first U.S. Congressional

hearings on Japanese science and technology, lectures at the U.S. Foreign Service Institute on Japanese science and technology, and has served as a consultant to the *Yomiuri Shimbun* and the Library of Congress on Japanese calligraphy. He received a BA from Keio University and an MA from the University of Minnesota, both in Political Economy. He has received awards and grants from the Ford Foundation, American Philosophical Society, University of Minnesota (Shevlin Fellowship), and the National Institute of Public Affairs.



Figure A.1. Panelists and other team members at the Yaesu Fujiya Hotel in Tokyo, July 1997. From left: David Shaw, John Mendel, Lynn Jelinski, Donald Cox, Carl Koch, Richard Siegel, Herb Goronkin, Mike Roco, Cecil Uyehara, Evelyn Hu, Hiroshi Morishita.

Appendix B. Site Reports—Europe

- Site: **Centre National de la Recherche Scientifique (CNRS)**
3, rue Michel-Ange
75794 Paris cedex 16 France
Tel: (33) 1-4496 40 00; Fax: (33) 1-4496 50 00
<http://www.cnrs.fr/> or <http://www.uiuc.edu/cnrs/>
- Date visited: 17 October 1997
- WTEC: R.W. Siegel (report author), D.M. Cox, H. Goronkin, E. Hu,
C. Koch, J. Mendel, D.T. Shaw
- Hosts: Dr. Catherine Bréchnignac, Director General of CNRS
Fax: (33) 1-4496 4913
E-mail: catherine.brechignac@cnrs-dir.fr
Dr. J.F. Baumard, Director, CNRS Materials Program and
Laboratory of Ceramic Materials and Surface
Treatments, Limoges
Dr. Christian Colliex, Director, CNRS Laboratory Aimé
Cotton, Orsay
Dr. Henri Van Damme, CNRS, Centre de Recherche sur la
Matière Divisée (CRMD), Orléans
Dr. François Gautier, CNRS, Strasbourg
Prof. Jean-Pierre Jolivet, Université Pierre et Marie Curie,
Paris
Dr. Jean-Paul Pouget, CNRS, Department of Physical and
Mathematical Sciences
Dr. Jacques Prost, Director, Institute Curie, Paris
Dr. Albert Masson, CNRS Research Director

BACKGROUND

The panel spent the afternoon of 17 October from 13:30 to 17:00 at the headquarters of the Centre National de la Recherche Scientifique (CNRS) in Paris as guests of the CNRS Director General, Dr. Catherine Bréchnignac. Dr. Bréchnignac had the previous July taken over this important position after

being Director of Physical and Mathematical Sciences at CNRS (the post now held by Dr. Jean-Paul Pouget) and Director of the CNRS Laboratory Aimé Cotton in Orsay. She graciously and generously assembled a group of nine senior leaders in the area of nanostructure science and technology to meet with the WTEC panel. The CNRS programs in the area of nanostructure science and technology are very extensive and range nationwide, from Lille to Marseille and from Rennes to Strasbourg, with the heaviest concentration being in the Paris area.

RESEARCH AND DEVELOPMENT HIGHLIGHTS

According to Dr. Bréchnac, who began with an overview of the CNRS activities, about 300 researchers in 40 physics laboratories and 200 researchers in 20 chemistry laboratories are involved in nanotechnology research with annual funding of about FFr. 18 million, much of which (~ FFr. 12 million) comes from the interdisciplinary Ultimatech Program within the CNRS. An additional FFr. 9 million is spent annually via contracts for nanotechnology research in about 45 laboratories paid on a 50%/50% basis by industry and the CNRS. These latter efforts appear to be particularly effective with regard to eventual technology transfer toward commercialization, in that this research is carried out within industrial surroundings, such as Thomson, St. Gobain, Rhône Poulenc, and Air Liquide. Particularly impressive was the degree of interaction and awareness apparent among the various participants in the French nanotechnology network, something clearly fostered to considerable advantage by the CNRS structure and its excellent management.

The CNRS research program ranges broadly across the full spectrum of nanotechnology. Synthesis of nanostructures using molecular beam, cluster deposition, and lithographic methods is being carried out, as are more classical chemical and electrochemical approaches. In addition, soft chemistry and biosynthesis efforts are underway. A wide range of scientific instrumentation for characterization and manipulation of nanostructures is being employed and/or developed. These include synchrotron radiation, near-field microscopies—scanning tunneling microscopy (STM) and atomic force microscopy (AFM)—and spectroscopies (STM, optical), magnetic and electron microscopy, and atom manipulation. The scientific and technological contexts of the CNRS nanotechnology research range over such diverse topics as nanomagnetism, molecular electronics, nanotubes, large-gap semiconductors, oxide layers, self-organization, catalysis, nanofilters, molecular sieves (zeolites), hybrid materials, therapy problems, and agrochemistry. Utilizing a roundtable format for the remainder of the

discussions, the French participants described the activities in their own spheres of interest.

Research on Nanoparticles and Related Technologies

Dr. J.F. Baumard, Director of the Materials Program at CNRS and the Laboratory of Ceramic Materials and Surface Treatments (ENSCI) in Limoges, described the activities associated with the Department of Chemical Sciences at CNRS. The main research issues, under investigation at numerous university and industrial laboratories around France, are concerned with nanoparticles and related technologies:

- nanomaterials—a number of interfacial problem areas:
 - solid-gas interfaces and their relationship to adsorption and catalysis applications
 - solid-liquid interfaces in relation to dispersions, (soft) nanochemistry, and membranes
 - solid-solid interfaces and interphases in nanocomposites, more conventional composites, and hybrid materials
- nanosystems for molecular electronics and handling of species at the nanoscale level
- ceramic matrix nanocomposites containing intergranular metal nanoparticles and/or high-aspect-ratio carbon nanotubes
- interdisciplinary research:
 - in the area of adsorption and catalysis, 7 different laboratories are synthesizing oxyfluoride compounds with nanoporous architecture
 - in the area of dispersions, about 25 laboratories are investigating (soft) nanochemistry, membranes, and colloidal mixed systems
 - about 10 laboratories are researching Si-based (Si/C/N) nanophase ceramic powders in nanocomposites, composites, and hybrid materials

Research on Carbon and Other Nanotubes

Dr. Christian Colliex, the new Director of the CNRS Laboratory Aimé Cotton in Orsay, described the major types of research under development in France on carbon and other (e.g., BCN) nanotubes. The synthesis, elaboration, purification, and integration of nanotubes are being carried out by various methods at a number of locations:

- arc-discharge at Montpellier and Peleiseau
- solar furnace at Odeillo
- laser ablation at Chatillon

- catalytic routes at Orléans and Grenoble
- microscopic and macroscopic characterization performed by means of electron microscopy (high-resolution imaging, analysis, and electron energy loss spectroscopy—EELS) at Chatillon and Orsay
- near-field microscopy (STM and AFM) at Toulouse
- Micro-superconducting quantum interference device work (microSQUIDs) at Grenoble
- Raman spectroscopy at Nantes and Bordeaux
- Nuclear magnetic resonance (NMR) at Montpellier
- measurements of physical properties of nanotubes are also being made:
 - of mechanical properties at Chatillon
 - of conductivity, transport, and magnetism at Saclay, Orsay, and Grenoble

In addition, a variety of nanotube applications are being investigated in the areas of nanoelectronics, nanocomposites, and storage media. Also, significant CNRS network research programs (so-called GdR or Groupements de Recherche) are underway or planned. One on fullerene research (1992-1996) ended recently, and another on single- and multi-walled nanotubular structures has been proposed at about FFr. 1.5 million. Both are led by P. Bernier at Montpellier, who is also the coordinator of a European effort on nanotubes for microstructure technology (NAMITECH) that includes laboratories from Montpellier, Stuttgart, Valladolid, Namur, Nantes, Orléans, and Dublin and is funded at about FFr. 1.5 to 2 million. In all these French efforts, research ideas come from scientists in laboratories—they “bubble up from the bottom.”

A new NEDO (Japan) effort on production, characterization and properties of novel nanotubular materials, coordinated by Sumio Iijima (formerly with NEC-Tsukuba and now at Nagoya University), includes efforts at NEC-Tsukuba, Tokyo, MIT, Rehovoth, and Orsay.

Research on the Rheology and Mechanics of Nanoparticle Arrays

Dr. Henri Van Damme (CRMD-Orléans) discussed ongoing, broad-based French activities in the fundamental rheology and mechanics of ordered and disordered arrays of nanoparticles with controlled interactions. Various dispersed nanoparticle systems are being investigated:

- sol-gel soft glass and colloidal crystals for optical applications
- complex fluids such as ferrofluids and “smart” gels
- mechanical reinforcement of rubber, plastics, and concrete

- porous aggregates of nanoparticles as aerogels to make glass or for damping (localized modes) or for their plasticity in part-forming applications
- “aggregate engineering” with nanoparticles, in which the physics and chemistry of the aggregates is very important, and especially their fractal nature in many mechanical applications
- consolidated nanomaterials, such as ceramics, metals, and cements, for their increased hardness (metals), wear resistance, and ductility (ceramics and cements)

An exciting effort by a 6-laboratory network, with some additional funding by industry, investigating the possibility of making ductile cement (“nanoconcrete”), which could have a strong future impact in this field, was also described.

Research on Magnetic Nanostructures

Dr. François Gautier (Strasbourg) described the extensive work on magnetic nanostructures, including those for magnetic recording and sensors, being carried out in France through a wide-ranging CNRS network and EU-level interactions as well:

- synthesis of various new nanostructures and nanosystems consisting of superlattices, nanowires, quantum dots, and nanoparticles, including work with filled nanotubes and also with the “atomic sawing” of multilayers by dislocation shear to form multilevel nanostructures with various architectures
- investigation of a number of related physical properties and their applications, including giant and colossal magnetoresistance (GMR, CMR), tunneling and magneto-Coulomb effects, magneto-optics, and rapid spin-flip femtomagnetism
- study of fundamental magnetization processes such as nucleation, magnetization reversal, and hysteresis
- work on new experimental methods and instrumentation such as microSQUIDs and nanocalorimetry

Most of the GMR work is being done in a joint laboratory at Thomson CSF (Orsay) led by Prof. Albert Fert, the pioneer of GMR, and jointly funded by CNRS, Thomson, and l’Université d’Orsay. Such laboratories are a special and apparently very effective feature of the CNRS national research program.

Research on Chemical Synthesis of Nanomaterials

Prof. Jean-Pierre Jolivet (Université Pierre et Marie Curie, Paris) described the work on the chemical synthesis of nanomaterials being carried out in the area of chemistry of condensed matter at the University under Prof. Jacques Livage, Director. This research is jointly supported by the CNRS and various industries, such as St. Gobain and Rhône Poulenc. The main topics of this work are

- nanostructured organic-inorganic hybrids
- oxide nanoparticles
- nanocomposites
- bioencapsulation

Wide-ranging application fields include dispersions and coatings, high surface area materials, modification of bulk properties (mechanical, optical, electrical, and magnetic), and immunology. For example, hybrid networks of organic and inorganic materials interpenetrated at the nanometer scale (e.g., a Zr metal network and a polymerized organic network former) could be synthesized using a sol-gel route from heterofunctional molecular precursors and engineered to yield improved mechanical properties of coatings by varying the proportions of the two constituents.

Also discussed were research efforts on the mechanisms involved in the interactions between the precursors and the control of the size and dispersion of various nanostructured entities. The mean particle sizes of nanoparticles of magnetic spinel iron oxides, for example, have been controlled by means of controlling the chemistry of the oxide-solution interface to make composites in polymers or silica glasses; the magnetic behavior of the dispersed state in the nanocomposite is thus controlled.

Research on Self-Organized Soft Nanostructures

Dr. Jacques Prost, Director at the Institut Curie (IC) in Paris, described work in progress at the IC on a variety of self-organized soft nanostructures, including lyotropic liquid crystals (softeners, detergents), block copolymers (polymer alloys), stealth vesicles (for drug delivery or gene therapy), and Langmuir-Blodgett films with grafted antibiotic surface layers. He went on to discuss a variety of related areas in analytical nanostructures, made by patterning surfaces with filled nanocavities, and in DNA-based bionanotechnology used to form nanoelectronics (wires, single-electron transistors), much of it done in the United States or Germany. He cited strong efforts in France at the IC, École Nationale Supérieure, and Strasbourg on DNA molecule system micromechanics and on molecular motors for motility assays.

Research on Growth of Nanstructure Materials by Direct Cluster Deposition

Finally, Dr. Albert Masson, CNRS Research Director and a close colleague of Drs. Bréchnignac and Colliex at the CNRS and Laboratoire Aimé Cotton, then described extensive and impressive work on the growth of nanostructured materials by means of direct cluster deposition from molecular beams, research done only by the CNRS in France at Orsay and Lyon. A variety of nanomaterials, including metals, semiconductors, and insulators, have been synthesized and studied for a number of their properties. They have been well characterized by several methods, including transmission electron microscopy, Raman and electron spectroscopies, STM, AFM, EELS, and grazing-angle X-rays, along with simulations.

CONCLUSION

The WTEC panel's visit concluded with a general discussion among the participants. It was clear on the scientific side that much more theory, in both the modeling and *ab initio* areas, would be extremely useful to the future development of the nanotechnology field, in France and elsewhere. In terms of the functionality of national research efforts, in nanotechnology and otherwise, there appears to be excellent (and rather unique) networking in France across disciplinary lines and traditional areas, which seems to be largely a result of the highly effective GdR research groups set in motion with money from the CNRS. There is some concern about the effectiveness of transferring science to engineering and then to manufacturing, but the joint CNRS programs with industry can often (but not always) overcome this problem.

Site: **École Polytechnique Fédérale de Lausanne (EPFL)**
Institut de Physique Experimentale (IPE)
Département de Physique
CH-1015 Lausanne-Ecublens, Switzerland
Tel: (41) 21-693 3320; Fax: (41) 21-693 3604
<http://www.ipent.epfl.ch>

Date Visited: 14 October 1997

WTEC: H. Goronkin (report author), M.C. Roco

Hosts: Dr. André Chatelain
E-mail: andre.chatelain@epfl.ch
Dr. Jean-Philippe Ansermet
Dr. Klaus Kern

BACKGROUND

The École Polytechnique Fédérale de Lausanne (EPFL) is one of three federally funded research institutions in Switzerland. The other two are the Paul Scherrer Institute and Eidgenössische Technische Hochschule (ETH) in Zürich. EPFL was founded in 1853 as a technical institute of the University of Lausanne. The Laboratory of Experimental Physics was founded in 1947 and has traditionally explored the boundaries between pure and applied science. Starting with activities in piezoelectric properties of crystals, nuclear magnetic resonance, and surface and thin films, EPFL turned its attention to nanoclusters in the 1970s. Today, the main focus is on nanoscale physics of clusters, surfaces, and nanoscaled materials.

RESEARCH AND DEVELOPMENT HIGHLIGHTS

André Chatelain has been involved in cluster physics research for 30 years. He asks the questions, “How many atoms are needed for such bulk-like properties as melting, magnetism, conductivity?” “How many atoms are required for the Curie Temperature to be exhibited?” Clusters are size-selected from a molecular beam and characterized with a Stern-Gerlach magnet, after which the deflection is measured and the clusters are accelerated through a column in which time of flight measurements are made. Connections between cluster and bulk properties such as hysteresis and coercivity have not yet been made.

Chatelain's group has developed techniques for fabricating carbon nanotubes in higher concentrations than previous methods. By fixing a single nanotube to a scanning tunneling microscope (STM) tip, currents as high as 1 mA have been obtained from the tube tip. Typical currents are in the 10 pA to 1 nA range. Using a phosphor screen, fluctuations in the spot position have been related to fluctuations in electron density over the surface of the nanotube tip. It is not known whether this arises from thermally induced structural alteration of the tip or changes in electron density due to local charging.

Klaus Kern has a large group working on self-organized growth of nanostructure arrays. The novelty of his approach lies in his use of periodic dislocation arrays that serve to isolate nucleating adatoms. This has been demonstrated using a Pt(111) substrate precovered with 1.5 monolayer of silver that forms a pseudomorphic layer, and a second Ag layer that forms a trigonal dislocation network. Subsequent Ag adatoms are repelled by the dislocations and form into a network of regularly spaced individual islands. Deposition is performed below 110 K. Kern states that these experiments open a new method to create almost monodispersed, regularly spaced, superlattice nanostructures using the natural properties of crystals.

Jean-Philippe Ansermet uses polycarbonate membranes with $6 \times 10^8/\text{cm}^2$ pores with gold sputtered on the back side as a template for magnetic nanowires. Magnetic material is plated into the pores, which are 20-200 nm in diameter and about 6 μm high. Ni or Co is plated in order to study anisotropic magnetoresistance (AMR), and layered materials are used for giant magnetoresistance (GMR) structures. A structure consisting of 300 ten-nanometer layers of Cu and Co gave a 40% GMR ratio at room temperature. One of the difficulties of this approach is making contact to individual wires. Ansermet masks the top of the membrane and introduces gold into the plating solution. Plating is halted when contact is made to one wire, or perhaps, a few wires.

Ansermet is considering how AMR is related to GMR. His approach uses the curling spin wall to separate domains in the wire. He explains that the curl avoids surface charge along the wire. He claims that if the spin flip length (~ 50 nm in Co/Cu) is less than the length of a domain, the system is an appropriate analog-to-GMR structure. His prototype experiments show that the AMR ratio is enhanced by using the curl domain wall.

Site: **Eidgenössische Technische Hochschule (ETH)
Solid State Physics Laboratory
ETH Hönggerberg HPF E3
CH-8093 Zürich, Switzerland
<http://www.phys.ethz.ch/solid>**

Date Visited: 15 October 1997

WTEC: E. Hu (report author), H. Goronkin, M.C. Roco, D.T. Shaw

Hosts: Prof. Dr. Klaus Ensslin (principal contact)
Tel: (41) 1-633 2209; Fax: (41) 1-633 1146
Dr. Hans von Känel

BACKGROUND

Eidgenössische Technische Hochschule Zürich (ETHZ), the Swiss Federal Institute of Technology in Zurich, was founded by the Swiss government in 1854 as a polytechnic university. Until 1969, it was the only national university in Switzerland; today, it is part of an ETH domain comprising ETHZ, EPFL (École Polytechnique Fédérale de Lausanne, the polytechnic institute at Lausanne) and four national research institutes. The ETH itself comprises about 12,000 registered students, 330 professorships, and 700 lecturers. Each year, about 1,250 students receive an ETH diploma and another 450 students complete a doctoral thesis.

RESEARCH AND DEVELOPMENT HIGHLIGHTS

ETHZ is carrying out a broad spectrum of nanoscience research, spanning synthesis, processing, and characterization, ranging from fullerenes to ferroelectric to magnetic materials and encompassing electronic devices and nanorobots (*Nanowissenschaften* 1996). The funding sources seem largely to emanate from the Swiss National Science Foundation, often under the auspices of a *National Research Program* (such as NFP 36) or a *Swiss Priority Program*; funding is also provided by industrial sources such as IBM Rüschlikon or Ciba-Geigy.

Specific Project Highlights

Professor Dr. Ensslin, Professor of Physics at ETHZ, is also formally head of the Paul Scherrer Institute Laboratory for Micro- and Nanostructures; a position specifically designed to enhance close collaborations between the two institutions. A long-time contributor to the study of functional nanostructures, Professor Dr. Ensslin described some current projects undertaken in his laboratory at ETHZ:

- Use of an atomic force microscope (AFM) to locally oxidize a structure, forming a “quantum point contact” directly, without need for electron-beam lithography or extensive alignment procedures. Professor Dr. Ensslin noted the ease of use of commercially available AFMs and their ready adaptability to lithography and materials modification at the nanoscale (Held et al. 1997).
- Establishment of low temperature (1 K), high magnetic field (10 tesla) capabilities to carry out scanning tunneling microscope (STM) spectroscopy of semiconductor nanostructures in the quantum hall regime.
- Wave function spectroscopy in specially tailored quantum wells grown at the University of California in Santa Barbara.

The WTEC team also visited the laboratory of Dr. Hans von Känel, who has developed an ultrahigh vacuum system for in situ growth and processing of Si, Si/Ge materials that allow monitoring of the growth process; low-temperature, controlled materials modification; and STM analysis. The system is also used for characterization of nanomechanical properties through the ability to prepare and “load” (sputter-deposit materials) cantilever probes in situ.

REFERENCES

Nanowissenschaften an der ETH Zürich. 18 May 1996.

Held, R., T. Heinzel, P. Studerus, K. Ensslin, and M. Holland. 1997. Fabrication of a semiconductor quantum point contact by lithography with an atomic force microscope. *Applied Physics Letters* Nov.

Site: **IBM Zürich Research Laboratory**
Säumerstrasse 4
CH-8803 Rüschlikon, Switzerland
Tel: (41) 1-724 8111; Fax: (41) 1- 724 8964
<http://www.zurich.ibm.com>

Date Visited: 13 October 1997

WTEC: H. Goronkin (report author), M.C. Roco

Hosts: Dr. Hans Biebuyck, principal contact
Fax: (41) 1-724 0809
Dr. Heinrich Rohrer, Science and Technology Department
Wanda Andreoni
R. Allenspach
James Gimzewski
Peter Vettiger

BACKGROUND

The IBM laboratory in Rüschlikon employs approximately 200 people. The WTEC team visited the Science and Technology Department, formerly called the Physics Department. This department has about 50 people, of whom approximately 40 are scientists (including pre- and post-docs). In recent years, the lab's scope has evolved beyond mostly basic research to a problem-oriented mission in support of existing and alternative exploratory technologies that are on IBM's radar screen.

Heinrich Rohrer provided an introduction to the Science and Technology Department, pointing out the need for new ideas to move beyond the limits of present day technologies and devices.

The laboratories the WTEC team visited are well equipped and of a size normally found in universities. Many of the experimental apparatuses are set up by highly skilled technicians who also take an active part in the operation of the equipment for experimental purposes. Although the mission of the group is technology-driven, it is clear that science remains a key component and that the staff strives for understanding of the experimental results at the most basic level.

Collaborations with universities are numerous. The center leverages productivity considerably while fulfilling an educational purpose and creating a network of relationships of great value to all concerned. Some of

these collaborations are supported by European (ESPRIT) and Swiss national programs.

Scanning probe technology was born in the IBM labs, and it has opened numerous areas for research in Switzerland. Scanning probes are used for atomic and molecular manipulation as well as characterization. Since the technique is relatively inexpensive, it is ubiquitous and drives many of the country's research projects.

RESEARCH AND DEVELOPMENT HIGHLIGHTS

Peter Vettiger described the IBM Zürich approach to mass storage using silicon microcantilevers with tips to record bits in a polymer medium (e.g., PMMA). Writing is achieved thermomechanically by heating the tip and creating an indentation in the softened polymer. Erasing is done in blocks rather than in individual bits by heating entire storage subfields.

Vettiger demonstrated a 5 x 5 array of individually accessible tips. In this case, the tips were fabricated using anisotropically etched silicon so that the 5 x 5 array used a 5 x 5 mm area (KOH etching provides sidewalls with a 54° slope). In order to increase the density of tips, a new etching process was developed that provides vertical sidewalls so that a 32 x 32 array can fit into a 1 x 1 mm area. Parallel operation of 1000 cantilever/tips is envisaged with x-y addressing achieved through multiplexing. Bits of 20-40 nm in size have been demonstrated. This extrapolates to more than 60 Gbit/in² of data.

The array was demonstrated to image a test surface. In this demonstration, each tip provided an independent image.

James Gimzewski described the well-known buckyball abacus in which an STM tip is used to move C₆₀ molecules along well-defined linear paths. He pointed out that the buckyball molecule can also be used as an amplifier when it is compressed by a scanning probe tip. He is generally working on concepts for manipulating and assembling molecules with the STM to implement useful functions.

R. Allenspach described the center's magnetism activities. This work focuses on the study of ultrathin magnetic films and multilayers with Cu/Co as a model system and has a direct impact on the understanding of magnetic properties such as giant magnetoresistance (GMR), exchange coupling, and surface anisotropy. It has led to the discovery of anisotropy oscillations due to quantum confinement in a Cu overlayer on a Co film. This work also includes detailed studies of film growth and morphology and how these correlate with magnetic properties.

Hans Biebuyck is a former student of George Whitesides at Harvard University, who is well known for microcontact printing using elastomeric

stamps to transfer a pattern of self-assembling molecular layers to a substrate. The project he described encompasses both the science and pretechnology assessments of various high-resolution contact processing techniques like microcontact printing and microfluidic networks. The group has demonstrated the use of microfluidic networks for delivery of functionally distinct biomolecules onto targeted regions of a substrate and their application in localized biological assays. Stamps of very high quality and stability have been developed, and critical dimensions smaller than 50 nm have been achieved with microcontact printing.

Wanda Andreoni described the activities in computational materials science and the application of *ab initio* (Car-Parrinello) molecular dynamics techniques to various problems in science and technology, e.g., fullerenes, carbon nanotubes, and organic light-emitting structures for displays, catalysis, and chemical reactions. Some of this work is in direct support of ongoing local projects.

Site: **Interuniversity Microelectronics Center (IMEC)**
Kapeldreef 75
B-3001 Leuven, Belgium
Tel: (32) 16-281211; Fax (32) 16-229400
<http://www.imec.be/>

Date Visited: 16 October 1997

WTEC: E. Hu (report author)

Hosts: Dr. Marc Van Rossum, Head VLSI Materials and
Technologies, Advanced Semiconductor Processing Div.
Dr. John Randall, TI on assignment to IMEC
Dr. Wijn Magnus, PHANTOMS coordinator
Dr. Chris Van Hoof, Senior Researcher, Materials and
Packaging Division
Dr. Jan Genoe, software specialist – 8-band solver
Dr. Jo deBoeck, Senior Researcher, Novel Materials and
Components Group

BACKGROUND

IMEC (Interuniversity Microelectronics Center) was begun in 1984 by the Flanders government to strengthen the potential of Flemish universities and to strengthen the infrastructure in microelectronics. The general mission of IMEC is to strengthen local industry, set up new industry, and attract new industry by carrying out advanced, focused research. Initially, the lead-time on industrial technology was estimated to be five to ten years; actual operation has led to carrying out projects in the nearer-term future (3-10 years, or even under 3 years). The initial investment was ~ \$80 million and 150 people. Currently, IMEC has >700 people, 100 of whom are nonpayroll (industrial participants, students with grants), and a >\$80 million budget, of which ~ 50% derives from the government, and 50% is contract research.

RESEARCH AND DEVELOPMENT HIGHLIGHTS

The WTEC team's host at IMEC was Dr. Marc Van Rossum, the Head of VLSI Materials and Technologies in the Advanced Semiconductor Processing Division. He spoke of three main areas of research being carried

out: (1) VLSI system design methodology; (2) materials and packaging; and (3) advanced semiconductor processing.

The advanced semiconductor processing area actually has 50% of the budget and less than 50% of the personnel. One-third of the capital expenditure in this area is associated with costs of running the pilot line. Currently, this area develops new process modules compatible with 0.25 μm and 0.18 μm lithographic design rules, as well as carrying out research in 0.1 μm . Assessments of the programs are carried out in five-year intervals; among the measures of success are the number of spin-off companies generated (an average of one per year) and the number of contracts generated with local industry.

Discussions with Dr. Chris Van Hoof, Senior Researcher in the Materials and Packaging Division, and Dr. Jan Genoe involved the following topics:

- InAsSb photovoltaic detectors operating in the 3-5 μm range, at 140 K (an improvement over InAs detectors) with CMOS camera readouts
- InGaAs (28% In) light-emitting detectors sensitive to 3.3 μm wavelength, with 10^{-4} efficiency, at >1 GB modulation rates

Dr. deBoeck is carrying out work on nanomagnetism and is the coordinator of an ESPRIT Program called SPIDER, on spin-dependent nanoelectronics, which looks at the possibility of combining semiconductor devices and ferromagnetic nanostructures. One approach in this regard is the formation of nanoscale MnAs ferromagnetic clusters in GaAs through the low-temperature MBE growth of MnGaAs (230°C - 280°C) and subsequent annealing at temperatures ranging from 625°C–730°C. Depending on the starting material composition and the annealing conditions, metallic clusters of 3 to 30 nm are formed, with saturation magnetization values that first increase and then decrease with annealing temperature. Photoluminescence studies of the predominantly GaAs surrounding matrix evidences good optical quality.

Discussions with Drs. van Rossum and Magnus centered on IMEC activities in new submicron electronic technologies, as well as on European-wide microelectronic and nanoelectronic programs. Dr. Wijn Magnus is the overall coordinator of the PHANTOMS (Physics and Technology of Mesoscale Systems) program, a network of institutions now including sites in Russia and Eastern Europe as well as in Western Europe. The strategic research domains comprising PHANTOMS are (1) quantum electronics, (2) nanometer-scale optoelectronics, (3) nanotechnology, and (4) novel circuit architectures. PHANTOMS meets twice yearly, and is attempting to put together a nanoelectronics roadmap. There has been an arrangement between 7 PHANTOMS institutes and the NRC at Ottawa through ECAMI (European-Canadian Mesoscopic Initiative), which was designed to facilitate short- to midterm visits. The initial program, which ended in 1997, was

successful, and negotiations are now underway to seek an extension of such an arrangement, to involve 14 European labs and 9 Canadian labs. A similar arrangement between PHANTOMS and institutions in the United States would be highly desirable, but it has not yet been possible to negotiate such an arrangement. The National Science Foundation (NSF), for example, usually recognizes bilateral proposals rather than working agreements with networks of institutions.

There was also discussion of the ESPRIT Advanced Research Initiative in Microelectronics (MEL-ARI) that includes projects launched under nanoscale integrated circuits initiative. These projects are to contribute to the research of future electron devices, such as single-electron electronics (transistors/memories based on Si, SiGe, or GaAs), molecular electronic devices, single-flux quantum logic circuits (high T_c superconductor-based) or magnetoelectronic devices. For all projects, nanofabrication is a key issue, and e-beam lithography, scanning probe microscopy, and stamping techniques are to be explored as possible technologies to produce future devices. Three associated projects deal with (1) low-energy coherent electron microguns, (2) nanolithography using chemically amplified resists, and (3) vertical SiGe MOS devices.

ESPRIT is currently operating within its “Fourth Framework” (1994-98). The Fifth Framework of ESPRIT is currently in the definition phase. During the 1st–4th frameworks, about \$13.6 billion European Economic Units (ECUs) were spent, of which 30% was spent on electronics. No figures were available for nanoelectronics specifically, but long-term research was ~10% of the total budget. Table B.1 provides a partial listing of ESPRIT projects in nanoelectronics.

TABLE B.1. ESPRIT Nanoelectronics Projects

Acronym	Project	Coordinator
SIQUIC	SiGe RTDs	D. Paul, Cambridge
FASEM	Single Electron Transistors	H. Launois
	4 x 4 memory based on Hitachi Cambridge device	CNRS, Bagneux
CHARGE	Coulomb Blockade	D. Haviland, KTH
QUEST	STM/AFM lithography	E. Dubois, ISEN, Lille
SPIDER	Spin Valve Nanoelectronics	J. deBoeck, IMEC
RSFQ-HTS	Single Flux Quantum Device	Rogalla, U. of Twente
QUADRANT	Cellular Automata, with University of Notre Dame	M. Macucci, Pisa
LASMEDS	Molecular electronics	P. Morales, ENEA
NANOWIRES	Nanowires	M. Welland, Cambridge

- Site: **Institut für Festkörper und Werkstofforschung (IFW)**
PF 27 00 16
D-01171 Dresden, Germany
Tel: (49) 351-4659 0; Fax: (49) 351-4659 540
<http://www.ifw-dresden.de>
- Date Visited: 14 October 1997
- WTEC: C. Koch (report author), R.W. Siegel
- Hosts: Prof. Dr. Ludwig Schultz, Director, Institute of Metallic Materials, IFW
Prof. Dr. Karl Leo, Institut für Angewandte Photophysik, Dresden University of Technology, D-01062 Dresden, DE
Fax: (49) 351-463 7065; <http://www.tu-dresden.de/>
Prof. Mark Golden, IFW, Spectroscopy Group, Department of Surfaces and Interfaces
Dr. Winfried Brückner, IFW, Institute for Solid State Research, Thin Film Department
Dr. Jürgen Eckert, IFW, Institute of Metallic Materials, Leader, Department of Metastable and Nanostructured Materials
Dr. Karl-Hartmut Müller, IFW, Institute for Metallic Materials, Department of Superconductivity, Magnetism
Dr. V. Neu, IFW, Institute for Metallic Materials, Department of Superconductivity, Magnetism
Dr. Norbert Mattern, IFW, Institute for Solid State Analysis and Structural Research, Department of X-ray Structural Analysis
Dr. Martin Heilmaier, IFW, Institute for Metallic Materials, Department of Strength, Environmental Effects
Dr. Roland Scholl, Fraunhofer Institute, Institute for Applied Materials Research, Department for Powder Metallurgy and Composite Materials, Winterbergstrasse 28, D-01277, Dresden, Germany

BACKGROUND

The Institute of Solid State and Materials Research, IFW Dresden, was founded in 1992. As an institute of the Wissenschaftsgemeinschaft Blaue Liste (WBL) it is funded by the Free State of Saxony and the Federal

Republic of Germany. It has a staff of over 400 employees and is devoted to applications-oriented fundamental research. It is a member of the Materials Research Association, Dresden, and is associated with the Dresden University of Technology and the Fraunhofer Institute. In 1996 the staff consisted of 235 permanent and 180 temporary employees, of which 220 were scientists. The budget for 1996 consisted of about DM 30 million basic financing and about DM 11 million in projects. The scope of the research includes studies of the relationships between fundamental and applications-related characteristics of metallic and nonmetallic functional materials and thin films, investigation of structural properties and failure mechanisms, and studies of processing variables for property optimization. The WTEC team was hosted by Prof. Dr. Ludwig Schultz, who is director of the Institute for Metallic Materials. Research on nanostructures and nanostructure science is carried on in many of the groups in IFW, with about one-third of the groups partly or mostly involved.

RESEARCH AND DEVELOPMENT HIGHLIGHTS

Investigators in several fields of nanostructure science made presentations to the WTEC team, after which we toured the laboratory facilities. Brief descriptions of the presentations are given below, with scientific and/or technical highlights.

Prof. Dr. Karl Leo Institut für Angewandte Photophysik, Technische Universität Dresden

Professor Leo gave a presentation on studies of electronic transport through single molecules in epitaxially grown organic heterostructures. This involves single-electron tunneling effects with single molecules. Common approaches using metal structures of ~ 30 nm size with capacitance of a few 10^{-17} F require temperatures of < 20 K. IFW's approach is to use molecules providing stable and reproducible "bricks" with a typical size of 1-2 nm. Organic molecular beam epitaxy (OMBE) was used to deposit molecules of perylene-tetra-carboxylic-dianhydride (PTCDA) on Au (111), which is on a cleaved mica substrate. PTCDA orients on lines on the Au lattice. Coulomb blockade measurements are made at room temperature with an STM tip. This can only be accomplished on an "ordered" molecular lattice that is locked into the Au lattice so it does not move. An insulating layer of deconethiol is placed between PTCDA and the Au, and the S in the

deconethiol binds to the Au. Preliminary I-V measurements have been made successfully.

Prof. Mark Golden
IFW, Spectroscopy Group, Department of Surfaces and Interfaces

Dr. Golden presented a review of his work on the electronic structure of fullerenes, nanotubes, and metal/fullerene multilayers. Spectroscopic methods are used for these studies and include X-ray absorption spectroscopy (XAS), angle resolved photoelectron spectroscopy (ARPES), X-ray photoelectron spectroscopy (XPS), and electron energy-loss spectroscopy (EELS). The facility for high resolution EELS measurements is a dedicated machine, i.e., not part of a transmission electronic microscope. Among the measurements made are charge states, bonding, plasmon dispersions, optical properties, and core level excitations. Various materials studied include C₆₀/metal multilayers, nanotubes, and doped fullerenes (off-ball doping-intercalation, on-ball doping such as C₅₉N, and in-ball doping-endothedral metallofullerenes such as Tm in C₈₂).

Dr. Winfried Brückner
IFW, Institute for Solid State Research, Thin Film Department

Dr. Brückner described his work on the electrical and mechanical properties of a resistive CuNi(Mn) thin film with a nanocrystalline structure. The CuNi(Mn) films, sandwiched between Ni-Cr films, had columnar grains about 30 nm in dimension, and were twinned. The temperature coefficient of resistivity (TCR) was a function of composition x of the Cu_{1-x}Ni_x films and of the temperature of thermal cycling. The initial negative TCR changed to positive after heating to $\geq 500^\circ\text{C}$. This was explained by the changes in the mechanical stresses in the films, which were influenced by formation of NiO and grain growth at the higher temperatures.

Dr. Jürgen Eckert
IFW, Institute of Metallic Materials, Leader, Department of Metastable and Nanostructured Materials

The four major thrusts of this group are: (1) basic principles of mechanically alloyed nanocrystalline materials, (2) high-strength lightweight

nanostructured alloys, (3) mechanically alloyed superconducting borocarbides, and (4) bulk metallic glasses.

In the first thrust the relationship to nanostructured research is that ball milling is a nonequilibrium processing method for preparation of nanoscale materials. In this regard the formation of nanocrystalline materials is studied by determining grain size as function of milling conditions such as temperature, milling intensity, and alloy composition. In terms of high strength lightweight alloys, Al and Mg alloys with mixed phases of nanocrystalline, amorphous, and/or quasicrystalline nanoscale microstructures are studied. Of special interest are Al-base (> 90 at.% Al) alloys with nanoscale quasicrystalline phases of 20-100 nm diameter surrounded by fcc Al phase of 5-25 nm thickness. The quasicrystalline phase comprises 60-80% volume fraction of the alloys. These alloys combine high strength (1,000 - 1,300 MPa fracture strength) and good ductility (6-25%). The suggested mechanisms for these excellent mechanical properties include the thin fcc Al layer around the quasicrystalline particles, a high density of phason defects and approximant crystalline regions with subnanoscale size, and the spherical morphology of the quasicrystalline particles with random orientations. The research is aimed at a better understanding of the mechanical behavior of these promising materials.

Bulk metallic glasses (e.g., $Mg_{55}Y_{15}Cu_{30}$) are prepared by solidification and mechanical alloying methods. The mechanically alloyed bulk metallic glass powders are consolidated at temperatures above T_g . Again some studies of mixed amorphous and nanocrystalline phases are carried out in these systems. That is, the nanocrystalline precipitates are used to strengthen the amorphous matrix.

Dr. Karl-Hartmut Müller
IFW, Institute for Metallic Materials, Department of
Superconductivity, Magnetism

Dr. Müller described the research program on the hydrogen-assisted preparation of fine-grained rare earth permanent magnets. The technique used is “hydrogenation disproportionation desorption recombination” (HDDR). The final structure is fine-grained, 100-500 nm, rather than nanoscale, but during the disproportionation and desorption steps the structures can be ~ 100 nm in size. An example of HDDR for Nd-Fe-B is as follows: Original cast alloy of $Nd_{16}Fe_{76}B_8$ with Nd-rich and $Nd_2Fe_{14}B$ phases is processed in four steps: (1) hydrogenation forms $NdH_{2.7}$ and $Nd_2Fe_{14}BH_{2.9}$; (2) disproportionation reaction results in a fine mixture of Fe, $NdH_{2.2}$, and Fe_2B ; (3) desorption provides a very fine mixture of Fe, Nd,

Fe_2B + $\text{Nd}_2\text{Fe}_{14}\text{B}$ nuclei; and (4) recombination yields fine grained $\text{Nd}_2\text{Fe}_{14}\text{B}$. Several rare earth permanent magnet alloys are studied at IFW using HDDR, including $\text{Sm}_2\text{Fe}_{17}\text{N}_3$ and $\text{Sm}_2\text{Fe}_{17-x}\text{Ga}_x$.

Dr. V. Neu

IFW, Institute for Metallic Materials, Department of Superconductivity, Magnetism

Dr. Neu described NbFeB magnet powders prepared by mechanical alloying. The goal of this work is to obtain high remanent, isotropic Nb-Fe-B powders for polymer-bonded permanent magnets. Mechanical alloying is used to obtain a nanoscale mixture of $\text{Nd}_2\text{Fe}_{14}\text{B}$ and aFe which provides for remanence enhancement via exchange coupling when the grain sizes are ≤ 30 nm. The mechanical alloying provides an amorphous + nc Fe structure which on annealing forms nc aFe + nc $\text{Nd}_2\text{Fe}_{14}\text{B}$ which behaves as a single magnetic phase. The powders can be bonded with polymers and form isotropic magnets with high remanence. In addition some Fe can be replaced by Co which increases the remanence (as well as the Curie temperature) and has provided $(\text{BH})_{\text{max}}$ values up to about 150 kJ/m^2 .

Dr. Norbert Mattern

IFW, Institute for Solid State Analysis and Structural Research, Department of X-Ray Structural Analysis

Dr. Mattern described work on soft ferromagnetic materials such as the “finemet”-like alloys (FeNiSiBNbCu) and FeZrB alloys. These materials are made by rapid solidification to obtain amorphous alloys, which are then partially recrystallized to give nanoscale (~ 50 nm) αFe particles in the amorphous matrix. Studies have included composition variations to influence nc grain size and studies of the crystallization kinetics. High nucleation rates and slow growth rates are desired and influenced by the alloy dopants. This research is funded by the federal government and by Vacuumschmelze and Siemens.

Dr. Martin Heilmaier

IFW, Institute for Metallic Materials, Department of Strength, Environmental Effects

Dr. Heilmaier described several projects involving dispersion hardening with nanoscale dispersoids. One project has the goal of dispersion strengthening of Ag to be used as casings for the BiSrCaCuO high T_C

superconductor. Mechanical alloying of Ag and Cr₂O₃ powders is followed by cold pressing, annealing in dry hydrogen, hot pressing at 500°C, and finally hot extrusion at 700°C. The mechanical alloying times were apparently too short in the initial study to provide a uniform distribution of the 40 nm Cr₂O₃ particles. A bimodal grain structure was observed with mean sizes of 10 μm and 0.3 μm composed of 60% pure Ag grains and 40% Ag grains with the nc oxide dispersoids. Even so, significant Hall-Petch hardening was observed at room temperature, along with increased creep resistance at 500°C in the dispersion-hardened Ag. Another project focuses on mechanical alloying of LL₂-(Al,Cr)₃ Ti intermetallic with Y₂O₃ nanoscale dispersoids of 5 nm size.

Dr. Roland Scholl
Fraunhofer Institute, Institute for Applied Materials
Research, Department for Powder Metallurgy and
Composite Materials

Dr. Scholl described an in situ data acquisition and monitoring system for a planetary ball mill. This is important for studies of the mechanical alloying/milling processes used for formation of nanocrystalline materials. The device measures the temperature and pressure via a transmitter in the lid of the milling vial. This was done for a Fritsch “pulverisette 5” planetary mill; the work was partially supported by Fritsch. An example was given for milling of Ti and C powders to form TiC. Good time resolution, about 10 ms, is available to monitor the reactions, which can occur during milling and provide feedback to optimize the milling parameters.

After the formal presentations and discussions, the WTEC visitors were given a tour of the IFW laboratories. We observed very impressive state-of-the-art facilities for processing, characterization, and property testing. The dedicated EELS facility referred to in the work of Dr. Golden (above) was particularly noteworthy.

Site: **Institute for New Materials (INM)**
Im Stadtwald - Gebäude 43
D-66123 Saarbrücken, Germany
Tel: (49) 681-9300 312/313; Fax: (49) 681-9300 223
<http://www.inm-gmbh.de/>

Date Visited: 13 October 1997

WTEC: J. Mendel (report author)

Hosts: Prof. Dr. Rudiger Nass (principal contact), Head of
Ceramics Department
Dr. Rolf Clasen, Director, Department of Glass Technology

BACKGROUND

Founded in 1988, the Institute for New Materials (INM) is located within the University of the Saarland. Currently, the Institute has 280 scientists and technologists who develop new materials that industry will need for the future. The institute's purpose is to further the utilization of new high technology materials on a large scale. It is a nonprofit limited liability company with institutional sponsorship.

RESEARCH AND DEVELOPMENT HIGHLIGHTS

At INM, research and development comprises basic research on highly innovative, high risk, long term programs as a basis for new technologies. The goal is to reduce the cycle time of 10-15-year programs (concept to commercialization). Products and processes are developed in close cooperation with industrial partners, who often provide the necessary financing. Since 1990, INM follows the scientific approach of integrating inorganic synthesis with chemical nanotechnology.

In addition to metals, nonmetal inorganic materials, and organic polymers of a singular nature, it is now possible to produce chemical composite materials on the molecular and nanoscale level. Processes such as sol-gel are used, in which liquid starting materials are utilized at low temperatures for nanoscale metal, ceramic, glass, and semiconductor particles. INM cites these high-interest features for preparing new materials as nanoparticles:

- small enough not to scatter light

- quantum effects—intrinsic properties of metal and semiconductor nanoparticles—for tailoring new properties
- large interfaces resulting from dispersion in a matrix so as to add another dimension for property tailoring

Specific Project Highlights

Dr. Rolf Clasen is currently preparing glass powders via the colloidal gel route. The advantages for this process are high purity powders.

Also in this same laboratory the following efforts are taking place:

- forming compacts of submicron silica particles by electrostatic deposition
- sintering behavior of submicron silica particles
- preparation of high purity silica glass tubes by centrifugal casting of colloidal gels

Role of Nanostructure Science within INM

INM is focusing on four basic areas for spin-off and adaptation towards commercialization:

1. New functional surfaces with nanomers: included are properties such as corrosion protection, wettability, coloration, micropatterned surfaces, porosity, or the ability for selective absorption of molecules.
2. New materials for optical applications: properties of lasers and ceramics are combined with those of polymers. Such features as optical filters, transparent conducting layers, materials for optical telecommunications, photochromic layers, and holographic image storage are under investigation.
3. Ceramic technologies: a simple precipitation process such as sol-gel provides for pilot-scale production of agglomerate-free powder.
4. Glass technologies: chemical incorporation of metal colloids with intelligent properties into glasslike structures are clearly possible.

Equipment

INM has available the following characterization tools:

- | | |
|-----------|--|
| 1. HR-TEM | 7. X-Ray Diffractometry |
| 2. HR-SEM | 8. GC/MS |
| 3. EDXS | 9. Laser Lab |
| 4. AFM | 10. Rheology Analyzing System |
| 5. NMR | 11. Mechanical Material Testing Facilities |
| 6. SAXS | 12. Optical Testing Services |

Listed below are services INM performs:

- Consulting
- Project Definition
- Project Formulation
- Contract Assistance
- Patent Search
- Project Implementation
- Technical Development
- Quality & Certification
- Pilot Production
- Troubleshooting

CONCLUDING REMARKS

The emerging new technologies under study at INM will play a dominant role in the 21st Century. Nanomaterials will be incorporated into technical components and systems in most sectors of the technology. They thus become powerful tools in the preparation of specialized materials.

Site: **Max-Planck-Institut für Kohlenforschung**
Kaiser-Wilhelm-Platz 1
D45470 Mülheim an der Ruhr, Germany
Tel: (49) 208-306 1; Fax: (49) 208-306 2980
<http://www.mpi-muelheim.mpg.de/>

Date Visited: 16 October 1997

WTEC: D. Cox (report author)

Host: Dr. John Bradley
Fax: (49) 208 306 2987
E-mail: bradley@mpi-muelheim.mpg.de

BACKGROUND

The Max-Planck-Institut für Kohlenforschung (the Max Planck Institute of Coal Research) in Mülheim was founded in 1912 as one of the first institutes of the former Kaiser-Wilhelm-Gesellschaft as an independent foundation. It is one of more than 70 Max Planck institutes in Germany but has kept its independent legal status under private law and is a recognized nonprofit organization. It is well known for its discoveries of the Fischer-Tropsch process and the Ziegler catalysts. The patents from these discoveries as well as others have generated significant additional income for the institute over the years (particularly notable are the patents of Karl Ziegler, whose first patent for the low-pressure polyethylene synthesis was granted in 1953) and have allowed it to generously fund research efforts of the staff. The expiration of the Ziegler patents has reduced the outside income, and as a result, the funding levels are beginning to come more into line with those of other Max Planck institutes.

This institute has a history of exploiting the inventions made in the institute by retaining ownership of all patents through a trusteeship (the Studiengesellschaft Kohle mbH) which grants licenses producing this additional income. Presently the institute has about 30 nonexpired patents and published patent applications. The Studiengesellschaft Kohle also grants licenses for the usage of software developed within the Max-Planck-Institut für Kohlenforschung; for example, the mass spectrometry software MassLib® was developed at this institute.

As of the time of the WTEC visit, the staff has about 220 permanent employees, about 50 of which are staff scientists. In addition, there are

about 100 graduate students, postdocs, and guest scientists distributed among about 24 research groups focusing in the following areas:

- Organic Synthesis
- Organometallic Chemistry
- Homogeneous Catalysis
- Heterogeneous Catalysis
- Supramolecular Chemistry
- Polymer Chemistry
- Coal Research

The institute has a rich history in the area of chemical catalysis, built in large part on Ziegler's Nobel Prize-winning work in ethylene polymerization. The present research areas at the institute focus on synthesis of novel materials for applications in catalysis, energy storage, and separations. The efforts that are particularly applicable to nanoscale science and technology are those involved in studying highly selective catalysts and in generating microporous inorganic oxide materials and high surface area materials for chemical energy storage. Research in these areas is centered in several of the groups at Mülheim, particularly those of Prof. Dr. M.T. Reetz, Dr. J.S. Bradley, Prof. Dr. W.F. Maier, and Prof. Dr. H. Bogdanovic.

The institute is very well equipped as are the individual research groups with world class capabilities in NMR spectroscopy, X-ray characterization and Modeling, Optical Spectroscopy, Mass Spectrometry, Electron Microscopies, and Chromatography as examples.

RESEARCH AND DEVELOPMENT HIGHLIGHTS

Research in the Group of Prof. H. Bönemann

Prof. Bönemann has developed widely applicable synthetic methods for the preparation of surfactant-stabilized colloidal metal nanoclusters (1-10 nm, mono- and plurimetalllic) based on reduction of metal salts with surfactant-containing reducing agents and the use of surfactant cation salts of metal complex anions. These materials, which have high metal nanocluster content and high solubility (up to 1 mole of metal/liter) in organic solvents or water, have been applied as catalyst precursors both in liquid dispersion and in supported form for a variety of organic reactions, e.g., selective (including enantioselective) hydrogenation and oxidation. Further fields of application are bimetallic fuel cell catalysts, magnetic fluids, nanometal pigments for magneto-optical data storage, and magnetic cell separation in biological samples.

Research in the Group of Prof. Dr. M.T. Reetz

Prof. Reetz, in addition to his research effort, is one of two scientific directors at the MPI für Kohlenforschung. He uses electrochemical reduction of metal salts to prepare highly dispersed colloidal transition metal nanoclusters and supported nanoclusters, a process for which a patent has been granted. Variation of the current density and the temperature as well as the polarity of the solvent during the electrochemical synthesis allows control of the size of the nanoclusters. The stabilizing surfactant shell surrounding these nanoclusters can be visualized with a combination of STM and high resolution TEM. The clusters are evaluated as catalysts for selective organic transformations including carbon-carbon bond forming reactions (*Science* 267:367, 1995).

Research in the Group of Dr. J. S. Bradley

Dr. Bradley has long been involved in metal cluster and metal colloid chemistry areas of nanoscale science and technology. He joined the MPI für Kohlenforschung in 1995. His present emphasis in nanoscale materials focuses on the development of new synthetic methods for colloidal transition metal nanoclusters, their spectroscopic characterization (infrared, NMR, and extended X-ray absorption fine structure [EXAFS] spectroscopy), and the use of in-situ kinetic catalytic probes to define their surface chemistry. In addition, research is ongoing on the preparation from organometallic precursors of microporous nonoxide ceramics and their use in base-catalyzed reactions. For example, high surface area (400 m²/g) silicon amidonitride with a mean pore diameter of 7 Å has been prepared.

Research in the Group of Prof. Dr. W.F. Maier

Prof. Maier's main research area is aimed towards design of new heterogeneous catalysts that will have isolated active centers in a microporous metal oxide matrix (amorphous microporous mixed oxides, AMM). Guidance for this approach is taken from the fact that enzymes and zeolites are the most selective catalysts, having in common an isolated active center and a shape-selective environment around the active site. Prof. Maier's group has developed techniques to prepare AMM materials by a special sol-gel process that allows control of the chemical composition, pore size (0.5-1.0 nm), porosity, and surface polarity in a single preparation step. AMM catalysts have a narrow micropore distribution comparable to those of zeolites, and a homogeneous elemental distribution. They have produced shape-selective catalysts based on microporous titania, zirconia, and

alumina. The AMM materials have been shown to be selective catalysts for oxidation, hydrogenation, alkylation, and hydrocracking.

AMM membranes, prepared by dip-coating of asymmetric support membranes, are then used as catalytic membrane reactors. The catalytic membrane reactor allows the combination of catalytic activity with the permselectivity of the membranes to improve the selectivity of heterogeneously catalyzed reactions. Novel applications of AMM membranes include poison-resistant catalysis and complete suppression of secondary reactions with membrane catalysts.

Research in the Group of Prof. Dr. B. Bogdanovic

The nanomaterial research in Prof. Bogdanovic's group focuses on the preparation of highly reactive, highly dispersed inorganic materials (metal and intermetallic cluster materials, metal hydrides, metal carbides) from molecular organometallic precursors. Materials based on active magnesium hydride were discovered for use as reversible hydrogen storage systems. Highly dispersed metals, intermetallics, and carbides have been evaluated in a variety of catalytic organic reactions.

Site: **Paul Scherrer Institute (PSI)**
Laboratory for Micro- and Nanostructures (LMN)
CH-5232 Villigen PSI, Switzerland
<http://www.psi.ch> (or http://www1.psi.ch/www_lmn_hn/)

Date Visited: 15 October 1997

WTEC: E. Hu (report author), H. Goronkin, M.C. Roco, D.T. Shaw

Hosts: Dr. Jens Gobrecht (principal contact), Head, Micro- and Nanostructures Laboratory
 Fax: (41) 56-310 2646; E-mail: gobrecht@psi.ch
 Dr. Werner Wagner, Head, Experimental Facilities
 Dr. Helena Van Swygenhoven, Experimental Facilities
 Dr. Thomas Jung

BACKGROUND

The Paul Scherrer Institute (PSI) is the largest Swiss-supported government laboratory. The approximate allocation of funding and division of personnel (1996) is as follows:

- government funding 158 million SF
- external funding ~28 million*
- PSI staff 880
- external staff 210
- doctoral students 230
- external users 650

*21% from industry, 29% from electricity generation industry and NAGRA for nuclear energy research, 8% from EU and Swiss National Fund

The allocation of budget (in SFr. millions) by field of research is as follows (parentheses show % of total allocation, including external funding):

- particle physics 13 (11)
- life sciences 14 (14)
- SS physics and materials sciences 39 (37)
- energy 34 (38)

Operated as a multidisciplinary national research lab, PSI provides research infrastructure and the operation of large scale facilities, such as the Spallation Neutron Source (SINQ), recently completed, and a synchrotron

light source (Swiss Light Source), which was to begin construction in Spring 1998. PSI interacts broadly with universities and polytechnical high schools. University students may carry out their doctoral studies in PSI laboratories. PSI personnel also carry out radiation safety training and reactor education.

NANOSTRUCTURE SCIENCE WITHIN PSI

The WTEC team's host at PSI was Dr. Jens Gobrecht, the Head of the Laboratory for Micro- and Nanostructures (LMN) in the Department of Applied Solid State Physics. Dr. Gobrecht estimated that in his own area about one-third of the personnel budget originates from external funding, and about 50 people are involved in the nano field. The areas of research are organized into three categories as follows:

- Micro- and Nanostructuring Technology, which includes (1) electron beam lithography, (2) focused ion beam science and technology, (3) hot embossing lithography, and (4) LIGA. The first two areas are partially funded through the Swiss Priority Program (SPP) MINAST (Micro and Nanostructure Technology: with a four-year budget of ~ SFr. 48 million). Research area 3 is partially supported through the Swiss National Research Program (NFP 36) on nanosciences. Another subarea of research is titled "Zeolites as Materials for Nanodevices."
- Molecular Nanotechnology, which includes (1) biochemical recognition of individual molecules, (2) nanostructured electrodes for amperometric immunosensors, (3) immunosensor for penicillin in milk, and (4) neurite growth on biofunctionalized microstructured surfaces.
- Nanostructured Semiconductors Materials Research, which includes (1) near infrared Brillouin scattering, and (2) work on Si/Si/Ge and Si/Ge/C systems

Funding Profile

As mentioned above, the LMN participates in a number of national initiatives involving nanostructure science. *National Research Programs* (Nationale Forschungsprogramm, NFP) are directed towards solution of specific problems and are largely interdisciplinary in nature. In 1993, Nanosciences was chosen as a subject area of NFP 36 (1996-2001). The *Swiss Priority Programs* (SPP), were developed to ensure that strategic research in Switzerland is on a par with international research and that Swiss universities have the competence and financial means to play an important role in that research. SPPs are long term projects and can last eight to ten years, encompassing both basic research and practical problem solving.

RESEARCH AND DEVELOPMENT HIGHLIGHTS

Among the projects discussed in greater detail are the following:

- 50 nm plated metal structures by e-beam lithography
- stamping of 80 nm features in PMMA; also, fundamental studies of the polymer itself; possible application, heterogeneous catalysis
- nanoporous Au membranes for filtration: 100 nm Au membrane with 200 nm pores, 660 nm period, substrate etched off
- single-ion lithography to form nanoposts
- a-Si/a-SiN superlattice on single crystal Si: MBE/UHV CVD connected by a tunnel: recrystallize with emission in the blue
- biochemical sensor: immunological reactions taken on nanostructured surface; application: test for antibiotics in milk
- showed streptavidin immobilized on mica (see Figure B.1)

Dr. Thomas Jung described his work on the STM manipulation of molecules, rather than atoms, thus availing himself of preassembled building blocks. The building blocks can be prefabricated by chemical methods to possess specific structural, chemical, and physical properties. In addition to preassembly, a molecular approach has the advantage of being carried out at room temperature. The molecular building blocks considered include C_{60} (as was used to form the “abacus”), customized porphyrins, and bimolecular systems involving planar aromatic systems and fullerenes. In particular, Dr. Jung described work utilizing Cu-TBPP on Cu (100); experiments have elucidated molecular adsorption, surface movement, positioning, and stability of the assembled structures (for further information see Gimzerski et al. n.d.).

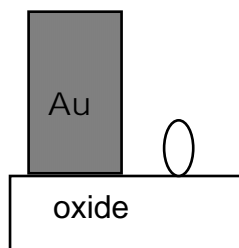

Figure B.1. Streptavidin immobilized on mica.

Team members also met with Drs. Werner Wagner and Helena Van Swygenhoven, members of the Department on Solid State Research at Large Facilities, associated with SINQ. In addition to providing support for outside researchers wishing to use the Spallation Neutron Source, members of this department also carry their own program of research in

nanostructured materials, interacting broadly with a number of collaborators, both in Europe and the United States. Nanostructured materials are synthesized by inert gas condensation (IGC), and evaluations of such materials are made with respect to structural, magnetic (e.g., for Fe, Co, Ni), mechanical, and electronic (Pd, Pt) properties. Molecular dynamics computer simulations of structural and mechanical properties are carried out in order to explore conditions for improved materials properties, such as ductility or wear-resistance. Research is being undertaken with industrial collaborators in this last area (nanoscaled multilayered coatings for wear-resistant coatings).

In addition to SINQ, the Large Facilities Department of PSI makes available its IGC facility, hot compaction unit, indenter, X-ray diffraction and density measurements, small angle neutron scattering, prompt gamma activation analysis, TEM, and SEM with EDX. SQUID and NMR are carried out in the laboratories of collaborators at École Polytechnique Lausanne, and positron lifetime measurements are made at the University of Gent.

REFERENCE

- Gimzerski, J.K., T.A. Jung, M.T. Cuberes, and R.R. Schlittler. *Scanning tunneling microscopy of individual molecules: Beyond imaging.*

Site: **Philips Research Laboratories**
Prof. Holstlaan 4
5656 AA Eindhoven, The Netherlands
Tel: (31) 40-27-42577; Fax: (31) 40-27-44282

Date Visited: 16 October 1997

WTEC: D.T. Shaw (report author), H. Goronkin, M.C. Roco

Hosts: Dr. L.G.J. Fokkink, Department Head, Physical Chemistry
Dr. Mark J. VanBommel, Senior Scientist in Inorganic
Materials and Processing
Dr. A.W.M. (Ton) deLaat, Colloidal Chemist
Dr. Erik A. Meulenkaamp, Research Scientist, Department of
Physical Chemistry
Dr. Bianca M.I. van der Zande

BACKGROUND

Philips is one of the most important manufacturers of electronic consumer products in Europe, with annual sales of more than \$40 billion. Roughly 70% of the Philips research comes from contracts from the company's product division; the rest is devoted to exploratory research, which typically does not lead to commercial products within three years. Among the exploratory research projects, an estimated 20% are related to nanoparticle/nanostructured materials. The laboratories have a wide spectrum of research activities that are of interest to this study, ranging from nanocrystalline materials synthesis, nanofabrication, and nanocrystal engineering to quantum transport in nanostructures and quantum theory of solids.

RESEARCH AND DEVELOPMENT HIGHLIGHTS

Dr. Mark J. VanBommel made a short presentation on nanoparticle coatings for consumer electronic applications (coatings for antiglare, antistatic, and antireflection uses). Depending on their specific applications, these nanoparticles need to have special properties (e.g., high electric conductivity, or low specular optical scattering). Antimony-doped tin dioxide (Sb:SnO₂) particles have been used for these applications, as an example. These nanoparticle coatings are typically produced by physical or

chemical wet deposition processes. Spray pyrolysis, spinning, or dip coating techniques are usually carried out in a controlled ambient environment. To avoid dull-looking surfaces, the primary particle diameter is usually less than 2 nm. Figure B.2 shows an electron micrograph of these particles. The electrical conductivity can be regulated by controlling the antimony concentration in SnO_2 .

Dr. A.W.M. (Ton) deLaat discussed briefly the production of nanometer-sized ceramic particles with very low sintering temperatures. Homogeneous green particles are important to prevent defects in sintered products; by using proper dispersants, dense and homogeneous layers have been obtained.

Dr. Erik A. Meulenlamp discussed size determination by absorbance measurements of ZnO nanoparticles and electrochemical properties of ZnO/ITO/glass electrode systems. ZnO nanoparticles produced by physical deposition are irradiated by light of various wavelengths. The shift of the absorbance peaks toward higher energy (or low wavelength) when the size of ZnO particles decreases (Figure B.3) clearly demonstrates the quantum size effect on bandgap energies. Figure B.4 shows the effects of electron accumulation for $E < -0.5\text{V}$ in a ZnO/ITO/glass electrode system.

Dr. Bianca M.I. van der Zande, who is on leave from Utrecht University, discussed the generation and optical properties of rod-shaped gold particles with diameters ranging from 10 to 30 nm. Aqueous dispersion of rod-like gold particles is obtained by electrode position in nanopores of anodized alumina. In the VIS/NIR absorption spectra, two absorption maxima are observed: one corresponds to the transverse plasma resonance, and the other to the longitudinal plasmon resonance, which moves to higher wavelengths when the particle aspect ratio is increased (Figure B.4).

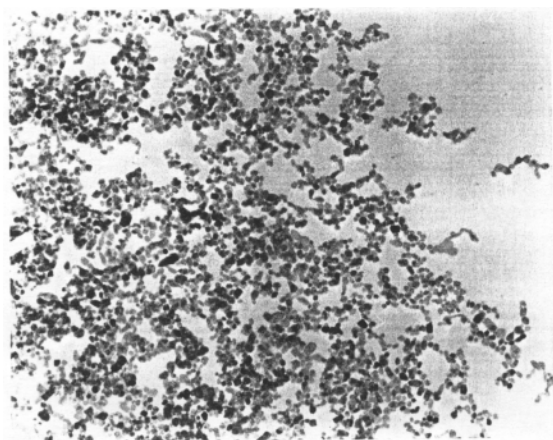

Figure B.2. Electron micrograph of antimony-doped tin dioxide particles (primary particle size ~20 nm).

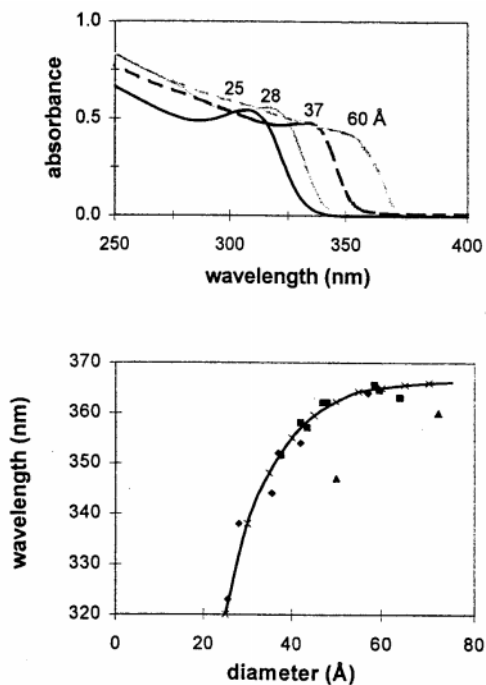

Figure B.3. Quantum size effect on the absorbance of ZnO.

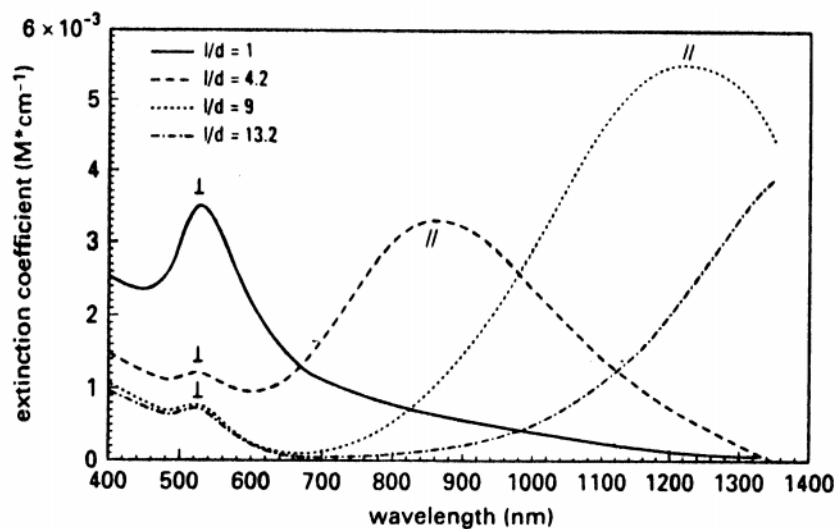

Figure B.4. Normalized experimental VIS/NIR absorption spectra of rod dispersions with aspect ratio $L/d = 1$ (spherical gold sol), $L/d = 4$, $L/d = 9$, and $L/d = 13$.

CONCLUDING REMARKS

From published papers, it is evident that Philips researchers are active in many other topics in nanostructures, including template synthesis of nanowires in porous polycarbonate membranes, self-assembled monolayers of metallic nanoparticles, and luminescence-tuning in semiconducting nanocrystallines.

Site: **Darmstadt University of Technology**
Department of Materials Science
Thin Films Division
Petersenstrasse 23
D-64287 Darmstadt, Germany
Tel: (49) 6151-16 6306; Fax: (49) 6151-16 6335
<http://www.th-darmstadt.de/ms/fg/ds>

Date Visited: 14 October 1997

WTEC: J. Mendel (report author)

Hosts: Prof. Dr. Horst Hahn, Head, Thin Films Division, Materials
Science Department
Dr. Markus Winterer, principal contact

BACKGROUND

The Darmstadt University of Technology has recently focused on nanomaterials. Its new building for material science was completed in 1992 and was officially dedicated in 1996. Here work includes particles, films, coatings, and bulk phase. Interest is in pores, grains, and clusters. Preparation methods can include gas vapor phase condensation, chemical vapor deposition, liquid plasma studies, chemical deposition, and sputtering. Electrical, mechanical, and spectral properties are all of interest.

There are 22 scientists in Professor Dr. Hahn's group. Interaction with industry and other technical centers occur frequently.

RESEARCH AND DEVELOPMENT HIGHLIGHTS

1. Preparation of SiC by chemical vapor synthesis (Sylkie Klein). This work emphasizes both high purity and high production rates.
2. Synthesis of $\text{ZrO}_2/\text{Al}_2\text{O}_3$ by chemical vapor synthesis (Vladimir Srdic). Beginning with aluminum alkoxide, particles are formed in the 4-9 nm size range. Flow rate of helium influences properties.
3. Impedance spectra on nano Y-stabilized zirconia (Pia Mondal). Powders are prepared by inert gas condensation. The lattice conductivity appears to be independent of grain size.

4. Synthesis and characterization of nanofilms with chemical vapor deposition and synthesis (Stefan Siegfried). Both boron carbide and silicon carbide are deposited on a silicon substrate.
5. Synthesis of metal-matrix composite coatings (Andreas Moller). Results lead to improved hardness, wear resistance, and thermal stability.
6. Very thin films (Stefan Flege). This work involves layer growth at 3,000 degrees Celsius for vapor metal/ceramics applications.

ANALYTICAL EQUIPMENT

- Mechanical Creep Device
- HRTEM
- IR
- Diffractometer
- Molecular Beam Instrumentation
- Low Pressure Flow Chemical Vapor Synthesis
- SIMS
- Electron Probe
- XRD
- SEM
- TEM
- Sputtering Equipment

FUNDING PROFILE

About 60-75% of the equipment is paid through state support. Additional funding takes place through industrial collaboration.

CONCLUDING REMARKS

The Thin Films Lab at the University of Darmstadt is strongly positioned for preparation and characterization of nanoparticle systems. Their work reflects the University's commitment to expand the understanding needed for particles, films, coatings, and bulk phase.

Site: **Delft University of Technology (DUT)**
Faculty of Chemical Technology and Materials Science
Delft Inst. of Microelectronics & Submicron Technology
Rotterdamseweg 137
2628 AL Delft, The Netherlands
<http://www.stm.tudelft.nl/> or <http://dimes.tudelft.nl>

Date Visited: 16 October 1997

WTEC: D.T. Shaw (report author), H. Goronkin, M.C. Roco

Hosts: Prof. Brian Scarlett, Department of Chemical Engineering
Dr. Cees Dekker, Faculty of Applied Physics

BACKGROUND

The nanoparticle/nanostructured materials/nanodevices research activities at the Delft University of Technology (DUT) reside primarily in the Faculty of Chemical Technology and Materials Science (STM) and Delft Institute of Microelectronics and Submicron Technology (DIMES). STM is one of the more research-oriented faculties of DUT, which is the largest, oldest, and most complete technical university in the Netherlands. About 40% of all PhD degrees awarded at the University have been in STM. Among the 3 research areas the program covers (biotechnology, chemical engineering, and materials science technology), the WTEC visit concentrated primarily on chemical engineering and materials science technology.

DIMES is a large national research center in microelectronics managed by the University. Funded by the government and accredited by the Royal Netherlands Academy of Arts and Sciences, DIMES was created in 1987 as a national facility for the fabrication of advanced integrated circuits and nanostructured devices. Its 300-odd staff members and graduate students actively explore the microelectronics field; studies range from carbon nanotube electronics to nanofabrication of single-electron tunneling devices. In addition to its vast (2,000 m²) clean-room fabrication facilities, the center is also a training ground for scientific specialists in advanced microelectronics in the Netherlands. Since its inception, more than a hundred PhD students have finished their dissertations using DIMES facilities. The Institute offers some twenty graduate courses, as well as extensive training support for research students. It coordinates its graduate education programs with the University's academic faculties, including the Faculty of Chemical Technology and Materials Science.

RESEARCH AND DEVELOPMENT HIGHLIGHTS

The Faculty of Chemical Technology and Materials Science (STM)

STM has strong programs in both nanoparticle generation and functional materials synthesis. Several professors in STM are active in the organization of an European Science Foundation program on Vapor-Phase Synthesis and Processing of Nanoparticle Materials. The principal objective of the program is to promote interdisciplinary collaboration between the leading research groups in Europe in aerosol and materials science. The program, with an annual budget of about FFr. 1.5 million (for meetings, workshops, and information dissemination), is coordinated by J. Schoonman of DUT and Prof. H. Fissan of the University of Duisburg, Germany.

Two major groups are engaging in nanoparticle/nanostructured materials research. One is led by Prof. J. Schoonman and the other by Prof. B. Scarlett, who was the WTEC team's host for the visit. Prof. Scarlett has several projects in nanoparticle technology, including the production of nanoparticles by electrospraying, electrostatic charging for micromixing, and nanoparticle formation in a laser-heated aerosol reactor. His group also developed photon correlation spectroscopy as a means to measure submicron particles in a gas, in situ. His coworker, Dr. J.C.M. Marijnissen summarized recent results on the generation of metal-oxide particles by bipolar mixing techniques. Different precursors (i.e., titanium tetrabutoxide, zirconium tetrabutoxide, etc.) have been used to generate metal-oxide particles. A project in collaboration with Prof. Schoonman concerns the generation of nanoparticles by laser-induced chemical vapor precipitation (LCVP). Although the LCVP technique is not new, the project's data in particle-generation parametric optimization are useful in scale-up production of Si, SiC, Si₃N₄, and SiC_xN_y nanoparticles. The research activities of Prof. Schoonman, have focused also on the synthesis of custom-designed structural and functional nanostructural materials. For example, his coworker Dr. A. Goossens reported the use of an electrostatic spray pyrolysis technique for the deposition of dense or nanoporous ceramic thin films for lithium batteries and other energy-related applications. A great variety of metal oxide nanocrystalline thin films have been synthesized, including TiO₂ and Li CoO₂. STM researchers have developed a technique called laser particle precipitation-aided chemical vapor deposition (LPPCVD), which produces thin films with very low substrate temperatures. Typically, the nanoparticle size is in the range of 10 to 30 nm.

Delft Institute of Microelectronics and Submicron Technology (DIMES)

Dr. Cees Dekker (Faculty of Applied Physics) made a short presentation on research activities in the area of quantum transport through nanostructures. Prof. Mooij (who was touring the United States at the time of our visit) heads the research program supported by DIMES. Four projects were discussed briefly:

1. Junction Arrays (Project Director, Hans Mooij) and Single Electronics (Project Director, Peter Hadly). The quantum behaviors of small circuits of superconducting tunnel junctions were studied experimentally and theoretically. A quality sample was designed and fabricated, in which quantum superpositions of charge states, as well as vortex states, have been experimentally observed. Quantum vortices were studied in one-dimensional arrays. Disorder was seen to lead to localization, while in periodic superlattices the vortices maintained their mobility. Fluctuations were studied in normal metals near a tunnel barrier.

In single electronics, there are three main efforts: (1) fabrication of small junctions for the study of charging effects, (2) understanding of high-frequency behavior of single-electron tunneling (SET) transistors, and (3) characterization of single-electron circuits. Figure B.5 shows an RS flip-flop consisting of four SET transistors, each with three gates fabricated by the group.

2. Quantum Dots (Project Director, Leo Kouwenhoven). Transport experiments on quantum dots were performed on a gated device, as shown in Figure B.6. Measurements of gate voltages vs. source-drain voltages show a shell structure corresponding to a 2-D harmonic confinement potential in normal atoms. Staff observed that the filling of a shell occurs according to Hund's rule: electrons occupying degenerate states prefer to have parallel spins, which lowers the total energy due to an increased exchange interaction.

3. Single Molecular Wires (Project Director, Cees Dekker). Single-wall carbon nanotubes were obtained from R.E. Smalley at Rice University for transport measurements. The nanotubes behave as coherent quantum wires at the single-molecular scale. The density of states appears to consist of well-separated discrete electron states. The approximate 0.4 meV energy separation corresponds to estimated 1-D quantum box where a 3 μm long nanotube constitutes the electron box. Electrical conduction through these discrete electron states appears to occur quantum coherently over micron-length distance.

For transport measurements of single metal nanoclusters, DIMES researchers showed results made on a 20 nm Pd cluster, which was trapped electrostatically between two nanometer-sized electrodes (Figure B.7).

4. NEXT Nanolithography (Project Director, Bart Geerligs). The Nanoscale Experiments and Technology Project is based on a facility for the fabrication and study of sub-10 nm structures. The project studies mesophysics on 10 nm to atomic-size structures and assesses the applicability of these mesophysical phenomena to future electronic devices. Main features characteristics of the NEXT system are: (1) working in an uninterrupted, clean, ultrahigh-vacuum environment, and (2) using maskless fabrication techniques based on scanning tunneling probes. On-going experiments in the facility include quantum electronic studies of metal quantum dots, 1-D mesoscale systems, and transport in molecules.

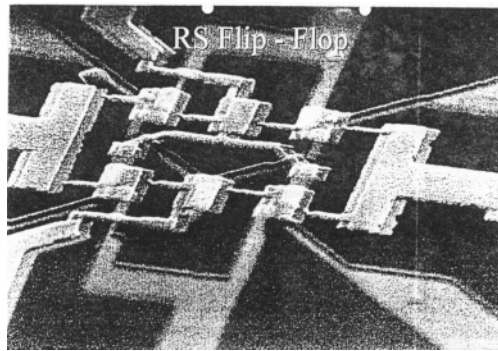

Figure B.5. RS flip-flop of four SET transistors, each with three gates.

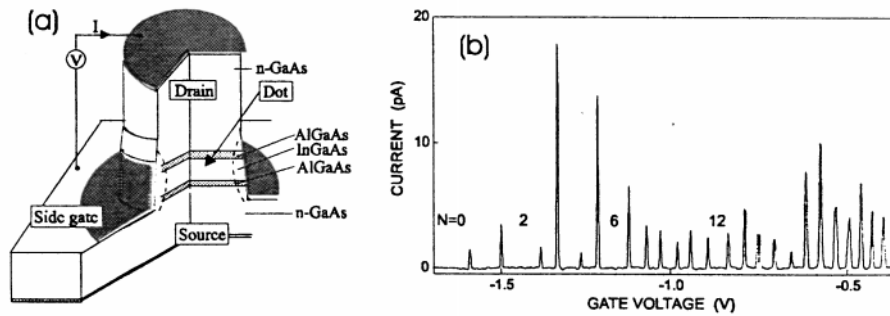

Figure B.6. (a) Schematic diagram of the gated quantum dot device and (b) the Coulomb oscillations in the current vs. gate voltage at $B = 0\text{T}$ observed for a $0.5\ \mu\text{m}$ diameter dot.

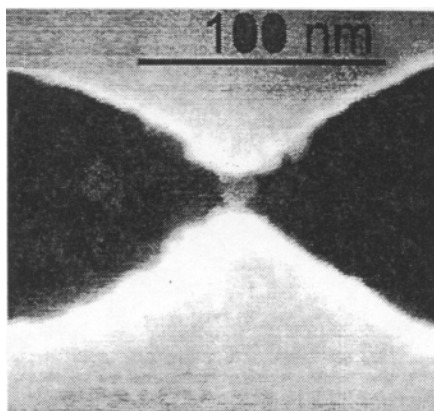

Figure B.7. Single Pd colloid cluster of 20 nm diameter that has been deposited between two nanoelectrodes.

CONCLUDING REMARKS

The research facilities in nanostructured materials at Delft University of Technology in general, and at DIMES in particular, are very impressive. Projects are carried out with close collaboration between researchers from industry and university. For many projects at DIMES it is common to have several industrial sponsors. Since the research is generally precommercial in nature, issues about intellectual property appear not to be a problem for these multi-industrial sponsorships.

Site: **University of Cambridge
Cavendish Laboratory
Toshiba Cambridge Research Center (TCRC)
Madingley Road
Cambridge CB3 0HE, United Kingdom
<http://www.phy.cam.ac.uk/> (Cavendish Laboratory)**

Date Visited: 15 October 1997

WTEC: J. Mendel (report author)

Hosts: Prof. Michael Pepper, Director, TCRC
Dr. Neil Greenham, Conjugated Polymers and Molecular
Solids Group (Cavendish Laboratory)
Dr. Andrew Shields, TCRC
Dr. Mark Leadbetter, TCRC

TOSHIBA CAMBRIDGE RESEARCH CENTER (TCRC)

Overview of the Center

The Toshiba Research Center (TCRC) was founded by the Toshiba Corporation of Japan as a laboratory pursuing fundamental research into the physics of semiconductor structures and associated topics. The intent is to provide an important part of electronics technology for the next century. This includes development of collaborative projects with academic institutions in the European community.

Accordingly, there is collaborative research with the Cavendish laboratory of Cambridge University on advanced growth and fabrication techniques. The Center maintains a close relationship with Toshiba Research and Development Center in Japan, and there are frequent reciprocal visits between the two centers.

Most research is for a 5- to 10-year horizon. Present staff totals about 18. All research is on semiconductors, on which ~ 50 papers have been published since 1991, the year the center was established. The work includes papers on electrical properties of quantum well structures where the electron wave function is controlled by application of a voltage to a controlling gate leading to a velocity modulated transistor. The center has a full in-situ cleaning chamber, which is used prior to regrowth studies.

Studies of electron propagation on curved and nonplanar surfaces are also taking place, partly as a result of observing the improved electrical

properties of advanced structures. Accordingly, the need to develop an optical facility became readily apparent. Surface orientation as a function of a magnetic field has led to the field taking on different values; electron deflection can take place as a result of the electron velocity in the magnetic field.

Extensive investigations into infrared properties as well as excitonic effects led to the discovery of the positively charged exciton. Included here were investigations on both positive and negative properties of excitons.

Funding Profile

Funding is by the Toshiba Corporation.

Research and Development Highlights

- quenching of excitonic optical transistors by excess electrons in GaAs quantum wells
- one-dimensional wire formed by molecular beam epitaxial regrowth on a patterned pnpn GaAs substrate

Concluding Remarks

The Toshiba Center is ideally positioned to explore electrical and quantum phenomena for semiconductor technology for the next century, due to its location, expertise of technical resources, and close association with collaborative communities such as Cavendish. Its path forward appears rewarding and certain.

CAVENDISH LABORATORY

Dr. Neil Greenham, associated with Prof. Richard Friend in the Conjugated Polymers and Molecular Solids Group, was the principal contact for this visit.

Overview of the Laboratory

Experimental and theoretical research in the Department of Physics at Cambridge is carried out in the Cavendish Laboratory. The laboratory was established 120 years ago by individuals such as Maxwell, Rayleigh,

Thomson, Rutherford, and Bragg. From this noteworthy beginning the laboratory has evolved into three major sections: Condensed Matter Physics, Radio Astronomy, and High Energy Physics.

The funding for the investigations at the laboratory come from a combination of government and industry. There are currently some 63 companies that sponsor research at Cavendish.

Research and Development Highlights

The following areas of research are active in the area of optical and electrical studies:

- characterization of conjugated polymers
- Electrical and electro-optical properties of polymer semiconductor devices
- optical excitations of conjugated polymers and related materials
- optical microcavities
- optoelectronic properties of semiconductor nanoparticles

Discussion

Conjugated polymers with delocalized electron systems behave as model organic semiconductors. Here activities such as design and synthesis of new polymers are of interest for the semiconductor physics of these materials. They give strong electro-optical and nonlinear optical responses. There is concern for polymer light-emitting diodes as well as photovoltaic and photoconductor diodes. Subpicosecond time-resolved spectroscopy is included also. There is considerable collaboration with the Chemistry Department in order to tailor these materials to the appropriate properties needed for these studies.

Equipment at Cavendish

- X-ray diffractometer
- Low energy electron diffraction
- High resolution electron energy loss measurements
- Scanning tunneling microscope
- Optical spectrometers
- Fourier infrared spectroscopy
- Ion beam & electron beam lithography
- Atom scattering facilities
- Electron microscopy
- Angle-resolved photoemission
- Tunable dye lasers
- Laser Raman
- Molecular beam epitaxy

HITACHI CAMBRIDGE LABORATORY

Although this site was not visited, it is included in the report for the reader's interest (see also <http://www-hcl.phy.cam.ac.uk/>).

Key Personnel: Prof. H. Ahmed, Microelectronics Research Center

Staff: Six Post Doctorates, 17 Research Students

Overview of the Laboratory

The purpose of this laboratory is to carry out research into physics and fabrication of novel electronic devices. Activities include

- extensive electron beam lithography
- focused ion beam implantation
- electron-beam-assisted deposition
- thin film processing
- collaboration with Cambridge Physics Lab

Discussion

The Microelectronics Research Center has regular collaboration on quantum effect devices with the Cambridge Physics Laboratory. There is extensive equipment sharing. For example: a femtosecond laser system, an ultra-low temperature scanning tunneling microscope and a powerful system are shared for purposes of characterization on structures that are fabricated in the Center.

Also, a newly organized group within the Center is investigating sensor structures including an infrared sensor based on free-standing micro-thermocouples. Work is in process on microsensors in silicon and GaAs and on single-molecule sensors.

Site: **University of Oxford**
Department of Materials
Parks Road
Oxford OX1 3PH, United Kingdom
<http://www.materials.ox.ac.uk>

Date Visited: 16 October 1997

WTEC: R.W. Siegel (report author), C. Koch

Hosts: Prof. Brian Cantor, Cookson Professor of Materials, and
Head of Department; Fax: (44) 1865-273738; E-mail:
head.department@materials.oxford.ac.uk
Prof. David Pettifor, Isaac Wolfson Professor of Metallurgy,
and Director, Materials Modelling Laboratory
Dr. Brian Derby, Director, Oxford Centre for Advanced
Materials and Composites
Dr. Patrick Grant
Dr. Amanda Petford-Long
Dr. Kenya A.Q. O'Reilly
Dr. Alfred Cerezo
Dr. Paul J. Warren
Dr. Steve Roberts
Dr. John L. Hutchison
Prof. Peter J. Dobson, Department of Engineering Science
Prof. Malcolm L.H. Green, Head, Department of Chemistry,
Inorganic Chemistry Laboratory
Prof. H.A.O. Hill
Prof. R.G. Denning
Prof. D. O'Hare
Prof. Paul Madden, Physical and Theoretical Chemistry
Laboratory
Dr. R.K. Thomas
Dr. C.D. Bain
Dr. F. Marken

BACKGROUND

The full day of 16 October from 9:30 to 15:30 was spent at the University of Oxford visiting the Head of the Department of Materials, Prof. Brian Cantor, and various other members of the Department. It was a very

interesting visit, with much to hear about in the area of nanostructure science and technology at this prestigious university. An additional one-hour visit at the end of the day was made to a group of faculty from the Department of Chemistry, Inorganic Chemistry and Physical and Theoretical Chemistry Laboratories. Although brief, the visit was quite effective, since it was held in a very informative roundtable format well organized by Prof. Malcolm L.H. Green and Prof. Paul Madden.

According to an initial overview of the University of Oxford and its Department of Materials presented by Prof. Cantor, the Department currently consists of about 330 people in total, with 20 academic staff and about 30 support staff, 80 research fellows and visitors, 80 postgraduate students, and the remainder undergraduate students. The Department's current annual research budget of ~£3 million, comes two-thirds from government and one-third from industry, with about 50% of this focused in nanoscale research activities. The research in general is quite broad-based and includes processing, characterization, and modeling activities in all classes of materials: metals, ceramics, polymers, semiconductors, and composites (see references list). The Department also houses the Materials Modelling Laboratory (Prof. David Pettifor, Director) as well as the Oxford Centre for Advanced Materials and Composites (Dr. Brian Derby, Director). In the important area of nanostructure characterization, the very impressive electron microscopy facilities here are particularly noteworthy, owing in part to the tradition left by Professor Sir Peter Hirsch, as are those in atom-probe field-ion microscopy. A series of visits with individual department staff ensued.

RESEARCH AND DEVELOPMENT HIGHLIGHTS

Dr. Patrick Grant reviewed the department's ongoing work in nanocrystalline sprayed coatings. This work utilizes a variety of spray processing methods including the Ospray process, electric-arc spraying, plasma spraying, and ink-jet spraying. He described some examples in more detail. For example, plasma spraying of titanium along with 100 μm diameter SiC fibers yielded multilayered structures with a matrix having a nanoscale substructure, owing to the rather stochastic process of oxide contamination. Work was planned to soon begin on spraying 600 nm diameter Al_2O_3 particles and 200 nm diameter SiC feedstock, as the research moved more toward the true nanoscale regime.

Dr. Amanda Petford-Long then described her work on nanolayered magnetic thin films. The primary focus of the work is on magnetic recording materials at the nanoscale. A significant collaboration is ongoing

between Dr. Petford-Long at Oxford, Prof. Ami Berkowitz at UCSD, and Hewlett-Packard, Palo Alto, who together are funding three post-doctoral researchers in electron microscopy, band-structure modeling, etc., mainly on spin-valve materials. These are made by spraying multilayered films, such as NiFe/Cu/Co/NiFe/MnNi. Additional funding comes from small companies in the UK and the Science Research Council. Also described were unique capabilities for mapping local magnetization in devices using Lorentz transmission electron microscopy. They are also working on nanocomposite optical films, such as Bi nanoclusters in an amorphous Ge matrix, made by pulsed laser ablation techniques.

Dr. Kenya A.Q. O'Reilly then described her work on the nucleation of nanocrystalline secondary phases and the heterogeneous nucleation of droplets on matrix surfaces studied by TEM in various alloy systems. Melt spinning is used to produce composites of low and high melting point materials. The method is apparently limited to about 20 nm diameter particles, for example with Pb in Al. Melting (freezing) is observed via differential scanning calorimetry (DSC) at different cooling rates to examine kinetics. Studies of Al/Al₃Zr sponsored by ALCAN have shown that small particles melt first and then interface regions. The excellent electron microscopy facilities in the Materials Department (consisting of ~ 14 instruments, presently) are used in this work. A new high-resolution FEG-TEM will be added in a few months to upgrade further these facilities.

Next, Dr. Alfred Cerezo and Dr. Paul J. Warren reviewed some of their current work involved with investigations of nanocrystalline and amorphous materials, mainly alloys, using atom-probe field-ion microscopy and high-resolution TEM. The position-sensitive atom-probe (PoSAP) field-ion microscope was pioneered in this group and represents the ultimate in combined structural and chemical nanoscale analysis, since it has atom-by-atom sensitivity. Kindbrisk, Ltd. in Oxfordshire has commercialized the instrumentation through a technology transfer arrangement with the University. A variety of phase decomposition studies are being carried out in order to develop an understanding of the mechanisms and effects of different such processes in nanocrystalline materials, including Al-based (high strength), Fe-based (soft magnetic), and Zr-based (high strength) alloys. Pulse electroplated Ni-Fe alloys have also been investigated because of their interesting increased hardness and improved magnetic properties.

Dr. Steve Roberts discussed the ongoing research in the Department on nanocrystalline ceramics and ceramic-matrix composites, the latter with Dr. Brian Derby. Most of this work is being carried out on the Al₂O₃/SiC system containing ~ 5% SiC particles, similar to the materials studied by Prof. Koichi Niihara in Osaka. The work is funded by BRITE/EURAM and the Engineering and Physical Sciences Research Council (UK) with some in-

kind support from UK industry. Using 30-40 nm SiC particles well dispersed (intra- or inter-granularly) in 3-4 μm grain size Al_2O_3 yields a factor of 2 increase in strength (cf. the factor of 4 increase found by Niihara's group at Osaka), but a similar fracture toughness and 2-3 times greater wear resistance compared with conventional Al_2O_3 . This material is found to be effective as a grinding medium, and good interactions with industry in the UK and abroad have resulted.

Dr. John L. Hutchison then discussed his work on supported metal catalysts and also on in situ high-resolution electron microscopy (HREM) observations of filling carbon nanotubes (multiwalled tubes now, but starting on single-walled tubes) with metals via reduction in the microscope. Dr. Hutchison is the director of the HREM facility, which has an environmental cell that has 0.25 nm resolution up to 20 mbar pressure and 500°C. He is also working on WS_2 and other related fullerene-like sulfides and selenides in collaboration with a group at the Weizmann Institute. These are found to give excellent lubricity in oil suspensions, since they apparently roll and don't slide.

The WTEC team's next visit on a very busy and interesting day was with Prof. Peter J. Dobson, Department of Engineering Science, who described the wide range of activities in nanoparticles and nanocomposites in his Department, much of it done in collaboration with colleagues in the Departments of Materials and Chemistry. They create a variety of nanoparticles via several methods, including colloidal, aerosol, gel/aerosol, sputtering, gas evaporation, and electrochemical routes. These nanoparticles (e.g., CdS, CdSe, ZnS, Ag/ZnO, etc.) are generally dispersed in a matrix to make a "high technology" paint or coating with a specific functionality. For example, semiconductor quantum dots with narrow size distributions for use as light emitters are being dispersed in a glassy or polymeric matrix to develop new display technology. Surface capping of the nanoparticles is also being investigated in order to optimize and control their dispersion and properties.

Finally, the last hour of the visit was spent with a group of eight faculty from the Department of Chemistry, Inorganic Chemistry and Physical and Theoretical Chemistry Laboratories in an informative roundtable format that was well organized and briskly guided by Prof. Malcolm L.H. Green, Department Head, and Prof. Paul Madden. First, Dr. R.K. Thomas spoke of neutron scattering studies of interfaces, for example the surfactant layer at an aqueous/silica surface. The interaction appears to be independent of silica particle size down to 5 nm, the smallest size looked at. Next, Dr. C.D. Bain described nonlinear optical studies related to tribology, work on crystal growth, and dissolution, as well as confined molecules trapped between glass ("lens") surfaces. Dr. F. Marken then discussed his work on

electrocatalysis using small particles, emulsions in aqueous media. *Ab initio* molecular dynamics simulations of Na clusters in zeolite Y were then described by Prof. P.A. Madden in terms of what the Na cluster looks like in the super cage after the sodalite cages are filled. Grain boundary migration in Na with symmetric tilt boundaries was also being simulated and could be followed for tens of picoseconds at two-thirds T_M using a simpler molecular dynamics (MD) approach than Car-Parrinello with Kohn-Sham for materials, such as Na, with spherically symmetric bonding. Prof. H.A.O. Hill then presented his work on nanoelectrodes for sensor applications in which a different enzyme could be placed on each nanoelectrode. Profs. Dobson and Hill and others are now using carbon nanotubes with redox proteins in a tube of 3 nm radius for such sensors. Results of a new project on nanostructured polymers were then described by Prof. R.G. Denning in which one-, two-, and three-dimensional nanostructures were being created using optical interference methods. It is planned to fill the ordered voids created in these polymers with TiO_2 or other high refractive index materials. Prof. M.L.H. Green then spoke of his elegant results with filled carbon nanotubes opened by reduction with Nd_2O_3 , $FeBiO_3$, or MoO_3 , for example. Dr. D. O'Hare ended this session with a discussion of mesoporous silicates used for nanochemistry with organometallic catalysts. The general issue was then raised about funding for nanoscale science in the UK and, while EPSRC has an initiative in microstructure materials, it was felt that the monies were small and insufficient, with money for people and equipment easier to obtain than actual research support. It was perceived that even EPSRC is now being focussed toward "wealth creation" and the situation appears that it is not going to be getting better.

At the end of this long and interesting day, it was very clear that the time allowed could not possibly do justice to all of the excellent work being done on nanostructure science and technology at Oxford, and that an hour with the Chemistry Department could really at best only whet one's appetite.

REFERENCES

- Anya, C.C., and S.G. Roberts. 1996. Indentation fracture toughness and surface flaw analysis of sintered alumina/SiC nanocomposites. *J. of the European Ceramic Society* 16:1107-1114.
- _____. 1997. Pressureless sintering and elastic constants of Al_2O_3 -SiC "nanocomposites." *J. of the European Ceramic Society* 17:565-573.
- Burden, A.P., and J.L. Hutchison. 1996. Real-time observation of fullerene generation in a modified electron microscope. *J. of Crystal Growth* 158:185-188.
- Cerezo, A., T.J. Godfrey, C.R.M. Grovenor, M.G. Hetherington, J.M. Hyde, J.A. Liddle, R.A.D. Mackenzie, and G.D.W. Smith. 1990. The position sensitive atom probe: Three dimensional reconstruction of atomic chemistry. *EMSA Bull.* 20(2)(Nov.):77-83.

- Chen, Y.K., A. Chu, J. Cook, M.L.H. Green, P.J.F. Harris, R. Heesom, J. Sloan, S.C. Tsang, and J.F.C. Turner. 1997. Synthesis of carbon nanotubes containing metal oxides and metals of the d-block and f-block transition metals and related studies. *J. Mater. Chem.* 7:545-549.
- Chen, Y.K., M.L.H. Green, J.L. Griffin, J. Hammer, R.M. Lago, and S.C. Tsang. 1996. Purification and opening of carbon nanotubes via bromination. *Adv. Mater.* 8(12):1012-1015.
- Chu, A., J. Cook, R.J.R. Heesom, J.L. Hutchison, M.L.H. Green, and J. Sloan. 1996. Filling of carbon nanotubes with silver, gold, and gold chloride. *Chem. Mater.* 8:2751-2754.
- Cook, J., J. Sloan, R.J.R. Heesom, J. Hammer, and M.L.H. Green. 1996. Purification of rhodium-filled carbon nanotubes using reversed micelles. *Chem. Commun.* 2673-2674.
- Daykin, A.C., A.K. Petford-Long. 1995. Quantitative mapping of the magnetic induction distribution using Foucault images formed in a transmission electron microscope. *Ultramicroscopy* 58:365-380.
- Feldman, Y., G.L. Frey, M. Homyonfer, V. Lyakhovitskaya, L. Margulis, H. Cohen, G. Hodes, J.L. Hutchison, and R. Tenne. 1996. Bulk synthesis of inorganic fullerene-like MS_2 ($M = Mo, W$) from the respective trioxides and the reaction mechanism. *J. Am. Chem. Soc.* 118(23):5632-5637.
- Green, M.L.H., A. Chu, J. Cook, J. Sloan, Y.K. Chen, E.S.C. Tsang, R.J.R. Heesom, and J. Hammer. 1996. Synthesis and characterization of nanotubes filled with elemental metals and metal oxides. Ch. 12 in *Proc., R.A. Welch Found. 40th Conf. on Chem. Research, Chemistry on the Nanometer Scale*, Oct. 21-22, Houston, TX.
- Lee, M.H., P.J. Dobson, and B. Cantor. Optical properties of evaporated small silver particles. *Thin Solid Films* 219:199-205.
- Morilla, M.C., C.M. Afonso, A.K. Petford-Long, and R.C. Doole. 1996. Influence of the relaxation state on the crystallization kinetics of Sb-rich SbGe amorphous films. *Philosophical Mag. A.* 73(4):1237-1247.
- Niu, F., I.T.H. Chang, P.J. Dobson, and B. Cantor. 1997. The influence of substrate temperature, substrate material and heat treatment on the microstructure of Ag/Si nanocomposite films prepared by r.f. co-sputtering. *Mater. Sci. and Eng.* A226-228: 161-167.
- Petford-Long, A.K., R.C. Doole, C.N. Afonso, and J. Solis. 1995. *In situ* studies of the crystallization kinetics in Sb-Ge films. *J. Appl. Phys.* 77(2)(15 Jan.):607-613.
- Pethybridge, G.D., P.J. Dobson, and R.J. Brook. 1994a. Aerogels. In *Novel synthesis and processing of ceramics*, ed. F.R. Sale. British Ceramics Proceedings 53, Inst. of Materials.
- _____. 1994b. Supercritical drying of barium titanate aerogels. In *Proc., Int. Symp. on Applications of Ferroelectrics*.
- Portier, X., A.K. Petford-Long, R.C. Doole, T.C. Anthony, and J.A. Brug. 1997a. In-situ magnetoresistance measurements on spin valve elements combined with Lorentz transmission electron microscopy. *IEEE Trans., Proc. of Intermag. 1997*.
- _____. 1997b. Lorentz transmission electron microscopy on NiFe/Cu/Co/NiFe/MnNi active spin valve elements. *Appl. Phys. Lett.* 71(14)(6 Oct.):2032-2034.
- Ross, A.D.M., A. Cerezo, J.S. Conyers, A.K. Petford-Long, S.J. Subrandu, and G.D.W. Smith. 1993. Atom-probe microanalysis of metallic nanostructured materials. *Mat. Res. Soc. Symp. Proc.* 286:167-172.
- Salata, O.V., P.J. Dobson, P.J. Hull, and J.L. Hutchison. 1994a. Fabrication of CdS nanoparticles embedded in a polymer film by gas-aerosol reactive electrostatic deposition technique. *Thin Solid Films* 251:1-3.
- _____. 1994b. Fabrication of PbS nanoparticles embedded in a polymer film by a gas-aerosol reactive electrostatic deposition technique. *Advanced Materials* 6(10):772-775.

- _____. 1994. Uniform GaAs quantum dots in a polymer matrix. *Appl. Phys. Lett.* 65:189-91
- Salata, O.V., P.J. Dobson, S. Sabesan, P.J. Hull, and J.L. Hutchison. 1996. Preparation of nanoparticulate CdS films suitable for opto-electronic device applications. *Thin Solid Films* 288:235-238.
- Sloan, J., J. Cook, M.L.H. Green, J.L. Hutchison, and R. Tenne. 1997. Crystallization inside fullerene related structures. *J. Mater. Chem.* 7:1089-1095.
- Sloan, J., J. Cook, J.R. Heesom, M.L.H. Green, and J.L. Hutchison. 1997. The encapsulation and in situ rearrangement of polycrystalline SnO inside carbon nanotubes. *J. of Crystal Growth* 173:81-87.
- Wakefield, G., P.J. Dobson, Y.Y. Foo, A. Lonl, A. Simons, and J.L. Hutchison. 1997. The fabrication and characterization of nickel oxide films and their application as contacts to polymer/porous silicon electroluminescent devices. *Semicond. Sci. Technol.* 12:1304-1309.

Site: **University of Karlsruhe (Universität Karlsruhe)**
Institut für Physikalische Chemie und Elektrochemie
Lehrstuhl II Kaiserstrasse 12,
D-76128 Karlsruhe, Germany
Tel: (49) 721-608 2094; Fax: (49) 721-608 7232
<http://www.chemie.uni-karlsruhe.de>

Date of Visit: 14 October 1997

WTEC: D. Cox (report author)

Hosts: Prof. Dr. Manfred Kappes, Physical Chemistry
Prof. D. Fenske, Organic Chemistry
Prof. H. von Löhneysen, Physics

BACKGROUND

The University of Karlsruhe has a strong effort in nanoscale science and technology. The effort encompasses several research groups in both the Chemistry and Physics Departments, as well as collaborative efforts with the Forschungszentrum Karlsruhe (FzK). The effort has both a strong experimental component and a strong theoretical component.

At present the formal structure is best exemplified by the two Sonderforschungsbereiche (SFB) programs at the university. The earliest one SFB-195 was started in 1992 and has a focus on electron localization. The present coordinator of SFB-195 is Prof. H. von Löhneysen, a professor in the Physics Department. Beginning in 1998 Prof. Dr. Manfred Kappes in the chemistry department will assume the role of coordinator. The focus of the program is on electron localization in macroscopic and microscopic systems, including clusters and cluster complexes. This is a multidisciplinary effort encompassing many research groups at Karlsruhe. Some of the groups participating in this program are those of

Prof. Dr. M. Kappes	Clusters, Physical Chemistry
Prof. D. Fenske	Semiconductor Cluster Complexes, Inorganic Chemistry
Prof. R. Ahlrichs	Theory
Prof. Freyland	Electron localization in metal salt systems
Prof. Hippler	Femtosecond spectroscopy of solvated electrons
Prof. H. von Löhneysen	UHV scanning probe techniques, Defect structures in Si
Prof. Schimmel	Fabrication and scanning probe techniques

The total effort is estimated at about 70-90 researchers, including postdoctoral and PhD students.

In addition to SFB-195, the Karlsruhe group has received approval for a second SFB commencing January 1998. This new SFB will obtain funds, initially ~ DM 2 million/year for three years, to pursue research on carbon materials. Again a strong multidisciplinary approach is evident, with groups from Physics, Chemistry and Engineering contributing. The goal of the new effort will be to understand carbon-fiber-reinforced materials. The approach will be multifaceted with studies of carbon deposition from the gas phase, chemical vapor infiltration and chemical synthesis of carbon structures including materials aspects of carbon nanotubes and fullerenes, gas phase kinetics and surface radical interaction on carbon surfaces to understand the fundamental growth mechanisms, and solid state physics of nanotubes and carbon materials for potential nanoelectronic properties. Some of the groups involved include those of Kappes, Fenske, Hippler, Hüttinger, Ahlrichs, and von Löhneysen at the University, and Rietschel at the FzK.

RESEARCH AND DEVELOPMENT HIGHLIGHTS

The WTEC team held individual discussions with Prof. Kappes, Prof. Fenske, and Prof. von Löhneysen, and visited the laboratories of Professors Kappes and von Löhneysen. It is clear from the discussions that nanoscale science is a high priority area in Karlsruhe, both at the university and at the FzK (Prof. Dr. H. Gleiter). As examples of efforts in this area, the research activities in the three groups we visited are summarized below.

Research in Prof. Kappes' Group

At the present time Prof. Dr. Kappes has a group of 12, consisting of 1 postdoc and 11 PhD students. The main focus of the research is to understand several fundamental physical, chemical, and electronic properties of metal and carbon (fullerene) clusters using spectroscopic and beam techniques. Efforts are focused on

1. photodissociation probes of mass selected transition metal clusters and derivatives
2. studies of charge separation and chemi-ionization processes in thermal energy collisions of alkali clusters with various molecules (e.g., O₂₉, C₁₂₉, C₆₀...)
3. isolation and characterization of larger fullerenes, endohedral metallofullerenes, and fullerene derivatives

4. cluster ion-surface scattering including the determination of fragmentation, delayed ionization, and neutralization rates upon collisions to obtain activation energies
5. probes of cluster ion penetration into HOPG, including tailoring of surface morphologies by controlled etching of nanometer-sized impact defects

The laboratory is well equipped, having several molecular/ion beam systems, many different laser systems for spectroscopic and particle generation, ultrahigh vacuum (UHV) STM for surface studies, Ti-Sapphire laser-based Raman spectrometer, HPLCs for fullerene extraction, and purification, among other equipment.

In addition to its experimental effort, the Kappes group collaborates with the theory group of Prof. Ahlrichs. Each PhD student may be expected to spend about one-quarter of his/her time performing theoretical studies, perhaps calculating electronic spectra of fullerenes, alkali clusters or transition metal clusters, properties of isomeric structures, and/or model spectra, e.g., IR or Raman, for many of the new neutral and ionic species being studied.

Research in Prof. Fenske's Group

Prof. Fenske's group consists of about 15 PhD students and has historically focused on synthesis and structure/X-ray, primarily of new metal calcogenide molecular clusters. In addition to the effort on synthesis, more recent studies are now directed to probing the stability of the ligand-stabilized clusters, via ligand alteration and cluster size and composition. One goal is to synthesize molecular clusters of well-defined size and geometry in order to investigate quantum confinement in such species. Recent successes are in the area of copper selenium molecular clusters stabilized by the protective ligand field of $(\text{PEt}_2\text{Ph})_x$. As an example, molecular clusters with cores of $\text{Cu}_{20}\text{Se}_{13}$, $\text{Cu}_{44}\text{Se}_{22}$, up to $\text{Cu}_{70}\text{Se}_{35}$, have been synthesized and characterized. The structures of the clusters smaller than $\text{Cu}_{70}\text{Se}_{35}$ are found to be spherical, whereas the structure of $\text{Cu}_{70}\text{Se}_{35}$ is pyramidal. The color of the material depends on the cluster's size. For nanoscale technology, the $\text{Cu}_{70}\text{Se}_{35}$ is found to be metastable. It decomposes under vacuum into smaller $\text{Cu}_{2x}\text{Se}_x$ clusters. When a sheet is coated with $\text{Cu}_{70}\text{Se}_{35}$, a nearly uniform coating of smaller clusters of $\text{Cu}_{2x}\text{Se}_x$ (quantum dots) is formed, thus creating a 2-D array of quantum dots. The next step—not a trivial one—will be to form interconnects. One thought is to use graphite surfaces using the beam techniques developed by Prof. Kappes. The semiconducting cluster complexes can then stick to the graphite surface at the defect site.

Research in Prof. von Löhneysen's Group

Prof. H. von Löhneysen in the Physics Department has a fairly large group of 20, with 5 postdocs and 15 PhD students. He has a well-funded operation and commented that funding in Germany may still be better than in the United States. However, he also felt that too much time has to be spent to get funding. He commented that the University of Karlsruhe strongly supports nanotechnology. He has strong interests and efforts in electron beam lithography, break junctions, metallic nanostructures, low temperature physics investigating nanostructures and thin films, metal insulator transitions, and magnetism/superconductivity. Research on break junctions is directed towards fabricating and characterizing nanometer structures with few atom contacts. Contacts are broken and then brought back together in a controlled fashion so that current voltage characteristics can be probed. A tour of his laboratories confirmed that support for equipment is certainly adequate, with strong capabilities in e-beam lithography, UHV STM, and 20 mK dilution refrigeration for low temperature physics studies.

Prof. H. von Löhneysen also outlined some of the other efforts in the Physics Department with some emphasis on nanoscale science. Prof. T. Schimmel uses STM treatments of surfaces to micromill and manipulate nanometer structures on surfaces, such as fabrication of small junctions. Prof. P. Wölfle carries out theoretical studies of phase coherence, and Prof. G. Schön is developing the theory for a single-electron current standard.

Site: **Universität des Saarlandes**
(Saarland University, Department of Technical Physics)
D-66041 Saarbrücken, Germany
Tel: (49) 681-302 5173; Fax: (49) 681-302 5222
<http://www.uni-sb.de/>

Date Visited: 13 October 1997

WTEC: J. Mendel (report author)

Hosts: Prof. Dr. Rainer Birringer, Physics, Principal Contact
<http://www.uni-sb.de/matfak/fb10/birringer>
Prof. R. Humleman, Physical Chemistry
Prof. R. Houbertz, Characterization
Prof. Veitz, Chemistry
Prof. Hufner, Chemistry
Prof. Beck, Chemistry

BACKGROUND

The University of the Saarland has a strong focus on nanotechnology. Of particular interest are the following areas of investigation within the Department of Technical Physics:

1. Inert gas condensation processes to produce nanostructured powders
2. Determination of grain size distribution in nanomaterials from X-ray diffraction profile analysis
3. Nanocrystalline metals and oxides by reverse microemulsions
4. Nanocrystalline metals and oxides with pulsed electrodeposition
5. Characteristics of one-dimensional tunnel junction arrangements
6. Size control synthesis of BaTiO₃ by sol-gel hydrolysis
7. Nanocrystalline copper by pulsed electrodeposition
8. Muon diffusion in nanocrystalline copper
9. Growth kinetics of nanocrystalline CuTi
10. Implantation of ions on the surface initiation of reactions with metal alkoxides
11. Characterization of nanoparticle surfaces
12. Use of photoelectron microscopy for resolving surfaces
13. Ultrasonic energy for creating nanoparticles

RESEARCH AND DEVELOPMENT HIGHLIGHTS

The inert gas condensation method has been optimized by using an aerosol flow condenser. Characterization of product resulted in an 80% reduction in the primary particle mean diameter and 17% reduction in geometric standard deviation. Flow conditions also determined the primary particle diameter and the geometric standard deviation.

There is considerable investigation on the synthesis of nanocrystalline metal oxides and the formation of NH_4MnF_3 by microemulsion techniques. Size and distribution of the primary reverse micelles were determined by dynamic light scattering.

An analytical approach is now available for determining the Coulomb blockade and single electron tunneling phenomena for arbitrary tunnel junctions coupled in series.

Size controlled synthesis of nanocrystalline BaTiO_3 by a sol-gel type hydrolysis is currently under study in a microemulsion nanoreactor.

EQUIPMENT

- Small Angle Scattering
- NMR
- GC/MS
- ESCA
- TEM
- Neutron Diffraction
- SEM
- AFM
- Scanning Tunneling Microscopy
- ESCA Nanoscope
- Nanodensitometer
- X-Ray Diffraction
- Differential Thermal Analysis
- Dilatometry
- Differential Scanning Calorimetry
- Porosity measurements
- Magnetism/Vibrating Sample Magnetometer

CONCLUDING REMARKS

The synthesis and properties of nanocrystalline materials include researching metals, metal oxides and nanocomposites. Preparation methods are by inert gas condensation and ball milling. Specific properties of interest are catalytic, sensor, magnetic and mechanical attributes. Such work is providing increased understanding and capability in the investigation of nanoscale science and technology at the University of the Saarland.

Appendix C. European Roundtable Discussions

STUTTGART ROUNDTABLE

Site: Stuttgart, Germany

Date: 13 October 1997

WTEC: C. Koch (report author), D. Cox, E. Hu, R.W. Siegel

Attendees:

University of Ulm

Prof. Dr. Peter Unger, Associate Professor, Dept. of Optoelectronics

Prof. Dr. Hans-Jorg Fecht, Fakultät für Ingenieurwissenschaften, Abt.

Werkstoffe de Elektrotechnik

Prof. Dr. Rolf Jurgen Behm, Abteilung Oberflächenchemie und Katalyse,
Fakultat für Naturwissenschaften

Prof. Dr. R.-P Franke, Zentralinstitut für Biomedizinische Technik,
Abteilung Biomaterialien

Prof. Dr. Witold Lojkowski, Abteilung Werkstoffe der Elektrotechnik

Dr. Joachim Spatz, Abteilung Oberflächenchemie III, Fakultat für
Naturwissenschaften

Max Planck Institutes

Prof. Dr. Klaus v. Klitzing, Max-Planck-Institut für Festkörperforschung

Dr. I.M.L. Billas, MPI für Festkörperforschung

Dr. P. Redlich, MPI für Metallforschung

Dr. Thomas Wagner, MPI für Metallforschung

Others

Prof. Dr. Manfred Kappes, University of Karlsruhe, Inst. Physikalische
Chemie

Dr. Victor Trapp, Project Manger, Fuel Cells, SGL Carbon Group, SGL
Technik GmbH

Dr. Margret Wohlfahrt-Mehrens, Electrochemical Material R&D, Solar
Energy and Hydrogen Research Center

Dr.-Ing. Wolfgang Kleinekathofer, Daimler Benz AG, Forschung und
Technik

A group of scientists from or near Stuttgart were invited to a roundtable discussion of their various research projects on nanoscale technology and materials. Names of attendees and their affiliations are listed above. The highlights of these presentations are given below, by institution.

Max-Planck-Institut für Festkörperforschung (MPI FKF)

Tel: (49) 711-689 0; Fax: (49) 711-689 1010

<http://www.mpi-stuttgart.mpg.de/start.html>

Professor Dr. Klaus v. Klitzing

Professor v. Klitzing described research on functional nanodevices at the Max Planck Institute (MPI). He also discussed the broader view of work on nanotechnology in Germany, particularly on III-V quantum structure devices. Summaries of work on this subject, financial supporters, and details of technical progress are summarized in *III-V-Elektronik Mesoskopische Bauelemente* (in German). There is broad cooperation between universities and industry on this project. Professor v. Klitzing briefly described some of his own research, including MBE growth and etching system for study of GaAs/AlAs/ AlGaAs:15/AlAs:6/GaAs and quantum dot lasers GaInP and InP. The ultimate single-electron tunneling transistor—which is being addressed at many laboratories—is the goal of much of the research.

The electronic properties of clusters are studied, e.g., gold clusters with well-defined number of atoms as contacts and islands for charge transfer. Some examples of low-dimensional electronic systems prepared by the chemistry department of the MPI FKF Stuttgart are “0-dimensional” CS_{11}O_3 , “one-dimensional” $\text{Na}_5\text{Ba}_3\text{N}$, and “two-dimensional” Ba_2N crystals. Prof. v. Klitzing is skeptical about the ultimate use of nano-semiconductor systems, such as quantum dots, for applications in mainstream microelectronics.

Dr. I.M.L. Billas

Dr. Billas in the group of Prof. Dr. T.P. Martin described the group’s work on clusters studied by means of time-of-flight mass spectrometry. Much of the work deals with metal-covered C_{60} or C_{70} molecules. C_{60} is an ideal template for growing shells of metal atoms. Several systems include alkali-metal, alkaline-earth-metal, and transition-metal-covered fullerenes. Fabrication of new exotic magnetic nanostructures is part of an interregional research project “magnetic nanostructures,” which includes researchers from adjacent regions of France and Germany partially funded by regional governments. The project collaborators are listed below:

France:*Rhône-Alpes region:*

Dr. A. Perez, University C. Bernard, Lyon

Prof. Dr. M. Broyer, University C. Bernard, Lyon

<http://www.univ-lyon.fr/>

Prof. Dr. B. Barbara, CNRS, Grenoble

Dr. K. Hasselbach, CNRS, Grenoble

<http://labs.polycnrs-gre.fr/>*Alsace region:*

Prof. Dr. J.-P. Bucher, University L. Pasteur, Strasbourg

<http://www-ulp.u-strasbg.fr/>Germany:*Baden-Württemberg region:*

Prof. Dr. H. Haberland, Frieberg University

Prof. Dr. T.P. Martin, MPI, Stuttgart

Prof. Dr. D. Weiss, Stuttgart and Regensburg

The research of this program includes fabrication and stabilization of nanosize magnetic structures (magnetic dots and clusters) and their characterization by time-of-flight mass spectroscopy, TEM and HRTEM, XRD, and absorption techniques, Rutherford Backscattering, and XPS. Magnetic properties are measured by magnetic force microscopy, magnetometry (microSQUIDs), magnetotransport measurements, and ultrafast magneto-optical measurements.

Max-Planck-Institut für Metallforschung<http://wwwmf.mpi-stuttgart.mpg.de/>**Dr. Thomas Wagner**

Dr. Wagner is staff scientist at the Max-Planck Institut für Metallforschung leading the “Thin Film Synthesis and Processing” group. His current research uses STM, TEM, coupled with standard surface analysis techniques, to characterize metal and ceramic films, multilayers, and alloy films with defined chemical composition grown by MBE and sputter deposition on a variety of substrates. The main thrust of his group is to investigate physico-chemical mechanisms of thin film growth like solid state reactions, nucleation processes, and interface formation during film deposition. The following thin film systems are under investigation:

Metal/Ceramic	Nb, Cu/Al ₂ O ₃	Al, Ag/MgAl ₂ O ₄	Si, Pd, Cu/SrTiO ₃
Ceramic/Ceramic	Ti ₂ O ₃ /Al ₂ O ₃	ZrO ₂ /Al ₂ O ₃	TiO ₂ /Al ₂ O ₃

In addition, special thin film systems are grown to study their mechanical properties (e.g., alloy films), thermal stability (grain growth, stability of boundaries), atomistic structure, and bonding interfaces.

Prof. Dr. Manfred Rühle

The main thrust of Prof. Rühle's group is use of state-of-the-art analytical tools to study materials and thin film microstructures and interfaces. One major goal of the research is to correlate chemical composition and microstructure of materials to their macroscopic properties. In this context, it is of fundamental interest to quantitatively investigate and model the growth, atomistic structure, and bonding at interfaces of both real materials and model systems. Such model systems are fabricated by different techniques, like ultrahigh vacuum diffusion bonding and molecular beam epitaxy. Major research activities are concentrated on electron microscopy and interfacial research. Analysis is carried out with tools such as HRTEM, analytical electron microscopy (AEM), and surface science techniques. Interfaces of these material systems have been studied both experimentally and theoretically: grain boundaries in metals, intermetallics and complex oxides, and metal/ceramic phase boundaries, including the following:

metal/metal:	NiAl/NiAl	Cu/Cu
metal/ceramic	Nb, Cu/Al ₂ O ₃	Al, Ag/MgAl ₂ O ₄ Pd, Cu/SrTiO ₃
ceramic/ceramic	Al ₂ O ₃ /Al ₂ O ₃	SrTiO ₃ /SrTiO ₃

Major research interests include those listed below:

1. processing of clean and well-defined surfaces and interfaces by diffusion bonding and MBE
2. growth and surface studies by modern techniques of surface science
3. quantitative investigation of materials, interfaces, and solid state reactions by high resolution (transmission) electron microscopy (HREM), analytical electron microscopy (AEM), and energy filtered convergent beam electron diffraction (CBED)
4. refined quantifications of results from electron microscopy investigations by methodical developments
5. computer simulation of boundary structures and bonding at interfaces by different techniques (e.g., *ab initio* methods)

Dr. P. Redlich

Dr. Redlich is also in Prof. Rühle's institute. His research interests are in the field of carbon nanofibers. Institute researchers use arc-discharge methods to synthesize their carbon nanotubes. They are also studying chemically modified C nanotubes. Using BC₄N as an anode they obtain a new material. They use HRTEM and EELS to characterize their materials. The interdisciplinary approach to these studies is emphasized with collaborations with experts in synthesis and characterization within MPI, Germany, and the United States.

University of Ulm

Albert-Einstein-Allee 45, D-89081 Ulm, Germany
<http://www.uni-ulm.de>

Prof. Dr. Peter Unger

<http://www-opto.e-technik.uni-ulm.de/index-e.html>

Dr. Unger is in the Department of Optoelectronics of the University of Ulm (K.J. Ebeling, Director). Research topics in the university include vertical cavity surface emitting lasers (VCSELs), Gbit data transmission using VCSELs, high-power semiconductor lasers, and nitride-based semiconductors (for LEDs, lasers). The funding of this research comes from the German Ministry of Education, Science, Research, and Technology (BMBF), Baden-Württemberg, German Research Society (DFG), the European Union, and industry (Siemens, Daimler-Benz, Telekom). The equipment used includes MBE (for GaAs, AlGaAs, InGaAs), GSMBE (for InP, GaInAsP, AlGaInP) and MOVPE (and GSMBE) for GaN, InGaN, and AlGaN. Lithography is both optical and e-beam, and dry etching is by RIE, CAIBE. Nanotechnology studies include epitaxial growth (quantum wells, nanometer accuracy, nanometer reproducibility) and lithography and dry etching (holograms, waveguides, and laser mirrors). No structures have nanometer-scale dimensions, but they do have nanometer-scale definition, accuracy, and side wall roughness.

Prof. Dr. Hans-Jorg Fecht

Dr. Fecht is in the Faculty of Engineering, Department of Electronic Materials/Materials Science. Dr. Fecht has a number of basic research and applied research projects, many of which involve nanoscale science and technology. The per-year funding level is about \$1.2 million. Eight projects are of particular interest for nanostructured materials research:

1. structure and properties of nanocrystalline (nc) materials prepared by cyclic mechanical deformation
2. high temperature mechanical properties of ceramic thermal barrier coatings
3. tomographic nanoanalytical microprobe/field ion microscopy
4. small angle neutron scattering of nanostructured materials
5. optimization of the wheel/rail contact for high speed trains—development of new steels that are more prone to the formation of nc surface layers due to friction-induced wear, as well as testing of nc coating technologies

6. development and modeling of nanostructured wear resistant coatings—examples are Ti-Al-N, SiC, and Fe-Cr-Si/WC to improve lifetime of wear parts and biomaterials (e.g., stents, pacemakers, etc.)
7. “Simulation of Microsystems,” a materials databank for materials used in microsystem technologies, including thin films and coatings and bonding technologies: development of physical models to describe the thermomechanical properties of nanostructured materials in microsystems
8. sensor clusters in extreme environments: development of new sensors that can withstand extreme current densities, temperatures (up to 1300 K) and pressures (2000 bar) using surface acoustic wave devices; new metallization schemes using nc/amorphous phase mixtures; and nc diamond as a new material for pressure sensors

Prof. Dr. Rolf Jurgen Behm

Dr. Behm is in the Faculty of Sciences, Department of Organic Chemistry and Catalysis. He described the fabrication of nanostructures by scanning probes. These included semiconductor materials where, e.g., scanning tunneling microscopy was used for direct local deposition of Si or Si-H_x species from a SiH₄ precursor gas on the Si(111)-(7x7) surface. Direct writing of nanostructures with lateral dimensions down to 40 nm is accomplished; similarly, nanofabrication of small Cu clusters on Au (111) electrodes is accomplished with the STM. Work is also carried out on the chemical properties of defined multicomponent particles of interest for catalysis. It is suggested that bimetallic catalysts may have a future, compared to single-component monolayers, which are too expensive. About 80% of this research is directed toward fuel cell catalysis. These programs are funded by government (BMBF, DFG, EU) and industry.

Dr. Margret Wohlfahrt-Mehrens

*Center for Solar Energy and Hydrogen Research, Baden-Württemberg,
Department of Electrochemical Material Research and Development*

The major function of the Center for Solar Energy and Hydrogen Research is to characterize materials—some of which may be nanostructured—for batteries, supercapacitors, fuel cells (direct methanol), and hydrogen storage (fuel cell, carbon nc materials). The center obtains its materials from others, since it does not make materials. At this time it is not possible to predict whether nanostructured materials will be useful in the above applications.

Prof. Dr. R.-P. Franke

Dr. Franke is in the Central Institute for Biomedical Technology, Department of Biomaterials. Dr. Franke described several interesting studies related to the interfaces between biomaterials and tissues. One study (funded by BMBF) involves the tribology of implants under load. The wear particles of the implant can be in the size range of nm to mm and lead to inflammation of the tissue and subsequent loosening of the implant. Nanostructures may be important in filtering devices, sensors, and artificial organs. Specificity—specific reactions by receptors—is important in organisms, while biomaterials typically react by nonspecific reactions. Placement of receptor-like molecules on biomaterials by nanomanipulation methods should open new opportunities. In general, there appear to be many new exciting research possibilities in the fields of wear, mechanical, and chemical properties of nc biomaterials.

Prof. Dr. Witold Lojkowski

Dr. Lojkowski is in the Department of Electronic Materials/Materials Science as visiting scientist from the Polish Academy of Sciences, High Pressure Research Center in Warsaw, Poland (a Center of Excellence). His major research interests at Ulm involve characterization of nc powder and high pressure sintering. In terms of characterization of nanomaterials, X-ray diffraction analysis is the methodology used. Ab initio calculations are made of diffraction spectra for model structures and compared with the experimental data. Information about size, shape, strain, and polytype-structure of the nanopowders is obtained.

Studies of the sintering of nc SiC and nc diamond are carried out at pressures up to 40 GPa and temperatures up to 2000°C. In situ X-ray diffraction studies are made under pressure to determine the processes taking place during sintering.

Dr. Joachim Spatz

Dr. Spatz is in the Faculty of Sciences, Department of Organic Chemistry/Macromolecular Chemistry (director, Dr. Marten Möller). He described his department's research on using diblock copolymers in ultrathin films for patterning. The phase organization of the diblock copolymers into micelles can be arranged in various ways on substrates. The distance between clusters can be about 10 nm and modified by changing the molecular weights. The chemical inhomogeneity of the diblock copolymer films can be used to deposit metals locally on either block "A" or "B." This

can provide masks on the nanometer scale with the limit so far of about 30 nm. Another method to approach limits of 1 nm uses the addition of metal compounds in solution to the core of a copolymer, then reduces the metal compound to the metal. An example is Au nanoparticles about 6 nm in diameter with the distance between them controlled by the polymer. Oxygen plasmas can be used to remove the polymer with the metal particles remaining in place. The particle size can be reduced with lower molecular weight polymers. Precise islands 5–20 nm and 10–200 nm apart can make high density quantum dot arrays, 1,000 dots/mm².

University of Karlsruhe

<http://www.uni-karlsruhe.de>

Prof. Dr. Manfred Kappes, Institute of Physical Chemistry

Prof. Dr. Kappes briefly described the scope of their work related to nanostructures. This includes studies of fullerenes, electronic structure of clusters, and use of clusters as projectiles to make well-defined defects on substrate surfaces. The details of the work in Prof. Dr. Kappes' laboratory are given in the report of the site visit to Karlsruhe (Appendix B).

SGL Technik GmbH

<http://www.sglcarbon.com/welcome.html>

Dr. Victor Trapp, Project Manager, Fuel Cells, SGL Carbon Group

Dr. Trapp provided an industrial perspective on work on carbon nanofibers as part of a large, \$1 billion per year, carbon company business. The present cost is about \$30/lb. The carbon nanofibers may be used in composites (for automotive, electronics applications), electrochemistry for electrodes, etc., and hydrogen storage. An industrial concern with carbon nanofibers is potential or possible health/environmental problems. This is a major obstacle to commercialization.

SWEDEN ROUNDTABLES

Site: **Royal Institute of Technology (KTH)**
SE-100 44 Stockholm, Sweden

Date: 15 October 1997

WTEC: D. Cox (report author), C. Koch, J. Mendel, R.W. Siegel

Hosts: Prof. K.V. Rao, Department of Condensed Matter Physics
Fax (and Tel): (46) 8-790 7771; Email: rao@cmp-kth.se
Prof. M. Muhammed, Materials Science and Engineering
Division of Materials Chemistry
Fax: (46) 8-790 9072
E-mail: mamoun@inorchem.kth.se

Attendees:

Docent Ingela Agrell, Foundation for Strategic Research
Prof. Tord Claesson, Dept of Physics, Chalmers Institute of Technology
Prof. C.G. Granqvist, Ångström Laboratory, Uppsala University
Prof. D. Haviland, Nanostructure Physics, KTH
Prof. Mats Jonson, Göteborg University
Prof. Ulf Karlsson, Materialfysik, KTH
Dr. Lazlo Kiss, Ångström Laboratory, University of Uppsala
Dr. Mirka Mikes-Lindbäck, ABB Corporate Research
Prof. Nils Mårtensson, MAX-Laboratories, Lund University
Prof. Arne Rosén, Department of Physics, Chalmers Institute of Technology
Prof. J. Roeraade, Dept of Analytical Chemistry, KTH
Prof. Lars Samuelson, Dept. of Solid State Physics, Lund University
Dr. Steven Savage, FOA (National Defense Research Institute)
Prof. Mats Wilander, Dept of Physics, Univ. of Göteborg/Chalmers

Background

The WTEC team's site visit to Sweden was greatly facilitated by Prof. Rao and Prof. Muhammed, who kindly organized a one-day workshop at the Royal Institute of Technology (KTH) in Stockholm. Groups from across Sweden involved in nanoscale science and technology were invited to send representatives to participate in this workshop. Representatives from the Royal Institute of Technology, Uppsala University, Chalmers University of Technology, Göteborg University, and Lund University, together with

program managers from four of the funding agencies in Sweden, contributed to the workshop.

Sweden has made a conscientious effort to have broad-scale information exchange in the area of nanoscale science and technology. There are several consortia (described below) that not only have a multidisciplinary composition but also multiorganizational composition in most instances. As examples, in the area of mesoscopic ($20 \text{ \AA} < \text{size} < 500 \text{ \AA}$) physics, 80-100 people are involved from various institutions in Sweden, and the Nanometer Structure Consortium at Lund has on the order of 100 people involved. Regular meetings are held by the National Board for Industrial and Technological Development (NUTEK) Competent Centers, and the scanning probe community has regular meetings for researchers throughout the country.

Presentation of Consortium Efforts

After introductory comments, which included a welcome from Prof. Ingmar Grenthe, the Vice President of the Royal Institute of Technology (KTH), overviews of four major consortia in the Nanoscale Science and Technology area were presented:

1. Clusters and Ultrafine Particles, presentation by Prof. Nils Mårtensson of Lund/Uppsala, the consortium leader
2. Nanometer Structure Consortium, presentation by Prof. L. Samuelsson of Lund University, the consortium head
3. Nanophase Materials Consortium, presentation by Prof. M. Muhammed, of the Brinell Center at KTH
4. Ångström Laboratory, presentation by Prof. C.G. Granqvist and Dr. L. Kiss of Uppsala University

These general consortia overviews demonstrated that significant effort is being expended in nanoscale science and technology throughout Sweden. In addition, there either is or is expected to eventually be, substantial industrial involvement in every consortium. Academia's strong and close ties to the industrial needs of Sweden were repeated several times during the workshop.

Reports on the Consortia

1. Consortium on Clusters and Ultrafine Particles

The Consortium on Clusters and Ultrafine Particles is one of the consortia that makes up the Interdisciplinary Materials Research Consortium (see Table C.I) sponsored by the Swedish Foundation for Scientific Research (SSF), the Natural Sciences Research Council (NFR), and NUTEK. The

present Consortium leader is Nils Mårtensson, who is also the new Director of MAX-Lab, the synchrotron facility at Lund. The three primary areas of focus of this consortium are (1) catalysis (clusters – nanophase materials), (2) nanostructured electrodes, and (3) hard materials.

The consortium consists of groups from several different universities and disciplines that collaborate in this area. For example, participants include Uppsala researchers from Physics in Surface Science, Liquid ESCA (electron spectroscopy for chemical analysis), Quantum Chemistry, and Dynamic Electrochemistry; University of Stockholm researchers from Physics in Theory; Linköping researchers in Theory of Spectra; and KTH researchers in Materials Chemistry and Ceramics. In addition there are strong interactions with industrial researchers.

Examples of research being carried out in this consortium are investigations of the fundamental properties of CO dissociation on supported metal clusters. XPS studies of the energy shift in the carbon 1s line have allowed investigators to follow CO dissociation on different nanosize rhodium clusters and conclude that clusters containing on the order of 1,000 rhodium atoms supported on alumina were the most adept at dissociating CO. Clusters containing both less and more rhodium dissociated a much smaller fraction of the CO. Similarly, bonding of organic acids on metals, e.g., formate and acetate on Cu(110), is being studied experimentally by XPS and modeled by theory.

These experiments are made possible by the use of the synchrotron radiation at MAX-lab, which is located at Lund University. The MAX-II is a third-generation facility, which means that it has been optimized for insertion devices (straight sections). The high intensity X-ray sources at MAX-lab have opened opportunities for X-ray lithography work in two areas that lab researchers are calling micromachining/LIGA process or nanostructuring/IC technology. Potential applications in micromachining include neuro chips, microactuators, microsensors, pressure senders, microparts, filters, flow meters/controllers, and fiberoptics connectors. Potential applications in nanostructuring are sub-0.13 μm microlithography, high speed FETs, biomaterials, fibers and particles, bioelectric sensors, binary diffraction optics elements, optical elements based on CGHs, and high aspect ratio nanostructures.

Another example is the MAX-Lab work on nanostructured semiconductor electrodes for photovoltaics, photoconductors, sensors, electrocatalysis, photocatalysis, electrochromism, electroluminescence, and batteries. The Graetzel cell, which uses particles with controlled morphology, allows optimization of devices that produce electrical energy from light.

2. Nanometer Structure Consortium

During the Stockholm workshop, Prof. Lars Samuelson presented an overview of the organization and work being carried out at the Nanometer Structure Consortium. Since this consortium is reviewed in detail at the end of Appendix C by Evelyn Hu, who separately attended a mini-workshop at Lund University on 14 October 1997, a separate overview of Prof. Samuelson's presentation is not given here.

3. Nanophase Materials and Ceramics Thematic Network at KTH

The Nanophase Materials and Ceramics Thematic Network is based at KTH and is part of the Brinell Centre. It was established in 1996/1997 and is funded by the SSF, KTH, and by participating industries. Prof. Mamoun Muhammed is project leader of the Nanophase Materials and Ceramics Thematic Network.

The Brinell Centre is a newly formed strategic research center coordinating research in materials science in the Stockholm area. The Brinell Centre performs interdisciplinary research and graduate education in materials science, with a focus on advanced engineering materials. It consists of 15 departments and institutes, mostly based in the Stockholm area. The Brinell Centre represents a very broad spectrum in materials science, ranging from basic physics and chemistry to industrial applications of materials science. One type of advanced material is based on nanomaterials. The center maintains a close relationship with both materials-producing and materials-consuming industries. Graduate students will spend at least 6 months work within an industrial company and accomplish a part of their thesis in work at the company.

The research programs at the Brinell Centre are organized within two *Interdisciplinary Research Programs* entitled (a) Computational Materials Science and Engineering, and (b) Precision Processing of Clean Steels; and three *Thematic Networks* entitled (a) Nanophase Materials and Ceramics, (b) Materials Science for High Temperature and Aggressive Environments, and (c) Surface Science and Coating Technology. The Thematic Networks cover large scientific areas that are also reflected in the graduate school program.

Thematic Network A: Nanophase Materials and Ceramics

This thematic network encompasses the groups of about six professors in the KTH. Nanophase materials are defined here as materials with a grain size in the 1-100 nm range and are found to exhibit greatly altered mechanical properties compared to their normal, large-grained counterparts with the same chemical composition. For example, nanophase materials are up to five times harder than the normal materials. This thematic network

focuses on fabrication and evaluation of the mechanical properties of alumina-based composites containing TiC and TiN nanoparticles. The project aims to study the enhancement of the mechanical properties of alumina composites by dispersion of nanoparticles of titanium carbide and titanium nitride. Scanning probe techniques are commonly used to study the interfaces and fabrication of alumina-based composites. Their mechanical properties are evaluated by nano-indentation, and then the indentation areas are mapped in order to better understand the mechanisms leading to improved mechanical properties of bulk alumina by nanoparticles. Another area of interest involves study of cerium oxide catalysts. Studies have shown that significant improvement in the oxygen storage capabilities of these materials has been achieved with neodymium, calcium, lead, or manganese doping. The program is funded “quite handsomely” by industry. For aerospace applications, nanogranular thermoelectrics based upon opals are being studied in collaboration with Allied Signal Corporation.

4. The Ångström Laboratory

The Ångström Laboratory is located at Uppsala University. It is a center in which expertise in materials science has been gathered together from diverse fields of chemistry, materials science, physics, electronics, etc. The facilities have been designed to expedite high technology research and there are specially equipped laboratories to offer optimal conditions for experiments, for example, rooms with extremely high air purity that are free from vibration. Four strategic research programs have been established at the Ångström Laboratory: the Center for Advanced Micro-Engineering, the Ångström Solar Center, the Batteries and Fuel Cells for a Better Environment Program, and the Energy Systems Program.

As an example of the lab’s world-class capability is its recent purchase and installation of a \$1 million apparatus to fabricate large quantities of ultrafine particles. The apparatus can be operated in several different modes, such as Gas Evaporation Mode or Direct Gas Deposition Mode, depending on the material to be fabricated. The equipment will allow researchers to produce high purity, nearly perfect nanocrystals with a narrow size distribution (2-3 nm in diameter) at a very high production rate (20 gm/hr). Several types of nanoparticles are being produced and examined by different researchers. These include active metal particles, isolated metal particles, nanochains of ferromagnetic nanoparticles, and ceramic nanoparticles. Studies include fabrication of Fe-Ag films for experimental investigation of giant magnetoresistance (GMR) properties, as well as use of “ordinary” nanoparticles to fabricate films from nanopaste for studies of their electrical and thermal resistivity properties.

Reports from Funding Agencies of Sweden

In addition to presentations overviewing consortia efforts, four presentations were given by managers from four different Swedish funding agencies describing nanoscale science support in their respective agencies. Summaries of these presentations follow.

NUTEK

Dr. H. Hakansson stated that NUTEK budgets are being reduced to about SKr. 26 million for 1998, whereas over 50 applications have been received that request support in the amount of SKr. 150 million. NUTEK nanoscale program areas are (a) active materials and nanofunctional materials; (b) microsystems technology; and (c) peripherals.

Natural Sciences Research Council (NFR)

The Natural Sciences Research Council presentation by Dr. U. Karlsson emphasized that the NFR primarily supports basic research. The budget for physics is about SKr. 82.5 million, of which about 25% is for condensed matter physics. It was estimated that about 20-30% of the total NFR chemistry and physics budget supports nanoscale science initiatives, continuing the NFR history of strongly supporting nanoscale science efforts. It supports the Materials Science Consortia, of which the Nanometer Structure Consortium and the Clusters and Ultrafine Particles Consortium are part, and it also supports the National Facility at Göteborg University, which consists in part of experimental physics groups from Lund, Göteborg, Uppsala, Stockholm, and Umea Universities. Interestingly, the NFR also supports "senior research positions." At present it provides support for positions in the following areas: low dimension structures, mesoscopic physics, surface chemistry, and theory (4 positions). Two other positions are presently under consideration, one in cluster chemistry and another in the physics of small structures.

Swedish Foundation for Strategic Research (SSF)

The Swedish Foundation for Strategic Research is a relatively new organization, created in January 1994 with a SKr. 6 billion budget. As described by Dr. Marika Mikes-Lindback, the goal of the foundation is to support scientific, technical, and medical research. One objective is to build up competence in a field and then get companies founded to commercialize products in that field. Projects are 100%-funded by SSF. There are six main

programs, of which five are vertically oriented and one (Materials) is horizontally oriented. Two programs have large components of nanoscale science and technology:

Interdisciplinary Materials Research Consortia, receives about SKr. 42 million in support, about 25% of that for projects involving nanoscience. Table C.1 lists the Interdisciplinary Materials Research Consortia, together with their objectives and 1998 funding levels.

TABLE C.1. Sweden's Interdisciplinary Materials Research Consortia & 1998 Funding Levels

Consortium Leader	Objectives	1998 SKr (M)
Ångström Consortium Soren Berg	Methods and processes for preparation of surface coatings with controllable structure and composition	5.9
Thin Film Growth Lars Hultman	Growth of thin films for power electronics, for magnetic multilayers, and for wear-protective coatings	6.3
Nanometer Structures Lars Samuelson	Nanometer structures and their applications; fabrication and characterization	5.5
Clusters and Ultrafine Particles Nils Mårtensson	Physical and chemical methods for synthesizing and characterizing clusters and ultrafine particles	3.3
Biomaterials Bengt Kasemo	Physics and chemistry of surfaces and their interaction with biological systems	5.7
Theoretical and Computational Materials Physics Bengt Lundqvist	Theoretical and computer-aided methods and models and application to technologically relevant materials	4.7
Computer-Assisted Materials and Process Development Bo Sundman	Creation of a computer-based tool for materials and process development	4.1
Superconducting Materials Tord Claeson	Thin film HT _C materials preparation and characterization and optimization of their properties and applications	5.7

High Speed Electronics, Photonics, and Nanoscience/Quantum Devices receives SKr. 40 million in support, of which ~ 25% is targeted for nanoscience. This program is being established because Sweden believes that the microelectronics area is highly strategic for modern society and affects all sectors of industry as well as the information society generally. Its primary goal appears to be to open the pipeline to a continual supply of

well-trained and -educated researchers to industry. It is a joint strategic research program and graduate school at the Royal Institute of Technology (KTH), Chalmers University of Technology and Göteborg University (CTH/GU), and at Lund University (LU). The joint program is based on three research proposals submitted by CTH/GU (Components for High Speed Electronics), LU (Nanoscience) and KTH (High Speed Electronics and Photonics), all of which are judged to have current relevance to the Swedish microelectronics industry. The goal of the joint program is to “create research results within these research sub-fields, but specifically also to create novel ones by a strategic cooperation within and between the sub-fields and Swedish electronics industry.” The goal of the graduate school is to “provide Ph.D.s and Licentiate with a education which fulfills both the short term and the long term needs of the Swedish society and in particular the Swedish industry.” After the initial four-year startup period, students will be graduating at a rate of 15 per year, with 80% going to industry.

Defense Research Establishment (FOA)

The FOA is Sweden’s national defense research establishment. It has about 1,000 employees and an annual budget of SKr. 600 million. The defense research must function as a link between the possibilities offered by science and technology and the needs of the armed forces of Sweden. Dr. Steven Savage of the FOA’s Department of Materials gave a presentation entitled “Nanostructured Materials at FOA.” There has been a proposal presented to FOA to free up about 3% of the organization’s funds for nanoscale research programs. At present, there are only some small efforts that involve nanoscale materials within existing projects:

- molybdenum, chemical precipitation, and dynamic consolidation
- additives to new explosive compounds, e.g., aluminum or iron oxide particles
- high-strain-rate properties of nanostructured aluminum alloys
- coating 50 μm particles to create energetic materials with conducting layers
- fullerenes as optical limiters for laser protection

In an attempt at international collaboration, the FOA is participating in an EU project application for fabrication and study of nanostructured light materials. The coordinator of this project is Prof. Brian Cantor of Oxford University.

Individual Presentations from Research Groups

The last part of the workshop at KTH was devoted to presentations from individuals who gave brief overviews of the nanoscale science and technology research efforts in their individual groups.

Prof. David Haviland, now at KTH, described his efforts in nanostructure physics. He uses lithographically defined nanostructures to study electronic transport phenomena such as Coulomb blockage, spin-dependent transport, and theory involving quantum optics in nanostructures and diffraction optics in nanostructures. Prof. Haviland collaborates closely with Profs. P. Delsing and T. Cleason of the Single Electron Group at Chalmers.

Prof. K.V. Rao of KTH described his group's research in large scale applications of soft magnetic materials. The work is entitled Functional Nanometric Science and consists of three primary thrusts:

1. Production by several different techniques such as thin film deposition using rf laser ablation, rf sputtering, and e-beam deposition; rapid solidification technology such as melt spinning to produce GMR materials; and chemical co-precipitation techniques.
2. Characterization using surface probe microscopy; atomic force, scanning tunneling, and magnetic force microscopy (AFM, STM, and MFM) are key techniques.
3. Applications of nanostructures, under study as magnetic dots, novel GMR materials, high T_c -based tapes from nanosize precursors, nanolithography and carbon nanotubes and fullerenes as nanoscale electrodes.

Prof. Arne Rosén of Chalmers University of Technology and Göteborg University presented a detailed overview of the nanoscale science being carried out in his Molecular Physics Group. The title of his talk, "Clusters, Fullerenes, Nanotubes and Nanowires: New Building Blocks in Nanoscience," accurately describes the presentation. A brief description of the key areas of interest is given here. The key research areas in his group cover six main themes:

1. surfaces and catalysis
2. metal clusters
3. fullerenes and nanotubes
4. combustion engine research (there is a center dedicated to this work)
5. medical-related research
6. related other projects

Two areas that are almost entirely devoted to nanoscale work are the metal cluster and the fullerene and nanotube research areas. In both areas there is a strong experimental effort, coupled with a strong theoretical effort.

For example, the metal cluster experimental approach is directed towards studies of reactivity and electronic properties of free (molecular beam) metal clusters and studies of size-selected deposited metal clusters. The theory then examines electronic structure of free metal clusters, calculations of electronic structure for adsorbates on clusters, ab initio molecular dynamics (MD) calculations of clusters and adsorption on clusters, MD simulations of thermal properties, and simulations of cluster atom collisions. The approach taken in this group closely ties experiment to theory, as well as basic science to applied science.

Prof. Bengt Kasemo oversees nanoscience research that consists of three main thrusts:

1. Nanofabricated model catalysts. In this thrust, modern micro- and nanofabrication methods are used to provide a new avenue to prepare controlled model catalysts that are expected to realistically mimic real supported catalysts. These catalysts consist of 2-D arrays of active catalysts deposited on active or inactive support materials. Particle size, shape, separation, and support can be systematically varied. The structures are easily accessible to scanning probe imaging and surface analysis techniques. The 2-D analogs of supported catalysts are illustrated by Pt particles in the size range 10-500 nm deposited on alumina and ceria manufactured by electron beam lithography. The sintering mechanisms of Pt particles on support materials and the role of oxygen supplied from support material (e.g., ceria) in catalytic reactions are being studied.
2. Nanofabricated metal particles. Nanofabrication is used to create arrays of Ag particles of 100-200 nm in size and of different shapes in order to study the influence of these parameters on the ability to detect individual biological molecules using surface enhanced Raman spectroscopy. Kasemo's group has successfully shown this for colloidal Ag suspensions (3-D) as well as 2-D arrays of nanofabricated Ag particles made by electron beam lithography.
3. Colloidal lithography for biomaterials applications. Different methods are being explored to create surfaces of interest for biomaterials testing and applications by using large area topographic patterning of nanoscale features by colloidal lithography (8-200 nm). Specifically of interest is how nanometer-scale topography influences biomolecule and cell adhesion and function at surfaces.

Prof. Tord Claeson described the work in Nanoelectronics, Nanoscience at Chalmers University of Technology. Approximately 100 people are involved in this research effort. The main areas of interest are in high electron mobility transistors, electron hole drag phenomena, fabrication of junctions with small capacitance, phase coherent transport with possible

applications to superconducting mirrors, and biological applications in which they have shown that nanoscale TiO₂ fibers are engulfed by cells without cell collapse, whereas silica fibers cause cell collapse.

Prof. Mats Jonson overviewed the theoretical efforts at Göteborg University. About 15 theorists are involved in study of mesoscopic systems. Efforts are directed towards theoretical understanding of phase coherence in mesoscopic systems, strong electron correlation effects, nonequilibrium situations, high frequency microwave response, and mixed metal superconducting materials.

Summary

In the general discussion at the end of the workshop, the following themes were emphasized:

- In Sweden there is a good and close relationship between experiment and theory. Most groups or programs have a strong experimental as well as theoretical component.
- There is a strong sensitivity towards industry. Industry in Sweden puts money into development but not so much into research. One comment was that there are too few people with PhD-level education in industry. Programs were described during the workshop where this is being addressed.
- Large industrial firms in Sweden appear to be more closely coupled to the academic community in the universities than are smaller firms.
- Most technical research in Sweden is carried out in universities. Sweden does not have an institute/ national laboratory organization equivalent to that in some other countries.
- Nanoscale research is of interest to several industries, such as those interested in ceramics, powder metallurgy, thin films, electronics, magnetic materials, catalysis, and energy storage.

Site: **Nanometer Structure Consortium
Lund University
Department of Solid State Physics
Box 118, S-221 00 Lund, Sweden
Tel: (46) 46-222 00 00; Fax: (46) 46-222 36 37
<http://anders.ftf.lth.se/nm/nm.html>**

Date: 14 October 1997

WTEC: E. Hu (report author)

Host: Prof. Lars Samuelson, Consortium Coordinator
E-mail: laars.samuelson@ftf.lth.se

WTEC panel co-chair Evelyn Hu participated in a mini workshop at the University of Lund at which several scientists made presentations on their work, some working within the Nanometer Structure Consortium there, and some working in academia and industry at other locations.

This consortium, based at Lund University, was initiated about 1990. The Coordinator is Professor Lars Samuelson of Lund. It primarily involves the Lund University Solid State Physics group, although the interaction encompasses other departments at Lund, as well as collaborators at other universities such as Chalmers. Having a 10-year lifetime, the consortium is primarily funded by the Natural Sciences Research Council (NFR), and the National Board for Industrial and Technological Development (NUTEK). The consortium is guided by an Advisory Board, which includes industrial members and academic leaders both from Sweden and from other countries. The Chair of the Advisory Board is from industry. Industrial participation is considered important, and Lund hosts an adjunct Professor from Ericsson, who spends 20% of his time at the university, advising students and student projects. The very strong industrial support and commitment is believed to be linked to Swedish industry's recognition of the importance of long term research carried on within the universities. In addition to the funding from NFR and NUTEK, the consortium receives funding from the Research Council for Engineering Sciences (TFR) and also participates within ESPRIT programs, funded by the European Union.

As a point of interest, the graduate student population in this area is *not* diminishing in Sweden, as is true in many other countries. Part of the reason may lie in the fact that graduate students are given stipends, which are designed to be competitive with what MS students would be paid in industry (total funding for students is collected from grants, the university, and the

government). Another factor may be that industry hiring of PhD students has been more stable than in other European countries.

The consortium seems well equipped, having moved into new, expanded facilities in 1983. There are small clean room spaces for TEM and e-beam writing, extensive growth capabilities (gas source MBE, CBE), a newly installed ultrahigh vacuum chemical vapor deposition system for growth of silicon-based materials, and a host of characterization tools: micro PL, atomic force microscopy (AFM), and low temperature, high magnetic field apparatus. A highlight of the program is synthesis of aerosol particles (metals, subsequent conversion to semiconductors: GaAs, InP) with size selection, and the use of AFM manipulation to controllably position the particles. The consortium also makes use of the on-site synchrotron source, MAX-Lab, a national (and international) user facility that has recently brought up a larger, brighter ring that will be used for X-ray lithography, surface studies, and structure studies for biological samples.

The consortium held its annual review on the 13th and 14th of October, with a mixture of invited talks from outside speakers, and talks and posters presented by the consortium students. The invited speakers included Dr. Suhara from Tokyo Institute of Technology and Professor Fukui of Hokkaido University. Both researchers are carrying out joint projects with the consortium. Among the invited speakers were the following:

Thomas Lewin from Ericsson Microwave Systems offered an industrial perspective on quantum nanoelectronics, pointing out that although he could not give an answer to “what would nanoelectronic devices be used for,” that 50 years ago, one could hardly have predicted the current importance of the transistor. He noted that in 1948, at the time of invention of the transistor, the primary “high tech” companies were major vacuum tube suppliers such as GE, RCA, and Philco. Within ten years, catalyzed by the invention of the transistor, dominance of these companies had been ceded to Motorola, Texas Instruments (which had formerly specialized in geophysics), and Fairchild (which had formerly specialized in camera and instrumentation for air surveys).

Lewin noted the importance and pervasiveness of Moore’s Law, and how the transistor has been the pacesetter for technological development; whether we are prepared or not, the scaling down of current technology will place us in the “Nano Era” by about 2010 or so, and we should be prepared for it (Fig. C.1).

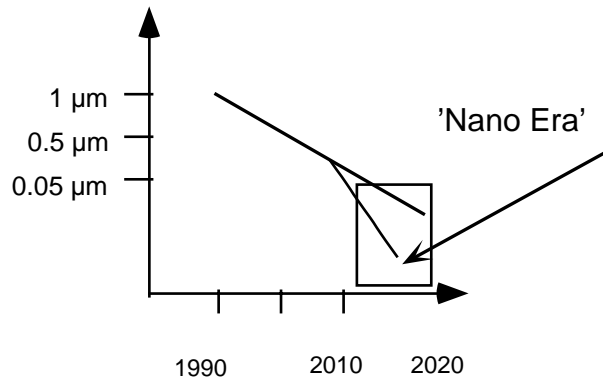

Figure C.1. Moore's Law in the "Nano Era."

Another interesting talk and industrial perspective was given by Dr. Sandip Tiwari of IBM, who spoke on "Nanocrystal and quantum-dot memories." His plan is to integrate and take advantage of silicon quantum dots in a more natural way, within the context of "mainstream" silicon electronics. This would entail the controlled and discrete charging of nanodots, placed immediately above a gate oxide in a MOS device, as a means of controlling the source to drain current, with an enormous gain in output compared to input signal. His claim is that such an application can operate at room temperature, integrate and enhance a dominant technology, and not suffer from many of the drawbacks of nanodots, such as long charging/access times and variations in dimension.

Appendix D. Site Reports—Japan

OVERVIEW OF NANOPARTICLE / NANOTECHNOLOGY RESEARCH IN JAPAN

Lynn Jelinski

When considered together, the WTEC panel's visits to Japanese sites revealed several important trends that augur well for Japan's success in nanotechnology. These trends include a substantial capital infrastructure, the high quality of the science, vigorous exchange of personnel, existence of mechanisms for scientific renewal, and established and growing collaborations between academia and industry.

Capital Infrastructure. The panel was impressed with the very large and recent investments in capital equipment for nanotechnology and microelectronics, both at the national labs and at universities. In places such as JRCAT, NRIM, ONRI, Osaka University, RIKEN, Tohoku University, and Tokyo University, panelists toured room after room of state-of-the-art fabrication and synthesis equipment, characterization equipment, and carefully designed cleanrooms for micro- and nanotechnology. Given this infusion of capital into infrastructure, Japan is well positioned to assume a leadership role in nanotechnology and nanoparticle science.

Quality of the Science. As would be expected for any large-scale and far-ranging laboratories tour, the WTEC panel encountered some research that mainly takes the work of others and advances it forward, perhaps with a new twist or wrinkle. However, the panel also encountered research groups that are defining the field and creating, rather than riding, the wave of scientific discovery and development. Examples of Japanese institutions where worldwide scientific leadership has occurred or is emerging in nanotechnology and nanoparticles include ETL, the Institute of Molecular Science, JRCAT, Kyoto University, NAIR, NEC, NRIM, RIKEN, and Tohoku University. The organizations that have a world leadership position tend to be those that have chosen a focus area (e.g., organometallic chemistry at IMS; nanoparticle synthesis at Tohoku University), rather than those that have lots of people working on too broad a range of subject areas.

Flow of Personnel and Ideas. The panel was impressed with the large numbers it observed of international postdoctoral fellows, students, visiting

scientists, and temporary researchers. There are apparently a number of programs in place in Japan to encourage international collaboration and cooperation. This flow of scientists and ideas in the field of nanoparticles and nanotechnology suggests that international scientists feel they have much to learn from Japan. This open flow of personnel also ensures that Japan has ready and early access to new ideas and technologies from abroad.

Mechanisms for Scientific Renewal. Focusing on the national labs such as IMS, NAIR, NRIM, and RIKEN, the team was impressed with their agility in moving into new scientific areas. Panelists heard of mechanisms to close down nonproductive programs, mechanisms to ensure fresh turnover of faculty (e.g., at IMS), and mechanisms to develop consensus on new areas of science (e.g., the Intelligent Materials Forum). Such mechanisms will help ensure Japan's leadership role, not only in nanotechnology and nanoparticle science, but in many other important areas of research and development.

Collaborations Between Academia and Industry. The panel was impressed with the large number of collaborations evident between academic labs and industrial workers. Many of the academic labs are staffed with long term visitors from industry. A single lab may have workers from competing industries, working side-by-side on company-specific projects. There does not appear to be particular concern about intellectual property rights.

Site: **Electrotechnical Laboratory (ETL)**
Ministry of International Trade and Industry (MITI)
1-1-4 Umezono, Tsukuba-shi
Ibaraki 305, Japan
Tel: (81) 298-54 5220; Fax:(81) 298-54 5088,

Date Visited: 22 July 1997

WTEC: R.W. Siegel (report author), D.M. Cox, H. Goronkin,
J. Mendel, H. Morishita, M.C. Roco

Hosts: Dr. Koichiro Tamura, Director-General of ETL
Dr. Tsunenori Sakamoto, Director of Electron Devices
Division; E-mail: tsakamot@etl.go.jp
Dr. Masanori Komuro, Leader, Micro-Beam Section,
Electron Devices Division
Dr. Junji Itoh, Electron Devices Division
Dr. Hiroshi Yokoyama, Leader, Molecular Physics Section,
Supermolecular Science Division
Dr. Hiroyuki Oyanagi, Leader, Exotic Matter Physics
Section, Physical Science Division

BACKGROUND

The afternoon of July 22 from 13:30 to 16:00 was spent at the Electrotechnical Laboratory (ETL) of the Agency of Industrial Science and Technology (AIST) of the Ministry of International Trade and Industry (MITI). It is more than 100 years old and is the largest national laboratory in Japan, with ~ 530 researchers and an annual budget of \$100 million, according to a general introduction to ETL presented by its Director-General, Dr. Koichiro Tamura. Of this budget, ~ 15-20% is currently focused on various aspects of nanotechnology. The four major fields of research and development activities at ETL are (1) Electronics and Bioelectronics, (2) Energy Technology, (3) Information Technology, and (4) Standards and Measurement Technology.

RESEARCH AND DEVELOPMENT HIGHLIGHTS

The work in the Electronics and Bioelectronics area, in which most of the nanotechnology efforts reside, is carried out primarily in four divisions,

which are themselves each comprised of several sections. These divisions, their constituent sections, and their respective leaders are as follows:

Physical Science Division (Dr. Hajime Shimizu)

Fundamental Physics Section (Dr. Shuji Abe)
Exotic Matter Physics Section (Dr. Hiroyuki Oyanagi)
Electron Physics Section (Dr. Hajime Shimizu)
Applied Physics Section (Dr. Shin-ichi Kuroda)

Materials Science Division (Dr. Kazuo Arai)

Materials Fundamentals Section (Dr. Hideyo Okushi)
Nonequilibrium Materials Section (Dr. Akihisa Matsuda)
Quantum Materials Section (Dr. Sadahumi Yoshida)
Superconducting Materials Section (Dr. Hideo Ihara)
Optoelectronic Materials Section (Dr. Toshiro Tani)

Electron Devices Division (Dr. Tsunenori Sakamoto)

Device Functions Section (Dr. Shigeki Sakai)
Device Synthesis Section (Dr. Toshihiro Sekigawa)
Process Fundamentals Section (Dr. Keizo Shimizu)
Micro-Beam Section (Dr. Masanori Komuro)
Microstructure Electronics Section (Dr. Kazuhiko Matsumoto)
Superconductivity Electronics Section (Dr. Akira Toukairin)

Supermolecular Science Division (Dr. Tetsuo Moriya)

Molecular Physics Section (Dr. Hiroshi Yokoyama)
Molecular Electronics Section (Dr. Hideaki Shimizu)
Molecular and Cellular Neuroscience Section (Dr. Toshio Iijima)

After an introduction to the ETL, our host, Dr. Tsunenori Sakamoto, Director of the Electron Devices Division, kindly provided answers to the questions posed by the WTEC panel prior to its visit. He said that his researchers are focusing on a single-electron device that can operate at room temperature (“smaller is better”) using scanning tunneling microscopy (STM) and electron-beam fabrication technologies, but he indicated that they were not yet successful. ETL is seven years into its 10-year Quantum Functional Device (QFD) Project (1990-2000), having spent about \$40 million so far, with \$8-9 million per annum anticipated for the

remainder of the project. According to Dr. Sakamoto, the proposals for the direction of ETL's work come "randomly" from industry, university, laboratory researchers, and MITI officials. His division expects a follow-on project on one-electron devices, and he also indicated that MITI has begun a new five-year project on fullerenes/nanotubes in Tsukuba at the National Materials Laboratory with funding of \$20-30 million for five years. Collaborations between ETL and the U.S. National Institute of Standards and Technology exist in the areas of STM and liquid crystals.

Technical presentations and laboratory visits followed. The laboratory facilities at ETL are extensive and excellent. They are typical of a mature and well funded research establishment in that all the necessary equipment is available, but the excesses have been avoided of other newer laboratories the panel visited, where there sometimes seemed to be more new expensive equipment than people to use it effectively.

Dr. Sakamoto continued with a description of some research activities at ETL on nanotechnology. He described an STM nanooxidation process for creating a one-electron device showing quantum blockade behavior. The process consists of an STM tip with a water droplet between it and a 3 nm thick layer of Ti on an SiO₂ layer on an Si substrate. TiO_x is formed at the STM tip/H₂O/Ti interface. ETL researchers are also doing this on stepped alpha-Al₂O₃ substrates. This technology has now flowed into other laboratories.

Dr. Masanori Komuro then described an electron-beam writer with a 3 nm diameter beam in ultrahigh vacuum—UHV (10⁻⁹ torr). Since the normal resolution of polymer resists (e.g., PMMA) with electron-beam lithography and a 50 keV electron gun is about 10-20 nm, higher resolution is needed. His staff report being able to do much better, yielding smaller features, with SiO₂ films using electron beam lithography. A single-electron transistor, written by W dots or wires from WF₆ using electron-assisted deposition, was reported to operate at 230 K.

Dr. Junji Itoh, standing in for Dr. Seigo Kanemaru (Senior Researcher in the Electron Devices Division), then reported on nanostructure activities in the area of vacuum microelectronics. Work was being carried out to create ultraminiature field-emitter tips (Mo, Si) for field emission displays. The tips have about 10 nm radii, can be created in two-dimensional arrays, and show increased emission levels. Because of problems with the stability of emission currents in conventional tips from reduced gas adsorption from the ambient atmosphere, development of MOSFET-structured emitter tips is being pursued, which will enable the combination of light emission and Si-based electronics on the same device structures.

Next, Dr. Hiroshi Yokoyama, Leader of the Molecular Physics Section, described ETL's Scanning Maxwell-stress Microscope (SMM), a new

instrument that can look at nanoscale electrical characteristics (work function or charge distribution) as well as structure (topography) by detecting electric long range forces with about 1 mV sensitivity. The instrument is based on an STM or atomic force microscope (AFM), but by oscillating the probe (tip), it is possible to obtain additional information regarding dielectric constant, etc. (Yokoyama et al. 1994; Yokoyama and Inoue 1994). With the SMM, it is even possible to look at living cells under water. The instrument is in use at ETL in various experimental forms, but it is also now beginning to be commercialized by Seiko Instruments (in a price range of \$500 thousand to \$1 million) in a UHV version with variable temperature capabilities (70-500 K) and both SMM and AFM modes of operation. Future directions for the research work in this area will investigate semiconductor nanodevices under UHV conditions and problems in nanobiology under water. New functionalities for the SMM will be developed using higher frequencies to investigate band structure and the effects of doping, as well as optoelectrical investigations in combination with near-field optical microscopy (an effort funded by AST).

Finally, Dr. Hiroyuki Oyanagi described some work in the Physical Science Division on probing nanostructures with EXAFS. Dr. Oyanagi's group has a close relationship with a number of other groups worldwide. Its EXAFS studies are being carried out at an undulator beamline at the Photon Factory about ten miles from Tsukuba. They have been able to induce local melting by optical excitation and subsequent quenching-in of disordered regions in Se, and they are hoping to use this method for memory applications, if it can be done microscopically. Dr. Oyanagi also mentioned very briefly some work going on in ETL's Materials Science Division on nanostructured one-dimensionally modulated GaAs quantum well systems.

REFERENCES

- Yokoyama, H., T. Inoue, and J. Itoh. 1994. *Appl. Phys. Lett.* 65:3143
Yokoyama, H., and T. Inoue. 1994. *Thin Solid Films* 242:33.

Site: **Hitachi Central Research Laboratory
Planning Office
1-280 Higashi-Koigakubo
Kokubunji-shi
Tokyo 185-8601, Japan
Fax: 81-423-27-7695**

Date Visited: 22 July 1997

WTEC: E. Hu (report author), L. Jelinski, C. Koch, D. Shaw,
C. Uyehara

Hosts: Dr. Shigeo Nagashima, Deputy General Manager and Head
of the Planning Office
Dr. Tadashi Ikeda, Head, Research Cooperation Center,
Planning Office
Ms. Yuko Nakamura, Research Cooperation Center,
Planning Office
Dr. Masanobu Miyao, Head, Electronics Material Center,
Electron Devices Research Department
Dr. Toshio Katsuyama, Sr. Researcher, Optoelectronics
Research Department
Dr. Atsushi Kikukawa, Research Scientist, Advanced
Research Laboratory
Dr. Masaaki Futamoto, Chief Research Scientist,
Information Storage Research Department.
Dr. Kazuo Yano, Sr. Researcher, Systems LSI Research
Department

INTRODUCTION

The Research Cooperation Center Planning Office of Hitachi Central Research Laboratory hosted the WTEC team's visit. We were greeted by Dr. Shigeo Nagashima, Deputy General Manager and Head of the Planning Office. Exact figures were not available as to the representation of nanotechnology research at Hitachi.

RESEARCH AND DEVELOPMENT HIGHLIGHTS

Dr. M. Miyao discussed the enhanced emission of light from SiGe quantum well devices, relating the quality of light emission with the quality of the interfaces of the quantum well, and the correlation lengths between Ge atoms.

Dr. T. Katsuyama gave a presentation on exciton-polariton quantum wave devices, achieved through confinement of excitons within quantum wires. He discussed a number of novel ways of forming the quantum wires. One method involved the formation of Au islands on GaAs or InAs surfaces. Upon heating, these Au dots formed liquid alloys of In/Au or Ga/Au. For substrates immersed in an arsine/trimethylgallium ambient, the liquid droplets provided the nucleation points for the selective growth of compound semiconductor whiskers (or quantum wires) as long as 1.5 μm , with a 15 nm diameter.

Dr. A. Kikukawa discussed some ways of achieving ultrahigh density recording using indentation by an atomic force microscope (AFM) tip (Fig. D.1). In addition to the recording of data through AFM indentation, read-out by AFM was also characterized. Dr. Kikukawa claimed a read-out rate of 1.25 MB/s with a 25 nm pit size.

Dr. M. Futamoto gave an excellent presentation on ‘near-term’ issues for improved materials for magnetic storage. He showed some examples of materials control at the nanostructure scale required for the formation of magnetic materials suitable for magnetic recording and novel magnetic “spin valves” (Fig. D.2). He showed charts on trends in recording areal density (Fig. D.3) and perpendicular recording using CoCrTa (Fig. D.4).

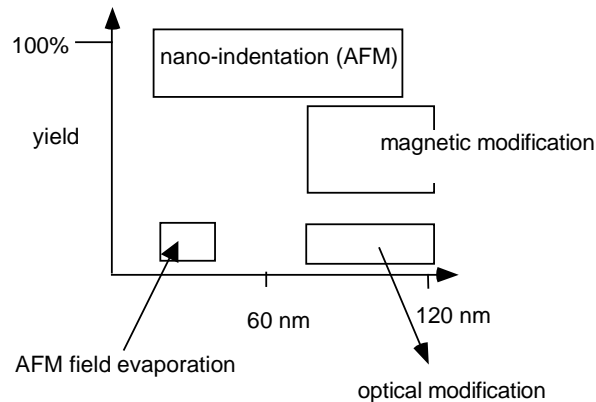

Figure D.1. Concept for high density data recording using nano-indentation (Hitachi).

50Å Ta
300Å CrMnPt
30Å Co
25Å Cu
10Å Co
50Å NiFe
50Å Ta

Figure D.2. Spin valve structure.

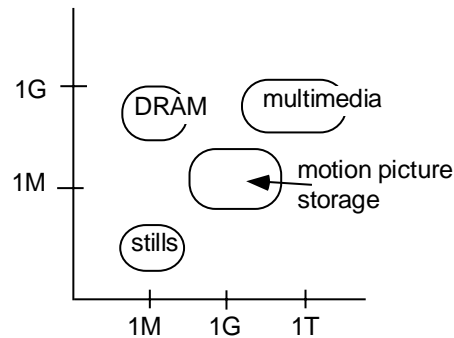

Figure D.3. Need for storage capacity, in bytes (Hitachi).

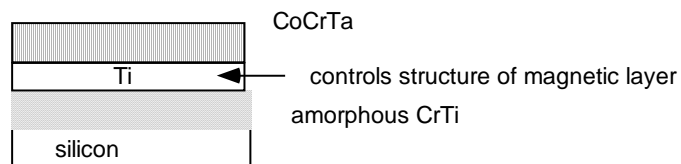

Figure D.4. Perpendicular recording using CoCrTa (Hitachi).

Dr. K. Yano discussed single-electron transistor (SET) memory schemes (Fig. D.5) where quantum dots would form the gate of the device. He described a memory cell ($0.8 \mu\text{m} \times 0.5 \mu\text{m}$) comprising the SETs, using a 2.5 V signal to carry out the 'reading' of the information bit, 10 V to erase a bit, and 15 V to write a bit. Although 10^7 write and erase cycles have been demonstrated, the operation of this memory cell is still rather slow (on the order of microseconds). Dr. Yano suggested that SET technology might be more easily demonstrated in memory devices, rather than in logic devices.

Dr. Yano also described work on novel polysilicon transistors (Fig. D.6) and on ladder-shaped memory cell arrays based on single-electron transistors (Fig. D.7).

The WTEC team's hosts were pessimistic about single-electron logic, stating that reliability requirements are severe. They stated that memory is different—it is possible to use conventional CMOS circuitry to insert different cell structures.

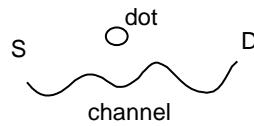

Figure D.5. Single electron memory concept.

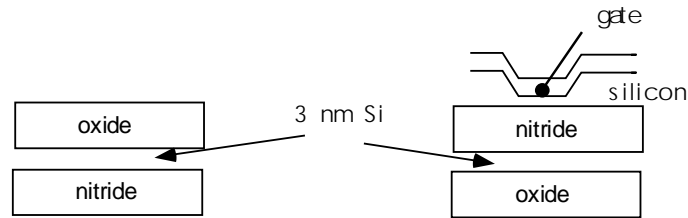
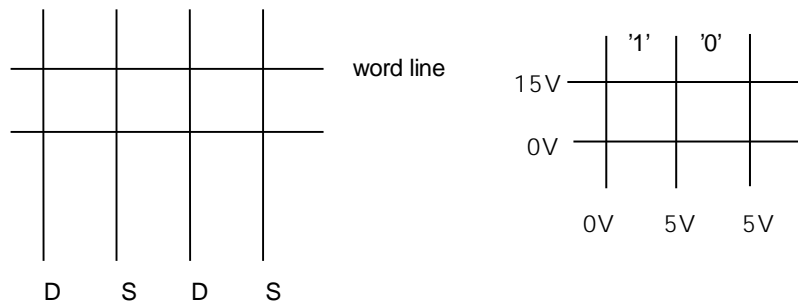

Figure D.6. Polysilicon transistors.



read 2.5 V, erase -10 V, write, 15 V
 0=0.01 nA, 10 seconds, slow writing time at 9 V
 w/erase 10 μ sec, still slower than DRAM
 showed 10^7 write/erase cycles

Figure D.7. Ladder-shaped memory cell array.

Site: **Institute for Molecular Science (IMS)
Okazaki National Research Institutes (ONRI)
Myodaiji, Okazaki 444, Japan
Tel: (81) 564-55 7240; Fax: (81) 564-55 5245**

Date Visited: 23 July 1997

WTEC: L. Jelinski (report author)

Hosts: Dr. Mitsuo Ito, Director-General
Dr. Mitsuhiro Shionoya, Professor
Dr. Makoto Fujita, Associate Professor
Dr. Takahiro Kusukawa, Assistant Professor
Dr. Tatsuhisa Kato, Associate Professor
Dr. Kyuya Yakushi, Professor
Dr. Yoshihito Watanabe, Professor

BACKGROUND

The Institute for Molecular Science (IMS) is one of three institutes under the umbrella of the Okazaki National Research Institutes. The other two are the National Institute for Basic Biology and the National Institute for Physiological Sciences. Together, they employ over two hundred professionals and about 180 technical and support staff. Each of the three Institutes is headed by a Director-General, who reports to the President. The Institutes are funded by the Ministry of Education, Science, Sports, and Culture (Monbusho).

RESEARCH AND DEVELOPMENT HIGHLIGHTS

Research at IMS is directed toward understanding the properties of molecules and molecular assemblies, and to the design and synthesis of new materials, especially those with novel properties. IMS is strongly oriented toward basic research. The faculty members have few teaching duties and can devote themselves full-time to research.

IMS has an unusual, almost Harvard-like method for ensuring that research remains fresh and of high quality: it imposes the rule that none of the assistant and associate professors can remain at IMS as full professors. Instead, they must go to another institution for promotion, as IMS always hires its full professors from outside. The faculty members with whom I

spoke, including junior professors, thought that this policy worked quite well.

Research at IMS that falls within the scope of this report is in the general category of synthesis of novel materials, some with inspiration from biology and some with biomolecules as the building blocks. Most of the work that involves nanoparticles involves some form of organometallic chemistry. The hallmarks of the research are two-fold: creativity, and the soundness by which the new materials are characterized and evaluated. Much of the research the WTEC team saw on this visit has been published in high quality journals such as *Nature* and the *Journal of the American Chemical Society*, attesting to the international reputation of IMS and the high quality of the research. Several of the faculty members have good collaborations with other scientists in Japan. One has an ongoing and productive NSF-funded collaboration with the University of Rochester, and another introduced the visiting WTEC team member to a visiting researcher, on leave from Emory University, who was spending six months in his lab.

Japan seems to be in a leadership role in the production of metallofullerenes. IMS has a large-scale facility for producing fullerenes, and Prof. Kato has been successful in producing C_{82} that contains Sc, Y, and La *inside* the cage structure. Kato is now using the metal inside the fullerene as a way to “tune” the reactivity of the outside. For example, he has shown how LaC_{82} can be reacted with disilanes and diazo compounds to form adducts. A combination of electron spin resonance (ESR) and theory is being used to explain the reactivity of the precursor and the products obtained. One could imagine how this ground-up assembly of nanomaterials could be polymerized to produce larger molecules with novel properties.

Another area of research involves the characterization of magnetic transport and optical properties in phthalocyanines (Pc). Of special interest is $PtPc(AsF_6)_{0.5}$, whose transport properties are being studied under high pressure.

Prof. Shionoya, a very young full Professor who recently came to IMS from Hiroshima University, is using novel combinations of DNA, metal ligands, DNA templating, and proteins to produce molecular wires and molecular hoops through which DNA could be threaded. He is also using double-stranded peptides whose helix pitch could be controlled by an entrained copper that could be induced to go from $Cu(I)_{tetrahedral}$ to $Cu(II)_{square\ planar}$, perhaps by electrons delivered by an STM tip. Figure 7.6 (p. 123) summarizes Prof. Shionoya’s vision of how bioinspiration could be used to produce nanodevices.

In a very creative and careful series of single point mutations, Prof. Watanabe has uncovered evidence for, and verified the existence of a “push-pull” mechanism for cytochrome C peroxidase. This was done by drawing

an analogy between peroxidase and cytochrome P-450, and using insights gleaned from similarities in the active site.

Finally, Prof. Fujita's work involves the approach of using self-assembly by transition metals to form organized large structures. He has been able to make various nanocages, which have potential applications for controlled drug release. He has also used three-dimensional organometallic cage compounds to achieve a "ship-in-a-bottle" synthesis of organic molecules and is currently producing nanostructured molecules with larger cavities than have ever been made before.

Site: **Joint Research Center for Atom Technology (JRCAT)
Angstrom Technology Partnership (ATP)
c/o National Institute for Advanced Interdisciplinary
Research
1-1-4 Higashi, Tsukuba, Ibaraki 305, Japan
Tel: (81) 298-54 2570; Fax: (81) 298-54 2575**

Date Visited: 22 July 1997

WTEC: R.W. Siegel (report author), D.M. Cox, H. Goronkin,
J. Mendel, H. Morishita, M.C. Roco

Host: Dr. Eiichi Maruyama, Executive Director and General
Director of Research Center
E-mail: maruyama@jrcat.or.jp

BACKGROUND

Tuesday morning 9:30 to 12:00 noon of 22 July was spent in Tsukuba visiting the Joint Research Center for Atom Technology (JRCAT), an organization founded in February of 1993 through a joint contract between the National Institute for Advanced Interdisciplinary Research (NAIR) and the Angstrom Technology Partnership (ATP). These latter organizations were created by the Agency of Industrial Science and Technology (AIST) of the Ministry of International Trade and Industry (MITI). The central focus of JRCAT is the Atom Technology Project, a ten-year effort begun by AIST in fiscal year 1992 as one of its Industrial Science and Technology Frontier Programs under the official title, *Research and Development of Ultimate Manipulation of Atoms and Molecules*. AIST's total ten-year budget for this project is about ¥25 billion (~ \$250 million), which flows mostly (~ 90%) through the New Energy and Industrial Technology Development Organization (NEDO) and hence ATP, with the balance (~ 10%) flowing directly through NAIR. The distinct advantage of this imbalance for JRCAT is that the NAIR funds are hard (national) monies that cannot be used for hiring people, while the ATP funds are soft (invested) monies that can be used very flexibly. The Atom Technology Project is envisioned as comprised of overlapping efforts in atom manipulation, nanoscale self-organization, and critical-state phase control based on in situ dynamic measurement and control complemented by *ab initio* calculation.

The WTEC panel visit was hosted by Dr. Eiichi Maruyama, Executive Director of ATP and the Atom Technology Project Leader, who presented a

very informative and extensive introduction to JRCAT and its research efforts. JRCAT presently has 36 administrators and about 100 research scientists, of whom 35 are from industry, 28 are from national laboratories, 7 are from universities, 26 are postdocs, and four are PhD candidates. About 60% of the scientific staff are supported from ATP and 40% from NAIR. Of these, there are 78 PhDs, 21 foreign scientists, and 3 female scientists. The total funding flow has been reasonably steady since FY1995 at about ¥2.5 billion per annum, with significant fluctuations in the first three years for initial capital expenditures. The publication of research results in “major” journals (i.e., those with high citation impact factors, such as *Nature*, *Science*, *Physical Review Letters*, *Applied Physics Letters*, and *Physical Review B*) appears to be used as a measure of research program success. There have been a significant number of such publications (~ 120 per year) from JRCAT during FY94-FY96.

RESEARCH AND DEVELOPMENT HIGHLIGHTS

The Atom Technology Project research program is lead by Project Leader E. Maruyama along with Deputy Project Leaders K. Tanaka (experiment) and K. Terakura (theory) and is organized into 11 groups in four general areas. These are as follows (with leader):

Solid Surface and Solid Material

- Measurement and control of atomic level structures by mechanical probe—19 scientists (H. Tokumoto)
- Observation and formation of atomic scale structure using beam technology—8 scientists (M. Ichikawa)
- Measurement and control of surface reactions for nanostructure fabrication—7 scientists (M. Ozeki)
- Atomic level analysis and control of II-VI semiconductor surface—6 scientists (T. Yao)
- Exploration of transition metal oxides and organic molecular system—8 scientists (Y. Tokura)
- Exploration of amorphous semiconductors, magnetic thin films, solid-liquid interfaces—15 scientists (K. Tanaka)

Cluster in Free Space

- Formation and control of clusters in ion trap and on solid surface—4 scientists (T. Kanayama)

Organic Molecular Structure

- Scanning probe microscopy (SPM) and optical analysis for DNA and organic molecular structure—11 scientists (T. Okada)

Quantum Simulation of Atomic and Molecular Processes

18 scientists are working on several programs, including the following:

- Organic molecular system, new techniques for computer simulation (K. Terakura)
- Semiconductor materials (T. Uda)

The theory group is also responsible for the JRCAT Supercomputer Laboratory, introduced in March 1994.

Formal evaluation of the research program is held only at its midpoint (six years) and end (ten years), but annual reports are produced. Successful efforts are expected to be transferred to industry. Some projects are continued under new programs, and others are terminated after these evaluations. The second phase (next 4 years) of JRCAT will see increased collaboration with industry, a new study on spin-electronics applications, and an effort to maintain top-level atom technology. The primary scope of the Atom Technology Project will continue to include nanostructure formation and control of surfaces and interfaces (especially in semiconductor and related materials); spin electronics (new materials and measurements); observation and manipulation of atoms and clusters; and theoretical simulation (emphasizing good interaction with experimental groups).

In carrying out its mission, JRCAT interacts with foreign universities via contact and exchange of scientists (e.g., with the University of Birmingham in the UK). Also, the science and technology laws in Japan were changed ca. 1995 to allow Japanese university professors to have more significant interaction with JRCAT and other industries.

The WTEC panel also made visits to four JRCAT research laboratories, the Advanced Interdisciplinary Laboratories of Drs. K. Tanaka, K. Ichikawa (H. Watanabe, host) and Y. Tokura (A. Asamitsu, host), and the Theoretical Research Laboratory of Dr. K. Terakura. The group of Dr. H. Tokumoto was unfortunately away at a conference that day; it is active in attempts to create nanoscale ferroelectric domains by scanning force microscopy (SFM) for nonvolatile, high density memories, sensors and actuators, but is mainly working at the micron scale at present. It also works on self-assembled monolayers (SAM) on surfaces, particularly those that are electrically conductive. All of the groups are extremely well equipped with all of the latest facilities and capabilities necessary to carry out their respective missions.

The Tanaka group laboratory is located in a specially vibration-isolated separate building in the NAIR facilities. The primary research themes of this group are (1) fabrication of semiconductor nanostructures and investigation of their defect structure, (2) creation of magnetic superstructures and searching for new magnetic materials, and (3) elucidation at atomic/molecular levels of the electric double layer at solid-liquid interfaces. Work is ongoing in developing high resolution Raman spectroscopy for the study of molecules on surfaces. It was reported that information from individual molecules can be obtained by coupling to surface plasmon polarization, which enhances the signal by three orders of magnitude. Also, atom manipulation (atom and layer removal) by scanning tunneling microscope (STM) tips is being carried out on Si (mainly) and high temperature superconductors in a UHV-STM without damaging the surrounding regions.

The Ichikawa group has as its primary research themes (1) development of an atomic manipulation system using beam technology and extremely high vacuum pumping, (2) development of surface/interface characterization technologies, and (3) exploration of surface/interface reactions useful for nanostructure formation. The laboratory contained a state-of-the-art 30 keV UHV field-emission scanning electron microscope (SEM) with an SPM being used for Si-based nanostructures. For this development project, a unique STM with atomic resolution was developed on a 6-axis manipulator in the UHV-FE-SEM, but because of unique problems with vibration isolation, the system requires a special isolation room. Electron holography using a biprism to produce 2 coherent beams from the FE (field emission) gun was also in place on the SEM and was being used to create nanoperiodic structures (with 17 nm wavelengths) on SiO₂. In another major development project, a multifunctional Surface Analysis System, with Auger analysis with a 1.4 nm diameter beam probe, was built in this group. About \$2.5 million was spent on each of these two major development projects.

The Tokura group (also partly at the University of Tokyo) focuses on the synthesis and physics of oxide electronic materials and organic molecular systems. Examples of current work are the floating-zone crystal growth, in a parabolic mirror image furnace (manufactured by NEC), of large single crystals (e.g., Pr_{0.65}Cu_{0.35}MnO₃); investigation of natural one-dimensionally modulated nanostructured superlattices (...+ insulating + magnetic + insulating +...) for giant or colossal magnetoresistance (GMR or CMR) applications; and studies of electric-field-induced resistivity changes in ... + insulating + metallic + insulating + metallic + ... multilayers, such as Pr_{1-x}Ca_xMnO₃ (e.g., x = 0.3), below 100 K. A main focus of the group's research is using laser ablation to build layers by cluster assembly on stepped substrates of SrTiO₃ for functional device applications. A system

with five movable targets and a fixed laser is being used for this work, and the studies are carried out as a function of substrate temperature and oxygen partial pressure.

Finally, the WTEC team visited the Terakura theory group, led by Dr. Kiyoyuki Terakura, who has been at JRCAT for about three and a half years. This world-class theory group specializes in first-principles, state-of-the-art quantum simulations of atomic and molecular processes in the areas of semiconductor surfaces, transition metal compounds, and exotic materials such as conducting organic solids (e.g., DCNQI-M, with M = Li, Ag, Cu). The group also develops new computational methodologies for approaching such problems and is responsible for the large-scale supercomputer system at JRCAT, consisting of two main computers—a vector-parallel computer (VPP500/32) and a massively parallel computer (128 node CM-5E). The theory group has good interactions with the experimental efforts at JRCAT; although frequently the experimentally investigated systems can be rather complex for fundamental theoretical simulation, serious theoretical efforts are made to benefit the experimental program. The Terakura group also has extensive external collaborations with NEC, Hitachi, Fujitsu, and various universities in Japan and abroad. In addition to its normal publications, the theory group disseminates the results of its efforts in a series of well-prepared annual reports.

Site: **Kyoto University**
Graduate School of Energy Science
Yoshida, Sakyo-ku
Kyoto 606-01, Japan
Fax: (81) 75-753 5464

Date Visited: 25 July 1997

WTEC: C. Koch (report author), D.M. Cox, J. Mendel, H. Morishita,
R.W. Siegel

Host: Professor Paul Hideo Shingu, Dean

BACKGROUND

This visit concentrated on the laboratory of one professor, Professor Paul Hideo Shingu at Kyoto University. He has a group of associates and graduate students (about 15) and is funded by the Ministry of Education, Science, Sports, and Culture (Monbusho).

RESEARCH AND DEVELOPMENT HIGHLIGHTS

Professor Paul Hideo Shingu was the WTEC panel's host. He is the Dean of the Graduate School of Energy Science at Kyoto University. He is a pioneer in the use of severe mechanical deformation to produce nanocrystalline (nc) microstructures. He was the first researcher to demonstrate the synthesis of nc materials by mechanical alloying (high energy ball milling) in the Ag-Fe immiscible system in a paper published in 1988. His group was the first to point out that nc materials can be made by MA. Much of his group's work in this area is summarized in a paper by P.H. Shiugu in *Materials Transactions JIM* 36:96 (1995). In order to be better able to define the mechanism(s) involved in creation of nc materials by severe plastic deformation, Prof. Shingu turned to the method of repeated press-rolling of component foils or powder mixtures. This "deterministic" mechanical alloying has allowed for both experimental studies of the developing microstructure—by, for example, high resolution transmission electron microscopy (HRTEM)—and the modeling of the microstructure by computer simulations. He and his coworker, Dr. K.N. Ishihara, have used chaos theory to model the microstructure obtained in shearing of dissimilar components, based on several simple approaches such as the baker's transformation, linear shear, and parabolic shear. The iteration of certain

mapping generates chaos. It is noted that the application of precisely deterministic mapping can generate a chaotic mixing of initially macroscopically separated structures by a surprisingly small number of repeated applications of a mapping. This is analogous to the structures observed experimentally due to the mechanical deformation.

Among the systems Shingu's group has studied are immiscible systems such as Ag-Cu and Cu-Fe, which form metastable solid solutions; Ag-Fe, which forms an nc composite microstructure; and Co-Cu, which exhibits the giant magnetoresistance (GMR) effect.

The preparation of multilayers by repeated rolling requires careful control of the process. Component foils (or powder compacts) are first annealed in vacuum, pressed together in vacuum, annealed, then repeatedly rolled and annealed. The selected annealing temperature is critical to maintaining the planarity of the layers and to avoid their spheroidization, while relieving the deformation strains to allow further rolling.

HRTEM of the layered structures reveals nc grains within the layers, with rotation of the grain into an apparent epitaxial relationship with the other component.

The panel's other observations on this visit include the following:

- the rolling of mixed powder compacts has produced results similar to those with foils
- a number of mechanical and magnetic measurements have been made on these samples
- it is believed this method of repeated rolling could be scaled up to commercial quantities, since rolling technology is well developed in the steel industry, as one example
- Shingu's group consists of several professionals, one technician, and 15-20 graduate students

A tour of the laboratory facilities revealed several critical processing devices such as a pseudo hot isostatic press (HIP), a good four-high rolling mill, and a vacuum hot press. Characterization facilities, such as a transmission electron microscope, are shared with others in the Department.

Professor Shingu's research differs in the smaller scale of his effort from that carried on by the large groups at national laboratories and IMR at Tohoku University. However, the innovative and creative studies done in his group have made significant contributions to the field of nanostructured materials.

REFERENCE

See also Yasuna et al. 1997. *J. Appl. Phys.* 82(5):2435-2438.

Site: **Nagoya University**
Department of Crystalline Materials Science
Furocho, Chikusa-ku
Nagoya 464-01, Japan
Fax: (81)-52-789-3821

Date Visited: 25 July 1997

WTEC: D. Shaw (report author), E. Hu, L. Jelinski, M.C. Roco,
C. Uyehara

Hosts: Professor Uichiro Mizutani
Professor Toshiharu Fukunaga
Professor Nobuo Tanaka
Professor Jun-ichiro Inoue

RESEARCH AND DEVELOPMENT HIGHLIGHTS

Professor Toshiharu Fukunaga, Nanoparticles by Mechanical Milling

The X-ray diffraction spectrum of milled graphite was the same as for amorphous material. The density decreased from 2.2 to 1.85 g/cm³ in 36 hours of milling. Neutron diffraction confirmed the disorder. These results were analyzed to calculate the radial distribution factor that gives the coordination number, which reduced from 3.01 to 2.82 in the 36 hours. It is believed that this describes production of dangling bonds in the milled material. Assuming the crystalline structure is unchanged upon milling, only the size of the particles changes and the coordination number decreases. The size was estimated to be about 27 Å.

Transmission electron microscopy (TEM) before milling showed a layered graphite-like structure. After milling the material was amorphous.

Ball milling is done at low temperature. The equipment has a 150 G (x gravity) capability but 10 G is used in work in this department.

Trigonal selenium was also milled. Using the same analytical procedures as above, it was estimated that the particles contained about 22 atoms.

Li and graphite were milled together. The Li incorporates into the graphite and coats the balls to produce a gold-colored LiC₆ film. The Li is inserted into the hexagonal C network if the milling intensity is kept low. The potential application is to batteries. One of the technical challenges is to remove the material from the balls.

Professor Nobuo Tanaka, Electron Microscopy

Prof. Tanaka described nanobeam drilling using e-beam, which showed approximately 1 nm square windows drilled with a cylindrical beam. The lattice was distorted around the periphery of the window.

Tanaka discussed a number of other issues, including granular magnetoresistive structures and mass production of fine particles, but it was not clear whether the work was done at Nagoya University or pulled from the literature.

Tanaka showed a video of two sharp gold tips coming together to create a liquid-like interface. The tips were electrolytically sharpened. As seen in the video, the tip diameter was about 10-15 atoms. As the tips separated, the liquid-like region took on the lattice constant of one of the two tips. Previously, this demonstration had been reported with a tip and a flat surface.

Professor Jun-Ichiro Inoue, Transport Phenomena in Macroscopic Magnets

Prof. Inoue has calculated the magnetoresistance ratio vs. surface/volume ratio of FeCr granules in a matrix. The model was independent of matrix material and distance between clusters. Although the assumed spacing was 2-5 Å, interactions were not included. Data from Tohoku University of a tunnel diode with Co-AlO granular barrier had a four order of magnitude drop in resistivity and a constant MR ratio of about 19% at 4.2 K. The barrier thickness was about 1.0 μm, and the maximum voltage was 1.0 V. Typical barrier thickness reported in the literature is about 10-15 Å, so the Tohoku data applies to fields that are about 1E7 lower than structures designed for memory cells or hard drive heads.

The decrease in resistivity was explained by the charging energy of the single-electron-like granules, although this explanation seems unlikely to this author.

Site: **National Institute for Advanced Interdisciplinary
Research (NAIR)
Cluster Science Group
1-1-4 Higashi
Tsukuba, Ibaraki 305, Japan
Tel: (81) 298-54 2540; Fax: (81) 298-54 2949**

Date Visited: 23 July 1997

WTEC: D.M. Cox (report author), H. Goronkin, E. Hu, J. Mendel,
H. Morishita

Host: Dr. Harutoshi Takeo, Leader of Cluster Science Group
E-mail: takeo@nair.go.jp

BACKGROUND

NAIR, the National Institute for Advanced Interdisciplinary Research is one of 15 research institutions of AIST, the Agency of Industrial Science and Technology. The focus of the AIST laboratories is concentrated on R&D programs judged to be capable of raising the level of Japan's technology in four main ways:

1. nurture new leading-edge technology that will lay the basis for future technical innovation
2. establish basic technical standards
3. meet the society's needs for earthquake prediction, pollution prevention, and environmental preservation
4. embrace all basic or general research that is appropriate for a national research organization

NAIR was founded in January 1993 with an objective of pursuing interdisciplinary research themes covering fundamental and frontier areas of industrial science. The institute is dedicated to the creation of international intellectual properties in broad fields of basic and strategic R&D, where national funds are expected to play a positive role. NAIR is characterized by the tripartite collaboration of industrial, academic, and governmental sectors, as well as by international cooperation. It is portrayed as an innovative attempt to overcome institutional boundaries by bringing together scientists of diversified specialty—not only from research institutes under AIST and the Science and Technology Agency (STA), but also from universities and research organizations in the private sector—to engage in intensive joint research.

RESEARCH AND DEVELOPMENT HIGHLIGHTS

NAIR had four main research projects at the time of the WTEC visit:

1. The Atom Technology Project. This project has as its goal the ultimate technology for manipulating atoms and molecules; it started in January 1993 and runs until March 2002; total budget is ¥25 billion.
2. Research on Cluster Science Project. The goal of this project was experimental and analysis of the character of clusters; it ran from January 1993 until March 1998; total budget was ¥1 billion.
3. Research on Bionic Design Project. The goal of this project was to advance understanding in cell and tissue engineering and molecular machines; it ran from January 1993 until March 1998; total budget was ¥1 billion.
4. Basic Research on Next Generation Optoelectronics. The goal of this project is large capacity optical memory; this is a new program with seed money first available in April 1996; start date appeared to be April 1998, running until March 2003; total budget in April 1996 was ¥80 million for defining program goals and directions.

In addition to the above projects, NAIR has carried out several two- to three-year feasibility studies since its formation in 1993. The Atom Technology Project is the subject of a separate review in the JRCAT site report (p. 256 of Appendix D). The remainder of this report will focus on the Research on Cluster Science Project.

Research on Cluster Science

Dr. Harutoshi Takeo, the Cluster Science Group Leader, greeted the WTEC panel and first presented an overview of the science projects in his group, then led the panel on a tour of the laboratories. The cluster group consists of about 30 researchers, with nine regular research staff members, seven staff members on assignment from other AIST institutes, one from a university, 9-11 postdoctoral fellows, of which seven or eight are foreigners, and two to three graduate students. To further broaden the perspectives of the Cluster Science Group, it organizes a yearly workshop to which it invites 15-20 outside researchers. Over the lifetime of the project over 90 outside scientists will have participated in and contributed to these workshops.

The Cluster Science Group's research areas fall roughly into four areas:

1. clusters in collisionless environments (molecular beams)
2. clusters in liquid or solution
3. clusters stabilized on surfaces or in matrices
4. clusters stabilized in a nanocage such as a zeolite

In the collisionless environment the main activities are focused on probing the structure and reactivity of clusters under single collision conditions. The research facilities, which have been designed and built entirely from scratch since mid-1993, include a Fourier transform ion cyclotron resonance mass spectrometer with which cluster structures are studied via laser spectroscopy; cluster chemical reactivity is being probed through controlled introduction of various molecular species. A second apparatus, a cluster beam system, combines infrared pumping of molecular adsorption on clusters with resonantly enhanced multiphoton ionization techniques to interrogate cluster and molecular bonding. Bonding of aniline and aniline dimers to a variety of different molecules has been studied.

To study the properties of liquid clusters, an expansion liquid droplet source together with a time-of-flight mass spectrometer (reflectron mode) was built. Study of mixtures of water/ethanol solutions have shown an evolution from clusters consisting of mostly water molecules complexed with one or two ethanol molecules for high concentration of water in the mixture, to clusters consisting of mostly ethanol molecules complexed with one or two water molecules when the ethanol concentration in the mixture reaches 40% or more. Such studies allow fundamental intermolecular interactions of molecules in liquids to be investigated.

To probe the properties of clusters on supports, several sophisticated pieces of experimental apparatus were built. One especially impressive experiment uses a liquid metal source (heated crucible) to produce clusters that are deposited on a cryogenic substrate in order to stabilize them. The apparatus is interfaced with an X-ray source. The substrate with different cluster deposits is rotated in-situ, allowing X-ray determination of the structure to be investigated as a function of the metal type, the cluster size, the substrate material, and the temperature. Interestingly, gold clusters with size < 6 nm are found to have icosahedral structure and not the fcc structure of bulk gold. Upon warming the substrate, the clusters sinter and the development of the fcc structure can be followed as a function of temperature. Studies of gold-copper alloy clusters also show icosahedral structure for clusters less than about 6 nm. Several other metal and metal alloy systems will be examined.

To investigate the quantum properties of nanometer-sized materials, the Cluster Science Group is attempting to stabilize metal clusters in the channels of zeolites. Specifically they have put sodium into the channels of an LTA zeolite in the hopes of producing a quantum wire. The sodium-doped materials have been shown to exhibit photochromic behavior, exhibiting reversible darkening upon exposure to light. In contrast, potassium-doped zeolites investigated by another group exhibited ferromagnetic behavior.

One of the researchers has developed a terahertz spectrometer capable of probing molecular vibrations in the 15-30 cm^{-1} range. At the time of the WTEC visit, this spectrometer appeared ready to be applied to real problems.

CONCLUDING REMARKS

In the short time it has existed, the NAIR cluster group has put together some of the best approaches of any group in Japan to study fundamental science issues. They began with virtually no equipment in 1993 and have designed and built a series of sophisticated apparatuses, each focused on probing a specific fundamental issue of cluster science. The unfortunate event was the termination of this effort in March of 1998. In this particular instance, the researchers are just beginning to harvest the results of careful and thoughtful design of state-of-the-art equipment. In at least one instance the apparatus was just coming on line at the time of the panel's visit, and that particular scientist will have only a few months to generate data before termination of the program.

It was the WTEC panel's perception that several of the researchers (almost all fairly young) did not yet have positions to which they could move. Some of the older researchers obviously will be able to return to their sending organization, but several were hired directly into this project and had no ties to any outside organization. We were informed that each researcher will be allowed to keep his equipment in the new position, which is certainly good news, but "the termination of the program" was a theme that had certainly raised the anxiety level of many of the staff. The quality of the research and the novelty with which these young researchers have approached science could serve as a model for other groups in Japan; namely, the researchers were allowed (even encouraged) to identify interesting cluster science problems and then design experimental apparatus to probe these problems, rather than to just buy equipment. This appears to have born fruit, but the fruit may dry up before harvest can occur.

Site: **NEC**
Electron Devices Laboratory
34 Miyugaoka
Tsukuba, Ibaraki 305, Japan
Fax: (81) 298-56 6135

Date Visited: 23 July 1997

WTEC: H. Goronkin (report author), D. Cox, J. Mendel,
H. Morishita, M.C. Roco, R.W. Siegel

Hosts: Dr. Kohroh Kobayashi, General Manager, Fundamental
Research Laboratories
Dr. Jun'ichi Sone, Senior Manager, Advanced Device
Research Lab
Dr. Y. Ochiai, Manager, Advanced Device Research Lab
Dr. K. Tanaguchi, Manager, Exploratory Research Lab

BACKGROUND

Funding: 1% of NEC's sales go to its Corporate Research Laboratory
(including the Fundamental Research Laboratories)
70% of funding is from the corporate level
30% is contract funding from business groups
15% of funding for Fundamental Research Laboratories is
from business groups and national projects

Targeting: Business group R&D, from three to five years
Fundamental R&D Labs, from five to ten years

Staffing and Foci of NEC Labs: Tsukuba: 300 (devices, materials, fundamental orientation)
Kawasaki: 1,100 (computer and communication systems,
software, and components)
Princeton: 50-60 (computer science and physical science)
Berlin, Bonn: (computers and communications software for
parallel computers and ATM transmission technologies)

RESEARCH AND DEVELOPMENT HIGHLIGHTS

K. Taniguchi—Si, Ge, C Clusters

- the Exploratory Research Lab has synthesized buckyball magic numbers of 20, 24, 46, and 60 and has achieved >100
- change bonding from van der Waals to covalent by changing number of atoms in the ball
- doping provides conductivity and superconductivity
- need ionized Si or Ge; quench to remove electron and form 20 or 24 atom cages
- modify substrate to form clusters by adding electrons by doping, ion implantation, e-beam
- critical temperature for silicon cages is 6-8 K

Y. Ochiai—Nanofabrication

The Goal of the Advanced Devices Research Lab is 10 nm scale lithography using e-beam. It needs a capability by 2007 for manufacturing 16 Gbit DRAMs. Previous work on short gates includes 100 nm in 1987, 45 nm in 1993 using a 50 keV field emitter beam having less than 5 nm beam diameter at 100 pA; and 40 nm in 1997.

The lab is using $T_{ox} = 3.5$ nm and is working on 1 nm SiO_2 . Although tunneling will exist, it is believed that the small area of the gate oxide will limit gate current to a negligible fraction of the channel current.

W/L scaling is not maintained at 2:1.

The lab developed an e-beam resist (Calixarene, molecular weight 1,000) for the 10 nm project in which resolution is limited by the six benzene ring length to 6 nm; 10 nm lines show smooth edges and regular spaces. The resist was licensed to other companies for commercialization.

Atom Beam Holography

Starting with a Ne discharge, the neon momentum is decreased and the atoms are trapped in a laser beam. The Ne atoms are allowed to fall under gravitational attraction and they pass through a hologram plate before dropping onto a microchannel plate, where they excite an image. The large mass of Ne compared to electrons provides a large increase in resolution. According to quantum mechanics, the wave of a single Ne atom can pass through thousands of holographic channels simultaneously where it is diffracted and then recombined to form images on the microchannel plate. It

is hoped that this can be used for future 1 nm lithography. It currently takes seven hours to form an image. This project began in 1995 in collaboration with the University of Tokyo.

Jun'ichi Sone—Nanoelectronics

Encouraged by Advanced Device Lab's success with e-beam lithography using Calixarene resists to obtain 10 nm features, various device structures become possible. The Lab's goal is to look for the classical-quantum crossover in MOSFET structures. There are many potential problems, including source-drain tunneling (S-D) and tunneling through the gate insulator. An EJ MOSFET (electrically variable junction MOSFET) was fabricated with gate lengths from 134 nm to 32 nm. A second gate located over the channel control gate was used to modulate the resistance of the source and drain virtual access regions. Satisfactory saturating characteristics were obtained down to 32 nm. At 32 nm, short channel effects were observed; however, no S-D tunneling was observed. At this writing, a 15 nm gate was achieved but results were not reported. It is hoped that when quantum effects are observed, useful novel devices can be made.

The advanced e-beam lithography with PMMA resist was used to fabricate a metallic single-electron transistor using Al/Al₂O₃/Al island/Al₂O₃/Al. The process involves opening a 20 nm window between source and drain. The Al is oxidized to form Al₂O₃, and Al is deposited in the window to form the island region. Extremely reproducible drain current peaks as a function of gate voltage were obtained. Unlike semiconductor SETs, for example, where the peaks are of uneven height, the lack of depletion and charging of defects provides uniform heights in the metallic system. It is believed that 10 nm islands could provide room temperature operation.

CONCLUDING REMARKS

NEC's Electron Devices Laboratory is one of the top labs in the world in nanoelectronics. This lab seems to be able to quickly start new programs in promising areas and to change direction when fundamental obstacles block the path to progress. The Atom Beam Holography and the 10 nm gate projects are at the leading edge. The lab appears to be clear in its understanding of how its research fits into future company needs and how the research must be directed to produce world-leading results.

Site: **National Industrial Research Institute of Nagoya (NIRIN)**
1 Chome Hirate, Kitaku
Nagoya 462, Japan
Fax: (81) 52911 1661

Date Visited: 25 July 1997

WTEC: J. Mendel (report author), D.M. Cox, C. Koch, H. Morishita,
R.W. Siegel

Hosts: Dr. Shuzo Kanzaki, Chief Senior Researcher
Dr. Mutsuo Sando, Research Manager
Dr. Sakae Tanemura

BACKGROUND

The National Industrial Research Institute of Nagoya (NIRIN) has as its mission to carry out advanced materials research on ceramics, metals, composites, and related materials. Established in 1952, its main research field is material science and technology. There is close cooperation with domestic and global universities; there are also efforts to interface with other national research institutes.

Within Japan's National Industrial Research Institutes (NIRI) there are six major technical departments. In 1996, the annual budget for NIRI was \$92 million (US). Total staff is 220 who participate in the Institute. For this visit, the WTEC panel focused on the area of synergy ceramics and materials.

In the area of synergy ceramics, the emphasis is on structural control for improving a specific property of a given material. Here there is effort to simultaneously control structural elements at every stage (from atomic scale to the macro scale). This approach is referred to as "hyperorganized structure control." In the area of synergy ceramics, there are a total of 30-35 people involved in the investigation of ceramics and metals. Size can be classified into four major categories for creating superior ceramic materials: (1) atomic and molecular scale, (2) nanoscale, (3) microscale, and (4) macroscale. In the hyperorganized approach to structure control, effort is made to harmonize and trade off functions, such as strength and toughness or electrical conductivity and stress sensitivity. In 1994, the synergy ceramics project was launched to foster collaboration among national research laboratories, universities, and industries. Part of the program is under the sponsorship of the New Energy and Industrial Development Organization

(NEDO) and is entrusted to the Fine Ceramics Research Association (FCRA).

The Synergy Ceramics Project is divided into *core research* and *satellite research* projects. Core research is being carried out at NIRIN and at the Synergy Ceramics Laboratory located in the Japan Fine Ceramic Center (JFCC) by researchers from FCRA, NIRIN, and several national universities. Satellite research is being carried out by 12 industrial organizations participating in the FCRA and by the Osaka and Kyushu National Research Institutes.

The projects that the WTEC panel were introduced to constitute only a portion of the core research. There are also many other topics being pursued as part of the Synergy Ceramics program.

RESEARCH AND DEVELOPMENT HIGHLIGHTS

Specific projects for synergy ceramics include the following:

1. alumina ceramics containing lanthanum oxide (La_2O_3)
2. alumina ceramics doped with SiO_2
3. alumina ceramics doped with both La_2O_3 and SiO_2 producing anisotropic grain growth of Al_2O_3 and in situ plate growth of La_2O_3
4. scaling of Si_3N_4 with Y_2O_3 and SiO_2 ; thermal conductivity values of SiN_4 are dependent on the processes of scaling and casting to improve strength, toughness, and Young's modulus
5. nanoporous silica films with one-dimensional throughput channels of 10-20 nm; high temperature oxides of Fe_2SiO_4 were prepared for evaluation as molecular sieves and particulate filters
6. preparation of submicron emulsions of Al_2O_3 , surfactant and water; here, a silica coating is deposited on alumina powder; this coating makes the alumina surface negative over a broad pH range

EQUIPMENT

1. ISO pressing (12 tons/cm²)
2. Ceramic furnaces
3. Superplasticity measurement device
4. High resolution TEM

FUTURE DIRECTIONS

The final year for this five-year program on synergy ceramics is 1998. It is anticipated that this program will continue in the pursuit of the synthesis of nanoporous materials for absorbing oil and identified particulates; the preparation ligands include ferrous materials such as ferrous disilicate; also of interest is the synthesis of ceramic materials with polymers that have low coefficient of friction similar to teflon.

RESPONSE TO WTEC QUESTIONNAIRE

Attached below are discussions on cluster engineering by Dr. Sakae Tanemura in response to the technical questions posed by the WTEC panel before the visit.

NIRIN's Research Activities on "Cluster Engineering" by Prof. Dr. Sakae Tanemura

Scientific Drivers

Those important to cluster engineering are as follows: new phenomena (cluster and surface interaction in both soft and hard collision cases; cluster coalescence and/or diffusion on the surface; solid state properties of assembled and/or embedded clusters).

Applications

Cluster itself is nanoscale material and shows the size-dependent quantum effect. If we can use a size-controlled cluster as a building block for nanostructure fabrication on a surface, we can fabricate new types of electronics (multiemitter-type resonance transistor, multitunnel junctions, and new magnetic devices having multivalued recordings with superhigh density). We will accomplish this by the combination of any materials and generally any substrates. "Cluster engineering" will help to break through some of the present difficulties faced by silicon technologies for nanostructures and will be a promising complement to silicon technologies.

Critical Parameters to Control

To move a high density size controlled cluster beam from the source to another vacuum vessel for deposition (for deposition by soft landing and/or

hard collision); to identify a cluster source; and deal with cooling and filtration will require specific knowledge for installation to operate effectively.

To realize soft landing and/or hard collision deposition of clusters on a substrate, and to have ion optics to accelerate and decelerate ionized clusters will require specific designing skill.

To control the assembled parameters (parameters to control self-diffusion, migration and/or coalescence of deposited clusters, as well as the surface crystallinity of the substrate), including introduction of regular steps and/or kinks and termination of crystal bonds of surface atoms, will require extensive systematic research.

Current Status

These investigations have just begun with the cluster groups in Japan, the United States, and Europe, and the work is at a fundamental stage. Rapid progress will be expected within three to five years if certain research resources are available.

Time Scale to Completion and Manufacturability

It is difficult to estimate the time scale for ultimate application. This will be very much affected by the nanoscale requirements by semiconductor and memory industries. We must identify needs for large capacity and high speed memory requiring relatively small amounts of power.

R&D Philosophy

Our philosophy, directions, and basic concept are described in published brochures.

Overall Japanese R&D Activities on Cluster Engineering

I don't know the overall R&D of nanotechnology throughout Japan. The definition of nanotechnology should be defined clearly. As far as I am concerned with cluster engineering in Japan, here are the other leading laboratories and/or persons working in this area:

1. JRCAT and NAIR (AIST, MITI) at Tsukuba: Atom Technologies group, particularly Dr. Y. Kanayama, ("Atom Technologies" project is a typical national project on nanostructures and being well funded by AIST, MITI)
2. Metal & Inorganic Material Institute, Tohoku Univ. at Sendai: Profs. K. Suzuki, K. Sumiyama and A. Kasuya. They are funded by "Strategic

Fundamental Research Fund” of Science & Technology Agency (STA) as three-year projects of about \$2.5 million.

3. Ion Engineering Research Laboratory, Kyoto Univ. at Kyoto, Prof. I. Yamada and Dr. Z. Matsuo. Dr. Z. Matsuo is doing research on argon-cluster sputtering (no data for funding).
4. Cluster Lab., Toyota Inst. of Tech. at Ichikawa, Chiba, Prof. T. Kondow. The funding is given by the Kompon (Fundamental & Generic) Laboratory of Nippon Denso Co.
5. Chemistry Dept., Faculty of Science & Technology, Keio Univ., Prof. K. Kaya (no data for funding).

Educational Initiatives

All occur in the above-mentioned universities. I have already supervised my postgraduate student on cluster deposition.

NIRIN has already inaugurated international cooperation work on Cluster Engineering with Frei University, Department of Physical Chemistry, Berlin, Prof. Woeste's lab (experiments); and with Wien Technical University, Department of General Physics, Wien, Prof. G. Betz (MD simulation of cluster impact).

We welcome international cooperation on any subject related to cluster engineering.

REFERENCES

- Hirao, K., T. Nagaoka, M.E. Brito, and S. Kanzaki. 1994. Microstructure control of silicon nitride by seeding with rod-like b-silicon nitride particles. *J. Am. Ceram. Soc.* 77:1857-62.
- Hirao, K., M. Ohashi, M.E. Brito, and S. Kanzaki. 1995. Processing strategy for producing highly anisotropic silicon nitride. *J. Am. Ceram. Soc.* 78:1687-90.
- Hirao, K., A. Tsuge, M.E. Brito, and S. Kanzaki. 1993. Preparation of rod-like b-Si₃N₄ single crystal particles. *J. Ceram. Soc. Jpn.* 101:1071-73.
- Kanzaki, S., and H. Matsubara. 1994. New and developing research on advanced ceramics. *Bull. Ceram. Soc. Jpn.* 29: 124-30 (in Japanese).
- Yasuoka, M., K. Hirao, M.E. Brito, and S. Kanzaki. 1995. High-strength and high-fracture-toughness ceramics in the Al₂O₃/LaA₁₁O₁₈ systems. *J. Am. Ceram. Soc.* 78:1853-56.

Site: **National Research Institute for Metals (NRIM)**
1-2-2 Sengen
Tsukuba 305, Japan
Fax: (81) 298-59 2008

Date Visited: 23 July 1997

WTEC: C. Koch (report author), E. Hu, D. Shaw, C. Uyehara

Hosts: Dr. Masatoshi Okada, Director General
Dr. Mikihiro Kobayashi
Dr. I. Nakatani
Dr. N. Koguchi
Dr. M. Murayama
Dr. W. T. Reynolds
Dr. M. Ohnuma
Masatoshi Saito

BACKGROUND

The WTEC panel's host at the National Research Institute for Metals (NRIM) was Dr. Masatoshi Okada, Director General of NRIM, and the panel had presentations/discussions with Drs. M. Kobayashi, I. Nakatani, N. Koguchi, M. Murayama, W. T. Reynolds, and M. Ohnuma.

NRIM is a national laboratory devoted to the development and improvement of new and advanced metallic (and other) materials. It is funded by the Science and Technology Agency (STA). There are about 330 researchers out of a total staff of 415 people and an annual budget of about \$100 million.

We were greeted by Dr. Masatoshi Okada, who then described his organization. The laboratory can be divided into four major parts: (1) research in advanced physical field (high magnetic fields, high resolution beams, extreme high vacuum), (2) research for materials science, (3) research for materials development, and (4) social-needs-oriented research. Researchers in various areas related to nanostructured materials presented descriptions of their research.

RESEARCH AND DEVELOPMENT HIGHLIGHTS

Dr. M. Kobayashi described his work on particle assemblage. At present this work is focused on micron-scale particles ($\sim 5 \mu\text{m}$ particles) and toward the preparation of “smart” materials. Particles are assembled by electrostatic force by several methods involving, for example, the atom probe or electrostatic patterning by electron beams with particles attracted to the patterned regions. Examples of materials include SiO_2 particle assemblages for gas (e.g., CO) sensors and Ni-base magnetostrictive particles for actuators.

Dr. I. Nakatani has a program involved with research on quantum magnetic properties. Studies involve magnetic substances with sizes of around (a) 100 nm, (b) 10 nm, and (c) 1 nm in dimension.

- a) A novel reactive-ion etching method was developed and applied to producing ferromagnetic Fe-Ni thin wire arrays with 250 nm width and spacing.
- b) Magnetic relaxation phenomena of iron nitride or cobalt ferrofluids were studied. These are colloidal 10 nm diameter ferromagnetic particles. The relationship between the viscosities of the magnetic fluids and volume fractions of solid particles was determined. It was stated that these ferrofluids possess the highest performance achieved in the world.
- c) Giant magnetoresistance (GMR) was observed for 2 nm Fe particles embedded in SiO_2 or MgF_2 . The GMR effect is due to spin-polarized electrons tunneling between the Fe particles.

Dr. N. Koguchi described his group’s work on direct formation of GaAs/AlGaAs quantum dots by droplet epitaxy. The process consists of forming Ga droplets on the inert S-terminated AlGaAs substrate and reacting the droplets with As to produce GaAs microcrystals. First, a molecular beam of Ga is put on the substrate, followed by an As molecular beam. About 10 nm GaAs particles are formed. The photoluminescence of these structures is being studied.

Dr. M. Murayama and Dr. W.T. Reynolds (on sabbatical from VPI) described their studies of the microstructure of a variety of structural materials with nanoscale features. Included in their studies are fine atomic clusters in Al-base alloys in which clusters not resolvable with high resolution electron microscopy were revealed by special tomographic three-dimensional atom probes. NRIM has two of the three existing in the world. All materials they study with the atom probe are nanostructured, including

- magnetic materials — Co–12Cr–2Ta thin films
Fe-Zr-B amorphous/nc structures
- structural materials — steels (e.g., piano wire)
high strength Al-base alloys
(from A. Inoue’s group at Tohoku University)

The piano wire—Fe–0.8%C—with a pearlitic structure—after strains of 4.0 assumes a nanocrystalline structure with 5 nm carbide particles, along with some amorphous regions.

Dr. M. Ohnumo described studies of GMR behavior in Co-Al-O granular thin films. This work is in collaboration with H. Fujimori from Tohoku University.

A new thrust of NRIM is enhanced cooperative programs with industry and universities, and with international programs. NRIM is designated as a Center of Excellence and is charged with development of state-of-the-art facilities for extreme high vacuum, high resolution beams, and high magnetic fields.

Site: **Osaka National Research Institute (ONRI)**
Interdisciplinary Basic Research Section
AIST, MITI
1-8-31 Midorigaoka
Ikeda, Osaka 563, Japan
Tel: (81) 727-51 9690; Fax: (81) 727-51 9630

Date Visited: 24 July 1997

WTEC: D.M. Cox (report author), C. Koch, J. Mendel, H. Morishita,
R.W. Siegel

Hosts: Dr. Masatake Haruta, Chief Senior Researcher;
Head, Interdisciplinary Basic Research Section
E-mail: haruta@onri.go.jp
Dr. S. Tsubota
Dr. M. Okumura
Dr. Cunningham
Dr. Ando
Dr. Kohei Fukumi
Dr. Teruo Kodama, Director General of ONRI
Dr. Noboru Wakabayashi, Senior Officer for Research
Planning

BACKGROUND

This WTEC site visit was hosted by Dr. Masatake Haruta, the Chief Senior Researcher at Osaka National Research Institute (ONRI), who presented an excellent overview of the AIST laboratories under MITI. ONRI is one of 15 national laboratories, of which 8 are located in Tsukuba. ONRI, founded in 1918, is the fourth oldest research institute of MITI. At ONRI there are five major research departments and one research section:

- Department for Energy Conversion
- Department of Energy and the Environment
- Department of Optical Materials
- Department of Materials Physics
- Department of Organic Materials
- Interdisciplinary Basic Research Section

These research departments focus on three primary areas: (1) energy related materials, (2) optical materials, and (3) fundamental research. The

major components of energy related materials are energy storage using new battery technology; molten carbonate fuel cells; production, storage, transportation, and application of hydrogen energy; and catalysis. In optical materials the focus is on nonlinear optical materials and application of optical measurements. In fundamental research the focus is on thin film and ion beam technology, material design and characterization, and bioengineering of molecular complexes of peptides.

RESEARCH AND DEVELOPMENT HIGHLIGHTS

ONRI is very proud of its history of contributions to industry, with several major inventions, discoveries, and developments in the labs at Osaka. Four of these are as follows:

1. polyacrylonitrile (PAN)-based carbon fibers, which are used as carbon fiber reinforcements for plastics used in golf club shafts and fishing rods, as well as for aerospace applications
2. transparent conductive films of indium oxide (and tin oxide) via vacuum deposition, which advanced liquid crystal technology; the transparent conductive films are also used commercially as anti-icing coatings and have been applied to windshields of the Tohoku-Shinkansen bullet trains
3. inorganic spherical microcapsules with porous walls, with applications in cosmetics and deodorants
4. the discovery that nanosized gold catalysts have specific catalytic properties useful for odor removal, specifically for rest rooms; this work is a recent invention from Dr. Haruta's group

Dr. Haruta, our host, in addition to his responsibilities as Chief Senior Researcher at ONRI, is head of the Interdisciplinary Basic Research Section, which was founded in 1994 as a new research section for basic studies, with a primary aim to provide fundamental knowledge to the science world.

The technical update was provided by Dr. Haruta plus several other members of his group, Drs. Tsubota, Okunura, Cunningham, Ando, and Fukumi. The work on "gold catalysts" is a major focus for ongoing research and has led to the discovery that supported gold catalysts exhibit unique catalytic properties only in the case where the gold particles are nanoscale and highly dispersed (gold particles on the order of 1-5 nm in diameter supported on metal oxides such as TiO₂).

S. Tsubota and M. Okumura described catalyst preparation techniques, characterization, and present understanding of the behavior of these materials as a function of particle size. Specifically, the particle size effects have been examined as a function of (a) the pH of the initial Au solution, (b) the effect of calcining temperature on the TiO₂ supports, (c) comparison of

results using different synthesis techniques and parametric studies to optimize the catalyst fabrication, and (d) the wt% of Au loading.

The characteristic nature of the gold catalyst was the main topic of the science presentations from Dr. Haruta and members of his staff. This included evidence for the structure-sensitive character of the gold catalysts, namely, the strong dependence on particle size, type of support material, and the interface structure of the Au catalyst with the support. Gold catalysts have unique behavior, being active at low temperature. For example, CO oxidation occurs on nanoscale gold catalysts at temperatures as low as -70°C . In addition, the gold catalysts are found to exhibit very high selectivity for partial oxidation reactions, such as oxidation of propylene to propylene oxide with 100% selectivity at 50°C as well as near room temperature reduction of nitric oxide. A key scientific finding is the sensitive role that H_2O plays in activating the gold catalytic behavior. Similar results with Pd and Pt catalysts show effectively no propylene oxide yield, but give about 100% conversion to propane. The fundamental work on gold catalysts has led to “odor eaters” for the bathroom, a recent commercialization.

In addition to the ongoing studies on gold catalysts, there is a significant effort to apply the learning from the gold system to other catalyst systems, using, for example, Pt- or Pd-based catalysts with the expectation that particle size effects will lead to novel materials with highly specific functionality.

In addition to the catalysis work, the Basic Research Section also has efforts in developing optical gas sensors, and in studies of the unusual nonlinear optical properties of gold nanoparticles. The use of sputtered gold or nanoparticle gold colloids deposited on transition metal oxide surfaces has produced surfaces for which selective adsorption of H_2 and CO gases can be detected. The use of entirely optical techniques for selective detection of H_2 was being promoted, since such detection would eliminate the possibility of fire ignition or explosion in H_2 atmospheres. Dr. Ando summarized the optical gas sensor work as follows:

- Au nanoparticles on nickel oxide show enhanced selectivity to both CO and H_2
- Au nanoparticles on copper oxide show large selectivity and sensitivity to CO
- Au nanoparticles on cobalt oxide show two effects:
 - Enhanced selectivity to H_2 at the plasmon band of Au
 - Decreased absorbance (selectivity) to both CO and H_2 away from the Au plasmon center frequency.

The results open the possibility for strictly optical recognition of H_2 and CO.

Dr. Fukumi showed that nanoscale gold colloids dispersed in glasses exhibit novel nonlinear optical properties. The materials are produced by ion implantation of Au⁺ into silica glass. The Au⁺ ion energy is 1.5 MeV with densities of 10¹⁶-10¹⁷ Au⁺ ions/cm². Characterization by TEM showed the average particle size was 8.6 nm diameter. In these materials, the third order nonlinear susceptibility χ^3 was measured to be 1.2 x 10⁻⁷ esu, about four orders of magnitude higher than that obtained by a melting method used by others to produce the gold/glass system.

Following the technical presentations, the WTEC team enjoyed a lunch that Dr. Haruta had kindly arranged with the Director General of ONRI, Dr. Teruo Kodama, and Dr. Noboru Wakabayashi, the senior officer for research planning. After lunch the team had a tour of the lab facilities of the Interdisciplinary Basic Research Section. From these interactions we learned that funding for the National Laboratory at Osaka increased by 16% in 1996, but simultaneously, the permanent staff is decreasing. The decrease in permanent staff is somewhat compensated by the increase in (mostly) foreign postdoctoral support to the 30-40 person level.

The lab facilities for the Basic Science Section are impressive, consisting of several catalyst testing units and a special testing unit with all stainless steel surfaces that have been chromium oxide-coated to allow water vapor levels to be reduced to < 10 ppb. This is the only unit in the world with this capability, which has allowed this group to carefully isolate the role of water vapor in the catalytic reactions. Recent funding has allowed purchase of a new high resolution TEM (~\$1.3 million), and a new sophisticated surface science apparatus (>\$1 million) which at the time of the WTEC visit had been ordered but not yet delivered. The new equipment is to be used to better understand the differences and similarities of surface reactions occurring at low pressure under UHV conditions and those occurring in the higher pressure catalytic reactions carried out under actual processing conditions.

Site: **Osaka University**
Research Center for Intermaterials
Institute of Scientific and Industrial Research
8-1 Mihogaoka, Ibaragi-shi
Osaka-fu 567, Japan
Tel: (81) 6-879 8440; Fax: (81) 6-879 8444

Date Visited: 24 July 1997

WTEC: J. Mendel (report author), D.M. Cox, C. Koch, H. Morishita,
R.W. Siegel

Host: Prof. Koichi Niihara, Director

BACKGROUND

The Institute of Scientific and Industrial Research was founded in 1939 as part of Osaka University. Its whole purpose is to study scientific principles necessary for industry to make progress in the fields of electronics, computer science, and metallic and inorganic materials, as well as other disciplines in biochemistry and radiation science. In 1995 the Institute was restructured into 6 divisions and 24 departments. The six divisions are (1) Quantum Engineering; (2) Advanced Materials Science and Technology; (3) Organic Molecular Science; (4) Intelligent Systems Science; (5) Biological Science; and (6) Quantum Beam Science and Technology.

The Institute's budget in 1996 was \$25 million. For the area of Intermaterials, the budget amounted to \$4 million plus grants from companies. For the Department of Structure Ceramic Materials, there are a total of 25 individuals supporting this technology. Professor Niihara, who heads this department, had been at the institute for eight years. Eighty per cent of the students work on ceramics, both functional and structural, and 20% are involved with metals and polymers.

RESEARCH AND DEVELOPMENT HIGHLIGHTS

The main focus for programs within Structure Ceramic Materials is ceramic-based nanocomposites prepared by sintering methods. There is special emphasis placed on understanding the relationships between the nanostructure of materials and their mechanical properties. Ceramic nanocomposites can be divided into intragranular, intergranular, and

nano/nano composites. Intragranular and intergranular nanocomposites, even at elevated temperatures, result in remarkably improved mechanical properties, including (1) fracture toughness, (2) abrasive and cutting performance, (3) fracture mode, (4) fracture strength, (5) maximum operating temperature, and (6) creep resistance. As an example, toughness may increase 1.5 to 4 times in the $\text{Al}_2\text{O}_3/\text{SiC}$ system. Hybridization of micro- and nanocomposites using fiber-reinforced components results in toughness improvements at higher temperatures.

Specific Classifications

Multifunctional ceramics, then, can have some specific classifications:

1. micro-nano composites with enhanced toughness ($\text{Al}_2\text{O}_3/\text{SiC}$)
2. hard matrix/soft dispersion nanocomposites ($\text{Si}_3\text{N}_4/\text{BN}$)
3. soft matrix/hard dispersion nanocomposites
4. structural ceramics
5. nanopore composites as future targets

Preparation

The process for preparing these ceramic materials involves a sintering reaction where the challenge is to keep different size particles uniformly dispersed to prevent nonuniform distribution.

Wet ball milling is also used, where materials like Si_3N_4 are mixed with Al_2O_3 , Y_2O_3 , H_3BO_3 , and urea. After ball milling, the material is dried and subjected to hydrogen reduction. Such processes have yielded properties like high strength, excellent thermal shock resistance, good chemical inertness, and easy machinability similar to metals. Addition of chrome oxide has also yielded improvements in Young's modulus and fracture strength.

Although the institute has no formal process for patents, the work has resulted in the granting of 35 patents from this ceramic technology. Collaboration with the Massachusetts Institute of Technology and laboratories in Germany is ongoing.

Equipment

A tour of laboratory facilities showed a wide range of processing and characterization equipment. Included are (1) ceramic ovens, (2) Instron with filament-winding equipment (3) X-ray diffractometer with temperature range to 2000°C , (4) laser Raman, (5) hot isostatic press, (6) SEM, (7) AFM, (8) nano-indentor, and (9) spark plasma sintering systems.

Site: **RIKEN (Institute of Physical and Chemical Research)
Frontier Materials Research
Semiconductor Laboratory
2-1 Hirosawa Wako-shi
Saitama 315-01, Japan
Fax: (81) 48-462 4659**

Date Visited: 22 July 1997

WTEC: E. Hu (report author)

Host: Dr. Aoyagi, Coordinator, Frontier Research Program; Chief,
Semiconductor Laboratory
Dr. Katsuhiko Fujita, Exotic Nano Materials Group
Dr. Takashi Isoshima, Researcher, Biopolymer Physics Lab.
Dr. Hideo Yabuki
Yoshiro Miki, Director of the Frontier Research Program
Division and the Brain Science Planning Office

BACKGROUND

The Frontier Research Program was set up within the Institute of Physical and Chemical Research (RIKEN) within the Science and Technology Administration to be a more flexible program emphasizing

- multidisciplinary
- flexibility, obtained by recruiting researchers with the proper expertise, working under one-year contracts that can be extended (average age of the researchers is 35)
- international participation, with non-Japanese team leaders; 1/3 of the participants are from overseas
- active recruitment of young researchers
- external evaluation by world-class scientists
- forum to create new ideas

All programs have a fixed lifetime of eight years, extendible, with a mid-program review. The Frontier Materials Research program that the WTEC team visited was in Phase II of its activities.

Within the Frontier Materials Research Program were three subareas: (1) the Laboratory for Nano-Electronics Materials (Sugano), (2) the Laboratory for Nano-Photonics Materials (Sasabe), and (3) The Laboratory

for Exotic Nano Materials (Knoll). The emphasis is on basic research, rather than on applications (this was explicitly stated).

RESEARCH AND DEVELOPMENT HIGHLIGHTS

Dr. Aoyagi gave the WTEC team an introduction to some of his team's research activities.

Quantum wire growth: they used a technique similar to that developed by Kapon for the growth of (primarily) GaAs/AlGaAs and GaP/AlGaP quantum wires. The attempt was to improve that process and gain better control of the growth process, with a higher selectivity of incorporation, using the fact that the growth rates on the (111)A plane is minimal to zero. Measurements were done in a 40 T magnetic field; the researchers expected to observe a diamagnetic shift in the luminescence peak under the high field conditions, and obtained $123 \mu\text{eV}/\text{T}^2$ for the LH transition and $210 \mu\text{eV}/\text{T}^2$ for the HH transition. These are far larger shifts than expected ($110 \mu\text{eV}/\text{T}^2$ for bulk and $20 \mu\text{eV}/\text{T}^2$ for 2-D systems). Aoyagi attributes the discrepancy to the influence of the interaction of the electrons in the wire with the adjacent impurities.

Si nanostructure formation: these studies began with amorphous silicon deposited onto Si substrates and annealed in a hydrogen or nitrogen ambient. The result was the formation of Si nanocrystals, ~ 7 nm in size, embedded within an amorphous matrix. Emission in the blue was observed, with about 10^{-5} stated efficiency. Emission at 420 nm and 380 nm was observed. Simulations have been carried out to look at the effects of confinement on the relative regions of the amorphous and crystalline areas (Figure D.8).

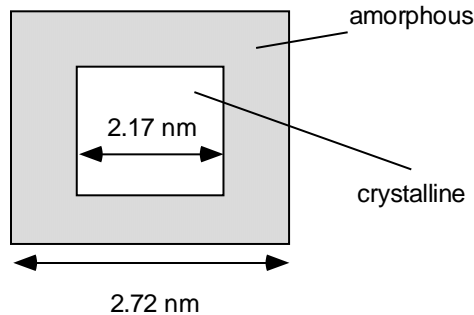

Figure D.8. Effects of confinement on the relative regions of the amorphous and crystalline areas.

GaN dot formation: dot formation is attempted on a nearly lattice-matched substrate: GaN on AlGaN (thin buffer layer, grown on SiC, $\sim 10^7$ defects/cm²). Growth is believed to proceed by step-flow. In order to promote dot formation (without the influence of strain), researchers chose to *control the surface energy*, by using a monolayer of silicon as a surfactant (this has been published in APL). They have achieved stimulated emission in these dots, with a density of greater than 10^9 /cm².

Transport: Dr. Aoyagi showed the WTEC team quantum dots formed by split gate structures, with a separate gate that allowed coupling between 2 dots. He observed interference fringes in the I-V, indicative of coupling, measurements taken at 10 mK. He also showed magnetoCoulomb oscillations, using the magnetic field rather than a gate to alter the interactions (Figure D.9).

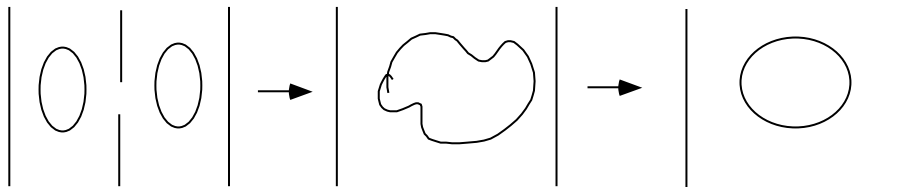

Figure D.9. MagnetoCoulomb oscillations using the magnetic field.

Dr. Aoyagi then took us for a brief tour of various labs in his area: a transport lab with three cryostats, an He 3/4 dilution refrigerator, and high field magnets (8 T); a JEOL e-beam writer, MOCVD capabilities (MBE was elsewhere), analysis lab with focused ion beam and photoluminescence spectroscopy.

- The WTEC team was then provided with some overviews of the research in the Exotic Nano Materials group. Dr. Katsuhiko Fujita discussed some of the projects within this group, headed by Dr. Wolfgang Knoll. He described a supramolecular architecture, building from a substrate to a metal layer, to a biological interface to proteins. Dr. Fujita described a project in which fabricated gratings of various periods were used to facilitate studies on the motility and growth of hippocampal neurons. Another project involved the integration of neurons with transistors, to be used as in-situ recording devices. Laboratory support included capabilities for the synthesis of biopolymers, as well as characterization facilities, including scanning tunneling microscopy (atmospheric and ultrahigh vacuum), and atomic force microscopy. A surface plasmon resonance microscope and a near field optical microscopy facility are also being developed.

Dr. Takashi Isoshima, a researcher in the Biopolymer Physics Lab (degree from Tokyo University), then described some of the experiments involving polymers for optical devices: ultrafast optical switching, low power consumption photorefractives. This group carries out its own polymer synthesis, molecular design, and modification, in order to enhance optical properties such as nonlinearity and absorption. The goal is to synthesize multicomponent, photorefractive materials with capabilities in electrooptic coefficient, photoconductivity, etc. He showed us an impressive optical characterization lab: subpicosecond systems, a time-resolved fluorescence setup (100 fs), three optical benches, and optical fiber devices for ultrafast multiplexing.

Dr. Hideo Yabuki then gave us a general overview of RIKEN, its history and current mission. RIKEN is a semipublic corporation, receiving 95% of its funding from the Science and Technology Agency. It is believed that this semipublic status gives it more autonomy. There is extensive collaboration with universities (University of Tokyo, Tokyo Institute of Technology, and others), with a number of dual appointments and joint doctoral courses. RIKEN collaborates extensively on an international scale and has established a number of laboratories outside of Japan; the Rutherford Appleton Laboratory was the first overseas lab to be established.

Yoshiro Miki, the Director of the Frontier Research Program Division and the Brain Science Planning Office (he has been at STA, in Materials Research, and then at MITI on an excimer laser project), spoke of a new priority project: a brain research institute. Citing a research effort that is only 10% of that carried out in the United States, promoters of the brain research institute hope that this will help to bring “brain science” in Japan up to world-class levels. Miki also spoke of the disconnect between RIKEN and the universities in terms of identifying important research priorities; there is a 10-15 years lag between initiation of RIKEN priority programs and observation of changes in university programs.

EQUIPMENT

Various laboratory equipment included a synthesis lab, with Langmuir Trough, Brewster angle microscope, an analysis laboratory with two STMs, a UHV STM, and AFM. WTEC's hosts described the development of a surface plasmon resonance microscope (magnification limited), and a near field optical microscopy facility that is being built under the coordination of Dr. Ruggiero Micheletto (current resolution is 100 μm).

Site: **Tohoku University**
Institute for Materials Research (IMR)
Katahira 2-1-1, Aoba-ku
Sendai 980-77, Japan
Tel: (81) 022-215 2000; Fax: (81) 022-215 2002

Date Visited: 21 July 1997

WTEC: E. Hu, C. Koch, and D. Cox (report authors), L. Jelinski,
M. Roco, R.W. Siegel, D. Shaw, C. Uyehara

Hosts: Prof. Kenji Suzuki, Director, Institute for Materials
Research; E-mail: suzuki@snap8.imr.tohoku.ac.jp
Prof. Masayoshi Esashi, Department of Mechatronics &
Precision Engineering
Prof. A. Inoue, Head, Nonequilibrium Materials Laboratory
Prof. H. Fujimori
Prof. Kenji Sumiyama
Dr. Changwu Hu
Dr. Elisabeth Kurtz
Dr. Darren Bagnall

BACKGROUND (Carl Koch)

Most of the WTEC team's visit to Tohoku University was focused on the Institute for Materials Research (IMR) which is directed by Professor Kenji Suzuki. IMR's historical roots go back to 1916; at first it was devoted to research on iron and steel. However, under the leadership of Professor Matsumoto it became a leading research laboratory in the 1970s and 1980s in the area of nonequilibrium processing techniques for producing metastable materials, in particular metallic glasses, an area in which it was a world leader. At present IMR is a large modern materials research center containing 26 research laboratories in which approximately 160 scientists, 120 technicians, 190 graduate students, and 70 visiting scientists carry out a variety of research projects. The major part of the financial support for the IMR is provided by the Ministry of Education, Science, Sports, and Culture (Monbusho). The specific groups in the IMR concerned with nanoparticles/nanostructured materials that the panel visited are those of Professors K. Suzuki and K. Sumiyama (metallic nanocluster assemblies), Professor Kasuya (semiconductor nanocluster assemblies), Professor H. Fujimori (magnetic nanostructured materials), Professor A. Inoue (nanostructured

bulk materials), and Professor T. Yao (semiconductor nanodevices). Brief descriptions of these research efforts are given below. In addition to visiting IMR, the WTEC team visited the Tohoku University laboratory of Professor Esashi in the Department of Machine Intelligence and Systems Engineering. Professor Esashi's research on micro/nano machines is also described.

RESEARCH AND DEVELOPMENT HIGHLIGHTS

Prof. M. Esashi (Lynn Jelinski)

Microsystems by Silicon Machining: This program at Tohoku University, under the direction of Prof. M. Esashi, is located on the "mountain" campus of Tohoku, about a 15-minute drive from the main campus. The program has five components and is staffed by 35 professionals. The components are:

- active catheter and piezoelectric films
- inertia measurement systems
- microactuators and thermal and fluidic micro systems
- ultrasensitive sensors and nanostructures
- semiconductor research institute

The professionals comprised postdoctoral fellows from a number of countries, resident staff, and employees of a number of companies, including Samsung, Ford, Hitachi, Asahi Optical, and Honda.

Prof. Esashi has been working in the area of microelectromechanical systems (MEMS) devices for the past 25 years and over that time built up a fairly sophisticated, albeit homemade, facility for producing MEMS devices and another facility for characterizing them. A number of biomedical devices have been produced over the years, including blood gas sensors, a 1 mm diameter, navigable catheter based on shape-memory alloy material, produced with an STM tip, using a heated silicon substrate.

In the past several years there have been major capital investments into the program, resulting in the building and equipping of a microfabrication facility and a separate nanofabrication facility.

The microfabrication facility, also called a Venture Business Laboratory, was constructed and outfitted with government money. Companies are encouraged to make use of the facilities. The names of 27 companies, most of them large and well known, were displayed in the entryway.

The microfabrication facility consisted of a 0.5 micron CMOS line for 2-inch wafers, and housed an impressive array of modern equipment, including He-Cd and Ar lasers for laser fabrication, and laser-induced CVD.

This facility was very heavily invested in etch equipment, which included a molecular beam etch station for fairly sophisticated controlled etching. There was room after room of characterization equipment, including field emission SEM, SIMS, an SEM for characterizing biological systems under water, and an in situ monitor. There was also highly specialized equipment, including an entire room devoted to sensor characterization, which housed an accelerometer tester that worked in vacuum and a position-sensitive device that also worked in vacuum.

The nanofabrication facility, a Class-1000 cleanroom, was about a year old. Like the microfabrication facility, it was equipped with an impressive array of new and sophisticated equipment, including an e-beam direct exposure system and a stepper/pattern generator. It is conservatively estimated that the facility cost \$10 million.

There was also a nanodevice characterization room, including ultrahigh vacuum AFM, STM, STEM, and ESCA. An in situ infrared ellipsometer was available for characterization of epitaxial layers.

While the size scale of the micro- and nanomachines we learned about were larger than that covered in this report, two projects bear description:

1. Esashi and coworkers (Ono et al. 1997) described the use of an ultrahigh vacuum STM to produce a silicon nanowire via field evaporation of silicon. A gold STM tip was positioned over a clean silicon substrate, the later of which was held at 700°C. At an applied sample voltage of 5 V (10 nA tunneling current) for 15 min., with the tip positioned 6 Å above the surface, growth of the silicon nanowire could be monitored by in situ SEM. The diameter ranged between 20-150 nm and the length was about 3 mm. Electron diffraction patterns showed that the wire was silicon, with between 2 and 15 at.% gold on its surface. It is posited that the field evaporation of silicon is enhanced by the formation of an Au-Si eutectic on the substrate.
2. In other work, the group described a self-supported silicon nanostructure that had been fabricated on a silicon diaphragm (Hamanaka et al. 1997).

Prof. H. Fujimori (Carl Koch)

The focus of Professor Fujimori's group is on new developments in the field of magnetic materials. A major part of this effort is directed at nanocrystalline (nc) Fe-based soft magnetic materials. A major method of processing utilizes preparation of amorphous precursors by melt spinning or sputtering followed by partial crystallization of nc bcc Fe particles. The nc Fe particles provide high magnetic moments and, if < about 20 nm in diameter, exhibit small crystalline anisotropy and superior soft ferromagnetic properties. An example given is an Fe-base amorphous alloy produced by

sputtering that contains Hf, Ta, C, which on crystallization gives 10 nm Fe particles whose grain boundaries are pinned by about 10 nm diameter carbide (e.g., $\text{Fe}_{80}\text{Hf}_8\text{C}_{12}$) particles, which stabilize the nm grain size up to elevated temperatures ($\sim 700^\circ\text{C}$). This material exhibits almost constant permeability μ' , with frequency up to about 10 MHz while the μ'' (imaginary, lossy) component rises at values between 1 and 10 MHz.

Another interesting topic involves preparation and property measurements of metal/nonmetal granular nc composites. Sputtering was used to form systems such as Fe/SiO₂, Co/Al₂O₃. As the oxygen concentration in the films increases, the electrical resistivity increases from metallic (10^1 – 10^2 $\mu\Omega\text{cm}$), to a ρ vs. T behavior with a ρ minimum with $\rho = 10^2$ – 10^3 $\mu\Omega\text{cm}$, to high resistivity (negative coefficient of ρ) with $\rho = 10^4$ – 10^{10} $\mu\Omega\text{cm}$. The low oxygen content composites show ferromagnetic behavior with high permeabilities—about double that of ferrites but with higher losses. A potential application is use as a high frequency inductor.

The oxygen-rich composites exhibit giant magnetoresistance (GMR). For example, the Co, Fe in Al₂O₃ provides an assembly of tiny tunneling junctions with $\Delta\rho/\rho_0$ about 7.8%.

Fujimori's magnetic materials program is expected to receive an additional \$3.8 million in government funding for the next five years in a new program entitled, "Nanostructurally controlled spin dependent quantum effects and new electronics and magnetics." A goal is a one-electron spin memory.

Prof. A. Inoue (Carl Koch)

Professor Inoue's large group (41 persons) studies amorphous, quasi-crystalline, and nc materials. The nc materials are typically prepared by crystallization of amorphous precursors, which can be bulk amorphous alloys, ribbons or wires produced by melt spinning, or rapidly quenched powders produced by powder atomization methods. Mechanical tests on nc/amorphous alloys from bulk amorphous samples exhibit increased yield strengths but little elongation in tension—that is, behavior similar to amorphous alloys even though 60–70 vol.% of the material is crystalline. Mg-base alloys have been successfully studied in this regard.

The equipment for processing, material characterization, and property measurements in Inoue's laboratory is very impressive indeed, with most nonequilibrium processing tools, sophisticated characterization, and property measurement facilities available.

The innovative work on metastable materials Professor Inoue has carried on over the years cannot be praised too highly. He and his coworkers are

responsible for a new class of soft ferromagnetic materials based on Fe-Zr-B compositions that consist of nanocrystalline bcc Fe particles in an amorphous matrix. These materials exhibit the lowest core losses at frequencies up to 400 Hz of any known material. They have also developed alloys based on Al or Mg, which are two-phase nanocrystalline and amorphous and which exhibit high strength, e.g., the Al alloys have more than double the strength of the strongest existing Al alloys, along with some ductility.

A major factor in his group is its close association with Japanese industry. This is illustrated by the fact that 20 of his 41-member group are employees of many companies, specially assigned to carry out research in his group.

Profs. K. Suzuki and K. Sumiyama (Don Cox)

Prof. Kenji Sumiyama and Dr. Changwu Hu gave highlights of some of the work being done in the areas of metallic nanocluster assemblies and work on fullerenes and carbon nanotubes, respectively. In the metallic nanocluster area the main focus is on developing different techniques for production of metallic clusters.

Prof. Sumiyama described five different techniques for production of metallic clusters that have been utilized by his group:

1. ionized cluster beam deposition
2. plasma sputtering with cluster aggregation
3. field emission of atoms from a metal (gold) tip
4. liquid metal ion source
5. laser ablation cluster source

For characterization their main tools are electron microscopes, e.g., SEM, FE-TEM, and STM examinations of clusters deposited on substrates. The primary use appears to be for evaluation of the cluster size and cluster size distribution from the various cluster production techniques. Every researcher appears to be well equipped, with each possessing electron microscopes for individual use. They reported plans to add electron holography capability to the field-emission TEM next year. In addition to use as cluster size and size distribution measurements, recent STM studies of selenium clusters deposited on HOPG were interpreted as the first evidence for six or eight metal atom rings covering an HOPG surface.

The ionized cluster beam apparatus is the most developed and was an early workhorse, with several publications reporting work using this source. More recently, a new plasma sputtering apparatus has been constructed over the last four years and has become the primary cluster synthesis apparatus at IMR. Drs. Suzuki and Sumiyama reported being able to produce clusters of

smaller sizes and with narrower size distributions than was possible with the ionized cluster beam apparatus and are optimistic that this source can be scaled up for much larger production than currently feasible. For example, with the plasma sputtering apparatus, they reported production of chromium clusters with sizes ranging between 3-4 nm with about 10% variation in size. Previously, the average cluster size was about 8-9 nm, but with a larger variation in size. Optimization of the helium and argon gas mixtures used in the plasma sputtering have resulted in better control of the cluster size and cluster size distribution, according to Prof. Sumiyama. The laser ablation cluster source is now being developed for production of transition metal clusters. The other two techniques, field emission and liquid metal ion source, are not as versatile, being limited to materials that have relatively low melting points.

Dr. Changwu Hu (Don Cox)

Dr. Hu described the efforts at Tohoku in the area of fullerene and carbon nanotube production and characterization. Dr. Hu described three main items:

1. chemical reaction studies of C_{60} on Si(111)
2. polymerization of C_{60} and C_{84} by argon ion laser irradiation
3. production and characterization of single-walled carbon nanotubes

In (1), the chemical reaction of C_{60} on Si(111), C_{60} is deposited on Silicon(111) and then heated to 800°C. At 800°C STM shows that a monolayer of C_{60} in registry with the Si(111) surface is covering the surface. Upon further heating to 850°C, the C_{60} layer becomes disordered. Heating even further to 1100°C results in formation of SiC in the form of SiC clusters of about 50 nm diameter and 2-4 nm height. This technique is reported to be a novel low temperature route to SiC.

In (2) the fullerenes are observed by STM to polymerize upon irradiation by an Ar ion laser and form large (150 nm diameter) clusters. Additional studies showed that the STM pattern changed with changing bias voltage, suggesting some polymerization is induced by the STM electric fields.

Lastly, Dr. Hu reported recent results on characterization of nanotubes produced in the laboratory. The researchers report single-walled nanotube yields of 20-30%, and that the diameter of the single-walled nanotube depends on the metal used in their (metal catalyzed) production, e.g., nanotube radii of 0.5 nm, 0.65 nm, and 1.0 nm for Fe/Ni, Co, and La, respectively. Raman spectroscopy and STM are used to characterize the nanotube deposits. Attempts to interrogate the electronic structure have been unsuccessful thus far.

The overall picture is that this group at Tohoku is well equipped as far as the electron microscopy techniques are concerned and is primarily interested in developing larger scale production techniques for both metallic clusters and for carbon nanotubules. It was not clear what the ties to future technology development may be.

Prof. T. Yao's Lab: Drs. D. Bagnall and E. Kurtz (Evelyn Hu)

Dr. Takafumi Yao's general research goal is "to exploit new optoelectronic materials for the 21st century." The WTEC team's visit to Professor Yao's laboratories was hosted by two postdocs working with him: Dr. Elisabeth Kurtz and Dr. Darren Bagnall. Drs. Kurtz and Bagnall are two of three foreign (JSPS) postdocs working within Dr. Yao's lab. (This laboratory is apparently one of three under Professor Yao's supervision; another one is located in Tsukuba). They described projects in the nanostructured growth of wide bandgap materials: ZnO and CdSe.

Dr. Bagnall spoke of *Plasma-Assisted MBE of ZnO for Blue-UV Emitters*. A plasma source of oxygen was used to assist the epitaxial growth of ZnO on sapphire substrates. Free exciton emission dominates at room temperature, and pulsed, optically-excited lasing was observed up to 500 K, with fairly large thresholds: 2.5 MW/cm². With the large amount of strain between ZnO and sapphire, it would not be surprising to observe nanostructure growth (e.g., islands). In fact, AFM traces showed evidence of pyramidal structure: this was *not* thought to be the basis of the excitonic emission. Bagnall hopes to grow quantum wells in this material structure.

Dr. Kurtz described the growth of self-organized quantum dots in the CdSe material system: (111)A ZnSe was grown on a GaAs substrate, and CdSe dot structures were subsequently nucleated on this surface. The (111)A surface was utilized because it provided a smooth, featureless surface. The dots had typical diameters of 47 nm, with a height/diameter ratio of 19%. There are some interesting differences in these dots compared to self-organized dots in the III-V materials, such as InAs/GaAs:

- They have less stability: the dot dimensions are not stable with time, due to Ostwald ripening.
- Under different growth conditions, the dot *sizes* do not change, although the densities do change. Typical densities range from 5-25(μm)⁻² (using atomic layer epitaxy with either 1 or 3 cycles of growth). In the III-V materials, the dot diameter and dot density are usually coupled, i.e., one cannot change one parameter without having the other parameter also vary.

Both projects used cathodoluminescence, photoluminescence, and AFM measurements in their analysis. There was a lack of modeling effort complementing the experimental work of the group. There seemed to be access to a broad range of characterization tools within or external to the Yao group—such as near field scanning optical microscopy. The WTEC team was taken for tours of some of the Yao labs, which include five MBE stations, cathodoluminescence (CL), photoluminescence (PL), X-ray analysis, and a UHV STM.

REFERENCES

- Ono, T., H. Saitoh, and M. Esashi. 1997. Si nanowire. In growth with ultrahigh vacuum scanning tunneling microscopy. *Applied Physics Letters* 70(14)(7 April).
- Hamanaka, H., T. Ono, and M. Esashi. 1997. Fabrication of self-supported Si nano-structure with STM. In *Proc. of IEEE, MEMS '97* (January), pp. 153-158.

Site: **Tokyo Institute of Technology**
Nagatsuta, Midori-ku
Yokohama 226, Japan
Tel: (81) 45-924 5759; Fax: (81) 45-924 5779

Date Visited: 21 July 1997

WTEC: L. Jelinski (report author), E. Hu, M.C. Roco, D. Shaw,
C. Uyehara

Host: Professor Masuo Aizawa, Faculty of Bioscience and
Biotechnology; E-mail: maizawa@bio.titech.ac.jp

BACKGROUND

The Tokyo Institute of Technology has two campuses, one at Tamachi and another at Nagatsuta. The Nagatsuta Campus is about 20 years old, and the Faculty of Bioscience and Biotechnology was moved there about six years ago.

RESEARCH AND DEVELOPMENT HIGHLIGHTS

Professor Aizawa, whose laboratory the WTEC team visited at the Tokyo Institute of Technology's Nagatsuta Campus, was the project leader of a ten-year national MITI project on bioelectronic devices. The project, which ended in 1995, involved eight electronics companies and two national labs for its initial five-year period. One of the electronics companies dropped out and did not participate in the second term. An example of the work performed in the project is that by Mitsubishi, which produced an artificial protein that binds an electron acceptor and electron donor.

It appears that much of what was accomplished in the MITI bioelectronics project was accomplished in Aizawa's laboratory (see below). He set out to answer the question, "Are biological systems ideal for molecular electronics or not?" Parts of the project that are being continued appear to be in the form of RIKEN's Brain Research Center. Formulation of ideas for somewhat related work is being carried out by the Intelligent Materials Forum, whose members are working to promote a national project in this area. (The president of the forum is Toshinori Takagi; Aizawa is the vice president.) The idea of intelligent materials is to incorporate sensing and transduction and information processing into the same materials. The

idea of forming a “Nanospace Laboratory” was just coming together at the time of the WTEC visit.

Aizawa has been a world leader in bioelectronics. His review on molecular interfacing for protein molecular devices and neurodevices (Aizawa 1994) describes subjects such as the coupling of electron transfer proteins (e.g., glucose oxidase) to solid surfaces, conducting polymer wires that couple the enzyme to the surface, and electrically modulated activity of molecular-interfaced enzymes.

More recent work, not yet published at the time of the WTEC visit, involved developing methodology to orient antibodies on surfaces. The key to making this work was to genetically modify protein A, known to bind the non-antigen binding stalk of the “Y” of the antibody, so its C-terminal carried a cysteine. The modified protein A was then bound to a gold surface via the well-known alkylthiol/gold chemistry. The ability to control the orientation of proteins on the surface is a major step forward in the ability to use these systems for drug targets, biochemical purifications and separations, and for sensing and diagnostic applications.

In other experiments, liposome nanoparticles were engineered by coupling to phosphatidyl choline, a peptide corresponding to one antigen binding domain of an antibody (Kobatake et al. 1997). These nanoparticles were used as the basis for a new fluoroimmunoassay.

REFERENCES

- Aizawa, M. 1994. Molecular interfacing for protein molecular devices and neurodevices. *IEEE Engineering in Medicine and Biology* (February/March).
- Kobatake, E., H. Sasakura, T. Haruyama, M.-L. Laukkanen, K. Keinänen, and M. Aizawa. 1997. A fluoroimmunoassay based on immunoliposomes containing genetically engineered lipid-tagged antibody. *Analytical Chemistry* 69(7): 1295-1298.

Site: **The University of Tokyo**
Department of Chemical Engineering
Faculty of Engineering
Kogakukan #5, Room 709
Bunkyo-ku, Tokyo 113, Japan
Fax: (81) 3-5689 7352

Date Visited: 22 July 1997

WTEC: D.T. Shaw (report author)

Hosts: Prof. H. Komiyama, Dept. of Chemical Systems Engineering
Dr. H.S. Zhou
Dr. Fumihiko Wakai, Professor, Center of Materials Design,
Tokyo Institute of Technology, Yokohama

BACKGROUND

The University of Tokyo is the oldest and the most prestigious university in Japan. Prof. Komiyama belongs to the Department of Chemical Systems Engineering, which is one of three departments (the other two are the Department of Applied Chemistry and the Department of Chemistry and Biotechnology) in the Department of Chemical Engineering. His work on nanoparticles has focused on the synthesis and optical properties of nanocomposites of metal/organic, organic/metal, metal/semiconductor, and semiconductor/semiconductor particles. More recently, coated self-assembled nanoparticles have also been studied.

Overall, Prof. Komiyama's work on nanoparticles and nanoparticle structures has focused on fundamental studies of the effects of quantum confinement of heterostructured nanoparticles and nanoparticle structures. Prof. Komiyama's laboratory is extremely well equipped and has formed strong connections to other research laboratories both within and outside Japan. At the present time, all his research projects appear to be experimental. In fact, the last theoretical work was conducted in cooperation with Prof. Joseph W. Haus (Physics Department, Rensselaer Polytechnic Institute, RPI) who visited him for one year in 1992.

RESEARCH AND DEVELOPMENT HIGHLIGHTS

Dr. H.S. Zhou, who is now a researcher at the Electrotechnical Laboratory at Tsukuba City, showed me his work with Prof. Komiyama on the study of conformational change of protein cytochrome b-562 absorbed on colloidal gold particles. Cytochrome b-562 is a small cylindrical haem protein (diameter ~2.5 nm and height ~5 nm) found in the periplasm of *E. coli*. Depending on the degree of coverage, the protein on the gold particles (diameter ~ 31 nm) can be in side-on or tail-on conformation. Maximum optical shift occurs when protein particles are in side-on conformation with an effective composite particle size of 36 nm. Other work in this area includes the synthesis of semiconductor/semiconductor (such as CdS/PbS) and metal-coated (such as AuS/Au, Ag/polydiacetylene) particles. Some of this work was partially inspired by the theoretical work carried out while Prof. Haus was visiting Tokyo University on leave from RPI in 1992. In recent years, special emphasis has been placed on experimental projects because of the great influx of equipment funds from the government. At present, nanoparticles are fabricated by colloidal chemical vapor deposition and physical vapor deposition techniques (e.g., laser ablation, sputtering, and electron cyclotron resonance).

Dr. Fumihiro Wakai was invited by Prof. Komiyama to make a presentation on his work on superplasticity. Dr. Wakai was associated with the National Industrial Research Institute of Nagoya. He is now a professor at the Center of Materials Design at the Tokyo Institute of Technology in Yokohama. His work (*Nature* 1990, 344:421) on $\text{Si}_3\text{N}_4/\text{SiC}$ composites has led to the discovery of superplasticity in nanocrystalline covalent ceramic materials. Currently, he is also the director of a large cooperative project between Japan and Germany (Prof. Fritz Aldinger, Max-Planck-Institut für Metallforschung), supported by the Japan Science and Technology Corporation, that commenced its operation in October 1966. The objectives of the cooperative project are to explore the nanostructures of the superplastic grain boundaries and to develop new synthesis techniques for maximum superplastic deformation at elevated temperatures. In addition, Prof. Komiyama mentioned the possibility of investigating the miniaturization of superplastic testing and characterization with a very small amount of materials.

CONCLUDING REMARKS

Although I spent all of my visit with Prof. Komiyama's group, there are several other groups at the University of Tokyo that are conducting

significant research in nanotechnology. These include the Physics Department (theoretical and experimental work on quantum-confinement and functional materials) and the Department of Applied Chemistry (TiO_2 particles).

Although my two-hour visit concentrated on composite nanoparticles/nanostructures as described above, I know from my previous visit in October 1996 that Prof. Komiyama is also active in areas related to amorphous silicon and other metal and semiconductor nanostructured materials. He is one of the research leaders in the one-step CVD synthesis of AlN, TiN, SiN, SiC, TiC, and ZrO (single or two components) nanostructured materials.

Site: **Toshiba Research and Development Center
1 Komukai, Toshiba-cho
Saiwai-ku, Kawasaki 210, Japan
Tel: (81) 44-549 2318; Fax: (81) 44-520 1287**

Date Visited: 24 July 1997

WTEC: H. Goronkin (report author), E. Hu, L. Jelinski, M.C. Roco,
D. Shaw, C. Uyehara

Hosts: Mr. Haruo Nakatsuka, R&D Center
Dr. Koichiro Inomata, R&D Center
Dr. Masaaki Tamatani, Materials and Devices Research Labs
Dr. Shuji Hayase, Materials and Devices Research Labs
Dr. Takashi Kawakubo, Materials and Devices Research Labs
Dr. Atsushi Kurobe, Advanced Research Laboratory
Mr. Kunio Yoshihara, Advanced Semiconductor Devices
Research Laboratories

BACKGROUND

Toshiba has a history over 100 years. In 1939, Shibaura Engineering Works and Tokyo Electric Company were merged to a single company named Tokyo Shibaura Electric Company. In 1978, it changed its name to Toshiba Corporation.

Toshiba has a 3-layered R&D organization with long-, medium- and short-term elements: the corporate laboratories work on new technology that may be applied to products 5 to 10 years later; the development laboratories are working on technology for deployment 3 to 5 years later; the engineering departments in the operating divisions have as their most important task the solution of problems inherent to present products.

RESEARCH AND TECHNICAL HIGHLIGHTS

The following sections summarize the ongoing work in various Toshiba laboratories concerned with nanostructure technologies, based on presentations made to the WTEC panel by our hosts.

A. Kurobe, Advanced Research Laboratory

“Study of Shapes Produced by Stranski-Krastanov Growth in Cold-Walled UHV-CVD”

With a silicon buffer, hut-shaped Ge dots with (001 x 010) alignment were obtained. Without a buffer, dome-shaped Ge dots were obtained. Using H-terminated Si wafers by exposure of atomic hydrogen, domes were obtained.

The H-free wafers with a prior annealing at 750°C contained the hut dots. Thermal desorption spectroscopy supports the difference in the surface: Dihydride desorbs at 415°C. Monohydride desorbs at 550°C. Annealing at 750°C removes all H. Atomic hydrogen exposure produces a monohydride surface. The goal is study of interaction of dots with 2DEG. The plan is to move to a SiO₂-Si system to increase barrier height.

K. Inomata, Research and Development Center

“Advanced GMR”

Working on spin electronics for high density heads, 20 Gbit in 2002 is forecast. Toshiba researchers have achieved >10% GMR ratio in layered films at room temperature. They have also achieved > 30% in nanogranular films with a coercive field of 0.1 T.

The most promising approach is the tunnel junction. It has > 25% MR ratio but drawbacks include high resistance and strong fall-off of the magnetoresistance ratio with applied voltage and pinholes in the ultrathin insulator barrier.

Dr. Inomata described two structures for possible use in future memory and logic. One new proposed structure consists of two ferromagnetic (FM) layers sandwiching a barrier containing 8 nm granules of FM material in an SiO₂ matrix. The total barrier thickness is about 10 nm. Inomata and coworkers explained that the size and distribution of the FM granules must be carefully controlled. The FM contact polarization can be switched either parallel or antiparallel to the granules and to each other to provide high or low current transport through the barrier. No data were provided.

A second proposed structure places the two FM electrodes on the same surface of granular FM materials. This is a transistor structure in which lateral conduction can be controlled by the relative polarization of the contacts. No data were provided.

T. Kawakubo, Materials and Devices Research Laboratories

“Epitaxy of Ferroelectric (FE) Materials”

The goal of this project is to control FE properties by orientation and strain of the epitaxial material.

The researchers use (Sr, Ba)TiO₃ with SrRuO₃ electrodes, which have good metallic conduction. By reducing the thickness and sputter conditions, good performance (saturating hysteresis loop) at 1.0 V has been obtained. This material is also under investigation for DRAM charge storage capacitors. With 20% Ba content, the dielectric constant is about 900. An SiO₂ equivalent thickness of 0.085 nm was obtained. The leakage current was 4×10^{-8} A/cm² between ± 1.3 V. This was said to be satisfactory for 0.12 μ m DRAM. TiAlN/Pt barrier layers were used.

M. Tamatani, Materials and Devices Research Laboratories

“Nanoparticle Phosphors Made by Thermal Plasma”

This project produces spherical particles compared to faceted particles. These particles have the particle size in the same region as those of commercially available materials. They must be heat treated in oxygen or hydrogen to restore luminescence efficiency comparable to that of the commercial phosphors. The thermal plasma also produces nanoparticle phosphors, which could be used as labeling agents for analysis.

Site: **ULVAC Japan, Ltd.**
Vacuum Metallurgical Company (VMC)
516 Yokota, Sanbu-cho, Sanbu-gun
Chiba 289-12, Japan
Fax: (81) 467-87 3383

Date Visited: 23 July 1997

WTEC: D. Shaw (report author), C. Koch, R.W. Siegel, C. Uyehara

Hosts: Dr. Chikara Hayashi
Dr. Masaaki Oda

BACKGROUND

The Vacuum Metallurgical Company (VMC) is a subsidiary of ULVAC Japan, Ltd., which is a relatively large conglomerate of 30 companies employing over 3,500 people. The principal products of VMC include sputtering targets; complex shaped Ti-alloy cast parts; reactive and refractory metal sheet, wire, and shapes; and service coating for processing equipment for semiconductors, display panels, etc.

VMC's ultrafine-particle (UFP) business is based on early work by Dr. Hayashi and colleagues on gas-phase particle nucleation (evaporation and condensation) and deposition by using nanoparticles dispersed in tiny gas jets (in the 10 micron diameter range). VMC commercialized magnetic UFP in 1971, and Dr. Hayashi (at the time, president of ULVAC) served as the leader of a UFP project in Japan's Exploratory Research in Advanced Technology (ERATO) program from 1981-1986. ERATO has been supported by the now renamed government organization, Japan Science and Technology Corporation (JST). The UFP project investigated the physical, chemical, and biological properties of nanoparticles.

Over the years, VMC has improved the magnetic UFP technique and now offers a large quantity of metallic and organic particles; gas-evaporation and gas-deposition equipment for producing fine pattern of contacts and conductive lines for electronic devices; and UFP paste (dispersed liquid) with coating system.

RESEARCH AND DEVELOPMENT HIGHLIGHTS

Although the basic design of the induction-heating chamber for the ultrafine-particle generation was developed by Hayashi and Oda in the

1970s, the performance of the chamber has been steadily improved through a series of government-subsidized R&D programs at VMC. At present, there is an impressive list of UFPs that are produced in large scales under reasonably controlled conditions. These include chain-aggregate ferromagnetic UFPs, metallic (e.g., Au, Ag, Cu, Pd, Ni, Al, Sn, etc.) isolated UFPs, and coated UFPs (e.g., ZnO-coated Cu and polymer-coated Fe). These particles are used for the formation of thick films for various applications, including electronics, optics, etc. Application fields presently being pursued by VMC are shown in Table D.1.

CONCLUDING REMARKS

VMC is in many ways similar to Nanophase Technologies Corporation in the United States. They both use the principle of gas-phase condensation for particle generation. Both are market-driven companies that try to break into various new markets. Thus, their targeted markets, as shown in Table D.1, are very similar. At the present time, the UFP revenue for VMC is about \$4 million. Dr. Hayashi indicated that he hopes to increase the UFP business in VMC to about \$10 million in two or three years.

TABLE D.1. UFP Applications and Processes at VMC

Applications	Coating Methods	Effects
ELECTRONICS		
Metalizing of ceramic parts (Eliminating electric discharge)	Dipping or printing	Reduce processes and materials (replacing vacuum deposition)
Formation of electrodes of chip condensers	Dipping	
Formation of test circuits	Drawing with a microdispenser	Decrease firing temperature
Repairing of electric circuit of LCDs or PDPs	Repainting with a microdispenser	
Formation of electric circuits	Screen printing	
OPTICS		
Coating of infrared reflectors	Dipping	Reduce processes
Coating of laser reflectors		
Repairing of reflectors		
ARTS		
Decoration of ceramics or glass utensils	Pad painting	Reduce processes, decrease firing temperature
Coating of accessories	Dipping	Replace electroplating
Replacing of gold leaf	Spraying	Reduce processes

NOTES ON FUNDING OF NANOTECHNOLOGY RESEARCH IN JAPAN

M.C. Roco

Introduction

Government organizations and very large corporations are the main source of funding for nanotechnology research and development in Japan. Small and medium-size companies play a minor role. All large Japanese corporations devote a significant portion (generally ~ 10% in the electronics industry) of their income to R&D. Japanese corporate research tends to be product-oriented, but there is also a well-established culture within the corporate and scientific community of planning for the next generation of technological innovation. As evident in the foregoing site reports, nanotechnology R&D is decidedly a part of the present and future planning of both government and industry labs, and funds are allocated accordingly.

Government funding for nanotechnology research should be viewed in the context of the overall increase of public support for basic research since 1995 as a result of passage of Japan's Science and Technology Basic Law No. 130 (effective November 15, 1995). The law proposes to allocate approximately ¥17 trillion (~\$148 billion¹) for basic research to Japanese universities, industry, and national laboratories from 1996 to 2000. The main recipients of the 1996 government budget for science and technology (\$23.3 billion/year) were the Ministry of Education, Science, Sports, and Culture (known as Monbusho), which received 46.5% of the S&T budget; the Science and Technology Agency (STA), which received 25.9%; and the Ministry of International Trade and Industry (MITI), which received 11.9%. In 1997 the university system received \$935 million from Monbusho as "grants-in-aid" for research, and \$239 million from other ministries, however, it appears that the ministry with the largest allocation of funds specifically earmarked for nanotechnology R&D is MITI.

The information on funding presented here is based on interviews with Japanese colleagues during the WTEC panel's visit in July 1997, using the nanotechnology definition adopted by this study. All budgets are for the fiscal year 1996 (April 1, 1996 to March 31, 1997) and are approximate. In many institutions it was difficult to separate the exact contribution of research related to nanostructure science and technology, and for those institutions, only the total budget, as available, is given.

¹ The exchange rate used throughout this overview is ¥115 = \$1, unless otherwise stated; the budgets given are for FY 1996.

A. Main Japanese Government Organizations Sponsoring Nanotechnology R&D

MITI / AIST (Agency of Industrial Science and Technology)

Total budget, \$2.75 billion/year; nanotechnology budget from all sources below, ~\$60 million/year

National Institute for Advancement of Interdisciplinary Research (NAIR), Tsukuba City

- Joint Research Center for Atom Technology (JRCAT), ten-year budget of ~\$220 million (1992-2001); \$25 million/year
- Research on Cluster Science, ~\$10 million (1992-1997); \$2 million/year
- Research on Bionic Design, ~\$10 million (1992-1997), 50% for nanotechnology; \$1 million/year

Electrotechnical Laboratory, Tsukuba City

- Total budget, ~\$100 million/year; nanotechnology budget, ~\$17 million

Osaka National Research Institute, Osaka

- Total budget, ~\$26 million/year; estimated nanotechnology budget, ~\$3 million/year

National Industrial Research Institute of Nagoya (NIRIN), Nagoya

- Total budget, ~\$25.2 million/year (1996); estimated nanotechnology budget, ~\$2.5 million/year

MITI's Quantum Functional Devices (QFD) Program

- Ten-year budget ~\$64 million (1991-2001); estimated nanotechnology budget, ~\$6.4 million/year

Science and Technology Agency (STA)

Total budget, \$6 billion/year; estimated nanotechnology portion was ~ \$35 million/year in FY 1996

Institute of Physical and Chemical Research (RIKEN), Wako City

- Total budget, \$300 million/year; nanotechnology budget is included in Frontier Materials research

National Research Institute for Metals (NRIM), Tsukuba City

- Total budget, \$130 million/year; nanotechnology work in various projects

National Institute for Research in Inorganic Materials (NIRIM), Tsukuba City

- Total budget, \$35 million/year; nanotechnology budget, ~\$0.8 million

Japan Science and Technology Corporation (JST)

- Administration of ERATO Program (Exploratory Research for Advanced Technology), including 4 nanotechnology projects, each with total budgets of \$13-18 million for five years:
 - Quantum Wave Project (1988-1993)
 - Atomcraft Project (1989-1994)
 - Electron Wavefront Project (1989-1994)
 - Quantum Fluctuation Project (1993-1998)

Ministry of Science, Education, Sports, and Culture (Monbusho)**Total budget, \$10.8 billion/year**

Nanotechnology programs are supported at universities and national institutes, as well as via the Japan Society for Promotion of Science (total resource allocation unknown).

Tokyo University, Tokyo

- University of Tokyo's Research Center for Advanced Science and Technology
- Institute of Industrial Engineering
- Chemical Engineering (H. Komiyama) (A newsletter "Quantech" for a loose network on nanotechnology in Japan is edited here)

*Kyoto University, Kyoto (H. Shingu)**Tokyo Institute of Technology, Yokohama (M. Aizawa)*

- Bioelectronic Devices—10 year MITI project was completed in 1996

Tohoku University, Institute of Materials Science, Sendai

- Total budget, \$44 million/year

*Nagoya University, Nagoya**Osaka University, Osaka, K. Niihara's lab*

- Total budget, \$25 million/year

*Institute of Molecular Science, Okazaki (M. Fujita)**Exploratory Research on Novel Artificial Materials and Substances for Next Generation Industries*

- Five-year university-industry research project sponsored by the Japan Society for the Promotion of Science (JSPS), part of Monbusho "Research for the Future" Program

- e.g., at IMR, Tohoku University, JSPS funds “Nanostructurally Controlled Spin Depending Quantum Effects and New Electronics and Magnetics”; total 5-year budget 1996-2001, \$3.8 million

B. Industry

Hitachi Central R&D Lab., Tokyo (T. Ikeda)

Annual sales Hitachi are about \$70 billion/year; R&D spending as percent of total sales is on the order of 10%. There are seven corporate laboratories with 3,000 personnel. Nanotechnology takes a significant percentage of precompetitive research at Hitachi, perhaps as much as \$280 million per year.

NEC Fundamental Research Laboratories, Tsukuba (J. Sone)

Annual sales are about \$40 billion/year; R&D is 10% of total sales; Precompetitive research (Central group) spends about 1% (or \$30 million per year); Nanotechnology-related precompetitive research is 50% of that (or \$15 million/year); it also receives partial support from government (for example, 20% of funding for devices)

Toshiba Research Center

Annual sales are \$52 billion/year; R&D expenditures as a percentage of total sales are comparable to other Japanese corporations; nanotechnology-related precompetitive research is about \$20 million/year.

Nihon Shinku Gijutsu (ULVAC)

Vacuum Metallurgical Co., part of a conglomerate of 35 companies, had at the time of the WTEC visit ~\$4 million in particles sales per year for electronics, optics, and arts; it planned to expand that investment to ~\$10 million/year within three years. A major focus of ULVAC is marketing.

Other companies with large nanotechnology research programs are NTT, Fujitsu, Sony, and Fuji Photo Film Co.

Comments

Strengthening of Japan's nanotechnology research infrastructure in the past several years has been fueled by both the overall increase of government funding for basic research and by larger numbers of academic and industry researchers choosing nanostructured science/technology as their primary field of research. The main drivers are technological innovation and potential industrial applications, with several exceptions where the driver is scientific curiosity. A system approach has been adopted in most laboratory projects, including multiple characterization methods and processing techniques for the same objective. The university-industry interaction is stimulated by new MITI projects awarded to universities in recent years that encourage use of research personnel from industry. Issues that are being addressed already are more extensive use of peer review, promotion of personnel mobility and intellectual independence, rewarding researchers for patents, promotion of interdisciplinary and international interactions, and better use of the physical infrastructure. The three major government organizations (MITI, STA, and Monbusho) allocated an estimated total of \$120 million for nanotechnology in fiscal year 1996.

Appendix E. Site Reports—Taiwan

OVERVIEW OF NANOPARTICLE / NANOTECHNOLOGY RESEARCH IN TAIWAN

David T. Shaw

In 1996, the total product value of integrated circuits (IC) produced in Taiwan reached \$7.8 billion. From 1995 to 1997, IC products have grown at an average of 50-60% per year. The current state of IC manufacturing and product technology in Taiwan, as summarized in Tables E.1 and E.2, is two to four years behind the leading countries. However, the technology gap is closing fast as Taiwan invests heavily in nanotechnology R&D. In 1996, more than 400 research projects amounting to more than \$7 million were supported by the National Science Council in such diverse microelectronic fields as VLSI technology, amorphous silicon, microelectromechanical systems, and electronic packaging. These projects share a common theme: the development of submicron or nanometer technology.

TABLE E.1. Current State of IC Manufacturing Technology in Taiwan

Item	Taiwan's Level	Leading Country	Leading-edge Technology Level
CMOS	0.25 μm (R&D) 0.35 μm (production)	Japan, U.S.	0.18 μm (R&D) 0.25 μm (production)
BiCMOS	0.8 μm (production)	Japan	0.35 μm (production) 0.25 μm (R&D)
Bipolar	2.5 μm	Japan	1.0 μm (production)
GaAs	Circuit design and 0.6 μm process	U.S.A., Japan	0.35 μm (R&D)

TABLE E.2. Current State of IC Product Technology in Taiwan

Item	Taiwan's Level	Leading Country	Leading-edge Technology Level
DRAM	64 M (R&D) 16 M (production)	Japan, Korea	1G (papers published) 256 M (production)
SRAM	4 M (pilot run) 1 M (production)	Japan	64 M (papers published) 16 M (production)
ROM	Introduction of 64 M mask ROM in 1994 by UMC	Japan	Introduction of 64 M mask ROM by Sharp
Flash Memory	4 M Flash (production) 16 M Flash (pilot run)	U.S., Japan	64 M/256 M Flash (R&D) 32 M (production)
MCU	4 bit, 8 bit	U.S.	16 bit (production) 32 bit (announced)
MPU	RISC CPU	U.S.	RISC: 64 bit 200 MIPS
A/D D/A converter	A/D: 8 bit, 20 MHz D/A: 8 bit, 120 MHz	U.S., Europe	A/D: 8 bit, 650 MHz D/A: 8 bit, 100 MHz
Power IC	Discrete bipolar Discrete MOS	Japan, Europe	Smart power

Site: **National Taiwan University (NTU)**
1, Sec. 4, Roosevelt Rd.
Taipei, Taiwan ROC

Date Visited: 16 April 1997

WTEC: D. Shaw (report author)

Hosts: Prof. C.Y. Mou, Department of Chemistry
Fax: (886) 2-3636359
Prof. S.F. Cheng, Department of Chemistry

BACKGROUND

NTU is widely considered to be the most prestigious university in Taiwan. The first university on the island, established nearly 100 years ago, it is also the most renowned and the most competitive university in Taiwan. NTU alumni play key leadership roles in all levels of government, industry, and academia. I met with about a dozen professors from various departments (Chemistry, Chemical Engineering, Physics, and Electrical Engineering) and had an informal exchange of information on nanoparticle technology.

DISCUSSION

During the discussions, it became clear that R&D on nanoparticle technology is generally new on campus. All the departments represented at this meeting are considered to be large departments, having more than 50 faculty members. Most of the research in the Electrical Engineering Department covers traditional silicon-based IC processing with some limited optoelectronic device studies. Research programs on submicron photoresistance are being initiated by the Department of Chemical Engineering, while programs on quantum lasers are being conducted by the newly established Institute of Optoelectrical Engineering.

A project in the Chemistry Department is of interest to nanostructure scientists: “Synthesis and Application of Mesoporous Molecular Sieves” (Project Principal Investigator, Prof. C.Y. Mou; Co-Principal Investigators, Prof. S.F. Cheng, Prof. P.Y. Wan, and Dr. S.P. Liu). The investigators have successfully synthesized mesoporous aluminosilicate MCM-41, which consists of hexagonal arrays of nanometer-sized cylindrical pores (*Science*

1996, 273:765). As illustrated in Fig. E.1, a liquid crystal phase-transformation mechanism was used for formation of the nanostructure. The complex tubules-within-a-tubule structure is now being explored for various applications, including catalysis, separation technology, and optoelectronics (Fig. E.2).

SUMMARY

Besides the mesoporous membrane project discussed above, the related nanoparticle/nanostructure projects at NTU are generally in their early stages. There is, however, a considerable amount of interest in this research area. The Institute of Optoelectrical Engineering is very well equipped and is staffed by a group of enthusiastic graduate students. Most of the projects under consideration are related to the development of silicon IC devices.

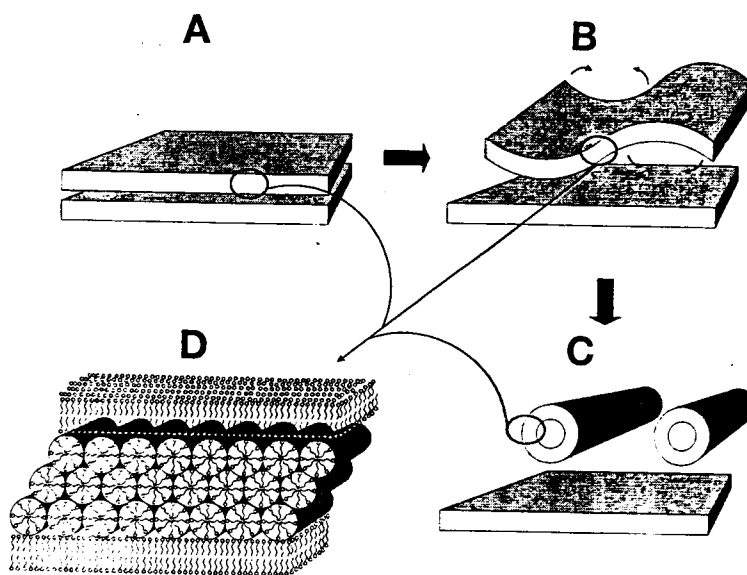

Figure E.1. Proposed mechanism for the formation of the microtubular morphology of MCM-41: (A) mixed lamellar-hexagonal membrane phase; (B) acidification leads to membrane curvature; (C) neutralization bends the membrane into tubules; (D) the membrane consists of a hexagonal array of cylindrical micelles.

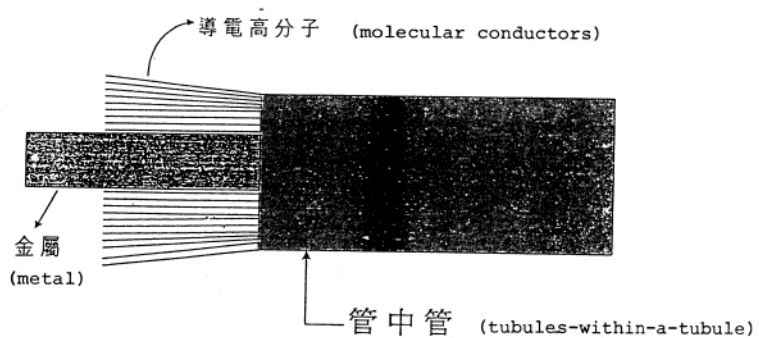

Figure E.2. Molecular conducting device.

Site: **National Chiao-Tung University (NCTU)**
Hsinchu, Taiwan ROC

Date Visited: 17 April 1997

WTEC: D. Shaw (report author)

Hosts: Prof. M.S. Feng, Deputy Director, National Nano Device
Laboratory,
Department of Materials Science and Engineering
Dr. M.C. Jiang, Associate Researcher, National Nano
Device Laboratory
E-mail: mcj@mail.ndl.nctu.edu.tw

BACKGROUND

NCTU has the most abundant resources for microelectronic research among the universities in Taiwan in terms of manpower, equipment, and research funds. It boasts of six research institutes in the College of Electronics Engineering and Computer Sciences, covering such subject areas as information engineering, control, communication, optoelectronics, and computer science. The Institute of Electronics, the biggest of the six institutes, has more than 40 faculty members, whose research ranges from model simulation and nanometer-sized MOS and bipolar devices, to thin-film deposition and multilayer superlattice fabrication. In addition, there is a Semiconductor Center, which appears to be a training center for semiconductor production engineers. A complete line for IC processing based on 10 cm wafers is housed in its Class-10,000 cleanroom facilities. Situated near the Science/Industrial Park in Hsinchu, NCTU is a major force in Taiwan's high-tech industry. Its close relationship with industry is also reflected in the university's numerous research grants and contracts from industrial firms. According to university officials, in 1995 NCTU ranked first among the institutes worldwide in publications in *IEEE Transactions on Electronic Devices* and *Electron Device Letters*. The crown jewel of NCTU is the National Nano Device Laboratories (NDL).

I was met by Prof. M.S. Feng, Professor at NCTU's Institute of Materials Science and Engineering and Deputy Director of NDL. During an official briefing, Prof. Feng told me that NDL was founded in 1993 as Taiwan's response to the increasingly competitive world of VLSI R&D. By the end of 1995, NDL had completed advanced R&D work on 0.18 micron IC process modules. Prof. Feng told me that NDL's goal is to reach 0.13 micron

processing by the year 2000. Overall, unlike the corresponding facilities at Cornell University in the United States, NDL is a production R&D facility with a carefully laid out roadmap for the development of IC technology.

DISCUSSION

Dr. M.C. Jiang, an associate researcher at NDL, led me through a guided tour. He showed me some of the key modules completed so far by the NDL personnel:

- the design, technologies, and manufacturing of 250 nm and 180 nm devices
- growth of ultrathin (4 nm) oxide and shallow trench isolation for p-channel 120 nm processes
- SiGe-based microwave device technology
- process development and application of ECR-RIE etching
- selective tungsten CVD for 0.20 μm via holes
- CVD-TiN, CVD-Al and CVD-Cu for advanced metallization
- Al Damascene process for 0.25 μm metallization
- chemical-mechanical polishing (CMP) processes for dielectrics and metals
- low-K (SiOF, SOG) and high-K (BST, Ta₂O₅) dielectrics
- shallow junction process for 120 nm devices
- surface characterization of semiconductors (SIMS, ESCA, AFM, etc.)
- 100 nm e-beam lithography

In addition to the module development work, NDL provides equipment services to universities and other organizations for semiconductor-related research. The four major universities mentioned in the Overview in this Appendix are all frequent users of NDL's equipment. In fact, many of the research achievements in NDL would not be possible without the input from the other universities, which have their graduate students conduct their experiments at NDL.

SUMMARY

To integrate resources among research organizations, Taiwan's National Science Council (NSC) and Taiwan's Ministry of Economy have encouraged cooperation between major universities and research institutes to conduct massive-scale R&D projects on advanced technology. The joint project between NDL and the Synchrotron Radiation Research Center (SRRC) on

X-ray lithography is a good example of such principles at work. The project started in April 1996 and will last for three years. SRRC will build a beam line and a cleanroom to house lithographic tools under the guidance of NDL. Both sides will share their equipment, expertise, and manpower. This project marks Taiwan's first attempt towards deep submicron X-ray lithography.

Site: **National Tsing-Hua University (NTHU)**
No. 101, Sec. 2, Kuang Fu Road
Hsinchu, Taiwan 300, ROC

Date Visited: 18 April 1997

WTEC: D. Shaw (report author)

Hosts: Prof. M.K. Wu, Chairman, Research and Development
Council, Materials Science Center and Physics Dept.
E-mail: mkwu@phys.nthu.edu.tw
Prof. C.C. Chi, Director, Materials Science Center and
Physics Dept.

BACKGROUND

Compared to NCTU, which is very technology-oriented, NTHU's R&D strength lies mainly in basic R&D. Physics, Chemistry, and Materials Science have been the strongest fields of study at NTHU. Nanoparticle/nanostructure R&D, however, is in its initial stage and is carried out mostly at the Materials Science Center.

DISCUSSION

There are several groups actively working on projects related to nanoparticle technology.

Professor David Z.Y. Ting, a condensed matter theorist, has developed techniques to study (1) disorder effects in semiconductor alloys and superlattices; (2) electronic and optical properties of quantum wells and superlattices; (3) heterostructure tunnel device physics; (4) 3-D modeling of quantum transport in nanostructures; and (5) light extraction from light-emitting diodes. His current research projects include

- clustering effects in alloy tunnel barriers
- thermoelectric properties of type-II superlattices
- 3-D simulations of magnetotunneling in nanostructures
- multiband quantum transmitting boundary methods for non-orthogonal basis
- magnetotunneling in interband tunnel structures
- resonant tunneling via InAs self-organized quantum dot states

Professor S. Gwo of the Physics Department has been involved in the growth of self-organized semiconductor nanostructures by MBE. He has ample experience in nanostructure fabrication for advanced electronic and optoelectronic devices. He is also involved in the atomic-scale studies of dopants in semiconductors and in the development of UHV scanning probe microscopy and spectroscopy for optical measurements. Professor T.P. Peng of the Department of Materials Science and Engineering (in collaboration with Professor M.K. Wu and Dr. S.R. Sheen of the Materials Science Center), has been working on the preparation of nanoparticles by vapor condensation, high-energy ball milling, or magnetron sputtering. Their current research projects cover

- sintering or grain growth behavior of nanoparticles
- chemical reactivity of nanoparticles and application of nanoparticles in catalysis
- characterization of the interface structure of nanoparticles
- chemisorption, diffusion, and solution of gases in nanocrystalline materials
- fabrication and structural characterization of metal/metal or metal/ceramic nanocomposites
- effects of particle size on the second-order phase transitions, such as order-disorder, superconductivity, ferroelectricity, and piezoelectricity
- kinetics and mechanism of nucleation and growth of nanoparticles in an amorphous matrix

SUMMARY

Impressive progress has been made in nanoparticle/nanostructured research at NTHU. Under the leadership of Professors M.K. Wu and C.C. Chi, the university has established a network connecting the microfabrication capabilities of NCTU, the chemical processing techniques of NTU, and the analytical and materials processing capabilities at their own Materials Research Center to perform the only organized research effort in this area. They also plan to expand their characterization capabilities to include some of the atomic force microscopy techniques developed at the Academia Sinica. Their future research activities will be directed toward semiconducting functioning materials and nanophase materials for biological sensor applications.

Site: **National Chung-Chen University (NCCU)**
Taiwan 621, ROC

Date Visited: 11 April 1997

WTEC: D. Shaw (report author)

Hosts: Prof. W.H. Lee, Chairman, Department of Physics
E-mail: whlee@phy.ccu.edu.tw
Prof. D.P. Tsai, Associate Professor, Department of Physics
E-mail: dptsai@phy.ccu.edu.tw
Prof. C.C. Chen

BACKGROUND

NCCU is a relatively new university in the south of Taiwan, but its scientific research laboratories are very well equipped. I visited the Physics Department, which is small, having about fourteen faculty members. The department is guided by its energetic leader, Prof. W.H. Lee, who joined the university from the Industrial Technology Research Institute in Hsinchu. Prof. Lee, who is an old acquaintance of mine, told me that they had been fortunate enough to attract a group of young energetic researchers, most of whom had received their advanced degrees in the United States.

DISCUSSION

During an informal gathering, I first gave a brief summary on the R&D activities in nanoparticle/nanostructure technology in the United States. This was followed by discussions with several professors, most of whom have joined the university during the last four to five years. The most impressive research was presented by Prof. C.C. (Jay) Chen, who had just come back from working with Prof. A.P. Alivisatos at the Lawrence Berkeley Laboratory (University of California at Berkeley).

Prof. Chen's work (*Science* 1997, 276:398) shows that there is a practical optimal size for metastable nanocrystals, which is also the largest size at which the nanocrystals can be synthesized defect-free. Thus, a much wider range of materials may be metastable in nanocrystals than in bulk solids. Figure E.3, taken from Prof. Chen's paper, illustrates the various size evolution of the kinetic barriers to structural transformation in defect-free nanocrystals. For small nanocrystals ($d < 2$ nm), the barriers are small and

the kinetics are dominated by interface contributions. Eventually, the barriers will be volume-dominated. This understanding of solid-solid phase transition kinetics will help us to define general rules that are important in the future synthesis of new metastable nanocrystals.

Prof. C.R. Wang of the Chemistry Department is developing an innovative electrodeposition technique for the synthesis of metallic particles. Prof. D.P. Tsai is a leading authority in Taiwan on atomic force and scanning near-field optical microscopies. He has developed a working relationship with Prof. P.C. Cheng at SUNY/Buffalo and is applying some of his AFM and SNOM techniques to nanotribological and other nanotechnological problems.

SUMMARY

One of NCCU's problems is its inability to attract top-notch graduate students, partially because qualified students are attracted to more prestigious universities such as NTU, NTHU, and NCTU in the north part of the island. This situation may change when the government formally establishes a second Science/Industrial Park a short distance from the campus in 1999.

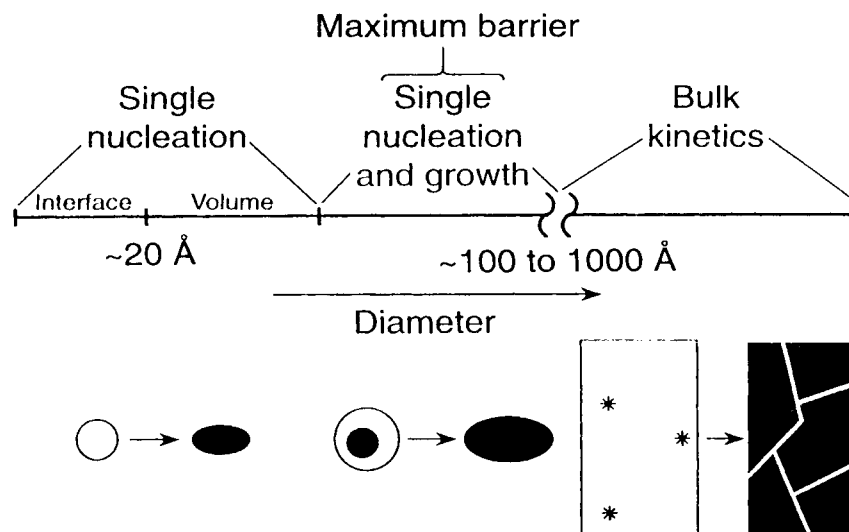

Figure E.3. Illustration of the various size regimes of the kinetics of solid-solid phase transitions. Defects, which act as nucleation sites, are indicated by asterisks in the cartoon of the bulk solid.

Site: **Industrial Technology Research Institute (ITRI)**
Materials Research Laboratory (MRL)
195-5 Chung Hsing Rd., Section 4
Chutung, Hsinchu, Taiwan 310, ROC

Date Visited: 19 April 1997

WTEC: D. Shaw (report author)

Hosts: Dr. L.C. Lee, Director, Materials Research Laboratory
Fax: (886) 35-958662
Dr. C.M. Wang, Deputy Director, Materials Research
Laboratory

BACKGROUND

Located at the center of the Science/Industrial Park in Hsinchu, ITRI is the largest research organization in Taiwan devoted to production-oriented R&D of industrial technologies. Unlike the other institutions previously discussed, which are supported by the National Science Council (corresponding with our National Science Foundation), ITRI is supported by Taiwan's Ministry of Economic Affairs (MOEA). There are six laboratories and three centers, among which only the Materials Research Laboratory (MRL) is related to nanotechnology.

DISCUSSION

I was received by Dr. L.C. Lee, Director, and Dr. C.M. Wang, Deputy Director, of MRL. They mentioned that MRL's materials development programs cover such areas as electronic polymers, magnetic materials, organic-photoelectronic materials, superconducting materials, organic composites, and ceramics. With suitable molecular structure design, formulation, and synthesis, polymers have given the electronics industry photoresistant, low-EM interference materials. Organic composites have produced lightweight, high strength, fatigue-resistant, and anticorrosive structures. Ceramics with specified mechanical or electromagnetic characteristics at various temperature ranges have been developed. Superconducting materials have been prepared for certain high-precision, low-temperature applications.

In the area of nanoparticle technology, my hosts candidly admitted that MRL is a very new player. They introduced me to Dr. Geoffrey W. Shuy who recently joined MRL and is in charge of nanoparticle R&D. Dr. Shuy showed me MRL's laboratory for ceramic and diamond thin-film synthesis. He also mentioned the institute's interest in semiconducting nanoparticles because of their novel optical properties.

SUMMARY

One of the constraints for all research programs at ITRI is that the Institute receives only 50% of its budget from MOEA; the rest must be contributed by industry. This rigid industrial cost-sharing requirement from MOEA makes it necessary to conduct only those projects that are close to commercialization. During the discussion about future research projects in nanoparticle technologies, this cost-sharing requirement repeatedly came up as an obstacle to doing any electrooptical projects (e.g., semiconducting nanocrystals). Instead, the laboratory's R&D work will probably be directed to coating- and structural-materials-related applications.

Appendix F. Glossary

2DEG	2-dimensional electron gas
A/D	Analog to digital
AAAR	American Association for Aerosol Research
ADC	Analog-digital converter
AEM	Analytical electron microscopy
AFM	Atomic force microscope/microscopy
AFOSR	Air Force Office of Scientific Research
AIST	(Japan) Agency of Industrial Science and Technology
AIST	(Japan, MITI) Agency of Industrial Science and Technology
AMLCD	Active matrix liquid crystal display
AMM	Amorphous microporous mixed (oxides)
AMO	Atomic, molecular, and optical
AMR	Anisotropic magnetoresistance
ARO	(U.S.) Army Research Office
ARPES	Angle-resolved photoelectron spectroscopy
ASET	(Japan) Association of Super-Advanced Electronics Technologies
ASTC	Australia Science and Technology Council
ATP	(Japan) Angstrom Technology Partnership
ATP	Adenosine triphosphate
<i>B</i>	Magnetic flux density
B/H loop	Closed figure showing <i>B</i> (magnetic flux density) compared to <i>H</i> (magnetic field strength) in a magnetizable material—also called hysteresis loop
bcc	Body-centered cubic
BMBF	(Germany) Ministry of Education, Science, Research, and Technology (formerly called BMFT)
BOD-FF	Bond-order-dependent force field
BRITE/EURAM	Basic Research of Industrial Technologies for Europe, European Research on Advanced Materials program
CAD	Computer-assisted design
CAIBE	Chemically assisted ion beam etching
CBE	Chemical beam epitaxy

CBED	Convergent beam electron diffraction
cermet	Ceramic/metal composite
CIP	Cold isostatic press
CMOS	Complementary metal-oxide semiconductor
CMP	Chemical mechanical polishing
CMR	Colossal magnetoresistance
CNRS	(France) Centre National de la Recherche Scientifique
CNSF	China National Science Foundation
CRMD	Centre de Recherche sur la Matière Divise (part of CNRS, France)
CRT	Cathode ray tube
CSM	Covalent shell model
CVD	Chemical vapor deposition
CVI	Chemical vapor infiltration
D/A	Digital to analog
DARPA	(U.S.) Defense Advanced Research Projects Agency
DM	Deutsche mark
DOC	(U.S.) Department of Commerce
DOD	(U.S.) Department of Defense
DOE	(U.S.) Department of Energy
DSC	Differential scanning calorimetry
e-beam	Electron-beam (lithography, etc.)
EC	Evaporation/condensation generators
EC	European Community (or Commission)
ECAMI	European-Canadian Mesoscopic Initiative
ECNM	European Consortium on NanoMaterials
ECU	European currency unit
EDX(S)	Energy-dispersive X-ray (spectroscopy)
EELS	Electron energy loss spectroscopy
EM	Electromagnetic
ENEA	(Italy) National Agency for Energy, Environment and New Technologies
EPFL	(Switzerland) École Polytechnique Fédérale de Lausanne
EPSRC	(U.K.) Engineering and Physical Sciences Research Council
ERATO	(Japan) Exploratory Research for Advanced Technology Program
ERC	(U.S., University of Illinois) Engineering Research Center on Microelectronics
ESCA	Electron spectroscopy for chemical analysis

ESPRIT	European Commission's information technologies program
ESR	Electron spin resonance
esu	Electrostatic unit
ETL	(Japan) Electrotechnical Laboratory
ETRI	(Korea) Electronics and Telecommunications Research Institute
EUSPEN	European Society for Precision Engineering and Nanotechnology
EXAFS	Extended X-ray absorption fine structure spectroscopy
fcc	Face centered cubic
FCRA	(Japan) Fine Ceramics Research Association
FE	Field emission
FEG-TEM	Field-emission gun – transmission electron microscope
FET	Field effect transistor
FE-TEM	Field-emission transmission electron microscope/microscopy
FETs	Field-effect transistors
FF	Force field
FFr	French franc
FIB	Focused ion beam
FIFO	First in - first out
FIM	Field-ion microscope/microscopy
FM	Ferromagnetic
FOA	(Sweden) National Defense Research Institute
FPMD	First-principles molecular dynamics
FzK	(Germany) Forschungszentrum Karlsruhe
GC/MS	Gas chromatograph mass spectroscopy
GDS-DFT	Gaussian dual space density functional theory
GIC	Graphite intercalated composites
GMR	Giant magnetoresistance
GP	Guinier-Preston
GPC	Gas phase condensation
GPS	Global Positioning System
GSMBE	Gas source molecular beam epitaxy
GVB	Generalized valence bond
HBFF	Hessian-based force field
H _c	Coercivity
HDDR	Hydrogenation disproportionation desorption recombination
HDS	Hydrodesulfurization
HFET	Heterojunction field effect transistor

HIP	Hot isostatic press
HMDS	Hexamethyl-disilazane
HOPG	Highly oriented pyrolytic graphic
HP	(U.S.) Hewlett-Packard
HPHT	High pressure/high temperature
HPLC	High performance liquid chromatography
HREM	High resolution electron microscope/microscopy
HRTEM	High resolution transmission electron microscope (see also HREM)
T_c	High superconducting transition temperature
i.d.	Inner diameter
IC	(France) Institut Curie
IC	Integrated circuit
icd	internal coordinate dynamics
IGC	Inert gas condensation
IMEC	(Belgium) Interuniversity MicroElectronics Center
IP	Ionization potential
IPE	(Switzerland) Institute of Experimental Physics at EPFL
IR	Infrared
ISDN	Integrated Services Digital Network
ITO	Indium tin oxide
I-V	Current-voltage
JFCC	(Japan) Japan Fine Ceramic Center
JIM	Japanese Institute of Metals
JRCAT	(Japan) Joint Research Center for Atom Technology
JSPS	Japan Society for the Promotion of Science
K	Degrees kelvin
KOH	Potassium hydroxide
KTH	(Sweden) Royal Institute of Technology
LCD	Liquid crystal display
LCT	Liquid crystal templating
LCVP	Laser-induced chemical vapor precipitation
LED	Light-emitting diode
LIGA	(German acronym) Lithographie, Galvanoformung, Abformung
LINK	(U.K.) nanotechnology programme
LPPCVD	Laser particle precipitation-aided chemical vapor deposition
LSI	Large scale integration/integrated (circuits)
LTMC	Layered transition metal chalcogenide

MA	Mechanical alloying
MBE	Molecular beam epitaxy
mCP	Microcontact printing
MD	Molecular dynamics
MEL-ARI	(Europe, ESPRIT) Microelectronics Advanced Research Initiative
MEMS	Microelectromechanical systems
MFM	Magnetic force microscopy
microSQUID	Micro-superconducting quantum interference device
MIMIC	Micromolding in capillaries
MITI	(Japan) Ministry of International Trade and Industry
MOCVD	Metal organic chemical vapor deposition
Monbusho	(Japan) Ministry of Education, Science, Sports, and Culture
MOS	Metal oxide semiconductor
MOSFET	Metal oxide semiconductor field-effect transistor
MOVPE	Metal organic vapor phase epitaxy
MPI	(Germany) Max Planck Institute(s)
MRAM	Magnetic random access memory
MR-CI	Multireference configuration interaction
MRI	Magnetic resonance imaging
MSC	(U.S., California Institute of Technology) Materials and Process Simulation Center
MTJ	Magnetic tunnel junction
mTM	Microtransfer molding
MWNT	Multiwalled nanotube
NAIR	(Japan) National Institute for Advanced Interdisciplinary Research
NASA	(U.S.) National Aeronautic and Space Administration
nc	Nanocrystalline
NCA	Nanoparticle chain aggregate
NCAP	Nematic curvilinear aligned phase material
NCCE	(U.S., NSF) National Center for Computational Electronics
NDL	(Taiwan) National Nano Device Laboratories
NEDO	(Japan) New Energy and Industrial Technology Development Organization
NEIMO	Newton-Euler inverse mass operator method for modeling
NEMD	Nonequilibrium molecular dynamics
NEOME	(Switzerland) Network for Excellence on Organic Materials for Electronics

NFR	(Sweden) Natural Sciences Research Council
NIH	(U.S.) National Institutes of Health
NION	(U.K.) National Initiative on Nanotechnology
NIRIM	(Japan) National Institute for Research in Inorganic Materials
NIST	(U.S.) National Institute of Standards and Technology
NMR	Nuclear magnetic resonance
NNUN	(U.S.) National Nanofabrication Users Network
NOR	not or (used in logic circuits)
NRC	(Canada, also Australia) National Research Council
NRIM	(Japan) National Research Institute for Metals
NRL	(U.S.) Naval Research Laboratory
NSF	(U.S.) National Science Foundation
NSOM	Near-field scanning optical microscope/microscopy
NSS	Nanoscale systems
NUTEK	(Sweden) National Board for Industrial and Technological Development
o.d.	Outer diameter
OECD	(Int'l.) Organization for Economic Cooperation and Development
OLED	Organic light-emitting device
OMBE	Organic molecular beam epitaxy
ONR	(U.S.) Office of Naval Research
PAN	Polyacrylonitrile
PB	Polybutadiene
PBC	Periodic boundary conditions
PCD	Polycrystalline diamond
PCR	Polymerase chain reaction
PDLC	Polymer-dispersed liquid crystals
PDMS	Polydimethylsiloxane
PHANTOMS	(Europe) program to investigate physics and technology of mesoscale systems
PL	Photoluminescence
PMMA	Polymethylmethacrylate
p-n junctions	Positive-negative
PoSAP	position-sensitive atom-probe
PS	Polystyrene
PS-GVB	Pseudospectral generalized valence bond
PVD	Physical vapor deposition

PVDF	Poly(vinylidene fluoride)
QCA	Quantum cellular automata
QCL	Quantum cascade lasers
QD or Q-dot	Quantum dot
QEq	Charge equilibration
QM	Quantum mechanics/mechanical
QUEST	(U.S.) Center for Quantized Electronic Structures, UCSB
rf	Radio frequency
RCMM	Reduced cell multipole method
redox	Reduction-oxidation
RGB	Red, green, blue
RHEED	Reflection high energy electron diffraction
RIE	Reactive ion etching
RIKEN	(Japan, STA) Institute of Physical and Chemical Research
RT	Room temperature
RTD	Resonant tunneling diode
SAM	Self-assembled monolayer
SAMIM	Solvent-assisted microcontact molding
SAW	Surface acoustic wave device
SAXS	Small angle X-ray scattering
SBIR	(U.S.) Small Business for Innovative Research program
SED	Single electron device
SELETE	(Japan) Semiconductor Leading Edge Technologies, Inc. (consortium)
SEM	Scanning electron microscope/microscopy
Sematech	(U.S.) Semiconductor Manufacturing and Technology Institute
SEMPA	Scanning electron microscopy with polarization analysis
SEP	Size-dependent evolutionary pattern
SET	Single-electron transistor
SFM	Scanning force microscopy/microscope
SFr	Swiss franc
SIMS	Secondary ion mass spectrometry
SINQ	(Switzerland) Spallation Neutron Source
SIRI	(Japan) Semiconductor Industry Research Institute
SMM	Scanning Maxwell-stress Microscope
SNOM	Scanning near-field optical microscopy
SOI	Silicon on insulator

SOQD	Self-organized quantum dot
SPC	Statistical process control
SPD	Superplastic deformation
SPM	Scanning probe microscopy
SQUID	Superconducting quantum interference device
SRC	(U.S.) Semiconductor Research Corporation
SRRC	(Taiwan) Synchrotron Radiation Research Center
STA	(Japan) Science and Technology Agency
STARC	(Japan) Semiconductor Technology Academic Research Center
STEM	Scanning transmission electron microscope/microscopy
STM	Scanning tunneling microscope/microscopy
STN	Super twisted nematic
STTR	(U.S.) Small Business Technology Transfer program
SUNY	(U.S.) State University of New York
SWNT	Single-walled nanotubes
T	tesla
TBC	Thermal barrier coating
TCR	Temperature coefficient of resistivity
TEM	Transmission electron microscope/microscopy
TFR	(Sweden) Research Council for Engineering Sciences
TFT	Thin film transistors
T_M	Melting temperature
TMS	Tech molecular sieves; family of transition metal oxides
TMV	Trapped magnetization vortice
TSR	Tetrahedral shaped recess
UFF	Universal force field
UFP	Ultrafine particle
UHV	Ultrahigh vacuum
UHV CVD	Ultrahigh vacuum chemical vapor deposition
UHV-FE-SEM	Ultrahigh vacuum field emission scanning electron microscope
UHV STM	Ultrahigh vacuum scanning tunneling microscope
ULSI	Ultra large scale integration/integrated (circuit)
VC	Vanadium-carbon
VCSELs	Vertical cavity surface-emitting lasers
VLSI	Very large scale integration/integrated (circuit)
WC/Co	Tungsten carbide/cobalt

WTEC	World Technology Division of the International Technology Research Institute at Loyola College, Baltimore, MD
XAS	X-ray absorption spectroscopy
XPS	X-ray photoemission spectroscopy
XRD	X-ray diffraction

