

# Wildfire Recovery Tips

## Northern Idaho

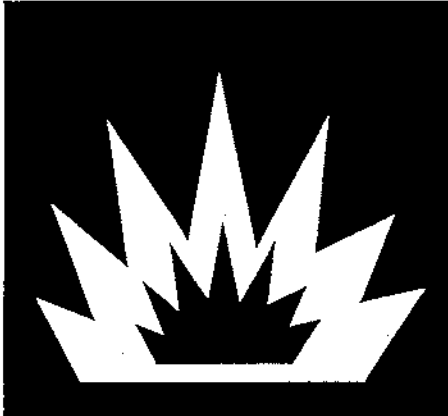

Slopes left denuded by range or forest fires are especially susceptible to accelerated soil erosion, flash flooding, and debris flows because of the absence of vegetation and roots to bind the soil.

This booklet contains some techniques that homeowners can use to avoid or reduce these hazards.

The Natural Resources Conservation Service and your local soil conservation district are available to answer your questions and provide assistance as you recover from the aftermath of a wildfire.

### Revegetation

Vegetation is one of the most important factors influencing soil erosion. It helps control erosion by shielding the soil from the impact of raindrops, maintaining a soil surface capable of absorbing water, and by slowing the amount and velocity of runoff.

There's a good chance that native seeds on your property are still alive and will germinate. Old and new vegetation will help protect the soil from erosive rains. In severely burned areas, seeding may be needed.

Your first step is to field check the burned area and map out areas that have burned intensively and thus have very little seed under the ash.

White ash shows where the fire was very hot and seeds most likely destroyed. Areas burned that were in thick brush without a grass understory will not have enough seed.

Desirable seeds are grasses and forbs. The minimum amount is an aggregate of 25 viable seeds per square foot drilled and 50 viable seeds per square foot broadcast.

Exposed earth areas like new roads, firebreaks, and steep embankments—including cut and fill slopes—should also be planted.

### Contents

Vegetative Practices	page no.	Structural Practices	page no.
Recommended grasses and forbs	2	Jute Netting	6
Seeding Guide	3	Sandbag Protection	8
Hydroseeding and Hydromulching	4	Silt Fence	10
What are Hydrophobic Soils?	19	Straw Bale Check Dams	12
		Straw Bale Dikes	14
		Straw Mulching	16
		Burlap Bag Check Dams	18

## Recommended grasses and forbs

These plants are recommended for use on burned areas in northern Idaho. They were selected based on the depth and types of soil, average annual rainfall, availability of seed, reseeding ability, and amount of growth produced.

Seeds are available from commercial seed suppliers, listed in the yellow pages of your telephone directory under "Seeds and Bulbs—Wholesale and Growers."

**'Sherman' Big Bluegrass** is a long-lived native bunchgrass. Recommended sites include intermediate and favorable brush sites, sunny places on mountain brush ranges, burned-over forested areas, and meadows at lower elevations.

**'Covar' and 'Bighorn' Sheep Fescue** is a long-lived, short stature introduced bunchgrass with short leaf blades. It is more drought tolerant than other fescues. Top production is low, but ground cover and root production are excellent. A very good erosion control and understory species that competes well with weeds.

**'Goldar' Bluebunch Wheatgrass** is a long-lived, drought tolerant wide-spread native bunchgrass. It begins growth early in spring and again with fall rains. Recommended sites include sagebrush, ponderosa pine, mountain brush, and juniper ranges. Secar Snake River wheatgrass can be used on hot, droughty, southerly slopes as an alternative.

**'Luna' Pubescent Wheatgrass** and **'Rush,' 'Greenar,'** or **'Tegmar' Intermediate Wheatgrass** are sod-forming, long-lived introduced grass. They begin growth very early in the spring and remain green into summer.

**'Pryor' Slender Wheatgrass** is a short-lived native bunchgrass with good seedling vigor. It is valuable in erosion-control seed mixes because it develops rapidly, is drought tolerant, and compatible with other species. It tolerates a wide range of conditions and adapts well on mountain brush areas.

**'Sodar' Streambank Wheatgrass** is a long-lived, drought tolerant creeping sod-former adapted to fine-medium textured, well drained soil. It has excellent seeding vigor and is particularly well adapted for erosion control.

**'Bannock' or 'Critana' Thickspike Wheatgrass** is a long-lived, native sod-forming grass characterized by drought tolerance and early spring growth. It is adapted to disturbed range sites and dry areas subject to erosion.

**'Garnet' or 'Bromar' Mountain Brome** is a short-lived native bunchgrass with good seedling vigor. It is valuable in erosion control seed mixes because it develops rapidly, moderately shade tolerant, and compatible with other species. Recommended sites include mountain brush, aspen, conifer forest, and areas in mountain valleys.

**'Durar' Hard Fescue** is a long-lived, short statured introduced bunchgrass with short leaves. Top production is low, but ground cover, root production, erosion control, and weed competition are excellent. Recommended for forestlands and other higher rainfall areas.

**'Manchar' Smooth Bromegrass** is a long-lived, introduced sod-forming grass. Once established it has the ability to suppress invasion of undesirable vegetation recommended for mountain brush and burned-over forestlands.

**'Latar' or 'Paiute' Orchardgrass** is a long-lived, shade tolerant introduced bunchgrass. It is well adapted to mountain brush and pine zones for erosion control mixes.

**Alfalfa** is a very productive perennial. Varieties for low precipitation sites include **'Ladak,' 'Trevois,' 'Ranger,'** and **'Nomad.'**

**'Delar' Small Burnet** is a perennial winter-active forb that grows to 2 feet tall. It is semi-evergreen and deep rooted. Growth is most vigorous in fall and spring. It establishes with ease.

**Yellow Sweetclover** is an introduced, tall, stemmy, deep-rooted biennial legume commonly used as a cover crop for perennial seeding. **'Madrid'** is an adapted variety.

## Seeding Guide

<u>Recommended Plants</u>	<u>Drill</u>		<u>Seeding Rate</u> <u>lbs/10,000 sq. ft. area</u>
	<u>Seeding Rate</u> <u>lbs/acre</u>	<u>Broadcast Rate</u> <u>lbs/acre</u>	
Bluegrass, Big	2.5	5.0	1.2
Fescue, Sheep and Hard	4.0	8.0	1.8
Wheatgrass, Bluebunch (SRW)	8.0	16.0	3.7
Wheatgrass, Intermediate	12.0	24.0	5.5
Wheatgrass, Pubescent	12.0	24.0	5.5
Wheatgrass, Slender	8.0	16.0	3.7
Wheatgrass, Streambank	7.0	14.0	3.2
Wheatgrass, Thickspike	8.0	16.0	3.7
Mountain brome	12.0	24.0	5.5
Smooth brome	8.0	16.0	3.7
Orchardgrass	3.0	6.0	1.3
Alfalfa	6.0	12.0	2.8
Small Burnet	20.0	40.0	9.2
Yellow Sweetclover	6.0	12.0	2.8

Seed mix: These seeding rates are full rates per acre if seeded as a single species. If you desire different species in a mix, multiply this rate by the percent of each you want in your mix to total 100% or more.

### Methods of seeding

Seeds can be broadcast by hand or with a hand-operated seeder, hydroseeded, drilled, or seeded by air.

Most homeowners and small landowners will find broadcasting to be the most economical method. Hydroseeding requires roads for equipment access and a nearby water supply. Use aerial seeding on large acreages.

### When to seed

The best time to seed is after October 20 and before winter rain or snow. Timeliness of rains will affect how well the plants will grow in spring.

Protect exposed earth areas like roads, fire-breaks, and steep embankments with straw mulch at the rate of 2 tons per acre. Anchor the mulch by punching with shovels or crimping equipment. A 74-pound bale of straw will cover 800 square feet.

### Reducing fire danger

Reduce fire hazards by waiting until grasses and forbs set their seed in mid-summer to fall before mowing or clipping.

Use a lawnmower to produce a safe zone around structures. Mowing to 3-4 inches height with a nylon filament weed whip or similar equipment will produce a safe zone in the 30- to 70-foot zone.

Consider mowing around shrubs and trees beyond 100 feet. The resulting grass mulch will provide erosion protection against early rains.

### Seed specifications

Total amount of seed purchased should equal the acres burned multiplied by the recommended seeding rate per acre. Include any roads and fire-breaks in the burned acreage.

If the seed is coated by the supplier or is less than 80% Pure Live Seed (PLS, % germination x % purity), the amount of seed purchased should be adjusted.

Seed supplies of each species should be obtained in separate bags and keep cool and dry.

Check seed tags for species and the percent germination and purity. Increase the seeding rate if percent germination multiplied by the percent purity shows less than 80% PLS.

### Low PLS adjustment

**Example:** When recommended seeding rate is 10 pounds per acre. 90% purity x 70% germination = 63% PLS. Adjustment factor is  $80/63 = 1.3$ . Adjusted seeding rate is  $1.3 \times 10 \text{ lbs/acre} = 13 \text{ lbs/acre}$ .

Coated seed adjustment is needed if the seed is coated by the supplier with inoculant or other materials. No adjustment is needed when you inoculate alfalfa or other legume seeds at the site.

Recommended seeding rates are based on uncoated seed and need to be adjusted as shown in this example after making any adjustment for low PLS:

**Example:** Coated alfalfa seed or other small seeded legumes. Adjustment factor = 1.5. Adjusted seeding rate is  $1.5 \times 9 \text{ lbs/acre} = 13.5 \text{ lbs/acre}$ .

### Equipment and materials needed

Equipment and materials should be ready before you start. This list of items will minimize disruptions and let you finish seeding in one day:

- \* 1 hand operated cyclone seeder for each person doing seeding
- \* Weighing scale, at least 20-pound capacity
- \* At least 2 plastic buckets
- \* Seed targets. At least 2 pieces of 2x2-foot soft cloth or cardboard with corrugations exposed, nailed to small wood frame, or at least 4 pieces of 1x1-foot soft cloth attached to open wire frame
- \* 4 grocery bags and 2 marker pens
- \* Inoculant. Specific type for each legume. Omit if seed is coated by supplier.

### Getting started

Inoculating legumes enables them to “fix nitrogen” which improves the health of plants and provides additional fertility for other plants.

Inoculate alfalfa and other legume seeds (if supplier hasn't) the evening before or early on seeding day so seed will dry by seeding time. Re-inoculate seed coated over 30 days ago or seed that hasn't been kept cool and dry.

### Seeding specifications

Divide seed of each species into equal amounts and label bags. Keep cool and dry. When seeding a mixture, broadcast each species separately, if possible, to get the most uniform distribution of seed.

Adjust seeder according to the manufacturer's instructions based on half the seeding rate when doing arid seeding. Base it on the full seeding rate when doing a single once-over seeding. Set out 2 seed targets 10 feet apart and offset 10 feet. With the hand operating seeder half full, start broadcasting and walk between the 2 seed targets. Stop and check the seed count at each target. Adjust the seeder and repeat until the number of seeds per square foot agrees with your approximate target of 50 minimum seeds per square foot.

Broadcast in 2 directions to achieve a uniform distribution of seed. Using half the seed of a species, broadcast as you walk across the slope, starting at the top of the burn area. Notice how far the seed is thrown. When you reach the other edge of the burn area, move downslope a distance equal to the width of throw.

Continue broadcasting and walk back across the slope, trying to avoid gaps. Repeat this process all the way to the bottom edge. When several people are seeding, move across the slope together. Adjust your walking pace so you have enough seed to finish.

Using the remaining half of the seed repeat the procedure going downslope. On gentle slopes you may be able to broadcast walking back up the slope. On steep slopes, it is best to broadcast only walking downslope because you need to maintain the same walking speed used to calibrate the seeder. Using several people will make this easier.

Broadcast in one direction if conditions don't allow seeding in two directions. Broadcast the remaining seed in the same direction across the slope while walking midway between your previous lines of travel.

Repeat the process for each species.

## Hydroseeding and Hydromulching

The terms hydroseeding and hydromulching are often used interchangeably.

- **Hydroseeding** is applying a slurry of water, wood fiber mulch, seed and fertilizer to prevent soil erosion and provide an environment conducive to plant growth.
- **Hydromulching** is applying a slurry of water, wood fiber mulch, and often a tackifier to a slope to prevent soil erosion.

### When to use

General recommendation: On steep, highly erosive slopes that have been partially or completely denuded of vegetation due to fire, apply seed to the site first and then hydromulch over the seed.

This is a fairly expensive erosion control method that is often reserved for areas close to roads, bridges, homes, and other structures. Use is sometimes restricted due to lack of access roads and adequate water supplies. Slope lengths of 125-225 feet can be treated.

*For small landowners, this technique will need to be hired out. Check the listings under “Landscape Contractors” in the yellow pages of your telephone directory.*

# Hydroseeding and Hydromulching

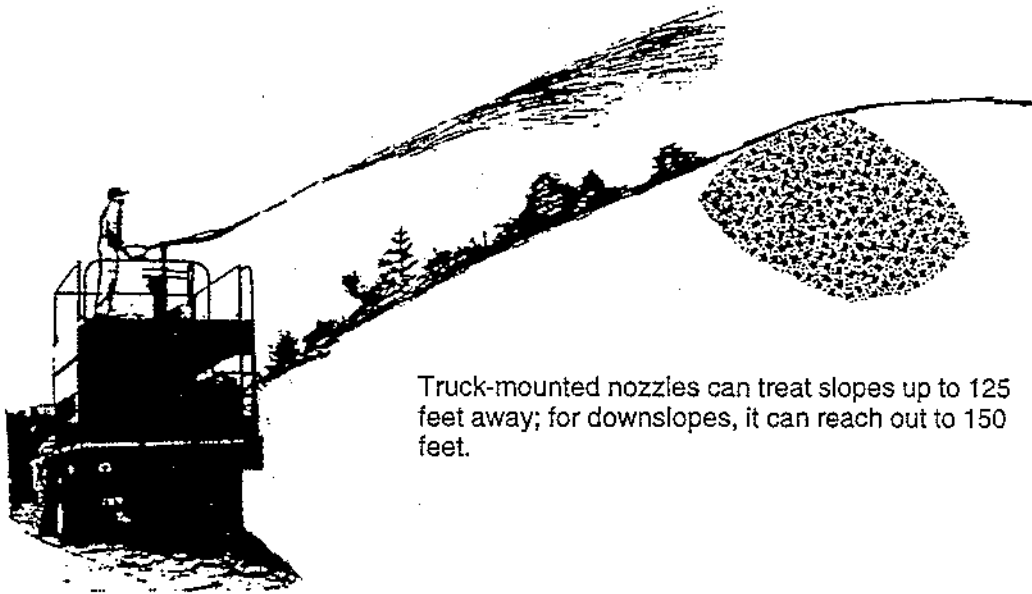

Truck-mounted nozzles can treat slopes up to 125 feet away; for downslopes, it can reach out to 150 feet.

**Hydromulching:** Tank mix includes water, wood fiber, and tackifier (optional).

**Hydroseeding:** Tank mix includes water, wood fiber, seed, fertilizer (optional after fire) and tackifier (also optional). General recommendation--apply seed to site first and then hydromulch on top of seeding.

200 to 225 feet of slope can be treated by first using 100 to 150 feet of hose pressurized by the tank truck.

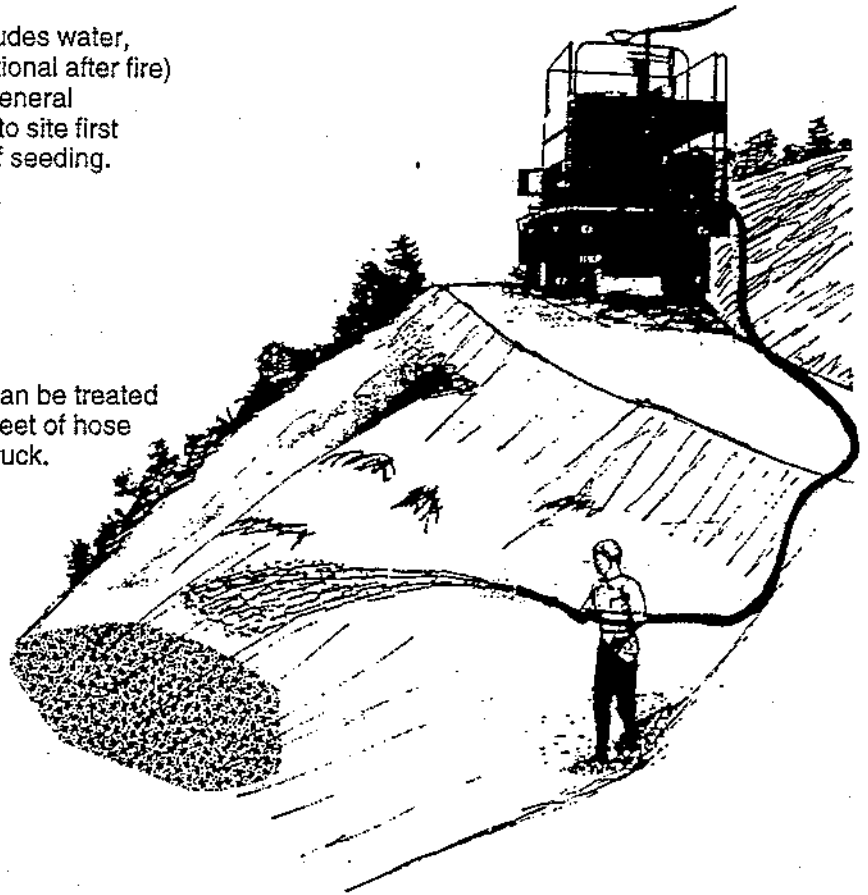

## Jute Netting

Netting made of jute can be laid and anchored over straw or other mulch to protect it from wind and water damage. Netting will help reduce soil erosion and provides a good environment for vegetative regrowth.

Jute is a biodegradable material that will eventually decompose and is not a threat to the environment.

### When to use

Jute netting can be used on areas that may erode near structures such as homes, roads, and bridges or on small, steep, disturbed areas.

Netting can also be applied alone (without mulch) as an alternative to straw or wood mulches on flat sites for dust control and seed germination enhancement.

It should not be used alone where runoff quantities are expected to be high.

The use of jute netting is not appropriate in all situations. Examples of when it may **not** be appropriate:

- Steep slopes with sandy soils
- Steep slopes with many rocks on the surface
- Steep slopes with a significant amount of fire burned vegetation remaining.

### Specifications

The soil surface should be reasonably smooth. Remove rocks and other obstructions which rise above the level of the soil and mulch.

Jute netting should be cloth of a uniform plain weave of undyed and unbleached single jute yarn. The material should weigh about 1.2 pounds per linear yard and have approximately 78 warp ends per width of cloth and 41 weft ends per linear yard.

Most nurseries, hardware stores, and lumber yards can help find netting that meets these recommended specifications.

Individual rolls of jute should be applied up and down the slope--never along the contour.

Bury the upper end of the netting at the top of the disturbed area in a trench at least 6-8 inches deep.

Lay out rolls so edges overlap each other by at least 4 inches across the slope.

**Extremely important:** When more than one roll is required going down the slope, the ends going down the slope should overlap by at least 3 feet.

Anchor the netting to the soil surface with anchor pins or staples. Anchor pins are made of rigid 0.12-inch diameter or heavier galvanized wire with a minimum length of 10 inches for hook or "J" type pins. Staples should be of wire .09 inch in diameter or greater and should have "U" shaped legs that are at least 6 inches in length. Longer staples are needed for sandy soils.

Staples or anchor pins need to be driven perpendicularly into the slope face and should be spaced about 5 feet apart down the sides and center of the roll.

Spacing between staples at the upper end of a roll and at the end overlap of 2 rolls should not be greater than 1 foot.

The netting should go beyond the edge of the mulched or seeded area at least 1 foot at the sides and 3 feet at the bottom. If there is existing vegetation at the boundaries of the area, the netting should be continued into the stable vegetated area or to the edge of a structure.

## Jute Netting

Netting made of jute can be laid and anchored over straw or other mulch to protect it from wind and water damage. Netting will help reduce soil erosion and provides a good environment for vegetative regrowth.

Jute is a biodegradable material that will eventually decompose and is not a threat to the environment.

### When to use

Jute netting can be used on areas that may erode near structures such as homes, roads, and bridges or on small, steep, disturbed areas.

Netting can also be applied alone (without mulch) as an alternative to straw or wood mulches on flat sites for dust control and seed germination enhancement.

It should not be used alone where runoff quantities are expected to be high.

The use of jute netting is not appropriate in all situations. Examples of when it may **not** be appropriate:

- Steep slopes with sandy soils
- Steep slopes with many rocks on the surface
- Steep slopes with a significant amount of fire burned vegetation remaining.

### Specifications

The soil surface should be reasonably smooth. Remove rocks and other obstructions which rise above the level of the soil and mulch.

Jute netting should be cloth of a uniform plain weave of undyed and unbleached single jute yarn. The material should weigh about 1.2 pounds per linear yard and have approximately 78 warp ends per width of cloth and 41 weft ends per linear yard.

Most nurseries, hardware stores, and lumber yards can help find netting that meets these recommended specifications.

Individual rolls of jute should be applied up and down the slope--never along the contour.

Bury the upper end of the netting at the top of the disturbed area in a trench at least 6-8 inches deep.

Lay out rolls so edges overlap each other by at least 4 inches across the slope.

**Extremely important:** When more than one roll is required going down the slope, the ends going down the slope should overlap by at least 3 feet.

Anchor the netting to the soil surface with anchor pins or staples. Anchor pins are made of rigid 0.12-inch diameter or heavier galvanized wire with a minimum length of 10 inches for hook or "J" type pins. Staples should be of wire .09 inch in diameter or greater and should have "U" shaped legs that are at least 6 inches in length. Longer staples are needed for sandy soils.

Staples or anchor pins need to be driven perpendicularly into the slope face and should be spaced about 5 feet apart down the sides and center of the roll.

Spacing between staples at the upper end of a roll and at the end overlap of 2 rolls should not be greater than 1 foot.

The netting should go beyond the edge of the mulched or seeded area at least 1 foot at the sides and 3 feet at the bottom. If there is existing vegetation at the boundaries of the area, the netting should be continued into the stable vegetated area or to the edge of a structure.

# Jute Netting

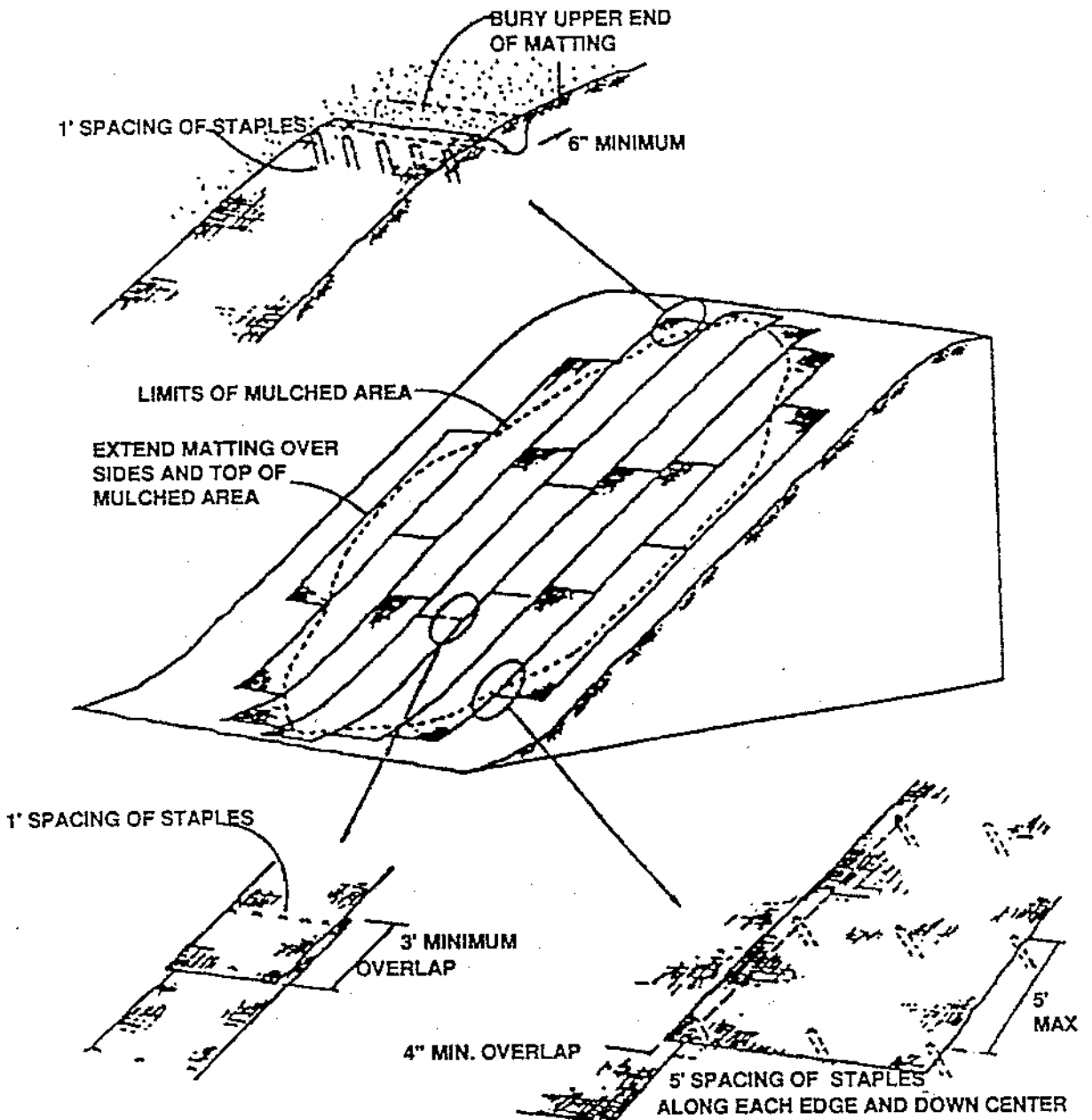



## Sandbag Protection

An inexpensive temporary barrier or wall, 1 to 2 feet high, can be constructed by stacking sand-filled or earth-filled sandbags. They can be placed to divert mud and other debris flows away from buildings. They will not, however, provide protection from high debris flows.

### When to Use

- To protect building sites vulnerable to low mud debris flows from steep, erodible slopes that are partially or completely void of vegetation due to wildfire burns.
- As an inexpensive, temporary protection method for homes before predicted rainfall.

**Note:** Sandbags deteriorate when exposed to continued wetting and drying for several months. If the bags need to be used for more than a few months, cement can be mixed with the sand. The cement and sand mixture will harden when the bags dry.

### Methods and Materials

Sandbag barriers are easy to construct. Burlap bags, sand, plastic, lumber, cement and plywood are readily available at local lumber yards. Some fire stations and other emergency centers can also help with materials.

Place filled sandbags to direct debris flows away from buildings, pools and other structures. Clear a path for the debris. Do not try to dam or stop it.

Protect your most valuable property first. Debris can enter a building through doors and windows, so they should be boarded up and waterproofed with plastic sheets. **Remember:** Sandbags will not seal out water.

Work with your neighbors and be prepared to use your property to provide good protection for the community.

### How to Fill Bags

Fill sandbags one-half full. Use sand, if available, or local soil. Fold the top of the sandbag down and place the bag on its folded top (see illustration).

### How to Place Bags

Refer to the illustration. Place each sandbag as shown, finishing each layer before starting the next. Limit placement to two layers unless they are stacked against a building or pyramided.

It is important to place the bags with the folded top in the upstream or uphill direction facing the flow of water to prevent them from opening when water runs by.

# Sandbag Protection



FILL HALF FULL  
FOLD TOP UNDER

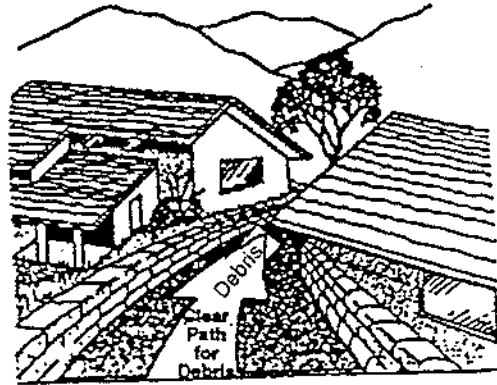

Directing flows between buildings

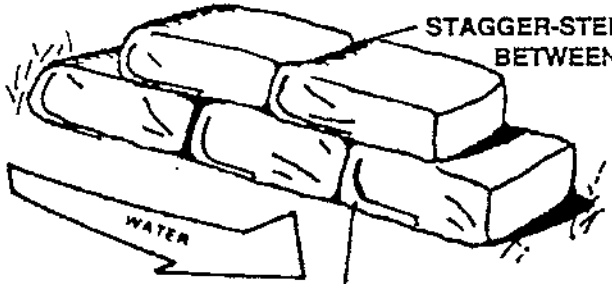

STAGGER-STEP BAGS  
BETWEEN ROWS

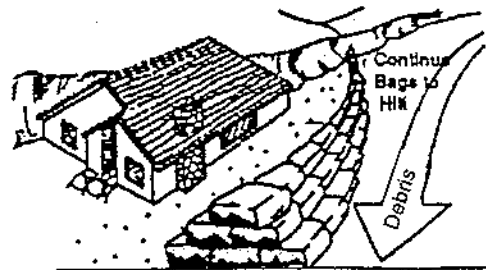

Directing debris away from buildings

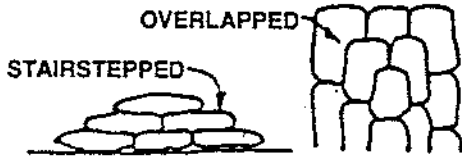

OVERLAPPED

STAIRSTEPPED

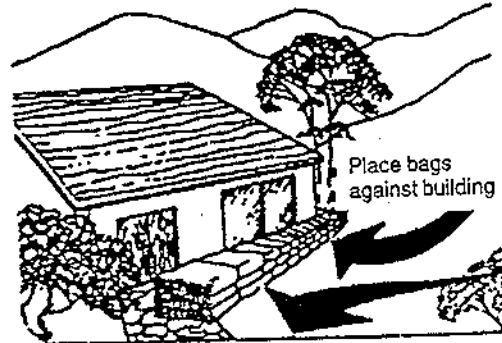

Place bags  
against building

Building protection

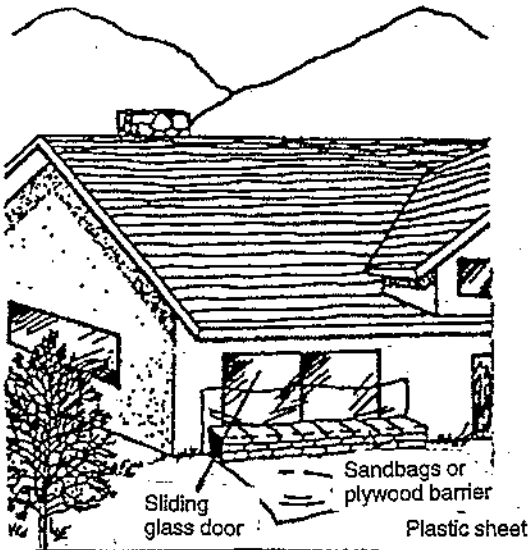

Sliding glass door sealing

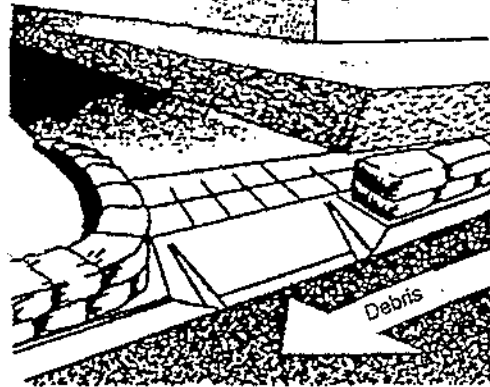

Controlling debris/storm flows in streets

## Silt Fence

A silt fence made of woven wire and fabric filter cloth is a temporary barrier that can be used to catch sediment-laden runoff from small areas of disturbed soil.

Silt fences are easy to construct. Materials are available from hardware stores, nurseries, and lumber yards.

### When to use

Major considerations for use of silt fences are slope, slope length, and the amount of drainage area from which the fence will catch runoff.

Here are some design considerations:

<u>Slope Steepness</u>	<u>Maximum Slope Length</u>
2:1 = 50%	50 feet
3:1 = 33%	75 feet
4:1 = 25%	125 feet
5:1 = 20%	175 feet
<5:1 = <20%	200 feet

For longer slopes, add additional silt fences.

### Drainage Area

The area that contributes runoff to be caught by the silt fence should not be greater than 1/2 acre for 100 feet of fence.

### Type of Runoff

Silt fences are designed to catch runoff that is in the form of "sheet flow," not "concentrated flow."

Sheet flow differs from concentrated flow in that the runoff is spread evenly over the ground surface, like a sheet, rather than concentrated in small rills or gullies.

### Methods and Materials

**Fence Posts**--Posts should be at least 36 inches long. Wood posts should be of hardwood with a minimum cross sectional area of 3 inches. Steel posts should be standard "T" or "U" section and should weigh no less than 1 pound per linear foot.

**Wire**--Wire fence should be at least 14 gauge with openings no larger than 6x6 inches.

# Silt Fence

## Fabric Properties:

Filter fabric properties should be as follows (hardware store personnel can help you with these):

Fabric Property	Minimum Acceptable Value	Test Method
Grab tensile strength (LBS)	90	ASTM D1682
Elongation at Failure (%)	50	ASTM D1682
Mullen Burst Strength (PSI)	190	ASTM D3786
Puncture Strength (lbs)	40	ASTM D751 (mod)
Slurry flow Rate (gal/min/sf)	0.3	
Equivalent Opening Size	40-80	US Std Sieve
Ultraviolet Rad. Stability	90	ASTM-G-26

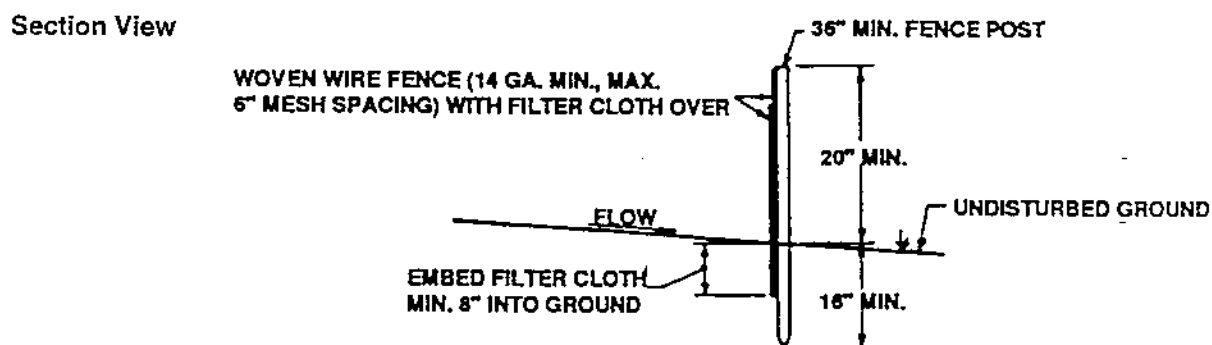
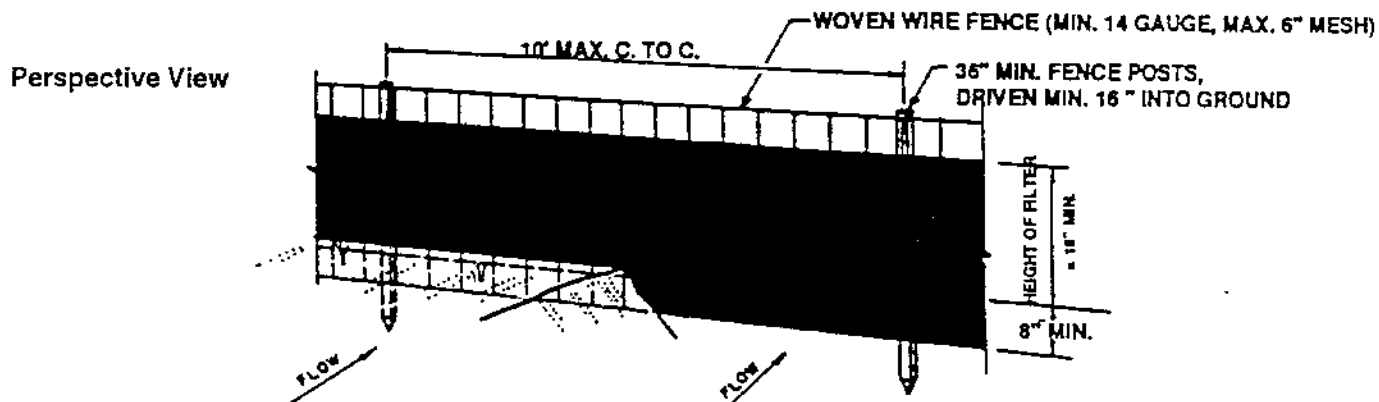

## Construction Notes

1. Woven wire fence to be fastened securely to fence posts with wire ties or staples.
2. Filter cloth to be fastened securely to woven wire fence with ties spaced every 24" at top and midsection.
3. When 2 sections of filter cloth adjoin each other, they shall be overlapped by 6" and folded.
4. Maintenance shall be performed as needed and material removed when "bulges" develop in the silt fence.

## Straw Bale Check Dams

Straw bale check dams are temporary sediment barriers constructed of straw bales located across small drainages. They are temporary structures used to slow debris flows in small channels. They are not intended to provide protection from large storm events nor to control debris flows in water bodies such as creeks, streams, or rivers.

### Planning Criteria

0-15% slope

Maximum drain area: 1 acre

Maximum slope length between check dams: 200 feet

15-20% slope

Maximum drain area: 1/2 acre

Maximum slope length between check dams: 100 feet

Greater than 20% slope

Not Recommended

### Methods and Materials

Bales should be bound with wire or nylon string. Twine bound bales are less durable. Place the bales in rows with ends tightly abutting adjacent bales.

**Downstream Row** (refer to illustration): Dig a trench across the small channel, wide enough and deep enough so the top of the row of bales placed on their long wide side is level with the ground.

The tops of bales across the center of the channel should all be level and set at the same elevation. Place the bales in position and stake them according to the instructions that follow.

**Upstream Row:** Dig another trench across the small channel, upstream and immediately adjacent to the first row of bales. This trench should be wide enough to accommodate a row of bales set vertically on their long edge. It should be deep enough so that at least 6 inches of each bale is below ground, starting with the bale in the channel bottom.

The trench should be as level as possible so the tops of the bales across the center of the channel are level and water can flow evenly across them.

Continue this trench up the side slopes of the small channel to a point where the unburied bottom line of the highest bale (point "C," illustration) is higher than the top of the bales that are in the center of the channel (point "D," illustration).

### Staking

Drive 2x2 stakes or #4 rebar through the bales and into the ground 1-1/2 to 2 feet for anchorage. The first stake in each bale should be driven toward a previously laid bale to force the bales together (see illustration).

### Maintenance

Inspect bale check dams after each storm period. Shovel work may be needed to rebuilt the soil berm on the upstream side. Remove any loose straw so it does not enter storm drains.

Remove the bales and stakes once permanent drainage and stabilization are re-established.

Use the straw as mulch in other areas.

# Straw Bale Check Dams

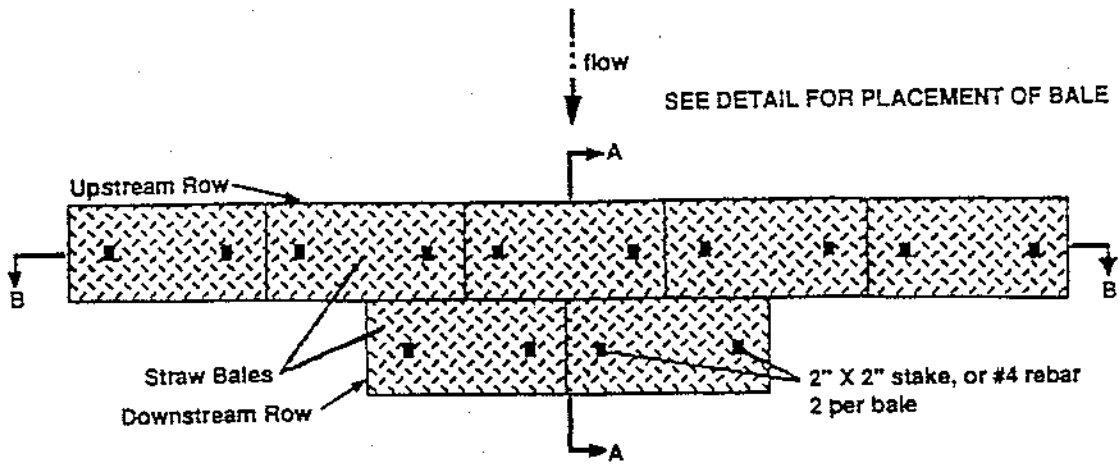

## Section A-A

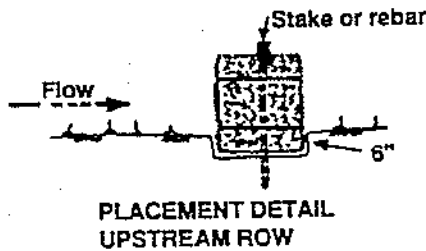
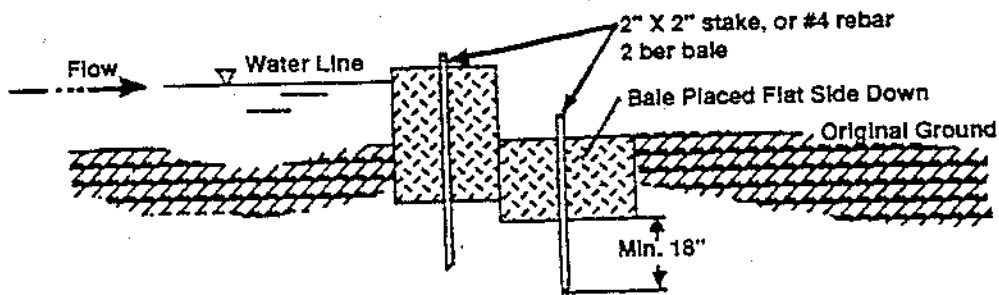

Remove #4 rebar after  
straw bales are no longer  
in place

## Section B-B

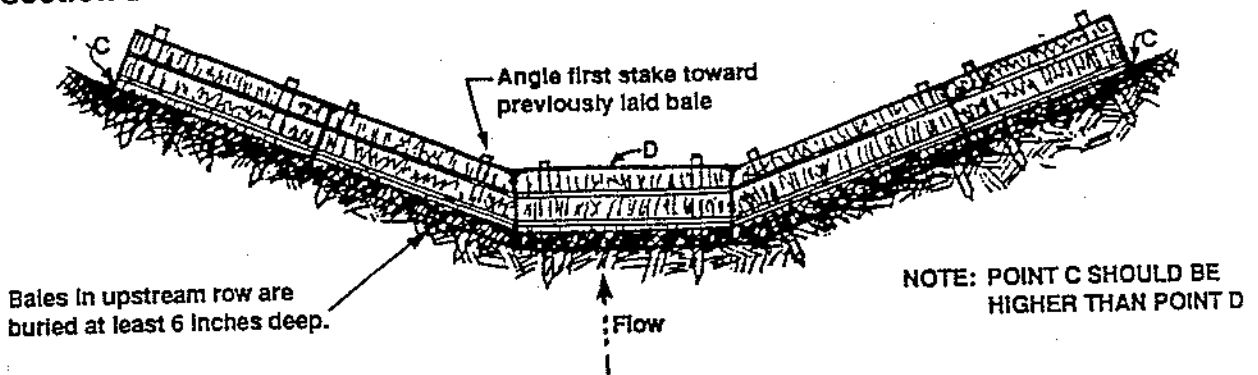

## Straw Bale Dikes

Straw bale dikes are a temporary sediment barrier constructed of straw bales located downslope of a disturbed area or around a storm drainage outlet to redirect debris flows or trap debris materials.

They are usually installed in areas requiring protection from sedimentation expected from predicted rainfall events that will cause erosion.

They are intended to provide protection for a limited time period, usually less than 3 months.

### Installation Tips

Drainage area limits:

**0-15 % slope:** Maximum drainage area 1 acre, maximum slope length 200 feet

**More than 15 % slope:** Maximum drainage area 1/2 acre, maximum slope length 100 feet

Bind bales with wire or nylon twine (twine-bound bales are less durable). Place bales in a row with ends tightly abutting adjacent bales. Do not place bales with wire or twine touching--see illustration. Compress some loose straw between adjacent bales to close voids. The tops of bales should all be level and set at the same elevation.

### Staking

Each bale should be embedded in the soil a minimum of 4 inches. Drive 2x2 stakes or rebar through the bales and into the ground 1-1/2 to 2 feet for anchorage. The first stake in each bale should be driven toward a previously laid bale to force the bales together--see illustration.

### Maintenance

Inspect dikes and provide necessary maintenance following each storm period. It is important to ensure that loose straw does not enter storm drain facilities.

Remove bales once permanent drainage and stabilization are re-established.

Used straw as mulch in other areas.

# Straw Bale Dikes

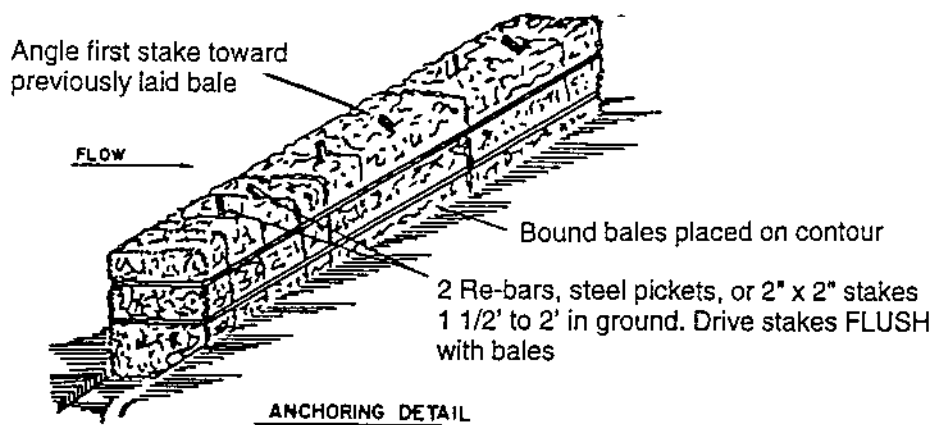
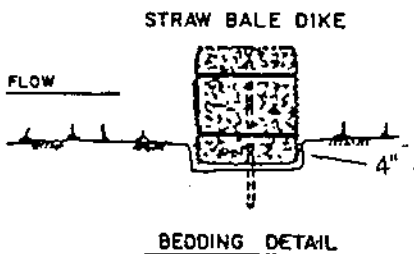
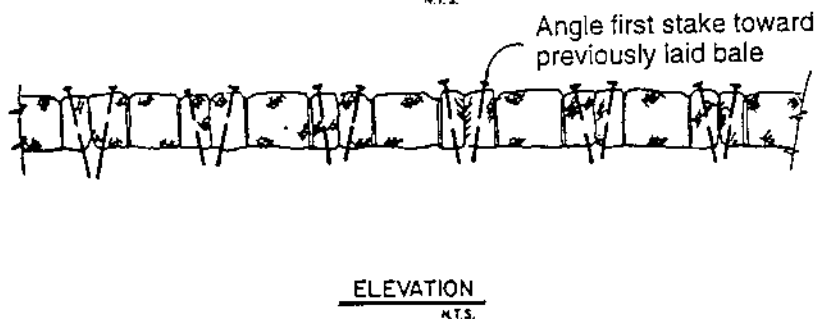
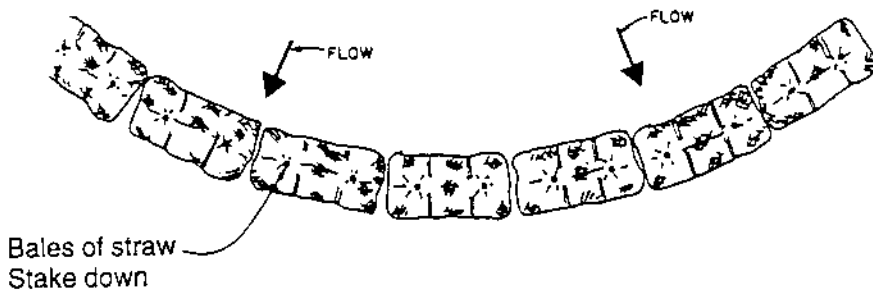
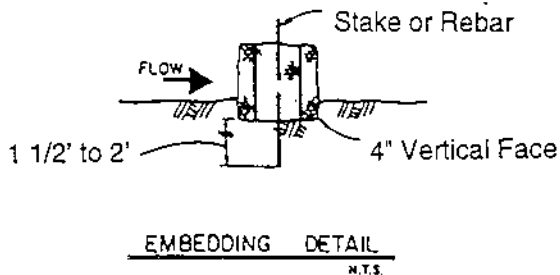



## Straw Mulching

Straw mulching should be used on slopes that have been seeded and have high potential for erosion. It will provide a protective cover to reduce erosion and aid in revegetation.

Mulching requires some type of anchoring by matting, crimping, or other methods to prevent blowing or washing away.

Straw mulch forms a loose layer when applied over a loose soil surface. To protect the mulch from wind drifting or being moved by water, it must be covered with a netting such as jute, punched into the soil with a spade or roller, or sprayed with a tacking agent.

Straw mulch should cover the entire seed or bare area and extend into existing vegetation or be stabilized on all sides to prevent wind or water damage which may start at the edges.

### Methods and Materials

On gentle to moderate slopes, straw mulch can be applied by hand broadcasting to a uniform depth of 2-3 inches.

On steep slopes, the straw should be blown onto the slope to achieve the same degree of cover.

When applied properly, about 20-40% of the original ground surface can be seen. The application rate per acre should be about 2 tons, or one 74-pound bale per 800 square feet. Straw should be clean barley or wheat straw.

## Anchoring

**Hand Punching**--Use a spade or shovel to punch straw into the slope until all areas have straw standing perpendicularly to the slope and embedded at least 4 inches into the slope. It should be punched about 12 inches apart.

**Roller Punching**--A roller equipped with straight studs not less than 6 inches long, from 4-6 inches wide and about 1 inch thick, is rolled over the slope.

**Crimper Punching**--Like roller punching, the crimper has serrated disk blades 4-8 inches apart which force straw mulch into the soil. Crimping should be done in two directions with the final pass across the slope.

**Matting**--Use on large, steep areas which cannot be punched with a roller or by hand. Jute, wood excelsior or plastic netting can be applied over unpunched straw.

# Straw Mulching

## SPREAD THE STRAW

MARK OFF 800 SQ FT. PLOTS

SPREAD EVENLY

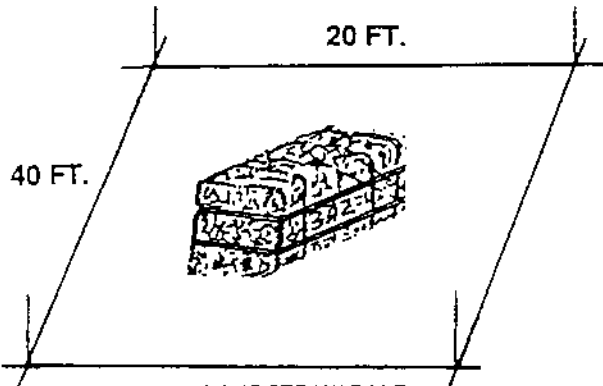

PLACE ONE STRAW BALE PER PLOT (~74 POUNDS). THIS IS EQUIVALENT TO 2 TONS PER ACRE.

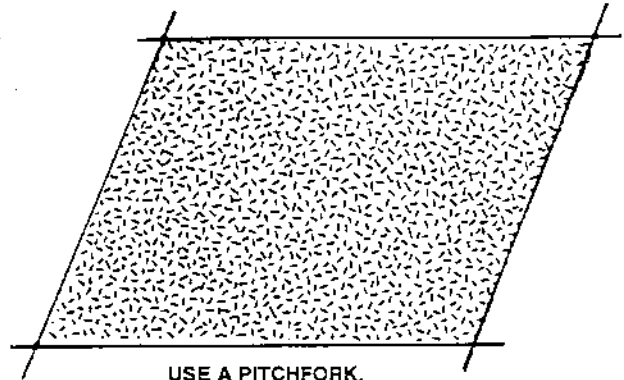

USE A PITCHFORK, SPADING FORK, OR BY HAND

## ANCHOR THE STRAW

CRIMP BY HAND

OR

USE PLASTIC NETTING

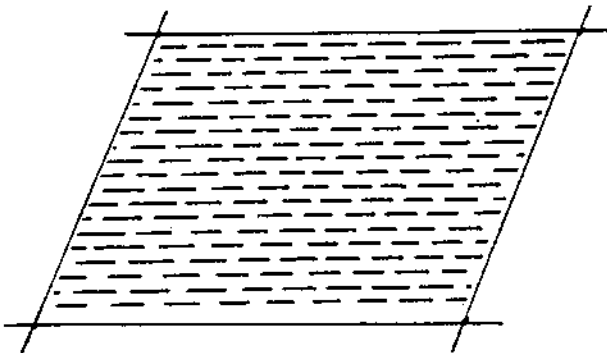

WORK ACROSS THE SLOPE. PUNCH STRAW 4 INCHES DEEP. A SQUARE END SPADE WORKS WELL. MAKE PUNCH EVERY 12 INCHES.

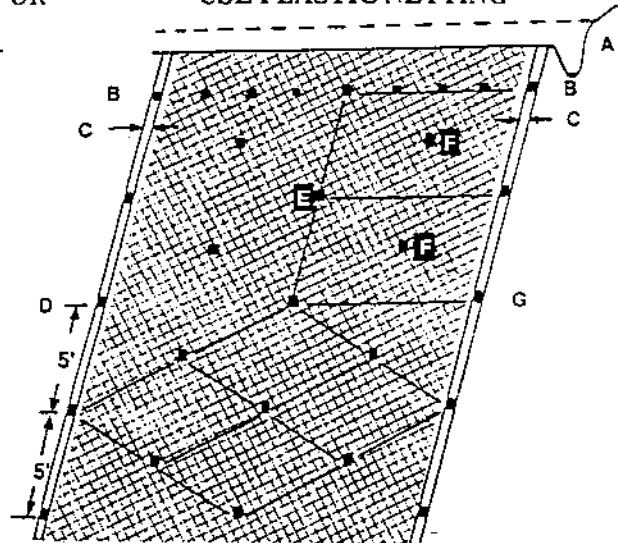

### Construction Notes

1. Lay matting in strips down the slope over the straw. Bury upper end in 6-8 inch deep and wide trench. Most netting comes in 14-17 feet wide rolls.
2. Secure the upper end with stakes every 2 feet.
3. Overlap seams on each side 4-5 inches.
4. Secure seams with stakes every 5 feet.
5. Stake down the center every 5 feet.
6. Stake middles to create diamond pattern that provides stakes spaced 4-5 feet apart.
7. Use pointed 1x2 inch stakes 8-9 inches long. Leave 1-2 inch top above netting or use "U" shaped metal pins at least 9 inches long.
8. When joining 2 strips, overlap upper strip 3 feet over lower strip and secure with stakes every 2 feet like in "B" above.

# Burlap Bag Check Dams

Gravel-filled bags can be used to construct sediment barriers, diversions, and basins on slopes up to 25%.

Bags should be made of burlap material. Fill material can be coarse sand or gravel.

Place the bags in layers, with each layer overlapping the joints in the previous layer, and packed tightly. Fill the bags one-half full. Tie or fold down the top of the filled bag. If folded, place the bags with the folded top in the upstream or uphill direction, facing the flow of water. Limit placement to 2 layers high.

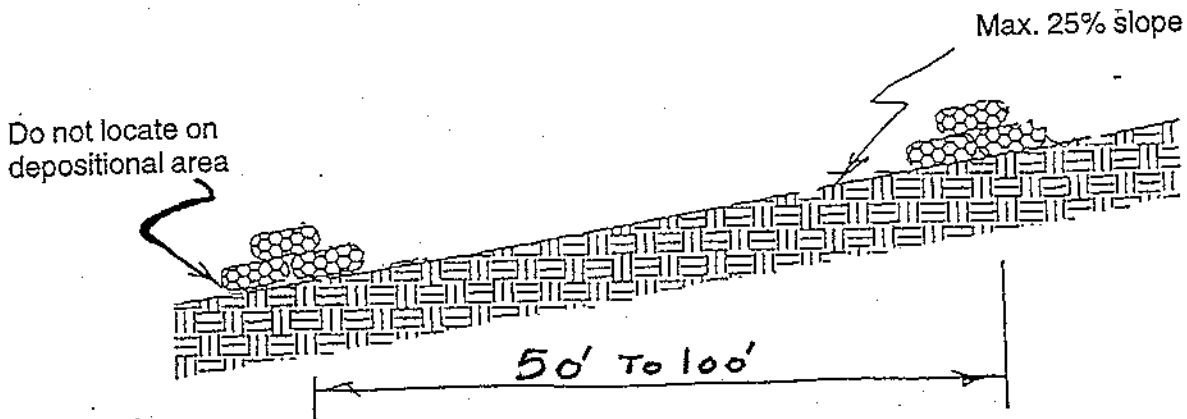
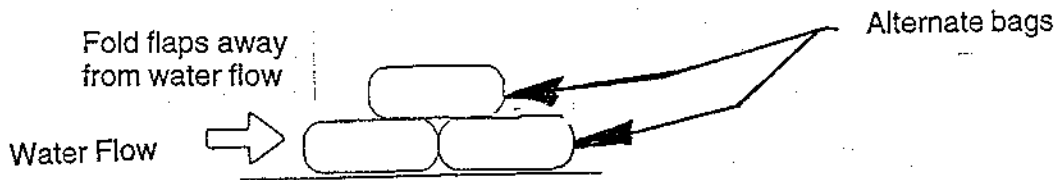
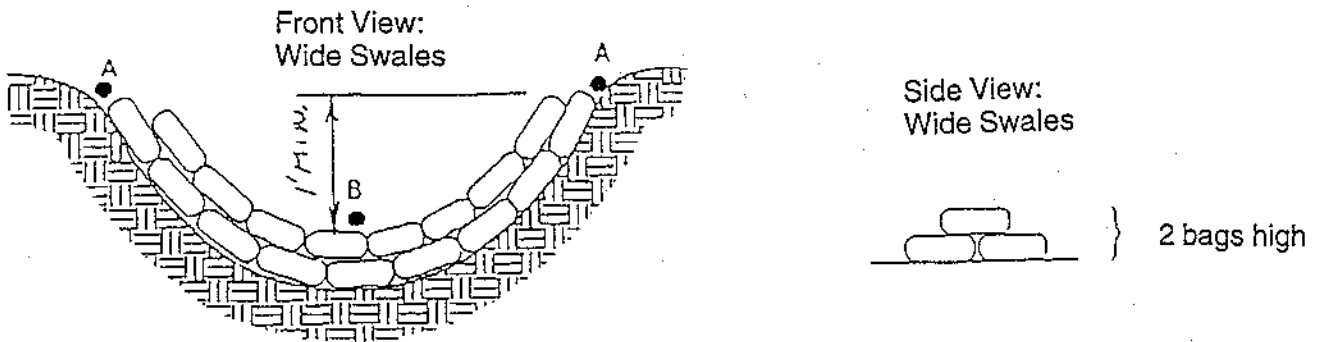

# What are Hydrophobic Soils?

## Definition

Wildfires burn dead and living vegetation that accumulates on the soil surface. This burning produces volatile hydrophobic substances which can penetrate the soil up to a depth of 6 inches. When these substances penetrate the cool soil, they condense and coat the soil particles, making the soil hydrophobic or water repellent.

Soils that are water repellent exhibit a decreased water infiltration rate and an increased water runoff rate, creating extreme soil erosion potential.

Initially, rain or irrigation water will run off hydrophobic soils instead of infiltrating and promoting germination of seed and growth of roots. This makes it difficult to establish a stand of vegetation.

Water repellency will be the worst where fuel and burn temperatures were extreme, especially under trees, sagebrush, and around buildings that burned to the ground.

## Field Check

Field check for water repellent soil conditions by digging a shallow trench with a vertical wall and applying water droplets from the surface down in centimeter increments.

- If water sits as a ball on the soil for 10 to 40 seconds, it is moderately hydrophobic.
- If more than 40 seconds, it is strongly hydrophobic.

## Treatment

On gentle slopes, hoe the soil a few inches deep to break up the hydrophobic layer. This will allow water to penetrate the soil surface for seed germination and root growth.

On steeper slopes, lightly spray the soil surface with a soil wetting product (surfactant). This will break up the hydrophobic substances coating soil particles the way dishwashing detergent breaks up grease. Then water can penetrate the soil readily.

Soil wetting products can be purchased at lawn and garden stores.

# Hazards from Debris Flows

Debris flows are shallow landslides, saturated with water, that travel rapidly downslope as muddy slurries, carrying rocks and debris.

Even moderate precipitation can cause major flooding on a wildfire damaged watershed because of the absence of vegetation and roots to bind the soil.

The areas directly downslope are especially subject to damage.

For example, a moderate rainstorm of 1 to 2.26 inches triggered the 1959 Boise Foothills flood event. The greatest intensities of rainfall ranged from .35 to .50 inch in 5 minutes. Large debris flows covered the 100-year floodplain and flooded some of Boise's northern neighborhoods and downtown corridor.

## **What can be done to avoid or reduce the hazard of debris flows?**

To be safe, assume that all drainages in steep, hilly areas are capable of carrying debris flows and are especially vulnerable after a wildfire.

### **Avoid building sites at the bottoms and mouths of steep ravines and drainage courses.**

These areas are the most likely to be inundated. The outer banks of bends along such ravines should also be avoided, because swiftly flowing debris avalanches can "ride up" out of the bottom of the stream channel where it bends.

### **Avoid building on or below steep slopes. In general, the steeper the slope, the greater the risk.**

If these areas must be used, consult with a soils engineer and engineering geologist. They will be able to evaluate the potential for problems and give advice on the best way to minimize the risk to life and property.

### **Limit the height and slope of cuts and fills in human-modified slope cuts.**

Properly compact fills and key them into bedrock and properly control the flow of water onto slopes.

### **Stay alert to the amount of rain falling locally during rainstorms.**

Concerns for flooding and debris flows are based on moderate to high amounts of moisture over short periods. Minimal precipitation rates that could trigger possible flooding and debris movement are estimated at .40 to .50 inch per hour.

The U.S. Department of Agriculture (USDA) prohibits discrimination in all its programs and activities on the basis of race, color, national origin, sex, religion, age, disability, political beliefs, sexual orientation, or marital or family status. (Not all prohibited bases apply to all programs.) Persons with disabilities who require alternative means for communication of program information (Braille, large print, audiotape, etc.) should contact USDA's TARGET Center at 202-720-2600 (voice and TDD).

To file a complaint of discrimination, write USDA, Director, Office of Civil Rights, Room 326W, Whitten Building, 14<sup>th</sup> and Independence Avenue, SW, Washington, DC 20250-9410 or call 202-720-5964 (voice or TDD). USDA is an equal opportunity provider and employer.