

Thermal Spray Process Reliability: Sensors and Diagnostics

Summary of a Workshop held at
National Institute of Standards and
Technology

Stephen D. Ridder

U.S. DEPARTMENT OF COMMERCE
Technology Administration
Metallurgy Division
Materials Science and Engineering Laboratory
National Institute of Standards and Technology
Gaithersburg, MD 20899



NIST

National Institute of Standards and Technology
Technology Administration, U.S. Department of Commerce

Thermal Spray Process Reliability: Sensors and Diagnostics

Summary of a Workshop held at National Institute of Standards and Technology

Stephen D. Ridder

U.S. DEPARTMENT OF COMMERCE
Technology Administration
Metallurgy Division
Materials Science and Engineering Laboratory
National Institute of Standards and Technology
Gaithersburg, MD 20899

January 2001



U.S. DEPARTMENT OF COMMERCE
Donald L. Evans, Secretary

TECHNOLOGY ADMINISTRATION
Karen H. Brown, Acting Under Secretary of Commerce
for Technology

NATIONAL INSTITUTE OF STANDARDS AND TECHNOLOGY
Karen H. Brown, Acting Director

TABLE OF CONTENTS

TABLE OF CONTENTS.....	i
DISCLAIMER.....	ii
WORKSHOP SUMMARY.....	1
Purpose.....	1
Results.....	1
WORKSHOP AGENDA.....	2
PRESENTATIONS.....	3
Introductory Presentations.....	3
Workshop Presentations.....	3
DISCUSSION.....	6
CONCLUSIONS.....	9
ATTENDANCE LIST.....	11
Industry.....	11
Academia.....	13
National Labs (non NIST).....	14
NIST.....	15
PRESENTATION SLIDES.....	17
<i>Torch-Based Sensor Systems</i> S. D. Ridder (NIST).....	17
<i>Plume-Based Sensors and Measurements</i> S. P. Mates (NIST).....	21
<i>Substrate-Based Sensors:</i>	
<i>Optical Sensing of Thermal Spray Substrates</i>	
<i>and Coatings</i> J. Geist (Sequoyah Tech.).....	27
<i>Substrate-Based Sensors:</i>	
<i>Radiation-Stimulated Sensing of Coating Properties</i> D. Basak (NIST).....	31
<i>Substrate Analysis: Surface Texture</i> M. R. Stoudt (NIST).....	37
<i>Substrate Analysis: Grit Blasting</i> R. D. Jiggetts (NIST).....	41
<i>In-Flight Temperature Measurement in the</i>	
<i>Thermal Spray Process</i> J. R. Fincke (INEEL).....	45
<i>Opportunities and Challenges for Advanced Process Control</i>	
<i>in the Thermal Spray Industry</i> C. Moreau (NRC-CNRC).....	55
<i>Materials of Interest:</i>	
<i>NIST Ceramic Coatings Program</i> S. J. Dapkunas (NIST).....	65

<i>Materials of Interest:</i>	
<i>Metal Coating Systems</i>	F. S. Biancaniello (NIST)73
<i>Variability in Thermal Spray Materials: A Problem or an Opportunity?</i>	C. C. Berndt (SUNY Stony Brook)77
<i>NIST Role in Microstructure Characterization and Relationships Between the Microstructure and Properties for</i>	
<i>Thermally Sprayed Deposits</i>	J. Ilavsky (NIST).....93
<i>Rapid, Low Investment Tooling</i>	D. Collins (Ford Motor Corp.)99
<i>Imaging Pyrometer for Monitoring the Surface Temperature of a Spray Formed Steel Billet</i>	J. E. Craig (Stratonics, Inc.).....105
<i>High Enthalpy Plasma Spray</i>	L. George (Progressive Technologies, Inc.)113
NIST THERMAL SPRAY RESEARCH125

DISCLAIMER

This report is intended as a record of the presentations and discussions that took place at a NIST Metallurgy Division sponsored workshop. The opinions, conclusions, or recommendations that are expressed herein are those of the organizers or individual presenters and do not necessarily reflect the views of NIST. All references to commercial equipment in this report are for identification purposes only and in no way constitute any endorsement or evaluation of the relative merits of such equipment by NIST.

WORKSHOP SUMMARY

Purpose

This report covers the second workshop on Thermal Spray (TS) coatings sponsored by the NIST Metallurgy Division. The first of these workshops, held in November, 1998, was documented in NISTIR 6460. The objectives of this current workshop included the presentation of NIST work on thermal spray sensors and diagnostics, as well as exploring the possibilities for collaborations with U.S. industry. Attendance from outside NIST was approximately 35, of whom approximately 15 could be classified as thermal spray producers and users and 20 as the thermal spray diagnostics community including instrument makers, universities, and national laboratories.

In the December 2000 issue of the *Journal of Thermal Spray Technology*, R.C. Tucker, Jr. discussed many of the issues covered in this workshop and stressed the need for higher quality in thermal spray coatings. Tucker's comments are recommended background reading for this report¹.

Results

The workshop participants expressed several needs and concerns regarding the use of sensors and process measurement technology. A coatings properties database of materials characterization, mechanical properties, and statistical analysis needs to be established. New technology for deposit and substrate property measurements is needed, especially sensors to measure deposit thickness and techniques to measure residual stresses in thick deposits. There are questions concerning the calibration of non-contact temperature sensors, specifically as to how variations in material properties (e.g. particle shape, oxidation, etc.) will affect emissivity. Simple, reliable, rugged sensors are required for industrial environments. The research community must show a correlation of improved sensor performance and accuracy to improved product performance.

¹ R. C. Tucker, Jr. "Comments on the Status and Future of Thermal Spray Coatings," *JTST*, Vol 9 No 4, 2000, pp. 431-433.

WORKSHOP AGENDA

Monday, January 8, 2001

Morning Session: Sensors and Diagnostics

- 8:15 Registration
- 8:30 Welcome..... D. Hall, Deputy Director, MSEL
- 8:40 Introduction, Workshop Goals.....R. J. Schaefer (NIST)
- Thermal Spray Sensors and Control Strategies:
- 8:50 Torch-Based Sensor Systems S. D. Ridder (NIST)
- 9:10 Plume-Based Sensors and Measurements.....S. P. Mates (NIST)
- Substrate-Based Sensors:
- 9:30 Real-Time Analysis of Substrate Temperatures J. Geist (Sequoyah Technologies)
- 9:45 Post-Deposition Thermal AnalysisD. Basak (NIST)
- 10:00 Break
- Substrate Analysis:
- 10:20 Surface TextureM. R. Stoudt (NIST)
- 10:35 Grit-Blasted Surfaces.....R. D. Jiggetts (NIST)
- 10:50 Modeling, Sensor and Calibration needsJ. R. Fincke (INEEL)
- 11:05 Opportunities and Challenges for Advanced Process Control
in the Thermal Spray IndustryC. Moreau (NRC-CNRC)
- 11:20 Discussion: Sensors and Diagnostics
- 12:00 Lunch

Afternoon Session: Materials and Microstructures

- Materials of interest:
- 1:00 Ceramic Coatings Program OverviewS. J. Dapkunas (NIST)
- 1:20 Metal Coating Systems.....F. S. Biancaniello (NIST)
- 1:40 Variability in Thermal Spray Materials: A Problem or an Opportunity? ... C. C. Berndt (SUNY Stony Brook)
- 2:00 Processing-Microstructure-Properties Relationships of Metallic and Cermaic Deposits.....J. Ilavsky (NIST)
- 2:20 Panel Discussion:Process Control and On-Line Needs
System Diagnostics and Development Needs
- 3:00 Break
- 3:30 Lab Tour
- 5:00 Adjourn
- 6:00 Dinner, Holiday Inn

Tuesday, January 9, 2001

Morning Session: Industrial Processes and Project Planning

- 8:30 Summary of Previous Day's Conclusions:R. J. Schaefer (NIST)
- 8:45 Arc-Stabilized Plasma Spraying..... L. George (Progressive Technologies, Inc.)
- 9:00 Rapid Tooling Using Twin Wire Arc Spray Guns D. Collins (Ford Motor Company)
- 9:15 Process Control Issues in the Thermal Spray Industry D. Crawmer (TS Technologies)
- Substrate-Based Sensors:
- 9:30 Discussion of NIST-Industry Modes of Interaction.....J. T. Lynch (NIST, Office of Technology Partnerships)
- 9:40 Discussion:
- 10:00 Break
- 10:30 Report to Meeting by Industrial Group, Compilation of Recommendations
- 11:00 Action Plan: Projects and Collaborations
- 12:00 Adjourn

PRESENTATIONS

Introductory Presentations

The program started with an introductory welcome by **D. E. Hall**, Deputy Director of the NIST Materials Science and Engineering Laboratory. This was followed by a slide presentation by **R. J. Schaefer** outlining the goals of the workshop.

Workshop Presentations

The program on Monday morning was devoted to the presentation of NIST work on sensors and diagnostics since the previous workshop on November 19, 1998, while the afternoon included presentation of materials aspects of NIST work, including the *Ceramics Coatings Program* and metallic coating materials. Before the laboratory tour which ended the day, there was a discussion of the topics on which NIST was seeking guidance. These were grouped under four categories, which were judged to be important based on needs expressed in previous workshops and on the NIST measurement mission:

- Thermal Spray Materials
- Calibration and Resolution
- Materials Measurements and Evaluations
- Cost, Ease of Use

The program on Tuesday morning included a summary of the comments from the previous day, with additions from the audience. This was followed by presentations from industrial attendees, and a presentation by Terry Lynch of the NIST Office of Technology Partnerships describing the different possible working relationships between NIST and industry. The workshop concluded with comments that were invited from the outside participants on what areas they thought would be most valuable for NIST to pursue.

Monday

The NIST work on the Sensors and Diagnostics project was presented as three parts: torch-based sensors, plume-based sensors, and substrate-based sensors. Torch-based sensors were described by **S. D. Ridder** of the NIST Metallurgy Division. These include sensors that measure the input to the torch of the numerous parameters such as electric power, water and gas flow, and thermal spray powder flow. This presentation emphasized recent work with measurement of powder feed rate using a Coriolis meter, which has much higher time resolution than the powder flow rate sensors that are normally used. This type of measurement (of a powder entrained in a gas flow) is a new application for a Coriolis meter and it appears to provide valuable information but will require considerable further study for calibration. There also was a brief discussion about data acquisition and control issues.

S. Mates, also of the NIST Metallurgy Division, discussed plume-based diagnostics, including measurements of temperatures and velocities of particles using two-color imaging pyrometry. He described in some detail the calibration work on this instrument and the extensive challenges related to understanding material emissivities.

Several aspects of substrate-based sensors were then discussed. **J. Geist**, of Sequoyah Technologies, described optical sensing of substrate and deposit temperatures during a spray deposition process, as applied to spray deposition onto a rotating cylindrical substrate. This presentation included a discussion of the features seen in the InGaAs sensor data stream during a typical deposition experiment. **D. Basak**, Guest Researcher at NIST from the University of

Tennessee, described two other substrate-based sensor systems. The first was a reflectometer intended for measurements of emissivity, as well as surface roughness parameters. The second was a pulsed-laser coating analysis instrument intended for analysis of several coating properties, essentially by probing the thermal diffusivity.

The following two talks discussed surface topography: **M. Stoudt**, of the NIST Metallurgy Division, discussed the different parameters that are used to describe surface roughness, with the point being made that the commonly cited parameter R_a is not in itself a characteristic measure of the suitability of a substrate for good adhesion. **R. Jiggetts**, also of the NIST Metallurgy Division, then described some measurements of the topography of grit-blasted surfaces, undertaken with the goal of understanding the progression of topography as the sample progresses from under-blasted to properly blasted to over-blasted, and correlating this progression to what might be observed by a non-contact sensor such as the reflectometer described by **D. Basak**.

J. Fincke of the Idaho National Engineering and Environmental Laboratories described the need for good emissivity values to enable better comparison of measured temperatures to those predicted by models. He showed a plot of collected values of emissivity as a function of temperature for tungsten, with such large scatter that the data were essentially useless. The following questions were raised:

How much of this scatter results from difficulty in measuring the emissivity? and,
How much of this scatter results from the actual emissivity variations?

C. Moreau of the National Research Council Canada described the opportunities and challenges for advanced process control in the thermal spray industry. He described a procedure in which a “green window” was identified representing the range of particle parameters which always gave acceptable coating quality. He also described open-loop and closed-loop approaches for operation with a model-based controller.

In the afternoon, the focus shifted to thermally sprayed materials. **S. Dapkunas** of the NIST Ceramics Division reviewed the Ceramics Coatings Program, which has focussed on thermal spray deposition of thermal barrier coatings. This project developed Standard Reference Materials for particle size distribution, and developed a wide range of coating characterization measurements, including microstructure, residual stress, thermal conductivity, and elastic modulus. The current status of the NIST Object Oriented Finite Element (OOF) project was also described. This public domain software tool simulates and elucidates macroscopic properties of complex materials microstructures.

F. Biancaniello of the NIST Metallurgy Division described some of the alloys the Division has worked on which have potential as thermal spray coatings, including nitrogenated stainless steels, white cast iron, and quasicrystals. The performance of these materials as thermal spray coatings, with outstanding combinations of corrosion and/or wear properties, could be beneficially explored by combining the NIST capabilities in atomization and thermal spray.

C. Berndt, of SUNY Stony Brook, discussed whether variability in thermal spray coatings was a problem or an opportunity. He discussed the wide range of powder types used for both abrasive blasting and coating deposition and the problems of coating characterization. Surface roughness is recognized as an important issue. With regard to characterization, he emphasized the usefulness of Weibull charts for an understanding of the statistical nature of important properties. During his talk and at other times, he pointed out the benefits of using the Journal of Thermal Spray Technology

and the Thermal Spray Society as media for spreading information.

J. Ilavsky of the NIST Ceramics Division discussed characterization techniques and structure-property relationships. He showed how scattering techniques could be used to determine characteristics such as Porod surface area, which provide a bulk average measure of anisotropic surface area distribution. Such techniques may provide a better statistical measure than does direct metallography for correlation to processing conditions or properties.

Tuesday

R. Schaefer summarized subjects that had been identified as important during the discussions on Monday. After additions from the audience, the list included:

I. Materials:

- A. Variability of feedstock materials: chemistry, particle size, size distribution, and morphology
- B. Material selection
- C. Properties of monolithic vs. sprayed materials
- D. Bond strengths
- E. Modeling of failure modes
- F. Residual stress distributions, CTE

II. Calibration and Resolution

- A. Temperature measurements
 1. Absolute values are more important for R&D applications.
 2. Long-term stability is more important for industrial process.
 3. Extrapolation to high temperatures - how much difference does it make?
 4. Changes in emissivity due to particle oxidation, etc. can be real. How can one handle them?
- B. Time variations
 1. Powder pulsing - influenced by powder feed mechanism, powder characteristics, presence of gun, etc.
 2. Torch pulsing - can convert to broader distributions downstream.
 3. Do these have any effect on deposit properties?

III. Materials Measurements and Evaluations

- A. Roughness: What is the topography - adhesion linkage?
- B. Mechanical testing: What is the appropriate 4-point bend configuration?
- C. Statistical treatment of data
- D. Variability of hardness test data

IV. Cost, Ease of Use

Simple, real-time sensors are needed (coating thickness, deposition efficiency,)

D. Collins of Ford Motor Company then described Ford's use of multiple twin wire arc spray guns to produce sheet metal stamping dies. They deposit tool steel alloys with a thickness of typically 19 mm to 25.4 mm ($\frac{3}{4}$ " to 1") onto a sacrificial ceramic form, producing finished dies with sizes ranging up to 0.9 m \times 0.9 m (3' \times 3'). Larger dies can currently be formed by joining these, but the goal is direct spraying of pieces with footprints of 2.4 m \times 2.4 m (8' \times 8'). Spray-formed tools can be produced in (1 to 2) weeks compared to the (4 to 18) weeks required by conventional practices, and there is a 25 % to 30 % cost savings. Residual stresses are an important topic because of the need to maintain dimensional tolerances.

J. Craig of Stratonics described the use of a two-wavelength camera in Ford's facility to analyze the surface temperature of the deposit. The camera uses an InGaAs detector with a 320 × 240 pixel array and a cooled focal plane. To make temperature measurements, the spray forming head is moved aside.

L. George of Progressive Technologies described the benefits of an axial feed gun technology which they have developed. This system has a stabilized arc with a uniform spray plume that results in high spray rates and improved deposition efficiency.

D. Crawmer discussed process control issues in the thermal spray industry and summarized the difficulty of defining the control and reliability challenges in Crawmer's First Law, "The only absolute in thermal spray is that there are no absolutes." The industry needs improved, inexpensive sensors to compensate for the many complex variables and complex interactions, and the lack of operator skill and regular maintenance. It needs data acquisition tools for statistical analysis of the process. It needs tools for control, process diagnostics, and troubleshooting. Important technical aspects include surface preparation, powder quality, powder delivery, and plasma characteristics. Crawmer discussed some details of each of these aspects and concluded that cost effective sensors and controls could be an effective short-term solution for the problems. (Slides for his presentation were not available to include in this report.)

DISCUSSION

Visitors were asked to express their opinions, based on what they had heard about NIST's capabilities, of what kind of work would be most valuable for NIST to do, particularly with respect to possible collaborations. The following comments were offered:

Sandia National Laboratory:

R. Neiser: Sensors to measure the substrate and deposit can have a bigger impact than in-flight measurements and emissivity.

A. Mayer: On-line coating thickness measurement is an important parameter that needs more attention.

Bechtel Bettis, Inc.:

T. Hicks: Identification of a reproducible operating window for a quality product and development of nondestructive tests for quality control need to be addressed.

Los Alamos National Laboratory:

R. Castro: Use NIST expertise in powder processing in conjunction with plasma spray research.

Naval Surface Warfare Center:

L. Kohler: NSWC is currently working with the Osprey process; however, attended mainly to stay aware of latest sensor work.

SUNY Stony Brook:

A. Kulkarni: There is a need for coating thickness measurement sensors and for a standardized test for thermal cycling.

Sulzer Metco:

G. Wuest: There is a need for improved gas atomization to deliver a narrower range of particle sizes in an economic way. Also, materials property measurements, especially non-destructive, need to be developed.

Crucible Compaction Metals:

B. Hann: CCM attended as a powder metal producer to be educated on the needs of the thermal spray industry.

Drexel University:

R. Knight: Drexel is looking for a role for students. NIST could have access to their facilities such as an HVOF system. Drexel would like to see the development of a coatings properties database for designer information.

Stratonics:

J. Craig: Stratonics would like NIST to continue to support sensors, especially calibration work.

Thermal Spray Society:

C. Berndt (SUNY Stony Brook): The ASM TSS has 1000+ members who could contribute. For example, a data pooling effort could be initiated on materials characterization, mechanical properties, and statistical analysis. A roadmap is needed for the thermal spray industry.

Ford Motor Company:

R. Allor: Work needs to be directed on property measurements of deposits. More work is needed on twin-wire arc spray, in particular, on measuring residual stresses in deposits (i.e. neutron scattering.) Round robin testing is needed.

Micro-Motion:

R. Winget: Micro-Motion would like to continue working with NIST on Coriolis meter for measurement of powder flow.

Progressive Technologies:

L. Pollard: Efforts should be applied to the development of spray parameters for different materials.

L. George: An in-situ coating thickness measurement sensor is needed.

Thermal Spray Technologies:

D. Cramer: Standardized calibration of emissivities is needed; pick a few key coating materials to work on.

National Research Council of Canada:

C. Moreau: More work is needed on diagnostics, the effects of shape of particles, vapor clouds, the effect of oxidation on emissivity, and what do we do about it. Temperature calibrations in a reproducible manner are also needed.

Idaho National Environmental and Engineering Laboratory:

J. Fincke: Optical properties of coating materials are needed, including the effects of evaporation and oxidation. More work should be carried out on high temperature thermophysics.

Siemens Westinghouse Power:

R. Subramanian: (Comments were sent by e-mail after workshop.) Work is needed on the correlation of superior accuracy in sensors and diagnostics to superior performance and reliability of coatings. Robust and simple sensors for use in the field are also needed.

CONCLUSIONS

Based on participant comments, the following were identified as important issues that NIST should address directly or pursue as a collaborative project with outside researchers:

A coating properties database of materials characterization, mechanical properties, and statistical analysis should be developed.

A need for more measurements of deposit properties such as residual stresses was expressed. Also, new deposit and substrate property sensors are needed, especially one for coating thickness.

Calibration procedures and emissivity data, especially as affected by variations in material properties (particle shape, oxidation) were cited as needs (caution - primarily by the sensor community rather than the Thermal Spray user community).

Simple, reliable, rugged sensors are needed for industrial environments.

A correlation of improved sensor performance and accuracy to improved product performance should be shown.

NIST expertise in powder production by atomization should be combined with thermal spray work.

ATTENDANCE LIST**Industry**

Richard Allor
Ford Motor Company
2101 Rotunda
Dearborn, MI 48121 USA
rallor@ford.com

Jacques Blain
TECNAR Automation Ltée
1321 Hocquart Street
St. Bruno, QB J3V 6B5 CANADA
450-461-1221
450-461-0808 (fax)
jblain@tecnar-automation.com

Andrew Burns
Siemens Westinghouse Power
4400 Alafaya Trail
Orlando, FL 32826 USA
407-736-6656
407-736-2334 (fax)
andrew.burns@swpc.siemens.com

Dave Collins
Ford Motor Company
Southgate, MI 48195 USA
313-206-4455
dcollin7@ford.com

James E. Craig
Stratonics, Inc.
23151 Verdugo Drive, Suite 114
Laguna Hills, CA 92653-1340 USA
949-461-7060
949-461-7069 (fax)
info@stratonics.com

Daryl Crawmer
Thermal Spray Technologies
515 Progress Way
Sun Prairie, WI 53590 USA
608-825-2772
608-825-2737 (fax)
dcrawmer@tstcoatings.com

Shmuel Eidelman
SAIC
11705 Dinwiddie Drive
Rockville, MD 20852 USA
703-676-6491
703-676-5323 (fax)
eidelman@apo.saic.com

Jon Geist
Sequoyah Technologies
4410 Winding Oak Drive
Olney, MD 20832 USA
301-774-7280
jon.geist@ieee.org

Lou George
Progressive Technologies
4201 Patterson Ave
Grand Rapids, MI 49512 USA
616-957-0871
616-957-3484 (fax)
lcg@ptihome.com

Brian A. Hann
Crucible Compaction Metals
1001 Robb Hill Road
Oakdale, PA 15071
toll free-888-923-2670
412-923-2670
412-788-4240 (fax)
hann@cruciblecompaction.com

Trevor Hicks
Bechtel Bettis, Inc.
P.O. Box 79
West Mifflin, PA 15122 USA
412-476-7214
412-476-6235 (fax)
hickstg@bettis.gov

William Kratochvil
Praxair-TAFA
146 Pembroke Road
Concord, NH 03301 USA
603-233-2101
603-225-9585
william_kratochvil@praxair.com

Chijoke Mcbokenerc
Ford Motor Company
20000 Rotunda Drive
Dearborn, MI 48121 USA
313-390-8596
313-390-0514 (fax)

Francois Nadeau
TECNAR Automation Ltée
1321 Hocquart Street
St. Bruno, QB J3V 6B5 CANADA
450-461-1221
450-461-0808 (fax)
fnadeau@tecnar-automation.com

Larry Pollard
Progressive Technologies
4201 Patterson Ave
Grand Rapids, MI 49512 USA
616-285-8350
616-957-2509 (fax)
lfp@ptihome.com

Luc Pouliot
TECNAR Automation Ltée
1321 Hocquart Street
St. Bruno, QB J3V 6B5 CANADA
450-461-1221
450-461-0808 (fax)
lpouliot@tecnar-automation.com

Allen Roche
Ford Motor Company
2101 Village Road
SRL, MD 3135
Dearborn, MI 48124 USA
313-390-8889
313-390-0514 (fax)
aroche1@ford.com

Samir
Ford Motor Company
20000 Rotunda Drive
Dearborn, MI 48121 USA
313-337-6495

Ramesh Subramanian
Siemens Westinghouse Power
4400 Alafaya Trail
MC 303
Orlando, FL 32826 USA
407-736-5591
407-736-2334 (fax)
ramesh.subramanian@swpc.siemens.com

Jason Ting
Crucible Research
6008 Campbells Run Road
Pittsburgh, PA 15025
412-923-2955
412-788-4665 (fax)
jason@crucibleresearch.com

Richard Winget
Micro Motion
7101 Union Court
North Wales, PA 19454 USA
610-666-3317
215-368-8002 (fax)
dickw@micromotion.com

Gregory Wuest
Sulzer Metco (US), Inc.
1101 Prospect Ave.
Westbury, NY 11590 USA
516-338-2217
516-338-2488 (fax)
gregory.wuest@sulzer.com

Academia

Christopher C. Berndt
SUNY at Stony Brook
306 Old Engineering
Stony Brook, NY 11794 USA
631-632-8507
631-632-8525 (fax)
cberndt@notes.cc.sunysb.edu

Richard Knight
Drexel University
32nd & Chestnut Streets
Dept. of Matls Engineering
Philadelphia, PA 19104 USA
215-895-1844
215-895-2332 (fax)
knightr@drexel.edu

Anand Kulkarni
SUNY at Stony Brook
676 Chapin Complex
Stony Brook, NY 11790 USA
631-632-8515
631-632-8440 (fax)
anand.kulkarni@sunysb.edu

Thierry Renault
Laboratoire SPCTS
Faculte des Sciences
123 av AThomas 87060
Limoges, FRANCE
335-55457437
335-55457211 (fax)
threnault@multimania.com

Michel Vardelle
Laboratoire SPCTS
Faculte des Sciences
123 av AThomas 87060
Limoges, FRANCE
335-55457437
mvardelle@unilim.fr

National Labs (non NIST)

Jean-Francois Bisson
National Research Council Canada
75 De Mortagne Blvd.
Boucherville, QB J4B 6Y4 CANADA
450-641-5287
450-641-5106 (fax)
jean-francois.bisson@nrc.ca

Richard G. Castro
Los Alamos National Laboratory
P.O. Box 1663
Los Alamos, NM 87544 USA
505-667-5191
505-667-5268 (fax)
rcastro@lanl.gov

James R. Fincke
INEEL
P.O. Box 1625
Idaho Falls, ID 83415 USA
208-526-2031
208-526-5327 (fax)
jfl@inel.gov

Leslie Kohler
NSWC
9500 MacArthur Blvd.
West Bethesda, MD 20817 USA
301-227-5096
301-227-5548 (fax)
kohlerLK@nswccd.navy.mil

Andrew Mayer
Sandia National Labs
1515 Eubank, SE
MS 1130
Albuquerque, NM 87123 USA
505-845-4380
505-844-6611 (fax)
ajmayer@sandia.gov

Christian Moreau
National Research Council Canada
75 De Mortagne
Boucherville, QB J4B 6Y4 CANADA
450-641-5228
450-641-5106 (fax)
christian.moreau@nrc.ca

Richard A. Neiser
Sandia National Laboratories
MS 1130
Albuquerque, NM 87185 USA
505-845-4380
505-844-0457 (fax)
raneise@sandia.gov

Maria Posada
NSWC
9500 MacArthur Blvd.
West Bethesda, MD 20817 USA
301-227-5017
301-227-5576 (fax)
posadam@nswccd.navy.mil

A. K. Vasudevan
Office of Naval Research
800 N. Quincy Street
Arlington, VA 22217 USA
703-696-8181

NIST

Mail Address for NIST employees:

Name

NAT'L INST STDS & TECH
100 BUREAU DR STOP xxxx
GAITHERSBURG, MD 20899-xxxx

Clare M. Allocca
STOP 4730
301-975-4359
301-548-1087 (fax)
clare.allocca@nist.gov

Frank S. Biancaniello
STOP 8556
301-975-6177
301-869-5629 (fax)
frank.biancaniello@nist.gov

Debasis Basak
STOP 8555
301-975-5930
debasis.basak@nist.gov

Stanley J. Dapkunas
STOP 8520
301-975-6130
301-990-8729 (fax)
stanley.dapkunas@nist.gov

Jan Ilavsky
NIST
UNICAT, Bldg 438E, ANL
Argonne, IL 60439 USA
630-252-0866
630-252-0862 (fax)
ilavsky@nist.gov

Rodney D. Jiggetts
STOP 8555
301-975-5122
301-869-5629 (fax)
rodney.jiggetts@nist.gov

Steven P. Mates
STOP 8556
301-975-8114
301-869-5629 (fax)
steven.mates@nist.gov

Richard E. Ricker
STOP 8553
301-975-6023
301-975-4553 (fax)
richard.ricker@nist.gov

Stephen D. Ridder
STOP 8556
301-975-6175
301-869-5629 (fax)
stephen.ridder@nist.gov

Robert J. Schaefer
STOP 8555
301-975-5961
301-975-4553 (fax)
robert.schaefer@nist.gov

Mark R. Stoudt
STOP 8553
301-975-6025
301-869-5629 (fax)
mark.stoudt@nist.gov

Torch-Based Sensor Systems

S. D. Ridder (NIST)

The NIST Metallurgy Division has initiated a research program to investigate coatings produced by the Thermal Spray (TS) technique. The focus of this research is the development of measurement tools that will aid in the understanding and/or control of this plasma spray process.

This talk will include a discussion of the results of recent work done at NIST on torch-based sensor systems as well as a brief description of the NIST TS facility and TS control system.

This process uses plasma jets (generated by either DC or AC arcs) to melt or soften coating feed-stocks and then propel this material onto various substrates.

The geometry and operating parameters of the plasma jet hardware, or “gun”, depend on the intended function of the resulting coated part. This slide shows three regions within the TS process that can be monitored and controlled:

- 1) **torch-based** parameters
- 2) spray **plume-based** parameters
- 3) **substrate-based** parameters

Thermal Spray
Diagnostics, Sensors, and Control Strategies
For Reliable and Reproducible Coatings

Torch-Based Systems

F. Biancaniello, P. Boyer, R. Jiggetts,
S. Mates, **S. Ridder**, and R. Schaefer

Metallurgy Division
National Institute of Standards and Technology
Gaithersburg, MD 20899

Thermal Spray Process Reliability:
Sensors and Diagnostics
January 8, 2001

NIST
National Institute of Standards and Technology
Technology Administration, U.S. Department of Commerce



Thermal Spray
Diagnostics, Sensors, and Control Strategies
For Reliable and Reproducible Coatings

Torch-Based Systems

OUTLINE

- 1) Thermal spray process overview
- 2) Important torch-based sensors
- 3) Powder mass flow-rate control
 - a) current technology performance
 - b) Coriolis meter design & testing
 - c) new technology performance
 - d) Coriolis meter results
- 4) NIST TS facility and PC control system
- 5) Proposed future work in torch-based sensors

NIST
National Institute of Standards and Technology
Technology Administration, U.S. Department of Commerce



Thermal Spray
Diagnostics, Sensors, and Control Strategies
For Reliable and Reproducible Coatings

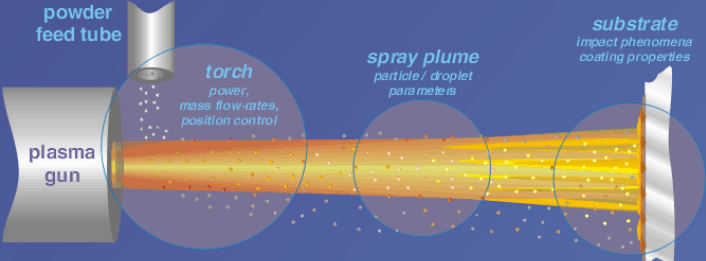

diagnostics,
modeling (CFD),
and process control

diagnostics
and sensors:
(temperature,
velocity, and
size distribution)

diagnostics
and sensors
(temperature, velocity,
thickness, porosity,
thermal conductivity)

NIST
National Institute of Standards and Technology
Technology Administration, U.S. Department of Commerce



Torch-Based Sensor Systems (cont.)

S. D. Ridder (NIST)

These are the important TS torch parameters. Most torch control consoles provide controls that regulate the time-averaged arc current and process gas flow-rate. Arc efficiency and stability are not usually measured or controlled. Arc efficiency can be calculated by measuring the power loss to the torch cooling water. Arc stability can be monitored by measuring the arc voltage at sufficiently high sampling rates (≈ 20 kHz for most DC Air Plasma Spray (APS) systems) to resolve the voltage spikes that result from arc restrikes. Torch position is often controlled by robotic manipulators or translating stages and/or rotary tables.

The current technology for powder mass flow-rate control relies on the use of an electronic mass balance. The measurement of powder flow-rate with a mass balance requires a considerable integration time to resolve the changes in the powder hopper mass as powder is being fed to the torch. Also, vibrations from the powder feeder or from nearby machinery must be removed from the mass balance readings either by mechanical damping or by using electronic or software filters.

The powder mass flow sampling rate is, therefore, limited to ≈ 0.1 Hz with the corresponding resolution of flow-rate fluctuations limited to < 0.05 Hz.

Coriolis meters are used in a large variety of industrial processes to measure mass flow-rate of liquids, gases, and slurry mixtures (powders suspended in liquids).

One design splits the process flow into two "mirror image" u-shaped flow paths (U-tubes) as shown in this schematic drawing. The U-tubes are equipped with a driver coil and magnet that vibrate the tubes at resonant frequency. The tube vibrations are sensed as sine waves with pickoffs positioned upstream and downstream from the driver. When fluid within the U-tubes is stationary the pickoff signals are in-phase. When fluid flows within the vibrating U-tubes an undulating twist occurs, as shown in the lower drawing, as the vibrating U-tube momentum combines with the flow momentum (the Coriolis effect). The twist is sensed by a phase shift in the pickoff signals that is directly proportional to the mass flux through the tubes.

The split process flow is recombined after traveling through the U-tubes.

Thermal Spray
Diagnostics, Sensors, and Control Strategies
For Reliable and Reproducible Coatings
Torch-Based Systems

2) Important torch-based sensors

Arc parameters

- 1) potential & current (power)
- 2) arc efficiency (heat loss to cooling H₂O)
- 3) arc stability (time resolved power)

Gas mass flow-rate control

Powder mass flow-rate control

Torch (spray gun) position control

NIST
National Institute of Standards and Technology
Technology Administration, U.S. Department of Commerce



Thermal Spray
Diagnostics, Sensors, and Control Strategies
For Reliable and Reproducible Coatings
Torch-Based Systems

3) Powder mass flow-rate control

a) current technology performance

Mass flow-rate measured with electronic balance

Data update is ≈ 0.1 Hz

Cannot resolve flow-rate fluctuations > 0.05 Hz (period = 20 s)

Technology is limited by vibrations and noise in electronic balance

NIST
National Institute of Standards and Technology
Technology Administration, U.S. Department of Commerce



Thermal Spray
Diagnostics, Sensors, and Control Strategies
For Reliable and Reproducible Coatings
Torch-Based Systems

3) Powder mass flow-rate control

b) Coriolis meter design

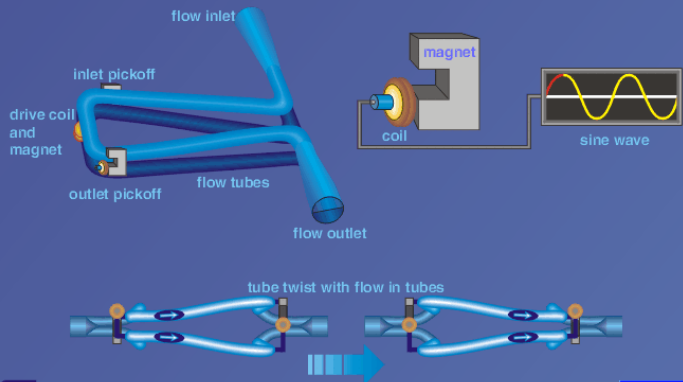

NIST
National Institute of Standards and Technology
Technology Administration, U.S. Department of Commerce



Torch-Based Sensor Systems (cont.)

S. D. Ridder (NIST)

Using a Coriolis meter to measure the mass flow-rate of fluids with suspended solids, as found in powder feed TS systems, requires testing to determine the extent of momentum coupling between the gas and suspended powder.

Initial testing at NIST was done with an experimental configuration schematically shown in this slide. This setup allowed independent measurement of powder mass using the Coriolis meter and a precision electronic balance.

Some of the performance capabilities are shown in this slide. The resolution of the mass flow-rate measurement is dependent on the calibration procedure. The measurement uncertainty of mass flow rate for the meter used in these tests is ≈ 0.05 g/min for liquids flowing at 15 g/min and ≈ 0.3 g/min for gases flowing at 15 g/min. Measurement uncertainty for gas/powder mixtures should approach those for pure gases, however, it is likely to vary with the density and particle size distribution of the powder.

Some of the initial Coriolis meter test results are shown in the upper graph of the following slide. During this filling sequence the powder feeder set-point was raised from 10 g/min to 25 g/min. Coriolis meter data is shown as the black line trace. A periodic oscillation is evident as well as a transient pulse that occurred when the diverter valve was sequenced.

The lower graph in this slide shows powder flow-rate data along with the spray plume luminosity measured with a photodiode during an experiment with the torch operational. This graph provides clues to the cause of the periodic oscillations in the powder flow rate. The plume luminosity fluctuates in direct correspondence with the oscillations in the Coriolis meter data. The bottom trace in this graph shows the powder feeder pulses that are generated by a tapping mechanism that is used to prevent powder clumping from blocking the flow channels. These pulses are also in direct correspondence with the luminosity and Coriolis meter data and are likely the cause of the powder flow oscillations. The lower graph also includes a trace of the data generated by the electronic scale on the powder feeder. This trace shows the relatively slow sampling rate compared to the Coriolis meter data.

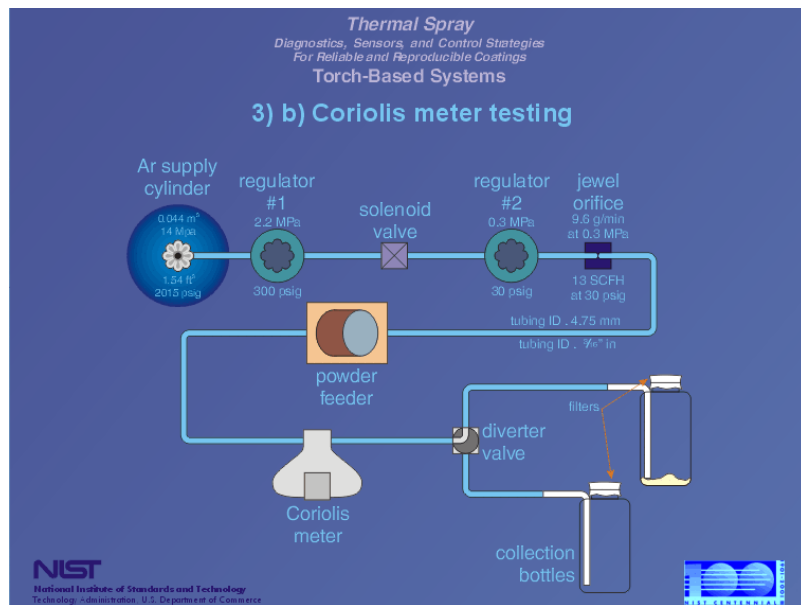

Thermal Spray
Diagnostics, Sensors, and Control Strategies
For Reliable and Reproducible Coatings
Torch-Based Systems

3) Powder mass flow-rate control

c) new technology performance

- In-line system sees entire powder / gas flow stream
- Data update is ≈ 20 Hz
- Can resolve flow-rate fluctuations > 5 Hz (period = 0.2 s, 100 X faster)
- Can be used as feedback sensor to control flow-rate
- Requires calibration and testing but has promise as more accurate sensor

NIST
National Institute of Standards and Technology
Technology Administration, U.S. Department of Commerce

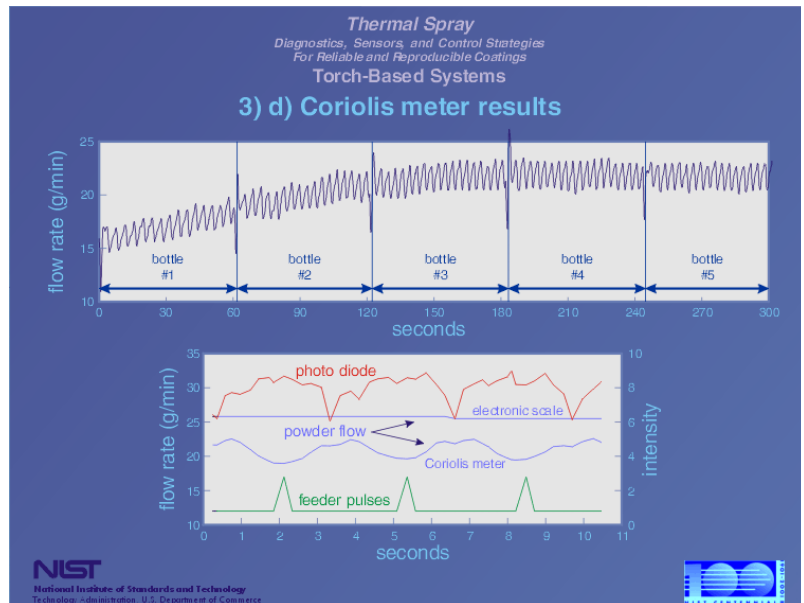

Torch-Based Sensor Systems (cont.)

S. D. Ridder (NIST)

The NIST TS facility is shown in this slide. A DC powder feed torch is shown mounted to a 3-linear axis, stepping motor driven manipulator. An imaging pyrometer is shown to the right of the spray torch mounted on a 2-linear a 3-linear axis, 1-rotational axis, stepping motor driven manipulator.

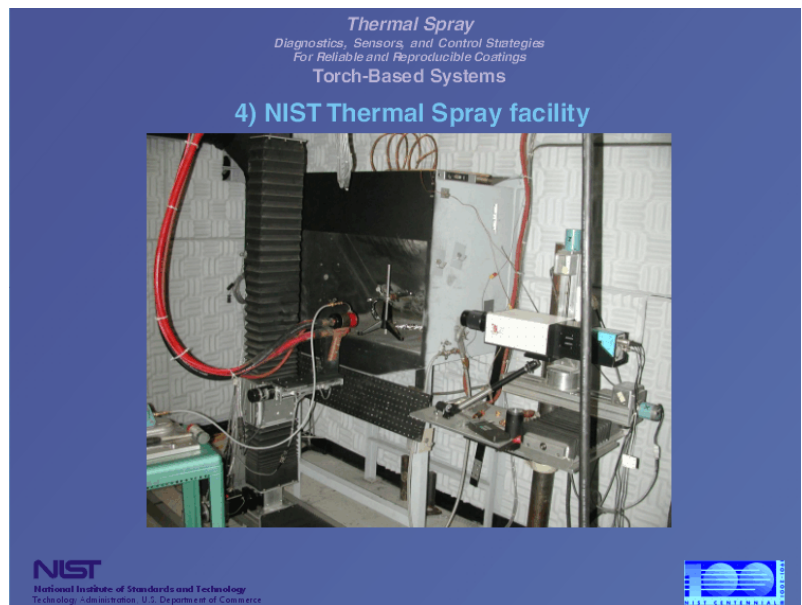

This slide shows two front panel views of the operator interface for the NIST TS control system. Torch operating parameters and position are monitored, controlled, and saved for post processing analysis. The data acquisition and control hardware and software are designed around modules that allow for rapid modification to incorporate new sensor and control features.

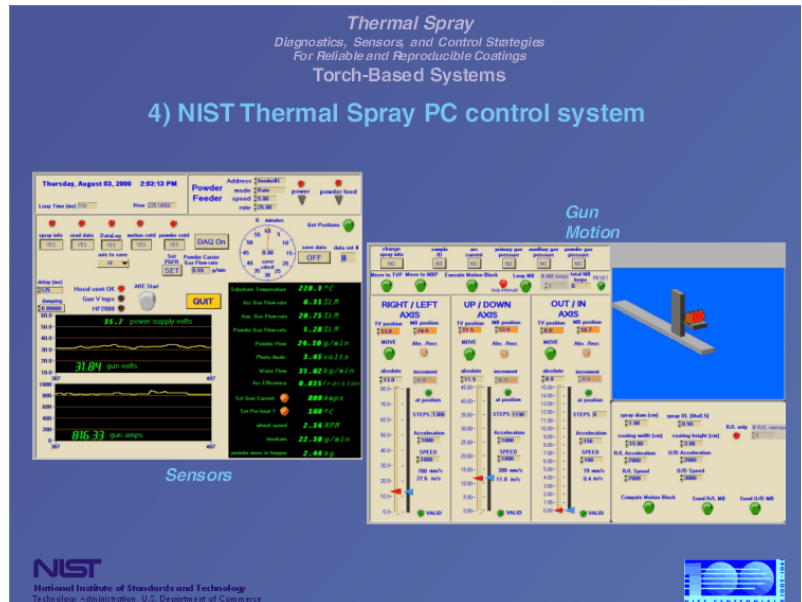

A list of planned activities for the NIST TS project are shown in this slide. When arc current control and arc efficiency measurement are added to the PC controller a TS process model will be added that will automatically adjust the arc current and gas flow-rates to provide the particle velocity and temperature entered as setpoints. The model will be configured to account for the effects of electrode wear, arc gas mixture chemistry, powder chemistry and size distribution, and other effects as determined by experimental data.

Thermal Spray
Diagnostics, Sensors, and Control Strategies
For Reliable and Reproducible Coatings
Torch-Based Systems

5) Proposed future work in torch-based sensors

- Calibrate Coriolis meter and quantify effect of powder feed fluctuations
- Install axial powder feed torch (better statistical control of TS plume)
- Sensors to monitor arc efficiency and electrode wear
- Improved gun position control with LVDTs and new motor controller
- Expand PC controller to include all arc parameters

NIST
National Institute of Standards and Technology
Technology Administration, U.S. Department of Commerce

Plume-Based Sensors and Measurements

S. P. Mates (NIST)

NIST Activities in Particle Diagnostics for Thermal Spray

Steven Mates
NRC Post-Doc
Metallurgy Division
January 8, 2001



Outline

- Introduction
- NIST activities in Thermal Spray Particle Sensing: Imaging Pyrometry
 - *how it works; calibration; emissivity issues*
- Summary
- Current & Future Direction (?)



Repeatability refers to the ability to spray a given coating onto a part time after time with consistent microstructure and properties. If process controls were sufficient, the operator skill level needed to achieve reproducible coatings would be lessened.

The consensus is that the available controls are not sufficient, but it is not clear exactly what more needs to be measured to achieve sufficient process control.

Repeatability in TS Coatings

- Repeatability problems linked to:
 - *torch component wear*
 - *booth set-up*
 - *operator skill*
 - *available controls are insufficient*
- Additional sensors are needed to improve reliability
 - *Plume-based sensors*



Plume-Based Sensors and Measurements (cont.)

S. P. Mates (NIST)

Particle diagnostics are favored as a means of improving process reproducibility because they yield information on the physics of the coating process itself, which is considered to be an improvement over simply monitoring torch power or gas pressures. Thermal spray particle sensors fill two roles. They are used in QC operations to “tune” thermal spray torches to ensure consistent coating deposition. They are also widely used in R&D applications, including developing parameter sets for new spray materials, evaluating improved spray torches, and studying relationships between processing conditions and coating properties.

Single particle sensors are the most developed of the plume-based sensor technologies. Early papers describing their use in thermal sprays include Sakuta and Boulos¹ and Fincke². More recent work has been published by Moreau^{3,4} involving an instrument commercialized by Technar Systems of Canada. Single particle sensors have been widely used in research labs on a variety of coating materials and spray processes⁵.

Ensemble particle measurement techniques are becoming more popular for plume monitoring because they are cheaper and less complex than individual particle sensors but may still provide adequate data to achieve the desired level of reproducibility. Ensemble measurement techniques acquire data that are related to some average temperature and velocity of the particle stream. Efforts are being made to model the response of ensemble sensors as a combination of individual particle temperature signals having statistical distributions similar to those measured by single particle sensors⁶. Spectroscopy has also been used to measure ensemble particle temperatures⁷. Ensemble sensors are targeted specifically to quality control applications, possibly involving feedback control strategies, where it is believed data on individual particles may not be needed.

Plume-Based Sensors

- Measure particle plume characteristics non-intrusively
 - *particle temperature, velocity and size distributions*
 - *physically related to coating microstructure & properties*
- Uses
 - *locating & maintaining a desired spray condition (quality control)*
 - *Thermal Spray R&D*
- Sensor Technology
 - *single particle; ensemble; multi-particle*

NIST
National Institute of Standards and Technology
Technology Administration, 1101 University of Maryland Drive

Single Particle Sensors

- General Characteristics
 - *Measure individual particles*
 - *Small measurement volume*
 - *Scanning yields spatial distributions of temperature & velocity within spray plume*
 - *Measurement uncertainty $O(100\text{ K})$*
 - *Particles are detectable above 1500 K to 1800 K*

NIST
National Institute of Standards and Technology
Technology Administration, 1101 University of Maryland Drive

Ensemble Particle Sensors

- Technique
 - *detects light signal from large volume of the spray plume*
 - *signal related to the average particle temperature*
- Advantages
 - *less costly & complex*
 - *can handle large particle flux*
- Disadvantages
 - *limited to quality control applications*

NIST
National Institute of Standards and Technology
Technology Administration, 1101 University of Maryland Drive

Plume-Based Sensors and Measurements
(cont.)

S. P. Mates (NIST)

Imaging pyrometry measures multiple individual particles simultaneously by imaging a large volume of the spray plume. Measuring particles across the entire plume eliminates the need to scan the sensor to obtain spatial distributions of particle properties, and increases particle data rates. A fast-shutter CCD camera freezes individual particle streaks so they can be measured. Particle velocity is determined by measuring streak lengths and dividing by the exposure time, while particle temperature is determined from their two-color intensity ratio.

Two images of the particle plume, representing different spectral bandwidths, are focused side-by-side on a single CCD array. Software scans each image to identify individual particle streaks, compute their intensity at each wavelength, and determine their apparent ratio temperature and velocity. By integrating the intensity over each entire streak, the intensity measurements are less sensitive to optical aberrations and de-focusing.

In this experiment, torch parameters were selected to vary particle temperatures but maintain constant particle velocities using a simplified one-dimensional model to estimate the plasma jet enthalpy and dynamic pressure.

Imaging Pyrometry

- Yields individual particle data like single particle sensors
- Large measurement volume like ensemble sensors
 - scanning not needed
 - fast data rates (100's to 1000's per second)
 - visual measurement
 - time-resolved measurement
 - both QC and R&D uses

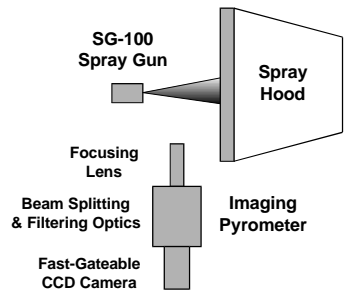

How Imaging Pyrometry Works

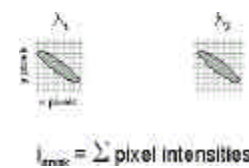
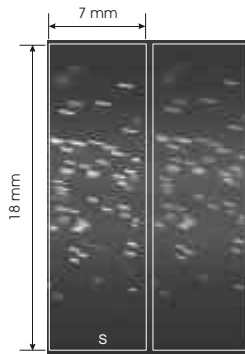

Individual particle temperatures are calculated from:

$$T = f \frac{i_{streak, \lambda_2}}{i_{streak, \lambda_1}}$$

Sample Temperature Distributions

(varied arc current and main gas flow rate)

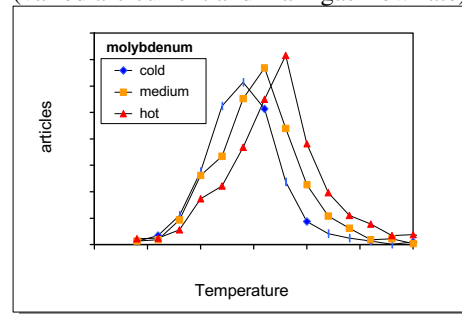

Plume-Based Sensors and Measurements (cont.)

S. P. Mates (NIST)

These uncertainties are comparable to uncertainties for single-particle sensors. Other measurement uncertainties from sources including, but not limited to, detector uniformity, chromatic aberration, electronic shuttering, and background rejection have been examined and require further study.

Particle detectability varies among spray materials because of differences in particle size and emissivity. Improvements in detectability can be achieved using CCD cameras with greater near-IR sensitivity, or by reducing the sensor's depth of field, although this reduces particle measurement rates.

Direct, time-resolved measurements of the particle stream are a unique capability of multi-particle sensing techniques like imaging pyrometry. In this example, the frame-to-frame average particle temperature (M_o) varies by 20 %, which could be caused by fluctuations in the powder feed rate, unsteady power delivery from the arc, turbulent motion of the plume, or a combination of these effects. The effects of such fluctuations in the spray on coating reproducibility have yet to be investigated.

Initial Performance Evaluation

- Estimated Random Uncertainties
 - 1 % to 4.5 % on Temperature, <10 % on Velocity
- Temperature distributions obtained to date are similar to single particle techniques
- Particle detectability
 - particle size, emissivity dependent
 - molybdenum (40 μm) 1700 K, zirconia (15 μm) 2000 K

NIST
National Institute of Standards and Technology
Technology Administration, 1101 University of Maryland Drive

Time Resolved Particle Data

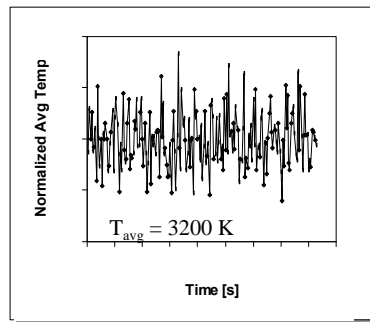

20 % p-p variation in average particle temperature over several seconds

Due to variations in particle flux, plasma jet enthalpy, momentum

NIST
National Institute of Standards and Technology
Technology Administration, 1101 University of Maryland Drive

Temperature Calibration

- Why Calibrate?
 - measurement portability
 - estimating uncertainties
 - use results quantitatively
- Challenges
 - high temperatures (> 3000 K) require unique cal source
 - absolute temperature & emissivity of the calibration source must be characterized

NIST
National Institute of Standards and Technology
Technology Administration, 1101 University of Maryland Drive

Plume-Based Sensors and Measurements (cont.)

S. P. Mates (NIST)

Originally this facility was designed for measuring melting temperatures of alloys and pure materials subject to fast heating rates. During these experiments samples of W were heated in steps with an electric current to known temperatures up to the melting point, yielding calibration data up to about 3650 K. The thermodynamic temperature and emissivity of the calibration source were measured to obtain calibration data equivalent to a blackbody. Typical calibrations using W strip lamps or blackbodies are limited to about 3000 K, forcing the sensors to extrapolate to measure particle temperatures for high melting point materials.

Temperature Calibration Facility

Calibration versus a tungsten rod of known absolute temperature and emissivity to 3650 K

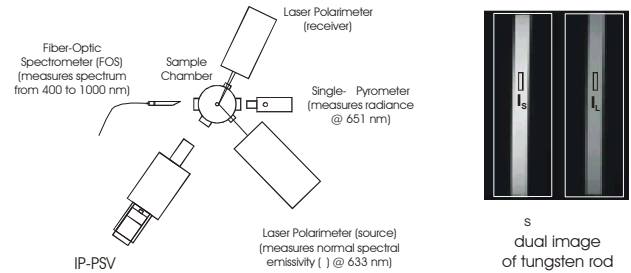

The Emissivity Problem

- **Emissivity:** Ratio of energy emitted by real surface compared to a perfect emitter (blackbody) at same temp

$$= \frac{Q(\lambda, T)_{\text{realsurface}}}{Q(\lambda, T)_{\text{blackbody}}}$$

- The emissivity of real surfaces is usually *wavelength-dependent* $e = e(\lambda)$
- Two-color pyrometry generally assumes that it isn't : *graybody assumption*

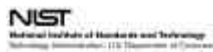

Because the emissivity of Mo decreases over the pyrometers' operating wavelength range, an 80 K bias error results at 2100 K. This error grows with temperature. Correcting for the emissivity variation of the calibration source allows an accurate measure of "gray body" particle temperature. However, this temperature will deviate from the absolute particle temperature if the particle emissivity varies across the wavelength region of interest.

Example of Emissivity Effects: Molybdenum

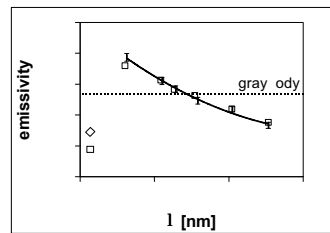

Emissivity variation with wavelength of pure molybdenum

$$i_r(T) = \frac{i_2}{i_1} \times \epsilon(T) \quad (\text{emissivity correction})$$

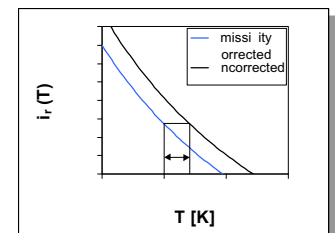

Plume-Based Sensors and Measurements (cont.)

S. P. Mates (NIST)

Improved particle detectability and a better understanding of measurement accuracy are two immediate goals for imaging pyrometry. Several interdisciplinary divisions within NIST are interested in measuring the emissivity of individual particles using Raman spectroscopy. Data from these experiments can be used to improve confidence in particle measurements by two-color pyrometry. Comparisons between simpler ensemble sensing techniques and more complex individual particle sensors can be used to evaluate the possible application of the former to R&D applications.

References

1. T. Sakuta and M. I. Boulos, "Novel Approach for Particle Velocity and Size Measurement Under Plasma Conditions," *Rev. Sci. Instrum.*, Vol 59, No 2, 1988, pp. 285-291.
2. J. R. Fincke, C. L. Jeffery, and S. B. Englert, "In-flight measurement of particle size and temperature," *J. Phys. E: Sci. Instrum.*, Vol 21, 1988, pp. 367-370.
3. M. Prystay, P. Gougeon, and C. Moreau, "Correlation between Particle Temperature and Velocity and the Structure of Plasma Sprayed Zirconia Coatings," pp. 517-523 of *Thermal Spray: Practical Solutions for Engineering Problems*, C.C. Berndt (Ed.), ASM International, Materials Park, OH-USA, 1996.
4. C. Moreau, "Opportunities and Challenges for Advanced Process Control in the Thermal Spray Industry," *this report*, p. 55.
5. J. R. Fincke and R. A. Neiser, "Advanced Diagnostics and Modeling of Spray Processes," *MRS Bulletin*, Vol 25, No. 7, 2000, pp. 26-31.
6. J. R. Fincke, "In-Flight Temperature Measurement in the Thermal Spray Process," *this report*, p. 45.
7. K. Hollis and R. Neiser, "Particle Temperature and Flux Measurement Utilizing a Nonthermal Signal Correction Process," *JTST*, Vol 7, No 3, 1998, pp. 392-402.

Summary

- Imaging Pyrometry as a thermal spray sensor
- Accurate calibration requires known source temperature and emissivity
- Particle emissivity effects can be significant

NIST
National Institute of Standards and Technology
Technology Administration | 100 Bureau of Standards

Current & Future Direction ?

- Further expand and evaluate the capabilities of imaging pyrometry
- Investigate particle emissivity
- Are simpler sensors the answer everyone is looking for?

NIST
National Institute of Standards and Technology
Technology Administration | 100 Bureau of Standards

Optical Sensing of Thermal Spray Substrates and Coatings

J. Geist (Sequoyah Technology, LLC)

Optical Sensing of Thermal Spray Substrates and Coatings

Jon Geist
Sequoyah Technologies, LLC

The goal of this project is to study the feasibility of using optical techniques to characterize different properties of substrates and coatings.

Optical Sensing of Thermal Spray Substrates and Coatings

- location in process
 - pre-deposition
 - real time
 - post-deposition
- type of data
 - defect detection for quality control
 - X-Y scan gives uniformity variations
 - coating property determination
 - data + models gives coating properties

The project is currently looking into the possibility of determining coating thickness by measuring the temperature of the coating optically while heated by variable-frequency, modulated-laser radiation.

Optical Sensing of Thermal Spray Substrates and Coatings

- substrate/coating temperature
 - real-time feasibility demonstrated
- substrate/coating reflectance
 - substrate quality monitor partially demonstrated
- coating defect detection (relative)
 - hardware under development
- coating properties (absolute)
 - theory being developed

Optical Sensing of Thermal Spray Substrates and Coatings (cont.)

J. Geist (Sequoyah Technology, LLC)

The experiment described here is real-time monitoring of the surface temperature of a thermal spray coating with InGaAs photodiodes. This slide shows the side and top views of the experimental set. A lens is mounted at the left end of the lens holder shown in the figure. The tip of a fiber optic is mounted on the other end of the lens holder. The lens focuses the fiber-optic tip onto the rotating cylinder substrate. The other end of the fiber optic is butted against the photodiode. Baffles are used to prevent most of the plasma and spray plume radiation from falling on the portion of the cylinder that is viewed by the photodiode. For these experiments the spray gun moves as shown by the dashed lines, while the lens holder remains in a fixed position.

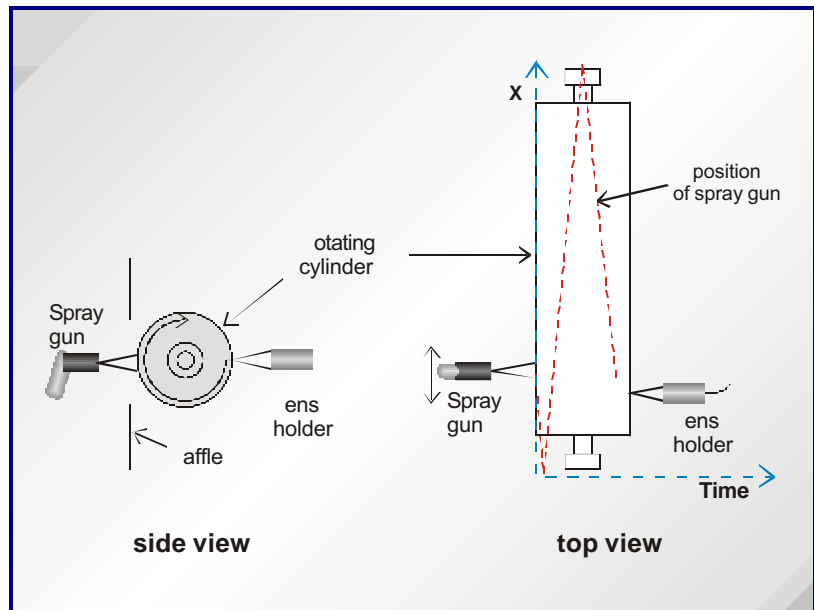

The next slide shows the measured output from the photodiode as a function of time. The temperature corresponding to the photocurrent, which is a very non-linear function of photocurrent, is shown on the right-hand side of the graph. The photocurrent from the InGaAs photodiode used to record this data was calibrated for radiance temperature with a nickel blackbody that was built for this project. The blackbody was heated in a muffle furnace and its temperature was measured with two type-K thermocouples. One of the thermocouples was located near the front and the other near the rear of the blackbody. The calibration was carried out at about 560 K as measured by the thermocouples and extrapolated to other temperatures by integrating the product of the nominal spectral responsivity of the photodiode and the blackbody radiance for the unknown temperature. This procedure was tested by measuring the radiance temperature of the blackbody at 700 K based on the calibration at 560 K.

The lower curve was recorded during a complete traverse of the spray gun down the cylinder from the home position to the end of the cylinder closest to the home position, up the cylinder in the other direction to beyond the end of the cylinder, and back down the cylinder to the starting (home) position. During this traverse the plasma was running but no powder was being fed to the spray gun.

The upper curve was recorded the same way, but with powder being fed to the spray gun. One complete traverse of the cylinder by the spray gun covers the period from about 460 s to 520 s. Starting around 460 s, the gun starts to move toward the near end of the cylinder and the signal starts to rise because a portion of the cylinder near the portion being viewed by the lens is being heated and some of that heat is being conducted toward the viewed portion of the cylinder.

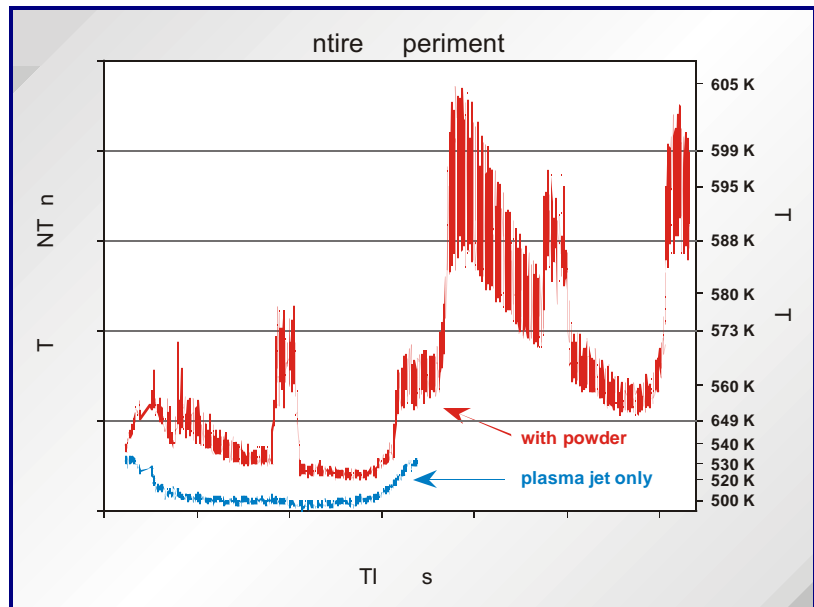

At about 462 s, the gun passes over the viewed portion of the cylinder and heats this portion directly, which causes a sharp increase in the signal. As the gun continues past the viewed portion of the cylinder on its way to the near end of the cylinder and back to the viewed portion of the cylinder, the signal continues to rise slowly until the gun reaches the viewed portion, which causes another sharp increase in signal. As the gun continues its traverse toward the far end of the cylinder, the viewed portion of the cylinder cools slowly until the gun again approaches the home position. The large increase in signal near 490 s is an artifact caused by stray light that entered the lens holder during the time that the gun was spraying into the air after it had passed the far end of the cylinder. Improvements in baffling removed this feature in a later experiment. All of the same features are apparent in the data recorded from about 405 s to 460 s including the stray light artifact at, but the detailed shapes of some of the features are different.

Optical Sensing of Thermal Spray Substrates and Coatings (cont.)

J. Geist (Sequoyah Technology, LLC)

This is a more detailed look at the data from the upper curve in the previous slide acquired between 475 s and 479 s when the photocurrent was relatively high (hot region.) What looks like noise on the data is actually a periodic temperature variation having the same frequency as the rotational frequency of the cylinder. This is due to the stationary sensor that acquires data from one circular region on the cylinder. The sampling rate, which was not quite high enough, has introduced some spurious features in what should be a periodic function of time.

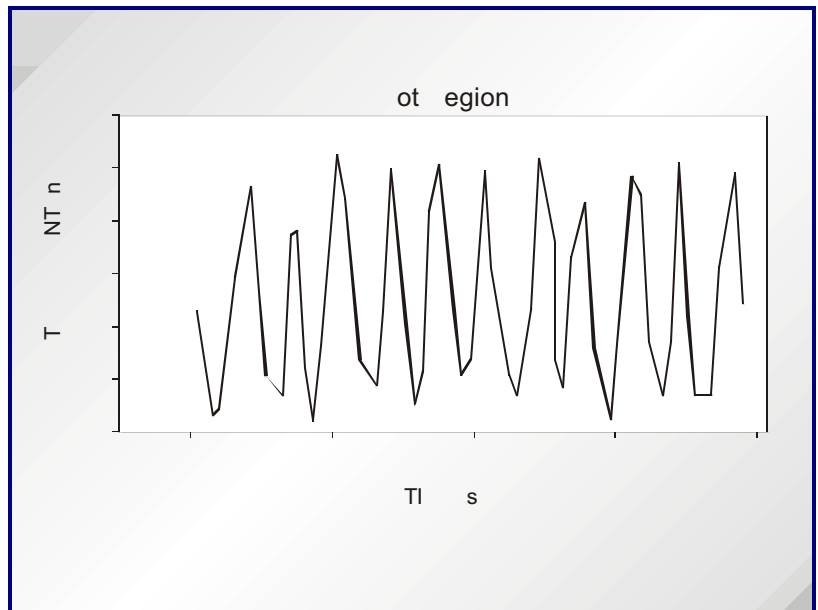

This is a more detailed look at the data from the upper curve in the previous slide acquired between 501 s and 505 s when the photocurrent was relatively low (cool region.)

Both the amplitude of the peak-to-peak variation in the photocurrent and the average value of the photocurrent decreases with time after the gun has passed the lens holder at the end of one traverse and the beginning of the next. It is the decay of these signals that was analyzed and shown in the next slide.

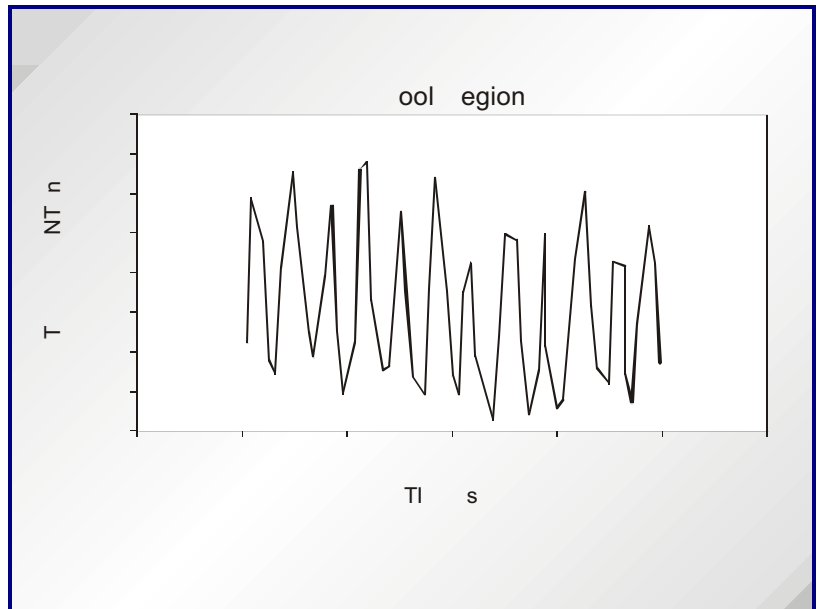

The ratio of the average peak-to-peak variations in photocurrent I and temperature T to the average photocurrent $\langle I \rangle$ and temperature $\langle T \rangle$ respectively, can be used to rule out various possible explanations for the periodic variation in photocurrent. The measured decay in the amplitude of the peak-to-peak variation results in a time constants, τ , of 44.9 s. The decay of the average temperature, $\langle T \rangle$, calculated from the average photocurrent, $\langle I \rangle$, results in a time constants, τ , of 248.1 s.

Analysis of Photocurrent Variations

time	$I/\langle I \rangle$	T	$\langle T \rangle - 300 \text{ K}$
476.9 s	0.456	17.8 K	294.6 K
502.8 s	0.281	10.0 K	265.4 K
		44.9 s	248.1 s

Conclude: Variations not due to emissivity variations: $I/\langle I \rangle$ is not constant
 variation in cylinder wall thickness gives $\tau = 156 \text{ s}$
 spray plume overlap gives $\tau = 0.63 \text{ s}$

Conclude: Variations probably due to quasi-periodic powder feed-rate fluctuations

Optical Sensing of Thermal Spray Substrates and Coatings (cont.)

J. Geist (Sequoyah Technology, LLC)

This slide is an illustration of different sources of periodic photocurrent variations.

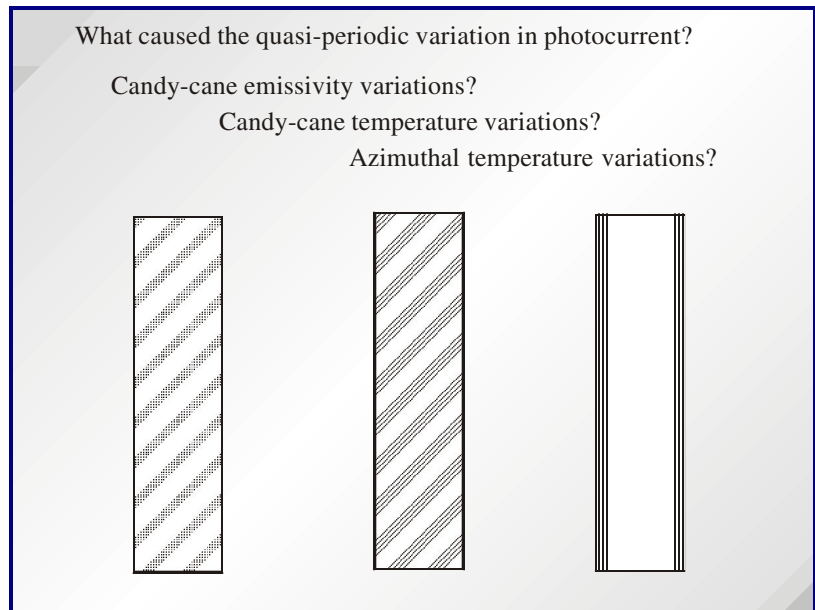

This pattern of temperature variation could be caused by variable wall thickness of the cylinder as shown in this slide, however; the time constant, τ , for this decay is 156 s, which doesn't match either of the measured time constants shown previously.

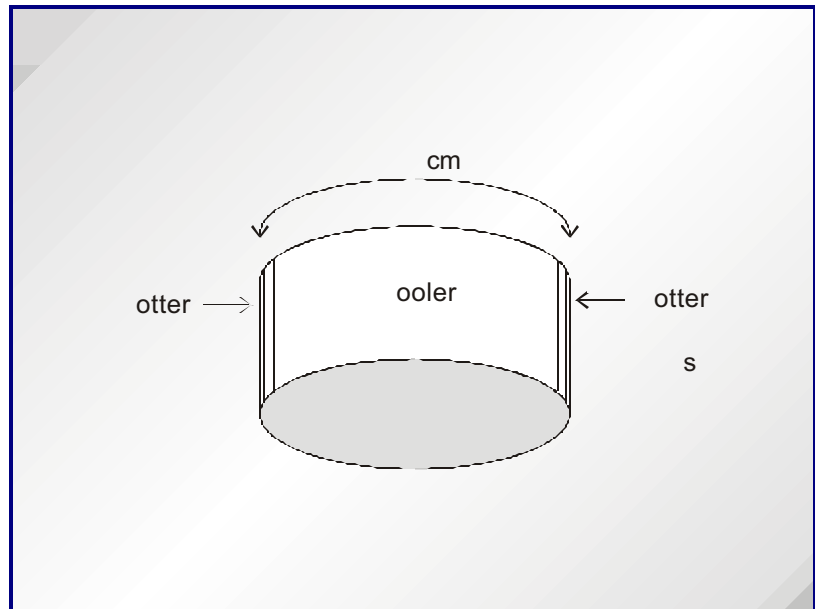

Another pattern of temperature variation could be caused by imperfect overlap of the spray plume on the cylinder as shown here, but the time constant for the decay in this case, 0.63 s is too small to explain the measured data.

The same pattern, but with a larger spacing between two adjacent hotter regions would explain the data, however; a quasi-periodic fluctuation in the powder feed-rate could also produce the required heat flux variations that would result in an appropriate decay in temperature that would match the measured decay in the amplitude of the peak-to-peak variations corresponding to the τ value of 44.9 s.

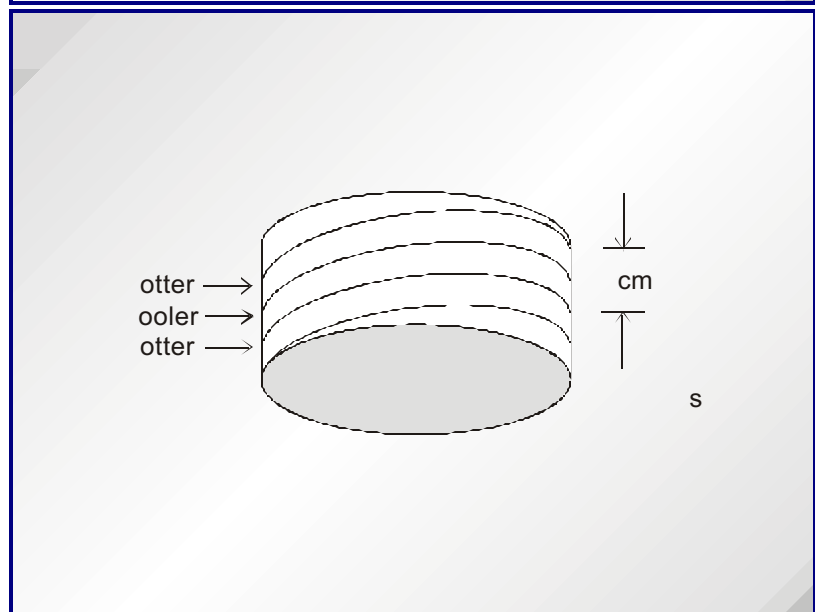

Radiation-Stimulated Sensing of Coating Properties

D. Basak (NIST)

The measurement of bi-directional reflectance requires the directional qualifiers, the angle of incidence and the angle of exitance, to be specified. The quantity of practical interest is the hemispherical bi-directional reflectance, which is the integration of the weighted average of the reflectances measured at all points in the hemisphere above the sample.

Measurement of surface optical properties, such as reflectivity and emissivity helps in characterizing substrate quality, such as roughness.

The photograph shows the bi-directional reflectometer, with three motor-driven goniometers. Two goniometers which rotate about the horizontal axis have the radiation source and the detector attached to them, while a third goniometer rotates about the vertical axis and has the sample resting on it. Coordinated movement of the three goniometers allows for the measurement of bi-directional reflectance for several values of incidence angle, exitant angle, and zenith angle.

Radiation-Stimulated Sensing of Coating Properties

Bi-Directional Reflectometer and Pulsed-Laser Coating Analysis Instrument

Debasis Basak
Metallurgy Division
National Institute of Standards and Technology

NIST
National Institute of Standards and Technology
Technology Administration, U.S. Department of Commerce



Radiation-Stimulated Sensing of Coating Properties

- Reflected Radiation
 - measure bi-directional reflectance
 - calculate surface optical properties
 - directional-hemispherical reflectance
 - directional emissivity
 - surface roughness parameters

Bi-Directional Reflectometer



Radiation-Stimulated Sensing of Coating Properties (cont.)

D. Basak (NIST)

Schematic of the bi-directional reflectometer, showing the incident, exitant and zenith angle with respect to the plane of the sample surface.

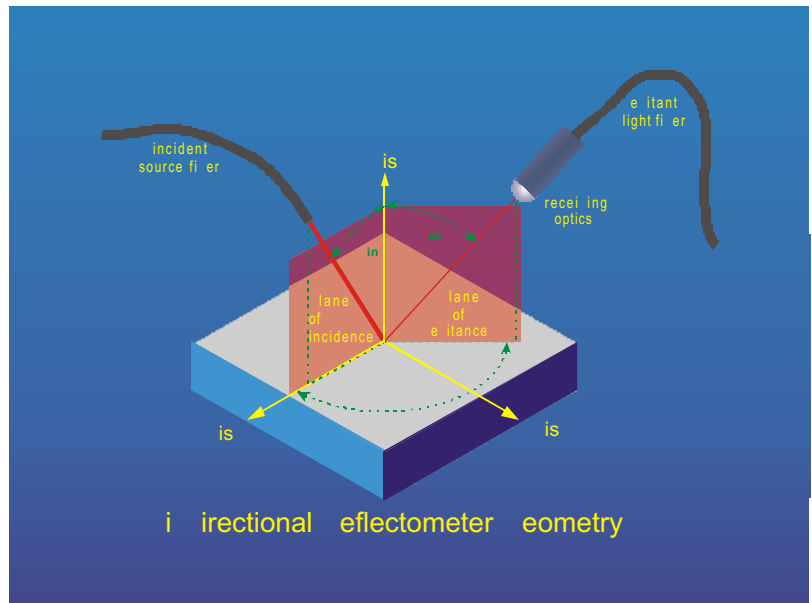

These data on grit blasted specimen show that reflectance can be used to distinguish between under blasted and properly blasted sample. The distinction between over blasted and properly blasted sample is, however, not quite good.

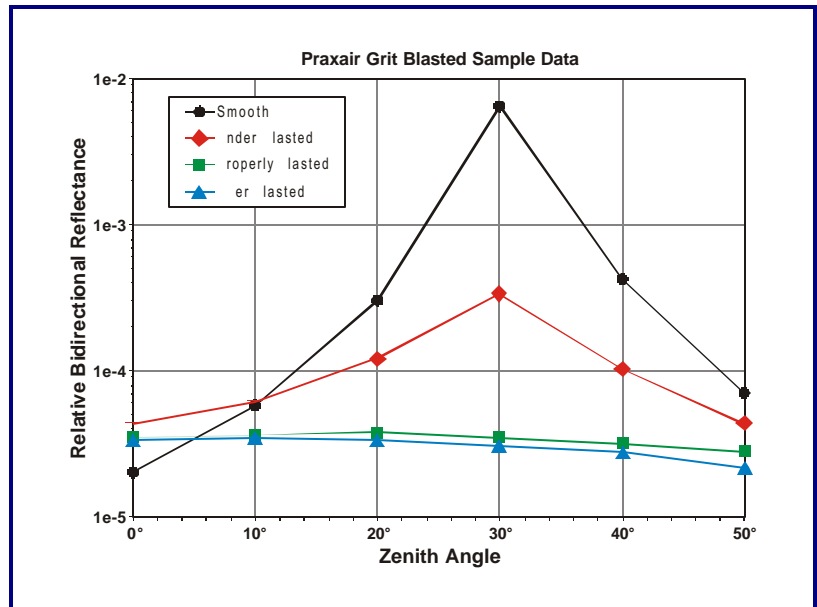

Photograph of the important components of the Pulsed Laser Coating Analysis Instrument.

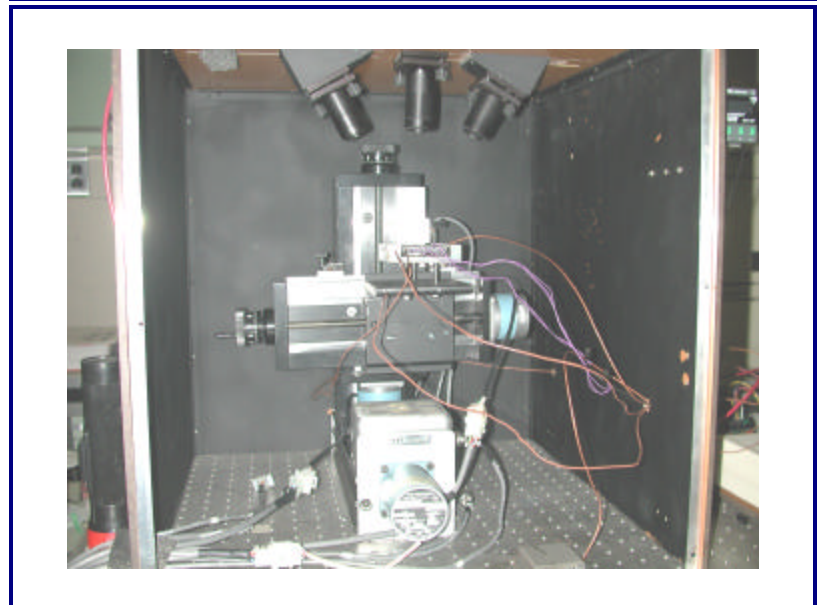

Radiation-Stimulated Sensing of Coating Properties (cont.)

D. Basak (NIST)

The scanning system consists of three linear motion-control devices, whose computer-controlled coordinated movement scans the surface of the sample while looking for differences in the emitted signal. Such differences can be correlated to non-ideal conditions existing on the surface of the sample.

The optical system essentially consists of a laser beam focussed on the sample and two optical channels one for the collection of the emitted radiation and the other for the collection of the total radiation.

MAIN COMPONENTS

- **Optical System :**
 - Diode Laser : 980 nm, 150 mW
 - TTL Compatible Modulator
 - Long pass 980 nm blocking filter
 - Lenses for the laser and two detectors
 - InGaAs detector: amplified, switchable -gain
- **Scanning System:**
 - Three stepper-motor driven sliding devices : movement in x, y, or z direction
 - Motion control hardware / Computer / GUI
- **Heating System:**
 - Embedded tube heaters
 - Temperature Controller
 - Thermocouple
- **Data Acquisition System:**
 - Data Acquisition Hardware Box
 - Computer / Graphical Interface designed in LabView programming language

SCANNING SYSTEM

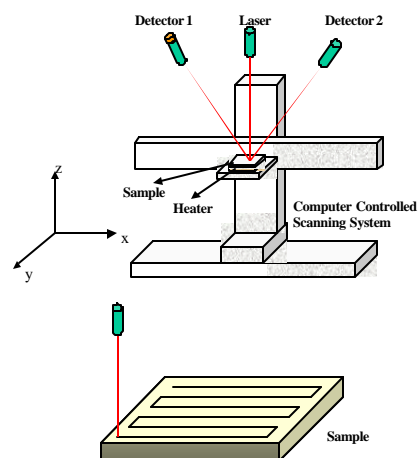

OPTICAL SYSTEM

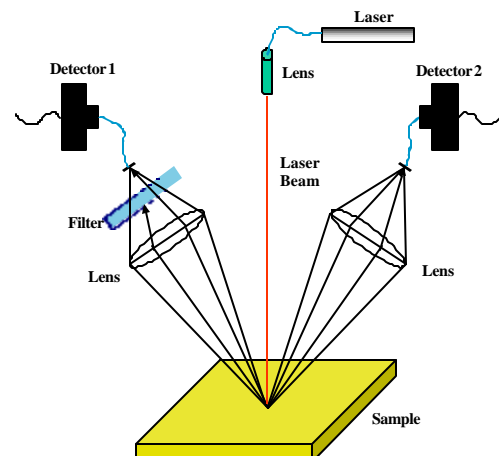

Radiation-Stimulated Sensing of Coating Properties (cont.)

D. Basak (NIST)

Qualitative analysis can be used to detect and identify the position of defects, such as voids and porosity while quantitative analysis is used to determine physical quantities, such as thermal conductivity and thickness.

A range of properties can be determined by the use of appropriate models. Some of the quantities of interest are listed, of which the one of immediate interest is thickness.

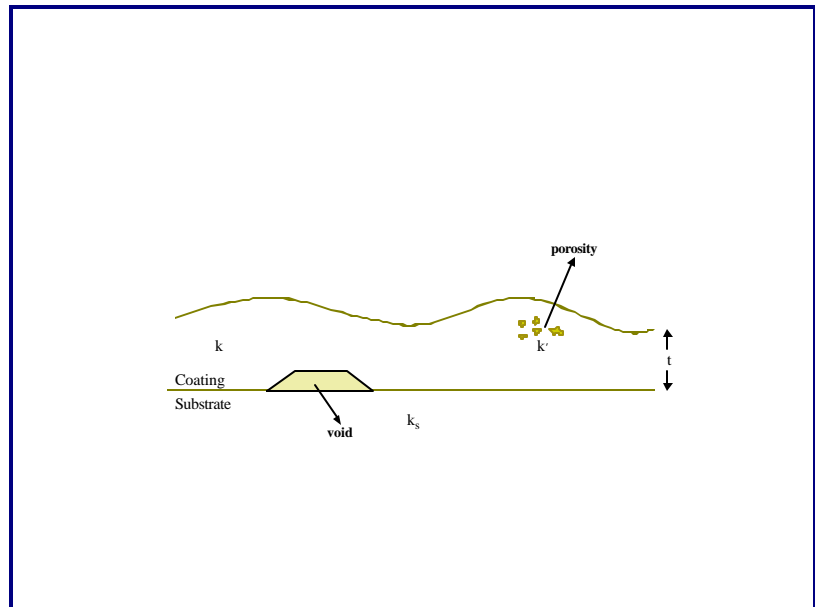
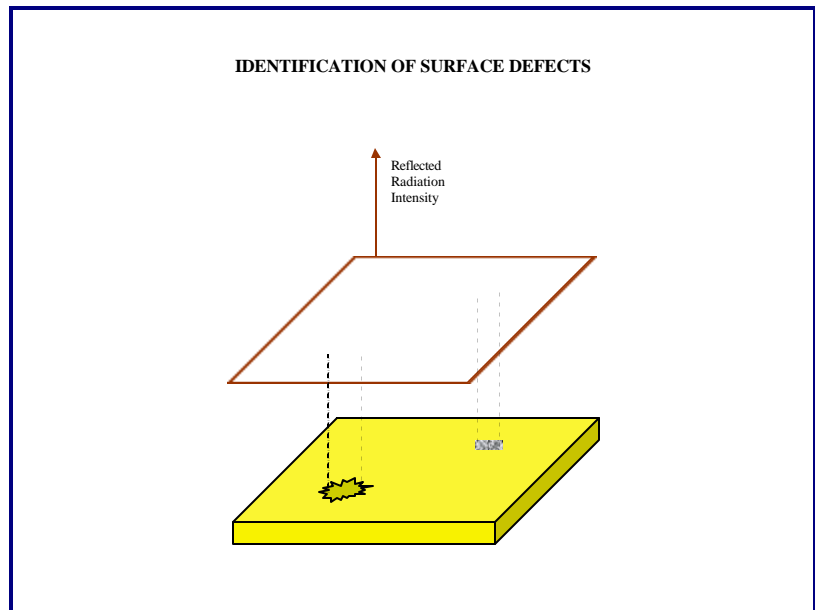

Radiation-Stimulated Sensing of Coating Properties

- **Emitted Radiation**
 - measure excess emitted radiation due to surface heating by incident (pulsed) radiation
 - calculate coating properties
 - thickness
 - density
 - heat capacity
 - thermal conductivity
 - bond adhesion

Radiation-Stimulated Sensing of Coating Properties (cont.)

D. Basak (NIST)

Radiation-Stimulated Sensing of Coating Properties

results of X-Y scan of coating to detect non-uniformity of properties

qualitative

detect non-ideal conditions, e.g., de-bonding, porosity

calculation with models provide properties data

quantitative

thermal conductivity, specific heat, density

Substrate Analysis: Surface Texture

M. R. Stoudt (NIST)

This talk was designed to provide an overview of the surface roughness measurement to stimulate a discussion about substrate surface preparation and how the adhesion of thermal spray coatings can be improved.

The literature contains about 50 different parameters to describe surface roughness and the most common of these are the height-based descriptors. Parameters of this type require the establishment of a mean, or regression, line. The roughness is then described in terms of the relative distribution about the mean line. Some of the more familiar height-based parameters are shown.

The arithmetic average roughness (R_a) is one of the more frequently used roughness parameters; as it is a fairly simple measurement. However, the averaging parameters have imbedded factors that need to be considered.

Substrate Surface Roughness Issues In Thermal Spray Coating Adhesion

Mark R. Stoudt
Materials Performance Group

NIST
National Institute of
Standards and Technology



Common Height-based Surface Roughness Descriptors

Schematic Surface Roughness Profile

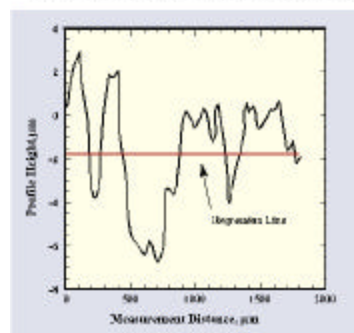

- R_a (arithmetic mean roughness)
- R_q (rms mean roughness)
- R_m (mean depth)
- R_z (avg peak-to-valley height)
- R_{max} (max peak-to-valley height)

A Closer Look At R_a

Pro's:

- Provides a reasonable assessment of the general roughening behavior.
- Represents the change in surface morphology relative to the regression line.
- Is symmetrical; can be used in statistical analyses

Con's:

- Does not provide information about how the material has been redistributed during roughening.
- Contains significant limitations as a result of the averaging technique.

Substrate Analysis: Surface Texture (cont.)

M. R. Stoudt (NIST)

The schematic diagram illustrates how an averaging roughness parameter can produce the same result for two distinctly different surface morphologies. It also demonstrates how Ra does not provide information about the distribution of the peaks on the surface.

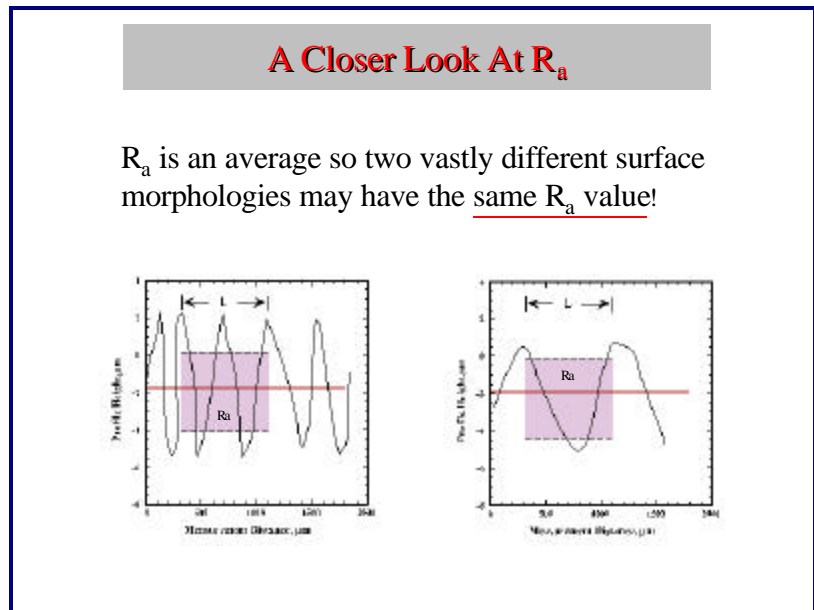

This is an actual case where the Ra value is the same for two different surface morphologies. The micrographs shown are from experiments performed on 5052 aluminum. The figure on the left is a fine-grained specimen pulled in tension to nominally 10 % plastic strain. The figure on the right is also 5052 aluminum, but it has a much larger grain size and it was pulled to nominally 4 % plastic strain. Factoring in the range of measurement errors, the two figures have the same Ra.

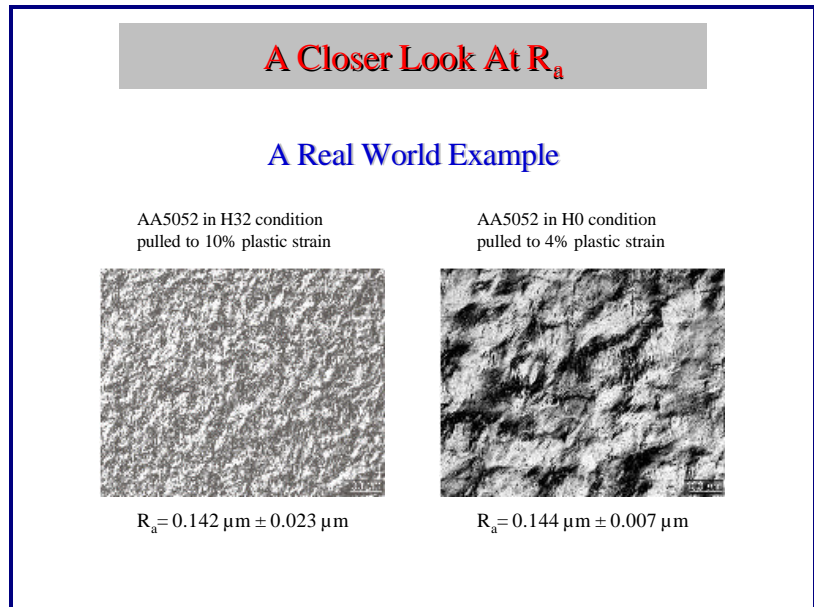

No single parameter is sufficient to fully characterize a surface. However, there are several approaches to achieve a complete measure of the surface roughness:

One approach is to simply combine different parameters. Most systems are computer controlled and the different parameter types provide flexibility in how the data can be interpreted.

A second approach is to map the surface topography. Several techniques are available for this purpose and a 3D representation of the surface is generally more easy to interpret.

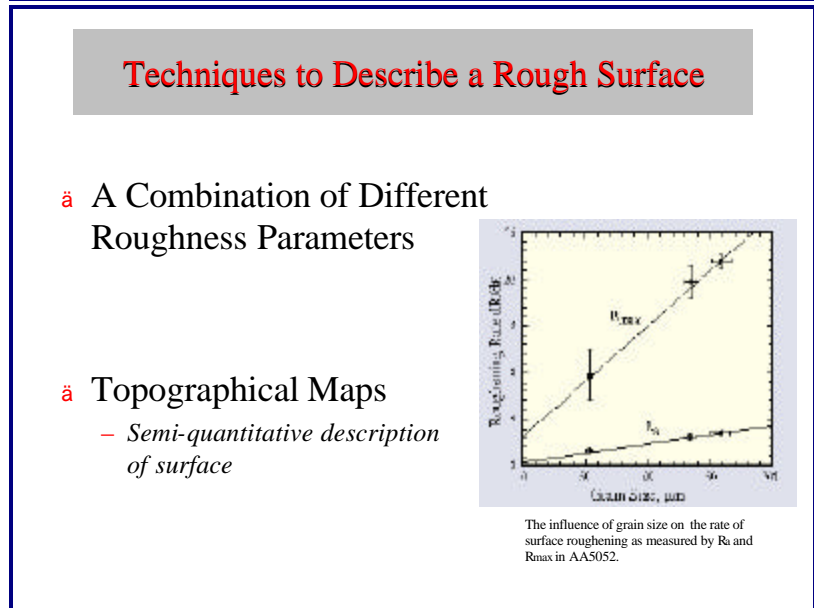

Substrate Analysis: Surface Texture (cont.)

M. R. Stoudt (NIST)

A better approach is to apply statistics to the roughness data. The periodic nature of the sampling in a roughness measurement permits the application of a time series analyses to the data. An analysis of this type reveals details about the distribution of the roughness features on the surface. Thus, an analysis containing both a height-based parameter and a spatial distribution will produce a complete characterization of the surface roughness.

Grit blasting is a common practice for surface preparation prior to the application of a TS coating. While this technique produces a fairly good film adhesion, the literature indicates the range of an acceptable surface to be quite small. The results from our study on grit blasted carbon steel substrates reveal that it is relatively easy to distinguish between an under-blasted and a proper condition. However, distinguishing between a proper and an over-blasted condition is considerably more difficult and the two produce substantially different adhesion properties. A more detailed characterization of the surface roughness is necessary to elucidate what constitutes a proper condition.

Some of the key questions as viewed from a substrate surface roughness perspective are listed here. The answers to these questions should help resolve the surface preparation issue as well as increase our understanding of how the different aspects of the roughness influence the adhesion.

Techniques to Describe a Rough Surface

à **Treat the Surface as a Random Process**

Roughness profiles usually contain both random and periodic components, and directional characteristics.

Roughness profiles are completely characterized when the height distribution and spatial correlation functions are known.

- *Gaussian statistics*
- *Cumulative Probability Density function*
- *Spectral Power Density function*
- *Autocovariance and autocorrelation functions*

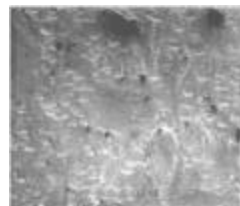
Key Surface Roughness Issues Facing Adhesion of Thermal Spray Coatings

Blank (unblasted)

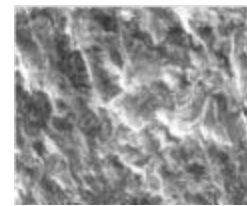

Properly -Blasted

Grit-blasted mild carbon steel substrates

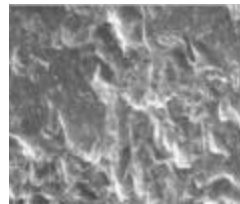

Under-Blasted

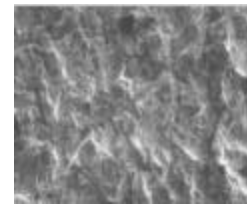

Over-Blasted

SEM photos courtesy of R. Jiggetts

Key Surface Roughness Issues Facing Adhesion of Thermal Spray Coatings

- à How do we quantify a "properly prepared" surface condition?
- à What are the determining surface roughness factors and what is the acceptable the operational range?
- *Valley depth, angle, density, and distribution*
- à How do the "proper" surface conditions vary with changes in the metallurgical conditions of the substrate?
- à What is an appropriate test method to quantify adhesion?

Substrate Analysis: Grit Blasting

R. D. Jiggetts (NIST)

Many discussions have stemmed from one simple question. "How do you determine a properly prepared substrate?"

Substrate Analysis: Grit Blasting

The National Institute of Standards & Technology
MSEL
Metallurgy Division
Materials Processing Group

Rodney D. Jiggetts

F. Biancaniello
S. Ridder
S. Mates
M. Stoudt
R. Schaefer
P. Boyer

NIST
National Institute of Standards and Technology
Technology Administration, U.S. Department of Commerce



Substrate Analysis:
Grit Blasting

GRIT BLASTING

One of the commonly used processes in Substrate Preparation

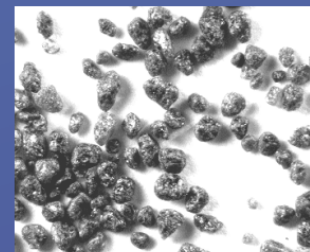
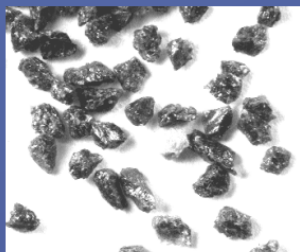

How do you determine what is a **"PROPERLY"** Grit Blasted Surface?

- 1) By the **"Maximum"** roughness measurement?
- 2) By the **"Maximum"** number of peaks per length measured?
- 3) By an Adhesion Test?

NIST
National Institute of Standards and Technology
Technology Administration, U.S. Department of Commerce



Substrate Analysis:
Grit Blasting

Outline

- NIST's Grit Blasting Facility
- Grit Impact on Surface
- Substrate Surface Analysis Results:
 - 1) Profilometry
 - 2) Metallography
 - 3) Image Analysis
- Summary
- Future Work/Goals

NIST
National Institute of Standards and Technology
Technology Administration, U.S. Department of Commerce



Substrate Analysis: Grit Blasting (cont.)

R. D. Jiggetts (NIST)

To determine if grit blasting removed, or moved the surface of a substrate, a mild steel substrate was coated (electro-deposited) with Ni then the coating was polished down to 25 μm. The substrate was then grit blasted under normal conditions. Metallography shows that the surface "is" removed and moved.

Substrate Analysis:
Grit Blasting

Grit Blasting Facility



- Suction/Vacuum
- Recirculating
- 793 kPa (adjustable) Line

Robotics

Consistency/Repeatability

Software - LabVIEW®

- Speeds
- Positionings



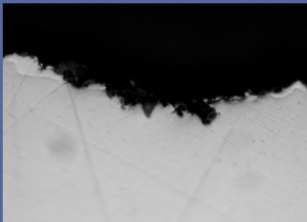

Substrate Analysis:
Grit Blasting

Grit Impact on Surface

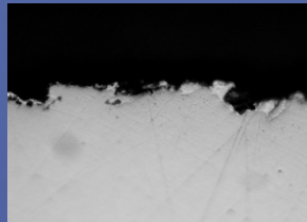

Ni Coating
(electro-deposited)



SEM
(Grit Blasted Surface)

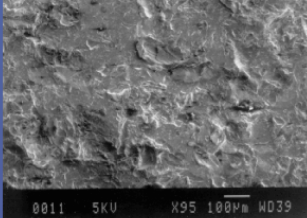

0011 5KV X95 100μm WD39

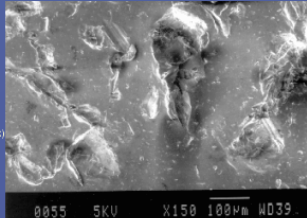

0055 5KV X150 100μm WD39





Substrate Analysis:
Grit Blasting

Profilometry Results

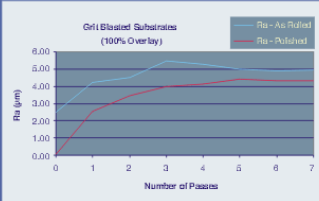

Grit Blasted Substrates
(100% Overlay)

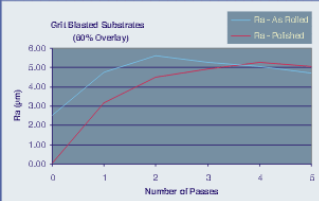

Grit Blasted Substrates
(90% Overlay)

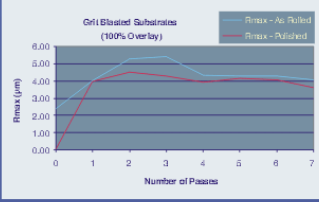

Grit Blasted Substrates
(100% Overlay)

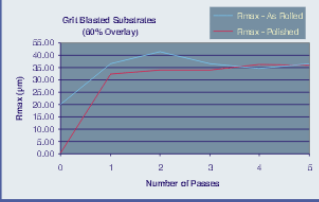

Grit Blasted Substrates
(90% Overlay)





Substrate Analysis: Grit Blasting (cont.)

R. D. Jiggetts (NIST)

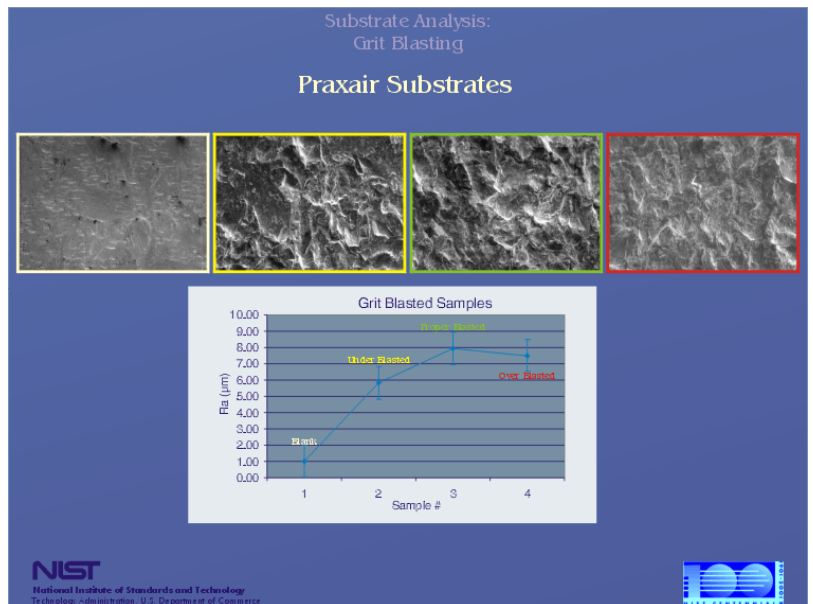
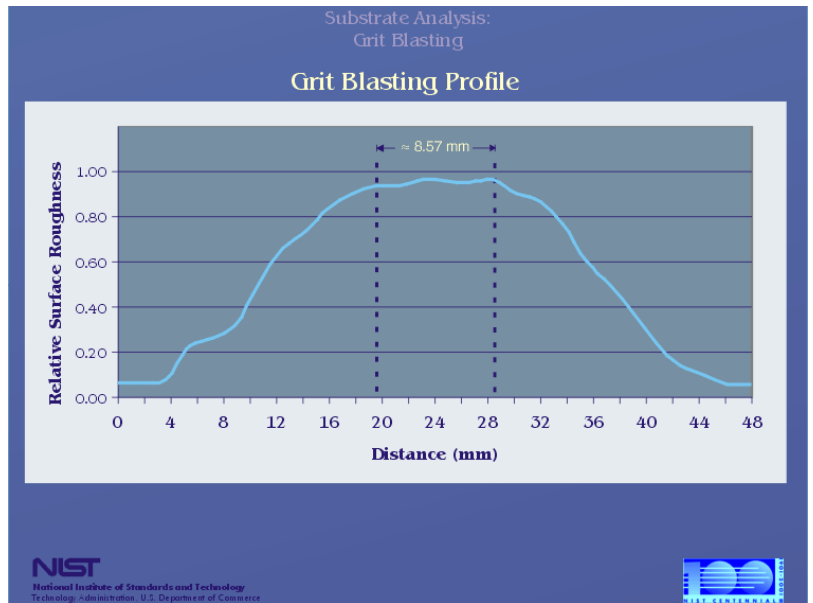

A metallographic evaluation of the three conditions (Under/Properly/Over blasted) reveals that the under blasted surface has less, and smoother surface peaks than the properly blasted surface has. In the over blasted surface condition the peaks are folded over, and in some instances broken off due to excessive grit blasting.

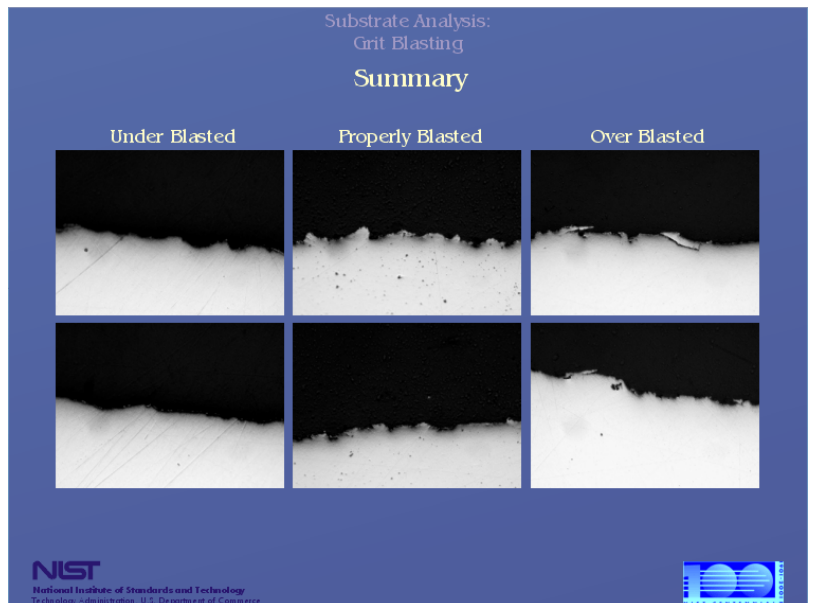

Substrate Analysis: Grit Blasting (cont.)

R. D. Jiggetts (NIST)

Substrate Analysis:
Grit Blasting

Future Work/Goals

- Correlate Data with the Reflectometry Work in progress
- Correlate Data with Adhesion Test
- Correlate Substrate Roughness with Coating Roughness

NIST
National Institute of Standards and Technology
Technology Administration, U.S. Department of Commerce



In-Flight Temperature Measurement in the Thermal Spray Process

J. R. Fincke (INEEL)

General References:

J. R. Fincke, D. C. Haggard, and W. D. Swank, "Particle Temperature Measurements in the Thermal Spray Process," *JTSC*, 2001, vol. 10, no. 2, pp. 255-266.

J. R. Fincke and R. A. Neiser, "Advanced Diagnostics and Modeling of Spray Processes," *MRS Bulletin*, 2000, vol. 25, pp. 26-31.

J. R. Fincke, et al, "Diagnostics and Control in the Thermal Spray Process," to be published in *Surface and Coatings Technology*.

In-Flight Temperature Measurement in the Thermal Spray Process

Jim Fincke

Idaho National Engineering and Environmental Laboratory

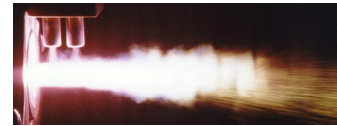
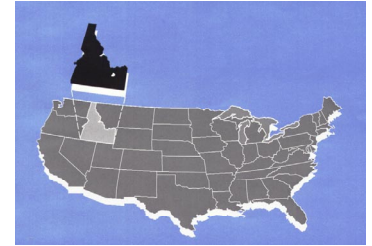

T-meas ppt

Plasma Spray Fabrication Process

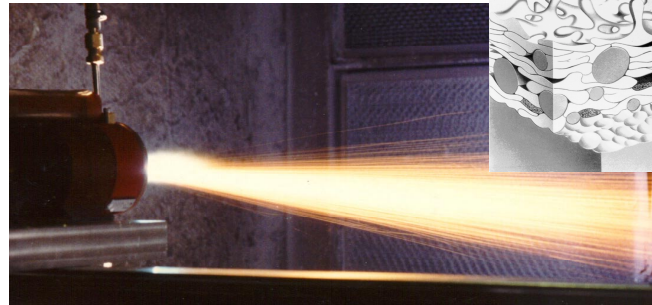

T-meas ppt

OUTLINE

- Methods Covered
 - Ensemble Average
 - Single Particle
- Issues and Limitations
- Control
- Summary

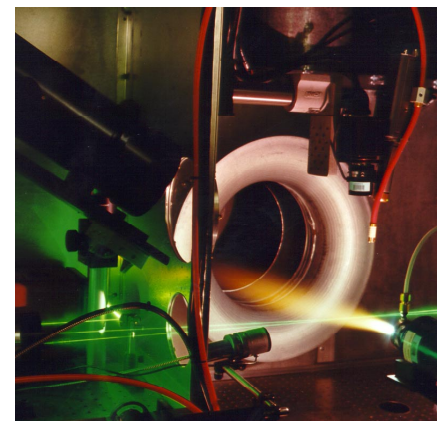

T-meas ppt

In-Flight Temperature Measurement in the Thermal Spray Process (cont.)

J. R. Fincke (INEEL)

Ensemble techniques observe many particles simultaneously. The particle ensemble is characterized by distributions of particle size and temperature. In addition, the particle temperature may be correlated with size.

ENSEMBLE TEMPERATURE MEASUREMENT



T-meas ppt

BIVARIATE GAUSSIAN REPRESENTATION OF PARTICLE SIZE AND TEMPERATURE DISTRIBUTION

ASSUME THAT THE PARTICLE SIZE DISTRIBUTION IS APPROXIMATELY NORMAL

$$f_d(d_p) = \frac{1}{\sigma_d \sqrt{2\pi}} \exp\left[-\frac{(d_p - d_m)^2}{2\sigma_d^2}\right]$$

AND THAT FOR A GIVEN PARTICLE SIZE THAT THE TEMPERATURE DISTRIBUTION IS ALSO NORMAL. UNDER THESE ASSUMPTIONS THE PDF FOR THE PARTICLE ENSEMBLE IS GIVEN BY A BIVARIATE GAUSSIAN

$$f(d_p, T) = \left(\frac{1}{\sigma_d \sqrt{2\pi}} \exp\left[-\frac{(d_p - d_m)^2}{2\sigma_d^2}\right] \right) \left(\frac{1}{\sigma_T \sqrt{1-\rho^2} \sqrt{2\pi}} \exp\left[-\frac{(T-b)^2}{2\sigma_T^2(1-\rho^2)}\right] \right)$$

WHERE

$$b = \mu_T + \rho \frac{\sigma_T}{\sigma_d} (d_p - d_m)$$

THAT IS, THE CONDITIONAL PDF OF T IS NORMAL WITH MEAN **b** AND VARIANCE $\sigma_T^2(1-\rho^2)$

BIVARIATE GAUSSIAN REPRESENTATION OF PARTICLE SIZE AND TEMPERATURE DISTRIBUTION

FOR $\rho = 0$ THE DISTRIBUTIONS OF TEMPERATURE AND DIAMETER ARE INDEPENDENT AND UNCORRELATED, FOR $\rho \neq 0$ THE MEAN PARTICLE A A FUNCTION OF DIAMETER IS GIVEN BY

$$T_m(d_p) = \mu_T + b(d_p - d_m)$$

WHERE $b = \rho \frac{\sigma_d}{\sigma_T}$

IF ρ IS NEGATIVE THE SIZE AND TEMPERATURE ARE INVERSELY CORRELATED. THE INTENSITY CONTRIBUTION DUE TO AN INDIVIDUAL PARTICLE IS GIVEN BY

$$I(\lambda) = \frac{c_1 \epsilon_\lambda \Delta \lambda \Omega \pi \frac{d_p^2}{4}}{\lambda^5 \left(e^{\frac{c_2}{\lambda T}} - 1 \right)}$$

In-Flight Temperature Measurement in the Thermal Spray Process (cont.)

J. R. Fincke (INEEL)

BIVARIATE GAUSSIAN REPRESENTATION OF PARTICLE SIZE AND TEMPERATURE DISTRIBUTION

INTEGRATING OVER ALL SIZES AND TEMPERATURES YIELDS THE EXPECTED VALUE OF THE OBSERVED INTENSITY RATIO

$$R_m = \frac{\bar{I}_{\lambda_1}}{\bar{I}_{\lambda_2}} = \frac{\int_{d_{\min}}^{d_{\max}} \int_{T_{\min}}^{T_{\max}} I(\lambda_1, d_p, T) f(d_p, T) dT dd_p}{\int_{d_{\min}}^{d_{\max}} \int_{T_{\min}}^{T_{\max}} I(\lambda_2, d_p, T) f(d_p, T) dT dd_p}$$

AND FINALLY THE TEMPERATURE IS SOLVED FOR

$$T = \frac{c_2 \left(\frac{1}{\lambda_2} - \frac{1}{\lambda_1} \right)}{\ln \left(R_m \frac{\epsilon_{\lambda_2}}{\epsilon_{\lambda_1}} \left(\frac{\lambda_1}{\lambda_2} \right)^5 \right)}$$



T-meas.ppt

ESTIMATED ERROR IN MEASURED ENSEMBLE AVERAGE TEMPERATURE

EFFECT OF PARTICLE TEMPERATURE DISTRIBUTION, $d_p = \text{constant}$ and $\rho = 0.0$

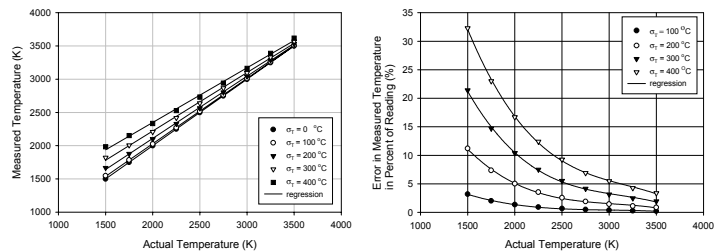

T-meas.ppt

ESTIMATED ERROR IN MEASURED ENSEMBLE AVERAGE TEMPERATURE

EFFECT OF PARTICLE TEMPERATURE DISTRIBUTION, PARTICLE TEMPERATURE IS CORRELATED WITH PARTICLE SIZE
 $\sigma_T = 300 \text{ K}$, $d_{p \text{ mean}} = 40 \mu\text{m}$, $\sigma_p = 15 \mu\text{m}$

$\Delta T = \text{temperature difference between largest (105 } \mu\text{m) and smallest (5 } \mu\text{m) particles}$

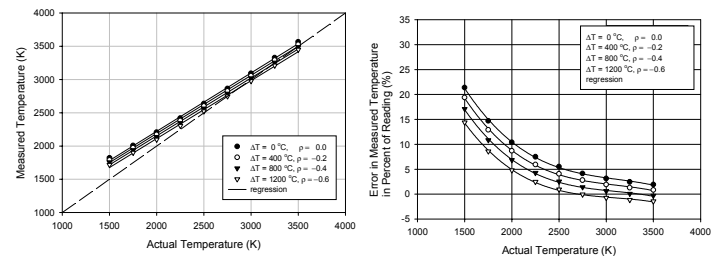

T-meas.ppt

In-Flight Temperature Measurement in the Thermal Spray Process (cont.)

J. R. Fincke (INEEL)

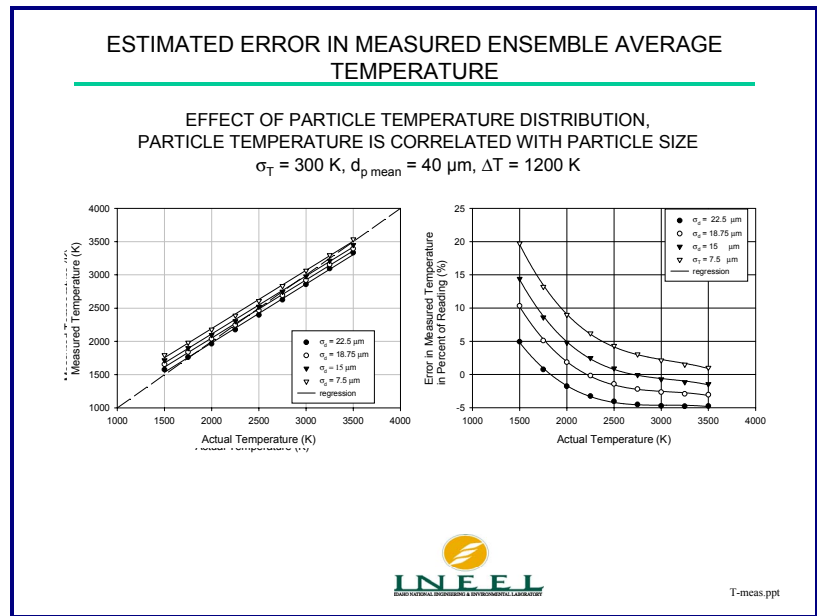

Single particle techniques observe one particle at a time. A phase Doppler laser velocimeter has been integrated with a high-speed two-color pyrometer to simultaneously measure particle size, velocity, and temperature at the INEEL.

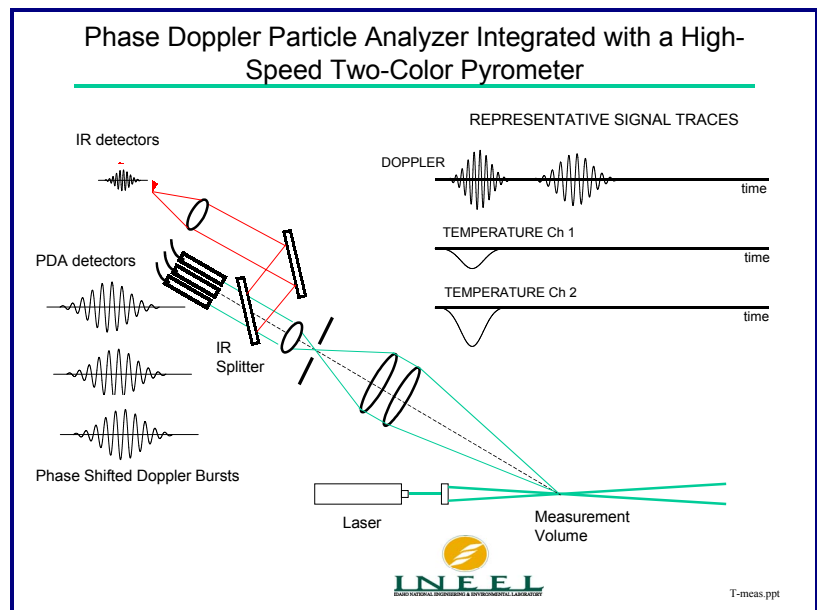
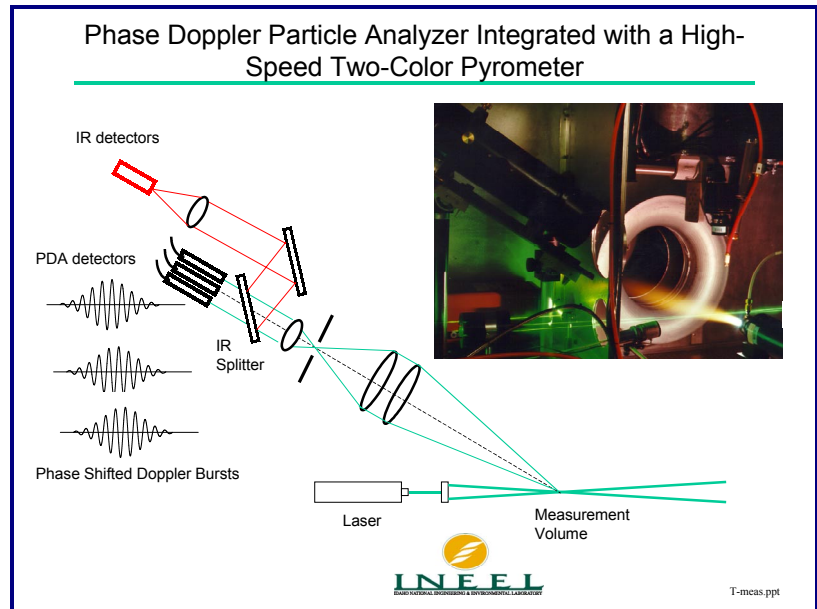

In-Flight Temperature Measurement in the Thermal Spray Process (cont.)

J. R. Fincke (INEEL)

Temperature measurement uncertainty is due to interference from scattered background light, vaporization, and from uncertainty in emissivity.

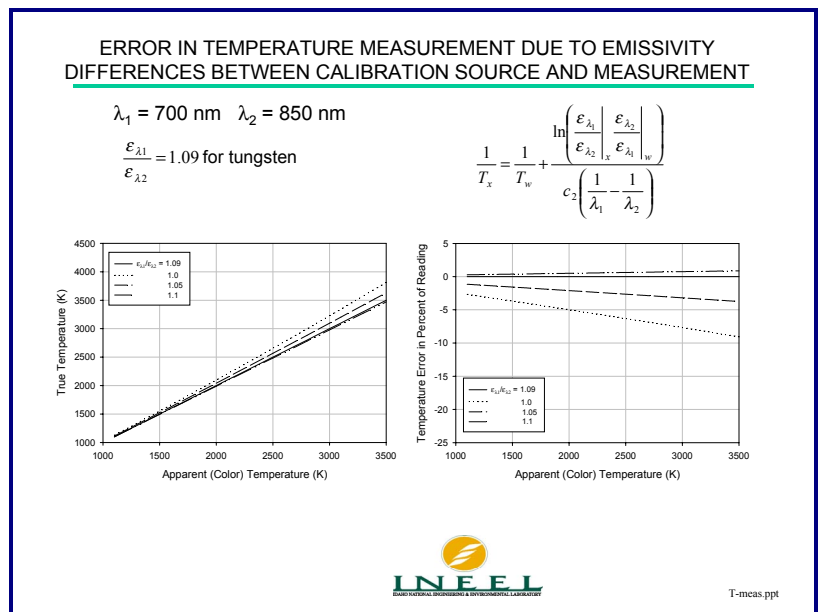
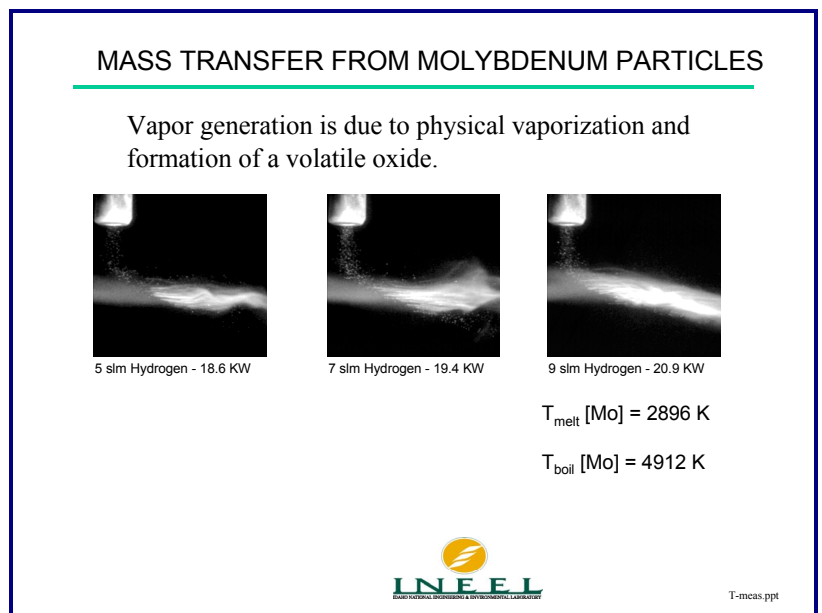
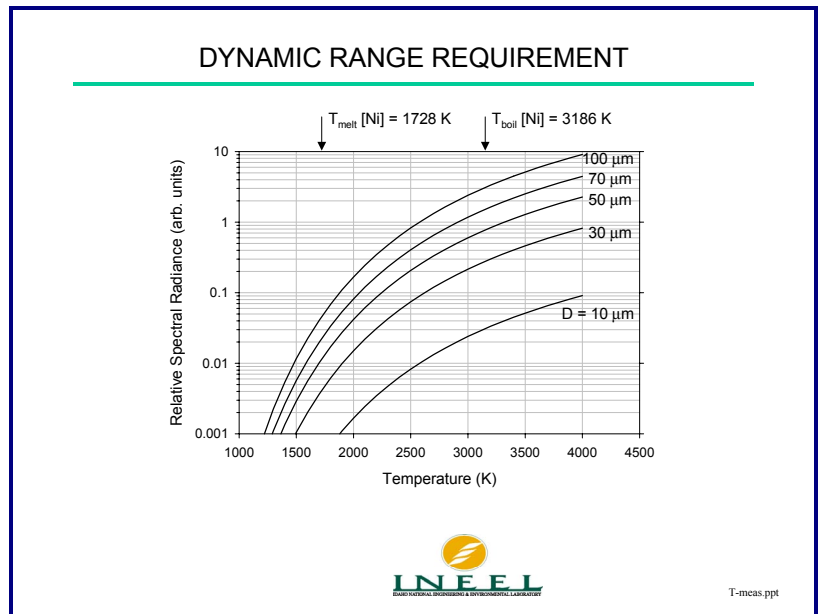

In-Flight Temperature Measurement in the Thermal Spray Process (cont.)

J. R. Fincke (INEEL)

Other sources of uncertainty are measurement system noise and the internal temperature distribution in transparent particles.

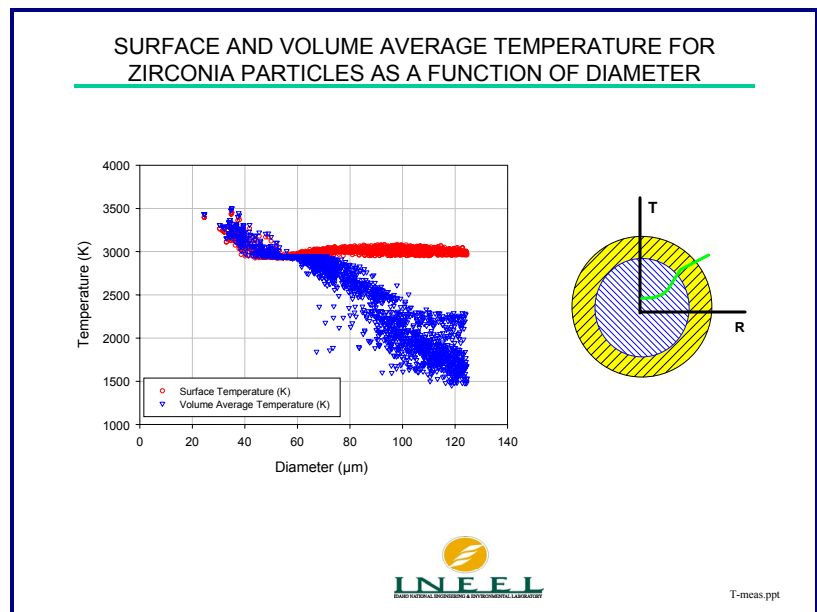
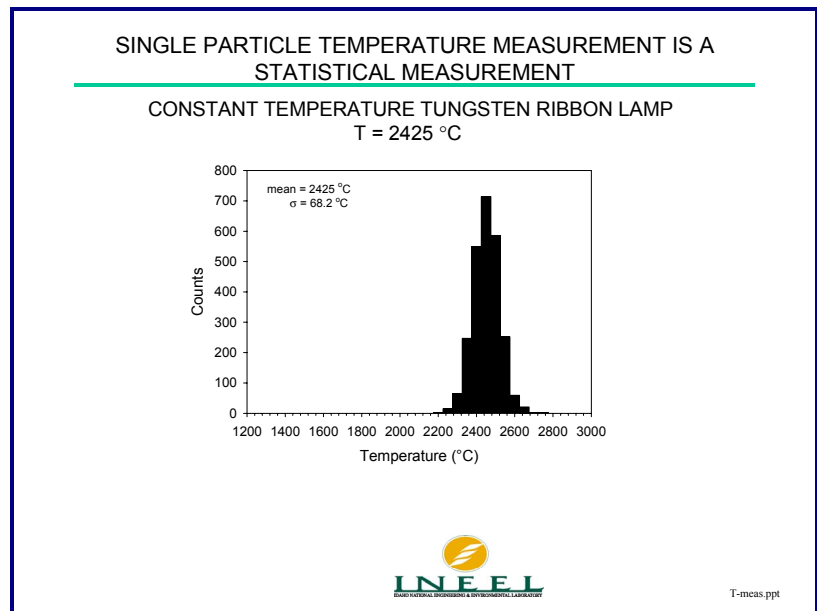
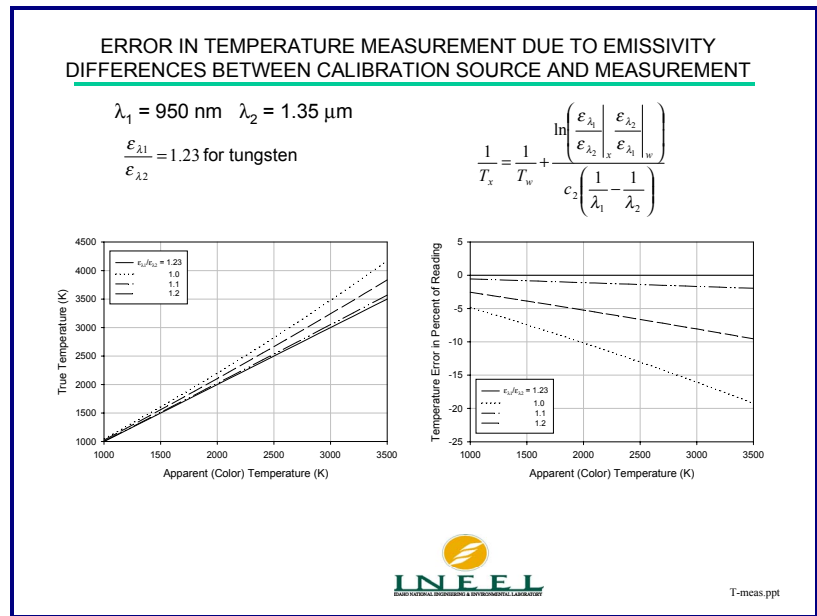

In-Flight Temperature Measurement in the Thermal Spray Process (cont.)



J. R. Fincke (INEEL)

Control systems that utilize particle diagnostics have been developed and demonstrated.

Typical diagnostics screen showing measured distributions of particle velocity, temperature, and size and the correlations between velocity and diameter, velocity and temperature, and temperature and size.

Instrument Development and Closed Loop Control

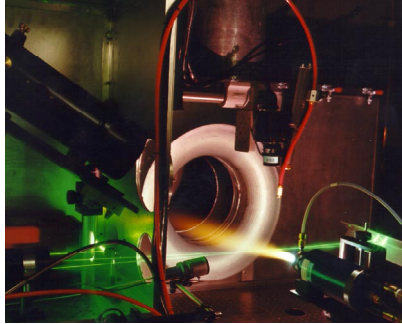
- Laboratory diagnostic is a modified state-of-the-art laser Doppler velocimeter system integrated with a high-speed two color pyrometer system
- Production floor diagnostics for ensemble particle temperature and spray pattern.
- Developed a new, stand-alone instrument for measurement of particle velocity and temperature and incorporated the capability for active feedback process control.

T-meas ppt

On-Line Diagnostic and Control Capability

Laser Based Laboratory Particle Diagnostics



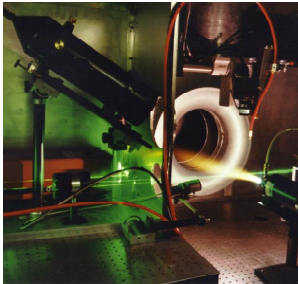
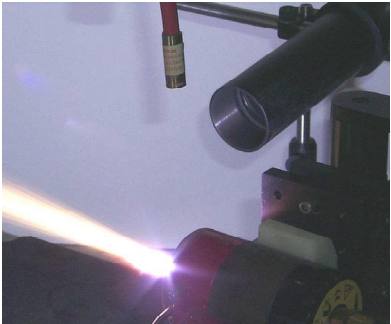

Passive Diagnostics with active control capability

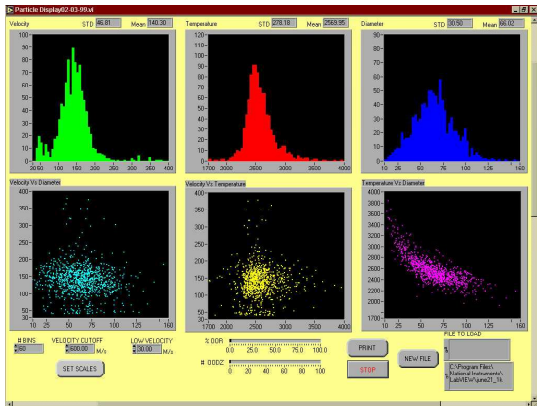
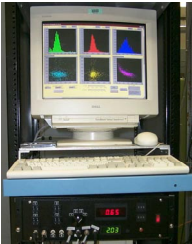

T-meas ppt

On-Line Diagnostic and Control Capability





T-meas ppt

In-Flight Temperature Measurement in the Thermal Spray Process (cont.)

J. R. Fincke (INEEL)

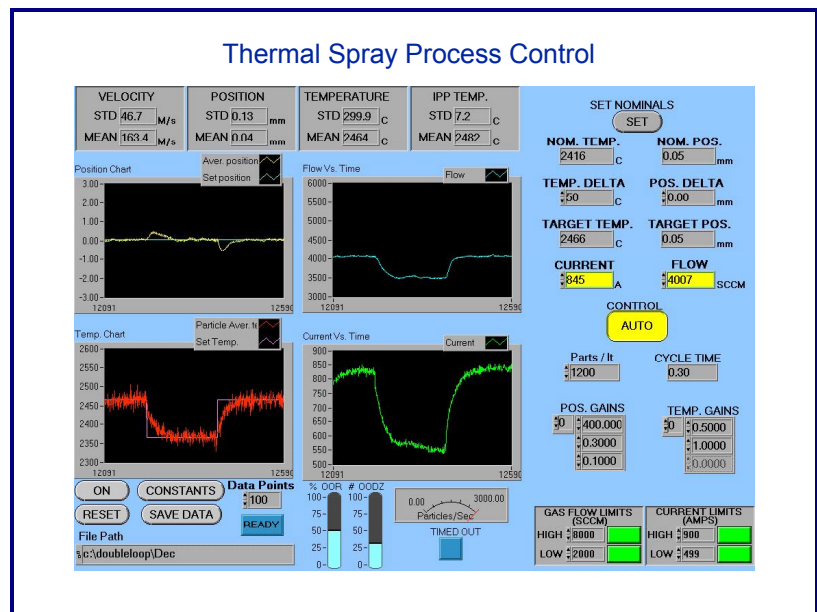
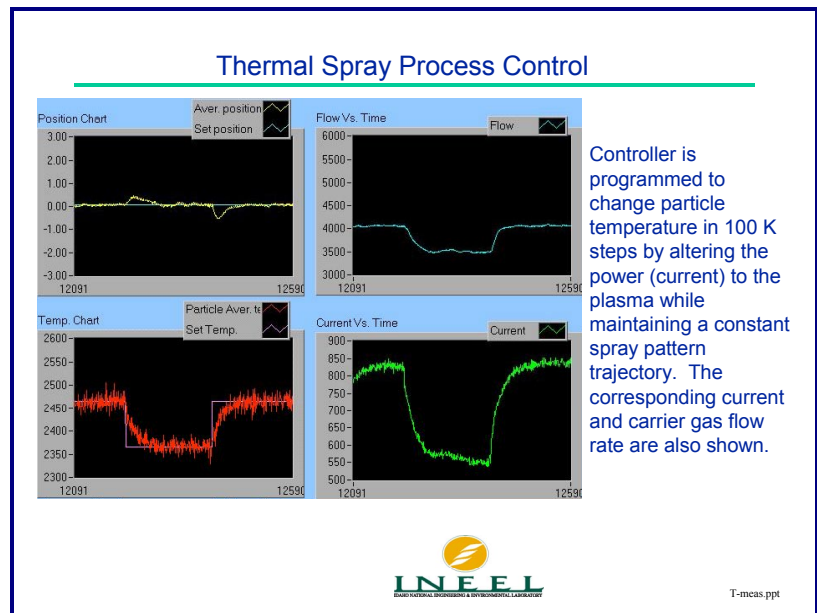
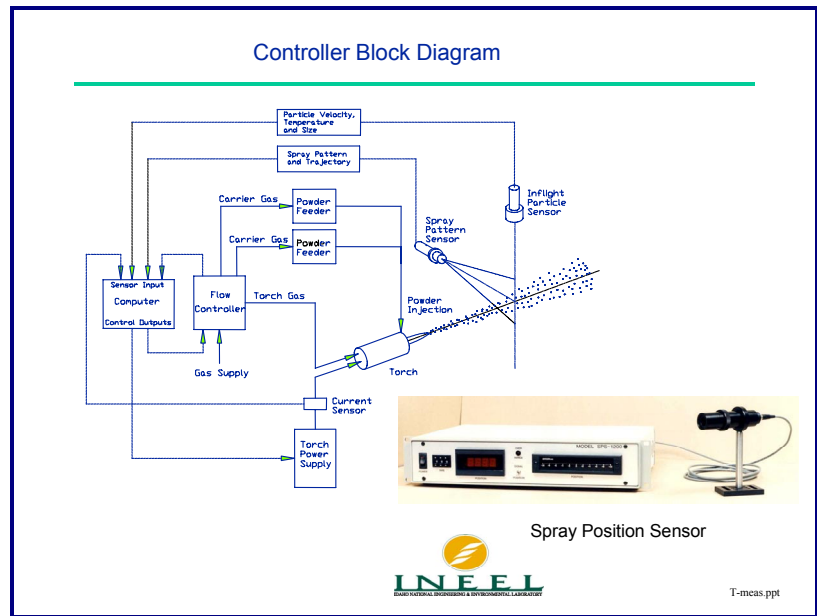
Controllers are capable of setting and maintaining particle temperature, velocity, and spray pattern trajectory.



In-Flight Temperature Measurement in the Thermal Spray Process (cont.)

J. R. Fincke (INEEL)

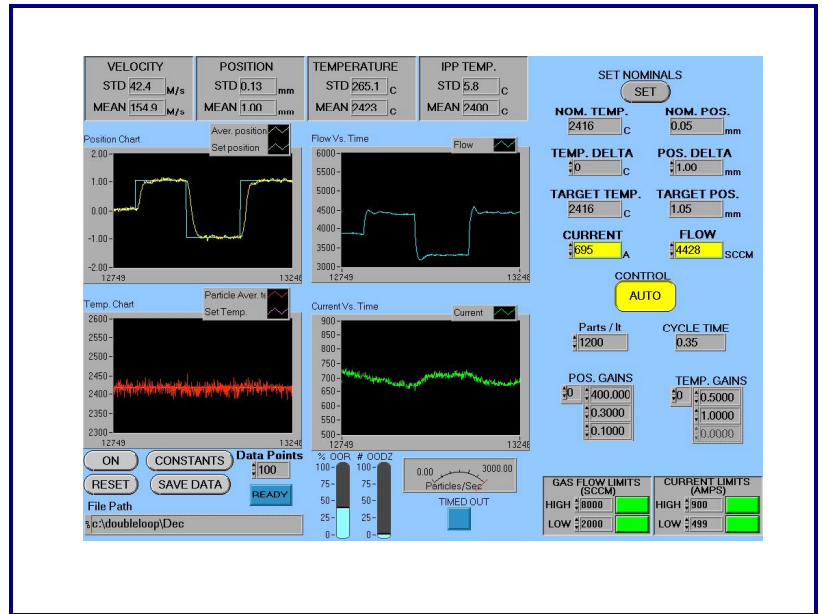

*Opportunities and Challenges for
Advanced Process Control in the Thermal
Spray Industry*

C. Moreau (NRC-CNRC)



**Opportunities and Challenges for
Advanced Process Control in the
Thermal Spray Industry**

**Christian Moreau and Jean-François Bisson
Materials and Processes Section**

Thermal Spray Process Reliability: Sensors and Diagnostics Workshop
January 8 and 9, 2001
NIST, Gaithersburg, MD



Introduction

- A closer control of the spray conditions is necessary to:
 - increase the reproducibility of the coating characteristics on the production line
 - reduce testing during production
 - reduce time for coating optimization
 - both very time consuming
 - increase electrode lifetime (possibly)
- Various sensors are currently available on the market



**Commercial Sensors for Monitoring
Particle Characteristics**

- Individual particle monitoring
 - DPV-2000
 - temperature, velocity and diameter
 - Therma Viz and Spraywatch cameras
 - temperature and velocity
- Global particle jet monitoring
 - IPP-2000
 - temperature
 - Accuraspray
 - temperature and velocity

*Opportunities and Challenges for
Advanced Process Control in the Thermal
Spray Industry* (cont.)

C. Moreau (NRC-CNRC)



What's Next?

- Determine the best way to monitor and control key spray parameters on the production floor
 - simplicity, robustness, efficiency and reliability
- Develop control systems and implement them in production
 - it is not a single-step process!



In this Presentation

Examples of recent developments and challenges in implementing particle sensors in the industry.

- monitoring spray particles in production
- controller for plasma spraying
- fluctuation of the particle characteristics



Monitoring Particle Parameters in Production at Pratt & Whitney Canada

- Production: mostly plasma sprayed TBC's
 - Bondcoat: NiCoCrAlY
 - Topcoat: YSZ (20 % yttria)
- The objective is to reduce the frequency of qualification tests by monitoring key particle parameters

Topcoat is YSZ (20 % mass fraction yttria)

Opportunities and Challenges for Advanced Process Control in the Thermal Spray Industry (cont.)

C. Moreau (NRC-CNRC)



Implementation of the New Approach in Production at PWC

- Three stages:
 - measure with the DPV-2000 the variation of the particle parameters with gun age
 - establish the effect of these variations on the coating quality
 - determine the limits of the particle parameters within which the coating quality is always acceptable (green windows)



Monitoring Particle Parameters before Spraying

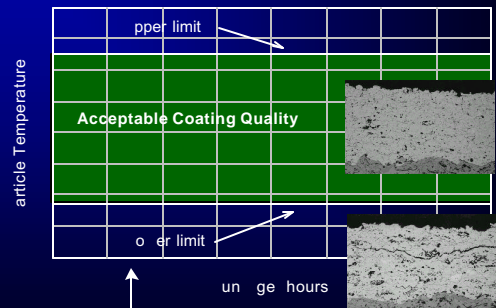

Comparison of the Two Quality Control Approaches

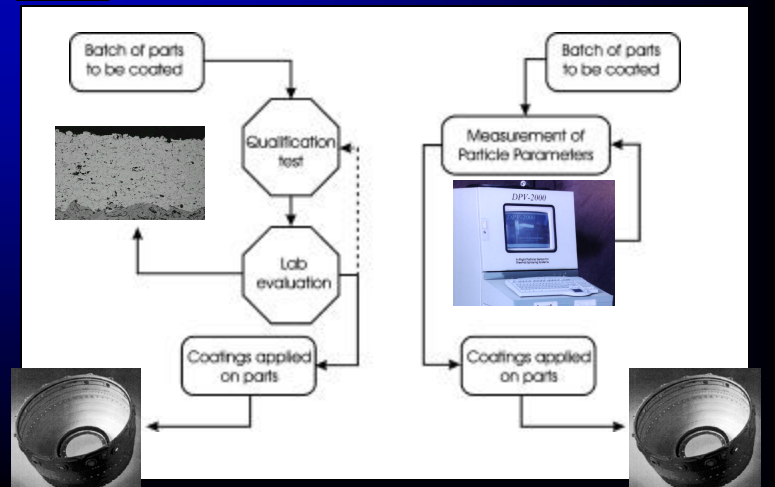

*Opportunities and Challenges for
Advanced Process Control in the Thermal
Spray Industry (cont.)*

C. Moreau (NRC-CNRC)



Controller for Plasma Spraying

- The role of a controller is to stabilize the particle parameters in order to produce coatings having consistent properties
- Different approaches possible:
 - PID
 - model-based controller:
 - open-loop (manual closed-loop)
 - closed-loop



Model - Based Controller Developed at NRC in the Surftec Program

- Development of a controller that will suggest to the operator corrections to be made in order to stabilize the temperature and velocity of the sprayed particles
 - adapted for use with all existing spray equipment
 - give the operator the possibility to accept or reject the proposed changes (gain confidence with time)
 - can easily be integrated with a modern computer-based console (closed-loop)



Instabilities of the Process

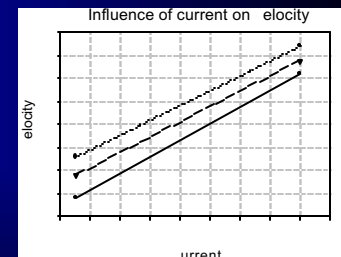
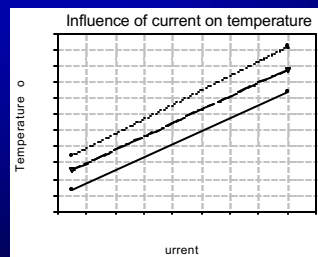

- Accurate prediction of the settings that will provide a specific particle state is not possible
- Better precision on the effect of an input spray parameter change on particle condition

Opportunities and Challenges for Advanced Process Control in the Thermal Spray Industry (cont.)

C. Moreau (NRC-CNRC)



Linear Model Around the Nominal Operation Point

- For a control strategy based on the manipulation of two variables (current, primary gas), the resulting equations for the temperature and the velocity are as follows :

$$T = (m_1 \cdot C) + (m_2 \cdot P)$$

$$V = (m_3 \cdot C) + (m_4 \cdot P)$$

C = Current T = Temperature
 P = Primary Gas V = Velocity
 m_x = Slope



Linear Model Around the Nominal Operation Point

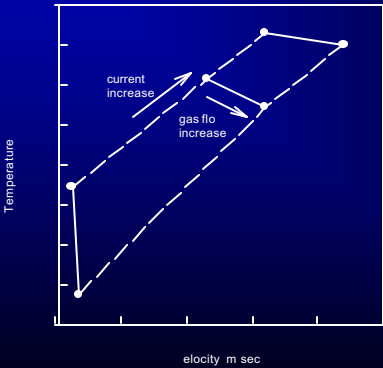

Temperature

Velocity m/sec

current increase

gas flow increase

ria sta ili ed ironia



Open - Loop Control

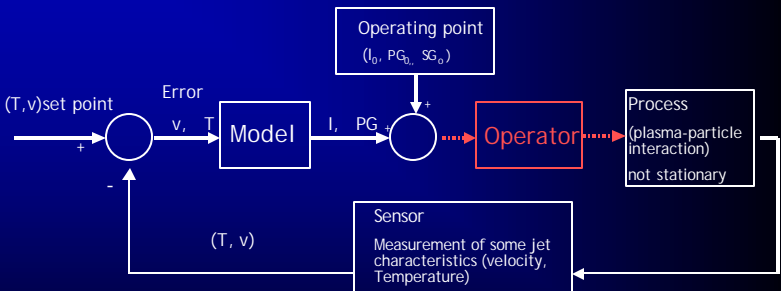

(T,v) set point

Error

Model

Operator

Process (plasma-particle interaction) not stationary

Sensor Measurement of some jet characteristics (velocity, Temperature)

Operating point (I_0, PG_0, SG_0)

Opportunities and Challenges for Advanced Process Control in the Thermal Spray Industry (cont.)

C. Moreau (NRC-CNRC)



Effect of Input Spray Conditions on Particle Parameters

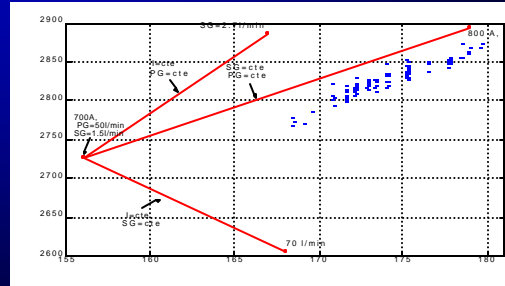

The evolution of the particle velocity and temperature with the gun age is often coupled as indicated in the graph. In this case, the current appears the premier tool for regulating the process.

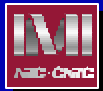

Controlled Process

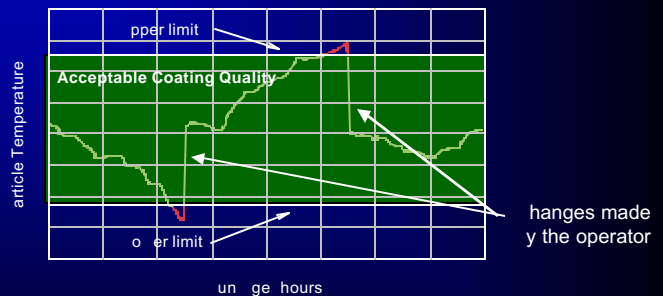

The width of the green windows is adjusted to assure the coating quality and to limit the number of changes to be carried out by the operator.



Closed - Loop Control

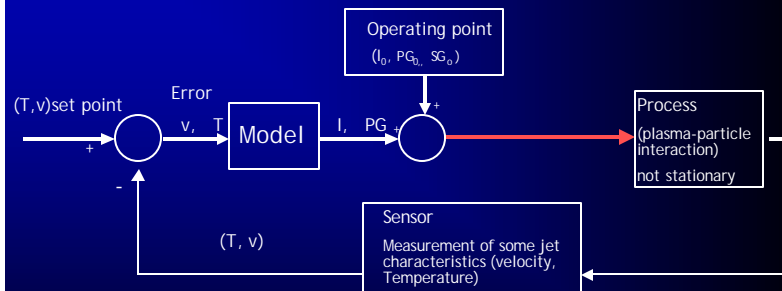

Direct link with modern PC-based consoles

Opportunities and Challenges for Advanced Process Control in the Thermal Spray Industry (cont.)

C. Moreau (NRC-CNRC)



Plasma Fluctuations

Related to the movement of the arc root on the anode surface leading to large voltage fluctuations

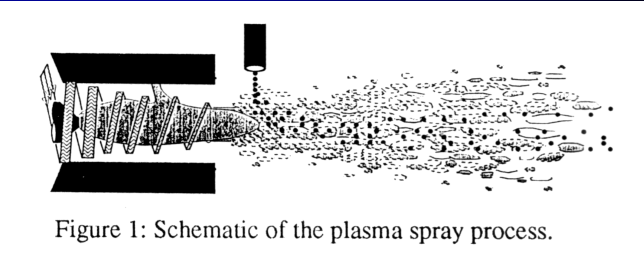

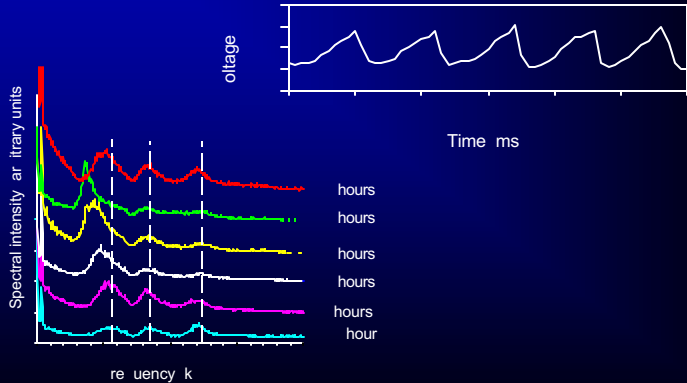

Figure 1: Schematic of the plasma spray process.

after uang *et al* roc ITS o e p



Voltage Signature Evolution



Spectral intensity or arbitrary units

frequency k

voltage

Time ms

hours
hours
hours
hours
hours
hour



Influence of the Plasma Fluctuations on Particle Parameters

- Time-resolved particle diagnostics with the DPV-2000
 - comparator generates a pulse when the voltage exceeds a threshold
 - pulse can be delayed to trig the DPV at specific time delay after the threshold is crossed.
 - particle parameters are evaluated as a function of the time offset.

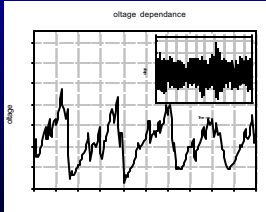

voltage dependence

voltage

*Opportunities and Challenges for
Advanced Process Control in the Thermal
Spray Industry (cont.)*

C. Moreau (NRC-CNRC)



Influence of the Plasma Fluctuations on Particle Parameters

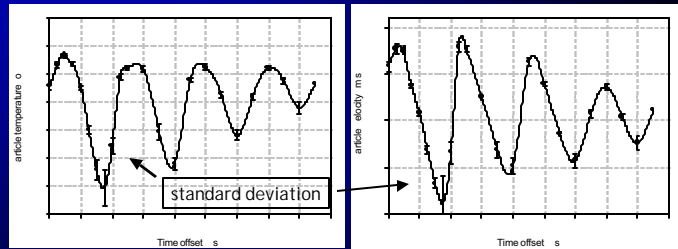

- Alumina particles: 25-35 microns
- Sensor position: 50 mm downstream
- Mean values and standard deviations (not time-resolved):
 - $T = 2763 \pm 173$ C
 - $V = 360 \pm 66$ m/s



Important Fluctuation of the Particle Flow Rate

- Very few particles at specific time delays
- Particle not detected are likely at very low temperature (below 1600 C) and do not contribute to the coating formation
- Duty cycle of about 50% low deposition efficiency

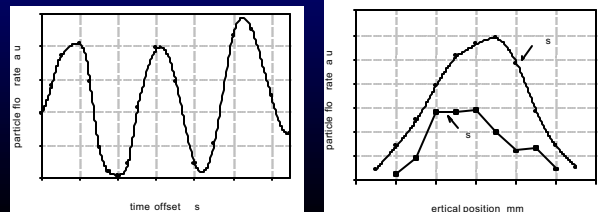

Conclusion - Opportunities

- Commercial sensors are available to monitor key spray parameters
- Possibility to use these sensors for monitoring and controlling more closely thermal spray processes on the production line
 - better reproducibility
 - lower spray cost by reducing impact of time-consuming steps (quality control and coating optimization)
- Opening and/or consolidating new or existing markets (aerospace, land-based turbines, automotive, etc)

*Opportunities and Challenges for
Advanced Process Control in the Thermal
Spray Industry (cont.)*

C. Moreau (NRC-CNRC)



Conclusion - Challenges

- Developing new controllers that will be easy to use, reliable and well adapted to the production floor
- Gain confidence of the sprayers and users in this new technology
 - this step is already on its way but must continue on a larger basis



Conclusion - Challenges

- Developing a better understanding of the influence of key parameters on the structure and properties of the deposited coatings
 - plasma fluctuations
 - temperature of the substrate and top coating surface during spraying
 - surface preparation
 - etc.
- Developing the corresponding sensing and control technology according to the actual needs of the industry.

NIST Ceramic Coatings Program

S. J. Dapkunas (NIST)

NIST Ceramic Coatings Program

S. J. Dapkunas
Ceramics Division
January 8, 2001



Ceramics/MSEL

Objective

- Provide the measurement methods and models required to improve the reliability of ceramic coatings

Ceramics/MSEL

Focus

- Thermal Spray Deposition
- Thermal Barrier Coatings

Ceramics/MSEL

NIST Ceramic Coatings Program (cont.)

S. J. Dapkunas (NIST)

Approach**Capitalize on:**

- Industry and academia's processing capability
- NIST's measurement, characterization and modeling capability

Ceramics/MSEL

Reliability

Reliability = Reproducible Processing + Property and Performance Prediction

Ceramics/MSEL

Reproducible Processing

- Development of Standard Reference Materials for particle size distribution of PSZ and WC/Co
- Chemical analysis of feedstock and deposits
- Relate microstructure to processing parameters

Ceramics/MSEL

NIST Ceramic Coatings Program (cont.)

S. J. Dapkunas (NIST)

Property and Performance Prediction

- Characterization of microstructure by SANS/USAXS
- Residual stress measurements
- Thermal conductivity measurements
- Elastic modulus measurements by instrumented indentation and neutron diffraction
- Neutron diffraction analysis of time/temperature effects on phase stability of PSZ
- Thermal conductivity prediction using OOF
- Lifetime prediction using fracture mechanics

Ceramics/MSEL

NIST Object Oriented Finite Element (OOF) Project

Public domain software to simulate and elucidate macroscopic properties of complex materials microstructures

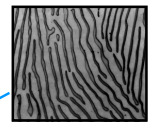
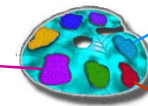
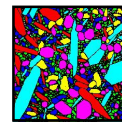

1999 Technologies
of the Year Award

<http://www.ctcms.nist.gov/oof>

Ceramics/MSEL

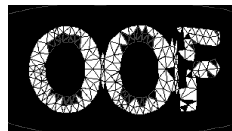
***OBJECTIVES***

- **To combine materials microstructure, data, and theory in an easy-to-use graphical interface designed for materials scientists**
- **To provide a vehicle for incorporating well-known properties into complex systems**
- **To operate on real and simulated materials microstructures**

Ceramics/MSEL

NIST Ceramic Coatings Program (cont.)

S. J. Dapkunas (NIST)

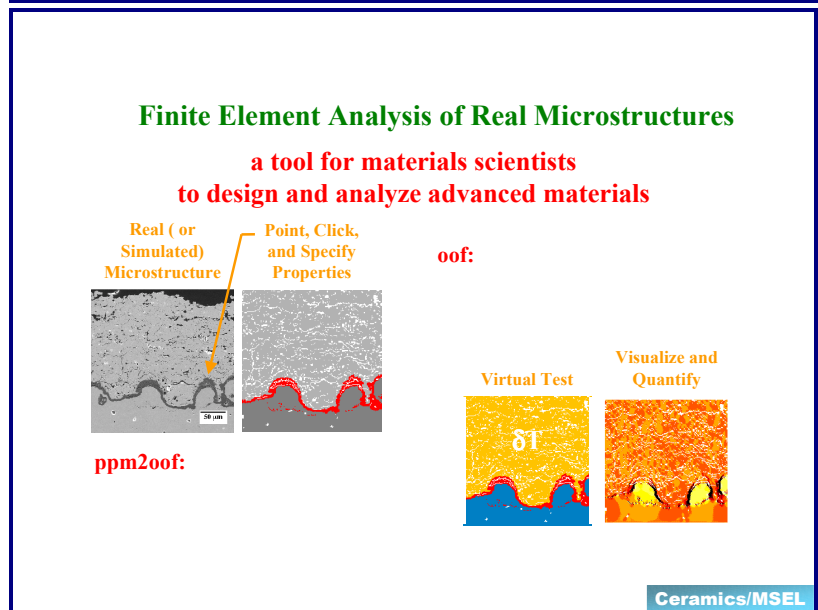
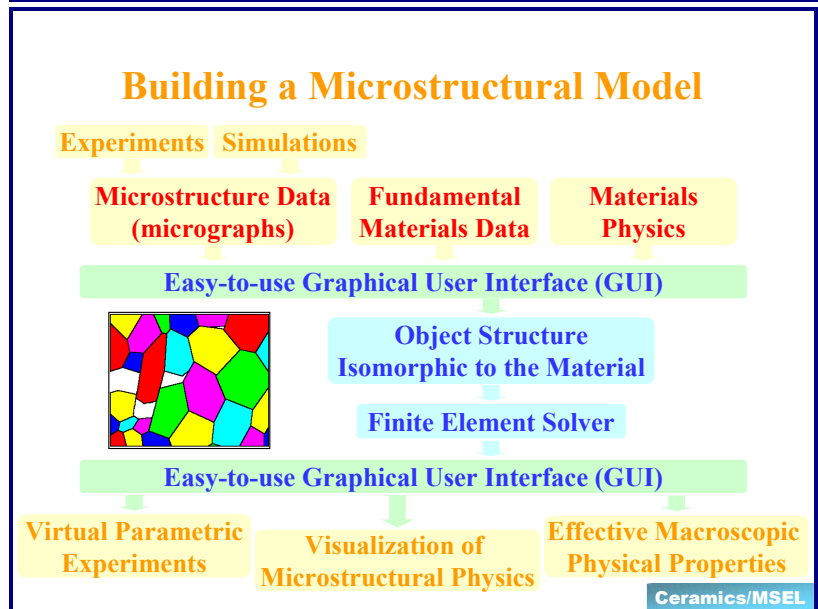
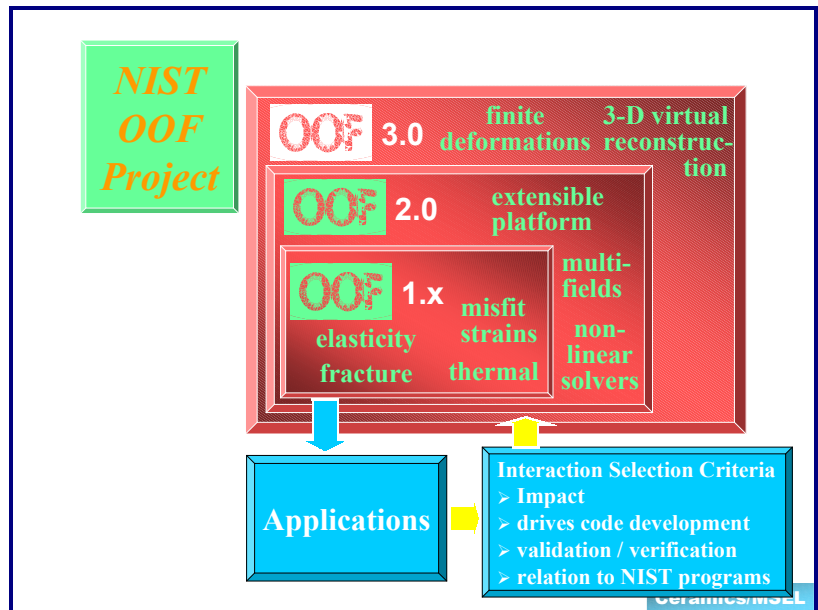

NIST Ceramic Coatings Program (cont.)

S. J. Dapkunas (NIST)

Simulation Procedure

Air-Plasma-Sprayed Thermal Barrier Coating

after thermal cycling
from 25 °C to 1150 °C
(≈75 % of life)

α -Al₂O₃ thermally
grown oxide scale

René N5 substrate
(not shown)

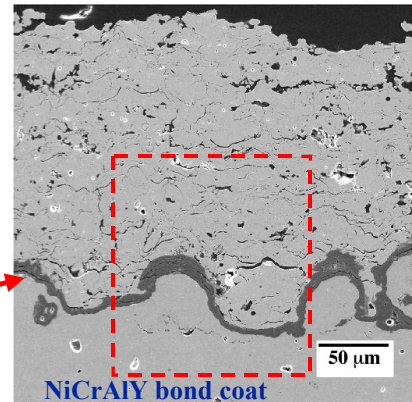

Ceramics/MSEL

Simulation Procedure

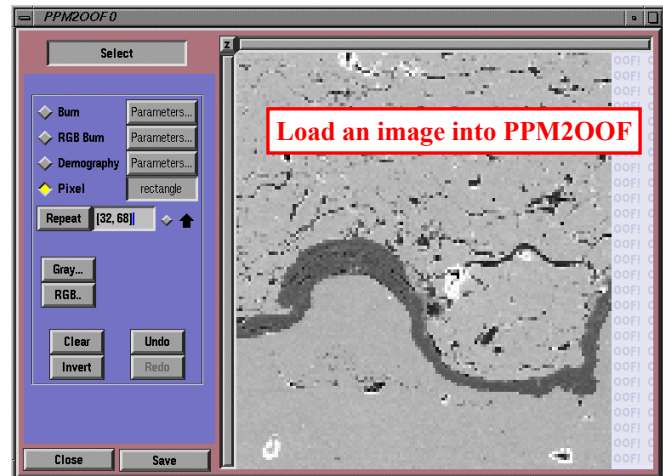

Ceramics/MSEL

Simulation Procedure

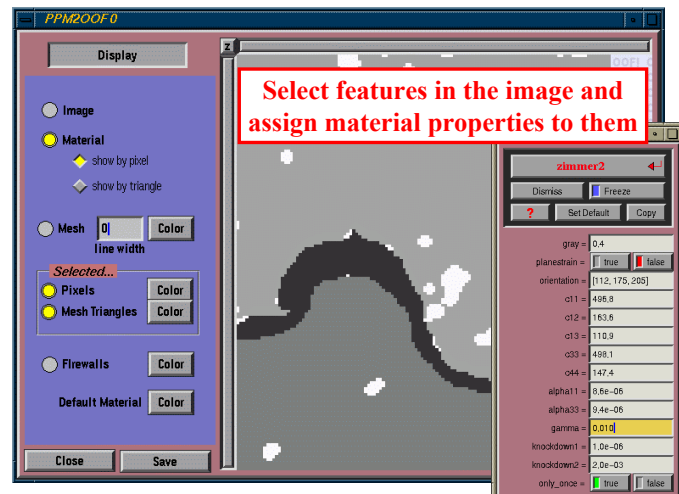

Ceramics/MSEL

NIST Ceramic Coatings Program (cont.)

S. J. Dapkunas (NIST)

Simulation Procedure

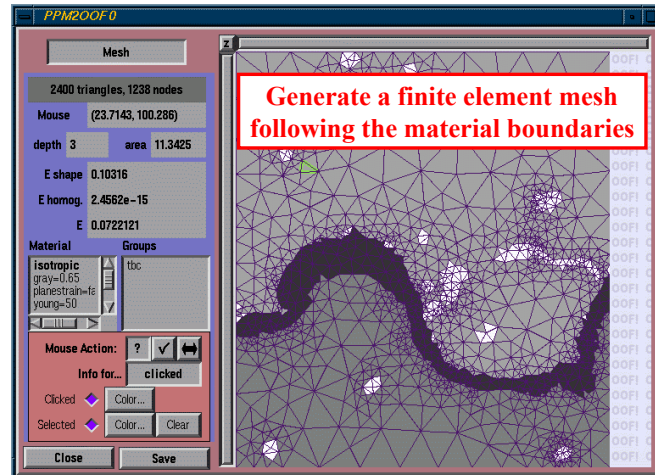

Ceramics/MSEL

Simulation Procedure

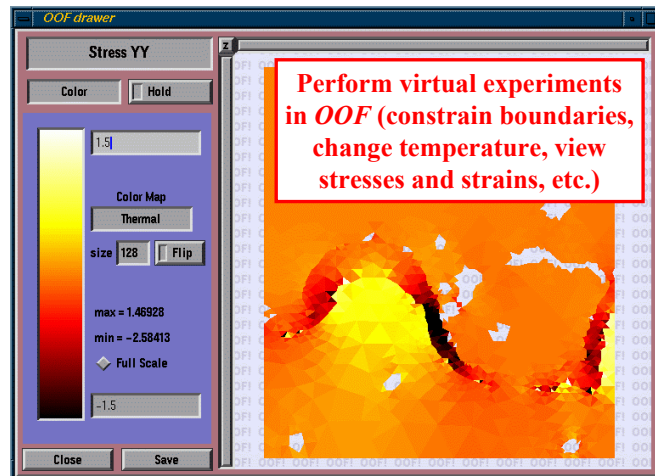

Ceramics/MSEL

Lifetime Prediction

- Fracture mechanics based
- OOF to predict stresses above bond coat

Ceramics/MSEL

NIST Ceramic Coatings Program (cont.)

S. J. Dapkunas (NIST)

Microstructure Based Thermal Conductivity Prediction

- Object oriented finite element (OOF) modeling
- Capture microstructure, predict conductivity, validate

Ceramics/MSEL

Importance of Thermal Conductivity Characterization

Thermal properties are crucial to part design.

TBC properties are highly dependent on processing parameters and location on the part.

As TBC's are used in more critical applications in gas turbine design, accurate characterization of thermal conductivity becomes more important.

Laser flash measurements of thermal conductivity are time consuming, expensive, and require special expertise. Accordingly, such measurements:

- are rarely made during materials development
- are used sparingly by turbine part designers
- are typically not included in production qualification and quality control

Ceramics/MSEL

Thermal Conductivity Simulations

Benefits of an Inexpensive, Widely Available, Rapid Predictor of TBC Thermal Conductivity

Optimization of thermal conductivity (and other properties) during TBC material development

New TBC materials with lower thermal conductivity designed on the computer

More accurate cooling and life predictions for gas turbine parts by designers

Spray vendors qualify their TBC's for thermal conductivity

Ceramics/MSEL

NIST Ceramic Coatings Program (cont.)

S. J. Dapkunas (NIST)

Thermal Conductivity Simulations

- **Developing OOF 2**
- **Thermal conductivity module for OOF 1.x (posted on web October 13, 2000)**
- **Library of plasma sprayed TBC microstructures with widely varying thermal conductivities**

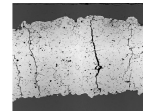
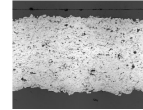

Ceramics/MSEL

8 % YZS (mass fraction of yttria is 8 %)

Phase Stability in 8 % YZS

- Neutron diffraction
- Exposures to 1400 °C, 1000 hours

Ceramics/MSEL

Materials of Interest: Metal Coating Systems

F. S. Biancaniello (NIST)

Prior research at NIST in rapid solidification processing of advanced materials has resulted in the development of several new metal powder alloys with unique properties that are readily adaptable as TS coatings. The three alloys discussed in this presentation: white cast iron, high nitrogen stainless steel, and a stable quasi-crystal; were produced at NIST as powders by gas atomization. Primarily intended for consolidation and use in bulk form, these alloys are of particular interest for coatings to enhance surface wear and/or corrosion properties.

Rapidly solidified White Cast Iron (WCI) powder consists of a mixture of Fe_3C and ferrite (iron.) It is more commonly found as a surface layer on high carbon iron alloy castings where proximity to the mold wall promotes the necessary rapid solidification rate for Fe_3C precipitation.

These new High Nitrogen Stainless Steel (HNSS) powders contain a 100 % austenite microstructure with nitrogen contents approaching the maximum solubility. The chemical composition provides this alloy with a unique combination of strength, ductility, and corrosion resistance not found in other stainless steels.

Quasi-crystals were first discovered by NIST researchers in melt spun ribbons of Al alloys in the 1980's. These new stable quasi-crystal powders can be used to produce coatings with high wear resistance and low coefficient of friction.

Metal Coating Systems

F. Biancaniello, A. Duckham, R. Jiggetts,
S. Ridder, and M. Williams

Metallurgy Division
National Institute of Standards and Technology
Gaithersburg, MD 20899

Thermal Spray Process Reliability:
Sensors and Diagnostics
January 8, 2001

NIST

National Institute of Standards and Technology
Technology Administration, U.S. Department of Commerce



Metal Coating Systems

OUTLINE

- 1) New metal coating systems
- 2) Why they are of interest
- 3) Characterization of coating systems
 - a) microstructures
 - b) hardness data
- 4) Applications
- 5) Summary

NIST

National Institute of Standards and Technology
Technology Administration, U.S. Department of Commerce



Metal Coating Systems

1) New metal coating systems

White Cast Iron

Fe	C	Si	Mn	Cr	O	Cu	Mo	Ni
bal.	3.62	1.38	1.03	0.389	0.298	0.225	0.139	0.104

High Nitrogen Stainless Steel

Fe	Cr	Ni	Mn	Mo	N	Si	O	C
bal.	29.49	12.85	9.0	1.92	0.88	0.50	0.042	0.02

Stable Quasi-crystal

Al	Fe	Cu	Cr	O	C	N	B
bal.	15.70	14.80	14.40	0.088	0.003	0.003	0.009

NIST

National Institute of Standards and Technology
Technology Administration, U.S. Department of Commerce



Materials of Interest: Metal Coating Systems (cont.)

F. S. Biancianiello (NIST)

This slide shows micrographs of Hot Isostatic Press (HIP) consolidated ingot and TS coatings made with WCI powder. Also shown are Vickers microhardness data from the ingot, coating surface, and coating cross section.

Metal Coating Systems

2) Why they are of interest

- White Cast Iron**
very hard, wear and erosion resistant
- High Nitrogen Stainless Steel**
very strong, UTS = 850 MPa (150 ksi)
YS = 700 MPa (100 ksi)
hard & ductile, ≈ Rc 30, 60 % elongation
no intermetallics (in NIST version)
possible replacement for hexavalent Cr
- Stable Quasi-crystal**
very hard, low coefficient of friction
stable to 800 °C

NIST National Institute of Standards and Technology Technology Administration, U.S. Department of Commerce

Metal Coating Systems

3) Characterization of coating systems

Microstructures and Hardness: White Cast Iron

hardness data (HV₅₀)

NIST National Institute of Standards and Technology Technology Administration, U.S. Department of Commerce

This slide shows micrographs and Vickers microhardness data of (HIP) consolidated ingot and TS coatings made with HNSS powder.

These NIST developed HNSS alloys were specially formulated to eliminate the intermetallic precipitates often found in HNSS that must be removed by solution treatment and rapid quenching. The precipitates seen in the ingot material are silicates that result from a special degassing procedure and have not been found to adversely affect corrosion or impact properties.

Metal Coating Systems

3) Characterization of coating systems

Microstructures and Hardness: HNSS

hardness data (HV₅₀)

NIST National Institute of Standards and Technology Technology Administration, U.S. Department of Commerce

Materials of Interest: Metal Coating Systems (cont.)

F. S. Biancaniello (NIST)

This slide shows micrographs and Vickers microhardness data of Hot Isostatic Press (HIP) consolidated ingot and TS coatings made with stable quasi-crystal powder.

There are several coating applications where the unique properties of each of these materials could show promise.

Metal Coating Systems

3) Characterization of coating systems

Microstructures and Hardness: Stable Q-xtal

The figure displays three micrographs and their corresponding Vickers hardness data (HV₂₆):

- bulk material HIPped:** Shows a fine, uniform microstructure with a hardness of 816 HV₂₆.
- TS coating surface:** Shows a surface with a distinct microstructure and a hardness of 839 HV₂₆.
- TS coating heat-treated:** Shows a surface with a more complex, cracked microstructure and a higher hardness of 962 HV₂₆.

NIST
National Institute of Standards and Technology
Technology Administration, U.S. Department of Commerce

Metal Coating Systems

4) Applications

- White Cast Iron**
 - disc brake rotors
 - cylinder bores
- High Nitrogen Stainless Steel**
 - disc brake rotors
 - cylinder bores
 - hydraulic cylinders
 - replace hexavalent Cr
- Stable Quasi-crystal**
 - disc brake rotors
 - cylinder bores
 - hydraulic cylinders

NIST
National Institute of Standards and Technology
Technology Administration, U.S. Department of Commerce

Metal Coating Systems

5) Summary

- NIST has ongoing interest in processing advanced particulate materials
 - kinetics and thermodynamics of phase stability
 - material property measurements
 - predictive models
- Extensive metallurgical processing lab
- Extensive micro-characterization facilities

NIST
National Institute of Standards and Technology
Technology Administration, U.S. Department of Commerce

*Variability in Thermal Spray Materials:
A Problem or an Opportunity?*

C. C. Berndt (SUNY at Stony Brook)

Variability in Thermal Spray Materials: A Problem or an Opportunity?

Christopher C. Berndt
SUNY at Stony Brook

cberndt@notes.cc.sunysb.edu
<http://DOL1.eng.sunysb.edu/tsl/berndt1.html>

C. C. Berndt - NIST & Variability

1

Table of Contents

Total of 38 slides

slides 3-5	Historical Background and Introduction
slide 6	The Origins of Variability
slides 7-11	Grit Blasting and Roughness
slides 12-17	Feedstock and Safety
slides 18-19	Plasma Processing
slide 20	The Microstructure
slides 21-29	Mechanical Properties and Testing
slide 30	Thermal Properties
slides 31-34	Equipment Variables
slides 35-37	“Visions and Dreams”
slide 38	Focus on Applications and the Customer

C. C. Berndt - NIST & Variability

2

The beginning of TS starts with a “father”

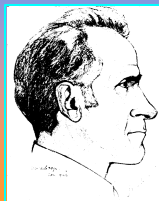

The late Dr. M.U. Schoop,
Inventor of the Metal-
Spraying Process.
From a sketch completed in
1922

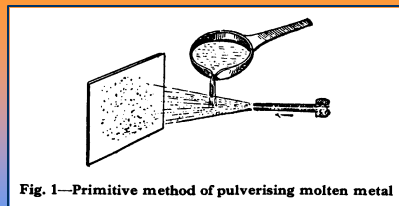
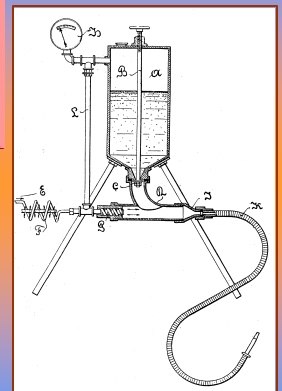

Fig. 1—Primitive method of pulverising molten metal

Ref. Ballard

C. C. Berndt - NIST & Variability

3

Variability in Thermal Spray Materials:
A Problem or an Opportunity? (cont.)

C. C. Berndt (SUNY at Stony Brook)

A Method of Producing Bodies and Coatings of Glass and Other Substances

Fig. 1.

E. Morf
UK Patent 28,001
May 29, 1913

Fig. 2.

Fig. 3.

C. C. Berndt - NIST & Variability 4

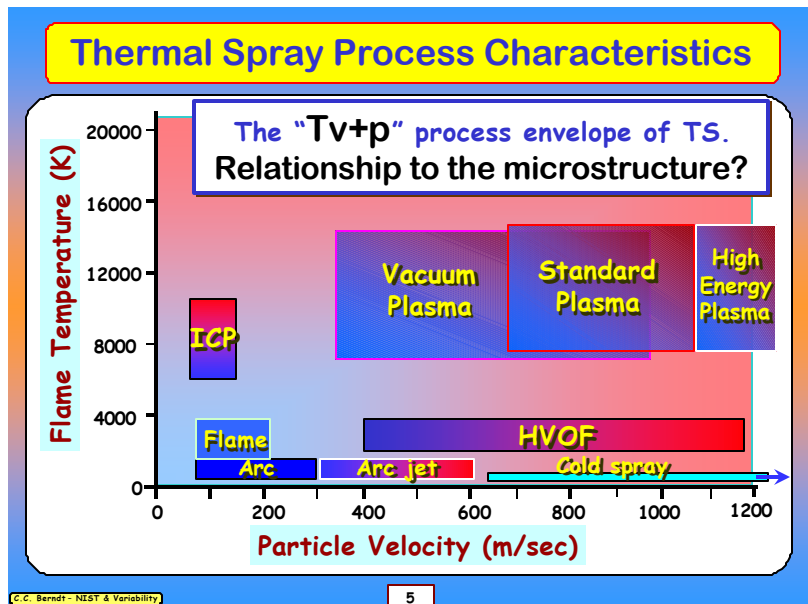

The Origins of Variability?

Surface preparation	<ul style="list-style-type: none"> • Substrate nature • Grit blast procedure • Roughness of surface
Thermal spray processing	<ul style="list-style-type: none"> • Temperature • Velocity • Particle size distribution • Equipment variables
Feedstock	<ul style="list-style-type: none"> • Particle size distribution • Homogeneity • Density
Post-processing	<ul style="list-style-type: none"> • Machining • Other coatings (for dual coating systems)
Testing methods / Quality control indicators	<ul style="list-style-type: none"> • Is the test representative of the operating environment? • Statistical basis for tests

C. C. Berndt - NIST & Variability 6

*Variability in Thermal Spray Materials:
A Problem or an Opportunity?* (cont.)

C. C. Berndt (SUNY at Stony Brook)

Summary of Abrasive Characteristics

Abrasive	Composition	Mohs Hardness	Density (lbs./cu. ft)	Dusting	Recycling
Silica sand • Best quality • Average quality	Crystalline silica	7.0	100	Low	No
	Crystalline silica	6.5	100	High	No
Staurolite / zircon	Iron alum. silicate	7.5	125	Moderate	No
Garnet • Almandite • Andradite	Fe alum. silicate	7.5	125	Low	Yes
	Calcium silicate	6.5	115	High	No
Olivine	Iron silicate	6.5	120	High	No
Specular hematite	Iron oxide	6.0	145	Moderate	Yes
Copper slag	Iron silicate glass	6.0	100	Mod	No
	Nickel iron glass	6.0	100	High	No
Iron slag	Iron silicate glass	6.0	100	High	No
Coal boiler slag	Ca, iron silic. glass	6.0	90	High	No
Steel grit / shot	Iron (steel)	6.0	140+	Low	Yes
Baking soda	Sodium carbonates	2-3	66	High/low*	No
Crushed glass	Alkaline silic. glass	6.0	100	High	No
Organic media	various	2-3	40-60	n.a.	No

* High when used dry, low when used with water

C. C. Berndt - NEST & Variability

Ref.: J.D. Hansink, "An Introduction to Abrasives for Protective Coating Removal Operations" JPCL, April 2000.

Types of Abrasive Blast Media

Natural Minerals

- Silica sand
- Garnet
- Olivine
- Staurolite / Zircon
- Specular Hematite
- Other minerals

Mineral Slags

- Copper slag (sulfide ores)
- Nickel slag (non-sulfide)
- Iron slag
- Coal boiler slag

Organic Media

- Corn cobs
- Nut shells
- Grain hulls

Manufactured Media

- Steel grit and shot
- Crushed glass (cullet)
- Aluminum oxide
- Plastic pellets
- Glass beads
- Ct wire – Metal pellets
- Soda-based soluble media
- Other

Ref.: J.D. Hansink, "An Introduction to Abrasives for Protective Coating Removal Operations" JPCL, April 2000.

C. C. Berndt - NEST & Variability 8

Grit Types

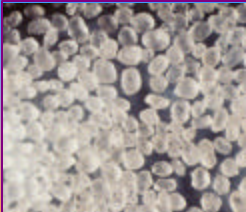

1. Well-rounded silica sand



2. Staurolite / zircon



3. Almandite garnet



4. Steel shot



5. Coal Slag



6. Corn cob blast media

C. C. Berndt - NEST & Variability 9 Ref.: J.D. Hansink, JPCL, April 2000.

Variability in Thermal Spray Materials:
A Problem or an Opportunity? (cont.)

C. C. Berndt (SUNY at Stony Brook)

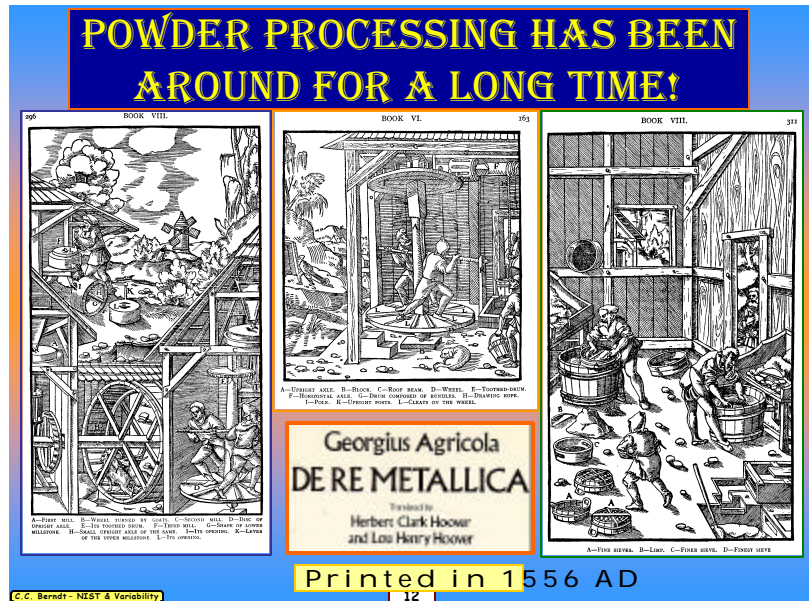
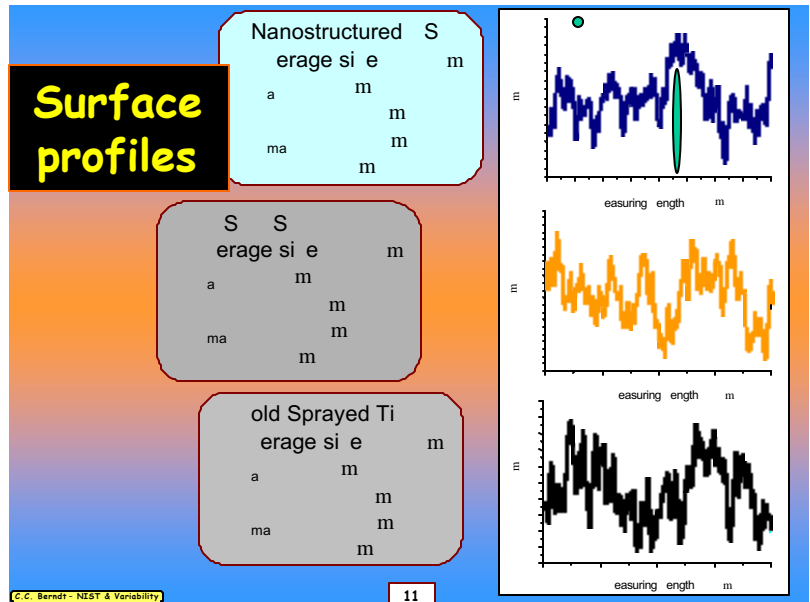
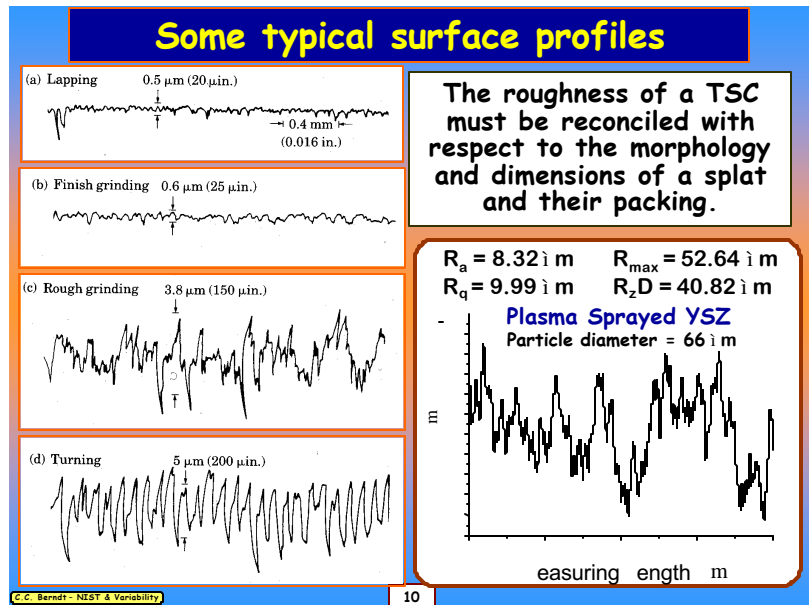

Variability in Thermal Spray Materials:
A Problem or an Opportunity? (cont.)

C. C. Berndt (SUNY at Stony Brook)

Feedstock morphologies

YSZ Powders

Standard reference material from NIST

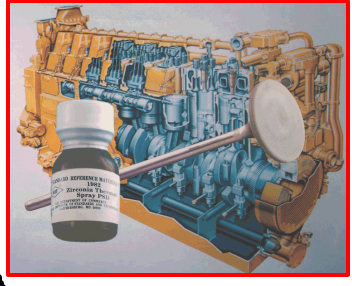

Spherical

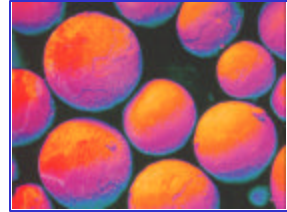

Hollow

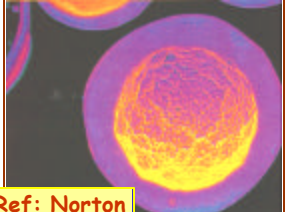

Ref: Norton

C.C. Berndt - NIST & Variability 13

Powder Characteristics (ZrO₂-Y₂O₃)

Powder type	Fused + crushed	Sintered + crushed	Spray dried	Plasma fused	Sol-gel
Particle shape	blocky-angular	blocky-angular	spherical	spherical	spherical
Microstructure and Porosity	dense	dense-porous	porous	dense-hollow	dense
Grain size	coarse	coarse	medium-fine	medium-fine	fine
Bulk density (g/cm ³)	2.7	2.1	1.8	2.3	2.6
Hall-flow (secs)	32	40	40	34	22

C.C. Berndt - NIST & Variability Acknowledgement to Dr. Karlis A. Gross, Monash University, Australia

Material	Lot	Hall flow (s)	Apparent density g/cm ³
8%YSZ-HOSP	A	77.9	2.27
20%YSZ-S/D	B	47.3	1.52
24%CSZ-HOSP	C	34.1	2.40
CaTiO ₃	D	117.4	1.05
Mullite	E	71.6	1.16
8%YSZ-S/D	F	52.2	1.44
8%YSZ-S/D-S	G	(a)	1.10
8%YSZ-F/C	H	45.1	2.55
8%YSZ-solgel	I	39.2	1.72
8%YSZ-S/D-S	J	(a)	1.84
8%YSZ-S/D-S	K	40.3	2.00
8%YSZ-HOSP	L	51.3	2.27
8%YSZ-HOSP	M	81.7	2.26
8%YSZ-S/D-S	N	(a)	2.26
8%YSZ-S/D-S	O	46.3	1.76

(a) Material did not flow

Hall flow and apparent density of 15 TBC materials

There does not appear to be any simple relationship between Hall flow and the physical properties of the feed stock.

"Thick Thermal Barrier Coatings for Diesel Engines", M.B. Beardsley, JTST, 6[2] (1997) 181-186.

C.C. Berndt - NIST & Variability 15

*Variability in Thermal Spray Materials:
A Problem or an Opportunity?* (cont.)

C. C. Berndt (SUNY at Stony Brook)

Hazards posed by particulate materials



- Fine materials can be pyrophoric in nature, and therefore, be a spontaneous fire or explosive risk.
- The material may be carcinogenic.
- Very fine materials (0.5 to 5 μm) may be able to penetrate the alveoli and cause fibrosis of the lungs.
- Large quantities of very fine materials present in the environment can be inhaled during normal breathing and damage the lungs.
- Fine materials are a skin and eye irritant.



C. C. Berndt - NIST & Variability

16

**"The Feed Me Catch 22"
The biggest and most significant part of TS!**



- The feedstock that will most likely form a coating will be that which enters the TS process zone.
- The particles which are most easily "processed" are also the most difficult to feed into the TS process zone.

C. C. Berndt - NIST & Variability

17

Spray Parameters vs. DE and DR

How do these factors influence DE and DR?

	DE	DR
Plasma Processing Equipment		
• Torch type [anode, cathode, injector ring (in mm)]		
• Volts and Amps = Power (kW)		
• Primary gas and flow rate (slpm)		
• Secondary gas and flow rate (slpm)		
• Feed gas and flow rate (slpm)		
• Stand off distance (cm)		
Hardware		
• Traverse speed of torch (ms^{-1})		
• Powder injector (mm)		
• Substrate cooling (m^3s^{-1})		
• Spray foot print (cm^2)		

C. C. Berndt - NIST & Variability

18

Variability in Thermal Spray Materials:
A Problem or an Opportunity? (cont.)

C. C. Berndt (SUNY at Stony Brook)

Some characteristics of powders

ID	Material	Ratio	Type of powder	DE	Roughness Ra (um)	Hardness HV 0.2	Apparent density (g/cm ³)	Microtrac mean diameter (um)	Primary grain size diameter (um)
1	Cr ₂ O ₃		Agglom -sinter	53	2.04	1287	1.8	26	5
2	Cr ₂ O ₃		Fused	53	1.85	1156	2.1	22	20
3	Al ₂ O ₃		Fused	50	3.75	1060	1.8	36	30
4	Al ₂ O ₃ -TiO ₂	97/3	Fused	61	3.22	1069	1.7	38	30
5	Al ₂ O ₃ -TiO ₂	87/13	Blended	74	3.15	949	1.8	35	30
6	Al ₂ O ₃ -TiO ₂	87/13	Agglom -sinter	78	3.56	934	1.5	36	5
7	Al ₂ O ₃ -TiO ₂	87/13	Agglomerated	71	3.09	1012	1.1	-	3
8	Al ₂ O ₃ -TiO ₂	70/30	Agglom -sinter	75	3.90	887	1.4	40	5
9	Al ₂ O ₃ -TiO ₂	60/40	Blended	71	3.43	813	1.8	35	30
10	Al ₂ O ₃ -TiO ₂	60/40	Agglom -sinter	77	2.70	702	1.0	-	3
11	Al ₂ O ₃ -TiO ₂	60/40	Agglom -sinter	65	4.33	762	1.4	42	5
12	Al ₂ TiO ₅	70/30	Agglom -sinter	77	3.22	694	1.1	36	5
13	Al ₂ O ₃ -TiO ₂	30/70	Agglom -sinter	68	3.77	704	1.4	43	5
14	TiO ₂		Fused	63	4.31	807	2.0	33	25

C. C. Berndt - NIST & Variability

19

Effect of Ceramic-to-Metal Ratio

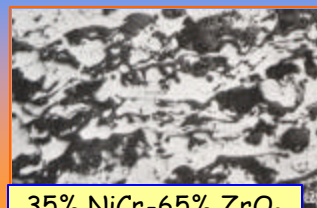

35% NiCr-65% ZrO₂

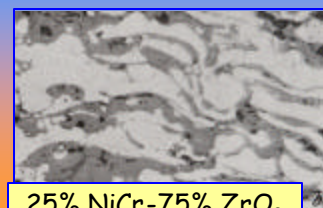

25% NiCr-75% ZrO₂

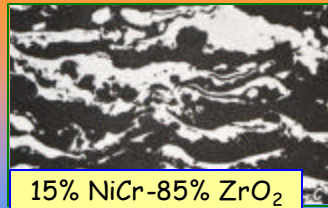

15% NiCr-85% ZrO₂

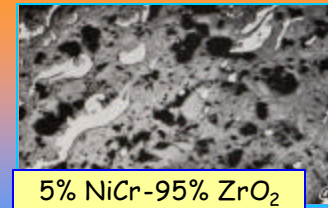

5% NiCr-95% ZrO₂

Arc Plasma Technology in Materials Science, D.A. Gerdeman and N.L. Hecht, Springer-Verlag, New York, 1972.

C. C. Berndt - NIST & Variability

20

Macro-Cracking Morphology:

A. Kucuk, C. G. Dambra, C. C. Berndt, U. Senturk, R. S. Lima

Thick top and bond coats on cold substrate at short S.D.

Vertical Cracks in top and bond coats. NO delamination in top coat.



Delamination in bond coat/substrate interface

Thick top and bond coat on hot substrate at short S.D.

Severe vertical cracking in top and bond coats. First vertical cracks in top coat then in bond coat. Finally, delamination in top and bond coat.



Severe delamination in top coat and bond coat/substrate interface

C. C. Berndt - NIST & Variability

21

Variability in Thermal Spray Materials:
A Problem or an Opportunity? (cont.)

C. C. Berndt (SUNY at Stony Brook)

Failure Modes for a TAT

- Complex assembly of coating, epoxy and support fixtures.
- Overall failure mode(s) reflects any “weak links” in this assembly.
- Does the TAT failure mode reflect that of service failure?

C. C. Berndt - NIST & Variability 22

Fracture Surfaces for a “bond coat + YSZ” TBC system

Sample 1 Features
Generally adhesive between the bc and YSZ

- 1.A Some bc can be observed.
- 1.B Bottom surface of YSZ detected.

Sample 2 Features
Mixed adhesive / cohesive mode.

- 2.A Some bc can be observed.
- 2.A “Crescent” of highly-adhering YSZ detected.

C. C. Berndt - NIST & Variability

New Procedure Lowers Statistical Scatter

- Increased Weibull modulus, $m=13.9$, indicates less scatter in the results for the optimized samples (red data).

C. C. Berndt - NIST & Variability 24

Variability in Thermal Spray Materials: A Problem or an Opportunity? (cont.)

C. C. Berndt (SUNY at Stony Brook)

Mechanical Property Variability: Weibull distribution plots.

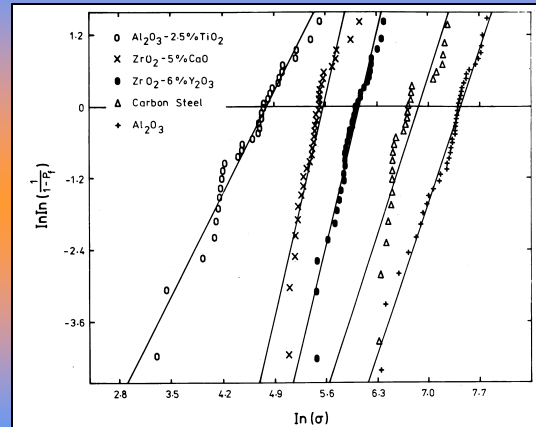

P. Ostojic and C.C. Berndt, "The Variability in Strength of Thermally Sprayed Coatings", *Surface and Coatings Technology*, 34 (1988) 43-50.

C. C. Berndt - NEST & Variability

25

Tensile Adhesion Test Values: Failure loads

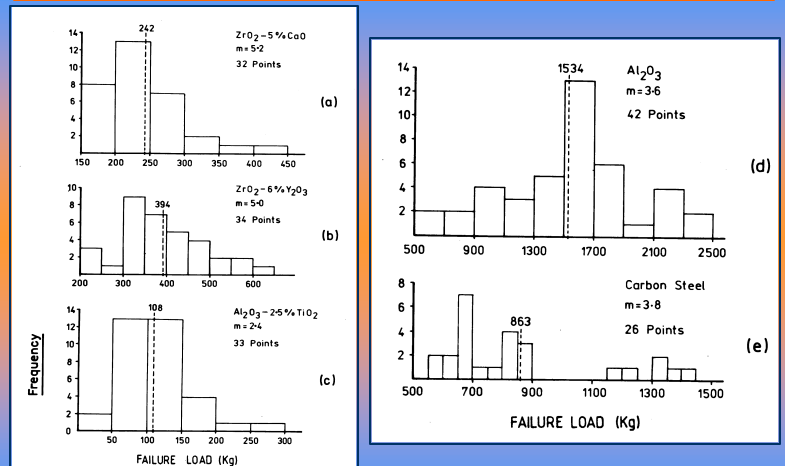

P. Ostojic and C.C. Berndt, "The Variability in Strength of Thermally Sprayed Coatings", *Surface and Coatings Technology*, 34 (1988) 43-50.

C. C. Berndt - NEST & Variability

26

Weibull Modulus of Indentation Tests

Confidence intervals for Weibull Modulus Values.

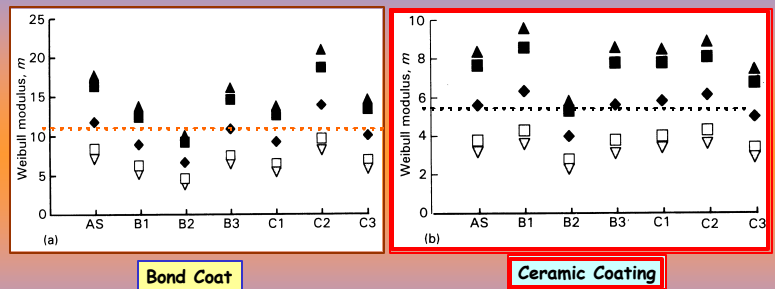

C.K. Lin and C.C. Berndt, "Statistical Analysis of Microhardness Variations in Thermal Spray Coatings", *J. Materials Science*, 30 (1995) 111-117.

C. C. Berndt - NEST & Variability

27

*Variability in Thermal Spray Materials:
A Problem or an Opportunity? (cont.)*

C. C. Berndt (SUNY at Stony Brook)

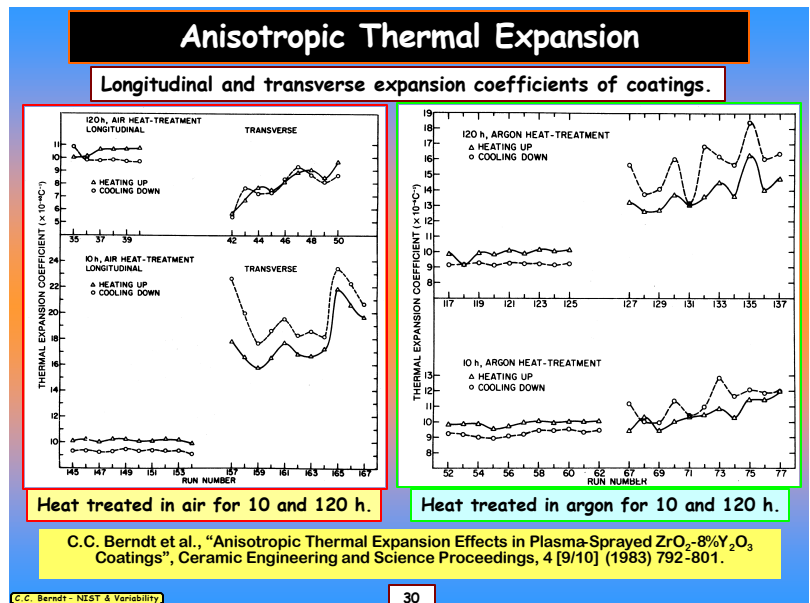
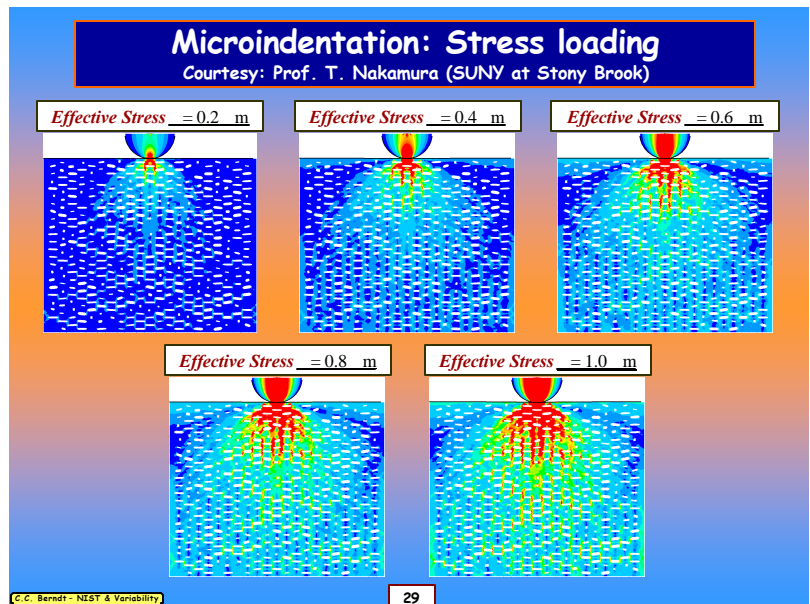
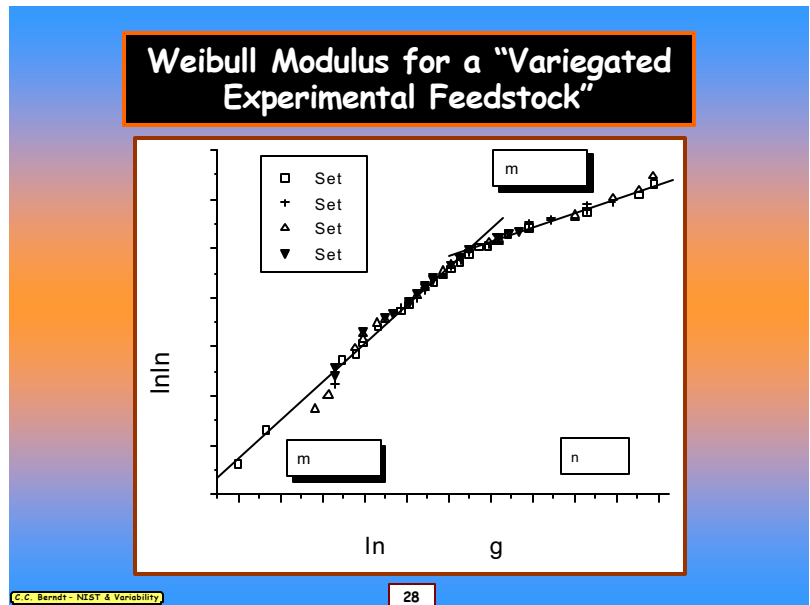

*Variability in Thermal Spray Materials:
A Problem or an Opportunity?* (cont.)

C. C. Berndt (SUNY at Stony Brook)

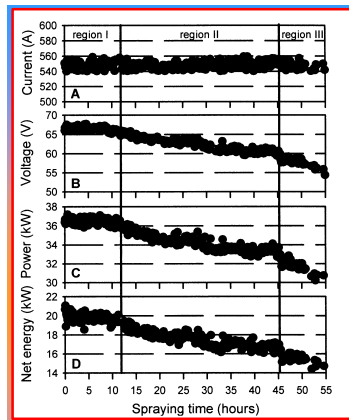

Evolution of the plasma gun parameters during 55 hours of spraying using the nominal operating conditions (constant arc current). Arc current (A) and DC voltage (B) are used in the calculation of the gun power (C) and plasma net energy (D).

"Wear" of Thermal Spray Equipment

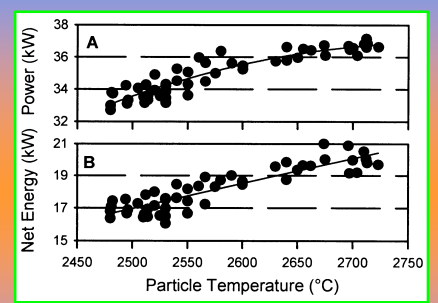

Correlation between particle temperature, gun power (A) and plasma net energy (B).

L. Leblanc and C. Moreau, "Study on the Log-Term Stability of Plasma Spraying", pp. 1233-1239 of "Thermal Spray: Surface Engineering via Applied Research, C.C. Berndt (Ed.), Pub. ASM International, Materials Park, OH-USA, 2000.

Control Feedback Loops for Thermal Spray

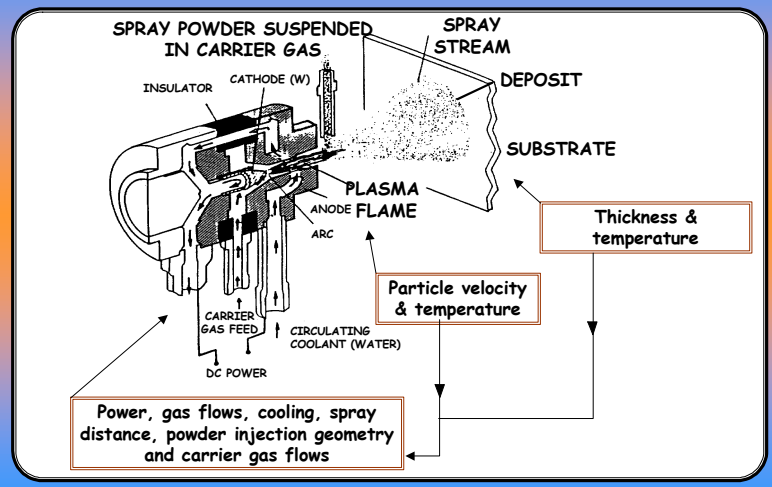

ON-LINE CONTROL (Thermal Spray)

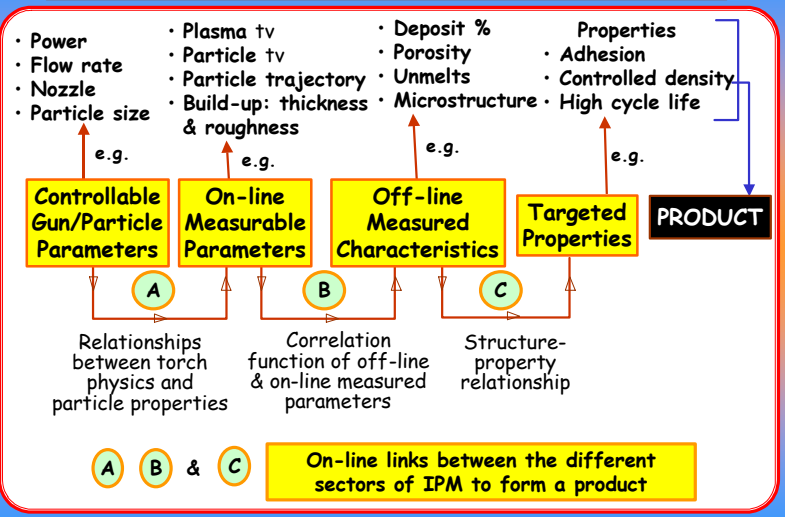

Variability in Thermal Spray Materials:
A Problem or an Opportunity? (cont.)

C. C. Berndt (SUNY at Stony Brook)

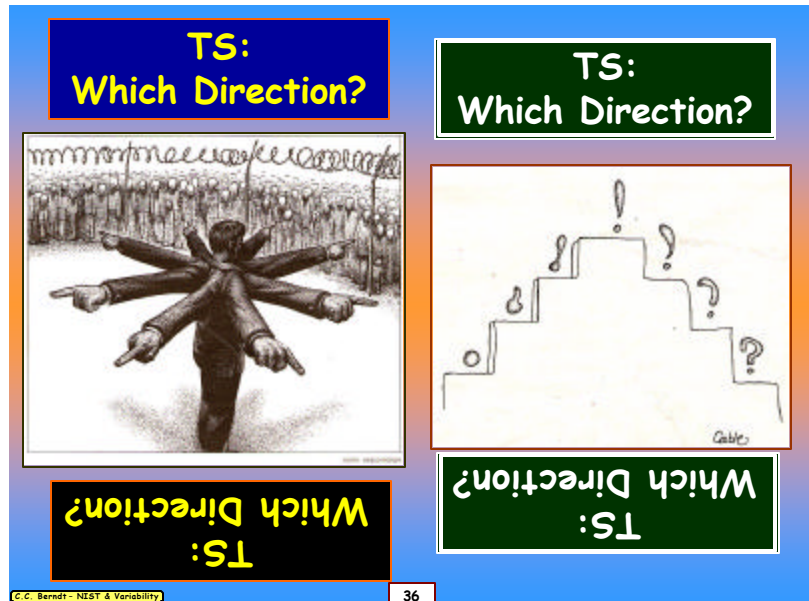
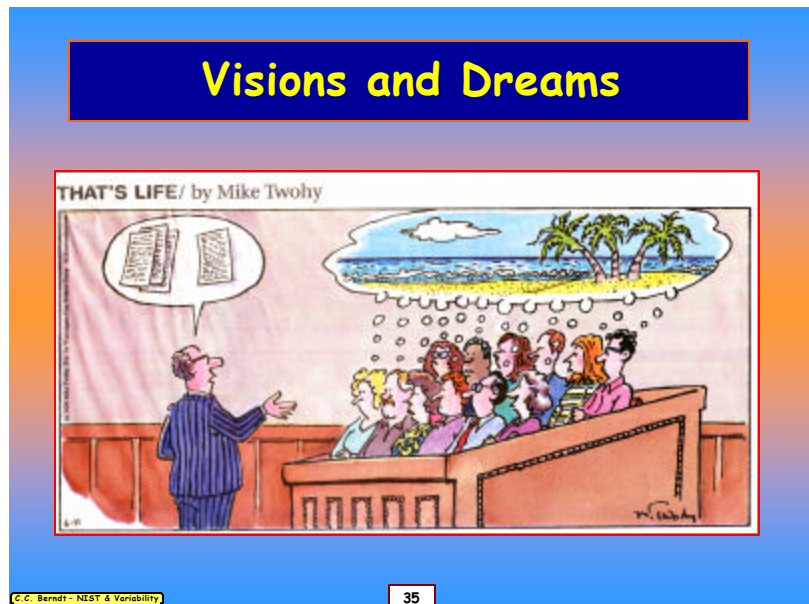
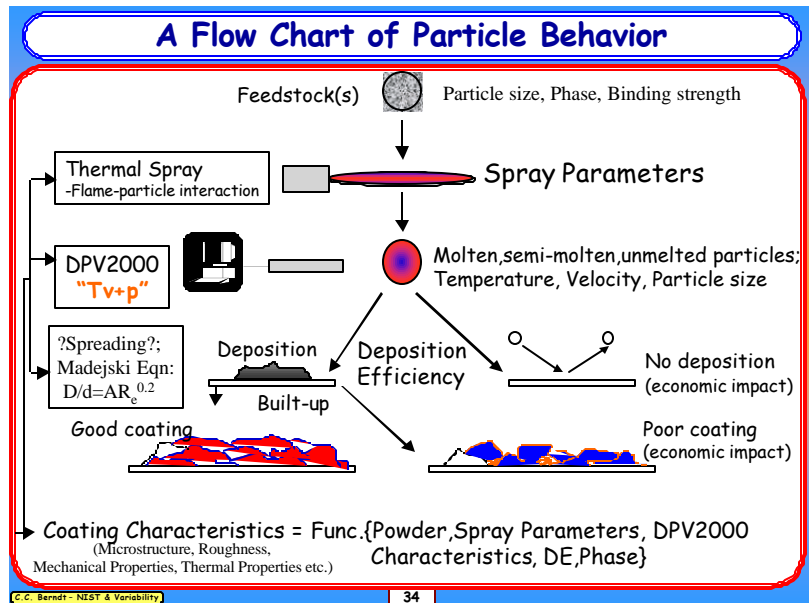

*Variability in Thermal Spray Materials:
A Problem or an Opportunity?* (cont.)

C. C. Berndt (SUNY at Stony Brook)

Concluding Remarks

1	• Variability in TS deposits arises due to the intrinsic nature of the TS processing zone.
2	• “Control of variability” may not necessarily be economically viable for all TS applications / markets.
3	• Variability of coatings is limiting TS growth and new markets.
4	• The “science” is <u>still</u> following the “engineering”>
5	• The present “combative mode” of industry and research institutions may be a short sighted vision to solve the really important problems that have yet to be identified.
6	• There needs to be coordination of TS activities on a national basis.
7	• Should we have standardized tests for TS materials?
8	• The Weibull Modulus is an example of a material characteristic that needs to be closely examined .
9	•

C. C. Berndt - NIST & Variability 37

C. C. Berndt - NIST & Variability 38

JTST - A Resource for Thermal Spray

C. C. Berndt - NIST & Variability 39

Variability in Thermal Spray Materials:
A Problem or an Opportunity? (cont.)

C. C. Berndt (SUNY at Stony Brook)

Some "models" of particle behavior!

Agglomeration, sintering etc. →



↑ **Spheroids**



C.C. Berndt - NIST & Variability

40

Feed Me!



C.C. Berndt - NIST & Variability

41

SPLAT, SPLATTER, SPLIT, SPOCH, SPLUTTER, and SPLASH!

ZIGGY/ by Tom Wilson



C.C. Berndt - NIST & Variability

42

*Variability in Thermal Spray Materials:
A Problem or an Opportunity? (cont.)*

C. C. Berndt (SUNY at Stony Brook)

Solidification Processing of Lamellae via Advanced Technology!



The cartoon strip consists of five panels. In the first panel, a man with a red tuft of hair splashes paint on a wall, saying "SPLAT!". A woman with black hair reacts, saying "WHY THAT LOOKS LIKE A HOUSE!". In the second panel, the man splashes again, saying "SPLAT!". The woman says "NOW IT'S A CAB!". In the third panel, the man splashes a third time, saying "SPLAT!". The woman says "LOOK! A BUNNY! AND A CROCODILE!". In the fourth panel, the man splashes a fourth time, saying "SPLAT!". The woman says "FIVE MORE! SEVEN!". In the fifth panel, the man is on the floor, saying "SPLAT!". The woman says "WHICH ONE LOOKS LIKE DADDY?". The man on the floor says "NO RESPONSE?".

C. C. Berndt - NIST & Variability

43

*NIST Role in Microstructure
Characterization and Relationships
Between the Microstructure and
Properties for Thermally Sprayed
Deposits*

J. Ilavsky (NIST)

*NIST role in microstructure
characterization and relationships
between the microstructure and
properties for Thermally Sprayed
deposits*

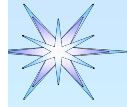

Jan Ilavsky

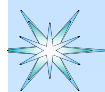

Content

- Introduction
- Microstructure characterization by SANS & SAXS – overview on ceramics
- Results on metals
- Novel methods of SANS & SAXS and their future
- Relationships between microstructure and properties

NIST

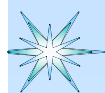

Microstructure

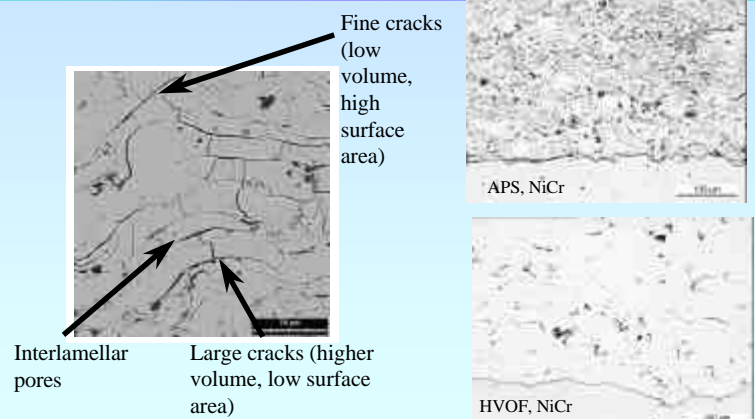

NIST

*NIST Role in Microstructure
Characterization and Relationships
Between the Microstructure and
Properties for Thermally Sprayed
Deposits (cont.)*

J. Ilavsky (NIST)

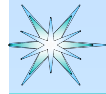

Introduction

- Project resulted in:
 - Microstructure characterization by Porod surface area
 - Microstructure characterization by MSANS – volumetric/size (model based) characterization
 - Basic microstructure – properties relationships
- Future:
 - Novel methods
 - Extension to metals
 - More detailed microstructure – properties relationships
 - Use of results in models

NIST

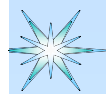

Microstructure characterization by Porod surface area

- Anisotropic Porod surface area distribution:
 - Separate void systems
 - Describe anisotropy
 - Quantitative specific surface areas for major void systems

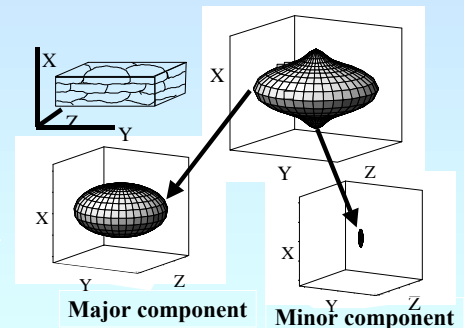

NIST



Can be done also on SAXS

Calcium silicate samples, deposits thinner than 0.5mm!

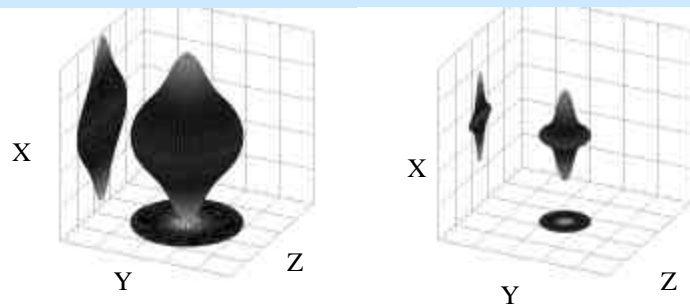

Samples from Sulzer Innotech, Switzerland

NIST

NIST Role in Microstructure Characterization and Relationships Between the Microstructure and Properties for Thermally Sprayed Deposits (cont.)

J. Ilavsky (NIST)

Showcase result

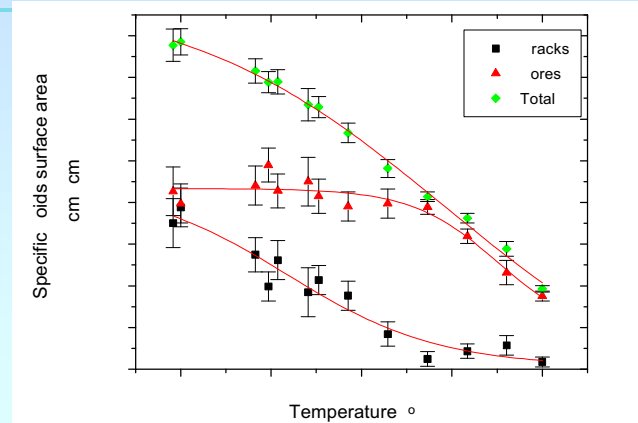

NIST

Amdry 142, in-situ SANS in furnace (50deg.C/hour)

Microstructure characterization by MSANS

- Based on model:
 - Interlamellar disk-like pores
 - Intralamellar disk-like cracks
 - “spherical” volumetric pores
- Combines Surface area measurements with volume of pores and anisotropic distribution of model pores
- Results in “sizes” of pores and volumes in the void systems

NIST

Showcase of MSANS results

YSZ (APS Amdry 142, 90 mm spray distance)
Effect of Heat Treatment (from MSANS)

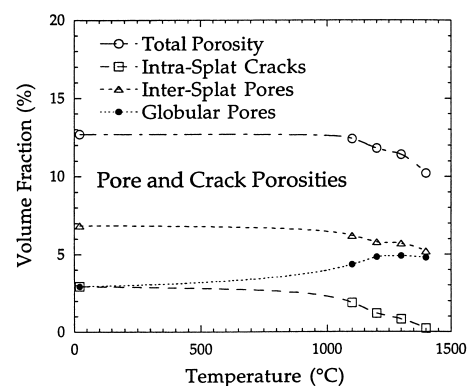

NIST

*NIST Role in Microstructure
Characterization and Relationships
Between the Microstructure and
Properties for Thermally Sprayed
Deposits (cont.)*

J. Ilavsky (NIST)

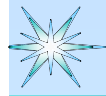

SANS results on metals

- Project with :
 - EMPA, PSI & Sulzer Switzerland
 - IPP, Skoda Czech republic
 - Supported by Eureka grant agency

**Find relationships between (spray parameters)
- microstructure and properties of metallic (Ni-
based) TS deposits (across wide range of spray
systems)**

- Use of wide range of microstructure characterization techniques, including SANS

NIST

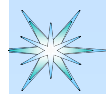

Some results of Porod SANS

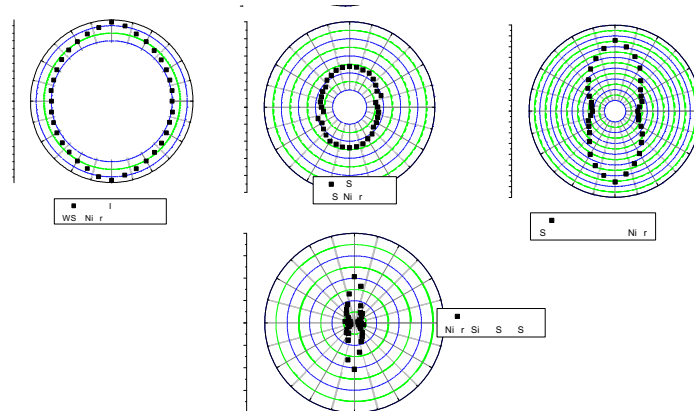

NIST

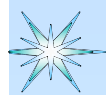

Novel methods of SANS/SAXS & X-ray studies of complex microstructures

- Near surface SANS/SAXS – getting anisotropic surface area characterization on thin deposits (closer to reality)
- MSANS from metallic deposits (Eureka, in less than month)
- Tomography with resolution useful for TS deposits (300 nm this year, 30 nm in few years)

NIST

NIST Role in Microstructure Characterization and Relationships Between the Microstructure and Properties for Thermally Sprayed Deposits (cont.)

J. Ilavsky (NIST)

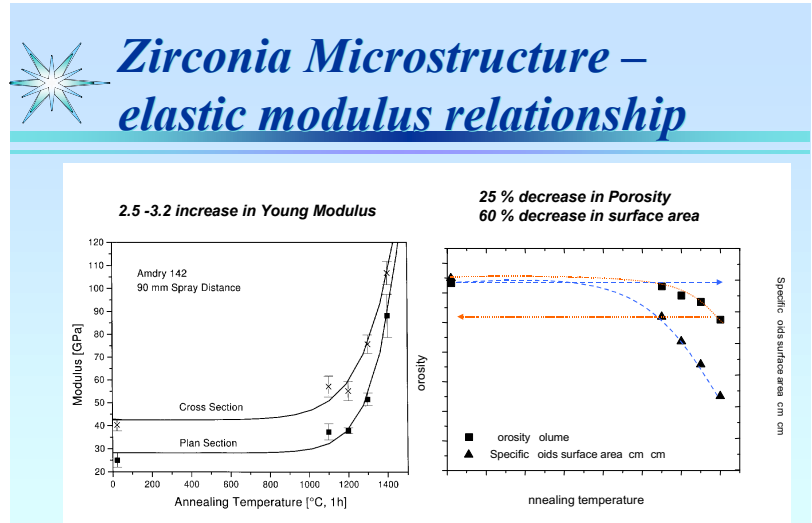

NIST

Microstructure properties relationships - anisotropy

- Found relationships between SANS characteristics and properties.
- Showcase: anisotropy of electrical conductivity and elastic properties directly related to SANS surface area anisotropy

1	$\frac{\sigma}{\sigma_0}$	0.9	3.1	3.8	8.6
2	c_L/c_T	1.1	1.4	1.4	1.4
3	E/E ₀	1.2	2.0	2.0	1.9
4	SANS aspect ratio to	1.1	1.4	-	2.6

- 1 Electrical conductivity anisotropy
- 2 Ultrasound speed anisotropy
- 3 Elastic modulus anisotropy
- 4 SANS surface area anisotropy

NIST

Future of the program...

- NIST more involved in metals – MSANS technique
- More detailed understanding of microstructure-properties relationships, useful for modeling.
- Understanding of spray processing parameters (impact speed and temperature) and microstructure, useful for modeling.
- X-ray and neutron techniques useful for industrially applicable deposits – and industrial research.

NIST

Rapid, Low Investment Tooling

D. Collins (Ford Motor Company)

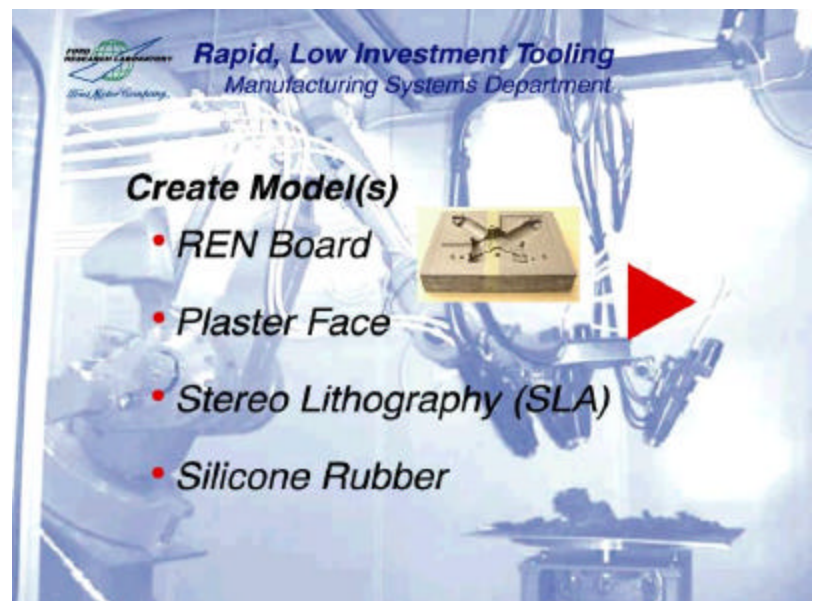
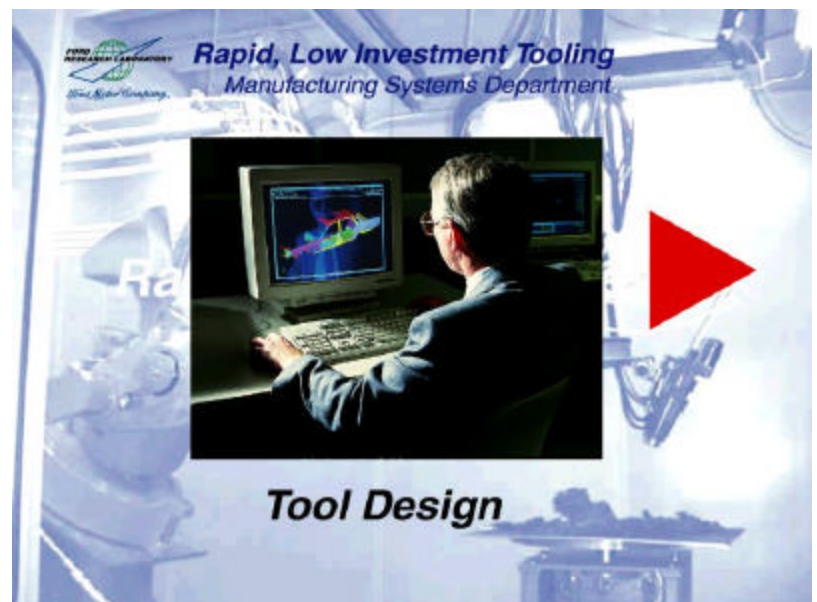

Rapid, Low Investment Tooling (cont.)

D. Collins (Ford Motor Company)

Rapid, Low Investment Tooling
Manufacturing Systems Department



Create Ceramic

- Cast
- Dry
- Freeze
- Fire

This slide features a background image of a robotic arm. In the center, there is an inset photograph of a man in a blue shirt working with a large, rectangular mold on a table. To the right of this inset is a red triangle pointing to the right. The text 'Create Ceramic' is positioned below the inset, followed by a list of four steps: Cast, Dry, Freeze, and Fire.

Rapid, Low Investment Tooling
Manufacturing Systems Department



Metal Spray Deposition

This slide features a background image of a robotic arm. In the center, there is an inset photograph showing a bright, glowing metal spray being deposited onto a surface. Above this inset is a smaller inset showing a finished, dark, irregularly shaped metal part. To the right of the main inset is a red triangle pointing to the right. The text 'Metal Spray Deposition' is positioned below the main inset.

Rapid, Low Investment Tooling
Manufacturing Systems Department

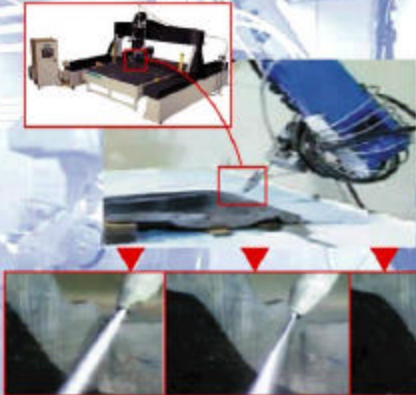

Deposit Trimming

- Water Jet
- EDM
- CNC Mill

This slide features a background image of a robotic arm. In the top left, there is an inset photograph of a CNC mill. Below it, there is a larger inset showing a water jet cutting process. At the bottom, there are three smaller inset photographs showing different stages of the trimming process. To the right of the main inset is a red triangle pointing to the right. The text 'Deposit Trimming' is positioned to the right of the main inset, followed by a list of three methods: Water Jet, EDM, and CNC Mill.

Rapid, Low Investment Tooling (cont.)

D. Collins (Ford Motor Company)

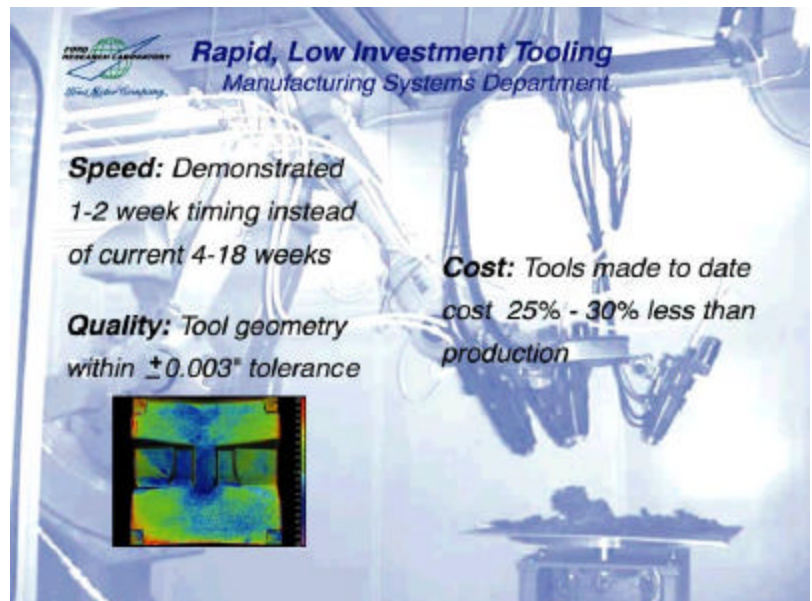
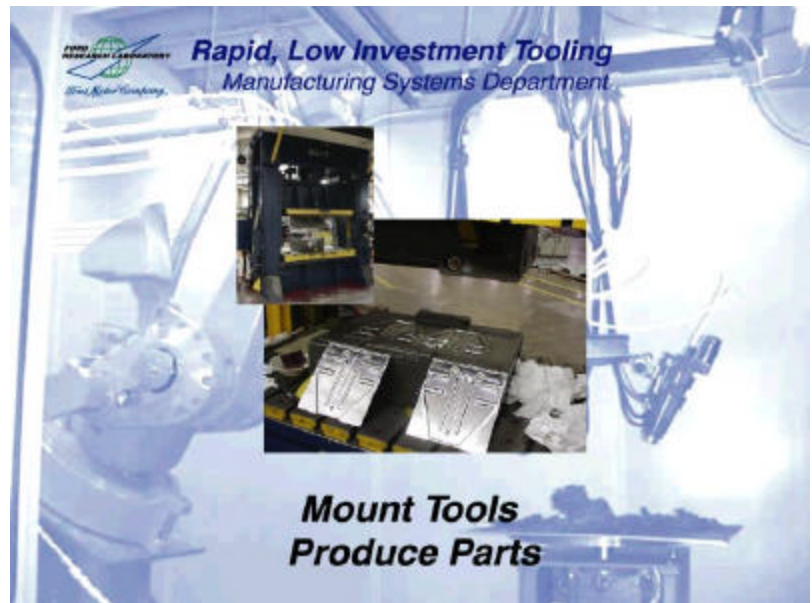

Quality: Tool geometry
within ± 0.08 mm (0.003")

Rapid, Low Investment Tooling (cont.)

D. Collins (Ford Motor Company)

Tool Size:

Demonstrated: 0.9 m × 0.9 m (36" × 36")

Goal: 2.4 m × 2.4 m (96" × 96") by 2004

Rapid, Low Investment Tooling
Manufacturing Systems Department

Tool Size: Demonstrated: 36" x 36"
Goal: 96" x 96" by 2004

2004 (96" x 96")

2000 (36" x 36")

1998 (18" x 18")

Rapid, Low Investment Tooling
Manufacturing Systems Department

Intellectual Properties: USA / Worldwide

- 22 Patents Issued WW based on 7 Original US Patents
- 34 Patents Pending WW based on 14 Original US Patent Submissions
- 3 New Invention Disclosures Submitted

Implementation:

Partnership established with **PRAXAIR** (LARGE TECHNOLOGIES)

- FRL Spray Facility
- Norwood Spray Facility
- Oxford University Joint Venture

Rapid, Low Investment Tooling
Manufacturing Systems Department

Close-up of tooling components.

Interior view of the spray facility.

Rapid, Low Investment Tooling (cont.)

D. Collins (Ford Motor Company)





Imaging Pyrometer for Monitoring the Surface Temperature of a Spray Formed Steel Billet

J. E. Craig (Stratronics, Inc.)





IMAGING PYROMETER FOR MONITORING THE SURFACE TEMPERATURE OF A SPRAY FORMED STEEL BILLET

Jim Craig, Stratronics, Inc.,

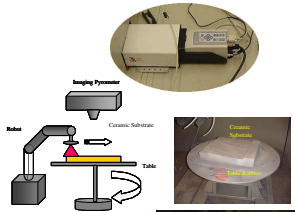
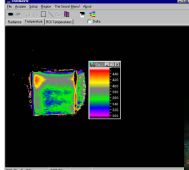

Outline

- *Motivation*
- *The Instrument*
- *Physics*
- *Two-Color-Imager*
- *Installation*
- *Thermal Measurements*
- *Results*
- *Future*

The deposition process requires a non-intrusive optical technique to measure the temperature of the spray formed billet. These accurate measurements must be made regardless of the environmental conditions. Dust will attenuate some of the light and so will deposition or coating of the sensing portal. Despite these problems we require accurate measurements during the deposition time, which can last many hours.

There should be minimal adjustment to the sensor over time. Routine calibration should be simple and be performed in-situ. Also we need to feed thermal information to a process controller so that the gun parameters and robot trajectory can be modified to make the spray more uniform in deposition temperature. Finally we would like to obtain information on the process in a research mode so that the process can be improved.

Motivation

- *Provide a robust non-intrusive method to measure the temperature of a spray formed steel billet during deposition process.*
- *Provide accurate thermal measurements despite optical conditions within the spray booth.*
- *Provide feedback and control information for the robot controller and the power to the spray guns.*
- *Provide research capability for future improvements to the process.*

Imaging Pyrometer for Monitoring the Surface Temperature of a Spray Formed Steel Billet (cont.) J. E. Craig

A new rapid prototyping process has been developed for the automotive industry by Ford Motor company. This process uses four twin wire arc TAFE model 8835 plasma spray torches, robot controlled to deposit steel metal at a high rate. Whereas many spray processes are geared towards millimeters or less deposition, in this process several cm of material are deposited in a short period of time.

Presently the process is limited to sprays of less than 0.7 m in diameter. Future improvements will push the size of the deposition to greater than 1 m².

The ThermoViz is a two-color imaging pyrometer. The FORD model works at the near IR wavelengths (1 to 1.7) μm, provided by a focal plane InGaAs detector. Since the surface temperature is near 300 °C the working wavelengths for the instrument were chosen to be 1.4 μm and 1.65 μm. The system acquires images at 30 Hz. These images can be averaged to reduce noise. The instrument acquisition system contains algorithms to provide scene rejection during the blocks of time where the spray gun is within the Field of View (FOV).

Radiation pyrometry is the calculation of the temperature of an object by measuring the photon flux from the source, and via Planck's law converting the photon flux into a temperature. For a blackbody this process is straight forward, however, since most objects do not emit like a blackbody there is a scaling term called the emittance that describes the divergence of the object from blackbody behavior.

The emittance is a function of temperature and wavelength. Sometimes this dependence is weak, as in our case where we will be looking at the deposition of steel onto a substrate.



Spray-Form Facility at FORD

Features

- *Robot controlled 4 head twin-wire arc plasma spray guns*
- *Rotating billet*
- *Exceptionally thick spray formed deposit*
- *Rapid Tool Formation*





ThermaViz Imaging Pyrometer

- *Two-color imaging pyrometer @ 1.4 μm to 1.6 μm*
- *InGaAs technology for low temperature surface measurements*
- *30 fps data acquisition*
- *Scene rejection and process control output*



ThermaViz installed at FORD



The Physics

Pyrometry: Measure the emission of light from a heated object and convert the measured photon flux into temperature.

$$L_e(\lambda, T) = C \cdot \epsilon \cdot \lambda^{-5} \{e^{-hc/\lambda T} - 1\}^{-1}$$

Where: $\epsilon < 1$ for any real object
 λ = wavelength of light

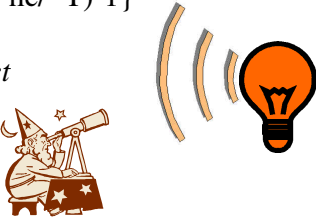

Imaging Pyrometer for Monitoring the Surface Temperature of a Spray Formed Steel Billet (cont.)

D. Collins and J. E. Craig

The hot steel surface has a gray emittance, meaning that the ratio of the emittance is near a constant over the temperature range of interest. Sometimes the emittance changes dramatically, for example across the surface of a pool of molten steel with oxidized sludge on the top. In this case, the emittance can vary by more than an order of magnitude. Therefore, although anywhere on the surface temperature is uniform, the photon flux emitted by the surface may change a great deal. A further complicating matter in the relation of temperature from the measured emitted photons is the fact that there may be opacity of the photons along their line of sight between the source and the detector. For example if there is a cloud of dust, the light levels may be reduced due to scattering. Also if there is a dust coating on the optical sensing element there will be a corresponding reduction in the measured photon flux from the source. Therefore, a pyrometer based on photon flux, or photon counting will interpret the reduction in the flux due to opacity or dust as a reduction in the temperature of the source.

A method for minimizing these affects in the temperature measurement is to measure the radiation in two bands simultaneously. This is called ratio pyrometry. If the emittance is slowly varying with wavelength and temperature, the ratio will not change and the ratio can then be converted to temperature, regardless of the fact that there is intervening opacity between the source and the sensing element. If the number of photons originating from the source are reduced due to scattering or absorption processes, then it is likely that the same number of each color photon (for the two-color pyrometer) will be reduced equally, thus the ratio will be unaffected, resulting in the correct temperature. Another important advantage to the ratio pyrometer, is that there is less user "guessing" of the emittance in the measurement process. There is no need to input an assumed emittance or slope term to convert the measured photon flux to a true temperature. Although the number of photons observed at the sensor goes as T^4 and only linearly with the emittance, it is true in some cases, such as a dusty environment, that the computed temperature from a single wavelength instrument will be off by as much as 50 °C for a source at 300 °C, while the ratio method will still provide the correct temperature.

We have chosen to implement a ratio imaging pyrometer for the reason of measurement robustness, calibration robustness, and minimal user interaction in the computation process. I will be describing our ThermaViz two-color imaging pyrometer, which measures the photon flux of a source at two different wavelengths simultaneously on a single focal plane array. The system is insensitive to the dust clouds produced during the spray forming process and insensitive to the reduction in overall light levels as the main optic window is coated during a deposition process that lasts several hours.

The two-color imaging pyrometer operates in the (1 to 1.7) μm range using InGaAs detector technology. The camera can acquire 30 Hz of imagery at a 12 bit resolution. The two wavelength bands are selectable and have been chose between (1.4 and 1.65) μm to maximize sensitivity at 300 °C. The system includes sophisticated thermal image processing software with scene rejection capability. More about this as we move further along in the talk. The present FOV of the system is 0.6 m. This limitation is provided by the optical front end of the instrument and is envisioned to be relaxed in the future as the spray form deposition process is improved to allow for larger part coating. The temperature range of the instrument is between about 180 °C and 500 °C. One setting for the instrument is provided to allow for maximum sensitivity of the system between 180 °C and 350 °C and a second higher setting which has a low temperature threshold of about 250 °C.



Emittance

- *The emittance of an object is a function of wavelength and temperature.*
- *However, a hot steel surface during deposition has a gray emittance ratio.*
- *In a dusty environment the reduction of intensity may not be an emittance problem.*



Ratio Pyrometry

Why ratio pyrometry ?

Don't forget that the user may not be a thermographer or professional with extensive experience with pyrometry.

The instrument must be robust and able to be operated by a technician, with minimal user input (no emittance dial necessary, no slopes etc.)



The Two-Color Imager

- *Indigo camera operating from 1 μm to 1.7 μm at 30 fps.*
- *2 Color band pass at 1.4 μm and 1.6 μm .*
- *Image processing providing real time thermal images with active scene rejection.*
- *0.6 m field of view.*
- *Temperature from 180 °C to > 500 °C.*
- *Windows 2000 System.*

Imaging Pyrometer for Monitoring the Surface Temperature of a Spray Formed Steel Billet (cont.) J. E. Craig

The pyrometer works by imaging the source onto a slit in the optical head. The slit is then imaged through two optical paths where each path has a different pass band. The short and long wavelength images are formed simultaneously on a single focal plane. Great care is taken to assure that the magnification of each leg of the system is the same, and that the registration of each image is carefully measured. The pixels of the long wavelength image are ratioed with their companion pixels in the short wavelength image. This provides essentially 32,000 ratio pyrometers or radiometers. A system model of the instrument is then used to convert the ratio data to temperature data. The data can also be expressed as if obtained from two single color thermal imagers.

Operation of the Two-Color Imager

- Scene is imaged onto a slit
- Image on slit is split into a short wavelength image and a long wavelength image
- Image is reconstructed onto the Focal Plane Array
- Pixels are ratioed from the two images to produce a thermal image

2 simultaneously obtained images

Thermal Image

Installation at Ford

- *Initial installation Dec 2000*
 - Imager Target Temperature range = 250 °C
 - Imager Location Defined
 - Operating environment defined
- *Final installation Feb 2001*
 - Imager target temperature = 350 °C
 - Plasma light mitigation implemented
 - Communication to process controller implemented

Pyrometer Installation

- Pyrometer was located above rotating table
- Robot raster scan spray pattern and table rotation to provide even thermal spray distribution

Imaging Pyrometer

Robot

Ceramic Substrate



Table

Ceramic Substrate

Table Rotation

Imaging Pyrometer for Monitoring the Surface Temperature of a Spray Formed Steel Billet (cont.) J. E. Craig

Calibration of the imager is provided by measuring the temperature change of a gray body cavity which is very nearly a blackbody. The aspect ratio (length/diameter) of the cavity is much larger than 5 implying that the cavity is 99 % of a blackbody. The temperature standard is provided by a thermocouple imbedded in the cavity, thus the source temperature is probably known to about 1 °C. The imager is also calibrated in-situ using a 102 mm (4") graybody surface source that can attain a temperature in excess of 450 °C.





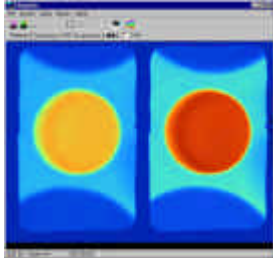

Thermal Image of a Gray-body Cavity Calibration Source

Radiance Images

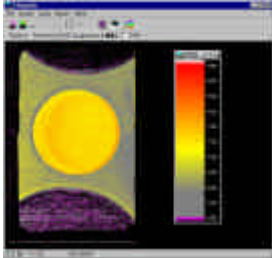

Thermal Image





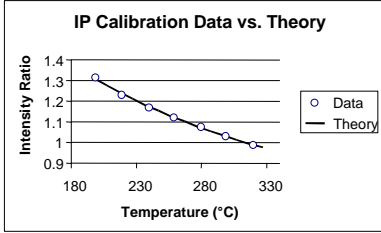

ThermaViz Low Temperature Calibration

- *The first installation of the Ford instrument was for low temperature*
- *Calibration of the instrument showed $T = 2^\circ\text{C}$*
- *Low temperature limit was 200 °C*



Low Temperature Calibration

Calibration *In-situ*

- *Calibration with a 102 mm (4") steel block "gray" source.*
- *Second installation included a higher temperature range.*
- *In-situ calibration showed $T = 2^\circ\text{C}$ (ratio mode).*
- *Dynamic range from 200 °C to greater than 500 °C.*

Imaging Pyrometer for Monitoring the Surface Temperature of a Spray Formed Steel Billet (cont.) J. E. Craig

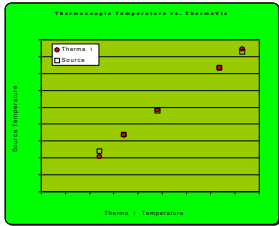

Thermal Measurements

- *Square*
- *Rectangle*
- *Hood element*
- *Fly wheel element*
- *Square with thermocouple probes*



Plasma Light Contamination

- *Plasma Light distorts measurements during deposition*
- *Require threshold to record data during robot parking*



The Rectangle Test Target



Schematic of target

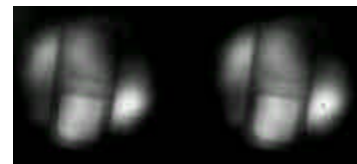

Radiance image

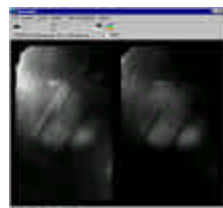

White light image of target

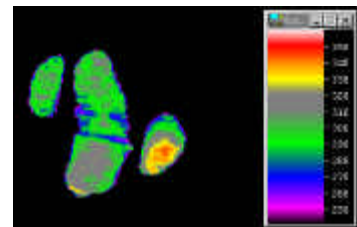

Thermal Image

Imaging Pyrometer for Monitoring the Surface Temperature of a Spray Formed Steel Billet (cont.) J. E. Craig

 **Instrumented Ceramic Square**

Ceramic Square with thermocouples inserted from the bottom side.

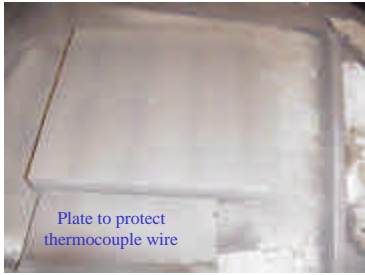
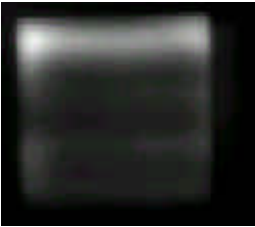
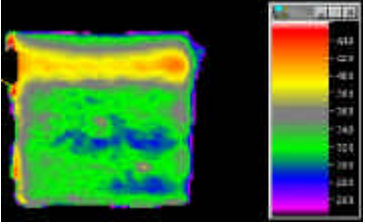



Plate to protect thermocouple wire





Radiance Image

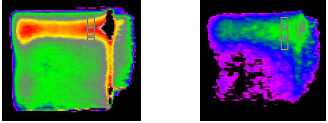
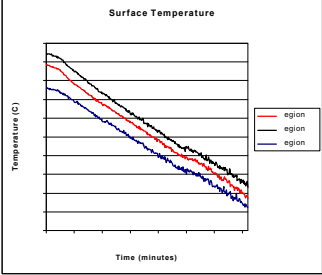

 **Instrumented Ceramic**

- *Ceramic Square thermal measurement as a function of time.*
- *Thermocouple and surface IP measurement agreed until steel-billet became thick.*

 **Complex Hood Topology**

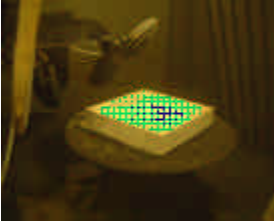

Ceramic Hood Form

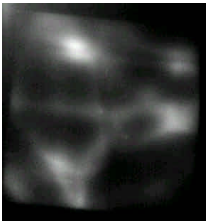

Radiance Image



Form after short deposit time

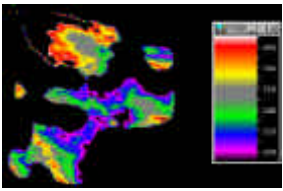

Thermal Image during spray

Imaging Pyrometer for Monitoring the Surface Temperature of a Spray Formed Steel Billet (cont.) J. E. Craig



Finished Product

- *Steel Billets are created by the thermal spray process.*
- *Tool Steel is used to stamp sheet metal*



Steel Cap (tool)



Stamped Metal Product



Hood Stamping Tool

- *Inner hood stamping tool.*
- *12 small sections bonded together to make a large one.*



Results

- *Temperature measurements within 1 °C in two-color mode.*
- *Temporal measurements at 30 fps*
- *Active scene rejection due to stray plasma light*
- *RS 232 communication to the process controller*

High Enthalpy Plasma Spray

L. George (Progressive Technologies, Inc)



HE™ Plasma Technology

High Enthalpy Plasma Spray

Today's Presentation

- Discuss Traditional Plasma Gun Technology
- Present *PROGRESSIVE*'s "HE" Series of Plasma Guns
- Compare Performance Characteristics with Traditional Plasma Guns

Plasma Process Development

Objectives

- Provide a stabilized electric arc
- Introduce powders efficiently into the plasma plume
- Provide improved heating of powder particles
- Eliminate segregation of powder particles

High Enthalpy Plasma Spray (cont.)

L. George (Progressive Technologies, Inc)

Plasmatron Technology

Definitions

- Plasmatron
 - The plasma generator inside a plasma torch
- Plasma Spray Gun
 - Plasmatron + Powder Injection (Powder Port)

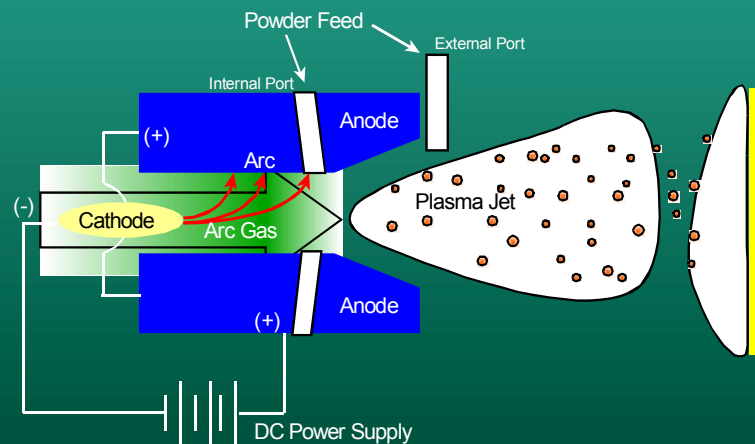
Traditional Plasma Spray Torch***PROGRESSIVE* Plasmatron**

With Stabilized Electric Arc

- Stabilized Electric Arc
 - Elongated Arc (1.5" - 4")
 - High Voltage (150-300 Volts)
 - Low Amperage (200-500 Amps)
 - Tungsten Anode
 - Long Life & No Spitting

High Thermal Efficiency

Elongated Arc (40 mm to 100 mm) (1.5" to 4")

High Enthalpy Plasma Spray (cont.)

L. George (Progressive Technologies, Inc)

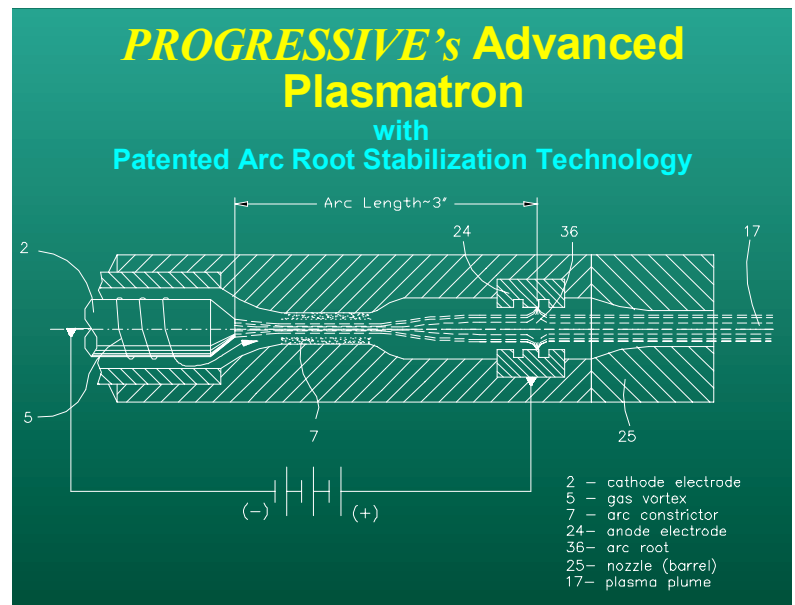
Arc length ≈ 76 mm (3")**Patented Arc Root Stabilization
Technology****Benefits**

- Gun Does Not Function in Restrike Mode
 - Minimum Voltage Ripple
 - Highly Stable Plasma
 - Very Low Electrode Wear
 - Efficient Ternary Gas Operation
 - High Enthalpy Generated \Rightarrow Increased Spray Rates
 - Higher Plasma Ionization \Rightarrow Increased D.E.

**PROGRESSIVE's Advanced
Plasmatron****Superior Plasma Plume Generation**

- 100HE™ plasmatron operates efficiently with ternary plasma gas mixtures such as $\text{Ar} + \text{N}_2 + \text{H}_2$
 - Nitrogen and Hydrogen are complementary plasma gasses
 - 20-30% higher enthalpy than conventional plasma
 - Typical enthalpy of 100HE™ $\text{Ar} + \text{N}_2 + \text{H}_2$ plasma: 10-14 kJ/l
- Higher heat transfer to powders due to 30-40% more thermal conductive gas mixtures.
 - N_2 and H_2 thermal conductivity peaks are located adjacently at ~ 4000 °K and ~ 7000 °K

High Enthalpy Plasma Spray (cont.)

L. George (Progressive Technologies, Inc)

**PROGRESSIVE's Advanced
Plasmatron**

Superior plasma plume properties

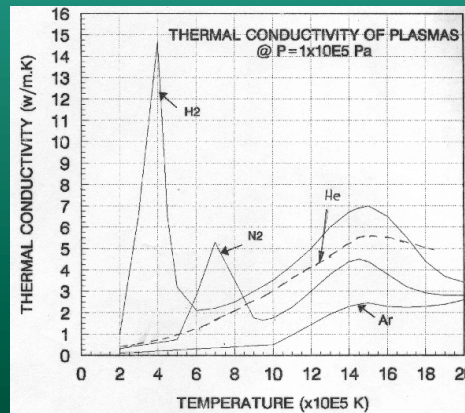
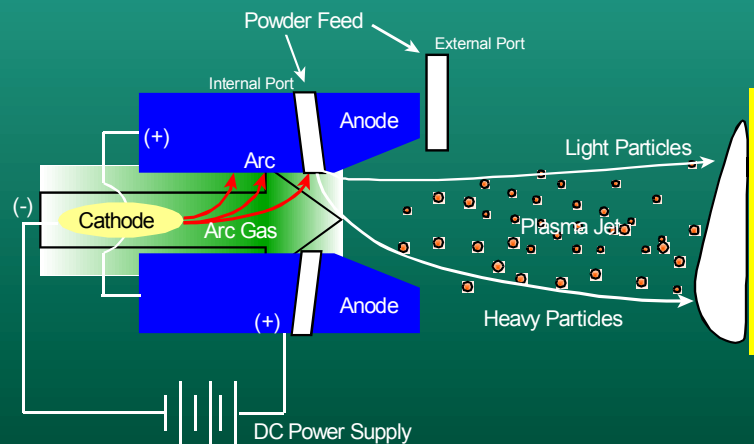
**Traditional Powder Injection****Powder Injection**

Traditional Radial Feed

- External Powder Feed
 - Injects particles outside of the gun after the gas begins to expand
 - Particles have shorter dwell time in jet
 - Very sensitive to powder size distribution
- Internal Powder Feed (Nozzle = Anode Electrode)
 - Injects powder inside the nozzle throat
 - Provides better particle heating
 - Electric arc root disturbs powder injection
 - Arc root melts powders → spitting
 - Arc restrike turbulence → Loss of powder → Low D.E.
 - Particle segregation → Non uniform heating

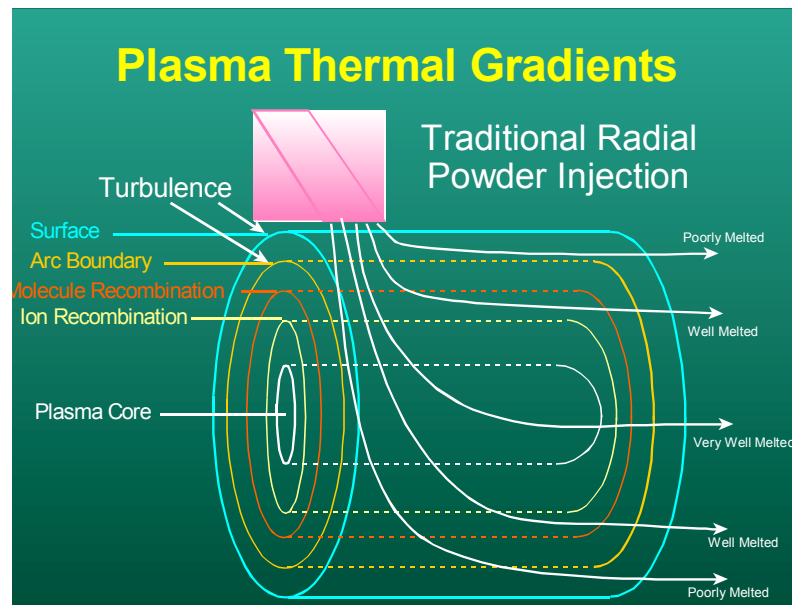
*High Enthalpy Plasma Spray (cont.)**L. George (Progressive Technologies, Inc)*

In-Flight Particle Segregation

Leads to Problems

- Low Spray Rates
 - Lower Productivity
- Low Deposit Efficiency
 - Powder Waste
- Higher Coating Costs!
- Solution?

Patented Axial Powder Injection Technology

- The plasma plume is split and then re-converged by the axial injector in order to bring powder in the center
- Particles are injected along the axis of the nozzle

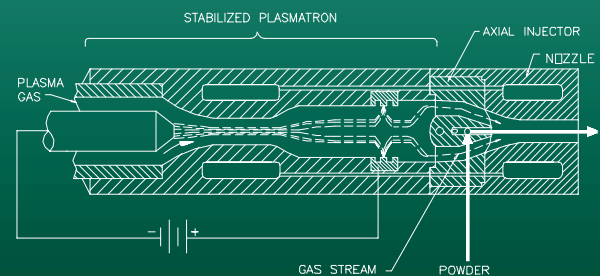

High Enthalpy Plasma Spray (cont.)

L. George (Progressive Technologies, Inc)

Axial Powder Injection Technology

- *PROGRESSIVE's* 100HE Plasma Gun accepts Patented Axial Powder Injection Technology
 - Increased Powder Entrainment in the Plume
 - Increased Heat Transfer to Powder
- With Axial Feeding of Powder
 - Particles travel in direction of the plasma flow
 - Little or no segregation
 - Rapid particle acceleration
- Most Suitable for Metals, Alloys and Carbides Due to its High Velocity

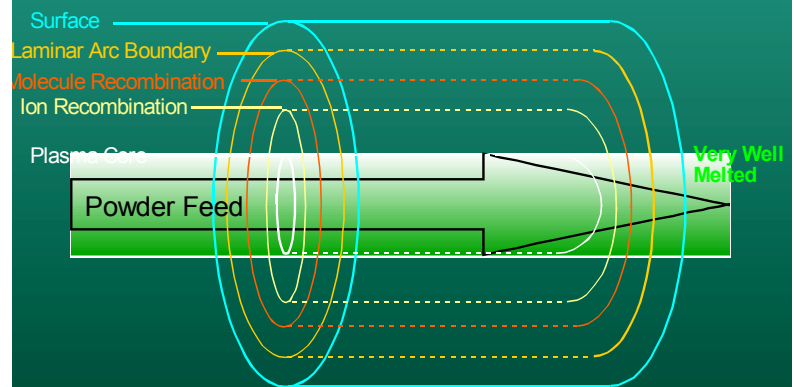
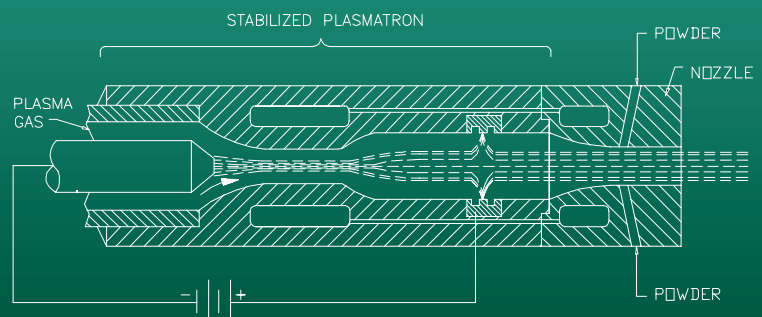
Axial Powder Injection**Advanced Radial Injection Technology**

High Enthalpy Plasma Spray (cont.)

L. George (Progressive Technologies, Inc)

Advanced Radial Injection Technology

- PROGRESSIVE's 100HE™ plasma guns accept both axial and radial injection as quick screw-on attachments.
 - Simultaneous axial and radial injection for dissimilar materials is also possible.
- The separation of the anode from the nozzle (barrel) and the stabilization of the electric arc allow the efficient use of radial injection particularly for high melting point ceramics:
 - Lower particle velocity for improved melting
 - No arc boundary turbulence at injection port = laminar powder feeding = Uniform particle heating = High Deposit Efficiency (Ex: 80-90% for YSZ)
 - Anode separated from nozzle = No arc-powder interference
 - Symmetrical powder ports for high plume loading = High spray rates

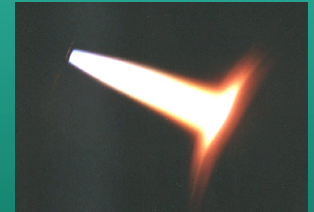
**PROGRESSIVE's
Powder Injection**

- Reduced In-flight Particle Segregation
 - Higher Deposition Efficiency (up to 95%)
- Increased Plasma Loading
 - Higher Spray Rates (up to 4 times)
- Increased Plasma Ionization
 - Higher DE
 - Less Powder Waste
- Reduced Coating Costs!

PROGRESSIVE Plasma System**Benefits**

- Conventional \$1,000 coating at ½ the cost
 - Takes 1/4 the time to produce
 - 75% increase in productivity
- Enables additional revenue through increased volumes
- Faster return on capital investment
- Substantial savings in powder consumption

High Enthalpy Plasma Spray (cont.)

L. George (Progressive Technologies, Inc)

Yttria Stabilized Zirconia

Microstructure 200X

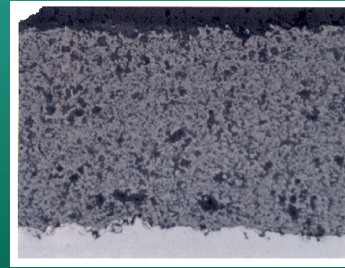

Composition: ZrO_2 - 93%, Y_2O_3 -7%
 Particle Size: $-45 +10\mu$

Spray Rate: 100 g/min
 Dep. Eff.: 79%
 Porosity: 7 - 10%

Yttria Stabilized Zirconia

Microstructure 200X

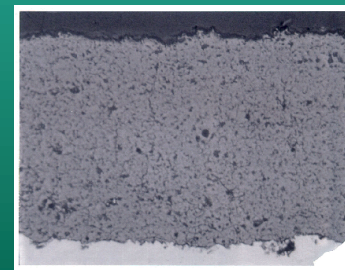

Composition: ZrO_2 - 93%, Y_2O_3 -7%
 Particle Size: $-45 +10\mu$

Spray Rate: 100 g/min
 Dep. Eff.: 80%
 Porosity: < 3%

Chromium Oxide

Microstructure 100X

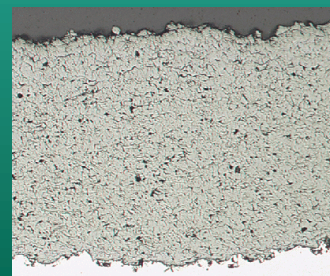

Composition: Cr_2O_3 - 99.9%

Spray Rate: 100 g/min
 Dep. Eff.: 60%
 Avg. Hardness: 1300 DPH

High Enthalpy Plasma Spray (cont.)

L. George (Progressive Technologies, Inc)

Aluminum / Silicon Polyester

Microstructure 100X



Composition: Aluminum/Silicon 60%
Polyester 40%

Spray Rate: 100 g/min
Dep. Eff.: 85%
Avg. Hardness: 62.9 HR15Y

Air Sprayed Metallic Coatings

- Low Oxide Air Sprayed Coatings
- Near Complete Powder Entrainment in Plasma Plume due to Axial Feed



316L Stainless Steel - Air Sprayed

Gas Velocities

100HE™ Gun with 1.250" Barrel

- Ceramics Parameters
 - ▶ 500 - 800 m/s
 - ▶ Use 1/2" to 3/4" bore
- Metallics / Carbides Parameters
 - ▶ 1800 - 3000 m/s
 - ▶ Use 1/4" to 3/8" bore

Ceramics Parameters

Use 13 mm to 19 mm (1/2" to 3/4") bore

Metallics / Carbides Parameters

Use 6.4 mm to 9.5 mm (1/4" to d") bore

High Enthalpy Plasma Spray (cont.)

L. George (Progressive Technologies, Inc)

Concentric Gas Shrouds

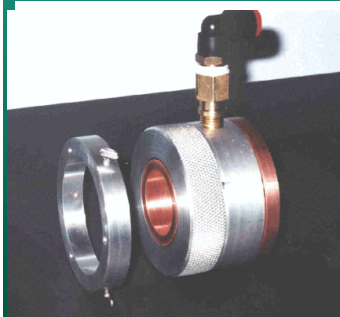

- Multiple Concentric Gas Shrouds
 - Surrounds jet with inert gas
- Reduces oxidizing effect of Oxygen in surrounding air
 - Results in fewer oxide inclusions in coating

2 Major Advances in Plasma Spray Technology

- Elongated Electric Arcs
 - 40 mm to 100 mm (1.5 in to 4 in)

ENHANCED PLASMATRONS

WITH FLEXIBLE POWERS: 10 - 200 kW

- Elongated Electric Arcs
 - 1.5 - 4 in
- High Voltage Electric Arcs: 150 - 300 V
 - 200 - 250 V typical
- Stabilized Electric Arc
 - No Restrike
- Separation of the Anode from the Plasma Barrel
- Ternary Gas Operation Ar+N₂+He/H₂
- Self Aligning Electrodes
- Long Electrode Life
- High Process Stability

ADVANCED POWDER INJECTION

WITH FULL POWDER ENTRAINMENT

- Powders Injected into the Output Plasma Barrel
 - Separated from the Anode
- Residence Time is Easily Controlled by the Length of the Output Plasma Barrel
- Particle Velocity is Easily Controlled by the Bore Size of the Output Plasma Barrel
- Gas Shrouding is Very Efficient

50NB™ & 100HE™ Plasma Systems

Single Cathode Design - High Efficiency

50NB™

20-50 kW

Narrow Beam for High Target Efficiency

100HE™

80-100 kW

High Energy for High Production Rates

High Enthalpy Plasma Spray (cont.)

L. George (Progressive Technologies, Inc)

50NB™ & 100HE™ PLASMA SPRAY GUNS

- Reduced Dependence on Carrier Gas Flows
- Control of Particle Residence Time
- Increased Control of Particle Melting
- Gas Velocities Comparable with HVOF
- Easy Parameter Development

NIST Thermal Spray Research

Title: Ceramic Coatings Program (see *presentation on page 65*)
following from: <http://www.msel.nist.gov/ceramiccoatings.htm>

The Ceramic Coatings Program addresses plasma spray deposited and physical vapor deposited ceramic thermal barrier coatings (TBC) used in aircraft, land-based turbines, and diesel engines as well as wear resistant coatings used in many applications. These materials are a significant portion of the nearly one billion dollar North American ceramic coatings market. A primary goal of this program is to improve the reliability of ceramic coatings. Collaborations have been established, e.g., Pratt and Whitney, General Electric, Caterpillar, METCO, Praxair Coating Technologies, as well as the Thermal Spray Laboratory at the State University of New York at Stony Brook, NASA Lewis Research Center and the Thermal Spray Laboratory at Sandia National Laboratory, to enable research on relevant materials and to transfer results to users. Collaborations are also underway with Bundesanstalt für Materialforschung und -prüfung (BAM) and Deutsche Forschungsanstalt für Luft-und Raumfahrt (DLR), both in Germany, for the development of characterization techniques for thin, hard coatings and TBCs. A strong attribute of the coatings research program is the use of common materials for which complementary data can provide a more complete understanding of processing-microstructure-property relationships. Participants in the NIST program are located in MSEL, i.e., Ceramics Division, Materials Reliability Division, Metallurgy Division, and the NIST Center for Neutron Research, as well as in the Chemical Science and Technology Laboratory. The program has the following elements:

- Development of predictive models for the long-term reliability of ceramic coatings under operating conditions.

- Relating microstructural characteristics such as fine voids and phase stability to thermal and mechanical properties.

- Developing and validating microstructure based models that predict coating performance.

- Development of measurement methods such as online instrumentation for improved control of thermal spray processes and thermal properties.

Title: Processing-Structure-Property Data for Thermal Spray Coatings

The consensus of the participants of this workshop was that the reproducibility and reliability of TS coatings need to be improved in order to realize the full benefits of this technology. Also, the processing procedures and properties of TS coating systems are not well documented or available. A Web-based source of TS coating processing-microstructure-property data could provide valuable guidance to current users and potential users of this technology.

In response to this need, the NIST thermal spray diagnostics project will assemble such a database through a Working Group formed under the auspices of the ASM Thermal Spray Society and co-chaired by Christopher Berndt of SUNY (also Editor of the Journal of Thermal Spray Technology), Richard Knight of Drexel University, and Stephen Ridder of NIST. The workshop participants and others from the TS community will provide data to be critically evaluated by the working group before inclusion in the thermal spray coating database. It is expected that this database of processing-microstructure-property data will be disseminated through the equipment producers when new equipment is purchased, through ASM or NIST to current users, and through the well-attended ASM short courses on “Thermal Spray Technology” taught by Berndt and Knight. A meeting is being planned to discuss the formation of this Working Group, the structure of the database, and a priority list of coating systems to be included.

Although the specific needs for database information have not been established, it is anticipated that, for most coating systems, the required data will include substrate composition, substrate residual stress, substrate cleaning and/or roughening by grit blasting, substrate preheat, powder feedstock data, powder flow rate, particle temperature and velocity in plasma jet, gun position and velocity information, and the resulting coating properties. In order to produce high-priority, accurate data that are needed but not available, NIST will work with the Center for Thermal Spray Research at SUNY - Stony Brook, Sandia National Laboratories, and INEEL to define and carry out thermal spray processing experiments under well controlled operating conditions. The generation of this database information requires the use of process measurement tools that provide the process parameter and coating property data as well as providing the process controls necessary for producing reproducible TS coatings. It is expected that an additional deliverable will be a "best practices" guide for thermal spray processing.

