

UNITED STATES
CONSUMER PRODUCT SAFETY COMMISSION



LABORATORY TEST MANUAL

FOR

16 CFR Part 1633:

Standard for the Flammability (Open Flame) of Mattress Sets

January 2008

This test manual was prepared by CPSC staff and has not been reviewed or approved by, and may not necessarily represent the views of, the Commission.

TABLE OF CONTENTS

1. SCOPE3

2. SUMMARY OF 16 CFR PART 1633 STANDARD3

3. PERFORMANCE REQUIREMENTS3

4. GENERAL EQUIPMENT LIST4

5. TIMELINE5

6. SAFETY.....6

7. SPECIMEN INSPECTION6

8. SAMPLE CONDITIONING.....6

9. CALIBRATION OF TEST INSTRUMENTS.....7

 9.1 Calorimetry Hood7

 9.2 Propane Flow Control System7

10. TEST PREPARATION11

 10.1 Test Area Conditions11

 10.2 Prepare Test Floor Area11

 10.3 Camera Placement11

 10.4 Burner Assembly Inspection.....13

11. SETTING BURNER TIMERS17

 11.1 For Calibration of Propane Flow Control System17

 11.2 For Testing17

12. DATA COLLECTION17

13. TEST PROCEDURE18

14. TERMINATION OF TEST31

15. TEST REPORT AND CERTIFICATION31

16. SPECIMEN PLACEMENT: TRADITIONAL AND NON-TRADITIONAL PRODUCTS32

 16.1 Products Less Than Six Inches Thick.....32

 16.2 Segmented Products.....32

 16.3 Non-Rectangular Products33

 16.4 Folded or Compressed Products33

17. APPENDICES34

 Appendix A: Description of Test Equipment35

 Appendix B: Sample Data Sheet.....40

 Appendix C: Sample Data Sheet for Calibration of Propane Flow Control System41

 Appendix D: Sample Log Sheet for Calibration of Propane Flow Control System42

 Appendix E: Calculations for Calibration of the Propane Flow Control System43

 Appendix F: Sample Log Sheet for Correction Factor (C-factor) of Calorimeter System.....44

 Appendix G: Test Frame Design Considerations45

 Appendix H: Directions for Setting 700-HX Timers.....46

 Appendix I: Practice for Calorimetry Hood Calibration and Validation.....48

 Appendix J: Guidance on Early Termination of Test50

1. SCOPE

This U.S. Consumer Product Safety Commission (CPSC) staff laboratory test manual is a reference guide designed to assist with the testing procedures specified in the *Standard for the Flammability (Open-Flame) of Mattress Sets* codified at 16 CFR Part 1633 (the Standard).

This test manual is not the complete mandatory standard, but an additional tool that may be used in conjunction with the requirements specified in the Standard. The test manual is provided for advisory and guidance purposes only and is not intended to be fully inclusive of the test procedures, nor is it intended to replace or supersede any sections of the Standard. In case of any discrepancies between this manual and the Standard, the Standard will supersede this test manual.

The test manual also identifies testing equipment used to conduct testing in accordance with the Standard. The descriptions and pictures are not meant to serve as specifications or recommendations of any brand, make, or model of instrumentation that must be used in order to comply with the Standard, but rather as examples for clarification purposes.

2. SUMMARY OF 16 CFR PART 1633 STANDARD

The Standard establishes open flame flammability requirements that all mattress sets, as defined in §1633.2(c), must meet before sale or introduction into commerce. The test method specified in the Standard (set forth in §1633.7) measures the flammability performance of a mattress set specimen by exposing the specimen to a specified flaming ignition source and allowing it to burn freely in a controlled test area. The test area must be one of two configurations, either an open calorimeter (or furniture calorimeter) or a test room meeting specified dimensions. The flaming ignition source is specified as a pair of propane burners that impose differing heat fluxes for differing times on the top and side of the specimen. Measurements of the time-dependent heat release rate from the specimen are made during and after exposure to the specified burners in order to quantify the energy generated by the fire. The rate of heat release is measured by oxygen consumption calorimetry.

3. PERFORMANCE REQUIREMENTS

A specimen fails to meet the requirements of the Standard if either of the following occurs:

- The peak heat release exceeds 200 kilowatts (kW) at any time within the 30 minute test.
- The total heat release exceeds 15 megajoules (MJ) for the first 10 minutes of the test.

4. GENERAL EQUIPMENT LIST

Perform the mattress open flame test in a facility that has the ability to perform oxygen consumption calorimetry with an acceptable level of accuracy, capture the data produced during a test, and calibrate according to the directions provided in the Standard. It is recommended that a relevant reference document such as *ASTM E2067 Standard Practice for Full-Scale Oxygen Consumption Calorimetry Fire Tests* be consulted for more information. Beyond those basic facility requirements, the list below is a suggested equipment list for performing open flame mattress flammability tests. Some equipment is required (indicated by an asterisk, “*”) while other equipment is recommended. Refer to *Appendix A, Description of Test Equipment* for information on test equipment. Specific equipment lists are provided at the beginning of each test section.

1. Burner alignment platen*
2. Burner assembly *
3. Burner stand-off foot jig*
4. Calcium silicate or fiber cement board*
5. Calibrated spring scale (250 gram capacity)*
6. Connecting hose for test meter
7. Data sheets
8. Diaphragm-type test meter*
9. Duct tape*
10. Extra frame crosspieces*
11. Fire suppression system/apparatus
12. Instrumentation for measuring temperature, humidity, and atmospheric pressure
13. Lubricant for burner assembly*
14. Multipurpose lighter
15. Non-combustible material to be used as filler (ex. aluminum foil)
16. Non-combustible material to be used as risers for test frame (ex. ceramic tile or brick)
17. Placard*
18. Propane flow control system*
19. Propane, Chemically Pure (CP)*
20. Razor blade or box cutter
21. Ruler or other appropriate distance measurement device
22. Sand diffusion burner
23. Scrapers
24. Side burner screen*
25. Stop watch or a watch with a “seconds” hand
26. Test frame*
27. Thermal imaging device
28. Top burner screens*
29. Video camera(s) and/or still camera(s) and tripods*
30. Video lights*
31. Video media

5. TIMELINE

The following timeline outlines the basic steps for performing the mattress open flame test as described in 16 CFR Part 1633.

Time	Task	Laboratory Manual Reference
48 Hours Before Test	Inspect and Condition Specimens	Sections 7 and 8
48 Hours – 20 Minutes Before Test	Monitor Conditioning Area	Section 8
	Calibrate/Check Test Instruments	Section 9
	Prepare Test Area	Section 10
20 Minutes Before Test (Maximum)	Place Specimen on Test Frame	Section 13
	Align Burner	
2 Minutes Before Test	Start Camera(s)	
1 Minute Before Test (Minimum)	Start Data Logging	Section 12 and 13
TEST START	Ignite Specimen	Section 13
During Test	Document Performance and Observations	
30 Minutes After Ignition	Suppress Remaining Flames	Section 13 and 14
3-5 Minutes After Suppression	Record Baseline with Data Acquisition System	Section 13
Post-Suppression (When Safe)	Clean Up and Prepare for Next Test	

6. SAFETY

Testing personnel should have personal protective equipment available that is appropriate for large-scale fire testing and be cleared and trained to use it. A fire suppression system capable of handling large-scale fires should be charged and ready to use when testing specimens. Monitor all ignited specimens closely for rapid fire growth that would present a danger to test personnel and/or the test facility. Monitor suppressed samples for re-ignition and dispose of properly.

7. SPECIMEN INSPECTION

Inspect specimens as they are placed in the conditioning room for manufacturing defects or damage during handling. The presence of faults including, but not limited to, snags, discolorations, skipped stitches, tears, and holes should be noted and recorded by the test operator. Leave hangtags and labels on the specimens, but remove packaging or plastic to allow the specimens to condition. Repeat an inspection before testing a specimen, being sure to note and record any findings on the test report.

8. SAMPLE CONDITIONING

Condition samples according to the requirements in §1633.7, shown in Table 1.

Table 1. Conditioning Requirements: Mattress Sets/Sleep Surfaces

Temperature Range	Relative Humidity	Duration of Conditioning
18 - 25 °C (65 -77 °F)	< 55%	Minimum of 48 hrs continuous

Place samples in such a way as to allow air flow around the entire specimen. Do not stack or otherwise leave specimens touching each other during conditioning. Do not compress the ignition surface of the specimen during conditioning. The maximum allowable time between removal of a specimen from the conditioning room and the specimen ignition is 20 minutes.



If a sample is out of the conditioning room longer than 20 minutes, then return the specimen to the conditioning room. Recondition a returned specimen three times as long as it was out of the conditioning room. Example: If a specimen is out of the conditioning room for 40 minutes, it must be returned to the conditioning room and reconditioned for at least 120 minutes.

9. CALIBRATION OF TEST INSTRUMENTS

9.1 Calorimetry Hood

Equipment List:

- Propane (or other calibration gas of known heat of combustion)
- Sand diffusion burner

Procedure:

Perform the calibration of the calorimetry system using common fire laboratory practices with at least two heat release rate (HRR) calibration points, 75 and 200 kW. The frequency of calibration and number of points used to calibrate should be determined by the stability of the calorimetry system. It is recommended that these data be maintained in order to track performance of the calorimetry system over time. See *Appendix I: Practice for Calorimetry Hood Calibration and Validation* for a recommended calibration procedure.

9.2 Propane Flow Control System

Check the gas flow rate of each burner at the beginning of each test series. The gas flow rates of each burner are listed in Table 2.

Table 2: Burner Gas Flow Rates

Burner	Flow Rate (L/min)	± (L/min)
Top	12.9	0.1
Side	6.6	0.05

Values are based on Standard Atmospheric Pressure (101 ± 5 kilopascals (kPa)) at a temperature of 22 ± 3 degrees Celsius ($^{\circ}\text{C}$).

Equipment List:

- Burner assembly
- Connecting hose
- Diaphragm-type test meter
- Instrumentation for measuring temperature, humidity, and atmospheric pressure
- Propane flow control system
- Propane, CP
- Stop watch

Procedure:

1. Refer to *Figure 1*. Install the diaphragm-type test meter (DTM) downstream of the propane flow control system in the line of the burner to be measured by connecting the hose from the input of the DTM to the connector on the control box for the burner to be tested (1) and connecting the

burner hose to the DTM outlet (2). In the example below, the top burner is evaluated.

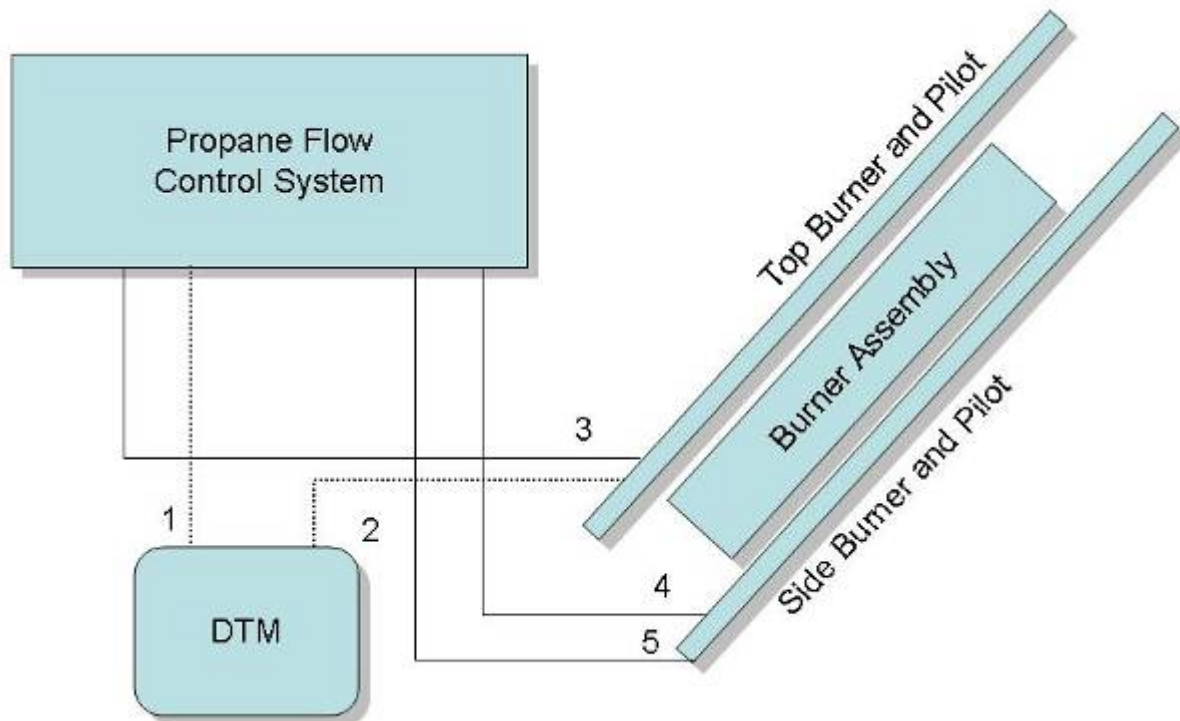

Figure 1. Installation of the DTM in Line with the Burner Assembly

2. Connect the pilot hoses (3,5) and remaining burner hose (4) to the propane flow control system.
3. Inspect the burners for build up or blockages that could impede gas flow. (See *Section 10.4 Burner Assembly Inspection.*)
4. Open the main valve on the propane tank and set the gas pressure to 20 ± 0.5 psig.
5. Plug in the propane flow control system and make sure that the red emergency stop button is pulled out, thereby engaging the power supply. Open the box and set the timers for the burner to be calibrated to 9999 seconds (or the maximum range possible). (See *Appendix H: Directions for Setting 700-HX Timers.*)
6. Open the ball valves for both burner pilots. (Fig.2)
7. Ignite both pilots.



Figure 2. Step 6 Open the ball valves for both burner pilots.

8. Open the ball valves for both burners.
9. Turn both burner switches to "ON" position. (The burners should ignite.) (*Fig.3*)
10. Allow the gas to flow for two to three minutes until the burners and DTM are stabilized. Check all connecting points for gas leakage.
11. Set the horizontal burner flow.



Figure 3. Step 9 Turn burner switches to "ON" position.



Maintaining a log of flow settings such as that shown in *Appendix D: Sample Log Sheet for Calibration of Propane Flow Control System* is helpful for determining the range of flow settings as well as identifying any changes in the propane flow control system over time.

12. Record the barometric pressure and temperature of the test room.
13. Record the pressure and temperature in the DTM. (*Fig.4*)
14. Use a stopwatch to record the greater of a complete rotations or at least one minute of complete rotations while counting the number of rotations. This decision should be based on the capacity of the DTM used.
15. Calculate the propane gas flow rate using the recorded time and number of rotations (total flow in that time). (See *Appendix E: Calculations for the Calibration of the Propane Flow Control System*.)

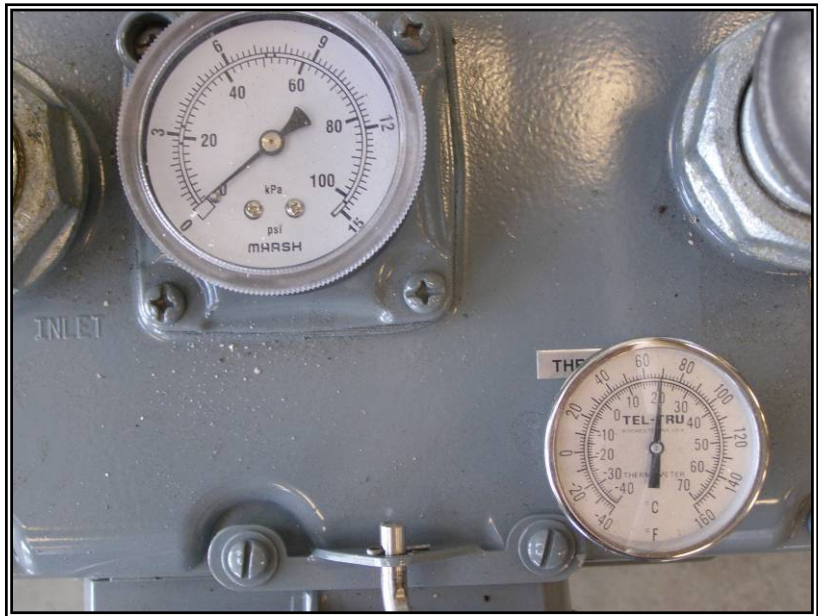

Figure 4. Step 13 Record the pressure and temperature in the DTM.

16. Use the pressure and temperature readings to convert the flow rate to standard conditions.
17. Repeat this measurement for two additional flow settings so as to have settings somewhat above and below the value of interest.
18. Plot the flow versus meter reading(s), fit a best line (possibly quadratic) through these points to find the correct meter setting to get the flow rates listed in Table 2.
19. When three points have been measured with the first burner, shut off the gas at the propane flow control system and allow the gas remaining in the line to burn off. Connect the DTM in line with the second burner and repeat the calibration procedure.
20. After completion of the calibration procedure, re-set the timers for the top and side burners to 70 and 50 seconds, respectively. (See *Appendix H: Directions for Setting 700-HX Timers.*)



Mark the correct flow rate on the instrumentation with tape so that the correct flow rate can be quickly ascertained and adjusted, if necessary, at the beginning of each test.

10. TEST PREPARATION

10.1 Test Area Conditions

Maintain the test area conditions as listed in Table 3.

Table 3. Test Area Conditions

Temperature	15 - 27 °C (59 - 80.6 °F)
Relative Humidity	0 - 75%

10.2 Prepare Test Floor Area

Equipment List:

- Calcium silicate or fiber cement board
- Cleaning materials, as needed

Procedure:

1. Clean the floor area under the calorimetry hood. Ensure that the floor is free of large debris, dirt, residue, etc. prior to each test. In addition, the floor must be free of standing water and at ambient temperature.
2. To aid in test clean up and/or to protect the floor, sheets of calcium silicate or fiber cement board may be placed under the center of the calorimetry hood to cover the area under the test frame.



Do not use dry wall sheets or similar combustible paper products that may ignite and contribute heat energy. Aluminum foil should not be used since its high reflectivity may impact test results.

10.3 Camera Placement

Equipment List:

- Video camera(s) and/or still camera(s) and tripod(s)
- Video lights
- Video media

Procedure:

1. Place a video or still camera to obtain a full view of the following:
 - Ignition side of the specimen
 - Flame impingement area during ignition
 - Test floor so that melt pool fires can be seen

2. Load video media into camera(s).
3. Place video light to illuminate specimen.



It is recommended that a second camera be placed to obtain a full view of the non-ignition side of the specimen. (See *Figure 5.*)

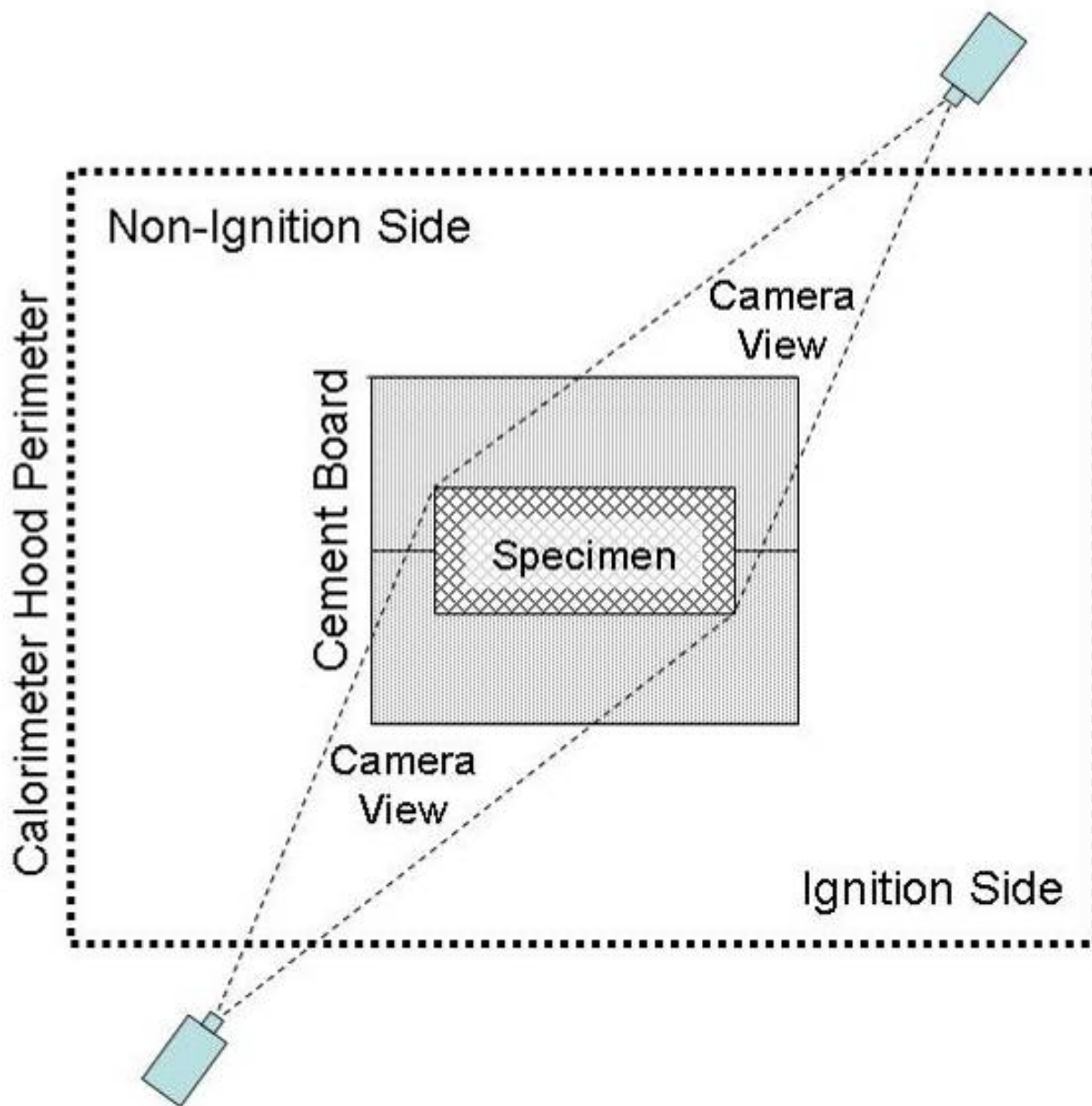

Figure 5. Recommended Camera Placement for Open Calorimeter Testing

10.4 Burner Assembly Inspection

10.4.1 Prepare burner assembly

Equipment List:

- Burner assembly
- Lubricant for burner assembly
- Propane Flow Control System
- Razor blade or box cutter

Procedure:

Complete the following before starting the alignment procedure:

- Check the burner assembly pivot point for the top burner arm. With the pivot point pin removed, make sure the pivot point is clean and lightly lubricated to allow smooth, free movement. Make sure the setscrew is finger tight, but allows free movement of the burner arm. (Fig.6)
- Check the burner assembly pivot point for the side burner arm. Make sure the setscrew for the pivot point is locked in place to prevent movement during the test.
- The burner holes of each burner are manufactured five degrees (5°) out of plane. Make sure that the flame jets of the two burners point *toward* each other. This check is best accomplished by running both burners in a draft-free area and observing the flames from the front of the assembly. (Fig.7)

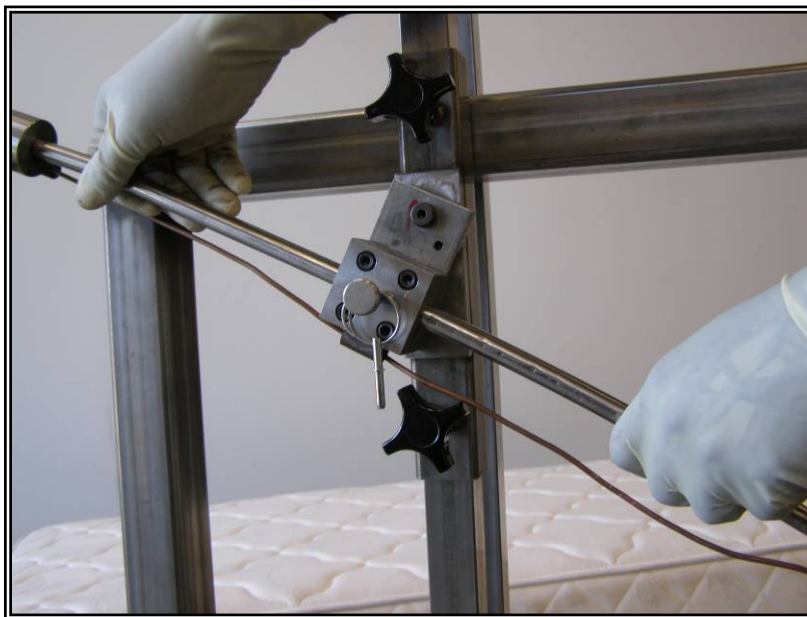

Figure 6. *Bullet 1* Check for ease of movement at pivot point and burner arm.

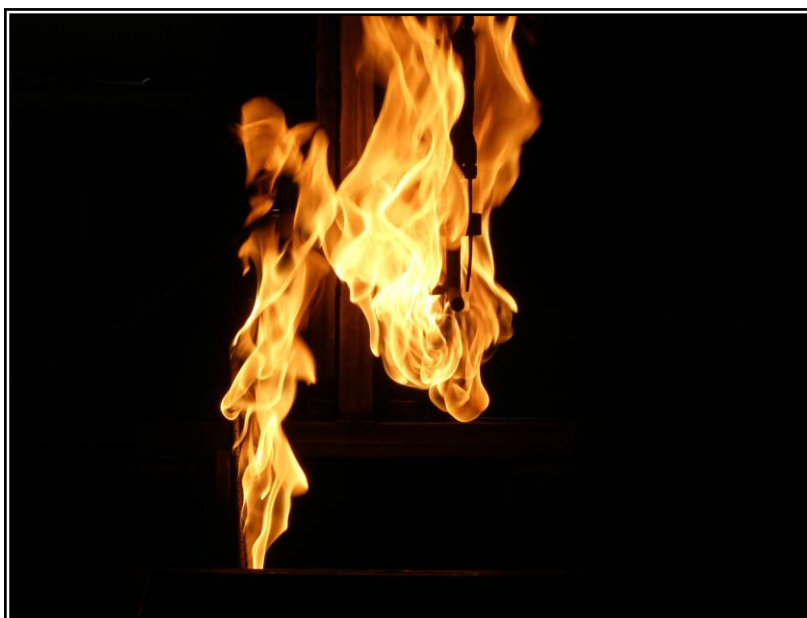

Figure 7. *Bullet 3* Flame jets toward each other.

- Wipe residue from both burners with a clean, dry, lint-free rag or paper towel. Do not use solvents of any kind. If needed, burn off stubborn residue with a small torch. Be sure that the burner holes are not obstructed. If necessary, clean holes with a piece of bare copper wire. Do not scratch burners or use cleaning utensils that may enlarge burner holes.
- Check gas fittings for tightness (especially at the burner connections; the burners should be connected tightly to their feed lines, unable to shift or rotate about the tubing connections).
- Wipe residue from the stand-off feet with a clean dry, lint-free rag or paper towel. Remove stubborn residue with a box cutter or similar tool. (Fig.8)
- Check the burner stand-off feet for straightness and perpendicularity between the foot pad and the support rod.

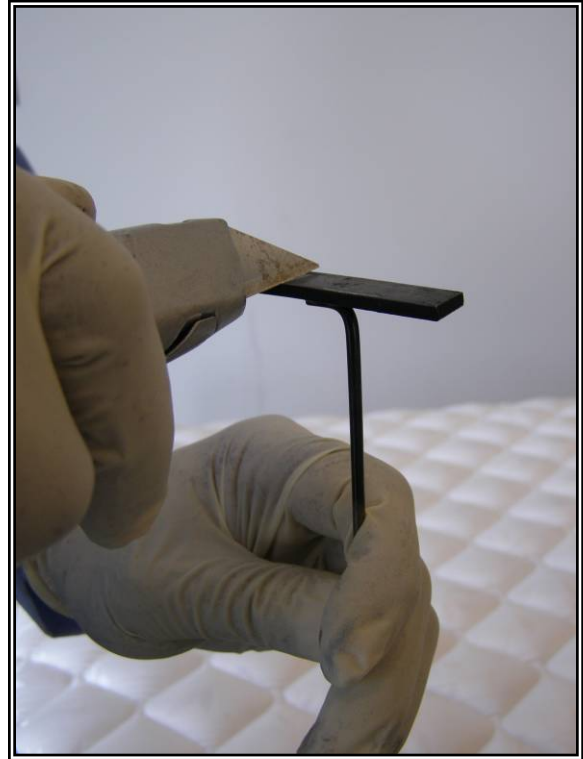

Figure 8. *Bullet 6* Clean burner stand-off feet.

10.4.2 *Burner assembly flow rate and timer confirmation*

Equipment List:

- Burner assembly
- Fire suppression system/apparatus
- Propane flow control system
- Stop watch or a watch with a “seconds” hand

Procedure:

1. Charge the hose line to be used for fire suppression with water.
2. Connect a hose from the propane tank to the propane flow control system connection. (Fig.9)



Figure 9. *Step 2* Connect propane supply.

3. Connect the burner assembly hoses to the propane flow control system. (Fig.10)



Label hoses and connectors to increase test efficiency.

4. Turn power on for the control box by plugging in the propane flow control system power cord and making sure that the red emergency stop button is pulled out, thereby engaging the power.
5. Set propane pressure to 20 psig (± 0.5 psig) using the regulator on the gas supply. Open the valve so that gas is supplied to the propane flow control system.
6. Check for gas leakage.
7. Set burner timers to 70 and 50 seconds for the top and side burners, respectively. (See *Appendix H: Directions for Setting 700-HX Timers.*)
8. Adjust pilot tubes to rest just behind the front surface of the burners. (Fig.11)
9. Turn on gas flow to pilots by opening the ball valves. Ignite pilots.



Figure 10. Step 3 Connect hoses to control box.

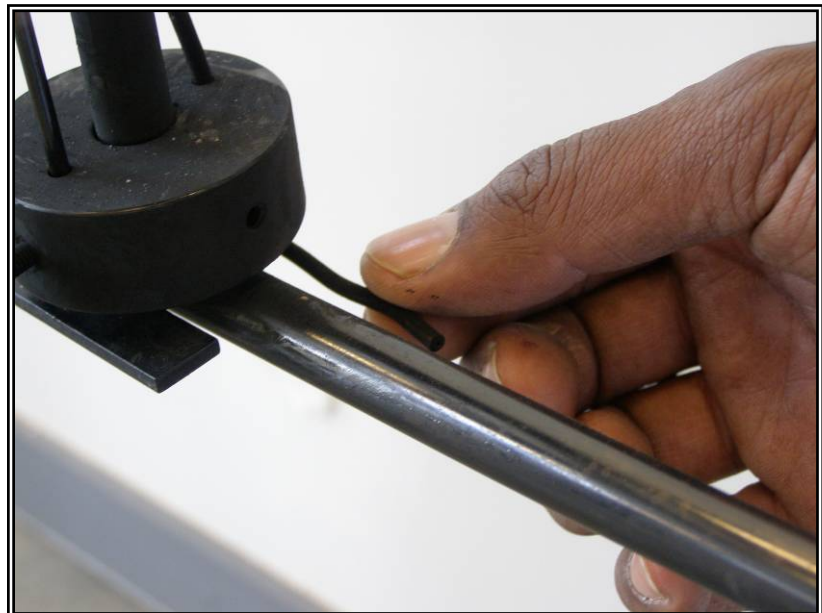

Figure 11. Step 8 Adjust pilot tubes.

10. Set pilot flow valves to nominal 2 cm flames. (*Fig.12*)
11. Simultaneously ignite the burners and start a stop watch to verify timers are set correctly.
12. Check the settings of the flowmeters, with both burners running simultaneously, to assure the values give the requisite propane gas flow rates for each burner.
13. Turn off pilot and burner ball valves.



Figure 12. Step 10 Set pilot flow.

11. SETTING BURNER TIMERS



Before setting burner timers, make sure all pilots and burners are turned off.

11.1 For Calibration of Propane Flow Control System

Set the timer to the maximum time (See *Appendix H: Directions for Setting 700-HX Timers*).

11.2 For Testing

Set the timer for the top burner to 70.00 seconds and the side burner to 50.00 seconds (See *Appendix H: Directions for Setting 700-HX Timers*).

12. DATA COLLECTION

Heat release rate (HRR) data from the calorimeter instrumentation should be sampled at least once every six seconds. It is recommended that data be sampled once every second for increased accuracy.

13. TEST PROCEDURE

Background

This test exposes the surfaces of a mattress and its foundation to gas burner flames of a specified intensity. That intensity is intended to be comparable to the level experienced by a mattress when bedclothes are burning on it. As in all gas burner tests, the exposure intensity requires careful control of certain factors.

- *The necessary exposure intensity or heat flux is found only at a specific distance from the burner head and that distance depends on the gas flow rate to the burner. Therefore, it is essential to set both the gas flow to each burner and the stand-off distance correctly in order to achieve the proper sample surface exposure.*
- *Similarly, it is essential to keep the burner parallel to the sample surface; otherwise, the heat flux will be too high on one side of the burner feed tube and too low on the other side.*
- *Finally, the burner flames should not be significantly disturbed by laboratory air flow fluctuations or the flame movement this causes will lower the average heat flux to which the sample surfaces are exposed.*

Attention to these issues will minimize operator-to-operator and lab-to-lab variability.

Equipment List:

- Burner alignment platen
- Burner assembly
- Burner stand-off foot jig
- Calibrated spring scale (250 gram capacity)
- Data sheets
- Duct tape
- Extra frame crosspieces
- Fire suppression system/apparatus
- Instrumentation for measuring temperature, humidity, and atmospheric pressure
- Multipurpose lighter
- Non-combustible material to be used as filler (ex. aluminum foil)
- Non-combustible material to be used as risers for test frame (ex. ceramic tile or brick)
- Placard
- Propane flow control system
- Propane, CP
- Razor blade or box cutter
- Ruler or other appropriate distance measurement device
- Scrapers
- Side burner screen
- Stop watch or a watch with a “seconds” hand
- Test frame
- Thermal imaging device
- Top burner screens
- Video camera(s) and/or still camera(s) and tripods
- Video lights
- Video media

Procedure:

1. Place the test frame in the test area according to the test configuration being used. See §1633.7(2) for more information on the test configurations.
2. Check the test frame for residual combustible material. If present, remove material with scrapers.
3. Note the time that the specimen is removed from the conditioning room so that the 20 minute maximum time out of the conditioned environment is not exceeded.
4. Center the specimen on the test frame. When centering the specimen keep in mind the following:
 - a. If the mattress is narrower or wider than the foundation, shift the mattress so that the side to be exposed to the burners is in the same plane as the foundation. If the mattress specimen is a slightly different dimension than the foundation specimen, note the measurement difference (cm/in) on the test report.
 - b. If there are unique construction features (e.g., handles, zippers, etc.), place the test specimen on the frame so the side with the unique construction features is exposed to the burners. (See *Section 16. SPECIMEN PLACEMENT: TRADITIONAL AND NON-TRADITIONAL PRODUCTS.*)
 - c. If the specimen is a different size or shape than the test frame, modifications should be made to the frame to accommodate the specimen. If there are open spaces between the specimen and the test frame, use extra cross pieces or non-combustible fillers to cover spaces at corners and along sides of test frame (see *Appendix G: Test Frame Design Considerations*). (Fig.13)

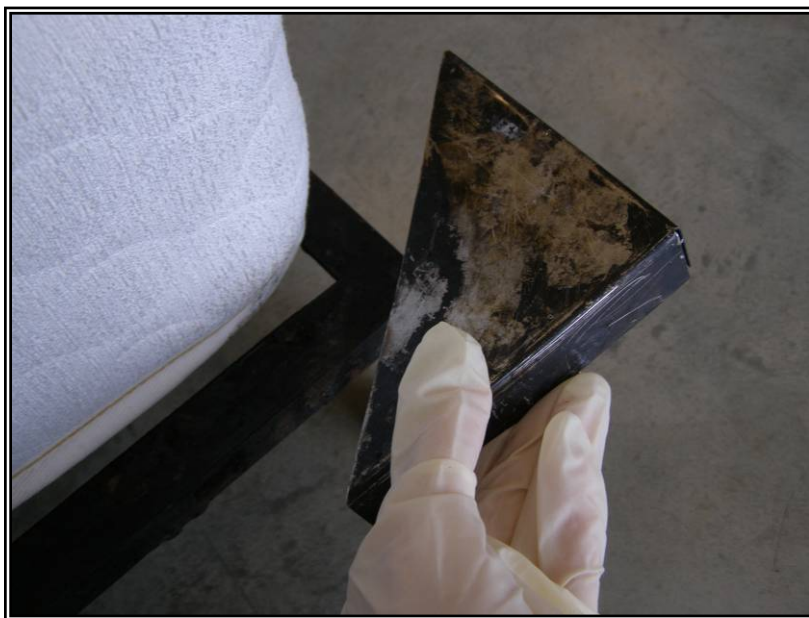

Figure 13. Step 4.c Close open spaces between the test frame and specimen.

5. Inspect the specimen for defects and note any findings. Remove any tags or labels on the specimen carefully so that the specimen is not damaged.
6. Place video cameras according to instructions. (See *Section 10.3 Camera Placement.*)
7. Place the burner assembly adjacent to the test specimen.

- Place the appropriate platen within 30 cm (1 ft) of the longitudinal center of the side of the mattress with the shorter side on top.



The intended location of the stand-off foot of the top burner is not to be in a dimple or crease caused by the quilting of the mattress top. If a “construction feature” such as a handle or seam is within 1 ft of the longitudinal center of the mattress, the burner should be aligned with this feature.

- Carefully slide the platen laterally inward from the edge of the mattress so that its side makes contact with either:

- the top and bottom edge of the mattress.

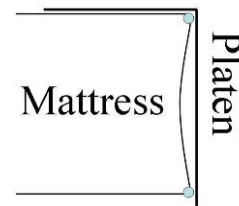

- the vertical side of the mattress.

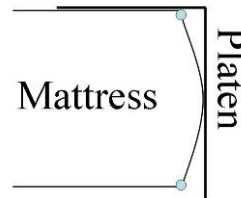

- Secure the platen using a strip of duct tape to assure that it stays tightly in place against the side of the mattress. (*Fig.14*)



Figure 14. *Step 10* Secure the platen.

11. Place the burner assembly adjacent to the test specimen with both burner arms secured (pivot point pinned in position), with stand-off feet of both burners fully retracted. Make sure that the pilot tubes do not extend beyond the burner head faces to prevent damage to the pilot tubes. (Fig.15)



Figure 15. *Step 11* Check pilot tube.

12. With the top burner moved high enough on its vertical support column to allow the top burner to pass over the top of the mattress, move the burner assembly forward until the side burner touches the vertical section of the platen. Lower the top burner (on its vertical support column) until it rests very lightly on the horizontal section of the platen. (Fig.16)



Figure 16. *Step 12* Lower the top burner onto the platen.

13. After the above height adjustment, remove the pivot pin for the top burner so that it exerts only the force of the burner's weight on the flat surface of the platen. Loosen the pivot point set screw of the top burner and adjust the burner position so that its full length is over the top surface of the platen. Tighten the pivot point set screw when finished. (Fig.17)



Figure 17. Step 13 Adjust top burner height.

14. Adjust the top burner so that it is parallel to the platen surface by bending the copper tube section of the burner feed line. The burner should be no more than 1/8 inch out of parallel over its full length. The weight of the burner should not be helping to force the burner into its parallel orientation. Reinstall the top burner pivot pin when finished. (Fig.18)



Figure 18. Step 14 Make burner face parallel to platen.

15. Move the entire burner assembly in/out until the top burner head outer end is 13 to 19 mm ($\frac{1}{2}$ to $\frac{3}{4}$ in) in from the corner bend of the platen. Tighten the thumb screw and reinsert the pivot point pin when complete. (Fig.19)



Figure 19. Step 15 Position burner head.



Mark the platen at 13 and 19 mm ($\frac{1}{2}$ and $\frac{3}{4}$ in) in from the corner bend to assist in aligning the edge of the burner.

16. Loosen the side burner arm thumb screw and move the side burner arm in and out until the outer end of the burner head is parallel to and lightly touching the platen. At this point, do not move the burner assembly. If necessary, make the side burner parallel to the platen by bending its copper tube section. (Fig.20)



Figure 20. Step 16 Position the side burner.

17. If the platen is not flat and/or vertical, align the side burner parallel to the mattress/foundation sides by the best visual estimate after the platen has been removed.



If the platen impedes the side burner placement, remove it so that the burner can be adjusted more accurately.

18. Tighten the side burner arm thumb screw.

19. Depending on the dimensions and configuration of the specimen, align the side burner according to the following criteria:

- a. For mattress-foundation sets: The center of the burner is aligned at the mattress-foundation interface. (Fig.21)



Figure 21. Step 19.a Mattress-foundation alignment.

- b. For mattress only: The center of the burner is aligned at the mattress-test frame interface. (See *Section 16. SPECIMEN PLACEMENT: TRADITIONAL AND NON-TRADITIONAL PRODUCTS* for products less than six inches thick.) (Fig.22)



Figure 22. Step 19.b Mattress only alignment.

For either case above, the following criteria must also be met:

- Maintain the top edge of the burner at no higher than one inch below the top edge of the mattress.
- Ensure that the bottom edge of the burner is at least one inch above the floor.

It may be necessary to elevate the test frame to meet these criteria. Use non-combustible riser material that exhibits low re-radiation of heat (e.g., brick, tile, etc.). Place these “risers” in such a way that they will contribute as little as possible to the fire through re-radiation of heat and provide a surface for burning materials that drip or fall from the test specimen. (Fig.23)



Figure 23. *Step 19* Test frame elevated with bricks.

If there are unique construction features (e.g., handles, zippers, etc.) within one foot of the center of the long side of the specimen, place the side burner so that the unique construction feature(s) is exposed to the burner. (Fig.24)

20. Move the burner assembly perpendicularly back away from the mattress about 30 cm (1 ft).



Figure 24. *Step 19* Construction feature.

21. Set the offset of the burner stand-off feet using the appropriate jig side (e.g., top or side burner) by placing the jig fully onto the burner tube (on the same side of the tube as the stand-off foot). Loosen the set screw and slide the foot out to the point where it is flush with the bottom end of the jig. Make sure the long axis of the foot is parallel to the burner tube. (Fig.25)



Figure 25. Step 21 Set stand-off foot distance with jig.



It is important to use the correct side of the spacer jig with each burner. Double check that the correct side is being used. Clearly mark the jig.

22. Remove the top burner arm pivot point pin. (Fig.26)

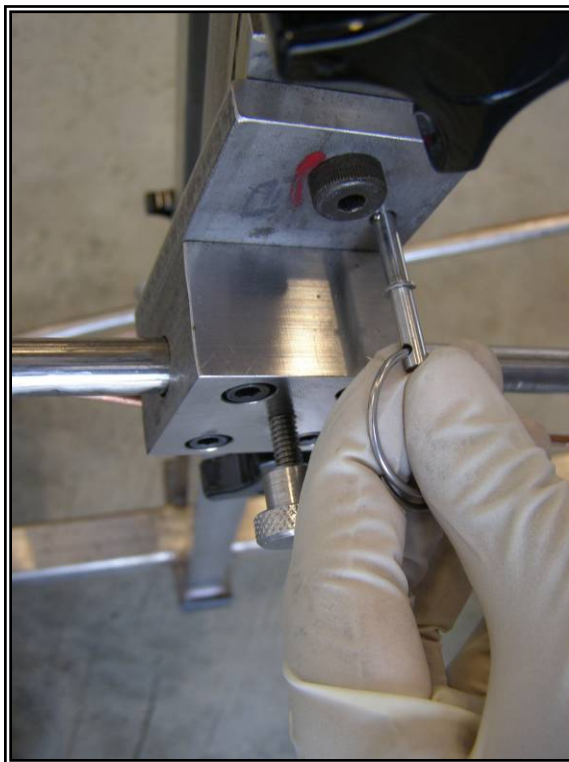

Figure 26. Step 22 Remove pivot point pin.

23. Set the downward force of the top burner by holding the burner arm horizontal; hook a spring scale onto the stand-off foot thumbscrew. Move the small and large weights on the burner arm so that the spring scale reads 170 to 225 g (6 to 8 oz). (Fig.27)



Figure 27. Step 23 Measure downward force using spring scale.

24. Replace the top burner arm pivot point pin. Remove the sheet metal platen if it has not yet been removed.

25. Remove the top burner arm pivot point pin. Hold the top burner up and slide the burner assembly forward until the side burner stand-off foot just touches the mattress and/or foundation side. Check that the stand-off foot of the top burner is not being placed in a dimple or crease caused by the quilt pattern on the mattress top surface. If necessary, move the burner assembly laterally along the mattress enough to remove the top burner foot from any such depression. (Fig.25)



Figure 28. Step 25 Burner stand-off foot should not be in a depression.

26. Release the top burner, placing the outer end of the burner tube at 6 to 12 mm ($\frac{1}{4}$ to $\frac{1}{2}$ in) out beyond the uppermost corner/edge of the mattress. (For a pillow top mattress, this means the outer edge of the pillow top portion and the distance may then be greater than 6 to 12 mm ($\frac{1}{4}$ to $\frac{1}{2}$ in) from the side of the main mattress body). (Fig.29)



Figure 29. Step 26 Final placement of top burner.



In the case that the top burner is improperly positioned, move the entire burner assembly, not the top burner alone. It may be necessary to retract the side burner in order to properly position the top burner. Because the downward force of the top burner has already been set, any adjustment to the top burner may change the force applied to the surface of the specimen and require that the force be checked and adjusted.

27. Slide the side burner forward until its stand-off foot just touches and is parallel to the side of the mattress and/or the foundation. (If necessary, loosen the vertical burner arm thumb screw and move the vertical burner arm in/out.) At this point do not move the burner assembly. If necessary, make the vertical burner parallel by bending its copper tube section. (Fig.30)



The foot should depress the surface it first contacts by no more than 1 to 2 mm.

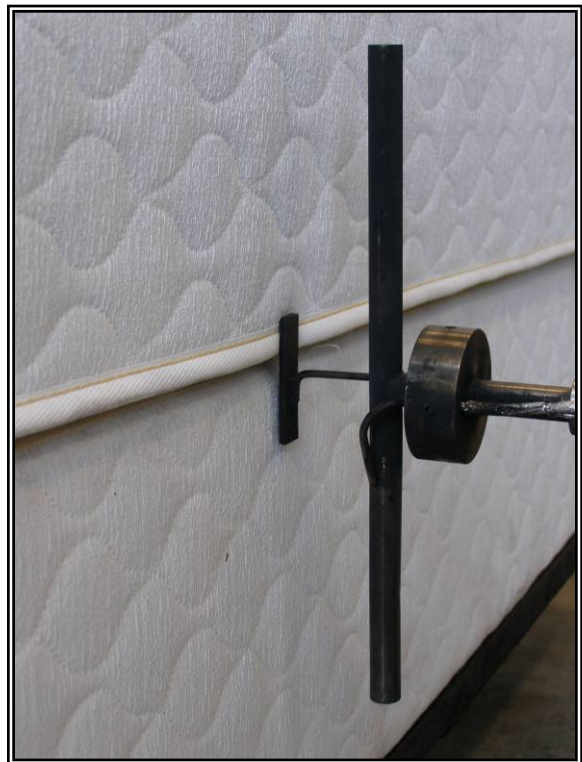

Figure 30. Step 27 Final side burner placement.

28. Make sure all thumb screws and set screws are adequately tightened.

29. Determine the calorimetry system baseline at this point. Avoid the area under the calorimetry

hood until this procedure is complete.

30. Place a placard(s) with specimen name, date and time of test, and name and location of test facility in view of the camera(s).
31. Start the video lights and video camera(s) and data logging systems (or, if not using video, take a picture of the setup) two minutes before ignition. If using a still camera, take a picture within the first 45 seconds of ignition and at least once every 5 minute interval ending at 30 minutes.
32. Once the calorimetry system baseline procedure has been completed, open pilot ball valves one at a time. (Fig.31)
33. Ignite pilots.



At this time, confirm that the specimen has been out of the conditioning room for less than 20 minutes and that sufficient time remains that the specimen will be ignited before 20 minutes elapse. If 20 minutes

has been or will be exceeded before specimen ignition, refer to *Section 7. SAMPLE CONDITIONING*.

34. Adjust the pilot flame size to the minimum height necessary to ignite the burners being very careful to avoid a jet flame that could prematurely ignite the test specimen.
35. If there are drafts in the test area, place screens around the burners. Place screens approximately 1 foot from the top burner or a distance sufficient to control drafts, but not interfere with the test. Use non-combustible material to elevate the side burner screen to approximately one inch above the top of the burner. (Fig.32)
36. Be sure that burner switches are in the “OFF” position. Open burner ball valves one at a time.



Figure 31. Step 32 Open pilot ball valves.



Figure 32. Step 35 Screens placed around burners.

37. Ignite burners by simultaneously turning both burner switches to “ON” (timers will turn off burners at appropriate times). Also, start a 30 minute timer of the test duration. (Fig.33)

38. Check and, if necessary, adjust propane flow rates immediately. (Fig.34)

39. When both burners have timed out, remove any screens used.

40. Carefully lift the top burner tube arm while pulling the

burner assembly away from the specimen surface, producing as little disturbance to the specimen as possible.

41. Turn off power to both timers by turning burner switches to “OFF” position.

42. Turn off pilots and burners at their ball valves.

43. Remove the burner assembly from the specimen area to facilitate the camera view of the full ignition side of the specimen. In the case of the room-based configurations, remove the burner assembly from the room.

44. Record observations throughout the test. Note the time and nature of any unusual behavior.

45. Once the test has been terminated, allow the data acquisition system to continue collecting data until the fire has been out for several minutes to

allow the system to return to its pre-test condition. It is recommended that sufficient time be allowed for data capture after all smoke has ceased in order to perform a drift correction of the data.



Figure 33. Step 37 Turn burner switches to "ON" position.



Figure 34. Step 38 Check flow rates.

14. TERMINATION OF TEST

The test interval is 30 minutes. Do not terminate tests prior to 30 minutes unless:

- The fire develops to such a size as to require suppression for the safety of the facility and/or test personnel.

For further guidance on terminating a test, see *Appendix J: Guidance on Early Termination of Test*.

15. TEST REPORT AND CERTIFICATION

Include a data sheet for each specimen tested, a summary sheet for each sample tested, and any other relevant test documentation in the test report. The designated test operator will be responsible for certifying the test results.

16. SPECIMEN PLACEMENT: TRADITIONAL AND NON-TRADITIONAL PRODUCTS

When deciding how to best handle test specimens, test personnel should consider the following points:

- Test all specimens with the intended sleep surface exposed to the top burner. If more than one surface is promoted as a sleep surface or if the sleep surface is undefined, both surfaces will need to be evaluated.
- Expose discontinuities (i.e., segment edges) or construction features (i.e., zippers, handles, vents) that are found within one foot of the center of the long side of the sleep surface to the side burner. Because these items may be points of failure, it is important to evaluate their performance.
- Specimens that do not fit the standard test frame will need to be supported with extra supports or will need a test frame design that supports the specimen around its perimeter and contains sufficient cross pieces to keep the specimen from sagging (see *Appendix G: Test Frame Design Considerations*).

16.1 Products Less Than Six Inches Thick

For products less than six inches thick, the side burner center will not be able to be aligned at the mattress-foundation or mattress-test frame interface. (Fig.35) In order to maintain the side burner at one inch below the top surface of the mattress, the burner center will be below the typical interface point. (Fig.36) Note that the height of the test frame will require that the frame be raised for specimens tested as a mattress alone.

Maintain the bottom of the side burner at least one inch above the test floor. (Fig.37)

16.2 Segmented Products

Segmented sleep products such as flip chairs should be tested with the intended sleep surface up in an extended configuration. If the intended sleep surface is undefined, both surfaces may need to be tested. Minimize gaps between segments when positioning the specimen on the



Figure 35. 16.1 Alignment of the side burner for thin specimens.



Figure 36. 16.1 Side burner one inch below top of specimen.

test frame. The side burner should be placed at the interface of two segments if such an interface exists within one foot of the longitudinal center of the specimen.

16.3 Non-Rectangular Products

Products that do not conform to the rectangular shape of a standard mattress may require a different test frame from that described in the regulation. Ensure that the modified test frame meets the same criteria as that described in the standard for height and provide sufficient support for the specimen.

Top and side burner placement should follow the general guidelines for rectangular mattresses. If there is no “long side” for a sample (e.g., round mattress), place the burners at the location of a discontinuity or construction feature.

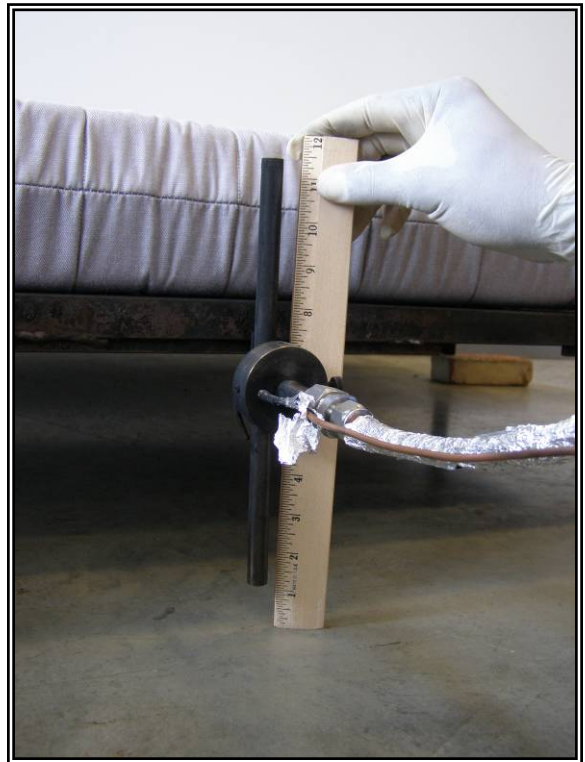

Figure 37. 16.1 Side burner one inch above test floor.

16.4 Folded or Compressed Products

Sleep products that are folded (e.g., convertible sofa bed mattresses) or compressed for transport or storage may require extra time to condition in order to ensure that the specimen is in the correct state for testing. Folded products may need extra conditioning time to completely unfold and provide a flat specimen for testing. Compressed products may need extra conditioning time to fully expand and realize their intended, uncompressed state.

17. APPENDICES

Appendix A: Description of Test Equipment	35
Appendix B: Sample Data Sheet	40
Appendix C: Sample Data Sheet for Calibration of Propane Flow Control System	41
Appendix D: Sample Log Sheet for Calibration of Propane Flow Control System	42
Appendix E: Calculations for Calibration of the Propane Flow Control System	43
Appendix F: Sample Log Sheet for Correction Factor (C-Factor) of Calorimeter System	44
Appendix G: Test Frame Design Considerations	45
Appendix H: Directions for Setting 700-HX Timers	46
Appendix I: Practice for Calorimetry Hood Calibration and Validation	48
Appendix J: Guidance for Early Termination of Test	50

Appendix A: Description of Test Equipment

Burner alignment platen: The burner alignment platen is a 24 gauge stainless steel sheet metal platen with dimensions 30 mm (12 in) wide by 610 mm (24 in) long with a 90 degree bend 355 mm (14 in) from one end. A modified platen may be needed to accommodate different dimensions of non-standard mattresses while maintaining the function of the platen. The platen is intended to ensure that the burners are parallel to the mattress top and side surfaces.

Burner assembly: (Fig.38) The burner assembly is composed of two T-shaped burners mounted to a central support frame. The top (sometimes referred to as *horizontal* or *burner 1*) burner impinges flames on the top of the specimen. The side (sometimes referred to as *vertical* or *burner 2*) burner impinges flames on the side of the specimen. A pilot tube should be attached to each of the burners in such a way as to provide a sufficient ignition source for the burner. Attach stand-off feet to the burners in such a way as to provide the appropriate offset distance of the burner from the specimen. Screws and pins provide stability to the arms supporting the burners. Weights are located on the arms supporting the burners for balance and to provide the appropriate downward force on the top of the specimen. Specifications for the burner assembly components can be found in §1633.7(a)(6).

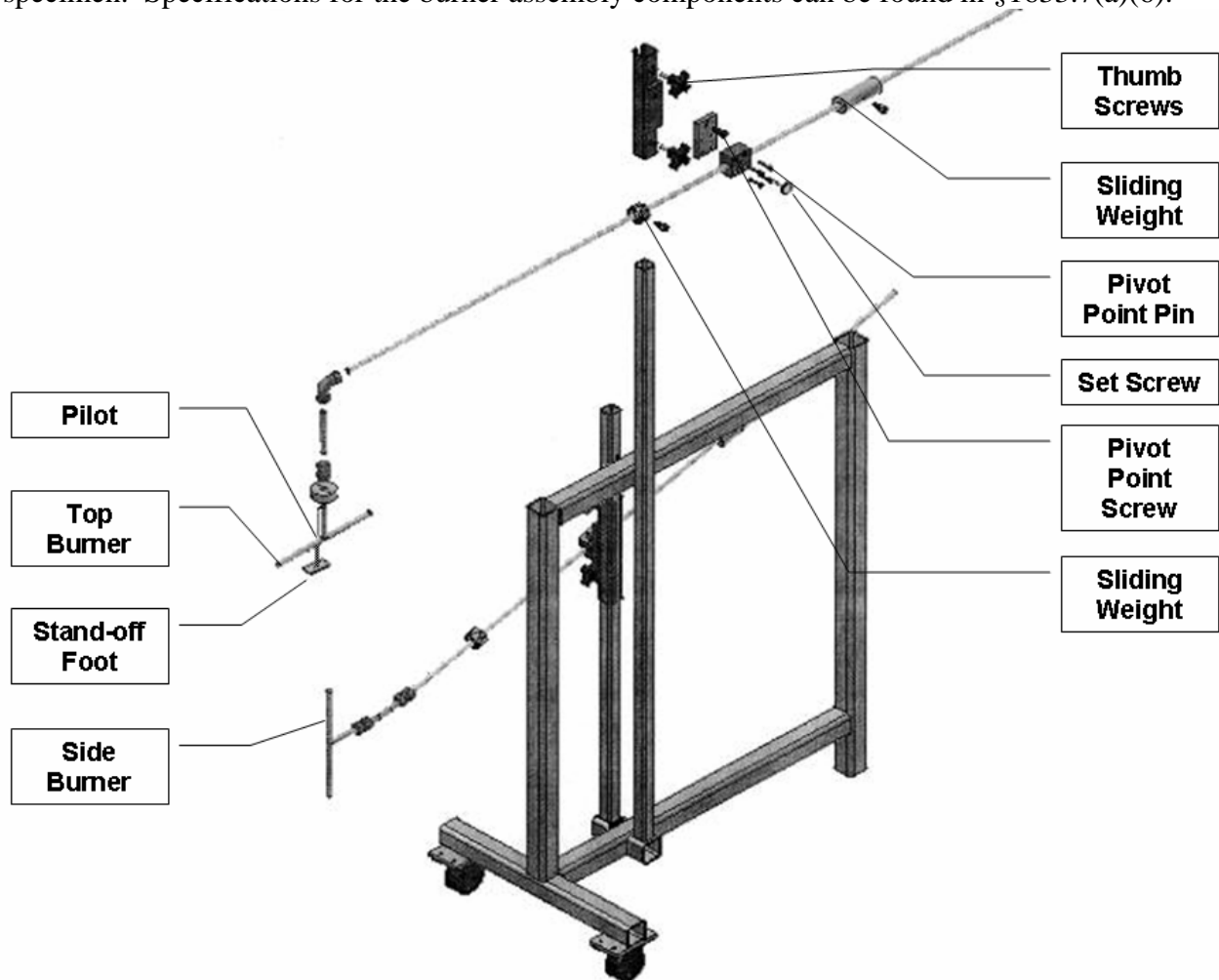

Figure 38. *Burner Assembly*

Burner stand-off foot jig: (Fig.39) The stand-off foot jig is used to set the proper distance of the stand-off foot from the face of the burners, thereby ensuring that the proper heat flux is impinging upon the specimen from each burner. There are different offsets from the specimen for each burner. Ensure that the stand-off foot jig meets the specifications shown in *Figure 10* of the Standard. Label each side of the jig with the name of the burner for which it is used.



Figure 39. Burner stand-off foot jig

Diaphragm-type test meter: (Fig.40) Also known as a dry test meter, this apparatus is used to calibrate the flow of propane through the propane flow control system. A diaphragm test meter functions based on positive displacement of a fixed volume of gas per rotation and its reading is therefore independent of the type of gas being measured. However, gas temperature and pressure can have a significant impact on the measurement

of flow rate and must be taken into account when calculating the flow rate. (See *Appendix E: Calculations for Calibration of the Propane Flow Control System.*)

Extra frame cross pieces: The use of extra frame cross pieces is optional. Extra cross pieces can serve to fill gaps between a specimen and the edge of the frame or to support a specimen that is sagging. When considering the use of extra supports, one must keep in mind several criteria:

- The extra supports should not raise the specimen substantially above the plane of the test frame. For tips on how to build an “adjustable” frame, see *Appendix G: Test Frame Design Considerations.*
- The extra supports should be minimal, only what is needed to close a gap or provide support.
- Make the extra supports of the same or a similar material as that used to produce the test frame so that temperature does not affect the supports and frame differently.



Figure 40. Diaphragm-type test meter

- Make the supports out of stock sufficient to withstand the temperatures of the test without bowing.

Lubricant for burner assembly: Use a light, all-purpose lubricant to lubricate moving parts of the test apparatus.

Non-combustible material (filler): Use non-combustible filler material to fill gaps between the specimen and test frame. CPSC staff fabricated metal corner pieces to fill open spaces at the corner of the mattress-frame interface. Aluminum foil may be used as a filler if only a small amount is needed.

Non-combustible material (risers): Use risers during testing to provide sufficient elevation of the test frame to maintain a one inch space between the bottom of the side burner and the test floor. These risers should be non-combustible, have low re-radiation of heat, and provide proper elevation and support of the frame. Brick or ceramic tile may be used. Alternately, one may manufacture risers to fit the needs of a specific product(s) to be tested.

Propane: Chemically pure (CP) propane is used for the test. CP propane is expected to be 99% pure. CPSC staff considers propane gas that is specified to be nominally 99%-100% pure to have a net heat of combustion of 46.5 ± 0.5 MJ/kg.

In the United States, CPSC staff understands that HD-5 is a gas mixture that is at least 90% propane with the remaining 10% being variable amounts of ethane, propylene, and butane. While we do not believe that HD-5 is equivalent to CP propane, if the net heat of combustion is verified as equivalent, any variance in the heat of combustion and flow rate due to the mixture would be expected to be small and the effects on the heat flux from the burners would also be expected to be small. However, the HD-5 gas must have a verified net heat of combustion of 46.5 ± 0.5 MJ/kg.

Propane flow control system: (*Fig.41*) The propane flow control system is the mechanism used to ensure that the proper flow of propane reaches the burners and control the time of flame impingement on a specimen. The burner switches start the flow of propane to the burners. The rotameter-type flowmeters control the amount of gas reaching the burners. The pilot flow control regulates the amount of gas reaching the pilots for the burners. The pilot ball valves allow the flow of propane to the pilots for the burners. The emergency power switch controls power to the control system. The burner ball valves allow the flow of propane to the burners.

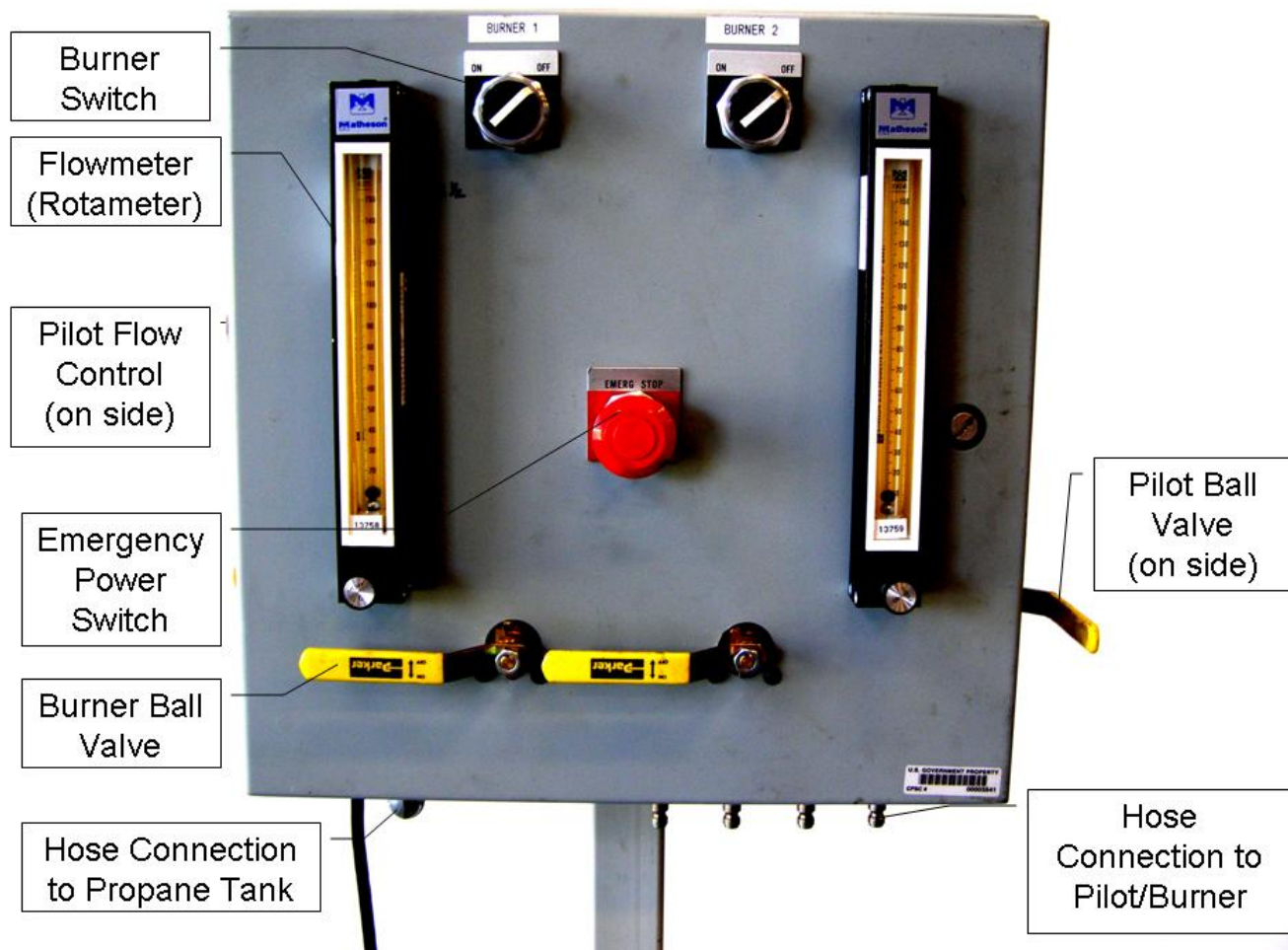

Figure 41. Propane flow control system

Sand diffusion burner: A sand diffusion burner is used to calibrate the calorimeter system. The burner has a 0.3 by 0.3 m (12 in by 12 in) top surface and a 0.15 m (6.0 in) depth. The burner is filled 100 mm (4 in) deep with Ottawa sand to diffuse the gas. See a relevant reference such as *ASTM E2067 Standard Practice for Full-Scale Oxygen Calorimetry Fire Tests* for more information.

Side and top burner screens: Use two burner screens for the top burner and one burner screen for the side burner to control drafts. Manufacture the screens from at least a triple layer of window screen wire 25 cm high with reinforcement sufficient to support the screens in use. Use a non-combustible riser for the side burner screen.

Test frame: Construct the test frame from steel angle iron sufficient to withstand the range of temperatures during testing. The top surface of the test frame must be 115 mm (4.5 in) from the test floor. The test frame must be completely open except for two cross pieces 25 mm (1 in) wide at the 1/3 length points. If sagging of the specimen greater than 19 mm (0.75 in) below the test frame occurs, cross pieces may be added to provide extra support. See *Appendix G: Test Frame Design Considerations* for more information.

Thermal imaging device: The use of a thermal imaging device such as an infrared (IR) camera is optional. A thermal imaging device can be used to identify thermal activity within the specimen that cannot be seen by test personnel.

Appendix B: Sample Data Sheet

**DATA SHEET
MATTRESS OPEN FLAME IGNITION**

Specimen Name: _____ Date: _____

Repetition: _____ Operator: _____

Specimen Size:	Twin	Specimen Type:	Mattress/Foundation
	Full		Mattress Only
	Queen		Futon
	King		Other: _____
	Other: _____		

Specimen Description:

Test Facility: _____

Temperature: _____ C / F %RH: _____

Time Out of Conditioning Room: _____

Test Start Time: _____

Notes:

Test End Time: _____

End of Test: Self-Extinguished
Suppressed
Burned Completely

Approved By

Appendix C: Sample Data Sheet for Calibration of Propane Flow Control System

Test Operator:

Date:

Ambient Barometric Pressure:

Barometric Pressure in DTM:

Ambient Temperature:

Temperature in DTM:

Top Burner	Setting:		
	Rep 1	# of rev	time
	Rep 2	# of rev	time
	Rep 3	# of rev	time
			AVG
	Setting:		
	Rep 1	# of rev	time
	Rep 2	# of rev	time
	Rep 3	# of rev	time
			AVG
	Setting:		
	Rep 1	# of rev	time
	Rep 2	# of rev	time
	Rep 3	# of rev	time
			AVG
Side Burner	Setting:		
	Rep 1	# of rev	time
	Rep 2	# of rev	time
	Rep 3	# of rev	time
			AVG
	Setting:		
	Rep 1	# of rev	time
	Rep 2	# of rev	time
	Rep 3	# of rev	time
			AVG
	Setting:		
	Rep 1	# of rev	time
	Rep 2	# of rev	time
	Rep 3	# of rev	time
			AVG

Appendix E: Calculations for Calibration of the Propane Flow Control System

Note the ambient atmospheric pressure (P_{am}), the temperature at the meter (T_{meter}), and the pressure at the meter (P_{meter}). Take the time measured to make one revolution and find the flow, $Q_{measured}$, in liters per minute (L/min) or cubic feet per minute (ft³/min). NOTE: The capacity of DTMs may be different. Correct values to standard atmospheric conditions P_{std} (101 kPa) and T_{std} (22° C).

$$Q_{corrected} = Q_{measured} [T_{std} / T_{meter}] * [P_{meter} / P_{std}]$$

It is recommended that a spreadsheet template be designed to automate the calculation and graphing process. The figure below is a screenshot of an example spreadsheet for this purpose.

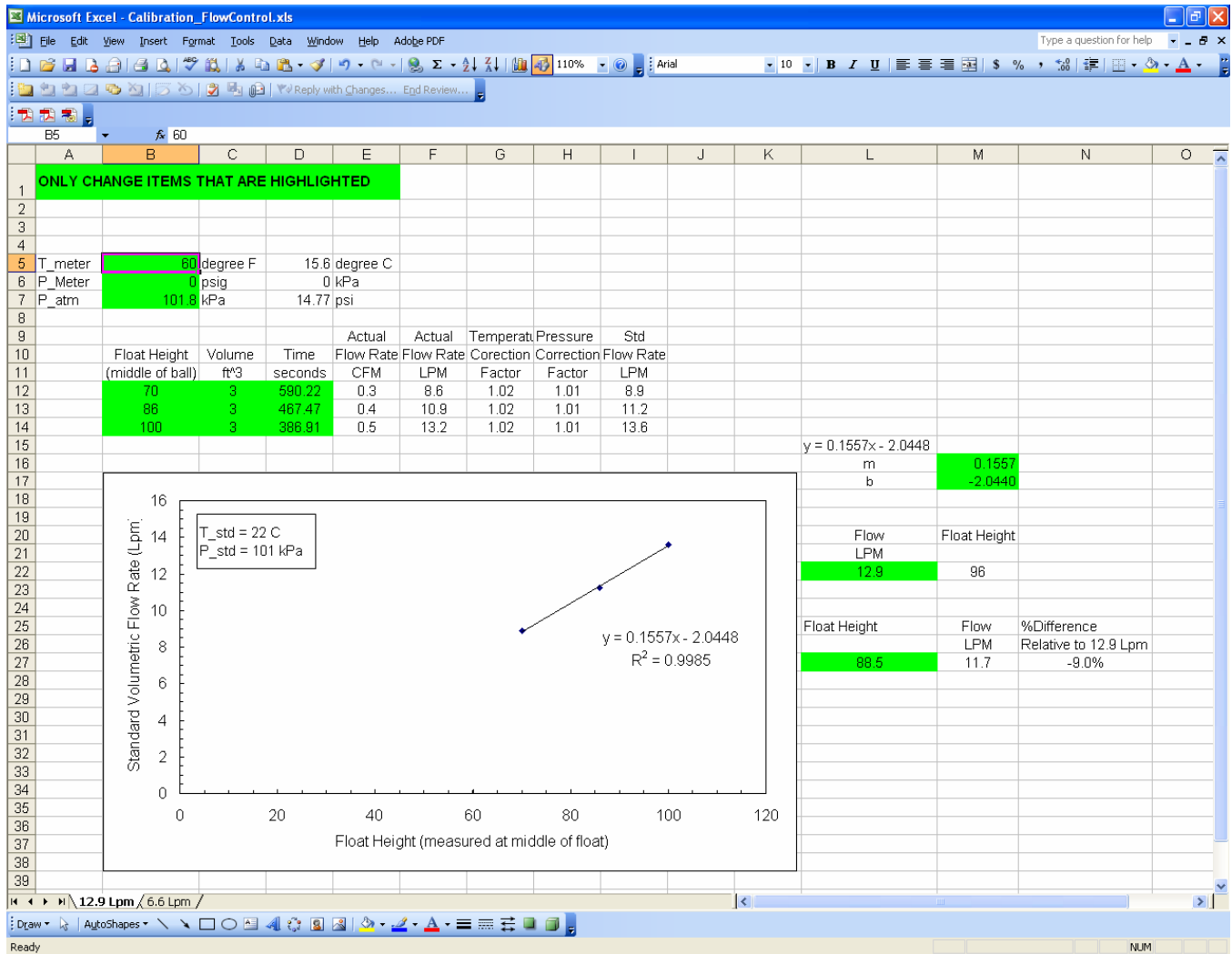

Figure 42. Example Spreadsheet for the Calibration of the Propane Flow Control System

Appendix G: Test Frame Design Considerations

The test frame should meet several design criteria.

- The top of the frame should provide a flat surface on which to place the specimen. The interface of the frame and bottom edge of the specimen should be unobstructed (i.e., no edges should extend upward).
- The frame should support the perimeter of the specimen with no gaps (i.e., the frame should match the dimensions of the specimen).
- Use the minimum number of cross support bars needed to provide sufficient support under the specimen.
- Maintain the frame height called for in the Standard (4.5 inches) unless the frame must be lifted so that the side burner will be 1 inch above the test floor when aligned.

The frames used by CPSC staff were designed to accommodate specimens that did not fit or were not properly supported by the twin frame described in the Standard. Lack of rigidity and variable perimeter dimensions of some mattresses will require additional supports or modified frame dimensions. The added supports minimize sagging, and the proper frame size provides support on all sides of the test specimen. CPSC staff used adjustable frames that would allow the frame to accommodate mattresses that were smaller or larger than a twin size mattress.

Horizontal support bars were constructed to provide support on all four sides of a sample if its dimensions are smaller than the standard twin size mattress and/or to provide additional support to minimize sagging of a highly conformal mattress (e.g., a futon) below the bottom of the test frame.

An example test frame is described in the diagram below.

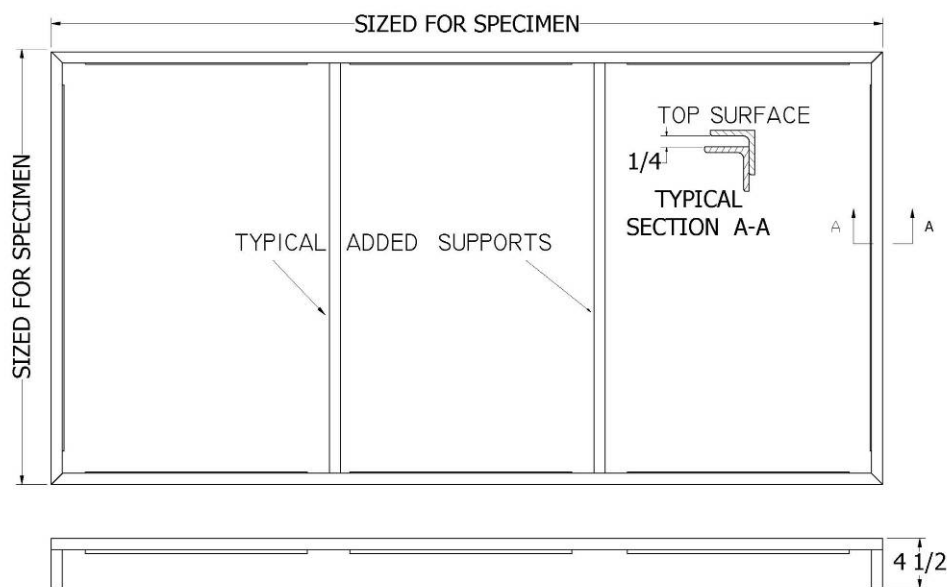

Figure 43. Example test frame

Appendix H: Directions for Setting 700-HX Timers



Before setting burner timers, make sure that the gas flow to all pilots and burners is turned off.

For Calibration

1. Open propane flow control system to gain access to the timers. Make sure that the unit has power.
2. To clear the timer display, press and hold the “MODE” button until the screen display changes. (Fig.44)
3. To change the time setting, repeatedly press the “D” key until the decimal point is no longer displayed and an “s” is shown in the lower right corner of the timer screen. (Fig.45)
4. To return to the active screen, press and hold the “MODE” key until numbers are displayed on the screen.
5. Set the timer to the maximum time. Repeatedly press the “A” button (either up or down) until “9” is displayed. Repeat for the “B”, “C”, and “D” buttons. (Fig.46)
6. Repeat steps 1 – 5 for the second timer.
7. Close the door on the control box and lock.

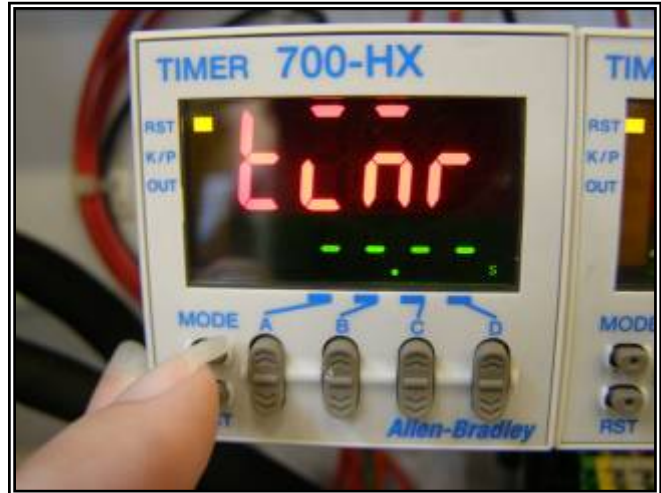

Figure 44. Step 2 Press and hold MODE button

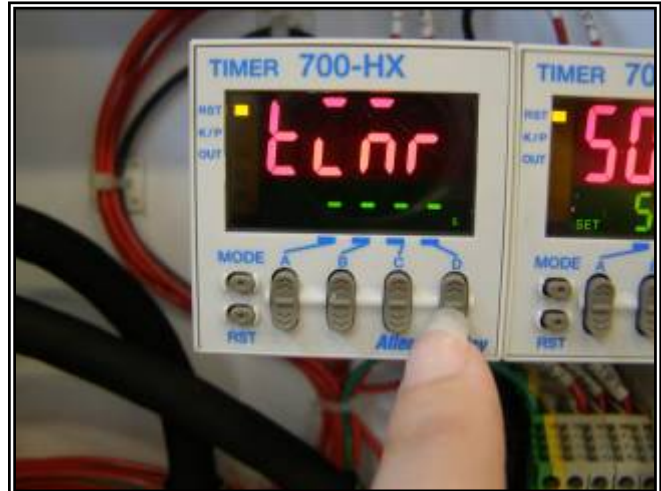

Figure 45. Step 3 Change time setting



Figure 46. Step 5 Timer set to maximum time

For Testing

1. Follow instructions below, setting the timer for the top burner to 70.00 seconds and the side burner to 50.00 seconds.
2. Press and hold the “MODE” key to clear the timer.
3. Set the timer accuracy by repeatedly pressing the “D” key until there are two places behind the decimal point and an “s” is displayed in the lower right side of the timer screen. (- -. - -)
4. Press and hold the “MODE” key until numbers are displayed on the screen.
5. Enter the correct time setting using the “A”, “B”, “C”, and “D” buttons.

Appendix I: Practice for Calorimetry Hood Calibration and Validation

There are numerous technical considerations involved in the measurement of heat release rate by oxygen consumption calorimetry. Practitioners are referred to *ASTM E 2067-03 (Standard Practice for Full-Scale Oxygen Consumption Calorimetry Fire Tests)* for a current consensus document on the best approach to various facets of this measurement technique.

It is recommended that five (5) HRR calibration points be used to calibrate the calorimetry system. Hold HRRs of 75, 150, 200, 350 and 500¹ kW (or a range of HRRs used during testing appropriate for the test configuration and hood capacity) for at least five minutes each, taking measurements at least once every six seconds (once per second is recommended). It is recommended that a calibration be performed at the beginning of each test series or weekly, whichever is a shorter duration of time. Perform daily validation checks of the calorimetry system before the first test each day using two HRR points, 75 and 200 kW. The validation check results should differ by no more than five percent (5%) from the calibration results. It is recommended that these data be maintained in order to track performance of the calorimetry system over time.

For regular calibration/validation, it is recommended that propane or methane gas (or a mixture² with a known or measured heat of combustion) be burned in a sand diffusion burner. Position the burner surface at the approximate height of the top surface of the specimen to be tested under the center of the calorimetry hood. The HRR values from the metered gas input are compared to those calculated from the oxygen consumption measured by the sensors to obtain a correction factor (c-factor) for the system. It is recommended that a calorimeter calibration log be maintained (See *Appendix F: Sample Log Sheet for Correction (C-factor) of Calorimeter System*).

In addition to regular calibration/validation checks, a system validation program comprised of three tests as outlined below is encouraged to evaluate the stability of the hood and instrumentation.

The first test determines the effect of the magnitude of the HRR on the performance of the hood. It is recommended that five HRR calibration points be used for this purpose. Hold HRRs of 75, 150, 200, 350 and 500 kW (or a range of HRRs used during testing appropriate for the test configuration and hood capacity) for at least five minutes each, taking measurements at least once every six seconds (once per second is recommended).

The second test determines what effect the rate of airflow through the hood has on the performance of the hood³. At least three airflow levels are recommended: 3000, 5000, and 7000 cfm (or a range of airflows used during testing appropriate for the test configuration and hood capacity). During this test, hold the HRR set point constant while the airflow through the hood is changed. Hold each airflow rate for at least five minutes.

¹ It is increasingly difficult to get constant heat release rate fires with liquefied hydrocarbons such as propane when the fire size gets much larger than 200 kW. This is a result of the heat of vaporization of the liquid causing a temperature drop and, thus, a vapor pressure drop off. ASTM E 2067-03 has some discussion of possible remedies.

² In general a mixture of liquefied hydrocarbons will not provide a constant heat of combustion since the most volatile component(s) will be evolved first. Any mixture used for this purpose would have to be known to have a very nearly constant heat of combustion or would have to be analyzed with each use.

³ In general, it is not a good idea to change the hood flow rate during an actual test since this can cause errors in the heat release rate seen during and just after the change. ASTM E 2067-03 has some discussion of this point.

The third test determines what effect the placement of the calibration burner relative to the perimeter of the hood has on the performance of the hood. For this test, move the calibration burner to four different perimeter locations under the hood, while the airflow through the hood and the known HRR are held constant. It is recommended that the four locations be analogous to the north, east, south, and west positions under the hood at approximately one foot inside the perimeter of the hood. Maintain each burner position for at least five minutes.

Further analyses to determine the uncertainty level of the calorimetry system are encouraged.

Appendix J: Guidance on Early Termination of Test

Special circumstances or laboratory practices indicate a need for early termination of the test. Test experience has shown that under certain conditions when all signs of combustion have ceased, the test may be terminated before the 30 minute test interval has elapsed. In order to end a test before the 30 minute test interval has elapsed (other than for safety reasons), all of the following conditions must be met and measured for five consecutive minutes:

- All signs of combustion have ceased as indicated by no visible smoke production, no smoldering or afterglow, and no open flames.
- Absolute minimum of five minute test time regardless of "no signs of combustion."
- Some method of verifying that the combustion has ceased.



One cannot rely on the calorimeter data to determine that combustion has ceased. We suggest the use of a high quality thermal imaging device as a reasonable way to make this determination. Use the device to characterize the thermal activity of the specimen for at least five minutes.