Chemical Science and Technology Laboratory

Annual Report – FY2004



NIST

National Institute of Standards and Technology
Technology Administration, U.S. Department of Commerce

NISTIR 7202

NISTIR 7202

**Chemical Science and Technology Laboratory
Annual Report - FY2004**

**Willie E. May, Director
William F. Koch, Deputy Director
Chemical Science and Technology Laboratory**

February 2005



**U. S. DEPARTMENT OF COMMERCE
Carlos Gutierrez, Secretary**

**TECHNOLOGY ADMINISTRATION
Philip J. Bond, Under Secretary for Technology**

**NATIONAL INSTITUTE OF STANDARDS AND TECHNOLOGY
Hratch G. Semerjian, Acting Director**

Compiled and Edited by Ellyn S. Beary and Pedro Espina.

Cover design by Ann L. Leith.

For information contact NIST/CSTL

Telephone: 301-975-8300

Facsimile: 301-975-3845

E-Mail: cstl@nist.gov

Web Sites: www.nist.gov
www.cstl.nist.gov

Any mention of commercial products is for information only. It does not imply recommendation or endorsement by the National Institute of Standards and Technology, nor does it imply that the materials or equipment mentioned are necessarily the best available for this purpose.

February 2005

Table of Contents

	Page
Message from the CSTL Director	iii
A. CSTL Overview	1
B. CSTL Programs	15
1. Automotive and Aerospace (Transportation)	17
2. Biomaterials	21
3. Pharmaceuticals and Biomanufacturing	25
4. Chemical and Allied Products	29
5. Energy and Environmental Technologies	41
6. Food and Nutritional Products	57
7. Forensics and Homeland Security	59
8. Health and Medical Technologies	75
9. Industrial and Analytical Instruments and Services	91
10. Microelectronics	111
11. Measurement Standards	121
12. Data and Informatics	133
13. Technologies for Future Measurements and Standards	143
C. Exploratory Research	157
D. Staff Recognition	167

A Message from the CSTL Director



The Chemical Science and Technology Laboratory is one of seven discipline-based technical operating units at the National Institute of Standards and Technology. All of us in CSTL are proud to share with you our Annual Report for Fiscal Year 2004. While this report represents only a snapshot of our activities, it illustrates the wide breadth of research that we conduct and measurement services that we provide.

During this past fiscal year, Dr. William F. Koch served as Acting Director and ably led CSTL through an aggressive strategic planning process. He began serving in this capacity in July 2003, when Dr. Hrach Semerjian was appointed the Deputy Director of NIST. I became Director of CSTL in late December 2004 having served as Chief of CSTL's Analytical Chemistry Division for the past ten years. It is both an honor and a privilege to take over the helm, and to advance the creative research activities and delivery of world-class measurement services for which CSTL has become internationally renowned.

This past year has witnessed many changes in our Laboratory. In addition to the leadership changes just mentioned, many other changes have occurred, including our move into our new Advanced Measurement Laboratory—a truly unique facility with respect to air cleanliness, and temperature, humidity, and vibration control. All proceeded in a very smooth manner with no adverse impact on the research and measurement services that CSTL provides. This is truly a testament to both the depth of leadership within our Laboratory, and the quality, creativity, and dedication of our staff.

We have been challenged in recent years with relatively flat budgets. Therefore, it has become all the more important to rigorously set our priorities and to focus our efforts on projects and programs that will provide the largest benefits to US citizens, and return on investment for our Nation. In this regard, we will continue to be proactive in communicating the breadth and depth of our capabilities as well as the quality and impact of our work. We will continue to strengthen our interactions with industry and other stakeholders in order to help us prioritize our work. We are grateful for the candid input and ideas that these colleagues have shared with us in the past and look forward to continued fruitful interactions.

In closing, the NIST Chemical Science and Technology Laboratory has world-class facilities, and the most comprehensive array of chemical, physical, and engineering measurement capabilities of any group working in the general area of chemical science and technology. We will continue to be well-positioned as “a world-class research laboratory recognized by the Nation as the primary source for the chemical, biochemical, and chemical engineering measurements, data, models, and reference standards” that are required to enhance US competitiveness in the world market and facilitate improved quality of life. While maintaining our focus on NIST's core mission responsibilities for the measurements and standards that we have traditionally supported, we are expanding our programs in Bioscience and Health, Nanometrology, Data and Informatics, and Homeland Security. The main body of this report reflects the increased focus in these areas and the critical synergistic relationships that exist among our research programs in measurement science, and the measurement services that we provide to our customers.

Willie E. May, Director
Chemical Science and Technology Laboratory



<http://www.nist.gov>

Hratch Semerjian, Acting Director
Richard Kayser, Acting Deputy Director

From automated teller machines and atomic clocks to mammograms and semiconductors, innumerable products and services rely in some way on technology, measurement, and standards provided by the National Institute of Standards and Technology. NIST is a non-regulatory federal agency within the US Commerce Department's Technology Administration. Founded in 1901, NIST's mission is to develop and promote measurements, standards, and technology to enhance productivity, facilitate trade, and improve the quality of life. Technology advances account for up to half of new economic growth. It strengthens America's security, improves the health of the American people, and creates new jobs and opportunities to support our future prosperity. NIST plays a key role in enabling the hard work and innovative ideas of the American people to strengthen our technology leadership. NIST works with the private sector to develop and apply the technology, measurements and standards that industry needs for new and improved products and services. In FY 2004, NIST had an operating budget of about \$771 million and employs about 3,000 scientists, engineers, technicians, and support and administrative personnel. About 1,600 guest researchers complement the staff. In addition, NIST partners with 2,000 manufacturing specialists and staff at affiliated centers around the country. NIST carries out its mission in four cooperative programs:

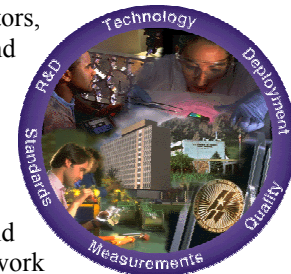

- ***The Measurement and Standards Laboratories*** provide technical leadership for vital components of the nation's technology infrastructure needed by U.S. industry to continually improve its products and services. NIST's seven discipline-based Measurement and Standards Laboratories work at all stages of the pipeline from advancing basic science and pioneering new measurement methods to the development of standard test methods, materials, and data to ensure the quality of commercial products. The seven NIST Laboratories are: Electronics and Electrical Engineering Laboratory (EEEL), Manufacturing Engineering Laboratory (MEL), Chemical Science and Technology Laboratory (CSTL), Physics Laboratory (PL), Materials Science and Engineering Laboratory (MSEL), Building and Fire Research Laboratory (BFRL), and Information Technology Laboratory (ITL).
- ***The Advanced Technology Program (ATP)*** bridges the gap between the research lab and the market place, stimulating prosperity through innovation. Through partnerships with the private sector, ATP's early stage investment is accelerating the development of innovative technologies that promise significant commercial payoffs and widespread benefits for the nation.
- ***The Manufacturing Extension Partnership (MEP)*** was established in 1989 as the first federally funded extension centers to help small manufacturers improve their capabilities and performance, which is a necessity for survival in the global marketplace. Today, the Manufacturing Extension Partnership is a nationwide network of more than 400 not-for-profit centers and field offices. The centers, serving all 50 States and Puerto Rico, are linked together through NIST. MEP makes it possible for even the smallest firms to tap into the expertise of knowledgeable manufacturing and business specialists all over the U.S.
- ***The Baldrige Quality Program*** is an outreach program associated with the Malcolm Baldrige National Quality Award that promotes performance excellence among U.S. manufacturers, service companies, educational institutions, and health care providers; conducts outreach programs and manages the annual Malcolm Baldrige National Quality Award which recognizes performance excellence and quality achievement.



A. Overview

The Chemical Science and Technology Laboratory (CSTL) of the National Institute of Standards and Technology (NIST) is the United States' reference laboratory for chemical measurements. CSTL is entrusted with developing, maintaining, advancing, and enabling the chemical measurement system for the US, thereby enhancing US industry's productivity and competitiveness, assuring equity in trade, and improving public health, safety, and environmental quality. With current world events, the need for accurate and timely chemical and biological measurements is more important than ever. CSTL is ready to meet these new challenges.

Today NIST's vision is to be the global leader in measurement and enabling technology, and delivering outstanding value to the nation. NIST provides scientific leadership for the Nation's measurement and standards infrastructure and ensures the availability of essential reference data and measurement capabilities. To discharge these responsibilities, NIST maintains expertise in a broad range of science and technology areas. The Chemical Science and Technology Laboratory is responsible for measurements, data, and standards in chemical, biochemical, and chemical engineering sciences. Building on a hundred-year history of technical excellence, today's CSTL has the most comprehensive array of chemical, physical, and engineering measurement capabilities and expertise of any group worldwide working in chemical science and technology.

NIST's Vision

Preeminent Performance: *Future economic competitiveness, national security, and public well-being will be shaped by revolutionary developments in the biosciences, nanoscience, and information and knowledge management – a transformation enabled by NIST's unique measurements, standards, and enabling technologies and services.*

NIST's Mission

... is to develop and promote measurement, standards, and technology to enhance productivity, facilitate trade, and improve the quality of life.

CSTL first developed its mission, vision and goals statements in 1992, and then updated them in 1995 and 1998. While they were clearly aligned with the NIST mission and vision, ours were articulated separately. As our thinking in strategic planning has evolved, CSTL now refers to its role in NIST's mission in the following manner: **CSTL fulfills NIST's mission by addressing customer needs for measurements, standards, and data in the areas broadly encompassed by chemistry, biosciences, and chemical engineering.**

Likewise CSTL looks to the NIST Strategic Plan to identify CSTL's part in its realization. This strategic plan is by its nature visionary, long term, and at a high level. It sets a clear direction and course for NIST. CSTL, in the context of this plan, identifies, explores, develops, and refines those opportunities that lie in the areas of chemistry, chemical engineering, and bioscience. CSTL's strategy and substructure is flexible and fluid enough to respond quickly to changes in National priorities, escalating and changing customer needs, and the rapid evolution of science and technology.

CSTL is working toward a Shared Vision – one that all can understand and embrace. The most current version is simply stated: that CSTL is seen by its staff and stakeholders as providing value to our customers with the right measurements, standards, and data at the right time. *Some measures of success are:* we identify our customer needs in an open and consistent process; we understand, anticipate, and respond cost-effectively to customer needs; we balance research and services, projects and people, and new and existing strengths, skill sets, and expertise; we work collaboratively and in partnership to leverage resources for the best strategic and stakeholder outcomes; we advance the fundamental science basis for global measurement systems, and we consistently assess the value and impact of our work.

As we developed this vision, certain key points emerged: this vision is dynamic – it will become clearer and may shift focus over time; it is not about repackaging what we're already doing; we must develop and/or adapt specific strategies and tactics to achieve this vision; not everything or everyone is always going to fit; and communication, transparency and teamwork will become norms throughout CSTL in order to foster effective involvement and trust, and enable the best ideas to emerge.

In pursuit of this Vision, CSTL provides technical leadership for the Nation's measurement and standards infrastructure in synchrony with NIST's Strategic Plan. The Strategic Plan allows us to respond to National priorities, changing customer needs, and the rapid evolution of science and technology. Although the details of the strategic planning process have varied over the years, its essential characteristics — **customer-focus** and **openness to all stakeholders** — have been preserved and even enhanced. Our project planning and priority setting are driven by our three goals listed below:

Measurement Standards: *Establish CSTL as the pinnacle of the national traceability and international comparability structure for measurements in chemistry, chemical engineering, and biotechnology, and provide the fundamental basis of the nation's measurement system.* This objective is achieved by:

- Developing and demonstrating international comparability for chemical and physical measurements;
- Supporting and strengthening the traceability structure in the US; and
- Supporting and strengthening voluntary standards organizations.

Chemical and Process Information: *Assure that US industry has access to accurate and reliable data and predictive models to determine the chemical and physical properties of materials and processes.* This objective is realized by:

- Developing benchmark data for the properties of important substances, classes of substances, and systems;
- Developing data collections, data prediction methods, and models to meet high-priority industrial and national needs;
- Contributing to the development of consensus standards for key properties, substances, and processes; and
- Developing procedures or protocols for data access, facilitating data exchange, and disseminating formatted data.

Measurement Science: *Anticipate and address next-generation measurement needs of the Nation.* This final goal is achieved by:

- Maintaining a strong and cutting-edge research program to support the Nation's measurement and standards infrastructure, and
- Establishing new measurement capabilities to support new and advanced technology development and dissemination.



CSTL Organizational Structure, Leadership, and Resources

CSTL is organized to reflect the technical expertise that is the foundation of our technical programs and allows us to accomplish our mission. The Laboratory consists of five Divisions: the Biotechnology Division, the Process Measurements Division, the Surface and Microanalysis Science Division, the Physical and Chemical Properties Division, and the Analytical Chemistry Division. Each Division employs a group structure organized to achieve synergy and critical mass in its technical program areas.



The discipline-based organizational structure provides a snap shot of core competences and technical expertise, but does not adequately describe the dynamic vision of the CSTL operations in the current technology environment that requires a multidisciplinary approach that is responsive and agile. This model was developed by the CSTL leadership team in FY 2004, and is embraced as an operational vision. The key points are that CSTL is comprised of its entire staff from bench to technical leaders through senior management. All have a key role to play in making CSTL an organization that is seen by all (staff and stakeholders) as providing value to our customers with the right measurements, standards and data at the right time. The “point of contact model” is based on the understanding that technical opportunities enter the organization at every level, and then are focused by a champion (division chief, technical leader, senior scientist) drawing on his/her own expertise as well as other members of the management team, technical leaders, and experts to address the scope of the opportunity, the role for NIST and CSTL, and other cross-disciplinary issues. If the opportunity is a high priority based on our criteria, the best team is then assembled across technical divisions to provide the greatest impact for the customer.

This philosophical change in the role of leadership and operations has served us well over the past year. This past 18 months saw transitions in leadership at all levels culminating in the appointment of CSTL’s new Director, Willie E. May, in December of 2004. This resulted in a cascade of leadership changes within the Analytical Chemistry Division including the appointment of a new Chief, Stephen A. Wise. The Group Leader position he vacated was filled by Lane C. Sander. There were similar changes in the Biotechnology Division as Vincent L. Vilker was detailed to the Center for Advanced Research in Biotechnology (CARB) and Robert N. Goldberg became Acting Chief. His position as Group Leader was filled by Adolfas Gaigalas. The facility with which CSTL achieved these major changes is a testament to its successful succession planning.

To achieve its goals, CSTL maintains an experienced, well-educated professional staff. The full-time permanent staff numbered 249 in FY04, in addition to 79 temporary and part-time employees. Also, there were 237 guest researchers working closely with CSTL staff in various aspects of the research program. The technical capabilities of CSTL staff are extensive; they hold degrees in chemistry, physics, engineering, biology, and computer science. A capable technical-support staff augments the professional staff. Approximately 80% of our scientists have PhD degrees.

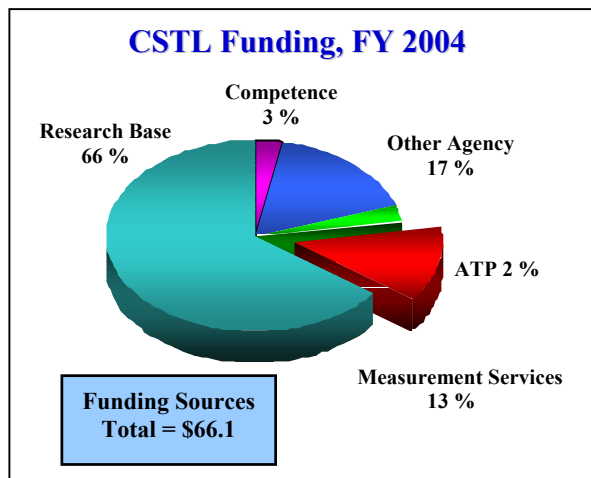
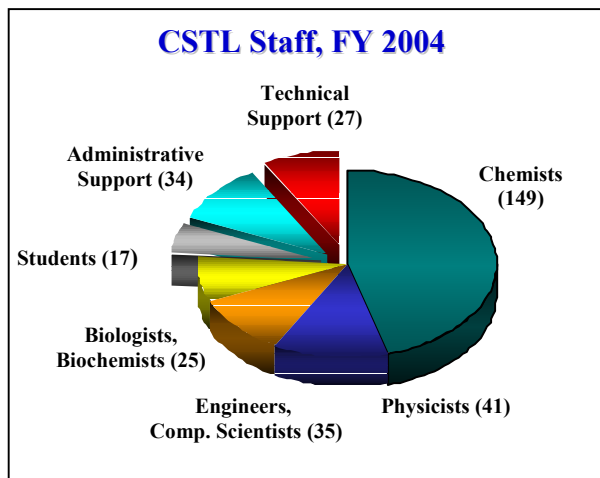

CSTL's physical facilities are located at the major NIST sites in Gaithersburg, Maryland and Boulder, Colorado. In addition, CSTL shares facilities at the Center for Advanced Research in Biotechnology (CARB) with University of Maryland Biotechnology Institute in Rockville, Maryland. The Hollings Marine Laboratory (HML) in Charleston, South Carolina is a cooperative research facility involving NIST, the National Oceanic and Atmospheric Administration, the South Carolina Department of Natural Resources, the College of Charleston, and the Medical University of South Carolina.



All five CSTL divisions have a presence on the Gaithersburg campus. In addition, the Physical and Chemical Properties Division has operations located in Boulder; the Biotechnology Division has its structural biology activity located at CARB; and the Analytical Chemistry Division is the primary liaison with HML, having scientist from two of its groups located in Charleston.

In the last quarter of 2004 we began expanding our efforts in the Hollings Marine Laboratory (HML) to Marine Health and Bioscience, and are exploring opportunities for collaboration with NOAA in their major initiative in Oceans and Human Health. CSTL's Biotechnology Division and Physical and Chemical Properties Division are part of the expansion, which include new areas of research in protein characterization, and the development of critical Mass Spectral Databases. We are also increasing our efforts and research in marine genomics and leveraging these efforts through collaboration with the Department of Marine Genomics of the South Carolina Department of Natural Resources, one of the HML partners. In addition we are looking at future opportunities for collaborations with NOAA that utilize new facilities at the HML such as the Biohazard Level 3 laboratories and the new NMR laboratory.



The Analytical Chemistry and Biotechnology Divisions have now been located in the Advanced Chemical Sciences Laboratory (ACSL) for over five years, the first new research facility on the NIST Gaithersburg Campus in over thirty years.

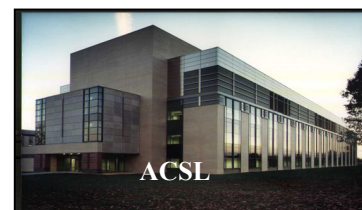

In March 2004, our long-anticipated move to the Advanced Measurement Laboratory took place. This move involved most of the staff from the Surface and Microanalysis Science Division as well as the Pressure and Vacuum Group in the Process Measurements Division. The state-of-the-art instruments moving into the AML have already demonstrated enhanced performance due to the superior environmental control. The high-performance Auger instrument that took four years to barely attain the required resolution specification of 10 nm in Building 222, easily met these specifications at installation in the AML Building 217. Similarly the Analytical Electron Microscope met a 0.19 nm resolution specification easily in the AML. This bodes well for attaining the two-to-five fold improvement in resolution expected from the next-generation instrumentation that is now being acquired. We can now confidently say that the AML is truly the premier environment for nanoscale measurements. Attention is now being directed to



*Baseline temperature (20 °C) can be controlled to within ± 0.25 °C with accuracies up to ± 0.01 °C
Baseline humidity of 40% to 45% RH can be*

improving the facilities in Gaithersburg and Boulder not located in the ACSL and AML.

CSTL Strategic Directions

CSTL has, by design, invested in five major areas since 1997: Biotechnology, Nanotechnology, Healthcare, Data and Informatics, and International Measurement Standards. These areas of investment have been refined over the last few years to meet the challenge of rapidly changing needs in high-impact areas, and to enhance the vibrancy of our core competencies. These strategic thrusts, listed below, define our unique role and channel our core competencies to address existing and anticipated stakeholder needs, while cross-cutting organizational lines.

CSTL core competencies are the scientific expertise and infrastructure in measurement science, measurement standards, and properties data that provide the stability and agility to meet our customers' needs. CSTL views these competencies as critical to the future viability of our organization. They are dynamic and relevant, enabling new as well as promoting change in existing technologies, and leave CSTL and NIST poised to meet both current and next generation measurement and standards needs.

1. Nanometrology for chemical characterization, device characterization, and processes at the sub-micrometer scale.
2. Biometrology for biochemically- or cell-derived materials, devices, or processes.
3. Properties Information Infrastructure technologies for generation, evaluation, and dissemination of chemical and physical property information.
4. Process Metrology for chemical engineering processes
5. Chemical Metrology for the chemical characterization of materials and complex mixtures.

The relationship to the NIST Strategic Focus Areas (SFAs) is still just as clear, and the obvious mapping to our previous thrusts permits us to track our new and continuing investments. We have chosen to focus on the metrological aspects of these emerging and changing areas to more clearly describe to our staff what specific role CSTL should play, so as not to confuse our customer-aligned programs with our mission-driven thrusts. Homeland Security is not explicitly named in the CSTL thrusts, but our role in this vital National priority is clearly a part of all five of our areas of emphasis. In addition to this emphasis on measurement science and research, CSTL is fully committed to providing the measurement services required by its customers; this includes: constantly aligning our efforts with the NIST role in the National Measurement System; implementing quality systems to support CSTL measurement services; designing and implementing the best and most efficient ways to deliver current and next-generation services.

NIST Strategic Focus Areas:

- Nanometrology
- Biosystems and Health
- Information/Knowledge Management
- Homeland Security

Selection of new projects for reprogramming and identification of projects to be phased out requires specific criteria. The CSTL Management Council uses the following criteria for its decision-making. The first five are aligned and in harmony with the five NIST priority-setting criteria.

1. Industrial Need – The magnitude and immediacy of industrial need is assessed.
2. Match to Mission – CSTL meets customer needs for measurements, standards, and data in the areas broadly encompassed by chemistry, biosciences, and chemical engineering.
3. Making a Difference – CSTL’s contribution is unique and critical for success.
4. Nature and Size of Impact – The measure of anticipated impact relative to investment is evaluated (rate of return).
5. Timely Quality Output – CSTL has the ability to respond in a timely fashion with high-quality output.
6. Science/Technology (S&T) Opportunity – Recent scientific and technological advances present new opportunities for CSTL.

NIST revisits and refines these criteria from time to time, having recently added an element of “impact path” and “strategic significance of impact” that relate to criterion number 4 and “probability of success” which adds some dimension to criterion number 5. CSTL has added a sixth criterion in overall decision-making since we strongly believe that S&T opportunity can be a significant, even key, factor.

To provide our staff with stimulus for innovative ideas and new areas of research, CSTL continues its tradition of one-year funding for small seed projects that evaluate the feasibility of new technologies and measurement methods. In FY2004, CSTL funded 14 such projects, following a rigorous internal peer review process. Progress reports for these projects are included in Section C of this Annual Report.

CSTL Programs

CSTL is a multifaceted, synergistic organization with a unique customer base. Perhaps the most remarkable aspect of the CSTL customer base is its breadth. The primary customers we serve are: industry; federal, state, and local government agencies; standards and industrial trade organizations; and the academic and scientific communities.

US industry is the largest consumer of our products and services. These customers come from established industrial sectors, such as the chemical manufacturers, and emerging industries, such as biotechnology and nanotechnology. The products and services they rely on are as varied as Standard Reference Materials (SRMs), Standard Reference Data (SRDs), calibration services, and novel measurement methods. Reference materials and calibrations provide traceability to the International System of Units (SI), which is essential to fair trade, improved reliability of measurements, and regulatory compliance. Data compilations facilitate modeling of chemical processes and rational product design. New measurement techniques ensure improved product quality and process efficiency, and in turn enhance competitiveness.

Federal, state, and local governments are another important consumer of our products and services. These agencies use our products and services in ways similar to the commercial sector, but in different arenas. For example, calibrations, evaluated data, and reference materials are used to ensure the reliability of environmental monitoring programs. Carefully characterized physiological samples lend credibility to forensics tests. Measurement technologies developed and perfected in CSTL verify compliance with international treaties. Other national laboratories exploit the expertise and techniques developed here in discharging their mandates.

A final group that uses our expertise includes trade organizations, standards committees, and the academic and scientific community. These groups rely on CSTL’s expertise for advice and guidance in establishing practical standards and uniform protocols. The academic and scientific communities rely on the data produced and compiled by our staff as touchstones for their own research.

CSTL has long utilized a customer-based programmatic structure to help focus CSTL projects and activities, as well as to provide a forum to articulate the nature and impact of our work. This customer focus, combined with the agility of our technical staff, permits CSTL to respond in a timely manner to changes in measurement needs within each industry segment, and changes in priorities among industries as well as National priorities. CSTL has identified 10 programmatic areas aligned with industrial segments and National priorities, and these are highlighted in Section B of this report. It is clear that those projects listed contribute to strengthening the metrological infrastructure of each industry sector. This structure remains deliberately flexible and modifications are made based on needs assessments and stakeholder input. Any modification is a reflection of CSTL's current level of activity with specific industries, and captures changes in priority both internal and external.

It is also beneficial to articulate CSTL projects by activities that cross-cut industry sectors. Therefore, CSTL has three cross-cutting programs that are mission-driven and are clearly aligned with CSTL's three strategic goals.

- 1. Automotive and Aerospace**
- 2. Biomaterials**
- 3. Pharmaceuticals and Biomanufacturing**
- 4. Chemical and Allied Products**
- 5. Energy and Environmental Technologies**
- 6. Food and Nutritional Products**
- 7. Forensics and Homeland Security**
- 8. Health and Medical Technologies**
- 9. Industrial and Analytical Instruments and Services**
- 10. Microelectronics**

- 11. Measurement Standards**
- 12. Data and Informatics**
- 13. Measurement Science for Future Standards and Technologies**

Measures of Success

CSTL employs many mechanisms to capture feedback on the quality, relevance and impact of our programs and activities. In its mandated review of NIST programs, the National Research Council (NRC) Board on Assessment (BoA) Panel for CSTL provides a rigorous peer review of the quality of our technical activities. The Panel is comprised of technical experts from industry, academia, and national laboratories covering the broad range of disciplines corresponding to CSTL program areas. Direct customer feedback on the quality of our work, external recognition of our technical staff, the leadership roles of our staff in standards activities, and the performance of CSTL in Key Comparisons conducted among other countries' National Metrology Institutes, under the auspices of CIPM Consultative Committees, provide further direct evidence for the quality and relevance of our technical programs. Our performance in CIPM Key Comparisons in a broad range of measurement fields, where our performance is compared to the best laboratories of the world, is an excellent measure of our capabilities and an opportunity to demonstrate our global leadership.

CSTL also organizes many workshops and meetings to assess the needs of specific industry segments, and to prioritize these needs to address the highest impact areas. Workshops, which bring together experts from NIST, industry, academia, and other national agencies, are a particularly useful and cost-effective means of developing competent technical strategies for meeting the NIST mission. CSTL interactions with other federal agencies also provide us with invaluable knowledge on measurements, standards, and data needs that may result from promulgation of new regulations, or new more sensitive and selective measurement methods that may be needed to improve the science base needed for decision making. Direct customer and stakeholder feedback on the relevance of our current work and anticipated measurement needs of industry is also sought out through ongoing interactions. This information is used to help develop programs in appropriate directions and assure that CSTL programs are effectively meeting the needs of our customers.

Other direct indicators of the relevance of our work are CSTL outputs, such as new calibration services, Standard Reference Materials (SRMs), Standard Reference Data (SRDs), publications, invited talks, patents, licenses, the number of companies using our calibration services, the number of institutions who purchase our SRMs in the US and abroad, and the number of institutions who purchase or license our SRD products, or download our web-based databases. The quality of Measurement Service delivery is another important performance measure for our customers. We constantly monitor and strive to improve the turnaround time of our calibration services. We have been successful in reducing the certification times of our SRMs (to less than two years), and improving our prioritization process to reduce out-of-stock items. CSTL is also making special efforts to expand our web-based data dissemination efforts, and to provide more standardized formatting and single-portal access to all CSTL databases.

Some of the CSTL outputs and interactions in FY2004 are summarized in the following table.

<i>Selected CSTL Outputs – FY2004</i>										
Div	Pubs	Talks	Committees	Seminars	Conferences	CRADAs	Patents Issued	SRMs/RMs	SRDs	Cals
830	1	20	12	8	1	0	0	0	0	0
831	120	152	39	3	22	3	1	8	2	0
836	65	45	76	13	5	1	0	1	0	682
837	38	90	80	10	4	4	1	3	5	0
838	86	114	83	21	5	6	0	2	16	0
839	71	159	135	36	6	3	0	135	0	323
Total	381	580	425	91	43	17	2	149	23	1005

¹ Publications appearing in print in FY 2004. Another 165 manuscripts have been submitted for publication.

² Committee totals include 61 editorships and the TRC

³ CRADA's signed this year only

⁴ There are a total of 44 active patents.

⁵ SRMs/RMs (Certificates issued)

⁶ Calibrations were performed for over 306 customers.

<i>Key:</i>			
830	Laboratory Office	837	Surface and Microanalysis Science Division
831	Biotechnology Division	838	Physical and Chemical Properties Division
836	Process Measurements Division	839	Analytical Chemistry Division
SRM – Standard Reference Material		SRD – Standard Reference Data	
		Cals. – Calibrations	

Lastly, economic impact studies, conducted by outside experts, investigate the impact of CSTL products and services on the US economy, thereby providing a quantitative tool for measuring the influence and reach of our programs.

Evaluations of the economic impact of NIST's metrology programs in specific technical areas are carried out through NIST-commissioned studies, performed by external contractors. These studies provide both qualitative assessments and quantitative estimates of the economic impacts resulting from the several categories of technology infrastructure that NIST provides to US industry. Quantitative estimates are provided either as benefit-to-cost ratios or as rates of return to the nation (social rate of return). The results of these impact assessments not only respond to the need to measure and analyze current and past performance but also contribute to future strategic planning. CSTL has completed six of these studies between 1997 and 2003 to help evaluate the impact of its standards and data products. In collaboration with the Mayo Clinic, the impact of measurement uncertainty on PSA measurement was initiated in FY 2004. The first phase of this work, Standards for Calcium Testing, was completed last year and is described below. In addition, we summarize some of the results of earlier impact studies, with updated information on subsequent activities and benefits accrued since the publication of each report.

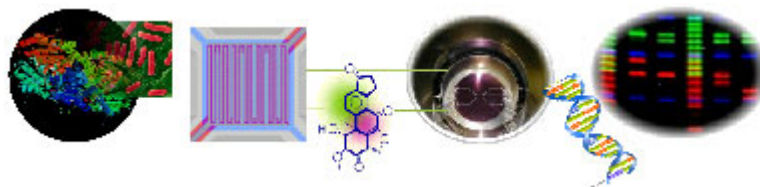

Standards for Calcium Testing:

NIST and the Mayo Clinic in Rochester MN jointly commissioned a study to evaluate the impact of clinical laboratory measurement variations on both patient care and healthcare costs. The issue of measurement variability is accentuated in recently developed integrated healthcare networks, which were designed to help reduce clinical practice variation. In this study mathematical models were designed and data analyzed from over 89,000 patients receiving calcium tests at the Mayo Clinic between 1998 and 1999. This data analysis was done in order to evaluate the impact of laboratory variation on total healthcare costs to help illustrate the importance of traceable standards and robust reference methods. Based on interviews with laboratory managers and equipment manufacturers, it was determined that calibration error has the potential to cause a bias of 0.1 mg/dL to 0.5 mg/dL in up to 15 % of the calcium tests. The study, published in 2003, revealed that patients with elevated or borderline calcium levels resulted in increased health care costs of up to \$31 per patient for an analytical bias of 0.1 mg/dL and up to \$89 per patient when the bias was 0.5 mg/dL. In the US, with approximately 3.55 million patients per year receiving serum calcium tests that are affected by systematic bias, the potential economic impacts range from \$60 million to \$198.8 million for analytical biases of 0.1 mg/dL and 0.5 mg/dL, respectively.



This is the first of a three-part study, and the impact of measurement uncertainty on PSA measurements is underway, to be followed by a similar study for uncertainties related to cholesterol measurements.

NTRM Gas-Mixture Standards:



The NIST Traceable Reference Materials (NTRM) program was created to help address the problem of increasing needs for reference materials with a well-defined linkage to national standards. An NTRM is a commercially produced reference material with a well-defined traceability to existing NIST standards for chemical measurements. This traceability linkage is established via criteria and protocols defined by NIST and tailored to meet the needs of the metrological community to be served. The NTRM concept has been implemented in the gas standards area to allow NIST to respond to increasing demands for high-quality reference materials needed to implement the "Emissions Trading" provisions of the Clean Air Act Amendment of 1990.

Currently NIST is working with the SGCs to reduce the uncertainty in the NTRMs. NIST has proposed to analyze individual NTRM gas cylinders and provide individual uncertainty analyses for each cylinder of the standard requested; these products would be known as *NTRM Prime*. This is driven by market demand for a "better product"; improvement in bottom-line profit by avoiding redundant analyses; and the desire to anticipate future changes in regulatory requirements particularly as they relate to emissions trading.

The NTRM program was created by NIST in collaboration with the US Environmental Protection Agency (EPA) and the specialty gas companies (SGCs) to increase the availability of NIST-certified reference materials. Under the program, SGCs follow NIST technical guidance to manufacture SRM-equivalent standards and submit these standards to NIST for certification. Once certified, the NTRMs are the functional equivalent of SRMs and are used to assay the large volume of secondary reference standards demanded by consumers to meet regulatory requirements. For this impact study, SGCs were surveyed, as well as end users such as electric utilities, transportation

equipment firms, petrochemical firms, commercial laboratories, and government agencies. Since NTRM program inception in 1992, 15 specialty gas companies have worked with NIST to certify over 8600 NTRM cylinders of gas mixtures that have been used to produce approximately 500,000 NIST-traceable gas standards for end users, with a market value of about \$140 million. Over the past decade, this process has been and continues to be an integral component of the high-accuracy reference gas supply chain. According to the economic impact study published in August 2002, the social rate of return of this program is 225 %, with a benefit-to-cost ratio estimated to be 24 to 1, and a net present value of \$56 million.

Cholesterol Standards:

Chemical metrology is at the heart of accurate medical diagnosis and the development of measures to improve our health and ensure long life. In the US more than one trillion dollars are spent each year on health care, which is about 14 % of the US gross domestic product (GDP). More than 20 % of these expenditures are for measurements.

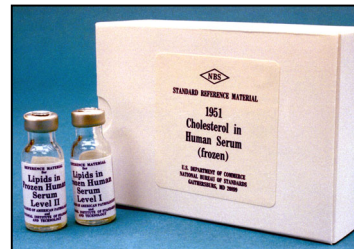

Over the last three decades, NIST, in cooperation with the College of American Pathologists (CAP), has developed a series of highly accurate and precise methods for a number of clinically important serum constituents, including cholesterol. These methods are recognized by the international clinical laboratory community as "definitive" and have been used to certify a series of cholesterol SRMs. The first pure crystalline cholesterol (SRM 911) was introduced in 1967. Using the definitive method, serum cholesterol SRMs were developed in 1981 (SRM 909) and again in 1988 (SRMs 1951 and 1952). These SRMs have led to a steady decrease in the measurement uncertainty from 18 % relative in 1969 to about 6 % in 1999. The economic consequences of NIST's Cholesterol Standards Program are experienced at several levels of the supply chain, from manufacturers to network laboratories, to clinical laboratories that ultimately deliver medical services to the consumer. The results of this study indicate that NIST has played an important economic role in support of a national effort to monitor, measure, and control cholesterol levels, thereby contributing to the reduced level of heart disease. The economic impact study estimates a benefit-to-cost ratio of 4.5, and a social rate of return of 154 %. The net present value was calculated to be more than \$3.5 million. This report was published in September of 2000, and the timeline extended from 1986 to 1999.

Recent Developments: NIST cholesterol SRMs remain an important part of the traceability chain for clinical laboratories and manufacturers of cholesterol measurement kits. Approximately 500 SRM units were sold per year over the past three years.

Beyond Cholesterol: These cholesterol SRMs, along with NIST's suite of clinical standards, also serve as important "high order" reference materials, providing measurement traceability for in vitro diagnostic (IVD) products. This level of traceability is required for IVD products to be imported into European markets, as specified in the EU IVD Directive that went into effect in December of 2003. Since US-based companies supply 60 % of the IVD products sold in Europe, it is critical to US industry that NIST maintain and expand SRMs that provide the required traceability. Specifically, the need for manufacturers to provide traceability statements to their customers and to calculate uncertainty for their device calibrators has its origins in this IVD Directive. In order to help manufacturers meet the implementation deadline, NIST's CSTL and ITL collaborated with industry representatives to develop and offer a widely accessible and broadly disseminated web cast workshop to provide the tools needed by the industry to perform uncertainty calculations for their calibrators and controls. NIST led the efforts in an international working group on Reference Materials and Reference Laboratory Procedures in establishing a process for identifying, reviewing against agreed upon criteria, and publishing a list of "higher order" Certified Reference Materials and Reference Measurement Procedures required for IVD industry compliance with the EU IVD Directive regarding in vitro diagnostic medical devices. Details are provided in the Measurement Standards section of this report.

Cholesterol SRMs have continued to play a critical role in the steady decrease in the measurement uncertainty from 18 % relative in 1969 to about 6 % in 1999, and 3 % today.

Sulfur in Fossil Fuels:

The sulfur content of fossil fuels is one of the most important intrinsic factors that determine fuel prices. The accurate determination of the sulfur concentration in fossil fuels is required as a result of environmental regulation that places increasingly lower limits on their sulfur content and the imposition of large fines for non-compliance. At every stage in the process (mining, transportation, buying and selling, and combustion) the sulfur content of both oil and coal must be determined in order to meet buyer and seller specifications that are dictated in large part by government environmental regulations. The efficient and cost-effective movement of coal and oil from the mine and well to power plants and refineries requires precise and accurate determination of sulfur content in two or more laboratories. For equity in trade and the efficient production of energy, it is mandatory that instrumentation in these laboratories be calibrated using accurate standards.

NIST has certified the sulfur content in about 30 coal and fuel oil SRMs to an accuracy of better than ± 0.1 % relative, using isotope dilution mass spectrometry. These SRMs provide industry with the primary calibration materials needed for instrumentation used in routine measurements. SRMs also provide industry with a strong traceability link to NIST for such measurements, whether they be for setting the price of fuel or for demonstrating compliance with environmental regulations. Surveyed industry representatives indicated that NIST SRMs have decreased the level of uncertainty associated with their measurements of sulfur content. This reduction has led to economic benefits throughout the supply chain. Included in the measures of economic benefits are improvements in product quality, production efficiency, and reductions in transaction costs and sulfur emissions to the environment. This study, published in February 2000 estimates a benefit-to-cost ratio of 113, and a social rate of return of 1,056 %. The Net Present Value was calculated to be more than \$400 million. The time period studied was from 1984 to 1999.

Recent Developments: The petroleum refining industry faces a June 2006 deadline to comply with stringent limitations on the sulfur content of highway diesel fuel. By this date, most refiners must meet a 15 $\mu\text{g/g}$ or parts per million (ppm) standard for at least 80 % of the highway diesel fuel produced, with a 500 $\mu\text{g/g}$ (ppm) cap on the remaining 20 % of their production. By 2010, all highway diesel fuel must meet a 15 $\mu\text{g/g}$ (ppm) cap. In addition, the industry expects that the EPA will propose similar regulations for the non-road diesel-fueled vehicles. The benefits to the industry in the 2000 Economic Impact report were derived from improved production efficiency in producing diesel fuel that complied with the 500 $\mu\text{g/g}$ (ppm) sulfur cap. The new cap of 15 $\mu\text{g/g}$ (ppm) sulfur puts additional constraints on the industry that translate to higher potential cost avoidance by the use of SRM standards. In December 2003, NIST released a new low-level diesel fuel SRM with a sulfur concentration of 11 $\mu\text{g/g}$ that will meet the new need of the industry. In addition, SRM 1616b Kerosene, to be released soon, has certified sulfur levels at approximately 8 $\mu\text{g/g}$, the lowest level of any Certified Reference Material available worldwide.

A testimony on the relevance of NIST low-sulfur in Diesel Fuel SRMs

“The development of (diesel fuel) SRMs directly supports the introduction of ultra-low-level diesel fuel with the implementation of the US EPA2007 highway heavy-duty and 2010 Tier 4 non-road diesel regulations. These regulations when fully implemented will provide roughly \$150 billion annually in health and welfare benefits to the American Public.”

**Margo Tsirigotis Oge, Director
Office of Transportation and Air Quality, EPA**

Alternative Refrigerants:

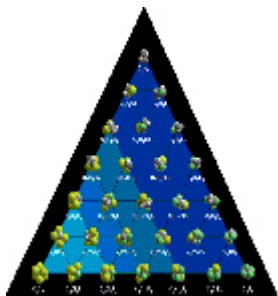

Occasionally, an accelerated R&D program must be undertaken to respond to industry needs that are constrained by set deadlines. With the timetable imposed by the Montreal Protocol of 1987 and the resulting requirement to develop new alternatives to CFCs, NIST engaged in research that would allow industry to make the switch to alternative refrigerants in a timely and economical fashion. NIST began by identifying the basic requirements for new refrigerants according to the new rules, and then started research on determining the physical properties of such candidate alternatives. NIST’s most effective form of information dissemination has been the REFPROP program, a computer software package that is available through NIST’s Standard Reference Data Program. The REFPROP program enables manufacturers and users of alternative refrigerants to model the behavior of refrigerant mixtures in their respective equipment, key in applying CFC replacements. A comparison of industry benefits with the funding stream of NIST’s research program estimated a social rate of return of at least 433 %, and a benefit-to-cost ratio of 4 to 1. This report was published in January 1998, and the period studied was from 1987 to 1996.

Recent Developments: The NIST REFPROP database has been updated several times since the economic assessment. Version 7.0 is the current public release, and version 8.0 is in *beta* testing with release expected in mid-2005. This database continues to be the primary technology transfer vehicle for the continuing work of CSTL on refrigerants. The latest version includes additional fluids and mixtures, improved property models, increased calculational speed, and an enhanced user interface with additional properties and calculation and plotting options. Version 8.0

DuPont phased-out their “Refrigerant Expert” package in 1999, and pointed their customers to REFPROP and CYCLE-D, and REFPROP has been licensed for use with the ASPEN and FLUENT process simulation package.

will greatly expand the list of fluids, including cryogenic fluids, hydrocarbons, and simple inorganics in addition to refrigerants. This expansion was already anticipated by the new title beginning with version 7.0: Reference Fluid Thermodynamic and Transport Properties with “Reference Fluid” replacing the “Refrigerant” of earlier versions. Its position as the *de facto* standard in the refrigeration industry is stronger than ever. In addition to direct use by engineers in industry (it is the number two seller among the databases distributed by the NIST Standard Reference Data Program), it provides the core property routines for the CYCLE-D and REFLEAK databases distributed by NIST as well as packages distributed by several refrigerant and equipment manufacturers to their customers. ISO recognizes the high quality of REFPROP and therefore specifies the same models (and thus the same property values) in its recently approved standard on refrigerant properties.

CSTL researchers will port the computational engine of REFPROP to the Thermo-Data Engine (TDE), a new NIST database providing on-demand correlation of experimental data. This will give TDE the advantage of the inherent thermodynamic consistency of representing properties with equations-of-state versus the present approach of representing different properties with discrete correlations. Models for aqueous (water-based) systems and hydrocarbon mixtures containing hydrogen and helium will also be developed.

Thermocouples:

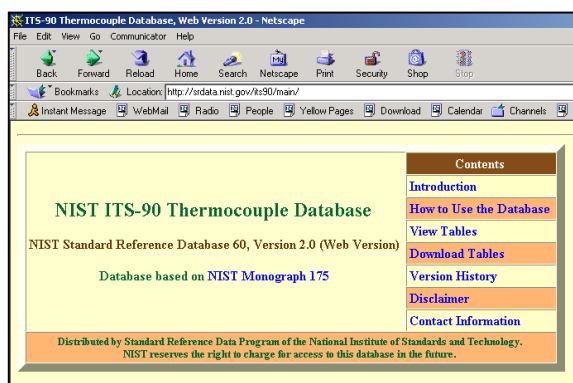

Now available online at
<http://srdata.nist.gov/its90/main/>

The NIST thermometry program includes both calibration services and research on thermocouples. Thermocouples are among the most commonly used sensors for monitoring and control of manufacturing processes. The annual sales of thermocouple products sold by the US thermocouple industry (suppliers of wire and thermocouple assemblies) into the US market are approximately \$280 million. The incorporation of these devices into higher levels of product structures across a broad base of domestic industries affects a much larger portion of the manufacturing sector, estimated to be on the order of \$80 billion.

Benefits were estimated based on surveys and interviews of the thermocouple industry and did not include the much larger, though diffuse, community of device users. Participants were asked to estimate the additional expenses that would have been incurred if NIST were to cease to provide primary calibration services. NIST expenditures included research on the fundamental and infrastructural aspects of

thermocouple principles, measurement, and test methods as well as calibration services. This study, published in July 1997, conservatively estimated the social rate of return to be 32%, and a benefit-to-cost ratio of 2.95.

Recent Developments: Currently, the ITS-90 relies on the fundamentally more accurate high-temperature platinum resistance thermometer to define the temperature scale in the range of 631 °C to 1064 °C. In this range, prior to the introduction of the ITS-90, less accurate type S (platinum-rhodium vs. platinum) thermocouples were used to define the temperature scale. Work at NIST based on the new scale definition led to new reference functions with improved accuracy for both type S and R thermocouples. Even more importantly, the new definition of the ITS-90 enabled the determination at NIST of highly accurate reference functions for pure element thermocouples, such as gold versus platinum and platinum versus palladium. In the range from 0 °C to 1000 °C, gold versus platinum thermocouples provide an order of magnitude more accuracy than the previous type S thermocouples commonly used as reference standards in industry.

Based on the NIST research, gold versus platinum thermocouples are now readily available to the user community from several US manufacturers.

The next sections of this Report will delve into each of CSTL's 13 programs individually, highlighting major activities and accomplishments in these areas for FY2004. Following the highlights of the 10 customer-focused programs, this Report addresses the three goal-aligned programs. Most of the details of the projects listed in the Measurement Standards, and Data and Informatics Sections are presented in the context of their impacted industry sector, and a reference is supplied to provide a more coherent view. CSTL, however, also works on the cutting-edge of metrology and develops tools to anticipate next-generation needs. These tools are not necessarily identified with a particular industry sector, and therefore are presented here in the program title: Technologies for Future Measurements and Standards, which reflects CSTL's third strategic goal.

Technical details of these activities can be found on CSTL's website or by contacting the principle investigators listed in the Report.

<http://www.cstl.nist.gov/>



B. CSTL Programs



Automotive and Aerospace

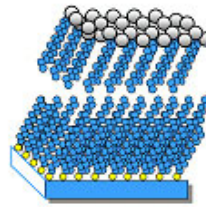

Biomaterials

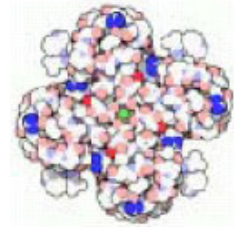

**Pharmaceuticals and
Biomanufacturing**



**Chemical and
Allied Products**



**Energy and
Environmental
Technologies**



Food and Nutrition



**Forensics and
Homeland Security**



**Health and Medical
Technologies**



**Industrial and
Analytical
Instruments and
Services**

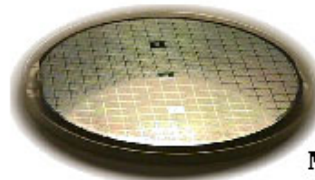

Microelectronics

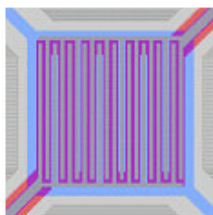

**Measurement Science for Future
Standards and Technologies**



Measurement Standards



Data and Informatics

1. Automotive and Aerospace (Transportation)



According to the Bureau of Transportation Statistics, in 2002 Americans traveled over 5 billion passenger miles (i.e., 18,000 miles/person). From those, 90% were traveled in our highway system, while 9% was traveled in our airways.

Recognizing the importance of the transportation industry to our national economy, CSTL provides standards for emissions testing and flow measurements to help the automotive and aerospace sectors meet their regulatory requirements. CSTL also works with the industry to provide physical and chemical property data that can be used in sophisticated computer models for next-generation combustion engine design, and provides a new generation of chemical standards and reference data to support advanced materials such as super alloys for high-technology jet engines.

provide physical and chemical property data that can be used in sophisticated computer models for next-generation combustion engine design, and provides a new generation of chemical standards and reference data to support advanced materials such as super alloys for high-technology jet engines.

When the California Low Emissions Vehicle (LEVII) regulation is fully implemented in 2010 it is estimated that smog-forming emissions in the Los Angeles area will be reduced by 57 tons per day, while the statewide reduction will be 155 tons per day.

Gas Mixtures Standards for the Automotive Industry: The *NTRM Prime* Program

W.D. Dorko (839)

Increasingly stringent environmental regulations place continuous demands on automobile manufacturers to improve the performance and quality of their vehicles. Among the requirements of these regulations is the traceability of emission test results to national standards. Through the NIST Standard Reference Material (SRM) and NIST Traceable Reference Material (NTRM) programs, CSTL helps support the traceability of gas standards needed by the automobile industry and other sectors of the US economy.

As part of the NTRM program, Specialty Gas Companies produce – in concurrence with NIST – batches of gas mixtures. The composition of these mixtures is analyzed and results are sent to NIST for review. NIST also analyzes 10% of the cylinders produced to ensure the quality of the claimed results. The concentrations of the components in the gas mixture are assigned based on NIST results and their uncertainties are estimated using both the NIST and Specialty Gas Producer data.



Recently, the automotive industry requested that NIST provide gas mixtures with uncertainties lower than those claimed for the NTRM products. One response would be for NIST to analyze individual NTRM gas cylinders and provide individual uncertainty analyses for each cylinder of the standard requested; these products would be known as *NTRM Prime*. A meeting of all interested parties will be held at the 2005 Pittsburgh Conference to further refine the scope of the proposed NTRM Prime program.

In the future, the automobile industry and other larger users of NTRMs will decide which gas mixtures are needed. NTRM producers are expected to manufacture the required products per industrial requests.



NIST will support NTRM manufacturers in providing the products necessary to meet regulatory requirements by increasing the number and concentration ranges of gas mixtures for which it maintains primary standards.

New Hydrocarbon Liquid Flow Standard for 0.2 L/min to 5 L/min

T. T. Yeh, P. I. Espina, and J. Aguilera (836)

Turbine-based power plants are heavily used in ships, aircraft, large ground vehicles, and portable electric plants by the US Department of Defense (DoD) and the commercial aircraft industry. Critical requirements for these include the performance of liquid flow meters used in turbine engine test stands.

The testing of modern, high-efficiency engines requires uncertainties that have begun to exceed the capabilities of NIST's liquid hydrocarbon flow standards which have an uncertainty of 0.12 % of reading. This prompted the DoD Calibration Coordination Group (CCG) to award NIST a grant aimed at developing a new generation of standards capable of providing traceability with uncertainties no larger than 0.025 % of reading. Recently we successfully concluded the first phase of this program, and today NIST has a new flow calibrator (see figure) designed to provide the requested performance.

NIST procured a volumetric displacement flow standard (also known as a piston prover) from Flow Dynamics Inc. (Phoenix, Arizona) – currently the only manufacturer of such systems in the US. Design features and specifications for the new flow standard were collaboratively selected by staff from NIST and the commercial supplier. Upon receipt of the standard, NIST completed an extensive effort to establish direct traceability for the time, temperature, and length measurements that are used by the standard to assess the liquid flow. A detailed uncertainty analysis for the flow standard was written and tests were conducted to validate its conclusions. Using this system, the NIST measurement uncertainty for hydrocarbon liquid flows has been reduced by more than a factor of ten to 0.01 % (k=2).

NIST hydrocarbon flow measurement standards support the needs of aircraft turbine engine manufacturing requirements for improved fuel efficiency, supporting military and commercial user requirements

In the coming year we will procure a 20 L Hydrocarbon Liquid Flow Standard and characterize it to cover flows from 2 L/min to 50 L/min. Ultimately, the new systems will replace our outdated gravimetric primary standard which has served this calibration service since 1954.

CSTL researchers improve the uncertainty of NIST's hydrocarbon liquid flow standards by more than a factor of 10.



A dual rotor turbine meter is installed in the test section of the 2 L Hydrocarbon Liquid Flow Standard.

The new 2-liter-capacity hydrocarbon liquid flow standard replaces a gravimetric system over the range of 0.2 L/min to 5 L/min. It evaluates the performance of flow meters using type II hydrocarbon calibration fluid that simulates flow meter characteristics in jet fuel by closely matching fluid viscosity and density values. The system is fully automated; once the operator specifies flow set points, the data are accumulated and stored for later analysis and report generation. This automation reduces data transcription errors and calibration costs for our customers.

T.T. Yeh, P.I. Espina, G.E. Mattingly, N.R. Briggs, and J. Aguilera, "An Uncertainty Analysis of a NIST Hydrocarbon Liquid Flow Calibration Facility", Proceedings of the 2004 Heat Transfer / Fluids Engineering Summer Conf. July 2004.

Propulsion Systems Demand Accurate Property Data

J.W. Magee, D.G. Friend, T.J. Bruno, M.L. Huber, E.W. Lemmon, A. Laesecke, R.A. Perkins, J.A. Widegren (838), I.M. Abdulagatov (Russian Academy of Sciences), and P.C. Andersen (2B Technologies)

As part of the Next Generation Launch Technology Program, NASA is designing advanced rocket engines that will combust a kerosene-based fuel known as RP-1. RP-1 is a complex liquid fuel that consists of more than 100 components, for which present-day thermophysical properties models are based on very limited data. NASA has concluded that RP-1 property estimation accounts for 70% of the uncertainty in the propulsion system design. NIST used a gas chromatography–mass spectrometry–infrared spectrophotometry method to chemically characterize RP-1. From its constituents, 20 compounds were selected as part of a surrogate mixture used for measuring and modeling thermophysical properties. Measurements of chemical composition, boiling temperature, density, heat capacity, viscosity, and thermal conductivity were conducted in a range of temperatures up to 700 K and pressures to 60 MPa.

Short equations of state and models for the transport properties were developed and implemented in a user-friendly program.



These accomplishments were presented to rocket fuels specialists during a workshop hosted at the NIST Boulder campus in December 2003. Participants from NASA, the Air Force, commercial rocket engine manufacturers, and academia were eager to use the new results, and interested in continued NIST efforts to explore other features related to fuel properties.

NIST improves the accuracy of thermo-physical properties of RFP-1 by developing new measurements and models, removing a key source of uncertainty in propulsion system design.

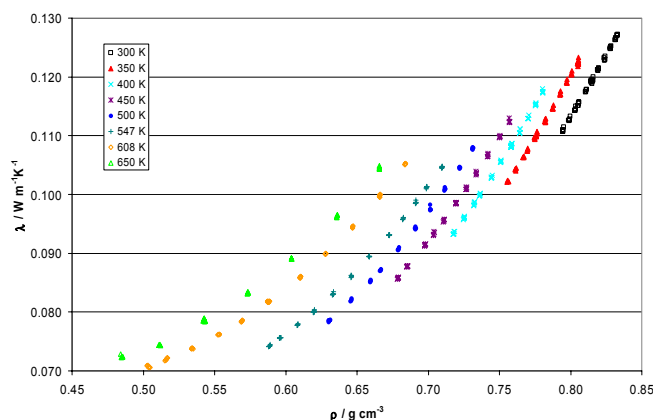

Accurate experimental results for thermal conductivity of RP-1 have replaced estimated values NASA had relied on since the 1950s

New Gas Standards for Calibrating Instrumentation Used for Measuring Emissions from Next-Generation Low-Emission Vehicles

W.J. Thorn III (839)

Since 1975, NIST and the US Motor Vehicles Manufacturers have worked together to develop gaseous Standard Reference Materials (SRMs), which by federal law are the Nation's standards for all mandated fuel economy and mobile-source emission measurements. Currently, the American Industry/Government Emissions Research consortium (AIGER) is working to help the automobile industry meet 2003 Federal Tier II and California LEV II emission regulations. NIST supports AIGER by maintaining inventories of required gas SRMs that consist of dilute mixtures of key pollutants such as hydrocarbons, carbon monoxide, and nitric oxide.



In 1998, NIST worked with a Specialty Gas contractor to blend cylinders of low NO standards at concentrations ranging from 0.5 $\mu\text{mol/mol}$ to 1.25 $\mu\text{mol/mol}$. The new standards exhibited excellent stability for more than 5 years and final concentration values with associated uncertainties were recently assigned. In 2001, AIGER requested the production of two new low NO SRMs at concentrations of 0.5 $\mu\text{mol/mol}$ and 1.0 $\mu\text{mol/mol}$ (SRMs 2737 and 2738 respectively). NIST and a contractor prepare the new working standards using NO in nitrogen blends. The NIST certification analysis for the new SRMs was completed in September 2004.

Driven by future requirements by AIGER, NIST continues to move NO analytical standards and measurement capability below 0.1 $\mu\text{mol/mol}$ levels.

NIST releases two new low-level nitrous oxide SRMs

SRM 2737 – 0.5 $\mu\text{mol/mol}$

SRM 2738 – 1.0 $\mu\text{mol/mol}$

Combustion Simulation Databases for Real Transportation Fuels: A New Community Collaboration

T. C. Allison, D. R. Burgess, Jr., J. W. Hudgens, W. Tsang, and J. A. Manion (838)

The economic, environmental, and health benefits that could be derived from improved combustion processes are enormous and well recognized. In September 2003, the leading experts from industry, academia, and government met at the NIST Workshop on Combustion Simulation Databases for Real Transportation Fuels to assess needs and opportunities to translate scientific understanding of combustion to technological development. Attendees affirmed the value of predictive models of combustion in the development of less polluting engines. The workshop concluded that a coherent effort is required to address the complexities associated with the combustion of real transportation fuels and that a standard infrastructure for the exchange of combustion-related data must be developed.

As a result of the workshop, NIST joined with other members of the combustion community in the PrIME (Process Informatics Model) collaboration. The goal of PrIME is to generate standard formats for combustion data, together with data libraries, analysis software tools, and the supporting IT infrastructure that will enable development of predictive models for combustion. The PrIME uses the DoE supported (CMCS) project to develop and support the IT infrastructure required for the effort. NIST's commitment to PrIME envisions the creation of new paradigms for scientific collaboration involving the construction of a traceable, comprehensive electronic repository of key data relevant to modeling combustion processes.

The initial data library consists of data from the NIST Chemical Kinetics Database and GRI-Mech 3.0 (the current "standard" model for combustion of small hydrocarbons). The library includes data collections on atomic properties, chemical species, thermodynamics, elementary kinetics, and transport, as well as bibliographic data. A collaborative workspace for the PrIME project has been created within the CMCS portal.

Ultimately the PrIME project will facilitate the rapid construction of predictive models for combustion chemistry.

Launching of the initial PrIME data repository is anticipated in the first half of 2005. Longer-term plans include the integration of sophisticated tools that reduce human efforts in model creation and reduction.

NIST/CSTL leads the creation of a standard infrastructure for the exchange of combustion data, which is critical to technological development.

<http://kinetics.nist.gov/RealFuels/>



2. Biomaterials

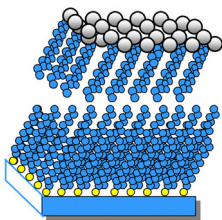

The biotechnology industry is making significant advances in the areas of biomolecular research for use in new environmentally friendly materials and process technologies. CSTL supports these efforts by developing measurement methods, standards and tools for quality control, as well as standards for calibration of specialized bio-based equipment. In addition, advances in tissue engineering continue to grow rapidly requiring standards to assure the integrity of tissue-engineered products during development, storage or shipment. Biocompatible materials used in the worldwide \$50 billion end-use device market account for current annual sales of approximately \$1 billion. End-use devices include implants, valves, grafts, pacemakers, bone repair and replacement devices, artificial organs, dental materials, drug-delivery systems, dialysis/separation/filtration systems, and catheters and stents.

In the US, the number of people above 65 years is expected to more than double from 35 million in 2000 to 71 million in 2020, and the demand for biomaterials for the regeneration and repair of tissues and organs is expected to increase accordingly.

Functional Reconstitution of Ion Channels in Polymerizable Lipid Membranes

D. K. Shenoy, W. Barger, A. Singh (NRL), R. G. Panchal (USAMRIID), M. Misakian (EEEL), V. M. Stanford (ITL), and J. J. Kasianowicz (831)

For the past four decades, the art of making planar lipid bilayer membranes has enabled the study of ion and macromolecular transport through single or multiple nanometer-scale pores. It is in such matrices that nanopore ion channels, which are the molecular basis of many cellular functions (e.g., nerve and muscle activity), have been shown to be capable of detecting and characterizing different ions, polynucleotides, and particular proteins. Because only weak intermolecular interactions stabilize liquid-crystalline phospholipid membranes (i.e., the membranes are too fragile), nanopore-based applications would benefit if ion channels could be functionally reconstituted and immobilized in robust ultra-thin films. Toward that goal, this study demonstrates that two different protein ion channels (formed by *Bacillus anthracis* protective antigen 63 and *Staphylococcus aureus* α -hemolysin) are fully functional in two different polymerizable lipid membranes in the liquid crystalline state. In addition, one of these channels functions even after the membrane is partially polymerized. Both the anthrax channel and the α -hemolysin channel spontaneously

Recent research conducted at NIST suggests that an anthrax pore might be useful for the rapid screening of anthrax therapeutics.

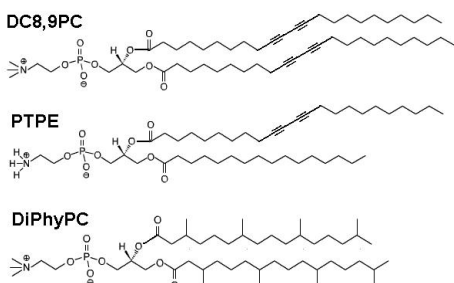

formed highly conducting nanopores in membranes formed by either of two polymerizable lipids (the top two structures shown to the right; DC8,9PC – 1,2-bis(10,12-tricosadiynoyl)-sn-Glycero-3-Phosphocholine, and PTPE – 1-Palmitoyl-2-10,12 Tricosadiynoyl-sn-Glycero-3-Phosphoethanolamine) and the nonpolymerizable control phospholipid diphytanoyl phosphatidylcholine (DiPhyPC). Exposure of the polymerizable lipids to UV light causes diynes in the hydrocarbon chains to covalently link with others in like neighboring lipid molecules.

The α -hemolysin ion channel remained completely functional in a PTPE bilayer membrane before and after the matrix was polymerized. The recordings in panel A show that in the absence of single-stranded DNA, the ionic current through a single α -hemolysin channel is quiescent. Adding 50-nucleotide long poly(thymidine) causes transient current blockades that occur at random intervals. Following UV illumination of the PTPE membrane, the polynucleotide-induced current blockades persist. Five of the characteristic poly[dT]-induced blockades that occurred after UV illumination are shown in panel B. Note that there are three predominant states (fully open, α and β). These states predominate before and after UV irradiation as is shown in the time series in panel C.

Since recent work suggests the usefulness of the anthrax pore for rapid screening of anthrax therapeutics, the ability to functionally reconstitute such channels into matrices that can be made robust is promising.

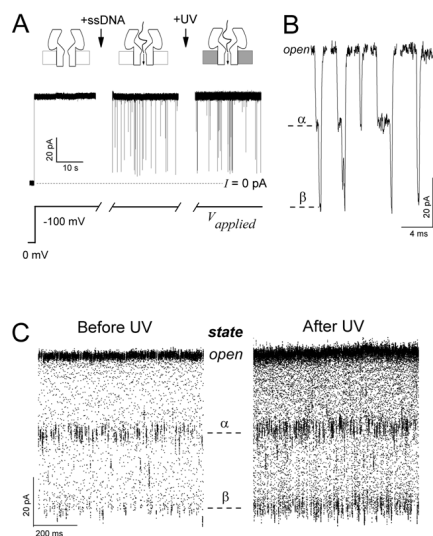

Cluster SIMS Depth Profiling in Polymeric Blends for Protein Drug Delivery Applications

C. Mahoney (837), P. Yu, and J. A. Gardella Jr. (State University of New York, Buffalo)

Poly(L-lactic acid) (PLLA) has shown particular promise as a biodegradable material because the degradation product, lactic acid, is readily metabolised by the body. In addition, the degradation rate can be easily controlled through variation of its relative mass. Polyethylene oxide (PEO)-containing copolymers, such as BASF's Pluronic[®] surfactants (containing polypropylene oxide (PPO) and PEO components) are also useful polymeric materials for biomaterial and pharmacological applications as they are neutral, highly biocompatible and pharmacologically inactive water-soluble polymers. The incorporation of PEO-containing copolymers into biodegradable PLLA-based drug delivery implant systems is expected to improve the interfacial biocompatibility of the polymeric devices as a result of the preferential migration of the PEO component to the surface. In addition, blend matrices of PEO and relatively hydrophobic PLLA is also expected to improve the three dimensional stability and the biological activity of water-soluble macromolecular drugs such as proteins or enzymes in the delivery systems via micelle formation. When used as drug-releasing matrices, these PLLA/Pluronic[®] blends have been proven to extend protein release and minimize the initial protein burst when compared to the pure PLLA homopolymers. The composition in the sub-surface region (10 nm -1000 nm) of these materials is highly important as it will determine the extent of initial burst release of any drugs present as well as the biocompatibility of the material. Until now, no methodology has been capable of yielding in-depth information from this region.



PLLA/Pluronic[®] blends have been proven to extend protein release and minimize the initial protein burst when compared to the pure PLLA homopolymers. The composition in the sub-surface region (10 nm -1000 nm) of these materials is highly important as it will determine the extent of initial burst release of any drugs present as well as the biocompatibility of the material. Until now, no methodology has been capable of yielding in-depth information from this region.

The surface chemistry as determined by both X-ray photoelectron spectroscopy (XPS) and time-of-flight secondary ion Mass spectrometry (TOF-SIMS) of these PLLA/Pluronic[®] blend materials indicates that there is an enrichment of the Pluronic[®] at the surface. However, these initial surface studies utilized monatomic primary ion beams, which cause significant subsurface damage particularly in organic and polymer samples. This increased beam-induced damage prevents the ability to obtain information as a function of depth in organic and polymer samples. Compared to conventional SIMS, "cluster SIMS" employing molecular rather than atomic primary ion beams often yields enhanced sensitivities, decreased accumulation of beam-induced damage, and increased sputter rates. These advantages have allowed us to obtain in-depth information from certain organic and polymeric materials for the first time.

The figure shows the resulting in-depth profiles obtained from a PLLA/Pluronic blend system containing a mass fraction of 25% Pluronic[®]. These profiles are consistent with a surface enrichment of Pluronic[®]-P104 surfactant, followed by a depletion zone, and then finally a constant bulk composition region. This effect was consistent over a range of concentrations (1% to 25%). Normalized signal intensities associated with Pluronic[®] ($m/z = 59$), PLLA ($m/z = 128$), and Si ($m/z = 28$) are plotted as a function of increasing SF_5^+ primary ion dose

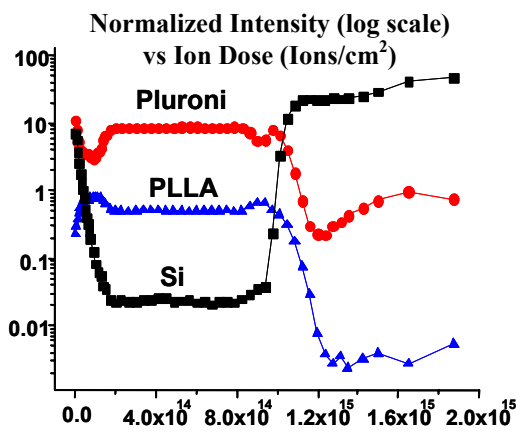

The depth profile shown here represents the team's first successful attempt to obtain in-depth information from polymeric blend systems using SIMS.

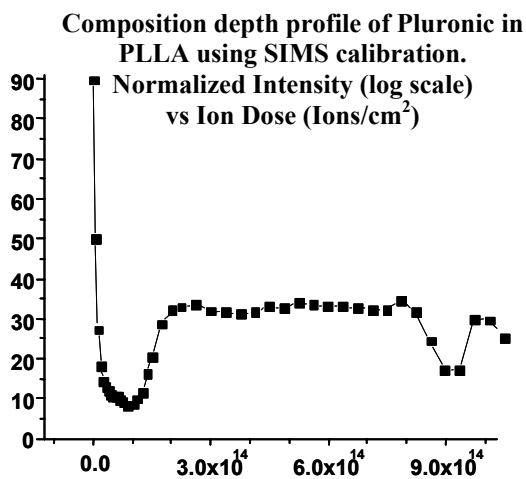

Because of the well-behaved nature of these materials under cluster ion bombardment, we have also successfully obtained quantitative depth profiles. These results demonstrate that with cluster primary ion bombardment, we are now able to successfully monitor and quantify the preferential segregation that occurs within certain multi-component polymer blends.

The development of cluster secondary ion mass spectrometry (SIMS) for in-depth analysis of polymeric biomaterials has potential long-term impact for quality control and product development in the biomedical/pharmaceutical arenas.

Future plans include the determination of the 3-D molecular structure of these and other drug delivery systems (such as drug eluting stents and insulin delivery systems). We plan to monitor the diffusion and release of proteins and drugs from these systems using cluster SIMS technology. In addition to this, collaborations are being established with pharmaceutical and biomedical device manufacturing industries in order to relate the 3-D compositional structure to the performance characteristics in real devices.

3. Pharmaceuticals and Biomanufacturing

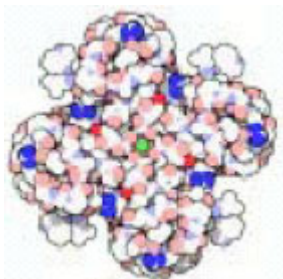

CSTL provides a breadth of resources that support the pharmaceutical industry including reference data as well as artifact standards such as optical filters and fluorescence standards used for instrument calibration. CSTL measurements and standards facilitate the drug discovery process, help optimize production of new pharmaceuticals, and ensure quality control in manufacturing processes. In addition, CSTL's fundamental

work in enzyme characterization promotes the transition to biomanufacturing leading to more environmentally sustainable manufacturing.

According to a recent Dept. of Commerce Report on the Pharmaceutical Industry, the US Government action has focused on creating the environment that would best encourage further innovation and yield a constant flow of new and innovative medicines to market. The goal has been to ensure that consumers would benefit from technological breakthroughs ...

A Proton-Coupled Dynamic Conformational Switch in the HIV-1 Dimerization Initiation Site Kissing Complex

M.-R. Mihailescu (CARB/UMBI) and J. P. Marino (831)

RNA and RNA-protein (RNP) complexes represent attractive targets for new drug therapies aimed at treating retroviral and bacterial infection. Modulation of RNA-protein interactions involved in retroviral gene expression could provide novel ways to combat viral infection, or enhance the effectiveness of existing antiviral agents.

NIST research focuses on the development of general approaches for detecting and quantifying RNA-protein and RNA-small molecule interactions, which can be employed in high-throughput screens (HTS) and for obtaining rapid structural information to guide rational drug design.

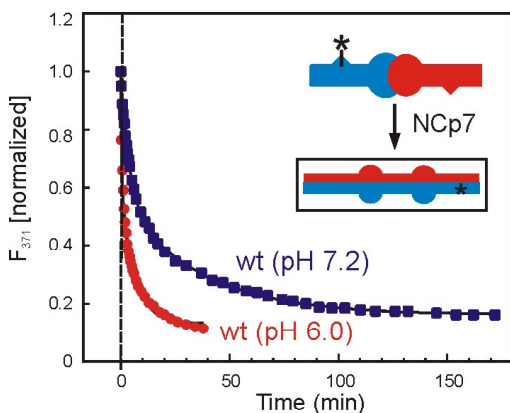

Plot of the normalized fluorescence decay as a function of time after NCp7 protein was added to a DIS kissing complex at pH 6.0 (red circles) and 7.2 (blue squares). Inset is a schematic of the NCp7 catalyzed structural isomerization of the kissing dimer. Asterisks indicate the position of 2-AP in the DIS24(GA)-4ap stem-loop.

In the human immunodeficiency virus type 1 (HIV-1), the dimerization initiation site (DIS) is the sequence primarily responsible for initiating the non-covalent linkage of two homologous strands of genomic RNA during viral assembly. In a structural rearrangement catalyzed by the HIV-1 nucleocapsid protein (NCp7) and suggested to be associated with *maturation* of the budded viral particle, the DIS converts from a metastable kissing dimer to an extended duplex. Using fluorescence and NMR methods, we have demonstrated that the DIS kissing dimer displays localized conformational dynamics that result from the specific protonation of the N1 base nitrogen of the DIS loop residue A272 at near physiological pH. The rate of NCp7 catalyzed maturation of the DIS kissing dimer has also been shown to directly correlate with the observed proton-coupled conformational dynamics, where NCp7 is found to convert the dynamic A272 protonated state with a faster rate. Taken together, these results reveal a novel role for base protonation in modulating local RNA structure and demonstrate a mechanism for promoting the chaperone mediated structural rearrangement of a kinetically trapped RNA conformational state.

The RNA conformational 'switch' identified in the HIV-1 DIS dimer represents a possible new target for antiviral drugs. Through collaboration with researchers at the HIV-1 Drug Resistance Program at the National Cancer Institute, researchers at CARB plan to screen large public domain libraries of low relative molecular mass compounds that target DIS and inhibit its functional role in genome dimerization and maturation.

Recent publication on this research:
M.R. Mihailescu and J. P. Marino
(2004) *Proc. Natl. Acad. Sci., USA.*,
101(5), 1189-1194.

Leveraging Traceability for Chemical Spectrophotometry Through the Commercial Sector

J.C. Travis, M.V. Smith, M.D. Maley, and G.W. Kramer (839)

Recognizing that the NIST model has been successfully emulated in commercially-produced traceable CRMs, NIST is terminating the production of individually-certified neutral-density filter Standard Reference Materials[®] (SRMs[®]) for chemical spectrophotometry. Sales of SRMs 930e, 1930, and 2930 (0.001 < T < 0.9, neutral-density glass filters for the visible spectrum) will cease when existing stocks are depleted. Production of SRM 2031a (0.1 < T < 0.9, metal-on-fused-silica neutral-density filters for the UV and visible spectral regions) will be curtailed to end sales on schedule with the glass filters.



The controlled termination of NIST's long-standing program for the individual certification of spectrophotometric absorbance standards will capitalize on the International Organization for Standardization (ISO)/NIST description of traceability in order to stimulate a more efficient and leveraged model for supplying certified reference materials (CRMs) for absorbance.

End users are encouraged to purchase CRMs from secondary suppliers who are appropriately accredited to Guide 17025 or Guide 34 of the ISO, or who possess documentation consistent with the NIST traceability policy. Such commercial suppliers may also recertify expired NIST SRMs, although NIST will continue to offer recertification for the 3500+ sets of SRM filters in the field.

In a related move, transmittance and absorbance measurements, used in solid filter recertification and future batch SRM production, will soon feature traceability through the regular transmittance scale maintained by NIST. This will result in a single U.S. national scale for regular spectral transmittance measurements conducted in support of both physical and chemical metrology. This



transmittance scale is routinely compared to other national transmittance scales through measurements coordinated by the Comité Consultatif de Photométrie et Radiométrie (CCPR) of the Bureau International des Poids et Mesures (BIPM).



In the long term, these changes are expected to benefit affected industries (e.g. pharmaceuticals, chemical products, and health technologies) by supporting a robust and responsive system of fit-for-purpose reference materials that are manufactured by competing commercial sources. NIST is attempting to avoid near-term anxiety in the heavily regulated pharmaceutical sector by implementing extensive educational activities during the one- to two-year period required to sell out the stocks of these filters.

In order to facilitate the transition, NIST has widely publicize these changes by making presentations at FACSS 2004 and EAS 2004 as well as providing information on the NIST web site and in anticipated announcements in trade magazines.

Thermodynamics of the Hydrolysis Reactions of Nitriles

Y. B. Tewari and R. N. Goldberg (831)

The use of nitrilase enzymes has attracted substantial interest in the biotechnology community because conventional chemical methods for nitrile hydrolysis entail the use of harsh conditions such as the use of concentrated acids or bases and high temperatures. Such harsh conditions are generally not useful when sensitive complex molecules or chiral compounds are involved. Most importantly, the chemical methods do not permit the asymmetric synthesis of chiral compounds. In contrast, the nitrilase-catalyzed reactions proceed under mild conditions and produce a high yield of a stereospecific product. The importance of nitrilase enzymes has led recently to the commercial development of a library consisting of over 200 new forms of this enzyme.

NIST provides thermodynamic data for nitrilase enzyme reactions. The nitrilase enzymes catalyze the direct hydrolysis of organic nitriles to the corresponding carboxylic acids, which are of increasing interest to the pharmaceutical, and other multi-billion dollar industries.

Publication in Press:
Y.B. Tewari and R.N. Goldberg,
“Thermodynamics of the hydrolysis reactions of nitriles”, The Journal of Chemical Thermodynamics.

Several representative (model) nitrilase-catalyzed reactions were selected for this investigation, which used HPLC and calorimetry combined with equilibrium modeling calculations. In all cases the reactions proceeded to completion. Specifically, the HPLC results (forward and reverse reactions) gave values of the apparent equilibrium constant K' having a lower limit of 350. A thermochemical cycle calculation showed that a value of the equilibrium constant for a typical ionic reference reaction for this class of reactions is on the order of 10^{11} . Values of the standard molar

enthalpy of reaction $\Delta_r H_m^\circ$ for the ionic reference reactions ranged from $-77 \text{ kJ}\cdot\text{mol}^{-1}$ to $-99 \text{ kJ}\cdot\text{mol}^{-1}$. The thermodynamic results obtained in this study provide quantitative data that can be used for the bioprocess engineering (design of bioreactors and conditions of reaction) of these enzyme-catalyzed reactions. The results are the first to be reported in the literature.

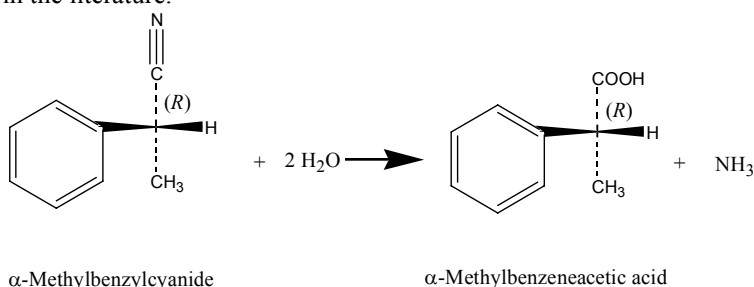

The nitrilase-catalyzed hydrolysis of α -methylbenzylcyanide to α -methylbenzeneacetic acid and ammonia

Chorismate Pathway Enzymes: Structural Studies

J.E. Ladner (831), E. Eisenstein, J. Parsons, and K. Calabrese (CARB/UMBI)

Aromatic hydrocarbons are difficult to produce synthetically, however the elucidation of natural biochemical pathways makes it easier to alter and utilize these pathways to make these and similar chemicals. In particular, the phenazines, which are produced by a branch of the chorismate pathway in some bacteria, are difficult to synthesize but are important potential drugs. Precise enzymatic mechanisms, and relationships between the structure and the physical properties can be predicted only when the detailed three-dimensional structures are known for the enzymes.

NIST studies how aromatic hydrocarbons are produced enzymatically in bacteria. This can be of great benefit to the pharmaceutical industry, and ultimately the public health.

Several species of *Pseudomonas*, including the human pathogen *P. aeruginosa*, produce secondary metabolites known as phenazines. Dozens of naturally occurring phenazines have been described, all of which share the characteristic tricyclic heteroaromatic ring system. Phenazines are redox active compounds that participate in reactions yielding superoxide and peroxide ions, and hydroxyl radicals. These toxic molecules are thought to control the growth of other microorganisms, provide *Pseudomonas* with a competitive growth advantage, and may enhance the ability of these pathogens to colonize human and other tissue.

Two operons in *Pseudomonas aeruginosa*, each containing seven genes, are involved in the biosynthesis of phenazine (*phzA-G*). A similar, single operon has been described in *P. fluorescens* 2-79. Each of these operons encode all of the genes required to produce phenazine-1-carboxylic acid (PCA) from chorismate. This research provides a better understanding of the phenazine pathway. Structures of the products of genes *phzF*, *phzG*, and *phzD* have been solved, and both biochemical and crystallographic methods to determine their roles, substrates, and products have been pursued. As the research moves forward enzymes that are homologues of these enzymes from other related pathways will be studied, and work to try to understand the details of how the enzymes perform their specialized tasks will continue.

Recent Technical Publications:

1. J.F. Parsons, F. Song, L. Parsons, K. Calabrese, E. Eisenstein, J.E. Ladner, *“Structure and Function of the Phenazine Biosynthesis Protein PhzF from Pseudomonas fluorescens”* 2-79. *Biochemistry* 43, (2004).
2. J.F. Parsons, K. Calabrese, E. Eisenstein, J.E. Ladner, *“Structure of the Phenazine Biosynthesis Enzyme PhzG”* *Acta Crystallographica*, D60, (2004)

4. Chemical and Allied Products



NIST/CSTL provides reference data, theoretical models, and artifact standards that are important to the chemical industry. These standards are used for process design and quality control, and help ensure traceability of field measurements to reliable, world-recognized standards.

For the past several years, high energy costs had siphoned profits for the chemical industry despite the increase in demand for products. However 2003 showed improvements in profits and 2004 began with major US chemical companies posting their best results in years. According to a C&E News Report in December 2004, the “*upturn is no longer elusive, and although challenges remain, prosperity is finally returning to the chemical industry*”.

Often referred to as the keystone industry because nearly every sector of the manufacturing economy uses its products, the US chemical industry ranks among the world's leading industries, accounting for an estimated one-quarter of total world chemical production.

IUPAC Partnership Develops Standards and a Data Retrieval System for Ionic Liquids

J.W. Magee, J.A. Widgren, D.G. Archer, S.L. Outcalt, M.Frenkel, R.D. Chirico, Q. Dong, A. Laesecke, M.O. McLinden, R.A. Perkins (838), K.N. Marsh (U. of Canterbury, New Zealand), B.-C. Lee (Hannam U., Korea), and E.M. Saurer (U. of Notre Dame)

Ionic liquids, a class of organic salts that are liquid at or near room temperature, have been proposed as solvents for *Green Processing*. In spite of the many advantages that these fluids are predicted to offer, fundamental data on their physical and chemical properties, property measurement methodology, high quality data on reference systems, standards for reporting thermodynamic data, and creation of a comprehensive database infrastructure for ionic liquids are needed to provide US industry with a knowledge base to exploit these solvents.

NIST works with the international community to address the lack of consistent requirements for reporting thermodynamic data for ionic liquids by employing the Guided Data Capture software developed in CSTL.

To achieve these goals in the shortest time possible and reach an international consensus on the central issues, two IUPAC projects have been initiated with NIST/CSTL involvement. The first of these IUPAC projects is *Thermodynamics of Ionic Liquids, Ionic Liquid Mixtures, and the Development of Standardized Systems*. The lack of consistent requirements for the publication of thermodynamic

This IUPAC task group has convened international discussion of the issues by conducting two IUPAC workshops on ionic liquids, held at the 17th IUPAC Conference on Chemical Thermodynamics (Rostock, Germany) at the 18th IUPAC Conference on Chemical Thermodynamics (Beijing, China) and a 3rd Workshop will be convened in Boulder as part of the 19th IUPAC Conference on Chemical Thermodynamics in 2006.

data for ionic liquids has led to major barriers to an unambiguous interpretation of the data and a critical evaluation with regard to their uncertainties. This drastically diminishes the value of the reported numerical data for use in a variety of engineering applications. To address these issues, a standardization in reporting thermodynamic data for ionic liquids could be accomplished by an expansion of the Guided Data Capture (GDC) software developed by the NIST's TRC Group, formerly known as the Thermodynamic Research Center (TRC).

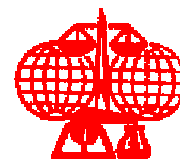

International Union of Pure and Applied Chemistry

Outcomes of the first workshop were reported in a special section of the *Journal of Chemical and Engineering Data*. In Beijing, the IUPAC Task Group planned an international round robin study of a reference substance, 1-hexyl-3-methylimidazolium bis(trifluoromethylsulfonyl)amide, abbreviated as [hmim][Tf₂N]. Using NIST-supplied reagents, 1.5 kg of [hmim][Tf₂N] was synthesized at the University of Notre Dame and then was shipped to NIST.

Preface to Special Section: Papers Presented at the Workshop on Ionic Liquids, ICCT, Rostock, Germany, July 28 to August 2, 2002. J. W. Magee, *J. Chem. Eng. Data* 2003 48, 445.

After drying and chemical characterization at NIST, samples were packaged under an inert atmosphere and were shipped to the participating laboratories. NIST will coordinate round robin studies of density, heat capacity, and viscosity, and will participate in measurements of those properties plus thermal conductivity, electrolytic conductivity and industrial gas solubility.

The second IUPAC project *Ionic Liquids Database* is addressing the need for an open-access, public-domain data storage system scoped to cover information pertaining to ionic liquids. The vision for this project is to create a distributed-access data retrieval system for ionic liquids and their mixtures that encompasses chemical structure, solvent properties, ionic liquids use in synthesis, reviews, reactions and catalysis, manufacturer information, benchmark properties and models, and thermophysical and thermochemical data. During FY 2004, the task group met to share a common vision and to divide the data collection effort among the participants.

The NIST measurement program continues to provide benchmark physical properties data for selected ionic liquids that are liquid-phase at room temperature and both air- and moisture-stable. For 1-butyl-3-methylimidazolium hexafluorophosphate, considered to be the archetypal ionic liquid, we have published the first reports of thermodynamic properties of the ideal gas state at temperatures to 1500 K and high-accuracy thermodynamic properties in condensed states (crystal, glass, and liquid) covering a range of temperatures from 5 K to 550 K. A study of the viscosity of three hydrophobic ionic liquids and the effect of a dilute water impurity has been completed.

Y.U. Paulechka, G.J. Kabo, A.V. Blokhin, O.A Vydrov, J.W. Magee, and M. Frenkel, *“Thermodynamic Properties of 1-Butyl-3-methylimidazolium Hexafluorophosphate in the Ideal Gas State”* J. Chem. Eng. Data 2003, 48, 457-462.

G. J. Kabo, A. V. Blokhin, Y.U. Paulechka, A.G. Kabo, M.P. Shymanovich, and J.W. Magee, *“Thermodynamic Properties of 1-Butyl-3-methylimidazolium Hexafluorophosphate in the Condensed State”* J. Chem. Eng. Data 2004, 49, 453-461.

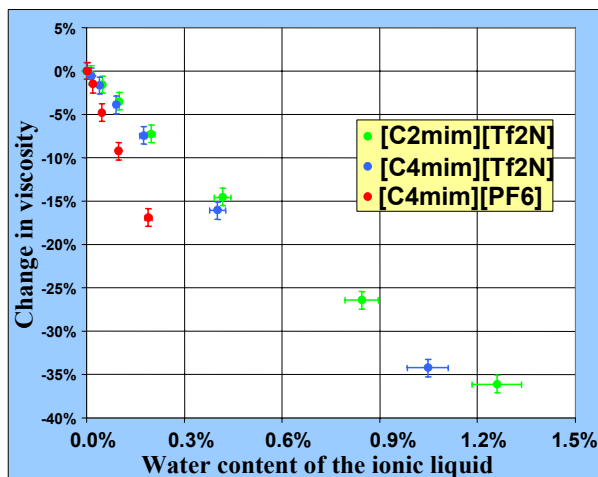

Anomalously high sensitivity of transport properties (in this case kinematic viscosity) to water content has been revealed by recent NIST measurements on ionic liquids.

In the future, properties studies will continue with new measurements of thermodynamic density, heat capacity, enthalpy of solution, gas solubility, and also expanded transport property measurements, such as thermal conductivity and electrolytic conductivity, a key electrical characteristic. Structure-property relationships for physical properties will be explored by analyzing evaluated data in our database. Modifications that support ionic materials will be applied to the TRC Source Database at NIST and to the Guided Data Capture application to facilitate the storage and retrieval of ionic liquids property data.

Second Industrial Fluid Properties Simulation Challenge

R.D. Mountain, D. Friend, R.D. Johnson, A.M. Chaka, F. Case (Case Scientific), D. Frurip, J. Moore, J. Olson (Dow), J. Golab, (BP Amoco), P. Gordon (ExxonMobil), P. Kolar (Mitsubishi Chemical), R. Ross (3M), and M. Schiller (DuPont)

The Industrial Fluid Properties Simulation Challenge is an opportunity for the molecular simulation community to predict fluid properties that are not available in the open literature. This competition is an open, biannual program that is sponsored by the Computational Molecular Science and Engineering Forum (CoMSEF) of the American Institute of Chemical Engineers (AIChE) and by the Theoretical Subdivision of the American Chemical Society (ACS) Physical Chemistry Division.

NIST in collaboration with scientists at Dow, BP Amoco, Case, Mitsubishi Chemical, 3M, and DuPont have organized the Second Industrial Fluid Properties Simulation Challenge.



The goal of the Second Industrial Fluid Properties Simulation Challenge was to evaluate and benchmark the available molecular simulation methods and force fields on problems that have significant industrial relevance. This process will encourage the continued development of better algorithms, methods, and force fields, while improving the alignment of academic efforts with industrial needs. Molecular simulation has been identified as a promising technology for predicting thermophysical properties in the Vision 2020 Roadmap for the Chemical Industry. The industrial participation within the organizing committee was even stronger than for the first challenge, and the financial contributions from this sector, which were applied largely for prizes for the most successful entrants, were substantial. Further, the number and quality of the entries submitted to the challenge indicated an increased interest in the process, and the contest has attained a truly international stature, with entrants, judges, and organizers from around the globe.

The three problems in the challenge were announced at the 2003 Fall ACS meeting. Entrants had one calendar year to complete their projects. Benchmark values and uncertainties for the specific problems presented were determined by scientists at NIST and Dow Chemicals, through a combination of new experiments and extensive evaluation of available information. These benchmark results were used to evaluate the second challenge entries. There were five entries in problem 1, five entries in problem 2, and two entries in problem 3.

Challenge 2003 was to predict:

- vapor pressure and heat of vaporization (problem 1)
- Henry's law constants (problem 2)
- heats of mixing for specific materials and conditions (problem 3)

The entries were evaluated in a two-step, double blind process. In the first step, experts in the area of molecular simulation, who were not associated with the organizers and were not entrants, evaluated the overall scientific quality of the entries. Then the entries were ranked by the organizing committee in terms of how accurately the simulation based predictions of fluid properties reproduced the experimental values. The experimental values were not available in the open literature so the entries were predictions.

The results of the competition were announced at a special session of the National Meeting of the AIChE in November 2004. For some of the problems, the entrants were able to produce reasonable predictions for the unknowns, at a level nearly adequate for some industrial purposes. However, for the most challenging problems, especially heats of mixing of the assigned aqueous system, considerable work will be needed before the technique will produce reliable results.

More information is found on the website at
<http://www.cstl.nist.gov/FluidSimulationChallenge/>

Computational Chemistry Illuminates Atomistic Processes at Complex Interfaces

A.M. Chaka (838)

The chemistry of interfaces is of fundamental importance for a wide variety of environmental, industrial, and biological processes such as migration of pollutants in groundwater, catalysis, microelectronics, corrosion, and sensors. Progress in understanding these processes has been limited because the traditional techniques of surface science require ultrahigh vacuum (UHV) and clean, ideal crystalline surfaces, which may have little resemblance to real surfaces in complex environments. Recent advances in experimental surface science, however, have made it possible to conduct experiments on surfaces exposed to high concentrations of chemical species. These new instrument capabilities have revealed dramatic changes in surface chemistry upon exposure to high concentrations of reactants, as indicated by surface structural relaxations and Scanning Tunneling Microscope currents (which measure electronic energy levels), but are incapable of identifying the chemical structures or processes responsible.

NIST partners with key experimental groups to illuminate the chemistry occurring at complex metal oxide surfaces and to extend and validate the theoretical methods developed to predict and understand the surface chemistry for “real” systems.

The situation in quantum theory for surfaces was similar to that in experimental, for example, electronic structure calculation by Density Functional Theory (DFT) is well established for calculating surface structure and energy only at 0 K under vacuum. We have collaborated in the development of new theoretical methods to extend DFT quantum mechanics to capture the thermodynamics and structure of real surfaces in equilibrium with multiple species in the environment at finite temperatures and pressures.

The hematite (0001) surface, $\alpha\text{-Fe}_2\text{O}_3$, is important for many reasons. It is the catalytic surface used commercially to convert ethyl benzene to styrene, the most prevalent mineral surface exposed to ground and surface water, and is a model surface to study corrosion for ferrous-based metals. The first high-oxygen-pressure STM work on the hematite (0001) surface indicated the presence of two distinct chemical domains. These were first interpreted as distinct iron- and oxygen-terminated regions with the $\text{Fe-O}_3\text{-Fe-R}$ and $\text{O}_3\text{-Fe-Fe-R}$ structures, indicated by cleavage planes shown in the figure.

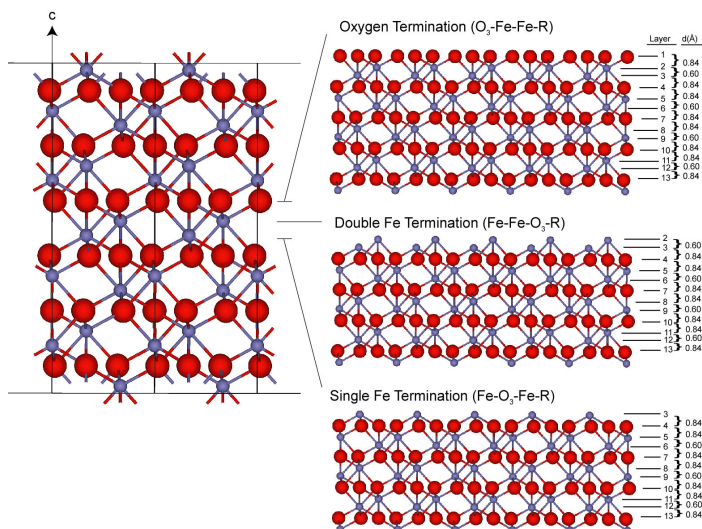

$\alpha\text{-Fe}_2\text{O}_3$ bulk unit cell and surface models for the three possible “clean” terminations that can result from cleavage. Large spheres are O and small spheres are Fe. The surface models are annotated with the labeling scheme used to identify the various atomic layers and the layer spacings for ideal (unrelaxed) atomic positions.

More recent experimental work and our theoretical surface energy calculations indicated that the lowest energy surface that would be formed under the experimental conditions was not the O_3 -structure but was a O=Fe (ferryl) structure that resulted from dissociation of oxygen on the Fe-terminated surface.

High resolution STM image of the $\alpha\text{-Fe}_2\text{O}_3$ (0001) film prepared at the FHI in 10 Pa (10^{-2} mbar) of O_2 at 1020 K (size 30 x 30 nm^2 , $V_t = 1.4$ V, $I = 1$ nA) showing the multiple domains of iron- and oxygen-termination. The lattice of protrusions with approximately 5 Å periodicity is clearly seen in the inset (size 3 nm^2 x 3 nm^2). The unit cell is indicated.

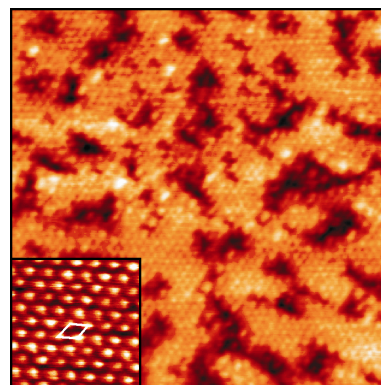

The predicted threshold pressure and temperature for the formation of Fe=O was in quantitative agreement with experiment, further validating the first-principles methods used in the model. Theoretical calculations also obtained a Fe=O vibrational stretching frequency of 981 cm^{-1} in excellent agreement with the 989 cm^{-1} band observed by infrared reflection absorption spectroscopy (IRAS). The power of computational chemistry has provided great insight and discovery in surface chemistry that had not been previously observed on an iron oxide surface, and a manuscript describing this work has been submitted to *Physical Review Letters*.

In another example of the value of our methodology for calculating surface chemistry, we addressed the reactivity of water at surfaces. Recently, scientists at Stanford University, University of Chicago, Lawrence Berkeley National Lab, and University of Alaska Fairbanks, made the puzzling observation that hematite is much more reactive towards trace amounts of water than the isostructural $\alpha\text{-Al}_2\text{O}_3$ (corundum, sapphire), yet is more stable to weathering in nature. Washing the cleaved native hematite mineral surface with dilute acid and immersing it in water resulted in formation of two distinct (one dominant and one minor) domains of unknown chemical structure but with significantly different surface structure relaxations.

To identify these structures and understand the differences in reactivity between iron and aluminum oxide, over thirty model surface structures were examined that might result from water physisorption and dissociation by both heterolytic and homolytic mechanisms. The surface energy phase diagrams for α -Fe₂O₃ and α -Al₂O₃ (0001) indicated that the reaction of iron atoms on the surface to form a fully hydroxylated (HO)₃Fe-O₃-R structure occurs at a water vapor pressure threshold many orders of magnitude lower than for aluminum, consistent with experimental observations. Calculations on the model systems also indicated that this hydroxylated surface iron atom can be readily hydrolyzed and solvated when exposed to an aqueous environment. The underlying oxygen layer becomes hydroxylated in this process to form a very stable structure that is resistant to subsequent hydrolysis. The relaxations calculated for this stable hydroxylated oxygen layer were consistent with the dominant domain observed in the experiments. The minor domain is consistent with residual hydroxylated surface iron atoms.

T.P. Trainor, A.M. Chaka, P.J. Eng, M. Newville, G.A. Waychunas, J.G. Catalano, G. E. Brown, Jr, "Structure and Reactivity of the Hydrated Hematite (0001) Surface," Surface Science, 573, (2004).

Hence with the integration of experiment and theory we have successfully identified the surface chemistry that characterizes the fundamental interactions of iron and aluminum oxides with oxygen and water, two of the most prevalent and reactive species in the environment. This knowledge of surface structure and reactivity provides a foundation for subsequent investigations into the molecular mechanisms of catalysis, corrosion, and adsorption and transformation of pollutants in groundwater.

Systematic Validation and Improvement of Quantum Chemistry Methods for the Prediction of Physical and Chemical Properties

C.A. Gonzalez, R. D. Johnson, and K.K. Irikura (838)

The use of modern computational chemistry methodologies in the prediction of molecular properties has become increasingly popular mainly due to significant improvements in the algorithms, the accuracy of the methods, and the advent of powerful computer resources. This is particularly true in the area of thermochemistry, where researchers in industry and academia perform quantum chemistry calculations on a routine basis. Recently, there has been an increased interest in the use of theoretical predictions of physical and chemical properties made by state-of-the-art quantum chemistry methodologies to fill gaps in the available experimental data. This approach could potentially eliminate the cost of experimental measurement and will be particularly useful in cases where extrapolations based on available experimental data are not possible or are unreliable. However, despite the aforementioned progress, the predictive power of most of the quantum chemistry methodologies has not been established on solid ground due to the lack of knowledge of their relative uncertainties. To understand these uncertainties an exhaustive and systematic validation of these methodologies involving robust strategies to compare theory and experiment is necessary. In addition, the results of such validations must be widely available to the scientific community so new scientific discoveries could leverage from this knowledge.

A team of NIST researchers is working on an integrated approach that will lead to the systematic validation as well as improvements of popular and new theoretical methods using high quality experimental data.

The NIST approach involves the development of state-of-the-art databases in order to disseminate the accuracy, reliability and transferability of the most popular quantum chemistry methodologies in the prediction of physical and chemical properties of a large variety of chemical systems ranging from isolated atoms and molecules to condensed phase. The theoretical methodologies being studied include semi-empirical Hamiltonians, wavefunction-based *ab initio* molecular orbital theory, and Density Functional Theory (DFT) while the experimental data used in the validation include measurements already available in the literature and also made by researchers at NIST.

Assessing the Accuracy and Reliability of Density Functional Theory. Density Functional Theory (DFT) has become one of the most widely used quantum chemistry methods mainly due to its relatively low computational expense. The electronic energy within the DFT formalism is a functional of the electron density that consists of an "exchange" energy term and a "correlation" energy term. Although in principle there exists a universal DFT functional that can describe the electronic problem exactly, the discovery of such a functional has eluded scientists for years. In practice, arbitrary forms for the DFT functionals are parameterized in order to reproduce the experimental energetics of a relatively small set of molecular systems.

CSTL researchers have performed a systematic validation of a particular family of DFT functionals, the so-called “hybrid-GGA”, in order to assess their accuracy and transferability to different chemical properties. The performance of these functionals in the prediction of properties such as singlet-triplet gaps, reaction barriers, dipole moments, and polarizabilities showed a marked erratic behavior leading to the conclusion that these functionals are not transferable to the computation of different chemical properties. In addition, the results of this work indicate that the major source of error can be traced back to the “exchange” functional, which exhibits significant spurious and uncontrollable electron “correlation” energy due to the empirical parameterization used in the development of these functionals.

DFT Classical Barrier Error (in kcal mol⁻¹) Relative to CCSD(T)
for CH₃ + H₂ → CH₄ + H₂

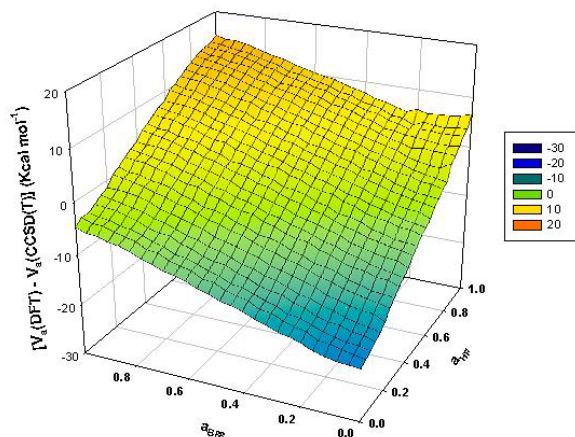

These derivatives (or potentials as they are known) are critical in the calculation of molecular properties in a “variational” manner and are difficult if not impossible to implement for reliable XC functionals such as the Meta-GGA DFT due to their complicated mathematical forms. In this work, we have developed a general and simple methodology called the “Approximate Self-Consistent Potential” (ASCP) that allows scientists to compute the corresponding derivatives without the knowledge of a closed form. The method has been implemented in two of the most popular quantum chemistry packages and tested in the calculations of absolute energies and atomization energies of 20 different molecules. The results indicate that the method is robust and sufficiently general.

Improvements to the Accuracy of Density Functional Theory. In order to solve the problems exhibited by the “exchange” functionals we proceeded to develop a rigorous and efficient method (the SC- α method) for the calculation of the exact “exchange” functional. This method has been implemented in various popular quantum chemistry software packages and it has been tested in more than 40 molecules; the results have shown the possibility of computing the exact “exchange” functional in complicated polyatomic systems at the computational cost comparable to the inexpensive Hartree-Fock formalism. Encouraged by these results, we focused in procedures that could improve the “exchange-correlation” functional as a whole. One of the most difficult steps in the generation of “exchange-correlation” functionals (XC) that do not require empirical parameters (and therefore, making it more general than the semi-empirical “hybrid-GGA” functionals) is the development of closed forms for the derivatives of these functionals with respect to the electron density.

I. Gonzalez, C. Gonzalez, V.V. Karasiev, E. Ludena, A. Hernandez, “Basis Set Dependent SC Alpha Exchange-Only and Exchange-Correlation Calculations” J. Chem. Phys. 118, 8161, 2003.

Quantifying Uncertainty in Prediction of Enthalpies of Formation and Vibrational Frequencies. It is well recognized that a complete expression of experimental measurement includes both the central value and its associated uncertainty. The central value alone is incomplete. Throughout computational science, the results of models are usually reported without their associated uncertainties, making them incomplete. The term *virtual measurement* refers to a prediction from a computational model together with its associated uncertainty, and emphasizes the analogy with experimental (physical) measurement. Our investigation of the uncertainties associated with predictions from quantum chemistry models are intended to help “virtual measurements” supplant “calculated results.” The results from *ab initio* calculations differ from experiment by systematic biases, not random errors. For a given *ab initio* calculation corrections can be applied to compensate for this bias and an uncertainty can be determined from the distribution of corrections for a class of molecules. We use the experimental and *ab initio* data contained in the NIST Computational Chemistry Comparison and Benchmark Database (CCCBDB), which contains data for over 600 molecules, over 100 calculations for each molecule, and over 4000 vibrational frequencies. We combine



<http://srdata.nist.gov/cccbdb/>

this data with analysis based upon the *Guide to the Expression of Uncertainty in Measurement*, published by the International Organization for Standardization (ISO), to determine biases and uncertainties. We have applied this to enthalpies of formation and vibrational frequencies. This allows us to upgrade these

“calculated values” into “virtual measurements”. For the enthalpies of formation we found the class of molecules to be critical in determining the bias and uncertainties. For the vibrational frequencies we found the uncertainties to be orders of magnitude larger than previously believed. We plan to continue extracting such information from the CCCBDB to determine the uncertainties for other calculated properties as well.

K.K. Irikura, R.D. Johnson III, R.N. Kacker, “Uncertainty Associated with Virtual Measurements from Computational Quantum Chemistry Models,” Metrologia 41, 369-375, 2004.

Theory of Non-Bonded Interactions: Molecular Association and Assembly

C.A. Gonzalez, V.K. Shen, K.K. Irikura (838), and J.R. Errington (U. of New York, Buffalo)

Long-range inter-molecular forces play important roles in many chemical and biological systems. They control, among others, the base-base interactions leading to the double helical structure of DNA, the function of the special pair in photosynthetic reaction centers, the packing of aromatic crystals, the formation of aggregates, the conformational preferences of polyaromatic macrocycles and chain molecules, as well important bulk fluid properties. It has also been found that weak interactions can be important in atmospheric chemistry. For example, the molecule ClOO (chloroperoxy radical, formed by the collisions of the chlorine atoms with oxygen molecules) is critical in the catalytic, homogeneous destruction of ozone in the stratosphere. Most Cl-O₂ collisions lead to excited states of ClOO and we have found that many of these excited states surprisingly support weakly bound but stable van der Waals (vdW) complexes that must be considered to accurately predict the rates of ozone destruction.

The CSTL-led research team develops and validates efficient theoretical and computational methodologies for the description of long-range interactions in gas-phase and solution to enable prediction of thermodynamic and transport properties of fluids.

The molecular systems ideally suited for a detailed study of the inter-molecular potentials are vdW dimers and higher clusters of aromatic hydrocarbons formed as a direct consequence of intermolecular interactions. Given the maturity reached by quantum chemistry and the improvement in the algorithms used in quantum chemical calculations, it is logical to expect that highly correlated *ab initio* electronic structure methodologies could be a valuable tool to predict the structures and energetics of these clusters. We must assess the validity of these methodologies in the case of larger clusters of different aromatic molecules and possibly determine if alternative methodologies that incur lower computational expenses can be devised for these larger systems. Once the reliability and accuracy of these theoretical models are properly validated for gas-phase clusters they can be used for the generation of efficient and reliable empirical force-fields to be used in large-scale simulations of molecular systems in condensed phase such as liquids. This task, of course, also requires robust and efficient simulation methods that predict the different physical properties of bulk fluids in a reliable manner.

Fundamentals of van der Waals Interactions in Aromatic Clusters. The first phase of the project consisted of the use of second order Møller-Plesset perturbation theory, MP2, with different basis sets in order to optimize the geometries and compute the relative binding energies of the lowest energy conformers for the dimers, trimers, and tetramers of benzene, naphthalene, and anthracene. These systems are a prototype for vdW clusters containing large aromatic molecules dominated by a delicate balance between electrostatic and dispersion forces. They were chosen on the basis of the availability of reliable experimental data. Overall, the results obtained in this project indicate that the combination of molecular dynamics simulations using the MM3 force field, followed by full geometry optimizations at the MP2/6-31G level of theory appear to provide a reliable tool for the study of vdW aromatic clusters. One significant outcome of this research has been the realization that the use of a small basis sets such as 6-31G with the *ab initio* MP2 methodology predicts binding energies closer to the experimental results than the corresponding binding energies computed with larger basis sets. This surprising result is very important given that calculations of vdW clusters with larger basis sets are highly prohibitive due to the computational resources needed. Careful analysis of the data led to the conclusion that the

source for this interesting behavior is rooted at a fortuitous but systematic cancellation of errors between the lack of convergence of the perturbation method MP2 and deficiencies in the 6-31G basis set. Given that the study of larger vdW clusters involving more than four aromatic molecules is almost impossible even at the MP2/6-31G level, we have performed a systematic comparison of the results obtained with the very efficient methodology Hartree-Fock Dispersion (HFD) previously developed in our group and the results computed at the MP2/6-31G level of theory. It was found that HFD predicts structures (see figures) and binding energies in very good agreement with the MP2/6-31G results.

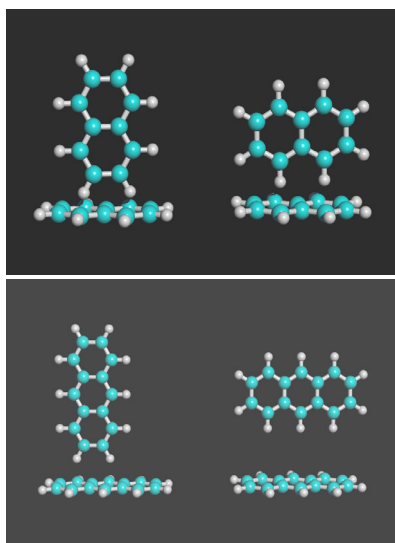

Figure shows computed structures of (C₁₀H₈)₂ and (C₁₄H₁₀)₂
With details in recent publication:

C. Gonzalez, E. Lim, "Evaluation HFD model as a practical tool for probing intermolecular potentials of small aromatic clusters: Comparison of the HFD and MP2 intermolecular Potentials", J. Phys. Chem. A 107, (2003).

Prediction of Mixture Phase Behavior Using Transition-Matrix Monte Carlo Simulation. The fluid-phase behavior of mixtures is a subject of immense industrial and technical importance. For example, in multi-component systems, it is the fact that different coexisting phases often have different chemical compositions that serves as the basis for fundamental unit operations, such as absorption, distillation, and liquid extraction. Thus, knowledge of the phase coexistence properties of mixtures is crucial to the design of effective separation processes. Because laboratory determination of mixture phase equilibria can be potentially expensive and time-consuming, it is highly desirable to have a computational means for this purpose. While molecular simulation is ideally suited for this, only within the last twenty years have advances in simulation methodologies made this goal a realistic one. Current state-of-the-art simulation methods directly simulate phase coexistence and only yield a single equilibrium point per simulation. Therefore, a large number of these simulations are required to obtain phase equilibria data over a range of thermodynamic conditions, which can take a substantial amount of time.

Building upon recently developed transition-matrix Monte Carlo methods, we have developed a new simulation methodology capable of precisely predicting an entire isothermal fluid-phase diagram in a single simulation in a significantly shorter amount of CPU time relative to existing methods. To validate the mixture transition-matrix Monte Carlo method (M-TMMC), we have investigated a number of binary mixtures whose phase behavior is well known, and also mixtures that are known to pose problems for conventional methods. M-TMMC produced results in excellent agreement with literature data in all cases. Additionally, we found that the relative uncertainties of the predictions were at most 0.2%, an order of magnitude improvement over current methods. Because the method determines the system's free energy as a function of density and composition, the utility of the information yielded by this approach goes far beyond that for use in determining phase equilibria, and it should therefore serve as a highly efficient computational tool for studying a wide range of phenomena at the molecular level.

The research team is extending this work in order to study vdW interactions between polar molecules, where dispersion forces and electrostatics interactions might be competitive with other forces such as hydrogen bonding. In addition, our HFD method will be used to probe the dynamics of cluster formation by means of Carr-Parinello simulations.

Integrated Transport Property Program for Key Systems: Data, Models, and Simulation

M. Huber, A. Laesecke, and R. Perkins (838)

CSTL researchers pursue an integrated strategy that combines experiment, theory and simulation in the development of advanced models for transport properties, leading to predictions of reliable information even when experimental data may be lacking.

Efficient design of chemical processing equipment for various industrial sectors such as transportation, petroleum refining, energy, and refrigeration requires reliable values for the transport properties viscosity and thermal conductivity. The primary approach is the critical assessment of all available experimental data and their representation by correlations, incorporating theory when possible. Here we have extended the model base to the viscosity and thermal conductivity of the linear alkanes *n*-octane, *n*-nonane, *n*-decane, and *n*-dodecane. These are the first such models for the heavier alkanes commonly present in liquid-phase fuels. The development of these transport properties formulations was driven in part by the industrial need/demand for accurate knowledge of the properties of hydrocarbon mixtures, including economically important fluids such as natural gas and jet fuels.

The new models represent the viscosity and thermal conductivity surfaces of these compounds over their entire fluid region, encompassing the dilute gas to the dense fluid and supercritical regions, at temperatures down to the triple point. They represent the available experimental data to within their experimental uncertainties and extrapolate in a physically meaningful manner. Our models for *n*-octane, *n*-nonane, *n*-decane, and *n*-dodecane have been presented in three manuscripts, and at the Properties and Phase Equilibria for Product and Process Design (PPEPPD) conference in Snowbird, Utah (May 16-21, 2004).

M.L. Huber, A. Laesecke, R. Perkins, “Transport Properties of *n*-Dodecane”, *Energy & Fuels* 18 (2004).

M.L. Huber, A. Laesecke, H.W. Xiang, “Viscosity correlations for minor constituent fluids in natural gas: *n*-octane, *n*-nonane, and *n*-decane”, *Fluid Phase Equilibria*, 224 (2004).

M.L. Huber and R.A. Perkins, “Thermal conductivity correlations for minor constituent fluids in natural gas: *n*-octane, *n*-nonane and *n*-decane”, *Fluid Phase Equilibria*, in press.

Complementing our experiment-based approach are computational studies of the properties of systems with model potentials. Such studies can improve fundamental understanding for conditions where measurements are not feasible. Results of high computational accuracy have been published for the shear viscosity, the self-diffusion coefficient, and the bulk viscosity. With comprehensive simulation data at over 350 state points, the temperature and density dependences of these properties of the Lennard-Jones potential are characterized for the first time over a wide range of fluid states. The simulation data for the bulk viscosity has revealed a large critical enhancement similar to that known for the thermal conductivity, but extending much farther into the supercritical region (it can be observed even at 4.5 times the critical temperature). From our simulations, the bulk viscosity is now known in a wider range of states for the Lennard-Jones model fluid than for any real fluid.

K. Meier, A. Laesecke, S. Kabelac, “Transport coefficients of the Lennard-Jones model fluid. I. Viscosity”, J. Chem. Phys., 121(2004)
K. Meier, A. Laesecke, S. Kabelac, “Transport coefficients of the Lennard-Jones model fluid. II. Self-diffusion”, J. Chem. Phys. 121 (2004)
K. Meier, A. Laesecke, S. Kabelac, “Transport coefficients of the Lennard-Jones model fluid. III. Bulk viscosity”, J. Chem. Phys. 122 (2005) in press.

The integrated program on transport properties represents a portion of our coordinated efforts on thermophysical properties. These are important to both our infrastructural work (information will be disseminated through such Standard Reference Databases as NIST REFPROP), and to the immediate needs of customers, such as a project on rocket propellant RP-1. The ongoing program will continue to focus on both immediate and specific demands for transport property information and on longer-term efforts to improve our predictive capabilities in these areas.

Thermodynamic Reference Data

E.W. Lemmon, M.O. McLinden, A.H. Harvey, and R.A. Perkins (838)

Databases are the primary technology transfer vehicle by which we deliver our collective expertise in fluid properties to our customers. Much of our theoretical, modeling, and experimental efforts are directed toward improving and extending the databases to meet customer needs.

New “short-form” equations of state (EOS) for twenty new fluids describe all of the thermodynamic properties using a fixed functional form based on the Helmholtz energy. The short fixed form allows us to calculate properties for fluids with limited data sets but with higher accuracies (typically 0.1 % to 0.5 % in density, 1 % to 3 % in liquid heat capacities and sound speeds) than previously attained for these fluids. REFPROP has also been improved by the addition of equations for the dielectric constant of both pure fluids and mixtures.

NIST expands the REFPROP (Reference Properties) database to include over 20 new fluids of industrial importance including hydrogen sulfide, carbon monoxide, nitrous oxide, toluene, xenon, and R227ea.

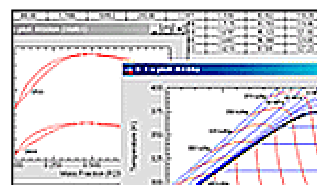

The REFPROP database has been the *de facto* standard in the refrigeration industry for many years. NIST was a key player in the new ISO standard for refrigerant properties, which adopts the same formulations as those used in REFPROP.

These new short-form equations of state are based on state-of-the-art EOS for reference fluids. We have advanced the state-of-the-art for EOS with new formulations for R125 and propane containing new terms and using new fitting techniques designed to make the equations more fundamentally sound. (Traditional high-accuracy EOS were highly empirical and did not have the proper behavior beyond the range of the data, while theoretically based EOS had proper qualitative behavior but were not of high accuracy.) The new functional form eliminates certain nonphysical behavior in the two-phase region.

The addition of nonlinear fitting constraints has yielded an equation that achieves proper phase stability, *i.e.*, only one solution exists for phase equilibrium at a given state. We have developed new fitting techniques to ensure proper extrapolation of the EOS at low temperatures, in the vapor phase at low densities, and at very high temperatures and pressures.

Development and validation of these high-accuracy equations of state require extensive, high-accuracy experimental data, and our recent measurements include the heat capacity (C_V) and density (p - ρ - T) of propane. Between C_V and p - ρ - T , our measurements cover the entire fluid range from the triple point to 500 K, including low-density gas states and compressed liquid states up to 36 MPa. The p - ρ - T data include extensive measurements near the gas-liquid critical point. These data, combined with new terms in the EOS, allow us to determine (using only single-phase data) the critical point at least as accurately as the available literature values.

CSTL researchers will port the computational engine of REFPROP to the Thermo-Data Engine (TDE), a new NIST database providing on-demand correlation of experimental data. This will give TDE the advantage of the inherent thermodynamic consistency of representing properties with equations-of-state versus the present approach of representing different properties with discrete correlations. Models for aqueous (water-based) systems and hydrocarbon mixtures containing hydrogen and helium will also be developed.

Critical Reference Materials for Mineral Commodities

J. R. Sieber, A.F. Marlow (839), S. A. Wilson (USGS), and J. T. Wolsiefer, Sr. (Silica Fume Association)

Mineral wealth has always been a key element of a thriving economy. As technology evolves, new mineral resources are exploited while traditional industries demand stockpiles of ever-improving quality. Thus, the need for mineral Standard Reference Materials (SRMs) remains but demands improved quality of compositional information. Likewise, the need for by-products SRMs is increasing as sustainability and economic pressures push for the transformation of these stockpiles into useful products.

SRM 1d is the fourth version of an important material. Argillaceous limestone – meaning ‘containing clay’ – is a critical natural resource. Besides its use as a building material, it is used to manufacture lime for agricultural and chemical processes, cement and concrete, and iron and steel. ASTM International Committee



E01 on Analytical Chemistry of Metals, Ores, and Related Materials, Committee C01 on Cement, Committee C07 on Lime and Limestone, Committee C09 on Concrete and Concrete Aggregates, and the National Lime Association expressed support for renewal of SRM 1c. Like its predecessors, SRM 1d will be used extensively for validation of ASTM International and in-house test methods at hundreds of laboratories around the world.

NIST has long supported US industries that rely on mineral resources.

***SRM 1d Argillaceous Limestone* exemplifies this long-term commitment, versions of SRM 1 have been provided by NBS/NIST since 1910.**

***SRM 2696 Silica Fume* exemplifies our responsiveness to new technology. This SRM was developed to support manufacture and use of this high-grade, small particle size silica to improve the strength and durability of concrete.**



Standard Reference Material 2696 Silica Fume is the culmination of collaboration by the Silica Fume Association and NIST with support from the Federal Highway Administration. SRM 2696 is intended primarily for evaluating chemical and instrumental methods of analysis of silica fume to satisfy product specifications. Silica fume, a by-product of metals refining, metamorphosed

from industrial waste to an important commodity in the past five to ten years. Certified values were established for silicon (as SiO_2) and six other chemical constituents, plus reference values for five constituents and Specific Surface Area by nitrogen absorption. All values are products of extensive testing by NIST and collaborating laboratories from manufacturers, distributors, state transportation departments, universities, and commercial laboratories. This allows us to leverage their expertise without the investment needed to develop it ourselves.

High-Performance Concrete containing silica fume can have very high compressive strength and durability due to low permeability. Reduced permeability helps prevent spalling due to the corrosion of steel reinforcing bars inside the structure following the infiltration of chlorine from salt. Silica fume is a byproduct of producing silicon metal and ferrosilicon alloys. No longer discarded in land-

Both SRM 1d and SRM 2696 were certified using X-ray fluorescence spectrometry (XRF) with borate fusion sample preparation in the matrix-independent approach developed during an Exploratory Research project several years ago.

fills, more and more silica fume is being used in concrete instead. Increasingly, state highway and transportation administrations require high-performance concrete in bridges and roadways. In response to the demand and to protect against the use of contaminated material, standard-writing organizations around the world are implementing specifications for the chemical composition and physical properties of silica fume.

<i>Constituent</i>	<i>SRM 1c</i>	<i>SRM 1d</i>
	<i>December 1978</i>	<i>October 2004</i>
SiO ₂	6.84 ± 0.16 (2.3 %) ^b	4.080 ± 0.071 (1.7 %) ^b
Fe ₂ O ₃	0.55 ± 0.06 (11 %)	0.3191 ± 0.0068 (2.1 %)
Al ₂ O ₃	1.30 ± 0.06 (4.6 %)	0.526 ± 0.013 (2.5 %)
TiO ₂ ^c	0.07 ± 0.02 (29 %)	0.0306 ± 0.0065 (2.1 %)
P ₂ O ₅	0.04 ± 0.02 (50 %)	0.0413 ± 0.0025 (6.1 %)
MnO ^d	0.025 ± 0.01 (40 %)	0.0105 ± 0.0003 (2.9 %)
CaO	50.3 ± 0.6 (1.2 %)	52.85 ± 0.16 (0.3 %)
SrO	0.030 ± 0.01 (33 %)	0.0303 ± 0.0010 (3.3 %)
MgO	0.42 ± 0.08 (19 %)	0.301 ± 0.010 (3.3 %)
Na ₂ O	0.02 ± 0.02 (100 %)	0.0109 ± 0.0016 (1.5 %)
K ₂ O	0.28 ± 0.02 (7.1 %)	0.1358 ± 0.0046 (3.4 %)
S	Not determined	0.1028 ± 0.0062 (6.0 %)
ZnO	Not determined	0.0022 ± 0.0003 (14 %)

^a Due to changes in definitions since 1978, the uncertainties for SRM 1c were multiplied by an expansion factor of 2 to make them comparable with SRM 1d.

^b The relative expanded uncertainty is given in parentheses.

^c This constituent is a reference value for SRM 1d.

^d Mn is certified as the element in SRM 1d.

Transport Coefficients and Molecular Dynamics

R. D. Mountain (838)

Details provided in the *Exploratory Research* Section of this Report.

5. Energy and Environmental Technologies



Many CSTL activities impact the energy industry sector, including reference data and models, fuel SRMs, metering standards, and flow calibrations. NIST's accurate and reliable flow standards and databases are critical to this industry both for process optimization and for use in custody transfer applications. CSTL also provides standards that allow this industry to verify compliance with environmental regulations. The Environmental Technologies industry sector, part of an estimated global market of \$530 billion, depends on NIST/CSTL for

Approximately 117,000 US companies are engaged in the business of environmental technologies, with 4,300 of those firms exporting internationally.

world-recognized artifact standards as well as reference data and models to demonstrate compliance with environmental regulations, and for reliable decision-making for environmental remediation, waste disposal, emissions trading, and other applications.

Standards Development and Measurements to Support Global Climate Change

G.C. Rhoderick (839)

Several species of gases found in the atmosphere that are known to contribute to the change in the radiative environment of the earth, have been developed as gaseous primary standards (PSMs). These gases are considered greenhouse gases and have been monitored throughout the atmospheric environment community worldwide for many years. These gases have also gained increased importance since the Kyoto protocol was designed and implemented to promote reduced emissions of greenhouse gases. PSMs were developed previously for methane (CH₄), carbon dioxide (CO₂), tetrafluoromethane (CF₄), nitrous oxide (N₂O), and sulfur hexafluoride (SF₆).

Gaseous Primary Standards were developed to support:

- NIST's in-house standards base for SRM certification,
- international comparison programs,
- NIST FTIR spectral database project, and
- International Halocarbon Experiment program sponsored by the World Meteorological Organization, NOAA, and NASA.



This past year an additional compound, 1,1,1,2-tetrafluoroethane (Halocarbon 134a), was studied and standards developed for the State of California Air Resources Board (CARB). This compound is a replacement for

halocarbons previously used as refrigerants but being phased out due to their high warming potential. Additionally, new PSMs were prepared at atmospheric levels and added to a suite of previously prepared standards. These compounds include carbon tetrachloride, chloroform, trichlorotrifluoroethane (CFC-113), 1,1,1-trichloroethane, and trichloroethylene.



A total of 22 gravimetrically prepared CH₄ in air primary standards now exist and are used to define the NIST primary calibration methane scale for laboratory measurements and traceability. The entire suite of primary standards range in concentrations from 0.8 μmol/mol to 10 μmol/mol. Eight of these PSMs also contain nitrous oxide, dichlorodifluoromethane, and trichlorofluoromethane. Two PSMs were submitted by NIST for evaluation in a BIPM International Comparison, the CCQM-P41 Greenhouse Gas comparison study. One PSM contains methane in air and the second mixture contains carbon dioxide in air. Three PSMs containing methane in air were also compared to methane-in-air PSMs prepared at the Climate and Diagnostics Laboratory at NOAA. A suite of three standards containing CF₄ and SF₆ were prepared to value assign the BIPM CCQM-K15 sample. A suite of four standards containing carbon tetrachloride, 1,1,1-trichloroethane, chloroform, trichlorotrifluoroethane, and trichloroethylene in air and five standards prepared in nitrogen containing the same compounds now exist at NIST. This suite of primary standards range in concentrations from 5 pmol/mol (ppt) to 100 pmol/mol. The PSMs containing these halogenated species can now be used to analyze real air samples as part of the World Meteorological Organization's International Halocarbon Experiment program.

These PSMs will lay the foundation for which atmospheric measurements can be underpinned and new SRMs be developed to support national ambient monitoring measurements of those species.

Absorption Coefficient Measurements of Aerosol Particle Agglomerates

C. Presser, C. Sheng (836), and A. Nazarian (SAIC)

Greenhouse effects associated with climate change may be influenced strongly by the chemical and physical properties of aerosol particles in the atmosphere. Currently, the largest uncertainty in predicting the change in Earth's global average temperatures over time is due in part to inadequate knowledge of the optical properties of atmospheric aerosols, such as soot and cloud condensation nuclei. Although a variety of methods are used to measure atmospheric aerosol black carbon mass, those based on thermal-optical analysis (TOA) are widely used in the US. TOA methodology makes critical and untested assumptions about the thermal and optical behavior of particulate matter (PM) on a quartz fiber collection substrate, as well as the instrument-produced by-products of pyrolysis. In response, we have developed a new approach to characterize the optical behavior of soot PM, which combines a laser driven thermal reactor (LDTR), an acoustic levitator, and optical pyrometry, as a well-controlled thermal environment for the non-intrusive determination of optical, thermal-physical, and chemical-kinetic properties.

Measurements were carried out in the LDTR to determine the effect of carbon shape and size on its absorption characteristics. This information is important for characterizing particles when their surface is not always spherical and well predicted by theory.

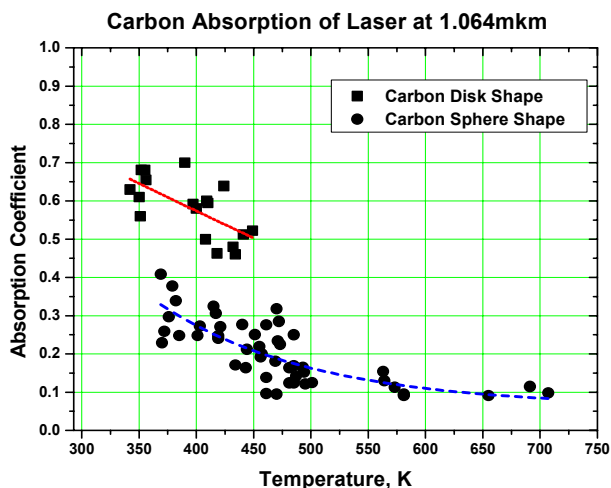

Variation of absorption coefficient with sample temperature for the sphere- and disk-shaped carbon.

The determination of the optical absorption characteristics of aerosol particulates with greater accuracy than other existing techniques has excellent potential to improve the performance of thermal-optical analyzers, which are used extensively to characterize aerosol particles that are collected in the atmosphere.

The CSTL-led research team studies the feasibility of a new measurement approach for the absorption coefficient of carbon-based aerosol particles at high temperature (up to 1200 K) using controlled laser heating.

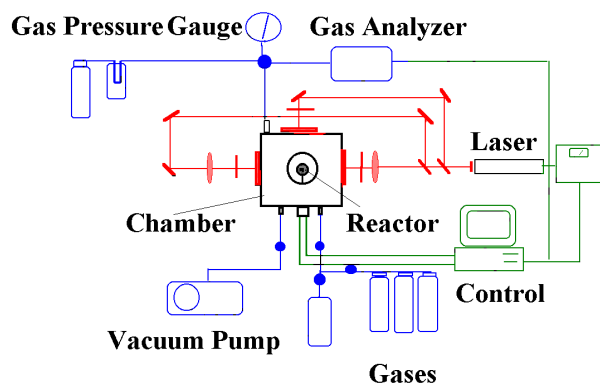

Schematic of Laser-Driven Thermal Reactor

Results were obtained for a spherical and disk-shape agglomeration of compacted particles over a range of laser heating temperatures. The figure presents the effect of heating on the determination of the absorption coefficient. The LDTR was modified to include a chemical sampling and analysis capability. A sampling probe and gas collection arrangement was fabricated and operated by vacuum pressure extraction of gases into a stainless steel accumulator with a septum. The septum allows collection of the gas into a syringe, which in turn provides sample for analysis in a gas chromatograph/mass spectrometer (GC/MS). The GC has a capillary column that allows separation for polycyclic aromatic hydrocarbons (PAHs). PAH identification is of interest since they are considered precursors to the formation of soot. The MS (which can scan from 10 to 800 mass/charge ratios) and NIST MS library are used to identify such candidate PAH molecules.

We plan to use this technique to develop a unique database that includes, in addition to soot absorption coefficient, other optical and physical properties for soot, other representative samples of particulate matter, and multiphase and multi-component liquid droplets that are representative of cloud condensation nuclei characteristics. These data will be used to provide input information for climate change models, and to improve the performance of optically based devices used to monitor particulate matter in the environment.

Establishing Measurement Traceability for Gaseous Mercury Emissions Monitoring

G.D. Mitchell and W.D. Dorko (839)

The Environmental Protection Agency (EPA) has announced that it will regulate emissions of mercury from coal- and oil fired power plants because of the known health risk posed by environmental exposure. The EPA is focusing its effort on both elemental (Hg^0) and ionic (Hg^{++}) mercury. Although coal-fired power plants are the largest source of mercury emissions to the air in the US, mercury is also emitted from other sources such as municipal waste combustors, medical incinerators, and hazardous waste combustors. Mercury emitted from power plants and other sources is carried by the wind and is eventually deposited onto the land and water. Once it enters the water (lakes, rivers, and wet lands) it is converted to methylmercury and can enter the food chain.

The EPA came to NIST for assistance in providing traceability in mercury gas standards, which are to be used to calibrate monitoring instruments to measure mercury to verify compliance with EPA emission allowances.

NIST worked with a commercial specialty gas vendor to procure three sets of gas mixtures of Hg^0 in nitrogen. The nominal concentrations of the Hg^0 in the cylinders are $2 \mu\text{g}/\text{m}^3$, $5 \mu\text{g}/\text{m}^3$, and $20 \mu\text{g}/\text{m}^3$. Another means of providing gas mixtures for instrument calibration purposes is to use a mercury vapor generator. One type of generator functions by passing a metered flow of nitrogen over a heated pool of mercury. The concentration of mercury in the gas stream is calculated by knowing the vapor pressure of Hg^0 at the thermostated temperature of the mercury pool, and the calibrated flow rate of the nitrogen. One system of this

NIST delivered to the EPA three cylinders of mercury in nitrogen whose concentrations are certified and traceable to the SI units. Also, a report was submitted detailing the findings concerning the performance of the mercury gas vapor generator.

Measured Conc. in EPA's three cylinders
 $(2.25 \pm 0.08) \mu\text{g}/\text{m}^3$
 $(5.99 \pm 0.18) \mu\text{g}/\text{m}^3$
 $(22.8 \pm 0.68) \mu\text{g}/\text{m}^3$

type was also evaluated by NIST by setting the parameters to generate mixtures at the same concentration levels as the cylinder gas mixtures.



The primary analytical instrument used to quantify the amount of mercury is a Nippon Instrument Corporation Model MA-2000 Mercury Analyzer (MA-2), which is equipped with a cold vapor atomic absorption (CVAA) detector. The MA-2 is an analytical system that can measure mercury in discrete liquid or solid samples. A weighed amount of a solid or liquid is put into a ceramic

boat that is then placed in a chamber of the analyzer. The way in which vapor samples are supplied to the MA-2 is to pass a measured volume of the gas containing the vapor through an external gold trap to collect the Hg. This gold trap is then placed in the MA-2 instrument boat and this is treated as described above for a solid sample. The traps that were used to trap the Hg^0 from the gas samples, either from the cylinders or the generator, were tested to determine that there was complete collection. The analyzer was calibrated periodically with quantitatively diluted Mercury in Water SRM 1641d and the cylinders analyzed and delivered to EPA.

The certified cylinder mixtures are to be used by EPA in their program to audit mercury monitoring sites to determine compliance with regulations. Up till this point they had no way by which to provide quality assurance for the audits. The program also provided data on the performance of a mercury generation device and these data showed that this

Comparison between generator output concentrations and measured results

	<u>Concentration, $\mu\text{g}/\text{m}^3$</u>		
	<u>Hg-20</u>	<u>Hg-05</u>	<u>Hg-02</u>
Generator Setting	20.86	5.13	2.48
Measured on MA-2	21.3	4.97	2.50
Difference: Measured to Set	+ 2.1%	- 3.1%	+ 0.8%

device is a viable alternate option for calibration and audit of mercury monitors. The cylinders containing the mercury mixtures are to be re-analyzed on a

periodic basis to determine whether or not there is any degradation of the Hg^0 concentration. Development work has already begun on a method for studying ionic mercury (Hg^{++}) to provide traceability for measurements being made in support of EPA's proposed regulations.

Standard Reference Materials (SRMs) and Quality Assurance Activities to Support Measurements of Organics on Air Particulate Matter Less Than 2.5 μm ($\text{PM}_{2.5}$)

S.A. Wise, J.R. Kucklick, B.J. Porter, D.L. Poster, M.M Schantz, R.O. Spatz, and R. Zeisler (839)

In 1997 the Environmental Protection Agency (EPA) issued new standards for air particulate matter (PM) under the national ambient air quality standards including new regulations for PM less than 2.5 μm ($\text{PM}_{2.5}$), which is the respirable PM fraction, in addition to the existing PM_{10} standards. Research recommendations have been made by the National Research Council at the request of Congress and EPA to focus on evaluating what types of particles cause detrimental health effects. To support compositional analyses and other investigations on the fine PM, quality assurance materials are necessary; however, few appropriate fine particulate materials are currently available to support this research.

NIST has entered an agreement with the EPA to develop SRMs to support analytical measurements of organic constituents in $\text{PM}_{2.5}$, to improve interlaboratory comparability of measurements, and to provide national measurement traceability.

The NIST/EPA agreement has focused on three projects with the goal of providing quality assurance and SRMs to support measurements of organic compounds in fine PM including:

(1) establishment of a interlaboratory comparison program to assess measurement comparability, (2) development of solution SRMs for compounds of interest for PM measurements, and (3) collection of bulk $\text{PM}_{2.5}$ for use as a future SRM. As part of the NIST/EPA collaboration, the Organic Speciation Working Group was formed in 2000 to assist in this effort by participating in interlaboratory comparison studies and by providing input for the development of SRMs to support these measurements. This group has participated in three interlaboratory comparison studies for the determination of polycyclic aromatic hydrocarbons (PAHs), nitrated PAHs, alkanes (including hopanes and cholestanes), sterols, carbonyl compounds (ketones and aldehydes), acids (alkanoic and resin), phenols, and sugars in PM-related samples. Based in part on the results of these studies and input from the Organic Speciation Working Group, priorities for the development of a number of calibration solution SRMs were identified including: aliphatic hydrocarbons, PAHs, nitro-substituted PAHs, hopanes/steranes, and ^{13}C -labeled and deuterium-labeled levoglucosan (for use as internal standards). SRM 1494 Aliphatic Hydrocarbons in Iso-Octane was issued in early 2004. SRMs 2260a PAHs in Toluene and 1491a Methyl-Substituted PAHs in Toluene, which are redesigned solutions with an expanded list of 53 PAHs and alkyl-substituted PAHs, were completed in late 2004. The remaining solution SRMs are in progress and will be completed in 2005.



The development of SRMs to support measurements for organic species in fine PM will expand the quality assurance capabilities to important source markers and species critical to human health.

Collection of a 200-g bulk sample of ultra-fine particulate matter at a site in Baltimore, MD with a high-volume sampler has been only partially successful. Two collections of 20 g each have been used to prepare an interim reference material and for distribution in the NIST/EPA interlaboratory comparison exercises for the determination of organic compounds. The results from the second interlaboratory study using the interim reference material have been used in conjunction with NIST measurements to assign concentration values for the compounds of interest. This interim reference material is now available to laboratories involved in EPA $\text{PM}_{2.5}$ research programs for use as a control or reference material. The second $\text{PM}_{2.5}$ material collected in Baltimore has been distributed to over 20 laboratories as part of the third NIST/EPA intercomparison study, and results will be available in early 2005. In addition, we are investigating alternative approaches to obtaining sufficient quantities of $\text{PM}_{2.5}$ for preparation of an SRM including preparation of a fine fraction material from existing PM SRMs and/or other total suspended PM. Additional organic compound classes have been identified by EPA for development of additional solution SRMs including additional sugars, saturated and unsaturated acids, and quinones.

Reference Material (RM) 8785 Air Particulate Matter on Filter Media

G.A. Klouda (837), J.J. Filliben (ITL), and H.J. Parish (SRI International)

Combustion aerosol has a major influence on air quality and is known to have a direct and indirect impact on the Earth's radiative forcing. For the most part, man's activities are linked to these emissions and account for a significant amount of the total carbon aerosol found in the atmosphere. To assess impacts and distinguish sources of combustion aerosol, numerous methods exist to quantify the amount of organic and black (soot) carbon, important in addressing air quality issues and estimating the warming and cooling effects of aerosol on our climate system. However, the results vary depending on which analytical method is used, leading to a variety of definitions of what constitutes black carbon.

NIST releases RM 8785 with reference values for black and organic carbon concentrations

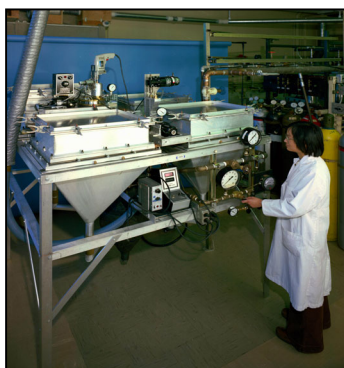

SRI Dust Generation and Collection System



Researchers in NIST's CSTL and ITL have collaborated with SRI International (Menlo Park, CA) to produce Reference Material (RM) 8785 Air Particulate Matter (PM) on Filter Media. RM 8785 was produced by resuspending SRM 1649a Urban Dust, sampling its fine fraction ($< 2.5 \mu\text{m}$ aerodynamic diameter) and filtering the $\text{PM}_{2.5}$ onto nearly 2000 quartz-fiber filters. Filter ID number and the gravimetrically determined mass of fine SRM 1649a uniquely identify each filter. RM 8785 is intended primarily for use in the evaluation of analytical methods used to characterize the carbon composition of atmospheric $\text{PM}_{2.5}$ for national ambient air quality standards (NAAQS) monitoring programs. Additionally, RM 8785 will provide the atmospheric chemistry and ocean-sciences community with a means to compare methods and laboratories for the measurement of black carbon.

Through an inter-laboratory and inter-method comparison involving NIST, Desert Research Institute (Reno, NV), and Sunset Laboratories Inc. (Tigard, OR), concentrations of total carbon, black carbon, and organic carbon were measured and values were assigned. Measurements were performed using two widely used thermal-optical protocols: one is from the Interagency Monitoring of Protected Visual Environments (IMPROVE), and the other is from the Speciation Trends Network-National Institute of Occupational Safety and Health (STN-NIOSH). RM 8785 has been assigned a reference value for total carbon concentration and information values for black and organic carbon concentrations corresponding to each method.



Influence of Oxygen on the Shelf Life of Coal Standard Reference Materials (SRMs)

R. Zeisler (839) and W.D. James (Texas A&M)

Long-term stability of SRMs is essential to customers' use of the materials. CSTL scientists and collaborators validated the stability of coal SRMs under proper storage conditions. Oxidative environments in combination with elevated temperatures have been found to promote the oxidation of coal samples and lead to changes in composition.

Initial evidence of change was provided by trace element data provided by instrumental neutron activation analysis (INAA) in SRM 1632b, which indicated a change in mass fraction values similar to the reported carbon change in the material. While a change in carbon content through loss of CO_2 may have been a plausible explanation for lower than previously measured carbon values, the measured decrease of a larger number of elemental content values may be explained in a gain of matrix mass, such as by irreversible oxidation and therefore increased matrix mass.

CSTL researchers and collaborators investigate the long-term stability of coal samples when users reported a change of -1.6% in the measured values of the carbon mass fraction of the SRM 1632b Trace Elements in Coal that was issued in 1985.

The newly developed SRM 1632c Trace Elements in Coal (Bituminous) was selected for the study. Twenty-six samples each were stored at three conditions: in liquid nitrogen vapor and at room temperature in the original containers packaged under argon, and for accelerated aging at 50 °C open to air. Under proper storage, the samples showed stable mass during the more than 4-year observation; only the ones stored open at higher temperature gained mass. To directly measure the presumed oxidation, a fast (14-MeV) neutron activation analysis (NAA) procedure was employed to determine mass fractions of oxygen in the coal samples.

The 14-MeV NAA is an effective procedure for the direct determination of oxygen. It demonstrated sufficient precision and accuracy to determine a relative change of about 5 % or more in the oxygen mass fraction of about 11 %.

The measurements provided by NIST give assurance that properly packaged coal SRMs, protected from oxygen and heat, are stable during their specified shelf life. Gravimetric monitoring of coal SRMs during storage should be employed by NIST and customers alike as a cost-effective quality measure.

For comparative storage, an analytical comparison of trace element content in the three storage conditions showed a lowering in mass fraction for 22 trace elements corresponding to the gain in sample mass.

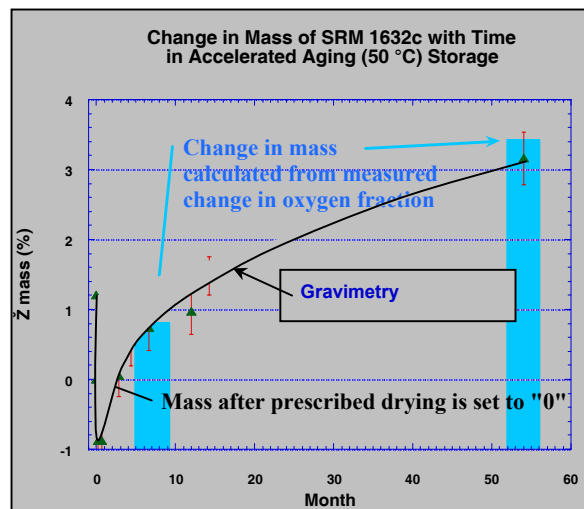

To evaluate the sample stability, test points were set at 6 months and 54 months for the oxygen determination, more frequent gravimetric tests were carried out for the samples in the open 50 °C storage. The gain in mass and in oxygen for the latter samples is illustrated in the figure. All gain in mass can be explained by the gain in oxygen content. No change in oxygen content was measured in the other storage conditions. As further validation of this gain in sample mass of coal under ox-

Developing Trace Analytical Methods and Gas Standards for Ammonia in Nitrogen

T.W. Vetter and W.J. Thorn (839)

Natural gas turbines used to produce electric power generate significant NO_x and SO_x pollutants as emissions. Ammonia is added to the exhaust stream to neutralize the acid gases forming nitrate and sulfate salts, which are collected. The EPA regulations for continuous emission monitors (CEMs) require that ammonia not exceed 3 μmol/mol excess in the stack emissions. Similarly, alternative fuels such as compressed natural gas (CNG) and hydrogen can generate ammonia in mobile source exhaust (cars and trucks), which must be monitored. Currently, there are no reference materials available.

CSTL is developing a primary method for assigning ammonia concentrations to gas standards in the 1.0 μmol/mol to 100 μmol/mol range. These standards are of interest to the EPA for mobile- and stationary-source monitoring; and of interest to specialty gas mixture vendors who service these applications.

Preliminary measurements were made this year evaluating three primary methods on a series of ten ammonia working standards from 5 μmol/mol to 640 μmol/mol. Ammonia concentrations for two of the working standards (40 μmol/mol and 160 μmol/mol) were determined by a classical titrimetric method with relative expanded uncertainties of less than 1 %. All of the working standards were measured during an evaluation of a commercial ammonia instrument, which catalytically oxidizes ammonia to nitric oxide (>95 % efficiency) and then measures the nitric oxide by chemiluminescence. This method is of high interest because of the availability of a large quantity of nitric oxide primary standards in support of NIST SRMs. Additionally, all of the working standards were measured by fourier transform infrared spectroscopy (FT-IR), and a non-linear regression plot of the measured absorbances vs. concentration was developed. NIST has compared the ammonia values measured by the three analytical techniques and found that the 2 % to 4 % differences between the methods are difficult to resolve because the ten working standards of ammonia are decaying in concentration over time compared to their gravimetric preparation values.

NIST ammonia in nitrogen working standards: NIST is working with BOC Gases to produce ammonia-in-nitrogen calibration gas standards by gravimetric dilution. For the first batch of 14 standards, FT-IR spectroscopy was used to measure ammonia absorbances as a function of the ammonia concentration and results indicated a non-linear FT-IR response curve for some of the cylinders. Work to produce a suitable suite of working standards is continuing.

Titration primary method for determining ammonia: The ammonia concentration was determined in two of the working standards whose nominal levels were at 40 $\mu\text{mol/mol}$ and 160 $\mu\text{mol/mol}$. The sample gas was metered into a solution of excess boric acid to form ammonium borate. The ammonium borate was neutralized by back titration with standardized hydrochloric acid to an original pH endpoint of the boric acid solution. The titrimetrically-determined mole fraction of ammonia in the two mixtures is $(37.5 \pm 0.3) \mu\text{mol/mol}$ and $(151.5 \pm 0.8) \mu\text{mol/mol}$.

Oxidation of ammonia to nitric oxide and chemiluminescence analysis: NIST evaluated a commercial instrument, which oxidizes ammonia to nitric oxide and then measures the chemiluminescence response. The two highest working standards were diluted using a commercial mass flow dilution system to generate ammonia reference mixtures similar to sample working standards being analyzed. Each of the working standards was assigned a concentration value, which was within 95 % of a similar NO response. The corresponding values for the two mixtures above are $(39.1 \pm 0.8) \mu\text{mol/mol}$ and $(155.7 \pm 0.8) \mu\text{mol/mol}$. All of the measured values are observed to be 4 % to 6 % below the gravimetric blend values; suggesting that these working standards are unstable. Using the ammonia chemiluminescence instrument, we will attempt to link ammonia concentration determination to our primary nitric oxide gas standards. Work will also continue on the titrimetric method to provide direct linkage to the SI. Permeation systems will also be investigated in order to provide the conversion efficiency parameter for the chemiluminescence instrument.

New Standard Reference Material (SRM) for Organic Contaminants in House Dust

M.M. Schantz, J.M. Keller, J.R. Kucklick, D.L. Poster, H.M. Stapleton, S. Vander Pol, and S.A. Wise (839)

House dust is a repository of pesticides and other chemicals used indoors or tracked in from outdoors, and as such can be used as an indicator of indoor exposure. Pesticides associate with house dust primarily through interior use of pest control formulations, vapor intrusion from foundation and crawl space treatments, and tracking-in of lawn and garden chemicals. PAHs derive from indoor sources such as combustion, cooking, and smoking, and from track-in of contaminated yard soil or residues from garage floors. PBDEs are commonly used flame retardant compounds added to many plastics, resins, and textiles which are then incorporated into products including TVs, computers, furniture, and carpets. NIST is developing a house-dust reference material with values assigned for a wide range of organic contaminants for quality control in these measurements.

NIST has produced SRM 2583 and SRM 2584 for lead and other trace elements in a house dust matrix. SRM 2585 Organic Contaminants in House Dust will be issued with concentration values assigned for pesticides, polycyclic aromatic hydrocarbons (PAHs), polychlorinated biphenyl (PCB) congeners, and polybrominated diphenyl ether (PBDE) congeners.

The house dust SRM 2585 will provide a control sample for laboratories routinely monitoring indoor dust. With the increased interest in the PBDE concentrations in all types of environmental samples, the assignment of concentrations for this group of compounds in many different matrices, particularly those associated with human exposure, will be important.

Over 100 contaminants, including pesticides, PAHs, PCB congeners, and PBDE congeners, will be value assigned in SRM 2585 using an approach similar to that used for other natural-matrix reference materials, such as mussel tissue and sediment. Three methods were used to quantify a number of pesticides, PAHs, and PCB congeners in the house dust. Using one of the methods, the material was found to be homogenous at a 1 g sample size. *Cis*- and *trans*-chlordane are present in the material at concentrations between 150 $\mu\text{g/kg}$ and 250 $\mu\text{g/kg}$. Fluoranthene and pyrene are present in the material at concentrations between 3000 $\mu\text{g/kg}$ and 4500 $\mu\text{g/kg}$. The individual PCB congeners are lower in concentration (<50 $\mu\text{g/kg}$ for each congener). Two methods were used to value assign the PBDE congeners in SRM 2585. PBDE 209 was the dominant PBDE congener in SRM 2585 at a concentration of 2600 $\mu\text{g/kg}$.

Method Development and Measurements of Polybrominated Diphenyl Ethers (PBDEs) in Tissue, Serum, and Sediment Standard Reference Materials (SRMs)

H.M. Stapleton, J.M. Keller, M.M. Schantz, and S.A. Wise (839)

Polybrominated diphenyl ethers (PBDEs) are flame-retardant compounds that are commonly added to many plastics, resins, and textiles that are then incorporated into products such as TVs, computers, furniture, and carpets. PBDEs can volatilize or leach out of the products in which they are applied and be transported long distances in the environment, due to their physico-chemical properties. PBDEs are now considered ubiquitous environmental contaminants and much attention has been focused on their transport, uptake, and fate in both humans and the environment. Presently, there is an increased need for measurements of PBDEs in environmental matrices and human serum. SRMs with certified concentrations for individual PBDE congeners are currently unavailable, and they are needed to ensure quality control for these measurements.

NIST researchers develop a gas chromatography/mass spectrometry (GC/MS) method quantify the flame-retardants PBDEs in a variety of existing natural matrix SRMs.

Legislation in the US is now being considered to reduce the use of PBDEs in consumer products. Numerous corporations that produce PBDE-laden products will be affected. These companies have expressed interest in having SRMs to test their products to ensure that they conform to these regulations.

Ten existing natural-matrix SRMs have been analyzed for determination of a suite of 26 PBDE congeners. These SRMs include marine mammal tissue, fish tissue, mussel tissue, human serum, marine sediment, and house dust. The GC/MS method, which uses on-column cool injection, has allowed for the measurement of the fully brominated PBDE congener (2,2',3,3',4,4',5,5',6,6'-decabromodiphenyl ether; BDE 209) using an isotope dilution quantification approach. This congener has often been difficult to measure due to its thermal instability. BDE 209 was observed to be the dominant PBDE congener in the sediment and house-dust SRMs, and thus, these SRMs will be useful for laboratories interested in routine measurements for BDE 209.

Other flame retardants such as hexabromocyclododecane (HBCD) are now being used at higher rates as a replacement for PBDEs in some parts of the world. Thus, there is interest in the measurements of HBCD in environmental samples. Additionally, evidence suggests that PBDEs may be metabolized by some organisms to hydroxylated and methoxylated derivatives. Preliminary evidence suggests that methoxylated PBDEs (MeOBDEs) are present in the marine mammal blubber and cod liver oil SRMs. Measurements are planned for HBCD and MeOBDEs in these environmental-matrix SRMs to provide reference values for these new flame-retardant-related compounds.

Standard Reference Materials (SRMs) for Contaminants in Marine Tissue and Sediment

S.J. Christopher, R.D. Day, W.C. Davis, S.E. Long, R.S. Pugh, M.M. Schantz, J.R. Kucklick, D.L. Poster, J.M. Keller, H.M. Stapleton, K.E. Sharpless, C.S. Phinney, B. J. Porter, E.A. Mackey, R.O. Spatz, C.E. Bryan, J.R. Sieber, R. Zeisler, S.A. Wise, and G.C. Turk (839)

Targeted environmental monitoring efforts, regulatory pressures, and compounds of emerging concern are expanding the list of potentially toxic contaminants that impact marine systems and challenging the analytical community to develop new measurement technologies for organic pollutants and trace metals. NIST is responding by providing marine-matrix SRMs to the marine environmental research community for method validation and quality assurance purposes and is at the forefront of developing and disseminating new analytical technologies for measuring contaminants in marine reference materials.

New classes of organic and organometallic contaminants have been certified in various marine tissue and sediment SRMs. New analytical approaches have been developed to certify trace elements fish tissue and in SRM 2703 Marine Sediment for Microsampling.

The value assignment of SRM 1947 Lake Michigan Fish Tissue highlights the collaborative effort undertaken to provide a marine reference material with a comprehensive suite of contaminant values, as well as information on nutritive properties. Several classes of compounds are represented in this material, ranging from selected trace elements, including total mercury and methylmercury, and organic contami-



nants, including polychlorinated biphenyl (PCB) congeners, chlorinated pesticides, and polybrominated diphenyl ether (PBDE) congeners to proximates and fatty acids. New methods were developed to measure compounds like PBDEs, which are flame-retardant compounds added to consumer plastic products. These compounds are chemically similar to PCBs, with levels increasing in the US population. PBDEs are currently being measured in two marine sediment SRMs (1941b Organics in Marine Sediment and 1944 NY/NJ Waterway Sediment) and three mussel tissue SRMs (1974b, 2977, and 2978). All PBDE measurements required the preparation of custom primary standards from chemically pure solutions and solids, reduction of background levels in the analytical blank, and development of gas chromatography mass spectrometry (GC/MS) methods to accommodate these thermally labile compounds.

Significant effort went into development of new complementary strategies for determination of organometallic species in marine tissue SRMs. For example, microwave-assisted acid extraction was used in combination with solid-phase microextraction gas chromatography-inductively coupled plasma mass spectrometry (SPME-GC-ICPMS) to measure organic and inorganic fractions of Hg and organotin compounds in SRMs 1947, 1946 (Lake Superior Fish Tissue), and bivalve tissues, SRM 1566b Oyster Tissue, SRM 2976 Mussel Tissue (Trace Elements and Methylmercury), and SRM 2977 Organics in Mussel Tissue. Some of these SRMs were also screened for As and Se content using liquid chromatography coupled to collision cell ICPMS, with the goal being to eventually provide concentration values to SRM customers tasked with measuring speciated forms of metals in various environmental matrices.

A new certification strategy was tested and implemented for determination of trace elements in SRM 1947 that is applicable to all homogeneous reference materials. Where multiple jars of a homogeneous NIST SRM need to be analyzed, a new standard additions/internal standard procedure was created to streamline certification measurement efforts. In the new procedure, multiple (typically 6) samples of the candidate certified reference material are accurately weighed into digestion vessels and gravimetrically spiked with an internal standard solution. Increasing amounts of a multi-element spike solution are then gravimetrically added to each vessel, ranging from no spike to a high spike, to effect a standard additions calibration curve. From this point on all measurements of the digested samples will be based on analyte/internal standard ratios, and all sample handling, including removal of the solutions from the digestion vessels and any subsequent dilutions, does not need to be done quantitatively. This is one of the main benefits of this approach. The other benefit is that we do not have to perform sample splits on each sample (SRM jar) to be measured. Values and uncertainties are calculated by linear regression of the measured analyte/internal standard ratios vs. the amount of standard added, and the slope of the standard additions curve can be used to predict concentration values in similar matrix controls run concurrently during experiments.

A new, more efficient, certification strategy that utilizes an internal standard produces standard addition curves that can be used to predict concentration values and does not require quantitative dilutions to produce quantitative results.

This research group is also developing a new marine sediment standard, SRM 2703. The SRM material was collected at the mouth of the Baltimore Harbor, and is primarily intended for use in evaluating analytical methods for the direct determination of selected elements in solid samples of marine or fresh water sediment and similar matrices. SRM 2703 was specifically developed for microsampling techniques. Direct and slurry sampling, as well as dissolution techniques using typically milligram size samples can employ this SRM to benchmark their procedures. A thorough homogeneity assessment of the material was conducted using instrumental neutron activation analysis (INAA), laser ablation inductively coupled mass spectrometry (LA-ICPMS), micro-beam X-ray fluorescence (μ XRF), and micro proton beam induced X-ray emission (μ PIXE) techniques complemented the INAA assay with homogeneity results for significantly smaller sample sizes.

Micro-PIXE images of SRM 2703. Sample were analyzed using a 3 MeV focused proton beam. Images were collected for all elements found in the PIXE spectrum. The total scan size of 750 μ m x 750 μ m was divided into 8 equal regions, each being quantitatively evaluated. Only sulfur showed heterogeneity directly observable from the 2D maps in all SRM samples. Detailed analysis of the spectra from 8 smaller regions revealed homogeneity of SRM 2703 for Al, Si, Cl, K, Ti, Mn, and Fe at the probed 1 μ g to 7 μ g sample size.

Analysis performed by a research team at Rudjer Boskovic Institute in Croatia.

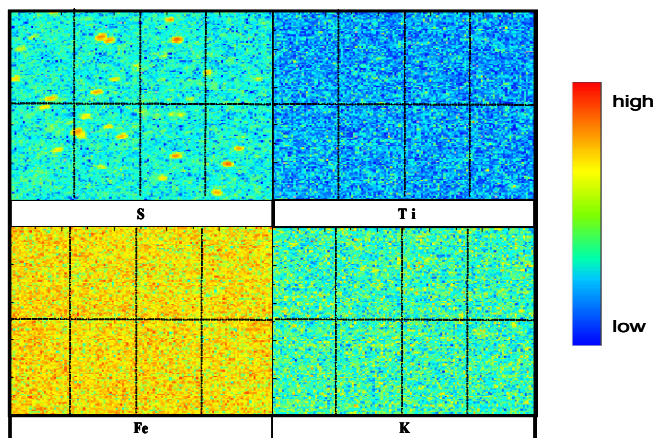

Additional measurements with several solid sampling procedures and dissolution procedures were provided by collaborating laboratories with the following techniques: atomic absorption spectrometry (AAS), inductively coupled plasma atomic emission spectrometry (ICPAES), and ICPMS, and X-ray fluorescence (XRF). All assays were designed to establish communicability of values between those conventionally certified in SRM 2702, representing the parent material, and the SRM 2703 measured at small sample sizes. These measurements confirmed that the composition of the material had not changed in processing and that the measured values in SRM 2702 can be utilized for value assignment of SRM 2703.

We will continue to develop analytical methods to measure environmental compounds of emerging concern in current issue and future marine tissue and sediment SRMs, including perfluorooctanesulfonate (PFOS), perfluorooctanoic acid (PFOA), other types of brominated flame retardants, classes of compounds like phthalate esters and their metabolites, which are prevalent in plasticizers, and representative compounds comprising the range of pharmaceutical and personal care products. We will also measure methylmercury and organotin compounds in marine sediment and tissue SRMs.

Marine Environmental Specimen Bank Activities

P.R. Becker, R.S. Pugh, M.B. Ellisor, J.R. Kucklick, S.J. Christopher, S.S. Vander Pol, R. Day, J.M. Keller, C. Bryan, H.M. Stapleton, and S.A. Wise (839)

Environmental specimen banking is the long-term preservation of representative environmental specimens for deferred analysis and evaluation. A systematic well-designed specimen bank program is not only a valuable component of real-time monitoring and basic research, but it also enables investigators to extend their research into the past and provides for future verification of analytical results. Formal environmental specimen banks are recognized internationally as integral parts of long-term environmental monitoring and research. There are two national environmental banking systems in the US, each having a different purpose. One is known as CASPIR™, the Centers for Disease Control and Prevention (CDC) and the Agency for Toxic Substances and Disease Registry (ATSDR) Specimen Packaging, Inventory and Repository. CASPIR cryogenically archives specimens for national public health investigations. The second is NIST's National Biomonitoring Specimen Bank (NBSB) that cryogenically archives specimens for environmental research. Both specimen banks include well-developed banking protocols, computerized sample tracking (chain-of-custody) systems, maintenance of many forms of data associated with original specimens, and large investments in state-of-the-art facilities and equipment required to store specimens over relatively long periods of time. Both programs have emphasized cryogenic storage, using ultra-cold (-80 °C) electric freezers and liquid nitrogen vapor storage (-150 °C), security systems, and monitoring of storage conditions 24 hours a day, 365 days a year.

NIST is expanding its environmental specimen banking activities through the recent development of the Marine Environmental Specimen Bank at the Hollings Marine Laboratory. With the increased interest in newly emerging contaminants, the Marine ESB will be a valuable resource for establishing temporal trends for these compounds in marine ecosystems.

The NBSB was originally established in 1979 by NIST at its Center for Neutron Research. In 2002, a NBSB satellite facility was established by NIST at the Hollings Marine Laboratory (HML) in Charleston, SC. This facility, the Marine Environmental Specimen Bank (Marine ESB) is devoted to the cryogenic banking of environmental specimens collected as part of ongoing research and monitoring programs conducted by other agencies, such as the National Oceanic and Atmospheric Administration (NOAA) and the U.S. Department of the Interior (DOI), in the marine and coastal environment of the US.



Although the banking of marine specimens has always been a major part of the NBSB (banking of mussels and oysters for NOAA's Mussel Watch Program, sediments and fish tissues for NOAA's National Status and Trends Program, and marine mammal tissues for NOAA and DOI), the establishment of the Marine ESB at the Hollings Marine Laboratory in association with NOAA, two institutions of higher learning and research, and a State marine research laboratory, has provided major resources and support for expansion of specimen banking nation-wide.

The National Marine Mammal Tissue Bank, which was established by Federal legislation in 1992, is maintained by NIST for the National Marine Fisheries Service and the Fish and Wildlife Service as a component of the NBSB and Marine ESB, with the Marine ESB providing the lead. Presently, NIST maintains 2,504 tissue samples collected from 885 individuals representing 37 species of marine mammals from throughout the US coastal waters, including Alaska. These samples are collected from strandings, animals taken incidentally in fishing operations, and animals harvested by Alaska Natives for food. Since the establishment of the Marine ESB, NIST has used its cryogenic banking expertise to develop protocols and to collect and archive blood and blubber samples for NOAA's ongoing bottlenose dolphin health assessment studies, eggs collected as part of a DOI environmental monitoring program on Alaska seabird colonies, and eggs and feathers collected as part of a DOI peregrine falcon monitoring program. To date, blood and blubber have



been collected from 215 bottlenose dolphins, 434 eggs have been archived from five species of arctic seabirds throughout Alaska as have 9 eggs and 26 feathers from the peregrine falcon program.

The primary function of the Marine ESB is to provide samples for retrospective analysis. In 2004, aliquots of blubber specimens collected from California sea lions during 1993 to 2002 and banked in the NMMTB were analyzed by NIST for polybrominated diphenyl ethers (PBDEs) and hexabromocyclododecane (HBCD), which are synthetic anthropogenic flame retardants that have now become ubiquitous contaminants; temporal trends have indicated concentrations are increasing rapidly in many matrices. The analysis of these banked samples was to determine if temporal trends for these compounds are also discernable in this species of marine mammal that is common on the west coast of the United States. The results indicate a significant temporal trend with HBCD with a doubling time of 2 years. The specimens archived in the Marine ESB will provide a valuable resource for investigating temporal environmental trends in these new compounds and for determining patterns of past exposure in marine biota.

NIST will continue to work with the HML partners and other Federal agencies and partners to expand environmental specimen banking. NIST staff are presently working with these partners to add banking as part of a future sea turtle health assessment program, to re-institute banking as part of the Mussel Watch Program, to establish a genetic cryo-bank as part of a National Genetics Archive initiative for marine biota, and to expand the banking of bird specimens to include other kinds of species and types of tissue samples on a national and international level. And finally, existing specimens being held by the bank are being identified for future work on identifying and measuring new contaminants of interest as related to issues on ocean and human health.

The establishment of the Marine ESB in association with the HML has provided a renewed interest in specimen banking as part of marine environmental monitoring and research. With the recognition that newly emerging compounds are appearing in the environment with potential environmental and health effects, the value of the specimens presently held by the bank for determining past exposure patterns and for evaluating temporal trends in concentrations of these compounds is becoming more apparent.

NIST Aids NOAA with Bottlenose Dolphin Health Assessments

J.R. Kucklick, S.J. Christopher, P.R. Becker, R.S. Pugh, M. Ellisor, J.M. Keller, C.E. Bryan, and J.E. Yordy (839)

Since 2000, NOAA has studied the health of bottlenose dolphins by collecting data and samples from animals captured and then released at locations along the US Atlantic and Gulf Coasts. Bottlenose dolphins accumulate persistent organic pollutants, such as polychlorinated biphenyls (PCBs) and brominated flame-retardants to some of the highest observed levels in wildlife, hence they are at risk from the toxic effects of these compounds. For instance, in Sarasota Bay, where sampling occurs twice per year, there is nearly complete mortality of dolphin calves born to first-time mothers. It is hypothesized that persistent organic pollutants off-loaded from the mother via milk play a major role in this reproductive failure. In 2002 NOAA asked NIST to provide technical assistance for the

NIST data help provide a basic understanding of contaminant burdens in bottlenose dolphins and provide exposure data for toxicological studies performed on the animals.

project by (1) designing a protocol for collecting, handling, and storing blood, blubber, and skin to be used for organic contaminant and/or trace element analyses, (2) permanently archiving blood and blubber samples for future study, (3) analyzing persistent organic pollutants and trace elements in samples collected during dolphin health assessments, and (4) providing technical assistance in the field during sample collection.

NIST developed a detailed protocol for collecting samples from bottlenose dolphins during health assessments. The protocol covers the collection of skin, plasma, whole blood, and blubber samples to be analyzed for trace elements (including mercury), persistent organic pollutants, and perfluorinated compounds, such as perfluorooctane sulfonate (PFOS). Since 2002 NIST personnel have successfully applied the collection protocol during 11 health assessments from 4 locations resulting in samples from over 150 dolphins. Seven additional health assessments are scheduled for fiscal year 2005. Subsamples of plasma and blubber are being archived in the Marine Environmental Specimen Bank. Blubber and blood samples are being analyzed for over 100 individual persistent organic pollutants including brominated flame-retardants. Blubber samples from 22 mother-calf pairs were analyzed revealing that the majority of the persistent organic pollutant load is passed to the calf. Milk samples collected from the mother dolphins and blood from mother and calf dolphins are currently being examined to better understand contaminant transfer from milk, especially for the brominated flame retardant compounds. Trace elements including mercury were determined in blood samples from dolphins sampled in Sarasota Bay, Florida and coastal New Jersey. A technique has also been developed to measure mercury in skin biopsy samples. This may allow the use of skin collected from remote dart biopsies to be used for the assessment of mercury.



Analytical work completed for NOAA ties measurements to a national metrology laboratory with a history of providing high-quality measurement data to NOAA. Since the dolphin health assessments are long-term projects, NIST's involvement will provide continuity in the analytical data generated on the project.

NIST will continue to work with NOAA as they expand their dolphin health assessment project to other areas along the coastal US. Work is underway to make use of high-throughput techniques for the analysis for persistent organic pollutants in blood and blubber. The target list will be expanded to include other types of compounds of emerging concern, such as additional flame retardants and perfluorinated compounds. A control material for dolphin blood will be developed and value assigned to provide a benchmark for blood analysis.

Interlaboratory Comparison Exercises for Organic Contaminants and Trace Elements in Marine Mammal Tissues

J.R. Kucklick, S.J. Christopher, P.R. Becker, R.S. Pugh, M.B. Ellisor, S.S. Vander Pol, E.A. Mackey, R.O. Spatz, B.J. Porter, M.M. Schantz, G.C. Turk, and S.A. Wise (839)

Laboratories measuring contaminants in the marine environment must assess the accuracy and precision of their measurements. Quality control of measurements made on marine environmental samples is vital to the accurate assessment of marine pollution and its effects on wildlife and human health. Representative control materials needed to benchmark analytical methods and measurements are often limited or not available for many marine matrices of interest (*e.g.*, marine mammal tissues and marine fishes). Consequently, analysis may be undertaken on samples without control materials that are similar in nature to the sample. To help address this need, NIST along with other US Government sponsors, initiated several programs to assess the data quality of laboratories performing chemical measurements on marine-related samples.

NIST helps benchmark and improve the quality of analytical data on the marine environment by conducting interlaboratory comparison exercise programs.



The first such program for environmental measurements was initiated in 1987 and funded in part until 2000 by the National Oceanic and Atmospheric Administration's (NOAA's) National Status and Trends Marine Monitoring Program (NOAA/NS&T). This program provides mechanisms for assessing the interlaboratory and temporal measurement comparability of polycyclic aromatic hydrocarbons, polychlorinated biphenyl (PCB) congeners, and chlorinated pesticides in bivalve mollusk, sediment, and fish samples. The program includes components for developing improved analytical methods, producing NIST Standard Reference Materials (SRMs) and other

control materials, conducting annual interlaboratory comparison exercises, and coordinating workshops to discuss exercise results. This program continues as the NIST Intercomparison Program for Organic Contaminants in the Marine Environment with partial support from fees paid by the participants, and it served as the model for the Interlaboratory Comparison Exercises Program for Organic Contaminants and Trace Elements in Marine Mammal Tissues.

Independent analytical methods at NIST (inductively coupled plasma mass spectrometry and instrumental neutron activation analysis) produced data to provide a reliable benchmark to assess the performance of participating laboratories.

ence Material, SRM 1945 Organics in Whale Blubber. The organics exercise has been successful as a source of data on constituents that were not certified in SRM 1945; for example, fatty acids and brominated flame retardants were determined in this SRM by six of the participating laboratories. The trace element exercise has led to the development of three trace element control materials from marine mammal livers, a pilot whale liver homogenate in 1991, and beluga whale and pygmy sperm whale liver homogenates in 1997 and 2003, respectively. The trace element exercise also used an innovative approach to arrive at a consensus mean and uncertainty data using a maximum likelihood solution model developed in NIST's Information Technology Laboratory.

The SRMs and control materials developed through this program and the interlaboratory comparison exercises are mandated for use by researchers in the US who are funded by NOAA to perform measurements of trace elements and organic contaminants in marine mammal tissues. NIST will continue to administer and coordinate interlaboratory comparison exercises for chemical analysis of marine mammal tissues. Future exercises will ask participants for compounds of emerging interest such as brominated and fluorinated compounds, toxaphene congeners, and organometal contaminants, such as butyl tins and methylmercury. The next round of interlaboratory comparisons will occur in 2005. Also in 2005, the data compiled from the exercises using SRM 1945 as a control will be used to assist in updating the Certificate of Analysis with values for additional polychlorinated biphenyl congeners, brominated diphenyl ether congeners, toxaphene, and fatty acids.

Results:
Comparability of measurements for organic contaminants has improved for those laboratories with a longer history of participation in the exercises, e.g., those that have participated since 1999 have improved their accuracy by 10% and their precision by 20%.

Detection of Trace Anthropogenic Contamination in Aquatic Ecosystems using Fluorescence Excitation-Emission Matrix Spectroscopy

R.D. Holbrook (837) and P.C. DeRose (839)

Aquatic resources play a key role in supporting and maintaining human activity. Aquatic systems provide potable water supplies to meet growing drinking and agricultural water requirements, and are used as receiving streams in the disposal of treated wastewater effluent. However, the nearly ubiquitous presence of trace organic contaminants in receiving streams has prompted worldwide concern about their impact on human health, largely due to the documented sexual disruption of aquatic wildlife caused by some trace contaminants as documented in the literature (for example, *Environmental Science and Technology*, 2003, 37, 1142-1149). Current analytical procedures for measuring trace organic contaminants in aqueous samples are both expensive and laborious, indicating the need for a sensitive screening method that is capable of detecting organic compounds that originate from biological wastewater treatment systems.

CSTL scientists investigate the use of fluorescence excitation-emission matrix spectroscopy, or EEM, as an applicable means of distinguishing treated wastewater effluent from "uncontaminated" receiving water samples.

The high frequency of contaminant detection in aquatic systems and extremely low biologically-active concentration (i.e., ng/L) recently led the National Research Council to recommend better monitoring of receiving streams. A simpli-

fied screening method would facilitate a wider range of samples/environments being examined. It is expected that environmental practitioners would be the immediate beneficiaries, followed by the general public, if a link between these compounds and human health is established.

Results:

The signature fluorescence distribution of downstream samples is noteworthy due to the extensive treatment processes employed at the advanced wastewater treatment facility. The fluorescence distribution of treated effluent derived from less advanced technology is even more unique.

A method of EEM collection and data analysis was developed using samples collected upstream and downstream of an advanced wastewater treatment facility. The EEM procedure took approximately 20 minutes per sample, required little sample volume (< 10 mL) and few preparation requirements. Data analysis was adopted from the article of Chen et al (*Environmental Science and Technology*, 2003, 37, 5701- 5710). A unique fluorescence distribution was observed for the downstream samples as shown in the figure, indicating that the presence of treated effluent could be detected using EEM. Specifically, a significant increase in fluorescence intensity was observed in region 1 (aromatic proteins) at excitation wavelength between 230 nm and 260 nm and emission wavelength between 300 nm and 340 nm as seen in the table.

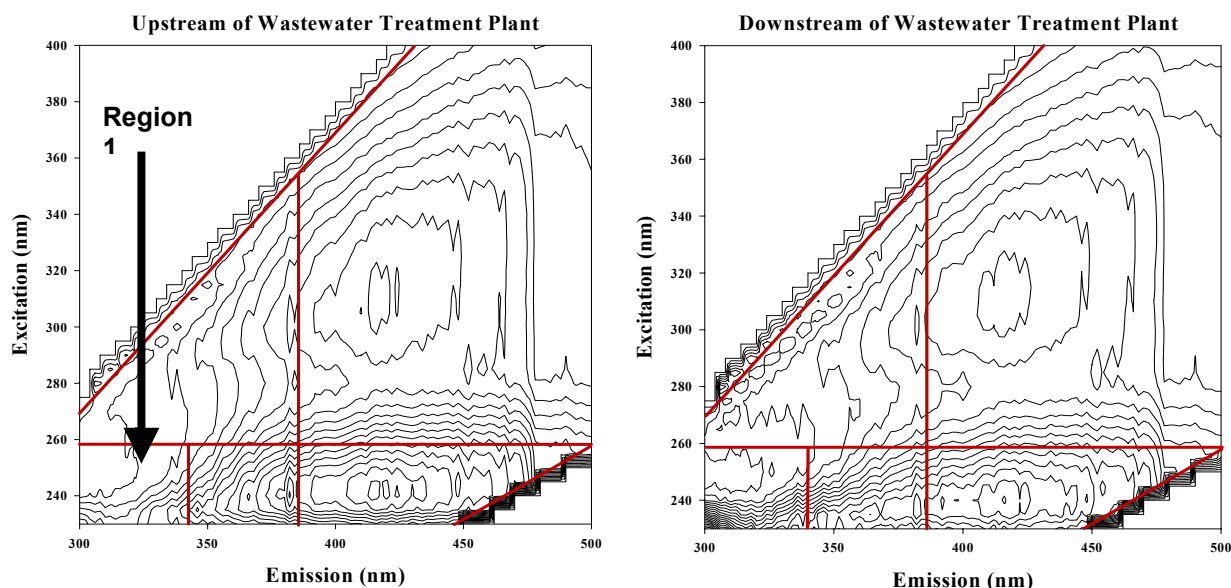

Typical EEM contour plots of upstream (left) and downstream (right) samples. The red lines are the superimposed regions that are described in the table. Note the increase in fluorescence intensity in Region I (lower left area) between the upstream and downstream samples. Each contour line represents 1/20 of the maximum fluorescence intensity.

Excitation-Emission Region Description and Results of Regional Integration of Upstream and Downstream Samples

	Organic Matter Type	Excitation Wavelength (nm)	Emission Wavelength (nm)	Portion of Total Fluorescence Signal (%)	
				Upstream (n = 6)	Downstream (n = 15)
Region I	Aromatic Proteins	230 to 260	300 to 340	9.9 ± 0.3	13.5 ± 2.3
Region II	Aromatic Proteins	230 to 260	340 to 380	25.5 ± 0.8	26.3 ± 1.3
Region III	Fulvic Acids	230 to 260	380 to 500	42.5 ± 0.5	38.7 ± 3.1
Region IV	Soluble Microbial Products	260 to 400	300 to 380	8.8 ± 0.1	9.4 ± 0.6
Region V	Humic Acids	260 to 400	380 to 500	13.3 ± 0.4	11.9 ± 0.9

Results are average ± 1 standard deviation

Simultaneous Determination of Sulfur Isotopic Composition and Concentration in Environmental Samples Using a $^{33}\text{S}/^{36}\text{S}$ Double Spike Technique

J.L. Mann, W.R. Kelly, and R.D. Vocke (839)



Recently the National Research Council (NRC) identified several “Grand Challenges” in environmental research for the next generation. Included in these is “understanding Earth’s major biogeochemical cycles and their interaction with the global climate.” The biogeochemical cycling of sulfur in the atmosphere and the formation of sulfate aerosol particles has important consequences for global climate. The variability of sulfur isotope ratios in nature, caused by mass-dependent fractionation during biogeochemical processing, provides a chemical tool for tracing the various sources of sulfur aerosols and a useful tool for understanding the sulfur cycle. Snow and ice cores provide archives of the sources, sinks, and processing of sulfur that reflect changes in this cycle through time. These archives can be used to assess the current and historical changes in

sulfur source contributions to remote regions of the Earth including polar, temperate, and tropical regions. Typical concentrations of sulfate in these regions are 25 ng/g to 100 ng/g (ppb); thus, 300 g to 4000 g of sample is required to obtain enough sample ($\approx 33 \mu\text{g S}$) for traditional isotope ratio mass spectrometric (IRMS) analysis. Global atmospheric sulfur cycling is a dynamic process that varies on short timescales and these large quantities of sample can mask seasonal changes in sulfur sources. Consequently, an analytical technique that allows the reduction of sample needed for analysis is required to minimize masking and increase the resolution.

CSTL researchers developed a thermal ionization mass spectrometric (TIMS) method that shows considerable promise as a tool for the measurement of low concentration sulfate samples for both the isotopic composition of sulfur and its concentration.

In this study we have focused on the use of multi-collector TIMS combined with a $^{33}\text{S}/^{36}\text{S}$ internal standard for simultaneous determination of sulfur isotopic composition and its concentration in low ($< 1 \mu\text{g}$) sulfate (SO_4^{2-}) samples. The isotopic ratios are stated in parts-per-thousand (‰) difference from the Vienna Canyon Diablo Troilite (VCDT) isotope-ratio standard, as defined by the formula $\delta^{34}\text{S} (\text{‰}) = [({}^{34}\text{S}/{}^{32}\text{S})_{\text{sample}}/({}^{34}\text{S}/{}^{32}\text{S})_{\text{VCDTstd}} - 1] \times 1000$.

The fundamental limitation to accurate and precise isotopic ratio measurements by thermal ionization is that the measured ratio differs from the true ratio in the source as a result of instrumental fractionation during vaporization of the sample from the filament. To address this changing ratio and to improve precision and accuracy in the $^{34}\text{S}/^{32}\text{S}$, a well-characterized $^{33}\text{S}/^{36}\text{S}$ internal standard was added to the samples and was used to calculate a fractionation factor (α) that corrects for this changing ratio (instrumental fractionation) to give the true ratio in the source. The $^{32}\text{S}/^{33}\text{S}$ ratio that has also been corrected for instrumental fractionation was used to calculate the sulfur concentration. This technique has a significant advantage over the IRMS technique that is limited to only isotope composition measurements.

Three International Atomic Energy Agency (IAEA) standards were used for this study. The $\delta^{34}\text{S}$ values (reported relative to VCDT ($\delta^{34}\text{S} = -0.3 \text{ ‰}$)) determined were $-0.38 \text{ ‰} \pm 0.15 \text{ ‰}$ (1s), $22.65 \text{ ‰} \pm 0.04 \text{ ‰}$ (1s), and $-32.47 \text{ ‰} \pm 0.07 \text{ ‰}$ (1s) for IAEA-S-1, IAEA-S-2, and IAEA-S-3, respectively. Each standard showed less than 0.5 ‰ variability (IAEA-S-1 $\approx 0.4 \text{ ‰}$, IAEA-S-2 $< 0.2 \text{ ‰}$, and IAEA-S-3 $\approx 0.2 \text{ ‰}$). The uncertainties are comparable to or better than those reported for IRMS, the typical method used for isotope ratio analysis.

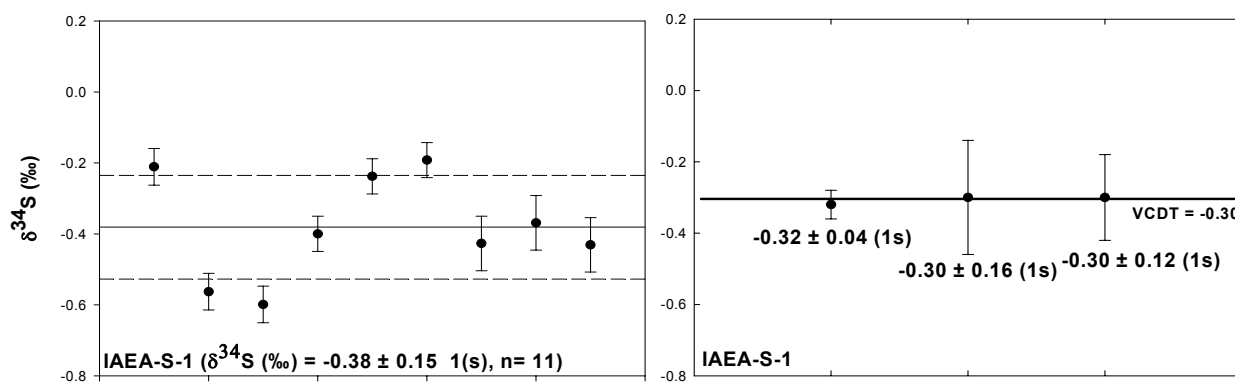

The figure shows the NIST result for IAEA-S-1 along with those of the Institute for Reference Materials and Measurements (IRMM, Belgium), and China's Institute of Mineral Deposits. These laboratories used a modified gas source (IRMS) mass spectrometer equipped with a molecular flow inlet system to determine the absolute isotope abundance ratios of the three standards. All labs obtained the same $\delta^{34}\text{S}$ value for IAEA-S-1, the benchmark standard, and IAEA-S-2 within the uncertainties. This does not hold true for IAEA-S-3 where our values are the same as that obtained for the Beijing laboratory but is significantly different than the value obtained by IRMM. This may potentially be due to scale contraction that is related to the gas source technique and which is eliminated by our technique. In each case our uncertainties are comparable or better than those obtained by the other labs. It is important to note that these measurements were made on samples ranging from 13 μg to 65 μg , which are smaller than the amounts used by the other laboratories (84 μg to 125 μg). Our precisions on concentration measurements range from 0.07 % to 0.23 % (% relative standard deviation), which is comparable to or an improvement over our present measurement capability (0.2 %) and includes a greater variability in the typical sample size taken for measurement.

The availability of TIMS instruments in laboratories around the world will make this technique immediately available to the scientific community and can be used for any applications requiring highly accurate and precise measurements of sulfur such as low-sulfur fossil fuels.

CSTL researchers are applying this technique to low sulfur concentration snow and ice samples from Greenland and Krygstan. The data obtained will allow the team to examine the degree of anthropogenic contribution to the sulfur cycle on a seasonal basis in these remote regions, and to assess the spatial variability of global anthropogenic influence.

6. Food and Nutritional Products



CSTL supports the food industry by providing reference measurements and reference standards for quality assurance and to help ensure compliance with nutritional labeling regulations. CSTL provides robust metrological traceability for nutrients in food products, contaminants and adulterants in food products, detection of genetic modifications in food products, and chemical composition and contaminants in dietary supplements/nutraceuticals. More than 50% of the US population uses dietary supplements, accounting for roughly \$10 billion in sales every year.

The US processed food and beverage industry is a major participant in the global market. Almost half of the world's top 50 food processing firms are headquartered in the US.

Development of Standard Reference Materials (SRMs) for Dietary Supplements

S.A. Wise, L.C. Sander, and K.E. Sharpless (839)

The enactment of the Dietary Supplement Health and Education Act (DSHEA) in 1994 by the U.S. Congress has promoted growth in the nutritional supplement industry, due in part to the way in which dietary supplements are regulated. DSHEA provides a legal definition of dietary supplements that classifies these materials separately from food additives and pharmaceutical drugs. Requirements for product labeling are less stringent than for drugs, and the burden of proof for the safety of dietary supplements is placed on the Food and Drug Administration (FDA). A variety of botanical-containing products are marketed as dietary supplements, e.g., St. John's wort, ginkgo, saw palmetto, and green tea. Botanical reference materials with assigned values for active and/or marker compounds are needed to address two primary concerns in the botanical dietary supplements community: safety and efficacy. Potential health risks may result from contamination (e.g., pesticides, toxic elements), adulteration (presence of unlabeled foreign materials including pharmaceuticals), or variability in product composition (e.g., changes in levels of active constituents). Secondly, product quality and consistency must be maintained through verification of dietary supplement label claims. These needs can be addressed by the development of analytical methods and reference materials to support chemical composition measurements for dietary supplements.

The availability of botanical dietary supplement matrix SRMs with certified concentrations of active/marker constituents and contaminants and a multivitamin/multielement tablet SRM will provide the measurement tools necessary to assess the quality of dietary supplements.



Bitter Orange: The dried outer peel of the fruit of bitter orange has been used medicinally, it is an appetite suppressant.

of dietary supplement label claims. These needs can be addressed by the development of analytical methods and reference materials to support chemical composition measurements for dietary supplements.

Beginning in 2001, NIST, FDA, and NIH Office of Dietary Supplements (ODS) initiated a multi-year program to develop Standard Reference Materials (SRMs) and analytical methods for a number of botanical and botanical-containing dietary supplements. The goal of this collaborative program is to provide SRMs for eight to ten different botanical dietary supplements over a six-year period. Based on NIH priorities and needs, NIST is developing SRMs for the following dietary supplement materials: ephedra, *Ginkgo biloba*, saw palmetto, bitter orange, green tea, St. John's wort, β -carotene and tocopherol mixtures, and multivitamin/multielement tablets. Each botanical material SRM will consist of a suite of matrices including plant, extract, and finished product. The first SRM suite for ephedra-containing dietary supplements (SRMs 3240-

3244) has been completed (see Technical Report that follows). The second SRM suite for *Ginkgo biloba* has been prepared and measurements of ginkgolides and flavonoids are nearing completion. Plant and extract materials for the next suites, saw palmetto and bitter orange, were obtained in 2004; a carrot oil, representing a natural carotene mixture, was also obtained.



NIH-ODS is also collaborating with the US Department of Agriculture (USDA) to establish the Dietary Supplement Ingredient Database (DSID). The DSID project will report the results of a systematic survey of supplement composition, including chemical composition of ingredients with the primary focus on vitamin and mineral supplements. To support the DSID project, NIST and NIH-ODS have expanded

their collaboration to develop dietary supplement matrix SRMs to include a multivitamin/multielement supplement. SRM 3280 Multivitamin/Multielement Tablets is a commercial multivitamin/multielement tablet which will be value assigned for concentrations of 18 elements and 15 vitamins and carotenoids for which label claims are made. The candidate material for the multivitamin/multielement tablet SRM was received in mid-2004, and methods development and measurements are currently underway. Completion of the multivitamin and multielement SRM is scheduled for early 2006. Acquisition of the St. John's wort and green tea are in progress and will be completed in early 2005.

The next priorities for SRM development include: β -carotene (e.g., a mixture of β -carotene isomers), vitamin E (e.g., d- α -tocopheryl acetate/d,l- α -tocopheryl acetate and a mixture of the tocopherol and tocotrienol isomers), black cohosh, and a number of berry materials (e.g., cranberries and blueberries).

Development of Ephedrine Alkaloid-Based Dietary Supplement Standard Reference Materials (SRMs)

L.C. Sander, K.E. Sharpless, J. Brown Thomas, B.J. Porter, T.A. Butler, M. Satterfield, S.E. Long, L.A. Mackey, K.E. Murphy, L.J. Wood, R.D. Vocke, L.L. Yu, and S.A. Wise (839)

The FDA issued a ruling that declared dietary supplements that contain ephedrine alkaloids to be adulterated in December 2003. This ruling was based on mounting evidence of health risks associated with the use of ephedra, and in effect bans the use of ephedrine alkaloids (regardless of their botanical origin) in dietary supplements. Ephedra-containing dietary supplement SRMs are intended for use in method validation and as control materials for analytical methods used in the determination of ephedrine alkaloids, and should prove to be useful to support such methods and to demonstrate the absence of ephedrine alkaloids in ephedra-free products.

NIST provides critical ephedrine alkaloid-based SRMs that support FDA's goal of ensuring the safety of dietary supplements.



Photograph of voucher specimen representative of plants used in the preparation of SRM 3240 *Ephedra sinica* Stapf Aerial Parts

NIST, working in collaboration with the National Institutes of Health Office of Dietary Supplements (NIH-ODS) and FDA, Center for Drug Evaluation and Research (CDER) and Center for Food Safety and Applied Nutrition (CFSAN), has recently issued a suite of Standard Reference Materials® (SRMs) that contain ephedra. Five SRMs are available: SRM 3240 *Ephedra sinica* Stapf Aerial Parts, SRM 3241 *Ephedra sinica* Stapf Native Extract, SRM 3242 *Ephedra sinica* Stapf Commercial Extract, SRM 3243 Ephedra-Containing Solid Oral Dosage Form, and SRM 3244 Ephedra-Containing Protein Powder. In addition, SRM 3245 Ephedra Suite is available and contains two bottles each of the five ephedra-containing materials. The SRMs are certified for levels of ephedrine alkaloids and selected toxic trace elements (As, Cd, Hg, and Pb). In addition, the level of synephrine (an ephedrine-like alkaloid present in many ephedra-free dietary supplements) is certified in SRM 3243, and levels of caffeine are certified in SRM 3243 and SRM 3244. Information on proximates (i.e., moisture, solids, ash, protein, carbohydrates, fat), vitamins, amino acids, and nutrient elements is also included with SRM 3244.

The SRMs are provided primarily for use in method development and as control materials to support analytical methods for the determination of these constituents. In the absence of a formal regulatory environment, the SRM suites will assist manufacturers of dietary supplements to characterize raw materials voluntarily and to prevent the use of materials

SRMs 3240 through 3244 represent the first in a series of dietary supplement SRMs to be offered by NIST with certified values for organic constituents and selected trace elements.

that are contaminated or adulterated. In addition, the SRMs will assist self-assessment of consistency and quality in finished products. The goal of this ongoing effort is to provide tools to the dietary supplement industry and measurement communities that will lead to improved quality of dietary supplements, and ultimately reduce public health risks that could potentially be associated with these products.

7. Forensics and Homeland Security



NIST has provided DNA standards for human identification since 1992, and continues to refine and extend that effort. CSTL has had a long history of assessing standards needs and developing new measurement technologies for crime scene investigations in which handguns or explosives are used. The forensic community depends on us for both for quality assurance and to provide legally defensible analyses uses reference standards. CSTL is also active in the development of microsensor arrays and other measurement technologies for the identification of explosives, as well as chemical and biochemical weapons. CBRNE (Chemical, Biological, Radiation, Nuclear, Explosives) related measurements, methods, and standards is a major new area of expansion for CSTL.



Identification of Chemical Warfare Agents Using Temperature Programmed Microsensor Arrays

D.C. Meier, J. Evju, R.E. Cavicchi, S. Semancik (837), and Z. Boger (Israel AEC)

Reliable and sensitive detectors for chemical warfare (CW) gases are needed to protect both military personnel and civilians. Microsensors, particularly if they respond reliably and quickly, are inexpensive, consume little power, and are far more practical for widespread use than large, complex analytical instruments. CSTL is developing microsensors – for fast CW agent warning – that are micro-electro-mechanical systems (MEMS) and have many of these desired features. This work was supported by the Department of Defense.



The microsensors can rapidly identify three chemical warfare (CW) agents and a CW agent simulant by analyzing the electrical responses of an array of four microhotplate conductometric sensors with tin oxide and titanium oxide thin sensing films as seen in the figure. The measurements were done at the Edgewood Chemical and Biological Center (ECBC) on the CW agents sulfur mustard (HD), sarin (GB), tabun (GA), and chloroethyl ethyl sulfide (CEES), a sulfur mustard simulant. Analyte concentrations from nanomol/mol (ppb) to micro-mol/mol (ppm) were determined. The microsensor arrays were “trained” to recognize and quantitate the agents by exposing them to each CW agent at four different concentrations and twenty different operating temperatures. In addition, a blank response was obtained by exposing the arrays to dry air at different microsensor temperatures. All these data were used to “train” the neural network so that it could recognize each agent signature relative to a dry air background. The total time needed for scanning the sensor temperature, collecting response observations, and performing the ANN data analysis is about 15 seconds. Since detection time is critical in CW agent monitoring, a method called recursive elimination that allows the scan time to be decreased was investigated, while still allowing for accurate identification and quantification of agents. Through this “pruning” process the microsensor scan time can be cut by 40% to 80%. Finally, recent results show that these sensors can identify low concentrations of warfare agents and simulants even when the microsensors are exposed to interferences such as diesel fuel and water vapor at concentrations that are 10^4 to 10^6 times higher than the target species.

NIST fabricated microhotplate-based conductometric microsensors have temperature programmed operation and employ artificial neural network (ANN) signal processing methods to analyze data.

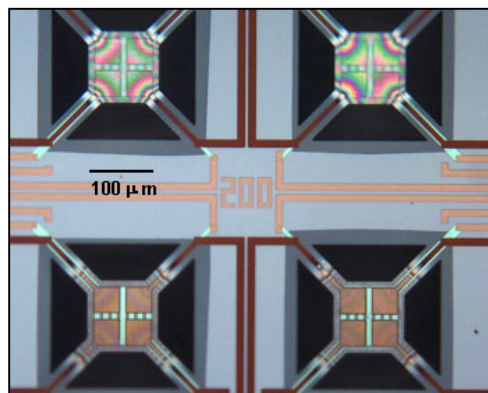
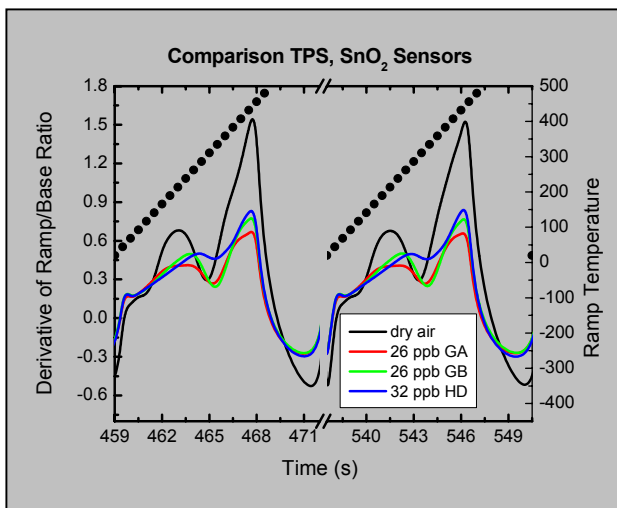

Image of a microarray device with two TiO_2 (top) and two SnO_2 (bottom) sensing elements. (The color variations and banding reflect differences in oxide film thicknesses that are the result of temperature gradients that affect chemical vapor deposition rates.)

Similar research is underway to detect other chemical species to demonstrate the versatility of the microsensors for a variety of applications including industrial process monitoring, and breath analysis for disease diagnosis and biometric identification.

Derivatives of temperature programmed sensing data from SnO₂ microsensors have been used to identify Tabun, Sarin, and Sulfur Mustard.

Experimentation will continue at NIST and ECBC to examine the reproducibility and long-term stability of these devices, and the robustness of this approach against a wider range of interferences.



Advanced InkJet Printing Technology for Trace Explosives Standards

G.J. Gillen, R.A. Fletcher, J.R. Verkouteren, M.R. Verkouteren, and G.A. Klouda (837)

Current national priorities in homeland security have led to an unprecedented level of utilization of trace explosive detection systems for counter terrorism and law enforcement. A critical and immediate need is to develop a chemical metrology and standards infrastructure to support the widespread operational deployment of tabletop, handheld and portal-based trace explosive detection systems now being used in airports, military installations, and in law enforcement applications.

CSTL researchers are exploring drop-on-demand inkjet printing as a low cost, flexible, and reproducible method for preparation of explosive standards over a wide range of concentrations on almost any substrate.

A new piezoelectric inkjet printer system at NIST has been used to prepare prototype explosive Standard Reference Materials on a variety of substrates. Inkjet printing potentially offers a flexible, rapid, and reproducible method for preparation of explosive standards. Using a single standard solution, a large range (10⁶) in deposited quantity of explosive can be achieved by changing the number of drops delivered to the sample without the need for serial dilutions. Using four printheads allows mixtures of virtually any composition to be prepared. The NIST printer system has been used to prepare prototype calibration standards by drop-on-demand printing of RDX, PETN, and TNT from isobutanol solutions onto various substrates. The concentration of explosives delivered in individual inkjet droplets is determined by GC-MS analysis or by determination of droplet diameter using digital camera imaging with high-frequency strobe illumination.

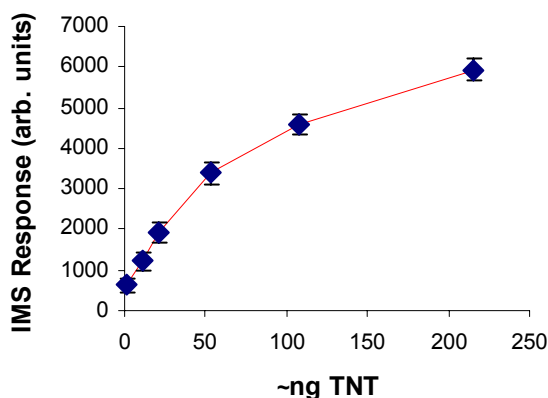

IMS response curve for TNT standard inkjet printed directly on collection swipe

A second sample type involves printing of digitized human fingerprints using RDX or TNT as the printing media. To visualize the location of the fingerprint, a fluorescent dye is co-jetted with the explosives.

Work continues to improve the quantitative delivery of solution using inkjet printing. The NIST printer system is being modified to use optical particle counting for real-time evaluation of the number of drops ejected and the individual droplet size. The next phase of the project will be to print explosives containing polymers to more accurately simulate actual high explosive materials.

Inkjet printed fingerprint containing TNT and fluorescent dye

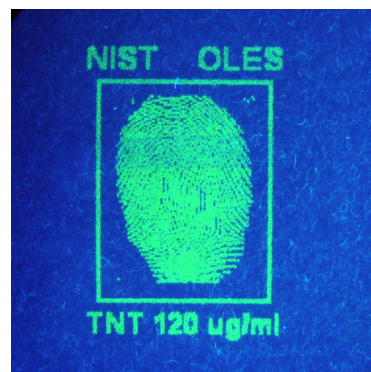

Determination of Traces of Fissionable Materials Using Delayed Neutron Activation Analysis

R.M. Lindstrom, E.A. Mackey, and G.P. Lamaze (839)

Delayed Neutron Activation Analysis is being established at NIST for the measurement of small quantities of fissionable nuclides such as ^{235}U and ^{239}Pu . Since tiny traces of fissionable uranium or plutonium can be left behind when these materials are handled or transported, this analytical method can be applied to the analysis of "swipe" samples, an important tool in nuclear forensics. Using neutrons from the NIST

research reactor, the delayed neutrons from fission in these traces can be used to detect and quantitate U and Pu in swipe samples. After a brief neutron irradiation, the sample is placed quickly into a neutron detector array and the neutron emission rate measured and compared with that of a standard. The method is well-tested, matrix independent, and nondestructive, while being specific and sensitive. The system being built at NIST is calculated to have a detection limit for either of these species about 10 picograms, based on a straightforward extrapolation from published practice. The analysis time is less than 2 minutes per sample.

Preliminary tests have been performed using uranium standards prepared by depositing solutions containing known amounts of uranium onto filter papers, irradiating, and counting on a detection system with one ^3He detector surrounded by hydrogenous moderator. Two shielding configurations were tested, one using water as the moderator and the other using polyethylene. Based on these results and a review of the literature, a final detection system was designed. This consists of ten neutron detectors in a 30 cm by 30 cm cylindrical moderator of polyethylene, lined with 2 cm of lead to absorb gamma radiation. The design of the manual system incorporates the existing pneumatic rabbit assembly for irradiation control. Incorporated in its design is the ability to unload a sample from the receiver after irradiation with compressed air. This feature will be used to move the sample rapidly to the neutron detector through a polyethylene flight tube. To improve sample throughput further, the transfer system can be readily automated with computer control in the coming year. It has been demonstrated elsewhere that ^{233}U , ^{235}U , and ^{239}Pu can be distinguished by the relative yields of delayed neutron precursors with different half-lives, and also of several fission products. We plan to add a gamma-ray detector into the neutron moderator to exploit this signature. In addition, the specificity and sensitivity of this method of analysis will be put to use in certifying trace uranium in Standard Reference Materials.

Detection and measurement of small traces of fissionable uranium and plutonium can be done by delayed neutron activation analysis. The method is intrinsically specific to nuclear fission, the sensitivity is excellent, and the procedure is simple, rapid, and readily automated for high throughput.



Production of Uniform Particle Standards Using the Vibrating Orifice Particle Generator and Quantification by Optical Particle Sensor

R.A Fletcher, G.A Klouda, and G.J Gillen (837)

Currently there are no standard test materials for calibrating trace explosive detection devices like Ion Mobility Spectrometers (IMSs) for Homeland Defense and there is also a need for test particles to support basic research in particle removal from surfaces using air jets and swipe technologies. The Vibrating Orifice Aerosol Generator (VOAG) can produce monodisperse particles from 0.5 μm to 50 μm made from solution. Each particle contains the same amount of desired test compound that can be controlled by the solute concentration in solution. The precision and accuracy of the VOAG was determined at NIST to be approximately 1% using aerosol sedimentation (velocimetry) – heterodyne elastic light scattering experiments.

CSTL researchers are developing a method to produce accurate and precise particle standards of known composition, size, and number for testing IMS instruments, trace analysis, particle testing and for pharmaceutical research.

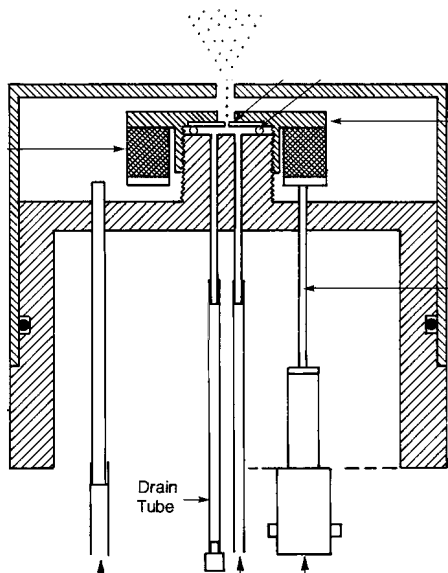

The VOAG allows a wide range of compounds to be made into uniform particles. This is accomplished by dissolving the solute material in the appropriate solvent and delivering the solution by constant pressure through the 20 μm orifice that vibrates at 10 kHz to 100 kHz (driven by a piezoelectric crystal). The number of particles made per second is the same as the driving frequency. The particle stream is dispersed by turbulent clean air flow and then subsequently dried in aerosol form in clean dry air. These dry, uniform particles of known composition are collected on a substrate such as a filter or impacted onto a plate or surface. One complication is that although the number of particles made is known and related directly to the crystal oscillation frequency, the number delivered to the substrate can be greatly diminished due to particle loss during transport from generator to substrate.

The ability to make trace particle standard test materials in a custom fashion for many materials is a valuable addition to our capabilities. Instruments that detect trace explosives and trace drug quantities can be tested and their performance quantified.

An important addition to the VOAG for generation of standard particles would be a capability to accurately quantify the number of particles delivered to the substrate. The detection method must be on-line, non-intrusive and non-destructive. One approach would be to use an in-line optical particle sensor (an individual particle extinction sensor) that would count each particle that passes through the sensor region and that is subsequently collected on the substrate. An additional benefit of this approach is that an extinction sensor can provide particle size and particle uniformity information in a rapid manner.

The operating characteristics and verification of precise particle-making capabilities using a VOAG has been demonstrated. For trace explosive research, we have used the VOAG to produce 8 μm fluorescein particles containing a trace amount of RDX (mass fraction RDX = 6.7×10^{-5} %) as shown in the figure. The particles appear agglomerated due to the heavy loading on the filter but were single particles as an aerosol. These particle-filter collections were examined by a commercial trace explosives detector based on IMS and gave a positive alarm for RDX.

Fluorescence optical micrograph of fluorescein-RDX particles produced by the VOAG

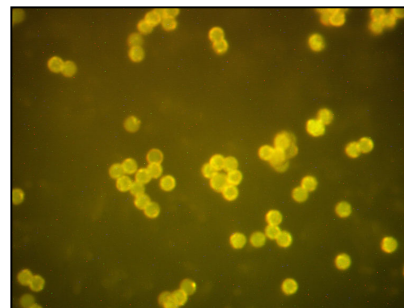

We are developing an in-situ particle counter that will be used in-line to detect monodisperse particles as they are being deposited on the substrate. Several experts in optical particle sensor design have been contacted and a system has been designed and will be fabricated in FY2005. The detector, which will be based on an extinction or light scattering sensor, will permit not only counting of the deposited particles but also a measure of particle size and uniformity. Also, we hope to extend the capabilities of the VOAG to produce custom biodegradable polymer spheres containing known amounts of pharmaceuticals to support a growing program in microanalysis of biomaterials and drug delivery systems.

Portal Filter Particle Collection Efficiency Using Monodispersed Aerosol

G.A. Klouda, R.A. Fletcher, and G.J. Gillen (837)

NIST has established the capability to evaluate the performance of air filtration systems. Although general filter specifications are usually available from manufacturers, many filter manufacturers know less about the performance of their filters for an aerosol of a particular size and composition. In a time of strong National Defense against terrorist attacks, an existing technology has emerged as one of the most effective means of detecting high-energy explosives and identifying potential perpetrators. Trace explosives detection systems are almost entirely based on ion mobility spectrometry (IMS) that relies on efficient microscopic-size particle sampling to concentrate trace explosives for subsequent desorption (heating) of these compounds into the IMS for detection.



To meet the immediate need to screen people's clothing for trace explosives in a noninvasive way at airports and government facilities, two emerging portal technologies were designed to utilize air jetting and convective airflow to dislodge and transport microscopic particles from clothing to filters for desorption into an IMS system. However, prior to this work no data existed on just how efficient these filters were at collecting particles of known size and composition.

Filters were evaluated using airborne particles ranging in diameter from $0.08 \mu\text{m}$ to $8 \mu\text{m}$ at operational airflow velocities (10 m s^{-1}). The filter collection efficiency was measured by generating aerosol of known size using two standard methods, either a Collison Nebulizer for aerosolizing polystyrene latex (PSL) spheres or a vibrating orifice aerosol generator (VOAG) to produce sticky liquid oleic acid aerosol of known size. The dried and neutralized aerosol flows through a filter holder, with and without the filter in place, and into an optical particle analyzer to determine the particle concentration.

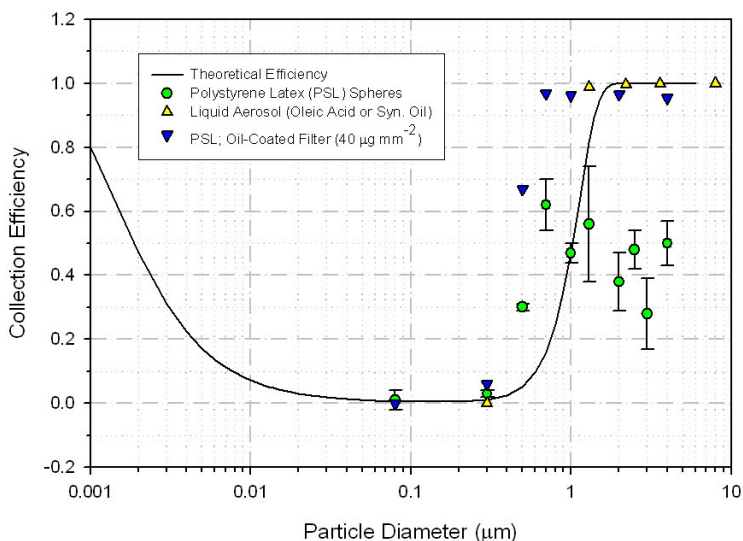

Future experiments will include the use of the VOAG to generate an aerosol of a high explosive and of a plastic binder, similar to a composite explosive (for example, C4) for evaluating filter efficiency and for developing a standard test surface for IMS. NIST capability of generating and counting monodispersed aerosol can be applied to virtually any filtration system.

A CSTL research team along with the Transportation Security Administration and the Department of Homeland Security, have characterized the collection efficiency of the metal-fiber filter material used by the manufacturers of portal systems.

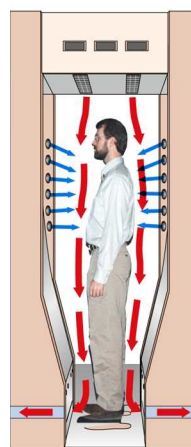

Commercial portal systems are based on airjet or convection airflow technologies

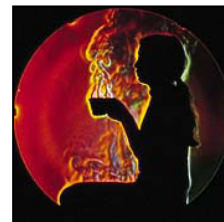

The filter efficiency is calculated from the concentration measured with and without the filter present. These results will likely lead to a better understanding of what size of explosive particles are collected, and consequently possible ways of improving the sampling and collection efficiencies.

The figure shows the filter collection efficiency plotted vs. particle size for different type aerosols. PSL variability is due to particle bounce. Collection efficiency is greater when filter fibers are coated with oil or for sticky particles, e.g., oleic acid.

NIST Trace Explosive Vapor Preconcentrator (EVAP) Test Facility

M.R. Verkouteren and G.J. Gillen (837)

The work described here is part of a larger effort in CSTL that is focused on strengthening the chemical metrology system that supports the widespread operational deployment of trace explosive detectors needed by first responders and security screeners. This effort is funded by the U.S. Department of Homeland Security (Office of Domestic Preparedness) through the NIST Office of Law Enforcement Standards. The standard test system will be used to compare existing methods and materials used in trace explosive chemical preconcentrators, and to provide comprehensive benchmarks for future improvements to preconcentrator technologies.

Stakeholders include portal/detector manufacturers such as GE Ion Track and Smiths Detection, and the Transportation Security Administration (TSA), which has a broad and immediate mandate to advance and deploy explosive detectors at airports to screen passengers and luggage.

CSTL researchers improve the sensitivity of trace explosive detection at airports and other public venues by establishing standards for testing chemical processing technologies that preconcentrate the vapors of RDX, HMX, PETN, TNT, and other explosives.

This project is part of a larger effort in CSTL focused on strengthening the chemical metrology system that supports the widespread operational deployment of trace explosive detectors needed by first responders and security screeners.



The major technical challenge involved the design and fabrication of a robust system that integrated the ability to monitor multiple aspects of performance, allowed flexibility of configuration, and was fairly easy to operate.

Shown in the figure is a schematic of EVAP with peripherals that include a regulated air flow controller, hydrator, and hygrometer, through which air of desired humidity (<10% to 90% relative humidity) and flow rate (<1 L/min to 20 L/min) may be supplied. Resistive heating of the primary grid is performed with an operational power supply, where the output voltage and amperage may be adjusted to give the desired heating rate (1 °C/s to 500 °C/s). The EVAP was designed so that the two grids could be monitored by infra-red (IR) thermometry through BaF₂ (IR-transparent) windows. Other components include a thermoelectric (TE) Peltier cooling module and an interface for future residual gas analysis – i.e., measurements of explosive vapors in the air stream that were not condensed on the collection grid.

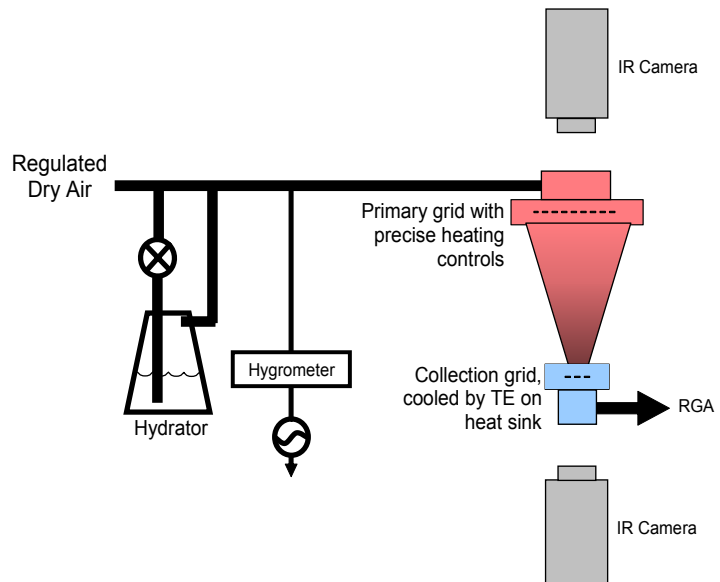

Temporal temperature distribution of a metal substrate, heated resistively to vaporize explosive particles in the EVAP, is revealed by infra-red thermometry. Downstream, explosive vapors are recaptured on a cooled collection grid (not shown).

Demonstration of capabilities involved determining the collection efficiency of the EVAP with respect to explosive type, heating rate, and airstream velocity and humidity. These four variables all proved to be significant. Under the operational ranges tested, RDX – but not PETN or TNT – was collected. Collection was enhanced at low heating rates, low air flow rates, and high airstream humidity levels.

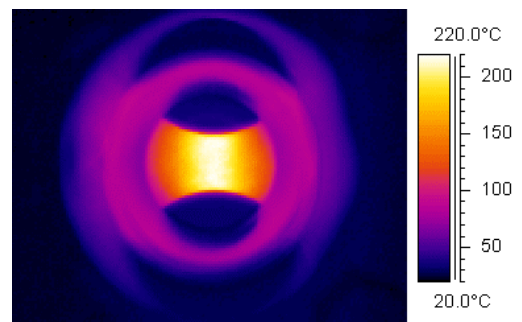

Morphology and chemical derivation of collector surfaces will be explored in the next year, as well as over 25 operational variables that may govern the explosive collection efficiency of vapor preconcentrators. We have designed fractional factorial experiments to explore the significance and interrelationships among these variables, and measurements and multivariate analysis will be performed to characterize comprehensively the EVAP performance.

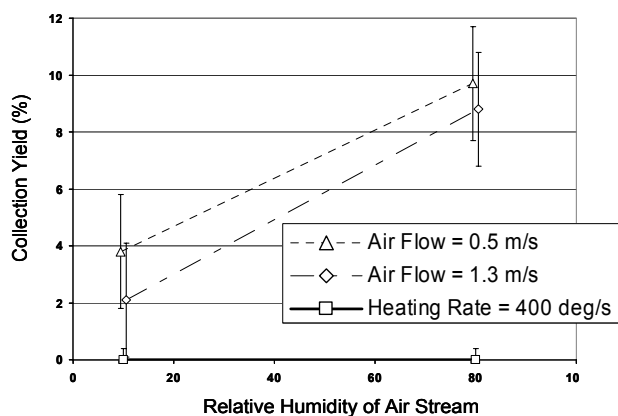

Results for vapor collection of RDX on 316L stainless steel mesh at 70 °C. Collection was enhanced by slow heating rate (20 °/s), low air flow (0.5 m/s face velocity on collector), and high water vapor content of air stream (relative humidity = 80 % at 20 °C). Error bars are standard uncertainties based on reproducibility of replicated ion mobility spectrometry measurements.

Explosives on Surfaces: A Sticky Problem

T.J. Bruno (838) and K.E. Miller (U. of Denver)

With heightened awareness of homeland security issues, the detection of explosive or energetic materials at high sensitivity and with a low error rate has become a pressing priority. Explosive compounds need to be detected on a variety of surfaces – clothing, suitcases, shoes, etc. Every surface will interact with the compounds and the degree of adhesion will vary, surface to surface. By and large, detection of these compounds relies on getting the molecules off the surface and into the gas phase. While there have been significant advances in instrumentation for both laboratory and in-the-field application, a device to be used for airport security will require certification by Federal authorities. Certification will depend upon a sound understanding of device performance and thus, knowing the energetic effects of surfaces, ubiquitous in all measurement scenarios, must be part of the certification process.

The CSLT-led team measures enthalpy of energetic materials for homeland security applications.

The most fundamental measure of the interaction strength with a surface is the enthalpy, ΔH . On solids, this describes an adsorption process (ΔH_{ADS}), while on polymers and liquids, an absorption process (ΔH_{SOL}). The vapor-phase concentration of explosive compounds is dependent on the enthalpies associated with the surface upon which the explosive residues have sorbed. Surprisingly, there has been very little attention given to this important parameter, primarily due to the experimental difficulties associated with its determination. In earlier work on sorption, we developed a technique to use capillary gas chromatography to measure the surface energetics of organics on soil surrogates. We have extended this work to energetic materials and measured the enthalpy of trinitrobenzene (TNB), trinitrotoluene (TNT), and hexahydro-1,3,5-trinitro-1,3,5-triazine (RDX) sorbed on a polydimethyl siloxane surface. This surface is used as a gas chromatographic stationary phase, and it also is used as a lubricant, release agent, coating, and as a principal component in silicone rubbers. The ΔH_{SOL} for TNB, TNT, and RDX were measured to be (57.85 ± 0.2) kJ/mol, (59.48 ± 0.2) kJ/mol, and (62.36 ± 0.2) kJ/mol, respectively. We also determined (by measurement of Kováts retention indices) that the energy required to desorb an explosive is similar to that required for C_{14} to C_{16} *n*-alkanes suggesting perhaps a surrogate for instrument calibration. Moreover, we noted that the enthalpy of vaporization for pure TNT and TNB are higher (by approximately 20 kJ/mol) than the ΔH_{SOL} values. This means that it takes less energy to “desorb” an explosive molecule from PDMS or “PDMS-like” material than it would to volatilize (for example by heating) a molecule from a solid particle of the pure explosive. One potential application, suggested by this discovery, would be the development of enhanced polymeric release surfaces for wipe testing.

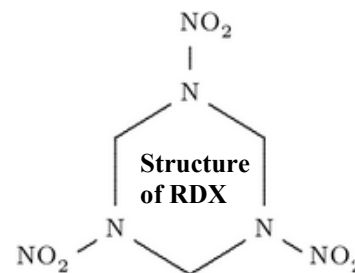

In addition to the vapor phase measurements, we have made similar measurements in the liquid (water) phase. Here, we have used a clay surface as a soil surrogate. These measurements are significant in that residual energetic materials in the environment are a serious threat, especially in live-fire military training venues.

For example, we measured ΔH_{ADS} for RDX = (24.7 ± 0.7) kJ/mol, while that for benzene was measured as (18.9 ± 1.3) kJ/mol. These data indicate that while the enthalpies are not especially high, one can expect RDX to persist in the environment longer than benzene.

A retention plot showing the capacity factor of benzene and RDX plotted against temperature, in water as the mobile phase. This illustrates the environmental persistence of energetic materials such as RDX.

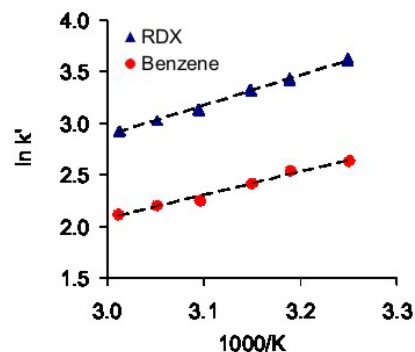

A NIST Reference Material to Support Explosive Device Measurements

W.A. MacCrehan and M. Bedner (839)

To deter explosives crime, national, state, and local forensic laboratories measure the additives in smokeless powder (gunpowder). US military laboratories also measure the chemical composition of such propellant powders to determine the stability of munitions. CSTL is providing a new reference material to support the quality of these measurements.

This new reference material consists of 5 g of a rifle-type smokeless powder. Reference values were assigned for four commonly determined additives, nitroglycerin, diphenylamine, N-nitrosodiphenylamine, and ethyl centralite. An ultrasonic solvent extraction method was developed to quantitatively recover these analytes. Mean values determined by micellar capillary electrophoresis and liquid chromatography were in good agreement. Since the LC technique provided lower uncertainty in the measurements, it was used for the final value assignment.

With the development of this smokeless powder RM, forensic laboratories will have a reliable material for the development and validation of measurement methods for improvised explosives devices. The RM may also be used as a proficiency challenge sample to test operator and laboratory performance in explosives measurements as part of laboratory accreditation activities under American Society of Crime Laboratory Directors/Laboratory Accreditation Board (ASCLD/LAB). In addition, US military laboratories can use the additive reference values in the NIST RM to assure accurate measurement when assessing the stability of munitions.

In Aug 2004, NIST released a new reference material, RM 8107 Additives in Smokeless Powder, to support the quality of the forensic and military smokeless powder measurements.



Pipe Bomb Ingredients and RM 8107

CSTL researchers are working to develop a particulate explosives material that can be used to test explosives detection equipment used for airport security screening, for evaluation of suspicious packages by first responders, and in forensic laboratory post-blast investigations.

The smokeless powder RM 8107 was developed to help assure the quality of 'low explosives' type measurements. However, terrorist explosives incidents often involve the use of 'high explosives' such as TNT and RDX (ingredients of military and plastic explosives). In conjunction with NIST's Offices of Law Enforcement Standards (OLES) and the Department of Homeland Security, we are developing a reference material for these high explosives. An inert solid matrix will be coated with commonly used military explosives.

Candidate Material for an Explosive Residues on Soil Reference Material

B.A. Benner, Jr. and W.A. MacCrehan (839)

Concerns have been raised by the detection of explosive compounds in the ground water surrounding our military munitions facilities. There is insufficient understanding of the environmental fate of the components leaching of incompletely and unexploded ordinance. An explosives-on-soil material would support the explosive residues measurements in the on-going remediation of these munition proving grounds. In addition, this material would be appropriate for use in verifying measurements that are part of landmine detection, forensic post-blast investigations, and trace explosives residue detection.

NIST is developing an Explosive Residue on Soil Reference Material (RM) for environmental and forensic explosives analysis.

A total of approximately 45 kg of bulk soil was collected at a military munitions proving ground. The bulk material was dried and a portion was sieved to particle sizes between 90 μm and 212 μm , mixed, and irradiated by a standard ^{60}Co procedure to minimize microbial activity that might change the levels of analytes during storage. This processing yielded about 1.5 kg of suitable candidate material. The concentrations of key explosive compounds were evaluated in this candidate material. One-gram sub-samples were solvent extracted and analyzed by gas chromatography with negative ion chemical ionization mass spectrometric (GC/NICI-MS) detection for measurement of explosive compounds, including 2,4,6-trinitrotoluene (TNT), hexahydro-1,3,5-trinitro-1,3,5-triazine (RDX), and 1,3,5,7-tetranitro-1,3,5,7-tetraazacyclooctane (HMX), and related degradation products. The concentrations of the nine analytes including the high explosives, smokeless powder additives, and their microbial degradation products were determined to be in the range of ng/g to $\mu\text{g/g}$.

Work continues to refine the GC/NICI-MS and liquid chromatography/mass spectrometric (LC/MS) methods for measurements of these explosive analytes in this natural-matrix material. Evaluation of the long-term stability of this soil will be an important component of the development of a reference material for these unstable analytes. We will monitor the material to determine whether ^{60}Co irradiation was successful in eliminating any further microbial degradation of 2,4,6-trinitrotoluene (TNT) that was noted in this soil prior to irradiation.

Evaluation of Oleoresin Capsicum (Pepper Spray) Canisters for Chemical Content and Reliability

E. White V, R.G.. Christensen (ret), K.W. Phinney, B.J. Porter, L.C. Sander (839), C. Presser (836), and R.Q. Thompson (Guest Researcher)

Pepper spray is used by law enforcement officers to subdue non-cooperative individuals. It is effective 85% to 90% of the time and its use reduces the number of injuries to officers and suspects, and the number of use-of-force complaints. The causes of failures have not been established, but may include low concentrations of the active ingredients, poor delivery, and variable subject response. The goal of this study is the determination of the identities and concentrations of the ingredients and the mechanical performance of pepper spray units to establish potential modes of failure and hazards in handling.

A program to characterize the chemical compositions and the physical characteristics of pepper spray products has been established in CSTL at the request of the NIST Office of Law Enforcement Standards and with funding from the National Institute of Justice.

A variety of products representing a cross section of those used by law enforcement agencies have been selected for study. The identities and concentrations of the active ingredients are determined by liquid chromatography/electrospray mass spectrometry and the identities of carriers and propellants by gas chromatography. Physical testing includes measurement of the number of 1-second bursts in a canister, a range test, a spray pattern test, drop tests, and, for the products that produce fogs, the measurement of the droplet size. Improved analytical methods have been developed for the determination of the active ingredients.

An improved liquid chromatographic (LC) separation for eight naturally occurring capsaicinoids, the active ingredients in pepper spray, and two internal standards, N-vanillyl octanamide and decanamide, has been developed. Satisfactory quantitative results have been demonstrated for the measurement of the analytes in mixtures with positive ion atmospheric pressure ionization electrospray mass spectrometry (API-ES-MS) for detection. Authentic samples of the com-

pounds have been purchased or synthesized and their purity determined. The analytical method has been tested on several naturally occurring capsaicin mixtures and on pepper sprays.

New instrumentation has been developed to support this effort. A test chamber has been constructed for physical testing. Semi-automated devices have been fabricated and tested for determining canister spray capacity, for performing pattern and range tests, and for performing drop tests. Environmental chambers have been constructed for storage of canisters under controlled conditions. Phase Doppler interferometry instrumentation is presently being set up to measure particle sizes near the point of impact within the test chamber.

Tests have been performed on several canisters that have failed in actual field use. The composition of one such canister, reported to have caused injuries during a training exercise, was characterized by API-ES-MS. The spray was consistent with a synthetic (rather than natural) product, and the total level of active constituents was comparable to sprays formulated with natural pepper extracts. A second canister reported to have failed during use was found to exhibit a weak spray pattern that was not centered in the direction in which the canister was aimed.

CSTL is providing a reliable set of quantitative chemical and physical measurements on a representative set of canisters that is expected to provide a basis for determining the most likely causes of failures in the field and to provide a benchmark against which manufacturers can assess the performance of their products.

Ethanol in Water Standard Reference Materials

M.M. Schantz (839)

The levels of blood-alcohol that determine whether an individual is considered legally impaired varies depending on the circumstances, State, and even the month in which the testing is occurring. As a result, practitioners in the field of alcohol testing have a need for reliable and stable standards at several concentrations. Most blood alcohol levels in driving under the influence (DUI) cases fall in the range of 0.1% to 0.3% (the average blood alcohol for a DUI traffic stop is 0.16 % to 0.17%). By providing SRMs with concentration levels set to legally relevant points, the accuracy of blood- and breath-alcohol testing will be improved.

Accurate calibration of instrumentation, such as the one pictured here, is critical in areas of forensic testing where quantitative analysis directly affects criminal prosecutions, as is the case with the determination of ethanol in blood and breath. Blood- and breath-alcohol testing can be imposed on individuals operating private vehicles such as cars, boats, or snowmobiles, or operators of commercial vehicles like trucks, planes, and ships. Two new ethanol in water SRMs, SRM 1828b and SRM 1847, with six and three concentration levels, respectively, have been issued to replace the previous SRM 1828a, which had only four concentrations levels.

The redesigned concentration levels in NIST Ethanol in Water SRMs have made them more useful to the forensic community for use as reference solutions for breath-alcohol instruments.



**SRM 1828b is tailored to legally relevant reference points.
SRM 1847 is for calibration of breath-alcohol instruments**

The concentration levels in SRM 1828b, Ethanol-Water Solutions (Blood-Alcohol Testing: Six Levels), have been tailored to legally relevant points, specifically 0.02% and 0.04% for “zero tolerance” and occupational alcohol testing, 0.08% and 0.1% for state drunk driving laws, and 0.2% and 0.3% for an average and high level for blood alcohol measurements. In addition, three concentration levels of ethanol in water (2%, 6%, and 25%) have been prepared as SRM 1847, Ethanol-Water Solutions (Breath-Alcohol Testing: Three Levels), for use as reference solutions for breath-alcohol instruments. The SRMs were prepared gravimetrically, and the concentrations of ethanol in water were confirmed at NIST by using gas chromatography with flame ionization detection, the analytical method of choice for blood- and breath-alcohol testing in the forensic laboratory. Because some laboratories, particularly in California, are required to verify their primary standards of ethanol in water by using titrimetry, the National Metrology Laboratory (CSIR-NML) in Pretoria, South Africa provided measurements for each of the nine concentrations of ethanol in water using a titrimetric method, shown to be very precise and accurate. The National Analytical Reference

An additional solution of the ethanol in water azeotrope will be made available in FY05 as SRM 2900. Feedback from customers indicated that the azeotropic mixture is needed in addition to those levels now available in SRMs 1828b and SRM 1847 for use as a starting point in the preparation of the customers' working calibration solutions.

Laboratory (NARL) in Sydney, Australia (another national metrology laboratory) also provided measurements for four of the solutions (0.08%, 0.1%, 0.2%, and 6%) using an exact matching isotope dilution-gas chromatographic method, also demonstrated to be a very precise and accurate method. The certified concentrations of ethanol in water in the SRMs are based on a combination of the gravimetry, NIST, CSIR-NML, and NARL measurements. The relative expanded uncertainties for the certified concentrations are less than 1.2% for each concentration level.

Raman Libraries

S.J. Choquette (839)

Portable Raman spectrometers are currently in use by first responders – hazardous materials (hazmat) specialists, law enforcement officers, safety and security personnel – to identify unknown substances in real-time with minimal handling. Such materials include explosives, drugs of abuse, and bio/chemical agents. The issue with spectral libraries in general is that the origin, purity, and physical state of the compound are typically never specified. It is also quite infrequent that the instrument state of the analyzing spectrometer is adequately known. Although parameters such as spectral resolution may be listed, the calibration state of either axis (wavelength and intensity) are rarely given. Quality systems, which might assure the veracity of the data, are infrequently, if ever, used for spectral acquisition. Raman spectral libraries have the additional challenge in that the spectra are instrument dependent, due to the variety of laser excitation wavelengths used and nature of the measurement.

In 2004 a test set of compounds comprising 14 persistent organic pesticides (POPs) was chosen for assessment and to aid in the development of standardized protocols for inclusion of compounds into a spectral library. Efficient mechanism and methods for transferring this data to the commercial sector is ongoing.

of compounds based upon input from Raman vendors and NIST's prior experience in developing SRMs based upon these materials. GC-FID and differential scanning calorimetry were employed to verify the purity of the materials. Raman spectra were acquired on research grade instruments employing 514 nm, 785 nm and 1064 nm laser irradiation. Each instrument was calibrated in both x and y axes using NIST SRMs. Spectra were corrected for scattering and incorporated into a searchable library. Arrangements are in progress to measure these compounds using commercial grade systems to assess the efficacy of software algorithms to identify the 14 POPs utilizing these reference data. A collaboration has been initiated with a NIST mathematician to develop algorithms for automated Raman spectral searches. This is an important and necessary extension of this work to compare instruments of widely disparate capabilities.

NIST provides both the physical standards and the validated Raman spectral libraries to:

- **impart confidence in Raman measurements,**
- **provide measurement traceability to national standards,**
- **improve the Raman determination efficacy,**
- **ensure evidentiary acceptance of Raman measurements.**

Because Raman is an emission process, the spectra are convolved with the instrument response. This is quite varied from vendor to vendor, even given the same laser excitation wavelength. The goal of this work is to develop a standardized protocol for measurement of these compounds by Raman spectroscopy and then develop the protocols for transferring this reference data to commercial instrumentation.

To this end, 14 POPs were chosen as a test set

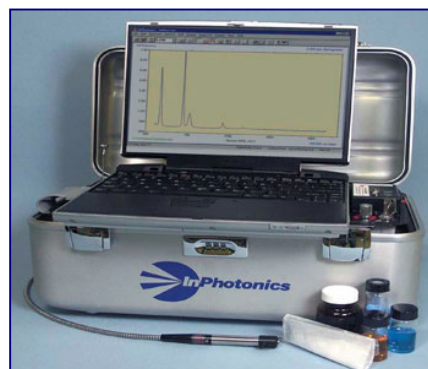

Commercial Portable Raman Spectrometer

NIST Support of the CDC Laboratory Response Network for Chemical Terrorism

K.E. Murphy, M.M. Schantz, G.C. Turk, B.A. Benner, Jr., T.A. Butler, and L.J. Wood (839)

NIST evaluated the stability of CN in frozen blood-based proficiency standards, which are used by the Centers for Disease Control and Prevention (CDC) to assess measurement capabilities of members of the Laboratory Response Network (LRN), a network of national laboratories that are equipped to rapidly test for human exposure to chemical and biological weapons. Cyanide (CN) has a long history of use as a chemical weapon and the need for methods and standards for measurement of CN was identified by CDC as a top priority. CN exposure is indicated by measuring the CN content of whole blood, however CN is very reactive and blood CN concentrations can decrease or increase over time depending on the method of storage. As a result, there are no commercially available CN standards to underpin the accuracy of blood CN measurements. CDC contracted a commercial standards supplier to produce a suite of blood-based CN standards. The standards are composed of a blank level and three elevated levels containing CN concentrations of nominally 0.075 mg/kg, 0.3 mg/kg, and 1.5 mg/kg. Standards are supplied as 0.5-mL aliquots of the CN-spiked blood packaged in 5-mL headspace vials and stored frozen at $-50\text{ }^{\circ}\text{C}$. We have accurately measured the CN content of each level and have monitored the CN concentrations for over one year.

The analytical method developed in CSTL has been adapted by CDC for use by the Laboratory Response Network.

five samples from each level were performed on a bi-monthly basis for a period of 14 months. The CN concentration remained stable for the nominal 0.3 mg/kg and 1.5 mg/kg levels, but increased slightly for the blank and nominal 0.075 mg/kg (low) level. The figure shows the data for the 0.075 mg/kg level, in which the measured CN concentration is plotted versus analysis date, and the solid black line shows the trend in CN concentration. In general, the average CN concentration for all levels was higher than the target nominal values. This may be partly due to endogenous CN in the blood stock, but may also be a result of the artifactual production of CN from freezing the blood. Overall, results for the three elevated levels show a variability of less than 6 % relative (1s, n = 33). These results demonstrate a considerable improvement over data reported in the literature for the stability of CN-spiked blood standards and validate the viability of storage at $-50\text{ }^{\circ}\text{C}$.

CSTL researchers have developed a new method for the determination of cyanide in human whole blood and used the methodology to evaluate the stability of cyanide in frozen blood-based proficiency standards.



CSTL scientists developed a new method for the measurement of CN based on headspace gas chromatography/mass spectrometry (GC/MS) using a labeled cyanide internal standard ($\text{K}^{13}\text{C}^{15}\text{N}$). In addition we have completed measurement of the CN content and stability of CDC supplied proficiency standards. Measurements of

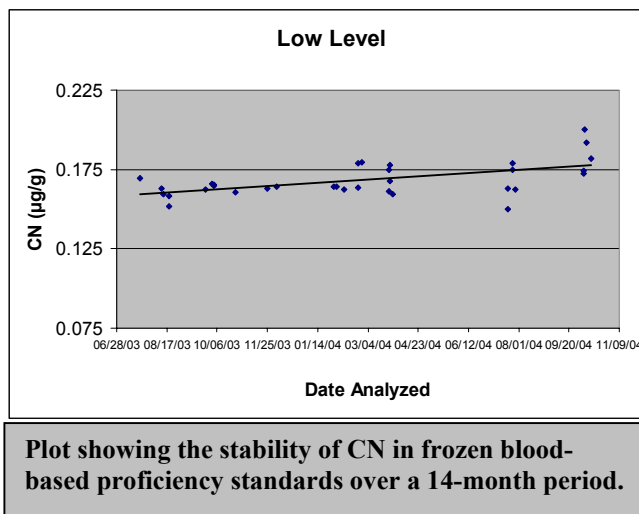

An integrated public health system is vital in the event of a chemical terrorism attack. In the past two years Congress has appropriated \$95 million for chemical terrorism preparedness. There are currently 62 public health laboratories in the chemical component of the LRN, over 40 of which are Level 2 designate laboratories. Level 2 laboratories are tasked with the analysis of CN, toxic metals, and lewisite in human samples. Inclusion in the network requires participation in a rigorous quality assurance program, which includes the analysis of proficiency standards. The data NIST has provided to characterize the CDC blood-based proficiency standards will help ensure that network laboratories provide accurate measurements in the event of a chemical terrorism incident involving CN.

Characterization of the Catalytic Domain of Class I Adenylyl Cyclase from *Yersinia pestis*

S-K. Kim, S. K. Reddy, and P. Reddy (831)

Yersinia pestis bacterium is the causative agent of bubonic and pneumonic plague. Because of its potential for major public health impact and as a bioterrorism agent, *Y. pestis* has been classified as a Category A pathogen by the Center for Disease Control and Prevention. Adenylyl cyclase (AC) is one of the important virulence factors in the pathogenesis by bacterial pathogens such as *Bacillus anthracis*.

The *Yersinia pestis* chromosome has two genes for adenylyl cyclase, *cyaA* and *cyaB*. The *cyaA* gene encodes 850 amino acids (aa) Class I adenylyl cyclase (YpAC1) and the *cyaB* gene encodes 179 aa Class IV adenylyl cyclase (YpAC2). YpAC1 is the subject of this study. YpAC1 has discrete amino terminal and carboxyl terminal domains. These domains interact with each other to produce a low-activity form of the enzyme.



Yersinia pestis adenylyl cyclase has discrete amino terminal and carboxyl terminal domains. These domains interact with each other and the protein complex exhibits low adenylyl cyclase activity.

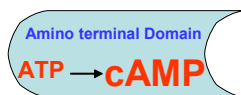

Removal of carboxyl terminal domain by genetic manipulation results in a free amino terminal catalytic domain with enhanced adenylyl cyclase activity and thereby produces high concentration of cAMP in the cell.



Interaction of carboxyl terminal domain with sugar transport regulatory proteins in the cell results in a weaker interaction between the amino and carboxyl terminal domains resulting in a free amino terminal domain with enhanced adenylyl cyclase activity with concomitant high cAMP concentration.

The highly active adenylyl cyclase utilizes ATP, the primary source of energy in cells, and produces a supraphysiological concentration of cyclic AMP (cAMP). In anthrax disease, an elevated concentration of cyclic AMP inhibits the activity of the gene transcription factor NF- κ B, a protein that would normally stimulate the production of several inflammatory factors that coordinate immune response. Cyclic AMP thus disables the proteins in the signaling cascade. This leads to the cell death of the host.

The NIST study was aimed at understanding, on a molecular basis, the connection between the fundamental genetic information that defines *Y. pestis* and the presumptive virulence factor adenylyl cyclase. This type of understanding could lead to a basis either for therapeutic intervention or for a vaccine for this biothreat agent.

Removal of the carboxyl terminal domain by genetic manipulation resulted in a free amino terminal catalytic domain with enhanced adenylyl cyclase activity. The activity of the amino terminal domain was found to be four-fold higher than that of the full-length holoenzyme. This result suggests that the carboxyl terminal domain is inhibitory to the catalytic function and that this carboxyl terminal domain regulates the activity of the amino terminal domain. Mutagenesis studies revealed important amino acid residues for catalysis in the catalytic domain. Mutagenesis of Asp-114 and Asp-116 resulted in a complete loss of activity. This Asp-x-Asp catalytic signature is conserved in the infamous *Bacillus anthracis* adenylyl cyclase toxin. Adenylyl cyclases have been definitively shown to be virulent factors in bacterial pathogenesis. For these reasons, the adenylyl cyclase gene is an important target for gene knockout experiments and is also a useful working model to produce a vaccine against *Y. pestis*. Gene knockout experiments are planned with other Federal Laboratories having a Biosafety Safety Level 3 capability.

Evaluation of Genetic Variation in Major US Population Groups using Human Identity Testing Markers

J. M. Butler, M.C. Kline, P.M. Vallone, J.W. Redman, A.E. Decker, and M.D. Coble (831)

A set of approximately 650 anonymous population samples from US Caucasians, African Americans, and Hispanics (self-declared ethnicities) have been purchased from a commercial blood bank. Over the past two years, these samples have been characterized across a variety of genetic loci used in human identity testing. Results from these samples are being used to evaluate performance of individual markers and various combinations of loci to enable differentiation of the samples. Concordance studies have also been performed with these samples between in-house multiplex polymerase chain reaction (PCR) assays and commercial kits to verify the absence of allelic dropout due to PCR primer binding site mutations.

To date a total of 8 manuscripts has been published or submitted describing our results across these samples. Over 85,000 allele calls have been made so far on these samples. These population samples will likely become some of the most well characterized samples in the world. Decisions are being made about useful loci to pursue in future assays that are developed at NIST based on variation observed in these samples.

The focus of this research work was to examine the ability of commonly used and new genetic markers to differentiate between samples of US populations.

Information collected from these study samples is being made available over the Internet through the NIST STRBase website:
<http://www.cstl.nist.gov/biotech/strbase/NISTpop.htm>

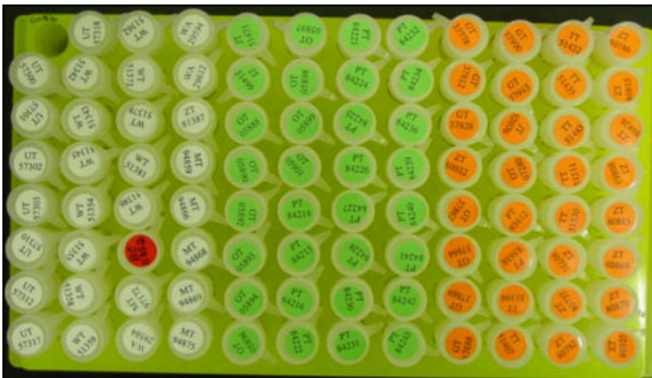

These samples have also been useful in a beta-test of a new commercial kit for Y-chromosome short tandem repeat (Y-STR) amplification being released in December 2004 by Applied Biosystems. Future plans include testing new loci in this set of samples.

The tops of 95 sample tubes are shown each at a concentration of approximately 1 ng/μL with different color labels representing the various ethnicities.

Microfluidic Devices for Rapid DNA Analysis for Human Identification

W.N. Vreeland, L.E. Locascio (839), M.Gaitan, J. Geist, J. Shah (EEEL), N.Y. Morgan, P. Smith, T. Pohida and J. Kakareka (NIH), C.W. Kan and A. E. Barron (Northwestern University)

The National Institute of Justice estimates a backlog of a 542,700 cases for DNA analysis as of April 2004 and current forensic crime labs do not have the equipment capacity to address this backlog in a timely manner. Forensic DNA analysis or “fingerprinting” involves the measurement of the molecular size of several fragments of DNA produced in a specially designed molecular-biological reaction.

NIST’s development of a microfluidic device for forensic DNA analysis is addressing a major sample backlog by allowing for analysis techniques that are both faster and more economical, while still ensuring the data created are of the highest quality.

The NIST microfluidic device has auxiliary optics, pneumatics, and software to allow for rapid analysis of DNA “fingerprints” for human identification. The microfluidic devices are fabricated from common low-cost commercial plastics facilitating their application as single-use devices and thereby eliminating concerns of sample-to-sample cross contamination. Current device design and configuration are approaching the performance in salient figures-of-merit to current state-of-the-art equipment with the time required for analysis being reduced by nearly 90%.

The plastics that are used to fabricate NIST’s microfluidic devices must fulfill a variety of chemical, mechanical, and optical properties. In particular they must have (1) low permeability to aqueous buffers and salts, (2) low electrical conductivity, (3) glass-transition temperature between 110 °C and 120 °C, (4) low optical fluorescence, (5) high optical transparency, and (6) uniform thicknesses. Several commercial plastics were screened, and a medical-grade poly(methylmethacrylate) was determined to be the best match to these criteria (this is the same plastic that is used to fabricate disposable contact lenses for vision correction).

The microfluidic channel must also be of a particular architecture and design (see figure for a general device layout). Two physical parameters of the device design are important, including separation channel length and sample injector size. The separation channel length determines the time required for the analysis as well as its analytical selectivity, while the sample injector determines the sensitivity and efficiency. In both cases, the desirable aspect of one parameter is increased at the cost of the other. We have design, fabricated, and tested a systematic assortment of microfluidic channel designs to determine the most appropriate physical parameters for the NIST forensic DNA analysis. The final device design had an injector size of 100 μm and a separation channel length of approximately 9 cm. Results from this device are below.

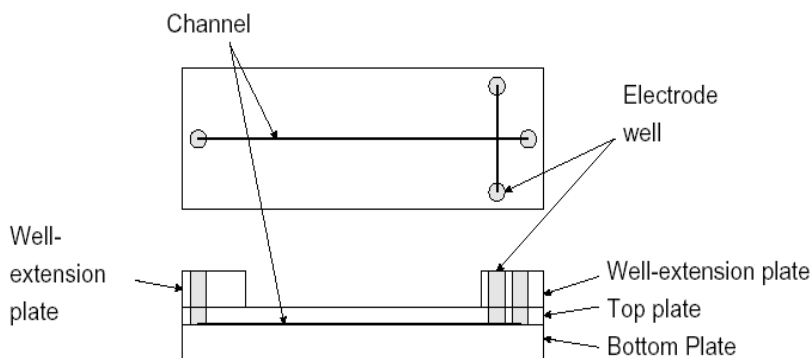

Top and side view of the single-channel microfluidic device currently being used in DNA separation experiments at NIST (not to scale).

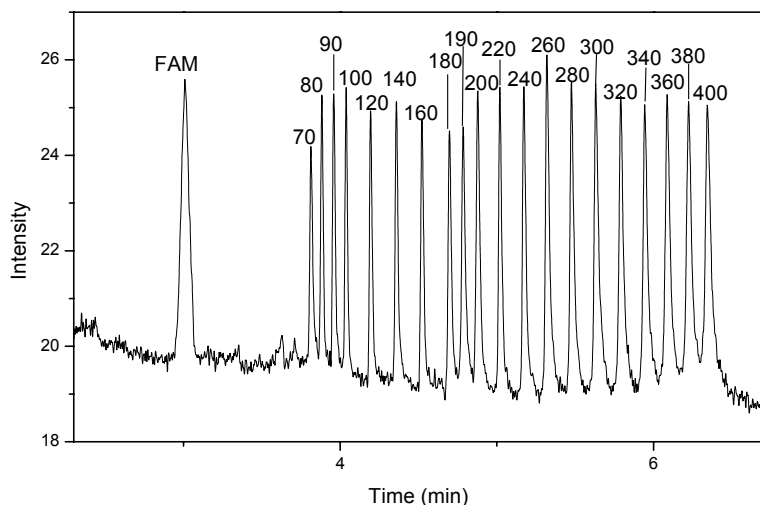

A demonstration of the NIST microfluidic DNA analyzer, showing the separation of a DNA “ladder” consisting of a variety of fragments of increasing size. Each peak represents a DNA fragment of particular size with larger fragments appearing later in time. The total analysis is performed in approximately 7 minutes.

Invention of a New Class of Ultra-Fast, Ultra-sensitive Mass Spectrometers for Kinetics, Reference Mass Spectrometry, and Homeland Defense Applications

J. W. Hudgens (838)

Details provided in the *Measurement Science for Future Standards and Technologies* section of this Report.

8. Health and Medical Technologies



CSTL provides quality assurance for the healthcare industry by providing the appropriate chemical and physical reference standards, developing reference methods and databases, and also by working closely with the clinical and medical community to transfer the accuracy of the highest level of metrology to high-throughput clinical laboratory measurements. Measurements are responsible for up to 15% of the \$1.7 trillion annual costs of healthcare in the US. A significant portion (25% to 30%) of these measurements are performed for non-diagnostic reasons, such as re-tests, error prevention, and detection. The meas-

Healthcare costs amount to approximately 14% of the GDP, an estimated \$1.7 trillion. By 2007, healthcare spending as percent of GDP is projected to reach over 16%.

urement infrastructure provided by NIST supports traditional clinical markers such as the measurement of cholesterol and calcium in serum, and newer protein based markers such as troponin, homocysteine, and folate, as well as DNA-based standards for HER2 testing standards and Fragile X Syndrome diagnosis. Technical details on the development of the newer standards are provided in this chapter.

In addition, CSTL provides the clinical community with standards needed to meet regulatory requirements, both national and international. For example, during FY 2004 the European Union Directive on In-Vitro Diagnostics (IVD) went into effect mandating that all devices sold in the EU be traceable to “higher order” standards and methods. CSTL worked with the IVD industry and the international community to ensure that US devices meet the traceability requirement so that US exports to the EU would continue without disruption. As the IVD Directive went into effect increased demand for clinical standards has been evident; NIST noticed a dramatic increase in the sales of NIST electrolyte in serum SRMs. In order to expand the availability of clinical SRMs and meet the traceability requirement, CSTL continues to develop both reference methods and standards and, along with the private sector, is investigating the feasibility of a Clinical Reference Laboratory Network.

Technical Procedures for a NIST-Traceable Clinical Reference Laboratory Network

G.C. Turk, S.E. Long, and D.L. Duewer (839)

The NIST-Traceable Clinical Reference Laboratory as conceived seeks to provide an efficient infrastructure for supplying clinical reference measurements for IVD manufactures. Such a network could provide the IVD industry with reference measurements traceable to NIST standards in a timely and efficient manner.

The study described here involved the measurement of calcium at various levels in blood serum, plasma, and urine. A subset of real samples of serum, plasma, and urine were measured both at NIST and the Mayo Clinic, using NIST calibration and validation SRMs, in order to establish an equivalence between NIST isotope dilution mass spectrometry measurements and measurements performed at Mayo Clinic. The study used individual patient samples that were split and analyzed by both NIST and the Mayo Clinic. The patient samples were pre-screened to cover the full range of calcium concentration for which the methods have been designed. All patient identification information was disassociated with the samples for this study. Further validation of the methods was provided by the analysis of NIST matrix SRMs by both NIST and the Mayo Clinic. These SRMs include SRM 956a (Frozen Human Serum) and SRM 2670a (Freeze Dried Urine). In addition, both NIST and the Mayo Clinic analyzed Candidate SRM 956b (Frozen Human Serum), which had not yet been certified, and for which the Ca concentration was unknown to the Mayo Clinic at the time of the analysis. The protocol called for the Mayo Clinic to use their normal calibration procedures, based on their in-house supply of calibrator solutions. They also prepared a set of NIST Calibrators by dilution of SRM 3109a (Calcium Solution). Five NIST calibrators were prepared at concentrations similar to those of the Mayo Calibrators. Mayo used their normal setup and calibration procedures and then analyzed the samples included in the study using a run order supplied by NIST. Each sample, including the NIST calibrators, was treated as an “unknown”, and value assigned based on the normal Mayo calibration procedure with their in-house set of calibrators.

NIST/CSTL led a collaborative effort with the Mayo Clinic and Dade-Behring, Inc. to test technical procedures that might be used to implement a NIST Traceable Clinical Reference Laboratory Network.



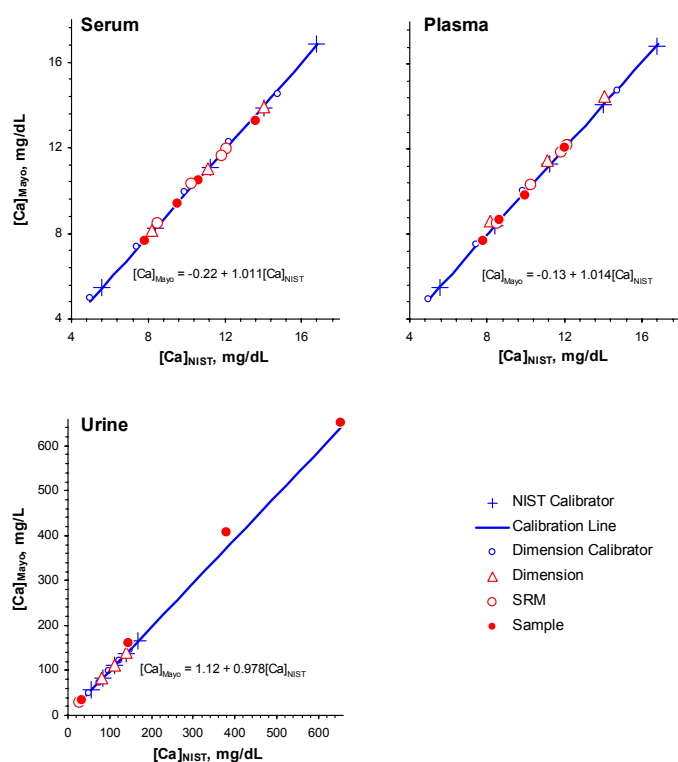

The ratio of the determined values of the NIST calibrators relative to the prepared values using the NIST certified values was calculated. This value, and associated uncertainty, was then used to convert all of the Mayo determined values of the test samples (traceable to the Mayo calibrators) to values traceable to the NIST calibrators and SRM 3109a. The conversion shift was small, but significant. The comparisons between NIST measurement results and those of the Mayo Clinic are illustrated graphically in the figure for each sample matrix. Initial results have been encouraging, and could potentially lead to the development of a network of laboratories with an expanded analyte and matrix coverage.

A NIST-Traceable Clinical Reference Laboratory Network would become an important component within the clinical chemical measurement infrastructure, with a positive impact on the accuracy of such measurements and on the quality and cost effectiveness of our healthcare system.

Development of Reference Methods and Reference Materials for Clinical Diagnostic Markers

M.J. Welch, D.M. Bunk, S. S-C. Tai, N. Dodder, B.C. Nelson, M.B. Satterfield, and L.T. Sniegowski (839)

NIST has a long-standing effort to promote accuracy in health-related measurements through development of reference methods and SRMs. SRM 2921 Cardiac Troponin Complex was issued in May 2004 and has been well received by the *in vitro* diagnostic industry. The material was developed with the assistance of the American Association of Clinical Chemistry (AACC), the International Federation of Clinical Chemistry (IFCC), and the manufacturers of clinical cardiac Troponin I (cTnI) assays. Since it is a widely used marker for detecting that heart attacks have occurred, more reliability in the assays was needed. SRM 2921 is a buffer solution containing a complex of heart muscle proteins, troponins I, C, and T and certified for the concentration of troponin I.

With implementation of the EU IVD Directive, it has become even more critical for NIST to develop new reference methods and SRMs to provide traceability for the US IVD industry so that this industry can maintain its strong position in European markets.



Certification of the concentration of cTnI in SRM 2921 was accomplished by two analytical methods, including amino acid analysis. Because of the inherent structural complexity of human proteins and because this complexity can have a substantial impact on immunoassay response, a thorough investigation of the chemical heterogeneity of cTnI and the other two troponin subunits, cTnT and cTnC, in SRM 2921 was performed. A commutability study is underway, involving nineteen cTnI assays currently on the market worldwide. Once accomplished, this demonstration of the commutability will put SRM 2921 in compliance with ISO 15194 and eliminate the last hurdle for this new reference material to be acknowledged by the Joint Committee for Traceability in Laboratory Medicine (JCTLM) as a higher order reference material for use worldwide.

Tai, S.S.-C., Bunk, D.M., White V, E., Welch, M.J., “Development (of methods for) ... Total Triiodothyronine ...” *Anal. Chem.*, **76**, 5092-5096 (2004).

Tai, S. S.-C. and Welch, M.J., “Development (of methods for) ... Total Cortisol ...”, *Anal. Chem.*, **76**, 1008-1014 (2004).

Reference method development has been completed and the methods published for thyroxine (T4) and triiodothyronine (T3), important markers for evaluating thyroid function, and cortisol, an important hormone in metabolism. These methods are all based on isotope dilution liquid chromatography/mass spectrometry (ID LC/MS). Tandem mass spectrometry (MS/MS) is used to provide greater

specificity in the measurements. These methods will be applied to the certification of a new hormones-in-human-serum SRM. This new SRM consists of two pools, one from normal adult males and one from normal, premenopausal adult females. Research is underway to develop new LC/MS-based reference methods for estradiol, progesterone, and testosterone, important hormones in development and reproduction. Improving the accuracy of clinical assays for hormones will improve diagnoses and result in earlier treatments, before serious health effects occur. This work should lead to capabilities for reference methods for synthetic pseudo-testosterone substances reportedly used by athletes to enhance performance. The new methods and the SRM will help improve accuracy of these assays and will also provide high order reference systems for traceability.

Measurements have been completed for a new SRM for homocysteine (HCY) and tetrahydrofolic acid (FOL) in serum. This new material has three levels: (high HCY, high FOL; normal HCY and FOL; and low HCY, low FOL). This work is a collaborative effort between NIST and the Centers for Disease Control and Prevention (CDC), both of which provided measurements for certification.



SRM 1951b Lipids in Frozen Human Serum was certified for total cholesterol and triglycerides (triglycerides only and total glycerides) this past year. This material is available, but additional information on HDL- and LDL-cholesterol, additional heart disease risk factors, will be added once measurements are completed at CDC using their proposed reference methods for these analytes.

NIST provides New Clinical Standards for:
Homocysteine - considered a risk factor for heart disease and other diseases associated with oxidative damage
Tetrahydrofolic acid - a strong antioxidant, which is known to reduce the risk of neural defects in fetuses and is believed to counteract the effects of homocysteine
Creatinine in Serum - measures kidney function for early detection of disease

The incidence of kidney disease is rising rapidly in the US. Early detection of kidney disease and treatment can prevent kidney failure, but early detection depends on better measurements of kidney function. Serum creatinine is the preferred measurement, but existing methods provide varying results, so NIST is developing a new creatinine-in-frozen-human-serum SRM to address this measurement problem. As part of this work, NIST has developed a new, rapid isotope dilution LC/MS method for serum creatinine to replace the tedious isotope dilution GC/MS method used previously at NIST.

Renewals: Several key SRM renewals were released this year. The renewal of SRM 956b Electrolytes in Frozen Human Serum is described in detail later in this chapter. For the renewal of SRM 965a Glucose in Frozen Human Serum, a new low-level material was added to address measurements of patients with severe hypoglycemia. The high-level material was raised so that it better addresses measurements of patients with severe hyperglycemia.

New Research: Research is continuing on development of a reference method for another risk factor for heart disease, C-reactive protein (CRP). Modest increases in CRP have been linked to arteriosclerosis and the increased risk of heart attacks. NIST, working with scientists at the Laboratory of the Government Chemist (LGC) in the UK and the Physikalisch-Technische Bundesanstalt (PTB) in Germany, is using a proteomics approach to isolate characteristic peptides from CRP for measurement by LC/MS. An isotope-labeled peptide will be used as an internal standard for this work. Research has also begun to investigate the quantitative potential of Matrix-Assisted Laser Desorption Ionization - Time of Flight (MALDI-TOF) mass spectrometry for biomolecules. To explore this potential, studies are underway on promising approaches for quantification of transferrin, an important iron-transporting protein in blood. Research is also underway on measuring various selenium-protein (anti-cancer agents) and iron-protein (iron-transport) combinations in blood.

PTB



Reissue of Electrolytes in Human Serum SRM Now Available

S.E. Long and K.E. Murphy (839)

Accurate and expedient clinical assessment of patient health status is often critically dependent on the quality of clinical testing measurements, and the availability of appropriate high-quality reference materials to provide a traceability basis for such clinical measurements is an important requisite. Electrolytes are undoubtedly the most commonly measured analytes in the clinical laboratory, and therefore the SRM 956 series, which provides certified values for electrolytes in blood serum, provides an extremely important resource to the clinical measurement community. To support the continuing regeneration of this material, it is necessary to develop and maintain higher-order analytical methods, which utilize state-of-the-art measurement technology.

New methods using isotope dilution inductively-coupled plasma mass spectrometry (ICP-MS) have been developed for the determination of lithium, total calcium, and potassium in human serum and have been used to certify SRM 956b, Electrolytes in Frozen Human Serum. Certification of five electrolytes, namely lithium, potassium, total calcium, sodium, and magnesium in three levels comprising SRM 956b has been completed. All of the certified values were obtained using ICP-MS, which has permitted a more efficient certification strategy. Certification measurements on the previous issue (956a) relied heavily on Thermal Ionization Mass Spectrometry (TIMS) and associated analytical methodology. While TIMS can provide unsurpassed accuracy and repeatability, it is an extremely slow technique. The new methods for calcium and potassium are based on shielded (cool) plasma ICP-MS. Significant effort was made to develop a robust method for the determination of lithium by ICP-MS. Lithium has not been routinely measured using this technique because of severe problems with instrument mass bias drift and significant inter-sample memory effects. In the new method these effects have been almost eliminated by the careful optimization of ICP-MS instrument conditions.

The analytical methods currently used for electrolyte measurements have been compiled into a methods manual, to be published both as a NIST 260 Series report and as an on-line document available to external users of the NIST web site.

A quadrupole ICP-MS instrument, configured with both collision cell and shielded plasma technology to reduce or eliminate spectral interferences has been installed. It is anticipated that this will provide new capabilities for the determination of clinical analytes that have been difficult to measure accurately using traditional instrumentation.

Sales of NIST's SRM 956 increased dramatically when the EU IVD Directive was implemented in December of 2003, and CSTL researchers developed new higher order analytical methods to meet the increased demand.



National Institute of Standards & Technology

Certificate of Analysis

Standard Reference Material® 956b

Electrolytes in Frozen Human Serum

Development of Reference Methods and SRMs for Toxic Species in Body Fluids

S.J. Christopher, W.C. Davis, C.E. Bryan, and R.D. Day (839)

The role of metals in health and medicine is all encompassing, with current research focusing on toxicology, drug delivery, degenerative diseases, imaging diagnostics, and development of various classes of metal-based drugs possessing chemotherapeutic, anti-inflammatory, anti-diabetic, or anti-microbial properties. Genomics and proteomics research will eventually lead to a better understanding of the role of metalloproteins in disease-proteins that may eventually serve as disease treatment targets. Fundamentally, all of this research is underpinned by the quality of analytical measurements in clinical samples like blood and urine. To address this we are developing accurate and sensitive analytical methods that can measure analytically difficult elements in a timely manner and producing clinical reference materials that are closely aligned with industry needs.

CSTL researchers develop novel analytical methods for challenging analytes in clinical materials that are highly accurate and sensitive.

The new calibration approaches developed for dolphin blood health assessments proved to be robust and applicable to similarly matched matrices of human and animal origin.

Collision cell Inductively-coupled Plasma Mass Spectrometry (ICPMS) was used for the determination of interference-prone trace elements (As, Cd, Co, Cr, Cu, Mo, Ni, Pb, Rb, Se, Sr, V, Zn) in dolphin whole blood. The method is based on gravimetric solution handling, and an internal standard ratio-based approach to quantification using the method of standard additions. A mixing scheme that facilitated preparing and running the samples in a “dilute and shoot” manner was developed to avoid a time consuming, high-

temperature and pressure sample decomposition. All clinical samples were prepared in a diluent consisting of several high purity chemicals: 1% 1-butanol + 1% ammonium hydroxide + 0.01% EDTA + 1% Triton X-100 + 1% nitric acid in a balance of high purity water (all by mass). The combined effects of this chemical suite serve to reduce the viscosity of the nebulized samples and ameliorate the differential ionization effects induced by carbon in individual analytical samples: 1-Butanol acts to reduce matrix effects by elevating the carbon in all matrices so that variable, sample-to-sample ionization effects are minimized, especially for As and Se. Ammonium hydroxide lyses red blood cells, EDTA prevents the loss of metals by precipitation or absorption, and Triton X-100 prevents blockage of the ICPMS nebulizer and torch injector tube. The calibration scheme was streamlined to avoid the numerous sample splits typically encountered in a standard additions experiment by using the slope of a blood standard additions curve to predict the concentration in unknown blood samples successfully, with any subtle matrix effects being compensated by the internal standards. A collision cell gas was used effectively to open isotopic channels for numerous interference-prone elements, including As and Se, by breaking apart background species generated in the plasma.

Another example involves the certification of methylmercury at low levels in SRM 966 Toxic Elements in Bovine Blood. This project involved development of new instrumentation and highly sensitive methods to address a critical problem for the CDC, which needs to benchmark Me-Hg measurements in clinical samples for various public health exposure efforts. A gas chromatograph (GC) was successfully coupled to an ICPMS via constructing a home-built heated transfer interface, and solid-phase microextraction (SPME) headspace sampling of microwave extracted samples was implemented to acquire the needed sensitivity to address this analytically challenging problem. Non-ideal extraction conditions can yield poor recovery or chemical transformation so several optimization

Detection limits for Me-Hg using the SPME-GC-ICPMS method were 4.2 pg/g, while identical headspace sampling and chromatographic conditions allowed for separation and detection of organo-tin species at the fg/g level.

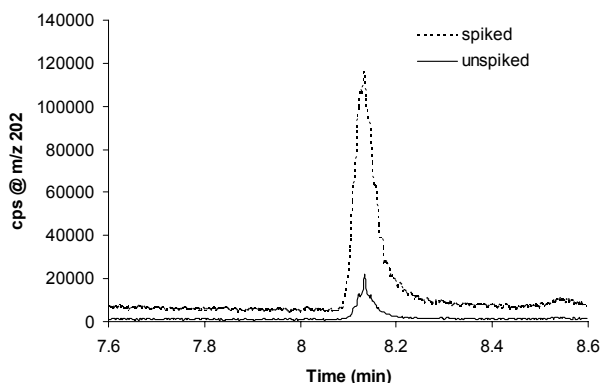

studies were undertaken to gauge species liberation, degradation, and transformation during sample preparation and extraction, which are all circumstances presenting an obstacle for accurate quantification of any chemical species. Both methylmercury and inorganic mercury were monitored in SRM 966 and quantified during the method testing phase and the sum of the methyl and inorganic mercury species were in excellent agreement with certified values for total Hg. The method of standard additions provided the means for Me-Hg quantification. The chromatogram for the spiked and unspiked extracted methylmercury in SRM 966 Toxic Elements in Bovine Blood is shown in the figure.

Based on this work, GC-ICPMS will be used to solve ultra-trace speciation problems involving Hg and Sn chemical species, and the use and isotope dilution methods for species quantification will be explored. Liquid chromatography-collision cell-ICPMS methods will be used to certify organoarsenic compounds in a urine SRM. The method of double isotope dilution will be applied to a pharmacokinetics study. NIST staff will work closely with FDA staff that will assist with modeling the dynamics of orally administered MeHg in the blood of diamondback terrapins. Enhanced performance of the pharmacokinetics models will result from high-accuracy measurements and the ability to quantify dose and background levels of blood Hg among replicates independently, eliminating model noise arising from individual variability.



This work demonstrates that CSTL's measurement capabilities can accurately benchmark the next generation of measurements for metals in clinical samples, regardless of chemical form or whether the samples are derived from human or non-human sources.

The Development of Two Standard Reference Materials: Heteroplasmic Mitochondrial DNA Mutation Detection Standard (SRM 2394) and Fragile X Human DNA Triplet Repeat Standard (SRM 2399)

B.C. Levin, D.K. Hancock, and K.L. Richie (831)

Human mitochondrial DNA (mtDNA) mutations are important for the forensics and healthcare communities. If a mutation is present in every mtDNA molecule, detection is routine; however, low-frequency mutations, heteroplasmies (the existence of two nucleotides at the same site), or single nucleotide polymorphisms (SNPs), scattered throughout the DNA in the presence of a majority of mtDNA with the “Cambridge Reference Sequence” are almost impossible to detect. Therefore, NIST has developed heteroplasmic human mtDNA Standard Reference Material, SRM 2394, to provide quality control for detecting low-frequency mutations, SNPs in either mtDNA or in pooled nuclear DNA samples, or in heteroplasmic sites in mitochondrial DNA (mtDNA). SRM 2394 contains mixtures of two 285 base pair (bp) PCR products from two cell lines (CHR and GM09947A) that differ at one nucleotide position. The CHR cell line designated polymorphic has a T at np 6371 and the GM09947A cell line containing the “Cambridge Reference Sequence” has a C at that site. SRM 2394 is composed of 10 tubes, one tube containing only the DNA with the polymorphism, one tube containing the DNA whose sequence agrees with the “Cambridge Reference Sequence” and 8 tubes containing different percentages of the polymorphic/CRS mtDNA mixtures (in which the mass fractions of

In 2005, NIST will release SRM 2394, Human Mitochondrial DNA, to benchmark measurements made for the forensic identification and for mitochondrial diseases diagnosis.

Many of the procedures used in the Inter-laboratory Evaluation were unable to detect the heteroplasmy if present below 20%. This is an indication that in many real-life cases, low-frequency mutations remain undetected and that more sensitive mutation detection techniques are urgently needed.

Before the final SRM was prepared, twelve laboratories including NIST participated in an Interlaboratory Evaluation (ILE) of a prototype of SRM 2394. This ILE was a blind study in which the investigators could use any mutation detection method of their choice. The methods included: automated DNA sequencing with three different chemistries and different sequencers; denaturing gradient gel electrophoresis (DGGE); the use of a designer peptide nucleic acid (PNA); the Luminex 100 system; the “LigAmp” procedure; and denaturing high-performance liquid chromatography. The NIST team used several of the techniques in the certification process, and the graph shows the NIST data acquired using the Luminex 100 system

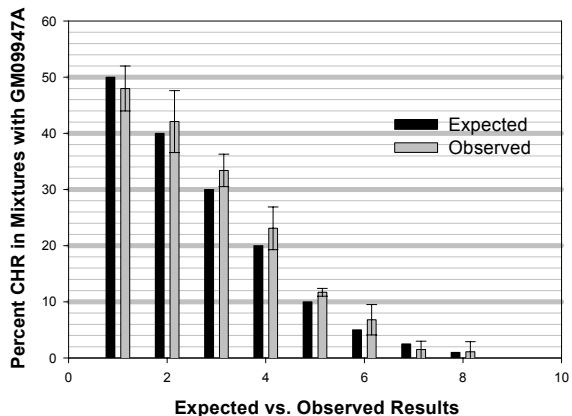

Heteroplasmy Detection of SRM 2394 Using Luminex 100 System (NIST data)

Fragile X Human DNA Triplet Repeat SRM 2399 to be released early in 2005: Fragile X syndrome is the most common form of inherited mental retardation and affects approximately 1/4000 to 1/6000 males. This genetic disease has been associated with the expansion of an unstable CGG repeat in the FMR1 gene on the X chromosome. SRM 2399 is intended to provide clinical diagnostic laboratories with the quality control and quality assurance that they are correctly and accurately determining the number of triplet repeats in fragile X patient families (those individuals with normal and pre-mutation numbers of repeats). Late-onset of neurological symptoms has recently been shown in male carriers of pre-mutation alleles, a range covered by this SRM. SRM 2399 consists of 9 vials of polymerase chain reaction (PCR) products generated from DNA obtained from fragile X cell lines or patient samples. Each vial of PCR product contains a different number of CGG repeats.



This NIST SRM provides the fragile X positive control required by the American College of Medical Genetics Guidelines for any genetic testing.

Validation of Mitochondrial Changes in Cancer

C.D. O'Connell and J.P. Jakupciak (831)

In the past several years, homoplasmic changes have been reported in the DNA sequence of the mitochondrial genome in patient tumors. Changes can be identified by comparing tumor sequence to that of normal tissue or blood from the same individual. Lung cancer, responsible for more cancer related deaths than any other tumors in both men and women, remains a difficult problem for early detection, and biomarkers for this purpose are not currently available.

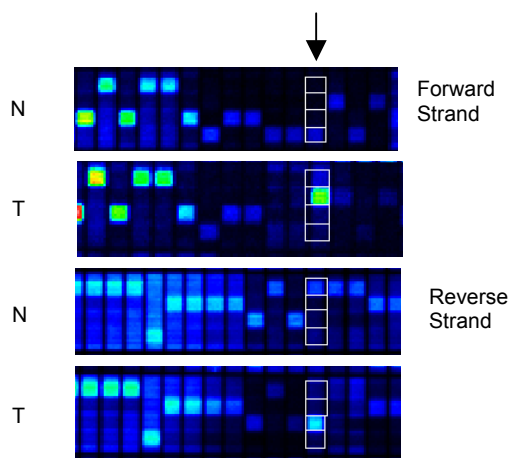

MitoChip detection of a T>C homoplasmic mutation in a lung cancer patient. Both forward and reverse DNA strands are sequenced on the MitoChip. N: normal blood, T: tumor

As a validation laboratory for the National Cancer Institute's Early Detection Research Network (EDRN), NIST scientists are measuring the frequency of mutation and specific mutations associated with lung cancer.



CSTL researchers have successfully completed a pilot study to develop a robust, high throughput protocol to directly sequence the entire mitochondrial genome (16,568 base pairs) to detect these mutations. This protocol was used to validate reported lung cancer mutations in previously analyzed clinical samples. In this preliminary study, we detected mutations in the tumor tissue from 5 of 11 (45%) lung cancer patients. Further, the protocol provided 100% sequence coverage where DNA quality was high (19/22 mitochondrial genomes). This protocol demonstrated that lung cancers could be detected at increased sensitivity compared to other biomarkers under consideration, and was sufficiently robust to fully sequence both clinical materials with a propensity for degradation and that are large in size. The protocol was labor intensive, with the need for robotics to provide the necessary throughput for clinical laboratory use. To address this concern, a mitochondrial sequencing chip (MitoChip) was developed during the course of the pilot study.

NIST scientists are evaluating the MitoChip capabilities for the detection of both homoplasmic and heteroplasmic mutations. Initial studies are promising, with mutations detected in 6/8 lung tumors with respect to the patient's blood. Further studies are underway to address the metrics critical for reproducible, sensitive detection of tumor-specific mutations, and to validate the MitoChip in other body fluids useful for early tumor detection. This work is expected to provide a measurement base for the clinical use of resequencing (genotyping) microarrays.

Manuscript submitted to the Journal of Molecular Diagnostics: J.P. Jakupciak, W. Wang, M.E. Markowitz, D. Ally, S. Srivastava, A.Maitra, P.E. Barker, D.Sidransky and C.D. O'Connell, "Mitochondrial DNA as an Early Detection Cancer Biomarker".

High-Throughput Bioimaging with Quantum Dots: HER2 Testing Standard

Y. Xiao and P.E. Barker (831)

Nanotechnology is increasingly advancing from the bench to commercial and medical applications. Semiconductor quantum dots are nanoscale binary crystals that exhibit properties intermediate between the atomic and the bulk regime. This includes high luminosity, stable fluorescence, and single-wavelength excitation for a multitude of colors. Although many applications of emerging nanotechnologies have been envisioned, bioimaging with luminescent quantum dots has driven this research area toward clinical application and products that cross many disciplines and platforms.

CSTL scientists demonstrate the first application of semiconductor quantum dot fluorospores to FISH testing of HER2 to improve measurement accuracy and reliability.

Cancer detection is also evolving toward more quantitative, molecularly targeted agents that combine diagnostic and therapeutic features, termed “theranostics”. This class of analytes represents the vanguard of future personalized medicines. A primary example is the breast cancer diagnostic Herceptin (trastuzumab) and its target HER2, a cell-surface receptor gene amplified and over expressed in roughly one-third of the 180,000 new breast tumors diagnosed each year. Unfortunately, the tumors that overexpress HER2 are not always correctly diagnosed because of the lack of universal standards in clinical testing laboratories.

NIST has initiated the development of a HER2 Testing Reference Standard that will find use in any current or future testing platform.

Two technologies, IHC (immunohistochemistry) and FISH (fluorescence in situ hybridization) have been used to select patients whose tumors over express HER2, and who are candidates for Herceptin therapy. These methods may not always agree. This poses a dilemma for clinicians and for insurance payors. Herceptin costs up to \$40,000/year/patient and carries side effects that include cardiotoxicity in some patients. Thus, there is ample justification for investment in more quantitative analytical methods for HER2 testing. For NIST, this involves identification of candidate RM and SRM materials (cell lines and cell- free test substrates) an order of magnitude more complex than previous standards projects. In this case, analytes include various biological forms of HER2: the gene, the mRNA transcript, the protein, and the cell-surface receptor.

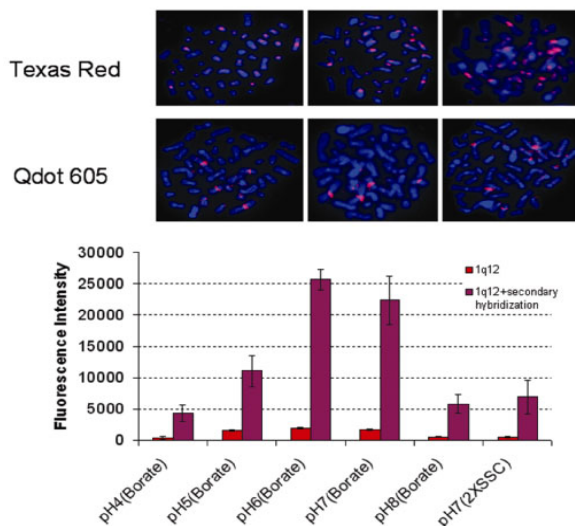

This work has generated three lots of candidate reference materials, and the beginning stages of a certification process for a NIST HER2 testing standard are underway.

The initial NIST studies demonstrated the first application of semiconductor quantum dot fluorophores to FISH testing of HER2. The background technology has been reviewed in context of applied genetic technology. In new work, the pH dependence of quantum dot fluorophores is explored in detail, and microfluidics has been recruited to bear on quantitation of fluorescence behavior of FISH probes detected with quantum dots.

Y. Xiao, P.E. Barker, *“Semiconductor Nanocrystal Probes for Human Metaphase Chromosomes”*, Nucleic Acids Research 32, (2004).

Standard Reference Material for Measuring DNA Damage Related to Disease and Aging

H. Rodriguez, P. Jaruga, and M.M. Dizdar (831)

Every living cell produces free radicals as part of its normal metabolism. Free radicals are known to result in oxidative DNA damage. This type of DNA damage has been associated with numerous age-related diseases such as cancer, atherosclerosis, and Parkinson’s and Alzheimer’s diseases. Free radicals can take over as the body’s antioxidant defense mechanisms weaken, a condition referred to as oxidative stress. Additionally, external sources of free radicals (such as air pollution, radiation, ultraviolet light and certain drugs) can tip the balance in the wrong direction. Oxidative DNA damage can be repaired by enzymes in normal cells, but for a variety of reasons the cellular repair process may fail or slow down, resulting in elevated levels of oxidative DNA damage that may lead or contribute to disease process and aging.

CSTL scientists pioneered the development of methods for detecting and quantifying oxidative DNA damage at levels of approximately one modified base per million DNA bases.

The analysis techniques developed at NIST to detect oxidative damage are able to positively identify and accurately quantify numerous DNA base lesions caused by free radicals. Other techniques generally measure only one modifica-

tion and present no structural evidence for verification; such results might be misleading and might not reflect the overall rate of DNA damage.

A new NIST SRM (2396) is under development and will help scientists better measure oxidative DNA damage implicated in the progression of cancer and other diseases, as well as in the aging process. The new SRM can be used to calibrate methods for measuring oxidative damage in a DNA sample by techniques that use a combination of chromatography and mass spectrometry. Free radicals produce more than twenty different types of lesions in the nitrogen-containing heterocyclic compounds or "bases" of DNA.

SRM 2396 is intended for use in the measurement of oxidative DNA damage by gas chromatography/mass spectrometry (GC/MS), and liquid chromatography/mass spectrometry (LC/MS), using the isotope-dilution technique for quantification in both cases.

The structures of the components of SRM 2396. Alloxan and 5-hydroxyhydantoin result from oxidation in aqueous solution and acidic treatment of dialuric acid, respectively.

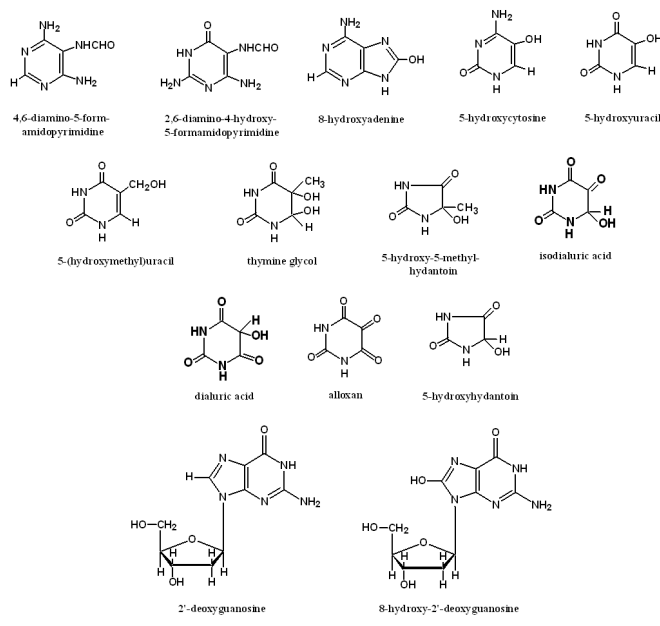

SRM 2396 contains the stable-isotope labeled analogues of eleven of the most-studied DNA bases modified by free radicals, and that of an intact nucleoside for DNA quantification shown in the figure. These compounds are used as internal standards for the measurement of analogous unlabeled lesions in DNA. Users can also calibrate their methods and equipment by using the components of this SRM. The SRM is expected to help establish measurement accuracy and consistency among different laboratories and will be available to the NIST SRM standard.

Microanalytical Technologies to Support NIH Measurement Programs

L.E. Locascio (839), M. Gaitan, N. Morgan (EEEL), P. Smith, T. Pohida, T. Phillips, E. Perruccio, and P. Becerra (NIH)

NIST recently established collaborations with NIH scientists to fabricate microsystems based on micro-electro-mechanical systems MEMS and microfluidics to support and improve the measurement capabilities of medical researchers at the NIH laboratories.

NIST and NIH researchers collaborate to enhance medical research using microfluidics and microengineering.

There are two distinct ongoing projects with different teams at NIH whose research involves the following:

- *Study of the immune response to Herpes Papilloma Virus (HPV)* - developing chip-based microfluidic devices to be used in multi-analyte immunoaffinity capture and detection of proteins related to HPV in cervical secretions.
- *Study of vision-related diseases involving defective neuronal differentiation or cell survival* - patterned immobilization of mammalian retinal cells using microfluidic channels to guide their growth and to facilitate observation of their behavior under different conditions and treatments.

Details of each of the projects are described in the following paragraphs.

Human Papilloma Virus: This work involves an epidemiological study of the immune response to the Herpes Papilloma Virus (HPV), for which the simultaneous isolation of multiple proteins from microliter samples of cervical secretions is required. For this purpose, the NIST/NIH team is developing a microfluidic system capable of multi-analyte detection in a single small volume sample by performing

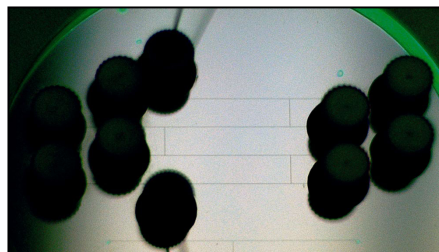

Microfabricated silicon/glass device with 4 different arms for antibody

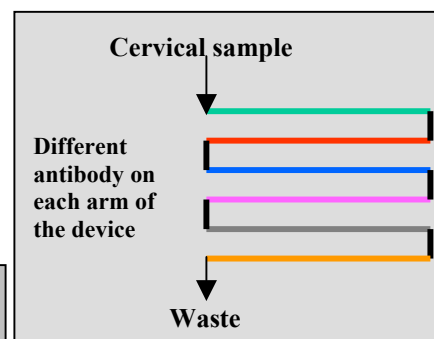

multiple sequential heterogeneous immunoassays on chip. Microfluidic channels designed in a serpentine pattern are fabricated at NIST using silicon and glass substrates as shown in the figure. Different antibodies are then covalently immobilized to each separate arm of the chip so that the system is capable of measuring a number of analytes equal to the number of arms. The channel device architecture has several advantages over existing array technology including the fact that the device is reusable, and the captured proteins can be extracted after measurement with their biological activity intact. The system is designed so that the basic methodology can be applied to many different applications relevant to clinical and biological research at both institutions.

Vision-related disease: There exist a number of techniques that have been used for patterning cells on surfaces. The strategy often used to adhere single (mammalian) cells involves immobilization of extracellular proteins onto the surface for further adhesion of the cells by interaction with these proteins.

Overnight growth (approx. 18h) of retinal cells on poly(ethyleneimine). Cell growth is observed on the polycation surface areas (within the dotted black

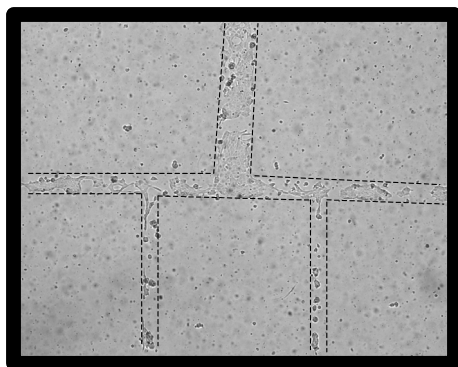

This team of researchers has shown that micro- and nanotechnology can be of great use to those involved in clinical research allowing for very elegant small volume sample manipulation and treatment as demonstrated by the early success of this work.

In this work, immobilization of rat retinal epithelial cells is accomplished using micropatterned polyelectrolyte multilayer (PEM) -coated surfaces. PEMs were deposited in discrete lines using a (poly)dimethyl-siloxane (PDMS) microfluidic network on top of a flat PDMS slab. The layers were formed by sequentially flowing the polyions throughout the microfluidic network. Retinal cells, seeded on flat PEMs/PDMS surfaces adhered and grew on the PEM areas preferentially as shown in the two figures.

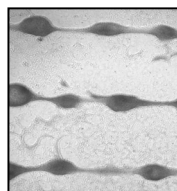

Two weeks' cell growth on poly(ethyleneimine). Cells are covering all the polycationic area.

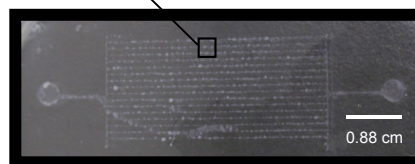

DNA Detection in Microfluidic Channels

R. Zangmeister and M. Tarlov (836)

To meet the need for real-time DNA detection in microfluidic systems, a unique fluorescence-based DNA microfluidic assay was developed that does not require labeling of sample DNA. The assay is based on the displacement of a short sacrificial fluorescent-tagged DNA strand by a longer untagged DNA sample, or target, strand as it is electrophoresed through a DNA-containing hydrogel plug immobilized in a microfluidic channel. The assay is rapid and does not require labeling of sample DNA.

CSTL researchers develop a microfluidic DNA diagnostics method that is compatible with "lab-on-a-chip" platforms and can detect DNA target molecules in real time.

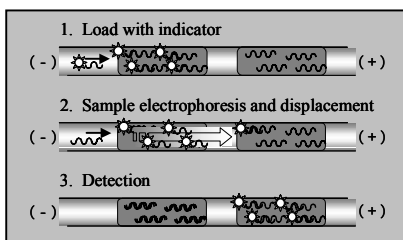

This assay is designed for real-time monitoring of nucleic acid solutions by the electrophoresis of sample DNA through hydrogel plugs formed in a microfluidic channel. The main procedures of the assay are illustrated in the figure to the right. A DNA probe sequence designed to recognize a target DNA strand is chemically tethered in a hydrogel plug formed in a microfluidic channel. A short, fluorescently tagged indicator sequence is hybridized with a portion of the probe sequence (step 1), forming a stable duplex under the conditions used for the assay. The DNA sample to be analyzed is driven through the hydrogel by applying an electric field along the microchannel. If the target DNA strand is

present, it binds to the entire probe sequence and displaces the indicator sequence (step 2). The displaced fluorescently tagged indicator sequence is then driven by the electric field into a second hydrogel located downstream where it is captured and detected (step 3).

The figure displays an actual analysis of a solution containing a random 20-mer DNA target strand. In this analysis the 20-mer strand displaces a 10-mer indicator sequence. The displacement event signals the presence of the 20-mer target in the analyte solution. No displacement is seen when a mismatched target strand of equal length is used.

This research has been presented and published:

- Gordon Conference on Microfluidics
- microTAS 2003
- Analytical Chemistry (2004; 76(13); 3655-3659).

This approach to DNA assay explores a new detection method for compounds where fluorescent tagging is not possible, e.g., detection of toxic metals such as lead in blood samples. Because of the success of this assay, other hydrogel-based assays are being explored including the incorporation of catalytic DNA molecules that sense toxic lead ions in water.

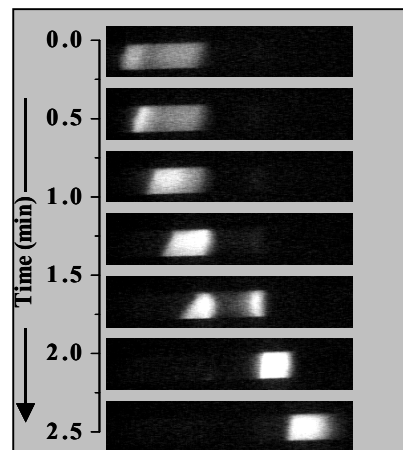

Mass Spectrometry in Health and Environmental Science

S.E. Stein, P. Neta, and L. Kilpatrick (838)

The health of a cell and of an organism is reflected by the proteins that it contains. The recent delineation of the human genome coupled with radically new, sensitive methods for biomolecule detection by mass spectrometry has made it possible to measure a large fraction of these proteins, opening up a range of new, targeted methods for disease detection and prevention. To do this requires the ability to identify massive numbers of proteins, often at low concentrations and with poor separation so that any analysis experiment must deal with mixtures of hundreds or thousands of different proteins.

CSTL launches the first large-scale attempt to determine the variability of peptide spectra.

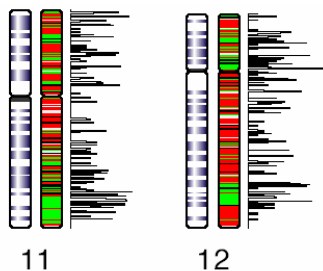

<http://www.peptideatlas.org/>

The use of mass spectra for protein identification is illustrated with recent work from the Peptide Atlas project. In this figure, the usual reproduction of the gene (in black and white) is coupled with a stick diagram representing the number of peptides identified by their mass spectra. The colored bands are an attempt to show whether there are more (green) or fewer (red) peptides than expected. The project has cataloged 225,000 spectra for more than 26,000 proteins. The number of spectra and proteins analyzed has grown dramatically in the last few years, but little attention has been paid to the basic reproducibility of peptide mass spectra and to the development of effective means of establishing their accuracy. There has not been any significant measure of the reproducibility of the spectra from the same individual, the reproducibility of the spectra from different individuals, and the variations that are mapped to disease states. This information is required in order to establish reliable collections of peptide spectra for use in research and

clinical studies. The mass spectra for these proteins are being generated by liquid chromatography (LC), mass spectrometry (MS), and specifically by LC/MS/MS. In these experiments the proteins are chemically broken apart by specific enzymes in well-understood and predictable ways. The resulting mixtures are separated by liquid chromatography, the ions are produced by an electrospray apparatus, and then the molecular ions are fragmented to give spectra that are characteristic of the specific peptide that has been eluted. The small components, peptides, can be identified and their identity tied back to the genome. In this way, peptide spectra become fingerprints of the protein and can even establish its particular chemical state (such as post translational modifications). This mechanism has been refined by researchers around the world and the ease with which the experiments can be done is a major part of the explosion in information on the proteome.

The first large-scale attempt to determine the variability of these peptide spectra is being done at NIST. In this project we are using thousands of openly available spectra along with some specific measurements made at NIST. By looking at the variability created by changing the apparatus and measurement conditions in well-understood ways, we are beginning to understand the best way to establish a measure of confidence in a peptide spectrum and to define new algorithms to compensate for this variability in identification of the proteins by electrospray LC/MS/MS. An example of the data can be seen in the figure. Here we use a very slightly modified version of the NIST MS search software to display and search a given protein mass spectrum produced from instruments at NIST (both in the NIST Gaithersburg labs and at the NIST facilities at the Hollings Marine Laboratory in Charleston, SC) with the data for the same protein from other laboratories.

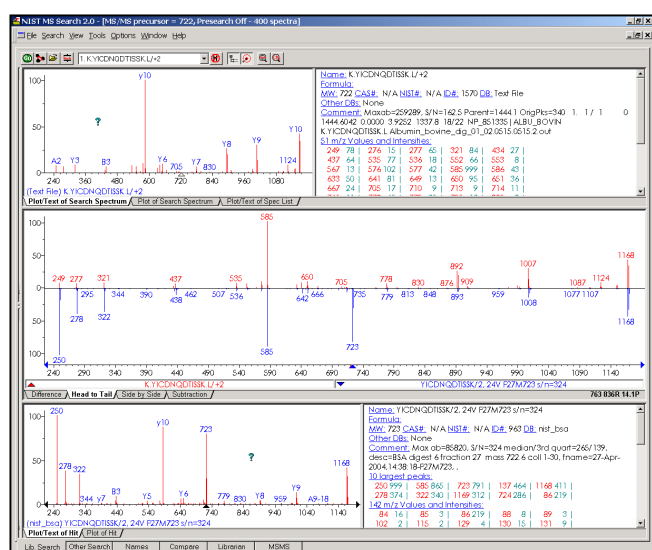

Plans are being developed to build high-quality libraries of commonly observed peptides from both directed measurements of selected proteins at NIST and from the vast and growing information available in repositories being developed in the health science community. This will enable a significant increase in reliability of protein identification as well as enable the development of refined methods for using sequence information for matching experimentally determined peptide spectra. While the scale of this work is very large, the tools developed for use with EI mass spectrometry here at NIST along with tools for the specific problems raised with mass spectra of proteins in other institutions make the effort possible.

NIST and NIH Unveil New HIV Bioinformatics Database

T. N. Bhat (831) and A. Wlodawer (NIH)

AIDS is a major health concern in both the East and the West and in both the developed and developing countries. Structural data play an important role in AIDS research, however the ability to retrieve structural data on AIDS-related molecules is far from satisfactory. Drugs provide the only proven method for the treatment of AIDS. While there are several web resources on AIDS-related drug development, structural information on proteins that are potential targets for AIDS are scattered and data exchange between these resources is difficult. Structural data play a crucial role in the development of drugs and in understanding drug resistance as evidenced by the fact that a large fraction of the current drugs for the treatment of AIDS were developed using structure-based approaches.

CSTL utilized existing experience with physical and chemical properties databases to develop a new structural database for AIDS research with novel techniques to annotate and browse.

Publication in press:
M.D. Prasanna, J. Vondrasek, A. Wlodawer, T.N. Bhat, "Application of INChI to curate, index and query 3-D structures", PROTEINS: Structure, Function, and Bioinformatics (2004).

Despite the wide and expanding availability and use of physical, chemical, and biochemical data collections, the ability to organize and retrieve structure data remains antiquated. While it is possible to query compounds whose physical structures are known in advance, the ability to query compounds in large, complex structural collections is unsatisfactory. To enable the bioinformatics community to have a more efficient means of accessing complex data, NIST researchers have developed a standardized techniques to annotate, index, and present structural data. This method establishes metadata, ontology, and data standards to express structures in terms of standard fragments of chemical and structural significance.

<http://xpdb.nist.gov/hivpdb/hivpdb.html>

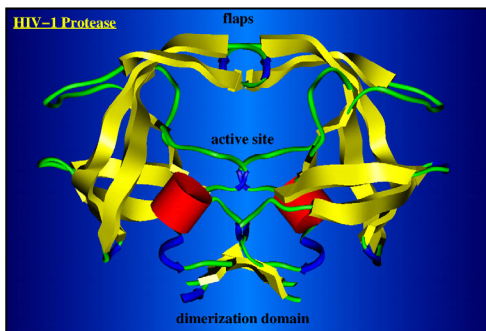

The new NIST/NIH online database contains the structures of HIV protease, and compounds targeted against this enzyme. The HIV Structural Reference Database is a specialized resource that permits faster and more reliable access of standardized data related to the design and development of compounds against HIV. It also provides improved resources for analyzing the drug resistance for those drugs that are currently used to treat AIDS. The availability of such a resource to industry is anticipated to stimulate the development of new and better drug products.

The HIV Standard Reference Database will annotate and distribute structural data on AIDS-related molecules with special emphasis to technological growth and drug development. The plan is to focus on all aspects of the data and information interoperability of structural data. Data standards, data uniformity, data quality, data archival, and distribution are just a few of these issues. This database will receive, annotate, archive, and distribute structural information about AIDS-related proteins and the compounds that inhibit them. These proteins play a crucial role in the maturation of the AIDS virus, and some of the compounds (inhibitors) are the most effective drugs thus far developed against AIDS. The database provides a crucial platform for AIDS research efforts directed toward the development of new drugs and treatments. This effort will also entail the expansion of the content of the data, the enhancement of the quality and uniformity of the data, the development of unique navigation and structural analysis tools, and the offering of comprehensive downloadable data from the resource.

The NIST HIV Standard Reference Database has received about one million hits in the past six months.

Thermodynamics of the Redox Reaction for Fatty Acid Desaturase

V. Reipa, V.L. Vilker (831), and J. Shanklin (Brookhaven National Laboratory)

A proper ratio of saturated to monounsaturated fatty acids contributes to cell membrane fluidity. Alterations in this ratio have been implicated in various disease states including cardiovascular disease, obesity, non-insulin-dependent diabetes mellitus, hypertension, neurological diseases, immune disorders, and cancer. Since desaturase enzymes play a critical role in these processes, they are potential targets for therapeutic intervention. Fatty acid biosynthesis in higher organisms has also attracted increased interest because of the possible use of plant oils as renewable sources for reduced carbon and for environmental cleanup.

The mechanistic details of these reactions are just beginning to emerge. Thus far, the absence of thermodynamic property data hampers further progress in desaturase research and its applications. To address this issue, CSTL researchers have measured, for the first time, the redox potential E'° for the redox reaction of the only structurally characterized member of the desaturase family of enzymes. These measurements used a methodology developed in CSTL. By using nano-crystalline metal oxide electrodes and spec-

NIST-led research team closes a critical gap by addressing the absence of the thermodynamic property data for the desaturase cycle.

Recent Publication:

V. Reipa, J. Shanklin, and V.L. Vilker, "Substrate binding and the presence of ferredoxin affect the redox properties of the soluble plant Δ^9 -18:0-acyl carrier protein desaturase," *Chemical Communications* 21 (2004) 2406.

troscopic monitoring we were able to follow enzyme redox state in the presence of its cofactors. This methodology will be applied to elucidate the role of the different fatty acid substrates in desaturase activity.

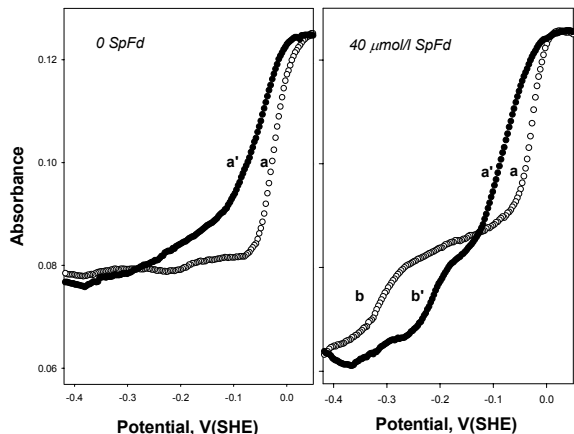

Absorbance at 340 nm vs. the potential of substrate-free (○) and 18:0-ACP bound (●) Δ^9 -18:0-ACP desaturase. The left panel curves were recorded in solutions without spinach ferredoxin (SpFd); the right panel results were obtained in the presence of spinach ferredoxin.

Crystal Structure of the Complex between Thrombin and the Central ‘E’ Region of Fibrin

I. Pechik (American Red Cross and CARB), J. Madrazo, and L. Medved (American Red Cross), and G. L. Gilliland (831)

A new frontier area in structural biology, X-ray crystallography, is providing details of the interactions of biological macromolecules. As structural genomics efforts ramp up, structures of many components of complex macromolecular systems will be determined.

NIST and American Red Cross scientists have begun investigating structural complexes that are essential for the formation of blood clots.

A structural investigation of the nonsubstrate interactions of thrombin with fibrin, which play an important role in modulating its procoagulant activity, was undertaken. To establish the structural basis for these interactions, inhibited thrombin in complex with a fragment, E_{ht} , corresponding to the central region of fibrin, was crystallized, and the structure of the complex was determined at 3.65 Å resolution. This was a challenging effort that used X-ray data from twinned crystals and a phasing procedure that employed molecular replacement. The structure reveals a complex consisting of two thrombin molecules bound to opposite sides of the central part of E_{ht} in a way that seems to provide proper orientation of their catalytic triads for cleavage of fibrinogen fibrinopeptides (see figure).

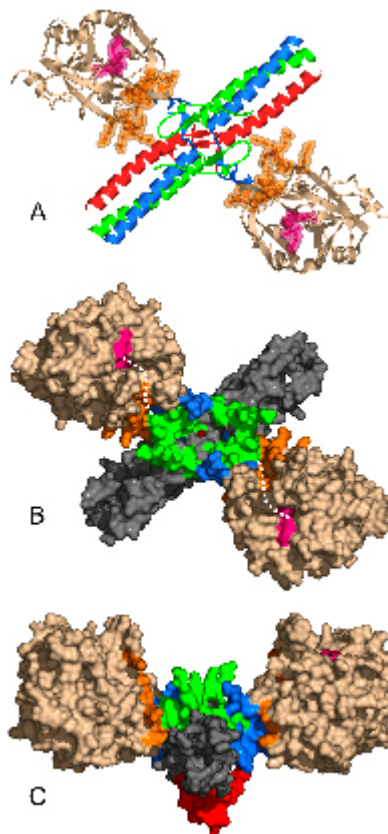

Panel A and B represent, respectively, a ribbon diagram and the solvent accessible surface of the complex viewed along a non-crystallographic 2-fold symmetry axis perpendicular to the plane of the page.

Panel C represents the complex viewed along the axial projection of the coiled coil domains. $A\alpha$, $B\beta$, and γ chains in *panel A* are in blue, green, and red, respectively. NH_2 -terminal portions of the $A\alpha$ and $B\beta$ chains and that of γ chain forming the funnel-shaped and the γN -domains, respectively, in *panels B* and *C* have the same color scheme as in *panel A*, while their remaining portions forming the coiled coil domains are in grey.

The structure was consistent with a large body of biochemical data that mapped these binding sites. This work had identified a large number of charge-charge interactions, which were evident in the structure, but the presence of a central region rich in hydrophobic contacts was not predicted. These findings are of significant value to future healthcare studies developing drugs and therapies for diseases and for blood clotting.

Recent Publication:

I. Pechik, J. Madrazo, M.J. Mosesson, I. Hernandez, G.L. Gilliland, and L. Medved, “Crystal Structure of the Complex between Thrombin and the Central ‘E’ Region of Fibrin”, Proc. Natl. Acad. Sci. USA 101, 2718-2723 (2004).

Standards for Fluorescence Microarray Analyses

G.W. Kramer, P.C. DeRose (839), and A. Gaigalas (831)

DNA microarrays, also known as DNA or gene chips, have become important tools for gene expression analyses and are poised to revolutionize clinical diagnostics and enable personalized medical care—where treatment can be individually tailored to a specific person through genetics-based diagnoses. The related protein microarrays show great promise for pharmaceutical drug discovery research as well as clinical diagnostic tools. For microarrays, single-stranded genetic or protein material (probes) is bound in an array to a surface the size of a standard microscope slide permitting tens of thousands of molecular reactions to be tracked in parallel when an analyte solution is washed over the array. To accommodate this many sites in such a small area, the individual spots of genetic material or protein must be very small, commonly on the order of 10 μm to 100 μm in diameter. Target DNA or protein in the analyte solution are labeled with a fluorescent dye and allowed to interact with the probes bound on the surface of the array. A favorable interaction leads to a fluorescence signal from the appropriate spots. A device called an array scanner or reader detects which spots in the array fluoresce and how much.

CSTL works with the US manufacturers of microarray scanners to identify specifications for physical artifact standards for device quantification. This includes: finding suitable fluorescent materials; identifying appropriate fabrication methods; and creating instrumentation for certifying the fluorescence of such standards.

Today, there is no consensus method for microarray assays; there are multiple technologies for fabricating microarrays ranging from nano-pipetting to pin-printing to photolithography, and there are several types of scanners. The method variations and uncertainties are so great currently that the biological information obtained from microarray assays is often a function of the method and equipment used, and comparisons of results generated by differing technologies is not possible. If artifact standards for microarray assays can be created and certified, assay quantitation can be improved, results will be intercomparable, and the measurements can be made traceable ultimately back to the SI. The purpose of this project is to develop such standards in collaboration with the manufacturers of microarray readers.

Today, there is no consensus method for microarray assays; there are multiple technologies for fabricating microarrays ranging from nano-pipetting to pin-printing to photolithography, and there are several types of scanners. The method variations and uncertainties are so great currently that the biological information obtained from microarray assays is often a function of the method and equipment used, and comparisons of results generated by differing technologies is not possible. If artifact standards for microarray assays can be created and certified, assay quantitation can be improved, results will be intercomparable, and the measurements can be made traceable ultimately back to the SI. The purpose of this project is to develop such standards in collaboration with the manufacturers of microarray readers.

An initial technical workshop on fluorescence standards for microarray assays co-sponsored by Agilent Technologies and NIST was held in late 2002 and attended by representatives from the major array reader manufacturers. The purpose of the workshop was to develop technical specifications for fluorescence intensity, uniformity, and detection limit standards for the calibrating and validating microarray readers. Several parameters such as the excitation and emission wavelengths of the fluorescent tags seemed to be common across the industry; however, there were diverging views on other specifications such as spot size and the form factor of the array. Following the initial technical workshop, the participants worked out many issues concerning the types of standards, intensity levels, form factors, etc. in teleconferences. It was agreed that unpatterned artifacts for each of two colors (similar to the dyes Cy3 and Cy5 that are commonly used now) would be developed. One set of artifacts with fluorescence intensities in the mid-to-high range would serve as uniformity/homogeneity standards and to measure signal-to-noise ratios for bright features, while a second set of materials would be developed with low fluorescence levels to serve as detection limit standards and to measure signal-to-noise ratios for dim features. A second technical workshop was held at NIST in the spring of 2003 to come to agreement on many of the physical factors and to begin the search for appropriate fluorescent materials and application processes to fabricate the standards.

Through quarterly teleconferences, the group continues to refine parameters and to search for suitable materials. The working group has also developed a set of procedures and specifications for testing the suitability of candidate materials. The primary difficulty is finding materials with acceptable spectral characteristics that can withstand the high laser light intensity without photodegrading.

NIST is collaborating with private sector firms in the search for candidate materials. The examination of several glass technologies with Schott Glass, Inc. is ongoing, and a CRADA with Evident Technologies, Inc. to study the use of nanocrystal composites has been established.



The development of artifact standards for quantitative fluorescence assays on microarrays is a first step in a multi-requirement process for standardizing microarray assays. However, it is essential that this process go forward to allow the use of microarrays in clinical settings instead of just research venues. Microarrays have a very promising future, not only in the clinical/biotech/pharmaceutical applications that are being developed now, but also for general chemical analyses.

Reference Material 8640 for the Calibration of Flow Cytometers

A. Gaigalas and L. Wang (831)

The release of RM 8640 represents an important step in an effort to quantitate fluorescence intensity in flow cytometer measurements. The RM consists of six vials each containing a suspension of microspheres with different amount of immobilized fluorescein isothiocyanate (FITC).

Each vial of RM 8640 contains a suspension of microspheres with an assigned value of “molecules of equivalent soluble fluorophore”(MESF). A significant effort was made in developing an original methodology for assigning the MESF values to the microspheres. The assignment is based on the comparison of fluorescence yield of the microsphere suspension with the fluorescence yield of a solution of SRM 1932. The SRM 1932 is a fluorescein solution with a certified concentration of fluorescein. The graph below shows the relationship between the assigned values of MESF and the flow cytometer response given by the channel number and is a typical calibration of a flow cytometer. The “channel number” refers to the digital number associated with the average height of the fluorescence pulse arising from the passage of the microsphere through the flow cytometer. This calibration can be used to assign MESF values to cells with labeled antibodies. Extension of the work to quantitation of multicolor flow cytometer measurements is underway.

CSTL researchers developed a scientific basis for quantitative fluorescence intensity measurements for flow cytometry.

New Reference material (RM) Released:

RM 8640 - used for the calibration of flow cytometers that are used to detect and measure the number of surface receptors on living cells. The type and number of receptors is an indicator of the state and health of the cells and is of critical importance to health care and biothreat detection.

The six RM suspensions were mixed together and passed through a cytometer. The graph shows the relationship between the assigned values of MESF and the response of the flow cytometer given by the channel number. The result for the microsphere with no immobilized FITC is not shown.

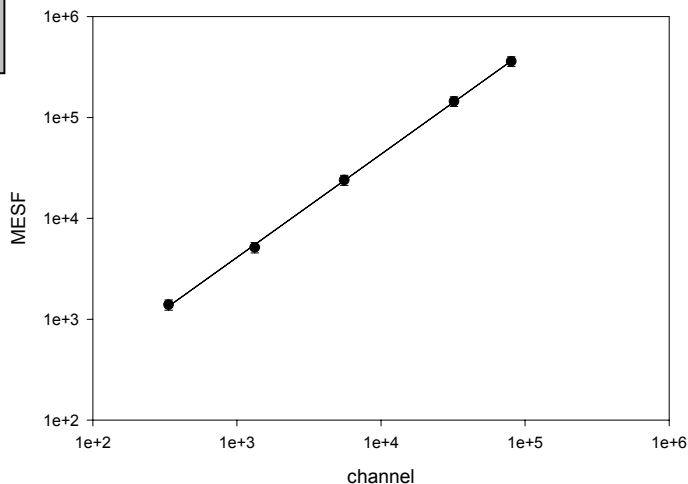

9. Industrial and Analytical Instruments and Services



Instrument manufacturers depend on NIST/CSTL for data, and physical and chemical standards data for instrument calibration, and to provide traceability to national standards to the end users of their products and instruments. CSTL work supports both mature analytical applications, as well as the newest technologies such as high-throughput screening, and cutting edge research for next-generation semiconductor manufacturing.

The US is the largest producer of industrial and analytical instruments in the world – it is highly competitive, globalized and technologically advanced. Many larger US companies derive a significant portion of their revenues from international sales and have manufacturing operations throughout the world.

Development of a Calibration System for Refrigerant Leaks

P.J. Abbott (836)

In recent years, the detection of gas leaks in commercial and industrial refrigeration systems has become of paramount importance. Emissions of HFC (hydrofluorocarbons) have been determined to contribute to environmental problems such as global warming. Many countries either limit or are considering placing limits on the emission of these and other types of refrigerant gases. In order to ensure compliance with emissions limitations, it is necessary to quantify leaks in cooling systems. This requires accurate calibration of refrigerant-leak detecting equipment.

In general, refrigerant-leak artifacts are not very accurate due to the lack of availability of calibration standards. Recognizing this international need, NIST has developed a calibration system for refrigeration leak artifacts that is specifically designed to account for their discharge into atmospheric pressure. Refrigerant leaks are detected using “sniffers” to probe suspected leaks, all done in situ at atmospheric pressure. This is in contrast to the more common leak detection technique that relies on evacuating the vessel of interest and using a mass-spectrometer-based helium leak detector to find and quantify the leak.

CSTL research paves the way for a NIST calibration service for refrigerant leaks.

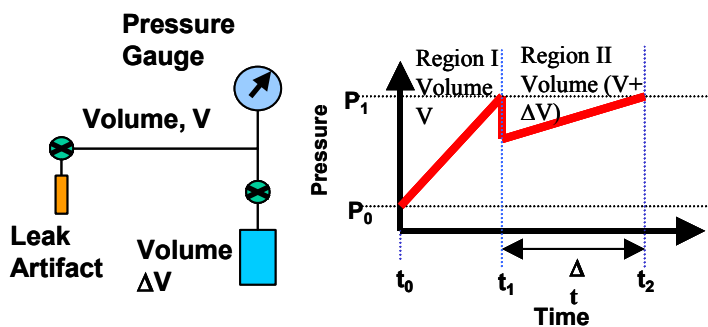

Our new calibration system is based on the “Delta P Delta V” pressure rate-of-rise technique. This method measures the rate of pressure change inside sealed volumes in response to an inflowing source of gas (a leak artifact). The process is illustrated in the diagram. To calculate the flow rate of gas, it is only necessary to know the pressure rates-of-rise in Regions I and II, and the volume, ΔV . Because the flow rate is measured at atmospheric pressure, the temperature of the calibration system is actively controlled to a few millikelvins in order to minimize components contributing to the overall performance uncertainty of the leak artifact under test.

In FY 2004, final system parameters were characterized, and the calibration method was tested using a leak artifact that had been calibrated using the NIST Primary Vacuum Flow Standard. A helium-leak artifact having a flow rate of approximately 4×10^{-11} moles per second at 23 °C was used, and the results obtained with the new calibration system were consistently within 2% of this value. The uncertainty budget for the calibration system is approximately 5%.

Future testing at atmospheric pressure with a refrigerant leak will be done in conjunction with the Italian and German National Metrology Institutes (*Istituto di Metrologia "Gustavo Colonnetti"* and *Physikalisch-Technische Bundesanstalt*, respectively), which are concurrently developing systems based on different measurement processes for calibration of refrigerant leaks. This work will lead to a NIST calibration service for refrigerant leaks.



Primary Acoustic Thermometry

G.F. Strouse, D. C. Ripple, M.R. Moldover (836), and L. Pitre (BNM/INM, France)

The most accurate determinations of thermodynamic temperature above 700 K use relative radiance measurements referenced to a black body. When the black body is operated near 700 K its thermodynamic temperature can be determined using constant volume gas thermometry (CVGT). Unfortunately, two CVGT measurements made at NIST differ from each other for reasons that are not well understood. The difference has led to an estimated uncertainty of 13 mK for temperatures near 700 K, and 50 mK for temperatures near the gold point (1337.33 K). Similar inconsistencies occurred below 273.16 K, reaching $\pm 0.005\%$ at 90 K and below.

In response, NIST developed spherical and quasi-spherical, noble-gas-filled cavities that function as acoustic thermometers. We measured the frequencies of the cavities' acoustic and microwave modes while enclosed in a high-performance thermostat. From the obtained data we determine the speed of sound in the noble gas, which in turn, revealed the thermodynamic temperature, T . Simultaneously, we measured the cavity-wall temperature with standard platinum resistance thermometers calibrated on the International Temperature Scale (ITS-90), thus allowing the determination of the deviation between the ITS-90 and the thermodynamic temperatures ($T - T_{90}$).

Microwave and acoustic data were acquired in the interval from 85 K to 505 K using two resonators (one copper and one steel) and two gases (helium and argon). In the limited region of overlap, from 217 K to 273 K, the results agreed within combined uncertainty, and the determination of ($T - T_{90}$) had a standard uncertainty of 0.6 mK. The figure displays these data along with acoustic thermometry data from other laboratories and data that were used to establish the ITS-90.

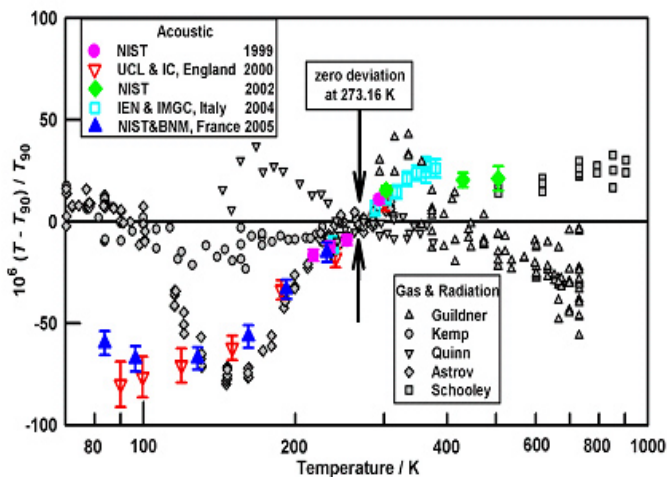

Fractional deviations from the ITS-90 in ppm (10^6). The colored symbols represent acoustic thermometry; the black symbols represent gas and radiation thermometry used to develop the ITS-90.

NIST has developed spherical and quasi-spherical, noble-gas-filled cavities that function as acoustic thermometers. For acoustic thermometry, the measured quantities are frequencies and temperatures. For constant volume gas thermometry the measured quantities are pressures and temperatures; thus, the two approaches to thermometry have different systematic effects.

The NIST approach to acoustic thermometry has been adopted by independent groups in England and Italy, and a NIST Guest Researcher from BNM/INM is expected to continue acoustic thermometry below 77 K when he returns to France in 2005.

These experiments have resolved the long-standing discrepancy in NIST's CVGT results and are expected to be incorporated into a new temperature scale reducing the errors in the ITS-90 by a factor of 5 to 8.

We also have indications that acoustic thermometry might work in the range from 3 K to 24.6 K where NIST currently supports the ITS-90 using an interpolating gas thermometer as a primary standard. In the coming year, we shall investigate the feasibility of using an acoustic scale realization method, which could yield an easier to use and more accurate instrument. Using a rebuilt version of the high-temperature (steel) acoustic thermometer this work will be extended to 700 K and higher.

Atomic Standard of Pressure

M.R. Moldover, J.W. Schmidt (836), E.F. May (Univ. of New South Wales, Australia), and Y. Wang (EEL)

The primary pressure standard at NIST, below 300 kPa, is a 3 meter mercury manometer. Above 300 kPa, the pressure standards are commercially manufactured piston-cylinder sets. These sets are complicated artifacts. In operation, the cylinder and piston deform significantly and the piston rotates continuously to insure gas lubrication. Because of these complications, piston-cylinder sets are calibrated using the primary-standard mercury manometer below 300 kPa, and their performance is extrapolated to higher pressures using numerical models of the coupled gas flow and elastic distortions. The extrapolation cannot be checked with existing technologies; thus, it is not fully trusted. Furthermore, piston-cylinder sets exhibit a poorly-understood species and gas flow dependencies. When $\epsilon(p,T)$ of helium becomes the pressure standard, it will be possible to test models of piston-cylinder sets and to reduce their uncertainty.

The figure is a sketch of an experiment that compared two techniques for measuring $\epsilon(p,T)$, the dielectric constants of helium and argon in the ranges 0.1 MPa to 7 MPa and 0 °C to 50 °C. One technique uses cross-capacitors and a capacitance bridge. As sketched in Figure 1, the cross capacitor has four electrodes. In contrast, most capacitors have two electrodes. The extra electrodes compensate for surface contamination (oxides, adsorbed water, or films of oil). The symmetry of the cross capacitor makes it insensitive to microscopic displacements of its electrodes. The second technique for determining $\epsilon(p,T)$ measures the microwave resonance frequencies of gas-filled quasi-spherical cavity, i.e., a cavity with a shape that intentionally differs from a perfect sphere. (In the figure, quadrants of a perfect sphere have been cut out of the cavity and the asphericity is exaggerated.) The microwave resonances of a spherical cavity occur in overlapping multiplets; the resonances of a quasi-spherical cavity are separated into easily measured, non-overlapping components.

CSTL researchers are developing a novel primary standard for pressure in the range 0.3 MPa to 5 MPa. The new standard will determine the pressure $P(\epsilon,T)$ by measuring and calculating the dielectric constant $\epsilon(p,T)$ of helium.

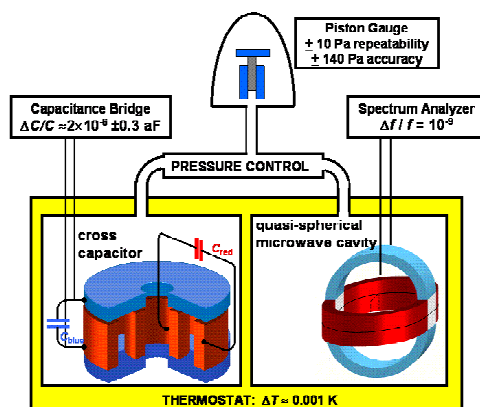

Comparison experiment. The dielectric constant of either helium or argon is measured simultaneously with a cross capacitor (left) and with a quasi-spherical cavity (right).

The graph shows recent test results. We measured $\epsilon(p,50^\circ\text{C})$ of helium and argon. The center panel of the graph shows the differences between $\epsilon(p,50^\circ\text{C})$ measured using a cross capacitor and $\epsilon(p,50^\circ\text{C})$ measured using a quasi-spherical cavity. The differences have a standard deviation (S.D.) of only 8×10^{-8} . This standard deviation is a factor of 6 smaller than that of our previous report two years ago.

The data in the graph are limited by imperfections of the capacitance bridge, which is the best one commercially available. We asked NIST's Small Business Innovative Research Program (SBIR) to seek a greatly improved capacitance bridge. One vendor demonstrated that factor-of-10 improvements are feasible and won an SBIR Phase II contract to make a prototype bridge having such improved performance.

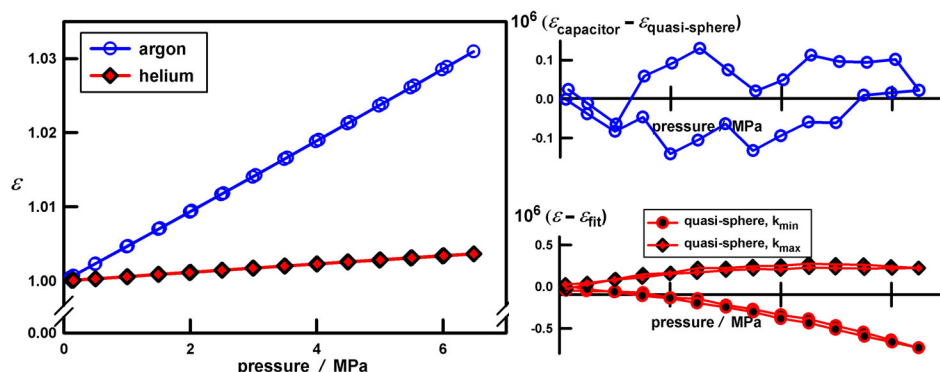

Technology Services
Small Business Innovation Research

Today, measurements of $\epsilon(p,T)$ made with a quasi-spherical cavity have 10 times the resolution of measurements made with the existing capacitance bridge. However, the cavity is not yet an accurate realization of the pressure standard because we do not

know the elastic constant k_T that determines how the cavity shrinks under applied pressure. The ultrasonic resonance technique used to measure k_T of solids gave poor results when we applied it to the copper cavity. We shall overcome this problem by constructing new microwave cavities out of copper-plated hard metals.

This research will *revolutionize* the realization of pressure standards. Since gas-filled, quasi-spherical cavities are excellent acoustic thermometers we can determine the imperfections of the internationally accepted temperature scale ITS-90. We can also measure more accurately the primary constituents in natural gas and these data can be used for *state-of-the-art* metering technologies.

Progress Toward Realizing Pressure with Dimensionally-Based Piston Gauges

J.W. Schmidt, A.P. Miiller, W.J. Bowers, and D.A. Olson (836)

A mercury manometer is NIST’s pressure standard in the atmospheric range. This project seeks to use piston gauges as an alternative means for establishing pressure without reference to another pressure artifact.

An accurate determination of pressure has many important applications, including altitude determination of aircraft, measurement of barometric pressure, and monitoring and control of pressure in manufacturing processes. The pressure standard for NIST in the atmospheric range is presently a mercury manometer. Piston/cylinder assemblies (i.e., piston gauges) are an alternative means for establishing pressure; through use of a variety of piston diameters and mass loads they can operate from the atmospheric range to several hundred MPa (tens of thousands of psi). Dimensional measurements and flow models allow a direct determination of the effective area of a piston gauge, and therefore the pressure it can generate, without reference to another pressure artifact for its calibration. The ability to measure the dimensions of the piston/cylinder assemblies that are extremely round and straight have allowed us to contemplate piston gauge pressure standards whose uncertainties approach the best manometers.

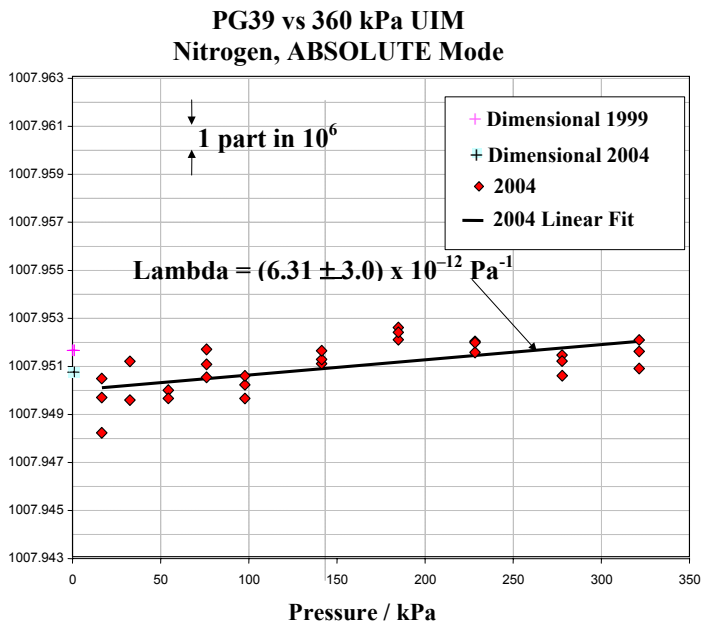

Comparison of effective area of PG39 vs Pressure in kPa from NIST UIM, 1999 dimensional data, and 2004 dimensional data, showing agreement to 1 in 10^6 .

Realizing pressure by two independent techniques provides independent methods for realization of primary pressure standards and more credence to the uncertainties claimed by each.

At NIST an additional independent realization of the pressure unit provides a means to check the operation of our primary mercury manometers and a primary standards having considerably greater operating range



For the last few years, NIST has been studying two 35 mm diameter piston gauges as potential primary standards, designated as PG 38 and PG 39. The artifacts have been used as check standards for the NIST Ultrasonic Interferometer Manometer (UIM) for the last decade. Those comparative measurements have shown PG 38 and PG 39 to be stable within a few parts in 10^6 . This year, the piston and cylinder of both PG 38 and PG 39 were accurately dimensioned by Physikalisch Technische Bundesanstalt (PTB) and analyzed using a model of normal and shear forces on the base and flanks of the piston. PG 39 was also dimensioned by PTB in 1999, and these two sets of measurements have been used to evaluate the dimensional stability of the artifact and the repeatability of the dimensioning method.

The dimensional measurements indicate all four pieces are round to within ± 30 nm and straight to within ± 100 over a substantial fraction of their heights. Using the 2004 data, the model indicates an expanded relative uncertainty on the effective area of 4.4×10^{-6} for PG39. Operational effects, such as force determination under piston rotation, gas species, or gas mode, may increase the uncertainty when the artifact is used to generate pressure. The difference in the relative effective area between the 1999 and 2004 dimensional data for PG39 is less than 1×10^{-6} , and the difference between the 2004 dimensional data and a 2004 pressure comparison with this artifact is about 1×10^{-6} .

In the coming year, we will compare PG 38 against PG 39 to further verify the modeling technique, and propagate characterization of the artifacts to other piston gauge standards by direct calibration. This will revise the NIST pressure scale for gases up to 17 MPa, and provide lower uncertainties for our customers.

The NIST Hybrid Humidity Generator

G.E. Scace, C.W. Meyer, W.W. Miller, J. Hodges, and D.C. Ripple (836)

Gas streams of well-characterized humidity are generated for calibration of customer's hygrometers. The NIST Hybrid Generator generates humidity using two distinct physical principles. First, because the vapor pressure of water is well established as a function of temperature, a gas stream can be saturated at a known concentration of water vapor by passing the gas through a saturator, which is a serpentine passage maintained at a known, uniform temperature that contains a layer of water on its lower surface. Second, for the creation of low moisture levels (down to 3 parts in 10^6 mole fraction), the gas exiting the saturator can be reduced in water concentration by diluting the gas stream with dry gas. Present-day laminar-flow elements enable very accurate measurements of gas flow, resulting in low uncertainties of the water concentration of the diluted output stream. The use of a dilution scheme is very fast and efficient compared to operation of a saturator at cryogenic temperatures. Furthermore, a commercial pre-saturator initially brings the input gas to almost the desired moisture level, reducing the heat and mass transfer load of the saturator itself and allowing operation at high gas flow rates and high water concentrations.

In FY04, the pre-saturator, heat exchanger, saturator assembly, and the dilution system were completed. The heat exchanger and saturator, core elements of the generator, are shown in photograph. To facilitate efficient operation, the new generator is designed to allow full automation of the pre-saturator, dilution system, and saturator baths. We have also designed the system to support closed-loop control algorithms, in which the performance of the saturator is continuously monitored and the pre-saturator adjusted to give minimum uncertainties in the generated humidity.

The NIST Hybrid Humidity Generator has been designed to extend the humidity range provided by NIST, increase operational safety and efficiency, decrease calibration uncertainties, and eliminate the need for expensive cryogenic cooling.



The Hybrid Humidity Generator is nearly completed, its operation refined and automated, and its uncertainty documented. Use of the generator in regular calibration service is anticipated at the end of FY05.

Testing of a Nanogate Device as a Variable Flow Leak Element

P.J. Abbott, A. Lee (836), and James White (MIT)

Many critical industrial processes rely on generating and delivering accurate and precise flows of gas. Examples include leak testing of nuclear containment vessels, gas delivery in semiconductor processing, quantifying the emission of ozone-depleting chlorofluorocarbons, food processing and packaging, and testing of medical implants such as pacemakers. The gas flows required for these applications span a very broad range, from as low as 10^{-14} moles per second to greater than 10^{-6} moles per second. Several types of measurement instruments are currently used to cover this range including mass flow controllers, metal capillary leak elements, and permeation leak elements. Recently, a variable flow leak artifact using micro-electro-mechanical systems (MEMS) technology called the Nanogate was developed at the Massachusetts Institute of Technology (MIT) and holds excellent potential for covering this range with a single device.

CSTL pressure and vacuum experts characterize flow rate characteristics of the MIT developed Nanogate.

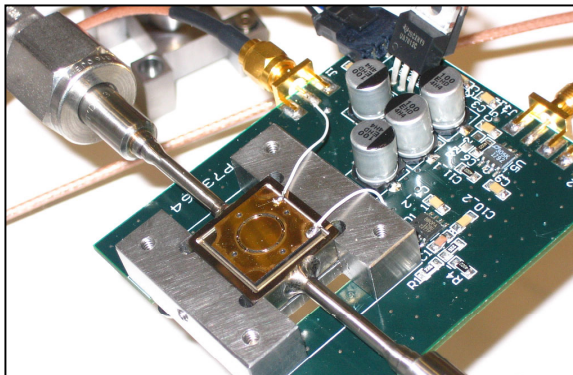

The Nanogate has the potential for generating gas flows over the entire range mentioned above, for many gases of interest, and offers the advantage of precise flow-rate control due to its ability to adjust its opening on a sub-nanometer scale using a picomotor actuator. The Nanogate is a micro-mechanical device that is designed to control a nanometer-sized gap. Precise control of the gate opening is accomplished by deflecting a cantilevered plate that is anchored by a torsion spring, as shown in the diagram.

To characterize operational performance of the Nanogate device, MIT researchers needed a way of generating accurately known flows of gas. CSTL staff members of the Pressure and Vacuum Group maintain low gas-flow standards over the range of 10^{-12} mol/s to 10^{-6} mol/s and can generate lower flows using a flow division technique. Initial testing of the Nanogate device with helium gas has agreed well with theory. A roughly parabolic dependence between helium flowrate and applied picomotor opening was obtained, and minimum leak rate changes on the order of 10^{-13} mol/s were obtained for 51.7kPa of helium at the inlet. Additional testing is planned with other gases over the complete range of the NIST low gas-flow standards. Given the fine resolution of the Nanogate opening, a minimum change in flow rate per applied pulse should be below 10^{-14} moles per second. This may make the Nanogate the most precisely controlled gas delivery valve in the world.

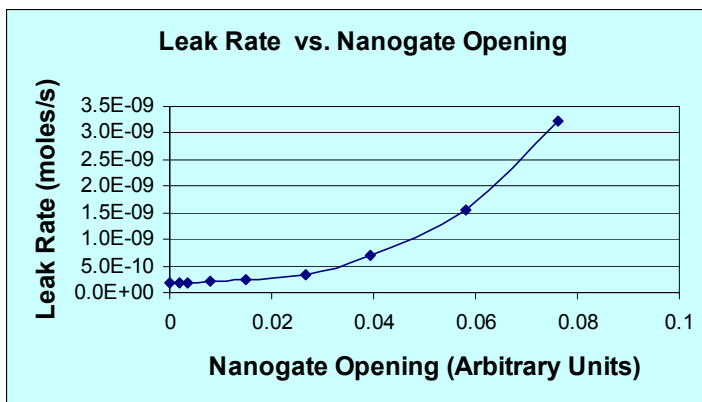

Gas Standards Based on Optical Spectroscopies

J.T. Hodges, P.M. Chu (836), and R. Ciurylo (University of Nicolas Copernicus, Poland)

This program involves the realization and dissemination of primary gas measurement standards based upon quantitative absorption spectroscopy. Precise spectroscopic measurements are used in conjunction with low-uncertainty methods of sample preparation. This approach yields absolute measurements of absorption line intensities for a variety of low-relative molecular mass target analytes such as CH_4 , H_2O , NO_x , O_3 and NH_3 .

New applications for gas standards demand high-precision measurements of relatively low concentrations for reactive and non-reactive systems motivates NIST to development of next-generation standards linked to intrinsic molecular properties.

The goal of this program is to shift the principal realization of traceable gas measurement from one based on consumable artifacts to one based on intrinsic standards. Advances in spectroscopic measurements finally make robust intensity measurements viable for quantitative gas metrology of certain species with an accuracy rivaling and potentially surpassing traditional measurements using artifact standards, particularly for reactive gases.

This novel variant of cavity ring-down spectroscopy (CRDS) yields absorption spectra in which the frequency axis and absorption coefficients are directly linked to high-precision frequency counting measurements and measurements of cavity photon decay times, respectively. We demonstrated line intensity measurements of H₂O with a relative precision better than 0.3% at H₂O mole fractions of 10⁻⁵. Automation of the spectrometer was also accomplished this year. The automation method required the development and integration of servo systems to tune the frequency-stabilized reference laser, to frequency-lock the ring-down spectrometer to the reference laser, and to lock the probe laser frequency to the ring-down spectrometer, respectively.

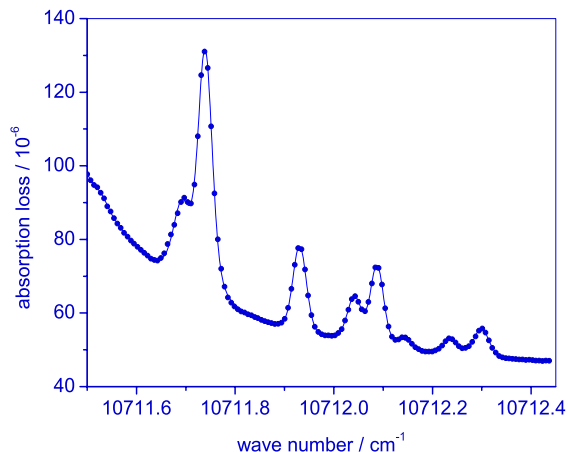

H₂O survey spectrum measured using frequency-locked cavity ring-down spectrometer.

CSTL researchers developed a new approach to cavity ring-down spectroscopy using continuous-wave lasers that are frequency-locked to frequency-stabilized ring-down cavities.

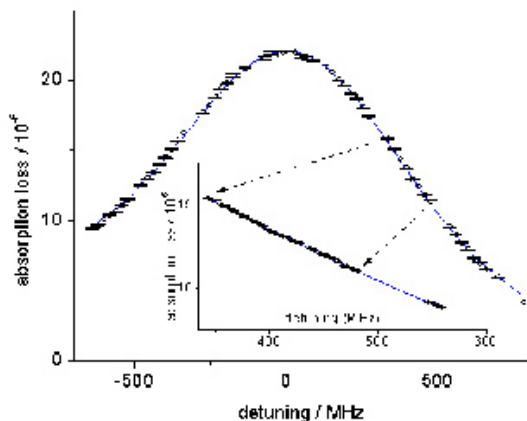

High-resolution scan of ro-vibrational H₂O transition obtained with frequency-locked CRDS technique.

Measurements of weak overtone spectra of H₂O made with the ring-down spectrometer, shown in the figures, demonstrate the sensitivity and spectral resolution of the instrument. As an alternative approach to existing primary and secondary gravimetric gas standards, the proposed technique will extend NIST capabilities in gas standards to lower concentrations than are anticipated to be achievable using current methods and to reactive species that are unsuitable for long-term storage in cylinders. Customers include users of NIST standard gas and users of molecular spectroscopy line intensity data. This work is relevant to emissions of toxic industrial compounds and emissions from ground and air transportation systems, air pollution monitoring, metrology of high-purity gases used in manufacturing processes, atmospheric science, defense, health-care diagnostics, and homeland security.

Advantages to NIST customers include: lower uncertainties, coverage of new species, potentially lower cost for standard mixtures, more flexibility in terms of dilution gases, and the availability of low-uncertainty molecular property data applicable to spectroscopic measurements of gas concentration.

We plan to use CRDS to measure spectral line shapes and line intensities of H₂O and CH₄, and we will pursue applications of CRDS to reactive gases. Comparisons to NIST primary thermodynamic and gravimetric gas standards will be made to maintain links with existing standards. To address measurement challenges of specific gas mixtures for which component species have overlapping absorption spectra, fourier-transform spectroscopy will be used to identify optimal wavelength regions where spectral interferences are minimized.

Characterization of the New Thermal Neutron Prompt Gamma Ray Activation Analysis Instrument

E.A. Mackey, R.M. Lindstrom, G.P. Lamaze (839), H. Chen-Mayer (PL), P. J. Liposky (MSEL), and D.L. Anderson (FDA)

A new thermal neutron prompt γ -ray activation analysis (PGAA) instrument was designed to provide greater sensitivities, better detection limits, and much lower background radiation. Experiments were performed to measure the improvements in element sensitivities and background count rates.

A sapphire filter was placed in the neutron beam shutter assembly to reduce the fast-neutron and low-energy γ -ray components of the beam. The fast-neutron component of the beam was reduced by a factor of five and the low-energy background γ -radiation by factors of 5 to 10. A new external beam tube, sample chamber, beam stop, and support structure were built and a new detection system installed. The new beam tube is made of two cylindrical aluminum sections lined with a lithiated polymer. The sample chamber was also fabricated from aluminum and lined with lithiated polymer, and may be evacuated to minimize the number of neutrons scattered and absorbed by air. The beam tube and sample chamber assembly is suspended from the aluminum support structure. The detection system consists of a 40% efficient germanium detector (resolution 2.0 keV at 1332.5 keV) and bismuth germanate Compton suppressor. The detection system shield consists of lead surrounded by borated and lithiated polyethylene, placed on a table attached to the support structure. The new, more compact beam stop is welded to the support structure. Capture gamma-ray photopeaks from H, B, C, N, Na, Al, Fe, Ge, I, and Pb in the background spectrum were either of lower intensity or eliminated with the new PGAA instrument when compared with the original instrument. The improved detection system, positioned closer to the sample, increased element sensitivity by 5% to 50%.

CSTL's new PGAA instrument has greatly reduced limits of detection when compared with those of the original instrument due to reduced gamma-ray backgrounds and increased element sensitivities.



The new PGAA instrument is safer to assemble for use and provides greater sensitivities, better detection limits, and much lower background radiation than the original instrument. Analyses of SRMs and other materials will benefit from these improvements. Additional work is in progress to prepare a suite of standards for the elements of interest for a broad range of neutron absorption and scattering matrices.

During the past year work was completed on the determination of 0.1% N in oil materials which would not have been possible without the previous instrument. We have also completed a comprehensive uncertainty assessment for this method and this instrument.

Effects of Backscattered Electrons on the Analysis Area in Scanning Auger Microscopy

C.J. Powell (837) and A. Jablonski (Institute of Physical Chemistry, Warsaw, Poland)

Auger-electron spectroscopy (AES) is a commonly used technique of surface analysis. For example, it is used in the semiconductor industry to identify unwanted particulates and other defects on wafer surfaces that are detected after various processing steps. In this and similar applications, a focused electron beam (with a width of about 10 nm) is directed onto the feature of interest, and a measurement made of the surface composition. Analysts typically assume that the detected Auger-electron signal originates from an area defined by the width of the incident beam. The analysis area, however, is gen-

The CSTL-led research team seeks to provide reference data, models, and reference procedures to enhance the accuracy and efficiency of surface analyses made by Auger-electron spectroscopy (AES) and X-ray photoelectron spectroscopy (XPS), thereby improving the traceability of chemical measurements.

erally much larger due to the detection of Auger electrons resulting from inner-shell ionizations induced by multiply scattered primary electrons in the vicinity of the sample surface (i.e., by so-called backscattered electrons).

The research team utilized a simple analytical model to estimate the effects of backscattered electrons on the analysis area in scanning Auger microscopy (SAM). For normally incident electrons, the radius r_a of the analysis area was calculated corresponding to detection of 80%, 90%, and 95% of the total Auger-electron signal as a function of two sample parameters, the backscattering factor R and a Gaussian parameter σ_b describing the radial distribution of backscattered electrons. For a reasonable range of these parameters, r_a depended linearly on σ_b and to a lesser extent on R . Values of r_a can be appreciably larger, by up to a factor of 100, than the typical widths of the incident beam in modern SAM instruments.

As an example, the figure shows the ratio of the Auger signal within an area of radius r_a to the maximum Auger signal (for an infinite radius) for an illustrative case in which $\sigma_b = 200$ nm and $R = 1.5$ (typical values for a primary-beam energy of 20 keV). In this example, two-thirds of the total Auger signal originated from ionizations by the primary beam and was emitted from an area of radius 30 nm. The remaining one-third of the total signal originated from ionizations by backscattered electrons and was emitted from a much larger area, with 90% from an area of radius about 310 nm, 95% from an area of radius of about 390 nm, and 99% from an area of radius of about 530 nm. The parameter σ_b can be up to about 1 μ m for some materials at a primary energy of 20 keV, and r_a can then be up to about 2 μ m (for detection of 95% of the total Auger intensity).

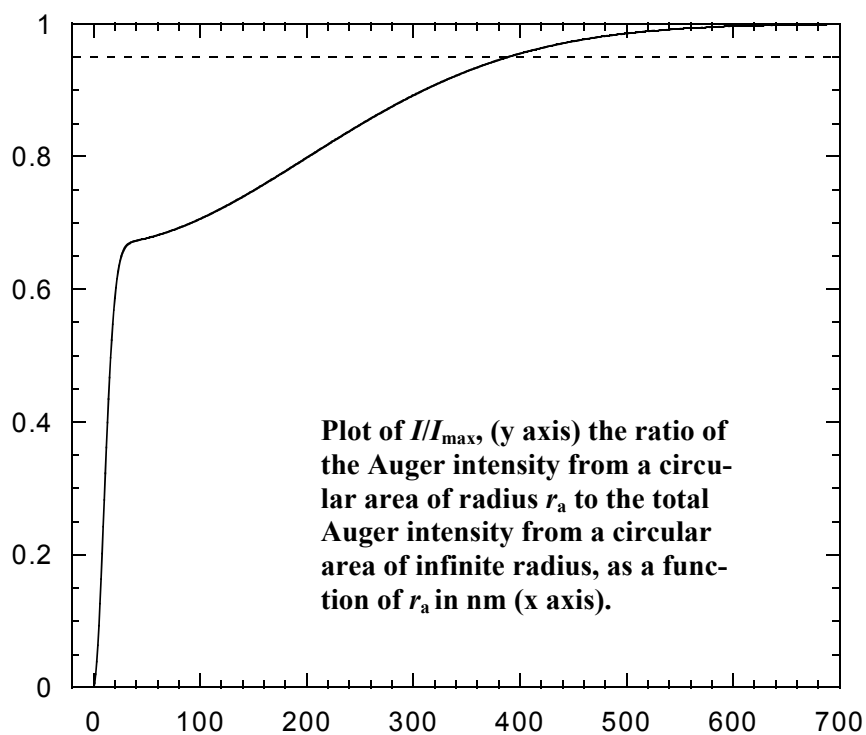

Monte Carlo simulations were made to investigate the radial distributions of Auger electrons from a thin copper film on substrates of silicon and gold for normally incident primary electrons with energies of 5 keV and 10 keV.

These simulations confirmed the general trends found in the first phase. Values of r_a (for detection of 95% of the total Auger intensity) ranged from 30 nm (Au substrate, primary energy of 5 keV) to 680 nm (Si substrate, primary energy of 10 keV).

A new NIST database for the Simulation of Electron Spectra for Surface Analysis (SESSA) of multilayered thin films by AES and XPS will be released in FY 2005. We plan to extend the capabilities of this database in the future to allow simulations of AES spectra for fine particles on surfaces and inclusions within samples.

Most "point" analyses by AES have been previously based on the implicit assumption that the entire detected signal originated from the feature of interest. When Auger analyses are required of fine particles on surfaces or of inclusions in matrices, it will generally be necessary to reduce the beam energy to ensure that most of the signal comes from the feature rather than from regions far from the feature. As a result, a tradeoff may have to be made between spatial resolution, analytical sensitivity, and validity of the analysis.

Uncertainties of Industrial Thermometers

K.M. Garrity, D.C. Ripple, G.F. Strouse, and C.D. Vaughn (836)

In spite of the maturity of commonly used industrial thermometers, including thermocouples, resistance thermometers, and liquid-in-glass thermometers, the uncertainty of these thermometers in calibration, and in use, is often poorly documented resulting in significant error in defining calibration interval requirements or sensor replacement. Both of these are very costly to many end-users.

Recent performance evaluation tests of two types of industrial thermometers have been completed. Because thermocouples are often installed in elevated-temperature environments for long periods of service, we have recently focused on documenting the drift characteristics of these sensors at elevated temperatures. In one set of tests, the drift of common base-metal thermocouples was measured over one year at a temperature of 200 °C. The observed drift rates (as large as 0.3 °C over one year for a fixed installation depth, and as large as 1 °C for variable depth) are highly predictable. Thus, the results of this study can be used to establish periodic replacement intervals in industrial applications, eliminating the need for expensive, and often impractical, periodic calibrations. In another set of tests, we determined the drift of thermocouples during the act of calibration. This drift is a key component in the calibration uncertainty that is often neglected in industry, resulting in an unrealistically optimistic calibration uncertainty. For liquid-in-glass thermometers, previously published repeatabilities had no clear statistical basis. We recently completed a study of the repeatabilities and calibration uncertainties of a selection of 18 liquid-in-glass thermometers over the range -20 °C to 400 °C. The results demonstrated that the now-obsolete published repeatabilities were a factor of 2.5 too large.

It is anticipated that the results of this work, and similar efforts in the future, will become the basis for changes in documentary standards issued by ASTM and other standards development organizations.

NIST methodology developed for testing of industrial thermometers is often adopted by industry, either by direct familiarity with NIST publications or by incorporation of NIST methods in consensus standards by ASTM or other organizations. The values obtained by NIST for both repeatability and drift are trusted in industry as an impartial assessment of expected sensor performance. Performance-testing results from well-conceived experiments provide a basis for rational change in their use and in the standards supporting such use.

The market for industrial thermometers is about \$380B; therefore CSTL scientists are conducting an ongoing project in sensor characterization to support their effective use in both industry and government.

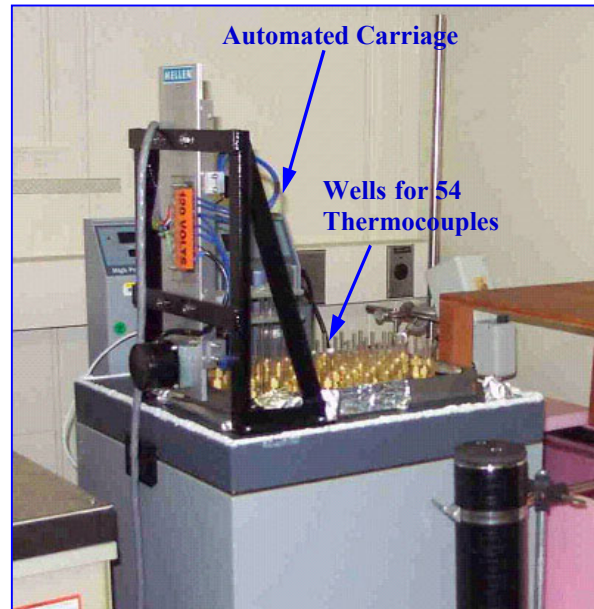

Stirred oil bath for the determination of long-term drift of thermocouples at 200 °C. The carriage allows testing of thermocouples under continuous thermal cycling by automated insertion and withdrawal from the bath.



Outreach Activities in Thermometry

D.C. Ripple, K.M. Garrity, C.W. Meyer, G.F. Strouse, W.L. Tew, and C.D. Vaughn (836)

The NIST Thermometry Group strives to maintain world leadership in thermometry, and to provide our users with all of the tools to attain traceability to NIST standards. For many decades, the NIST Thermometry Group has offered the Precision Thermometry Workshop at its Gaithersburg campus, and we continued this tradition in 2004. We have developed a number of additional training classes that complement the overview provided by the Precision Thermometry Workshop. At the 2004 Measurement Science Conference, we presented a newly developed workshop on the “Selection, Calibration, and Use of Contact Thermometers.” To provide more extensive hands-on training, we are developing a series of small workshops that provide intensive laboratory instruction on particular techniques, using the highest quality of equipment available at NIST. We have held the ITS-90 Fixed-Point Cell Mini-Workshop for several years, and last year a new workshop on Liquid-in-Glass Thermometers was added.

CSTL thermometry research is combined with outreach activities to provide increased visibility for our work, a mechanism for training and education of users, and a forum for cooperation and exchange of ideas with other scientists.



Recently the number of laboratories seeking accreditation in the field of thermometry has significantly increased. Many of these laboratories claim uncertainties comparable to those of many National Metrology Institutes. Staff from the NIST Thermometry Group have increased our efforts in accreditation activities by a) serving as technical assessors, through the National Voluntary Laboratory Accreditation Program (NVLAP), of laboratories claiming low levels of uncertainty, b) creating guidelines of appropriate levels of proficiency testing, c) designing and conducting proficiency tests, and d) assisting companies in meeting accreditation requirements in foreign countries. The expertise of NIST staff is an invaluable resource for companies seeking accreditation, and our involvement helps to ensure that accreditation is a reliable indicator of quality.

The CSTL team will continue involvement with Standards Development Organizations such as IEC, ASTM, and ASME.



Because of our outreach activities, the members of the NIST Thermometry Group are a world-renowned source of thermometry expertise. Several secondary calibration laboratories in the US have attained a level of competence in thermometry that is commensurate with many foreign National Metrology Institutes, partly because of ready accessibility to methods established at NIST. Future outreach activities will address the specific needs of particular industrial sectors. For example, workshops previously held in conjunction with a conference on semiconductor processing and with the ASTM committee on petroleum have led to requests for preparation of training materials for use in these industries.

Fluorescence Standards Suite for Spectral Correction of Fluorometers

P.C. DeRose, D.H. Blackburn, and G.W. Kramer (839)

Luminescence measurements have become the detection methods of choice for new clinical and biochemical assays, and related high-throughput techniques, due to their extraordinary selectivity and sensitivity. These new analytical methods are becoming increasingly more quantitative, requiring standards to calibrate the luminescence measuring instruments that they utilize and aid in the validation of the methods. Ideally, users would like to employ the same organic dye probes used for analyte detection as standards for fluorescence intensity and spectral correction. Unfortunately, organic dyes photobleach quickly, do not have long shelf lives in solution, have environment-dependent fluorescence, and are expensive to produce at high purity.

CSTL researchers work to prepare, characterize, and certify a set of fluorescent glass SRMs that will enable the shape and intensity of spectral emission to be calibrated on fluorometers in the near UV and visible regions of the spectrum.

After studying the characteristics of the different types of fluorescent materials, we found metal-oxide-doped (MOD) glasses to be the best choice for use as fluorescence standards for spectral correction and intensity. These glasses are

photostable, robust, relatively inexpensive, and can be made to suit most detection formats. Our research-grade fluorometer is being used to characterize the spectral characteristics of a series of MOD glasses to determine which will have the correct spectral shape and intensity for appropriate standards. A UV light chamber and a laser are also being used to irradiate the candidate glasses over a timed period. The fluorescence intensity of each glass is measured before and after irradiation to determine its rate of photodegradation.

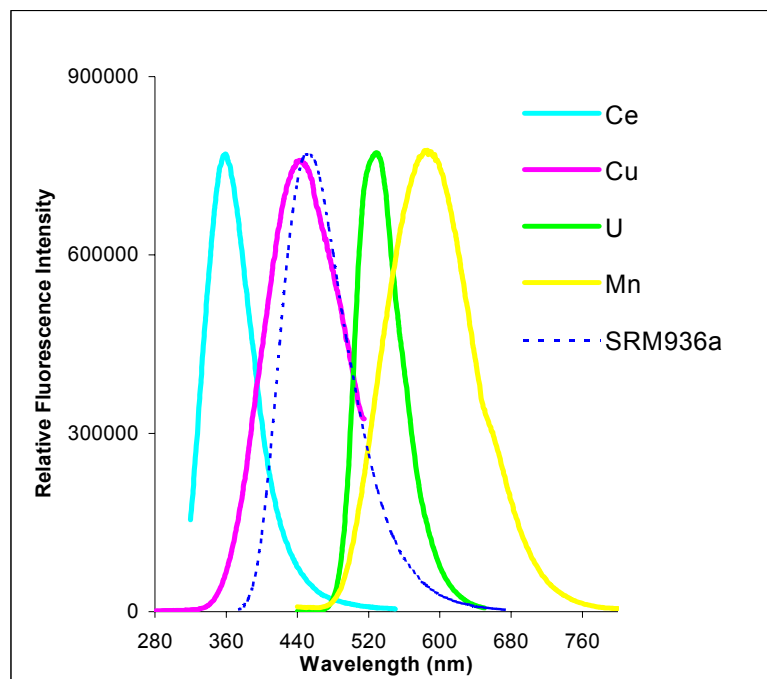

Spectral emissivity standard candidates have been identified with UV/violet, blue, green and yellow/orange fluorescence, corresponding to CeO₂, CuO, U₃O₈, and MnO₂ dopants, respectively. At this point, the U₃O₈ and MnO₂ glasses have been most thoroughly studied. They are both highly resistant to photodegradation and possess all of the desired characteristics for spectral emissivity standards.

Spectral emission profiles of each of the four glasses in the suite of standards, compared with that of SRM 936a

These standards are in the final stage of production and will be certified within the next year. They are being made in the form of a standard-sized cuvette with three polished long faces for 90-degree detection and one frosted long face for front-face detection.

The CeO₂ and CuO glasses have both been shown to have desirable spectral characteristics and are presently in the prototype stage of development. Once certified, the U₃O₈ and MnO₂ glasses can be used in combination with SRM 936a quinine sulfate dehydrate to cover the visible region from 400 nm to 700 nm as shown in the figure. (SRM 936a is a blue spectral emissivity standard that is the only standard presently sold for spectral correction of fluorometers.) The CeO₂ glass will be used to cover the near UV/violet from 350 nm to 450 nm. We hope to replace SRM 936a with the CuO glass, as the present standard is an organic dye that has many of the stability problems associated with organic fluorophores. Since all of these glasses are highly resistant to photodegradation, they can also be used as day-to-day intensity standards for instrument qualification.

We are searching for a suitable MOD glass for a red emission standard that would cover the region from approximately 680 nm to 800 nm, and beyond. We are presently working with a nanocrystal manufacturer to help us to identify such a nanocrystal-based material. We are also working with the same manufacturer and a glass manufacturer to develop fluorescent thin films to be used as intensity standards for microarray readers.

Molecular Simulation of Alkylsilane Stationary Phases in Liquid Chromatography

K. Lippa and L.C. Sander (839)

CSTL researchers develop models that clearly indicate the extent of molecular order within alkyl-modified surfaces and are consistent with spectroscopic studies. The results provide a compelling vision of alkyl-modified surfaces that will guide future development of materials for chromatography and biotechnology.

Covalently modified surfaces represent a unique state of matter that is not well described by liquid- or solid-phase models. The chemical bond in tethered alkanes imparts order to the surface in the form of anisotropic properties that are evident in chromatographic and spectroscopic studies. An understanding of the structure, conformation, and organization of alkyl-modified surfaces is requisite to the design of improved materials and the optimal utilization of existing materials. Computational simulations offer insights into the structure of covalently modified surfaces that may not be apparent through empirical observation.

Simulations offer several advantages over physical experimentation. Models provide a means to visualize the important features of a surface at the molecular level in a way that is not possible by physical experimentation. Models can be precisely described in terms of bonding densities, chain placements, temperature, etc. The influence of changes in specific aspects of the model can be tested directly without altering other parameters. For example, alkyl chain length effects can be studied by extension of existing chains without changing their placement on the silica surface. Simulations can provide insights into the conformation and dynamic aspects of physical materials; however, the utility of the data depends on the suitability and accuracy of the computational approach employed.

Molecular dynamics (MD) is a time-dependent simulation of molecular motion. Initially, velocities are assigned to atoms (often based on Boltzmann distribution) such that the net momentum is zero (i.e., no flow). After a finite time interval, the energy of the system is calculated. Forces on atoms are calculated, new velocities are determined, and the process is repeated. Coordinates are saved periodically, and analysis of the coordinates over time provides information on molecular motion. Monte Carlo approaches utilize random sampling to choose positions, orientations, etc. of molecules. The energy of each sample is calculated, and the new configuration is accepted or rejected.

An extension of the simulation effort is planned to probe the effect that various solvent environments in contact with the alkyl-modified surface may have on alkyl chain conformation.

Molecular mechanics calculations are typically used to calculate the energy at intermediate steps. Molecular mechanics computations are based on algebraic relations that describe the energy of the molecule(s) in terms of stretching, bending, torsions, electrostatic and van der Waals forces, etc. These terms constitute the force field; any required constants are provided by experiment or *ab initio* calculation (parameterization).

Investigation of Arsenic Oxidation-State Speciation in Primary Calibration Solutions and Effects on ICP-OES Measurements

L.L. Yu, T.A. Butler, and G.C. Turk (839)

CSTL researchers produce a highly precise and accurate arsenic standard by investigating and eliminating an unexplained bias between the gravimetric preparation value and the inductively coupled plasma optical emission spectrometric (ICP-OES) value of arsenic standards.

It is well known that the toxicity of arsenic is strongly tied to oxidation state speciation. Less understood is the effect that arsenic oxidation state has on measurement accuracy. Standards prepared from arsenic metal, which in principle should yield a more accurate and precise standard relative to those prepared from an arsenic compound, were frequently found to have inexplicable disagreements between batches when analyzed by using optical emission or mass spectrometry. The deviation, which can at times be as great as a few percent, frustrates the efforts of producing an accurate clinical standard for arsenic. Our studies of the cause of this disagreement between the arsenic standards point to differences in arsenic valence states between solutions. The results of an investigation into the kinetics of the reaction for the arsenic standard preparation elucidated why arsenic solutions comprised of varied arsenic species were produced. Guidelines were developed based on the investigation for producing a single-species arsenic standard, thus eliminating the measurement bias in the certification process, ensuring the production of more accurate and precise arsenic standards for clinical and general use.

investigation into the kinetics of the reaction for the arsenic standard preparation elucidated why arsenic solutions comprised of varied arsenic species were produced. Guidelines were developed based on the investigation for producing a single-species arsenic standard, thus eliminating the measurement bias in the certification process, ensuring the production of more accurate and precise arsenic standards for clinical and general use.

We analyzed sets of standard solutions prepared by dissolving arsenic metal with nitric acid and found both arsenic III and arsenic V to be present in these standards, including various lots of SRM 3103a, the arsenic spectrometric solution. Furthermore, we discovered that standards containing greater amounts of As III yielded somewhat lower signals in ICP optical emission spectrometry than those in which the predominant form of arsenic was As V. Similar results have also been observed using ICP mass spectrometry. This difference in the instrumental response of these two forms of arsenic will result in a measurement bias if samples and calibration standards differ in the form of arsenic. The figure below shows the results of a study of the kinetics of the arsenic metal digestion process. In the experiment small aliquots of solution were periodically withdrawn over a period of 40 hours from a digestion vessel as a piece of arsenic metal was being dissolved in a solution containing a volume fraction of 50% of concentrated nitric acid in water on a warm hot-plate. The withdrawn aliquots were analyzed using liquid chromatography with ICPMS detection to determine the fraction of the total dissolved arsenic present as As III. The results (see graph) show that at the beginning of the process most of the arsenic is present as As III, and all of the arsenic is present as As V after 25 hours. The discontinuities in the reaction curve occur when additional nitric acid / water is added.

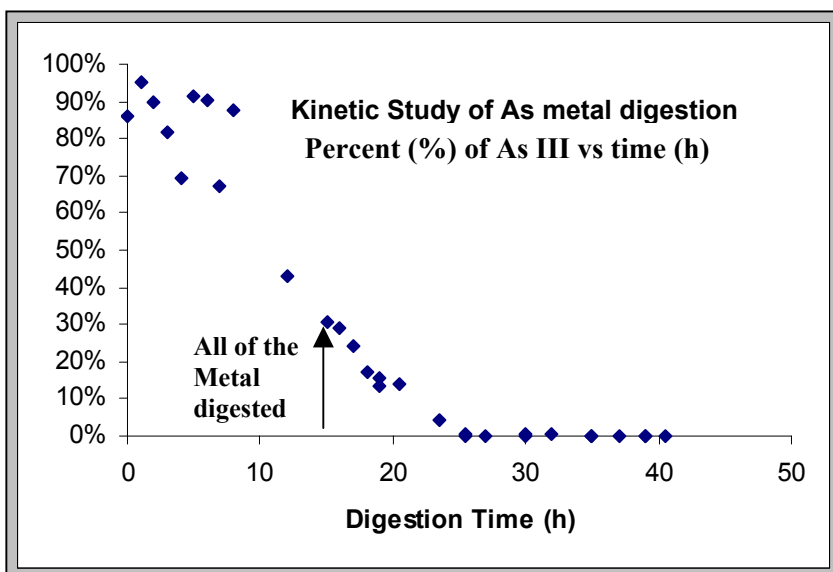

All of the metal appears to be dissolved after only 15 hours. If the process had been stopped after 15 hours, the resulting solution would contain a mixture of arsenic oxidation states. It is clear that this situation occasionally occurs in our production of arsenic solution standards, including SRM 3103a.

We have developed a procedure using iodine as an oxidant to convert solution standards containing mixed oxidation states of arsenic to As V, thus eliminating the source of bias.

The result of the research resolves a long-standing mystery regarding bias sometimes observed between the gravimetric preparation value of certain arsenic solutions and values determined spectrometrically using independent calibration solutions. A revised digestion procedure was developed as a result of this research to ensure the production of a more accurate and precise arsenic standard for clinical and general applications. The research also raises some questions regarding the accuracy of arsenic measurements by using plasma-source-based spectrometry techniques. Further studies will determine if other elements are susceptible to similar systematic bias. The underlying cause of the bias in plasma source spectrometry remains unknown.

New Series of Standard Reference Materials (SRMs) for Raman Intensity Correction

S. J. Choquette (839), W. Hurst (836), and E. Etz (837)

Raman spectroscopy is a nondestructive analytical method that has many qualitative and quantitative analytical applications in homeland security and forensics, as well as the pharmaceutical and biotechnology industries. Its major advantage over infrared (IR) spectroscopy as an analytical tool is that it may be used with little or no sample preparation. Because Raman scattering is a single beam emission process, the appearance of a compound's Raman spectra is highly dependent on the wavelength of the excitation source and the construction of the spectrometer. As a result, Raman spectral libraries are only useful for the specific instrument configuration upon which the spectra were measured. The development of a simple-to-use emission standard would allow the user to correct the sample spectra for instrument response. Corrected spectra, much like absorbance spectra, would be transferable between instruments, would be amenable to searching in corrected libraries, and would allow verification of instrument performance.

The CSTL research team developed a suite of inexpensive intensity correction standards for commercial Raman systems employing a number of laser excitation wavelengths.

The use of these new SRMs will enable the creation of standardized Raman spectral libraries, an increasingly important task given the number of spectrometer vendors marketing this technique to first responders, forensic scientists, and military personnel.

Currently three standards have been produced that are suitable for use with systems employing 785 nm lasers (SRM 2241), 532 nm lasers (SRM 2242) and 488 nm/514.5nm lasers (SRM 2243). The development of the standards will allow a traceable calibration of the system response to NIST standards, which is a necessary step for qualification of chemical instrumentation in the pharmaceutical industry.

Cyclohexane Raman Spectra on Three Raman Spectrometers Using 785 Excitation

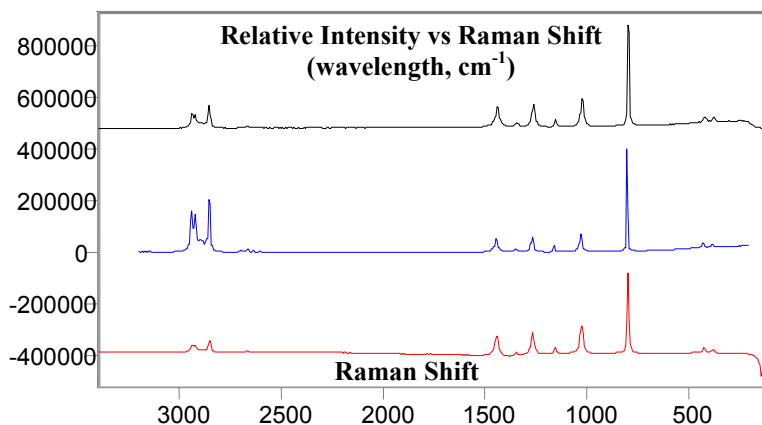

SRM 2241 Corrected Raman Spectra

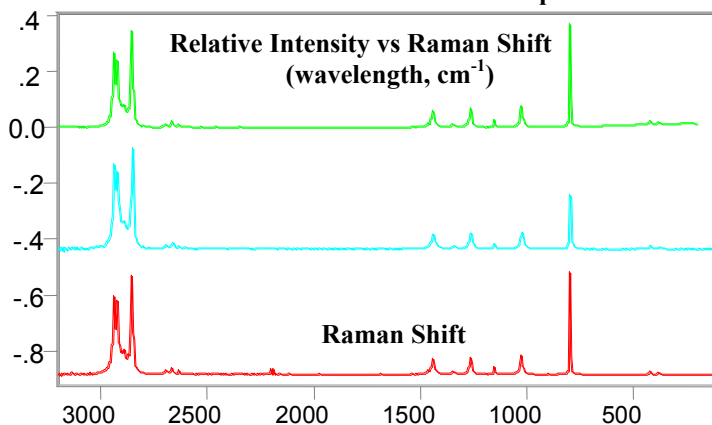

This year we completed work on SRM 2243: a relative intensity correction standard for 488 nm/514.5 nm systems, and initiated work on SRM 2244: a relative intensity correction standard for 1064 nm lasers. The latter is particularly important as our customer base for SRM 2244 is the pharmaceutical industry. FT Raman systems are widely used in this industry because of the large installed base of FT-IR systems (similar instruments/software) and also the Raman spectra of compounds excited with NIR excitation tend to exhibit less fluorescence interference. We have identified a suitable candidate glass for SRM 2244 and have initiated a round robin study with a number of instrument vendors to assess compatibility and utility of the glass. Based upon favorable feedback concerning this glass, a production melt was procured and is currently being processed by our glass shops. We anticipate delivery of this SRM in FY 2005.

The top graph depicts the uncorrected Raman spectrum of cyclohexane acquired on three different Raman systems. All three spectrometers used 785 nm laser excitation. As can be seen, the height of the bands is different with each spectrometer. The next graph shows those same spectra corrected with SRM 2241. The band heights of the spectra are now similar.

AMDIS – Automatic Mass Spectral Deconvolution and Identification Software

G. Mallard, S. Stein, and O. Toropov (838)

One of the most powerful tools for the analysis of complex mixtures is the combination of the gas chromatograph (GC) to separate the mixture into component parts, followed by the mass spectrometer (MS) to identify each component as it is eluted. This combination GC/MS is the most widely used analytical tool for low-concentration analysis for food safety and environmental monitoring. In addition it is widely used in general organic analysis, the development of new flavoring agents, the analysis of fragrances, and in many medical applications.

NIST's Automatic Mass Spectral Deconvolution and Identification Software (AMDIS) was originally developed for detection of chemical weapons in complex mixtures such as might be found in the environment or in chemical process streams. It was designed to work without analyst input as a method of insuring that sensitive business information that could be present in a process stream was not compromised.

At extremely low concentrations, it can be difficult to extract the signal from the data file due to the very complex background that is present. The time spent by an analyst trying to analyze the data file can be many hours. AMDIS is a solution to this problem.

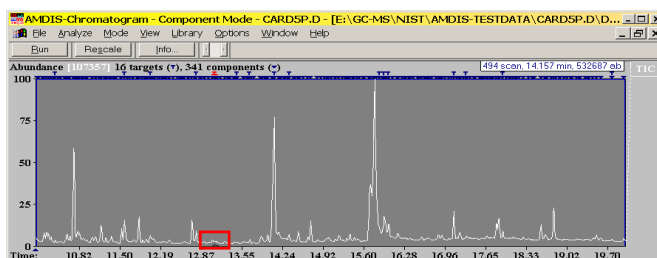

The data that AMDIS analyzes, such as those shown above (which is a plot of total MS ion current as a function of elution time from a GC) are not typically the large obvious peaks, rather they are the very small components that are not obvious to the user. In this case, AMDIS extracted 341 distinct components from this data file (information provided by the components label in the figure). Typical software provided with the instruments might have found 50, and the analyst would have still had more work to do to identify the large majority of peaks. AMDIS can of course analyze the larger peaks, but the time spent by the analyst on these is small and in most cases the answer is known before the analysis is done. It is the small components that can change the flavor, can be the toxic residues, and can be the indicator of disease. It is in extracting these small components that AMDIS excels. Shown in the figure to the right (in the top window) is an enlargement of the region indicated by the red rectangle in the previous figure. This is the location of the caffeine found in the data file. In the second window is a mass spectrum from the region (in red box the elution time plot) where the caffeine was found. The signal in this region is very small, as indicated by the full-scale abundance in each window. Here the white lines (displayed next to the extracted peaks) indicate the portion of the data that was used for identification the caffeine. The bottom panel shows the extracted data (again in white) compared to the library spectrum of the caffeine. The entire process takes a few minutes rather than the hours that an analyst would take to do determination manually.

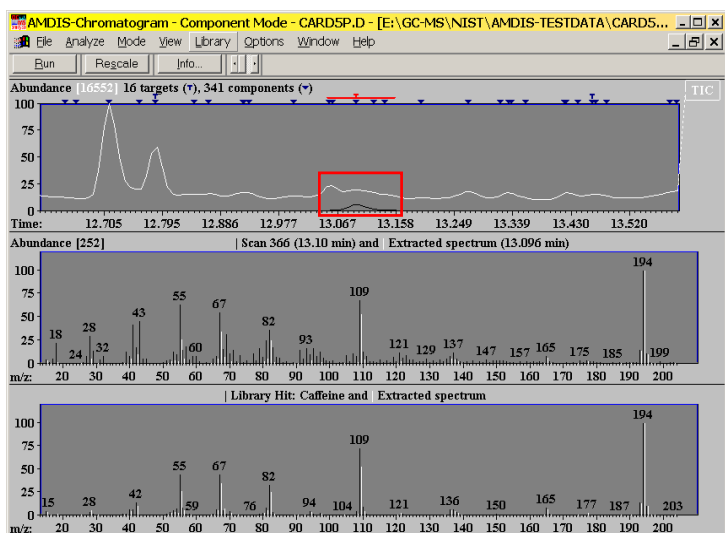

In the above example (cardamom oil with very low levels of pesticides) AMDIS found the pesticides, but also found low levels of caffeine.

Agilent Technologies incorporated AMDIS into a new set of tools for automatic analysis under the general name of Deconvolution Reporting Software.



In the last year the growth in the use of AMDIS by the organic analytical community has been very strong. One of the most exciting developments has been the incorporation of AMDIS into a new set of tools for automatic analysis developed by Agilent Technologies. The tools have been given the general name of Deconvolution Reporting Software (DRS) and incorporate Agilent Technologies run time locking technology, the NIST search software, and AMDIS in a combined tool. DRS allows users to identify pesticides more confidently and at lower concentrations and with more confidence than had been possible with the Agilent system alone.

AnIML – Analytical Information Markup Language

B.A. Schaefer (University of Kaiserslautern, Germany), D. Poetz (Fachhochschule Wiesbaden, Germany), A.D. Nguyen, and G.W. Kramer (839)

The interchange and storage of analytical chemistry data has long been hampered by multiple, incompatible data formats. Over the past 15 years, several different interchange formats have been developed that allow data generated by different vendor systems of a given technique to be exchanged. For example, using JCAMP-DX, users of most commercial fourier-transform infrared (FT-IR) and nuclear magnetic resonance (NMR) systems can interchange their respective data. However, in the last few years, the emergence of platform- and application-independence through the Internet has advanced the possibilities for data interchange beyond the capabilities of these protocols. Today's analytical chemists need not only to interchange data generated within a specific technique, they need to interchange, import, export, store, and

In collaboration with ASTM Subcommittee E13.15 on Analytical Data, we are creating an extensible markup language (XML) for analytical chemistry result data. Based in part on our previous SpectroML markup language for UV/visible result data, this ASTM effort is being called the Analytical Information Markup Language (AnIML).

combine all their data from multiple sources at multiple sites. Users are now no longer content with just having data plots. They need real access to their data within a report – they want to be able to expand plots, re-integrate peaks, overlay spectra, etc. without having to revert to the instrument or computer system that generated the original data. And, they don't want to have to purchase, learn, or even load proprietary programs to do this. In industrial settings, experimental data belong to and must be accessible to the entire organization, not just the laboratory personnel who generate it. Proprietary data formats and existing interchange programs simply cannot fill such corporate needs for data accessibility

AnIML will revolutionize data interchange, eliminate long standing barriers to data exchange, enable new data manipulation software, facilitate new web-based notions for data usage, and permit the development of realistic schemes for long-term data archival.

Over the past three years, we developed an XML-based mechanism for instrument-to-instrument, instrument-to-application, and application-to-application data interchange called SpectroML: an extensible markup language for molecular spectroscopy data. SpectroML was created initially to serve as a model implementation of a markup language for molecular spectroscopy and ultimately to provide a web-based mechanism for interchanging UV/visible spectral data generated on different spectrophotometers with our optical filters database. When our optical filters database was created as a replacement for paper records, we could import data only from the High Accuracy Spectrometer (HAS) used to certify the SRM optical filters. The complex and archaic data importation process badly needed to be modernized, and we wanted to be able to import data from our other spectrometers as well. Using SpectroML drivers/translators for the HAS-II, the PerkinElmer Lambda 900, and the Hewlett-Packard HP 8453 spectrometers, data from these instruments can now be converted into a single format SpectroML file and imported into our optical filters database. SpectroML is an integral part of the process for certifying and recertifying optical filter SRMs; plus, we can import research data taken on machines other than the HAS for comparison purposes.

Even before we developed SpectroML, we began to proselytize both instrument vendors and the ASTM E13 Molecular Spectrometry and Chromatography Committee about the merits of an XML-based approach to data interchange. In 2001, the ASTM E13 committee established a task group to develop a markup language for molecular spectrometry and chromatography, and in 2003 the task group was made into a full ASTM subcommittee—E13.15 on Analytical Data. E13.15 has been working with instrument vendors and the IUPAC Committee responsible for JCAMP-DX to develop a unified XML-based approach for interchanging molecular spectrometry and chromatography data called the Analytical Information Markup Language (AnIML). AnIML is based on a hierarchical model that calls for the initial development of a core markup language containing the elements common to all applicable analytical techniques. The core schema defining the common notions of sample information, measurement data, system information, quality assurance, etc. will be handled by ASTM E13.15. Technique-specific base documents will build on the core and will be the responsibilities of the respective E13 subcommittees in conjunction with other interested expert groups such as those from the IUPAC, American Society for Mass Spectrometry, etc. Data/instrument vendors are responsible for implementations of the instrument/origin specific base document extensions that will build on both the core and the technique-specific standards. Higher-level specifications could include organization-specified extensions that are company-specific and even end-user or application-specific extensions. The core is being built as much as possible to bridge previous data exchange standards work (e.g., ANDI and JCAMP-DX), and efforts are being made to collaborate with and include other organizations with similar interests and as much as possible to reuse terminology and concepts from existing standards.



Over the past year, the schemas for the core and technique definitions have been written and base documents for several techniques have been created. Since the metadata for individual techniques will be maintained in instance documents instead of schemas (to permit extension of technique metadata) the standard mechanism that applications use to validate XML documents syntactically cannot be used. Accordingly, we created a Technique Validator program that provides semantic and syntactical checking as well as some bounds/limits checking for AnIML files. We are now working with several groups of domain experts to develop AnIML. To solve the problem that most of the domain experts do not know XML, we have written a Technique Creator program that guides a user through the creation of a technique base document and then creates the XML code.

Currently, work is underway to implement the AnIML core schema and to develop an example implementation of a technique-specific AnIML schema for liquid chromatography photodiode array spectra. If successful, we can begin implementing AnIML for other techniques. The IUPAC committee has already converted their JCAMP-DX terminology to XML so progress should be rapid for those techniques supported by JCAMP-DX. The AnIML project also dovetails nicely with another IUPAC project to convert the IUPAC units and terminology documents (Green and Gold books) to XML.

XML for Microanalysis

J. H. J. Scott (837)

The rapid spread of XML technology in many fields of chemical analysis has led to renewed interest in applying XML to the data exchange and data storage problems faced by the microanalysis community. Information about all aspects of a microanalysis experiment (not just spectral results) can be captured by a well-designed Microanalysis Markup Language (MML), which should:

- Enable the free exchange of spectral information among microanalytical instrument users by developing an XML-compliant markup language for spectroscopy data.
- Provide a framework for sharing microanalysis data community-wide to allow more sophisticated theoretical model building and model assessment to take place.
- Create a document format for long-term archiving of microanalysis data that diminishes the effect of “bit-rot” and software decay and helps prevent the loss of data due to lost file formats.

After testing several variations of the markup language and exploring design tradeoffs, as well as implementing multiple working prototypes to store test data, we began to integrate the microanalysis XML effort into the ASTM E13.15 AnIML, which is the analytical data markup language project also CSTL-led but by an independent team as described in the previous article. The two projects can interoperate cleanly and a microanalysis component can be added to the AnIML project through the development of technique schemas (defined by the AnIML framework) based on common microanalysis data acquisition modalities such as scanning transmission electron microscope (STEM), scanning electron microscopy (SEM), and elemental analysis spectroscopies such as electron energy-loss spectroscopy (EELS) and energy-dispersive x-ray spectrometry (XEDS).

This year we implemented multiple working prototypes of Microanalysis Markup Language (MML) based on the original ASCII file format created in 1991 by the Electron Microscopy Society of America (EMSA) task force, currently the Microscopy Society of America (MSA). The larger CSTL team began to integrate concepts from SpectroML and AnIML, and began contributing to AnIML development by attending meetings, studying the schema and framework, and learning the role of ASTM Analytical Data Sub Committee E13.15. We estimate that the creation of new microanalysis technique schemas for AnIML covering spectroscopies and electron optical scanning techniques (STEM, SEM, Spectrum Imaging) will add significantly to their schema list while the XML-based metadata is already useful for storing information about spectrum imaging experiments to complement LISPIX.rpl files and 3D Chemical Imaging competence.

CSTL researcher creates new microanalysis technique schemas for AnIML covering spectroscopies and electron optical scanning techniques (STEM, SEM, Spectrum Imaging).

```
#FORMAT      : EMSA/MAS Spectral Data
File
#VERSION     : 1.0
#TITLE       : NIO EELS OK SHELL
#DATE        : 01-OCT-1991
#TIME        : 12:00
#OWNER       : EMSA/MAS TASK FORCE
#NPOINTS     : 20.
#NCOLUMNS   : 1.
#XUNITS      : Energy Loss (eV)
#YUNITS      : Intensity
#DATATYPE    : XY
#XPERCHAN    : 3.1
#OFFSET      : 520.13
#CHOFFSET    : -168
#SIGNALTYPE  : ELS
#XLABEL      : Energy
#YLABEL      : Counts
#BEAMKV      -kV: 120.0
#EMISSION    -uA: 5.5
```

Example file excerpts from the headers of the existing EMSA/MAS Spectrum File Format 1.0 (top), and Microscopy Markup Language (MML), a proposed XML-based enhanced format (bottom). Both formats are designed to be human-readable/editable and intuitive instead of efficient and parsimonious. The XML-based format has the added advantages of being extensible, web-aware, more easily validated, and more tolerant of vendor customization. It is also backed by a large, professionally-developed codebase, a suite of tools, and plentiful documentation on XML itself.

```
<?xml version="1.0"?>
<spectrum xunits="Energy Loss (eV)"
yunits="Intensity" signaltype="ELS">
<title>NIO EELS OK SHELL</title>
<date>1991-10-01</date>
<time>12:00</time>
<owner>EMSA/MAS TASK FORCE</owner>
<xperchan>3.1</xperchan>
<offset>520.13</offset>
<choffset>-168</choffset>
<beamkv>120.0</beamkv>
<emission-uA>5.5</emission-uA>
<probecurrent-nA>12.345</probecurrent-
nA>
```

In the coming year we plan to extend and refine the standard to resolve remaining questions while developing a more detailed model for XML use in spectrum imaging applications. We would also like to explore the use of XML in building a data pipeline for 3D Chemical Imaging at the Nanoscale.

Properties and Processes for Cryogenic Refrigeration

R. Radebaugh, P. Bradley, M. Lewis (838), J. Gary, and A. O'Gallagher (ITL)

Cryogenic temperatures are required for many technology areas, including infrared sensors for surveillance and atmospheric studies; superconducting electronics, magnets, and power systems; to create clean vacuums in semiconductor fabrication processes; for liquefaction of industrial gas; and many other existing and future applications. Proper measurements need to be established to characterize losses within cryocoolers and models need to be developed to optimize the design of such systems. Material properties at cryogenic temperatures also are needed by industry for the design of cryogenic equipment, but the data are difficult to find and interpret.

NIST scientists address issues associated with cryogenic refrigerators, i.e., cryocoolers, and materials performance that are limiting growth in all these technology areas.

http://cryogenics.nist.gov/NewFiles/material_properties.html

This year, we redesigned our web site to provide clear access to references for the database on cryogenic material properties and to graph each property as a function of temperature between about 4 K and 300 K. In addition, we developed two improved measurements techniques (based on hot-wire anemometers) that give good agreement for oscillating flow and used them to measure the complex flow-impedance of an inertance tube. As part of a CRADA with a medical device company, we completed measurements on the performance of a simple pulse tube refrigerator for dermatological pens to about $-90\text{ }^{\circ}\text{C}$ (such operating temperatures are higher than those normally achieved with pulse tube refrigerators). Using a compressor with a piston-position sensor we were able to characterize the overall system performance for this device.

In the future, we will continue expanding and improving the cryogenic materials database, and developing test methods and improvements in our cryocooler simulation models to address fundamental limitations to the efficiency of cryocooler systems.

This year, we redesigned our web site to provide clear access to references for the database on

A comprehensive article on the fundamentals of cryogenic refrigeration for both small and large superconducting systems was published: "Refrigeration for Superconductors," IEEE Proceedings on Electronic and Large Scale Applications of Superconductivity.

10. Microelectronics

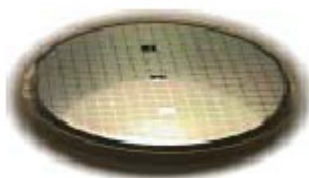

CSTL supports the microelectronics industry by providing the necessary physical standards for process control of parameters such as temperature and humidity. CSTL also provides reference materials to facilitate quality control in manufacturing, as well as providing reliable kinetic and thermophysical

The value of the US Semiconductor Manufacturing Equipment industry is \$15B, and the world market is about \$50B. Wafer fabrication equipment accounts for about 70% of the market.

property data to facilitate process modeling to meet critical industry needs. CSTL research remains on the cutting edge in order to provide dramatically improved measurement tools to keep advanced US microelectronics manufacturing globally competitive.

Nanofabrication of Test Architectures for Molecular Electronics Applications

J. D Batteas, J.C. Garno (837), C.A. Zangmeister (836)

The ability to precisely construct nanoscopic metal-molecule-metal junctions is of great importance for the development of robust molecule-based electronic and optoelectronic devices. By combining scanned probe lithography with electroless metal deposition, metal-molecule-metal junctions can be constructed where the dimensions and surface organization are dictated by the placement of surface groups active for electroless deposition, such as carboxylates, into a desired pattern. These structures will provide a means of reproducibly measuring transport (current-voltage) properties of ensembles of molecules with a fixed a real density to assess the role of the molecule in the transport process and to determine the scalability of per molecule conduction in such junctions.

The CSTL research team develops a robust, systematic nanoscale test structure to critically evaluate electrical properties of candidate materials that are used in the development of nanoscale molecular-based electronic devices.

The CSTL research team developed methodologies to construct confined molecular assemblies of metal-molecule-metal junctions with nanoscale dimensions for the evaluation of electron transport in small ensembles of molecules (10^2 's to 1000^2 's) to determine the scalability of per molecule conduction values in prototypical device architectures. To this end, automated scanned probe lithography is employed to pattern surfaces with self-assembled monolayers, where specific molecular linking groups are placed into organized structures on Au surfaces with features sizes ranging from approximately 10 nm to 200 nm in lateral dimension with the Au surface functioning as a bottom electrode. A completed metal-molecule-metal junction is then formed by the electroless deposition of metal yielding the top electrode. Here we have developed and demonstrated the needed fabrication capabilities to enable construction of these test architectures.

Patterning of metal-molecule-metal junctions with nanoscale dimensions, specifically Cu on carboxylic acid terminated SAMs on Au, has been demonstrated using a combination of automated scanned probe nanofabrication and electroless metal deposition. The architecture of the nanostructures formed can be precisely tuned in all dimensions by controlling the lateral 2-D pattern size of the fabricated structures, the surface density of reactive acid groups placed into the structure, and the concentration of reactants in the electroless metal plating solution. An overview of the key steps to fabricate the Cu nano-contacts is illustrated in the figure below. Using this approach metal structures ranging from approximately 20 nm to 200 nm in lateral dimension with 5 nm to 10 nm metal top contacts have been formed.

Scheme for fabrication of nanoscale metal junctions.

- A. First a resist layer is deposited on the surface.
- B. A structure of 16- Mercaptohexadecanoic acid (MHA) is then patterned into the resist by nano-grafting.
- C. The surface is then exposed to a Cu plating solution yielding C.

* AFM = Atomic Force Microscopy

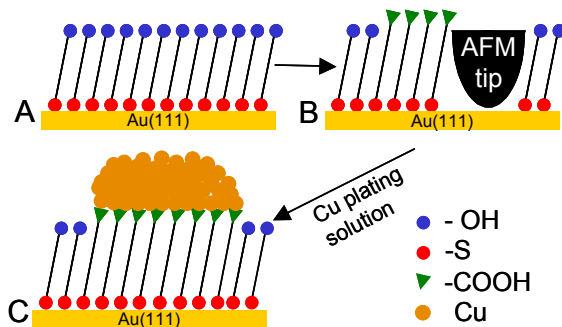

An array of final structures fabricated using this approach is shown in the figure to the right. The patterning process requires only on the order of 30 min for forming all of the junctions. This provides a means a fabricating a range of structures with varying dimensions to assess scalability of current with junction dimension and molecular packing density. This approach should be readily extended to other metals that can be electrolessly deposited such as Pt, and be applicable to the construction of more complicated multidimensional metallic structures including combined vertical and lateral junction geometries. Additionally, well-defined nanoscale metal-metal junctions can be also formed which may be employed in the development of enhanced optical spectroscopic methods for sensing.

Current experiments are now aimed at probing the electrical behavior of ensembles of molecules within the nano-patterned junctions. These measurements can then be compared to those from prototypical device structures. This approach for building nano-patterned metallic structures will also be transferred to Si substrates as a means to construct hybrid semiconductor-molecule-metal junctions.

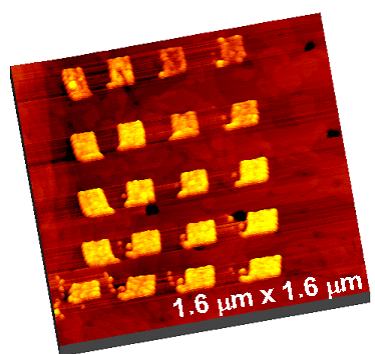

Topographic AFM image of nano-patterned array of sixteen 150 nm x 150 nm Cu structures (about 5 nm high) on carboxylic acid terminated SAMs.

Horizontal Growth and *In Situ* Assembly of Oriented Zinc Oxide Nanowires

B. Nikoobakht and S.J. Stranick (837)

Details provided in the *Measurement Science for Future Standards and Technologies* Section of this report.

Thermophysical Properties of Gases used in Semiconductor Processing

J.J. Hurly, K.A. Gillis, and M.R. Moldover (836)

The semiconductor industry identified the highest-priority process gases, “surrogate” gases, and the binary mixtures of process and carrier gases as well as targets for accuracy required to model manufacturing processes.

The semiconductor process industry uses CSTL-generated gas property values to model chemical vapor deposition (CVD) and to calibrate mass flow controllers (MFCs) that deliver process gases.

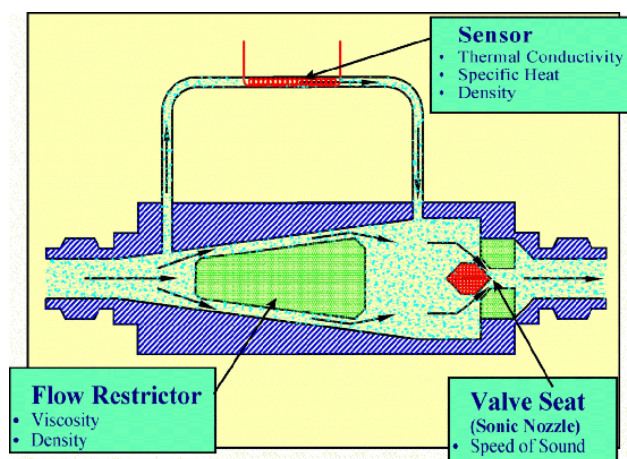

CSTL provides the data for the speed of sound, ideal gas heat capacity, viscosity, thermal conductivity, and the virial coefficients $B(T)$ and $C(T)$ that determine the pressure-density-temperature relation for more than 20 of these process and surrogate gases. We obtain the thermophysical properties by exploiting novel, accurate, NIST-developed acoustic resonators.

Acquired data are disseminated to our customers via our web site <http://properties.nist.gov/semiprop>.

The components of a generic mass flow controller (MFC) and the thermophysical properties required to model them.

After installing a Greenspan viscometer in a facility for handling hazardous gases, this year we used it to measure the viscosity and the speed of sound of 12 process and “surrogate” gases under the conditions listed in the enclosed table. As in our previous work, the speed of sound was used

to determine the ideal gas heat capacity to within 0.1% and virial coefficients that reflect each gas’s non-ideality. From the virial coefficients, we developed an equation of state that predicts the gas’s densities to within 0.1%.

The results of this research have been disseminated through publications in professional journals and by a series of talks at professional meetings.

J.J. Hurly, “Thermodynamic Properties of Gaseous Nitrous Oxide and Nitric Oxide from Speed-of-Sound Measurements,” Intl. J. of Thermophysics 24, (2003).

J.J. Hurly, K.A. Gillis, J.B. Mehl, M.R. Moldover, “The Viscosity of Seven Gases Measured with a Greenspan Viscometer,” Intl. J. of Thermophysics 24, (2003).

J.J. Hurly, Technical Editor of the Gases and Facilities Standards Committee of Semiconductor Equipment and Materials International, was honored for his “outstanding contributions” to the committee.

Gases and Conditions for Viscosity Data.		
Gas	Temperature Range (K)	Maximum Pressure (MPa)
He	298	3.3
Ar	200 - 375	3.3
N ₂	298	3.3
C ₃ H ₈	225 - 375	0.9
SF ₆	298	1.8
CF ₄	200 - 375	3.3
C ₂ F ₆	225 - 375	2.8
N ₂ O	225 - 375	3.4
NF ₃	225 - 375	3.4
BCl ₃	300 - 400	1.3
C ₁₂	280 - 400	3.2
HBr	225 - 400	3.3

The research team used a Greenspan viscometer to measure the speed of sound and viscosity of gases of importance to the Semiconductor Industry over a wide range conditions.



In the coming year, we will deploy a new monel spherical resonator and use it to measure the speed of sound in HF and SiF₄ to determine the “best in the world” equation of state for these difficult-to-handle gases. We also expect to measure the viscosity of four hazardous process gases: SiF₄, C₄F₈, CO, and CO₂. We anticipate that these results will decrease the viscosity uncertainty for these gases from about 10% of value to approximately 0.5%.

In Situ Calibration of Lightpipe Radiometers for Rapid Thermal Processing Between 300 °C to 700 °C

K.G. Kreider, W.A. Kimes, and D.C. Ripple (836); B.K. Tsai (PL)

Accurate temperature measurements are critical in rapid thermal processing (RTP) of silicon wafers for thermal oxidation and dopant anneals. Many RTP tools use lightpipe radiation thermometers (LPRTs) to measure the wafer temperatures during processing. These LPRTs can yield accurate temperature measurements when they are calibrated *in situ* or calibrated *ex situ* and used with the aid

The NIST team seeks to understand the metrology of *in situ* calibrations of lightpipe radiation thermometers in the range from 300 °C to 500 °C.

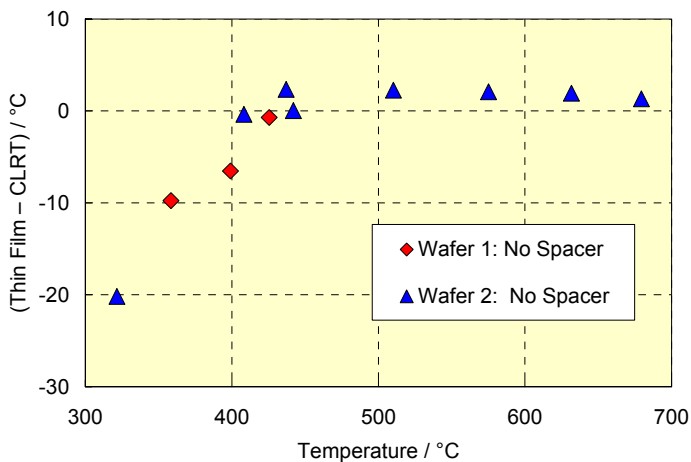

of a suitable model to correct for surface emissivity and chamber irradiation effects. Recent developments of LPRT sensor technology have enabled measurements to temperatures below 300 °C, compared to their previous lower limit of 500 °C. Use at these lower temperatures requires extreme care due to the relative increase in background irradiation compared to the weak signal produced by Planck emission from the wafer itself. This work seeks to understand the metrology of *in situ* calibrations of LPRTs in this temperature region.

The graph indicates the difference between wafer temperatures as measured by the NIST thin-film thermocouple wafer and as measured with a cable-less lightpipe radiometer (CLRT).

NIST has assessed the performance of commercial LPRTs and their calibration and temperature measurement uncertainty in RTP tools. We developed highly accurate blackbody calibration techniques for the LPRTs; characterized and measured the tempera-

ture sensitivity of the LPRTs; developed technology for *in situ* calibration of the LPRTs in the RTP tools using the NIST patented thin-film thermocouple calibration wafer; and measured the effects of wafer emissivity and LPRT proximity on the LPRT measurements in the RTP tool.

New commercial LPRTs couple the optical detector directly to the lightpipe resulting in improved detectors for low levels of radiance. These CLRTs are capable of measuring temperatures below 300 °C. Typical results of calibrating a CLRT against the NIST thin-film thermocouple (TFTC) calibration wafer from 315 °C to 700 °C in the NIST RTP test bed are shown in the figure. Below 550 °C, light leakage from the heating lamps of the RTP tool introduced a significant error in the LPRT readings. By measuring the transient response of the LPRTs following rapid energizing of the heating lamps, we were able to differentiate between the radiance of the wafer and ambient chamber light. This allowed us to correct for the ambient chamber light from the radiance of the wafer. Our results, which reported the uncertainties attainable for *in situ* calibrations with and without correction of chamber irradiation effects, were published and shared with the semiconductor fabrication industry.

The information provided by the NIST team will assist manufacturers and users of RTP tools to significantly improve the uncertainty of their temperature measurements.

The work that will follow will focus on the development and characterization of sensor technology for *in situ* calibration wafers. We are developing resistance sensors for use in the range 300 °C to 650 °C, where RTP tools are used in the formation of silicides and existing reference sensors are either fragile or unstable. We are also evaluating the sensitivity of commercial calibration wafers to perturbing heat fluxes.

Chemical Characterization of SiGe Single-Crystal Specimens and SiGe Films on Silicon with Electron Probe Microanalysis

R.B. Marinenko, D. Klinedinst, L. Richter, D. Simons, S. Turner, J.A. Small, E. Steel (837), and F. Stevie (NC State)

The research team investigated three aspects of SiGe thin-films in an effort to prepare reference materials of SiGe on Si. First we studied thin films of SiGe on 8-inch diameter Si wafers for heterogeneity using wavelength dispersive electron probe microanalysis (WD-EPMA). Twelve 2 cm x 2 cm specimens obtained from 2 different wafers were studied. The nominal compositions of the two films were 0.0384 and 0.341 mass fraction Ge, respectively; their approximate thickness was 95 nm and 170 nm, respectively. Secondary-ion mass spectrometry (SIMS) and ellipsometry revealed a circular halo-like region around the disk center that was thicker than for the rest of the disk thus suggesting specimen-to-specimen heterogeneity. With this knowledge, specimens were selected from a region in the wafer where the specimen-to-specimen thickness variation was expected to be minimal. Using a point beam – taking readings on 10 points per specimen – the extent of the point-to-point heterogeneity within each specimen and between specimens was assessed. The expanded uncertainty, including all heterogeneity contributions, was estimated to be no larger than 2.5% for Ge in 10 specimens.

The CSTL-led research team provides the semiconductor industry with a reference material for evaluation of SiGe components.

NC STATE UNIVERSITY

A heterogeneity assessment was conducted using WD-EPMA of five specimens cut from each of the SiGe14 and SiGe6.5 standard boules which were previously assessed for heterogeneity in 2003. The Ge in these five specimens had been analyzed with instrumental neutron activation analysis (INAA) and a sixth specimen had been analyzed by inductively-coupled plasma optical emission spectrometry (ICP-OES). We determined that the same sample-to-sample trends in the Ge composition shown by INAA were observed by WD-EPMA. Data, including backgrounds, were acquired at three different excitation potentials to enable quantification and evaluation of matrix correction procedures. This evaluation is ongoing and seeks to compare its results with those obtained using INAA and ICP-OES.

SiGe films on Si (approximately 4 μm thick) were prepared by ASM America. Given their thicker profile it is possible to treat them as bulk specimens with regard to quantitative electron microprobe analysis. Four specimens cut from two different disks with nominal compositions of SiGe10 and SiGe25 were tested using traverses and duplicate readings on random points to assess the heterogeneity. In addition, we acquired data at three excitation potentials with background readings for quantification. Using all these data we found that the expanded uncertainty ($k=3$ or 99% confidence interval) is less than 1% relative for both Si and Ge, which is only slightly greater than the counting statistics error predicted from Poisson statistics. Currently, evaluation of the random point heterogeneity data and the quantification procedures are in



process. Data from the standard boules will be used in conjunction with Monte Carlo calculations to determine the optimum voltage and corrections procedures for microprobe analysis of the thicker films. We will also continue to evaluate procedures for the quantitative electron probe analysis of the thinner films discussed in the first part of these studies.

CSTL plans to release the materials for distribution as “Interactive Materials”* during the first half of FY05.

***Interactive Materials** are materials that are donated by interested parties and distributed by NIST to private sector analysts. Data is submitted to the NIST IM Website, and evaluated by NIST staff that post collective results. This approach was designed to quickly make new materials (with some pedigree and evaluation) available to a specific community.

Non-Contact Free Carrier Density Measurements for Compound Semiconductors

J.E. Maslar and W.S. Hurst (836)

The transport of free carriers is central to the operation of all optoelectronic devices and thus, reliable measurements of the carrier properties are critical. Hall or capacitance-voltage measurements have been traditionally used to obtain this information, but they require electrical contact, which precludes their use *in situ* during growth, processing, and even on actual device layers.

The results obtained by CSTL researchers should facilitate the use of Raman spectroscopy for spatially-resolved, off-line characterization as well as for process monitoring and control during film growth and subsequent patterning processes.

Raman spectroscopy, as an optical technique that can be used for transport property determination, does not suffer from these limitations. It is non-destructive, spatially resolved, and can be applied to a specific buried layer, which is sometimes a problem for traditional electrical measurements.

The Raman spectra of n-type doped GaInAsSb epilayers shows a strong dependence on carrier density. The carrier density determined from the Hall effect measurement is indicated. The spectra are offset on the vertical scale for clarity.

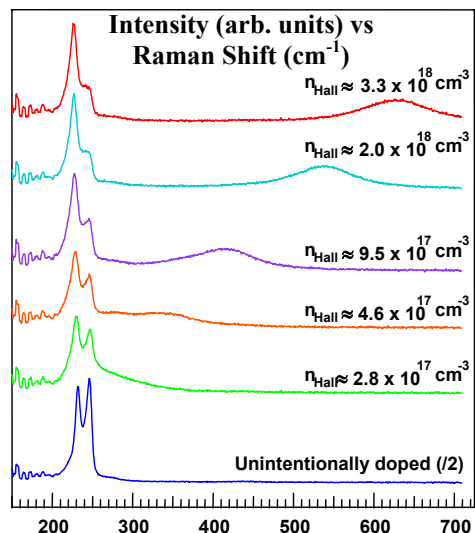

A number of issues are central to determining the accuracy and precision of Raman spectroscopy, including the semiconductor under investigation, the measurement system parameters, and the Raman spectral model used to fit the measured spectra.

Materials with a range of properties suitable for use in a variety of optoelectronic devices operating at different regions of the electromagnetic spectrum are being investigated. Our primary focus is on narrow band gap group III-antimonide materials and wide band gap group III-nitride materials. Spectroscopic systems were optimized for each material system after examining samples provided by various collaborators (thin films of narrow band gap GaSb, GaAsSb, GaInSb, and GaInAsSb; wide band gap GaN, and AlGaIn). Modeling of the Raman spectra from the different materials requires different spectral models that account for the differences in physical properties that make these materials suitable for different applications. Spectral models have been developed for n-type doped GaSb, p-type GaSb, n-type GaInAsSb, and n-type GaN. Efforts are underway to compare the results of the spectral models with electrical measurements to determine the suitability of the respective model.

Atomic Layer Deposition (ALD) – Process Models and Metrologies

J.E. Maslar, E. Moore, and W.S. Hurst (836); D.R. Burgess, Jr. (838)

Atomic layer deposition (ALD) is increasingly being used to deposit the thin (nanoscale) conformal layers required by many microelectronics applications, including high κ gate dielectric layers, diffusion barrier layers, copper seed layers, and DRAM dielectric layers. However, significant developmental issues remain for many of these applications.

A solution to some ALD developmental issues might reside in technology computer-aided design (TCAD), which was identified by the 2003 International Technology Roadmap for Semiconductors as “one of the few enabling methodologies that can reduce development cycle times and costs”. Yet many difficult challenges to development of validated, ALD process models that allow prediction of equipment influences on film properties have been identified, including chemical data (e.g., rate constants, cross sections, surface chemistry), reaction mechanisms, and reduced models of complex chemical reactions. In addition, due to a lack of fundamental physical and chemical data of sufficient accuracy, experimental validation is a “key difficult challenge across all modeling areas” and the “major effort required for better model validation is without doubt sensor development”. This project seeks to assist in addressing some ALD developmental issues by providing validated, predictive process models and associated metrologies.

CSTL researchers seek to develop *in situ* metrologies sensitive to Atomic Layer Deposition chemistry, and chemical reaction mechanisms leading to process model validation.

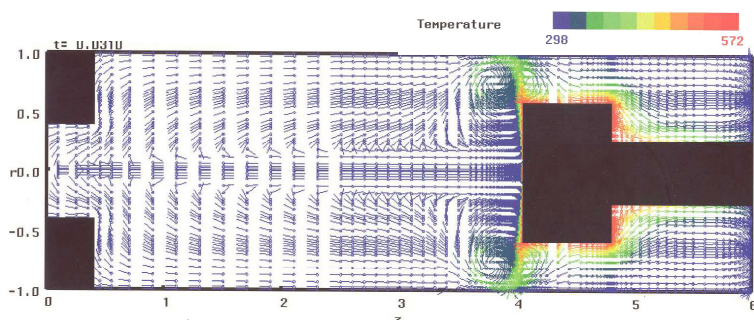

Simulation of the flow in the ALD reactor. Chamber pressure = 133 Pa (1 Torr); inlet gas flow rate = 200 standard cubic centimeters per minute; wafer surface temperature = 572 K.

This work involves two mutually-supporting directions: (1) the development of *in situ* metrologies sensitive to ALD chemistry and (2) development of ALD chemical reaction mechanisms. We expect that experimental results that elucidate ALD chemistry will aid in chemical mechanism development and ultimately in process model validation. Further, the most important reaction species will be identified as understanding of a particular ALD reaction improves, thus facilitating the design of improved process metrologies. Ultimately, aspects of both the metrology and reaction mechanism development will be required to create validated ALD process models.

els. ALD process models will be created by incorporating NIST’s chemical reaction mechanisms into commercial computational fluid dynamics codes and validating the resulting model under a range of parameters using experimental data collected during the course of this project.

Optically accessible ALD reactors have been constructed for *in situ*, high-sensitivity Raman and infrared absorption spectroscopic measurements. Hafnium oxide films will be deposited from tetrakis (dimethylamino) hafnium and water. A two-dimensional numerical model was developed to simulate the flow of gas and temperature of surfaces in the experimental ALD reactors. Chemical models of HfO_2 and Al_2O_3 ALD process chemistry are being developed and will be incorporated into the two-dimensional numerical reactor model.

During the upcoming year, ALD recipes will be optimized for our reactors. Then, during actual HfO_2 ALD, optical measurements will be performed on the deposition surface to determine the sensitivity of the optical measurements to various species present during ALD. Concurrently, we will search for correlations between specific growth steps uncovered by the more sophisticated optical methods with signals from conventional process monitors, such as a quartz crystal microbalance and mass spectrometer.

In-situ Monitoring of Ion Bombardment Energies in Plasma Etchers for Improved Wafer Yield and Throughput

M. Sobolewski (836)

During plasma etching silicon wafers are bombarded by reactive chemical species and energetic ions, resulting in selective removal of material from exposed areas of the wafer. The energy of ions striking the wafer surface plays an important role in determining the etching rate, the profile of etched features, and the extent of plasma-induced damage. To obtain the best results, the kinetic energy of ions must be carefully optimized and controlled.

Unfortunately, control of ion energy in industrial reactors is difficult because reliable methods for *in situ* monitoring are lacking. Traditional methods for measuring ion energy, which require that an ion energy analyzer be inserted into the plasma, are not compatible with industrial reactors. Typically, an analyzer will not survive very long when exposed to industrial plasmas, and it may cause contamination of the wafers being processed. Also, analyzers do not measure the ion energy at the most relevant location, the wafer surface.

CSTL researcher has developed a noninvasive method for monitoring the ion kinetic energy during plasma etching.

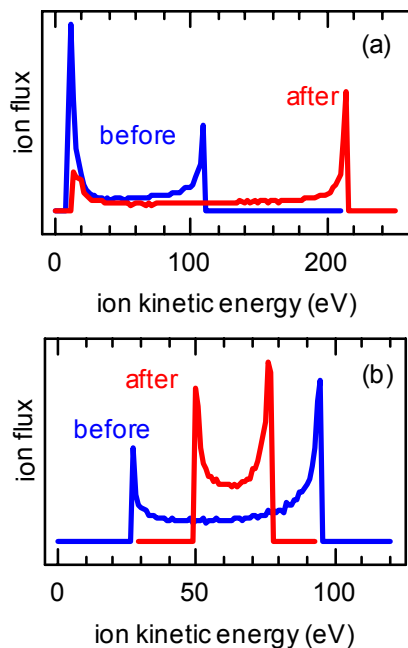

A CSTL researcher has developed and demonstrated a method for *noninvasive* monitoring of ion kinetic energy. It does not require that anything be inserted into the reactor. Instead it relies on measurements of the applied radio-frequency current and voltage, which are easily measured outside the reactor without any perturbation to the plasma or the process. These measurements are analyzed using electrical models of the plasma to determine the ion flux and ion energy distribution at the wafer surface.

Ar⁺ ion energy distributions obtained from noninvasive electrical measurements before (blue) and after (red) deposition of a conductive film on the inductive source window, for 1,000 Pa (10 mTorr) argon plasmas at 100 W inductive source power. (a) constant bias power at 1.0 MHz, and (b) constant bias voltage at 10 MHz.

The non-invasive monitoring technique now enables early detection of ion energy drift so that response strategies can be implemented to prevent costly wafer damage.

The method has been validated by comparisons with invasive ion energy measurements, and has recently been used to monitor drift in an inductively coupled plasma reactor. Over time, an electrically conductive layer builds up on insulating surfaces inside the reactor. This layer interferes with the operation of the inductive plasma source, causing a long-term downward drift in plasma density and ion flux. These changes in turn produce drifts in ion energy, which were monitored using the noninvasive technique. Depending on conditions, ion energies can either increase or decrease. In one experiment a change larger than 100 electron volts was detected. Such large changes in ion energy would certainly have deleterious effects on wafers being processed.

The technique developed in CSTL has provided a better understanding of drift mechanisms that could further help process technologists and equipment engineers to minimize and eventually eliminate ion energy drift.

In-Situ Characterization of Additives Governing Copper Electrodeposition

M.L. Walker, L.J. Richter (837), and T.P. Moffat (MSEL)

One of the critical issues facing the microelectronic/semiconductor industry is the robust fabrication of “on-chip” interconnections (wiring) between transistors and related devices. Due to its lower resistivity and superior electromigration characteristics, copper has replaced aluminum as the metal of choice for such interconnects. Interconnections are formed by electrodepositing copper into lithographically-defined sub-micrometer wide features (trenches and vias). The feature filling process occurs by superconformal or “bottom-up” growth that derives from a competition between electrolyte additives, such as inhibitors and catalysts, for available surface sites. A representative additive package to plating baths contains polyethylene glycol (PEG), chloride (Cl⁻) and sulfonate-terminated disulfides such as Na₂[SO₃(CH₂)₃S]₂ (SPS). Inhibition is provided by

Spectroscopic ellipsometry is a non-destructive optical technique capable of measuring optical characteristics of a surface, and is routinely used in the semiconductor industry to evaluate wafer quality.

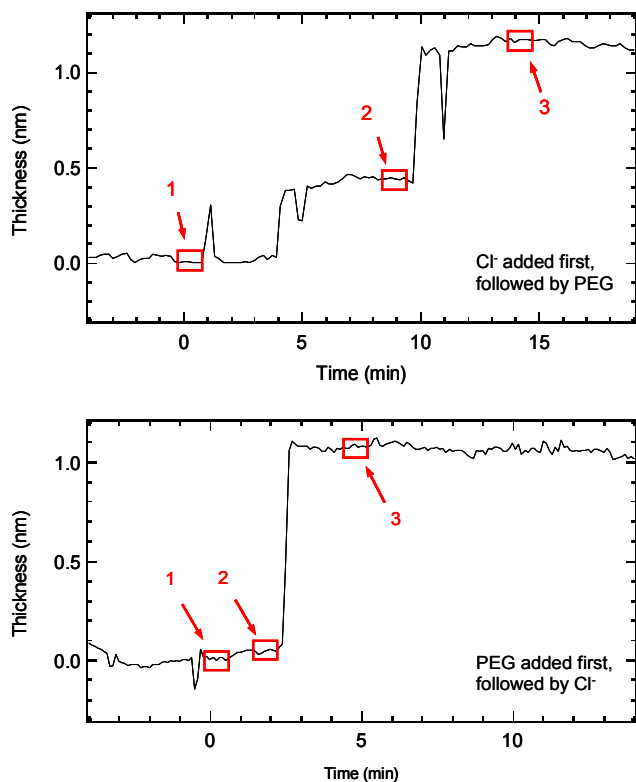

M.L. Walker, L.J. Richter, and T.P. Moffat, “In-Situ Ellipsometric Study of PEG/Cl⁻ Co-adsorption on Cu, Ag and Au”, submitted to J. Electrochemical Soc.

NIST researchers adapt a commercially available spectroscopic ellipsometer to evaluate the effect of additives on metal substrates in liquid-based environments to mimic the electrolytic plating baths used in the industry.

PEG/Cl⁻ while disruption of the PEG species by SPS/Cl⁻ leads to acceleration of the metal deposition. Incorrectly formulated baths can lead to uncontrolled electrodeposition, resulting in faulty interconnect creation and poor device performance. The PEG/Cl⁻ system was studied to more fully characterize synergies between bath components and probe the utility of spectroscopic ellipsometry (SE) for the *in situ* evaluation of electrodeposition. The formation of a film upon the addition of PEG and Cl⁻ was observed, and the results indicate that *in-situ* dynamic SE can accurately measure film thickness with better than 0.1 nm accuracy under certain conditions.

Ellipsometrically-determined model thickness trace of the layer formed on a copper substrate in the presence of the additives of PEG and Cl⁻ in an electrolytic bath at a plating potential. In the top graph baseline was established at “1”, Cl⁻ added after 4 minutes and measured at “2”, PEG was added at 10 minutes and measured at “3”.

In the second graph the baseline was established at 1, PEG added after 1 minute and measured at “2”, Cl⁻ added after 2 minutes and measured at “3”.

The results show the presence of Cl⁻ is necessary for the formation of a film, but a film eventually forms regardless of additive order. The adsorbed PEG film thickness is approximately 0.5 nm, consistent with a single layer of helically-wound PEG. Additional studies on gold and silver substrates established that chelation of copper ions is not necessary for film formation.

Studies on the three-component PEG/Cl⁻/SPS system are planned to build on the insights gained from the PEG/Cl⁻ system. Additionally, the use of other materials such as ruthenium as substrates for copper electrodeposition applications will be examined.

Characterization of Silicon Semiconductor Electronics Using SIMS Backside Depth Profile Analysis

E. Windsor, G. Gillen, P. Chi, D. Bright (837), and J. Bennett (International SEMATECH)

As silicon semiconductors continue to shrink, greater demands are placed upon the metrology techniques used to characterize these materials. If downscaling proceeds according to the schedule outlined by the International Technology Roadmap for Semiconductors, many metrology methods in current use will not have sufficient resolution to characterize future generation semiconductors. We envision that backside sample preparation combined with novel instrumental techniques such as C_{60}^+ cluster ion bombardment will extend the utility of secondary-ion mass spectrometry (SIMS) measurements to the characterization of future-generation silicon semiconductors.



This research team is working together with the Office of Microelectronic Programs (OMP) at NIST to develop metrology techniques for the characterization of future-generation semiconductors. SIMS is a useful characterization



tool because the technique has high analytical sensitivity and good depth resolution. State-of-the-art SIMS instruments are capable of reaching sub-micrometer depth resolution. Such resolution, however, is often not achieved when analyzing semiconductors due to limitations imposed by the samples themselves. This is particularly evident in the characterization of shallow dopant profiles and the investigation of diffusion of material through thin gate dielectric films. For both these examples, the analysis area is the ultra-shallow region of the silicon substrate. This region is buried below numerous layers of different materials that were deposited during the manufacturing process. Using SIMS to analyze the area of interest, one must first sputter through these different processing layers. Depth resolution is degraded while sputtering through these layers because of the development of surface topography (especially when sputtering through polycrystalline materials) and the occurrence of “knock-on” ion beam mixing. With backside depth profile analysis, high depth resolution is maintained by analyzing the sample from the back (substrate) side rather than the front side. This eliminates the need to sputter through the multiple processing layers on the front side of the wafer.

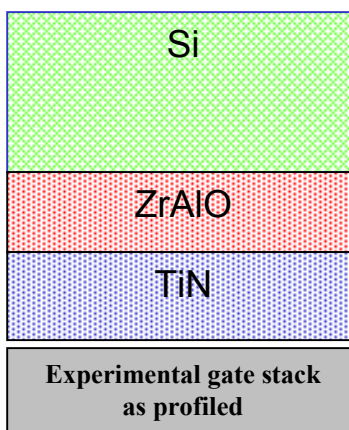

The backside depth profile method developed here can be applied to a variety of different samples including fully processed, patterned wafers.

We have prepared three-dimensional chemical images that illustrate artifacts produced during the grinding and polishing procedure. This was accomplished using secondary ion image depth profiling techniques to sequentially collect a stack of images during ion sputtering. These images were then combined to produce three-dimensional chemical images. The image below clearly shows the artifact of inclined polishing; the plane of polish is inclined relative to the surface of the sample.

By improving depth resolution, backside SIMS depth profile analysis should extend the utility of SIMS measurements to the characterization of future-generation semiconductor electronic devices.

If not corrected, this artifact will degrade the resolution of our SIMS analysis. By applying advanced image analysis techniques to the image stack, we minimized the effect of inclined polishing and improved the depth resolution of our SIMS analysis. Future plans include combining backside sample preparation with C_{60}^+ cluster ion SIMS depth profiling to further improve the depth resolution of SIMS measurements.

A CSTL-led research team developed a backside sample preparation method that uses grinding and polishing to remove the silicon substrate prior to SIMS analysis thus improving depth resolution.

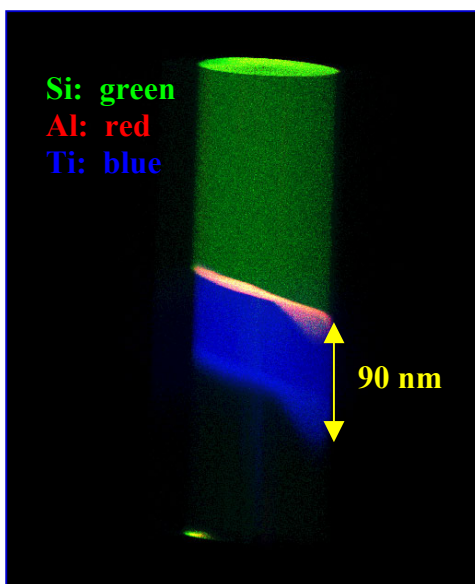

Neutron Transmutation Doping of Compound Semiconductors

R.M. Lindstrom (839)

Transmutation of silicon by nuclear reactions is used for the production of high-power rectifiers and other electronic devices. In this application, phosphorus is created by the capture of neutrons by ^{31}Si to make ^{32}Si , which decays to ^{32}P . Because silicon is transparent to neutrons, the phosphorus dopant is created uniformly through a large Si crystal. The process is also applicable to compound semiconductors.

CSTL researcher contributes to the investigation of the use of neutron transmutation doping for HgCdTe devices.

The same process is applicable to 1:1 compound semiconductors. Recently, neutron transmutation doping has been explored in two additional systems. In collaboration with the University of North Texas and the NIST Center for Neutron Research, films of $\text{Hg}_{0.8}\text{Cd}_{0.2}\text{Te}$ on $\text{Cd}_{0.95}\text{Zn}_{0.05}\text{Te}$ substrates were subjected to neutron irradiation. The goal was to transmute both Hg to Au and Te to As. An initial experiment, using neutron fluences of $(1 \text{ to } 2) \times 10^{16} \text{ cm}^{-2}$, showed that transmutation is feasible. The results of the experiment were published in *Physica E*. To study the effects of irradiation quantitatively, additional samples were exposed to a pure thermal neutron flux for fluences of $3 \times 10^{16} \text{ cm}^{-2}$ to $1.3 \times 10^{17} \text{ cm}^{-2}$; this work was reported at the US Workshop on the Physics and Chemistry of II-VI Materials held in Chicago during October 2004. The future applications of this technology depend on the results of characterization measurements now underway in our partner institutions.



**Materials Science and Engineering Laboratory
NIST Center for Neutron Research**

Properties and Processes for Cryogenic Refrigeration

R. Radebaugh, P. Bradley, M. Lewis (838), J. Gary, and A. O'Gallagher (ITL)

Details provided in the *Industrial and Analytical Instruments and Services* Section of this Report

11. Measurement Standards

*... anchoring the Nation's measurement infrastructure,
and supporting mature and emerging technologies*

NIST provides a wide variety of measurement, standards, and data services and programs to help US industry improve its international competitiveness, commercialize new technology, and achieve total quality in all facets of business operations. CSTL maintains and disseminates measurement standards for chemical, biomolecular, and chemical engineering measurements by developing Standard Reference Materials (SRM®s), Standard Reference Data (SRD), and by providing Calibration Services. CSTL partners with NIST Technology Services to help disseminate the standards to NIST customers.

With a significant role in NIST's Calibration Services, CSTL provides calibrations for volumetric test measures, pressure and vacuum gauges, thermometers, hydrometers, humidity measuring instruments, fluid flow meters and air speed instruments and optical filters. These calibrations help customers achieve the highest measurement quality and productivity. In addition, instrumentation manufacturers and other users rely on our calibration services to provide traceability to US national measurement standards. In FY 2004, CSTL performed a total of 682 calibrations for: airspeed, flow, humidity, thermometry, leak, vacuum, pressure, volume, and density, serving over 140 customers. In addition, 221 optical filter sets were re-certified for wavelength and/or absorbance in the UV and NIR spectral regions for more than 136 different companies.

SRMs provide scientists and engineers in industrial and academic research with internationally accepted standards for critical technical decision-making. NIST pioneered, and continues to lead, in the development of certified reference materials used for quality assurance. Traditionally, SRMs have been the primary tools that



NIST provides to the user community for achieving chemical measurement quality assurance and traceability to national standards. Currently, NIST catalogs nearly 1400 SRMs; in FY04 NIST sold approximately 30,400 SRM units to more than 6,500 unique customers. Approximately 24,500 of the units sold were from the ≈1000 different types of materials that are certified for or support measurements of chemical composition.

CSTL provides technical leadership for most of the chemical and compositional standards produced by NIST. SRMs are used for three main purposes: to help develop accurate methods of analysis (reference methods); to calibrate measurement systems; and to assure the long-term adequacy and integrity of measurement quality assurance programs. NIST SRMs also legally constitute part of the National Measurement System infrastructure of the United States and, as such, are essential transfer mechanisms for national as well as international measurement traceability.



Physical Standards Development

Examples of Physical Standards research activities in CSTL:

Temperature – *Primary acoustic thermometry, Methods and devices to disseminate ITS-90*

Pressure – *Intrinsic pressure standards in the range of 0.3 MPa to 5 MPa*

Vacuum – *Next-generation vacuum gauging technology*

Flow – *High-accuracy liquid volume and density, hydrocarbon liquid flow*

Humidity – *Thermodynamic methods for generation of moisture in gases; cavity ring-down spectroscopy*



Chemical Standards Development

Examples of new reference materials in production from CSTL:

Health – *Human cardiac troponin complex, homocysteine, folic acid*

Dietary Supplements – *Ephedra standards, Ginkgo biloba, bitterorange*

Environmental – *Contaminants in fish tissue and marine sediment, sulfur in diesel fuel, house dust*

Chemicals – *Low-carbon steel, zeolites*

Commodities – *Aluminum alloys, electronic scrap artifact, titanium alloy*

Forensics/Homeland Defense – *Trace particulate explosives, drugs of abuse, arson test mixture*

NTRM

To meet the growing need for traceable standards, CSTL pioneered the NIST Traceable Reference Materials (NTRM) program. An NTRM is a commercially produced reference material with a well-defined traceability linkage to existing NIST primary standards. The first NTRM program in gas-mixture reference materials was developed in 1992 for the compressed gas industry. The high availability of gas-mixture reference materials as NTRMs has significantly aided vehicle emissions testing in the US and has become the cornerstone of emissions trading in the fossil-fueled electric power industry. During FY 2004, 15 new gas NTRMs were certified for three companies. These included two batches of very low level, and therefore analytically difficult, 20 $\mu\text{mol/mol}$ nitric oxide in nitrogen NTRMs. An additional 29 NTRM batches were recertified this year for 4 companies to extend their certification period by 4 years. Convinced of the success of the NTRM program, CSTL is examining this model as well as other mechanisms to reach markets where a high demand for NIST traceability exists.

A study conducted by RTI International documented the success of the gas-mixture NTRM program, estimating that the “net benefits” of the program projected through 2007 will be \$50M to \$63M with a social rate of return of about 225%.

One of these mechanisms by which CSTL meets the need for additional traceable standards is intrinsic standards development. Intrinsic standards can reduce the need for labor-intensive artifact standard production and repeated costly inter-laboratory measurement comparisons. A paradigm is envisioned in which appropriate SRMs are not supported in perpetuity, but are produced through enough cycles to establish the material as an intrinsic standard or transfer the continued production to the private sector with an acceptable traceability strategy. A specific step in this direction resulted from our publication of band positions of dilute acidic holmium oxide solution as an intrinsic wavelength standard. These values were determined from results of an international comparison involving fifteen institutions (fourteen National Metrology Institutes). In a related development, CSTL researchers have developed an algorithm to implement holmium oxide solution wavelength calibration and a proposed extended use of the material as a universal simultaneous standard for both wavelength and absorbance.

Intrinsic standards “based on well characterized laws of physics, fundamental constants of nature, or invariant properties of materials” (ANSI/NCSL Z540) have many uses in physical and chemical metrology.

CSTL scientists continually strive to improve the metrology that underpins our measurements, standards, and data. We are also keenly aware that we do not live in isolation in the US – we are part of a global community, with an interdependence that crosses the traditional economic, environmental, and social boundaries. The US-based companies we serve are global, and therefore they function and compete in a global market. In order to meet our customers’ growing needs we are proactive in the international metrology community to ensure that measurements made in the US are accepted worldwide. Providing the traceability structure for the US promotes equity in trade and industrial competitiveness in the world marketplace.

Selected Chemical and Physical Standards Activities in FY 2004 (Described in more detail elsewhere in this report)

Automotive and Aerospace

Gas Mixtures Standards for the Automotive Industry: The NTRM Prime Program

W. D. Dorko (839)

New Gas Standards for Calibrating Instrumentation Used for Measuring Emissions from Next Generation Low-Emission Vehicles

W.J. Thorn III (839)

New Hydrocarbon Liquid Flow Standard for 0.2 L/min to 5 L/min

T. T. Yeh, P. I. Espina, and J. Aguilera (836)

Pharmaceuticals and Biomanufacturing

Leveraging Traceability for Chemical Spectrophotometry Through the Commercial Sector

J.C. Travis, M.V. Smith, M.D. Maley, and G.W. Kramer (839)

Energy and Environmental Technologies

Standards Development and Measurements to Support Global Climate Change

G.C. Rhoderick (839)

Standard Reference Materials (SRMs) and Quality Assurance Activities to Support Measurements of Organics on Air Particulate Matter Less Than 2.5 μm ($\text{PM}_{2.5}$)

S.A. Wise, J.R. Kucklick, B.J. Porter, D.L. Poster, M.M. Schantz, R.O. Spatz, and R. Zeisler (839)

Reference Material (RM) 8785 Air Particulate Matter on Filter Media

G.A. Klouda (837), J.J. Filliben (ITL), and H.J. Parish (SRI International)

New Standard Reference Material (SRM) for Organic Contaminants in House Dust

M.M. Schantz, J.M. Keller, J.R. Kucklick, D.L. Poster, H.M. Stapleton, S. Vander Pol, and S.A. Wise (839)

Method Development and Measurements of Polybrominated Diphenyl Ethers (PBDEs) in Tissue, Serum, and Sediment Standard Reference Materials (SRMs)

H.M. Stapleton, J.M. Keller, M.M. Schantz, and S.A. Wise (839)

Standard Reference Materials (SRMs) for Contaminants in Marine Tissue and Sediment

S.J. Christopher, R.D. Day, W.C. Davis, S.E. Long, R.S. Pugh, M.M. Schantz, J.R. Kucklick, D.L. Poster, J.M. Keller, H.M. Stapleton, K.E. Sharpless, C.S. Phinney, B. J. Porter, E.A. Mackey, R.O. Spatz, C.E. Bryan, J.R. Sieber, R. Zeisler, S.A. Wise, and G.C. Turk (839)

Food and Nutritional Products

Development of Standard Reference Materials (SRMs) for Dietary Supplements

S.A. Wise, L.C. Sander, and K.E. Sharpless (839)

Development of Ephedrine Alkaloid-Based Dietary Supplement Standard Reference Materials (SRMs)

L.C. Sander, K.E. Sharpless, J. Brown Thomas, B.J. Porter, T.A. Butler, M. Satterfield, S.E. Long, L.A. Mackey, K.E. Murphy, L.J. Wood, R.D. Vocke, L.L. Yu, and S.A. Wise (839)

Forensics and Homeland Security

Advanced InkJet Printing Technology for Trace Explosives Standards

G.J. Gillen, R.A. Fletcher, J.R. Verkouteren, M.R. Verkouteren, and G.A. Klouda (837)

A NIST Reference Material to Support Explosive Device Measurements

W.A. MacCrehan and M. Bedner (839)

Candidate Material for an Explosive Residues on Soil Reference Material

B.A. Benner, Jr. and W.A. MacCrehan (839)

Ethanol in Water Standard Reference Materials

M.M. Schantz (839)

Health and Medical Technologies

Technical Procedures for a NIST-Traceable Clinical Reference Laboratory Network

G.C. Turk, S.E. Long, and D.L. Duewer (839)

Development of Reference Methods and Reference Materials for Clinical Diagnostic Markers

M.J. Welch, D.M. Bunk, S. S-C. Tai, N. Dodder, B.C. Nelson, M.B. Satterfield, and L.T. Sniegoski (839)

Reissue of Electrolytes in Human Serum SRM Now Available

S.E. Long and K.E. Murphy (839)

Development of Reference Methods and SRMs for Toxic Species in Body Fluids

S.J. Christopher, W.C. Davis, C.E. Bryan, and R.D. Day (839)

The Development of Two Standard Reference Materials: Heteroplasmic Mitochondrial DNA Mutation Detection Standard (SRM 2394) and Fragile X Human DNA Triplet Repeat Standard (SRM 2399)

B.C. Levin, D.K. Hancock, and K.L. Richie (831)

Standard Reference Material for Measuring DNA Damage Related to Disease and Aging

H. Rodriguez, P. Jaruga, and M.M. Dizdar (831)

Standards for Fluorescence Microarray Analyses

G.W. Kramer, P.C. DeRose (839), and A.G. Gaigalas (831)

Reference Material 8640 for the Calibration of Flow Cytometers

A. Gaigalas and L. Wang (831)

Industrial and Analytical Instruments and Services

Development of a Calibration System for Refrigerant Leaks

P. J. Abbott (836)

Critical Reference Materials for Mineral Commodities

J. R. Sieber and A.F. Marlow (839), S. A. Wilson (USGS), and J. T. Wolsiefer, Sr. (Silica Fume Association)

Gas Standards Based on Optical Spectroscopies

J. T. Hodges and P. M. Chu (836), and R. Ciurylo (University of Nicolas Copernicus, Poland)

New Series of Standard Reference Materials (SRMs) for Raman Intensity Correction

S. J. Choquette (839), W. Hurst (836), and E. Etz (837)

International Measurement Standards



Increased requirements for quality systems documentation for trade and effective decision-making regarding the health and safety of the US population have increased the need for demonstrating “traceability to NIST” and establishing a more formal means for documenting measurement comparability with standards laboratories of other nations and/or regions.

NIST is the US National Metrology Institute (NMI) and the agency of the US Government responsible for US efforts under the Treaty of the Metre. The Committee International des Poids et Mesures (CIPM), and its various consultative committees, organizes comparisons of national measurement standards. After review, the results of these comparisons are recorded in the BIPM database (Appendix B). In addition, coordination of similar efforts with Regional Metrology Organizations (RMOs) extend the comparison efforts to as many participants as practicable. In October, 1999, NIST signed the CIPM Mutual Recognition Arrangement (MRA).

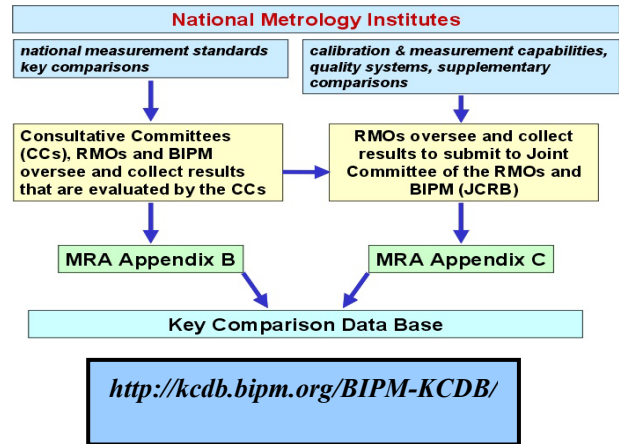

Since 1999 CSTL has systematically compared US national measurement standards to establish degrees of equivalence of US national measurement standard with those of other NMIs. These international activities add value to NIST standards and services, particularly for our customers involved in international trade. These MRA-related activities guarantee recognition of US standards by US trading partners.

The objectives of the MRA are:

- To establish the degree of equivalence of national measurement standards maintained by NMIs;
- To provide for the mutual recognition of calibration and measurement certificates (CMCs) issued by NMIs; and
- Thereby to provide governments and other parties with a secure technical foundation for the wider agreements related to international trade, commerce, and regulatory affairs.

For implementation of this MRA, the signatory NMIs agreed to:

1. Declare and document their calibration and measurement capabilities (CMCs) [Appendix C]
(<http://kcdb.bipm.org/AppendixC/default.asp>)
2. Participate in relevant international comparisons to support their CMCs [Appendix B]
(<http://kcdb.bipm.fr/BIPM/KCDB/>; <http://icdb.nist.gov>)
3. Implement and document the existence of a system for assuring the quality of the measurement services provided.

NIST and other National Metrology Institutes around the world have the responsibility for establishing, maintaining, and disseminating the highest level of metrological references for a given country or economy. The calibration and measurement services that these NMIs provide must be of high quality and delivered to our customers in a consistent and transparent manner.

Regional Metrology Organizations (RMOs) play an important role in the MRA. They have the responsibility for carrying out key comparisons within their regions. They also carry out supplementary comparisons and other actions to support mutual confidence in the validity of calibration and measurement certificates through the Joint Committee of the RMOs and the BIPM (JCRB). They are also responsible for the entries into the BIPM key comparisons database for the calibration and measurement capabilities of their member NMIs.



Systema Interamericano de Metrologia (SIM) is the RMO that includes the United States. The metrology organizations that make up SIM are known as: NORAMET (North America), CAMET (Central America), CARIMET (Caribbean), ANDIMET (Andes Region), and SURAMET (South America).

Regional cooperation leads to a wider harmonization of measurements and standards, facilitates free flow of trade, and is a necessary first step to globalization. NIST and National Research Council (NRC) Canada link SIM countries to the BIPM, and thus, provide greater opportunities for international trade and commerce. CSTL staff provides leadership for SIM by chairing the Chemical Metrology Working Group of SIM, and by serving as the US representative to the JCRB, in order to assure the effective, fair, and metrologically sound implementation of the MRA.

In order to most effectively address the unique needs of all 32 countries within SIM, CSTL has initially focused the SIM program on training and capability assessment rather than participation in MRA-driven key comparisons (KCs). During the past three years, eight inter-comparison exercises were carried out to assess the proficiency of SIM NMIs and/or their designated laboratories. Five additional exercises are planned for 2005.

CIPM Consultative Committees (CCs)

GLOSSARY

BIPM	Bureau International des Poids et Mesures
CIPM	Committee International des Poids et Mesures
CC	Consultative Committees
CCM	Consultative Committees for Mass
CCQM	Consultative Committee on the Quantity of Material
CCT	Consultative Committees for Temperature
JCRB	Joint Committee of the RMOs and BIPM
KC	Key Comparisons
KCRV	Key Comparison Reference Values
MRA	Mutual Recognition Arrangement/Agreement
RMO	Regional Metrology Organizations
SIM	Systema Interamericano de Metrologia

The CIPM has set up a number of Consultative Committees (a total of ten), which bring together the world's experts in their specified fields as advisers on scientific and technical matters. The first of these Consultative Committees (Electricity and Magnetism) was established in 1927, and the most recent was set up in 1998 (Acoustics, Ultrasound and Vibrations). A full listing can be found on the BIPM website. Among the tasks of these Committees are the detailed consideration of advances in physics that directly influence metrology, the preparation of Recommendations for discussion at the CIPM, the identification, planning and execution of key comparisons of national measurement standards, and the provision of advice to the CIPM on the scientific work in the laboratories of the BIPM.



The Consultative Committee for Temperature (CCT) was set up in 1937. Present activities concern matters related to the establishment and realization of the International Temperature Scale of 1990 (ITS-90) and thermodynamic temperature, extension and improvement of the ITS-90, secondary reference points, and international reference tables for thermocouples and resistance thermometers. NIST leads or is a member of eight of the nine Working Groups. CSTL staff members chair three of the Working Groups (Defining fixed points, Humidity measurements, and Calibration and measurement capabilities) and are members of three other Working Groups (Key comparisons, Uncertainties, and Thermodynamic temperature determinations).

The Consultative Committee for Mass and Related Quantities (CCM) was established in 1980. There are eleven Working Groups and present activities concern matters related to the comparisons of mass standards with the international prototype of the kilogram, considerations affecting the definition of the unit of mass, also density, pressure and force standards. CSTL interests overlap with five of the Working Groups (High Pressure, Low Pressure, Medium Pressure, Fluid Flow, and Viscosity) and a total of seven staff members participate in these Working Groups, with two serving as chair (although one has retired this year).

Consultative Committee for Amount of Substance: Metrology in Chemistry (CCQM) was created in 1993. Present activities concern primary methods for measuring amount of substance, and international comparisons, establishment of international equivalence between national laboratories, and advice to the CIPM on matters concerned with metrology in chemistry. CSTL is active in all seven of the CCQM Working Groups: Gas Analysis; Organic Analysis; Inorganic Analysis; Electrochemistry; Bioanalysis, Surface Analysis; and, Key Comparisons. These working groups are responsible for selecting and overseeing the operation of key comparisons that address chemical measurement-related issues important for international trade, environmental, health, and safety-related decision making. The CSTL director chairs the Organic Analysis Working Group, and a CSTL division chief co-chairs the Bioanalysis Working Group.

Participation in CCQM Key Comparisons is available only to top-tier NMIs around the world. Within the Americas, only the US, Canada, and Mexico have well-established programs in chemical metrology. While SIM is focusing entirely on training and capability assessment, Regional Chemical Metrology Working Groups in Europe and the Asian Pacific are forging ahead and conducting MRA-driven Key Comparison Studies. We have established agreements with the Chemical Metrology Working Group Leaders of both regions to allow non-CCQM member countries within SIM to participate in such studies as soon as they feel competent to do so. Once self-assessed capabilities of SIM member states are at an appropriate level, as determined based on performance in the SIM capability assessment studies, they can also request permission to participate in CCQM Comparisons.

Quality Systems Support Calibration and Measurement Capabilities (CMC) claims: A listing of Calibration and Measurement Capabilities is Appendix C of the BIPM Key Comparisons that was constructed as a means to implement the CIPM Mutual Recognition Arrangement. It is also required that a quality system be in place to support CMC claims. The NIST-level quality manual has been adopted for use and conforms to the requirements of ISO 17025. Each NIST Laboratory/Division disseminating measurement standards is required to have a fully documented quality system in place that summarizes and formalizes policies and approaches for addressing quality-related issues concerning the services that it provides. The approach is uniform across NIST, multi-tiered and modular. This quality system is used to support CMC claims both for chemical and physical measurement services provided by CSTL.

Chemical Metrology: About 1000 of the 3000 CMCs for chemical measurements in the BIPM database are from NIST/CSTL. CSTL has participated in 80 of the 93 Key Comparisons in chemical metrology and has led 40.

Physical Metrology: CSTL also has CMCs for Flow (14), Temperature and Humidity (99), Vacuum and Pressure (23), and is participating in or leading approximately 10 KCs in any given year. NIST is the pilot lab for KC Low-Pressure Gas Flow, the transfer standard development is near completion and the comparison is scheduled for mid FY05.

Selected Key and International Comparisons Completed in FY 2004

International Comparisons in Electrochemical Analysis

K.W. Pratt (839)

NIST participated in three international comparisons in the area of electrochemical analysis: SIM.8.11P in pH measurement, CCQM-K34 in assay of potassium hydrogen phthalate (KHP), and CCQM-P47 in electrolytic conductivity.

SIM Pilot Study SIM.8.11P, piloted by CENAM, was a follow-up to the previous SIM.8.P4, which had been piloted by NIST in 2000. Five participants, including NIST, performed Harned cell pH methods (primary method). The NIST results were in excellent agreement (within ± 0.0017 pH) with other experienced NMIs (those that had participated in previous CCQM pH Key Comparisons CCQM-K9 or CCQM-K17). The NIST uncertainties, which included all known Type A and Type B sources, were equal to or smaller than those of the other participating NMIs in the primary measurement. The reduction in the NIST combined uncertainty resulted from a threefold reduction in the Type A uncertainty of the extrapolation of the acidity function to obtain p_a° , the acidity function in buffer without added chloride (from which the pH is directly obtained). This reduction was directly attributable to the implementation of pre-equilibration of the Ag|AgCl electrodes used in the Harned cells.

The results of this Pilot Study correspond directly to the procedure for the certification of the phosphate pH SRM 186g and support the validity of its certification.

CCQM Key Comparison CCQM-K34 was designed to evaluate the agreement obtainable for the assay of potassium hydrogen phthalate (KHP) using high-accuracy assays. The seven participants each used coulometry. The NIST result and its estimate of uncertainty agreed well

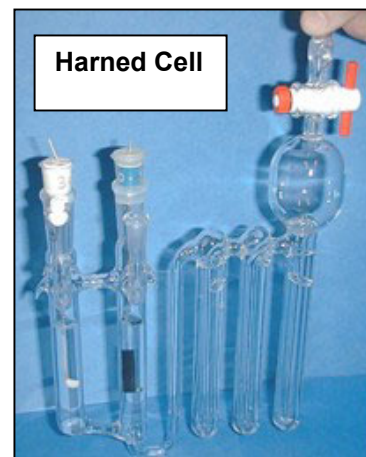

with those of the other “experienced” NMIs (who had participated in the corresponding pilot study, CCQM-P36). In addition, the NIST estimate of uncertainty was more complete than those submitted by all but one of the other participants (one included the same set of sources), in that more possible sources of uncertainty were included in the estimate.

CCQM Pilot Study CCQM-P47 evaluated the performance of NMIs in the measurement of electrolytic conductivity of two KCl solutions of nominal conductivity equal to 50 mS/m (500 $\mu\text{S}/\text{cm}$) and 5 mS/m (50 $\mu\text{S}/\text{cm}$). For the 5 mS/m solution, the pilot laboratory (NMI, Netherlands) discovered a time-instability in the solution as stored in the bottles used for distribution of the solution. Following discussion of the original results among the participants in April 2004, the pilot laboratory, NMI (Netherlands), decided to institute a time-dependent correction of the reference value. For the 50 mS/m solution, the NIST result was initially higher than the reference value. Following discussion at the CCQM Electrochemical Analysis Working Group, April 2004, the cell calibration procedure used at NIST was modified to eliminate the non-IUPAC primary calibrants that previously had been used. With this modification, the NIST result for the 50 mS/m solution was in excellent agreement with the reference value.



In addition to the above three comparisons, NIST also completed and submitted to the CCQM the Final Report of Pilot Studies CCQM-P19/P19.1, Assay of 0.01 mol kg⁻¹ Hydrochloric Acid, in which NIST was the pilot laboratory. The analyses for the two phases of this Pilot Study had been completed in preceding years, with 14 participants from NMIs worldwide. The submission of the Final Report formally completes this study and constitutes the official record of its results.

Sulfur in Diesel Fuel by Isotope Dilution Mass Spectrometry: Results of the CCQM K35 Key Comparison

W.R. Kelly, R.D. Vocke, J.L. Mann, and G.C. Turk (839)

Regulations in North America and Europe require that the petroleum industry and regulatory environmental agencies be able to measure accurately sulfur in diesel fuel between 5 $\mu\text{g}/\text{g}$ and 50 $\mu\text{g}/\text{g}$ with a total combined uncertainty of less than 1 $\mu\text{g}/\text{g}$. Both Europe and the United States will be moving to sulfur limits of 50 $\mu\text{g}/\text{g}$ and below fuels in the next year. Lower sulfur in fuels will make possible extremely efficient and long-lived after-treatment technologies based on noble metal catalysts.

NIST led a Key Comparison and associated Pilot Study to assess and document the capability of National Metrology Institutes (NMIs) to perform accurate determinations of sulfur in diesel fuel at and below future regulatory limits.

NIST planned and conducted a CCQM Key Comparison (K35) and a concurrent pilot study (P26.1) on sulfur in diesel fuel and kerosene, and the results were reported to the Inorganic Working Group of the CCQM in April 2004.

Participants in the studies measured sulfur concentrations in three candidate SRMs covering a wide range of sulfur concentrations.

The four laboratories shown in red were registered Key Comparison participants using isotope dilution mass spectrometry either with thermal ionization instruments (NIST and BAM) or inductively-coupled plasma mass spectrometry (LGC and IRMM). The other values were submitted as Pilot Study results. Shown in the figure are the mean values and total expanded uncertainties expressed as 95% confidence intervals and the individual determinations (solid circles to the right of the

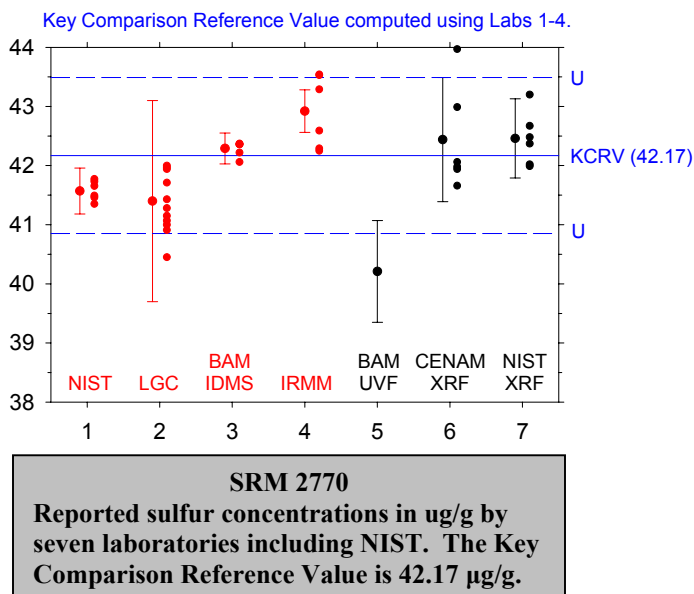

estimates) submitted by the NMIs. The Key Comparison Reference Value (KCRV) was computed using the Mixture Model Median method developed at NIST. The agreement among the four NMIs is considered good since the computed standard deviation is less than 1 $\mu\text{g/g}$.

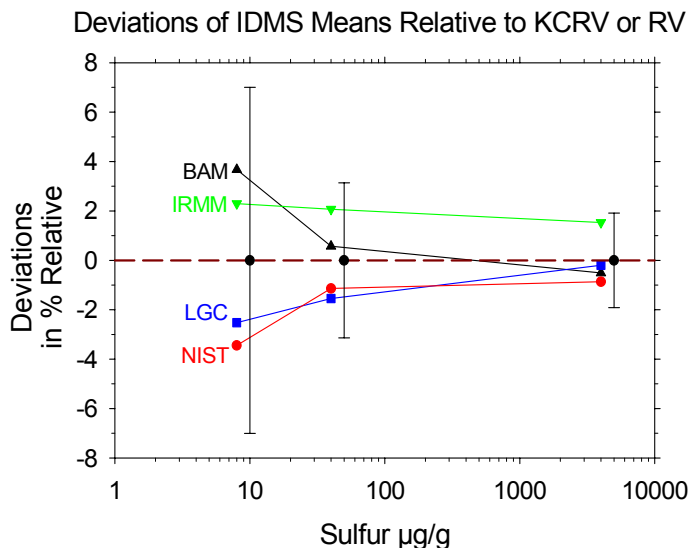

“Worldwide, many jurisdictions have recognized the public health and environmental costs of allowing motor vehicle fuels to contain High levels of sulfur. The EU, US, and Japan have led the way in sulfur reduction, and will reach near-zero sulfur levels later in this decade.”

The International Council on Clean Transportation

The results on all three samples are shown in the figure to the right as deviations from the reference values in relative percent. The reference values and total uncertainty are indicated by the points and error bars that are centered on the zero reference line. The reference values have been arbitrarily shifted to higher values for clarity of presentation. The greater spread in the data at the lower concentrations is a consequence of the greater influence of the blank.

CCQM K35 Key Comparison has demonstrated the capability of 4 NMIs to perform sulfur measurements in diesel fuel at a nominal 40 $\mu\text{g/g}$ concentration. Today the regulated upper sulfur limit in US on-road diesel fuel is 500 $\mu\text{g/g}$, but this limit will drop to 15 $\mu\text{g/g}$ in year 2006 and perhaps to near-zero (< 5 $\mu\text{g/g}$) in the next decade. Japan and Europe will adopt a 50 $\mu\text{g/g}$ limit in years 2004 and 2005. Europe will phase in a 10 $\mu\text{g/g}$ limit between 2005 and 2009 and Japan will adopt the same limit in 2007. The incremental measurement challenges increase non-linearly as sulfur concentrations decrease from 500 $\mu\text{g/g}$ to near zero levels. The regulatory agencies and the petroleum industry look to the national metrology laboratories to produce calibration standards with certified concentrations and uncertainties that will ensure a smooth and cost effective transition to low sulfur diesel fuel. CCQM K35 and P26.1 address present and near-future measurement needs at the NMI level.

The Joint Committee on Traceability in Laboratory Medicine (JCTLM)

Identification and Provision of “Higher Order” Certified Reference Materials and Reference Measurement Procedures Required for US Industry Compliance with the EU IVD Directive

W.E. May (839) and V.L. Vilker (831)

The goal of obtaining comparability of laboratory diagnostic test results will be possible only when common reference systems can be established for worldwide use. A critical step in reaching this goal is achieving traceability of reference measurement procedures and reference materials to a universally recognized and accepted reference point such as the International System of Units (SI). Recently, traceability requirements for medical devices to be imported into the European Community have been codified. The European Community In Vitro Diagnostic Directive (EC IVDD) states that “The traceability of values assigned to calibrators and/or control materials must be assured through available reference measurement procedures and/or available reference materials of a higher order” (98/79/EC, Annex1 (A) (3) 2nd paragraph). The Joint Committee on Traceability in Laboratory Medicine

The US IVD industry (ADVAMED) has asked NIST to work with our counterparts in Europe and the Asia-Pacific to provide the reference materials and methods of “higher order” that are urgently needed to comply with the requirements of the EU IVD Directive. Without timely completion of these standards, the industry’s access into the European market is seriously jeopardized.

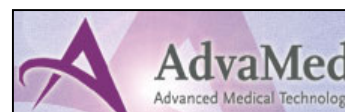

(JCTLM) was created to meet the need for a worldwide platform to promote and give guidance on internationally recognized and accepted equivalence of measurements in laboratory medicine and traceability to appropriate measurement standards. At present, neither reference materials nor reference methods are available for the vast majority of the chemical or biochemical species that are measured in medical laboratories using IVDs on a routine basis.

The JCTLM was established by the International Committee of Weights and Measures (CIPM), International Federation of Clinical Chemistry (IFCC) and Laboratory Medicine, and International Laboratory Accreditation Cooperation (ILAC)



NIST has provided the clinical measurements community with both neat chemical and human body fluid-based Standard Reference Materials for well-defined health status markers such as electrolytes (sodium, potassium, lithium and magnesium), cholesterol, creatinine, glucose, triglycerides, urea, uric acid, vitamins A, C, E and beta carotene, and several therapeutic and drugs of abuse for more than 20 years. Over the past few years, NIST has expanded its standards program in clinical diagnostics. A major portion of the expansion of the NIST program has involved the development of new standards for several protein, hormone, peptide, and other large biomolecule-based health status markers. Efforts have focused on development of reference methods and SRMs for: cardiac troponin I (heart attack occurrence and damage), C-reactive protein and homocysteine (heart attack risk), cortisol (endocrine function), folates (neural tube defects), glycosylated hemoglobin (diabetes status), prostate specific antigen (prostate cancer), and triiodothyronine and thyroxine (thyroid function). Many of these new markers show great promise from the clinical diagnostic perspective, but offer new and more difficult challenges for standardization. They are present in the blood at very low concentrations and many are thermally labile, very polar, and heterogeneous – both in conformation and in what is attached to them. Because of the vast market for tests for these new markers, many different measurement approaches have been developed that often provide quite different results. These discrepancies can lead to erroneous diagnoses and/or the need for retesting – both of which are very costly.

NIST expands its clinical reference material program, and develops new reference methods.

Availability of NIST Clinical Standards:

Three new SRMs were completed:

- Cardiac Troponin I (SRM 2921)
- Toxic Elements in Urine (SRM 2670a)
- Homocysteine and Folate in Human Serum (SRM 1955).

Three high-priority SRMs were renewed:

- Electrolytes in Human Serum (SRM 956b)
- Glucose (SRM 965a)
- Lipids in Human Serum (SRM 1851b).

NIST led the efforts of the JCTLM Working Group on Reference Materials and Reference Laboratory Procedures in establishing a process for identifying, reviewing against agreed upon criteria, and publishing a list of “higher order” certified reference materials and reference measurement procedures required for IVD industry compliance with the EU IVD Directive regarding in vitro diagnostic medical devices. In order to facilitate a fair and transparent review process, eight analyte categories were identified and review teams established for each. To the extent possible, each review team has representation from IVD manufacturers, National Metrology Institutes, accreditation organizations, and professional societies from the US, Europe, and the Asia Pacific Region.

On April 1, 2004, the JCTLM published its first List of Higher Order Reference Materials and Reference Measurement Procedures. This initial list (List I) comprises Certified Reference Materials (CRMs) and Reference Measurement Procedures for well-defined chemical entities or internationally recognized reference method-defined measurands (see examples in tables on the following page). Reference materials and measurement procedures included in List I are those that provide values that are traceable to the SI units; e.g., electrolytes, enzymes, drugs, metabolites and substrates, non-peptide hormones, and some proteins. List II was published during the last quarter of 2004, and comprises International Conventional Reference Materials, i.e., those for which the measurand(s) is/are not SI-traceable and/or no internationally recognized reference measurement procedure is available; for example, the WHO reference materials for coagulation factors, nucleic acids, and some proteins.



The current list contains approximately 100 reference measurement procedure entries for 58 different health status markers. Thirty of these “higher order” reference measurement procedures are from NIST. For reference materials, the list contains approximately 150 entries for 96 measurands; NIST SRMs provide traceability for 72 of these. A laboratory-based quality assurance audit program has been initiated to provide measurement results regarding the comparabil-

ity of multiple “higher order” reference materials for the same measurand on the list as well as to verify the veracity of the review process. Nominations are currently being accepted for high-purity substance reference materials and for human hair and body fluid-based reference materials and reference measurement procedures in the eight original plus five new analyte categories.

Reference Measurement Procedure					
Procedure Name and/or ID #	Analyte Name	Applicable Matrices	Measurement Principle	Reference Procedure Citation(s) or Document(s)	Reference Procedure Comparability Assessment Studies
NIST definitive method for serum cholesterol	cholesterol	lyophilized, fresh, or frozen serum	ID/GC/MS	Anal Chem 61, 1718-1723 (1989)	CCQM-K6; http://kcdb.bipm.org/appendixB/appbresults/ccqm-k6/ccqm-k6_final_report.pdf ; Clin Chem 36, 370-375 (1990)
U. Of Ghent reference method for cholesterol	cholesterol	lyophilized, fresh, or frozen serum	ID/GC/MS	Clin Chem 39,1001-6 (1993) [=part II of Clin Chem 39,993-1000 (1993)]; Eur J Clin Chem Clin Biochem 34, 853-60 (1996); Clin Chem 42, 531-5 (1996)	EUROMET 563
DGKC definitive Method for Serum Cholesterol	cholesterol	lyophilized, fresh, or frozen human serum or plasma	ID/GC/MS	Siekmann et al., Z. anal. Chem. 279, 145-146 (1976)	PTB - National Key Comparison for Accreditation
CDCAbell-Kendall method for cholesterol	cholesterol	lyophilized, fresh or frozen human serum	Spectrophotometry	Cooper, GR, et al, Clin Chem 32: 921-929, 1986	Clin Chem 36, 370-375 (1990)

Reference Materials							
Information about Material				Contact Information	References		Comments
Analyte	Matrix	Material Name and/or ID #	Estimated * Availability (months, as of Jan 2004)	- Producer - Country - Website - Email Address - Phone Number - Fax Number	Commutability Study Information and/or Citations	Other Relevant Publications	Hyperlink to Comparability Assessment Studies Comments
cholesterol	cholesterol	GBW09203b	60	NRCCRM China Tel: 086-10-64221811 Fax: 086-10-64213149 Email: cmservice@nrccrm.com.cn	Primary calibrator for higher order reference methods		
cholesterol	cholesterol	SRM 911b	21	NIST USA http://ts.nist.gov/srmdocs/230/232/232.htm Email: srminfo@nist.gov Tel: (301)975-6776 Fax: (301)948-3730	Primary calibrator for higher order reference methods		
cholesterol	human serum	JCCRM 211		HECTEF Japan http://www.ir6.co.jp/hectef/starte.htm Tel: 81-44-813-0055 Fax: 81-44-813-0224			NIST study presented at JCTLM Meeting, June 20, 2003, BIPM, Sevres, France
cholesterol	human serum (frozen)	SRM 1951b	60	NIST USA http://ts.nist.gov/srmdocs/230/232/232.htm Email: srminfo@nist.gov Tel: (301)975-6776 Fax: (301)948-3730	Material prepared following NCCLS Document C37-A "Preparation and Validation of Commutable Frozen Human Serum Pools as Secondary Reference Materials for	Previous lot (1951a) was measured in NIST study presented at JCTLM Meeting, June 20, 2003, BIPM, Sevres, France	
cholesterol	human serum (lyophilized)	SRM 1952a	60	NIST USA http://ts.nist.gov/srmdocs/230/232/232.htm Email: srminfo@nist.gov Tel: (301)975-6776 Fax: (301)948-3730		Method used for certification: Anal Chem 61, 1718-1723 (1989)	NIST study presented at JCTLM Meeting, June 20, 2003, BIPM, Sevres, France
cholesterol	human serum (lyophilized)	SRM 969c	38	NIST USA http://ts.nist.gov/srmdocs/230/232/232.htm Email: srminfo@nist.gov Tel: (301)975-6776 Fax: (301)948-3730		Method used for certification: Anal Chem 61, 1718-1723 (1989)	NIST study presented at JCTLM Meeting, June 20, 2003, BIPM, Sevres, France
cholesterol	human serum (lyophilized)	SRM909b	60	NIST USA http://ts.nist.gov/srmdocs/230/232/232.htm Email: srminfo@nist.gov Tel: (301)975-6776 Fax: (301)948-3730		Certification process described: Fresenius' J. Anal. Chem. 361:2 71-80 (1996). Method used for certification: Anal Chem 61, 1718-1723 (1989)	NIST study presented at JCTLM Meeting, June 20, 2003, BIPM, Sevres, France

12. Data and Informatics

... assuring that US Industry has access to accurate and reliable data and predictive models

For 30 years, NIST has provided well-documented numeric data to scientists and engineers for use in technical problem-solving, research, and development. These recommended values are based on data that have been extracted from the world's literature, assessed for reliability, and then evaluated to select the preferred values. These data activities are conducted by scientists at NIST and in university data centers.

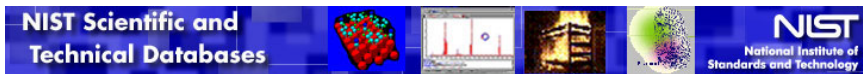

One of CSTL's goals is to assure that US industry has access to accurate and reliable data and predictive models to determine the chemical and physical properties of materials and processes. CSTL's data and informatics activities impact all industry sectors from biotechnology and microelectronics to energy and instrument manufacturers. Versatile interactive databases provide easy access to high-quality NIST data. Many databases are now available via the World Wide Web. The NIST *Standard Reference Database* (SRD) series has grown to over 80 electronic databases in chemistry, physics, materials, building and fire research, software recognition, and electronics. Through this program CSTL provides SRDs for Analytical Chemistry, Atomic and Molecular Physics, Biotechnology, Chemical and Crystal Structure, Chemical Kinetics, Industrial Fluids and Chemical Engineering, Materials Properties, Surface Data, and Thermodynamics and Thermochemistry. A few of the highlights in the area of Data and Informatics are described below, and a full listing of activities, with references to the appropriate program section, is also provided.

One data area of increasing focus for CSTL is bioinformatics. CSTL researchers work to develop adaptive, automated methods of processing and presenting biological and chemical data using connection tables that are sufficiently flexible and easy to use and allow users to find, with confidence, information for the most structurally-relevant data used in

NIST in collaboration with NIH developed a new structural database for AIDS research using novel techniques to annotate and browse.

<http://xpdb.nist.gov/hivpdb/hivpdb.html>

Medical Technologies section of this report. CSTL scientists also maintain other web-based bio-related databases: the Human Mitochondrial Protein Database and the Enzyme Thermodynamics Database.

NIST researchers are working with other scientists and organizations to establish data standards and more rapid methods of data entry in a number of data areas, including structural biology, thermodynamics, and kinetics. One example is the *Thermodynamics Research Center* (TRC). The TRC group is working with several journals to have the thermodynamic data from accepted articles go directly into the TRC database entry system through an electronic process. This assures that customers have the most up-to-date and complete information possible. The creation of data transfer and traceability standards is another key area of development. These standards remove barriers to the sharing of information and allow researchers to analyze results and collaborate in new ways. Another key concept is the establishment of the pedigree of data, in which enough information is retained to easily trace results and assign uncertainties to measured values, thus answering the vital question: "How good is that number?" In 2004, ThermoML was completed with incorporation of extensions for critically evaluated data, predicted data, and equation representations. It was also accepted as the foundation for the development of the IUPAC (International Union of Pure and Applied Chemistry) standard for thermodynamic data communications. In addition, in order to build an infrastructure for the process of global thermodynamic data communication, Guided Data Capture (GDC) software was

CSTL continues to be a prominent source of SRD products at NIST. In FY 2004, 3807 Mass Spectral units were sold through distributors to the GC/MS community, 363 Thermodynamics Research Center publications were distributed, and 654 units of CSTL databases were distributed directly to customers. In addition, over 2,500 CSTL products such as dynamic link libraries (DLLs), fluid property coefficients, and source code portions were incorporated into commercial software packages.



developed for mass-scale abstraction of experimental data from the literature. Additional TRC details are provided later in this section.

Over 2,500 *NIST Mass Spectral Libraries* are installed on GC/MS instruments each year. The most recent version of the library was released in 2002, and it remains the most comprehensive, reliable library of mass spectral ‘fingerprints’ to assist in the task of compound identification by GC/MS. GC/MS is the most widely used analytical tool for low concentration analysis for food safety and environmental monitoring. In addition it is extensively used in general organic analysis, the development of new flavoring agents, the analysis of fragrances and in many medical applications. However, at extremely low concentrations, it can be difficult to extract the trace signal from the mass spectrum due to the very complex background that is present. Therefore, a deconvolution software tool was developed by NIST. The *Automatic Mass Spectral Deconvolution and Identification Software (AMDIS)* was originally developed for detection of chemical weapons in complex mixtures such as might be found in the environment or in chemical process streams. It was designed to work without analyst input as a method of insuring that sensitive business information that could be present in a process stream was not compromised. In the last year the growth in the use of AMDIS by the organic analytical community has been very strong. One of the most exciting developments has been the incorporation of AMDIS into a new set of tools for automatic analysis developed by Agilent Technologies. The tools have been given the general name of Deconvolution Reporting Software (DRS) and incorporate Agilent Technologies run-time locking technology, the NIST search software, and AMDIS in a combined tool to allow users to identify pesticides at lower concentrations and with more confidence than had been possible with the Agilent system alone. More details are provided in the article entitled: *AMDIS – Automatic Mass Spectral Deconvolution and Identification Software* in the *Industrial and Analytical Instruments* section of this report.



The *NIST Chemistry WebBook* remains one of the most used resources for chemical and physical property data. The numbers of users, between 10,000 and 20,000 per week, and the variety of users, in industry, government and academia is a clear indication of the success of the WebBook. The fraction of returning users, typically 45% to 55%, is a good indication that the user community feels that the resource is valuable. The NIST Chemistry WebBook has been awarded "Best Chemistry Site on the Web - Portals and Information Hubs" by ChemIndustry.com Inc., John Wiley and Sons,

WebBook Statistics:

- over 650,000 distinct IP addresses access the WebBook each year
- between 10K and 20K users per week with around 50% return users
- an estimated average increase of about 28% in usage of the WebBook

<http://webbook.nist.gov/chemistry>

Inc., and the Royal Society of Chemistry, UK. The WebBook is second in total use among chemistry database web sites (only the Chemical Abstracts site has higher usage) and over 2,500 sites directly link to the WebBook, including essentially every technical library in the world. This year the Chemistry WebBook has been made available in other language versions; see details in *The NIST Chemistry WebBook Goes Multilingual* in the section that follows.

The WebBook is also a tool to aid future evaluation projects both at NIST and in collaboration with outside organizations. It is difficult to overstate the possible impact of the ongoing work on developing standard protocols for transmission of chemical data. The need for such standards has only grown as the use of the Internet in electronic commerce has grown. This need has been acknowledged by the large number of commercial as well as governmental entities, in particular those working on IUPAC and ASTM committees.

Selected Data Activities for FY 2004

The NIST Chemistry WebBook Goes Multilingual

P. Linstrom and W. G. Mallard (838)

The role of international trade is growing more important in the US economy each year. Although most US goods have a natural market in the Western Hemisphere, their export continues to be hampered by numerous factors. One such factor has been our limited ability to communicate with the non-English-speaking world. To address this challenge, NIST is actively working to make more of its information available in Spanish. The WebBook translations are part of this effort.

The NIST Chemistry WebBook is a widely used tool for both teaching and practicing chemistry worldwide, therefore NIST has made the WebBook available in more languages.

The need for as much information to be available in as many European languages as possible has been a driving force for numerous EU projects. Therefore, we have been cooperating with the European Commission to make the WebBook available in more languages. Since the NIST WebBook is extensively used in Europe this made it a prime candidate for the EU effort. The NIST role has been to provide the basic text in marked-up format ready for translation. The cost of the translation has been born by the EU. The first results of this are a set of web pages allowing the basic search to be done in French, Spanish, Czech, and Portuguese.

The W3C (World Wide Web Consortium) set standards for multilingual sites and they are supported by most of the new browsers. Using these standards, a Spanish-speaking user of the WebBook would be greeted in Spanish, and a user from Brazil would be greeted in Portuguese. Examples are shown to the right. In the future other languages will be added as the EU provides additional translation.

While it is impractical to translate every section of the WebBook, there are major portions of the opening screens that allow the users in other languages to more readily use the complex search features of the WebBook. We sought the expertise of Rui Pinto from Departamento de Química, Universidade de Aveiro, Portugal who came to NIST as a Guest Researcher to assist in this project, primarily to complete the Portuguese, Spanish, and French translations.

Because the WebBook has been conforming in its design to the most rigorous standards of W3C, the use of multiple languages with full support of the language-specific character sets was relatively straightforward to implement.

The National Institute of Standards and Technology (NIST) uses its best efforts to deliver a high quality copy of the Database and to verify that the data contained therein have been selected on the basis of sound scientific judgment. However, NIST makes no warranties to that effect, and NIST shall not be liable for any damage that may result from errors or omissions in the Database.

This meant that the preceding English version of the “disclaimer” could become what follows for the Czech version.

Národní Institut pro standardy a technologii (NIST) vynakládá maximální úsilí, aby zpřístupnil vysoce kvalitní databázi a mohl potvrdit, že zde obsažená data byla vybrána na základě řádného vědeckého posouzení. Přesto však NIST v této věci nedává žádné záruky a NIST nebude zodpovědný za jakoukoliv škodu, která může vzniknout v důsledku chyb nebo opominutí v Databázi.

Future changes will only require that the text be made available in standard formatted files.

Software for Phyloinformatics: Nextool, Nexplot and a NEXUS API in Perl

A. Stoltzfus (831), C. Liang, P.J. Yang (CARB/UMBI), W. Qiu and B. O'Brien (Hunter College, CUNY, NY)

Biological data make more sense when analyzed comparatively, in a historical (evolutionary) context, though it is often technically difficult to do so. Genome annotation, drug target discovery, biomolecule engineering, and medical genetics have come to rely increasingly on relatively crude forms of comparative sequence analysis. The success of a more robust approach will depend on software tools that facilitate the storage, exchange, processing, and visualization of genomic data together with phylogenetic trees. Our work focuses on developing and applying "phyloinformatics" tools that combine the rigor of evolutionary analysis with the scope of bioinformatics. These tools include procedures for data analysis, software applications, and database systems.

The NIST/UMBI/CUNY research team is developing procedures, software tools, and databases for analysis of genomic data that combine the rigor of evolutionary analysis with the scope of bioinformatics.

Libro del Web de Química del NIST

*Base de Datos de Referencia Estándar del NIST Número 69
Publicada en Noviembre, 2004*

NIST Livro de Química na Web

*Base de dados de Referência padrão do NIST número 69
Publicada em Novembro, 2004*

Cu-Zn Superoxide Dismutase

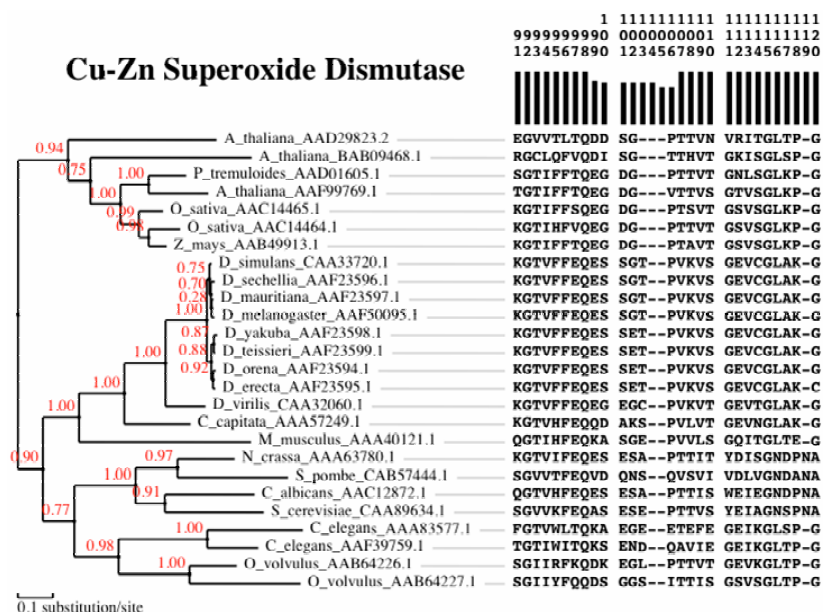

For over a decade, evolution researchers have relied successfully on a little-known data exchange format for comparative analysis known as NEXUS, which stores data sets, such as sequences to be compared, together with trees. To adapt this format and render it more accessible to the genome analysis industry, we have developed a NEXUS Applications Programming Interface (API) in Perl, the most commonly used computer language in bioinformatics. The utility of this software tool-box is demonstrated by two applications, Nextool and Nexplot. Nextool is a scriptable editor designed to automate tasks such as extracting subsets of data from a NEXUS file. Nexplot is a visualization tool that produces a customizable PostScript plot that combines sequence data (or other data) with a tree as shown in the figure.

ThermoML – An Emerging IUPAC Standard for Thermodynamic Data Communications

M. Frenkel, R. D. Chirico, Q. Dong, G. R. Hardin (838), and V. V. Diky (Belarussian State University)

Establishing efficient means for thermodynamic data communications is absolutely critical for provision of solutions to such technological challenges as elimination of data processing redundancies and data collection process duplication, creation of comprehensive data storage facilities, and rapid data propagation from the measurement to the data management system and from the data management system to engineering applications. Taking into account the diversity of thermodynamic data and numerous methods of their reporting and presentation, standardization of thermodynamic data communications is very complex. The ThermoML structure represents a balanced combination of hierarchical and relational elements. The ThermoML schema structure explicitly incorporates structural elements related to basic principles of phenomenological thermodynamics: thermochemical and thermophysical properties (equilibrium and transport), state variables, system constraints, phases, and units. Meta- and numerical data records are grouped into ‘nested blocks’ of information corresponding to data sets. The structural features of the ThermoML metadata records ensure unambiguous interpretation of numerical data and allow data-quality control based on the Gibbs Phase Rule. ThermoML covers essentially all experimentally determined thermodynamic and transport property data (more than 120 properties) for pure compounds, multicomponent mixtures, and chemical reactions (including change-of-state and equilibrium).

Researchers in the TRC Group have developed ThermoML, an XML (Extensible Markup Language)-based approach for storage and exchange of thermophysical and thermochemical property data.

Definitions and descriptions of all quantities related to the expression of uncertainty in ThermoML conform to the Guide to the Expression of Uncertainty in Measurement (ISO, 1993). In order to implement this extension of ThermoML, the TRC Group (formerly the Thermodynamic Research Center) made an interpretation of the US Guide to the Expression of Uncertainty in Measurement for the field of thermodynamics. In 2004, ThermoML was completed with incorporation of extensions for critically evaluated data, predicted data, and equation representations. In early 2004, ThermoML was accepted as the foundation for the development of the IUPAC (International Union of Pure and Applied Chemistry) standard for thermodynamic data communications.

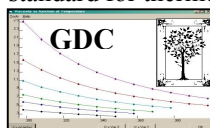

In order to build an infrastructure for the process of global thermodynamic data communication, Guided Data Capture (GDC) software was developed for mass-scale abstraction from the literature of experimental thermophysical and thermochemical property data for organic chemical systems involving one, two, and three components, chemical reactions, and chemical equilibria.

Global Data Communication Process

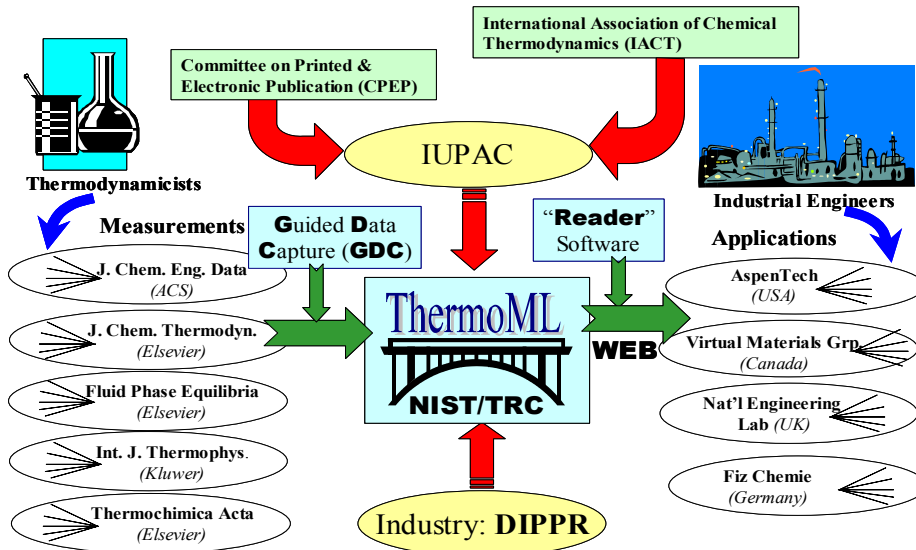

Combination of the software tools incorporating GDC and ThermoML allowed establishment of a new data communication process, which now includes major journals in the field of thermodynamics, such as the *Journal of Chemical and Engineering Data*, *The Journal of Chemical Thermodynamics*, *Thermochimica Acta*, and *Fluid Phase Equilibria*. As a result of the implementation of this process, hundreds of authors worldwide generate ThermoML files of their reported data at the time of publication. The TRC Group has designed and now supports Web distribution of the ThermoML files in the public domain without restriction.

Recommendations to IUPAC for a formal approval of ThermoML as a new IUPAC standard will be finalized in FY 2005.

The TRC Group has also been working with major data-user organizations (Aspentech, US; National Engineering Laboratory, UK; Fiz Chemie, Germany; Virtual Materials Group, Canada; Korean Institute of Science and Technology Information) to develop software 'readers' of the ThermoML files. In the near future ThermoML will be expanded to provide compound identification using the IUPAC-NIST Chemical Identifier (INChI).

ThermoData Engine: New Generation Expert System for Thermodynamic Data Critical Evaluation

M. Frenkel, R. D. Chirico, Q. Dong, C. Muzny, (838), V. V. Diky (Belarussian State University), and X. Yan (Texas A&M)

Traditionally, critical data evaluation is an extremely time- and resource-consuming process, which includes extensive use of labor in data collection, data mining, analysis, fitting, etc. Because of this, it must be performed far in advance of a need within an industrial or scientific application. In addition, it is quite common that by the time the critical data-evaluation process for particular chemical system or property group is complete (sometimes after years of data evaluation projects involving highly skilled data experts), it must be reinitiated because significant new data have become available. This type of slow and inflexible critical data evaluation can be defined as 'static.' These shortcomings have become magnified dramatically within the last 5 to 10 years due to the significant increase in the rate of publication of experimental and predicted thermodynamic data to be analyzed during the critical data evaluation process.

To address the weaknesses of "static" evaluations, the concept of a dynamic data evaluation system was developed at NIST. This concept requires very large electronic databases capable of storing essentially all experimental data known to date with detailed descriptions of relevant metadata and uncertainties. The combination of these electronic databases with expert-system software, designed to automatically generate recommended data based on available experimental data, leads to the ability to produce critically evaluated data dynamically or "to order". The dynamic data evaluation process dramatically reduces the effort and costs associated with anticipating future needs and keeping static evaluations current.

The NIST TRC Group developed the concept of a dynamic data evaluation. It combines electronic databases with expert-system software (designed to automatically generate recommended data based on available experimental data) to produce critically evaluated data 'to order'.

STATIC DATA EVALUATION

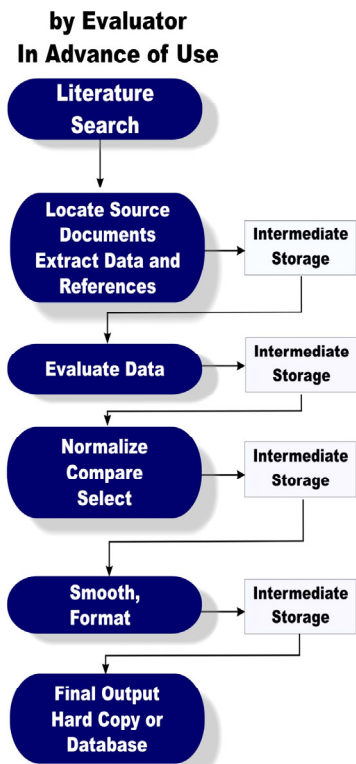

DYNAMIC DATA EVALUATION

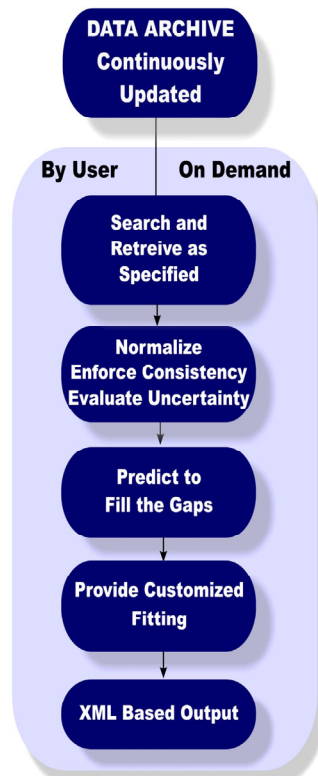

Functional comparison of static and dynamic data evaluation concepts.

Critically evaluated data produced by the deployment of the dynamic data-evaluation concept can rigorously be characterized with their quality assessments providing the ability to propagate reliable data-quality limits to all aspects of chemical process design. Implementation of the dynamic data evaluation concept consists of the solution of a number of major tasks: (1) design and development of a comprehensive database system structure based on the principles of physical chemistry and capable of supporting a large-scale data entry operation for the complete set of thermophysical, thermochemical, and transport properties for chemical systems including pure compounds, binary mixtures, ternary mixtures, and chemical reactions; (2) development of software tools for automation of the data-entry process with robust and internally-consistent mechanisms for automatic assessments of data uncertainty; (3) design and development of algorithms and software tools to assure quality control at all stages of data entry and analysis; (4) development of algorithms and computer codes to implement the stages of the dynamic data-evaluation concept; (5) development of algorithms to implement, target, and apply prediction methods depending on the nature of the chemical system and property, including automatic chemical structure recognition mechanisms; and (6) development of procedures allowing generation of output in a format suitable for application in major commercial simulation engines for chemical-process design.

The ThermoData Engine (TDE) software incorporates all major stages of the concept implementation including data retrieval, grouping, normalization, sorting, consistency enforcement, fitting, and prediction. The SOURCE data system is used in conjunction with TDE as the comprehensive storage facility for experimental thermophysical and thermochemical property data. In addition the NIST/TRC Ideal Gas Database is used as a source of thermodynamic property data in the ideal-gas state.

In FY 2004, the 'beta'-version of the first release of the TDE, focused on the thermodynamic properties of pure compounds, was produced and extensively tested within and outside NIST.

The software architecture emphasizes enforcement of consistency between related properties (including those obtained from predictions), assumes an imperfect source of original data, provides for flexibility in selection of default data models depending on the particular data scenario, incorporates a large variety of models for secondary fitting, and allows saving of critically evaluated data in the ThermoML format. The latter assures compatibility of the TDE software with any engineering application equipped with a ThermoML software 'reader.'



The "alpha" version of the TDE is scheduled for public release in FY05. Further development will include incorporation of the computational tools for generating equations of state on-demand depending on the data "scenario." Longer-term plans include expansion of the TDE to critical data evaluation for binary mixtures.

The IUPAC NIST Chemical Identifier (INChI)

D. Tchekhovskoi, S. Stein (838), S. Heller (Department of Agriculture, retired)

The question of clearly identifying a chemical has been present almost since the beginnings of modern chemistry. As the number of chemicals grew, the need for systematic naming produced a number of results. The most widely adopted of these is that of the International Union of Pure and Applied Chemistry (IUPAC). But for many chemicals the resulting names are complex and so common names are still widely used. For most chemists, the graphical structure is the best method for identifying a chemical. The structure provides graphic information that can allow a rapid understanding of the properties of the chemical that a long text name can never provide.

The complications of names even for very simple molecules are illustrated below:

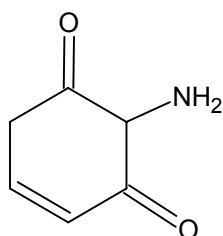

2-amino-4-cyclohexene-1,3-dione

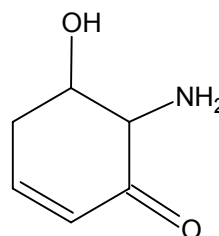

6-amino-5-hydroxy-2-cyclohexen-1-one

The numbering of both the amino group and the double bond changes in these names because of a set of rules for establishing precedence in functional groups. The structures allow the chemist to see the direct connection between the two molecules.

The complication with structures is that they are not easy to order in the sense that names can be ordered by simple alphabetical rules and they do not have an obvious storage method in the computer. Thus there has been a need to develop methods of describing a structure with a simple string that can be used both to order sets and to find a specific compound. Computer storage methods and search algorithms have been able for some time to process structural data but these have not been standardized (there is no agreed upon alphabet for structure representation in computers) and so the various systems for processing the data have not been able to easily communicate.

To accomplish this, much of what is normally viewed as “chemical information” was discarded and the molecules were trimmed to the minimum information needed to differentiate one from the other. In addition, a layered approach was developed to deal with some of the more complex issues of chemical structure.

The IUPAC-NIST Chemical Identifier (INChI)

The need for a uniform and open standard that could be adopted by the entire chemical community prompted the NIST/IUPAC project to develop a chemical identifier. The aim of the project was not to create another naming system for normal communication, but rather to create a naming system that would allow computers to uniquely identify a chemical.

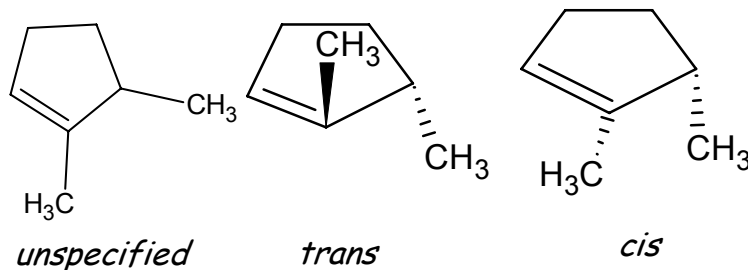

For example the two molecules in the illustration differ only in that one has the two methyl groups on the same side relative to the plane of the ring (on the right – called cis) and the other has the two methyl groups on opposite sides of the ring (in the center – called trans). On the left is a diagram that can be used to represent either of the molecules. The left diagram shows only the connectivity and does not specify if the molecule is cis or trans. The problem encountered prior to INChI is that the

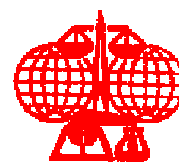

IUPAC

The goal of this research is to create a chemical naming system that would allow computers to uniquely identify a chemical, regardless of how it is drawn based entirely on the connectivity of the molecule – i.e., what atoms are connected to what other atoms.

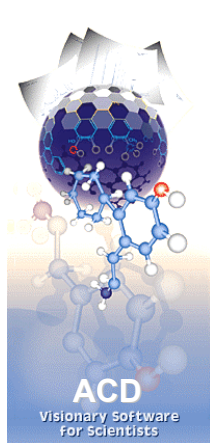

data retrieval was often dependent upon the way the molecule had been drawn. There is often a need to distinguish between the cis and trans form, and often a need to search for all possible forms, including cases where the configuration of the molecule was not known or it was known that a mixture was present.

The approach taken in developing INChI is a layered approach. This allowed as much information as was known to be specified, the search could be performed only on the information known, and the search could be stopped with less than full information. Thus, in the case above, a search for the cis isomer could be allowed to stop when it matched the connectivity or continued to find only the molecules that matched the geometric isomer. The methodology of INChI also conforms with the XML standards and the output of the method can be done in XML or in simple text.

The IUPAC NIST Chemical Identifier has been released for beta testing. The current version has been adopted by PubChem at NIH, is an integral part of the Chemical Markup Language (CML) standard, and has been integrated by ACD Labs in their widely used commercial drawing program, ChemSketch. In addition INChI will be integrated into the next version of the Chemistry WebBook so that anyone with access to the Internet can make use of this technology.

Selected Data Activities in FY 2004 ***(Described in more detail elsewhere in this report)***

Automotive and Aerospace

Benchmark Data on Liquid Fire Suppressants for Use in Aircraft

C. Presser and B. Johnson (836), C.T. Avedisian (Cornell University), G. Papadopoulos (Dantec Dynamics), J. Hewson (Sandia National Laboratory), D. Keyser (NavAir); P. Disimile, and J. Tucker (46th Air Force Test Wing)

Propulsion Systems Demand Accurate Property Data

J. W. Magee, D.G. Friend, T.J Bruno, M.L. Huber, E.W. Lemmon, A. Laesecke, R. . Perkins, J. A. Widegren (838), I. M. Abdulagatov (Russian Academy of Sciences), and P.C. Andersen (2B Technologies)

Combustion Simulation Databases for Real Transportation Fuels: A New Community Collaboration

T. C. Allison, D. R. Burgess, Jr., J. W. Hudgens, W. Tsang, and J. A. Manion (838)

Chemical and Allied Products

IUPAC Partnership Develops Standards and a Data Retrieval System for Ionic Liquids

J.W. Magee, J.A. Widegren, D.G. Archer, S.L. Outcalt, M.Frenkel, R.D. Chirico, Q. Dong, A. Laesecke, M.O. McLinden, R.A. Perkins (838), K.N. Marsh (U. of Canterbury, New Zealand), B.-C. Lee (Hannam U., Korea), and E.M. Saurer (U. of Notre Dame)

Second Industrial Fluid Properties Simulation Challenge

R.D. Mountain, D. Friend, R.D. Johnson, A.M. Chaka, F. Case (Case Scientific), D. Frurip, J. Moore, J. Olson (Dow), J. Golab, (BP Amoco), P. Gordon (ExxonMobil), P. Kolar (Mitsubishi Chemical), R.Ross (3M), and M. Schiller (DuPont)

Systematic Validation and Improvement of Quantum Chemistry Methods for the Prediction of Physical and Chemical Properties

C.A. Gonzalez, R. D. Johnson, and K.K. Irikura (838)

Thermodynamic Reference Data - REFPROP

E.W. Lemmon, M.O. McLinden, A.H. Harvey, and R.A. Perkins (838)

Forensics and Homeland Security

Explosives on Surfaces: A Sticky Problem

T.J. Bruno (838) and K.E. Miller (U. of Denver)

Raman Libraries

S.J. Choquette (839)

Health and Medical Technologies

NIST Launches New HIV Bioinformatics Database

T. N. Bhat (831); and A. Wlodawer (NIH-National Cancer Institute)

Thermodynamics of the Redox Reaction for Fatty Acid Desaturase

V. Reipa and V.L. Vilker (831); J. Shanklin (Brookhaven National Laboratory)

Mass Spectroscopy in Health and Environmental Science

S.E. Stein, P. Neta, and L. Kilpatrick (838)

Industrial and Analytical Instruments and Services

AnIML – Analytical Information Markup Language

B. A. Schaefer (University of Kaiserslautern, Germany); D. Poetz (Fachhochschule Wiesbaden, Germany);
A. D. Nguyen and G. W. Kramer (839)

AMDIS – Automatic Mass spectral Deconvolution and Identification Software

G. Mallard, S. Stein, and O. Toropov (838)

Microelectronics

Thermophysical Properties of Gases used in Semiconductor Processing

J.J. Hurly, K.A. Gillis, and M.R. Moldover (836)

Measurement Science for Future Standards and Technologies

A New Monte Carlo Application for Complex Sample Geometries

N. W. M. Ritchie (837)

13. Measurement Science for Future Standards and Technologies

... anticipating and addressing next-generation measurement needs of the nation

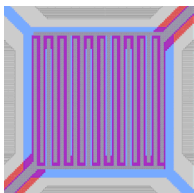

CSTL maintains a strong basic research program in broad aspects of measurement science that positions us with the capability to provide the required measurements, standards, and data to support future technology development. New measurement techniques are important for a host of industries including biotechnology, healthcare, environmental technologies, and the chemical process industry. Many of our activities, such as protein crystallography and materials microanalysis, are at the leading edge of science and technology.

Metrology Tools for Quantitative Cell Biology

J.T. Elliott and K.J. Langenbach (831)

Cell-based assays are utilized extensively in the biotechnology and pharmaceutical industry during multiple phases of product and drug development. Despite the widespread use of these assays, there has been little effort in developing metrics and standards to validate cell lines and the culture conditions before their use in an experimental setting. The absence of these validation procedures can cause complications when intra- or inter-laboratory data comparisons are required to fully interpret experimental results. The NIST research in quantitative cell biology has three dimensions: 1) development of indicator cells that express green fluorescent protein to report a cellular response, 2) development of highly reproducible extracellular matrix protein thin film substrates for use as reference cell culture substrates, and 3) automated fluorescence microscopy and image analysis methodologies for quantifying a cellular response.

Indicator cells under development contain an artificial gene encoding Green Fluorescent Protein (GFP), causing it to generate its own fluorescent signal if a property in the culture/material induces a specific cell response. As proof of principle, a mammalian fibroblast cell line has been engineered to fluoresce during proliferation using an artificial GFP-tenascin-C reporter gene. Rigorous biochemical studies designed to validate cellular biomarker response and to ensure the robust nature of the engineered cell line have confirmed that the activation of intracellular events associated with proliferation in these cells correlates with induction of cytoplasmic GFP.

In order to reproducibly control the adhesion substrate for cells, NIST has developed a series of biomimetic materials based on highly-reproducible ultra-thin films of biologically relevant extracellular matrix (ECM) proteins adsorbed onto alkanethiol self-assembled monolayers. The physical properties of these thin films and the cellular response to these films have been extensively evaluated to validate their biomimetic nature and their reproducibility in generating a cell response. The figure shows the population distribution of cell morphology on the reference fibrillar collagen films prepared one year apart (black vs. grey). This precise level of validation is critical to stakeholders for establishing the utility of the collagen thin films as reference cell-growth substrates.

CSTL leverages expertise in material and biological sciences toward meeting the metrology needs for the biotechnology and pharmaceutical industries.

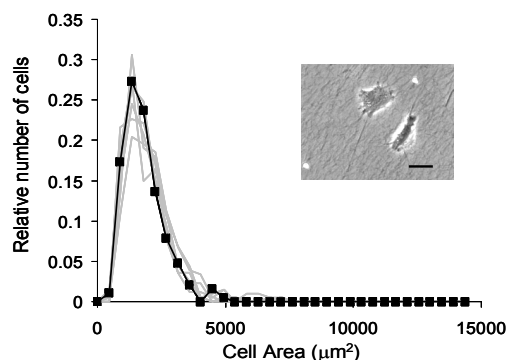

Cell morphology on reference fibrillar collagen films. (Black) prepared 2003; (Grey) prepared 2004.

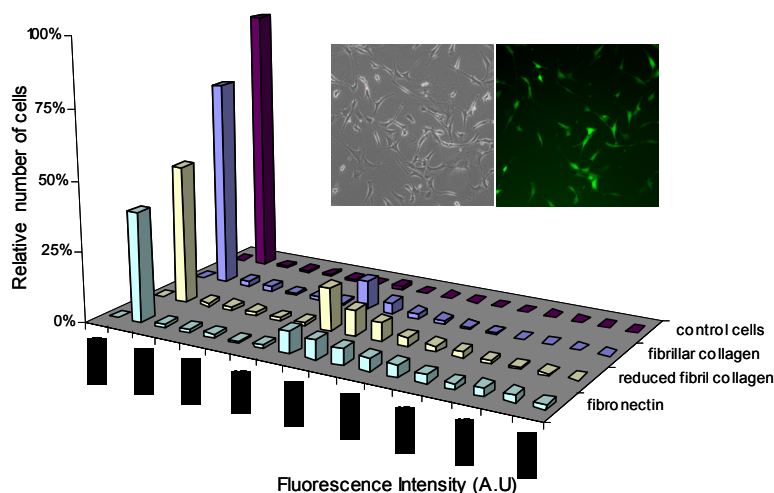

Histograms of GFP intensity from indicator cells on different reference ECM surfaces. The highest level of GFP expression occurred on fibronectin surfaces. Inset - phase and fluorescent pictures of GFP expressing cells.

NIST has adopted automated fluorescence microscopy and image analysis as the primary tool for rapidly quantifying how indicator cells respond to changes in culture conditions. Cells are stained with a novel two-color staining method developed in our laboratory which allows measurement of cell density, cell morphology, and level of response (GFP signal intensity) in cells. The identification of this high-contrast and robust staining procedure for fixed cells will be useful to any research group working to address how culture conditions, extracellular matrix modification, and biomaterial substrates influence cellular behavior. Histograms of indicator cell GFP intensity on different reference ECM substrates (inset: phase contrast and fluorescent image of indicator cells on reference ECM surface) are shown in the figure. The highest level of GFP expression occurs when the cells are cultured on a fibronectin surface.

Critical issues such as how cryopreservation and prolonged culturing influence cell behavior are being evaluated. In addition, future emphasis will involve the development of additional reference materials and protocols for standardizing measurements of cell-material interactions with the hope of bridging the gap between knowledge generation by basic scientists and product development in industry as well as addressing FDA concerns about quantitative cell measurements.

Protein Quantitation

N. Dodder and D.M. Bunk (839)

Proteins are measured in the clinical setting to assist in the diagnosis of a variety of diseases including heart attacks and cancer. Currently, the majority of these tests are performed using immunoassays. Although sensitive, fast, and relatively inexpensive, the specificity, accuracy, and precision of immunoassays can be a problem and necessitates a need for method validation through protein-based reference materials and methods. Two reference methods currently under development at NIST are based on liquid chromatography/tandem mass spectrometry (LC/MS/MS) and matrix-assisted laser desorption ionization time of flight (MALDI-TOF) mass spectrometry.

Initial studies explored the quantitative capabilities of MALDI-TOF mass spectrometry for the small protein human insulin. Investigations were made in sampling issues, such as the creation of homogenous sample spots, and in the automated use of the mass spectrometer, programmed to search sample spots to produce uniform sampling. Based on this research a quantitative MALDI-TOF method was developed for human insulin, using pig insulin as an internal standard. The linearity, dynamic range, and error of this technique were acceptable. However, further studies using larger proteins revealed limitations of this approach, particularly the limitations in finding internal standards that would be applicable for the measurement of large proteins.

CSTL researchers investigate new approaches to quantitative protein mass spectrometry to meet the need for new reference methods and materials to support clinical protein measurement.

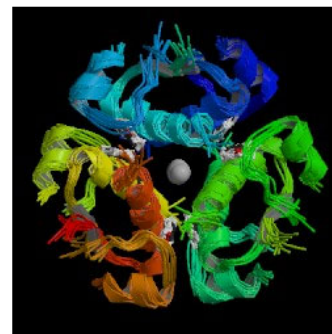

Structure of Insulin:
source [Protein Data Bank](#)

An alternative approach is currently under investigation, using some of the methodologies developed in the growing field of proteomics. Instead of measuring intact proteins, the peptides produced from the proteolytic digests of intact proteins are measured. Using this proteomics-based approach, we are developing methods utilizing both MALDI-MS and LC/MS/MS for quantitative protein measurements.



Because proteolytic digests, particularly trypsin digests, are at the core of our proteomics-based approach, we have devoted a large effort to understanding the practical nature of trypsin through fundamental studies of how experimental factors affect trypsin digests of analyte proteins. Guest Researchers from the United Kingdom (LGC) and Germany (PTB) have collaborated on this research effort. Successful quantitative measurements have been made on serum C-reactive protein using this approach.

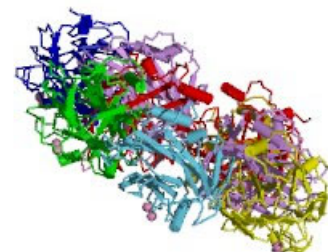

C-Reactive Protein
Source: *Protein Data Bank*

As the field of proteomics matures, more protein biomarkers will be discovered and used for clinical diagnoses. New immunoassays for protein biomarkers will require validation through more metrologically-sound methods, particularly methods based on mass spectrometry. Furthermore, accurate and precise protein quantification may help answer fundamental biological questions regarding protein expression and its relation to the genome and environment. Additionally, the techniques developed for protein quantification can also be used in the areas of drug discovery and biotechnology.

We are developing a quantitative method for serum transferrin using a combination of ion-exchange chromatography, tryptic digestion, and MALDI-MS. A quantitative method for serum transferrin will be an important component in the

Ongoing research at NIST includes the development of:

- **a quantitative mass spectrometric method for serum transferrin, and**
- **a reference method for C-reactive protein and its validation.**

on-going research at NIST to develop methods for serum iron speciation because transferrin is one of the principle serum iron transport proteins. We will also continue the development of a proteomics-based reference method for human C-reactive protein, a clinical biomarker for mild to severe inflammation as well as for cardiovascular disease. After further refinement of the C-reactive protein reference method developed thus far, a validation study utilizing patient serum samples is planned.

Nanobiotechnology: Nanoscale Chemical Reactions and Separations

L.E. Locascio, W.N. Vreeland (839), A. Jahn, and M. Gaitan (EEEL)

This project focuses on the development of nanoscale structures to facilitate the performance of ultra-small volume chemical reactions and separations. The work is associated with the Single Molecule Manipulation and Measurement NIST competence program whose purpose is to study the behavior of biomolecules one molecule at a time to elucidate the differences that make them uniquely beneficial or detrimental. The nanoscale structures that we are designing are composed most often of phospholipid molecules and are self-assembled spherical or tubular structures with diameters ranging from tens to hundreds of nanometers. We have demonstrated the use of these nanometer-sized structures for controlled chemical reactions using picoliters of reagents.

NIST researchers develop nanometer-sized structures that can ultimately be incorporated into microsystems (microfluidics and micro-electro-mechanical systems (MEMS) for use in studying the behavior of very small numbers of biological molecules with fine control.

Fabrication of microfluidic systems to facilitate the rapid and reproducible formation of liposomes with encapsulated fluorescent molecules: Due to their amphiphilic nature, when phospholipid molecules are dispersed in water they self-assemble into bilayer membranes to form structures called liposomes that are often spherical and encapsulate an aqueous internal volume. Liposomes made using bulk techniques range in size from 50 nm to tens of micrometers encapsulating volumes that are measured in attoliters to picoliters. Water-soluble molecules can be readily incorporated into the liposomes upon formation. The ultimate goal of our work is to use liposomes as discrete packages to sequester very

small amounts of reagents in order to finely control their reaction. For this purpose, two characteristics of the liposome population are critical – the liposome size and the number of encapsulated molecules contained inside each liposome. Ideally, we would like all liposomes in a given population to be identical with a diameter of approximately 100 nm and containing one encapsulated molecule. However, liposomes prepared from bulk techniques generally exhibit a very large polydispersity with either uncontrolled or unpredictable encapsulation efficiency. For example, liposomes made in our laboratory using established techniques range in size from 70 nm to 200 nm in the same preparation.

Demonstration of single-molecule encapsulation inside liposomes: Recently, we have demonstrated the automated and controlled formation of liposomes in microfluidic systems. In this work, we hydrodynamically focus a stream of lipid tincture at a microchannel cross-junction between two aqueous buffer streams. In a typical procedure, isopropyl alcohol (IPA) containing the dissolved lipids flows through the center inlet channel, and an aqueous phosphate-buffered saline solution flows through the two side inlet channels as shown in Figure 1a. When the two liquid phases come into contact, the IPA rapidly diffuses into the aqueous phase and *vice versa*. A fluorescence image of the liposome formation process is shown in Figure 1b where the IPA solution containing lipids also contains fluorescent dye that intercalates into the formed liposome membrane. Immediately downstream of the cross intersection (to the right in the image), the fluorescent intensity of the center stream increases indicating liposome formation (the quantum efficiency of the fluorescent dye in this experiment increases upon incorporation into a lipid membrane). The lipids self-assemble where the concentration of alcohol and buffer mixture is at a critical condition where lipids are no longer soluble. The flow rates of the alcohol and buffer channels are adjusted to control the degree of hydrodynamic focusing influencing both the dilution rate and the shear stress at the fluid/fluid interface. We have determined that changing this parameter allows us to maintain unprecedented control over the liposome size and homogeneity.

(a) White-light image of hydrodynamic focusing of IPA by buffer streams. Fluorescence images of (b) membrane-tracer fluorophore in IPA stream and (c) carboxyfluorescein (CF) in buffer streams.

Silicon/glass microchannels have trapezoidal cross sections with the following dimensions; depth = 40 μm , maximum width = 200 μm , minimum width = 147 μm .

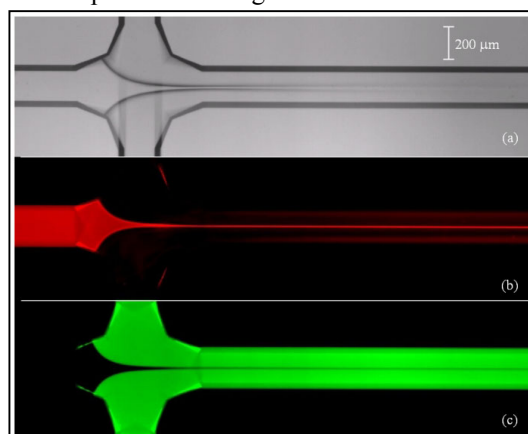

After formation, the liposomes flow downstream for collection as a tightly focused stream owing to the low Reynold's number laminar flow typical of microfluidics and the low diffusion coefficient of liposomes.

This work is critical to our efforts in the development of new tools for observing and characterizing single-molecule behavior. The characterization of single biomolecules, rather than the study of ensembles of biomolecules, is an important topic in the field of biology since it has been elucidated that the presence and behavior of the biological outlier or the mutant version of the biomolecule can facilitate amplification of that species resulting in catastrophic consequences as highlighted in recent reports on prions. This year, we have made considerable progress toward packaging single molecules, and performing controlled reactions with a few molecules. Future work will involve further characterization of encapsulated single DNA and RNA molecules so that we can study their behavior one at a time.

The NIST research team discovered that the characteristics of fluidic flow in a micrometer-scale channel can be used to precisely control the distribution of chemical conditions and mechanical forces so that they are constant on a length scale equivalent to that of a liposome. Hence, forming liposomes in micrometer-scale flow field results in more homogenous conditions during liposome self-assembly and resultant liposome populations that are more uniform in size, hence of low polydispersity.

Horizontal Growth and *In Situ* Assembly of Oriented Zinc Oxide Nanowires

B. Nikoobakht and S.J. Stranick (839)

Research in the area of nanoscopic materials has the potential for providing new classes of materials with performance and functionality not achievable by systems on large length scales. In the field of photonics, work is underway in the development of nanoscale light sources and detectors that are capable of operation at the single photon level. When coupled with the ability to manipulate and assemble these elements into hierarchical structures, nanodevices capable of performing sophisticated functions such as quantitative chemical measurement will be realized. Our recent efforts in this area have focused on developing methods for directed growth and assembly of semiconducting nanowires (NW).

CSTL develops an approach that promotes the horizontal growth, *in situ* alignment, and predictable positioning of ZnO nanowires (NWs), allowing for the large-scale production and assembly of ZnO NWs and NW arrays.

Research in the area of nanoscopic materials has the potential for providing new classes of materials with performance and functionality not achievable by systems on large length scales. In the field of photonics, work is underway in the development of nanoscale light sources and detectors that are capable of operation at the single photon level. When coupled with the ability to manipulate and assemble these elements into hierarchical structures, nanodevices capable of performing sophisticated functions such as quantitative chemical measurement will be realized. Our recent efforts in this area have focused on developing methods for directed growth and assembly of semiconducting nanowires (NW).

In the majority of semiconductor NW syntheses schemes, a thin catalyst film is used as the nucleation site/media for growth of NWs, resulting in standing NWs with diameters ranging from 20 nm to 120 nm. However, this approach has limited control over the diameter of the NWs making diameters smaller than 10 nm difficult to prepare. Perhaps more important for most device applications, NWs need to be assembled and aligned in the plane of the surface. To this end, we have developed a new technique for the growth of semiconductor NWs, which overcomes the limitations stated above. Using our approach, single-crystal NWs with adjustable diameters between 1 nm to 20 nm are grown horizontally (in the plane of the surface) along crystallographic directions on an *a*-plane sapphire surface.

a) Steps 1 through 4 show the preparation of Au lines as catalyst. Step 5 shows an Au line after growth of NWs. b) and c) Sapphire surface after growth of NWs. Large-scale assembly of NWs is seen in low (b) and high magnification images (c).

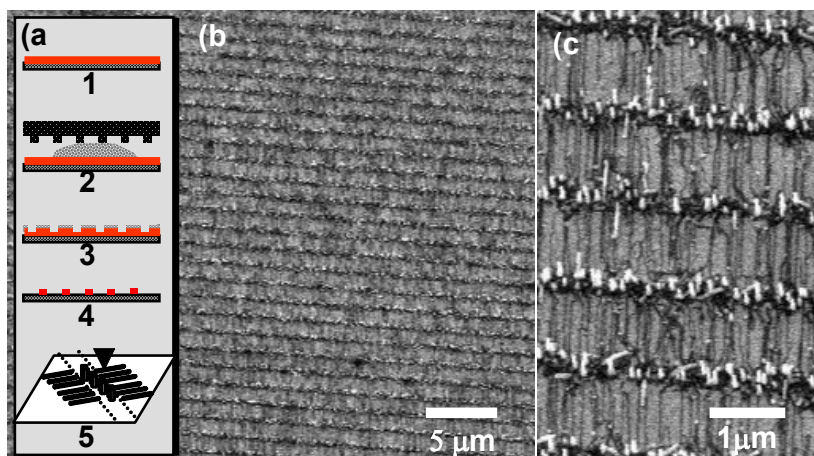

Our studies show that the crucial requirements for horizontal growth of NWs are the size of and the spacing between Au catalyst nanodroplets. To fulfill these geometric requirements, we have used thin Au lines (width < 200 nm) and/or lines of Au nanoparticles as nucleation sites for NWs growth (Figure 1a). Using a vapor-phase transport process at high temperature, each nanoparticle in the Au lines nucleates ZnO formation and becomes an NW. The figure is an example of the resulting oriented NW arrays formed using this procedure.

The methodology developed at NIST will provide an inexpensive and straightforward approach to the synthesis of semiconducting nanodevices (emitters and detectors) with multiple functionalities that can be integrated to form state-of-the-art measurement systems

B. Nikoobakht, C.A. Michaels, S.J. Stranick, M.D. Vaudin, "Horizontal Growth and *in situ* Assembly of Oriented Zinc Oxide Nanowires", *Appl. Phys. Lett.* 85, 3244 (2004).

This research has focused on the growth and manipulation of semiconductor ZnO nanowires. These methodologies are now being implemented in the fabrication of heterostructured (ZnO/GaN) NWs for use as nano-emitting sources (laser diodes) and nano-detectors (photodiodes) with emphasis on optical properties and performance suited for applications in sensing and spectrochemical analysis

Nanowires for Chemical Sensing

R. E. Cavicchi, C. B. Montgomery (836), P. M. Parthangal, and M. R. Zachariah (University of Maryland)

Nanowires (NWs), defined as electrically conducting structures with cross-sectional dimensions on the nanoscale, possess unique characteristics that make possible a host of new chemical sensing devices. Nanowires have a high fraction of their constituent atoms on the surface and therefore have electrical properties that are exquisitely sensitive to the chemical environment. The high aspect ratio of nanowires is also useful for producing high electric fields at the tips providing enhanced field-emission which may be utilized for species-dependent ionization of gases. While carbon nanotubes (CNTs) are an example that has received much attention, it is now possible to make nanowires of other materials ranging from semiconductors such as Si, CdTe, or ZnO to a variety of metals. To realize chemical sensors, methods of synthesis of nanowires must be developed that are compatible with integration onto chips. Sensing approaches that take full advantage of the unique properties of these materials must be developed.

We have pursued two methods for fabricating nanowires on sensor chip platforms. The first method takes advantage of recently developed methods for growing CNTs and NWs that start with a nanoscale metallic particle. For CNTs a chemical vapor growth is performed using a mixture of hydrogen and a carbon-containing species, such as methane, acetylene, or ethanol, with the substrate held at temperatures from 600 °C to 1000 °C. Nucleation occurs on the metal particle. For NWs the process is similar, but with different precursors. Novel to our approach is a vapor-phase synthesis that produces charged nanoparticles in an argon stream. Electric fields are used to size-select the nanoparticles and guide their deposition to specific locations on a substrate. Figure 1 a) shows an example of the use of an applied electric field on one of the pair of interdigitated comb electrodes to localize the deposition of Ni particles to one electrode, and 1b) shows CNTs localized to one electrode, produced by chemical vapor deposition (CVD) of acetylene using the Ni particles as nucleation sites.

The research team seeks to create nanowires and nano-materials for a new generation of chemical sensors with enhanced sensitivity and chemical selectivity

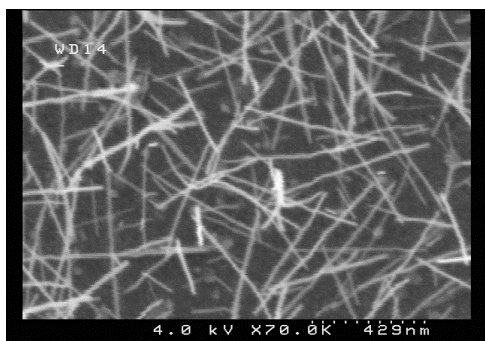
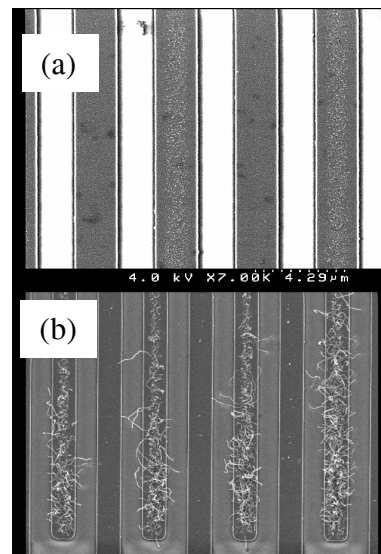

A second growth technique for nanowires takes advantage of our recent discovery that tungsten, when heated in the presence of a reducing gas, undergoes a significant change in morphology. We have developed a process for producing NWs of tungsten by a simple hydrogen plasma treatment of thin film or bulk tungsten that uses a much lower temperature (450 °C) than is required for the vapor deposition methods described above. Thin films of tungsten treated in this way are converted to NW "grass" as shown in the figure to the left. We have found that treatment of smooth tungsten filament wire results in a bristle coating of NWs, which may also be useful for applications where field emission is used. Tests have shown these NW films to be sensitive to volatile organics.

We are currently exploring treatments of the nanowires, including templated growth of other materials on CNTs and NWs. We are exploring the limits of field-guided deposition of nanoparticles, including a novel self-assembly approach that uses the concentration of electric fields at the tips of NWs. These new materials will be integrated with existing silicon micromachined sensing platforms in our group to perform chemical sensing via electrical measurements at a wide range of temperatures.

High Performance Oxide and Polymer Nanostructures for Advanced Solid State Chemical Microsensors

K.D. Benkstein, C J. Martinez, G. Li, D.C. Meier, S. Semancik (836), T. Mallouk (Penn State), and V. Dravid (Northwestern)

Efforts underway at NIST, and through collaborations with two universities, are aimed at developing nanoparticles, nanofibers, nanowires, nanotubes, and related structures of oxides and polymers for use in nanosensor arrays and microanalytical systems. These nanomaterials are being studied as signal transducers for chemical sensors and as elements for filtering and preconcentration of analytes prior to detection. The approach is to assemble hierarchical structures for chemical sensing applications from single nanostructures and various nanocomposite materials. These well-defined nanostructures will increase the surface area and active interfacial sites for adsorption and reaction of gas phase analytes, thereby leading to more sensitive chemical measurements. These structures are also designed to enhance diffusion of the target molecules to functional sites by introduction of various scales of micro- and nano-porosity.

Specific materials forms being studied include SnO₂ microshells, TiO₂ nanoparticles, porous SiO₂, nanofiber and nanowire polyaniline, nanowire oxides, and pure and doped SnO₂ sol gels dispensed by dip pen nanolithography. The SnO₂ microshells are formed via a solution phase, layer-by-layer deposition of SnO₂ nanoparticles on sacrificial polystyrene spheres. These solutions are deposited on microheater platforms and the polystyrene spheres are removed by rapid heating to leave hollow, nanoporous SnO₂ shells with ultrathin walls. The microheaters also provide electrical contacts to the SnO₂ microshells for chemical sensing measurements. The SnO₂ microshells have exhibited sensitivity factors as high as 50 for detecting 1000 μmol/mol methanol in air. Porous silica is being developed as a high-area support material for microscale preconcentrators and filters. This mesoporous material is formed by heating silsesquioxane/block copolymer blends to produce a highly porous SiO₂ structure. While much of our sensing research has focused on semiconducting oxides, conducting polymers are also now being investigated to expand the range of analytes that can be sensed by multielement microarrays. We have found that polyaniline nanofibers respond more than seven times faster than denser polyaniline films, and through a collaboration with Penn State, we are exploring the sensitivity and speed enhancements possible with polyaniline nanowires. Nanowires and nanotubes of polyaniline, SnO₂, and TiO₂ are all being studied as fundamental building blocks for constructing nanoarrays capable of analyzing complex chemical mixtures. Related oxide materials are being investigated with Northwestern, where dip pen nanolithography has been employed to pattern SnO₂ nanomaterials.

Higher sensitivity, stability, and reproducible fabrication of sensing materials are critical to next-generation sensing devices. The improved sensitivity, selectivity, and response time that can be attained by proper assembly of nano-building blocks is expected to impact many application areas including alarm triggers for counter-terrorism, trace gas detection in space exploration, and the monitoring of gaseous bioproducts for medical diagnostics.

The CSTL-led research team is developing nanoengineered materials for microsensors and microanalytical systems to increase sensitivity, selectivity, and stability of chemical detection and monitoring.

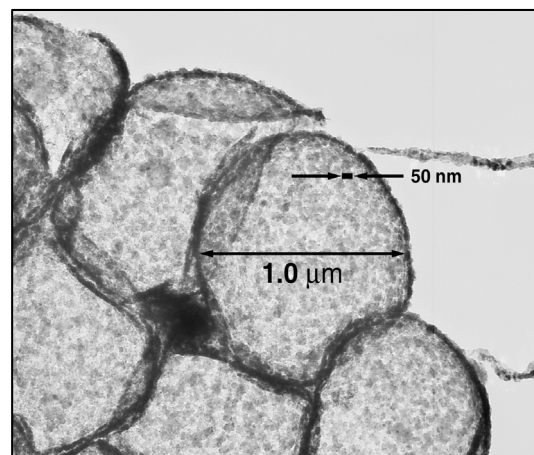

TEM image of SnO₂ microshells formed on sacrificial polystyrene spheres with layer-by-layer assembly of nanoparticles

Future studies at NIST and at collaborating institutions will develop more reproducible processing methods and explore the fundamental mechanisms responsible for sensing enhancements realized through nanoengineering. Methods of manipulating nanostructures, particularly single particles, wires, and tubes, onto microdevice platforms to enable electrical, and hence sensing, measurements, remains a challenge and will also be a focus of our studies.

Controlling "Injection Barriers" into Prototype Molecular Wires Through Substrate Coupling Chemistry

S. W. Robey (837), R. D. Van Zee, and C.D Zangmeister (836)

The drive to introduce organic molecular materials into electronic device applications (organic or molecular electronics) is motivated by a number of potentially attractive features, such as ease of fabrication, ability to fabricate on flexible substrates, and the wide extent to which organic materials can be functionalized via organic synthetic methods. A range of applications is foreseen for organic field effect transistors and light emitting diodes including, for instance, flexible displays and other low-cost flexible electronics.

In addition to replacing inorganic semiconductors in more or less conventional device architectures, organic systems are also of interest in the more speculative, and potentially more revolutionary, area of "molecular electronics". Here, it is envisioned that the nonlinear characteristics of individual molecules, or small ensembles, will provide the required device functionality, allowing low-cost chemical synthetic methods to replace, at least partially, multi-billion dollar semiconductor fabrication lines in the production of nanoscale device structures.

In either application format, charge injection at a molecule-contact interface plays a vital role in controlling transport and, thus, potential device performance. Interfacial charge injection is dictated by chemical bonding, and the resulting band line-up between the Fermi level of the contact and transport levels of the molecule. Information relating to band line-up is difficult to obtain using conventional techniques in the case of the single-molecule length-scale systems of interest in molecular electronics. We have employed a combination of one-photon (He I resonance excitation) and two-photon photoelectron spectroscopy, using sub-picosecond Ti:sapphire laser-based excitation, to determine the electronic structure, including injection barriers to both occupied and unoccupied levels, of oligio(p-phenylene-ethynylene)thiol (OPE) self-assembled monolayers, a system that has become a benchmark for theoretical and experimental studies in the area of molecular electronics.

One-photon photoelectron spectra of OPEs adsorbed on Au showing shift in band line-up by varying the linking group from thiol (black line) to isocyanide (red line).

The majority of studies of covalently bound monolayers on metallic surfaces involve thiol-coupling (R-SH) chemistry. Self-assembly of monolayers utilizing thiol chemistry is known to form robust, reproducible monolayers on a variety of metallic surfaces. However, it is important to characterize how the linker group affects the electronic spectra and consequently the band line-up of adsorbed monolayers. Thus, we have undertaken a study of understanding how the band line-up varies as a function of changing the linking chemistry between the molecule and the surface. One-photon photoelectron spectra in the figure shows that the substitution of the thiol-linker for isocyanide (R-NC) in OPEs adsorbed on Au shifts the position of the occupied and unoccupied states relative to the Fermi level by approximately 0.5 eV. Such a large variation will have a major impact on charge injection in molecular systems. Models for important aspects of the bonding in these two systems to Au have been developed that help explain the observed behavior.

This research team will build upon previous studies of understanding the effect molecular structure and linking-group chemistry have on controlling band line-up in covalently bound molecular systems. Our future work will focus on varying the metal onto which the molecule is adsorbed, as well as alkali metal doping of monolayer films.

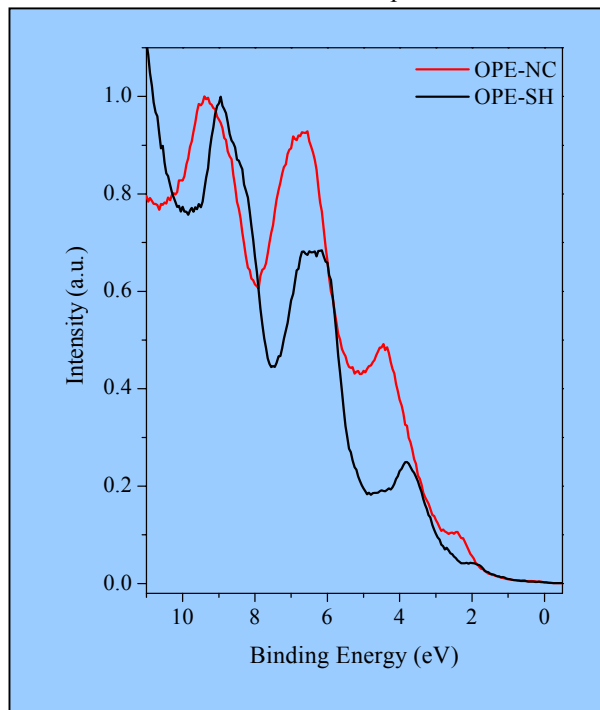

The results of the CSTL research add important insights to the factors controlling band alignment at metal-organic interfaces, a parameter that plays a critical role in potential applications of organic materials in emerging electronic technologies.

Quantitative Analysis of Submicrometer Particles in the Scanning Electron Microscope (SEM) Utilizing the ζ Factor Approach

J.A. Small, N.W.M. Ritchie, and J.M. Davis (837)

The analytical electron microscopy (AEM) approach for the quantitative analysis of ultrafine particles, 0.1 nm to 500 nm in size, involves the application of an elemental ratio procedure known as Cliff-Lorimer (CL). This procedure was designed for the AEM analysis of “infinitely” thin samples, for which there is negligible x-ray absorption. The basis for the CL approach is given in the equation to the right: Where k_{ab} is a proportionality constant calculated, using materials of known composition, for a given instrument at a given voltage, C_a and C_b are the concentrations of elements a and b, and I_a and I_b are the measured x-ray intensities.

$$C_a/C_b = k_{ab} \cdot I_a/I_b$$

This investigation was undertaken to determine if the CL approach is applicable to the analysis of ultrafine particles in the SEM at 25 kV to 30 kV for which x-ray absorption is not negligible. In this study, a modified CL analysis procedure was employed that includes a correction for x-ray absorption known as the ζ factor; this factor was defined in *Ultramicroscopy* in 1996.

During the past year we have made a series of measurements on glass shards of known composition that had been ground to produce a large number of ultrafine particles. The particles were analyzed at 25 keV.

Plot of the Al concentration in ultrafine glass particles analyzed by both the CL method and the modified CL, which includes the ζ factor.

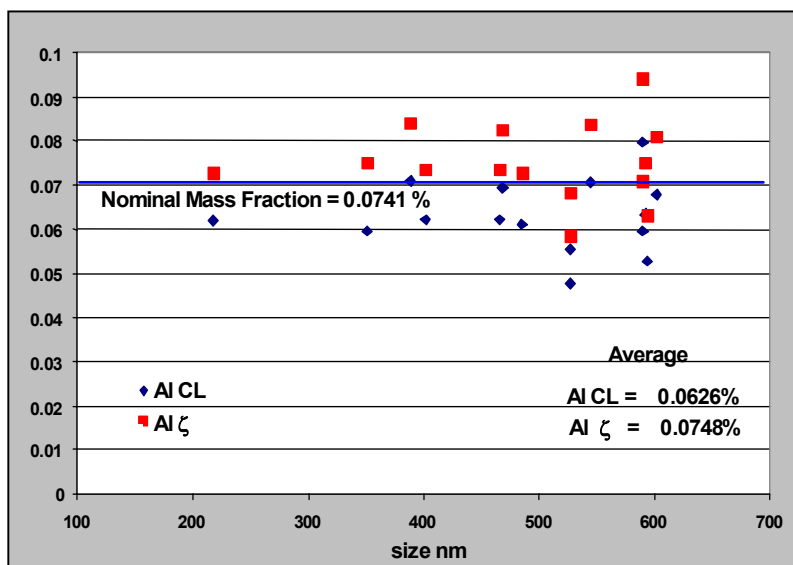

The results are shown in the figure, which plots the Al concentration analyzed by both the CL method and the modified CL that includes the ζ factor. The Al concentration from the CL method at a mass fraction of 0.063% has a negative bias compared to the nominal value of 0.074% as a result of not correcting for the absorption of the Al x-rays in the particles. In comparison, after the incorporation of the ζ factor into the CL method the mass fraction of Al percent is 0.075%, effectively removing the observed bias and bringing the average concentration more in line with the nominal value.

This study represents one of two methods we are currently investigating to improving the quantitative analysis of the ultrafine particles. The other approach involves reducing the accelerating voltage of the scanning electron microscope (SEM) to 5 kV or less for analysis. The rationale for this approach is that the x-ray generation and emission volumes at the low voltage will be contained within the particle volume to a much greater degree than excitation at a higher but more conventional voltage such as 15 kV. Future plans involve the comparison of these two methods and their effectiveness for the quantitative analysis of ultrafine particles.

Traditionally ultrafine particles have been analyzed in analytical electron microscopes, which often require large capital investments in excess of \$1M and have difficult sample preparation procedures. The SEM method described here could potentially offer a more economical approach.

A New Monte Carlo Application for Complex Sample Geometries

N. W. M. Ritchie (837)

Performing quantitative microanalysis on micrometer-sized particles has always been a challenge. The volume of the particle is typically smaller than the electron beam excitation volume and x-ray absorption corrections are complicated by surface topology. Some researchers have approached this problem by approximating the particle as a simple geometric shape such as a cylinder, a rectangular, or triangular prism.

While this approach is better than applying bulk correction methods, it may be possible to combine topological measurements from multiple imaging detectors to build a more accurate three-dimensional model of the unknown particle. This model could then become the input sample structure for a Monte Carlo simulation. The Monte Carlo simulation could be compared to Monte Carlo simulations of bulk references and the result could be iterated in a manner similar to the iterative correction processed used by the standard ZAF correction* scheme. The result is likely to be more accurate quantitative results. However, this scheme relies on the availability of a Monte Carlo model that can handle complex sample geometries. Our work seeks to develop a library of Monte Carlo simulation routines capable of handling samples of arbitrary geometric complexity.

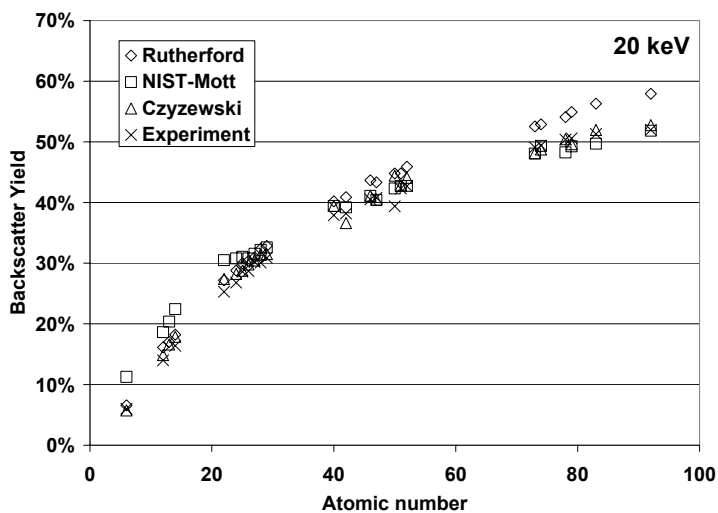

The modeled backscatter yield for various different implementations of the electron elastic scattering cross-section compared with published measured values from Heinrich. Rutherford corresponds to a simple screened Rutherford cross-section; NIST-Mott and Czyzewski are different implementations of the Mott cross-section. The Czyzewski cross-section reproduces the experimental results most accurately across the full range of atomic numbers.

Assigning particles to a descriptive class through quantitative microanalysis is hampered by morphologically induced particle-to-particle variance. We anticipate that by better modeling the shape of the particle we will be able to reduce particle-to-particle variance and thereby improve our ability to differentiate particles of similar but different materials. In the coming year, we plan to use the results from this Monte Carlo simulation to develop and evaluate more computationally efficient analytical expressions for quantifying particulate samples.

***ZAF Correction:** Conversion of the X-ray intensities to concentration based on measurement of the pure element intensities and composition of corrected factors for “atomic number effect” (Z), the “absorption correction” (A), and the “fluorescence correction” (F).

The CSTL research seeks to develop a library of Monte Carlo simulation routines capable of handling samples of arbitrary geometric complexity for performing quantitative micro-analysis on micron-sized particles.

We developed and tested a Monte Carlo simulation implemented in platform-independent Java code. We have evaluated various algorithms for electron elastic (see figure) and inelastic scattering cross section, electron energy loss, fluorescence yield and mass absorption coefficient. For each algorithm class, we selected the one that we determined produced the most realistic results. These algorithms have been implemented into a model in which the sample is represented by instances of a generic *Shape* interface. (*Shape* refers to a Java interface – a contract between a class’s user and implementer). The *Shape* interface represents samples of arbitrary complexity with sufficient detail for the purposes of this model. Implementations of the *Shape* interface have been created for basic shapes such as spheres, blocks, and the volume defined by the intersection of an arbitrary number of directed planes. In addition, implementations of the *Shape* interface have been created to represent the union of two or more *Shapes* and the difference of two *Shapes* (the volume of *Shape* A minus the intersection between *Shape* A and *Shape* B). By combining these *Shapes* programmatically, samples of arbitrary complexity can be built from primitive *Shapes*.

Improved Energy Stability in the NIST Microcalorimeter X-Ray Detector

T. Jach, J.A. Small, and D.E. Newbury (837)

Microcalorimeter x-ray detectors make up a new technology that combines some of the positive features of wavelength dispersive (high resolution) and energy dispersive (parallel detection over a wide energy range) detectors that have gained broad acceptance in the microanalysis community. Microcalorimeters which use a transition edge sensor (TES) have proven to be effective over energy ranges of 10 keV or more in applications such as x-ray fluorescence analysis with electron microscopes. TES microcalorimeter x-ray detectors have successfully demonstrated energy resolutions better than 5 eV. However, serious drifts in energy scale over extended counting times have set limits on both the long-term resolution and the calibration of these detectors. This is because the operating point of the detectors is the middle of the superconducting-normal phase transition. The successful operation of a microcalorimeter as an x-ray detector puts considerable constraints on the stability of all the electrical and thermal inputs to the instrument. Previously observed drifts of >10 eV/h have been reduced to 1 eV/h to 2 eV/h. This improved stability, shown in the figure, has resulted in the observation of x-ray fluorescence linewidths of 12 eV to 15 eV over a 6 h time period.

The detector is cooled to a substrate temperature of only 70 mK and maintained at its operating point by a complex feedback control system connected to a large superconducting magnet. We carried out a careful analysis of the performance of all the elements in the control system including the response function of the magnet under typical conditions of operation. We determined that the desired stability and performance of the detector required control of its substrate temperature to a precision of 23 μ K, that is, a variation of less than 5 parts in 10,000. By careful modification of the control circuitry, we have been able to realize this degree of temperature stability of the substrate. The energy scale of the spectra is now observed to be stable to within about ≤ 1 eV/h over a period of hours, under operating conditions in which a linewidth of 12 eV to 15 eV is readily obtained. X-ray spectra acquired over long durations under these conditions of substrate temperature stabilization show vastly improved stability and resolution.

Additional measures to stabilize the operating temperature are possible. Once realized, we can carry out a demonstration of the microcalorimeter detector with an electron microscope for quantitative microanalysis. We also anticipate replacing the actual detector element with higher resolution (< 4 eV) versions, which have been developed at NIST, Boulder. Combined with the achieved stability of the energy scale, we can start to look at characterizing chemical states of some elements by the energy of their fluorescence lines.

The CSTL research team investigated the sources of energy scale drift in the NIST-developed microcalorimeter x-ray detectors and has addressed the most critical elements.

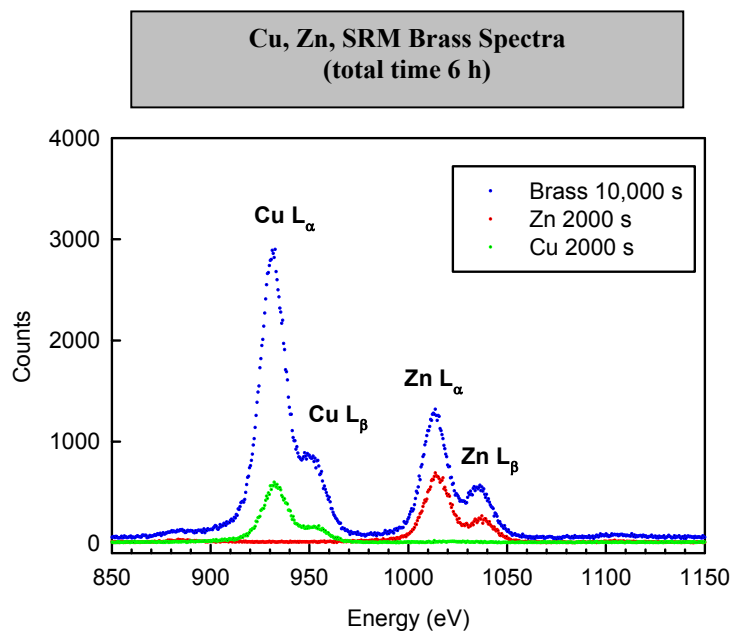

The drift in energy scale of the microcalorimeter x-ray detector has been a major limitation to the commercial development and marketing of this type of detector. There are currently a number of potential applications of this detector, particularly in the semiconductor industry.

Rapid Searching of Spectrum Image Databases for Rare Events, or Finding the Needle in the Haystack When You Don't Even Know You're Looking for a Needle!

D.S. Bright and D.E. Newbury (837)

Characterization of the microstructure of materials often requires detection of rare features, such as naturally occurring minority/trace phases or unintentional particulate contamination. X-ray mapping in the scanning electron microscope (SEM), a traditional tool for measuring elemental distributions with micrometer to nanometer spatial resolution, has recently been greatly enhanced by the development of x-ray spectrum imaging, in which a complete x-ray spectrum is stored at each pixel location visited by the beam. The silicon drift detector (SDD), described here in FY03 and whose development was aided by NIST Small Business Innovation Research (SBIR) grants, combined with digital signal processing enables x-ray count rates above 100 kHz, permitting recording of useful x-ray spectrum images in 200 s or less. The resulting stream of 200 Mbyte image databases is creating a demand for software tools that are quick and efficient at locating features of interest.

We have developed a software tool within the NIST LISPIX image processing platform that determines the MAXIMUM PIXEL SPECTRUM by finding the maximum value within each energy channel x-y plane and plotting this value versus energy.

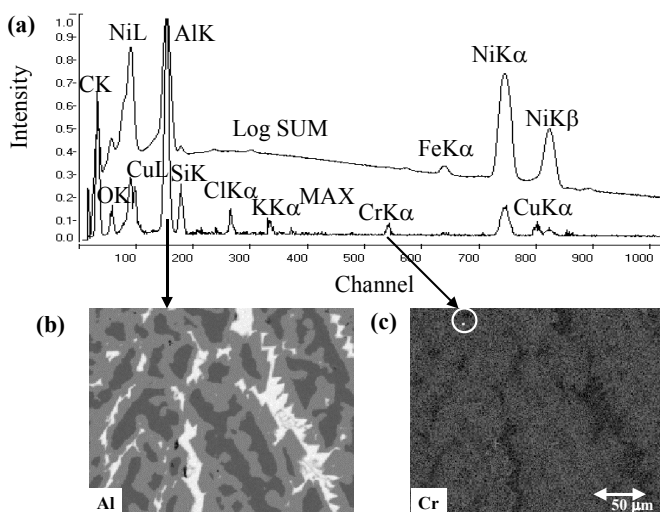

CSTL researchers have developed the *Maximum Pixel Spectrum*, a software tool that enables rapid searching of SEM x-ray spectrum image databases to detect rare features, even if the analyst does not know in advance which elements are present.

(a) SUM SPECTRUM (upper trace, log intensity) and MAXIMUM PIXEL SPECTRUM (lower trace, linear intensity). (b) A major feature (aluminum-containing areas recognized from peaks in the SUM. (c) A rare feature, chromium, detected at a single pixel (inside circle) from the MAXIMUM PIXEL SPECTRUM.

This new function is compared with the SUM SPECTRUM, similarly calculated by adding all values within a plane, as shown in Figure 1(a) for a spectrum image of Raney nickel, a methanation catalyst. Peaks in the SUM SPECTRUM correspond to common features in the x-ray spectrum image, as illustrated in Figure 1(b) where the aluminum-rich phases are highlighted. While these

same peaks are found in the MAXIMUM PIXEL SPECTRUM, additional peaks can be recognized that correspond to rare events, down to the single pixel level, shown in Figure 1(c) for a chromium contaminant that appears at a single pixel, or 1/51200 for a 256x200 scan. Note that the rare chromium feature has been found despite being completely unknown to the analyst.

The MAXIMUM PIXEL SPECTRUM has had an immediate impact in the microanalysis field. First publicly presented at the SCANNING 04 conference held in Washington in April 2004, the method was immediately adopted by a US manufacturer of microanalysis software systems, appearing in this vendor's system at the Microscopy and Microanalysis Conference in August and in their advertisement in *Microscopy Today* in September 2004. Other vendors are rapidly incorporating the MAXIMUM PIXEL SPECTRUM as a feature in their spectrum imaging software. We anticipate that the combination of SEM SDD x-ray spectrum imaging and derived spectrum image processing tools will have a broad impact in materials analysis, supporting technology, physical and biological science, and forensic applications. The MAXIMUM PIXEL SPECTRUM and the SUM SPECTRUM are members of a class of transformations known as "derived spectra" to distinguish them from the true spectra recorded in the spectrum image. We plan to investigate additional algorithms for derived spectra to seek software tools that can aid the analyst in other aspects of x-ray spectrum imaging. Other microanalysis spectroscopies, such as electron energy loss and Auger electron, may also benefit from derived spectrum tools.

This software tool is available free at <http://www.nist.gov/lispix/>

Evanescent Wave Cavity Ring-Down Spectroscopy (EW-CRDS) of Surface Hydroxyl Groups on SiO₂

A.C.R. Pipino (836) and I.M.P. Aarts (Eindhoven U. of Tech., The Netherlands)

The SiO₂ surface is ubiquitous in science, technology, and the environment. Whether used as a catalytic or chromatographic support or as the substrate for atomic layer deposition, the SiO₂ surface displays reaction chemistry that is largely controlled by the presence of surface silanol (SiOH) groups. Yet ambiguous results are often obtained in spectroscopic studies of silica gels or powders, which increase surface area to enable detection of the weak surface SiOH signals. To realize a decisive diagnostic probe of the planar SiOH on SiO₂ surface, we use evanescent wave ring-down spectroscopy (EW-CRDS) that is a variant of the gas-phase CRDS technique employing a miniature, ultra-low-bulk-OH fused-silica optical resonator with total-internal-reflection (TIR) mirrors.

Using EW-CRDS we have obtained vibrational combination band spectra of surface SiOH and adsorbed water on ultra-smooth amorphous silica in the 8000 cm⁻¹ region. By obtaining spectra at both s and p polarizations, we are able to identify the dipole orientation of the SiOH group for each observed spectral peak. Remarkably, we find evidence for crystalline character for both SiOH and adsorbed water layers, where the latter suggests the formation of an ice-like structure at room temperature. The combination band spectra for an OH mode of surface SiOH under dry nitrogen gas is shown for s and p polarizations are shown in the figure to the right. Note that the maximum optical loss for these weak surface spectra is only 2 × 10⁻⁶, which illustrates the very high sensitivity of EW-CRDS. Moreover, two SiOH bands are observed, which are both *highly polarized*. The p-polarized (8118 cm⁻¹) band indicates a mean orientation for the transition dipole that is perpendicular to the surface plane, while the s-polarized (8152 cm⁻¹) band indicates a parallel transition moment. Such spectra are consistent with the existence of a crystalline surface phase, similar to a facet of crystalline silicon dioxide.

The NIST-led research team demonstrates the capability of EW-CRDS detection as a probe and diagnostic tool for investigating chemistries at interfaces.

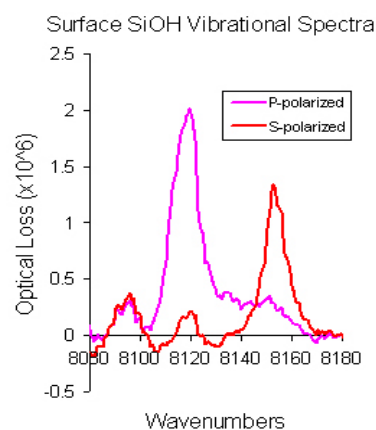

S and P OH mode polarized absorption spectra for SiOH.

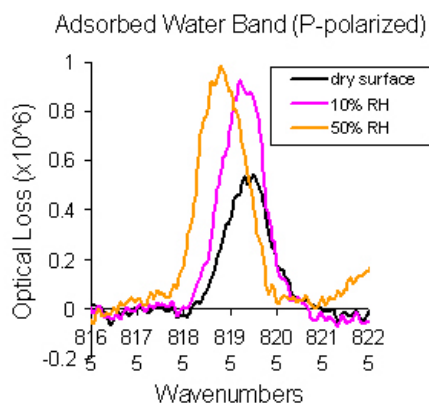

Shifts in water absorption on SiO₂ surfaces.

One of four adsorbed-water peaks is shown in the figure to the left.

Under dry nitrogen (no previous heating), adsorbed water is still present due to rather strong hydrogen bonding with the surface SiOH groups. Exposed to 10% relative humidity, the water band increases strongly and sharpens slightly. However, when exposed to 50% relative humidity, the water band shows only a slight additional increase by contrast, suggesting the band intensity saturates at one-monolayer coverage. Furthermore, this band and the three other observed adsorbed-water bands are also highly polarized, indicating an ordered water layer supported by the underlying ordered SiOH layer. The existence of an ice-like layer on silica at room temperature has also been inferred from sum-frequency generation (SFG) measurements and predicted in recent theoretical studies. EW-CRDS provides detailed surface structural information with the potential for absolute surface coverage and absolute surface reaction rate determinations.

being used at TU/e to probe thin-film structure and growth processes, including growth of amorphous, hydrogen-doped silicon and atomic-layer-deposition processes. Other current applications of EW-CRDS involve studies of the liquid/silica interface and novel size-selected nanoparticle catalysts.

TU/e technische universiteit eindhoven

Precision Densimetry for Primary Temperature Metrology

M.O. McLinden (838)

Details provided in the *Exploratory Research* Section of this Report

Chiral Temperature Gradient Focusing

D. J. Ross (839), K. Balss (836), K. Phinney, and W.N. Vreeland (839)

Details provided in the *Exploratory Research* Section of this Report

Computational Chemistry Illuminates Atomistic Processes at Complex Interfaces

A. M. Chaka (838)

Details provided in the *Chemical and Allied Products* Section of this Report

***Ab Initio* Mass Spectrometry**

Karl K. Irikura (838)

Details provided in the *Exploratory Research* Section of this Report

Invention of a New Class of Ultra-Fast, Ultra-Sensitive Mass Spectrometers for Kinetics, Reference Mass Spectrometry, and Homeland Defense Applications

J. W. Hudgens (838)

Details provided in the *Exploratory Research* Section of this Report

Development of ICP-OES Determination of Phosphorus as a Primary Measurement Tool for Quantitation of Plant Deoxyribonucleic Acid (DNA)

M.J. Holden (831), M. Winchester (839), J.R. Blasic, Jr., M. Dizdar, P. Jaruga, and Y. Tewari (831)

Details provided in the *Exploratory Research* Section of this Report

C. Exploratory Research

Since 1999, the CSTL laboratory director has invited all technical staff to submit Exploratory Research Proposals. The insights gained from these proposals have become an integral part of our strategic planning, and a mechanism to engage all staff scientists in this important process. Scientists are encouraged to begin to discuss ideas among themselves, and where appropriate, combine the ideas into a single proposal. Over the past six years 80 exploratory research projects have been funded, and CSTL has invested close to \$6M. More importantly, we have been able to provide “seed money” for critical areas of research such as new approaches to modeling, measurement methods, or data development and dissemination, as well as novel mechanisms to provide reliable and timely measurement traceability to our customers. Exploratory research most often supports anticipated metrological needs or *Future Measurements and Standards*. This research is not yet applied to a specific industrial sector, it is infrastructural, and cross-cuts our customer-based programs. The work described in the following pages is a result of the research from FY 2004 funded projects.

Optical Characterization of Organic Electronic Thin Films

L.J. Richter (837), M.C. Gurau (837), D.M. DeLongchamp (MSEL)

CSTL Program: *Measurement Science for Future Standards and Technology*

CSTL researchers demonstrate that vibrational spectroscopies can provide new insight into the structure of OE films and potentially may provide the basis for evaluation and monitoring of OE films by manufacturers.

Organic electronic (OE) devices are projected to revolutionize integrated circuits through new applications that take advantage of low-cost, high-volume manufacturing, nontraditional substrates, and designed functionality. OE devices, which rely on custom designed organic molecules and polymers instead of crystalline inorganic material such as silicon, present the electronics industry with fundamentally different measurement challenges. For example, the structural order in ultrathin OE films, particularly at the buried film/gate-dielectric interface, is thought to be critical to the achievement of high performance. However, x-ray diffraction techniques, the ‘gold standard’ for structural determination, are difficult with very thin films. Additionally, as many target applications require flexibility in the OE film, true crystalline order (which gives rise to diffraction) may be undesirable. In this exploratory research project, optical techniques originally developed for the characterization of molecules adsorbed at surfaces are explored as tools for the structural characterization of thin films.

Poly3hexylthiophene (P3HT) has emerged as a prototypical OE material. Transistors made from this material can achieve performance levels close to those of amorphous silicon. Data from traditional structural characterization tools, however, have not shown strong correlations with the electrical performance of P3HT films. Surprisingly, low relative molecular mass, highly crystalline films have poorer performance than high relative molecular mass films that appear highly amorphous.

Shown in the figure to the right (a) are absorption spectra for a high relative molecular mass P3HT film before and after annealing. The fine structure that appears near 2.0 eV after annealing has been attributed to an electronic excitation that spans multiple chains and is indicative of good interchain order. Shown in the main panel of the figure (b) are infrared spectra probing the alkyl side groups (features at 2800 cm^{-1} to 3000 cm^{-1}) and the thiophene ring (823 cm^{-1}).

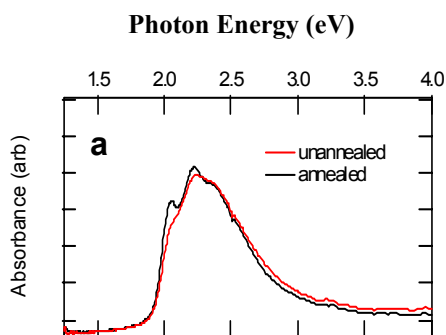
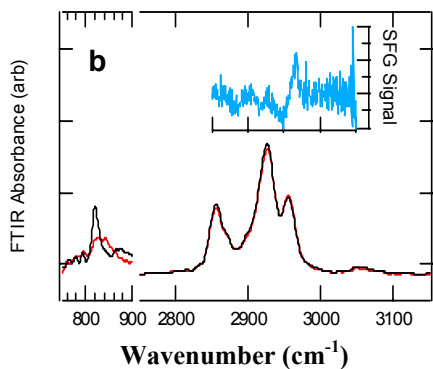

Infrared spectroscopy allows selective study of different parts of the polymer chain, but averages the information over the entire film. The alkyl side chains show little change upon annealing, indicating that, contrary to the behavior in bulk crystals, the alkyl groups do not drive the ordering of the thin films. Detailed analysis establishes that the alkyl groups are highly disordered. There is significant change in the thiophene ring feature, indicating that the chains adopt a more card-edge stacking structure upon annealing. The inset to Figure 1 (b) shows nonlinear vibrational spectra of the alkyl groups (SFG = sum-frequency generation). Unlike infrared spectroscopy

copy, the nonlinear spectroscopy is only sensitive to the surface of the thin film. The presence of the feature near 2960 cm^{-1} indicates that, while the alkyl groups are disordered in the interior of the film, they are highly ordered at the surface. The combination of the three spectroscopies (visible, infrared, and nonlinear) provides a detailed picture of the evolution of the structure that can be related to the electronic properties of the film.

Future work will be performed within the context of the FY05 NIST Competence Program on *Metrology to Enable the Realization of Organic Electronics Devices*.

The next challenges include correlating the spectroscopic results with direct measurements of the electrical performance of the films to establish the structural characteristics of high performance films. The optical techniques for orientation determination will be validated against direct techniques based on x-ray absorption. Models for the quantitative separation of the buried and free interfaces of ultrathin films via nonlinear optics will be developed and extended to higher order processes such as coherent anti-stokes Raman scattering.

Transport Coefficients and Molecular Dynamics

R.D. Mountain (838)

CSTL Program: *Chemical and Allied Products*

Molecular-level simulation of fluids has been identified as an enabling technology for the efficient determination of physical properties of fluids in conditions where the experiments are expensive and/or hazardous due to toxicity, flammability etc. In order for industrial modelers to realize the potential benefits of molecular simulations, two (at least) issues must be addressed. The first is the need for physically accurate representation of the interactions between the molecules of the fluid and the second is the need to develop more efficient simulation methods than are currently available. This work addresses the second of these issues.

CSTL scientist addresses the need for more efficient simulation methods for industrial modelers.

While it has been possible for decades to use molecular simulations to estimate the shear viscosity and the thermal conductivity of a model fluid, the computational resources required have been too large to move it from a research to an industrial setting. Recently, some novel methods for estimating these transport coefficients from simulations have been reported, but no systematic evaluation of the merits of these methods has been produced. The objective of this project is to determine the computational efficiency and accuracy of these methods compared with existing simulation methods.

This project is part of a larger effort in the Physical and Chemical Properties Division to improve molecular simulation methodology to the point where industrial property modelers will be comfortable adding these techniques to their toolkit because it will expand their ability to cope with fluids and state conditions where existing methods fail.

An interagency report, NISTIR 7170 has been issued and an archival publication on system size effects is in the early stages of preparation.

In order to concentrate on the second issue, namely accurate and efficient determination of transport coefficients, this project focused on the Lennard-Jones fluid, a widely studied model system

sometimes called the “fruit fly” of simulations. There are sufficient prior results available so that both accuracy and efficiency can be evaluated. Three unconventional methods were examined and one, Reversed Perturbation Nonequilibrium Molecular Dynamics, was found to be competitive with existing methods. This scheme is being further examined to see if the computational efficiency can be improved by reducing the system size without compromising accuracy.

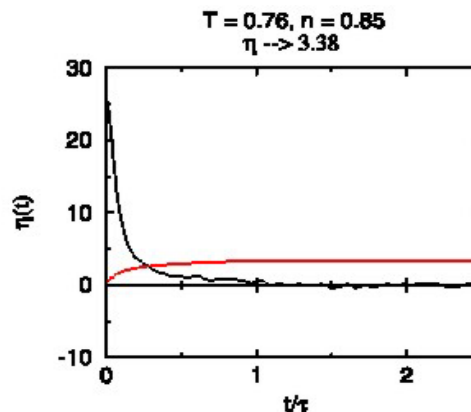

The averaged time correlation functions (solid line) and the time integral for the shear viscosity (dotted line) are shown in the graph

Ab Initio Mass Spectrometry

K.K. Irikura (838)

CSTL Program: *Measurement Science for Future Standards and Technology*

Traditional electron-impact (EI) mass spectrometry (MS) is used for detecting and identifying compounds in the vapor phase. Important applications include detecting toxic compounds, verifying compliance with international chemical weapons treaties, detecting chemical explosives, detecting illegal drugs, and laboratory analysis and synthesis of organic compounds.

Compounds are identified by comparing observed spectra with those of candidate compounds, which must be previously known (e.g., in the NIST Mass Spectral Database). Spectra cannot currently be predicted theoretically. However, theoretical developments at NIST over the past several years offer new opportunities for developing theoretical means for predicting EIMS. We would like to develop a predictive theory, which would make it possible to positively identify compounds not found in the standard databases.

CSTL researcher seeks to develop predictive theory for analytical mass spectrometry.

MS/MS has gained prominence recently as a key technology of proteomics.

an earlier Exploratory Research project, suggest how additional rules might be discovered theoretically. We are using these and other strategies to seek new rules, which will increase the power of MS/MS for proteomics applications. This will increase the speed and reduce the cost of protein sequencing.

Experts in CSTL conclude that MS/MS is a higher priority than EIMS. Fortunately, MS/MS is also the simpler chemical process from a theoretical perspective. A new NRC postdoctoral associate has explored the peptide fragmentation problem by examining certain general trends (e.g., the “glycine effect”) that have been observed in large data sets. Tripeptides have been chosen as the most appropriate model for the fragmentation of tryptic peptides. The goal is to understand the trends and to make them both quantitative and predictive, thus defining new fragmentation rules. Experimental measurements will be done to support the calculations.

Another type of mass spectrometry, tandem mass spectrometry (MS/MS) is the ionic equivalent of gas-phase pyrolysis. The standard procedure in proteomics research involves protein digestion followed by MS/MS analysis of the resulting peptide fragments. Sequence information is obtained from the spectra by using a few simple, empirical rules. However, about half the information in the spectra is discarded because it does not conform to the known rules. Recent computational chemistry techniques, developed in CSTL under

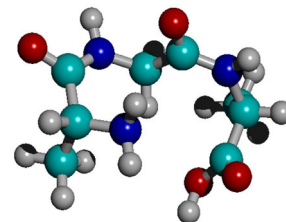

Example of protonated tripeptide structure

Invention of a New Class of Ultra-Fast, Ultra-Sensitive Mass Spectrometers for Kinetics, Reference Mass Spectrometry, and Homeland Defense Applications

J. W. Hudgens (838)

CSTL Program: *Measurement Science for Future Standards and Technology*

The project was designed to demonstrate the feasibility for improved mass spectrometers based on Hadamard-transform data acquisition. Hadamard mathematics describes the most accurate procedures for measuring properties of any ensemble. To the chemist, its most familiar form includes a digital representation of the fast-Fourier transform used in modern infrared spectrometers. A goal is to show that Hadamard MS/MS instruments are feasible and can rapidly resolve the chemical structures of components in a complex mixture. Hadamard mathematics suggest that such instruments can acquire comprehensive structure determination data of chemical unknowns as much as 3,000 to 600,000 times faster than current art.

CSTL researcher builds a prototype Hadamard time-of-flight mass spectrometer (HT-TOFMS), measures its performance, and uses test data to model a Hadamard-transform MS/MS instrument.

The first Hadamard time-of-flight (TOF) mass spectrometer incorporating an electron-impact ionizer has been invented, and constructed at NIST. The instrument appears similar to a commercial reflection TOF mass spectrometer; however, it contains a specialized electron gun, ion optics, and high-voltage electronics that are optimized for high-frequency modulation. Laboratory tests have demonstrated that this ionizer can switch ion streams on and off with a 5 ns rise-fall

time when modulated at 13 MHz. These performance specifications will permit Hadamard operation. Integration of this hardware with the necessary software is in progress.

Preliminary numeric simulations have been conducted and suggest that useful Hadamard MS/MS instruments are possible. The incorporation of test results from the present HT-TOFMS will help us optimize trial instrument designs and data acquisition procedures.

modulates the ion stream with a simplex code sequence that is derived from a Hadamard matrix. The simplex matrix is composed of rows of 1's and 0's that instruct the ionizer to switch the ion current on and off. With a Hadamard modulation frequency of 13 MHz, ≈ 500 distinct ion packets are simultaneously in flight. The signal from an HT-TOFMS initially looks like random noise. The mass spectrum is obtained by multiplying this "noise" by the inverse of the simplex matrix. The duty cycle of the HT-TOFMS is 50 %. Hence, the HT-TOFMS obtains a 25x to 50x sensitivity improvement from its higher duty-cycle. Other features of Hadamard mathematics further enhance sensitivity and reduce measurement uncertainties.

The demonstration that any conventional TOFMS can be converted into a more sensitive Hadamard instrument may accelerate adoption of this superior technology. Hadamard technology is expected to find application in fields of chemistry such as the study of the rates of chemical reaction or forensic analyses where high sensitivity, sample conservation, and high operational speed are essential. If Hadamard principles could be adapted to other variations of MS/MS, say those used in the drug discovery process, it would enable the acquisition of complete MS/MS data sets within the duration of a single high performance liquid chromatography (HPLC) peak. Currently, such data campaigns take days to execute and can require use of an expensive ($\approx \$1M$) ion cyclotron resonance MS in order to conserve sparse samples.

The present Hadamard mass spectrometer will be used to obtain feasibility data for an MS/MS instrument. The design target is an instrument that can measure the kinetics of complex hydrocarbon mixtures.

Plans include incorporating error correction algorithms into the NIST HT-TOFMS in order to generate benchmark reference data.

Algorithms that reduce the effects of mask errors (which in mass spectrometers arise from non-ideal ion current modulation) on the measurement quality are an active research area in mathematics. The community needs data from a well-characterized experiment to verify assumptions about the nature of Hadamard measurements. This data may facilitate improvements in other Hadamard application fields including microscopy, nuclear magnetic resonance (NMR), and medical magnetic resonance imaging (MRI).

Sonic Nozzles as Primary Standards

J. D. Wright and A. N. Johnson (836)

CSTL Program: *Industrial and Analytical Instruments and Services*

Critical flow venturis, often termed sonic nozzles, are widely used as gas flow standards by industry, are recognized as perhaps the most precise gas flow meters available today, and are the basis for metering gas flows over a very large range. Prior studies at the NIST flow laboratory as well as other flow laboratories, have shown that sonic nozzles maintain their calibration stability for more than 30 years within 0.2%. The ISO-9300 standard documents procedures for calculating flow from nozzles at the 0.5% relative uncertainty level via theoretical discharge coefficients. Because the dominant contributor to uncertainty in tests of sonic nozzle performance was the primary systems used to calibrate them, recent improvements in NIST primary standards allow much better validation of the theoretical calibration predictions. This will have a significant impact of flow measurement accuracy in industries where sonic nozzles are used as primary flow standards. Using the approach described here, users could have a sonic nozzle manufactured with a known throat diameter and use discharge coefficients obtained from references to calculate flow from the nozzle. The approach extends to flows that are too large to measure by conventional primary standard designs.

CSTL researchers seek to validate the theoretical calibrations of sonic nozzles, without calibration to primary standards, to facilitate inexpensive, portable, and accurate gas flow measurements in industrial settings.

Calibrations of a set of sonic nozzles have been completed using our new 34 L, 677 L, and 26 m³ PVTt primary gas flow standards, having uncertainties ranging from 0.05% to 0.13%. Additionally, the NIST Precision Engineering Division made nozzle shape and throat diameter measurements with uncertainty of 1 micrometer. The dimensional and experimental flow data were compared with the results of theoretical models and the agreement was excellent (<0.05%). This work validates much of the theoretical discharge coefficient predictions upon which ISO-9300 is based, in addition to identifying limitations of the model. It also identifies applications where users must exercise caution when using nozzles without flow calibrations. The results also show the importance of using the true nozzle shape, including the ratio of the throat radius to the radius of curvature, Ω , in calculating the discharge coefficient from the model.

Deviation from circularity (in μm) for a 4.83 mm nozzle plotted at 30 degree increments at five cross-sections, beginning at the nozzle throat and stepping upstream toward the nozzle inlet.

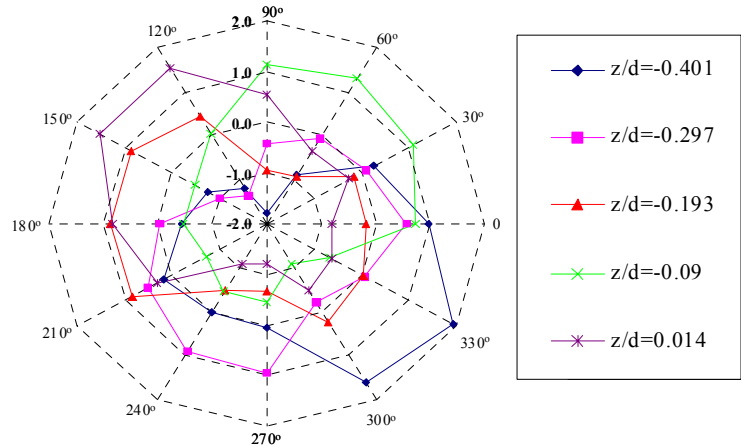

In the future we will extend this effort to smaller flows and smaller nozzle diameters where dimensional metrology capabilities are rapidly improving and we have extensive nozzle calibration data. We will also study the significance of nozzle shape defects, dirt deposited by flow, and unusual gas properties in causing departures from the expected flow behavior.

Precision Densimetry for Primary Temperature Metrology

M.O. McLinden (838)

CSTL Program: *Measurement Science for Future Standards and Technology*

Temperature is among the most important quantities in a vast array of applications, yet recent work at NIST and other National Metrology Institutes (NMIs) provides strong evidence that the currently accepted temperature scale, known as ITS-90, differs from the true thermodynamic temperature by about 11 mK at 505 K. This work has been done with acoustic resonators, which are the leading alternative to the traditional constant volume gas thermometer for the determination of thermodynamic temperatures. The present work explores a third, independent method and so would provide a consistency check on the acoustic results. This is important for any redefinition of the temperature scale. The new method is related to gas thermometry but avoids many of the practical difficulties, which have led to its virtual abandonment by the NMIs. With a constant-volume gas thermometer, the temperature is derived from the pressure ratio of a fixed quantity of gas at some temperature T and a reference temperature, usually the SI defining temperature of 273.16 K. However, with the densimeter, the pressure is held constant, and the density ratio measured at several pressures and extrapolated to zero pressure to yield the temperature.

This work was designed to address biases in the currently accepted international temperature scale (ITS-90).

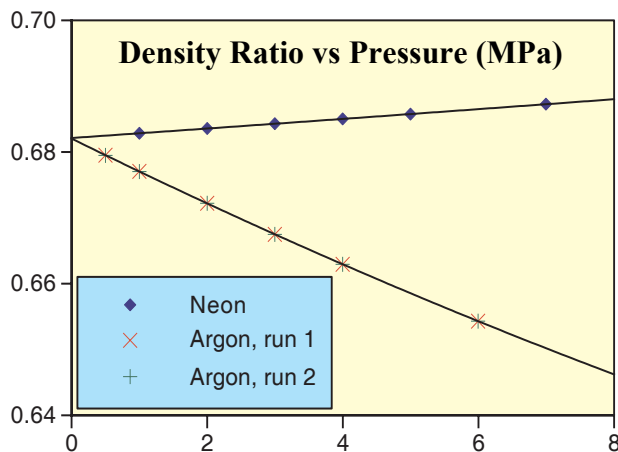

This research has included numerical studies to determine the optimum working gas and the measurement uncertainties needed to obtain a thermometer with an uncertainty of a few thousandths of a kelvin. Argon is the best gas with neon a close second.

This work is enabled by a new apparatus in CSTL, which is proving to be more accurate than older methods by a factor of ten. This densimeter operates on the familiar Archimedes

(buoyancy) principle and provides an absolute determination of density. Several twists on the conventional Archimedes experiment—including a differential weighing with two sinkers and a magnetic suspension coupling to separate the balance from the fluid being measured—reduce the uncertainties and allow operation over a wide range of temperature and pressure. For this project, experiments over the range of 234 K to 505 K with argon, nitrogen, and neon as the working gas have been carried out. Experimental protocols and data analysis have been demonstrated. Systematic errors in the magnetic suspension coupling were found, but, while not small enough to ignore, they were reproducible at the level of a few micrograms. While these experiments have demonstrated the feasibility of the method, the present densimeter has uncertainties that are too high for temperature metrology—in particular, the uncertainty in the sinker volumes is large. The method was inverted and used with the measured data to determine, *in-situ*, the sinker volumes as a function of temperature. This reduced the uncertainties in the sinker volumes, and thus the uncertainties of fluid densities measured with this apparatus, by a factor of four compared to values computed using literature values of thermal expansivity. Further development of this method into a temperature standard would require a significant effort involving temperature, pressure, density, length, and mass metrologists, but no insurmountable obstacles are foreseen.

Using Flow Cytometry to Assess the Utility of the Biomarker CD20 for the Diagnosis of B-Cell Chronic Lymphocytic Leukemia

L. Wang (831), A. Gaigalas (831), G. Marti (FDA), F. Abbasi (FDA)

CSTL Program(s): *Health and Medical Technologies, Forensics and Homeland Security*

Also Supports: *Biomaterials, Pharmaceuticals and Biomanufacturing*

B-cell chronic lymphocytic leukemia (B-CLL) is the most common hematologic malignancy in adults and accounts for 30% of all leukemias. Flow cytometry has been used to establish the phenotyping profile (identity) of B-CLL by detecting a variety of surface antigens CD5, CD19, CD20, and CD23 (note: CD stands for “cluster of differentiation”). It has been found that fewer CD20 cell receptors are present in B-CLL patients than in the normal state; this is referred to as “down regulation.” However, the number of CD20 cell receptors reported in the literature for the disease state varies by more than one order of magnitude. Because of this, the potential biomarker CD20 has limited use for the diagnosis of B-CLL.

This research team has assessed the utility of CD20 as a critical biomarker for the diagnosis of B-CLL. We found that signals from lymphocytes stained with CD20 that had been labeled with either fluorescein isothiocyanate (FITC) or with R-phycoerythrin (PE) were lower in B-CLL patients than in healthy blood donors. This finding required the use of carefully designed and executed control experiments. The fluorescence measurements were performed on lymphocytes stained with CD20 FITC, the MESF (Molecules of Equivalent Soluble Fluorophore) values were assigned to the stained lymphocytes based on calibration curves. The down regulation of CD20 in B-CLL patients was observed by comparison with values obtained from normal donors. Because PE has a much larger fluorescence signal than fluorescein, quantifying CD20 expression using CD20 with PE may give a tighter distribution and a smaller coefficient of variation and more accurate results. The work using PE as the fluorophore is in progress.

NIST/CSTL and FDA researchers work to reduce CD20 cell measurement uncertainty that has hampered research in B-cell chronic lymphocytic leukemia.

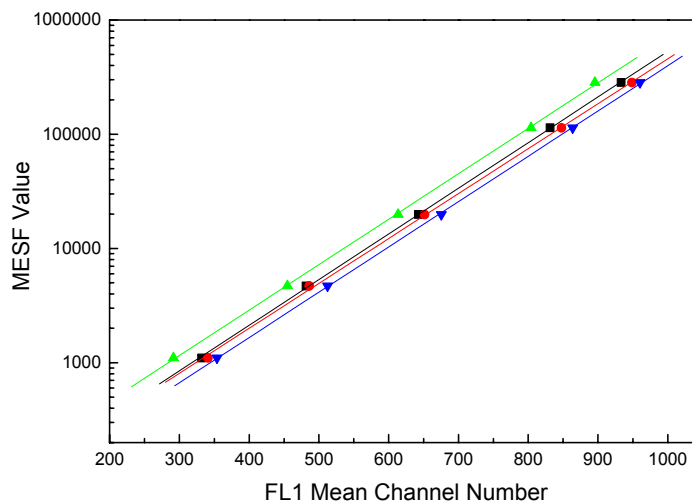

The figure shows calibration curves of a FACScan flow cytometer (BD Biosciences) involving four separate experiments using NIST reference material RM 8640. MESF (Molecules of Equivalent Soluble Fluorophore) values are shown as a function of the fluorescence channel number.

Development of ICP-OES Determination of Phosphorus as a Primary Measurement Tool for Quantitation of Plant Deoxyribonucleic Acid (DNA)

M.J. Holden (831), M. Winchester (839), J.R. Blasic, Jr., M. Dizdar, P. Jaruga, and Y. Tewari (831)

CSTL Program(s): *Measurement Science for Future Standards and Technology*

Also supports: *Biomaterials, Pharmaceutical and Biomanufacturing, Food and Nutritional Products, Forensics and Homeland Security, Health and Medical Technologies*

The successful detection and quantitation of biotech crop material in grain or food is highly dependent on the acquisition of pure and non-degraded DNA in a quantity that is appropriate for the limits of detection and quantitation of the measurement methods. The most important measurements, related to US export of biotech commodity crops and prepared foodstuffs, are the ones relevant to the detection of trace amounts of biotech material. Thus the amount of DNA that is used for the detection becomes critical. Laboratories currently use spectroscopic methodologies to quantitate DNA preparations, for example, DNA absorbance at 260 nm or fluorescent-dye binding. The values obtained can be seriously compromised by impurities in the DNA preparations or the state of the DNA itself.

The primary methods developed will support the development of Standard Reference Materials for the calibration and validation of plant DNA measurements using other methods that are appropriate for testing and research laboratories. In this project the primary measurands are phosphorus and the four nucleotide bases that comprise DNA. A substantial effort has been directed during FY04 toward the development of a high-performance inductively-coupled plasma optical emission spectrometric (HP-ICP-OES) method for determining the total mass of phosphorus present within a given sample of DNA. HP-ICP-OES employs a clever experimental design, a well-chosen internal standard, and an innovative drift correction technique to enable expanded uncertainties on the order of a few parts per thousand. A methodology for measuring phosphorus has been developed, and several determinations using phosphorus spectrometric solution standards as 'mock' DNA samples have been demonstrated. As a more realistic test, a sample of corn DNA has been successfully digested, and suitable phosphorus spectra have been acquired. Quantitation of real DNA samples using the HP-ICP-OES approach is forthcoming.

A remaining challenge concerns instabilities within the microconcentric nebulizer that is required for the combination of high sensitivity and small sample volumes. High Performance Liquid Chromatography (HPLC) is a second unrelated technique for the quantitation of phosphorus. The team has developed a suitable digestion protocol to release phosphorus and measured the phosphorus mass in DNA preparations. This methodology will provide an independent validation of the phosphorus content. Nucleotide analysis is the other critical component. This analysis is accomplished using both gas chromatography and liquid chromatography coupled with mass spectroscopy. These investigations have shown that DNA from corn kernels and soybeans responds differently to the digestion and analysis protocols that work with human DNA. Work is continuing to find the best protocol suitable for use with plant DNA.

CSTL researchers develop primary methods that provide accurate and traceable measurement of total plant DNA.

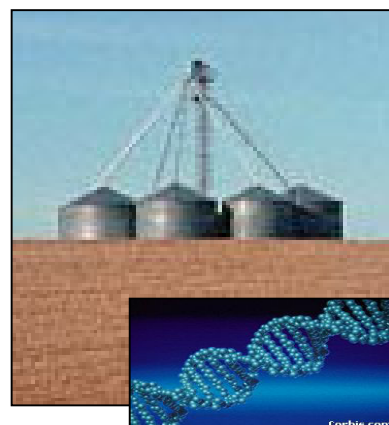

DNA quantitation plays an important role in commerce, for example it provides a basis for the detection of biotech crop material commingled with conventional crops.

The importance of this work has been highlighted recently in experiments we conducted to compare dye binding properties of plant DNA with that of animals and microbes. Significant differences in response were observed with two commonly used fluorescent dyes which highlight the inappropriate use of mammalian and microbial DNA as calibrants for plant DNA measurements and the necessity of new plant DNA Standard Reference Materials.

Chiral Temperature Gradient Focusing

D. J. Ross (839), K. Balss (836), K. Phinney, and W.N. Vreeland (839)

CSTL Program: *Measurement Science for Future Standards and Technology*

Temperature gradient focusing (TGF) was demonstrated for the simultaneous concentration and separation of the enantiomers of chiral molecules. The new technique was found to provide high performance in a number of areas desirable for chiral separations including rapid separation optimization and method development, facile peak order reversal (desirable for enantiomeric purity measurements), and high resolving power (comparable to capillary electrophoresis) in combination with greater than 1000-fold concentration enhancement for improved detection limits. In addition, chiral temperature gradient focusing was shown to offer a capability for real-time monitoring of the interaction of chiral analyte molecules with chiral selectors that could potentially be applied to the study of other molecular interactions.

CSTL researchers develop and demonstrate electrokinetic focusing methods for the high-performance separation of chiral molecules with an emphasis on molecules of biochemical and pharmaceutical interest.

The major accomplishment of the last fiscal year was to demonstrate that chiral TGF works using cyclodextrins as chiral selectors for the concentration and separation of chiral amino acids and pharmaceutical molecules. In addition, it was shown that this new technique can provide performance as good as and in some aspects superior to that provided by conventional techniques. Specifically:

- Greater than 1000-fold concentration enhancement of chiral molecules was demonstrated.
- Chiral TGF was shown to provide resolution comparable to capillary electrophoresis (the best available conventional technique).
- Method optimization was found to be very rapid with chiral TGF because the same focused sample could be retained and held focused in the separation channel while different temperature gradients, electric field strengths, different chiral selectors, or chiral selector concentrations were tested.
- Peak order reversal was also found to be very easy with chiral TGF. Simply by reversing the direction of the applied temperature gradient and the polarity of the applied voltage, the order of the focused enantiomer peaks could be reversed, facilitating the analysis of small amounts of impurity enantiomer in a nearly enantiomerically pure sample as shown in the figure to the right.
- It was also found that chiral TGF of chiral drugs in urine could be successfully performed with no sample preparation.

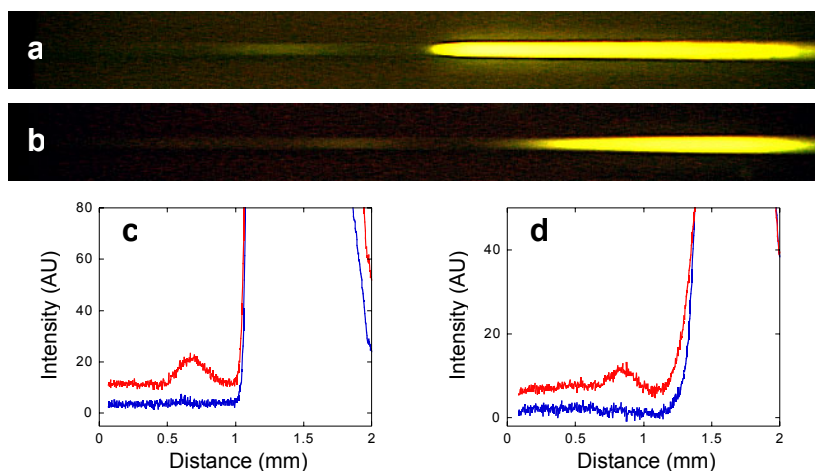

Chiral TGF separations can be performed in much shorter and simpler microfluidic channels or capillaries than conventional separation techniques such as HPLC and CE. Because of this, chiral TGF, and TGF in general, should be much more compatible with miniaturization and integration into microfluidic, lab-on-a-chip systems.

Trace analysis of enantiomeric purity by chiral TGF. (a) Dansyl-L-glutamic acid with a mole fraction of 0.05% dansyl-D-glu. Focusing conditions: T1 = 10 °C, T2 = 30 °C, +1000 V/cm (see Fig. 1A), 1 mol/L Tris-borate with 20 mmol/L g-CD. (b) Dansyl-D-glu with a mole fraction of 0.1% dansyl-L-glu. Focusing conditions: T1 = 40 °C, T2 = 10 °C, -1000 V/cm, 1 mol/L Tris-borate with 20 mmol/L g-CD. (c) Intensity vs. distance plots for (a, red curve) and similar results with no impurity (blue curve). (d) Intensity vs. distance plots for (b, red curve) and similar results with no impurity (blue curve). For clarity, the red curves in (c,d) have been offset.

Determination of Low Level Nitrogen by Radiochemical Neutron Activation Analysis

R.L. Paul and R.M. Lindstrom (839)

CSTL Program: *Industrial and Analytical Instruments and Services*

Many alterations of metal and semiconductors properties are ascribed to the presence of low-level nitrogen. Current industrial methods for measurement of nitrogen are not reliable below 1 mg/kg. CSTL researchers' expertise in radiochemical neutron activation analysis (RNAA) was exploited to develop a method to detect nanogram levels of nitrogen in materials. In this procedure, nitrogen is measured via the $^{14}\text{N}(n, p)^{14}\text{C}$ reaction with thermal reactor neutrons, and the ^{14}C formed is separated and quantified by beta counting. The method is matrix independent and chemically specific, and since detection is based on a nuclear rather than a chemical reaction, the results are independent of the chemical form of nitrogen. Furthermore, since only radioactive ^{14}C is being quantified, the blank problems inherent in non-nuclear methods for nitrogen analysis are avoided.

A quantified radiochemical neutron activation procedure that uses liquid scintillation counting was developed to measure low-level nitrogen in steels and other materials to meet a critical industrial need.

Several alternative procedures for oxidation of the steel have been tried including oxidation by fusion with $\text{Pb}_3\text{O}_4/\text{B}_2\text{O}_3$ in an enclosed system under a flow of argon. However this is both lengthy and expensive, and some unreacted steel remained even after an hour at 950 °C. In addition, there is no way to determine the fraction of ^{14}C recovered from the sample. However, the most promising method of attack is simple combustion in flowing oxygen at 900 °C to 1000 °C, with or without an accelerator, a method that has been used in the analysis of carbon in steel for many years. This proved to work well and was utilized in the procedure developed for low alloy steels and is described below.

The steel sample is mixed with a known amount of nonradioactive carrier (CaCO_3), before oxidation. The evolved CO_2 is precipitated as BaCO_3 , which is then weighed to determine the chemical yield and decomposed with HCl. Evolved CO_2 is quantitatively absorbed in the scintillator cocktail. Tests have verified that the fraction of BaCO_3 recovered is near 100 %. A known quantity of a ^{14}C -labeled BaCO_3 was decomposed with HCl, and $^{14}\text{CO}_2$ absorbed in scintillation cocktail. Repeated trials yielded consistent and quantitative results for low alloy steels. Preliminary measurements indicate that the proposed scheme has a high probability of success. This scheme will be tested first by burning samples of un-irradiated steel mixed with CaCO_3 carrier and a known amount of ^{14}C tracer. If the ^{14}C can be quantitatively measured, then the method will be further tested through analysis of several NIST SRM steels that are certified for nitrogen.

Results: A reliable method for measurement of nitrogen in a wide variety of materials could impact many industries. Foremost on this list is the US aerospace industry, which requires primary standards for accurate measurement of low-level nitrogen in titanium. The RNAA method could provide the industry with the means to improve safety standards for aircraft. The method could be extended to analysis of other materials, especially biologicals, where determination of nitrogen in proteins is essential.

Studying the Chemistry of Pharmaceuticals in Wastewater

M. Bedner and W.A. MacCrehan (839)

CSTL Program: *Energy and Environmental Technologies*

Pharmaceuticals and personal care products (PPCPs) are increasingly being recognized as a threat to human health and the environment. PPCPs are continuously released into the environment from human and agricultural waste and are frequently subject to waste treatment processes. Chlorination is the most widely-used chemical process for disinfecting wastewater and drinking water. Chlorine is a strong, non-selective oxidant that is capable of rapidly transforming pharmaceutical compounds. Understanding the chemical and toxicological nature of the transformation products is an important first step to determining what compounds should be measured in the environment.

Preliminary investigations conducted by CSTL researchers provide critical information to be used by environmental researchers determining the importance and fate of pharmaceutical compounds.

The identification of unknown transformation products using mass spectrometric detection is critical in investigating this measurement problem. Four pharmaceutical compounds that are frequently detected in the environment were evaluated and included; acetaminophen, metoprolol, sulfamethoxazole, and diclofenac. We have begun investigations of the pharmaceutical transformations using calibrated doses of chlorine (added as hypochlorite). Liquid chromatography was used to separate reaction products, which were evaluated and identified using four detection modes. All compounds were significantly transformed by reaction with chlorine. Acetaminophen was shown to form two toxic products, benzoquinone and *N*-acetyl-*p*-benzoquinoneimine, and at least ten additional products (see chromatogram). Metoprolol reacted to form one major product, a chloramine. Sulfamethoxazole formed two major products, both of which have a chlorine atom in the molecule, but only one of which appears to be a chloramine. Diclofenac forms at least five products, one of which has an additional chlorine atom. For all compounds, the products of the reactions tended to be more hydrophobic than the parent pharmaceutical, which might make them more bioaccumulative.



This project is still in its early stages, so there are many important aspects that need to be addressed. The transformation rates of the pharmaceutical compounds need to be evaluated at the ng/g levels typically found in wastewater to verify that the reactions will be significant. Also, as products are identified, targets for measurement in the environment need to be determined based on the potential for toxicity and/or bioactivity. In addition, there are other chemical processes including chloramination, dechlorination, and ozone-disinfection that might transform pharmaceutical compounds. The effects of these water treatment processes on pharmaceuticals will be investigated.

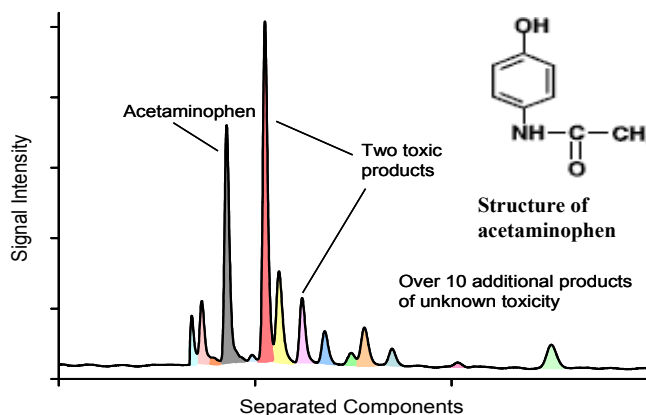

High-Throughput Bioimaging with Quantum Dots: HER2 Testing Standard

Yan Xiao and Peter E. Barker (831)

Details provided in CSTL Program: *Health and Medical Technologies*

New HIV Bioinformatics Database

T. N. Bhat (831) and A. Wlodawer (NCI, NIH)

Details provided in CSTL Program: *Health and Medical Technologies*

“Structure-Based Browsing and Retrieval” aspects of the work was supported by Exploratory Research

Computational Chemistry Illuminates Atomistic Processes at Complex Interfaces

A.M. Chaka (838)

Details provided in CSTL Program: *Chemical and Allied Products*

D. Staff Recognition

Our staff is CSTL's greatest resource. We are proud of all of them and their accomplishments, both at work and in their communities. In FY 2004, the following staff members were formally recognized for their achievements.



Steven Choquette (839), **Edgar Etz** (837), **Wilbur Hurst** (836), and **Douglas Blackburn** (839) received the Edward Bennett Rosa Award for the development of SRM 2241 through SRM 2244, Raman intensity correction standards that will enable U.S. industry to accurately inter-compare data. The Edward Bennett Rosa Award is granted for outstanding achievement in/or contributions to the development of meaningful and significant engineering, scientific, or documentary standards either within NIST or in cooperation with other Government agencies or private groups.

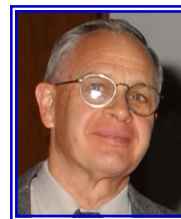

Rusty Day (839) received the Conference of Southern Graduate Schools (CSGS), Masters Thesis Award.



Colleen Bryan (839) received the Best Student Poster Award for "Non-Lethal Monitoring of Trace Elements in Bottlenose Dolphins, *Tursiops truncatus*" at the Southeast and Mid-Atlantic Mammal Symposium.

Michael Frenkel, **Robert Chirico**, and **Qian Dong** (838) received the US Department of Commerce Bronze Medal for their pioneering efforts in developing and promoting widespread acceptance of an important new communication process for thermodynamic data



R. F. Hafer and **A. Laesecke** (838) received the Best Paper Award by the Journal Measurement Science and Technology for their paper "Extension of the Torsional Crystal Viscometer to Measurements in the Time Domain," Meas. Sci. Technol., 14, 6633-6673 (2003).



Marcia Holden (831) received, in conjunction with the USDA Grain Inspection, Packers and Stockyards Administration Biotechnology Team, the 2004 USDA Group Honor Award for Excellence. This award was conferred for developing and implementing programs that have enhanced economic opportunities for United States producers and the grain industry to provide domestic and international confidence in United States grain.

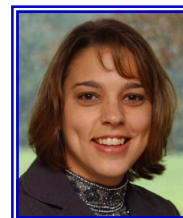

Donna Kimball (839) received the CSTL Secretarial Achievement Award for outstanding skills and providing extraordinary service to the staff and programs of CSTL.



Patrick Looney (836) was elected a Fellow of the American Vacuum Society (AVS) in recognition to his many contributions to advances in vacuum measurements technologies related to gauging and partial pressure analysis



Gary Mallard and Peter Linstrom (838) received the Judson C. French Award for their development of the NIST Chemistry WebBook, which has revolutionized the delivery of physical and chemical property data to NIST customers. The Judson C. French Award is granted for significant improvement in products delivered directly to industry, including new or improved NIST calibration services, Standard Reference Materials, and Standard Reference Databases.



Dave Matheu (838) received the Richard A. Glenn Award from the American Chemical Society (ACS) Fuel Division for his paper entitled “Automated Construction of Chemical Mechanisms for Challenging Pyrolysis Systems/Pressure-Dependent Automated Mechanism Generation”.



George Rhoderick (839) received the US Department of Commerce Bronze Medal for his outstanding efforts in the development of a series of Volatile Organic Compound (VOC) in Air standards.



Dean Ripple and Gregory Strouse (836) received the US Department of Commerce Bronze Medal for determining the errors in the ITS-90 within the industrially significant range from 273K to 505K and forming the basis for future temperature scale.



Dean Ripple (836) received the ASTM Award of Merit from Committee E-20 (Thermometry).



David Simons (837) was elected a Fellow of the American Vacuum Society (AVS) in recognition of his development of ion implanted Standard Reference Materials for advanced semiconductor metrology.



Mark Sobolewski (836) received the US Department of Commerce Bronze Medal for development of unique electrical measurement methods and mathematical models used in etching plasmas widely used in semiconductor manufacturing.



Michael Tarlov (836) received the US Department of Commerce Silver Medal for his seminal and outstanding contributions to the science and technology of self-assembled monolayers.



Cynthia Zeissler (837) received the US Department of Commerce Bronze Medal for extraordinary innovation in developing and applying spatially resolved radiation detection methods for homeland security and national defense.

The CSTL Divisions

CSTL's laboratory activities are primarily located at the NIST headquarters site in Gaithersburg, MD. We also have research activities in NIST laboratories in Boulder, CO, at the Center for Advanced Research in Biotechnology (CARB) in Rockville, MD, and at the Hollings Marine Laboratory (HML) in Charleston, SC.

Chemical Science and Technology Laboratory

Dr. Willie E. May, Director
(301) 975-8300
willie.may@nist.gov

Dr. William F. Koch, Deputy Director
(301) 975-8301
william.koch@nist.gov

Biotechnology Division

Dr. Robert N. Goldberg, Acting Chief
(301) 975-2584
robert.goldberg@nist.gov

- *DNA Technologies*
- *Bioprocess Measurements*
- *Structural Biology*
- *Cell and Tissue Measurements*

Process Measurements Division

Dr. James R. Whetstone, Chief
(301) 975-2600
james.whetstone@nist.gov

- *Fluid Flow*
- *Process Sensing*
- *Thermometry*
- *Pressure and Vacuum*
- *Thermal and Reactive Processes*
- *Fluid Science*

Surface and Microanalysis Science Division

Dr. Richard R. Cavanagh, Chief
(301) 975-2368
richard.cavanagh@nist.gov

- *Microanalysis Research*
- *Surface and Interface Research*
- *Analytical Microscopy*

Physical and Chemical Properties Division

Dr. Gregory J. Rosasco, Chief
(301) 975-2483
gregory.rosasco@nist.gov

- *TRC Group*
- *Chemical Reference Data*
- *Computational Chemistry*
- *Experimental Properties of Fluids*
- *Theory and Modeling of Fluids*
- *Cryogenic Technologies*

Analytical Chemistry Division

Dr. Stephen A. Wise, Chief
(301) 975-3112
stephen.wise@nist.gov

- *Spectrochemical Methods*
- *Organic Analytical Methods*
- *Gas Metrology and Classical Methods*
- *Molecular Spectroscopy and Microfluidic Methods*
- *Nuclear Methods*

Visit the CSTL Website at:
<http://www.cstl.nist.gov/>



February 2005