

Identification of SNPs in the Mitochondrial Genome to Resolve Common HV1/HV2 Types in Caucasian Populations.

Michael D. Coble¹, Rebecca S. Just², Jessica L. Saunier²;
Jennifer E. O'Callaghan²; Ilona H. Letmanyi², Christine T.
Peterson², Jodi A. Irwin²; Peter M. Vallone¹, John M. Butler¹,
and Thomas J. Parsons².

¹National Institute of Standards and Technology, Gaithersburg, MD, USA

²The Armed Forces DNA Identification Laboratory, Rockville, MD, USA

The Mitochondrial Genome

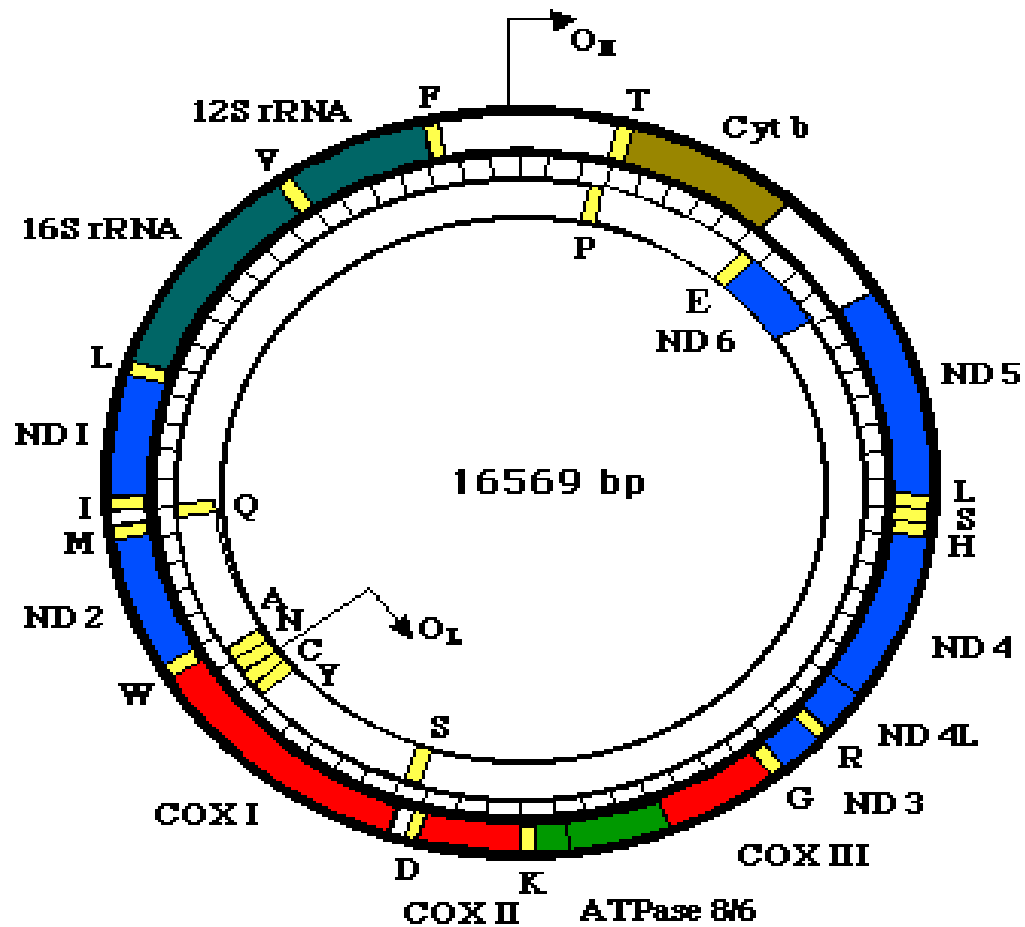

- | | | |
|--|--|---|
| ATPase 8/6 | Complex 1 | tRNAs |
| Cytochrome b | Complex 4 | rRNAs |

mtDNA as a Genetic Marker

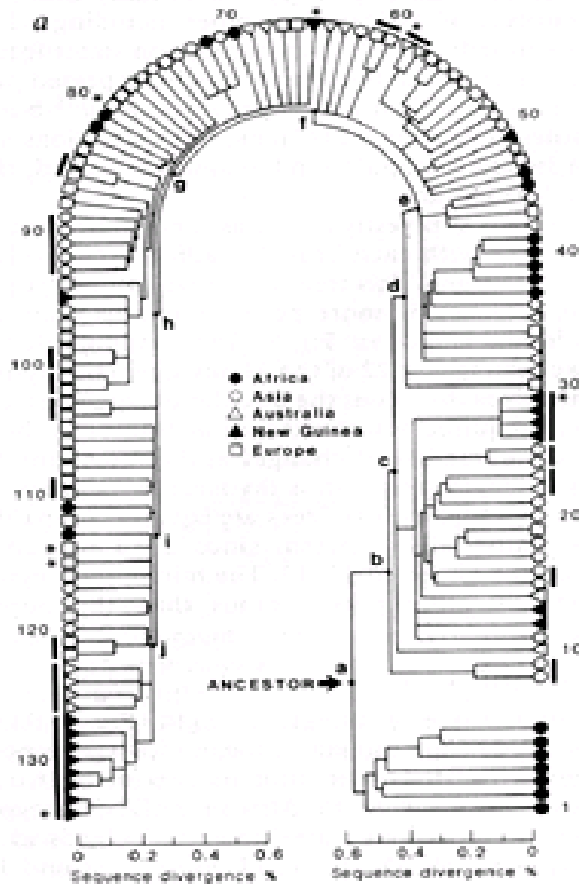

RFLP analysis of 134 individuals

Cann et al. 1987

“Out of Africa”

mtDNA as a Genetic Marker



Control Region Sequence
Analysis of 189 individuals

Vigilant et al. 1991

Mitochondrial Haplogroups

Herrnstadt et al.: Network Analysis of mtDNA Haplogroups

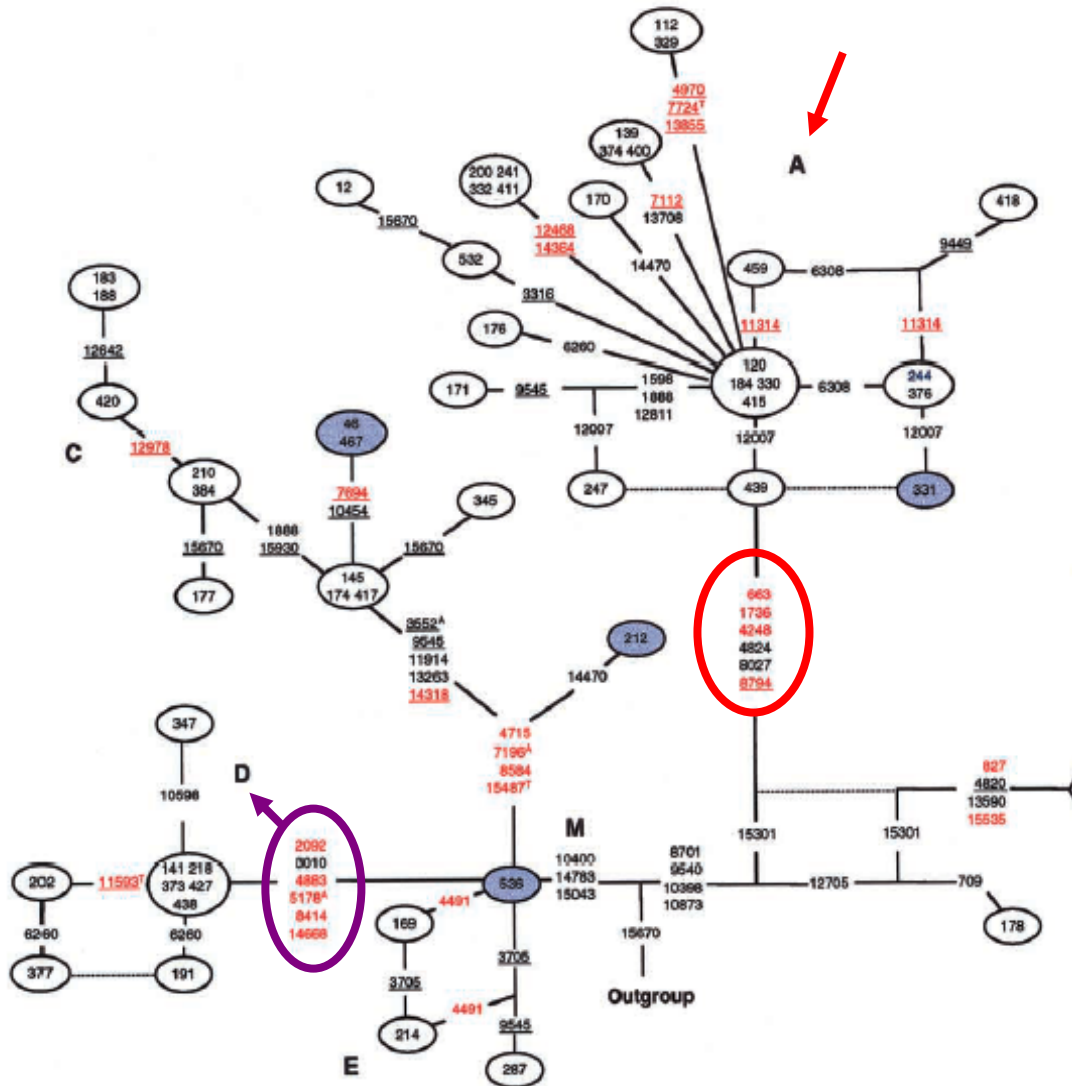

Haplogroup - A group of related haplotypes.

Each haplogroup cluster is defined by a set of specific, shared polymorphisms.

mtDNA Haplogroups (RFLP)

Human mtDNA Migrations

<http://www.gen.emory.edu/MITOMAP/WorldMigrations.pdf>
Copyright © Emory University, Atlanta, GA 30322

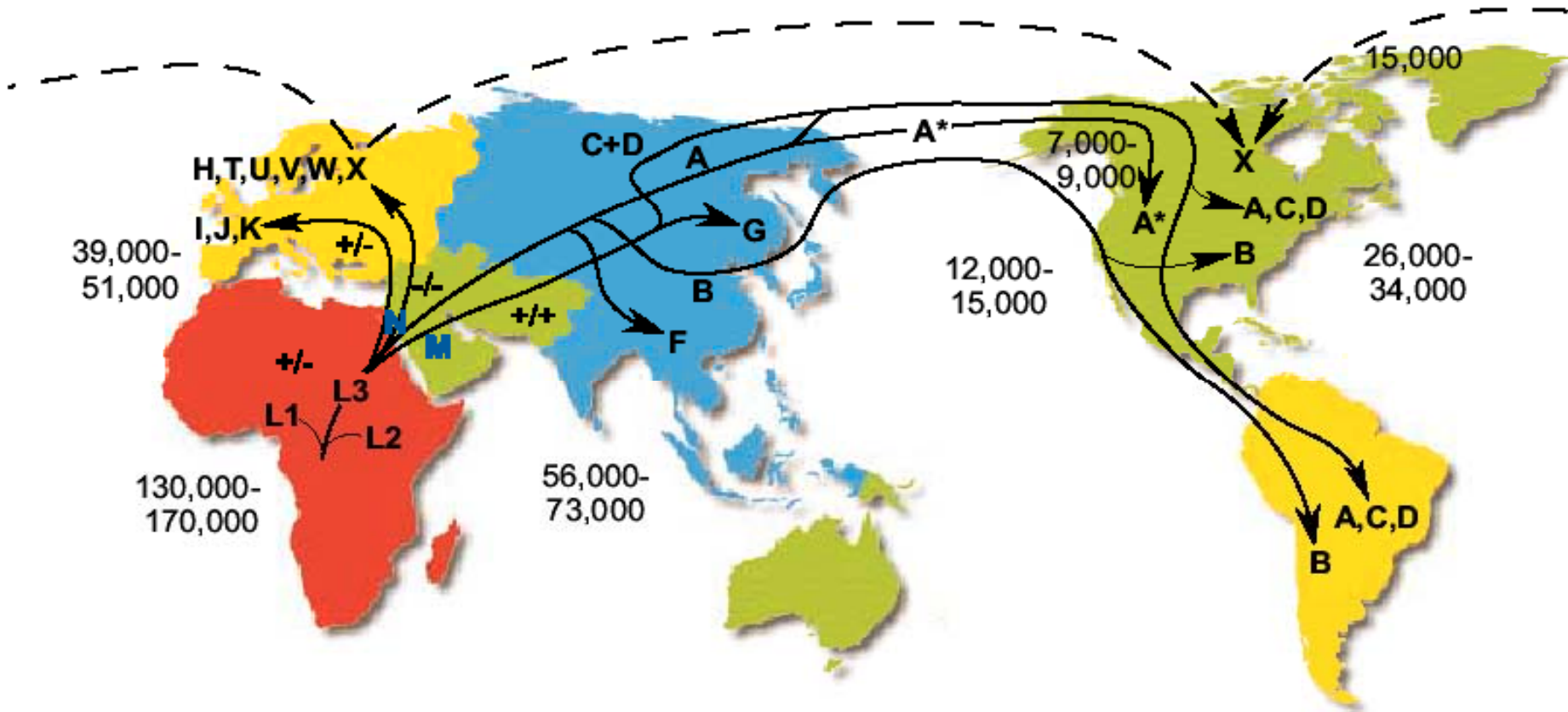

+/-, +/+, or -/- = Dde I 10394 / Alu I 10397
* = Rsa I 16329

Mutation rate = 2.2 - 2.9 % / MYR
Time estimates are YBP

Caucasian mtDNA Haplogroups (HV1/HV2)

- H - CRS +/- variants
- J - 16069 C-T 16126 T-C 73 A-G 295 C-T
- T - 16126 T-C 16294 C-T 73 A-G
- V - 16298 T-C 72 T-C

Macaulay et al. (1999) *AJHG* **64**: 232-249.

Allard et al. (2002) *JFS* **47**: 1215-1223.

mtDNA as a Forensic Tool

Advantages of Using mtDNA

- Maternal Inheritance
- Lack of Recombination
- High Copy Number
- Cases where:
 - DNA is degraded
 - Only maternal references are available
 - Samples with little or no Nuclear DNA
 - Shed Hairs
 - Fingernails

mtDNA as a Forensic Tool

Disadvantages of Using mtDNA

- Maternal Inheritance – You have many!
- Not a unique identifier
- Some mtDNA types are common in the population

Current mtDNA Amplification & Sequencing Strategy

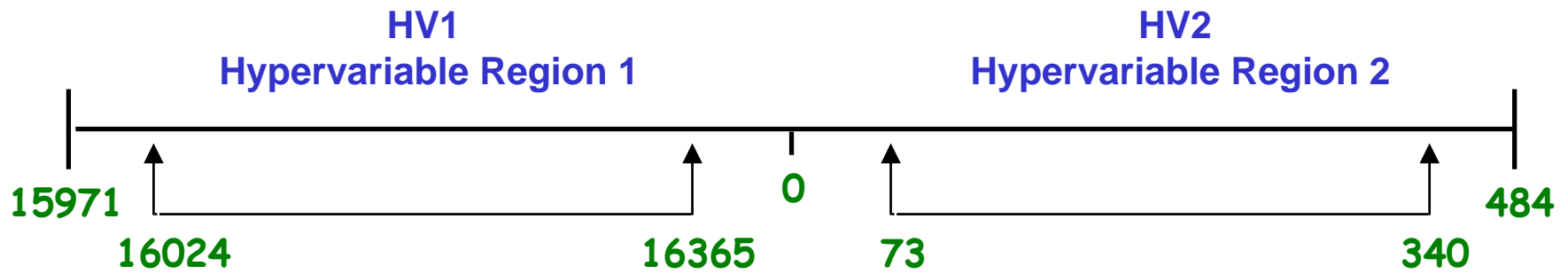

$$\text{HV1} + \text{HV2} = 610 \text{ bp}$$

Current mtDNA Amplification & Sequencing Strategy

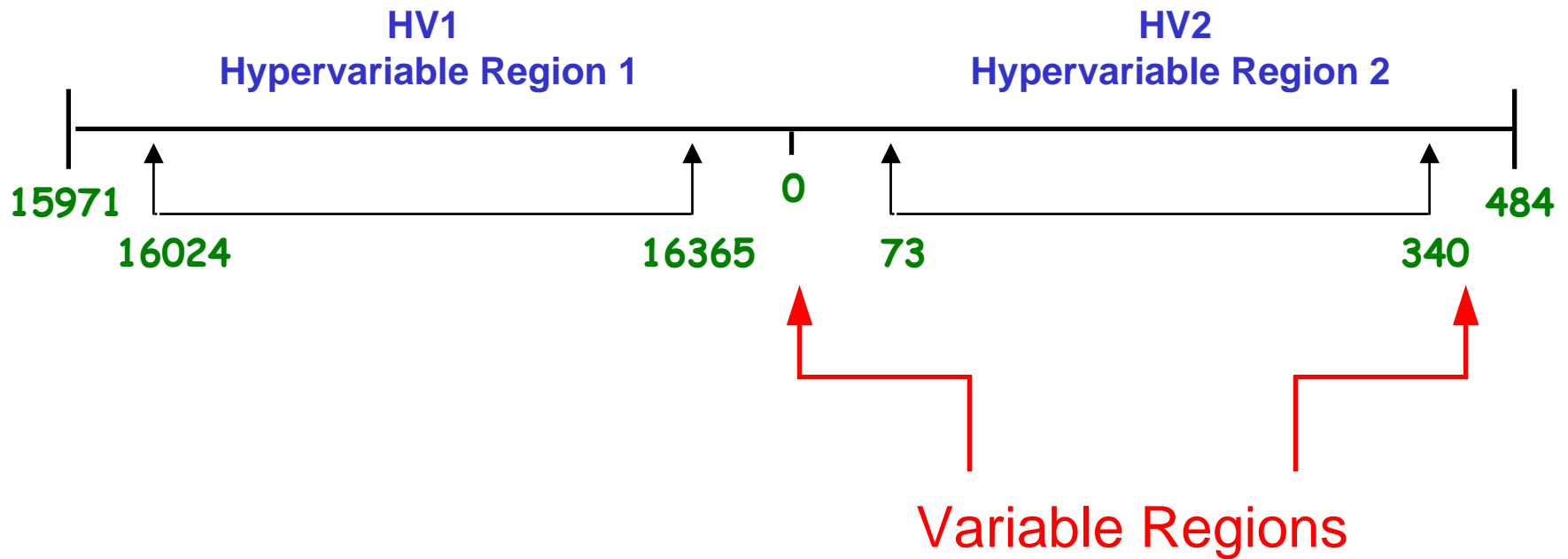

Current mtDNA Amplification & Sequencing Strategy

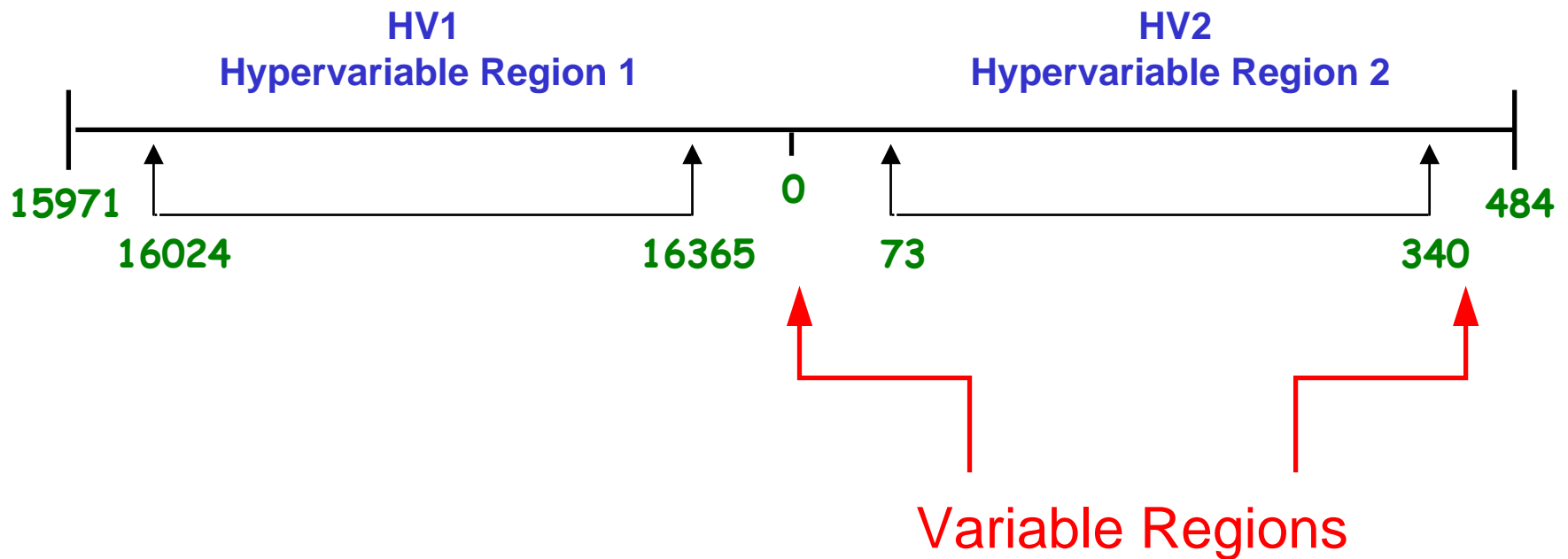

More Sequence Information

mtDNA Population Distribution Caucasians (n=1665)

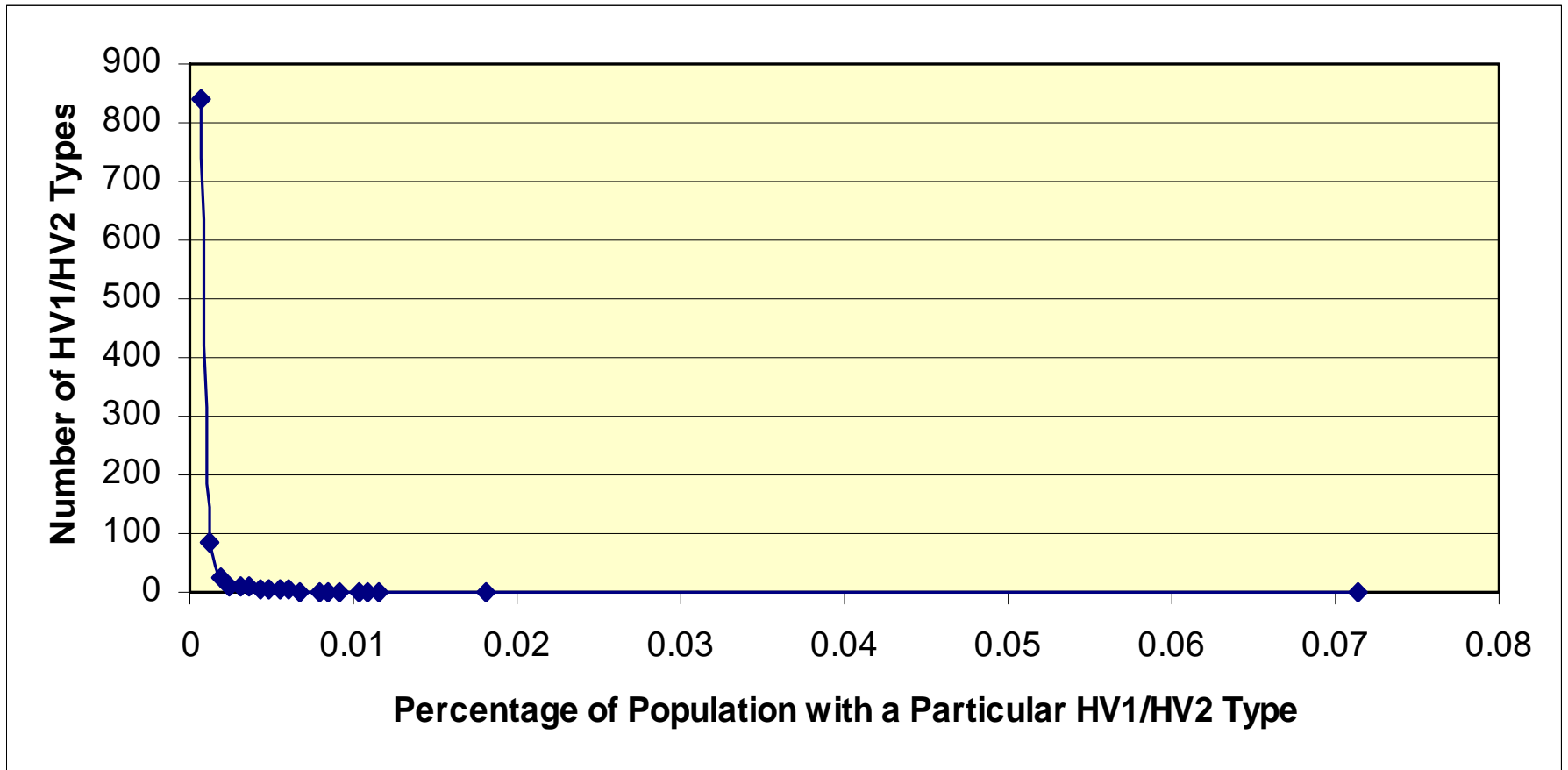

mtDNA Population Distribution Caucasians (n=1665)

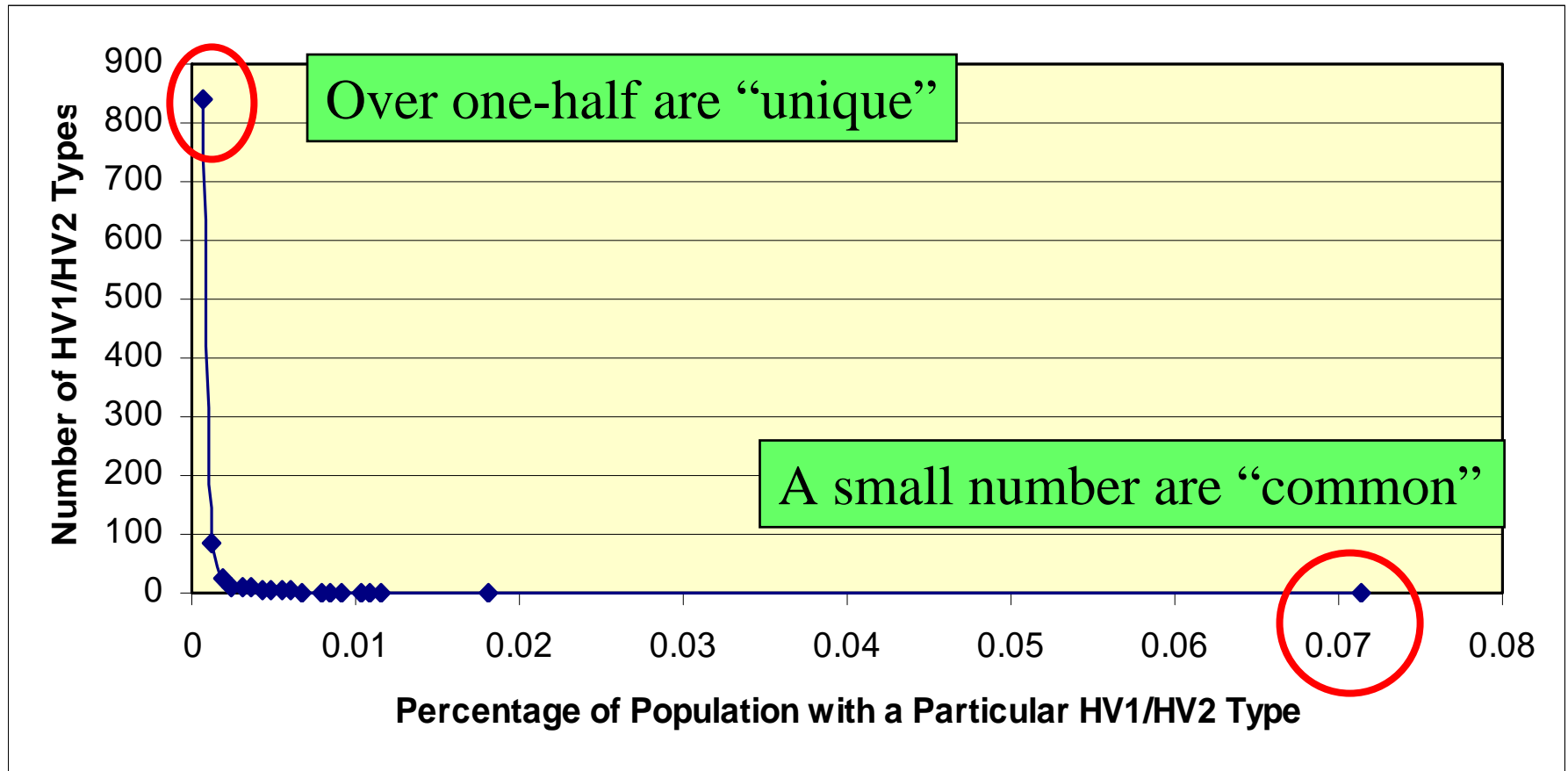

Framing the Problem

The greatest limitation for mtDNA testing lies with the small number of common types for which the power of discrimination is low.

~20% of the time, the Forensic Scientist encounters a HV1/HV2 type that occurs at greater than ~0.5% of the population

In database or mass fatality comparisons: multiple hits will occur for these common types.

A Case Example

- September 15, 1943 - B17F Bomber returning from a mission to Port Moresby, New Guinea



A Case Example

- The plane crashes in the Owen Stanley Mountain range due to “adverse weather.”
- Subsequent searches proved negative.
- 11 crewmen declared non-recoverable on July 22, 1949.

A Case Example

- October 9, 1992 - A private company helicopter discovers crash site.
- mtDNA testing reveals that 3/11 crewmen share the same HV type (263 A-G, 315.1 C).
- Further VR testing could distinguish 1 of the 3 crewmen (16519 T-C). However, 2 crewmen still matched.

A Case Example

- Partial dental records were used to associate 3 teeth among the 2 crewmen matching in the CR.
- One L femur could not be associated with either crewmen, and was buried in a grave containing group remains

Central Effort of the Project

- Sequence variation outside of HV1/HV2 can be used to distinguish Caucasian individuals sharing common types.

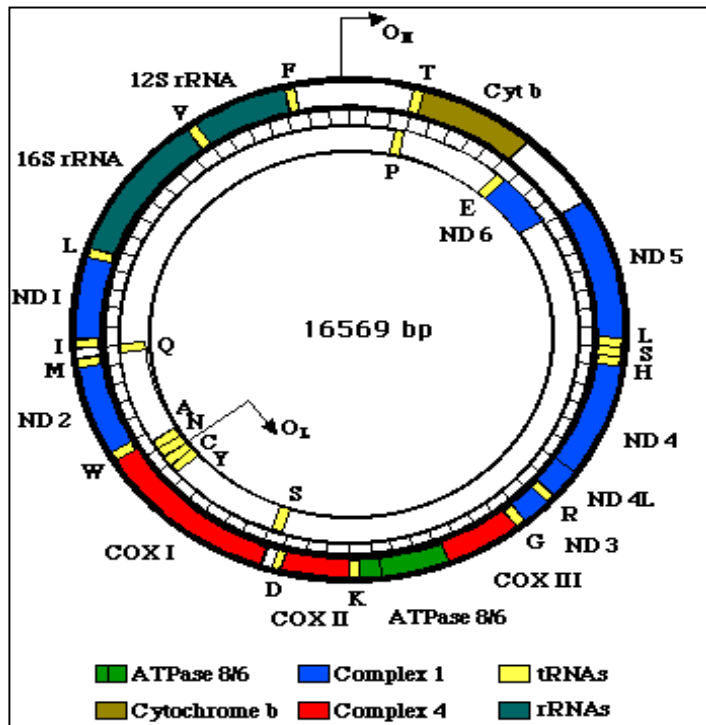

Coding Region – evolutionary rate is 4-fold less than the control region.

However...15X Amount of DNA

Ethical Considerations

- More than 100 characterized diseases associated with mtDNA mutations (Mitomap – www.mitomap.org)
- To avoid having forensic testing from evolving into genetic counseling, we focused on neutral SNPs in the mtGenome.

SNPs for Discrimination

- Non-coding sites in the control region (outside of HV1/HV2).
- Non-coding “spacer” regions throughout the mtGenome.
- Silent mutations in protein coding genes.

SNPs for Discrimination

- Practical application – A set of SNP sites that can be rapidly assayed to provide maximal discrimination.
- Avoids further sequencing.
- SNaPShotTM (ABI) – small amplicons, multiplexed - can conserve template.

Strategy for SNP Identification

- Sequence the entire genome of unrelated individuals sharing common HV1/HV2 types in the Caucasian population (focus on 18 of 22 common types that occur at a frequency of 0.5% or greater).

Common mtDNA Haplogroups

Com	Haplo	Seq (+ CRS)	
31	H1	CRS	
25	H2	152 C	
11	H3	16129 A	
8	H4	16263 C	
12	H5	16304 C	
11	H6	73 G	
7	H7	16162 G 16209 C 73 G	

Length Variation in HV2 C-stretch – ignored (see Stewart et al., 2001)

Common mtDNA Haplogroups

Com	Haplo	Seq (+ CRS)							
15	J1	16069 T 16126 C	73 G	185 A	228 A	295 T			
6	J2	16069 T 16126 C	73 G	228 A	295 T				
12	J3	16069 T 16126 C	73 G	185 A	188G	228 A	295 T		
3	J4	16069 T 16126 C	16145 A	16172 C	16222 T	16261 T	73 G	242 T	295 T
20	T1	16126 C 16294 T	16296 T	16304 C	73 G				
10	T2	16126 C	16163 G	16186 T	16189 C	16294 T	73 G	152 C	195 C
8	T3	16126 C 16294 T	16296 T	73 G					
25	V1	16298 C							
14	K1	16224 C 16311 C	73 G	146 C	152 C				
8	K2	16093 C 16224 C 16311 C	73 G						
7	K3	16224 C 16311 C	73 G						

241 total genomes from 18 common HV1/HV2 types
 (~14% of the total database)

Whole Genome Sequencing Strategy

- Human mtDNA standard reference material (Levin et al., 1999)

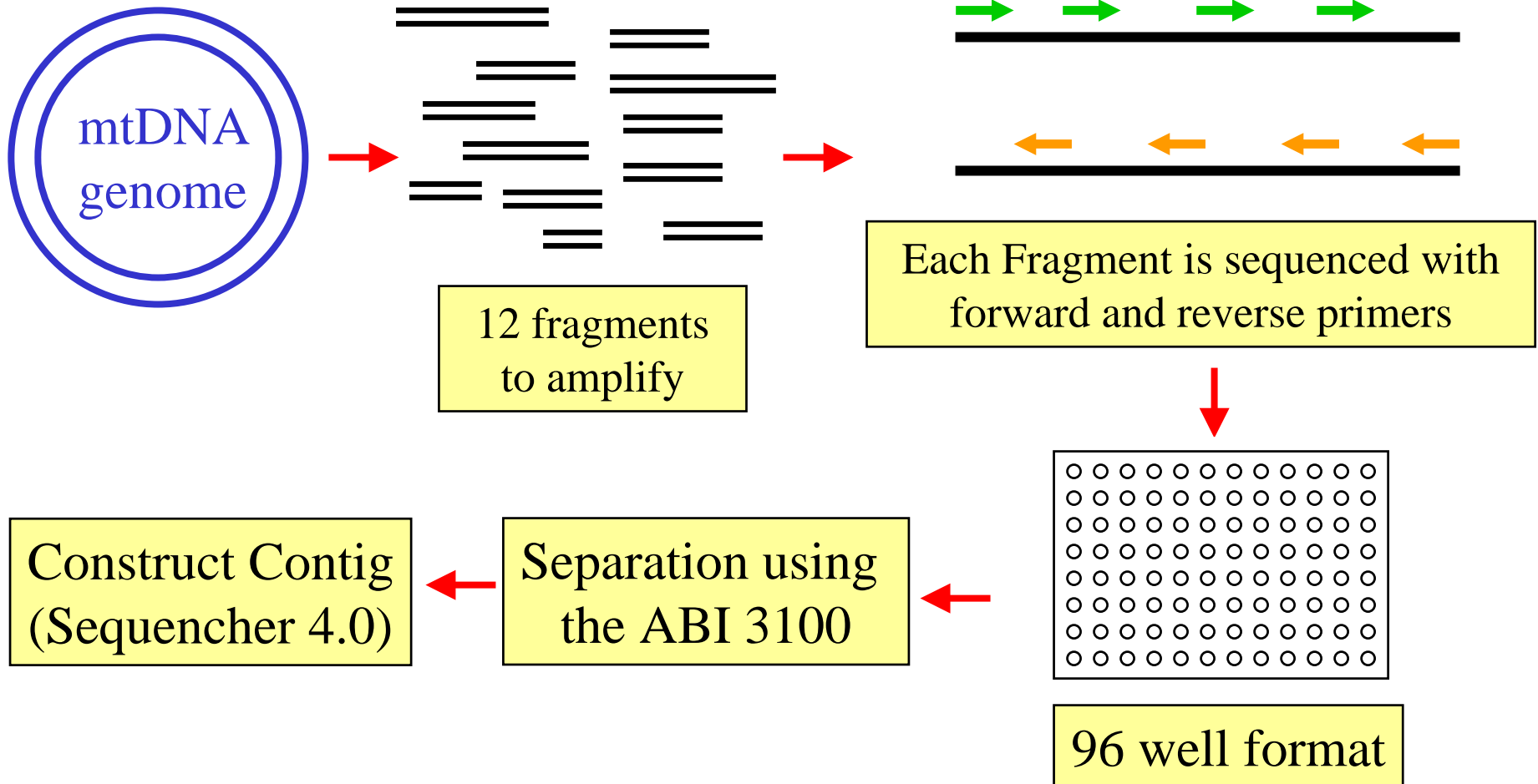

High Throughput Sequencing MWG RoboAmp 4200



High Throughput Sequencing from NIJ Support



Jennifer O'Callaghan

Rebecca Just

Jessica Saunier

Former Team Members – Christine Peterson and Ilona Letmanyi

Criteria for SNP Selection

- Neutral.
- Should be shared (within or among individuals sharing the common types).
- Non-redundant

The Nature of the SNPs

- Would the SNPs that resolve one group be useful for resolving other closely related groups?

Com	Haplo	Seq (+ CRS)	
31	H1	CRS	
25	H2	152 C	
11	H3	16129 A	“Hot Spots”
8	H4	16263 C	
12	H5	16304 C	
11	H6	73 G	
7	H7	16162 G 16209 C 73 G	

The Nature of the SNPs

- Are resolving SNPs **slow, rare polymorphisms** that occurred once during the evolution of a haplogroup?

OR....

The Nature of the SNPs

- Are resolving SNPs **slow, rare polymorphisms** that occurred once during the evolution of a haplogroup?

OR....

- Are resolving SNPs “universally” **fast hot spots**, useful for all haplogroups (L, M, N)?

OR....

The Nature of the SNPs

- Are resolving SNPs **slow, rare polymorphisms** that occurred once during the evolution of a haplogroup?

OR....

- Are resolving SNPs “universally” **fast hot spots**, useful for all haplogroups (L, M, N)?

OR....

- Are resolving SNPs a combination of the two?

263 A-G
315.1 C

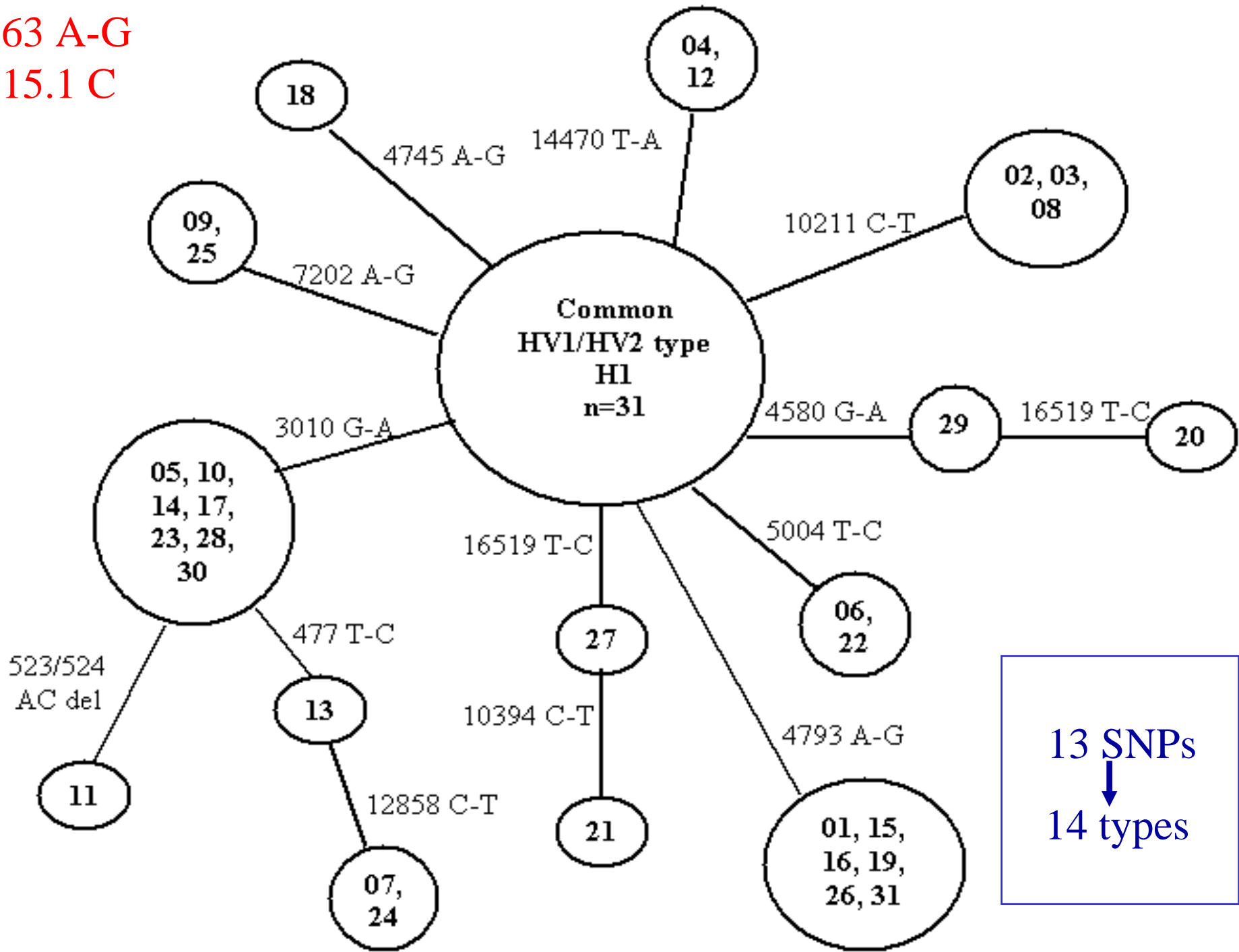

263 A-G
315.1 C

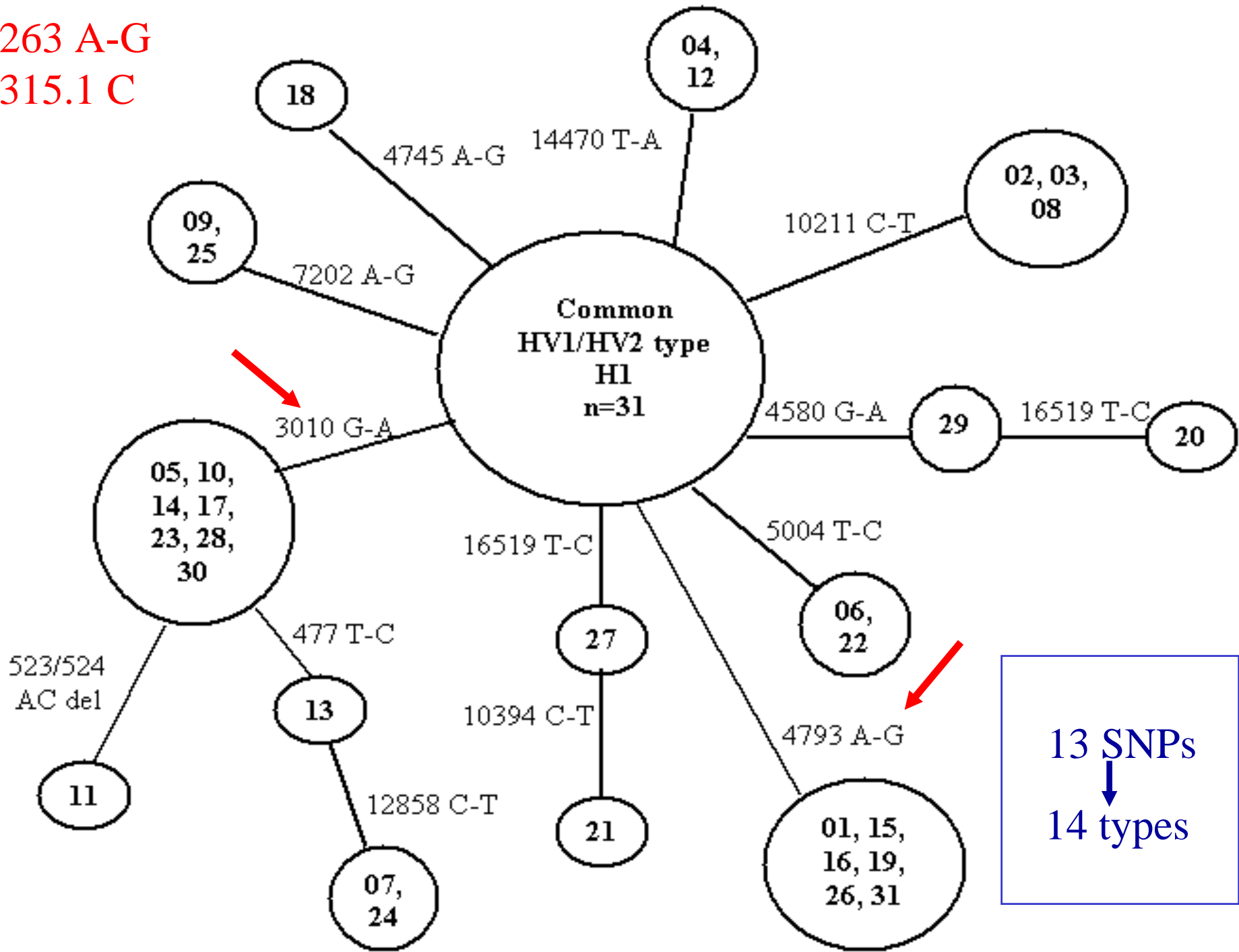

263 A-G
315.1 C

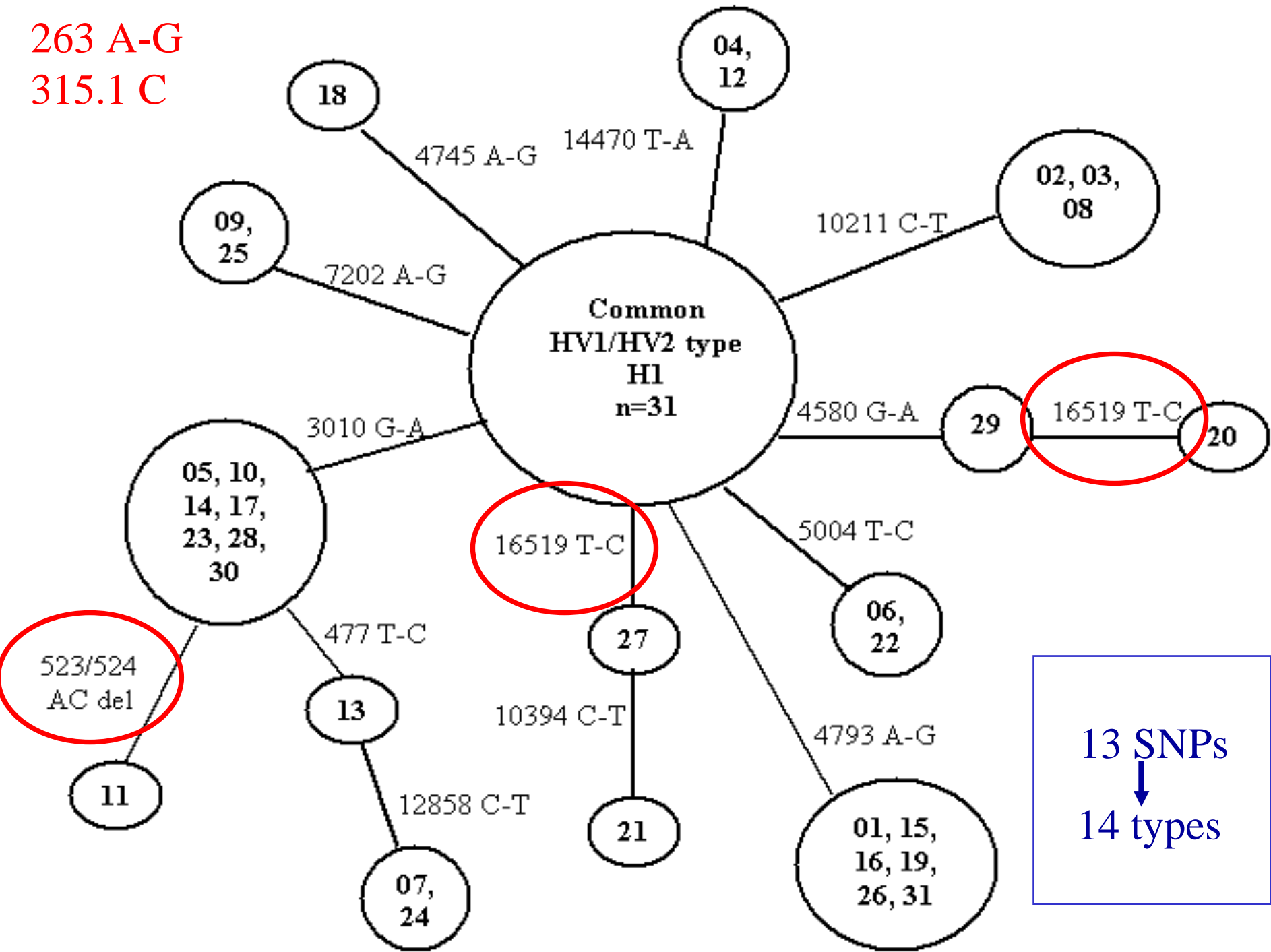

263 A-G
315.1 C

Haplogroup V (Reversion at 16298 C)

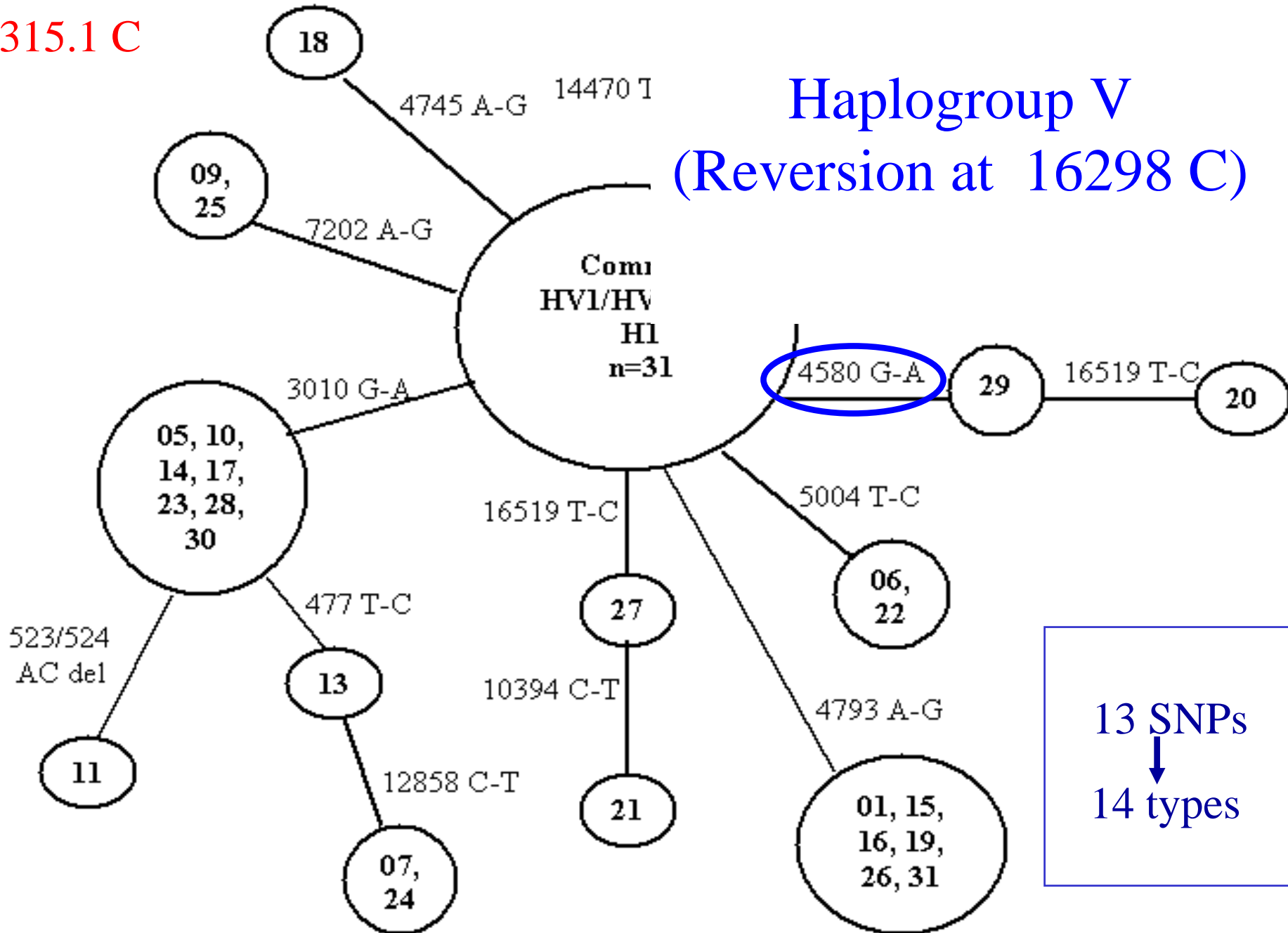

H4 - CRS + 16263 T-C

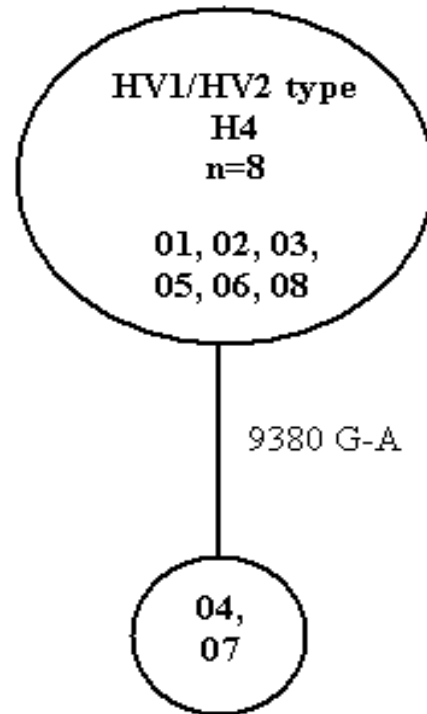

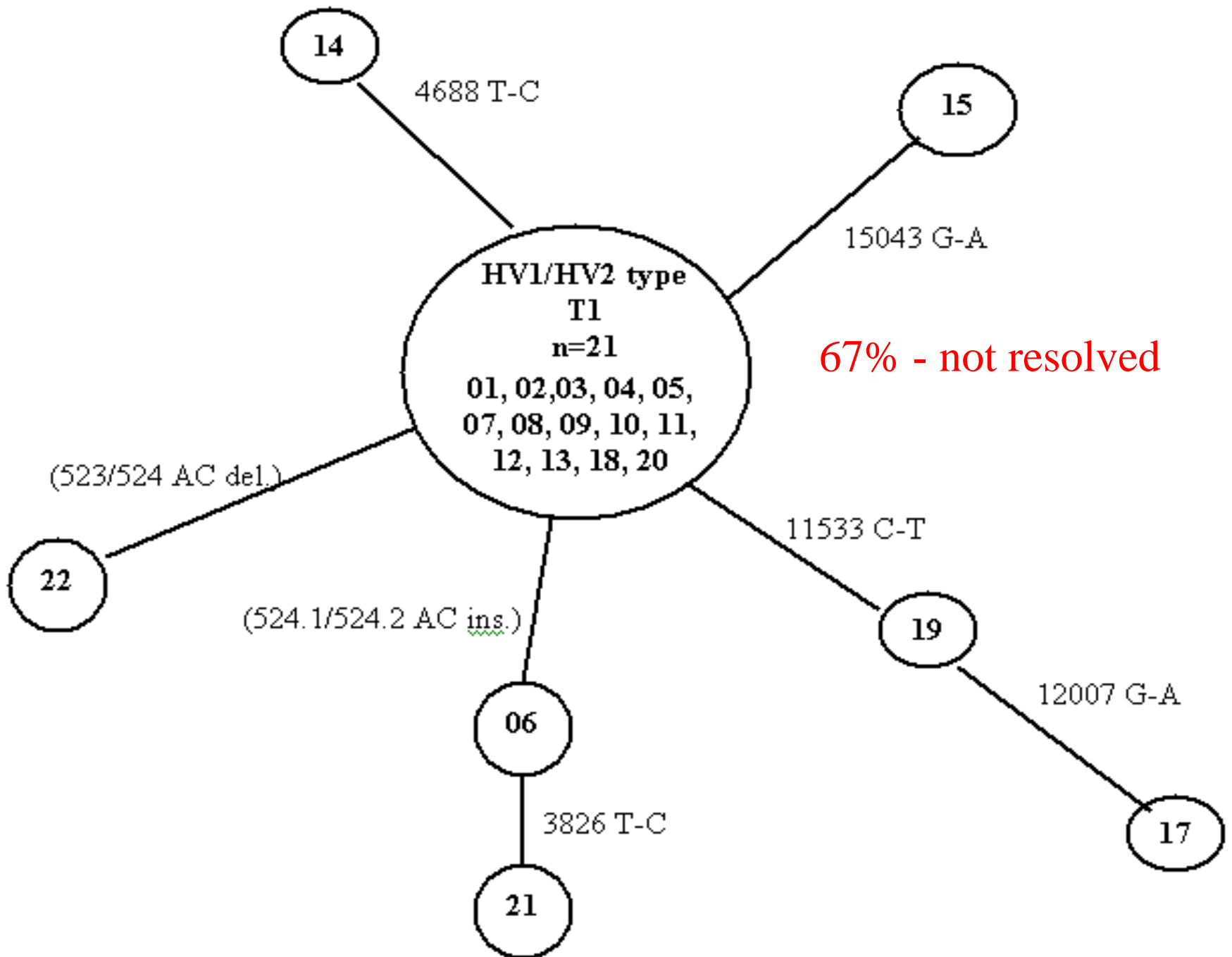

Summary

- 241 mtGenomes – 420 polymorphic sites in the coding region.
- 32/241 – matched one or more individuals over the entire mtGenome (0/12 H5 individuals matched; 4/8 H7 individuals matched).
- Homoplasies – common in HV1/HV2.

Summary

- Percentage of sites that varied ranged from 1.0% (16S rRNA) to 6.6% (non-coding regions outside of the control region).
- ATP Synthase 8 (4.8%) and ATP Synthase 6 (3.7%) showed the greatest variation in the protein coding genes.

Synonymous and Non-synonymous mutations, by Gene

Gene	Length	Synonymous	Nonsynonymous	Total	% NonSyn.
ND1	956	14	8	22	36.4%
ND2	1,042	25	11	36	30.6%
CO1	1,542	29	9	38	23.7%
CO2	684	14	4	18	22.2%
ATP8	207	3	5	8	62.5%
ATP6	681	7	20	27	74.1%
CO3	784	14	4	18	22.2%
ND3	346	5	2	7	28.6%
ND4L	297	5	1	6	16.7%
ND4	1,378	30	7	37	18.9%
ND5	1,812	39	15	54	27.8%
ND6	525	8	7	15	46.7%
CYB	1,141	23	15	38	39.5%
Total	11,341	216	108	324	33.1%

c.f. Mishmar et al. (2003) PNAS

SNPs for Forensic Discrimination

- 59 SNPs – that met our criteria (neutral, shared, non-redundant).
 - 49 – Protein coding (silent)
 - 8 – Control Region (outside HV1/2)
 - 1 – Non-coding spacer region
 - 1 – 16S rRNA*

* 3010 G-A

SNPs for Forensic Discrimination

A	B	C	D	E	F	G	H
477	477	72	482	4808	64	3826	64
3010	3010	513	5198	5147	4745	3834	4688
4580	3915	4580	6260	9380	10211	4688	11377
4793	5004	5250	9548	9899	10394	6293	12795
5004	6776	11719	9635	11914	10685	7891	13293
7028	8592	12438	11485	15067	11377	11533	14305
7202	10394	12810	11914	16519	14470	12007	16519
10211	10754	14770	15355		14560	12795	
12858	11864	15833	15884		16390	15043	
14470	15340	15884	16368		14869	16390	
16519	16519	16519				16519	
H1	H2 H3 H6	V1 H5	J1 J2 K2 K3	J4 T2 T3 H4	V1 H1 H2 H3	J1 J3 T1	K1

SNPs for Forensic Discrimination

A	B	C	D	E	F	G	H
477	477	72	482	4808	64	3826	64
3010	3010	513	5198	5147	4745	3834	4688
4580	3915	4580	6260	9380	10211	4688	11377
4793	5004	5250	9548	9899	10394	6293	12795
5004	6776	11719	9635	11914	10685	7891	13293
7028	8592	12438	11485	15067	11377	11533	14305
7202	10394	12810	11914	16519	14470	12007	16519
10211	10754	14770	15355		14560	12795	
12858	11864	15833	15884		16390	15043	
14470	15340	15884	16368		14869	16390	
16519	16519	16519				16519	
H1	H2 H3 H6	V1 H5	J1 J2 K2 K3	J4 T2 T3 H4	V1 H1 H2 H3	J1 J3 T1	K1

SNPs for Forensic Discrimination

A	B	C	D	E	F	G	H
477	477	72	482	4808	64	3826	64
3010	3010	513	5198	5147	4745	3834	4688
4580	3915	4580	6260	9380	10211	4688	11377
4793	5004	5250	9548	9899	10394	6293	12795
5004	6776	11719	9635	11914	10685	7891	13293
7028	8592	12438	11485	15067	11377	11533	14305
7202	10394	12810	11914	16519	14470	12007	16519
10211	10754	14770	15355		14560	12795	
12858	11864	15833	15884		16390	15043	
14470	15340	15884	16368		14869	16390	
16519	16519	16519				16519	
H1	H2 H3 H6	V1 H5	J1 J2 K2 K3	J4 T2 T3 H4	V1 H1 H2 H3	J1 J3 T1	K1

Allele-Specific Primer Extension

SNP Primer is extended by one base unit

ABI PRISM[®] SNaPshot[™]
Multiplex System

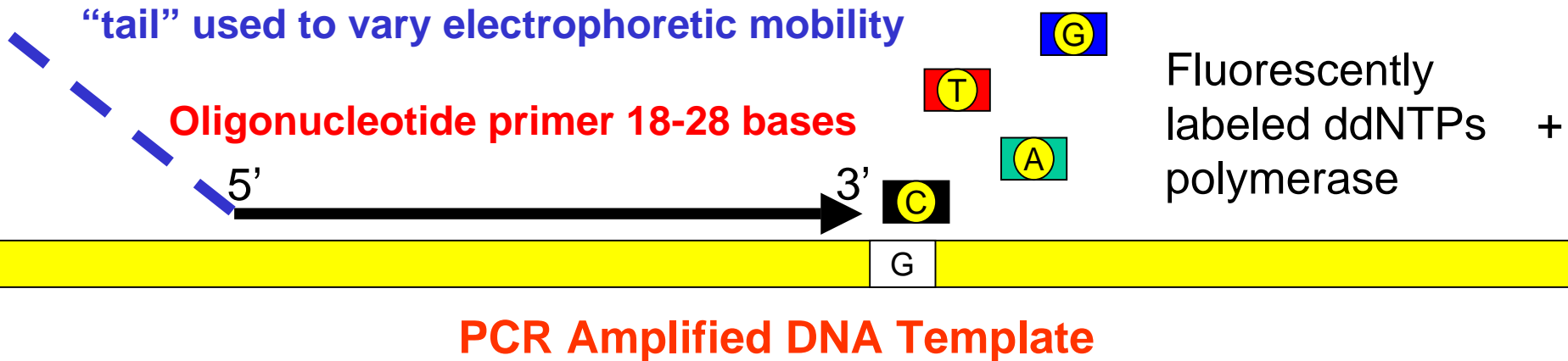

Products can be electrophoretically separated on an ABI 310, 3100

The SNaPShot™ Platform

Locus	SNP Primer Sequence	Length
3010-F	TCAGAAGTGAAAGGGGGC	18/ na
4763-R	TTTTTTTGTGGATCAGGACATCCC	19/ 26
10211-R	TTTTTTTAC TAAGAAGAATTTATGGA	20/ 30
5004-F	TTTTTTT TAGACCCAGCTACGCAAATC	20/ 34
7028-F	TTTTTTT GACACG TACTACGTTGTAGC	20/ 38
7202-F	TTTTTTT CCACAACAC TTTCTC GGCCT	20/ 42
16519-R	TTTTTTT TGTGGGCTATTTAGGCTTTATG	22/ 46
12858-F	TTTTTTT GCAGCATTCAAGCAATCCTATA	23/ 50
4580-R	TTTTTTT TGGTTAGA ACTGGAATAAAAGCTAG	25/ 54
477-F	TTTTTTT TTCCTCCCAC TCC CATACTAC	20/ 58
14470-R	TTTTTTT GGGAAATGATGGTTGTC TTTGG	21/ 62

Rebecca Hamm
Dr. Peter Vallone

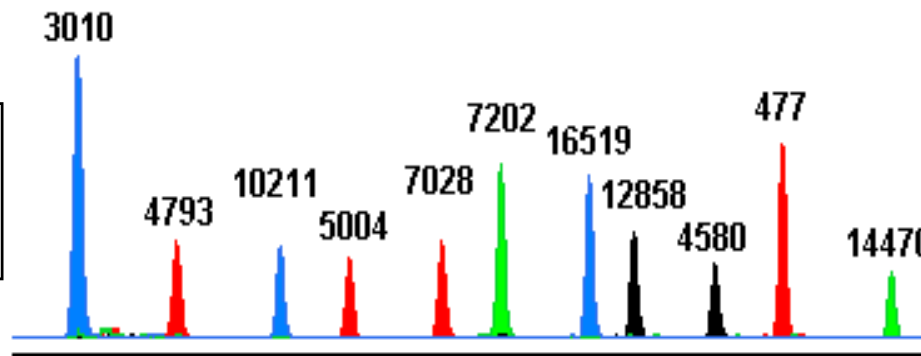

Vallone et al. *IJLM* (2004) **118**: 147- 157.

SNPs for Forensic Discrimination

18 common HV1/HV2 types, 241 individuals

SNPs for Forensic Discrimination

18 common HV1/HV2 types, 241 individuals



+8 Multiplexes (59 SNPs)

105 types (55 “unique”)

SNPs for Forensic Discrimination

18 common HV1/HV2 types, 241 individuals



+8 Multiplexes (59 SNPs)

105 types (55 “unique”)

+8 Multiplexes (with AC indel)

112 types (64 “unique”)

SNPs for Forensic Discrimination

18 common HV1/HV2 types, 241 individuals

+8 Multiplexes (59 SNPs) +8 Multiplexes (with AC indel)

105 types (55 “unique”)

112 types (64 “unique”)

6-fold improvement!

The Nature of the SNPs

A	B	C	D	E	F	G	H
477	477	72	482	4808	64	3826	64
3010	3010	513	5198	5147	4745	3834	4688
4580	3915	4580	6260	9380	10211	4688	11377
4793	5004	5250	9548	9899	10394	6293	12795
5004	6776	11719	9635	11914	10685	7891	13293
7028	8592	12438	11485	15067	11377	11533	14305
7202	10394	12810	11914	16519	14470	12007	16519
10211	10754	14770	15355		14560	12795	
12858	11864	15833	15884		16390	15043	
14470	15340	15884	16368		14869	16390	
16519	16519	16519				16519	
H1	H2 H3 H6	V1 H5	J1 J2 K2 K3	J4 T2 T3 H4	V1 H1 H2 H3	J1 J3 T1	K1

The Nature of the SNPs

- Are the SNPs useful for discrimination mostly slow, rare types restricted to a particular HV1/HV2 type

(OR)

- Do the SNPs have a general utility across many different haplotypes?
- How should one proceed to identify SNPs to resolve common HV1/HV2 types in other forensically relevant populations (e.g. African American)?

Why not survey the literature for Polymorphisms?

- Prior to Dec. 2000 - handful of complete human genomes (mostly RFLP data ~20% of the genome)
- Dec. 2000 - Ingman et al. (53 complete)
- June 2001 - Finnila et al. (192 genomes - CSGE)
- August 2001 - Maca-Myer et al. (42 complete)
- May 2002 - Herrnstadt et al. (560 coding only)

Why not survey the literature for Polymorphisms?

- Prior to Dec. 2000 - handful of complete human genomes (mostly RFLP data ~20% of the genome)
- Dec. 2000 - Ingman et al. (53 complete)
- June 2001 - Finnila et al. (192 genomes - CSGE)
- August 2001 - Maca-Myer et al. (42 complete)
- May 2002 - Herrnstadt et al. (560 coding only)

Problem - Very Few *Common* Types

Anderson		746 Sequences					
Posn.	Base	A	G	C	T	Gap	Ins
10192	C	1		743	2		
10197	G	2	744				
10199	C			745	1		
10211	C			745	1		
10238	T			31	715		
10245	T			1	745		

“H1”

3/31

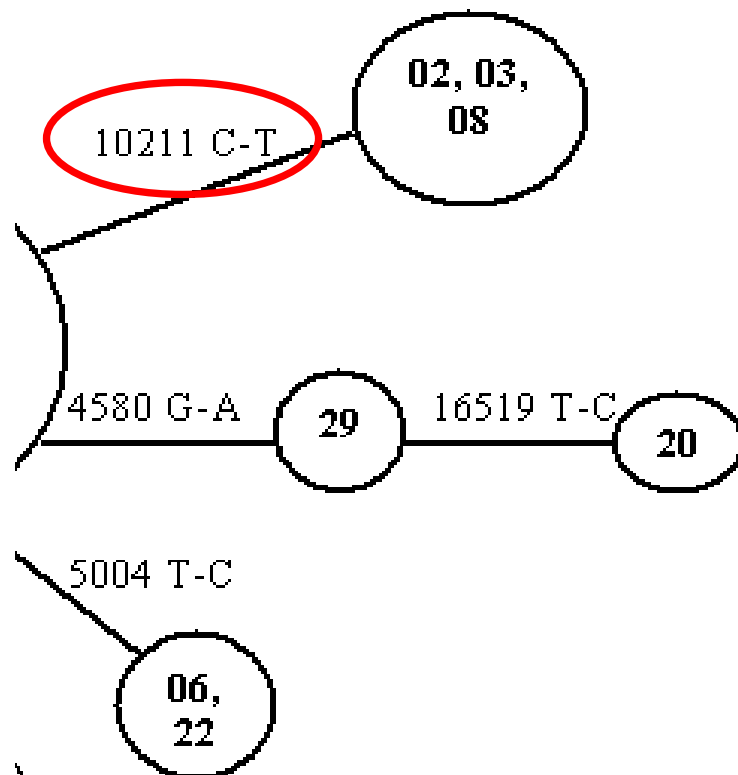

- mtDB - Human Mitochondrial Genome Database
- <http://www.genpat.uu.se/mtDB/>

Recent recommendations to increase forensic discrimination

- Andreasson et al. (2002) – Sequenced short fragments of the mtGenome that are most informative
- Lee et al. (2002) – Sequenced the CytB gene for Koreans
- Lutz-Bonengel et al. (2003) – Sequenced the ATPase and ND4 genes (highly variable genes)
- Poetsch et al. (2003) – Sequenced the ATPase genes

Flaws with this approach

- Variation in one gene is not guaranteed (or likely) to resolve *common* types.
- Focus on one segment could miss SNPs scattered throughout the mtGenome.
- Unintended effect of revealing medically significant information.

Mutation Rate Analysis in the mtDNA Coding Region

Mutation rate heterogeneity – the variation of mutation rates among sites.

Meyer et al. *Genetics* (1999)

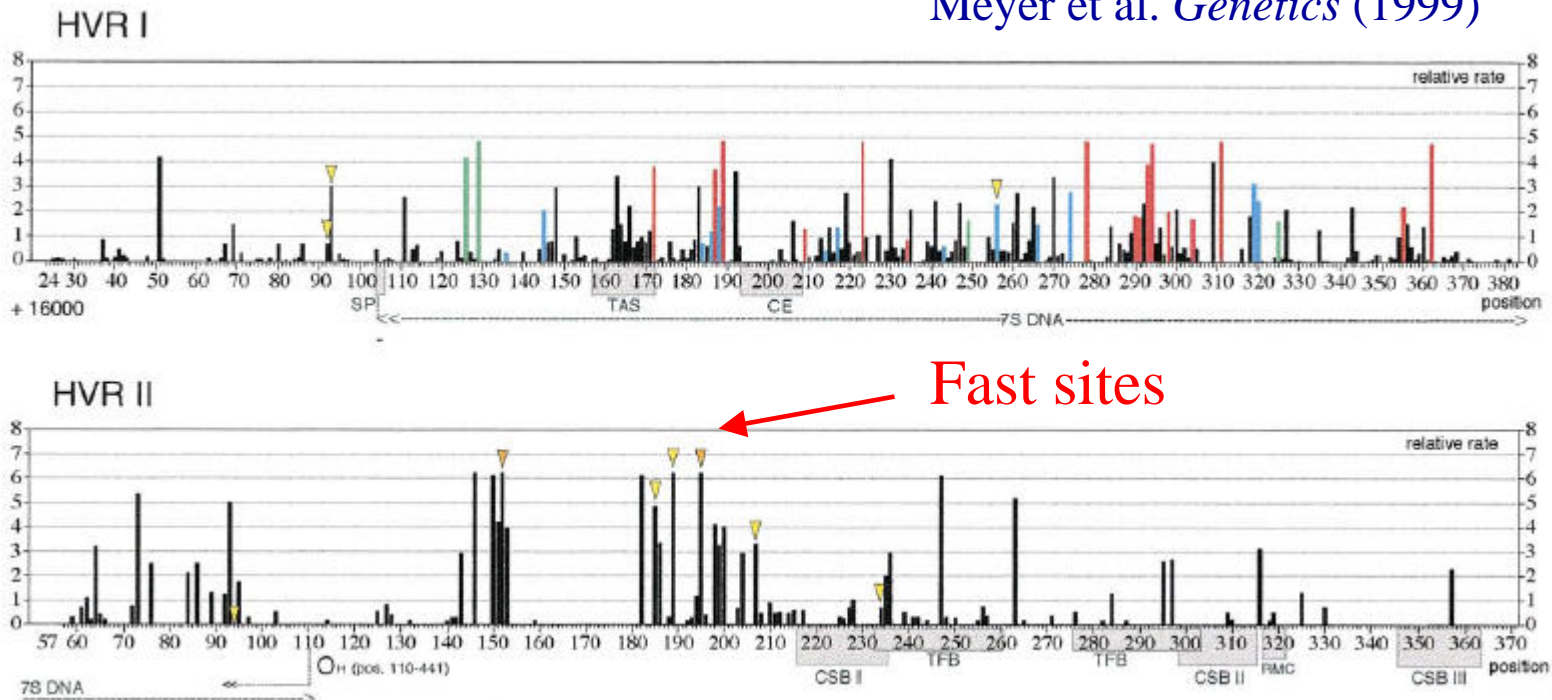

Mutation Rate Analysis in the mtDNA Control Region

Mutation rate heterogeneity – has been well characterized in the control region using a variety of methods for analysis (Parsimony, Maximum Likelihood, Pairwise Distance methods).

Mutation Rate Analysis in the mtDNA Coding Region – Previous Assumptions (I)

- Eyre-Walker et al. *Proc. R. Soc. Lond B* 1999. Using partial DNA sequences of the human mtDNA genome (filled with errors), this group observed a significant amount of recurrent mutations (homoplasy) in their data.
- Conclusion – **Recombination!** (between paternal and maternal mtDNA)

Mutation Rate Analysis in the mtDNA Coding Region – Previous Assumptions (I)

- Eyre-Walker et al. assume mutation rate *Homo*geneity...
- “There is no evidence of variation in the mutation rate.”
- (Mostly discredited for their poor data choice and method of calculating LD)

Mutation Rate Analysis in the mtDNA Coding Region – Previous Assumptions (II)

- Herrnstadt et al. (2002) *AJHG* – 560 coding region sequences.
- “One important result to emerge from these studies is the *relatively large number of sites* at which *homoplastic events* have occurred.”

(Referring to their Table 2)

Mutation Rate Analysis in the mtDNA Coding Region – Previous Assumptions (II)

- Yao et al. (2003) *AJHG* – in response to an Amerindian paper filled with sequence errors.
- “*Homoplasy* in the coding region is *much less* than in the control region and may have *only a few* hot spots (see, e.g., table 2 of Herrnstadt et al. [2002])”

How is Mutation Rate Variation Measured?

- Control region rates follow a negative binomial distribution (gamma distribution).

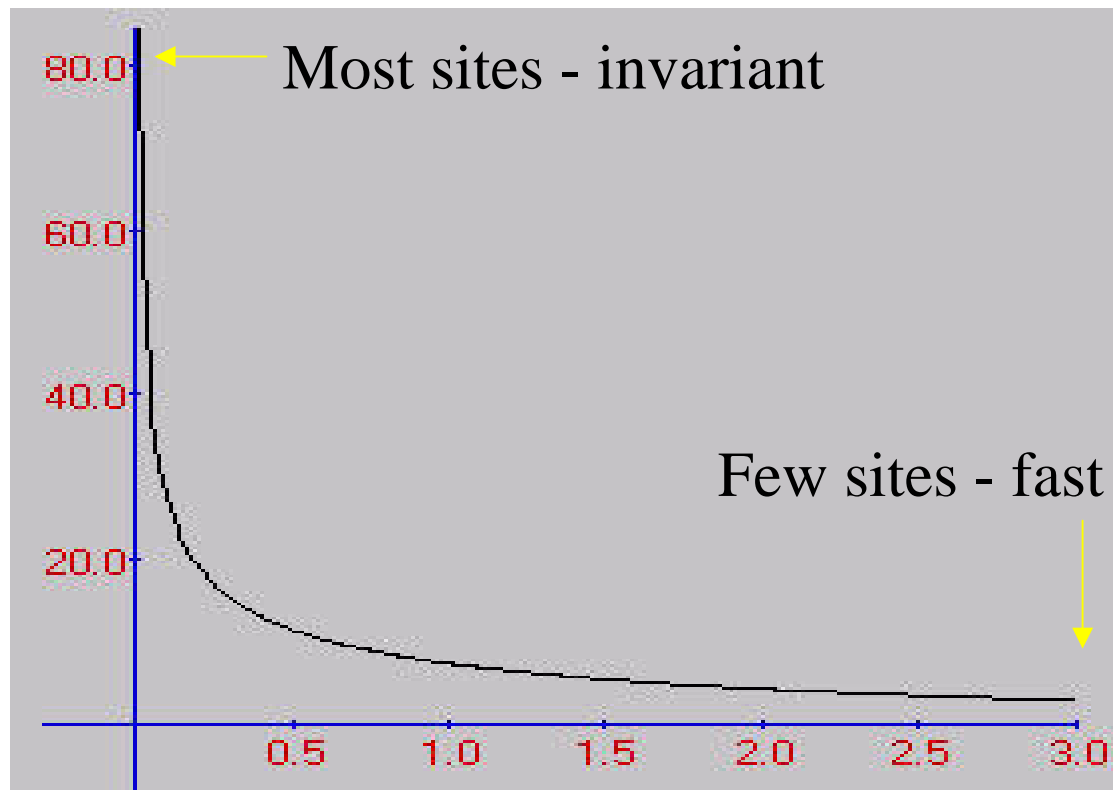

How is Mutation Rate Variation Measured?

- The SHAPE of the curve (α) is inversely related to the amount of heterogeneity

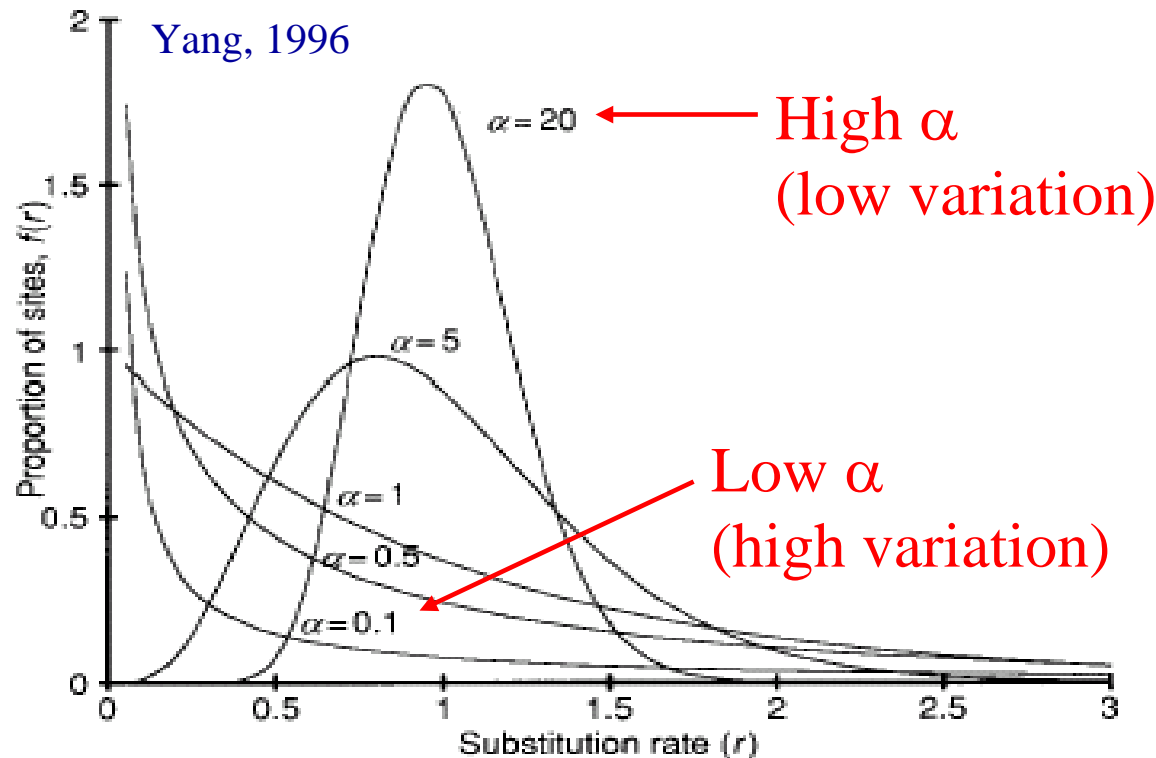

Current Literature

- Only one study has examined the mutation rate heterogeneity in the coding region.
- Meyer and von Haeseler (2003) *Mol. Biol. Evol.* Analyzed the 53 mtGenomes from Ingman et al. (2000).

Methods

- Parsimony analysis of phylogenetic trees (646 coding region sequences).
- Count the number of character changes mapped upon the MPT to determine the relative mutation rate.
- Calculate the α parameter using the method of Yang and Kumar (1996).

Results

- Analysis of 646 coding region genomes.

<u>Data Set (# genomes)</u>	Parsimony		NJ	
	<u>Tree Length</u>	<u>α estimation</u>	<u>Tree Length</u>	<u>α estimation</u>
Ingman HV1 (53)	144	0.2091	144	0.2081
Ingman Control Region (53)	273	0.0038	281	0.0036
Ingman Coding Region (53)	588	0.0075	588	0.0074
Ingman Full Data (53)	873	0.0050	876	0.0067
Total Coding Data (646)	2352	0.0086	2353	0.0083

Meyer and von Haeseler – α estimation = 0.002 (full data)

Extreme rate variation exists in the coding region

Relative Mutation Rates

Relative Mutation Rates in the Coding Region

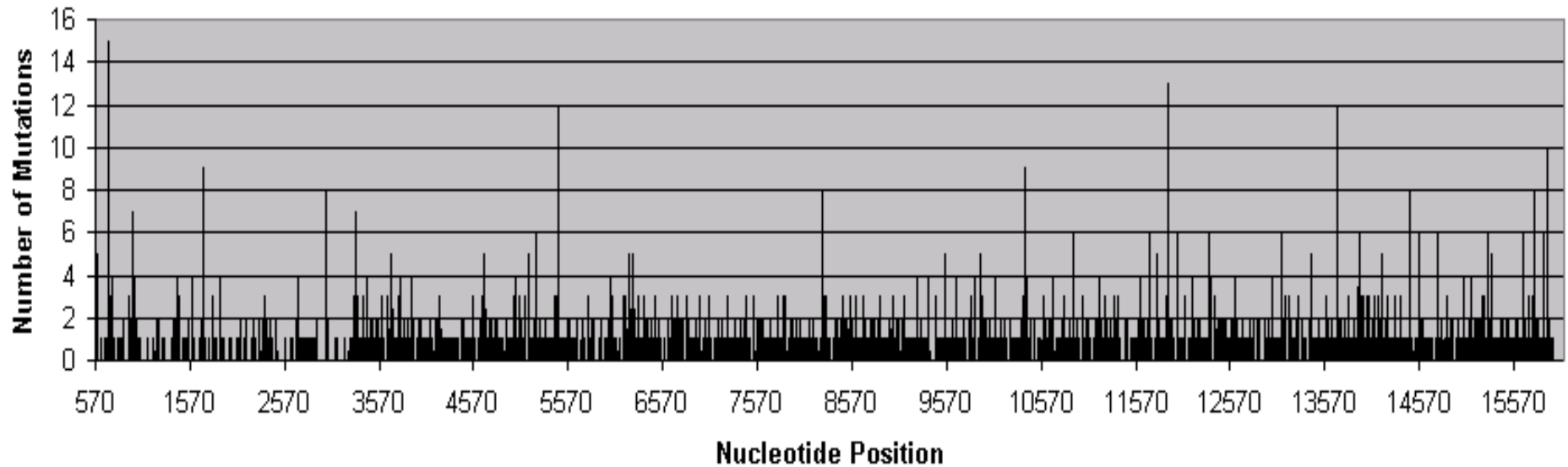

The Mutation Rate Spectrum

<u>Length</u>	<u>Character</u>	<u>Gene</u>	<u>codon</u>
15	709	12S	*
13	11914	ND4	3
12	5460	ND2	1
12	13708	ND5	1
10	15924	tRNA(thr)	*
9	1719	16S	*
9	10398	ND3	1
8	3010	16S	*
8	8251	COII	3
8	14470	ND6	3
8	15784	CYTB	3
7	961	12S	*
7	3316	ND1	1
6	5237	ND2	3
6	10915	ND4	3
6	11719	ND4	3
6	12007	ND4	3
6	12346	ND5	1
6	13105	ND5	1
6	13928	ND5	2
6	14569	ND6	3
6	14766	CYTB	2
6	15301	CYTB	3
6	15670	CYTB	3
6	15884	NC	-

19/25 – Protein Coding

Synonymous sites = 11

Non-synonymous = 8

The Mutation Rate Spectrum

- How does our rate spectrum compare to the rate spectrum of sites determined by the method of Meyer and von Haeseler (2003)?

The Mutation Rate Spectrum

Rate Score	Character	Length
175.21	15301	6
162.82	10398	9
155.20	8701	2
155.20	9540	1
155.20	10873	1
129.16	12705	2
119.30	7521	3
112.03	769	1
112.03	1018	1
112.03	3594	1
112.03	4104	2
112.03	7256	3
112.03	13650	1
105.84	11914	13
100.77	10400	1
100.77	14783	1
100.77	15043	4
96.96	10688	2
96.89	13105	7
89.38	825	1
89.38	2758	1
89.38	2885	1
89.38	8468	1
89.38	8655	1
89.38	10810	2
89.38	13506	1

Only 4 sites shared among the top 26 fastest sites as determined by Meyer and von Haeseler (2003)

Most of the “fastest” sites change once on our MPT

?????

0.0005

Phylogenetic Tree
from Ingman et al.
(2001) – 53 complete
human genomes

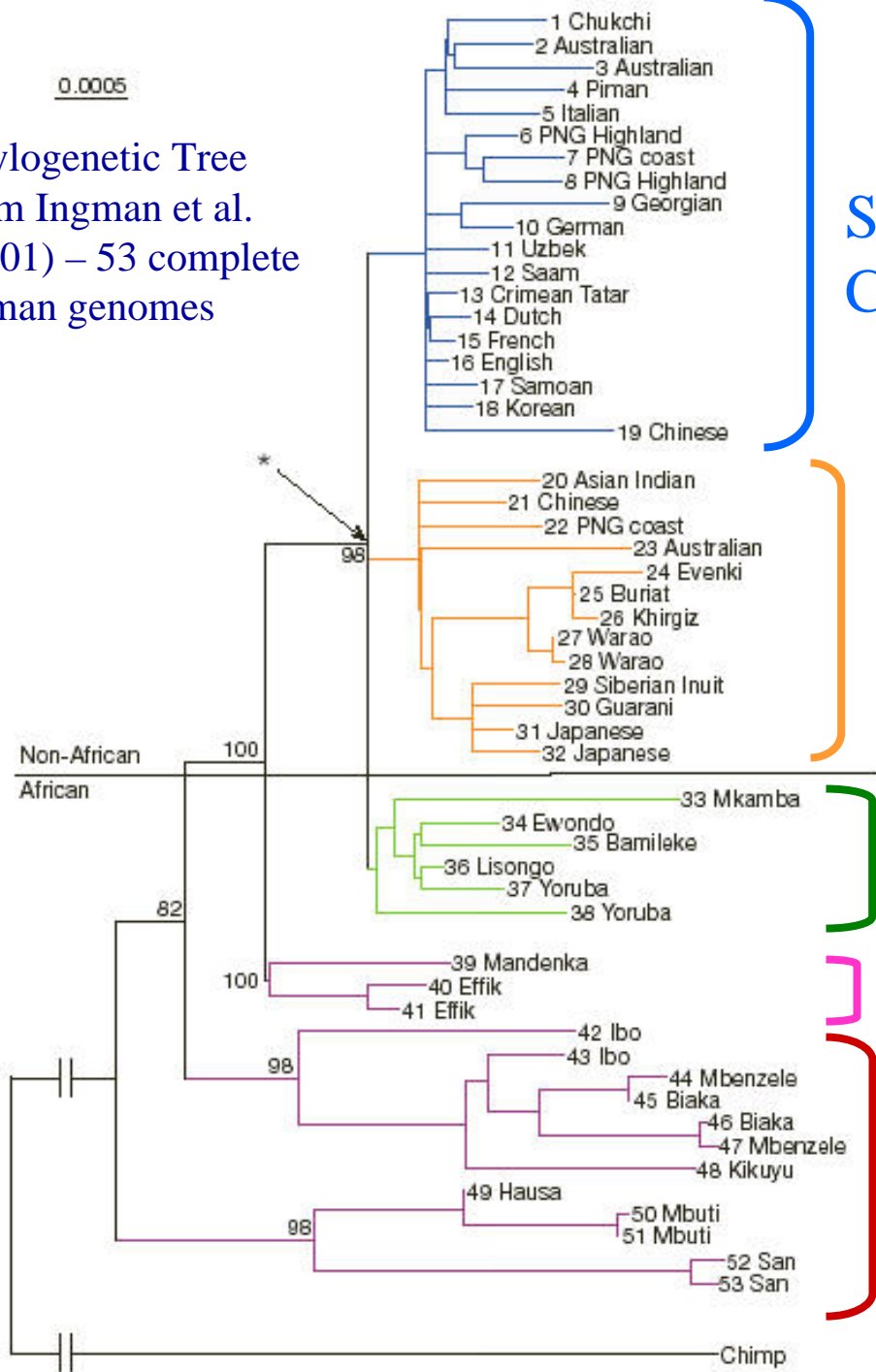

Super-haplogroup N (Asian and
Caucasian)

Super-haplogroup M (Asian)

Haplogroup L3 (African)

Haplogroup L2 (African)

Haplogroup L1 (African)

Skeleton Tree based on Human mtDNA Phylogeny

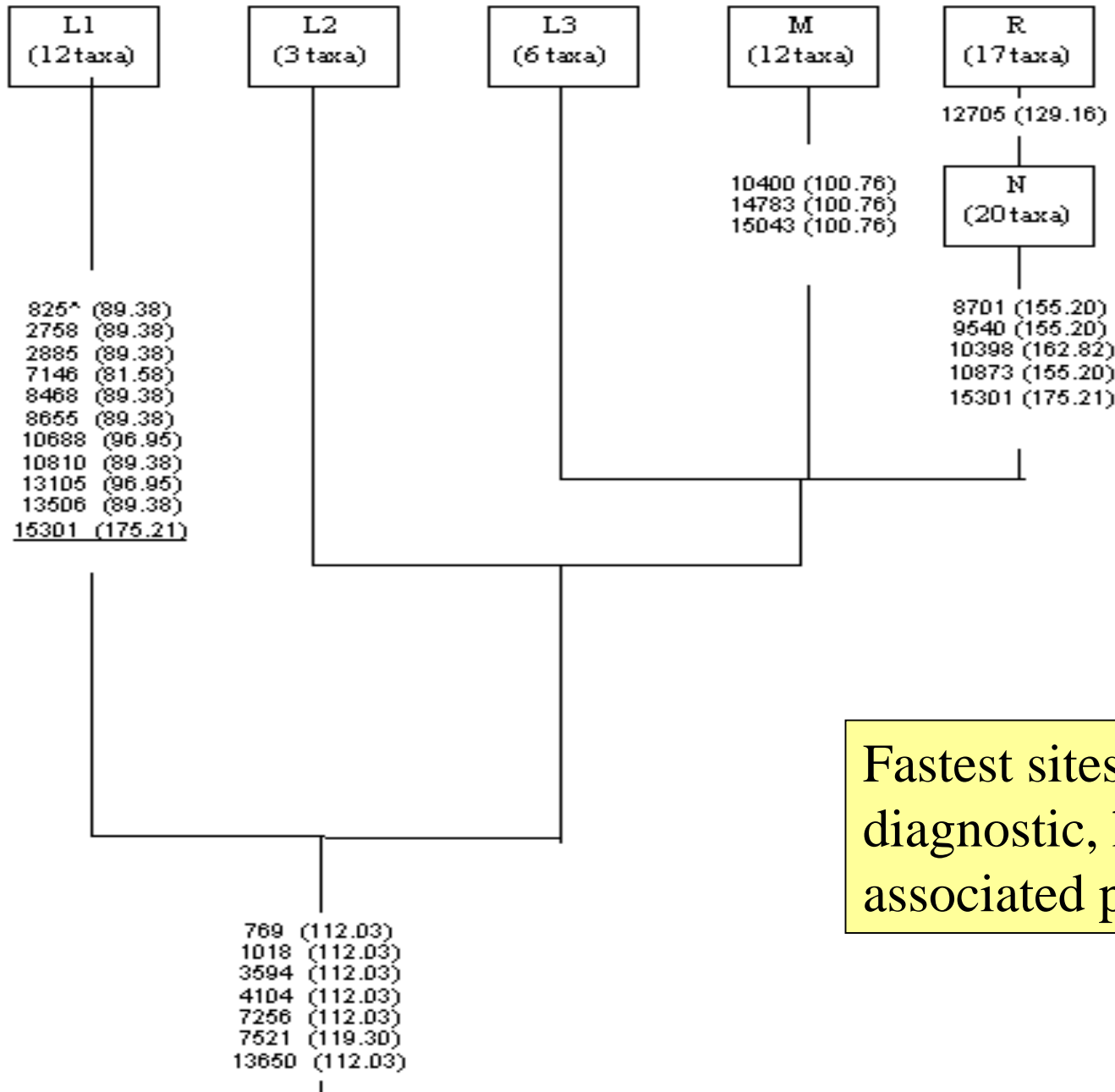

Fastest sites are actually diagnostic, haplogroup-associated polymorphisms!

Pairwise Genetic Distances to Estimate Mutation Rates

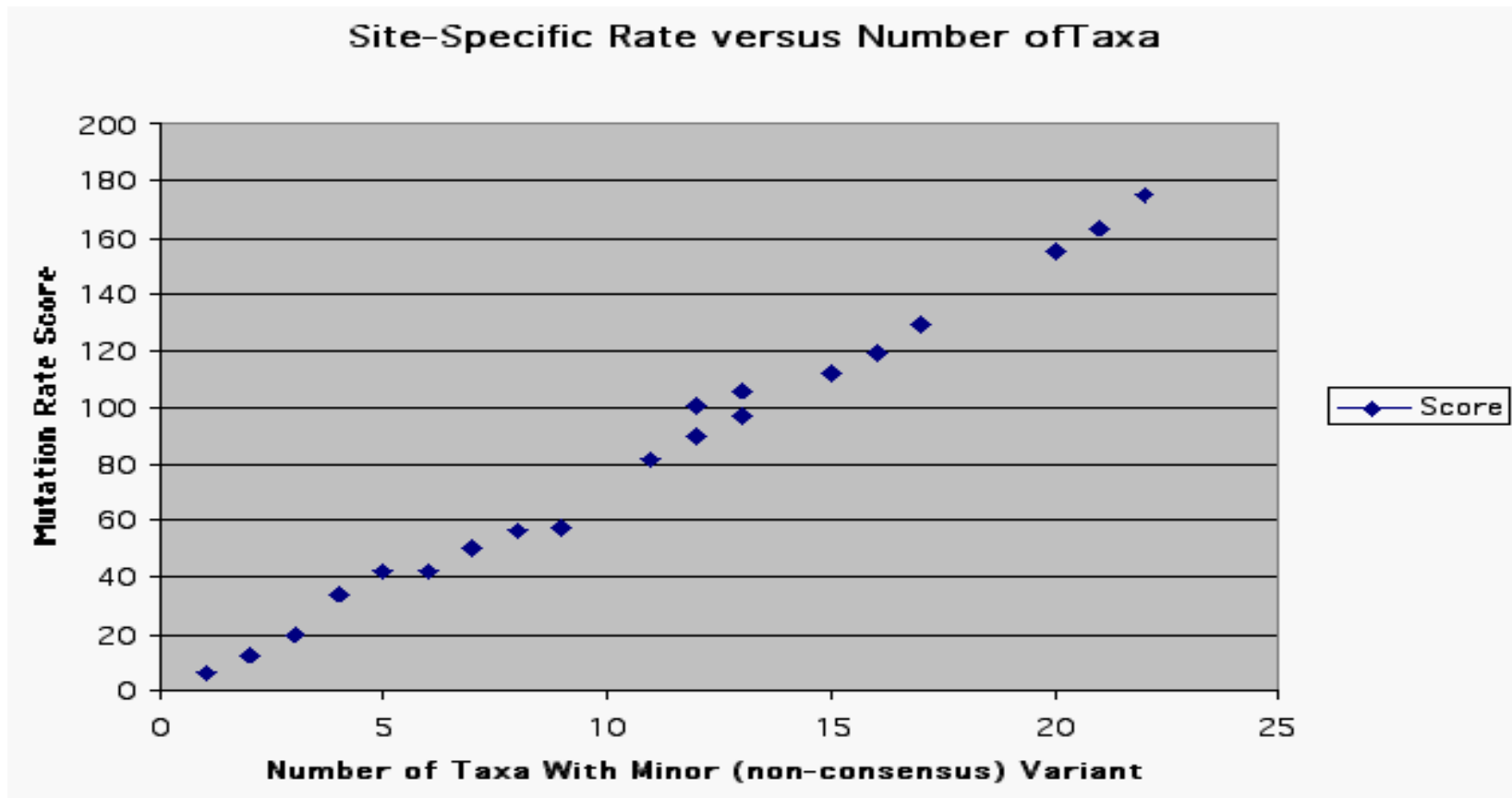

Pairwise Genetic Distances to Estimate Mutation Rates

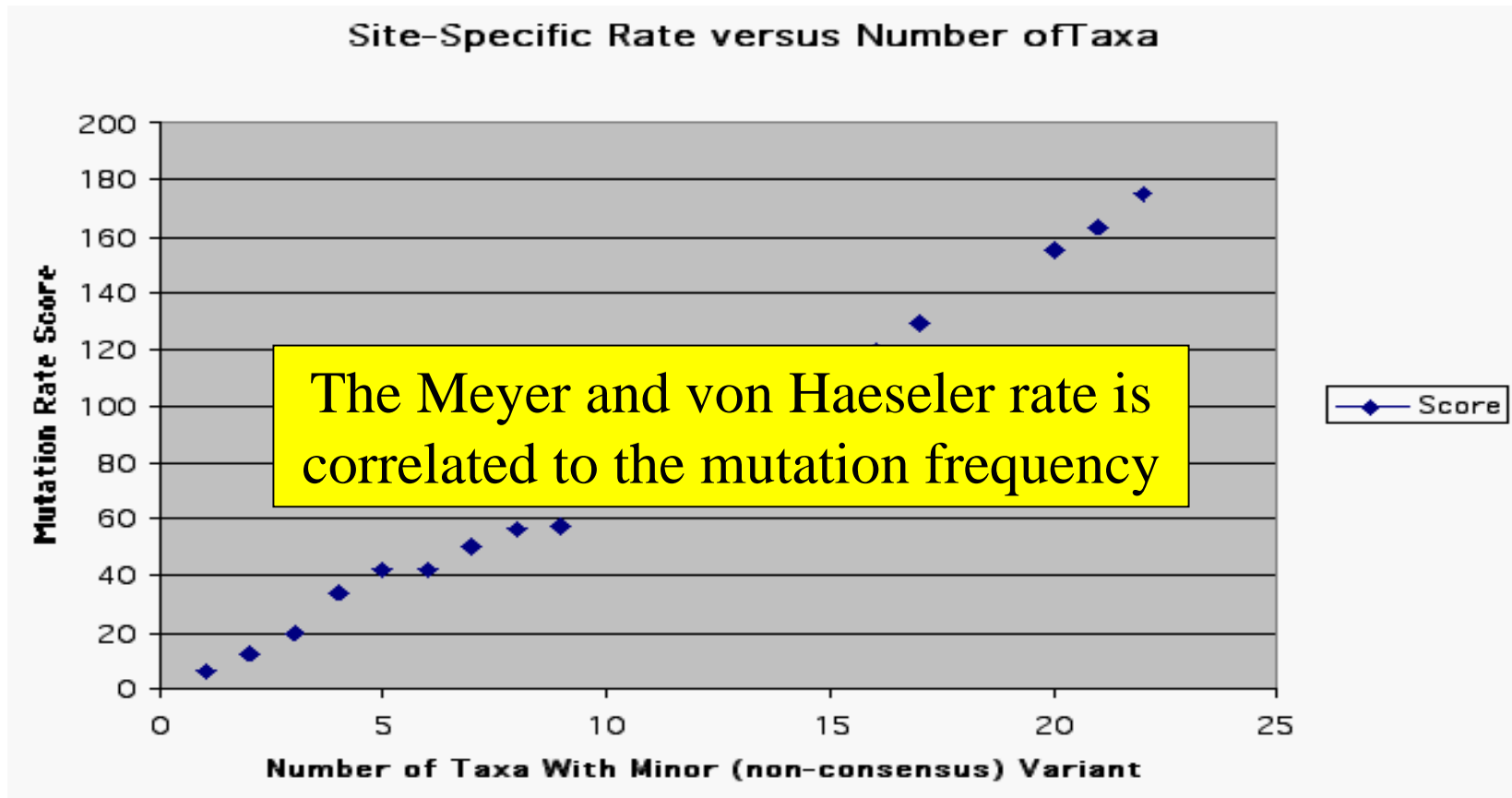

The Mutation Rate Spectrum

“It is hard to believe that 10400 has actually mutated ... because *no single homoplasious change* at this site has been observed in >900 coding-region sequences or fragments that cover site 10400...” (Yao et al. *AJHG* 2003 – in response to Silva et al. 2002).

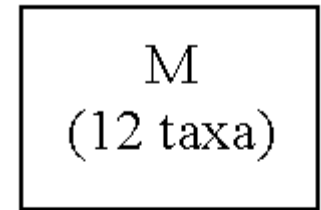

10400 (100.76)
14783 (100.76)
15043 (100.76)



Mutation Rate Analysis and the 8 Multiplex SNP Panels

<u>Length</u>	<u>Character</u>	<u>Gene</u>	<u>codon</u>	<u>241 Caucasians</u>
15	709	12S	*	Yes
13	11914	ND4	3	Yes -SNP
12	5460	ND2	1	Yes
12	13708	ND5	1	Yes
10	15924	tRNA(thr)	*	Yes
9	1719	16S	*	Yes
9	10398	ND3	1	Yes
8	3010	16S	*	Yes -SNP
8	8251	COII	3	
8	14470	ND6	3	Yes -SNP
8	15784	CYTB	3	
7	961	12S	*	
7	3316	ND1	1	
6	5237	ND2	3	Yes
6	10915	ND4	3	Yes
6	11719	ND4	3	Yes -SNP
6	12007	ND4	3	Yes -SNP
6	12346	ND5	1	
6	13105	ND5	1	Yes
6	13928	ND5	2	
6	14569	ND6	3	
6	14766	CYTB	2	
6	15301	CYTB	3	
6	15670	CYTB	3	
6	15884	CYTB	nc	Yes -SNP

Only 6 of the 59 SNPs are among the “fastest” sites

Mutation Rate Analysis and the 8 Multiplex SNP Panels

<u>Length</u>	<u>Character</u>	<u>Gene</u>	<u>codon</u>	<u>241 Caucasians</u>
15	709	12S	*	Yes
13	11914	ND4	3	Yes -SNP
12	5460	ND2	1	Yes
12	13708	ND5	1	Yes
10	15924	tRNA(thr)	*	Yes
9	1719	16S	*	Yes
9	10398	ND3	1	Yes
8	3010	16S	*	Yes -SNP
8	8251	COII	3	
8	14470	ND6	3	Yes -SNP
8	15784	CYT B	3	
7	961	12S	*	
7	3316	ND1	1	
6	5237	ND2	3	Yes
6	10915	ND4	3	Yes
6	11719	ND4	3	Yes -SNP
6	12007	ND4	3	Yes -SNP
6	12346	ND5	1	
6	13105	ND5	1	Yes
6	13928	ND5	2	
6	14569	ND6	3	
6	14766	CYT B	2	
6	15301	CYT B	3	
6	15670	CYT B	3	
6	15884	CYT B	nc	Yes -SNP

← What about
 ← These highly
 ← polymorphic
 mutations?

Mutation Rate Analysis and the 8 Multiplex SNP Panels

- How much information is lost by focusing only on mutations not associated with a potential for changing the phenotype?

Mutation Rate Analysis and the 8 Multiplex SNP Panels

- How much information is lost by focusing only on mutations not associated with a potential for changing the phenotype?

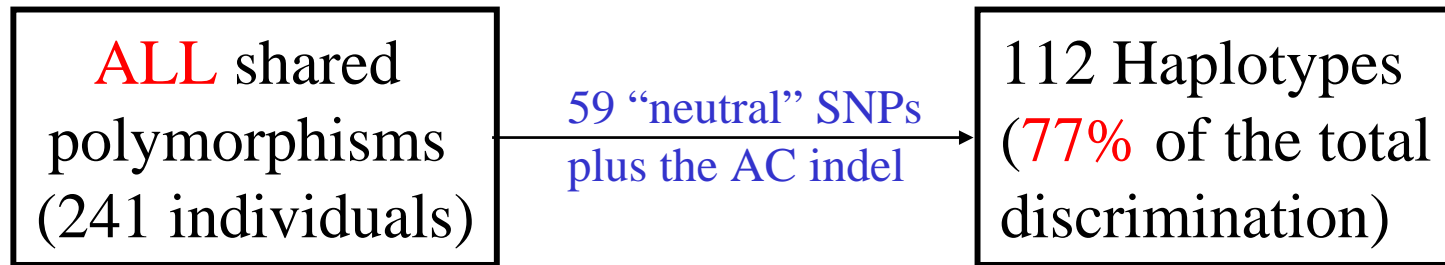

Mutation Rate Analysis and the 8 Multiplex SNP Panels

- How much information is lost by focusing only on mutations not associated with a potential for changing the phenotype?

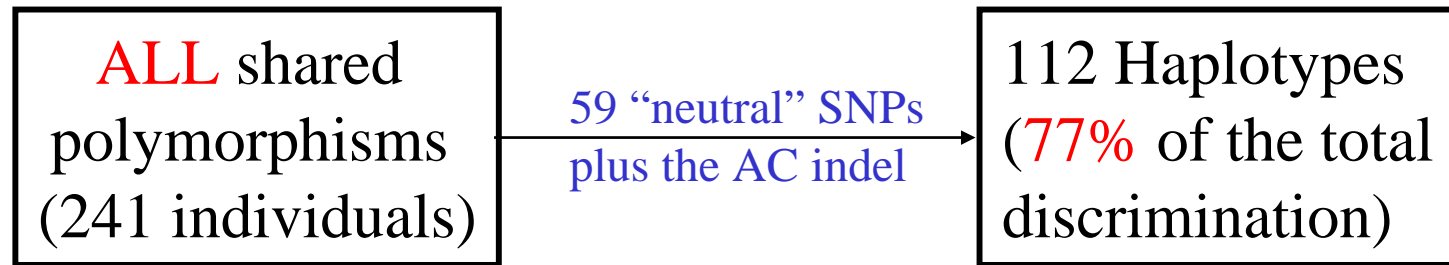

Additional SNP panels with fast, non-synonymous sites that vary widely in the population have been developed.

A Case Example

Skeletal remains - “H1” in the HV1/HV2 region.

Thought to belong to one of two individuals (**Smith** or **Jones**)

Family references for **Smith** and **Jones** were obtained.

Smith Family

263 A-G

315.1 C

Jones Family

263 A-G

315.1 C

A Case Example

Skeletal remains - “H1” in the HV1/HV2 region.

Thought to belong to one of two individuals (**Smith** or **Jones**)

Family references for **Smith** and **Jones** were obtained.

Smith Family

263 A-G

315.1 C

477 T-C

16519 T-C

Jones Family

263 A-G

315.1 C

16519 T-C

Remains tested for VR region: **477 T-C** and 16519 T-C

A Case Example

Smith Family

263 A-G

315.1 C

477 T-C

16519 T-C

Jones Family

263 A-G

315.1 C

16519 T-C

Remains tested for VR region: 477 T-C and 16519 T-C

Since there was a single difference between the remains and the Jones family, AFDIL could not make an exclusion

A Case Example

The remains and the family references were typed with multiplex A

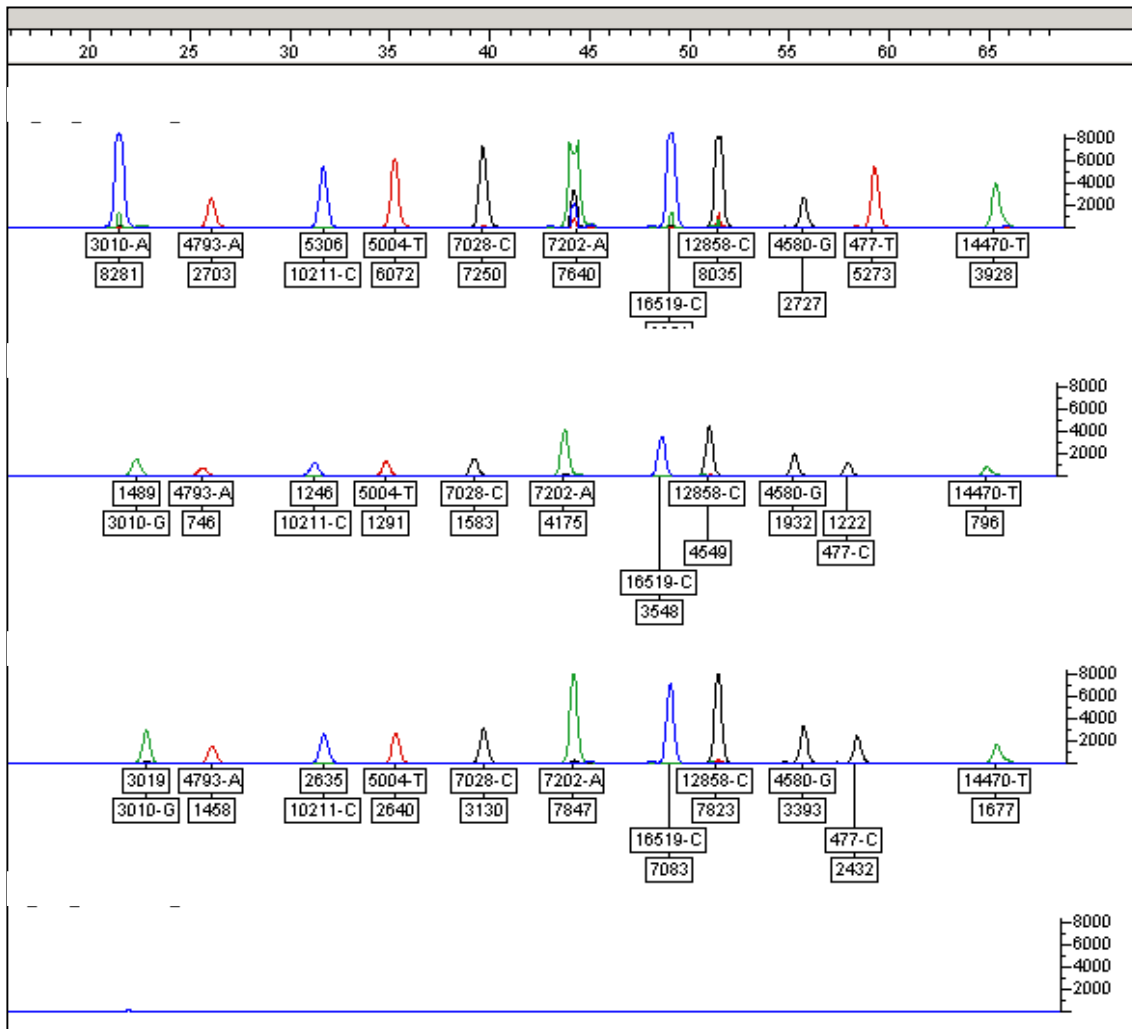

Jones Reference

Smith Reference #1

Smith Reference #2

Negative Control

A Case Example

Reference extracts confirmed the polymorphism at 477.

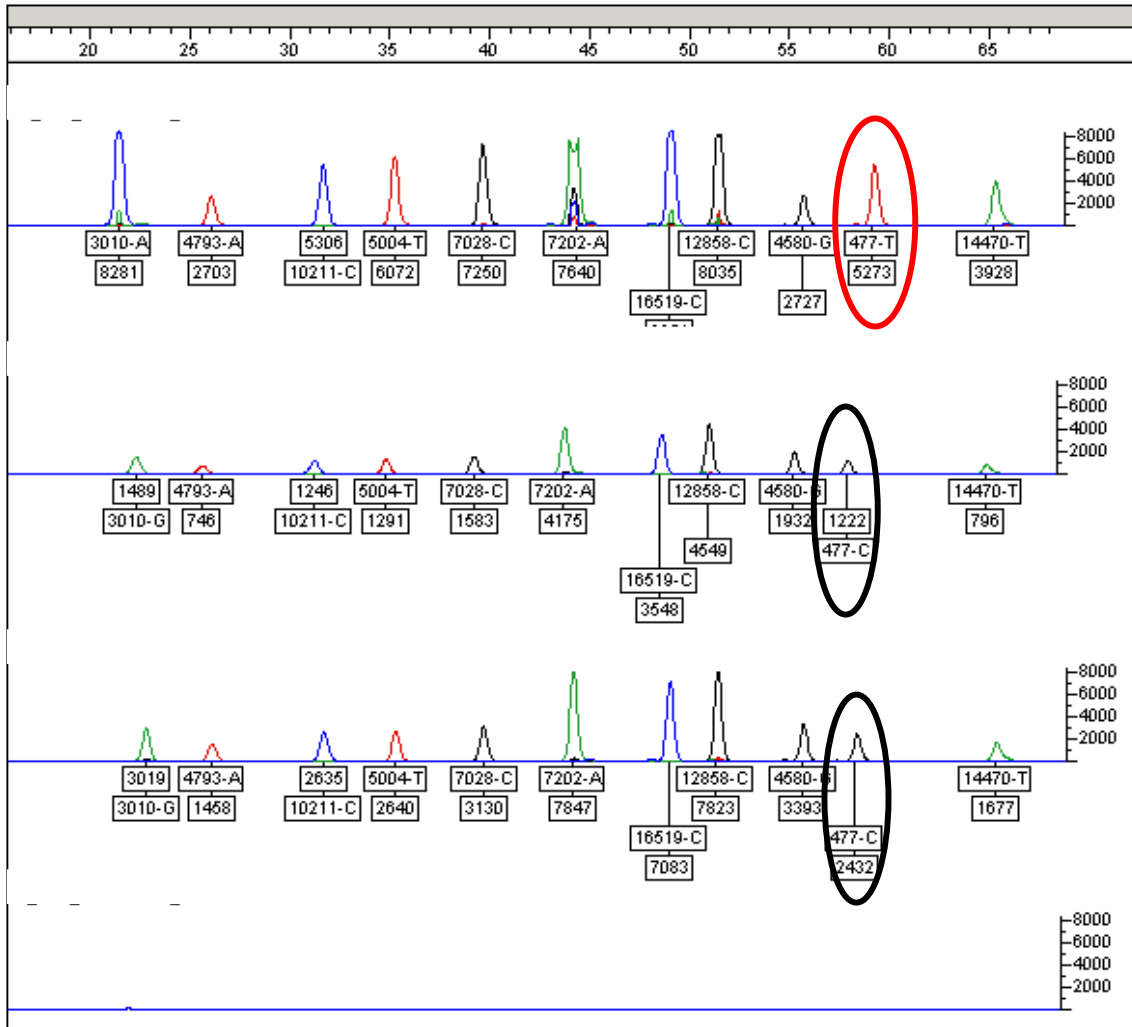

Jones Reference

Smith Reference #1

Smith Reference #2

Negative Control

A Case Example

An additional difference was observed at position 3010.

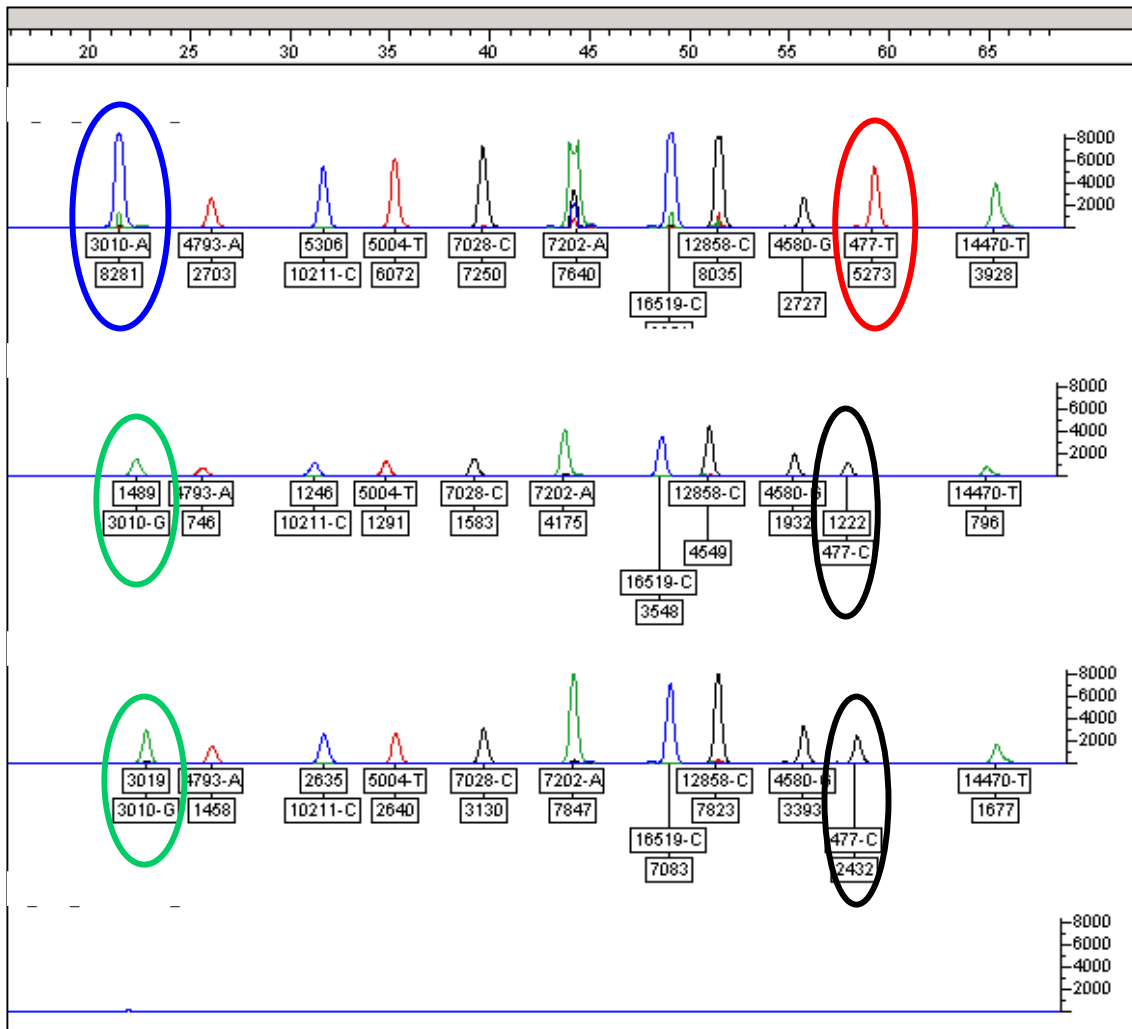

Jones Reference

Smith Reference #1

Smith Reference #2

Negative Control

A Case Example

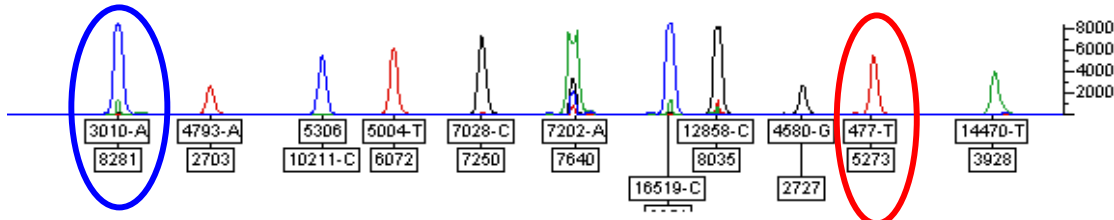
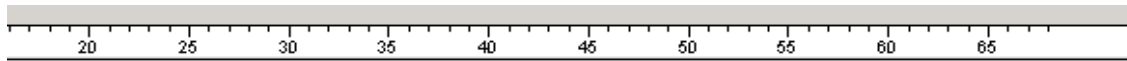

Jones Reference

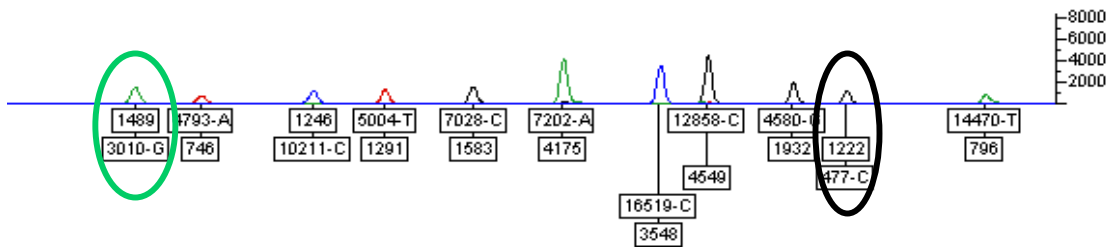

Smith Reference #1

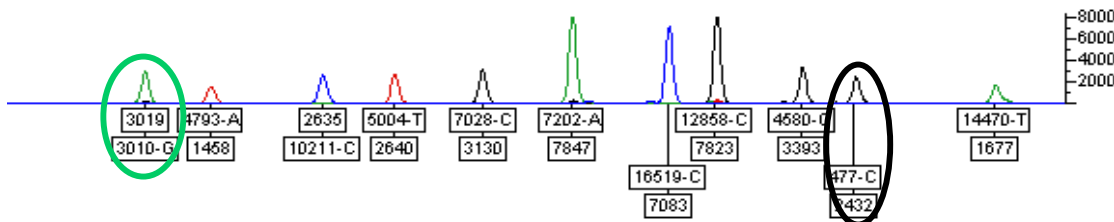

Smith Reference #2

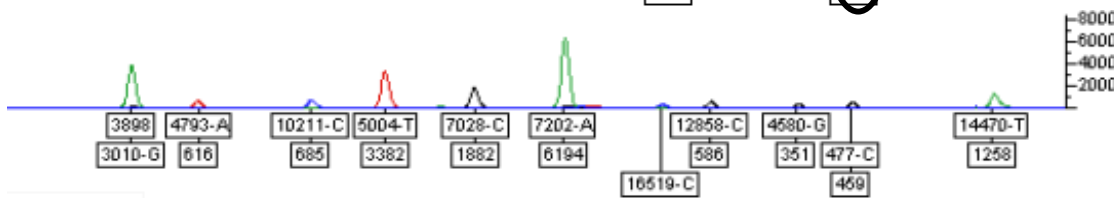

Bone Extract

15uL Reaction; 0.07Units/uL Taq; 31 cycles --- 100 RFU cutoff

A Case Example

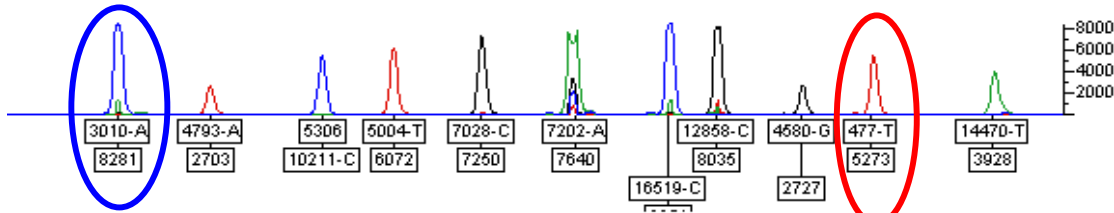
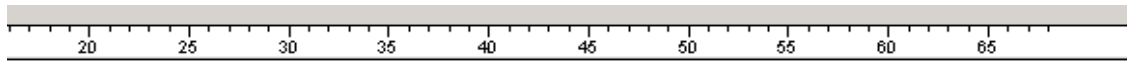

Jones Reference

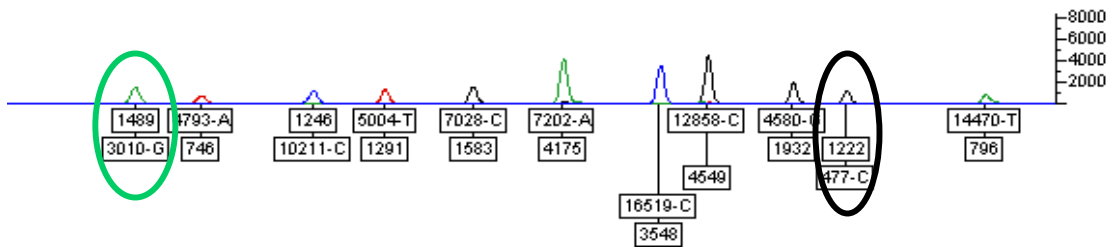

Smith Reference #1

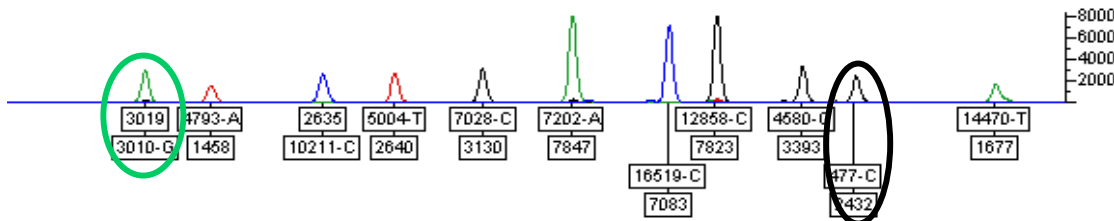

Smith Reference #2

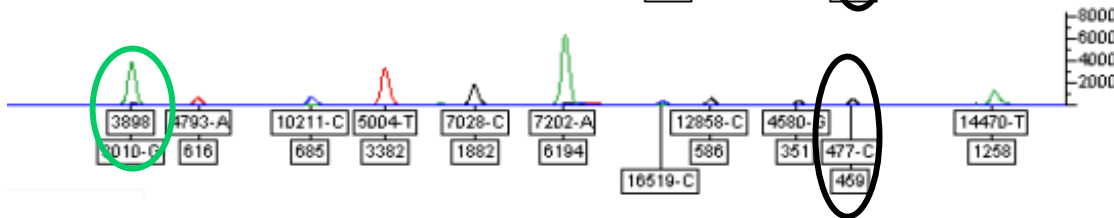

Bone Extract

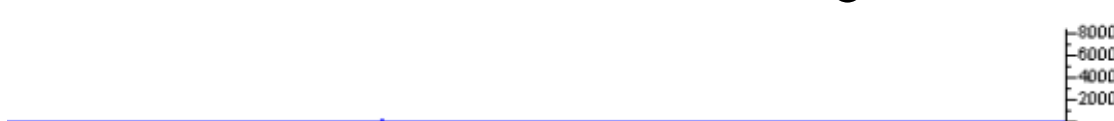

Negative Control

A Case Example

Smith Family

263 A-G

315.1 C

477 T-C

3010 A-G

16519 T-C

Skeletal Remains

263 A-G

315.1 C

477 T-C

3010 A-G

16519 T-C

Jones Family

263 A-G

315.1 C

16519 T-C

Remains – match exactly the **Smith family**, now 2 differences from the **Jones family** – can be excluded.

Summary

- Purpose – Maximize Discrimination.
- A **supplement** to current HV1/HV2 testing.
- When the Forensic Scientist encounters a common type, select the most discriminating SNP panel.

Summary

- We – focused on sites that are not associated with the potential for phenotypic change.
- Most of the informative sites are **rare, slow** polymorphisms that are useful for discrimination in a particular common type.
- A few SNP sites may be useful for resolving common HV1/HV2 types from various backgrounds.

Summary

- Mutation rate analysis of the coding region using parsimony-evaluated phylogenetic trees revealed extreme rate variation using a relatively large data set.
- Parsimony distinguished fast sites from slow, haplogroup-associated polymorphisms (compared to Meyer and von Haeseler, 2003).

Summary/Future Goals

- Future efforts to identify discriminatory SNPs to resolve common types in other populations – will require whole genome sequencing.
- Evaluation of non-synonymous sites that are not associated with diseases and are useful for forensic discrimination.

Publications

Michael D. Coble · Rebecca S. Just
Jennifer E. O'Callaghan · Iona H. Letmanyi
Christine T. Peterson · Jodi A. Irwin · Thomas J. Parsons

Single nucleotide polymorphisms over the entire mtDNA genome that increase the power of forensic testing in Caucasians

IJLM (2004) **118**: 137-146.

Peter M. Vallone · Rebecca S. Just · Michael D. Coble
John M. Butler · Thomas J. Parsons

A multiplex allele-specific primer extension assay for forensically informative SNPs distributed throughout the mitochondrial genome

IJLM (2004) **118**: 147- 157.

<http://www.cstl.nist.gov/biotech/strbase/NISTpub.htm>

Acknowledgements

National Institutes of Justice

2000-1J-CX-K010 and Dr. Lois Tully

The Armed Forces DNA Identification Laboratory

Co-Authors

(AFDIL)

Dr. Thomas Parsons
Rebecca Just
Jessica Saunier
Jennifer O'Callaghan
Christine Peterson
Ilona Letmanyi
Jodi Irwin

(NIST)

Dr. Peter Vallone
Dr. John Butler

Research Interns

Rachel Barry
Trina Bersola
Serena Filosa
Victoria Glynn
Carrie Guyan
William Ivory
Devon Pierce

Administration (AFDIL)

Col. Brion Smith
James Canik
Scott Carroll

Casework Section (AFDIL)

Suzie Barritt

ILM – Innsbruck, Austria

Dr. Walther Parson
Harold Niederstaetter

<http://www.cstl.nist.gov/biotech/strbase/Coble.htm>

michael.coble@nist.gov