

3. HEALTH EFFECTS

3.1 INTRODUCTION

The primary purpose of this chapter is to provide public health officials, physicians, toxicologists, and other interested individuals and groups with an overall perspective on the toxicology of iodine. It contains descriptions and evaluations of toxicological studies and epidemiological investigations and provides conclusions, where possible, on the relevance of toxicity and toxicokinetic data to public health. Section 3.2 contains a discussion of the chemical toxicity of stable iodine; radiation toxicity associated with exposure to radioiodine is discussed in Section 3.3.

A glossary and list of acronyms, abbreviations, and symbols can be found at the end of this profile.

Health effects of the element iodine are categorized by the chemical nature of stable iodine (^{127}I) and the radioactive nature of unstable isotopes (e.g., ^{131}I). Four radioactive isotopes (^{123}I , ^{125}I , ^{129}I , and ^{131}I) are of particular interest with respect to human exposures because ^{125}I and ^{131}I are used medically and all four isotopes are sufficiently long-lived to be transported to human receptors after their release into the environment. These isotopes of iodine emit, primarily, beta radiation (that travel short distances in tissues) and gamma radiation (that can penetrate the entire body). The radiation dose from these radionuclides can be classified as either external (if the source is outside the body) or internal (if the source is inside the body).

The external dose from iodine radionuclides arises primarily from the penetrating gamma radiation that can travel through air. Beta radiation emitted outside the body is normally of little health concern unless the radioactive material contacts the skin. Skin contact can allow the beta radiation to pass through the epidermis to live dermal tissue where it can contribute to the radiation dose to the skin. At very high external doses, beta (and gamma) radiation (e.g., greater than 3 Gy, 300 rad) can cause such adverse effects as skin erythema, ulceration, or necrosis (Agency for Toxic Substances and Disease Registry [ATSDR] 1999).

Once radioactive iodine is internalized, it is absorbed, distributed, and excreted in the same manner as stable iodine. The internal radiation dose from radioactive iodine is actually a measure of the amount of energy that the beta and gamma emissions deposit in tissue. The short-range beta radiation produces a

3. HEALTH EFFECTS

localized dose while the more penetrating gamma radiation contributes to a whole-body dose. Molecular damage results from the direct ionization of atoms that are encountered by beta and gamma radiation and by interactions of resulting free radicals with nearby atoms. Tissue damage results when the molecular damage is extensive and not sufficiently repaired in a timely manner.

In radiation biology, the term *absorbed dose* is the amount of energy deposited by radiation per unit mass of tissue, expressed in units of gray (Gy) or rad (see Appendix D for a detailed description of principles of ionizing radiation). The term *dose equivalent* refers to the biologically significant dose, which is determined by multiplying the absorbed dose by a quality factor for the type and energy of the radiations involved. Dose equivalent is expressed in units of sievert (Sv) or rem. The quality factor is considered to be unity for the beta and gamma radiation emitted from iodine radionuclides, so for these radionuclides, the absorbed dose (in Gray or rad) is numerically identical to the dose equivalent (in rem or sievert). The absorbed dose from internalized iodine radionuclides is estimated by taking into account the quantity of radionuclides entering the body (via ingestion or inhalation), the biokinetics (retention, distribution, and excretion) of the radionuclides, the rate at which the radionuclides decay to stable forms, the energies and intensities of the beta and gamma radiation emitted, and the characteristics of tissues that result in the energy of the emitted radiation being absorbed by tissues. Each tissue, therefore, can receive a different absorbed dose for a given amount of radioactivity that enters the body. The total absorbed dose to the body will reflect the integration of the absorbed doses for the all tissues. In summaries of the radioiodine toxicology literature provided in this profile, units of activity, absorbed dose, or dose equivalent are cited as reported in the literature and the corresponding conventional or SI units are provided in parentheses.

The EPA has published a set of internal dose conversion factors for standard persons of various ages (newborn; 1, 5, 10, or 15 years of age; and adult) in its Federal Guidance Report No. 13 supplemental CD (EPA 1999). For example, the EPA has estimated that the dose equivalent following ingestion of 1 Bq of ^{131}I is 2.2×10^{-8} Sv (assuming an integration time of 50 years for an adult following the initial exposure). Age-specific dose coefficients for inhalation and ingestion of any of the radioactive isotopes of iodine by the general public can be found in International Commission on Radiological Protection (ICRP) publications 71 (ICRP 1995) and 72 (ICRP 1996), respectively. Dose coefficients for inhalation, ingestion, and submersion in a cloud of iodine radionuclides can be found in U.S. EPA Federal Guidance Report No. 11 (EPA 1988). Dose coefficients for external exposure to radioisotopes of iodine in air, surface water, or soil contaminated to various depths can be found in U.S. EPA Federal Guidance Report No. 12 (EPA 1993).

3. HEALTH EFFECTS

The ICRP has developed reference values for dose coefficients that relate dose equivalents to a unit of activity to which a person might be exposed. For example, the ICRP (1996, 2001) has estimated that the dose coefficient for an acute exposure of an adult to ^{131}I is 2.2×10^{-8} Sv/Bq. Age-specific dose coefficients for inhalation and ingestion of any of the radioactive isotopes of iodine can be found in ICRP publications 71 (ICRP 1995) and 72 (ICRP 1996), respectively.

3.2 DISCUSSION OF HEALTH EFFECTS FOR STABLE IODINE BY ROUTE OF EXPOSURE

Section 3.2 discusses the chemical toxicity of iodine. Radiation toxicity resulting from exposure to radioiodine is discussed in Section 3.3.

To help public health professionals and others address the needs of persons living or working near hazardous waste sites, the information in this section is organized first by route of exposure (inhalation, oral, and dermal) and then by health effect (death, systemic, immunological, neurological, reproductive, developmental, genotoxic, and carcinogenic effects). These data are discussed in terms of three exposure periods: acute (14 days or less), intermediate (15–364 days), and chronic (365 days or more).

Levels of significant exposure for each route and duration are presented in tables and illustrated in figures. The points in the figures showing no-observed-adverse-effect levels (NOAELs) or lowest-observed-adverse-effect levels (LOAELs) reflect the actual doses (levels of exposure) used in the studies. LOAELs have been classified into "less serious" or "serious" effects. "Serious" effects are those that evoke failure in a biological system and can lead to morbidity or mortality (e.g., acute respiratory distress or death). "Less serious" effects are those that are not expected to cause significant dysfunction or death, or those whose significance to the organism is not entirely clear. ATSDR acknowledges that a considerable amount of judgment may be required in establishing whether an end point should be classified as a NOAEL, "less serious" LOAEL, or "serious" LOAEL, and that in some cases, there will be insufficient data to decide whether the effect is indicative of significant dysfunction. However, the Agency has established guidelines and policies that are used to classify these end points. ATSDR believes that there is sufficient merit in this approach to warrant an attempt at distinguishing between "less serious" and "serious" effects. The distinction between "less serious" effects and "serious" effects is considered to be important because it helps the users of the profiles to identify levels of exposure at which major health effects start to appear. LOAELs or NOAELs should also help in determining whether or not the effects vary with dose and/or duration, and place into perspective the possible significance of these effects to human health.

3. HEALTH EFFECTS

The significance of the exposure levels shown in the Levels of Significant Exposure (LSE) tables and figures may differ depending on the user's perspective. Public health officials and others concerned with appropriate actions to take at hazardous waste sites may want information on levels of exposure associated with more subtle effects in humans or animals (LOAELs) or exposure levels below which no adverse effects (NOAELs) have been observed. Estimates of levels posing minimal risk to humans (Minimal Risk Levels or MRLs) may be of interest to health professionals and citizens alike.

Levels of exposure associated with carcinogenic effects (Cancer Effect Levels, CELs) of iodine are indicated in Tables 3-1 and 3-2 and Figures 3-1 and 3-2.

Estimates of exposure levels posing minimal risk to humans (Minimal Risk Levels or MRLs) have been made for iodine. An MRL is defined as an estimate of daily human exposure to a substance that is likely to be without an appreciable risk of adverse effects (noncarcinogenic) over a specified duration of exposure. MRLs are derived when reliable and sufficient data exist to identify the target organ(s) of effect or the most sensitive health effect(s) for a specific duration within a given route of exposure. MRLs are based on noncancerous health effects only and do not consider carcinogenic effects. MRLs can be derived for acute, intermediate, and chronic duration exposures for inhalation and oral routes. Appropriate methodology does not exist to develop MRLs for dermal exposure.

Although methods have been established to derive these levels (Barnes and Dourson 1988; EPA 1990), uncertainties are associated with these techniques. Furthermore, ATSDR acknowledges additional uncertainties inherent in the application of the procedures to derive less than lifetime MRLs. As an example, acute inhalation MRLs may not be protective for health effects that are delayed in development or are acquired following repeated acute insults, such as hypersensitivity reactions, asthma, or chronic bronchitis. As these kinds of health effects data become available and methods to assess levels of significant human exposure improve, these MRLs will be revised.

A User's Guide has been provided at the end of this profile (see Appendix B). This guide should aid in the interpretation of the tables and figures for Levels of Significant Exposure and the MRLs.

3. HEALTH EFFECTS

3.2.1 Inhalation Exposure

Iodine is absorbed in humans when I₂ or methyl iodide vapors are inhaled (Black and Hounam 1968; Morgan and Morgan 1967; Morgan et al. 1967a, 1967b, 1968). Once absorbed, iodide would be expected to exert effects that are similar to that of iodide absorbed after ingestion, including effects on the thyroid gland and thyroid hormone status, sensitivity reactions, and cancer (see Section 3.2.2). Iodine (I₂) is a strong oxidizing agent; therefore, exposure to high air concentrations of I₂ vapor could potentially produce upper respiratory tract irritation and possibly oxidative injury. No studies were located regarding the following health effects in humans or animals after inhalation exposure to stable iodine:

3.2.1.1 Death

3.2.1.2 Systemic Effects

3.2.1.3 Immunological and Lymphoreticular Effects

3.2.1.4 Neurological Effects

3.2.1.5 Reproductive Effects

3.2.1.6 Developmental Effects

3.2.1.7 Cancer

3.2.2 Oral Exposure

The section that follows provides background information relevant to the various study summaries that are presented subsequently. A description of the approaches used to calculate doses of stable iodine is provided. The actual study summaries follow.

A large number of human experimental, clinical, and epidemiological studies on the effects of excess iodine on human health have been reported. The key studies that provide information on exposures associated with effects are summarized in this section of the profile. Oral iodine intakes were not directly assessed in many studies with sufficient accuracy to define dose-response relationships; however, measurements of urinary iodide provide a basis for estimating intakes in some of the studies (Konno et al.

3. HEALTH EFFECTS

1993b). Rather than describing the basis for estimating intakes from urinary iodine data in each of the study descriptions that follow, the general approach used is described here. If a 24-hour urinary iodide measurement was provided that could be regarded as a steady state value (relatively constant intake for at least 6 months), the intake was assumed to be equivalent to the 24-hour excretion rate. This assumption is consistent with information available on the toxicokinetics of iodide that indicates nearly complete absorption of ingested iodide and that urinary excretion accounts for >97% of the absorbed dose (see Sections 3.5.1.2 and 3.5.4.2). The assumption is also supported by studies in which 24-hour urinary iodide was measured before and after supplementation. For example, 31 patients received oral supplements of 382 µg I/day for 6 months. Prior to the supplementation, the mean 24-hour urinary iodide excretion rate was 36 µg/day (range, 13–69), whereas after 6 months of iodide supplementation, the mean 24-hour urinary iodide excretion rate was 415 µg/day (Kahaly et al. 1998). The difference between these two values, 379 µg/day, is nearly identical to the supplemental dose of 382 µg/day.

If a urine iodide concentration was provided for a morning sample that included overnight bladder urine, the measured concentration was assumed to represent the 24-hour average concentration and iodide intake was calculated as:

$$Intake_I = U_I \cdot 1.4 \quad \text{Equation (1)}$$

where U_I is the measured urinary iodine concentration and 1.4 is the average volume of urine excreted per day (L/day) for a 70-kg adult (ICRP 1981). Equation 1 is in reasonable agreement with observed relationships between morning bladder urine iodide concentrations and 24-hour iodide excretion rates (Konno et al. 1993b; Nagata et al. 1998). Urine iodide concentration from untimed (spot) samples, other than morning samples that included overnight bladder urine, were considered to be potentially too uncertain to derive intake estimates, unless paired urinary creatinine concentrations or a urinary iodide:creatinine ratio (µg I:g creatinine) was reported. Urinary iodide:creatinine ratios were converted to estimated iodide intake as follows, assuming a constant relationship between urinary creatinine excretion rate and lean body mass. The rate of creatinine excretion (e.g., E_{Cr} , g creatinine/day) was calculated from the relationship between lean body mass (LBM) and E_{Cr} :

$$LBM = 0.0272 \cdot E_{Cr} + 8.58 \quad \text{Equation (2)}$$

3. HEALTH EFFECTS

where the constants 0.0272 and 8.58 are the weighted arithmetic mean of estimates of these variables from eight studies reported in Forbes and Bruining (1976). Lean body mass was calculated as follows (ICRP 1981):

$$LBM = BW \cdot 0.88, \text{ males} \quad \text{Equation (3)}$$

$$LBM = BW \cdot 0.85, \text{ females}$$

where BW is the reported or assumed body weight for males (75 kg) and females (65 kg) (EPA 1997f). A mean value of 60 kg (females, 55 kg; males, 65 kg) was assumed for body weights of adult populations of the Asian Pacific countries (e.g., Japan, China, Marshall Islands). Iodide intake was calculated as:

$$Intake_I = U_{I/Cr} \cdot E_{Cr} \quad \text{Equation (4)}$$

where $U_{I/Cr}$ is the urinary iodide:creatinine ratio ($\mu\text{g I/g creatinine}$). This approach yields relationships between 24-hour urinary iodide excretion rates and the urinary iodide:creatinine ratios that are in reasonable agreement with observations (Konno et al. 1993b).

3.2.2.1 Death

Two recent reviews of the clinical case literature note that deaths have occurred after ingestion of iodine preparations (FDA 1989b; Pennington 1990b). A review of medical records from the New York City Medical Examiners Office revealed that, in a period of 6 years, there were 18 deaths from attempted suicides in which adults ingested iodine tinctures (Finkelstein and Jacobi 1937). Tinctures of iodine contain a mixture of molecular iodine (I_2) and sodium triiodide (NaI_3) and have iodine concentrations of approximately 40 mg/mL. Doses of iodine from ingestion of the tinctures ranged from 1,200 to 9,500 mg (17–120 mg/kg), and deaths usually occurred within 48 hours of the dose. In one case, an adult male ingested 15 g of iodine as a potassium iodide solution and survived the episode; 18 hours after the dose, his serum iodide concentration was 2.95 mg/mL (Tresch et al. 1974). Symptoms of toxicity that have been observed in lethal or near-lethal poisonings have included abdominal cramps, bloody diarrhea and gastrointestinal ulceration, edema of the face and neck, pneumonitis, hemolytic anemia, metabolic acidosis, fatty degeneration of the liver, and renal failure (Clark 1981; Dyck et al. 1979; Finkelstein and Jacobi 1937; Tresch et al. 1974).

3. HEALTH EFFECTS

Two cases of infant deaths were reported in which death was from complications related to compression of the trachea by a goiterous thyroid gland; the mothers had ingested potassium iodide during their pregnancies at doses of approximately 850 and 1,180 mg I/day (12 and 17 mg/kg/day) (Galina et al. 1962).

The LOAEL values in humans for exposures by the oral route are presented in Table 3-1 and plotted in Figure 3-1.

3.2.2.2 Systemic Effects

Systemic effects of oral stable iodine exposure, other than after massive acute iodine overload such as in cases of attempted suicides (see Section 3.2.2.1), are on the thyroid gland and are discussed in the section on Endocrine Effects. As noted in the introduction to this chapter of the profile, adverse effects on a wide variety of other organ systems can result from iodine-induced disorders of the thyroid gland, including disturbances of the skin, cardiovascular system, pulmonary system, kidneys, gastrointestinal tract, liver, blood, neuromuscular system, central nervous system, skeleton, male and female reproductive systems, and numerous endocrine organs, including the pituitary and adrenal glands. The reader is referred to authoritative references on these subjects for further information (Braverman and Utiger 2000).

Endocrine Effects. The principal direct effects of excessive stable iodine ingestion on the endocrine system are on the thyroid gland and regulation of thyroid hormone production and secretion. Adverse effects on the pituitary and adrenal glands derive secondarily from disorders of the thyroid gland. Effects on the thyroid gland can be classified into three types: hypothyroidism, hyperthyroidism, and thyroiditis. Hypothyroidism refers to the diminished production of thyroid hormone leading to clinical manifestations of thyroid insufficiency and can occur with or without goiter, a functional hypertrophy of the gland in response to suppressed hormone production and elevated serum thyroid stimulating hormone (TSH, also known as thyrotropin) concentrations. Typical biomarkers of hypothyroidism are a depression in the circulating levels of thyroxine (T_4) and/or triiodothyronine (T_3) below their normal ranges. This is always accompanied by an elevation of the pituitary hormone, TSH, above the normal range. Hyperthyroidism is an excessive production and/or secretion of thyroid hormones. The clinical manifestation of abnormally elevated circulating levels of T_4 and/or T_3 is thyrotoxicosis. Thyroiditis refers to an inflammation of the gland, which is often secondary to thyroid gland autoimmunity. The above three types of effects can occur in children and adults, in fetuses exposed *in utero*, or in infants during lactation.

Table 3-1 Levels of Significant Exposure to Iodine - Chemical Toxicity - Oral

Key to figure ^a	Species (Strain)	Exposure/ Duration/ Frequency (Specific Route)	System	NOAEL (mg/kg/day)	LOAEL		Reference Chemical Form
					Less Serious (mg/kg/day)	Serious (mg/kg/day)	
ACUTE EXPOSURE							
Death							
1	Human	1 d				17 (death)	Finkelstein and Jacobi 1937 I ₂ , NaI ₃
Systemic							
2	Human	14 d (C)	Endocr	0.0086			Chow et al. 1991 KI
3	Human	1 d (C)	Endocr	3.4			Delange 1996 Iodized oil
4	Human	14 d (C)	Endocr	0.069			Gardner et al. 1988 NaI
5	Human	7 d (W)	Endocr	0.46			Georgitis et al. 1993 I ₂ , I-
6	Human	14 d (C)	Endocr	0.024 ^b			Paul et al. 1988 NaI

Table 3-1 Levels of Significant Exposure to Iodine - Chemical Toxicity - Oral

(continued)

Key to figure ^a	Species (Strain)	Exposure/ Duration/ Frequency (Specific Route)	System	NOAEL (mg/kg/day)	LOAEL		Reference Chemical Form
					Less Serious (mg/kg/day)	Serious (mg/kg/day)	
7	Human	14 d (C)	Endocr	1			Robison et al. 1998 Nal
8	Human	14 d (C)	Endocr	1			Robison et al. 1998 I2
Immuno/ Lymphoret							
9	Human	8 d (C)				20 (fever)	Horn and Kabins 1972 KI
10	Human	5 d (C)				4.3 (ioderma)	Soria et al. 1990 KI
INTERMEDIATE EXPOSURE							
Death							
11	Human	9 mo (C)				12 (death from tracheal compression by goiter)	Galina et al. 1962 KI
12	Human	9 mo (C)				17 (death from tracheal compression by goiter)	Galina et al. 1962 KI

Table 3-1 Levels of Significant Exposure to Iodine - Chemical Toxicity - Oral

(continued)

Key to figure ^a	Species (Strain)	Exposure/ Duration/ Frequency (Specific Route)	System	LOAEL			Reference Chemical Form
				NOAEL (mg/kg/day)	Less Serious (mg/kg/day)	Serious (mg/kg/day)	
Systemic							
13	Human	4 mo (C)	Endocr			23 (clinical hyperthyroidism with thyrotoxicosis)	Ahmed et al. 1974 KI
14	Human	2 mo (C)	Endocr			7.3 (goiter in neonate)	Coakley et al. 1989 KI
15	Human	9 mo (C)	Endocr			6.4 (goiter and hypothyroidism in neonate)	Hassan et al. 1968 KI
16	Human	11 wk (W)	Endocr	15			Jubiz et al. 1977 KI
17	Human	90 d (C)	Endocr	0.0039	0.46 (subclinical hypothyroidism with gland enlargement)		LeMar et al. 1995 I2 ,I-
18	Human	9 mo (C)	Endocr	0.0047			Liesenkotter et al. 1996 KI

Table 3-1 Levels of Significant Exposure to Iodine - Chemical Toxicity - Oral

(continued)

Key to figure ^a	Species (Strain)	Exposure/ Duration/ Frequency (Specific Route)	System	LOAEL			Reference Chemical Form
				NOAEL (mg/kg/day)	Less Serious (mg/kg/day)	Serious (mg/kg/day)	
19	Human	9 mo (C)	Endocr			13 (goiter, hypothyroidism in neonate)	Martin and Rento 1992 KI
20	Human	28 d (C)	Endocr		0.39 (subclinical hypothyroidism with gland enlargement)		Namba et al. 1993 I-
21	Human	3 mo (C)	Endocr			5.4 (goiter in neonate)	Penfold et al. 1978 KI
22	Human	4 mo (C)	Endocr			6.6 (goiter in neonate)	Penfold et al. 1978 KI
23	Human	6 mo (C)	Endocr			0.05 (clinical hypothyroidism)	Shilo and Hirsch 1986 sea-kelp
24	Human	7 wk (C)	Endocr			2.6 (clinical hyperthyroidism with thyrotoxicosis)	Vagenakis et al. 1972 KI
25	Human	9 mo (C)	Endocr			4.6 (goiter in fetus)	Vicens-Colvet et al. 1998 ND

Table 3-1 Levels of Significant Exposure to Iodine - Chemical Toxicity - Oral

(continued)

Key to figure ^a	Species (Strain)	Exposure/ Duration/ Frequency (Specific Route)	System	LOAEL			Reference Chemical Form
				NOAEL (mg/kg/day)	Less Serious (mg/kg/day)	Serious (mg/kg/day)	
Immuno/ Lymphoret							
26	Human	NS (C)				23 (fever)	Horn and Kabins 1972 KI
27	Human	6 mo (C)				11 (ioderma)	Kincaid et al. 1981 KI
28	Human	8 mo (C)				8.6 (ioderma)	Soria et al. 1990 KI
CHRONIC EXPOSURE							
Systemic							
29	Human	11 yr (W)	Endocr	0.01 ^c	0.029 (subclinical hypothyroidism with gland enlargement)		Boyages et al. 1989 I-
30	Human	2 yr (C)	Endocr			2.9 (clinical hypothyroidism with goiter in neonate)	Iancu et al. 1974 Nal
31	Human	NS (W)	Endocr			1 (goiter with elevated serum TSH)	Khan et al. 1998 ND

Table 3-1 Levels of Significant Exposure to Iodine - Chemical Toxicity - Oral

(continued)

Key to figure ^a	Species (Strain)	Exposure/ Duration/ Frequency (Specific Route)	System	LOAEL		Reference Chemical Form	
				NOAEL (mg/kg/day)	Less Serious (mg/kg/day)		Serious (mg/kg/day)
32	Human	46 yr (F)	Endocr			0.22 (clinical hypothyroidism without autoimmunity)	Konno et al. 1994 I-
33	Human	68 yr (F, W)	Endocr	0.0046			Laurberg et al. 1998 I-
34	Human	16 mo (C)	Endocr	0.0039			Pedersen et al. 1993 KI
35	Human	81 yr (F, W)	Endocr	0.0023		0.012 (clinical hypothyroidism without autoimmunity; elderly adults)	Szablocs et al. 1997 I-
	Immuno/ Lymphoret						
36	Human	15 yr (C)				15 (fever)	Kurtz and Aber 1982 KI
37	Human	1 yr (C)				14 (ioderma)	Rosenberg et al. 1972 KI
	Cancer						
38	Human	NS (F)				0.0035 (thyroid cancer; in endemic goiter area)	Bacher-Stier et al. 1997 I-

Table 3-1 Levels of Significant Exposure to Iodine - Chemical Toxicity - Oral

(continued)

Key to figure ^a	Species (Strain)	Exposure/ Duration/ Frequency (Specific Route)	System	LOAEL		Reference Chemical Form	
				NOAEL (mg/kg/day)	Less Serious (mg/kg/day)		Serious (mg/kg/day)
39	Human	NS (F)				0.0035 (thyroid cancer; in endemic goiter area)	Harach and Williams 1995 I-

^a The number corresponds to entries in Figure 3-1.

^b Used to derive an acute oral MRL based on a no-observed-effect-level (NOEL) of 0.01mg/kg/day in healthy adult humans, for changes in serum thyroid hormone levels. The no-observed-adverse-effect-level (NOAEL) is 0.024 mg/kg/day.

^c Used to derive a chronic oral MRL of 0.005 mg/kg/day; dose divided by an uncertainty factor of 2 for human variability.

(C) = capsule; d = day(s); Endocr = endocrine; (F) = feed; kg = kilogram(s); LOAEL = lowest-observed-adverse-effect level; mg = milligram(s); mo = month(s); NOAEL = no-observed-adverse-effect level; NA = not specified; TSH = thyroid-stimulating hormone; (W) = drinking water; wk = week(s); yr = year(s)

Figure 3-1. Levels of Significant Exposure to Iodine - Chemical Toxicity - Oral
Acute (≤ 14 days)

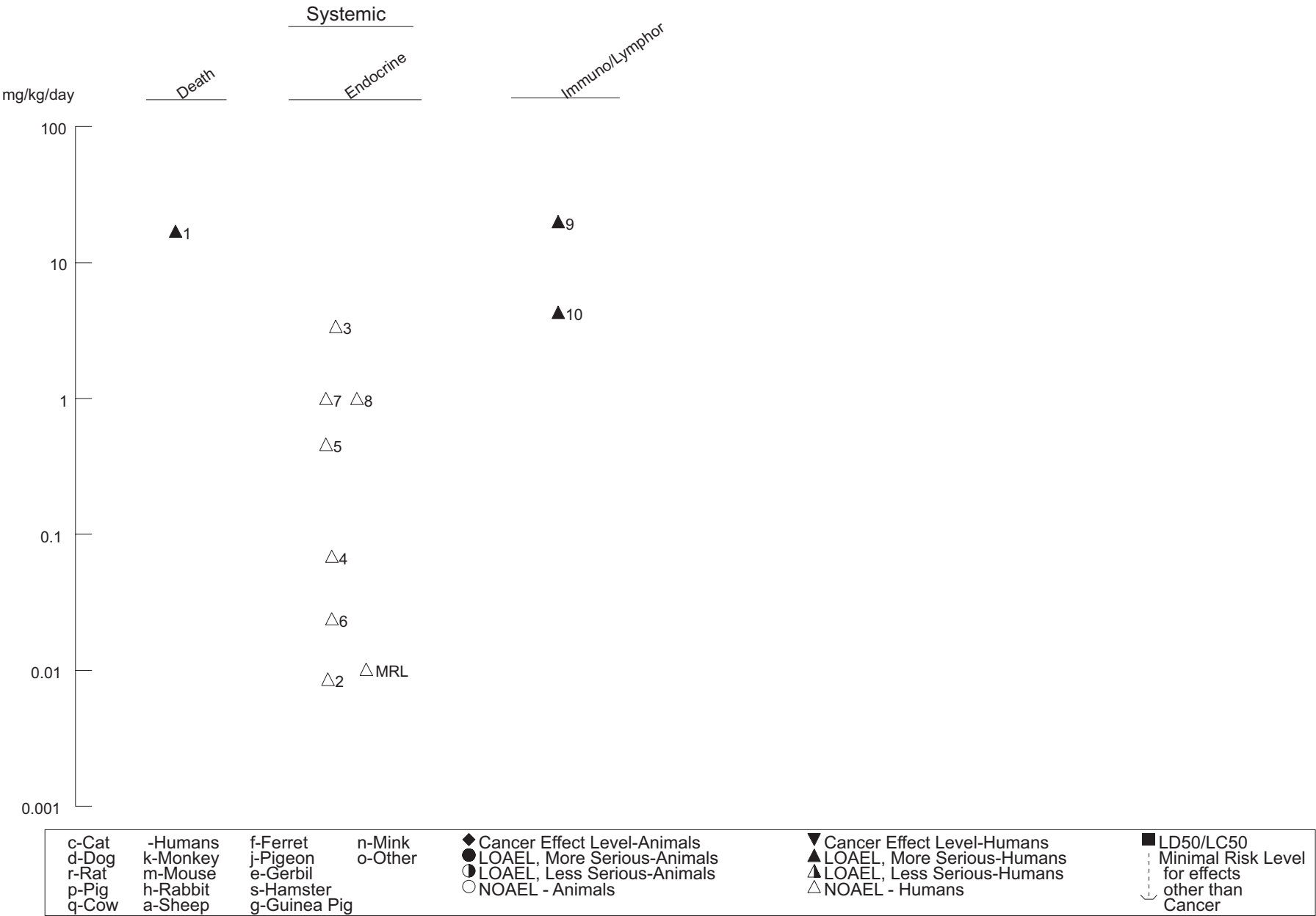

Figure 3-1. Levels of Significant Exposure to Iodine - Chemical Toxicity - Oral (Continued)
Intermediate (15-364 days)

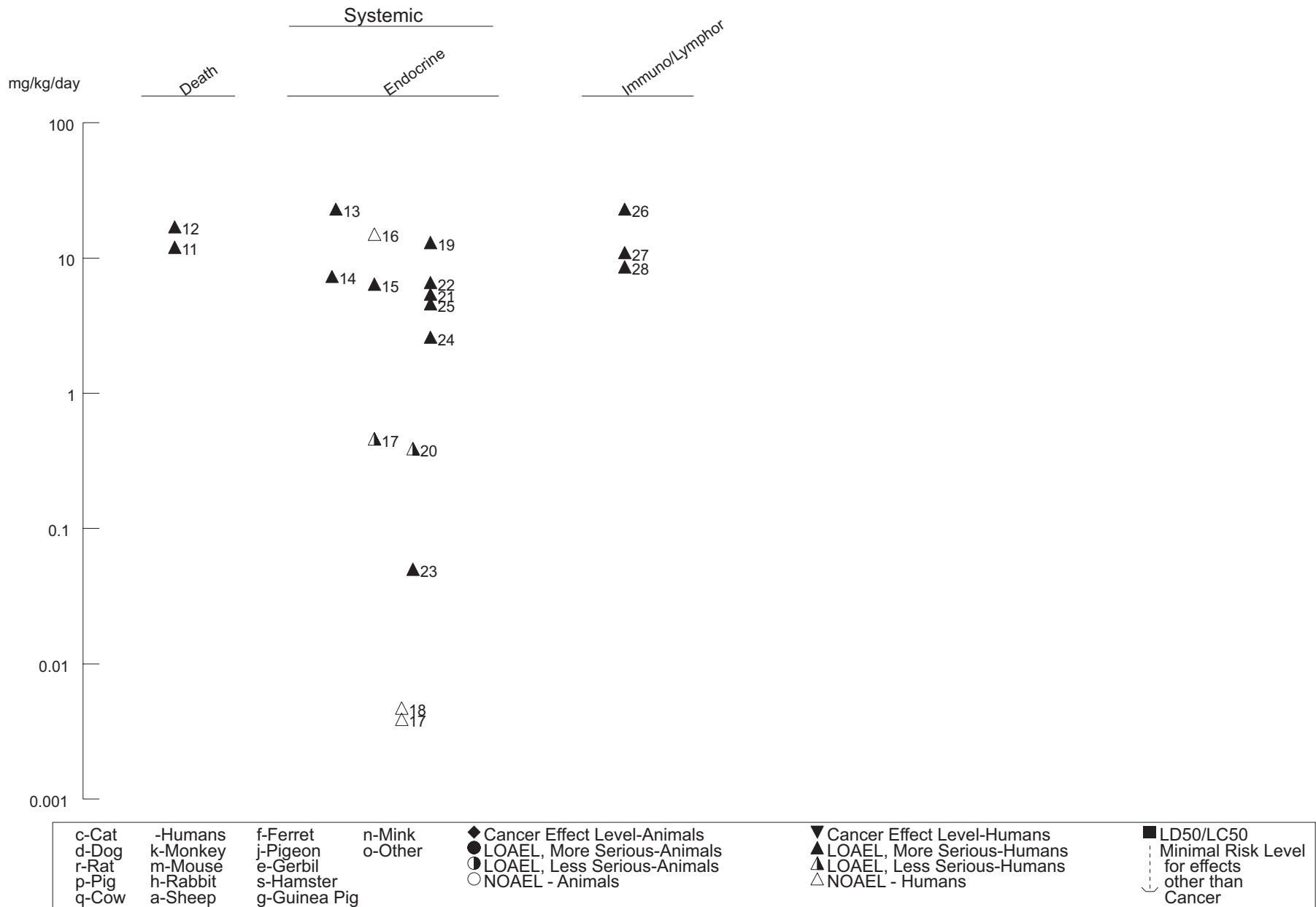
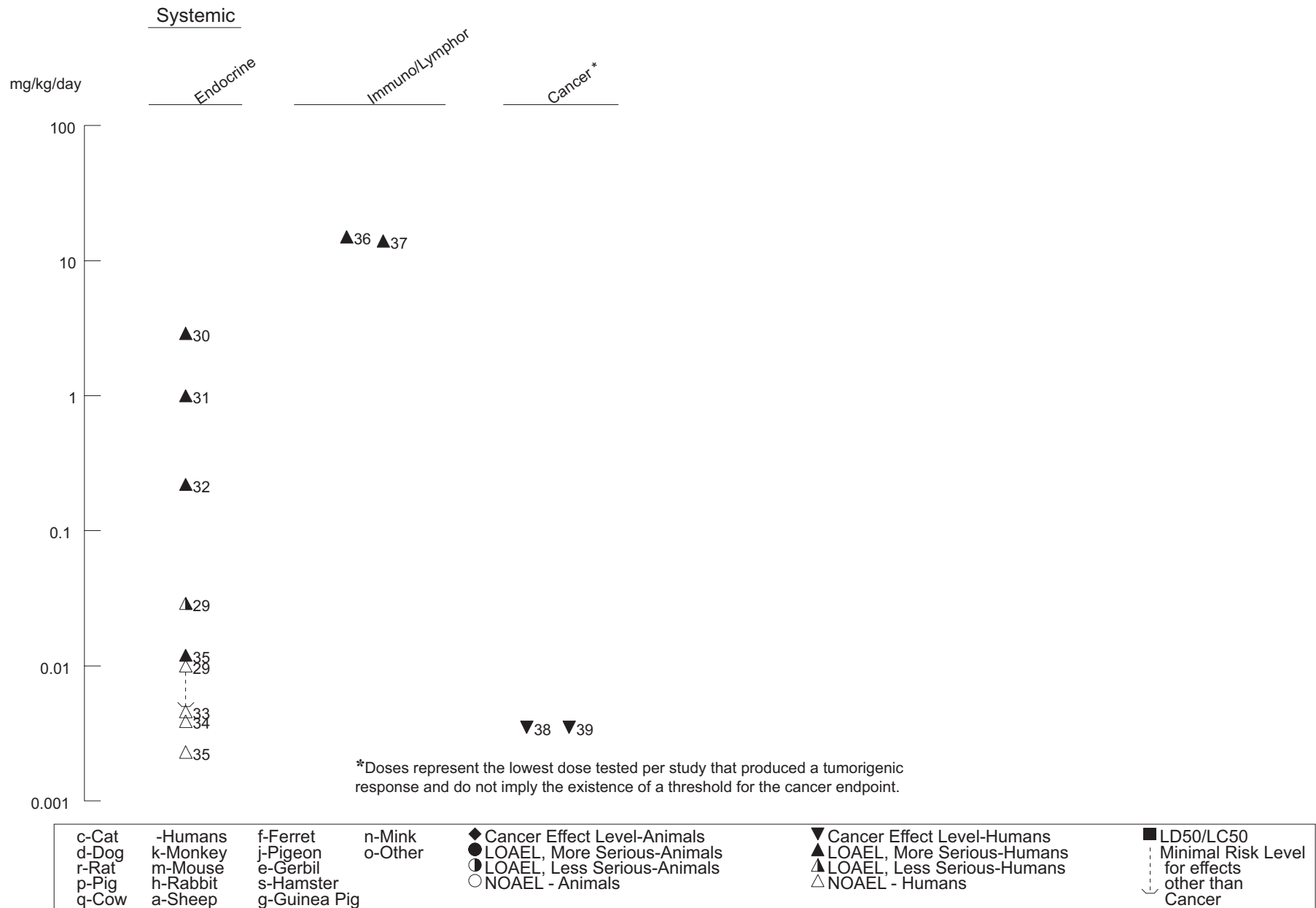

Figure 3-1. Levels of Significant Exposure to Iodine - Chemical Toxicity - Oral (*Continued*)
 Chronic (≥ 365 days)



3. HEALTH EFFECTS

Measurements of serum levels of thyroid hormones and TSH are often used as biomarkers of hypothyroidism and thyrotoxicosis in toxicology and epidemiology studies. In interpreting this literature in terms of human health risks, a distinction must be made between outcomes that have a high potential for producing clinical manifestations and outcomes that are not clinically significant. In this profile, an observed increase in serum TSH level and normal T₄ and T₃ levels is referred to as *subclinical hypothyroidism*. Similarly, the term *subclinical hyperthyroidism* refers to a condition in which the circulating levels of T₄ or T₃ are normal and the serum TSH concentration is suppressed. Typical normal ranges for these hormone levels are discussed in Section 3.9.2

Hypothyroidism

An acute iodide excess (above the preexisting dietary intake) transiently decreases the production of thyroid hormones in the thyroid gland; this is referred to as the acute *Wolff-Chaikoff effect* (Wolff et al. 1949). In normal people, this is followed by a return to normal levels of hormone synthesis, referred to as *escape* from the acute Wolff-Chaikoff effect, without a significant change in circulating hormone levels. Escape is thought to be the result of down regulation of the sodium-iodide symport (NIS), the iodide transporter in the thyroid gland, resulting in a decrease in the intrathyroidal iodine and the resumption of normal hormone synthesis (see Section 3.5.3.2 for further details on the Wolff-Chaikoff effect). An acute or chronic excess of iodide can also decrease circulating T₄ and T₃ levels and induce a hypothyroid state in some people who have underlying thyroid disorders. These effects are the result of a failure to escape from the acute Wolff-Chaikoff effect. Most people who experience iodine-induced hypothyroidism recover when the excess iodine intake is discontinued. Susceptible individuals include fetuses and newborn infants, elderly, patients who have underlying thyroid disease, and patients who have received treatment with antithyroid medications. A complete list of susceptible groups is presented in Table 2-2, recovery occurs when the excess iodine is discontinued.

Several studies have examined the acute effects of increased intake of iodine on thyroid hormone status in adults (Chow et al. 1991; Gardner et al. 1988; Georgitis et al. 1993; Namba et al. 1993; Paul et al. 1988; Robison et al. 1998). These effects, in subjects who have no underlying thyroid disease, result from a small iodine-induced decrease in thyroid hormone release, which is accompanied by a rise in serum TSH concentration, to maintain normal thyroid function. The studies included relatively small numbers of subjects (<30) and, therefore, had low statistical power; this complicates the generalization of findings to large populations (in particular, findings of no significant effect). However, an important attribute of these studies is that iodine intakes were controlled and quantified with high certainty. The results of these studies suggest that acute (14 days) increases in iodine intake of 1,500 µg/day (21 µg/kg/day) above the

3. HEALTH EFFECTS

preexisting dietary intake can be tolerated without producing a clinically adverse change in thyroid hormone levels, although such doses may produce a small reversible depression in serum T₄ concentrations and a small rise in serum TSH concentrations, both within the normal range of values for healthy individuals. Changes in thyroid hormone levels within normal ranges are not considered to be clinically adverse; however, they are indicative of a subtle suppression of thyroid hormone release. The above conclusions apply to healthy adults who have no prior history of thyroid disease, no detectable antithyroid antibodies, and no prior history of chronic deficiency or excessive iodine intakes (Gardner et al. 1988; Paul et al. 1988). One study found that subclinical hypothyroidism was induced by an acute increase of 500 µg/day (7 µg/kg/day) in elderly adults (Chow et al. 1991), suggesting the possibility that elderly adults may be less tolerant of an iodide excess than younger adults. Based on estimates of the background dietary intakes of the subjects in these studies, in most cases estimated from measurements of urinary iodide excretion, the total iodide intakes (including background dietary intake) that could produce subclinical hypothyroidism were approximately 1,700 µg/day or approximately 24 µg/kg/day (Gardner et al. 1988; Paul et al. 1988). Acute intakes of approximately 700 µg/day or approximately 10 µg/kg/day had no detectable effect on thyroid status in healthy individuals (Gardner et al. 1988; Paul et al. 1988). One study found no evidence for disturbances in thyroid hormone status in healthy adults who received doses of 300 µg/kg/day (approximately 20 mg/day) for 14 days (Robison et al. 1998). This suggests that, at least under certain conditions, exposure levels >10–24 µg/kg/day may be tolerated in some people. Brief summaries of the relevant studies that provide information on oral exposures to iodine that suppress the thyroid gland are provided below.

Healthy euthyroid adults (nine males, nine females) who had no history of thyroid disease or detectable antithyroid antibodies received daily oral doses of 1,500 µg I/day as sodium iodide for 14 days (Paul et al. 1988). Based on 24-hour urinary excretion of iodide prior to the iodide supplement, the background iodine intake was estimated to be, approximately, 200 µg/day; thus, the total iodide intake was approximately 1,700 µg I/day (approximately 24 µg/kg/day, assuming a 70-kg body weight). Serum concentrations of TT₄, FT₄, and TT₃ were significantly depressed (5–10%) compared to pretreatment levels and serum TSH concentrations were significantly elevated (47%) compared to pretreatment values. Hormone levels were within the normal range during treatment and, therefore, the subjects were not hypothyroid. In this same study, nine females received daily doses of 250 or 500 µg I/day for 14 days and there were no significant changes in serum hormone concentrations. Total intake was approximately 450 or 700 µg/day (6 or 10 µg/kg/day). Some of these women participated in the higher dose study 1 year earlier.

3. HEALTH EFFECTS

In a similar type of study, healthy, euthyroid, adult males (n=10) received daily oral doses of 500 µg I/day (as sodium iodide) for 14 days; there were no effects on serum thyroid hormone or TSH concentrations; however, dosages of 1,500 or 4,500 µg I/day produced small (10%) but significant, transient decreases in serum TT₄ and FT₄ concentrations and an increase (48%) in serum TSH concentration, relative to the pretreatment values (Gardner et al. 1988). Urinary iodide excretion prior to the dose ranged from 250 to 320 µg/day, suggesting that the background dietary intake was approximately in this same range (see Sections 3.5.1.2 and 3.5.4.2). The magnitude of the changes at the higher iodide dosages yielded hormone concentrations that were within the normal range and, thus, would not represent a significant thyroid suppression. This suggests that an acute oral intake of 500 µg/day above a preexisting dietary intake, or approximately 800 µg I/day total (11 µg/kg/day), is tolerated without thyroid gland suppression in healthy adult males, and intakes as high as 4,800 µg I/day (69 µg/kg/day) may be tolerated in some people without clinically adverse effects.

Another similar experimental study has been reported in which 30 healthy, elderly adult females, without evidence of thyroid peroxidase antibodies (TPA), received daily doses of 500 µg I/day (as potassium iodide) for 14 or 28 days (Chow et al. 1991). Serum concentrations of FT₄ were significantly decreased (change from pretreatment level, approximately -1 pmol/L) and serum TSH concentrations were significantly increased (change from pretreatment level approximately +0.6 mU/L) in the women who received the iodide supplements, relative to a placebo control group. On average, the magnitude of the changes did not produce depression in thyroid hormone levels below the normal range; however, five subjects had serum TSH concentrations that exceeded 5 mU/L, considered mildly elevated. The subjects had a lower dietary iodine intake than those in the Gardner et al. (1988) study; approximately 72–100 µg/day, based on urinary iodide measurements. Therefore, the total iodide intake was approximately 600 µg/day (9 µg/kg/day).

Higher acute iodine exposures have been shown to produce reversible thyroid gland hypertrophy, in addition to hormone suppression. The effects of tetraglycine hydroperiodide, an iodine compound used to purify drinking water, were examined in an acute experimental study (Georgitis et al. 1993). When dissolved in water, tetraglycine hydroperiodide releases I₂ and iodide (as a reduction product). Seven healthy adults, who had no history of thyroid disease, ingested 227 mL (8 ounces) of a flavored drink into which tetraglycine hydroperiodide had been dissolved; the dosage was 32 mg/day of iodine for 7 consecutive days (460 µg/kg/day). Seven age-, weight-, and height-matched controls received water without added iodine. A statistically significant decrease in serum concentration of T₄ and T₃ (14–15%) and a significant increase in TSH concentration (50%) occurred in the treatment group during the

3. HEALTH EFFECTS

treatment, relative to their pretreatment values, whereas no change occurred in the control subjects. Two subjects in the treatment group had T_4 concentrations below approximately 60 nmol/L, which is slightly below normal, and two subjects had TSH concentrations that were between 4.5 and 6 mU/L, which were slightly elevated and suggestive of mild thyroid impairment (it is not clear from the report if these were the same two subjects). In a more extensive study of similar design, eight healthy euthyroid adults (seven males, one female), who were negative for thyroid antimicrosomal antibody, ingested approximately 32 mg iodine/day (460 $\mu\text{g}/\text{kg}/\text{day}$) as tetraglycine hydroperoxide dissolved in juice or water, for 90 days (LeMar et al. 1995). The mean pretreatment 24-hour urinary iodide excretion rate was 276 $\mu\text{g}/\text{day}$. Thyroid gland volumes, as determined from ultrasound measurements, increased significantly during the treatment, with a peak volume 37% above the pretreatment volume and reverted to pretreatment volumes 7 months after the iodine dosing was discontinued. Serum TSH concentrations increased significantly during treatment, with only one subject having a 3-fold increase to a value above normal, 6.1 mU/L; this subject also had the highest thyroid volume during the treatment period. None of the subjects developed clinical hypothyroidism.

Daily doses of 27 mg I/day (390 $\mu\text{g}/\text{kg}/\text{day}$), as licorice lecithin-bound iodide, given for 28 days to 10 healthy, euthyroid adult males who were TPA negative resulted in a statistically significant, 15% increase in thyroid gland volume, as determined from ultrasound measurements, compared to pretreatment values (Namba et al. 1993). Serum concentrations of FT_4 and T_3 were decreased, and serum TSH and thyroglobulin (T_g) concentrations were significantly elevated, although the values were all within the normal ranges. All values, including thyroid gland volume returned to normal within 28 days after the last iodide supplement. In a clinical study of 22 hypothyroid adults from Japan who consumed an estimated 1–43 mg I/day (17–720 $\mu\text{g}/\text{kg}/\text{day}$, from consumption of seaweed), 12 patients reverted to a euthyroid state after 3 weeks of voluntary dietary iodine restriction (Tajiri et al. 1986). When seven of these patients who converted to a euthyroid state after dietary restriction received supplements of 25 mg I/day (420 $\mu\text{g}/\text{kg}/\text{day}$) as Lugol's solution (a mixture of 50 mg/mL I_2 and 100 mg/mL potassium iodide KI) for 2–4 weeks, all reverted to a hypothyroid state (serum TSH concentrations >5 mU/L). In this same study, 11 healthy euthyroid adults (8 females, 3 males) received 25 mg I/day for 14 days (420 $\mu\text{g}/\text{kg}/\text{day}$). The mean serum TSH concentrations significantly increased (40%) during the treatment compared to their pretreatment values; however, their TSH concentrations during treatment (3.9 mU/L) did not exceed the normal range (<5 mU/L).

In contrast to the results of the above studies, no clinical abnormalities in thyroid hormone status occurred when healthy, euthyroid, adult males ($n=6$ or 7), who had no history of thyroid-related illness, ingested

3. HEALTH EFFECTS

daily oral doses of 300 or 1,000 µg I/kg/day as either I₂ or sodium iodide for 14 days (Robison et al. 1998). Based on measurements of urinary iodide excretion rates, the pretreatment iodide intakes were approximately 100 µg/day. The high dosage (1,000 µg I/kg/day) produced a small but statistically significant increase in serum TSH concentrations compared to a sodium chloride control group; the TSH concentrations in the control group did not exceed the normal range (<5 mU/L) and reverted to control levels within 10 days after the iodine supplementation was ended. Serum TT₄ and TT₃ were not significantly different in the treatment groups, compared to the control group. As noted previously, studies of this size have low statistical power, which complicates the interpretation of findings of no significant effect.

In a more remarkable, intermediate-duration experimental study, four healthy adults (three males, one female) received a daily oral dose of approximately 1,000 mg I/day as a saturated solution of potassium iodide (30 drops/day, approximately 36 mg I/drop, 15 mg I/kg/day) for 11 weeks (Jubiz et al. 1977). A small, statistically significant decrease in the mean serum concentration of T₄ occurred (pretreatment, 8.8 µg/dL; treatment minimum 7.6 µg/dL) and an increase in TSH concentration (pretreatment, 7.3 mU/L; treatment maximum, 13.5 mU/L). The above changes were no longer evident within 1 week after the treatment was discontinued. In a similar study, eight euthyroid adults (seven male, one female), who were hepatitis patients, received daily oral doses of approximately 360 mg I/day (5 mg/kg/day) as a saturated solution of potassium iodide (10 drops/day, approximately 36 mg I/drop) for 60 days (Minelli et al. 1999). A small statistically significant decrease in the mean serum concentration of T₄ (pretreatment, 13.8 pmol/L; treatment minimum 13.2 pmol/L) and an increase in TSH concentration (pretreatment, 0.6 mU/L; treatment maximum, 1.7 mU/L) occurred. Two patients were reported to have developed transient elevated serum TSH concentrations during the iodide treatment, with normal concentrations of FT₄ and FT₃. There were no incidences of clinical hypothyroidism or hyperthyroidism. A nearly identical result was reported for eight euthyroid hepatitis patients who had previously received recombinant interferon-alpha therapy (but who did not develop thyroid dysfunction during therapy) and who subsequently received daily doses of approximately 360 mg I/day (5 mg/kg/day) as a saturated solution of potassium iodide for 60 days (Minelli et al. 1997). As part of the study reported by Jubiz et al. (1977), 13 patients with obstructive pulmonary disease who were receiving 1,000–2,000 mg I/day (14–28 mg/kg/day) as a saturated potassium iodide solution for periods of 1 month to 8 years exhibited unambiguous symptoms of hypothyroidism, including thyroid gland enlargement, depressed serum concentrations of T₄ (mean 2–2.7 µg/dL), and elevated serum TSH concentrations (20–35 mU/L). Serum T₄ and TSH levels returned to normal in all but one of the patients within 1 month after the iodide dosage

3. HEALTH EFFECTS

was discontinued. However, in the Jubiz et al. (1977) study, the presence of chronic thyroiditis was not determined.

The results of several epidemiological studies suggest that chronic exposure to excess iodine can result in or contribute to hypothyroidism. Thyroid status was compared in groups of children, ages 7–15 years, who resided in two areas of China where drinking water iodide concentrations were either 462 µg/L (n=120) or 54 µg/L (n=51) (Boyages et al. 1989; Li et al. 1987). Although the subjects were all euthyroid with normal values for serum thyroid hormones and TSH concentrations, TSH concentrations were significantly higher in the high iodine group. The prevalence and severity of goiter in the population were evaluated, the latter based on a goiter severity classification scale (Grade 0, no visible goiter; Grade 1, palpable goiter that is not visible when the neck is not extended; Grade 2, palpable and visible goiter when the neck is not extended). The high iodide group had a 65% prevalence of goiter compared to 15% in the low iodine group. The prevalence of more severe, Grade 2 goiter, was also higher in the high iodide group (15%) compared to the low iodide group (0%). Urinary iodine was 1,236 µg I/g creatinine in the high iodine group and 428 µg I/g creatinine in the low iodine group. Assuming a body weight of 40 kg and lean body mass of 85% of body weight, the above urinary iodine/creatinine ratios are approximately equivalent to iodine excretion rates or steady state ingestion rates of 1,150 µg/day (29 µg/kg/day) and 400 µg/day (10 µg/kg/day) in the high and low iodide groups, respectively.

Zhao et al. (2000) compared the prevalence of thyroid enlargement among children 5–15 years of age to drinking water and urinary iodine levels in residents of 65 townships in Jiangsu Province, China. This area had a high prevalence of childhood goiter, although urinary iodide measurements suggested dietary iodine sufficiency. Urinary iodine measurements were obtained for adults who resided in the same townships as the children. The prevalences of goiter and abnormal thyroid volume (not defined in the report) increased with increasing urine iodine concentration. The prevalences of goiter increased from 15% (802 µg I/L urine) to 38% (1,961 µg I/L urine). The prevalences of abnormal thyroid volume increased from 5 to 17% over this same range of urinary iodine concentrations. Assuming an adult urine volume of 1.4 L/day and an adult body weight of 60 kg, the observed range of urinary iodide concentrations in adults (520–1,961 µg I/L) corresponded to approximate intakes of 730–2,750 µg/day (12–46 µg/kg/day).

A survey of a group of Peace Corps volunteers revealed a high prevalence of goiter among volunteers who drank water from iodine filters (Khan et al. 1998). Of 96 volunteers surveyed, 44 (46%) had enlarged thyroid glands, 33 (34%) had elevated serum TSH concentrations (4.2 mU/L), and 4 (4%) had

3. HEALTH EFFECTS

depressed serum TSH concentrations (≈ 0.4 mU/L). The mean iodide concentration in filtered drinking water was 10 mg I/L, which corresponded to a daily intake of iodide from drinking water of 50–90 mg I/day (0.7–1.3 mg/kg/day, based on a reported daily water consumption of 5–9 L/day). This estimate was consistent with measured mean urinary iodide concentration of 11 mg/L, which corresponds to approximately 55–99 mg I/day excreted or ingested, assuming daily urine volumes similar to water consumption. When the excess iodine was removed from the drinking water, all measures of thyroid function returned to normal (Pearce et al. 2002).

In a study of elderly adults, thyroid status was compared in 423 residents (ages 66–70 years) of Jutland, Denmark who had iodine intakes of 40–60 $\mu\text{g/day}$ (0.7 $\mu\text{g/kg/day}$) and 100 residents of Iceland who had intakes of 300–350 $\mu\text{g/day}$ (5 $\mu\text{g/kg/day}$) (Laurberg et al. 1998). Subjects from the high iodine intake region had a significantly higher prevalence (18%) of serum TSH levels above the high end of the normal range (>4 mU/L) compared to subjects from the low iodine region (3.8%). The prevalence of serum TSH concentrations above 10 mU/L was 4.0% in the high iodine region and 0.9% in the low iodine region. Females in both regions had a significantly higher prevalence of elevated TSH concentrations than males. Serum concentrations of T_4 were not depressed, even in subjects with TSH concentrations that exceeded 10 mU/L. Thus, although the subjects appeared to be euthyroid, the higher iodine intakes were associated with a subclinical suppression of the thyroid gland as indicated by a high prevalence of elevated serum TSH concentrations. A study of elderly nursing home residents in the Carpathian Basin also revealed a prevalence of hypothyroidism that increased with increasing iodine intake (Szabolcs et al. 1997). Subjects were from one of three regions where, based on reported urinary iodine levels of 72, 100, or 513 $\mu\text{g I/g creatinine}$, the iodine intakes were approximately 117, 163, or 834 $\mu\text{g/day}$ (1.7, 2.3, or 12 $\mu\text{g/kg/day}$ for low, $n=119$; moderate, $n=135$; or high intake, $n=92$, respectively). The prevalence of serum TSH concentrations above the normal range was 4.2, 10.4, and 23.9% in the low, moderate, and high iodine groups, respectively. The prevalence of elevated serum TSH concentrations together with serum FT_4 concentrations below the normal range was 0.95, 1.5, and 7.6% in the low, moderate, and high iodine groups, respectively.

Several studies have found increased prevalence of hypothyroidism in residents of areas of Japan where dietary iodine intake is high as a result of consumption of seaweeds containing a high iodine concentration. In one study, urinary iodide and serum TSH concentrations were measured in a group of 1,061 adult residents of five coastal areas of Japan and in 4,100 residents of two inland areas (Konno et al. 1993a, 1994). The subjects were classified as having high or normal iodine intakes based on whether their urinary iodide concentrations were less than or greater than the high end of the *normal range*,

3. HEALTH EFFECTS

75 $\mu\text{mol/L}$ (9,500 $\mu\text{g/L}$). The urine samples were not timed and urinary creatinine concentrations were not reported; therefore, only rough estimates of the rate of urinary excretion of iodide ($\mu\text{g/day}$) and iodide intake can be made. The report indicates that the urine samples were collected in the morning and included night urine (i.e., urine voided on awakening). If it is assumed that the concentrations of iodide in the morning urine samples reflect the concentration for a 24-hour sample and that the 24-hour urine volume is approximately 1.4 L (ICRP 1981), then the 24-hour excretion and intake rates in the high iodine group may have been approximately 13.3 mg/day (0.22 mg/kg/day, assuming a body weight of 60 kg). Even if the morning urine samples were relatively concentrated compared to the 24-hour average, the above urine iodide concentrations suggest an iodide intake of several mg/day. This is consistent with other reported estimates that range from 1 to 5 mg/day in Japan among consumers of seaweed (Pennington 1990b). Examples of much higher intakes (25–40 mg/day, 0.4–0.7 mg/kg/day) have been reported in hypothyroid patients who consume seaweed (Tajiri et al. 1986). The prevalences of elevated serum TSH concentrations (>5 mU/L) and urine iodide concentrations ($>9,500$ $\mu\text{g/L}$) were both significantly higher in the coastal regions compared to the inland regions (Konno et al. 1994). Serum TSH concentrations were positively correlated with the urine iodide concentrations, and the prevalence of elevated serum TSH concentrations in the seven areas correlated positively with the prevalence of high urinary iodide concentrations. There were no significant correlations or associations with urine iodide and suppressed concentrations of serum TSH (<0.15 mU/L) or with the presence of thyroid antibodies.

A study of iodine supplementation for treatment of endemic goiter related to iodine deficiency provides additional evidence that increases in iodine intake can induce thyroid dysfunction, including thyroid autoimmunity. Otherwise healthy adults who had goiter but no evidence of clinical hypothyroidism or hyperthyroidism or antithyroid antibodies received either a placebo (16 females, 15 males) or 200 μg I/day (3 $\mu\text{g/kg/day}$ total intake) (16 females, 15 males) as potassium iodide for 12 months (Kahaly et al. 1997). A significant decrease in thyroid volume occurred in the treated group relative to the control group. Three subjects in the treatment group (9.7%, two females and one male) developed elevated levels of thyroglobulin and thyroid microsomal antibodies compared to none in the control group. Two of these subjects developed hypothyroidism and one subject developed hyperthyroidism; all three subjects reverted to normal thyroid hormone status when the iodide supplementation was discontinued. In a similar study, 31 adult euthyroid patients from an endemic goiter region who had goiter received 500 $\mu\text{g/day}$ potassium iodide (382 μg I/day, 5 mg I/kg/day based on reported median body weight of 75 kg) for 6 months, and 31 patients received 0.125 μg T_4 /day (Kahaly et al. 1998). Based on reported measurements of 24-hour urine iodide excretion, the preexisting iodide intake was approximately 40 $\mu\text{g/day}$ (range, 13–77, 0.6 $\mu\text{g/kg/day}$); thus, the total intake during treatment was approximately

3. HEALTH EFFECTS

420 µg I/day (6 µg/kg/day). After 6 months of iodide supplementation, the mean 24-hour urinary iodide excretion rate was 415 µg/day, which is consistent with the estimate of a total iodide intake of approximately 420 µg/day. Six of the patients who received iodide (19%) developed high titres of thyroglobulin and thyroid microsomal antibodies, compared to none in the T₄ group. Four of the high antibody patients became hypothyroid and two patients became hyperthyroid. The thyroid hormone status reverted to normal and antibody titres decreased during a 6-month period following the treatment in which the patients received a placebo.

People who have autoimmune thyroid disease may be at increased risk of developing thyroid dysfunction when exposed to excess iodide. Euthyroid patients (37 females, 3 males) from an iodine-deficient region, who were diagnosed with Hashimoto's thyroiditis and who were positive for antithyroid (thyroid peroxidase) antibodies, received an oral dose of 250 µg potassium iodide (190 µg I/day) for 4 months; a similar group of thyroiditis patients (41 females, 2 males) served as controls (Reinhardt et al. 1998). Based on urinary iodide measurements of 72 µg I/g creatinine before the iodide supplementation, the preexisting iodide intake was approximately 125 µg/day, for a total iodide dosage of 375 µg/day (5.8 µg/kg/day) in the treatment group. Seven patients in the treatment group developed elevated serum TSH concentrations (>4 mU/L) and one patient developed overt clinical hypothyroidism with a TSH concentration of 43.3 mU/L and a serum FT₄ concentration of 7 pmol/L. One patient in the treatment group became clinically hyperthyroid with a serum FT₄ concentration of 30 pmol/L and TSH concentration of <1 mU/L. One patient in the control group developed mild subclinical hypothyroidism. After the iodine supplementation was discontinued, three of the seven hypothyroid patients in the treatment group reverted to normal thyroid. An additional patient in the treatment group became hypothyroid, requiring T₄ supplements. The patient who became hyperthyroid while in the treatment group reverted to normal thyroid status after the iodide supplements were discontinued. In a smaller clinical study of patients from an iodine-deficient region, four of seven euthyroid patients with Hashimoto's thyroiditis who received 180 mg I/day (2.6 mg/kg/day) as a saturated potassium iodide solution for 6 weeks developed hypothyroidism, which reverted to normal after the iodide supplementation was discontinued (Braverman et al. 1971a). In addition to autoimmune diseases, other thyroid disorders predispose people to iodine-induced hypothyroidism (Table 2-2).

Maternal exposures to excess iodine during pregnancy have been shown to produce goiter and hypothyroidism in neonates. In general, clinical cases have involved maternal exposures to several hundred mg I/day during pregnancy. For example, in one clinical case, hypothyroidism and life-threatening goiter occurred in an infant born to a woman who consumed approximately 200 mg I/day

3. HEALTH EFFECTS

(2.9 mg/kg/day), as sodium iodide, for 2 years, including during pregnancy (Iancu et al. 1974). The infant was treated with levothyroxine and reverted to a normal gland and hormone status within 3 weeks after birth, without further hormone therapy. In another case, a woman ingested approximately 260–390 mg I/day (4.6 mg/kg/day) during pregnancy and her infant developed goiter *in utero*, which was successfully treated *in utero* with levothyroxine; the thyroid gland and hormone status of the infant was normal at birth (Vicens-Colvet et al. 1998). Coakley et al. (1989) reported, as part of the results of a screening program for congenital hypothyroidism, two cases in which women ingested iodide during pregnancy and gave birth to infants who had a transient goiter. In one case, the estimated total dose iodide dose was approximately 38.3 g I, of which approximately 15.3 g was ingested during the last month of pregnancy. These doses are equivalent to an average daily total dose of approximately 96 mg I/day during the first 8 months and 510 mg I/day (7.3 mg/kg/day) during the last month of pregnancy. Penfold et al. (1978) reported two cases, one of goiter without hypothyroidism in an infant born to a mother who ingested approximately 380 mg I/day (5.4 mg/kg/day) as potassium iodide during the last trimester of pregnancy, and the other case of goiter with hypothyroidism in an infant born to a mother who had ingested approximately 460 mg I/day (6.6 mg/kg/day) as potassium iodide during the last 4 months of pregnancy. In both cases, hypothyroidism and/or goiter were temporary and did not require thyroid hormone therapy. Hassan et al. (1968) reported three cases of neonatal goiter and hypothyroidism. In each case, the mother had ingested daily doses of potassium iodide during pregnancy; approximate doses were 450, 688, and 765 mg I/day (6–11 mg/kg/day). The goiter and hypothyroidism reversed with temporary thyroid hormone therapy. Bostanci et al. (2001) reported a similar outcome in an infant of a mother who ingested 130 mg I/day as potassium iodide during the last 4 months of pregnancy. Martin and Rento (1962) reported two cases of goiter and severe but reversible hypothyroidism in infants born to mothers who ingested potassium iodide during pregnancy; the approximate dosages were 920 and 1,530 mg I/day (13 and 22 mg/kg/day). In two cases, infants died with complications related to a goiterous thyroid gland compression of the trachea; the mothers had ingested potassium iodide during their pregnancies at doses of approximately 850 and 1,180 mg I/day (12 and 17 mg/kg/day) (Galina et al. 1962).

The above clinical cases demonstrate that doses of iodide exceeding 200 mg/day (2.8 mg/kg/day) during pregnancy can result in congenital goiter and hypothyroidism. There is also a large clinical experience with the lower doses of iodide supplementation given during pregnancy for the purpose of correcting or preventing potential iodine deficiency and for the management of Graves' disease during pregnancy. In a study of 35 women with Graves' disease who received 6–40 mg iodide (0.1–0.7 mg/kg/day, assuming a 60-kg body weight) as potassium iodide during pregnancy, 2 of 35 infants had serum TSH concentrations above normal at birth (>20 mU/L) and none had FT₄ concentrations below normal at birth (<10 pmol/L;

3. HEALTH EFFECTS

7 ng/L), suggesting that this level of iodide supplementation did not induce a hypothyroid state in the newborn, but did produce a subclinical elevation in TSH levels in some infants (Momotani et al. 1992). In a study of iodide supplementation during pregnancy in an iodide-deficient area of Denmark, 28 women received daily doses of 200 µg I/day from the 17th–18th week of pregnancy through the first 12 months after delivery and 26 women received no supplementation (Pedersen et al. 1993). Pretreatment urinary iodide levels were 51 and 55 µg/L, respectively, in the two groups, suggesting a preexisting dietary iodine intake of approximately 75 µg/day (assuming that the urine iodide concentration reflected the 24-hour average and that urine volume was approximately 1.4 L/day) and a total iodide intake of 275 µg/day (4 µg/kg/day). There were no statistically significant differences in serum TT₄, FT₄, T₃, or TSH concentrations in the infants in the two groups at birth, and there were no abnormal values for the hormones in any of the infants. In a similar type of study, 38 pregnant women from a potentially iodine-deficient region of Germany received daily doses of 230 µg I/day as potassium iodide during pregnancy and lactation and 70 women received no supplementation. Pretreatment urinary iodide levels were 53 µg I/g creatinine (median), suggesting a preexisting iodide intake of approximately 90 µg/day (Liesenkötter et al. 1996) and a total intake of 320 µg/day (5 µg/kg/day). Thyroid gland volumes were significantly decreased in infants from the supplemented group, compared to the control group (median control, 1.5 mL; median treated, 0.7 mL). One infant (1/38, 2.6%) from the supplemented group was classified as having an enlarged gland (>1.5 mL) compared to 14 (14/70, 20%) from the control group. The report indicates that “*no hypothyroidism or hyperthyroidism was observed in the mothers or newborns*”, although the end points evaluated, other than serum TSH, were not indicated.

In general, the aforementioned clinical case literature demonstrates that doses of iodide exceeding 200 mg/day (2.8 mg/kg/day) given to a mother during pregnancy can result in congenital goiter and hypothyroidism in the newborn infant (Coakley et al. 1989; Galina et al. 1962; Hassan et al. 1968; Iancu et al. 1974; Martin and Rento 1962; Penfold et al. 1978; Vicens-Calvet et al. 1998), although this effect has not been observed in all studies (Liesenkötter et al. 1996; Pedersen et al. 1993). An iodine-deficient status of the mother can also lead to goiter in the fetus and neurodevelopmental impairment of the fetus. Adequate iodine supplementation early in pregnancy can correct the deficiency and prevent maternal and neonatal goiter formation (Glinioer et al. 2001).

Iodized oil has been used to supplement intakes in populations that are iodine deficient in areas where supplementation with iodized table salt or drinking water is not practical. Iodized oil (ethiodiol) consists of a mixture of covalently iodinated fatty acids of poppy seed oil; the iodine content is approximately 38% by weight. Iodine in iodized oil is taken up in adipose tissue and has a much longer retention time in

3. HEALTH EFFECTS

the body than iodide salts; thus, epidemiological studies of iodized oil cannot be directly compared to those of iodide. Nevertheless, the studies provide some useful information on oral exposures to iodine that are tolerated during pregnancy without apparent adverse consequences to the fetal or neonatal thyroid. Delange (1996) reviewed epidemiological studies in which iodized oil was administered just prior to and/or during pregnancy to prevent maternal and neonatal hypothyroidism. A study of an iodine-deficient population in Algeria (with a 53% prevalence of goiter and 1% prevalence of congenital cretinism) compared thyroid status in infants born to mothers who received a placebo or a single oral dose of 240 mg I (3.4 mg/kg), as iodized oil, either 1–3 months prior to conception, during the first month of pregnancy, or during the third month of pregnancy. Neonatal serum concentrations of TSH were significantly lower in the treated groups compared to controls (treated, 4.6–4.9 mU/L; placebo, 12.4 mU/L) and serum T₄ concentrations were significantly higher compared to controls (treated, 10.4–11 µg/dL; placebo, 6.7 µg/dL). The incidence of infant hypothyroidism was 0 in 554 infants; the incidence in the placebo control was 2 in 982 (0.2%). A similar outcome occurred in a population from an iodine-deficient region of Malawi (59% prevalence of goiter, 1% incidence of cretinism), where pregnant women received either a placebo or an oral dose of 240 mg I as iodized oil (Delange 1996).

Hyperthyroidism

Oral exposure to excess iodide can, under certain circumstances, induce hyperthyroidism and thyrotoxicosis. The epidemiological and clinical literature suggests that hyperthyroidism occurs most often in people who have a previous history of iodine deficiency, goiter, or thyroid diseases including nodular goiter or Graves' disease (Braverman and Roti 1996; Fradkin and Wolff 1983; Leger et al. 1984; Paschke et al. 1994). Cases of iodine-induced hyperthyroidism in people who were euthyroid and without apparent thyroid disease have been reported (Rajatanavin et al. 1984; Savoie et al. 1975; Shilo and Hirsch 1986); however, only a few have provided dose information. In one case, a 72-year-old female without apparent preexisting thyroid disease developed clinical hyperthyroidism after ingesting approximately 2.8–4.2 mg I/day (0.05 mg/kg/day) in the form of sea-kelp tablets; her thyroid status reverted to normal within 6 months after she stopped taking the tablets (Shilo and Hirsch 1986). In another case, a 15-year-old male developed hyperthyroidism and thyrotoxicosis after receiving 1,440 mg I/day (23 mg/kg/day) as a saturated solution of potassium iodide for 4 months (Ahmed et al. 1974). The thyroid status reverted to normal within 6 months after the potassium iodide was discontinued.

In a clinical study, eight healthy adult euthyroid females, who had nontoxic goiter, received oral doses of 180 mg I/day (2.6 mg/kg/day) as a saturated potassium iodide solution for 10–18 weeks (Vagenakis et al. 1972). Four of the eight patients developed clinical hyperthyroidism and thyrotoxicosis. Two patients

3. HEALTH EFFECTS

developed thyrotoxicosis within 7–10 weeks after supplementation began, which became more serious after supplementation was discontinued. One patient developed clinical hyperthyroidism after 10 weeks of supplementation and then became overtly thyrotoxic after the iodide supplementation was stopped. A fourth patient developed subclinical hyperthyroidism during iodide treatment and became clinically hyperthyroid with thyrotoxicosis after supplementation was stopped.

What has been referred to as an *epidemic* of hyperthyroidism occurred in the midwestern United States between the years 1926 and 1928 (Kohn 1975, 1976). Clinical records suggest that the incidence of mortality from hyperthyroidism increased in Detroit during this period from approximately 2–4 deaths per 100,000 to approximately 11 deaths per 100,000 at the peak of the epidemic. Although there is considerable debate about the origins of the epidemic, the advent of aggressive supplementation of the diet with iodide in midwestern endemic goiter areas has been implicated as a contributing factor. More recent and more rigorous epidemiologic designs have been applied to several populations in which dietary iodide was supplemented as a prophylaxis for iodine deficiency and goiter (Lind et al. 1998; Stanbury et al. 1998). These studies confirm that iodide supplementation of iodide-deficient diets does indeed result in a detectable increase in incidence of hyperthyroidism.

In an epidemiology study conducted in Austria, the annual incidence of hyperthyroidism was evaluated in patients examined at nuclear medicine centers (where all thyroid examinations are conducted in Austria) before and after an upward adjustment was made in the use of iodized table salt in 1991 (Mostbeck et al. 1998). The mean urinary iodide concentration before the adjustment was 42–78 $\mu\text{g I/g creatinine}$ and after the adjustment was 120–140 $\mu\text{g I/g creatinine}$; these are approximately equivalent to 77–146 $\mu\text{g/day}$ (1.1–2.1 $\mu\text{g/kg/day}$) and 225–263 $\mu\text{g/day}$ (3.2–3.8 $\mu\text{g/kg/day}$), respectively. The analysis included 392,820 patients examined between 1987 and 1995 in 19 nuclear medicine centers. A significant relative risk of hyperthyroidism, both for Graves' disease and intrinsic thyroid autonomy, was found when the annual incidences of each in the postadjustment period (1991–1995) were compared to the preadjustment period (1987–1989). The highest relative risks were for Graves' disease, which were 2.19 (2.01–2.38, 95% confidence interval [CI]) for overt clinical disease and 2.47 (2.04–3.00) for subclinical disease. A regression analysis of the pre- and postadjustment incidences found a significant increasing trend for hyperthyroidism of both types in the postadjustment period and no trend in the preadjustment period. When the postadjustment incidence data were stratified by time periods 1990–1992 or 1993–1995, and by sex and age, higher relative risks were evident for intrinsic thyroid autonomy among males compared to females and in subjects older than 50 years compared to younger than 50 years. The incidence for

3. HEALTH EFFECTS

hyperthyroidism (all forms of overt or subclinical) was 70.1 per 100,000 in the preadjustment period and reached a peak of 108.4 per 100,000 in 1992, after the adjustment.

Data collected on the incidence of hyperthyroidism in Tasmania also show that a 2–4-fold increase in hyperthyroidism cases occurred within a few months after diets were supplemented with iodide for preventing endemic goiter from iodide deficiency (Connolly et al. 1970). The approximate supplemental dose was 80–200 µg/day from the addition to potassium iodide to bread. Mean 24-hour urinary iodide excretion rates suggested a total postsupplementation iodide intake of approximately 230 µg/day (3.3 µg/kg/day); range, 94–398 µg/day (1.3 – 5.7 µg/kg/day), some of which may have come from sources other than supplemented bread (Connolly 1971a, 1971b). The highest incidence of hyperthyroidism after the iodine supplementation began occurred in people over 50 years of age (Stewart 1975; Stewart and Vidor 1976).

A large multinational epidemiological study was conducted in Africa to evaluate the effectiveness and possible adverse consequences of the introduction of iodized salt into diets of populations residing in iodine-deficient and endemic goiter regions of Africa (Delange et al. 1999). In each study area, urine and table salt were collected from a group of 100–400 randomly-selected children, ages 6–14 years. Health care facilities were surveyed for information on thyroid disease in each area. In Zimbabwe, the incidence of hyperthyroidism increased by a factor of 2.6 within 18 months after the widespread introduction of iodized salt into the diet (from 2.8 in 100,000 to 7.4 in 100,000). Females accounted for 90% of the cases, with the highest incidence in the age group 60–69 years. The most common disorders were toxic nodular goiter (58%) and Graves' disease (27%) (Todd et al. 1995). Urinary iodide concentration in children increased by a factor of 5–10 over this time period. Urine samples were reported as “casual samples” and, thus, there is a large uncertainty in translating the concentrations into intakes. Median urine iodide concentrations ranged from 290 to 560 µg/L. Reported estimates of iodide intake from salt and seafood were 500 µg/day (7.1 µg/kg/day) and 15–100 µg/day (0.2–1.4 µg/kg/day), respectively. Increased numbers of cases of thyrotoxicosis along with an increase in urinary iodide levels (from 16 to 240 µg/L) occurred after iodized salt was introduced into the diet of an iodine-deficient population in the Kivu region of Zaire (Bourdoux et al. 1996).

An epidemiological study in Switzerland examined the incidence of hyperthyroidism before and after the iodine content of salt was increased from 7.5 to 15 mg/kg (Baltisberger et al. 1995; Bürgi et al. 1998). The study population included 109,000 people. The mean urinary iodide concentration was 90 µg I/g creatinine before the supplementation and 150 µg I/g creatinine after the supplementation. This is

3. HEALTH EFFECTS

equivalent to an increase in intake from approximately 170 to 280 µg I/day (4 µg/kg/day), assuming a body weight of 70 kg. During the first year after supplementation began, the combined annual incidence of hyperthyroidism diagnosed as either Graves' disease or toxic nodular goiter increased by 27% (from 62.3/100,000 to approximately 80/100,000). Subsequent to this increase, the incidence of hyperthyroidism steadily declined to 44% of the presupplementation rates, with most of the decrease resulting from a decline in incidence of toxic nodular goiter.

In an experimental study, adults with goiter who lived in an iodine-deficient region of Sudan received a single oral dose of 200, 400, or 800 mg iodine (3–11 mg/kg/day) as iodine oil (37–41 subjects per dose group) and their thyroid status was evaluated for a period of 12 months (Elnagar et al. 1995).

Approximately half of the subjects were clinically hypothyroid with serum T₄ concentrations <50 nmol/L and TSH concentrations >4 mU/L. One week after the iodine oil was administered, there was a dose-related increase in the incidence of serum TSH concentrations; 1 in 41 (2.5%) in the low-dose group, 3 in 37 (8.1%) in the middle-dose group, and 10 in 39 (25.6%) in the high-dose group, although the number of subjects exceeding 4 mU/L was not dose-related. One subject in the low-dose group and three subjects in the high-dose group became hyperthyroid during the observation period. One of the high-dose subjects remained hyperthyroid 1 year after the dose of iodine oil.

3.2.2.3 Immunological and Lymphoreticular Effects

Information on immunological effects of oral exposure to stable iodine in humans relates to thyroid gland autoimmunity or immune reactions (e.g., iododerma). The highest NOAEL values and all reliable LOAEL values in each duration category for immunological and lymphoreticular effects from exposures by the oral route are presented in Table 3-1 and plotted in Figure 3-1.

Excess iodide intake may be contributing factor in the development of autoimmune thyroiditis in people who are susceptible (Brown and Bagchi 1992; Foley 1992; Rose et al. 1997, 2002; Safran et al. 1987). Autoimmune thyroiditis is an inflammation of the thyroid gland that can lead to fibrosis of the gland, follicular degeneration, follicular hyperplasia, and hypothyroidism (Weetman 2000). IgG autoantibodies to thyroglobulin and thyroid peroxidase are consistent features of the disorder. Iodine appears to play an important role in autoimmune response as human lymphocytes recognize and proliferate in response to iodinated human thyroglobulin, but not iodine-free thyroglobulin (Rose et al. 1997). Poorly iodinated thyroglobulin is also less antigenic than iodine-rich thyroglobulin (Ebner et al. 1992)

3. HEALTH EFFECTS

Evidence for iodide inducing autoimmune thyroiditis in humans is incomplete. Autoimmunity, as indicated by IgG autoantibodies to thyroglobulin and thyroid peroxidase, has been observed in some studies in individuals whose iodide intakes were $<500 \mu\text{g}/\text{day}$ (Hall et al. 1966; Kahaly et al. 1997, 1998; Koutras et al. 1996), and not in other studies in which intakes were similar or higher (Boyages et al. 1989; Li et al. 1987). This variable dose-response relationship suggests that factors other than iodide intake play a role in the development of thyroid autoimmunity. Several studies have been conducted of people who reside in endemic goiter areas and who received iodide supplementation. In one study, otherwise healthy adults who had goiter, but no evidence of clinical hypothyroidism or hyperthyroidism or antithyroid antibodies, received either an oral placebo (16 females, 15 males) or $200 \mu\text{g I}/\text{day}$ ($3 \mu\text{g}/\text{kg}/\text{day}$ total intake) (16 females, 15 males) as potassium iodide for 12 months (Kahaly et al. 1997). Three subjects in the treatment group (9.7%, two females and one male) developed elevated levels of thyroglobulin and thyroid microsomal antibodies compared to none in the control group. Two of these subjects developed hypothyroidism and one subject developed hyperthyroidism; all three subjects reverted to normal thyroid hormone status when the iodide supplementation was discontinued. In a similar study, 31 adult euthyroid patients from an endemic goiter region who had goiter received either $500 \mu\text{g}/\text{day}$ potassium iodide ($382 \mu\text{g I}/\text{day}$, $5.1 \mu\text{g I}/\text{kg}/\text{day}$ based on reported median body weight of 75 kg) for 6 months, and 31 patients received $0.125 \mu\text{g T}_4/\text{day}$ (Kahaly et al. 1998). Based on reported measurements of 24-hour urine iodide excretion, the preexisting iodide intake was approximately $40 \mu\text{g}/\text{day}$ (range, 13–77, $0.6 \mu\text{g}/\text{kg}/\text{day}$); thus, the total intake during treatment was approximately $420 \mu\text{g I}/\text{day}$ ($6 \mu\text{g}/\text{kg}/\text{day}$). After 6 months of iodide supplementation, the mean 24-hour urinary iodide excretion rate was $415 \mu\text{g}/\text{day}$, which is consistent with the estimate of a total iodide intake of approximately $420 \mu\text{g}/\text{day}$. Six of the patients who received iodide (19%) developed high titres of thyroglobulin and thyroid microsomal antibodies, compared to none in the T_4 group. Four of the high antibody patients became hypothyroid and two patients became hyperthyroid. The thyroid hormone status reverted to normal and antibody titres decreased during a 6-month period following the treatment in which the patients received a placebo. A comparison of autoantibody titres of 27 adult patients who were diagnosed with iodide-induced goiter and/or hypothyroidism with 55 healthy adults revealed a significantly greater incidence of antibodies to thyroglobulin in the goiter patients (13 of 27, 48%) than in the healthy controls (9 of 55, 16%) (Hall et al. 1966). Iodide doses in the goiter group varied from 24 to $3,728 \text{ mg I}/\text{day}$ ($0.3\text{--}53 \text{ mg}/\text{kg}/\text{day}$). Koutras (1996) reported that 30% of a group of goiter patients developed thyroid autoimmunity several weeks after receiving 150 or $300 \mu\text{g}/\text{day}$ potassium iodide (115 or $130 \mu\text{g I}/\text{day}$, $1.6\text{--}1.9 \mu\text{g}/\text{kg}/\text{day}$); further details of the study were not provided. A small, but significant, rise in thyroid peroxidase antibodies was observed in Peace Corps workers in West Africa

3. HEALTH EFFECTS

when they were exposed for months to a greatly increased intake of iodine in their drinking water (Pearce et al. 2002).

Other studies have not found increases in autoimmunity associated with iodine supplementation. For example, thyroid status was compared in groups of children, ages 7–15 years, who resided in two areas of China where drinking water iodide concentrations were either 462 µg/L (n=120) or 54 µg/L (n=51) (Boyages et al. 1989; Li et al. 1987). Although the subjects were all euthyroid with normal values for serum thyroid hormones and TSH concentrations, TSH concentrations were significantly higher in the high iodine group. The high iodide group had a 65% prevalence of goiter and a 15% prevalence of Grade 2 goiter compared to 15% for goiter and 0% for Grade 2 goiter in the low iodine group. There were no differences in the serum titres of either thyroglobulin or thyroid peroxidase antibodies between the high and low iodine groups. Urinary iodine was 1,236 µg I/g creatinine in the high iodine group and 428 µg I/g creatinine in the low iodine group. Assuming a body weight of 40 kg and lean body mass of 85% of body weight, the above urinary iodine/creatinine ratios are approximately equivalent to iodine excretion rates, or steady state ingestion rates of 1,150 µg/day (29 µg/kg/day) and 400 µg/day (10 µg/kg/day) in the high and low iodide groups, respectively.

The effects of iodide on the development of autoimmune thyroiditis have been examined in animal models. In general, iodine does not induce autoimmune thyroiditis in outbred strains of rats; however, a susceptible inbred strain, the BB/Wor rat, has a high incidence of spontaneous autoimmune thyroiditis and does respond to iodide with an increased incidence of thyroid autoimmunity (Allen et al. 1986). This can be detected histologically as a lymphocytic infiltration of the gland (lymphocytic thyroiditis) accompanied by increased serum titres of antibodies to thyroglobulin, and increased serum TSH concentrations, indicating thyroid gland suppression (Allen and Braverman 1990). Weanling BB/Wor rats that were exposed to 0.05% iodide in drinking water for 8 weeks (approximately 85 mg/kg/day) had a significantly higher incidence of lymphocytic thyroiditis (27 of 35, 77%) compared to a control group (11 of 36, 30%) that received tap water. Similarly exposed outbred strains did not have an increase in lymphocytic thyroiditis. The spontaneous incidence of lymphocytic thyroiditis in the Buffalo strain rat (a Sprague-Dawley strain) is increased after neonatal thymectomy (Noble et al. 1976). In thymectomized Buffalo rats, 12 weeks of exposure to 0.05% iodide in drinking water (approximately 70 mg/kg/day) resulted in a significant increase in the incidence of lymphocytic thyroiditis (73%) compared to a control group that received tap water (31%) (Allen and Braverman 1990). The treatment group also had significantly higher serum TSH concentrations and significantly higher serum titres of antithyroglobulin antibody. In both of the above two studies, intake from food (Purina chow) was approximately

3. HEALTH EFFECTS

0.05 mg/kg/day. Obese strains of chickens are also highly susceptible to lymphocytic thyroiditis when exposed to excess iodine (Bagchi et al. 1985a).

Oral exposure to markedly excess iodide can produce allergic reactions in sensitive subjects. The reactions include urticaria, acneiform skin lesions, and fevers (Kubota et al. 2000; Kurtz and Aber 1982; Rosenberg et al. 1972; Stone 1985). There were also cases of more serious reactions involving angioedema (localized edema), vasculitis, peritonitis and pneumonitis, and complement activation (Curd et al. 1979; Eeckhout et al. 1987). Both humoral and cell-mediated immune responses are thought to be involved (Curd et al. 1979; Rosenberg et al. 1972; Stone 1985). In general, reactions to iodide have occurred in association with repeated doses exceeding 300 mg I/day.

Oral exposure to markedly excess iodide can produce skin lesions, referred to as ioderma, which are thought to be a form of cell-mediated hypersensitivity and unrelated to thyroid gland function (Rosenberg et al. 1972; Stone 1985). Characteristic symptoms include acneiform pustules, which can coalesce to form vegetative (proliferating) nodular lesions on the face, extremities, trunk, and mucous membranes. The lesions regress and heal when the excess iodide intake is discontinued. The clinical literature includes cases of ioderma that occurred subsequent to oral doses of iodide at 300–1,000 mg I/day (5–14 mg/kg/day) (Baumgartner 1976; Khan et al. 1973; Kincaid et al. 1981; Kint and Van Herpe 1977; PeZa-Penabad et al. 1993; Rosenberg et al. 1972; Shelly 1967; Soria et al. 1990). However, in many of these cases, preexisting disease and related drug therapy may have contributed to the reaction to the iodine; thus, the dose-response relationship for ioderma in healthy people remains highly uncertain. A typical regimen in the case literature was potassium iodide co-administered with theophylline and phenobarbital for treatment of obstructive lung disease. In at least two cases, transient dermal lesions typical of ioderma were elicited by a single oral dose of 360 or 500 mg iodide (5.1 or 7.1 mg/kg/day), as potassium iodide, and similar lesions were induced in these same patients by oral doses of aspirin, suggesting a possible cross sensitivity (Shelly 1967). In a more typical case, an adult male developed proliferating (vegetative) dermal lesions of the face, scalp, and trunk 5 days after receiving approximately 300 mg I/day (5.1 mg/kg/day) as potassium iodide (390 mg/day), along with penicillin for an acute respiratory tract infection (Soria et al. 1990). The lesions healed within 4 weeks after the potassium iodide was discontinued. Another adult male developed a vegetative dermal lesion of the neck and trunk after receiving approximately 600 mg I/day (10 mg/kg/day) as potassium iodide (720 mg/day) along with theophylline for obstructive pulmonary disease for 8 months (Soria et al. 1990). The lesions regressed within 3 weeks after the potassium iodide was discontinued and returned when an oral provocation dose of potassium iodide was administered. Another case of ioderma occurred in an adult female who received

3. HEALTH EFFECTS

oral doses of approximately 740 mg I/day (11 mg/kg/day) as potassium iodide (970 mg/day) for 6 months, as part of a treatment for obstructive lung disease (Kincaid et al. 1981). Other drugs included in the patient's treatment were ephedrine, theophylline, and phenobarbital. The lesions occurred on the face and conjunctiva of the eye, and healed several weeks after the potassium iodide was discontinued. A similar case occurred in an adult woman, similarly treated for 1 year with 990 mg I/day (14 mg/kg/day) as potassium iodide (1,300 mg/day) for asthma (along with ephedrine, theophylline, and phenobarbital) (Rosenberg et al. 1972). The vegetative lesions occurred on her face and arms and healed within 3 weeks after the potassium iodide was discontinued. In a more complex case, an adult female who was being treated for a variety of disorders, including polyarteritis nodosa, for which she was receiving cyclophosphamide and prednisone, and pneumonia, for which she was receiving an expectorant containing potassium iodide, developed vegetating dermal lesions on her face (Soria et al. 1990). The lesions healed within 1 month after the iodide expectorant was discontinued. She received vidarabine during this period, as the dermal lesions were, at that time, suspected of being a herpes simplex infection. One week after receiving approximately 400 mg I/day (6 mg/kg/day) as potassium iodide (520 mg/day), similar lesions of the skin and oral mucosa developed. The lesions healed within 3 weeks after the potassium iodide was discontinued.

Oral exposures to markedly excess iodide can induce fevers that are thought to have an immunological basis, and appear to be related to thyroid function (Horn and Kabins 1972; Kurtz and Aber 1982). Reported clinical cases have almost always involved a preexisting disease, usually pneumonia or obstructive lung disease in which potassium iodide was administered along with other drugs, including antibiotics, barbiturates, and methylxanthines; thus, the dose-response relationship for healthy people is highly uncertain. In one case, recurrent fevers occurred in an adult male who was receiving oral doses of approximately 1,080 mg I/day (15 mg/kg/day) as a potassium iodide solution (assumed, but not specified in the case report, to be a saturated solution) for approximately 15 years (Kurtz and Aber 1982). The fevers stopped within 2 weeks after the potassium iodide was discontinued. In another case, an adult male developed a fever 8 days after the start of a daily regimen of approximately 1,440 mg I/day as a saturated solution of potassium iodide for treatment of a respiratory illness; the fever stopped within 3 days after the potassium iodide was discontinued (Horn and Kabins 1972). In another case, an adult female developed a fever after a dosage of approximately 1,620 mg I/day (23 mg/kg/day) as a saturated potassium iodide solution along with ampicillin to treat pneumonia (Horn and Kabins 1972). The fever stopped within 36 hours after the potassium iodide was discontinued; at the same time, a regimen of diazepam, secobarbital, and glycerol guaiacolate was administered. The fever returned when a challenge dose of potassium iodide was administered. A fourth case involved an adult female diabetic patient who

3. HEALTH EFFECTS

received 1,080 mg I/day (15 mg/kg/day) as a saturated potassium iodide solution along with antibiotics, cortisone, and aminophylline for pneumonia (Horn and Kabins 1972). Four days after the potassium iodide treatments began, the patient developed a fever, which stopped when the potassium iodide was discontinued.

3.2.2.4 Neurological Effects

Exposure to excess stable iodine has been shown to produce subclinical hypothyroidism, and in sensitive individuals who have underlying thyroid disease, may take the form of hypothyroidism. Sensitive populations include fetuses, newborn infants, and individuals who have thyroiditis or a history of Graves' disease, many of whom have abnormal autoimmune disorders (see Section 3.2.2.2, Endocrine Effects). Of these iodine-induced forms of hypothyroidism, that occurring in the fetus or newborn infant has the greatest potential for producing neurological effects. This is because thyroid hormones are essential to the development of the neuromuscular system and brain. An iodine-induced hypothyroid state can result in delayed or deficient brain and neuromuscular development of the newborn (Boyages 2000b). Iodine-induced hypothyroidism in an older child or adult would be expected to have little or no deleterious effects on the neuromuscular system.

Exposure to excess stable iodine can also produce hyperthyroidism in sensitive individuals (see Section 3.2.2.2, Endocrine Effects). These include people who are initially iodine deficient, those who have thyroid disease, including nodular goiter, Graves' disease, those who have been previously treated with antithyroid drugs, , and those who have developed thyrotoxicosis from amiodarone or interferon-alpha treatments (Roti and Uberti 2001). Patients who develop thyrotoxicosis may experience neuromuscular disorders, including myopathy, periodic paralysis, myasthenia gravis, peripheral neuropathy, tremor, and chorea (Boyages 2000a); however, these are not likely to occur in iodine-induced hyperthyroidism, except in sensitive groups, already at risk for neurological problems.

3.2.2.5 Reproductive Effects

Oral exposure to excess stable iodine may produce hypothyroidism or hyperthyroidism (see Section 3.2.2.2, Endocrine Effects) and may cause disruption of reproductive function secondary to thyroid gland dysfunction. Hypothyroidism can produce changes in the menstrual cycle in humans, including menorrhagia (excessive uterine bleeding) and anovulation (no ovulation). Abortions, stillbirths, and premature births have also been associated with hypothyroidism (Longcope 2000a). Reproductive

3. HEALTH EFFECTS

impairments associated with hyperthyroidism include amenorrhea, alterations in gonadotropin release and sex hormone-binding globulin (SHBG), and changes in the levels and metabolism of steroid hormones in both females and males (Longcope 2000b).

The highest NOAEL values and all reliable LOAEL values in each duration category for reproductive effects from exposures by the oral route are presented in Table 3-1 and plotted in Figure 3-1.

3.2.2.6 Developmental Effects

Exposure to excess stable iodine may produce hypothyroidism and hyperthyroidism (see Section 3.2.2.2, Endocrine Effects), which could give rise to developmental defects secondary to thyroid gland dysfunction (Boyages 2000a, 2000b). Hypothyroidism may be associated with impairment in neurological development of the fetus or growth retardation (Boyages 2000a, 2000b; Snyder 2000a). Martin and Rento (1962) reported two cases of goiter and severe transient hypothyroidism, without neurological sequelae in infants born to mothers who ingested potassium iodide during pregnancy; the approximate dosages were 920 and 1,530 mg I/day (13 and 22 mg/kg/day). Growth acceleration may occur in childhood hyperthyroidism, which is thought to be related to accelerated pituitary growth hormone turnover or a direct effect of thyroid hormone on bone maturation and growth (Snyder 2000b).

The highest NOAEL values and all reliable LOAEL values in each duration category for developmental effects from exposures by the oral route are presented in Table 3-1 and plotted in Figure 3-1.

3.2.2.7 Cancer

Cancer effect levels (CELs) for stable iodine exposures by the oral route are presented in Table 3-1 and plotted in Figure 3-1.

The relationship between stable iodine intake and thyroid cancer has been examined in several epidemiology studies. The results of these studies suggest that increased iodide intake may be a risk factor for thyroid cancer in certain populations, in particular, populations residing in iodine-deficient (Bacher-Stier et al. 1997; Harach and Williams 1995; Franceschi 1998; Franceschi and Dal Maso 1999). Studies of populations in which iodine intakes are sufficient have not found significant associations between iodine intake and thyroid cancer (Horn-Ross et al. 2001; Kolonel et al. 1990) however, a recurrent observation is an apparent shift in the histopathology towards a higher prevalence of papillary

3. HEALTH EFFECTS

cancers, relative to follicular cancers, after increased iodine intake (e.g., dietary supplementation) in otherwise iodine-deficient populations (Bakiri et al. 1998; Belfiore et al. 1987; Feldt-Rasmussen 2001; Kolonel et al. 1990; Pettersson et al. 1991, 1996).

Two case control studies have been conducted on populations whose iodine intakes are sufficient; both found no significant association between iodine intake and thyroid cancer. A case control study of women residents of the San Francisco Bay area of the United States examined dietary habits, including iodine intake and other variables in 608 cases of thyroid cancer and 558 age- and ethnicity-matched controls, diagnosed during the period 1995–1998 (Horn-Ross et al. 2001). Dietary iodine intakes were estimated based on the results of a dietary habits questionnaire and published compilations of the iodine content of various foods. When cases and controls were classified according to dietary iodine intake (quintile), the risk of papillary thyroid cancer was significantly lower in women who consumed >273 µg I/day compared to women who consumed <273 µg I/day (<4.2 µg/kg/day); the odds ratio (OR) for the highest quintile (>537 µg I/day, >8.3 µg/kg/day) was 0.49 (95% confidence interval [CI] 0.29–0.84). When cases and controls were classified according to seafood consumption rates, ORs for papillary thyroid cancers were significantly elevated for consumption of >2.0 g/day of fish sauce/dried salted fish compared to none (limited to Asian women; OR 2.3, 95% CI 1.3–4.0). ORs for other types of seafood consumed were not significant. Other variables for which ORs were statistically significant included medical radiation of head or neck (OR 2.7, 95% CI 1.2–6.2), history benign goiter or thyroid nodules (OR 4.7, 95% CI 3.1–7.2), and family history of thyroid disease (ORs ranged from 1.5 hyper- or hypothyroidism to 6.1 for thyroid cancer).

Another case control study of residents of Hawaii examined dietary habits, including iodine intake and other variables in 191 cases of thyroid cancer and 441 age- and sex-matched controls, diagnosed during the period 1980–1987 (Kolonel et al. 1990). Dietary iodine intakes were estimated based on the results of a dietary habits questionnaire and published compilations of the iodine content of various foods. Female cases had significantly higher dietary iodine intakes than controls, although the group mean differences were not substantial; cases, 394 µg I/day (6.1 µg/kg/day); controls, 326 µg I/day (5.0 µg/kg/day). When cases and controls were classified according to dietary iodine intake (quartile), the ORs for thyroid cancer in females increased with increasing iodine intake; however, ORs were not statistically significant and there were no significant trends in the OR with increasing iodine intake. Other variables for which ORs were statistically significant included miscarriage (2.4), use of fertility drugs (4.2), and the combination of either of the former characteristics with an iodine intake exceeding 300 µg I/day or 4.6 µg/kg/day (4.8 or 7.3, respectively), or seafood intake exceeding 27 g/day (3.0 or 6.9, respectively). A limitation of this

3. HEALTH EFFECTS

study is that iodine intakes were estimated from dietary surveys and were not verified by measurements of urinary excretion of iodine.

Several cohort studies conducted on populations residing in iodine-deficient regions have found significant associations between thyroid cancer and iodine intake. A cohort study compared thyroid cancer rates in iodine-sufficient and iodine-deficient regions of Sweden during the period 1958–1981 (Pettersson et al. 1991, 1996). Iodine-deficient regions were defined as having had a goiter prevalence that was >33% in females and >15% in males, based on a 1930 survey. In Sweden, dietary iodine intake has increased over the study period as a result of dietary supplementation, which began in 1936 and was subsequently increased in 1966 and 1971 (Pettersson et al. 1996). Thus, iodine deficiency, even in the previously deficient regions has diminished. A multivariate model that included sex, age, dates of diagnosis, and region (i.e., iodine deficient or sufficient) as variables was applied to a sample of 5,838 thyroid cancer cases to estimate adjusted RR for thyroid cancer, where RR was the ratio of the adjusted cancer incidence rates for iodine-deficient:iodine-sufficient regions. The RR for papillary thyroid cancer was 0.8 (95% CI, 0.73–0.88), suggesting lower risk in the iodine-deficient regions, relative to the iodine-sufficient regions. The RR for follicular thyroid cancer was 1.98 (1.60–2.4) in males and 1.17 (1.04–1.32) in females, suggesting a 1.2- to 2-fold higher risk for follicular cancer in populations living in the iodine-deficient regions, relative to iodine-sufficient regions. The prevalence of papillary cancers was significantly higher, and follicular cancers were significantly lower in the iodine sufficient areas. Analysis of incidence of thyroid cancer as a function of dates of diagnosis revealed a significant trend for increasing follicular cancers in the iodine-deficient areas, but not in the iodine-sufficient areas. A significant trend for increasing papillary cancers was evident in both the iodine-sufficient and iodine-deficient regions.

Another cohort study examined the prevalence of thyroid cancer during the period 1979–1985 in populations living in iodine-deficient and iodine-sufficient areas of Sicily (Belfiore et al. 1987). Mean urinary iodine excretion rate in the deficient regions was approximately 19–43 $\mu\text{g I/day}$ (0.3–0.6 $\mu\text{g/kg/day}$) and, in the iodine-sufficient regions, was approximately 114 $\mu\text{g I/day}$ (1.6 $\mu\text{g/kg/day}$); the intakes in the two regions would be expected to be similar to urinary excretion rates. Randomly selected subjects from both regions were subjected to radioiodine thyroid scans to determine the presence of cold thyroid gland nodules, indicative of a possible tumor with suppressed iodine uptake. The prevalence of cold nodules in the iodine deficient region was significantly greater (72 of 1,683, 4.3%) than in the iodine-sufficient group (21 of 1,253, 1.7%). In the second phase of this study, all patients who had cold nodules in the two study areas, 911 patients from the iodine-deficient region, and 2,537 patients from the

3. HEALTH EFFECTS

iodine-sufficient region, were biopsied. The prevalence of thyroid cancer among patients who had one or more cold nodules was higher in the iodine-sufficient region (5.48%) than in the iodine-deficient region (2.96%). The prevalence of papillary tumors, relative to that of follicular tumors, was higher in the iodine-sufficient region (3.8) than in the iodine-deficient region (1.0). When the thyroid cancer prevalence among patients with cold nodules was adjusted for the estimated prevalence of cold nodules in the two regions, the estimated prevalence of thyroid cancer in the iodine-deficient region was significantly higher (127 in 100,000) than in the iodine-sufficient region (93 in 100,000).

The results of several ecological studies suggest that the incidence of thyroid cancer may increase in endemic goiter regions after supplementation of the diet with iodine. In Austria, iodized salt was introduced into the diet in 1963 and then increased further in 1991. The mean urinary iodide concentration before the adjustment was 42–78 $\mu\text{gI/g}$ creatinine and after the adjustment was 120–140 $\mu\text{gI/g}$ creatinine; these are approximately equivalent to 77–146 $\mu\text{g/day}$ (1–2 $\mu\text{g/kg/day}$) and 225–263 $\mu\text{g/day}$ (3–4 $\mu\text{g/kg/day}$), respectively (Bacher-Stier et al. 1997; Mostbeck et al. 1998). A retrospective analysis of medical records in the Tyrol region of Austria (1,063,395 inhabitants) concluded that the incidence of thyroid cancer increased from 3.1 per 100,000 year for the period 1960–1970 to 7.8 for the period 1990–1994 (Bacher-Stier et al. 1997). The prevalence of papillary tumors appeared to increase relative to that of follicular tumors after supplementation; the ratio of papillary:follicular tumors was 0.6 before supplementation and 1.5 after supplementation. Improved diagnosis may have contributed to the increased incidence. In support of this, a trend was observed towards increased prevalence of less advanced tumor stages in 439 patients for which complete medical records were available. The authors reported that “no excessive natural radiation has been found in Tyrol”.

A retrospective analysis of 1,000 consecutive patient records from endocrine wards in Algiers, recorded during the period 1967–1991, revealed significantly greater prevalence of differentiated follicular thyroid tumors in patients who resided in an endemic goiter region (53.6%; $n=581$) than in nonendemic regions (44.0%; $n=236$) (Bakiri et al. 1998). The prevalence of follicular tumors was significantly greater than that of papillary tumors in the endemic areas, whereas follicular tumors were less prevalent than papillary tumors in the nonendemic region. The ratio of papillary:follicular tumors was 1.2 in the endemic region and 0.8 in the nonendemic region. The mean urinary iodide concentration in the goiter endemic area was $<50 \mu\text{g I/g}$ creatinine and was $>80 \mu\text{g I/g}$ creatinine in the nonendemic region; these are approximately equivalent to $<95 \mu\text{g/day}$ (1.2 $\mu\text{g/kg/day}$) and $>150 \mu\text{g/day}$ (2.1 $\mu\text{g/kg/day}$), respectively.

3. HEALTH EFFECTS

A retrospective analysis of 144 cases of thyroid cancer in the Salta region of Argentina, diagnosed during the period 1960–1980, found that the prevalence of papillary tumors appeared to increase relative to that of follicular tumors after dietary iodine supplementation was initiated as prophylaxis for goiter; the ratio of papillary:follicular tumors was 1.8 before supplementation and 3.0 after supplementation (Harach and Williams 1995; Harach et al. 1985). The mean urinary iodide concentration before the supplementation was 9 µg I/g creatinine and after the supplementation was 110–150 µg I/g creatinine; these are approximately equivalent to 17 µg I/day (0.2 µg/kg/day) and 205–280 µg I/day (3–4 µg/kg/day), respectively.

3.2.3 Dermal Exposure

3.2.3.1 Death

No information was located on deaths associated with dermal exposure to iodine.

3.2.3.2 Systemic Effects

No information was located regarding respiratory, cardiovascular, gastrointestinal, hematological, musculoskeletal, hepatic, renal, dermal, ocular, body weight, or other systemic effects of dermal exposure to stable iodine.

Endocrine Effects. Povidone-iodine is a complex of I₂ and polyvinyl pyrrolidone and is widely used as a topical antiseptic for mouth, skin, and vaginal infections, and surgical procedures. Topical preparations of povidone-iodine contain approximately 9–12% iodine, of which a small fraction is in free solution (Lawrence 1998; Rodeheaver et al. 1982). Dermal exposure to povidone-iodine has induced acute toxicity in humans. In one case, hyperthyroidism and thyrotoxicosis developed in an adult male who, for 6 months, received povidone-iodine skin washes to treat dermal ulcers but had no other history of excess iodine intake or treatment with iodine-containing drugs (Shetty and Duthie 1990). The patient had elevated antithyroglobulin and thyroid peroxidase (thyroid microsomal) antibodies. The disorder eventually required therapy with propylthiouracil and radioiodine. It is possible that the povidone-iodine exposure may have aggravated a pre-existing autoimmune disorder in the patient rather than having been the cause of the thyrotoxicosis.

3. HEALTH EFFECTS

In a study of 27 neurological ward patients who received topical povidone-iodine treatments for various procedures and for periods of 3–133 months, serum iodide, T₄, and FT₄ concentrations were significantly higher than a group of 13 patients who did not receive povidone-iodine treatments (Nobukini et al. 1997). Eight of the 27 patients who received povidone-iodine treatments were clinically hyperthyroid (serum FT₄ concentration above the normal range) and 3 of 27 patients were suspected of having subclinical hypothyroidism (serum TSH concentrations above the normal range). None of these patients had elevated antithyroglobulin or thyroid peroxidase antibodies, suggesting that thyroid autoimmunity was not the cause of the apparent thyroid hormone disturbances. Serum FT₄ concentrations were significantly positively correlated with the duration of povidone-iodine exposure. In a similar study, the thyroid hormone status of 16 healthy nurses who regularly used povidone-iodine formulations, mainly for hand-washing and gargling, was compared to that of 16 hospital workers who had little or no contact with povidone-iodine (Nobukini and Kawahara 2002). Mean serum FT₄ levels were slightly, but significantly, higher in the groups of nurses compared to the comparison group (1.30 ± 0.15 ng/dL, 1.15 ± 0.14 , $p < 0.01$); however, serum TSH, FT₃, and FT₄ levels were within the normal range for all study participants.

Several cases of hypothyroidism induced by topical applications of povidone-iodine to wounds have been described. In one case, an adult female was exposed to approximately 22 mg iodine as povidone-iodine, 3 days/week for 22 months, when an open fistula was swabbed with povidone-iodine and packed with iodoform impregnated gauze (Prager and Gardner 1979). The patient developed clinical hypothyroidism with thyroid enlargement and became euthyroid within 6 weeks after the iodine treatment of the wound was discontinued. Another patient who had a small nodular goiter developed hyperthyroidism following betadine irrigation of a mediastinal wound, after cardiac bypass surgery (Rajatanavin et al. 1984). In another study, mouth rinsing with iodine-containing mixtures for gingivitis, for 6 months, induced a small decrease in serum T₄ and a compensatory rise in serum TSH; however, all values were well within the normal range (Ader et al. 1988).

Povidone-iodine gels are used for vaginal lubrication during labor checks prior to delivery. Use of povidone-iodine gels has been associated with increased serum iodide concentrations as well as changes in thyroid hormone status, indicative of subclinical thyroid gland suppression. In a study of 18 women who received intravaginal treatments with povidone-iodine gel during labor checks, serum iodide concentrations were significantly higher after the applications than before the applications (Jacobson et al. 1984). Serum TSH concentrations were significantly elevated (5.9 mU/L) in the povidone-iodine group compared to a group of 13 women who received vaginal lubricants that did not contain iodine (1.9 mU/L). There were no differences in the levels of T₄ or T₃ between the iodine and no-iodine groups.

3. HEALTH EFFECTS

Topical application of povidone-iodine during labor has been found to produce thyroid gland suppression in newborns. In a study of 30 women who received topical povidone-iodine in preparation for a cesarean section, newborn serum TSH concentrations (cord blood) were significantly higher than in newborns from 12 mothers who also underwent a cesarean section, but who were not exposed to povidone-iodine (Novaes et al. 1994); however, the levels were not above the normal range for newborns (>20 mU/L, de Zegher et al. 1994; Momotani et al. 1992). Serum concentrations of T_4 and T_3 were not different in the two groups of newborns. In a study of infants delivered by mothers who received intravaginal povidone-iodine during labor checks, serum TSH concentrations were significantly higher and T_4 and T_3 concentrations were significantly lower compared to 18 control infants delivered from mothers who were not exposed to povidone-iodine during labor (l'Allemand et al. 1983). Twenty percent of the infants from the treated mothers had serum TSH concentrations above the normal range for newborn infants (>20 mU/L) and serum T_4 concentrations below the normal range (<7 $\mu\text{g/dL}$) and, thus, were hypothyroid. All infants were euthyroid at 14 days after birth.

Daily douching with betadine for 14 days was associated with an increase in serum iodide levels, small decreases in T_4 , small rises in serum TSD, and a decrease in thyroid iodide uptake. All values returned to baseline within 2 weeks after the exposure (Safran et al. 1982).

Use of povidone-iodine for topical disinfection and surgical wound disinfection in infants has been shown to induce hypothyroidism and hyperthyroidism. In a prospective study, 17 premature infants (#36 weeks gestation), who were euthyroid with no indications of thyroid disorders, received topical povidone-iodine applications for various procedures beginning within 24 hours of birth (Brown et al. 1997). Five of 17 (29%) of the infants had a significant decrease ($<50\%$ of pretreatment value) in their serum T_4 concentrations compared to none of 14 control infants who received the same clinical procedures, but with topical application of a noniodine disinfectant (chlorhexidine). These five infants had serum T_4 concentrations that were below 40 nmol/L (3.1 $\mu\text{g/dL}$) 4–6 days after exposure to povidone-iodine, indicating mild hypothyroidism (60 nmol/L is low end of normal range), although their serum TSH concentrations were not elevated (<20 mU/L, de Zegher et al. 1994; Momotani et al. 1992). Their T_4 status reverted to normal within 10–25 days after treatment. There were no significant differences between the treatment and control group mean values for serum T_4 or TSH. Iodide concentrations in random untimed urine samples were approximately 24 times higher in the treatment group (1,800–3,600 $\mu\text{g/L}$) than in the control group (90–150 $\mu\text{g/L}$), indicating absorption of some of the topically applied iodine. In a study of 30 intensive care ward infants who received frequent topical applications of

3. HEALTH EFFECTS

povidone-iodine for various procedures, five infants (20%) developed clinical hypothyroidism with serum T_4 and T_3 concentrations below the normal range, serum TSH concentrations above the normal range, and thyroid gland enlargement (Chabrolle and Rossier 1978a, 1978b). Urinary iodide excretion at the time of treatment ranged from 2.9 to 4.8 mg I/day in four of the patients and was 0.14 mg I/day in one of the patients, suggesting daily absorbed doses of iodine in this same range. The thyroid hormone status reverted to normal after the povidone-iodine treatments were discontinued. A 30% incidence of hypothyroidism was reported in 10 intensive care ward newborns who received topical povidone-iodine applications for various procedures for >2 days in duration (l'Allemand et al. 1987). A newborn infant who received povidone-iodine irrigations of wound drains became clinically hyperthyroid without elevated serum titres of antithyroglobulin or thyroid peroxidase (thyroid microsomal) antibodies (Bryant and Zimmerman 1995). The patient became euthyroid within 1 month after the povidone-iodine irrigations were discontinued. Thyroid status of four infants with spinal bifida who received daily povidone-iodine antiseptic dressings were followed; two of the four patients became hypothyroid after 4 weeks of exposure and required treatment with T_4 (Barakat et al. 1994). The patients became euthyroid within 9 months after the povidone-iodine applications were discontinued. In a study of 47 neonatal intensive care patients who were exposed to topical povidone-iodine for varying lengths of time, no evidence of hypothyroidism was found (Gordon et al. 1995).

3.2.3.3 Immunological and Lymphoreticular Effects

Dermal exposures to povidone-iodine have produced localized and systemic allergic responses in humans. In one case, an adult male developed a reaction to application of povidone-iodine to an arm wound. The reaction consisted of itching of the extremities, urticaria, and angioedema (of the face), which were ameliorated with antihistamine treatment (López Sáez et al. 1998). A serum specific IgE assay detected reactivity in the patient's serum to various povidone-iodine and various other iodine preparations. Several case reports have been published that describe dermatitis in people who have been exposed to topical applications of povidone-iodine and subsequently reacted to dermal challenge tests to povidone-iodine (Nishioka et al. 2000; Okano 1989; Tosti et al. 1990).

Intravaginal applications of povidone-iodine have also induced allergic reactions in humans. In one case, an adult woman developed a bronchospastic reaction in response to application of povidone-iodine and an iodine-containing contrast medium (Moneret-Vautrin et al. 1989). The patient reacted in a dermal challenge test to povidone-iodine, but not the contrast medium, and the patient's serum tested positive for histamine release and basophil degranulation *in vitro*. In another case, anaphylaxis occurred in a patient

3. HEALTH EFFECTS

after an intravaginal application of povidone-iodine. The patient reacted to povidone-iodine in a dermal challenge test (Waran and Munsick 1995).

Although the above cases appear to implicate povidone-iodine as the causative agent in the allergic responses reported, povidone itself, without iodine, has also been shown to produce allergic reactions and anaphylaxis in humans and may have contributed to the reactions observed in some of these cases (Garijo et al. 1996).

3.2.3.4 Neurological Effects

No information was located on neurological effects associated with dermal exposure to iodine. Dermal exposure to excess iodine may produce mild transient hypothyroidism and hyperthyroidism (see Section 3.2.3.2, Endocrine Effects), which could give rise to neurological manifestations of thyroid gland dysfunction including impairments in neurological development and myopathies (Boyages 2000a, 2000b). However, based on the mild effects that have been observed in association with dermal exposures, such severe neurological sequelae are not likely.

3.2.3.5 Reproductive Effects

No information was located on reproductive effects associated with dermal exposure to iodine. Dermal exposure to excess iodine may produce mild transient hypothyroidism and hyperthyroidism (see Section 3.2.3.2, Endocrine Effects). Either could give rise to disruption of reproductive systems secondary to thyroid gland dysfunction; however, based on the mild effects that have been observed in association with dermal exposures, significant disruptions of reproductive function are not likely. Hypothyroidism can produce changes in the menstrual cycle in humans, including menorrhagia (excessive uterine bleeding) and anovulation (no ovulation). Abortions, stillbirths, and premature births have also been associated with hypothyroidism (Longcope 2000a). Reproductive impairments associated with hyperthyroidism include amenorrhea, alterations in gonadotropin release, and sex hormone-binding globulin (SHBG), and changes in the levels and metabolism of steroid hormones in both females and males (Longcope 2000b).

3. HEALTH EFFECTS

3.2.3.6 Developmental Effects

No information was located on developmental effects associated with dermal exposure to iodine. Dermal exposure to excess iodine may produce mild transient hypothyroidism and hyperthyroidism (see Section 3.2.3.2, Endocrine Effects). Use of povidone-iodine for topical disinfection and surgical wound disinfection in infants has been shown to induce hypothyroidism and hyperthyroidism, and topical application of povidone-iodine during labor has been found to produce transient, mild hypothyroidism in newborns (see Section 3.2.3.2, Endocrine Effects). Hypothyroidism or hyperthyroidism could give rise to developmental effects secondary to thyroid gland dysfunction (Boyages 2000a, 2000b). Developmental effects of hypothyroidism include severe impairment in neurological development of the fetus known as cretinism, or growth retardation (Boyages 2000a, 2000b; Snyder 2000a). Severe impairment of neurological development or growth retardation are effects only seen with severe, long-standing thyroid deficiency, not the transient form that has been associated with dermal iodine-induced hypothyroidism. Growth acceleration may occur in childhood hyperthyroidism, which is thought to be related to accelerated pituitary growth hormone turnover or a direct effect of thyroid hormone on bone maturation and growth (Snyder 2000b).

3.2.3.7 Cancer

No information was located on cancer in association with dermal exposure to iodine.

3.2.4 External Exposure

No information was located on health effects associated with external exposure to radioiodine.

3.3 DISCUSSION OF HEALTH EFFECTS FOR RADIOACTIVE IODINE BY ROUTE OF EXPOSURE

Section 3.3 discusses radiation toxicity associated with exposure to radionuclides of iodine and is organized in the same manner as that of Section 3.2, first by route of exposure (inhalation, oral, and external) and then by health effect (death, systemic, immunological, neurological, reproductive, developmental, genotoxic, and carcinogenic effects). These data are discussed in terms of three exposure periods: acute (14 days or less), intermediate (15–364 days), and chronic (365 days or more).

3. HEALTH EFFECTS

Levels of significant exposure for each route and duration are presented in tables and illustrated in figures. The points in the figures showing NOAELs or LOAELs reflect the actual dose (levels of exposure) used in the studies. Refer to Section 3.2 for detailed discussion of the classification of endpoints as a NOAEL, less serious LOAEL, or serious LOAEL.

Levels of exposure associated with carcinogenic effects (Cancer Effect Levels, CELs) of radioiodine are indicated in Tables 3-1, and 3-2 and Figures 3-1 and 3-2. Because cancer effects could occur at lower exposure levels, Figures 3-1 and 3-2 also show a range for the upper bound of estimated excess risks, ranging from a risk of 1 in 10,000 to 1 in 10,000,000 (10^{-4} to 10^{-7}), as developed by EPA.

Refer to Appendix B for a User's Guide, which should aid in the interpretation of the tables and figures for Levels of Significant Exposure.

3.3.1 Inhalation Exposure

A large amount of epidemiological literature exists on the health outcomes in populations exposed to radioiodine as a result of releases from explosions of nuclear bombs (e.g., Marshall Islands, Nevada Test Site), operational releases from nuclear fuel reprocessing facilities (e.g., Hanford Nuclear Site), and accidental releases from nuclear power plants (e.g., Chernobyl). Releases of these types resulted in mixed exposures to a variety of radioisotopes, and radiation doses from both external and internal exposure. However, doses from radioiodine that are significant to health effects derive largely from internal exposure to the thyroid gland as a result of absorption and uptake of radioiodine into the thyroid gland (see Section 3.5.2.2). Inhalation of airborne radioiodine is likely to have occurred after each of these releases and prior to ground deposition of radioiodine. However, the major contributors to thyroid radiation dose in each of these incidents are thought to have been from ingestion of milk, grains, vegetables, and water contaminated from atmospheric deposition of radioiodine. Ingestion of human breast milk is also considered to have been a contributor to doses received in nursing infants. For example, it has been estimated that, in seven Ukraine cities following releases of radioiodine from the Chernobyl nuclear power plant, inhalation of ^{131}I contributed between 2 and 13% of total absorbed radiation dose, whereas the ingestion pathway contributed from 87 to 98% (IAEA 1991). In the Marshall Islands, after the BRAVO bomb test, the inhalation pathway is thought to have contributed <1% of the absorbed radioiodine, with the ingestion pathway contributing 80–99% (Lessard et al. 1985). Because of the more substantial contribution of the oral pathway to the absorbed thyroid radiation doses, health

3. HEALTH EFFECTS

effects studies related to the Chernobyl accident, the Marshall Islands, the Hanford Nuclear Site, and the Nevada Test Site are discussed in the oral section of this profile (Section 3.3.2). However, the effects observed that have been related to the internal radiation dose to the thyroid gland are also directly relevant to inhalation exposures since inhaled radioiodine absorbed from either the respiratory tract or gastrointestinal tract would be expected to distribute to the thyroid gland (see Section 3.5.2.1).

3.3.1.1 Death

Deaths related to thyroid cancers (or to other cancers or causes) following the Chernobyl accident are being studied with well-controlled epidemiological designs and dose reconstruction efforts, and possible associations between mortality and radioiodine exposures may become evident once these studies have been completed. Thus far, very few deaths have been attributed to thyroid cancer. Although radiation-related deaths were recorded among emergency response personnel on site during the Chernobyl accident, these deaths were associated with external exposure to gamma radiation from molten fuel areas and not with exposure to radioiodine.

3.3.1.2 Systemic Effects

All of the information on systemic effects of inhaled radioactive iodine in humans relates to endocrine effects from exposures to radioiodine following the BRAVO nuclear bomb test in the Marshall Islands, the Chernobyl accident, and radioiodine releases from the Hanford Nuclear Site. Because oral ingestion of radioiodine is thought to have been the major contributor to exposure, these studies are discussed in detail in Section 3.3.2. No information was located regarding respiratory, cardiovascular, gastrointestinal, hematological, musculoskeletal, hepatic, renal, dermal, ocular, body weight, or other systemic effects of inhalation exposure to radioiodine. However, one epidemiological study examined health outcomes of infants of mothers who resided in the Belarus region before or after the Chernobyl accident (Petrova et al. 1997). The health outcomes observed in this study include respiratory, hematological, renal, and dermal effects; however, their association to radioiodine exposure has not been established. This study is discussed in greater detail in the sections of reproductive and developmental effects associated with oral exposures to radioiodine (Sections 3.3.2.5 and 3.3.2.6).

3.3.1.3 Immunological and Lymphoreticular Effects

All of the information on immunological effects of inhaled iodine in humans relates to thyroid gland autoimmunity and exposures to radioiodine following the BRAVO nuclear bomb test in the Marshall

3. HEALTH EFFECTS

Islands, the Chernobyl accident, and releases of radioiodine from the Hanford Nuclear Site. Because exposures in these incidents are thought to have been largely from oral ingestion of radioiodine, these studies are discussed in detail in Section 3.3.2.

3.3.1.4 Neurological Effects

Although not supported by observations, exposure to radioiodine at sufficient doses to produce hypothyroidism could potentially give rise to neurological manifestations of thyroid gland dysfunction including impairments in neurological development and myopathy (Boyages 2000a, 2000b). Congenital hypothyroidism can be associated with a severe impairment in neurological development of the fetus termed *cretinism*, which usually occurs in areas of endemic iodine deficiency. This condition would be highly unlikely in iodine-induced hypothyroidism secondary to inhalation of iodine.

3.3.1.5 Reproductive Effects

No information was located regarding reproductive effects of inhalation exposure to radioiodine. However, a large-scale retrospective analysis was conducted to evaluate pregnancy health and reproductive outcomes of women who were exposed to radiation resulting from releases from the Chernobyl nuclear power plant, including a major contribution from ^{131}I (Petrova et al. 1997). Although inhalation of radioiodine certainly occurred in this population, internal radiation doses resulting from this incident are thought to have been largely from oral ingestion of radioiodine (IAEA 1991). The study is summarized in greater detail in Section 3.3.2.5, which discusses the reproductive effects of oral exposures to radioiodine.

3.3.1.6 Developmental Effects

No information was located regarding developmental effects associated with inhalation exposure to radioiodine other than those related to the thyroid gland (e.g., Marshall Islands, Section 3.3.2.2). However, one epidemiological study examined health outcomes of infants of mothers who resided in the Belarus region before or after the Chernobyl accident (Petrova et al. 1997). Exposures resulting from this incident are thought to have been largely from oral ingestion of radioiodine (IAEA 1991) and, therefore, a summary of this study can be found in Section 3.3.2.6 on the developmental effects of oral exposures to radioiodine.

3. HEALTH EFFECTS

3.3.1.7 Cancer

Thyroid cancers have been associated with exposures to radioiodine following the BRAVO nuclear bomb test in the Marshall Islands and the Chernobyl accident. The occurrence of thyroid cancers has also been studied in populations exposed to radioiodine released from nuclear bomb tests at the Nevada Test Site and from operational releases of radioiodine from the Hanford Nuclear Site. Although the inhalation of radioiodine occurred in these incidents, oral ingestion of radioiodine is thought to have been the major contributor to thyroid radiation doses. Summaries of these studies can be found in Section 3.3.2.7 on cancer effects of oral exposures to radioiodine.

3.3.2 Oral Exposure

The section that follows provides background information on the exposure scenarios from the major radioiodine-releasing events for which health effects studies have been reported. The actual study summaries follow. A discussion of the relevant biokinetics of radioiodine is provided in Section 3.5.

Marshall Islands BRAVO Test. Several epidemiologic studies have examined thyroid gland disorders in residents of the Marshall Islands who were exposed to radioactive isotopes of iodine from atmospheric fallout after atmospheric nuclear bomb tests, in particular, the 1954 Castle *BRAVO* test. Residents of islands near and downwind from the test site on Bikini Atoll (e.g., Ailingnae, Rongelap, Utrik) were exposed to both internal radionuclides and external gamma radiation from fallout during the 2 days following the BRAVO test and prior to their evacuation. The estimated cumulative gamma radiation dose on these islands ranged from 69 to 175 rad (0.7–1.75 Gy) or approximately 10–50% of the estimated thyroid dose (Conard 1984). Later studies suggest that external radiation contributed approximately 4–16% of total thyroid dose (Hamilton et al. 1987). Internal exposures to the thyroid, resulting primarily from radioiodines, were much higher. Although inhalation of airborne radioiodine probably occurred during the fallout period immediately after the blast, ingestion of deposited radioiodine on locally prepared foods and drinking water during the subsequent 2 days prior to evacuation is thought to be the major contributor to the internal exposures (Lessard et al. 1985). Nursing infants would also have received internal exposures from ingestion of radioiodine in breast milk. Estimated total absorbed doses to the thyroid gland (external and internal) were 3.3–20 Gy (330–2,000 rad) on Rongelap (highest doses in children), 1.3–4.5 Gy (130–450 rad) on Ailingnae, and 0.3–0.95 Gy (30–95 rad) on Utrik (Conard 1984). Estimates of the internal radiation dose to the thyroid remain uncertain as they were based

3. HEALTH EFFECTS

primarily on measurements of radioiodine (principally ^{131}I) in a pooled urine sample, collected 16 days after exposure, from a subset of exposed people. Although these measurements allowed back extrapolation of the initial internal ^{131}I exposures, shorter-lived radioiodine species (^{132}I , ^{133}I , ^{135}I) could not be detected in the urine sample. These isotopes are thought to have contributed 2–3 times the thyroid radiation dose of ^{131}I (Conard 1984). It is generally agreed that external radiation exposures resulted nearly entirely from fallout and deposits of radionuclide-containing materials on the skin, rather than from direct photon irradiation from the blast, as the exposed populations were approximately 100–320 miles from the detonation site. In this respect, the Marshall Island exposures are very different from the Hiroshima and Nagasaki exposures, which were the result of an acute (single dose) exposure to mostly gamma radiation (with neutron contribution in Hiroshima). Sixty-six nuclear bomb tests were conducted in the Marshall Islands during the period 1946–1958. Comparisons of contemporary measurements ^{137}Cs in soils in the Marshall Islands with estimates of global fallout in the mid-Pacific region suggest contamination from local fallout occurred over much of the Marshall Islands (i.e., local ^{137}Cs :global ^{137}Cs ratio > 1) with particularly high local:global ^{137}Cs ratios (>10) on the islands of Bikini Atoll (test site), Enewatak Atoll (test site), Rongelap Atoll, and Utrik Atoll (Simon and Graham, 1997). The most recent epidemiologic study (Takahashi et al. 1997, 2003) investigated 4,762 inhabitants of the islands who were alive during the weapons testing years.

Chernobyl Accident. In 1986, a chemical explosion and fire at the nuclear power plant in Chernobyl in the Ukraine was caused by improper, unstable operation of the reactor, which allowed an uncontrollable power surge to occur; this resulted in the release of airborne radionuclides to the surrounding regions and contamination of soil and locally grown foods. The external radiation exposures were contributed largely by isotopes of cesium (e.g., ^{137}Cs), which accounted for approximately 90–98% of the external radiation dose accumulated over the subsequent decades of exposure (Mould 2000; UNSCEAR 2000; Vargo 2000). Radioiodine is estimated to have contributed approximately 50% of the internal radiation dose for children born in 1986 in the region and approximately 80% of the total radiation dose received during the first year after the release (Vargo 2000). Estimates of thyroid radiation doses have been derived from external thyroid gland scans that measure radiation (mostly gamma) from radioiodine in the thyroid. These measurements suggest that radioiodine doses to the thyroid gland were highest in small children at the time of the release, and were highest in locations nearest to the nuclear plant where people were not evacuated rapidly. The highest estimated doses were received within 30 km of the Chernobyl plant; median doses ranged from 2.3 Gy (230 rad) at age <1 year to 0.4 Gy (40 rad) in adolescents and adults (UNSCEAR 2000, Annex J, Table 22). Estimated median doses received in populations residing approximately 200 km from the plant (e.g., Mogilev region) were <0.3 Gy (30 rad) for all age groups

3. HEALTH EFFECTS

(UNSCEAR 2000). Although inhalation of airborne radioiodine is likely to have occurred after the accident, the major contributors to the absorbed thyroid radiation dose are thought to have been from ingestion of milk and leafy vegetables contaminated from atmospheric deposition of radioiodine. Ingestion of human breast milk is also considered to have been a major contributor to doses received by nursing infants. For example, it has been estimated that, in seven Ukraine cities, ingestion of ^{131}I contributed between 87 and 98% of total absorbed radiation dose (IAEA 1991). Endemic goiter in the Belarus population due to iodine deficiency (Gembicki et al. 1997) secondary to differences in the extent of use of stable iodine may have also contributed to the differences in the thyroid doses observed in Belarus compared to similarly contaminated areas of Finland.

Thyroid dose estimates, particularly peak dose rates, are largely based on extrapolations from thyroid gland ^{131}I measurements made within 1 to several weeks after the major release from the Chernobyl plant and ground monitoring of atmospheric deposition of radiocesium. One set of measurements of thyroid gland radioactivity came from postmortem measurements of thyroid glands from 416 people collected over the period from May 3 (8 days after the initial release) to August 4, 1986 in Bratislava (Beno et al. 1991). Back extrapolation of thyroid gland activities and consideration of temporal trends in both the thyroid gland data and atmospheric deposition allowed the estimation of transfer coefficients relating atmospheric deposition of radioiodine (kBq/m^2) and thyroid dose (μSv); the coefficients were $641 \mu\text{Sv}/\text{kBq}\cdot\text{m}^2$ in exposed children and $221 \mu\text{Sv}/\text{kBq}\cdot\text{m}^2$ in exposed adults (Beno et al. 1992). Based on this approach, and radiocesium measurements made in Belarus, thyroid radiation doses received in Belarus may have ranged from 0.12 to 24 μSv (12–2,400 rem) in children and from 0.04 to 8 μSv (4–800 rem) in adults (Bleuer et al. 1997). In Gomel, where the highest incidence of thyroid cancer in children has been reported, estimated doses were 1.2–12.3 Sv (120–1,230 rem) in children (Drobyshevskaya et al. 1996). Various other approaches have been used to estimate thyroid doses associated with the Chernobyl accident. In Ukraine, most of these rely on exposure estimates based on measured or assumed relationships between radioiodine and ^{137}Cs air levels, and models simulating pathways to humans, including milk ingestion (Ilyin et al. 1990; Likhtarev et al. 1995). Estimates of absorbed thyroid doses from ^{131}I based on ^{137}Cs deposition densities in seven Ukraine cities ranged from 80 to 240 cGy (rad) in infants, 64–190 cGy (rad) in children, and 19–57 cGy (rad) in adults (IAEA 1991). Almost all of the internal radiation exposure of the thyroid gland was received in the first 3 months after the accident, during which time, the ^{131}I activity decreased to <0.1% of the initial values. The continued ^{129}I exposure can be considered minimal, although it will persist for several decades for some populations because of environmental contamination and its longer decay half-life.

3. HEALTH EFFECTS

Nevada Test Site. During the period 1951–1958, 97 atmospheric nuclear bomb tests were conducted at the Nevada Test Site (NTS) in southern Nevada (NCI 1997). These tests were followed by nine surface detonations during the period 1962–1968 and approximately 809 below-ground tests, of which 38 were determined to have resulted in off-site releases of radioactive materials. In response to a mandate from the U.S. Congress, a dose estimation methodology was developed by the National Cancer Institute (NCI 1997), which has enabled estimates of population radiation doses to the thyroid gland of representative persons in each of the approximately 3,100 counties of the United States, from direct and indirect (e.g., ingestion of cow milk) exposures to ^{131}I resulting from the NTS activities, for the purpose of health assessments and epidemiologic investigations (Gilbert et al. 1998). The NCI analysis utilized dose reconstruction methods developed earlier by the off-site Radiation Exposure Review Board Project (ORERP) (Ng et al. 1990). In addition, an epidemiologic study of thyroid disease in a Utah cohort was conducted (Kerber et al. 1993) using dosimetric methods described in Simon et al. (1990). Geographic-specific geometric mean lifetime doses are estimated to have ranged from 0.19 to 43 cGy (rad) for a hypothetical individual born on January 1, 1952 who consumed milk only from commercial retail sources, 0.7–55 cGy (rad) for people who consumed milk only from home-reared cows, and 6.4–330 cGy (rad) for people who consumed milk only from home-reared goats (NCI 1997; NRC 1999). The actual dose received by any individual depended on age of exposure, location, and milk consumption habits. A discussion of the uncertainties and limitations of these population dose estimates for use in epidemiology studies and risk assessment can be found in a review of the NCI (1997) dose estimations conducted by the Institute of Medicine and the National Research Council (NRC 1999).

Hanford Nuclear Site. The Hanford Nuclear Site in southeastern Washington reprocessed uranium to produce plutonium. Radioiodine was released to the atmosphere during the early years of operation of the facility. Approximately 740,000 Ci (27 PBq) of ^{131}I was estimated to have been released to the atmosphere during the period 1944–1957 (CDC 2002). Thyroid radiation doses have been estimated using a dosimetry model developed in the Hanford Environmental Dose Reconstruction Project (Shipler et al. 1996). The estimated mean thyroid radiation dose in a study cohort of 3,191 people who resided near the facility was 174 mGy (± 224 , standard deviation [SD]) (17.4 \pm 22.4 rad), with a range of 0.0029–2,823 mGy (0.00029–282 rad). Mean thyroid doses in females and males were similar; 177 mGy (17.7 rad) and 171 mGy (17.1 rad), respectively. Doses varied geographically, with the highest doses received by people who lived near and downwind from the site.

3. HEALTH EFFECTS

3.3.2.1 Death

Although radiation-related deaths were recorded among emergency response personnel on site during the Chernobyl accident, these deaths were associated with exposure to gamma radiation from molten fuel areas and not with exposure to radioiodine (see Section 3.2.2 for a more detailed discussion of the exposures from Chernobyl accident). Deaths related to thyroid cancers (or to other cancers or causes) following the accident continue to be studied and possible associations between mortality and radioiodine exposures may eventually become evident. In general, radiation-induced thyroid cancers tend to be papillary carcinomas; these types of tumors tend to be non-fatal (30-year mortality was estimated to be approximately 8% in adults (Mazafaferrri and Jhiang 1994). However, papillary carcinomas that occur in young children, the predominant age group for thyroid cancers observed after the Chernobyl accident, are more fatal than when they occur in adults (Harach and Williams 1995).

The LOAEL values in humans for exposures by the oral route are presented in Table 3-1 and plotted in Figure 3-1.

3.3.2.2 Systemic Effects

The major systemic effects of exposures to radioiodine are on the thyroid gland; however, other systemic effects have been observed, including inflammation of the salivary glands (sialadenitis), following relatively high exposures to radioiodine such as those used for ablative treatment of thyroid cancers.

The highest NOAEL values and all reliable LOAEL values in each duration category for systemic (endocrine) effects from exposures by the oral route are presented in Table 3-1 and plotted in Figure 3-1.

Gastrointestinal Effects. The major systemic effects of exposures to radioiodine are on the thyroid gland; however, other systemic effects have been observed, including inflammation of the salivary glands (sialadenitis), following relatively high exposures to radioiodine such as those used for ablative treatment of thyroid cancers.

The highest NOAEL values and all reliable LOAEL values in each duration category for systemic (endocrine) effects from exposures by the oral route are presented in Table 3-1 and plotted in Figure 3-1.

3. HEALTH EFFECTS

Endocrine Effects.*Effects of Radioiodine on Thyroid Gland Function*

Extensive clinical use of radioiodine, principally ^{123}I and ^{131}I , for diagnostic purposes and ^{131}I for treatment of thyrotoxicosis has provided a wealth of information on the effects of relatively high acute exposures on thyroid gland function. Radioiodine is cytotoxic to the thyroid gland and produces hypothyroidism at absorbed effective doses to the thyroid gland exceeding 2,500 rad (25 Gy). Thyroid gland doses of approximately 10,000-30,000 rad (300 Gy) can completely ablate the thyroid gland (Maxon and Saenger 2000). Cytotoxic doses of ^{131}I are delivered for treatment of hyperthyroidism or thyrotoxicosis; administered activities typically range from 10 to 30 mCi (370–1,110 MBq). Higher activities are administered if complete ablation of the thyroid is the objective; this usually requires 100–250 mCi (3,700–9,250 MBq). An administered activity of 5–15 mCi (185–555 MBq) yields a radiation dose to the thyroid gland of approximately 5,000-10,000 rad (50–100 Gy) (Cooper 2000). Current diagnostic uses of radioiodine involve much smaller exposures, typically 0.1–0.4 mCi (4–15 MBq) of ^{123}I or 0.005–0.01 mCi ^{131}I (0.2–0.4 MBq). These exposures correspond to approximate thyroid radiation doses of 1–5 rad (1–5 cGy) and 6–13 rad (6–13 cGy) for ^{123}I and ^{131}I , respectively (McDougall and Cavalieri 2000). However, historically, higher doses have been used for diagnostic procedures (e.g., Dickman et al. 2003; Hall et al. 1996).

Several epidemiological studies have examined the relationship between oral exposure to ^{131}I and thyroid gland nodularity. Thyroid nodules are irregular growths of the thyroid gland tissue that can be benign or cancerous. Nodules can be detected by physical palpation of the gland or by various imaging techniques. Palpation detects only larger (>1 cm) nodules, whereas ultrasound can detect nodules that are not palpable (e.g., 1 cm or less). The complete description of a study by Rallison (1996) and by Kerber et al. (1993) is provided in Section 3.3.2.7, as it primarily relates to thyroid neoplasms. The study reported no difference in prevalence of thyroid nodularity detected by physical examination in a cohort living near the NTS when compared to a nonexposed cohort living remote from the NTS (Rallison 1996). However, when the thyroid radiation dose from ^{131}I was calculated for each subject in each location, there was a correlation between radiation dose and formation of neoplasia of the thyroid, but not to nonneoplastic nodules (Kerber et al. 1993).

The Hall et al. (1996a) study evaluated 1,005 women for thyroid nodularity who had been exposed to diagnostic levels of ^{131}I during the period 1952–1977 and whose diagnosis for thyroid abnormalities were negative. The subjects were evaluated for palpable thyroid nodules during the period 1991–1992. A

3. HEALTH EFFECTS

comparison group consisted of 248 women who attended a mammography screening clinic with no prior history of exposure to ^{131}I or thyroid disease. The average total administered ^{131}I activity was 0.95 MBq (26 μCi). Absorbed radiation doses to the thyroid gland were estimated based on the administered activity and dosimetry tables from International Commission on Radiological Protection (ICRP 1988). The average dose was 0.54 Gy (54 rad) (10^{th} – 90^{th} percentiles, 0.02–1.45 Gy; 2–145 rad). Thyroid nodules were detected in 107 of 1,005 (10.6%) exposed women and 29 of 248 (11.7%) nonexposed women. The relative risk (RR, based on odds ratios [ORs]) for thyroid nodularity for women exposed to ^{131}I was 0.9 (95% CI, 0.6–1.4) and was not statistically significant. A linear quadratic excess relative risk model revealed a statistically significant dose trend for thyroid nodularity (excess RR, 0.9/Gy). Hall et al. (1996a) suggest as an explanation for the lack of a significant RR for thyroid nodularity that the nonexposed control group was self-selected (i.e., the subjects voluntarily sought mammographic screening) and, therefore, may not have been an appropriate control group for comparison to the group of women who received radioiodine.

Clinical cases have been reported in which congenital hypothyroidism occurred after maternal exposures to high doses of ^{131}I during pregnancy for treatment of thyroid gland tumors (Green et al. 1971; Hamill et al. 1961; Jafek et al. 1974; Russell et al. 1957). However, the complex clinical picture and pharmacotherapy of the mothers for their thyroid condition during pregnancy makes direct associations between the radioiodine exposure and the clinical outcomes of the newborns highly uncertain. Exposures in these cases ranged from 11 to 77 mCi (0.4–2.8 GBq). Effects on the fetal and newborn thyroid would be expected if mothers received ablative doses of ^{131}I during pregnancy after approximately 12 weeks of gestation, when the fetal thyroid begins to take up iodide. A study of 73 infants and children born to 70 patients who received ^{131}I for ablative treatment of thyroid cancer 2–10 years (mean, 5.3 years) prior to pregnancy found no thyroid gland disorders (Casara et al. 1993). The maternal ^{131}I exposures ranged from 1.85 to 16.55 GBq (50–450 mCi); the mean exposure was 4.40 GBq (120 mCi). A similar finding was reported in a study of 37 patients (47 infants) who received ^{131}I , 1–60 months prior to conception (mean, 16.5 months); exposures ranged from 1.1 to 13.1 GBq (30–350 mCi), with a mean exposure of 3.67 GBq (100 mCi) (Lin et al. 1998).

Marshall Islands. Shortly after the BRAVO test, residents on three of the Marshall Islands were identified as having been exposed to external gamma radiation during the 2 days prior to their evacuation (Conard 1984): 64 residents of Rongelap (1.90 Gy, 190 rad), 18 residents of Ailingnae (1.10 Gy, 110 rad) and 150 residents of Utrik (0.11 Gy, 11 rad) (see Section 3.3.2 for a more detailed discussion of exposures from the Marshall Islands BRAVO test). Estimated total absorbed doses to the thyroid gland (external

3. HEALTH EFFECTS

and internal) were 3.3–20 Gy (330–2,000 rad) on Rongelap (highest doses in children), 1.3–4.5 Gy (130–450 rad) on Ailingnae, and 0.3–0.95 Gy (30–95 rad) on Utrik (Conard 1984). As part of a medical evaluation program, these individuals, the so-called BRAVO cohort, were evaluated periodically for health consequences of their exposures. Evidence of acute radiation sickness was prevalent early after exposures, including nausea and vomiting, hematological suppression, and dermal radiation burns. Cases of thyroid gland disorders began to be detected in the exposed population in 1964, 10 years after the exposure, particularly in exposed children; these included cases of apparent growth retardation, myxedema, and thyroid gland neoplasms (Conard et al. 1970). In 1981, when the children from Rongelap island were screened, it was discovered that 83% of the children who were <1 year of age at the time of the BRAVO test were found to have evidence of hypothyroidism (i.e., a serum concentration of TSH >5 mU/L). This group of children had received an estimated thyroid dose exceeding 1,500 rad (15 Gy). Prevalence of hypothyroidism and thyroid radiation dose decreased with exposure age: 25% for ages 2–10 years (800–1,500 rad, 8–15 Gy) and 9% for ages >10 years (335–800 rad, 3.35–8.00 Gy). Prevalences in the exposed groups from Ailingnae were 8% for exposure ages >10 years (135–190 rad, 1.35–1.90 Gy) and 1% on Utrik (30–60 rad, 0.3–0.6 Gy). In an unexposed group (Rongelap residents who were not on the island at the time of the BRAVO test), the prevalence was 0.3–0.4% (Conard 1984). At about the same time, in 1964, cases of palpable thyroid gland nodules began to be identified in health screening programs (Conard 1984). The prevalence of thyroid nodularity had an age/dose profile similar to that of thyroid hypofunction (i.e., elevated serum TSH). In 1981, thyroid nodules were found in 77% Rongelap residents exposed before the age of 10 years and in 13% of those exposed after 10 years. Prevalence in the Ailingnae populations was 29% in the population of children exposed before age 10 years and 33% in the population exposed after age 10 years. In the Utrik population, the prevalence of thyroid nodules was 8% in the population of children exposed before age 10 years and 12% in the population exposed after age 10 years. The prevalence of thyroid gland carcinoma, mainly papillary carcinomas, also appeared to be elevated in the exposed Rongelap population (6%) compared to the unexposed group (1%). In 1994, thyroid ultrasound examinations were performed on 117 of the original exposure group, 47 from Rongelap, and 70 for Utrik, and 47 residents of Rongelap who were on Majuro at the time of the BRAVO test, approximately 480 miles south of the test site on Bikini Atoll (Howard et al. 1997). Over the period 1965–1990, the case rate for thyroid nodules was approximately 3–8% per year in the exposed groups and approximately 3 times greater in females than in males. However, the 1994 ultrasound evaluations found relatively high, but not significantly different, prevalences of thyroid nodules in exposed (12–33%) and nonexposed (25%) groups or between males and females (Howard et al. 1997). The differences in the outcomes in 1994 and earlier may reflect the age differences at the time of examination, or possibly that palpation detects only larger (>1 cm) nodules, whereas ultrasound can detect nodules that are not palpable

3. HEALTH EFFECTS

(e.g., ≤ 10 mm). Ultrasound is more likely to detect clinically insignificant *nodules* that are actually normal variants of thyroid tissue. Another possible contributor to the differences between outcomes is that earlier studies may have been biased by greater screening/surveillance intensity given to the high-dose groups, whereas the Howard et al. (1997) study was a more systematic comparison across the dose range and used a more objective ultrasound criteria for diagnosing nodularity. Thyroid nodule incidence is highly susceptible to surveillance effects and these studies were not adequately controlled for such effects. A possibly related observation is an apparent high prevalence of iodine deficiency in the Marshall Islands, which may have contributed to a high background prevalence of nodular goiter (Hermus and Huysmans 2000; Takahashi et al. 1999).

A retrospective cohort study reexamined the prevalence of thyroid gland nodularity reported in the 1980s among residents of the Marshall Islands who were potentially exposed to ^{131}I from atmospheric fallout from the BRAVO test in 1954 (Hamilton et al. 1987). This study included residents on islands located 112–589 miles from the test site. The cohort consisted of 7,266 people known to have been residents on the islands (or *in utero*) in 1954 at the time of the BRAVO test. Each subject was examined for palpable thyroid nodules during the period 1983–1985. The examiners were blind to the estimated thyroid radiation dose received by each subject. Radiation doses to the thyroid gland were estimated to have been 21 Gy (2,100 rad) for residents of Rongelap (120 miles from the test site) and 2.80 Gy (280 rad) for residents of Utrik (321 miles). Residents of 12 other islands, who historically were thought not to have received exposures to radioiodine based on location (distance and/or position with respect to prevailing winds), were included in the study. The age-adjusted prevalence of thyroid nodularity was 37% among residents of Rongelap Island and 10.3% for Utrik Island. Prevalence among residents of the other 12 islands ranged from 0.8 to 10.2% and there were no statistically significant differences in prevalence among these 12 less-exposed islands. A prevalence of 2.45% was assumed for nonexposed populations, based on observed prevalence in the two most southern islands (Ebon and Mili), for the purpose of calculating ORs. A logistic regression model yielded a statistically significant effect of sex on OR for thyroid nodularity, with an OR 3.7 times higher in females. The model also yielded a significant trend for decreasing prevalence of thyroid nodularity with both distance and direction from the test site, with prevalence decreasing 3-fold per 100 miles (OR, 0.3 per 100 miles) from the site and 2-fold for every 10 degrees east or west of the site (OR, 0.59 per 10 degrees). The risk estimate for thyroid nodularity among the Marshall Islanders was 1,100 excess cases/Gy/year of exposure per 1 million people (0.0011/person-Gy/year, 0.000011/person-rad/year).

3. HEALTH EFFECTS

A large-scale screening program for thyroid disease was conducted in the Marshall Islands during the period 1993–1997 (Fujimori et al. 1996; Takahashi et al. 1997, 1999, 2003). Results of screening of 1,322 residents of Ebeye (in the Kwajalein Atoll, approximately 190 miles from Bikini Atoll) are reported in Takahashi et al. (1997). Evaluations included neck palpation, thyroid ultrasound, and fine needle aspiration biopsy if warranted (results on diagnoses relevant to thyroid cancer are discussed in Section 3.3.1.7). The examiners were blind to the estimated thyroid radiation dose received by each subject. Among 815 subjects born before 1954, the date of the BRAVO test, 266 (32.6%) were diagnosed with thyroid nodules, 132 (16.2%) were palpable. The prevalence of thyroid nodules (palpable and detected by ultrasound) was higher in females than males; however, as was observed in the Hamilton et al. (1987) study, the difference was significant only for palpable nodules (palpable: females 17.7%, males 9.3%; total nodules: females 35.9%, males 21.0%). In either case, nodule prevalence was 2–3 times higher among groups born during the bomb testing period (before 1958) than after the testing ended. A logistic regression model applied to the nodule prevalence data revealed significant effects of sex, age, and distance from Bikini Atoll on nodule prevalence (Takahashi et al. 1997). A more recent report on the screening program described the results of thyroid palpation and ultrasound (7,721 subjects), tests of thyroid hormone (1,050 subjects), and iodine status (urinary iodide, 309 subjects) (Takahashi et al. 1999). The study group included 5,263 residents of Majuro (approximately 480 miles from Bikini Atoll), 1,610 residents from Ebeye Island (192 miles), and 348 residents from Mejit (398 miles). Of the 7,221 subjects examined in the study (1993–1997), 4,766 (66%) were of an age to have potential exposures to radioactive fallout from bomb tests. The prevalence of thyroid nodules (palpable and detected by ultrasound) was approximately 3 times higher in females than males; among females, the prevalence was highest (13%, 407 of 3,151) among women born before 1959, the date of the last bomb tests. Thyroid hormone tests (T_4 , T_3 , and TSH) revealed no evidence of an unusual prevalence of thyroid gland dysfunction. Measurements of urinary iodide levels suggested mild to severe iodine deficiency in the population; approximately 21% of the adult subjects had urinary iodides in the range of 22–45 nmol I/mmol creatinine (25–50 μg I/g creatinine). This corresponds to a urinary excretion rate and iodine intake rate of approximately 40–80 μg I/day (based on an assumed body weight of 60 kg). Thyroid volumes were compared in subjects who had nodules and were iodine deficient with subjects who were iodine sufficient and who did not have nodules. Although there was no apparent indication of excessive prevalence of thyroid enlargement in either the iodine-deficient or -sufficient groups, subjects who had the largest thyroid volumes tended to fall in the deficient-nodular group. Thyroid nodularity occurs in populations that have experienced prolonged iodine deficiency, although it is usually associated with goiter (Hermus and Huysmans 2000). The observation of a high prevalence of iodine deficiency in the Marshall Island population may be an important confounding variable in many of the epidemiology

3. HEALTH EFFECTS

studies that have attempted to explore relationships between thyroid nodularity and radiation dose in the Marshall Island populations.

Chernobyl Accident. Subsequent to the release of radioactive materials from the Chernobyl power plant in 1986, an increased prevalence of thyroid nodules in children of the Belarus region was reported (Astakhova et al. 1996) (see Section 3.3.2 for a more detailed discussion of exposures from of the Chernobyl accident). An analysis of the results of ultrasound screening of 20,785 people in Belarus conducted during the period 1990–1995 revealed a prevalence of thyroid gland nodules that ranged from 4 to 22 per 1,000. Prevalence was highest (16–22 per 1,000) among residents from districts in which thyroid radiation doses were estimated to have been above 1 Gy (1.3–1.6 Gy, 130–160 rad). Verified diagnoses from patients who were referred for further examination as a result of ultrasound results revealed a prevalence of thyroid cancer of 2.5–6.2 per 1,000, or approximately 13–50% of nodule cases, among cases from districts where thyroid radiation doses were estimated to have been above 1 Gy (1.3–1.6 Gy, 130–160 rad) (see Section 3.3.1.7 for further discussion of thyroid cancer related to the Chernobyl release). Adenoma was diagnosed in 7–12% of thyroid nodule cases, nodular goiter was diagnosed in 5–22% of the thyroid nodule cases, and 7–64% of the nodule cases were diagnosed as benign cysts. In districts in which thyroid doses were estimated to have been <0.1 Gy, benign cysts predominated the diagnoses, with no thyroid cancers; approximately 0–25% were diagnosed as adenomas, 0–8% as nodular goiter, and 75–100% as benign cysts (predominantly cystic-dystropic types of goiter). Dietary iodine status was assessed from measurements of urinary iodine (Astakhova et al. 1996). Urinary iodide levels varied across regions in Belarus. Approximately 30–80% (mean 61%) of children and adolescents had overnight urinary iodine concentrations <100 µg/L, 10–50% (mean 26%) had concentrations <50 µg/L, and 0–25% (mean 9%) had concentrations <20 µg/L. These results suggest a substantial prevalence (on average 26 and 50% in some districts) of dietary iodine intakes below 50–70 µg/day (assuming a daily urine output of 1–1.4 L in children and adolescents). More recent measurements (made in 2000) suggest that dietary iodide deficiency in Belarus appears to have persisted since the Chernobyl accident (Ishigaki et al. 2001). The results of other thyroid screening programs (e.g., the Chernobyl Sasakawa Health and Medical Cooperation Project) also suggest a high prevalence of goiter among people born in Belarus between the years 1976 and 1986, which would be consistent with a high prevalence of iodine deficiency in the population (UNSCEAR 2000). Therefore, iodine deficiency may have contributed to the observed thyroid nodularity and also may be a confounding variable in susceptibility to thyroid cancer (Gembicki et al. 1997; Robbins et al. 2001).

3. HEALTH EFFECTS

Hanford Nuclear Site. The CDC (2002) has conducted a follow-up prevalence study of thyroid disease in populations that resided near the Hanford Nuclear Site in southeastern Washington during the period 1944–1957 (see Section 3.3.2 for a more detailed discussion of releases from the Hanford Nuclear Site). The study included 3,441 subjects who were born during the period 1940–1946 in counties surrounding the Hanford Nuclear Site. Thyroid disease was assessed from a clinical evaluation of each subject, which included assessments of ultrasound or palpable thyroid nodules, thyroid hormone status, thyroid autoimmunity, and parathyroid hormone status. Historical information on thyroid disease and information on radiation exposures were obtained by interviews and, when possible, review of medical records of participants. Thyroid radiation doses were estimated using a dosimetry model developed in the Hanford Environmental Dose Reconstruction Project. Information on residence history and relevant food consumption patterns (e.g., milk consumption, breast feeding, consumption of locally harvested produce) for each study participant was obtained by interview. The estimated mean thyroid radiation dose, based on 91 participants, was 174 mGy (± 224 , standard deviation [SD]) (17.4 ± 22.4 rad), and the range was 0.0029–2,823 mGy (0.00029–282 rad). An indication that the statistical power of the study was appreciably limited by the low distribution of thyroid doses is the fact that only 24 (0.8%) of the study population had estimated thyroid doses >1 Gy (100 rad) and only 7 (0.2%) had doses >2 Gy (200 rad). Doses varied geographically, with the highest doses received by people who lived near and downwind from the site. Health outcomes investigated included thyroid carcinoma, thyroid nodules, hypothyroidism, and hyperthyroidism (serum TSH levels), including Graves' disease, thyroid autoimmunity (serum antimicrosomal antibodies and antithyroid peroxidase), goiter, and hyperparathyroidism. Dose-response relationships were assessed using a linear regression model with adjustments for the following confounding and effect modifying variables: sex, age of first exposure, age of evaluation, ethnicity, smoking, and potential exposures from Nevada Test Site releases. Alternatives to the linear model, including linear quadratic and logistic models, were also explored. Incidence of thyroid disease was found to be unrelated to thyroid radioiodine dose for all outcomes evaluated (dose coefficients not significantly different from zero). Estimated dose coefficients, based on the linear model, were: thyroid cancer, 0.002 ± 0.004 per Gy (CI: < -0.001 – 0.017 , $p=0.25$, 20 cases, 0.6% prevalence); thyroid nodules (of any type), -0.007 ± 0.016 per Gy (CI: < -0.023 – 0.043 , $p=0.65$, 281 cases, 8.2%); hypothyroidism, -0.006 ± 0.019 per Gy (CI: -0.016 – 0.047 , $p=0.61$, 267 cases, 7.8%); hyperthyroidism, 0.011 ± 0.015 per Gy (CI: < -0.008 – 0.052 , $p=0.22$, 161 cases, 4.7%); thyroid autoimmunity, -0.024 ± 0.027 per Gy (CI: < -0.058 – 0.048 , $p=0.8$, 659 cases, 19.2%); goiter, -0.001 ± 0.008 (95% upper CL: 0.012, $p=0.74$, 14 cases, 0.4%); hyperparathyroidism, -0.000 ± 0.018 per Gy (95% upper CL: 0.013, $p=0.61$, 14 cases, 0.4%).

3. HEALTH EFFECTS

The CDC (2002) study was reviewed by the National Academy of Sciences (NAS 2000), which identified several sources of uncertainty in the study that need to be considered in interpreting the reported results. In particular, reliance on modeling thyroid radiation doses, based on environmental transfer coefficients, rather than direct measurements (which was not possible) may have introduced substantial uncertainty in the risk estimates, that may have been underestimated in the study. In particular, the NAS pointed out that the study utilized a transfer coefficient for radioiodine from cows to cow milk that was approximately twice that estimated from other studies. This could have contributed to an overestimate of thyroid doses in infants and children, and a lower statistical power of the study. Also, the study utilized survey information on the sources and amounts of milk consumed that was collected 40–50 years after the period of interest. Large uncertainties in estimates of these model parameters may have also decreased the statistical power of the study. Loss of power is particularly important in interpreting the generally negative findings of the study.

Effects of Radioiodine on the Parathyroid Gland

Cases of hypo- and hyperparathyroidism are rare outcomes in patients who receive ^{131}I treatments for ablative therapy of thyroid cancer or hyperthyroidism. The parathyroid gland is in close proximity to the thyroid gland. Although in most people, the parathyroid and thyroid glands are separated by more than 1 cm, in approximately 20% of people, the parathyroid gland is located within the thyroid gland capsule (Glazebrook 1987). The latter configuration would result in irradiation of the parathyroid gland with β emission from ^{131}I concentrated in the thyroid gland; β emission from ^{131}I has a tissue penetration distance of approximately 0.5–2 mm (Esselstyn et al. 1982). Cases of parathyroid dysfunction have been reported after exposures to ^{131}I ranging from 4 to 30 mCi (0.15–1.1 GBq) (Better et al. 1969; Burch and Posillico 1983; Eipe et al. 1968; Esselstyn et al. 1982; Fjälling et al. 1983; Freeman et al. 1969; Glazebrook 1987; Jialal et al. 1980; Rosen et al. 1984). A clinical follow-up study evaluated serum calcium status of 125 patients (106 females, 19 males) who received ^{131}I for treatment of hyperthyroidism during the period 1951–1960. The follow-up assessments occurred 16–26 years (mean, 21 years) after exposure to ^{131}I (Fjälling et al. 1983). A group of age- and sex-matched healthy subjects who had no history of irradiation to the head or neck region served as a control group. Exposures to ^{131}I ranged from 75 to 1,400 MBq (2–38 mCi). These corresponded to radiation doses to the parathyroid of 2–5 Gy in subjects whose parathyroid gland was 0.2 cm from the surface of the thyroid gland and 3–7.5 Gy in subjects whose parathyroid gland was at the surface of the thyroid gland. Two patients and two control subjects were found to have hypercalcemia and verified hyperparathyroidism (the exact basis for the verification was not reported). The ^{131}I exposures of the two patients were 140 and 450 MBq (3.8 and 12 mCi), respectively.

3. HEALTH EFFECTS

Hanford Nuclear Site. Hyperparathyroidism was assessed as part of the CDC (2002) study of health outcomes related to radioiodine releases from the Hanford Nuclear Site (see Section 3.3.2 for a more detailed discussion of releases from the Hanford Nuclear Site). The study included 3,441 subjects who were born during the period 1940–1946 in counties surrounding the site. Parathyroid hormone status was assessed from measurements of serum parathyroid hormone. Historical information on parathyroid disease was obtained by interviews and, when possible, review of medical records of participants. The estimated mean thyroid radiation dose, based on 91 participants, was 174 mGy (± 224 , standard deviation [SD]) (17.4 ± 22.4 rad), and the range was 0.00029–2,823 mGy (0.002.9–282 rad). Dose-response relationships were assessed using a linear regression model with adjustments for the following confounding and effect modifying variables: sex, age of first exposure, age of evaluation, ethnicity, smoking, and potential exposures from Nevada Test Site releases. Incidence of hyperparathyroidism was found to be unrelated to thyroid radioiodine dose (dose coefficients were not significantly different from zero). Estimated dose coefficients based on the liner model were -0.000 ± 0.018 per Gy (95% upper CL: 0.013, $p=0.61$) based on 14 cases (0.4% prevalence). Incidence of hyperparathyroidism was found to be unrelated to thyroid radioiodine dose. Uncertainties in the dose estimates for the cases need to be considered in interpreting these results.

Effects of Radioiodine on Testicular Endocrine Function

High exposures to ^{131}I may affect testicular endocrine function. Studies relevant to these end points (Wichers et al. 2000) are described in Section 3.3.2.5 (Reproductive Effects).

3.3.2.3 Immunological and Lymphoreticular Effects

Information on immunological effects of oral exposure to radioiodine in humans relates to thyroid gland autoimmunity. The highest NOAEL values and all reliable LOAEL values in each duration category for immunological and lymphoreticular effects from exposures by the oral route are presented in Table 3-1 and plotted in Figure 3-1.

Cases of autoimmune hyperthyroidism after exposures to ^{131}I for ablative treatment of hyperthyroidism have been reported. In three cases, thyrotoxicosis developed with serum antibodies to TSH receptor 3–6 months after the patients received oral treatments with 40–86 mCi ^{131}I (1.5–3.2 GBq) for reduction of

3. HEALTH EFFECTS

nontoxic goiter that was compressing the trachea (Huysmans et al. 1997a). Prior to the ^{131}I treatments, the patients were euthyroid and had no detectable TSH antibodies.

Marshall Islands. Large scale assessments of thyroid autoimmunity have been conducted in the Marshall Islands, where exposures to ^{131}I occurred as a result of fallout and contamination from test detonations of nuclear bombs during the period 1946–1958 (see Section 3.3.1.2, Endocrine, for a more complete description of these studies) (see Section 3.3.2 for a more detailed discussion of exposures from the Marshall Islands BRAVO test). In a thyroid screening program conducted during the period 1993–1997, 7,721 subjects were evaluated for various end points of thyroid size, nodularity, and function (Fujimori et al. 1996, Takahashi et al. 1997, 1999). Antithyroglobulin antibodies in serum were detected in 67 of 2,700 (2.5%) subjects examined (Fujimori et al. 1996). Although this prevalence is unremarkable compared to that found in other populations (10% in healthy adults) (Maccocci and Chiovata 2000; Takahashi et al. 1999), a statistical comparison with an appropriate referent population was not conducted. Furthermore, no attempt was made in this study to assess the relationship between antibody levels and radioiodine exposure.

Chernobyl Accident. A study that compared thyroid cancers in Belarus and Ukraine diagnosed after the Chernobyl releases with those diagnosed in Italy and France during the same time period found that the Belarus-Ukraine cases had a higher incidence of thyroid autoimmunity (i.e., elevated antithyroid peroxidase and thyroglobulin antibodies) than the Italy-France cases (Pacini et al. 1997) (see Section 3.3.2 for a more detailed discussion of exposures from of the Chernobyl accident). It is unclear to what extent the autoimmunity may be related to the exposures to radioiodine. Serum antithyroglobulin antibody titres were measured in 53 children ages 7–14 years (in 1993–1994) who received 0.4–3.2 Gy (40–320 rad) as a result of the Chernobyl release (Chernyshov et al. 1998). Antibody titres were detected in 80.6% of exposed children compared to 16.7% of a reference group that had no estimated exposure to ^{131}I , and there was a significant positive correlation between antibody titre and estimated thyroid ^{131}I dose. These results suggest a possible contribution of thyroid radioiodine exposure to thyroid autoimmunity. Other screening programs conducted in Belarus have not found relationships between thyroid autoimmunity and radiation exposure, as assessed by ^{137}Cs soil levels or body ^{137}Cs levels (UNSCEAR 2000). One of the largest programs, the Chernobyl Sasakawa Health and Medical cooperation project (1991–1996), conducted thyroid examinations, including serum antithyropoxidase and antithyroglobulin measurements, on approximately 160,000 children who were <10 years old at the time of the accident. No association between body or soil ^{137}Cs activity and thyroid antibody levels was observed in an analysis of this screening program (UNSCEAR 2000, Annex J).

3. HEALTH EFFECTS

Hanford Nuclear Site. Thyroid autoimmunity was assessed as part of the CDC (2002) study of health outcomes related to radioiodine releases from the Hanford Nuclear Site (see Section 3.3.2 for a more detailed discussion of releases from the Hanford Nuclear Site). The study included 3,441 subjects who were born during the period 1940–1946 in counties surrounding the site. Thyroid autoimmunity was assessed from measurements of serum antimicrosomal antibody and antithyroid peroxidase. Historical information on thyroid disease, including autoimmunity and related disorders (e.g., Graves' disease), was obtained by interviews and, when possible, review of medical records of participants. The estimated mean thyroid radiation dose in a population of 3,191 people who resided near the facility was 174 mGy (± 224 , standard deviation [SD]) (17.4 ± 22.4 rad), and the range was 0.0029–2,823 mGy (0.00029–282 rad). Dose-response relationships were assessed using a linear regression model with adjustments for the following confounding and effect modifying variables: sex, age of first exposure, age of evaluation, ethnicity, smoking, and potential exposures from Nevada Test Site releases. Incidence of thyroid autoimmunity was found to be unrelated to thyroid radioiodine dose (dose coefficients were not significantly different from zero). Estimated dose coefficients, based on the linear model, were -0.024 ± 0.027 per Gy (CI: < -0.058 – 0.048 , $p=0.8$) based on 659 cases (19.2% prevalence). Alternatives to the linear model including linear quadratic and logistic models were also explored.

Uncertainties in the dose estimation methodology used in this study have been discussed in NAS (2000). Major sources of uncertainty derived from the reliance on modeling thyroid radiation doses, based on environmental transfer coefficients, rather than direct measurements. In particular, the NAS pointed out that the study utilized a transfer coefficient for radioiodine from cows to cow milk that was approximately twice that estimated from other studies. This could have contributed to an overestimate of thyroid doses in infants and children, and a lower statistical power of the study. Also, the study utilized survey information on the sources and amounts of milk consumed that was collected 40–50 years after the period of interest. Large uncertainties in estimates of these model parameters may have also decreased the statistical power of the study. Loss of power is particularly important in interpreting the generally negative findings of the study.

3.3.2.4 Neurological Effects

Exposure of a fetus to large amounts of radioiodine would result in thyroid tissue ablation and in similar delayed brain and neuromuscular development, if the hypothyroid state was not corrected (e.g., with hormone replacement therapy) after birth. An example is a case of severe hypothyroidism with

3. HEALTH EFFECTS

neurological sequelae that developed at age 8 months in an infant whose mother received 99 mCi (3.7 GBq) of ^{131}I during her 6th week of pregnancy (Goh 1981).

3.3.2.5 Reproductive Effects

A clinical study of the outcomes of 70 pregnancies in patients who received ^{131}I for ablative treatment of thyroid cancer 2–10 years (mean, 5.3 years) prior to pregnancy revealed only two spontaneous abortions (Casara et al. 1993). The maternal ^{131}I exposures ranged from 1.85 to 16.55 GBq (50–450 mCi); the mean exposure was 4.40 GBq (120 mCi). Maternal gonadal radiation doses ranged from 11 to 20 cGy (11–20 rad). In a similar study, 37 patients received ^{131}I prior to conception (mean, 16.5 months prior to conception; range 1–60 months); at exposures ranging from 1.1 to 13.1 GBq (30–350 mCi) with a mean exposure of 3.67 GBq (100 mCi) (Lin et al. 1998); of 58 pregnancies reported, there were 8 spontaneous abortions and 2 threatened abortions. In a retrospective review of pregnancy outcomes of 154 women who received ablative ^{131}I therapy for thyroid cancer, two cases of infertility occurred in 35 patients who attempted to conceive (Smith et al. 1994). The ^{131}I exposure range was 77–250 mCi (2.8–9.2 GBq) with a mean exposure of 148 mCi (5.5 GBq). The above studies did not have control comparison groups.

The ATSDR (2000a) conducted a retrospective analysis of pregnancy outcomes (pre-term birth rates, fetal death) and infant deaths among residents who lived near the Hanford Nuclear Site (see Section 3.3.2 for a more detailed discussion of releases from the Hanford Nuclear Site). The study reviewed records of outcomes of 72,154 births, 1,957 infant deaths, and 1,045 fetal deaths that occurred in Washington counties near the Hanford Nuclear Site during the period 1940–1952. Subjects were assigned to one of four exposure categories based on the subject's address (zip code) at the time of the subject birth or infant death, and estimated ^{131}I exposures in 1945 in those areas were obtained from the Hanford Environmental Dose Reconstruction (HEDR) project (CDC 2002). The exposure categories were: *low*, #50th percentile of the 1945 HEDR estimate for the entire study area; *medium low*, >50th percentile and <75th percentile; *medium high*, ≥75th percentile and # 90th percentile; and *high*, >90th percentile (radioiodine doses associated with these percentiles are not reported in CDC 2002). Associations between ^{131}I exposure and outcomes were evaluated in a multivariate logistic regression model. Co-variables that were explored included sex of infant, age of mother, race of mother, occupation of father, and history of previous pregnancies, stillbirths, or infant mortality. Models were evaluated for outcomes recorded for 1945, the year in which exposures were estimated to be the highest, and also for the period May 1, 1945–April 30, 1946, which could have included exposures to the highest levels during early pregnancy. The adjusted odds ratios (low-exposure as the reference) for infant death for the high-exposure category were 1.1

3. HEALTH EFFECTS

(95% CI, 0.7–1.8) for the year 1945 and 1.3 (CI, 0.8–2.1) for the 1945–1946 period. The adjusted ORs for fetal death for the high-exposure category were 0.6 (CI, 0.2–1.6) for the year 1945 and 0.7 (CI, 0.3–1.7) for the 1945–1946 period. These results suggest that neither infant nor fetal death were significantly associated with estimated ^{131}I exposures. The adjusted odds ratios for preterm birth for the high-exposure category were 1.6 (CI, 1.0–2.6) for the year 1945 and 1.9 (CI, 1.2–3.0) for the 1945–1946 period, suggesting a possible association between preterm birth and ^{131}I exposures.

An assessment of uncertainties in the CDC (2002) study is provided in NAS (2000). Major sources of uncertainty derived from the reliance on modeling thyroid radiation doses, based on environmental transfer coefficients, rather than direct measurements, use of a relatively high value for the transfer coefficient for radioiodine from cows to cow milk, and reliance on survey information on the sources and amounts of milk consumed that was collected 40–50 years after the period of interest. Large uncertainties in estimates of these model parameters may have decreased the statistical power of the study. Loss of power is particularly important in interpreting the negative findings of the study.

A retrospective analysis was conducted to evaluate pregnancy health and reproductive outcomes of women who were exposed to radiation resulting from releases from the Chernobyl nuclear power plant, including a major contribution from ^{131}I (Petrova et al. 1997) (see Section 3.3.2 for a more detailed discussion of exposures from the Chernobyl accident). Interpretation of the results of this study, in terms of the contribution of radioiodine to the outcomes, is highly uncertain, as other factors could have affected the outcomes, including exposure to other forms of radiation, nutrition, or other chemical exposures. Nevertheless, because it is one of the only large-scale epidemiological studies that has focused on reproductive and developmental outcomes, and because of the substantial contribution that radioiodine made to radiation exposures after the Chernobyl releases, a brief description of the study is presented here. In the retrospective analysis, clinical records on 755,297 pregnancies that occurred in Belarus during the period 1982–1990 were evaluated. Approximately half of the women resided in Gomel and Mogilev, two districts that were relatively heavily contaminated with radioiodine and other radionuclides, and approximately half of the women lived in two relatively lightly contaminated areas, Brest and Vitebsk. Three categories of outcomes were evaluated: pregnancy outcome, including stillbirths, low birth weight, and neonatal or postneonatal mortality; maternal morbidity; and infant health, including intrauterine hypoxia, perinatal infection, respiratory disorders, and congenital anomalies. Annual incidence of maternal anemia, renal insufficiency (elevated serum BUN and creatinine), and toxemia appeared to increase more sharply in the heavily contaminated districts after 1986, the year of the Chernobyl releases (a statistical analysis of trend was not reported). Incidence of congenital

3. HEALTH EFFECTS

abnormalities and neonatal respiratory disorders also appeared to increase more sharply in the heavily contaminated districts after 1986 (no statistical analysis of trend was reported). Fetal death rates appeared to increase or not decline in contaminated districts to the same extent as in less contaminated districts.

A cohort study was conducted as part of this retrospective analysis (Petrova et al. 1997). Health records on 757 infants and their mothers who resided in radiation-contaminated or relatively uncontaminated areas of Belarus were analyzed. The prevalence of maternal toxemia was 4–5 times greater among women who resided in contaminated areas (25–30%) compared to women from the control areas. The prevalence of atopic dermatitis in infants who resided in contaminated areas was approximately 2 times higher (approximately 40%) compared to infants from control areas. The prevalence of anemia (low blood hemoglobin levels) was 6–7 times higher in infants from contaminated areas (18–20%). The contribution of radioiodine to the observed outcomes is highly uncertain as other factors could have affected the outcomes, including exposure to other forms of radiation, nutrition, or other chemical exposures.

Clinical cases of impaired testicular function have been reported following oral exposures to ^{131}I for ablative treatment of thyroid cancer (Ahmed and Shalet 1985; Handelsman and Turtle 1983; Pacini et al. 1994). Effects observed included low sperm counts, azospermia (absence of spermatozoa), and elevated serum concentrations of follicle stimulating hormone (FSH), which persisted for more than 2 years of follow-up. Exposures to radioiodine ranged from 50 to 540 mCi (1.8–20 GBq). A study of 103 patients who received ^{131}I treatments for thyroid cancer found low sperm counts and elevated serum FSH concentrations in some patients when examined 10–243 months after treatment (mean, 94 months) (Pacini et al. 1994). Exposures to radioiodine ranged from 30 to 1,335 mCi (1.1–49.4 GBq) with a mean exposure of 167 mCi (6.2 GBq).

Wichers et al. (2000) examined testicular endocrine function in 25 patients before and after they received ^{131}I for ablative treatment of thyroid carcinoma. The mean cumulative exposure was 9.8 ± 0.89 GBq (260 mCi). Serum concentrations of follicle stimulating hormone (FSH), luteinising hormone (LH), inhibin B, and testosterone were significantly different from pre-exposure levels. Increases in FSH (300%) and LH (100%), and decrease in inhibin B concentrations (88%) showed similar temporal patterns, with peak responses 3–6 months after exposure and a return to pre-exposure levels within 18 months following exposure. Peak levels of FSH (21 IU/L) exceeded the upper limit of the normal range (1.8–9.2 IU/L) and the lowest post-exposure levels of inhibin B (22 pg/mL) were below the lower limit of the normal range (75–350 pg/mL). Serum concentrations of LH remained within the normal

3. HEALTH EFFECTS

range (1.6–9.2 IU/L). Serum concentrations of testosterone were significantly higher (50%) than pre-exposure levels 12 and 18 months after exposure; however, concentrations remained within the normal range (10.4–34.7 nmol/L). These results suggest that exposures to high levels of ^{131}I may affect testicular endocrine function. A major limitation of this study is the lack of observations in a set of controls who underwent thyroidectomy but who were not exposed to ^{131}I .

The highest NOAEL values and all reliable LOAEL values in each duration category for reproductive effects from exposures by the oral route are presented in Table 3-2 and plotted in Figure 3-2.

3.3.2.6 Developmental Effects

A clinical study of the outcomes of 70 pregnancies in patients who received ^{131}I for ablative treatment of thyroid cancer 2–10 years (mean, 5.3 years) prior to pregnancy revealed only two spontaneous abortions (Casara et al. 1993). Of 73 infants born to the patients, one was diagnosed with tetralogy of Fallot's (pulmonic stenosis, atrial septal defect, and right ventricular hypertrophy) and the two other infants had low birth weights with subsequent normal growth rates. The maternal ^{131}I exposures ranged from 1.85 to 16.55 GBq (50–450 mCi); the mean exposure was 4.40 GBq (120 mCi). Maternal gonadal radiation doses ranged from 11 to 20 cGy (11–20 rad). A similar study was reported of 37 patients who received ^{131}I 1–60 months prior to conception (mean, 16.5 months); exposures ranged from 1.1 to 13.1 GBq (30–350 mCi) with a mean exposure to 3.67 GBq (100 mCi) (Lin et al. 1998); of 58 pregnancies reported, there were 8 spontaneous abortions and 2 threatened abortions. Birth weights of newborns of women who received ^{131}I were not different from newborns of maternal age-matched controls who did not receive ^{131}I and who were not thyroid cancer patients. A retrospective review of pregnancy outcomes of women who received ablative ^{131}I therapy for thyroid cancer found 3 spontaneous abortions and 4 premature deliveries out of 67 pregnancies in 32 patients (Smith et al. 1994). Two infants were born within 1 year of the maternal ^{131}I therapy and both died of congenital abnormalities; severe hypoparathyroidism and hypothyroidism in one case, and Down's syndrome and cardiac anomalies in the second case. The ^{131}I exposure range was 77–250 mCi (2.8–9.2 GBq) with a mean exposure of 148 mCi (5.5 GBq). Goh (1981) reported a case of cretinism that developed at age 8 months in an infant whose mother received 99 mCi (3.7 GBq) of ^{131}I during her 6th week of pregnancy.

ATSDR (2000b) conducted a retrospective analysis of pregnancy outcomes (pre-term birth rates, fetal death) and infant deaths among residents who lived near the Hanford Nuclear Site (see discussion of Reproductive Effects of Radioactive Iodine for a more detailed description of this study and Section 3.3.2

Table 3-2 Levels of Significant Exposure to Iodine - Radiation Toxicity - Oral

Key to figure ^a	Species (Strain)	Exposure/ Duration/ Frequency (Specific Route)	System	LOAEL		Reference Chemical Form
				NOAEL (rad)	Less Serious (rad)	
ACUTE EXPOSURE						
Systemic						
1	Human		Endocr			145 (thyroid gland nodularity) Astakhova et al. 1996 131 I
2	Human		Endocr			325 (thyroid gland nodularity) Conard 1984 131 I
3	Human		Endocr			2000 (thyroid gland nodularity) Hamilton et al. 1987 131 I
4	Human		Endocr			180 (thyroid gland nodularity) Pacini et al. 1997 131 I
Cancer						
5	Human					30 (thyroid cancer) Astakhova et al. 1998 131 I
6	Human					30 (thyroid cancer) Drobyshevskaya et al. 1996 131 I
7	Human	(F)				5 (kidney and liver cancer) Holm et al. 1991 131 I

Table 3-2 Levels of Significant Exposure to Iodine - Radiation Toxicity - Oral

(continued)

Key to figure ^a	Species (Strain)	Exposure/ Duration/ Frequency (Specific Route)	System	NOAEL (rad)	LOAEL		Reference Chemical Form
					Less Serious (rad)	Serious (rad)	
8	Human	(F)				6000 (thyroid cancer)	Ron et al. 1998 131 I
9	Human					20 (thyroid cancer)	Tronko et al. 1996 131 I
CHRONIC EXPOSURE							
Systemic							
10	Human	(F)	Endocr	17			CDC 2002 131 I
Cancer							
11	Human	(F)				9 (thyroid neoplasm)	Gilbert et al. 1998 131 I
12	Human	(F)				325 (thyroid neoplasm)	Kerber et al. 1993 131 I
13	Human	(F)				25 (thyroid neoplasm)	Rallison 1996 131 I

^a the number corresponds to entries in Figure 3-2.

Endocr = endocrine; (f) = feed; LOAEL = lowest-observed-adverse-effect level

Figure 3-2. Levels of Significant Exposure to Iodine - Radiation Toxicity - Oral
Acute (≤ 14 days)

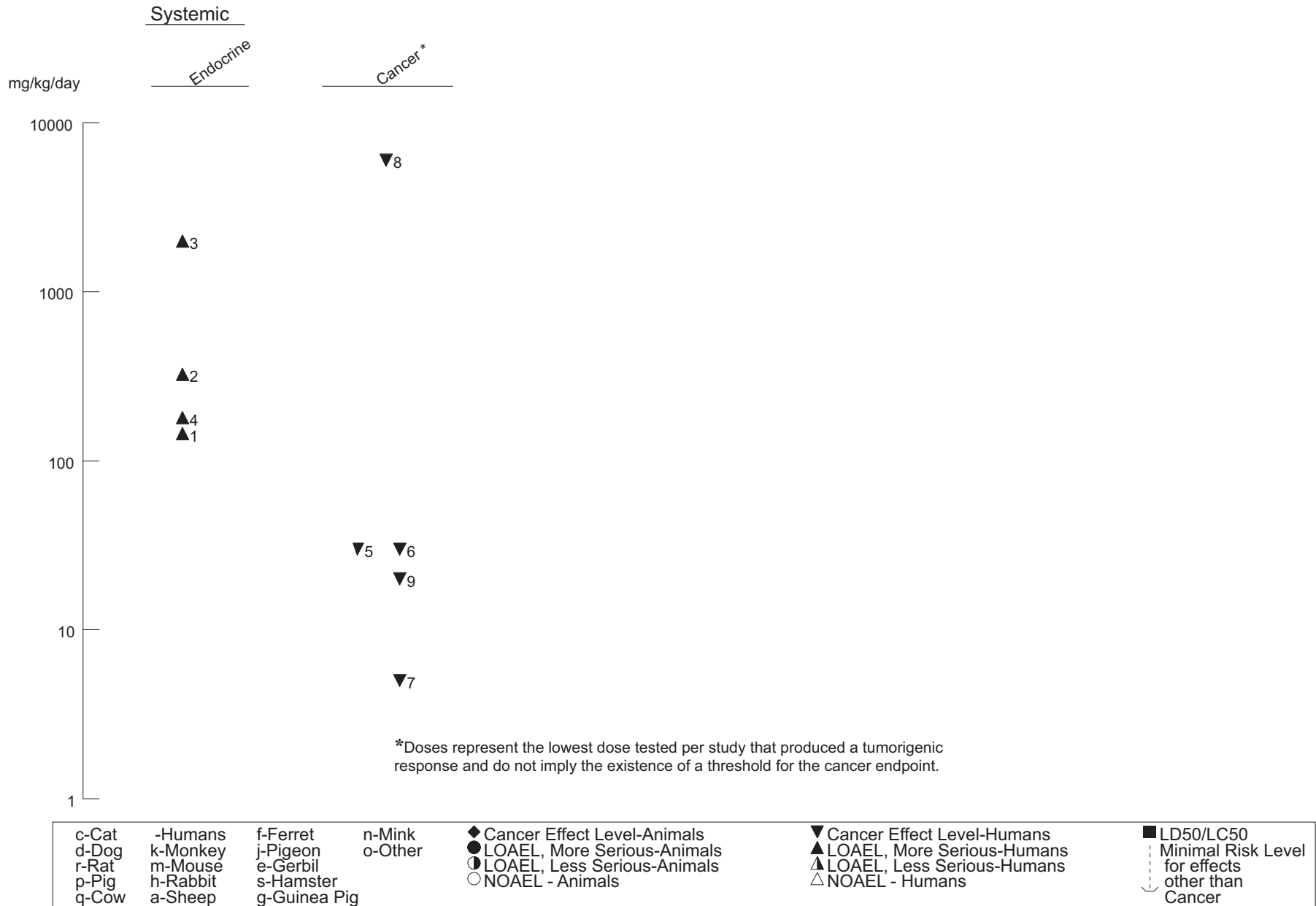
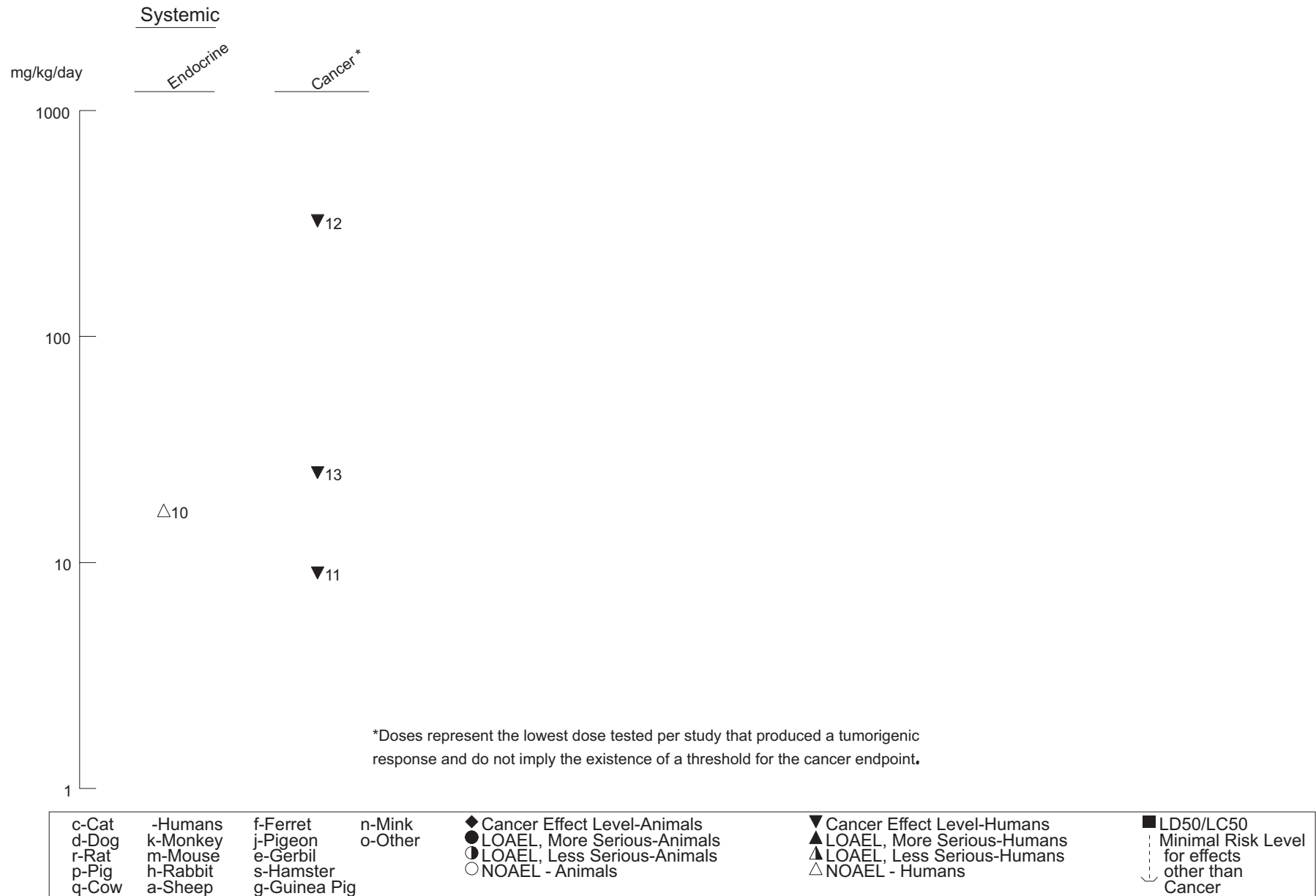

Figure 3-2. Levels of Significant Exposure to Iodine - Radiation Toxicity - Oral (*Continued*)
 Chronic (≥ 365 days)



3. HEALTH EFFECTS

for a more detailed discussion of releases from the Hanford Nuclear Site). The study reviewed records of outcomes of 72,154 births, 1,957 infant deaths, and 1,045 fetal deaths that occurred in Washington counties near the Hanford Nuclear Site during the period 1940–1952. Subjects were assigned to one of four exposure categories (low, medium low, medium high, high) based on the subject's address (zip code) at the time of the subject birth or infant death, and estimated ^{131}I exposures in 1945 in those areas were obtained from the Hanford Environmental Dose Reconstruction (HEDR) project (CDC 2002). Associations between ^{131}I exposure and outcomes were evaluated in a multivariate logistic regression model. Models were evaluated for outcomes recorded for 1945, the year in which exposures were estimated to be the highest, and also for the period May 1, 1945–April 30, 1946, which could have included exposures to the highest levels during early pregnancy. The adjusted odds ratios (low-exposure as the reference) for infant death for the high-exposure category were 1.1 (95% CI, 0.7–1.8) for the year 1945 and 1.3 (CI: 0.8–2.1) for the 1945–1946 period. The adjusted odds ratios for fetal death for the high-exposure category were 0.6 (CI: 0.2–1.6) for the year 1945 and 0.7 (CI: 0.3–1.7) for the 1945–1946 period. These results suggest that neither infant nor fetal death were significantly associated with estimated ^{131}I exposures. The adjusted odds ratios for preterm birth for the high-exposure category were 1.6 (1.0–2.6) for the year 1945 and 1.9 (1.2–3.0) for the 1945–1946 period, suggesting a possible association between preterm birth and ^{131}I exposures.

One epidemiological study has examined health outcomes of infants of mothers who resided in the Belarus region before or after the Chernobyl accident (Petrova et al. 1997) (see Section 3.3.2 for a more detailed discussion of exposures from of the Chernobyl accident). Interpretation of the results of this study, in terms of the contribution of radioiodine to the outcomes, is highly uncertain, as other factors could have affected the outcomes, including exposure to other forms of radiation, nutrition, or other chemical exposures. Nevertheless, because it is the only epidemiological study that has focused on reproductive and developmental outcomes, and because of the substantial contribution that radioiodine made to radiation exposures after the Chernobyl releases, a brief description of the study is presented here. As part of a retrospective cohort study, health records were analyzed on 757 infants and their mothers who resided in heavily radiation-contaminated areas of Belarus resulting from radionuclide releases from the Chernobyl nuclear power plant or relatively uncontaminated areas (Petrova et al. 1997). Prevalence of atopic dermatitis in infants who resided in contaminated areas was approximately 2 times higher (approximately 40%) compared to infants from control areas. The prevalence of anemia (low blood hemoglobin levels) was 6–7 times higher in infants from contaminated areas (18–20%). Interpretation of the results of this study, in terms of the contribution of radioiodine, to the outcomes, is

3. HEALTH EFFECTS

highly uncertain, as other factors could have affected the outcomes, including exposure to other forms of radiation, nutrition, or other chemical exposures.

The highest NOAEL values and all reliable LOAEL values in each duration category for developmental effects from exposures by the oral route are presented in Table 3-2 and plotted in Figure 3-2.

3.3.2.7 Cancer

Cancer effect levels (CELs) for iodine exposures by the oral route are presented in Table 3-2 and plotted in Figure 3-2.

The thyroid gland receives the highest radiation dose of any organ or tissue following an internal exposure to radioiodine (see Section 3.5, Toxicokinetics) and, therefore, cancer of the thyroid gland is the major health concern associated with radioiodine exposures. Children, in particular, are highly vulnerable to radioiodine toxicity. Cancer morbidity and mortality among populations that received exposures to radioiodine have been examined in several large-scale epidemiology studies. In general, these studies fall into several categories that can be distinguished by the sources of exposure and estimated radiation doses to the thyroid gland and include (Table 3-3): (1) exposure to high doses (10–20 mCi, 370–740 MBq; >10,000 rad, >100 Gy) achieved when ^{131}I is administered to treat hyperthyroidism (even higher doses are used to treat thyroid cancer); (2) exposures to moderately high doses (40–70 μCi , 1.5–2.6 MBq; 80–130 rad, cGy) associated with clinical administration of ^{131}I for diagnosis of thyroid gland disorders; (3) low doses from exposures to fallout from nuclear bomb tests (BRAVO test, 300–2,000 rad, cGy; Nevada Test Site, 1–40 rad, cGy); (4) low to high doses from exposures to releases from nuclear power plant accidents (Chernobyl, 10–500 rad, cGy); and (5) low to high environmental exposures from operational releases from nuclear fuel processing plants (Hanford Nuclear Site, 0.0001–284 rad, cGy). As a point of reference, the dose-response relationship for thyroid cancer and external radiation appears to extend down to thyroid doses of 0.1 Gy (10 rad) and predicts an excess relative risk (ERR) of 7/Gy for ages <15 years at exposure (Ron et al. 1995). Studies of thyroid cancers and external radiation exposure have found a strong dependence of thyroid cancer risk on age at exposure. Risk is substantially greater

3. HEALTH EFFECTS

Table 3-3. Estimated Thyroid Radiation Doses in Populations Studied for Radioiodine-related Cancers^a

Type of exposure	Estimated thyroid radiation dose (cGy) ^a	Reference ^b
Radioiodine therapy for hyperthyroidism	>5,000 ^c	Holm et al. 1991; Ron et al. 1998
Clinical diagnosis of thyroid gland disorders	80–130 ^c	Hall et al. 1996b
Marshall Islands BRAVO test	280–2,100 ^c	Hamilton et al. 1987; Lessard et al. 1985
Chernobyl power plant accident	<1–200 ^d	Astrakova et al. 1998
Nevada Test Site nuclear bomb tests	1–30 ^c	Gilbert et al. 1998; Kerber et al. 1993; Rallison 1996
Hanford Nuclear Site releases	17±22 (0.003–282) ^d	CDC 2002

^a1 cGy=1 rad^bSee text for additional references^cCohort means^darithmetic mean ± SD (range)

3. HEALTH EFFECTS

for radiation doses received prior to age 15 years when compared to risks for doses received at older ages, and this increased risk persists, possibly for the lifetime (Ron et al. 1995). This same general trend in age-dependence would be expected for internal exposures to radioiodine; thus, studies of adult exposures to radioiodine may not be directly applicable to predicting outcomes from exposures to children. The relatively high and acutely cytotoxic radiation doses to the thyroid gland that are achieved in the treatment of thyroid gland disorders, and outcomes on the thyroid, are not relevant for predicting outcomes from the much lower environmental exposures that occur in most U.S. populations; for example, exposures received as a result of nuclear bomb testing (Nevada Test Site) or operational releases from nuclear plants (Hanford Nuclear Site). This is in part because cell killing effects decrease the number of viable cells that might otherwise be transformed by radiation-associated mutagenesis. Uncertainties in estimating thyroid doses are also greater in persons who have thyroid abnormalities because of the nonuniform distribution of radioiodine in the thyroid gland (NCRP 1985). Nevertheless, high-dose studies are summarized because they provide useful information about the magnitude of radioiodine exposures that would present an elevated risk for thyroid and extrathyroidal cancers. Although not specified in most of these studies, it is likely that radioiodine was administered as a single dose by the oral route as either potassium or sodium iodide, as these are the common clinical practices. However, it is also possible, but highly unlikely, that some patients received the radioiodine by injection. Since absorption of an oral dose of iodide is nearly complete, this is unlikely to be a significant issue in interpreting the outcomes of the studies, except in considering the radiation dose to the gastrointestinal tract.

Breast cancer is also a concern with exposures to high levels of radioiodine after ablative therapy for hyperthyroidism because breast expresses NIS and can transport and accumulate iodide (see Sections 3.5.4.2 and 3.6.1, Distribution). However, the epidemiological literature to date has not implicated such exposures as a significant risk factor for breast cancer (Goldman et al. 1988; Green et al. 1995).

Therapeutic Doses of Radioiodine

Several studies have explored possible associations between radioiodine therapy for thyroid disease and cancer incidence or mortality. The Ron et al. (1998) study specifically assessed cancer outcomes in patients who received only ^{131}I , and distinguished these patients from those who received other types of treatments alone, or in combination with ^{131}I . This is an important design feature, as the study showed that other forms of treatment appear to be risk factors for cancer mortality. The Ron et al. (1998) study used a retrospective cohort design to examine cancer mortality in 35,593 patients (79% females; mean age, 46 years, 3% younger than 20 years) treated for hyperthyroidism (91% Graves' disease, 8% toxic

3. HEALTH EFFECTS

nodular goiter) in 25 U.S. hospitals and 1 British hospital (Ron et al. 1998). The mean total activity administered was 10.4 mCi (385 MBq; 5th–95th percentile, 3–27 mCi, 111–999 MBq). The mean total administered activity was 10.0 mCi (370 MBq) for treatment of Graves' disease and 17.0 mCi (629 MBq) for toxic nodular goiter. Cancers that occurred between the first visit of the patient to the clinic during the enrollment period (1946–1964) until either the death of the patient or the end of the calendar year 1990 were considered in the analysis. Estimates of expected numbers of cancer deaths were based on U.S. national mortality rates for the period 1958–1985. Patients were stratified into various categories of treatment, distinguishing those who received ¹³¹I as the only form of treatment from those who received antithyroid drugs or surgical treatments, alone or in combination with ¹³¹I. SMRs (observed/expected deaths) were calculated for various treatments (¹³¹I, surgery, antithyroid drugs, or combinations). This design allowed an assessment of the effects of possible associations between ¹³¹I exposure and cancer outcomes, independent of the potential effect of other treatments. The study identified 2,960 cancer deaths, 29 of which were classified as thyroid cancers. Among patients who received ¹³¹I as treatment alone (only ¹³¹I), SMRs were significantly elevated only for thyroid cancer (4.91; 95% CI, 2.45–8.79), but not for other cancers, or all cancers. Among all patients treated with ¹³¹I, alone or in combination with other treatments (any ¹³¹I), SMRs were also significantly elevated for thyroid cancer (3.94, 252–5.86), only. When stratified by latency (1–4 years, 5–9 years, 10 years or longer), in the latter group (any ¹³¹I), SMRs for thyroid cancer were highest 1–4 years after treatment (12.32, 6.38–21.61), but remained significantly elevated in the 10 years or longer group (2.78, 1.38–4.97). Radiation doses to specific organs were estimated for each patient based on the administered activity and dosimetry tables developed by the ICRP (1988). The estimated thyroid dose was 50–70 Gy (5,000–7,000 rad). When stratified by administered ¹³¹I activity (as a surrogate for thyroid dose), the SMRs for thyroid cancer in this group (any ¹³¹I) increased with increasing exposure, suggesting a possible dose effect on thyroid cancer mortality. The highest SMRs occurred in the group that received 15 mCi or more (7.05, 3.05–13.95), and in the group treated for toxic nodular goiter (18.88, 7.58–38.98), who would have received higher exposures and doses than Graves' disease patients (2.84, 1.62–4.61). SMRs for cancers in other tissues were also significantly elevated in the any ¹³¹I group; colorectal cancer, 1–4 years after treatment (1.42, 1.04–1.90); lung cancer 1–4 years (1.49, 1.01–2.12) and 5–9 years (1.41, 1.02–1.89) after treatment; and for non-chronic lymphatic leukemia, 5–9 years after treatment (2.10, 1.14–3.52). However, interpretation of these findings, in terms of the potential contribution of ¹³¹I to cancer mortality, is complicated by the finding of elevated SMRs in extra-thyroidal tissues in the groups that received treatments other than ¹³¹I, including buccal cavity, lung, breast, and brain. The results of this study indicate that high exposures to ¹³¹I for treatment of hyperthyroidism did not increase overall cancer mortality; however, it did appear to increase mortality for thyroid cancer. Interpretation of the effect on thyroid cancer mortality is

3. HEALTH EFFECTS

complicated by the potential impact of thyroid cancers that may have existed in these patients, undiagnosed, prior to the treatment. The observation that much of the apparent excess risk for thyroid cancer deaths occurred during the first 1–4 years after ^{131}I treatment, suggests a remarkably short latency for radiation-induced cancer mortality, or possibly other factors contributed to the outcome. Other uncertainties in this study include the use of exposure levels (mCi) as a surrogate for absorbed radiation dose to the thyroid. The relationship between administered activity and thyroid dose in hyperthyroid patients can be complicated by disease-related variation in thyroid gland size and iodide transport activity. Also, administered activity can co-vary with the severity of the initial hyperthyroidism; patients who received the highest activities tend to have the most severe disease, and disease severity could vary, independently with cancer mortality.

A retrospective cohort study conducted in Sweden examined cancer incidence among 10,552 patients (85% females; age 13–74 years) who received ^{131}I therapy for treatment of Graves' disease (51%) or toxic nodular goiter (42%) (Holm et al. 1991). The mean total activity administered was 506 MBq (13.7 mCi); however, this varied with the objectives of the therapy; 360 MBq (9.7 mCi) for treatment of Graves' disease and 700 MBq (18.9 mCi) for toxic nodular goiter. The distribution of the administered activity in the study population was as follows: 30% <220 MBq (5.9 mCi), mean, 150 MBq (4.1 mCi); 38% 221–480 MBq (6–13 mCi), mean 315 MBq (8.5 mCi); and 32% >480 MBq (13 mCi), mean 1,063 MBq (28.7 mCi). Cancers that occurred from 1 year after treatment (on or after 1958) until either the death of the patient or the end of the calendar year 1985 were considered in the analysis. Expected numbers of cancers were estimated from data from the Swedish Cancer Register for the period 1958–1985. Standard incidence ratios (SIR, observed/expected cancers) were significantly elevated for cancers of the lung (1.32, 95% CI, 1.07–1.59) and kidney (1.39, 95% CI, 1.07–1.76). Among toxic nodular goiter patients, who received, on average, twice the dose as Graves' disease patients, the SIR was also significantly elevated for liver cancer (2.14, 1.20–3.52). Among 10-year survivors, significantly elevated SIRs included stomach (1.33, 1.01–1.71), kidney (1.51, 1.06–2.08), and brain (1.63, 1.10–2.32). Doses to specific organs were estimated for each patient based on the administered activity and dosimetry tables developed by the ICRP (1988). Estimated average radiation doses to these tissues were: thyroid gland, >10,000 cGy (>10,000 rad); stomach, 25 cGy (25 rad); lung, 7 cGy (7 rad); kidney, 5 cGy (5 rad); liver, 5 cGy (5 rad); and brain (not reported). There were no significant dose trends. Notably, SIRs for thyroid cancer were not significantly elevated (SIR 1.29, 0.76–2.03). Some of the patients in this study received treatments other than ^{131}I for thyroid disorders, including antithyroid drugs (14%), surgery (3%), and/or thyroid hormone supplements (2%). Cancer mortality was examined in the same cohort (Hall et al. 1992a). Standard mortality ratios (SMRs) were calculated based on data from the Swedish Cause-of-

3. HEALTH EFFECTS

Death Registry. SMRs were significantly elevated for all cancers (1.14, 1.04–1.24), digestive tract cancers (1.28, 1.16–1.45), and respiratory tract cancers (1.31, 1.01–1.66) among patients who had greater than a 10-year follow up from the date of their exposure to ^{131}I , and for thyroid gland cancer during the first year (11.45, 2.8–33.72). There were no significant dose trends, although the SMR for thyroid gland cancer was approximately 4 times higher in patients who received >480 MBq (13 mCi) than in patients who received <221 MBq (6 mCi). The results of this study suggest that exposure to high levels of ^{131}I for treatment of hyperthyroidism increases cancer risk; however, several uncertainties complicate the interpretation of results, in terms of the contribution of ^{131}I to the elevated cancer risk. These include the lack of a dose trend for increased cancer incidence or mortality, and the potential contribution of treatments, other than ^{131}I to cancer incidence and mortality, which were not quantified in this study. Surgical treatment and antithyroid drug therapy appear to be cancer risk factors in hyperthyroid patients (Ron et al. 1998).

A retrospective study examined cancer morbidity and mortality in 7,417 patients (83% females; mean age, 57 years \pm 13, SD) treated for hyperthyroidism in the West Midlands region of the United Kingdom during the period 1950–1991 (Franklyn et al. 1999). The mean total activity administered was 308 MBq (8.3 mCi); 49% received <220 MBq (<6 mCi) and 17% received >481 MBq (>13 mCi). The follow-up period ranged from 1 year (74%) to ≥ 20 years (18%). Estimates of expected numbers of cancer deaths in England and Wales were based on International Agency for Research on Cancer (IARC) and World Health Organization (WHO) data. The SIR for all cancer types was 0.83 (95% CI, 0.77–0.90). The SIR for thyroid cancer was 3.25 (1.69–6.25) and for cancer of the small bowel, 4.81 (2.16–10.72). SIRs for all other cancers were <1 . Similarly, SMRs were 0.90 (0.82–0.98) for all cancer types, 2.78 (1.16–6.67) for thyroid cancer, and 7.03 (3.16–15.66) for cancer of the small bowel. Significant positive trends for increasing incidence with increasing cumulative radiation exposure were observed for bladder cancer and uterine cancer, although SIRs and SMRs for these cancers were not significantly greater than 1. The results of this study, consistent with those of the Hall et al. (1992a) and Ron et al. (1998), suggest that exposure to high levels of ^{131}I for treatment of hyperthyroidism increases the risk of cancer mortality; however, similar to the Hall et al. (1992a) study, the potential contribution of treatments other than ^{131}I (e.g., surgical treatment and antithyroid drug therapy, Ron et al. 1998), to cancer incidence and mortality, were not quantified in this study. Surgical treatment and antithyroid drug therapy appear to be cancer risk factors in hyperthyroid patients (Ron et al. 1998). Other potential uncertainties in interpreting the Franklyn et al. (1999) study include: (1) thyroid radiation doses were not reported; thus, it is difficult to compare the doses received to subjects in this studies with those in the Ron et al. (1998), Holm et al. (1991), and Hall et al. (1992a) studies; (2) the Franklyn et al. (1999) study did not stratify the subjects by

3. HEALTH EFFECTS

radiation exposure or dose, which may have varied depending on the nature of the original diagnosis of hyperthyroidism; and (3) the size of the cohort in the Franklyn et al. (1999) study was smaller than the other three studies (7,417 compared to 35,593 in Ron et al. 1998 study, and 10,552 in Holm et al. 1991 study).

A follow-up cohort study was conducted of cancer morbidity and mortality among 1,762 women who received ablative ^{131}I therapy for hyperthyroidism during the period 1946–1964 (Goldman et al. 1988). The follow-up period was 17 years. SMRs and SIRs were estimated based on age-, date-, sex-, and race-specific mortality incidence and mortality of the United States or Massachusetts population. The cohort was stratified into treatment categories that included only ^{131}I or ^{131}I in addition to other therapies for hyperthyroidism. SIRs in the ^{131}I -only group were not significantly elevated for any cancer type or group. SMRs in the ^{131}I -only group were significantly elevated for cancers of all causes (SMR, 1.2, 1.1–1.4, 95% CI, 10 cases). There were no significant radiation dose trends. Exposures ranged from 0.1 to >10 mCi (4–370 MBq). Although, like the Ron et al. (1998) study, cancer mortality risk was evaluated in patients who received only ^{131}I as treatment, the much smaller size of the Goldman et al. (1988) study makes it difficult to interpret comparisons of results to those from the Ron et al. (1998) study. Like the Ron et al. (1998) study, Goldman et al (1988) found elevated cancer mortality in patients who received treatments other than ^{131}I .

A follow-up study was conducted of cancer morbidity among 1,771 patients (21% males) who received ablative ^{131}I therapy for treatment of thyroid cancer during the period 1950–1990 (de Vathaire et al. 1997). The follow-up period was 10 years. Excess relative risk (ERR) was modeled using linear models (a quadratic model was also explored), taking into account sex, age at time of treatment, and cumulative activity of ^{131}I administered as variables. The mean administered activity of ^{131}I was 7.2 GBq (range, 3.8–57.6; 195 mCi, range, 103–156 mCi) which corresponded to a mean radiation dose to bone marrow of 0.34 Sv (range, 0.13–2.8; 34 rem, range, 13–280 rem). Using the cancer outcomes of patients who received 1–0.19 GBq of ^{131}I as the reference group, ERRs for colorectal cancer increased with increasing administered activity. In the patient group that received >3.7–7.5 GBq (>100–203 mCi) the ERR was 4.0 (90% CI, 1.3–12.2) and in the group that received >7.5 GBq (>203 mCi), the ERR was 4.9 (1.2–18.5). While this is a relatively small study, it supports an outcome of the much larger Ron et al. (1998) study in which SMRs for colorectal cancer were elevated among patients who received lower administered activities of ^{131}I for treatment of hyperthyroidism (mean 10.4 mCi, 385 MBq).

3. HEALTH EFFECTS

Diagnostic Doses of Radioiodine

A retrospective cohort study examined thyroid cancer incidence among 34,104 patients (80% females, 1–75 years of age) in Sweden who received ^{131}I for diagnosis of thyroid disorders during the period 1950–1969. The follow-up period was from 1958 to 1990 (Hall et al. 1996b). A total of 2,408 patients (7%) were exposed before 20 years of age and 316 patients were exposed before 10 years of age (1%). The diagnostic test was for a suspected thyroid tumor in 10,785 (32%) patients and for hypothyroidism, hyperthyroidism, or other reasons in 23,319 (68%) patients. The follow-up period ranged from 5 to 39 years after exposure (thyroid cancers detected within 5 years of the diagnostic test were excluded on the basis that they may have been related to cancer present at the time of the diagnostic test). The mean total activity administered was 2.4 MBq (65 μCi) for patients suspected of having a thyroid gland tumor and 1.6 MBq (43 μCi) for other patients. Radiation doses to the thyroid gland were estimated for each patient based on the administered activity and dosimetry tables developed by the ICRP (1988). The mean absorbed dose was 1.3 Gy (130 rad) for suspected thyroid tumor patients and 0.8 Gy (80 rad) for other patients. SIRs were calculated based on sex-, age-, and date-adjusted cancer incidence rates based on the Swedish Cancer Registry. Sixty-seven thyroid tumors were identified during the period of the study, of which 42 (63%) were in patients who received ^{131}I for diagnosis of a suspected thyroid gland tumor. SIRs were significantly elevated only in the latter group (2.86, 95% CI, 2.06–3.86), but not in patients tested for other suspected thyroid disorders. There were no significant dose trends for thyroid cancer in either group, and the presence of cancer may have predated the exposures to ^{131}I . A subsequent follow-up of this same cohort was conducted, which extended the follow-up period an additional 8 years from that reported in Hall et al. (1996b) and included thyroid cancers diagnosed as early as 2 years after diagnostic administration of ^{131}I , making the follow-up period 2–47 years (Dickman et al. 2003). Patients (1,767) who received diagnostic X-rays to the neck, prior to receiving ^{131}I , were also included in the study to explore the effects of external radiation on thyroid cancer incidence. Among patients who did not receive X-rays to the neck and who were not referred for diagnostic ^{131}I for suspicion of a possible thyroid tumor, the SIR for thyroid cancer was 0.91 (95% CI, 0.64–1.26). The estimated dose to the thyroid in this group was 0.94 Gy (94 rad). However, among patients who did receive X-rays prior to ^{131}I , the SIR was 9.8 (6.3–14.6). The results support the previous findings in this cohort (Hall et al. 1996b) that radiation doses to the thyroid resulting from diagnostic administration of ^{131}I are not associated with excess risk of thyroid cancer. The study also identifies X-ray exposures as an important variable that, if not controlled for, could confound studies of cancer outcomes in patients exposed to ^{131}I .

The incidence of cancer in extrathyroidal organs was examined in this same cohort (Holm et al. 1989). At that time, the cohort consisted of 35,074 patients, 31% of whom received ^{131}I for diagnosis of a suspected

3. HEALTH EFFECTS

thyroid gland tumor, 42% for suspected hyperthyroidism, 16% for suspected hypothyroidism, and 8% for other reasons (the basis for the diagnostic procedure could not be determined for 3% of the patients). The mean total activity administered was 52 μCi (range 1–960 μCi) (1.9 MBq, 0.04–36 MBq). The mean total administered activity was 71 μCi (2.6 MBq) for patients suspected of having a thyroid tumor, 48 μCi (1.8 MBq) for diagnostic tests for hyperthyroidism, and 40 μCi (1.5 MBq) for other diagnostic purposes. SIRs were significantly elevated for cancers of the endocrine organs other than thyroid gland (1.93, 1.62–2.29), lymphomas (1.24, 1.03–1.48), and leukemias (1.34, 1.11–1.60). The SIR for nervous system cancers was 1.19 (1.00–1.41). The SIR for thyroid cancer was significantly elevated only in the 5–9-year period of follow-up. There were no significant dose trends. In this study, unlike the Hall et al. (1996b) study, SIRs were calculated for all patients, regardless of the intended purpose of the diagnostic test, including patients who were administered ^{131}I for the diagnosis of suspected thyroid tumors.

A smaller retrospective cohort study compared thyroid cancer incidence among 789 patients (74% females) in Germany who received ^{131}I for diagnosis of thyroid disorders before the age of 18 years with 1,118 patients who received a diagnostic procedure on the thyroid that did not involve radioiodine (68% females) (Hahn et al. 2001). Diagnostic procedures occurred between 1958 and 1978 in the treatment group, and between 1959 and 1978 in the control group. The diagnosis made at the initial referral in the treatment groups was nodular goiter in 385 (49%) in patients, *no evidence of thyroid disease* in 199 (25%) patients, and hypothyroidism, hyperthyroidism, or other reasons in 205 (26%) patients. In the control group, the diagnoses included 600 (54%) cases of goiter, 327 (29%) of *no evidence of thyroid disease*, and 131 (12%) hypothyroidism, hyperthyroidism, or other reasons. Patients who had a history of external radiotherapy of the head or neck regions or thyroid cancer were excluded from the study. The follow-up period (1989–1997) ranged from 13 to 33 years in the treatment group and 9–33 years in the control group. The median total ^{131}I activity administered in the treatment groups was 0.9 MBq (24 μCi). Radiation doses to the thyroid gland were estimated for each patient based on the administered activity and dosimetry tables developed by the ICRP (1988). The mean absorbed dose was 1.0 Gy (100 rad); however, this varied with age of diagnosis; the range was 0.6–1.2 Gy (60–120 rad). SIRs were calculated based on sex-, age-, and date-adjusted cancer incidence rates based on the German Democratic Republic cancer registry for the period 1980–1989. Three cases of thyroid cancer were identified in the treatment group during the study period and two cases in the control group. SIRs were 5.3 (95% CI, 0.5–15.1) in the treatment group and 5.3 (1.1–15.3) in the control group. The relative risk (treatment compared to control) was 0.9 (0.1–5.1). Risk of thyroid cancer was not significantly associated with exposure to diagnostic levels of ^{131}I . A complication in the interpretation of these findings is that the response rate was very low: 3 cases in 1,058 patients, 0.28%; 2 in 795 in the treatment group.

3. HEALTH EFFECTS

A prospective study examined thyroid outcomes of children and adolescents (<20 years old) who received diagnostic doses of ^{131}I during the period 1946–1967 (Hamilton et al. 1987). Study groups consisted of 3,503 subjects who received diagnostic ^{131}I , 2,495 control subjects who did not receive ^{131}I and who were matched with the exposed subjects by sex-, age-, and diagnostic-test date, and a group of 1,070 siblings of the control group. The follow-up period was from entry into the study until 1986. Participants were surveyed with a questionnaire to identify those who had thyroid or neck surgery during the study period, and pathology reports and specimens were retrieved and reviewed by a panel of pathologists; neoplasms were classified and the results were compared with hospital pathology reports. The dose to the thyroid gland was estimated for each exposed subject based on the reported activity administered, percent thyroid uptake, and thyroid weight estimated from published thyroid growth tables. The median total absorbed dose was 20–40 rad (0.2–0.4 Gy) (95th percentile, 200–330 rads 2–3 Gy). The survey response rate was 63%. A total of 34 surgeries were reported, of which 19 were on subjects who did not have any thyroid disorder diagnosed at the time of entry into the study; 16 of these subjects had confirmed thyroid tumors; 10 benign, 8 of which occurred in the exposed group, and 6 malignant tumors, 5 of which occurred in the exposed group. Although these results are suggestive of a possible effect of ^{131}I exposure on thyroid tumor incidence, the differences between the exposed and control groups were not statistically significant. Shore (1992) reviewed the results of the Hamilton et al. (1987) study and calculated a relative risk for thyroid cancer of 2.9 (90% CI, 0.6–15) based on the internal comparison of the exposed and unexposed groups in the Hamilton et al. (1987) study. Based on the Surveillance, Epidemiology and End Results (SEER) cancer data for 1973–1981 (U.S. DHHS 1985), 3.7 thyroid cancers would have been expected in the Hamilton et al. (1987) study, compared to the 4 observed during the period of 5 or more years after the diagnostic test (one of the cancers reported in the Hamilton et al. (1987) study occurred with a latency of 2 years), which, according to Shore (1992), indicates an SIR of 1.1 (95% CI, 0.3–2.6).

Marshall Islands Nuclear Bomb Test BRAVO. Several epidemiological studies have examined thyroid gland disorders in residents of the Marshall Islands who were exposed to radioiodine from atmospheric fallout resulting from nuclear bomb tests (including the so-called BRAVO test; see Section 3.3.2 for a more detailed discussion of exposures from the Marshall Islands BRAVO test). A more complete discussion of these studies is presented in Section 3.3.1.2 (Endocrine), as the studies provide dose-response information on thyroid disorders other than cancer. However, cancer outcomes have been examined in what has become known as the BRAVO cohort, as well as in larger samples of the Marshall Island population. Almost all that is known about radioiodine doses to the thyroid from the BRAVO test exposures derive from a few urinary measurements collected 15 days after the exposures. These have

3. HEALTH EFFECTS

been estimated to have been (external and internal): 3.3–20 Gy (330–2,000 rad) on Rongelap (highest doses in children), 1.3–4.5 Gy (130–450 rad) on Ailingnae, and 0.3–0.95 Gy (30–95 rad) on Utrik (Conard 1984). The BRAVO test was not the only potential source of radioiodine exposure in the Marshall Island population, as numerous bomb tests were conducted in the Marshall Islands during the period 1946–1958.

The strengths of the Marshall Island studies include the relatively high range of thyroid radiation doses and the multiple thyroid screenings, which included, in the more recent studies, relatively objective assessments of nodularity by ultrasound. Limitations of the studies include: (1) large dose uncertainties in terms of total thyroid dose; (2) further dose uncertainties in terms of the fraction of the dose that was from ^{131}I rather than from short-lived isotopes of iodine and gamma radiation; (3) no attempt to estimate individual thyroid doses; (4) inequities between the exposed and unexposed populations in the intensity of thyroid screening; (5) the relatively small number of exposed subjects in the BRAVO cohort; (6) the potential confounding effects of prophylactic iodide administration and thyroid surgery in highly exposed subjects; and (7) thyroid radiation dose estimates not available for larger scale studies of populations in the Marshall Islands.

Evidence for a higher prevalence of thyroid cancer among the original 250 people known to have been heavily exposed as a result of the BRAVO incident has not been established; however, this may reflect the small size of the cohort (see section 3.3.2 for a more detailed discussion of exposures from the Marshall Islands BRAVO test). In 1982, a review of the diagnoses for thyroid nodules detected in 250 exposed and 1,303 nonexposed Marshallanese revealed 9 definitive carcinomas (3.6%) and 7 adenomas (2.8%) in the exposed group, and 6 carcinomas (0.5%) and 14 adenomas (1%) in the nonexposed comparison group (Conard 1984). Subsequent reviews of the thyroid pathology more or less agree with the conclusions of Conard (1984), although differences in the composition of comparison group have contributed to slightly different estimates of prevalence in the nonexposed population. For example, Howard et al. (1997) reported four cancers (1.8%) and one adenoma (0.4%) in a nonexposed comparison group. Takahashi et al. (1997) reviewed diagnoses of 22 cases of thyroid nodularity discovered in 1993 in an ultrasound screening program that evaluated 1,275 Marshall Island residents (mainly from Ebeye). The prevalence of thyroid cancer among patients referred for surgery-based thyroid gland ultrasound assessments suggested an overall prevalence of thyroid cancer of approximately 1.2% (15/1,275) in the population evaluated, or a 12% prevalence (15/123) of thyroid cancer among those who had palpable nodules. A follow-up to this study included the results of thyroid disease screening of 3,709 Marshall Island residents who were born before the BRAVO test and who lived anywhere in the

3. HEALTH EFFECTS

Marshall Islands during the period of bomb testing. The study group included an estimated 60% of the still-living population who resided in the Marshall Islands during this period. Combining findings from the previous study (Takahashi et al. 1997) and the follow-up, a total of 57 thyroid cancers were identified (1.5%), of which 92% were diagnosed as papillary cancers. Several factors confound attempts to associate thyroid cancers in the Marshall Islands population with radioiodine exposures, including lack of definitive dosimetry, outside of the small BRAVO cohort. Changes occurred in diagnostic techniques used to detect thyroid nodules, which would direct further diagnostic attention; in particular, the use of ultrasound for detecting small thyroid nodules began only in 1994. More recent studies have also suggested a relatively high prevalence of iodine deficiency in the Marshall Islands, which may have affected background thyroid cancer prevalence (Takahashi et al. 1999).

Nevada Test Site Nuclear Bomb Tests. During the period 1951–1958, 119 atmospheric nuclear bomb tests were conducted at the Nevada Test Site (NTS) in southern Nevada (NCI 1997). These tests were followed by 9 surface detonations during the period 1962–1968 and approximately 809 below-ground tests, of which 38 were determined to have resulted in off-site releases of radioactive materials. A dose estimation methodology was developed by the National Cancer Institute (NCI 1997), which has enabled estimation of population radiation doses to the thyroid gland from direct and indirect (e.g., *in utero*, ingestion of cow milk) exposures to ^{131}I resulting from the NTS activities for the purpose of health assessments and epidemiologic investigations (Gilbert et al. 1998; Kerber et al. 1993). A discussion of the uncertainties and limitations of these population dose estimates for use in epidemiology studies and risk assessment can be found in a review of the NCI (1997) dose estimations conducted by the Institute of Medicine and the National Research Council (NRC 1999).

The strengths of the NTS studies described above include the attempt to develop a systematic sampling frame, the careful, multiple thyroid screenings (two or more times), the relatively high follow-up rate, and the extensive attempt to characterize individual ^{131}I doses. Limitations of the studies include: (1) the substantial dose uncertainties, since no thyroid exposure measurements were available and individual milk and vegetable consumption was recalled more than 30 years after the fact; (2) the food-consumption and behavioral questionnaire was conducted after subjects knew their thyroid outcomes; (3) the modest sample size and, therefore, small number of thyroid neoplasms found, which limited the statistical power and precision; (4) the relatively low dose range, which also limited the statistical power and precision; (5) the restriction of the thyroid examinations to palpation (no ultrasound); and (6) the fact that the thyroid examinations were only partially blinded (i.e., examiners often knew the subject's geographic region).

3. HEALTH EFFECTS

A cohort study examined thyroid nodularity and performed diagnostic follow up in 2,678 adolescents (age 11–18 years) who resided in Utah or Nevada near the NTS during the early 1950s and in a comparison population of 2,132 adolescents who lived in Arizona. Examinations were conducted during the period 1965–1970 (Rallison et al. 1974). In a follow-up study conducted in 1985–1987, 1,962 of the original Utah-Nevada group and 1,160 from the Arizona group were reexamined (Rallison et al. 1990). Radioiodine doses were estimated for each Utah-Nevada subject based on histories of residence, local milk and leafy vegetable consumption, records of transport and deposition of radionuclides at their town and/or county of residence, and age-specific transfer factors relating iodine ingestion with iodine uptake in the thyroid gland (Kerber et al. 1993; Simon et al. 1990). Mean thyroid dose estimates were 150 mGy (15 rad) (maximum 4.6 Gy, 460 rad) in the Utah group, 50 mGy (5 rad) (maximum 0.84 Gy, 84 rad) in the Nevada group, and 13 mGy (1.3 rad) (maximum 0.45 Gy, 45 rad) in the Arizona group (the group names refer to cohort designations used in the study, which were based on the place of residence during the potential exposure period, and not necessarily where the entire radiation dose for each individual was received). In the 1965–1968 examinations, 76 of 4,819 people examined had palpable thyroid gland nodules, 22 of which were subsequently diagnosed as adenomas (20) or carcinomas (2). The prevalence of nodules was higher in the Utah-Nevada group (19.7/1,000) than in the Arizona group (10.8/1,000). Fifteen of the 22 neoplasms were found in the Utah-Nevada group (5.6/1,000) and 7 in the Arizona group (3.3/1,000) (Rallison et al. 1974). In 1985–1987, 125 new cases of thyroid nodularity were identified, 65 of which were diagnosed as neoplasms and 5 of the latter were carcinomas. Five carcinomas were reported in the group during the interval between the two examinations. Combining the results of the first and second evaluations, including the five carcinomas observed during the interval (a total of 12 carcinomas), resulted in similar prevalences in the two groups for nodules (Utah-Nevada 48.6/1,000, Arizona 36.6/1,000). Prevalence of neoplasms was not disparate: Utah-Nevada, 2.8/1,000 and Arizona, 4.8/1,000 (Rallison et al. 1990). Thyroid nodules were detected in 56 of 2,473 subjects; 38 of these lesions were diagnosed as nonneoplastic (28 were colloid adenomas, the other 10 were miscellaneous nonneoplastic lesions), 11 were benign adenomas (of these, 8 were follicular adenomas and there was one each of papillary, fetal, and Hurthle cell adenomas), and 8 were papillary carcinomas (Rallison 1996). Stratifying the outcomes by estimated thyroid radiation dose revealed a significant dose trend for neoplasms, but not for all nodules or for carcinomas alone. The group that received a dose exceeding 0.25 Gy (25 rad) had a thyroid neoplasm prevalence of 21–24/1,000, whereas groups that received <0.25 Gy had a prevalence of 4–5/1,000. The excess relative risk estimates per Gy were: neoplasms, 7.0 (lower 95% confidence limit [CL], 0.74, $p=0.019$); nodules, 1.2 (95% CL<0, $p=0.16$); and carcinomas, 7.9 (95% CL<0, $p=0.096$) (Kerber et al. 1993).

3. HEALTH EFFECTS

In a large scale ecological study, mortality and incidence of thyroid cancer in 3,053 U.S. counties were compared to estimated exposures to ^{131}I from releases from the NTS (Gilbert et al. 1998). Thyroid cancer mortality data were obtained from the National Center for Health Statistics for 1957–1994 and thyroid cancer incidence data from SEER for the period 1973–1994. County-specific or state-specific cumulative radiation doses were reconstructed based on NCI (1997) and were as follows (cGy, where 1 cGy = 1 rad): *in utero*, 4.3 cGy; 0–<1 year, 12.6 cGy; 1–4 years, 10.0 cGy; 5–9 years, 6.7 cGy; 10–14 years, 4.4 cGy; 15–19 years, 3.1 cGy; \geq 20 years, 1.1 cGy. During the study period, there were 12,657 cases of thyroid cancer and 4,602 thyroid cancer deaths. Age-, calendar-, sex-, and count-specific mortality and incidence rates in the United States were analyzed in relation to ^{131}I dose estimates, taking into consideration geographic location, age at exposure, and birth cohort. There were no significant dose-related trends (linear excess relative risk model) in either thyroid cancer mortality or incidence when all exposure age groups were composited or when exposure age groups 1–5 years or 1–15 years were considered separately. However, when the exposure age group <1 year was analyzed, a dose trend was weakly suggested by highly positive excess relative risks (ERR) for thyroid cancer deaths when doses were county-specific (ERR 10.6 per Gy, 95% CI, -1.1–29, $p=0.085$) or state-specific (16.6 per Gy, -0.2–43, $p=0.054$), and for thyroid cancer incidence when doses were county-specific (2.4 per Gy, -0.5–5.6). These outcomes were strongly influenced by two deaths and nine cases of thyroid cancer that occurred in individuals who received estimated cumulative doses exceeding 9 cGy (9 rad) before they were 12 months of age.

Chernobyl Nuclear Power Plant Accident. Clinical records and cancer registries from the Republics of Belarus and Ukraine show an increase in the incidence of thyroid cancer in children and adolescents, which became apparent approximately 4 years after the release of radioactive materials from the Chernobyl nuclear power plant in April 1986, but which has not been increasing in recent years, especially among those exposed at older ages (Cherstvoy et al. 1996; Drobyshevskaya et al. 1996; Prisyazhuik et al. 1991; Tronko et al. 1996) (see Section 3.3.2 for a more detailed discussion of exposures from the Chernobyl accident). Belarus recorded an annual incidence of 0.09 cases per 100,000 in 1986 among children between the ages of 4 and 17 years and 2.46 per 100,000 in 1991, with the highest incidence in the Gomel oblast; from 0.24 cases per 100,000 in 1986 to 12.5 per 100,000 in 1991 (Drobyshevskaya et al. 1996). In the Ukraine, annual incidence of thyroid cancer in children and adolescents (under 15 years of age) increased from approximately 0.05 per 100,000 prior to 1986 to 0.43 per 100,000 in 1992 (Tronko et al. 1996). In 1994, the incidence (per 100,000) was highest in regions nearest to Chernobyl: Chernihiv, 3.8; Zhytomyr, 1.6; and Kiev, 1 (Tronko et al. 1996). Jacob et al

3. HEALTH EFFECTS

(1998) estimated excess absolute risk of thyroid cancers in Belarus and Northern Ukraine for the period 1991–1995 using the cancer incidence in southern Ukraine as the control. The relationship between thyroid cancer risk and the estimated radiation dose to the thyroid was linear, with a slope of 2.3 (95% CI 1.4–3.8) per 10,000 person-year Gy. Although the available data strongly show that radiation exposure from the accident has led to the excess risk of thyroid cancer, especially in persons exposed as children, there is also much uncertainty in the radiation dose estimates. The observed trends for increased prevalence of thyroid cancer, as well as the magnitude of the thyroid cancer risk associated with radioiodine are highly uncertain because of factors that complicate the epidemiological picture, including the contribution external exposure, the effect of the intensive screening for thyroid cancer that followed the accident (Astakhova et al. 1998) on the baseline incidence of thyroid cancer, and the potential effects of iodine deficiency and endemic goiter in the population (Gembicki et al. 1997; Robbins et al. 2001).

The relationship between childhood thyroid cancer and radiation exposure was examined in a case-control study of children from Belarus (Astakhova et al. 1998). Cases included all children under age 15 years at the time of the accident who had confirmed pathology diagnoses of thyroid cancer during the period 1987–1992 and who could participate in the study (107 of 131 applicable cases in Minsk State Medical Institute records). Cases were matched with two control groups; one control group (Type 1) was randomly selected from an area of Belarus thought to have relatively low or no exposures from the Chernobyl accident (Brest, Grodno, and Vitebsk oblasts in north and west Belarus) but was otherwise matched with cases for age, sex, and urban/rural residence. A second control group (Type 2) was drawn from each Belarus district, including the more heavily exposed oblasts near Chernobyl (Minsk, Mogilev, and Gomel), in numbers proportional to the population census and was matched to cases by pathway to diagnosis, in addition to age, sex, and urban/rural residence. The objective of matching the pathway to diagnosis was to control for screening intensity as a possible contributor to an increased incidence. Diagnosis pathways were classified into three elements: (1) systematic endocrine screening; (2) incidental finding during physical examination not necessarily related to the Chernobyl releases; or (3) examination prompted by referral because of a swelling of the neck or other symptoms of possible thyroid enlargement or nodularity.

Average thyroid radiation doses were reconstructed based on thyroid gland ^{131}I measurements made on 200,000 residents of Belarus, after the Chernobyl release, and estimates of cow milk contamination and consumption for the area of residence of each case or control (vegetable and goat milk consumption was not included in the exposure estimates). If no cow milk consumption was thought to have occurred, exposure was assumed to have occurred principally from inhalation. Age-group thyroid doses were

3. HEALTH EFFECTS

constructed for each area of residence included in the study. Mean (standard deviation) of thyroid doses in the case group and controls were as follows: cases, 535 mGy (848) mGy; Type I controls, 188 mGy (386); and Type II controls, 207 mGy (286). For the purpose of estimating odds ratios (ORs), cases and controls were stratified into three thyroid dose categories. The resulting estimated dose distributions among thyroid cancer cases were 64/107 (59.8%) in the <0.3 Gy dose category, 26/107 (24.3%) in the 0.3–0.99 Gy dose category, and 17/107 (15.9%) in the \$1 Gy dose category. The corresponding distributions in Type 1 controls were 88/107 (82.2%) for <0.3 Gy, 15/107 (14.0%) for 0.3–0.99 Gy, and 4/107 (3.7%) \$1 Gy. The corresponding OR for the \$0.3 Gy category compared to <0.3 Gy was 3.11 (95% CI, 1.67–5.81) and for the \$1 Gy category compared to <0.3 Gy was 5.84 (1.96–17.3). ORs were significant when Type 2 controls were the comparison group (controls for pathway to diagnosis). For routine endocrine screening, ORs were 2.08 (1.0–4.3) for comparison of the dose categories \$0.3 Gy and <0.3 Gy, and 5.04 (1.5–16.7) when the dose category \$1 Gy was compared to <0.3 Gy. The OR for incidental findings was significant, 8.31 (1.1–58) when the dose category \$0.3 Gy was compared to <0.3 Gy. These results suggest that, after controlling for the effects of intensive screening for thyroid cancer that occurred after the accident, radiation dose to the thyroid gland was a significant contributor to thyroid cancers diagnosed in children who lived in Belarus during and after the Chernobyl releases and that this contribution is evident at doses exceeding 0.3 Gy. The OR estimates, however, are highly uncertain because of the relatively large uncertainties in the dose estimates.

An analysis of 251 thyroid cancer cases in children (14 years or younger) from Belarus who were diagnosed during the period 1986–1993 revealed a dose trend in incidence when the cases were organized by districts that reflected their respective mean thyroid doses (Drobyshevskaya et al. 1996). Incidence ranged from 81 to 201 per 100,000 where estimated average thyroid doses were above 1 Gy (1.2–1.6 Gy, 120–160 rad), and 14–55 per 100,000 where doses were between 0.1 and 0.5 Gy (10–50 rad). The highest incidence occurred in Bragin where individual thyroid doses were estimated to have ranged from 0.8 to 20 Gy (560, 80–2,000 rad) (mean, 5.6 Gy, 560 rad). Incidence was 9 per 100,000 in Braslav where the lowest measurable thyroid doses were reported (mean, 0.005 Gy, 0.5 rad). Children who were under 3 years old or *in utero* at the time of exposure accounted for 53% of thyroid cancer cases. This age-group was estimated to have received a thyroid radiation dose that was approximately 2–3 times that for older children (approximately 1.4 Gy average dose). However, 52% of the cancers were diagnosed in children who received an estimated thyroid dose of <0.3 Gy and 84% in children who received doses <1 Gy. Children under 3 years old accounted for 38% of the cancer cases among children exposed to <0.3 Gy. These results suggest that young children were particularly susceptible to lower radiation doses.

3. HEALTH EFFECTS

An analysis of 531 thyroid cancer cases in children and adolescents (under 18 years of age) from Ukraine who were diagnosed during the period 1986–1994 revealed that 55% of the cases were under age 6 years on the date of the Chernobyl release (Tronko et al. 1996). The annual incidence of thyroid cancer in children and adolescents (under 19 years of age) increased from approximately 0.05 per 100,000 prior to 1986 to 0.43 per 100,000 in 1992. In 1994, the incidence (per 100,000) was highest in regions nearest to Chernobyl: Chernihiv, 3.8; Zhytomyr, 1.6; and Kiev, 1 (Tronko et al. 1996). Thyroid radiation doses were estimated to have ranged from 0.01 to >1.5 Gy in the case group analyzed. Approximately 20% of the cases were estimated to have been exposed to 0.01–0.05 Gy (1–5 rad) and 80% to 0.1–0.3 Gy or less (10–30 rad).

A comparison of the demographics and pathology of thyroid cancers in Belarus and Ukraine, following the Chernobyl accident, with those diagnosed in Italy and France during the same time period also is suggestive of unique causes for the thyroid cancers in Belarus and Ukraine (Pacini et al. 1997). Thyroid cancers cases in 472 children and adolescents <21 years of age diagnosed in Belarus and Ukraine during the period 1986–1995 were evaluated. These included approximately 98% of all childhood cases reported during that period. The comparison group consisted of 369 cases of the same age groups consecutively diagnosed at two clinics in Italy (n=219) and France (n=150). The study revealed several differences in the Belarus-Ukraine cases when compared with the Italy-France cases. Most of the Belarus-Ukraine cases were 5 years of age or less, whereas most of the Italy-France cases occurred after age 14 years. The female:male ratio of the Italy-France cases was significantly higher (2.5) than the ratio in the Belarus-Ukraine cases (1.6). Most (94%) of the Belarus-Ukraine cases were papillary carcinomas with follicular carcinomas accounting for only 5% of cases, whereas 82% of the Italy-France cases were papillary and 15% were follicular carcinomas. Cancers diagnosed in the Belarus-Ukraine group, typical of thyroid cancer in early childhood, tended to be more invasive with extrathyroidal involvement more frequently than in the Italy-France cases. The Belarus-Ukraine cases also had a higher incidence of thyroid autoimmunity (i.e., elevated antithyroid peroxidase and thyroglobulin antibodies) than the Italy-France cases. These results suggest different factors contributed to the Belarus-Ukraine and Italy-France cases, radiation dose possibly being at least one factor.

In both Belarus and the Ukraine, the highest rates of childhood thyroid cancer have occurred in areas where exposure to other industrial contaminants are likely to have occurred and where there is evidence for widespread iodine deficiency. These factors may have affected the early appearance of thyroid cancer after the accident, when vigorous public health screening programs for thyroid abnormalities were

3. HEALTH EFFECTS

initiated. The incidence of thyroid cancer prior to the accident in these areas was poorly documented (Nikiforov and Fagin 1998).

The strengths of the Chernobyl thyroid studies described above include: (1) the large number of children who received substantial thyroid doses; (2) the studies included thyroid exposure measurements on more than 100,000 children; (3) the generally high level of thyroid surveillance in the population after the accident; and (4) that many children were screened with ultrasound, which provides relatively objective evidence of thyroid nodularity; one study (Astakhova et al. 1996) attempted to control for the intensity of thyroid surveillance. Limitations of these studies include: (1) substantial dose uncertainties and use of average doses in many of the studies rather than estimates of individual doses; (2) no thyroid dose estimates for many of the thyroid cancer cases; (3) the presence of iodine deficiency in the study populations may have affected both the thyroid radiation dose received from ^{131}I as well as the likelihood of a thyroid neoplasm; (4) greater intensity of thyroid screening and surveillance in the areas of highest exposure than in areas of lower exposure; and (5) lack of rigorous epidemiologic study designs in many of the studies (i.e., no systematic sampling design, no blinding of examiners with respect to likely thyroid dose, and irregular variations in thyroid screening). Several international efforts are underway to address these issues and to provide better information on health risk associated with the exposures that occurred following the Chernobyl accident (UNSEAR 2000).

Hanford Nuclear Site Releases. The CDC (2002) has conducted a follow-up prevalence study of thyroid cancer in populations that resided near the Hanford Nuclear Site in southeastern Washington during the period 1944–1957. The study included 3,441 subjects who were born during the period 1940–1946 in counties surrounding the Hanford Nuclear Site. Thyroid disease was assessed from a clinical evaluation of each subject, which included assessments of ultrasound or palpable thyroid nodules. Historical information on thyroid disease and information on radiation exposures were obtained by interviews and, when possible, review of medical records of participants, including pathology slides to confirm cancer diagnosis. Thyroid radiation doses were estimated using a dosimetry model developed in the Hanford Environmental Dose Reconstruction Project. Information on residence history and relevant food consumption patterns (e.g., milk consumption, breast feeding, consumption of locally harvested produce) for each study participant was obtained by interview. The estimated mean thyroid radiation dose, based on 91 participants, was 174 mGy (± 224 , standard deviation [SD]) (17.4 ± 22.4 rad), and the range was 0.0029–2,823 mGy (0.00029–282 rad). Doses varied geographically, with the highest doses received by people who lived near and downwind from the site. Dose-response relationships were assessed using a linear regression model with adjustments for the following confounding and effect modifying variables:

3. HEALTH EFFECTS

sex, age of first exposure, age of evaluation, ethnicity, smoking, and potential exposures from Nevada Test Site releases. Alternatives to the linear model were also explored including linear quadratic and logistic models. Incidences of thyroid carcinoma or nodules were found to be unrelated to thyroid radioiodine dose. As noted above, a final report of conclusions has not been published and the study is currently under review by the National Research Council. Strengths of the Hanford study include: (1) the extremely careful study design and methods; (2) the systematic sampling and high rates of subject location and participation; (3) blinded thyroid assessments by multiple examiners, along with ultrasound, which is a more objective assessment of thyroid nodularity; and (4) extensive attempts to model thyroid radiation doses in various locales, combined with self-reported or parent-reported estimates of milk and vegetable consumption to estimate individual thyroid doses. Limitations of the Hanford study include substantial individual dose uncertainties, since no thyroid exposure measurements were available and individual milk and vegetable consumption estimates were recalled 30–40 years after the exposure period studied; and statistical power and precision were limited by the model's sample size and relatively low dose range (0.8% of the study population had estimated thyroid doses >1 Gy [100 rad] and 0.2% had doses >2 Gy [200 rad]).

3.3.3 External Exposure

No studies were located on the toxicity of external exposures to radioiodine. The four radioactive isotopes of iodine that are of particular interest with respect to human exposures (^{123}I , ^{125}I , ^{129}I , and ^{131}I) emit, primarily, beta radiation, which would not be expected to produce adverse effects from external exposures, other than possibly to the upper layers of the skin.

3.4 GENOTOXICITY

Potassium iodide, I_2 , and povidone iodine (0.1–10 mg/mL) did not show mutagenic effects in L5178Y mouse lymphoma cells or in transforming activity in Balb/c 3T3 cells grown in culture (Kessler et al. 1980; Merkle and Zeller 1979). Potassium iodide and I_2 did not produce lethal mutations in *Drosophila melanogaster* when eggs were incubated in 0.38 mg/mL I_2 or 0.75 mg/mL potassium iodide (Law 1938). I_2 did not show mutagenic activity in His⁺ revertant assay in *Saccharomyces cerevisiae* (Mehta and von Borstel 1982a). Iodide is a free-radical scavenger and has been shown to decrease hydrogen peroxide-induced reversion in strain TA104 of *Salmonella typhimurium* (Han 1992).

3. HEALTH EFFECTS

Sodium iodate (NaIO_3) was not mutagenic when tested in the bacterial Ames assay, mouse bone marrow micronucleus test, or recessive lethal test in *D. melanogaster* (Eckhardt et al. 1982). Sodium iodate has radiosensitizing activity and has been shown to increase the number of gamma radiation-induced single-strand DNA breaks in bacteria (Myers and Chetty 1973). Iodate is a more active radiosensitizing agent than is iodide (Kada 1970; Kada et al. 1970; Noguti et al. 1971)

Chromosome aberrations (breakages, dicentrics, micronuclei) have been found in peripheral blood cells of patients who received ^{131}I ablative therapy for hyperthyroidism, in infants born to mothers who received such therapy during pregnancy, and in children exposed to radioiodine released from the Chernobyl nuclear power plant (Ardito et al. 1987; Ballardin et al. 2002; Baugnet-Mähieu et al. 1994; Boyd et al. 1974; Catena et al. 1994; Goh 1981; Gutierrez et al. 1999a; Lehmann et al. 1996; Monteiro et al. 2000; Ramírez et al. 1997, 2000) (see Section 3.3.2 for a more detailed discussion of exposures from the Chernobyl accident). The range of ^{131}I exposures in these cases was 15–200 mCi (0.6–7.4 GBq).

A significantly higher frequency of chromosome translocations (number of translocations per cell) was observed in blood lymphocytes from nine patients who received ^{131}I for ablative treatment of multinodular or autonomous goiter (0.55–0.85 GBq, 15–23 mCi) compared to lymphocytes obtained from six healthy adults (Lambert et al. 2001). A study of 21 patients who received various exposures to ^{131}I for ablative treatment of thyroid carcinoma found a significantly higher frequency of micronuclei in peripheral blood cells of patients compared to a group of 93 healthy controls (Catena et al. 1994). A significant exposure response relationship was observed at exposures that ranged from 35 to 202 mCi (1.3–7.5 GBq). A study of 10 patients who received ^{131}I for ablative treatment of thyroid carcinoma compared the outcomes of cytogenetic assessment of peripheral blood lymphocytes before or 1 and 10 days after their ^{131}I exposures (Baugnet-Mahieu et al. 1994). The patients received two oral doses of 840 MBq (13.7 mCi) given on 2 consecutive days. A small but statistically significant increase in “abnormal cells” (2.69%) and dicentrics (1.91%) occurred after exposure to ^{131}I . The presence of micronuclei and binucleated lymphocytes with micronuclei (BNMN) in blood lymphocytes was assessed in six patients, before and after they received who received ^{131}I (2.96–5.50 GBq, 80–149 mCi) for treatment of thyroid carcinoma (Ballardin et al. 2002). The estimated radiation dose to bone marrow was 25.5–52.5 cGy (25.5–52.5 rad). BNMN frequency increased after exposure to ^{131}I , reaching a peak response (3.6-fold increase above pre-exposure values) 7 days after exposure. Cytogenetic assessments of peripheral blood lymphocytes of five patients who received 15–40 mCi (0.6–1.5 GBq) for treatment of hyperthyroidism and four control subjects revealed dicentrics and rings in the treated patients, but no such abnormalities in the control subjects (Boyd et al. 1974). An increase in the frequency of micronuclei in

3. HEALTH EFFECTS

peripheral blood lymphocytes was observed of 12 adult women 1 week after they received 100–150 mCi ^{131}I (3.7–5.6 GBq) for treatment of thyroid cancer (Ramírez et al. 1997). The frequency of chromosome translocations in thyroid tumor tissue was compared among groups of patients who had tumors but no radiation history (n=24), patients who received ^{131}I or external radiation therapy (n=7), and children (n=40) who were residents of the Gomel, Brest, or Minsk regions of Belarus at the time of the Chernobyl accident (Lehmann et al. 1996). The frequency of translocations was highest in the patients who received radiation therapy and lowest in the patients that had no history of exposure to radiation. Translocation frequencies among Belarussian children were lower than in the radiation therapy patients and higher than in the patients who had no radiation history. The highest translocation frequencies among Belarussian children were observed in children from the Gomel region where ^{131}I exposures and thyroid radiation doses are considered to have been the highest of the three regions studied.

Goh (1981) reported a case of cretinism that developed at age 8 months in an infant whose mother received 99 mCi (3.7 GBq) of ^{131}I during her 6th week of pregnancy. The infant was hypothyroid and had no detectable thyroid gland function. Cytogenetic studies conducted on peripheral blood lymphocytes revealed chromosomal breakages in both the infant and mother.

3.5 TOXICOKINETICS

3.5.1 Absorption

3.5.1.1 Inhalation Exposure

Molecular iodine (I_2) is absorbed when humans are exposed to I_2 vapor. In volunteers who inhaled radioiodine I_2 vapor, essentially all of the inhaled vapor was retained and cleared from the respiratory tract with a half-time of approximately 10 minutes (Black and Hounam 1968; Morgan et al. 1968). Much of the clearance of the iodine from the respiratory tract was transferred to the gastrointestinal tract, suggesting that the initial deposition was primarily in the conducting airways and subject to mucocilliary clearance mechanisms. Observations in humans of relatively rapid absorption of inhaled I_2 are supported by studies in mice, rats, dogs, and sheep (Bair et al. 1963; Willard and Bair 1961).

Methyl iodide is also inhaled when humans are exposed to methyl iodide vapor. In volunteers who inhaled tracer concentrations of [^{132}I]methyl iodide, approximately 70% of the inhaled iodine was retained with a half-time in the respiratory tract of approximately 5 seconds, suggesting extremely rapid absorption at the alveolar-blood interface (Morgan and Morgan 1967; Morgan et al. 1967a, 1967b).

3. HEALTH EFFECTS

Studies of the absorption of inhaled inorganic iodide in humans are not available. However, in monkeys that inhaled particulate aerosols of radioiodine as sodium iodide (mass median diameter, $2.32 \mu\text{m} \pm 1.15 \text{ SD}$), inhaled iodide was retained in the respiratory tract with a half-time of approximately 10 minutes (Perrault et al. 1967; Thieblemont et al. 1965). In dogs and rats that were exposed to cesium chloride aerosols containing ^{131}I (mass median aerodynamic diameter, $1.4 \mu\text{m} \pm 1.7 \text{ SD}$), iodine was retained and rapidly cleared from the respiratory tract (McClellan and Rupperecht 1968; Thomas et al. 1970). Retention and relatively rapid absorption of iodine has also been observed in mice and sheep that inhaled radioiodine as either sodium iodide or silver iodide particulate aerosols (mean count diameter, $0.25 \mu\text{m}$) (Bair et al. 1963; Willard and Bair 1961).

3.5.1.2 Oral Exposure

Gastrointestinal absorption of iodine is generally considered to be approximately 100% after an ingested dose of water soluble iodide salts, such as potassium or sodium iodide. This conclusion is based on several types of observations made in human subjects who received oral doses of radioiodine compounds (the reader should note that where the chemical form of the radioiodine compound was not reported, which is the case for most of the radioiodine tracer studies described here, it is likely that it was sodium iodide, as this is a common form supplied commercially for pharmaceutical use). Fecal excretion of ^{131}I was $<1\%$ of the dose in seven euthyroid adult subjects who ingested a single tracer dose of ^{131}I , suggesting near complete absorption of the ingested radioiodine (Fisher et al. 1965). In the same study, 20 euthyroid adults received daily oral doses of potassium iodide for 13 weeks (0.25 or 1.0 mg I/day). Daily urinary iodine excretion was approximately 80–90% of the estimated daily intake, also suggesting near complete absorption. Similarly, in an acute ingestion study of nine healthy subjects, urinary and thyroid radioiodine accounted for 97% (± 5 , SD) of a single ingested tracer dose of radioiodine (^{131}I or ^{132}I), suggesting near complete absorption of the tracer dose (Ramsden et al. 1967). In this same study, two subjects ingested the tracer dose together with a dose of 5 or 15 mg stable iodide (the chemical form of the stable iodide was not specified, but presumably, it was either potassium or sodium iodide) and the recoveries of radioiodine in thyroid and urine were 96 and 98%, respectively. In one subject who ingested the tracer dose either after a fast (duration not specified) or with a “full stomach”, the recoveries of radioiodine in thyroid and urine were 97 and 98%, respectively (Ramsden et al. 1967).

Measurement of radioiodine uptake in the thyroid gland is also an indicator of absorption, although such measurements alone do not allow an accurate quantitative estimate of absorption without other

3. HEALTH EFFECTS

assumptions about the pharmacokinetics of iodine. Studies of iodine kinetics in subjects who received intravenous injections of tracer doses of radioiodine have shown that the fraction of an injected dose that accumulates in the thyroid is affected by many variables; however, it does not vary greatly among individuals who have the same iodine intake and whose thyroid glands are "normal" (see Section 3.5.2.2). This fraction has been shown to be similar (20–35%) when radioiodine (^{123}I , ^{125}I , or ^{131}I) is administered to adults by the intravenous or oral routes, suggesting extensive, if not complete, absorption of ingested radioiodine (Bernard et al. 1970; Gaffney et al. 1962; Ghahremani et al. 1971; Oddie and Fisher 1967; Pittman et al. 1969; Robertson et al. 1975; Sternthal et al. 1980; Van Dilla and Fulwyler 1963). Although the fraction of the oral dose of radioiodine taken up by the thyroid 1–2 days after an oral dose may be slightly higher in females than males, there is no evidence that this difference results from differences in absorption (Ghahremani et al. 1971; Quimby et al. 1950; Robertson et al. 1975).

Gastrointestinal absorption of iodine appears to be similar in children, adolescents, and adults, as assessed from measurements of 24-hour thyroid uptakes of radioiodine administered orally (Cuddihy 1966; Oliner et al. 1957; Van Dilla and Fulwyler 1963). Absorption in infants, however, may be lower than in children and adults. Evidence for this comes from studies in which thyroid uptake of radioiodine was measured in newborns who received tracer doses of radioiodine orally or by injection. In general, injection of the radioiodine intramuscularly or intravenously resulted in higher thyroid uptakes than when the radioiodine was administered by gastric tube, suggesting incomplete absorption of the oral dose. For example, in 8 healthy newborn infants (<36 hours postnatal) who each received a tracer dose of ^{131}I by gastric tube, the average peak thyroid uptake (30 hours after the dose) was approximately 50% of the dose compared to an average of 70% (25 hours after the dose) in 17 infants who received the tracer dose as an intramuscular injection (Morrison et al. 1963). The ratio of the thyroid uptakes after the oral and injected iodine doses suggests a fractional oral absorption of approximately 70%. In a study involving slightly older newborns (72–96 hours old), 15 newborns each received a tracer dose of ^{131}I by gastric tube and the average 24-hour uptake of radioiodine in the thyroid was 20% (range, 6–35%) (Ogborn et al. 1960). By contrast, in a study of seven healthy infants (<3 days old), the mean thyroid uptake 24 hours after an intramuscular tracer dose of ^{131}I was 70% (range, 46–97) (van Middlesworth 1954). In a study of 26 healthy newborns (<48 hours old) who each received an intravenous tracer dose of ^{131}I , the mean 24-hour thyroid uptake was 62% (range, 35–88) (Fisher et al. 1962). The rapid changes in iodine status and biokinetics in the early weeks of postnatal life make interpretations of comparisons between injection data for a few groups of infants with ingestion data for other groups highly uncertainty. Most or all of the differences in the thyroid uptakes observed in the above three studies may reflect differences in age and iodine status

3. HEALTH EFFECTS

Iodide incorporated into food appears to be nearly completely absorbed. In a dietary balance study in which dietary iodide intakes (170–180 µg/day) and excretion were measured in 12 healthy adult women over two 7-day periods, urinary iodide excretion was 96–98% of the daily intake (Jahreis et al. 2001). Iodine incorporated into bovine milk appears to be nearly completely absorbed when ingested. Cuddihy (1966) measured thyroid uptakes of radioiodine in euthyroid subjects who ingested radioiodine-contaminated cow milk for 14 days. The milk was collected from a cow that was fed ^{131}I in feed (endogenously incorporated). Thyroid uptake 24 hours after the last milk dose was approximately 23% of the dose. Since this value is within the range of 20–35% observed when a tracer dose of ^{131}I was administered orally or intravenously, it suggests that iodine that is endogenously incorporated into cow milk is extensively, if not completely, absorbed. A slightly different observation leads to a similar conclusion. Comar et al. (1963) compared radioiodine uptakes in each of 11 healthy adults who ingested ^{131}I in a capsule (containing an aqueous solution of radioiodine) or ^{131}I endogenously incorporated into cow milk. The 24-hour thyroid uptakes were nearly identical under each dosing condition (means, 19 and 20% of the dose) suggesting a similar absorbed fraction of the dose. Pendleton et al. (1963) measured ^{131}I in dairy cow milk from farms near the NTS, and in the thyroids or total bodies of families who lived on these farms (measured from external thyroid or total body counting). The average uptake of ^{131}I in 24 individuals was 17% (range, 5–47%) which is similar to that observed after ingestion or injection of radioiodine. Assessments of gastrointestinal absorption of iodine in other foods are not available, although Wayne et al. (1964) reported that radioiodine incorporated into watercress was completely absorbed when ingested by an adult (no details provided).

Little information is available on the gastrointestinal absorption of forms of iodine other than iodide. Iodine compounds, such as I_2 and iodates (e.g., NaIO_3), may undergo reduction to iodide before being absorbed in the small intestine, and absorption may not be complete (Cohn 1932). Iodine from the sodium salt of the thyroid hormone thyroxine (T_4) is absorbed when T_4 is ingested. In two adults who each received a single oral dose of 80 µg [^{131}I]- T_4 , the rate of fecal excretion of radioiodine was similar to that observed in three subjects who received the same dose intravenously (10–15% of the dose), suggesting substantial absorption from the gastrointestinal tract (Myant and Pochin 1950). In this same study, the sum of urinary excretion of radioiodine and thyroid uptake of radioiodine, 24 hours after the oral dose of [^{131}I]- T_4 , was approximately 25% of the dose, compared to an average of 33% (± 7) in six subjects who received the [^{131}I]- T_4 dose intravenously. This observation is also consistent with substantial, if not complete, absorption of T_4 from the gastrointestinal tract (at least 75% of the dose).

3. HEALTH EFFECTS

Observations in humans that indicate extensive absorption of ingested inorganic iodine are supported by experiments in animals. Iodine is extensively absorbed in rats when it is ingested as either I_2 or NaI. When fasted rats were administered oral gavage tracer doses of ^{131}I as either I_2 or NaI, 8–9% of the dose was excreted in feces in 72 hours and 34–35% of the dose was excreted in the urine (Thrall and Bull 1990). In the same study, similar results were obtained in rats that were allowed free access to food before the oral radioiodine dose; 6–7% of the dose was excreted in feces in 78 hours and 22–29% was excreted in urine (22% of the I_2 dose and 29% of the NaI dose). These results suggest that tracer doses of ingested iodine from NaI and I_2 are both nearly completely absorbed from the gastrointestinal tract in rats. In cows, tracer doses of ^{131}I ingested in the diet is nearly completely absorbed (Vandecasteele et al. 2000). When tracer levels of radioiodine (^{131}I) were administered orally, intravenously, or subcutaneously to four sheep, the peak thyroid uptake of radioiodine was similar, 17–19% of the dose (these values are not corrected for radioactive decay of the ^{131}I), suggesting extensive absorption from the oral route (Wood et al. 1963).

Povidone-iodine is a complex of I_2 and polyvinyl pyrrolidone that is widely used as topical antiseptic. Povidone-iodine preparations contain approximately 9–12% iodine, of which only a small fraction is free in solution (Lawrence 1998; Rodeheaver et al. 1982). Absorption of iodine ingested as povidone-iodine has been studied in rats. Rats that received single gavage doses of ^{125}I -povidone (dose not specified) absorbed approximately 3% of the dose, as assessed by measurements of the radioiodine that was retained in the gastrointestinal tract 24 hours after the dose (Abdullah and Said 1981). In the same study, absorption was approximately 10 or 5% when the povidone-iodine was administered in 10% ethanol solution and 5% when administered as a 0.2% solution of benzalkonium chloride.

3.5.1.3 Dermal Exposure

Systemic iodine toxicity has occurred following dermal exposures to iodine compounds, suggesting that these compounds of iodine are absorbed across the skin of humans (see Section 3.2.3). Harrison (1963) attempted to estimate absorption rates for solutions of potassium iodide or iodine (I_2), and gaseous I_2 in humans. Subjects received topical applications of ^{131}I as potassium iodide or iodine (I_2) and absorption was estimated from measurements of the cumulative urinary excretion of radioactivity and the 24-hour activity in the thyroid. Three subjects received a topical application of tracer concentrations of [^{131}I]KI on a 12.5 cm² area of the forearm. The site was left uncovered and after 2 hours, all of the applied radioactivity could be detected on the skin and approximately 90% of the radioactivity could be recovered from the skin by washing with soap and water. Absorption was estimated to be approximately 0.1% of

3. HEALTH EFFECTS

the applied dose (range, 0.09–0.13) based on 3-day cumulative urine radioactivity. Thyroid radioactivity 24 hours after the topical dose was below the limits of detection. If it was assumed that the 24-hour thyroid uptake was 30% of the absorbed dose and that all of the absorbed activity that was not recovered in urine was in the thyroid, absorption was approximately 0.16% in the three subjects (range, 0.13–0.19). In two subjects in this same study who received a similar topical application of aqueous tracer [^{131}I]I₂ along with 0.1 mg of [^{127}I]I₂ carrier, the absorption was estimated to be 0.06–0.09% of the applied dose, with the higher estimate assuming thyroid uptake of 30% of the absorbed dose. This study also estimated iodine absorption after dermal exposure to [^{131}I]I₂ vapor. When a 12.5 cm² area of skin was isolated and placed in contact with I₂ vapor for 30 minutes or 2 hours, approximately 90% of the total iodine content of the vapor was deposited on the skin. Approximately 50% of the deposited dose could be washed off with soap and water. Absorption varied depending on the amount of [^{127}I]I₂ carrier in the vapor (the concentration was not reported). At the lowest carrier amount (approximately 0.8 mg applied to the skin), absorption of ^{131}I was 1.2% of the activity that was on the skin at the end of the 2-hour exposure. With exposure to 3–5 mg carrier, which produced visible irritation of the skin (reddening or blistering), absorption was 27–78%. These observations suggest that exposure to I₂ vapors can result in deposition of iodine onto the skin and that dermal irritation produced by I₂, and possibly other irritants, may substantially increase the absorption of iodine after dermal exposure to I₂. Dermal absorption of I₂ vapor was indicated in an experimental study in which ^{131}I was detected in the thyroid glands of seven male adult volunteers who were exposed, whole body and without respiratory intake, to $^{131}\text{I}_2$ vapor (the exposure appears to have been to tracer levels) for up to 4 hours (Gorodinskiy et al. 1979).

Povidone-iodine, a complex with iodine and polyvinyl-pyrrolidone, and alcohol tinctures of iodine are widely used as a topical antiseptic. Iodine is absorbed to some extent when such preparations are applied to the skin, although quantitative estimates of the amount absorbed are not available for humans. Urinary iodine excretion has been shown to increase following the topical application of povidone-iodine to the hands and arms as part of a surgical scrub routine, indicating systemic absorption (Connolly and Shepard 1972). Increases in iodine concentration in maternal urine and umbilical cord blood have been observed in pregnant women who received dermal or vaginal applications of povidone-iodine prior to delivery for disinfection of the skin and fetal scalp electrodes, suggesting that absorption of iodine occurs with these uses of povidone-iodine as well (l'Allemand et al. 1983; Bachrach et al. 1984). Thyroid enlargement, hypothyroidism, and elevated urinary iodine excretion also have been observed in hospitalized infants who received frequent topical antiseptic scrubs with iodine-alcohol preparations as part of preparations for various clinical procedures (Brown et al. 1997; Chabrolle and Rossier 1978a, 1978b).

3. HEALTH EFFECTS

Some quantitative information is also available on dermal absorption of iodine in animals. When tracer levels of radioiodine (^{131}I) were applied to the shaved skin ($50\text{--}100\text{ cm}^2$) of four sheep, the peak thyroid uptake of radioiodine was 2–6% of the applied dose compared to 17–19% when the dose was given orally, subcutaneously, or intravenously (these values are not corrected for radioactive decay of the ^{131}I) (Wood et al. 1963). In a second study, two sheep received a tracer dose of radioiodine as either an oral dose or a topical dose; the peak thyroid uptake was 9–14% of the dose at 48–96 hours after the topical dose, compared to 30% at 48 hours after the oral dose (both values corrected for radioactive decay). The report of these studies does not specify whether the topical applications were occluded or whether the animals were restrained in any way from ingesting the topically applied radioiodine (e.g., licking the site of application). If ingestion of the radioiodine did not occur, then these studies suggest substantial absorption of topically applied iodine since, during the first 1–4 days after topical dosing, thyroid radioiodine uptake was approximately 30–50% of that observed after oral dosing, and thyroid uptakes after oral and parenteral dosing were similar.

Additional evidence for dermal absorption of iodine comes from a study of pigs. A solution (solvent not specified) containing a mixture of 85% [^{131}I] I_2 and 15% [^{131}I] NaI was applied to a 150 cm^2 area of abdominal skin on each of four immature pigs and allowed to dry on the skin; the site of application was not covered and it is not clear if the site was accessible to licking and ingestion of the applied radioiodine (Murray 1969). Approximately 95% of the applied dose was removed from the skin by washing the site of application 2 hours after the dosing. Peak thyroid uptake of radioiodine was approximately 0.2% of the dose, 1–2 days after dosing (the report does not indicate whether the radioiodine measurements were corrected for radioactive decay). In the same study, a 150 cm^2 area of clipped flank skin on each of four immature pigs was exposed for 25 minutes to a vapor of ^{131}I containing 85% gaseous ^{131}I , presumably [^{131}I] I_2 . The exposed areas were not covered or washed subsequent to exposure. Peak thyroid uptake of radioiodine was approximately 0.3% of the applied dose 5–7 days after dosing. The lower amount of absorption of radioiodine in the pigs compared to the results obtained in sheep (Wood et al. 1963) cannot be interpreted with the available information. It may reflect species differences in skin permeability to iodine, differences in the chemical form iodine applied to the skin (I_2 or I^-), or differences in the amounts of topically applied radioiodine that were ingested from licking the site of application.

Povidone-iodine, an ingredient of some iodine-based topical disinfectants, is absorbed across the skin of dogs. Topical application of povidone-iodine in dogs resulted in elevated serum iodide concentrations within 2 hours after application; the amount of iodine absorbed was not determined in this study (Moody et al. 1988). Evidence for absorption of iodine from topically applied povidone-iodine is also provided by

3. HEALTH EFFECTS

experiments with rats and mice. Topical application of povidone-iodine to 15–20 mm² of the shaved skin of either rats or mice 2 hours prior to an injection of radioiodine decreased radioiodine uptake in the thyroid by 90%, suggesting competition between the absorbed topically applied iodine and the injected radioiodine for thyroid uptake (Furudate et al. 1997).

3.5.1.4 Other Routes of Exposure

Iodine is absorbed systemically after intravaginal applications of povidone-iodine. Increases in iodine concentration in maternal urine, umbilical cord blood, and breast milk, and in infant urine have been observed following vaginal applications of povidone-iodine to pregnant women prior to delivery for disinfection of fetal scalp electrodes (l'Allemand et al. 1983). Increases in serum iodine concentrations have also been observed following irrigation of the lower colon and rectum with povidone-iodine during surgical procedures, suggesting absorption from the lower bowel (Tsunoda et al. 2000).

3.5.2 Distribution

3.5.2.1 Inhalation Exposure

The distribution of absorbed iodine is expected to be similar regardless of the route of exposure to inorganic iodine. This is supported by studies in which humans were exposed to tracer levels of [¹³²I]CH₃I and approximately 20–30% of the iodine retained in the respiratory tract was distributed to the thyroid gland and 30–60% was excreted in urine in approximately 10 hours; essentially identical results were obtained when a tracer dose of ¹³²[I]NaI was ingested (Morgan et al. 1967a, 1967b). Similar results were obtained when volunteers inhaled tracer levels of radioiodine as I₂ (Black and Hounam 1968; Morgan et al. 1968). The distribution of inhaled particulate aerosols of sodium iodide in monkeys also appears to be similar to ingested iodide (Perrault et al. 1967; Thieblemont et al. 1965). A complete discussion of the distribution of iodine after oral exposures to inorganic iodine is presented in Section 3.5.2.2, and is applicable to inhalation exposures.

3.5.2.2 Oral Exposure

The human body contains approximately 10–15 mg of iodine, of which approximately 70–90% is in the thyroid gland, which accumulates iodine in producing thyroid hormones for export to the blood and other tissues (Cavalieri 1997; Hays 2001; Stather and Greenhalgh 1983). The concentration of iodine in serum

3. HEALTH EFFECTS

is approximately 50–100 µg/L under normal circumstances (Fisher et al. 1965). Approximately 5% in serum is in the inorganic form as iodide; the remaining 95% consists of various organic forms of iodine, principally protein complexes of the thyroid hormones T₄ and T₃ (Fisher et al. 1965; Nagataki et al. 1967; Sternthal et al. 1980; Wagner et al. 1961).

The tissue distribution of iodide and organic iodine are very different and are interrelated by metabolic pathways that lead to the iodination and deiodination of proteins and thyroid hormones in the body (see Section 3.5.3.2). Iodide is largely confined to the extracellular fluid compartment, with the exception of tissues that possess specialized transport mechanisms for accumulating iodide; these include the thyroid, salivary glands, gastric mucosa, choroid plexus, mammary glands, placenta, and sweat glands (Brown-Grant 1961) (see Section 3.5.1). Serum concentrations of iodide, indicative of extracellular fluid concentrations, normally range from 5 to 15 µg/L; this would suggest a total extracellular iodide content of the human body of approximately 85–170 µg, assuming an extracellular fluid volume of approximately 17 L (Cavalieri 1997; Saller et al. 1998).

Iodide concentrations in the thyroid are usually 20–50 times that of serum (0.2–0.4 mg/dL, 15–30 nM); however, concentrations in excess of 100 times that of blood occur when the gland is stimulated by thyrotrophin (a TSH) and concentrations in excess of 400 times blood have been observed (Wolff 1964). Other tissues that can accumulate iodide to a concentration greater than that of blood or serum include the salivary glands, gastric mucosa, choroid plexus, mammary glands, placenta, and sweat glands (Brown-Grant 1961). Iodide taken up by the thyroid gland is utilized in the production of thyroid hormones, which are stored in the gland (see Section 3.5.3.2). This organic fraction of the thyroid iodine content accounts for approximately 90% of the iodine in the thyroid gland and includes iodinated tyrosine and tyrosine residues that comprise the thyroid hormones, T₄ and T₃, and their various synthesis intermediates and degradation products.

The thyroid hormones, T₄ and T₃, account for approximately 90–95 and 5% of the organic iodine in plasma, respectively (Fisher et al. 1965; Sternthal et al. 1980). Nearly all (>99%) of the T₄ and T₃ in plasma is bound to protein. The major binding protein for T₄ and T₃ is thyroxine-binding globulin (TBG), which has a high affinity for both hormones (Table 3-4) (Larsen et al. 1998; Robbins 1996). Other proteins that bind thyroid hormones, with lower affinity, include transthyretin (thyroxine-binding prealbumin), albumin, and various apoproteins of the high density lipoproteins HDL₂ and HDL₃ (3–6% of plasma hormones). The distribution of protein-bound thyroid hormones is largely confined to the plasma space, whereas the free hormones distribute to the intracellular space of a wide variety of tissues where

3. HEALTH EFFECTS

Table 3-4. Binding Characteristics of Major Human Thyroid Hormone-Binding Proteins

Parameter	Thyroxine-binding globulin	Transthyretin	Albumin
Molecular weight of complex (D)	54,000	54,000 (subunit) ^a	66,000
Plasma concentration (μmol/L)	0.27	4.6	640
T ₄ binding capacity (μg T ₄ /dL)	21	350	50,000
Association constants (M ⁻¹)			
T ₄	1x10 ¹⁰	7x10 ⁷	7x10 ⁵
T ₃	5x10 ⁸	1.4x10 ⁷	1x10 ⁵
Fraction of sites occupied by T ₄ ^b	0.31	0.02	<0.001
Distribution volume (L)	7	5.7	7.8
Turnover rate (percent/day)	13	59	5
Distribution of thyronines (percent/protein)			
T ₄	68	11	20
T ₃	80	9	11

^aTransthyretin consists of four subunits (54 kD) complexed with retinol binding protein

^bIn euthyroid state

T₃ = 3,5,3Ntriodo-L-thyronine; T₄ = 3,5,3N5Ntetraiodo-L-thyronine (thyroxine)

Source: Larsen et al. 1998

3. HEALTH EFFECTS

they exert the metabolic effects attributed to thyroid hormones. TBG and other binding proteins serve as reservoirs for circulating thyroid hormones and contribute to the maintenance of relatively constant free hormone concentrations in plasma.

Uptake of T_4 and T_3 into liver, skeletal muscle, and other tissues occurs by a saturable, energy-dependent carrier transport system (see Section 3.6.1). Lipoprotein transport mechanisms may also play a role in the uptake of thyroid hormones into certain tissues (Robbins 1996). Intracellular T_4 and T_3 exist as free hormone and are bound to a variety of intracellular proteins.

Maternal exposure to iodine results in exposure to the fetus (ICRP 2002). Radioiodine accumulation in the fetal thyroid commences in humans at approximately 70–80 days of gestation, and precedes the development of thyroid follicles and follicle colloid, which are generally detectable at approximately 100–120 days of gestation (Book and Goldman 1975; Evans et al. 1967). Fetal iodide uptake activity increases with the development of the fetal thyroid and reaches its peak at approximately 6 months of gestation, at which point, the highest concentrations in thyroid are achieved, approximately 5% of the maternal dose/g fetal thyroid (approximately 1% of the maternal dose) (Aboul-Khair et al. 1966; Evans et al. 1967). Fetal radioiodine concentrations 1–2 days following a single maternal dose of radioiodine generally exceed the concurrent maternal thyroid concentration by a factor of 2–8 with the highest fetal/maternal ratios occurring at approximately 6 months of gestation (Book and Goldman 1975; Millard et al. 2001). Following long-term exposure, either from ingestion of administered radioiodine or from exposure to radioactive fallout, the fetal/maternal ratio for thyroid radioiodine concentration has been estimated to be approximately 2–3 (Beierwaltes et al. 1963; Book and Goldman 1975; Eisenbud et al. 1963).

Iodine uptake into the thyroid gland is highly sensitive to the iodide intake. At very low intakes, representing iodine deficiency (e.g., 20 $\mu\text{g}/\text{day}$), uptake of iodide into the thyroid gland is increased (Delange and Ermans 1996). This response is mediated by TSH, which stimulates iodide transport and iodothyronine production in the thyroid gland (see Section 3.6.1). At very high intakes of iodine, representing an intake excess (e.g., $>1 \text{ mg}/\text{day}$), iodine uptake into the thyroid gland decreases, primarily as a result of decreased iodothyronine synthesis (Wolff-Chaikoff effect) and iodide transport into the gland (Nagataki and Yokoyama 1996; Saller et al. 1998). The fraction of an ingested (or injected) tracer dose of radioiodide that is present in the thyroid gland 24 hours after the dose has been measured in thousands of patients who received radioiodine for treatment of various thyroid disorders or for the assessment of thyroid function; these provide a comparative index of effects of various factors on the

3. HEALTH EFFECTS

distribution of absorbed iodide to the thyroid gland. A single oral dose of 30 mg iodide (as sodium iodide) decreases the 24-hour thyroid uptake of radioiodine by approximately 90% in healthy adults (Ramsden et al. 1967; Sternthal et al. 1980). The inhibition of uptake was sustained with repeated oral doses of sodium iodide for 12 days, with complete recovery to control (presodium iodide) uptake levels within 6 weeks after the last sodium iodide dose (Sternthal et al. 1980) or within 8 days after a single dose (Ramsden et al. 1967). Repeated oral doses of 1.5–2.0 mg iodide/m² of surface area produced an 80% decrease in thyroid uptake in children (Saxena et al. 1962).

The National Cancer Institute (NCI 1997) has analyzed data on 24-hour thyroid uptakes of radioiodine reported over the period from 1950 to 1980 and concluded that thyroid uptakes in adults have decreased in the United States over time from approximately 20–40% of the dose in the 1950–1960 period to approximately 15–20% currently (Cuddihy 1966; Dunning and Schwartz 1981; Kearns and Phillipsborn 1962; Kereiakes et al. 1972; Oddie and Fisher 1967; Oliner et al. 1957; Pittman et al. 1969; Van Dilla and Fulwyler 1963). This decrease appears to be related to a concurrent increase in the average dietary intake of iodide in the population from approximately 200 µg/day to approximately 800 µg/day (NCI 1997).

Twenty-four-hour radioiodine uptakes into the thyroid gland in males and females who experience similar iodide intakes are similar, although uptakes in females, as a percentage of the dose, appear to be 10–30% higher than in males (Ghahremani et al. 1971; Oddie et al. 1968a, 1970; Quimby et al. 1950; Robertson et al. 1975). Thyroid uptakes in newborns are 3–4 times greater during the first 10 days of postnatal life than in adults, and decline to adult levels after approximately age 10–14 days (Fisher et al. 1962; Kearns and Phillipsborn 1962; Morrison et al. 1963; Ogborn et al. 1960; Van Middlesworth 1954).

3.5.2.3 Dermal Exposure

The distribution of absorbed iodine is expected to be similar regardless of the route of exposure to inorganic iodine. A complete discussion of the distribution of iodine after oral exposures to inorganic iodine is presented in Section 3.5.2.2, and is applicable to inhalation exposures.

3.5.2.4 Other Routes of Exposure

The distribution of absorbed iodine is expected to be similar regardless of the route of exposure to inorganic iodine. A complete discussion of the distribution of iodine after oral exposures to inorganic iodine is presented in Section 3.5.2.2, and is applicable to inhalation exposures.

3. HEALTH EFFECTS

3.5.3 Metabolism**3.5.3.1 Inhalation Exposure**

The metabolism of absorbed iodine is expected to be similar regardless of the route of exposure to inorganic iodine. Inhaled methyl iodide and I₂ appear to undergo rapid conversion to iodide based on nearly identical distribution and excretion kinetics of radioiodine when it is inhaled as either methyl iodide or I₂, or ingested as sodium iodide (Black and Hounam 1968; Morgan and Morgan 1967; Morgan et al. 1967a, 1967b, 1968). A complete discussion of the metabolism of iodine after oral exposures to inorganic iodine is presented in Section 3.5.3.2, and is applicable to inhalation exposures.

3.5.3.2 Oral Exposure

Iodide in the thyroid gland is incorporated into a protein, thyroglobulin, as covalent complexes with tyrosine residues (Figure 3-3). The iodination of thyroglobulin is catalyzed by the enzyme thyroid peroxidase, which resides predominantly in the apical membrane of thyroid follicle cells, with the active sites of the enzyme facing the follicular lumen (see Section 3.5.1). The iodination reactions occur at the follicular cell-lumen interface and consist of the oxidation of iodide to form a reactive intermediate, the formation of monoiodotyrosine and diiodotyrosine residues in thyroglobulin, and the coupling of the iodinated tyrosine residues to form T₄ (coupling of two diiodotyrosine residues) or T₃ (coupling of a monoiodotyrosine and diiodotyrosine residue) in thyroglobulin (Figure 3-4). The T₄/T₃ ratio in the thyroid is approximately 15:1; however, the relative amounts of T₄ and T₃ produced depend, in part, on the availability of iodide. Low levels of iodide result in a lower T₄/T₃ synthesis ratio (Taurog 1996).

Thyroglobulin is stored in the follicular lumen. When the thyroid gland is stimulated to produce and release thyroid hormones, thyroglobulin is transported into the follicular cells (Taurog 1996). Uptake of thyroglobulin occurs by endocytosis at the apical membrane, which is followed by fusion of endocytotic vesicles with lysosomes. Proteolytic enzymes in the lysosomes break down the thyroglobulin into

3. HEALTH EFFECTS

Figure 3-3. Pathways Uptake and Metabolism of Iodide in the Thyroid Gland

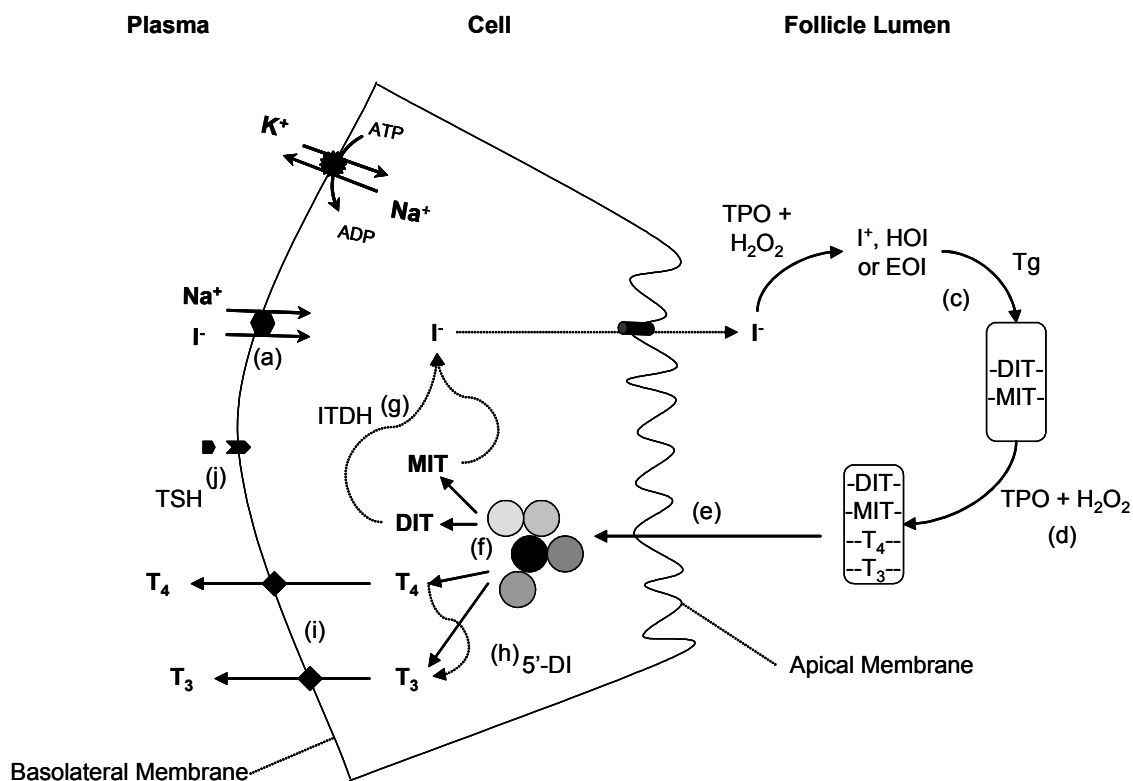

<u>METABOLIC STEP</u>	<u>INHIBITOR</u>
a. Iodine uptake	ClO_4^- , SCN^- , I^-
b. Iodine efflux	
c. Iodination	PTU, MMI
d. Coupling	PTU, MMI
e. Colloid resorption	Colchicine, Li^{2+} I^- , Cytoclasin B
f. Proteolysis	I^-
g. Deiodination of DIT and MIT	Dinitrotyrosine
h. Deiodination of T_4	PTU
i. Secretion of T_3 and T_4	
j. TSH receptor binding	

3. HEALTH EFFECTS

Figure 3-4. Thyroid Hormones and Metabolic Precursors

Thyronine

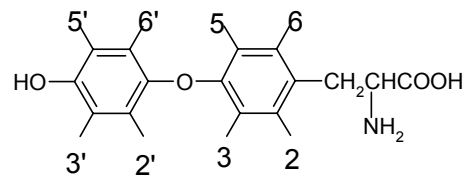
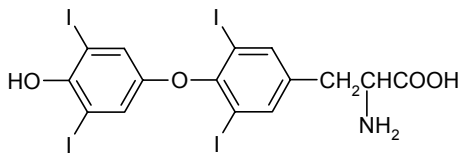
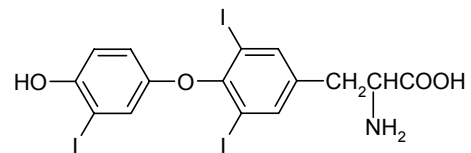
3,5,3',5'-Tetraiodothyronine (thyroxine, T₄)3,5,3'-Triiodothyronine (T₃)

Diiodotyrosine

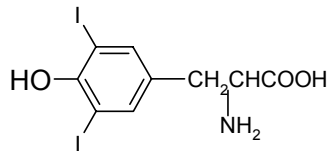

Iodotyrosine

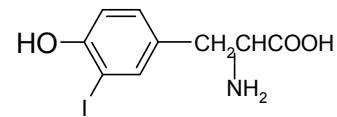

3. HEALTH EFFECTS

constituent amino acid residues, including T_4 , T_3 , monoiodotyrosine, and diiodotyrosine. T_4 and T_3 are exported to the blood, while monoiodotyrosine and diiodotyrosine residues are retained in the cell and deiodinated, and the iodide is recycled into the follicular lumen where it is reincorporated into thyroglobulin. Under circumstances of extreme stimulation of the thyroid gland, monoiodotyrosine, diiodotyrosine, and iodide can be released into the blood from the gland along with T_4 and T_3 . Although the T_4/T_3 ratio in thyroglobulin is approximately 15:1 in the iodide replete state, the hormone secretion ratio is lower, approximately 10:1; thus, some T_4 appears to undergo monodeiodination to T_3 in the thyroid gland.

All of the major steps of thyroid hormone synthesis and release are stimulated by the pituitary hormone, TSH, including uptake of iodine by the thyroid gland, iodination of thyroglobulin, endocytosis of thyroglobulin from the follicle lumen, and proteolysis of thyroglobulin to release thyroid hormone for export to blood (see Section 3.5.1). Hormone synthesis is also responsive to serum iodide concentration. An acute exposure to high oral doses of iodide (e.g., >1 mg) inhibits the production of iodothyronine in the thyroid gland; this effect is not dependent on changes in circulating TSH levels, and is referred to as the Wolff-Chaikoff effect (Wolff and Chaikoff 1948). The effect is temporary, and with repeated exposure to high doses of iodide, the thyroid gland escapes from the Wolff-Chaikoff effect and hormone synthesis resumes to normal levels (Wolff et al. 1949). The mechanism for the Wolff-Chaikoff effect appears to involve inhibition of both iodide transport and iodination reactions, possibly through an inhibition of the expression of NIS and thyroid peroxidase that is mediated by iodide or an iodinated metabolic intermediate (Eng et al. 1999; Spitzweg et al. 1999; Uyttersprot et al. 1997). Escape occurs when transport of iodide into the thyroid gland and the thyroid iodide concentration are sufficiently depressed to release the gland from inhibition of thyroid peroxidase, or other steps in the production of iodothyronines (Saller et al. 1998). A variety of chemical inhibitors of iodine thyroid metabolism have been described (Figure 3-3, see Section 3.10).

The major pathways of metabolism of iodine that occur outside of the thyroid gland involve the catabolism of T_4 and T_3 , and include deiodination reactions, ether bond cleavage of thyronine, oxidative deamination and decarboxylation of the side chain of thyronine, and conjugation of the phenolic hydroxyl group on thyronine with glucuronic acid and sulfate (Figure 3-5). Deiodination products formed in peripheral tissues are depicted in Figure 3-6. The monodeiodination of T_4 to T_3 is the major source of production of peripheral T_3 , which has a greater hormonal potency than T_4 , and together with the production of 3,3',5-triiodo-L-thyronine (reverse T_3 , rT_3), account for approximately 80% of total T_4 turnover in humans (Engler and Burger 1984; Visser 1990). The liver and kidney are thought to be major

3. HEALTH EFFECTS

Figure 3-5. Pathways of Metabolism of Iodothyronines

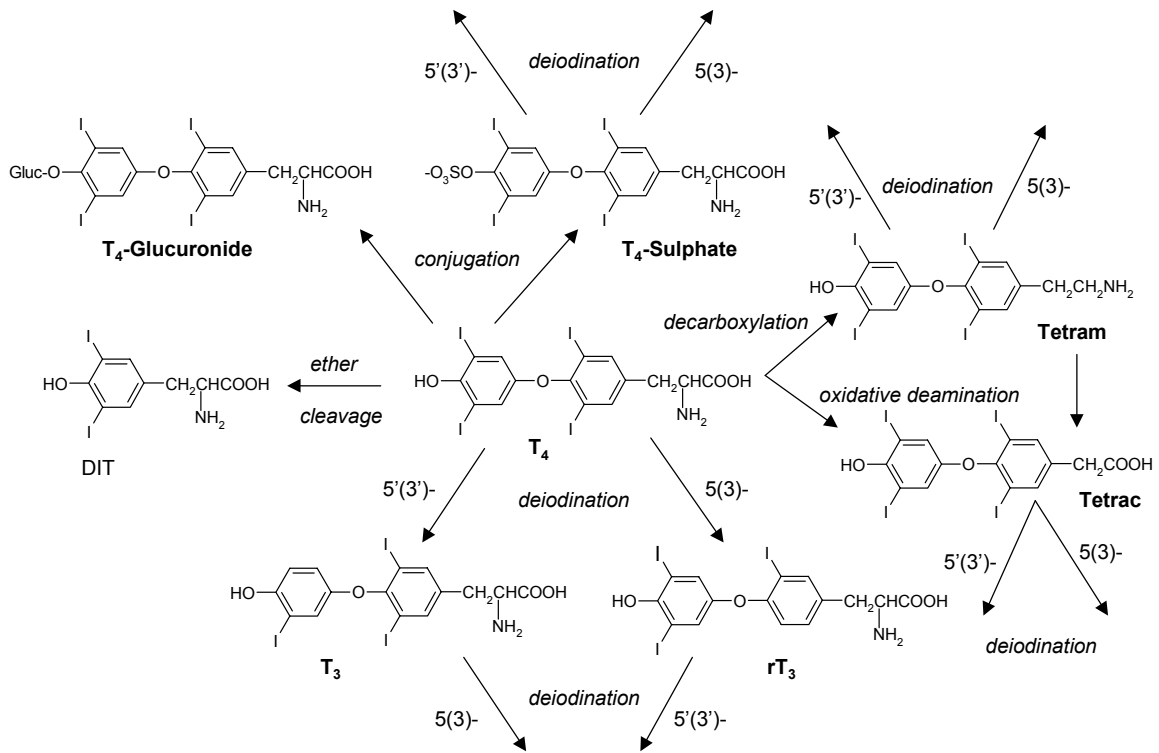

Source: Köhrle et al. 1987

3. HEALTH EFFECTS

Figure 3-6. Major Deiodination Pathways of Thyroid Hormones in Peripheral Tissues

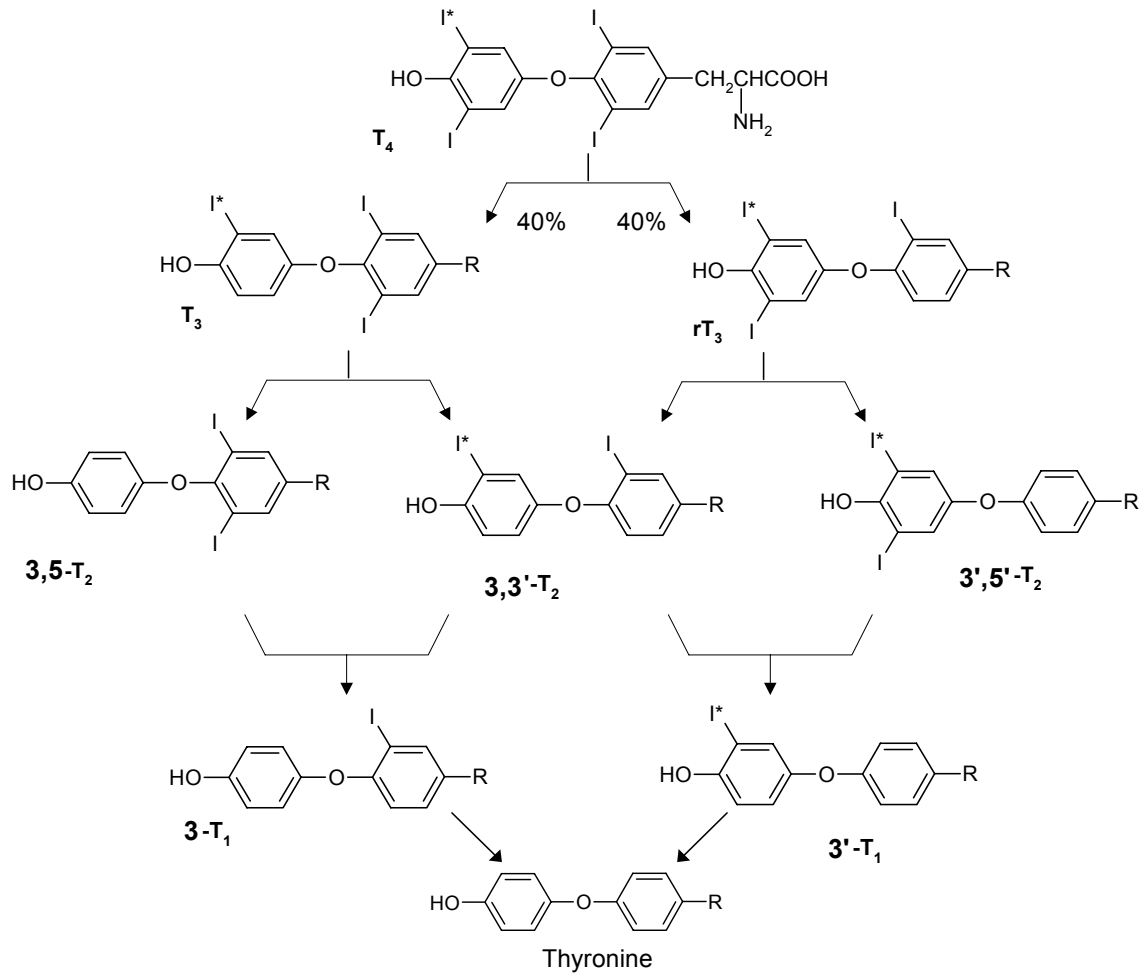

Source: Engler and Burger 1984

3. HEALTH EFFECTS

sites of production of T_3 in the circulation; however, local tissue production of T_3 from T_4 is thought to be the predominant source of T_3 in the brain and pituitary. Iodothyronine deiodinases also catalyze the inactivation of T_4 and T_3 . The activities of deiodinases are under feedback control, mediated by T_3 , T_4 , and reverse T_3 (rT_3), an inactive deiodination product of T_4 (Darras et al. 1999; Peeters et al. 2001). Deiodination of T_4 and T_3 also functions to deactivate the thyroid hormones. Iodide released from the deiodination reactions is either taken up by the thyroid gland or excreted in urine (see Section 3.5.4.2). Deiodination is catalyzed by selenium-dependent deiodinase enzymes (seleniodinases) (see Section 3.6.1).

Oxidative deamination and decarboxylation of the alanine side chain of the iodothyronines represents approximately 2 and 14% of total of T_4 and T_3 turnover, respectively (Braverman et al. 1970; Gavin et al. 1980; Pittman et al. 1980; Visser 1990). Enzymes that catalyze these reactions have not been well characterized. Activity has been demonstrated in homogenates of rat kidney and brain, and the metabolites have been detected in a variety of tissues, including kidney, liver, and skeletal muscle (Engler and Burger 1984). The products of side chain deamination and decarboxylation, the acetic acid analogues of the iodothyronines, undergo deiodination and conjugation with glucuronic acid and sulfate (Engler and Burger 1984; Green and Ingbar 1961; Pittman et al. 1972).

Sulfate conjugation of the phenolic group of iodothyronines occurs in the liver and probably in other tissues. In humans, the reaction in liver is catalyzed by phenolic arylsulfotransferase (Young 1990). Iodothyronines having one iodine moiety on the phenolic ring are preferentially sulfated (Sekura et al. 1981; Visser 1994). The sulfated products undergo deiodination. Although a minor metabolite of the thyroid hormones under normal conditions, the sulfation pathway becomes more important when Type I deiodinase is inhibited; for example, by treatment with propylthiourea (Visser 1994).

Glucuronide conjugation of the phenolic hydroxyl group of the iodothyronines occurs in the liver and probably other tissues. The identity of the glucuronyltransferase enzymes that participate in the conjugation of iodothyronines has not been determined in humans; however, in rats, the activity has been shown to occur for the microsomal bilirubin, *p*-nitrophenol, and androsterone uridine diphosphate (UDP)-glucuronyltransferases (Visser et al. 1993). The activity of the pathway is increased by a variety of chemicals that induce microsomal enzymes, including benzopyrene, phenobarbital, 3-methylcholanthrene, polychlorinated biphenyls (PCBs), and 2,3,7,8-tetrachlorodibenzo-*p*-dioxin (TCDD) (Visser 1990).

3. HEALTH EFFECTS

Ether bond cleavage is a minor pathway of metabolism of iodotyrosines under normal conditions; however, it explains the observation of diiodotyrosine in serum of some patients who received high dosages of T₄ or who had severe bacterial infections (Meinhold et al. 1981, 1987, 1991). The reaction has been observed in phagocytosing leukocytes, which would be abundant during bacterial infections (Klebanoff and Green 1973).

3.5.3.3 Dermal Exposure

The metabolism of absorbed iodine is expected to be similar regardless of the route of exposure to inorganic iodine. A complete discussion of the metabolism of iodine after oral exposures to inorganic iodine is presented in Section 3.5.3.2, and is applicable to inhalation or dermal exposures.

3.5.4 Elimination and Excretion

3.5.4.1 Inhalation Exposure

The excretion of absorbed iodine is expected to be similar regardless of the route of exposure to inorganic iodine. This is supported by studies in which humans were exposed to tracer levels of radioiodine as either I₂ or methyl iodide, and in studies in which monkeys inhaled particulate aerosols of sodium iodide (Black and Hounam 1968; Morgan et al. 1967a, 1967b, 1968; Perrault et al. 1967; Thieblemont et al. 1965). A complete discussion of the metabolism of iodine after oral exposures to inorganic iodine is presented in Section 3.5.3.2, and is applicable to dermal exposures.

3.5.4.2 Oral Exposure

Absorbed iodine is excreted primarily in the urine and feces, but is also excreted in breast milk, exhaled air, sweat, and tears (Cavalieri 1997). Urinary excretion normally accounts for >97% of the elimination of absorbed iodine, while fecal excretion accounts for approximately 1–2% (Hays 2001; Larsen et al. 1998). The whole-body elimination half-time of absorbed iodine has been estimated to be approximately 31 days in healthy adult males (Hays 2001); however, there appears to be considerable inter-individual variability in the half-time (Van Dilla and Fulwyler 1963).

The glucuronide and sulfate conjugates of T₄, T₃, and metabolites are secreted into bile. Estimates of the magnitude of the biliary pathway have been obtained from analyses of bile samples collected from

3. HEALTH EFFECTS

patients who underwent surgical cholecystectomy; the total secretion of T_4 and metabolites was approximately 10–15% of the daily metabolic clearance of T_4 (Langer et al. 1988; Myant 1956). More extensive quantitative information is available on the biliary secretion of iodothyronines conjugates in experimental animals, although these models may not represent the patterns or amounts of biliary secretion that occurs in humans. In rats, approximately 30% of T_4 clearance is accounted for by the biliary secretion of the glucuronide conjugate and 5% as the sulfate conjugate; once secreted, the conjugates undergo extensive hydrolysis with reabsorption of the iodothyronine in the small intestine (Visser 1990).

Iodide is excreted in human breast milk (Dydek and Blue 1988; Hedrick et al. 1986; Lawes 1992; Morita et al. 1998; Robinson et al. 1994; Rubow et al. 1994; Spencer et al. 1986). Simon et al. (2002) estimated a transfer coefficient for ^{131}I from intake to breast milk (ratio of steady-state ^{131}I concentration in breast milk to ^{131}I intake rate) to be approximately 0.12 day/L milk (" 1.5 SD). The fraction of the absorbed iodide dose excreted in breast milk varies with functional status of the thyroid gland and with iodine intake. A larger fraction of the absorbed dose is excreted in breast milk in the hypothyroid state compared to the hyperthyroid state. In the hypothyroid state, uptake of absorbed iodide into the thyroid and incorporation into iodothyronines is depressed, resulting in greater availability of the absorbed iodide for distribution to the mammary gland and breast milk. Several examples of this have been reported in the clinical case literature. A woman who was hyperthyroid and received an oral tracer dose of radioiodine as $^{123}\text{I}[\text{NaI}]$ during lactation excreted approximately 2.5% of the dose in breast milk collected over a 5.5-day period (Morita et al. 1998). The peak excretion (48.5% of the dose) occurred in the first postdosing collection of breast milk, which occurred 7 hours after the dose. A similar result, approximately 2.6% of the oral dose excreted in breast milk, was reported by Hedrick et al. (1986) for a hyperthyroid patient. By contrast, a hypothyroid patient excreted 25% of an oral dose of radioiodine (as $^{123}\text{I}[\text{NaI}]$) in breast milk in 41 hours (Robinson et al. 1994). The fractional transfer of absorbed iodine to breast milk in goats and cows decreases with increasing intake rates (Crout et al. 2000; Vandecastel et al. 2000).

Iodide is excreted in human tears. In an adult patient (hypothyroid with thyroid hormone supplementation) who received an oral tracer dose of ^{123}I radioiodine, approximately 0.01% of the dose was recovered in tears collected over a 4-hour period. The peak activity in tears was observed 1 hour after the dose and activity was present in tears 24 hours after the dose (Bakheet et al. 1998).

3. HEALTH EFFECTS

Iodide is secreted in saliva in humans (Brown-Grant 1961; Mandel and Mandel 2003; Wolff 1983). Salivary secretion of iodide may be an important pathway for recycling of iodine (Mandel and Mandel 2003). The quantitative contribution of the saliva pathway to excretion of iodine has not been reported, and is probably minimal, given the relatively small rate of production of saliva under normal circumstances, most of which is ingested (Brown-Grant 1961; Wolff 1983).

Appreciable amounts of iodide can be excreted in sweat, under conditions of strenuous physical activity (Mao et al. 2001).

Iodide appears to be excreted into the intestine by a mechanism other than biliary secretion of iodothyronine (and metabolic conjugates). Evidence in support of this comes from observations of radioactivity in the colon of patients who have no functioning iodothyronine production and who received doses of radioiodine. Kinetic analyses of the fecal excretion of radioiodine in euthyroid subjects also supports a direct blood-to-intestine excretion route for iodide (Hays 1993). Further support for a possible colonic excretory pathway in humans comes from experimental studies in cats and rats (Hays et al. 1992; Pastan 1957).

3.5.4.3 Dermal Exposure

The excretion of absorbed iodine is expected to be similar regardless of the route of exposure to inorganic iodine. A complete discussion of the metabolism of iodine after oral exposures to inorganic iodine is presented in Section 3.5.3.2, and is applicable to dermal exposures.

3.5.5 Physiologically Based Pharmacokinetic (PBPK)/Pharmacodynamic (PD) Models

Physiologically based pharmacokinetic (PBPK) models use mathematical descriptions of the uptake and disposition of chemical substances to quantitatively describe the relationships among critical biological processes (Krishnan et al. 1994). PBPK models are also called biologically based tissue dosimetry models. PBPK models are increasingly used in risk assessments, primarily to predict the concentration of potentially toxic moieties of a chemical that will be delivered to any given target tissue following various combinations of route, dose level, and test species (Clewell and Andersen 1985). Physiologically based pharmacodynamic (PBPD) models use mathematical descriptions of the dose-response function to quantitatively describe the relationship between target tissue dose and toxic end points.

3. HEALTH EFFECTS

PBPK/PD models refine our understanding of complex quantitative dose behaviors by helping to delineate and characterize the relationships between: (1) the external/exposure concentration and target tissue dose of the toxic moiety, and (2) the target tissue dose and observed responses (Andersen et al. 1987; Andersen and Krishnan 1994). These models are biologically and mechanistically based and can be used to extrapolate the pharmacokinetic behavior of chemical substances from high to low dose, from route to route, between species, and between subpopulations within a species. The biological basis of PBPK models results in more meaningful extrapolations than those generated with the more conventional use of uncertainty factors.

The PBPK model for a chemical substance is developed in four interconnected steps: (1) model representation, (2) model parametrization, (3) model simulation, and (4) model validation (Krishnan and Andersen 1994). In the early 1990s, validated PBPK models were developed for a number of toxicologically important chemical substances, both volatile and nonvolatile (Krishnan and Andersen 1994; Leung 1993). PBPK models for a particular substance require estimates of the chemical substance-specific physicochemical parameters, and species-specific physiological and biological parameters. The numerical estimates of these model parameters are incorporated within a set of differential and algebraic equations that describe the pharmacokinetic processes. Solving these differential and algebraic equations provides the predictions of tissue dose. Computers then provide process simulations based on these solutions.

The structure and mathematical expressions used in PBPK models significantly simplify the true complexities of biological systems. If the uptake and disposition of the chemical substance(s) is adequately described, however, this simplification is desirable because data are often unavailable for many biological processes. A simplified scheme reduces the magnitude of cumulative uncertainty. The adequacy of the model is, therefore, of great importance, and model validation is essential to the use of PBPK models in risk assessment.

PBPK models improve the pharmacokinetic extrapolations used in risk assessments that identify the maximal (i.e., the safe) levels for human exposure to chemical substances (Andersen and Krishnan 1994). Similar models have been developed for radionuclides. These models provide a scientifically sound means to predict the target tissue dose of chemicals and radiation in humans who are exposed to environmental levels (for example, levels that might occur at hazardous waste sites) based on the results of studies where doses were higher or were administered in different species. Figure 3-7 shows a conceptualized representation of a PBPK model. Figures 3-8 through 3-15 show models for radionuclides

3. HEALTH EFFECTS

Figure 3-7. Conceptual Representation of a Physiologically Based Pharmacokinetic (PBPK) Model for a Hypothetical Chemical Substance

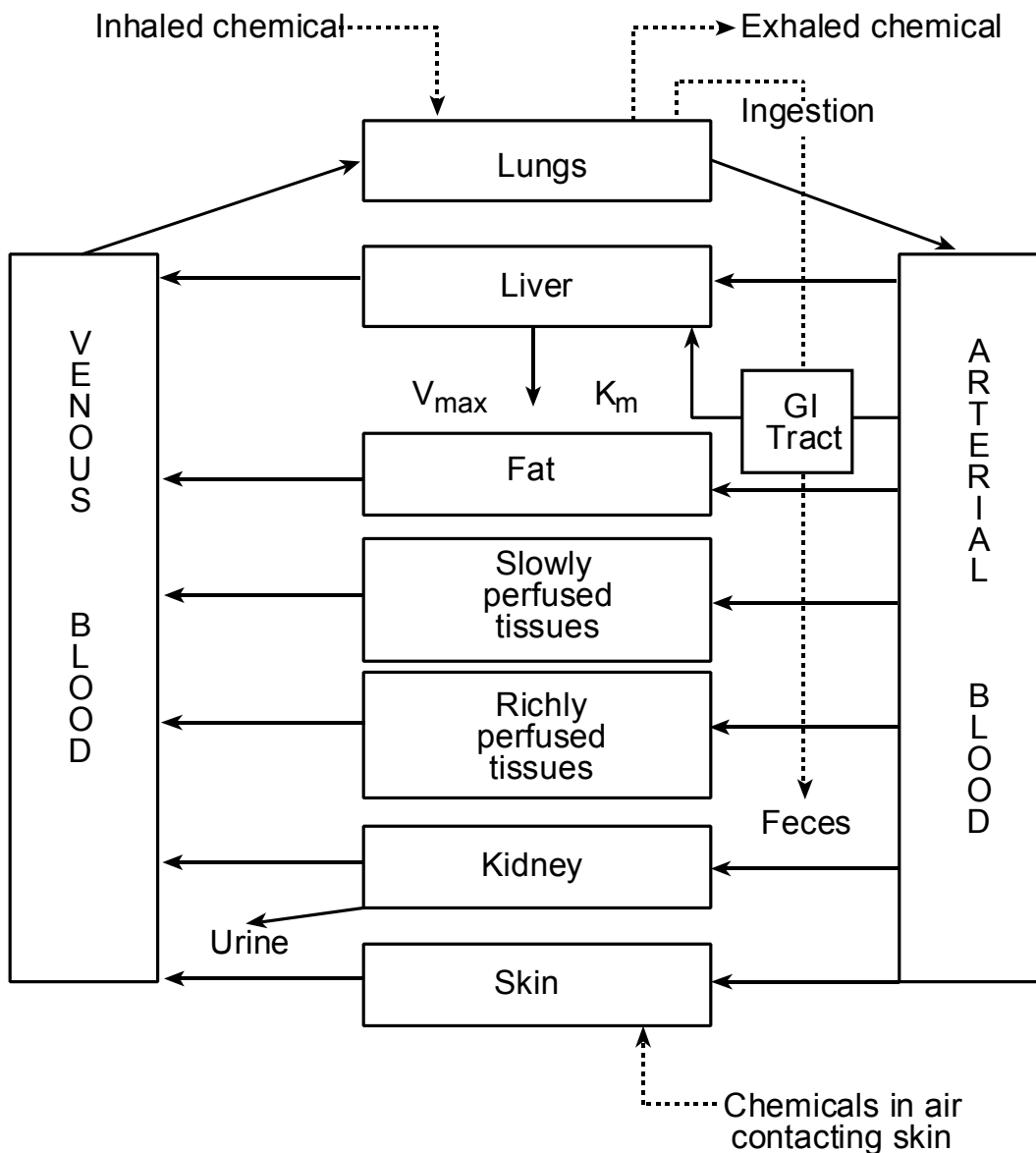

Note: This is a conceptual representation of a physiologically based pharmacokinetic (PBPK) model for a hypothetical chemical substance. The chemical substance is shown to be absorbed via the skin, by inhalation, or by ingestion, metabolized in the liver, and excreted in the urine or by exhalation.

Source: adapted from Krishnan et al. 1994

3. HEALTH EFFECTS

in general or specifically for iodine. The ICRP (1994b, 1996) developed a Human Respiratory Tract Model for Radiological Protection, which contains respiratory tract deposition and clearance compartmental models for inhalation exposure that may be applied to gases and vapors of iodine compounds and particulate aerosols of iodine. The ICRP (1979, 1989) also developed a biokinetic model for human oral exposure that applies to iodine. Several other multicompartamental models of iodine pharmacokinetics have been described, two of which are also described below because of either their extensive history of use in clinical applications of radioiodine (Oddie et al. 1955) or their potential value in environmental risk assessment (Stather and Greenhalgh 1983). The EPA (1998) has adopted the ICRP (1989, 1994a, 1995) models for assessment of radiologic risks from iodine exposures. The National Council on Radiation Protection and Measurements (NCRP) has also developed a respiratory tract model for inhaled radionuclides (NCRP 1997). At this time, the NCRP recommends the use of the ICRP model for calculating exposures for radiation workers and the general public. Readers interested in this topic are referred to NCRP Report No. 125; Deposition, Retention and Dosimetry of Inhaled Radioactive Substances (NCRP 1997). In the appendix to the report, NCRP provides the animal testing clearance data and equations fitting the data that supported the development of the human model.

Human Respiratory Tract Model for Radiological Protection (ICRP 1994)

Deposition. The ICRP (1994b) has developed a deposition model for behavior of aerosols and vapors in the respiratory tract. It was developed to estimate the fractions of radioactivity in breathing air that are deposited in each anatomical region of the respiratory tract. ICRP (1994b) provides inhalation dose coefficients that can be used to estimate the committed equivalent and effective doses to organs and tissues throughout the body based on a unit intake of radioactive material. The model applies to three levels of particle solubility, and a wide range of particle sizes (approximately 0.0005–100 μm in diameter) and parameter values, and can be adjusted for various segments of the population (e.g., sex, age, level of physical exertion). This model also allows the evaluation of the bounds of uncertainty in deposition estimates. Uncertainties arise from natural biological variability among individuals and the need to interpret some experimental evidence that remains inconclusive. It is applicable to gases and vapors of volatile iodine compounds (e.g., I_2 and methyl iodide) and particulate aerosols containing iodine, but was developed for a wide variety of radionuclides and their chemical forms.

The ICRP deposition model estimates the amount of inhaled material that initially enters each compartment (see Figure 3-8). The model was developed with 5 compartments: (1) the anterior nasal passages (ET1); (2) all other extrathoracic airways (ET2) (posterior nasal passages, the naso- and oropharynx, and the larynx); (3) the bronchi (BB); (4) the bronchioles (bb); and (5) the alveolar

3. HEALTH EFFECTS

Figure 3-8. Compartment Model to Represent Particle Deposition and Time-Dependent Particle Transport in the Respiratory Tract*

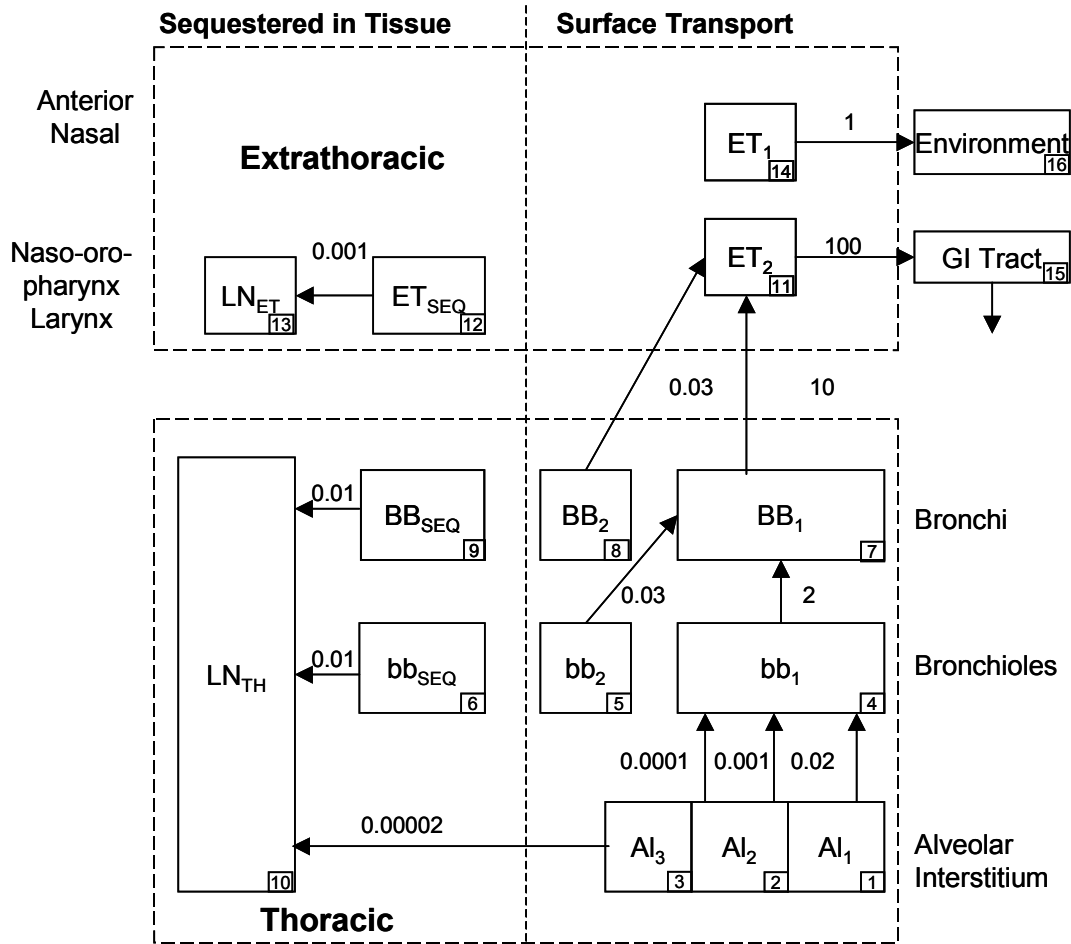

*Compartment numbers shown in lower right corners are used to define clearance pathways. The clearance rates, half-lives, and fractions by compartment, as well as the compartment abbreviations are presented in Table 3-6.

Source: ICRP 1994b

3. HEALTH EFFECTS

interstitium (AI). Particles deposited in each of the regions may be removed from each region and redistributed either upward into the respiratory tree or to the lymphatic system and blood by different particle removal mechanisms.

For extrathoracic deposition of particles, the model uses experimental data (where deposition is related to particle size and airflow parameters) and scales deposition for women and children from adult male data. Similar to the extrathoracic region, experimental data served as the basis for lung (bronchi, bronchioles, and alveoli) aerosol transport and deposition. A theoretical model of gas transport and particle deposition was used to interpret data and to predict deposition for compartments and subpopulations other than adult males. Table 3-5 provides reference respiratory values for the general Caucasian population under several levels of activity.

Deposition of inhaled gases and vapors is modeled as a partitioning process that depends on the physiological parameters noted above as well as the solubility and reactivity of compound in the respiratory tract (Figure 3-9). The ICRP (1994b) model defines three categories of solubility and reactivity: SR-0, SR-1, and SR-2:

- Type SR-0 compounds include insoluble and nonreactive gases (e.g., inert gases such as H₂, He). These compounds do not significantly interact with the respiratory tract tissues and essentially all compound inhaled is exhaled. Radiation doses from inhalation of SR-0 compounds are assumed to result from the irradiation of the respiratory tract from the air spaces.
- Type SR-1 compounds include soluble or reactive gases and vapors that are expected to be taken up by the respiratory tract tissues and may deposit in any or all of the regions of the respiratory tract, depending on the dynamics of the airways and properties of the surface mucous and airway tissues, as well as the solubility and reactivity of the compound. Molecular iodine (I₂) and methyl iodide are classified as SR-1 compounds (ICRP 1995). Deposition of molecular iodine vapor is assumed to occur in ET1 (10%), ET2 (40%), and BB (50%) regions of the respiratory tract, whereas 70% of inhaled methyl iodide is assumed to deposit uniformly in ET2 and deeper regions of the respiratory tract (ICRP 1995).
- Type SR-2 compounds include soluble and reactive gases and vapors that are completely retained in the extrathoracic regions of the respiratory tract. SR-2 compounds include sulfur dioxide (SO₂) and hydrogen fluoride (HF).

Mechanical Clearance from the Respiratory. This portion of the model identifies the principal clearance pathways within the respiratory tract. The model was developed to predict the retention of various radioactive materials. The compartmental model is linked to the deposition model (see Figure 3-8) and to reference values presented in Table 3-6. Table 3-6 provides clearance rates and deposition fractions for each compartment for insoluble particles. The table provides rates of insoluble particle transport for each

3. HEALTH EFFECTS

Table 3-5. Reference Respiratory Values for a General Caucasian Population at Different Levels of Activity^a

	3 mo	1 yr	5 yr	10 yr			15 yr		Adult	
				Male	Female	Both	Male	Female	Male	Female
Resting (sleeping); Maximal workload 8%										
Breathing parameters:										
$V_T(L)^b$	0.04	0.07	0.17	—	—	0.3	0.500	0.417	0.625	0.444
$B(m^3h^{-1})^b$	0.09	0.15	0.24	—	—	0.31	0.42	0.35	0.45	0.32
$f_R(min^{-1})^b$	38	34	23	—	—	17	14	14	12	12
Sitting awake; Maximal workload 12%										
Breathing parameters:										
$V_T(L)$	N/A	0.1	0.21	—	—	0.33	0.533	0.417	0.750	0.464
$B(m^3h^{-1})$	N/A	0.22	0.32	—	—	0.38	0.48	0.40	0.54	0.39
$f_R(min^{-1})$	N/A	36	25	—	—	19	15	16	12	14
Light exercise; Maximal workload 32%										
Breathing parameters:										
$V_T(L)$	0.07	0.13	0.24	—	—	0.58	1.0	0.903	1.25	0.992
$B(m^3h^{-1})$	0.19	0.35	0.57	—	—	1.12	1.38	1.30	1.5	1.25
$f_R(min^{-1})$	48	46	39	—	—	32	23	24	20	21
Heavy exercise; Maximal workload 64%										
Breathing parameters:										
$V_T(L)$	N/A	N/A	N/A	0.841	0.667	—	1.352	1.127	1.923	1.364
$B(m^3h^{-1})$	N/A	N/A	N/A	2.22	1.84	—	2.92	2.57	3.0	2.7
$f_R(min^{-1})$	N/A	N/A	N/A	44	46	—	36	38	26	33

^aSee Annex B (ICRP 1994b) for data from which these reference values were derived

^b V_T = Tidal volume, B = ventilation rate, f_R = respiration frequency

h = hour; L = liter; m = meter; min = minute; mo = months; N/A = not applicable; yr = year(s)

3. HEALTH EFFECTS

Figure 3-9. Reaction of Gases or Vapors at Various Levels of the Gas-Blood Interface

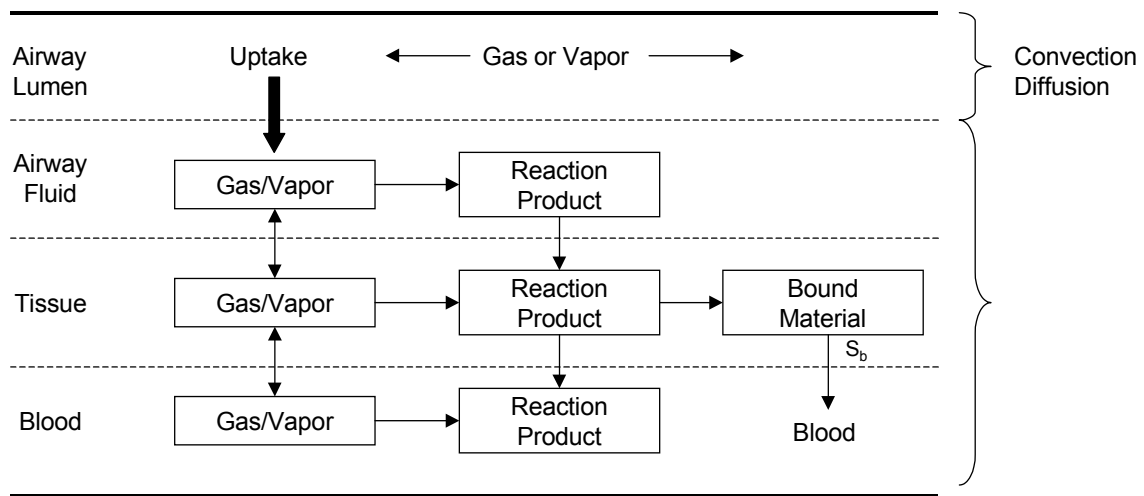

Source: ICRP 1994b

3. HEALTH EFFECTS

Table 3-6. Reference Values of Parameters for the Compartment Model to Represent Time-dependent Particle Transport from the Human Respiratory Tract

Part A

Clearance rates for insoluble particles				
Pathway	From	To	Rate (d ⁻¹)	Half-life ^a
m _{1,4}	Al ₁	bb ₁	0.02	35 days
m _{2,4}	Al ₂	bb ₁	0.001	700 days
m _{3,4}	Al ₃	bb ₁	0.0001	7,000 days
m _{3,10}	Al ₃	LN _{TH}	0.00002	No data
m _{4,7}	bb ₁	BB ₁	2	8 hours
m _{5,7}	bb ₂	BB ₁	0.03	23 days
m _{6,10}	bb _{seq}	LN _{TH}	0.01	70 days
m _{7,11}	BB ₁	ET ₂	10	100 minutes
m _{8,11}	BB ₂	ET ₂	0.03	23 days
m _{9,10}	BB _{seq}	LN _{TH}	0.01	70 days
m _{11,15}	ET ₂	GI tract	100	10 minutes
m _{12,13}	ET _{seq}	LN _{ET}	0.001	700 days
m _{14,16}	ET ₁	Environment	1	17 hours

See next page for Part B

3. HEALTH EFFECTS

Table 3-6. Reference Values of Parameters for the Compartment Model to Represent Time-dependent Particle Transport from the Human Respiratory Tract (continued)

Part B

Partition of deposit in each region between compartments^b

Region or deposition site	Compartment	Fraction of deposit in region assigned to compartment ^c
ET ₂	ET ₂	0.9995
	ET _{seq}	0.0005
BB	BB ₁	0.993-f _s
	BB ₂	f _s
	BB _{seq}	0.007
bb	bb ₁	0.993-f _s
	bb ₂	f _s
	bb _{seq}	0.007
Al	Al ₁	0.3
	Al ₂	0.6
	Al ₃	0.1

^aThe half-lives are approximate since the reference values are specified for the particle transport rates and are rounded in units of d⁻¹. A half-life is not given for the transport rate from Al₃ to LN_{TH}, since this rate was chosen to direct the required amount of material to the lymph nodes. The clearance half-life of compartment Al₃ is determined by the sum of the clearance rates from it.

^bSee paragraph 181, Chapter 5 (ICRP 1994) for default values used for relating f_s to d_{ae}.

^cIt is assumed that f_s is size-dependent. For modeling purposes, f_s is taken to be:

$$f_s = 0.5 \text{ for } d_{ae} \leq 2.5\sqrt{\rho/\chi} \mu\text{m and}$$

$$f_s = 0.5e^{0.63(d_{ae}\sqrt{\rho/\chi}-2.5)} \text{ for } d_{ae} > 2.5\sqrt{\rho/\chi} \mu\text{m}$$

where

f _s	=	fraction subject to slow clearance
d _{ae}	=	aerodynamic particle diameter/(μm)
ρ	=	particle density (g/cm ³)
χ	=	particle shape factor

Al = alveolar-interstitial region; BB = bronchial region; bb = bronchiolar region; BB_{seq} = compartment representing prolonged retention in airway walls of small fraction of particles deposited in the bronchial region; bb_{seq} = compartment representing prolonged retention in airway walls of small fraction of particles deposited in the bronchiolar region; d = day(s); ET = extrathoracic region; ET_{seq} = compartment representing prolonged retention in airway tissue of small fraction of particles deposited in the nasal passages; LN_{ET} = lymphatics and lymph nodes that drain the extrathoracic region; LN_{TH} = lymphatics and lymph nodes that drain the thoracic region

Source: ICRP 1994b

3. HEALTH EFFECTS

of the compartments, expressed as a fraction per day and also as half-time. ICRP (1994b) also developed modifying factors for some of the parameters, such as age, smoking, and disease status. Parameters of the clearance model are based on human evidence for the most part, although particle retention in airway walls is based on experimental data from animal experiments.

The clearance of particles from the respiratory tract is a dynamic process. The rate of clearance generally changes with time from each region and by each route. Following deposition of large numbers of particles (acute exposure), transport rates change as particles are cleared from the various regions. Physical and chemical properties of deposited material determine the rate of dissolution, and as particles dissolve, absorption rates tend to change over time. By creating a model with compartments of different clearance rates within each region (e.g., BB_1 , BB_2 , BB_{seq}), the ICRP model overcomes problems associated with time-dependent functions. Each compartment clears to other compartments by constant rates for each pathway.

Particle transport from all regions is toward both the lymph nodes and the pharynx, and a majority of deposited particles ultimately are swallowed. In the front part of the nasal passages (ET_1), nose blowing, sneezing, and wiping remove most of the deposited particles. Particles remain here for about a day. For particles with AMADs a few micrometers or greater, the ET_1 compartment is probably the largest deposition site. A majority of particles deposited at the back of the nasal passages and in the larynx (ET_2) are removed quickly by the fluids that cover the airways. In this region, particle clearance is completed within 15 minutes.

Ciliary action removes deposited particles from both the bronchi and bronchioles. Though it is generally thought that mucocilliary action rapidly transports most particles deposited here toward the pharynx, some of these particles are cleared more slowly. Evidence for this is found in human studies. For humans, retention of particles deposited in the lungs (BB and bb) is apparently biphasic. The “slow” action of the cilia may remove as many as half of the bronchi- and bronchiole-deposited particles. In human bronchi and bronchiole regions, mucus moves more slowly the closer to the alveoli it is. For the faster compartment, it has been estimated that it takes about 2 days for particles to travel from the bronchioles to the bronchi and 10 days from the bronchi to the pharynx. The second (slower) compartment is assumed to have approximately equal fractions deposited between BB_2 and bb_2 , both with clearance half-times estimated at 20 days. Particle size is a primary determinant of the fraction deposited in this slow thoracic compartment. A small fraction of particles deposited in the BB and bb regions is retained in the airway wall for even longer periods (BB_{seq} and bb_{seq}).

3. HEALTH EFFECTS

If particles reach and become deposited in the alveoli, they tend to stay imbedded in the fluid on the alveolar surface or move into the lymph nodes. The one mechanism by which particles are physically resuspended and removed from the AI region is coughing. For modeling purposes, the AI region is divided into three subcompartments to represent different clearance rates, all of which are slow.

Particle clearance from the alveolar-interstitial region has been measured in humans. The ICRP model uses two half-times to represent clearance: about 30% of the particles have a 30-day half-time, and the remaining 70% are given a half-time of several hundred days. Over time, AI particle transport falls and some compounds have been found in lungs 10–50 years after exposure.

Absorption into Blood. The ICRP model assumes that absorption into blood occurs at equivalent rates in all parts of the respiratory tract, except in the anterior nasal passages (ET_1), where no absorption occurs. It is essentially a 2-stage process, as shown in Figure 3-10. First, there is a dissociation (dissolution) of particles; then the dissolved molecules or ions diffuse across capillary walls and are taken up by the blood. Immediately following dissolution, rapid absorption is observed. For some elements, rapid absorption does not occur because of binding to respiratory-tract components. In the absence of specific data for specific compounds, the model uses the following default absorption rate values for those specific compounds that are classified as Types F (fast), M (medium), S (slow), and V (instantaneous):

- For Type F, there is rapid 100% absorption within 10 minutes of the material deposited in the BB, bb, and AI regions, and 50% of material deposited in ET_2 . Thus, for nose breathing, there is rapid absorption of approximately 25% of the deposit in ET and 50% for mouth breathing. Type F iodine compounds include molecular iodine (I_2) and particulate aerosols of silver iodide and sodium iodide. For Type M, about 70% of the deposit in AI reaches the blood eventually. There is rapid absorption of about 10% of the deposit in BB and bb, and 5% of material deposited in ET_2 . Thus, there is rapid absorption of approximately 2.5% of the deposit in ET for nose breathing, and 5% for mouth breathing. ICRP (1995) does not identify any Type M iodine compounds.
- For Type S, 0.1% is absorbed within 10 minutes and 99.9% is absorbed within 7,000 days, so there is little absorption from ET, BB, or bb, and about 10% of the deposit in AI reaches the blood eventually. ICRP (1995) does not identify any Type S iodine compounds.
- For Type V, complete absorption (100%) is considered to occur instantaneously. Methyl iodide is classified as a Type V compound (ICRP 1995).

3. HEALTH EFFECTS

Figure 3-10. The Human Respiratory Tract Model: Absorption into Blood

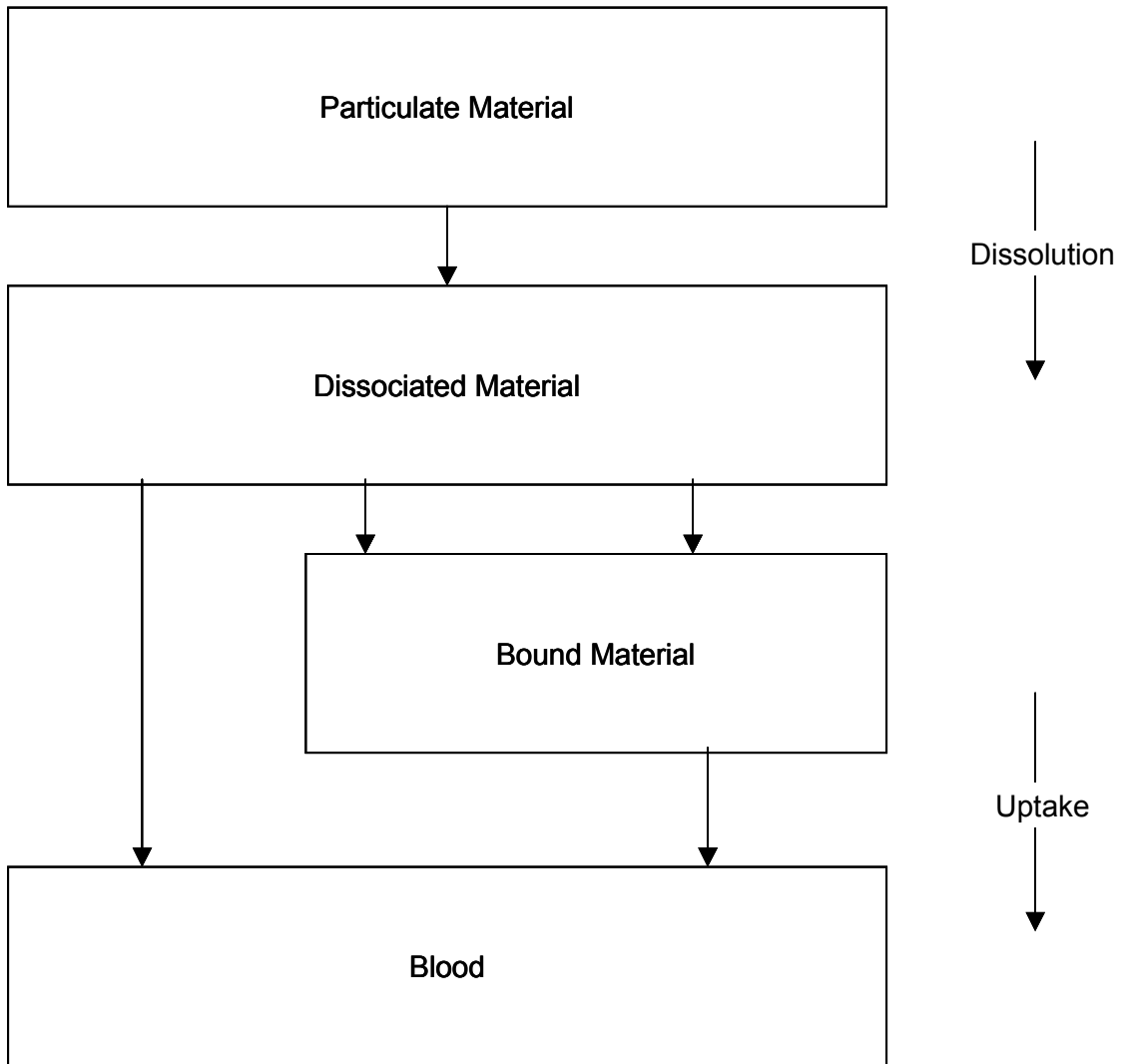

Source: ICRP 1994b

3. HEALTH EFFECTS

EPA (2002) Iodine Biokinetics Models**Description of the models.**

EPA (2002a) developed PBPK models of the kinetics of ingested or injected iodide in rats and humans. The models were developed simultaneously with models of perchlorate biokinetics. When combined, the iodide and perchlorate models simulate the acute competitive inhibition of iodide transport by perchlorate in thyroid and other tissues that have NIS activity. The adult rat model has been extended to include pregnancy and maternal-fetal transfer of iodide, and lactation and maternal-pup iodide transfer through milk.

The adult rat and human models have the same structure and differ only in values for physiological and some of iodide parameters (Figure 3-11, Table 3-7). Both models simulate eight tissue compartments: blood, kidney, liver, skin, stomach, thyroid, fat, other slowly perfused tissues, and other richly perfused tissues. Uptakes from blood into the vascular compartments of the tissues are simulated as flow-limited processes. Distributions within blood, skin, stomach, and thyroid are simulated as diffusion-limited processes with first-order clearance terms. Transport of iodide within tissues that have NIS activity are simulated with tissue-specific affinity constants and maximum transport velocities. This includes uptake of iodine into thyroid follicle cells and secretion of iodide into the follicle lumen. Active transport of iodide into the stomach lumen and in skin is also simulated in the models. Excretion is simulated with a first-order clearance term for transfer of iodide from the kidney into urine.

Extensions of the adult rat model to simulate iodide kinetics during pregnancy include the addition of two additional compartments representing the mammary gland and placenta. Uptake of iodide into the mammary gland tissue from the mammary tissue vascular space is simulated as an affinity- and capacity-limited transport process, representing the activity of NIS in this tissue. Uptake of iodide into the placenta from blood is simulated as a flow-limited process. Exchanges of iodide between the placenta and fetus are simulated with first order clearance terms. The fetal model is identical in structure to the adult (non-pregnant) model, with adjustments in the physiological and iodide parameters to reflect the fetus.

The lactating rat model includes a milk compartment in mammary tissue and a first-order clearance term for describing secretion of iodide from mammary tissue into milk. Transfer of iodide from milk to the neonate is simulated as a first-order clearance process. The neonate model is identical in structure to the

3. HEALTH EFFECTS

Table 3-7. Chemical-specific Parameters for the Adult Male Rat and Human PBPK Models for Iodide^a

Partition Coefficients (unitless)	Rat	Human
Slowly Perfused/Plasma PS_	0.21	0.21
Richly Perfused/Plasma PR_	0.40	0.40
Fat/Plasma PF_	0.05	0.05
Kidney/Plasma PK_	1.09	0.05
Liver/Plasma PL_	0.44	0.44
Gastric Tissue/Gastric Blood PG_	1.40	0.50
Gastric Juice/Gastric Tissue PGJ_	3.00	3.50
Skin Tissue/Skin Blood PSk_	0.70	0.70
Thyroid Tissue/Thyroid Blood PT_	0.15	0.15
Thyroid Lumen/Thyroid Tissue PDT_	7.00	7.00
Red Blood Cells/Plasma	1.00	1.00
Max Capacity, Vmaxc (ng/hr-kg)		
Thyroid Colloid Vmaxc_DT	4.0×10^{-7}	1.0×10^8
Thyroid Follicle Vmaxc_T	5.5×10^4	$\sim 1.5 \times 10^5$
Skin Vmaxc_S	5.0×10^{-5}	7.0×10^5
Gut Vmaxc_G	1.0×10^6	9.0×10^5
Plasma Binding Vmaxc_Bp	–	–
Affinity Constants, Km (ng/L)		
Thyroid Lumen Km_DT	1.0×10^9	1.0×10^9
Thyroid km_T	4.0×10^6	4.0×10^6
Skin Km_S	4.0×10^6	4.0×10^6

3. HEALTH EFFECTS

Table 3-7. Chemical-specific Parameters for the Adult Male Rat and Human PBPK Models for Iodide^a

Partition Coefficients (unitless)	Rat	Human
Gut Km_G	4.0x10 ⁶	4.010 ⁶
Plasma Binding km_B	–	–
Permeability Area Cross Products (L/hr-kg)		
Gastric Blood to Gastric Tissue PAGc_	0.10	0.20
Gastric Tissue to Gastric Juice PAGJc_	0.10	2.00
Skin Blood to Skin Tissue PASKc_	0.10	0.06
Plasma to Red Blood Cells PARBcc_	1.00	1.00
Follicle to Thyroid Follicle PATc_	1.0x10 ⁻⁴	1.0x10 ⁻⁴
Lumen to Thyroid Follicle PADTc_	1.0x10 ⁻⁴	1.0x10 ⁻⁴
Clearance Values (L/hr-kg)		
Urinary excretion CLUc_	0.05	0.1
Plasma unbinding Clunbc_	–	–

^aSource: EPA 2002a

3. HEALTH EFFECTS

Figure 3-11. Structure of EPA (2002) PBPK Model of Iodine in Adult Male Humans and Rats

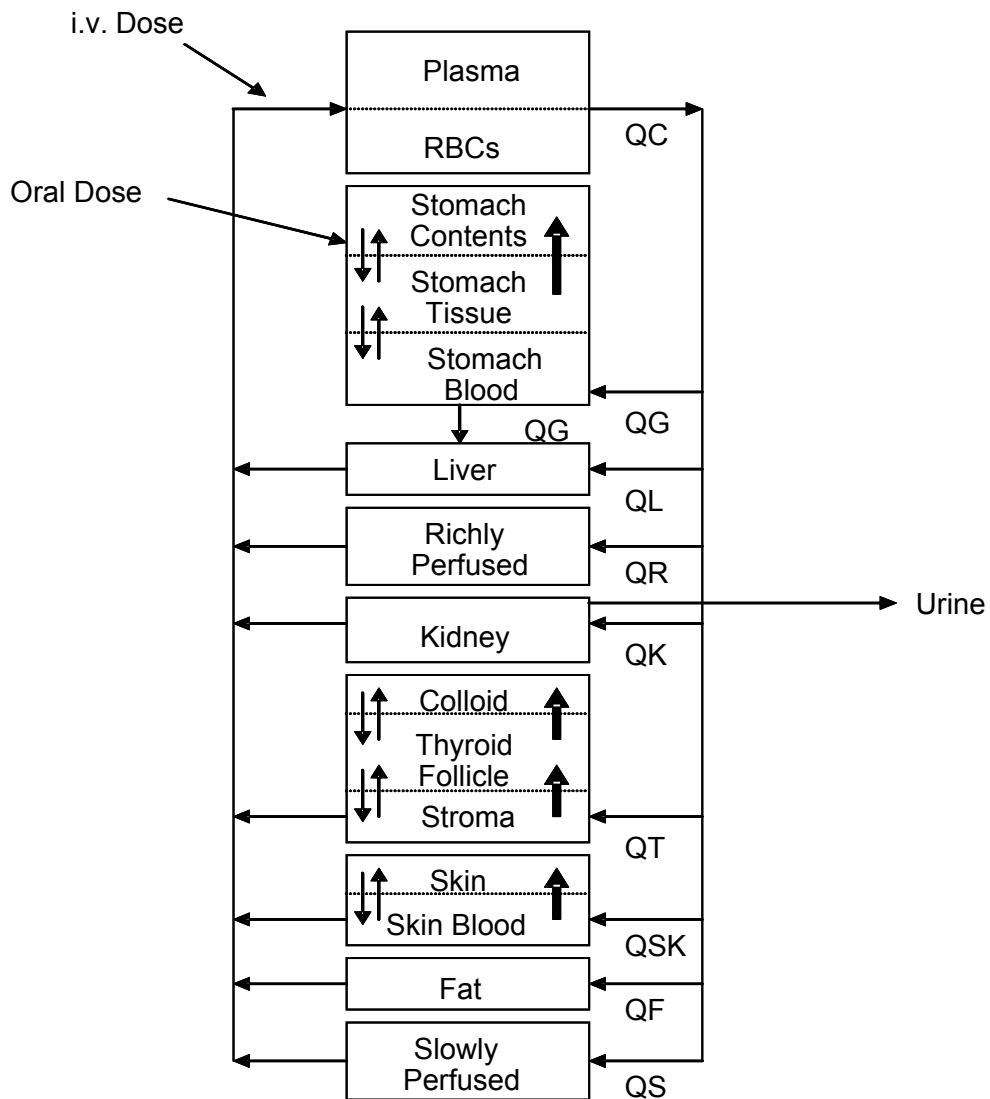

Thick arrows within tissue compartments indicate transfers that are affinity- and capacity-limited (e.g., NIS). Thin arrows within tissue compartments are diffusion limited transfers. Q indicates flow for flow-limited transfers.

3. HEALTH EFFECTS

adult (nonpregnant) model, with adjustments to the physiological and iodide parameter values to reflect the neonate.

Validation of the model.

The rat iodide model has been evaluated for predicting serum and thyroid iodine concentrations in adult rats that received acute intravenous injection of radioiodine (EPA 2002a). Model predictions corresponded reasonably well with observations. The model also predicted reasonably well the inhibition of radioiodine uptake in the thyroid produced by an acute intravenous dose of perchlorate; however, the model under-predicted thyroid iodide uptake in rats that received perchlorate in drinking water for 14 days at doses >1 mg/kg/day. Thus, the model simulated a greater inhibition of thyroid uptake of iodide in animals that received repeated doses of perchlorate than was actually observed. The inability of the model to accurately predict the effect of repeated exposures to perchlorate on thyroid iodide uptake is not surprising, since the model does not simulate the hormonal regulation of NIS activity and organification of iodide in the thyroid. In animals that received repeated exposures to perchlorate, induction of NIS and thyroid hormone production are likely to have occurred secondary to elevations in serum TSH (EPA 2002a; Uyttersprot et al. 1997). Such a response could have partially restored thyroid iodide uptake to higher levels than would be predicted if induction is not taken into account.

The adult human model also predicted reasonably well radioiodine in serum, thyroid, gastric contents, and urine in subjects who received an intravenous dose of radioiodine (Hays and Solomon 1965), when model parameters were calibrated to achieve good correspondence to the observations. Similarly, model predictions of thyroid radioiodine uptake in subjects who received oral doses of perchlorate agreed with observations when the kinetic parameters for iodide in the thyroid (i.e., maximum transport into the thyroid follicle) were adjusted to achieve good correspondence to the observations (EPA 2002a). When the model was calibrated by adjusting the maximum transport rate for iodide into the thyroid follicle, it accurately predicted the observed time course for radioiodine uptake in a Graves' disease patient who received a single tracer dose of radioiodine (Stanbury and Wyngaarden 1952); however, the model substantially over predicted iodine uptake after the same patient received a dose of perchlorate. Here again, the error in predictions of the effect of perchlorate on iodine uptake may reflect humoral regulation of iodide transport and organification mechanisms or the response to perchlorate in Graves' disease patients that is not simulated in the model.

The rat maternal/fetal models were evaluated by comparing predictions of radioiodine concentrations in mammary gland and placenta, and maternal and fetal serum and thyroid following single intravenous

3. HEALTH EFFECTS

injections of radioiodine, with or without concurrent injection of perchlorate or exposure to perchlorate in drinking water (EPA 2002a; Versloot et al. 1997). Model predictions were in reasonable agreement with observations for rats that received single injections of iodide with or without single injections of perchlorate; however, the model under-predicted maternal thyroid iodide levels in animals that received repeated oral exposures to perchlorate.

Similar outcomes occurred in evaluations of the lactating dam/neonate model (EPA 2002a). The model accurately predicted serum and thyroid iodine concentrations in the dam and neonate following single intravenous injections of radioiodine, with or without concurrent injection of perchlorate. However, the model under predicted maternal iodide levels in dams that received repeated exposures to perchlorate in drinking water.

Risk assessment.

The rat and human models have been used to calculate human equivalent exposure levels for perchlorate that would be expected to produce the same degree of inhibition of iodide uptake into the thyroid gland (EPA 2002a). These estimates have been used to extrapolate dose-response relationships for perchlorate observed in rats to humans.

Target tissues.

The models are designed to calculate iodine concentrations in serum and thyroid.

Species extrapolation.

The models are designed for applications to rat or human dosimetry and cannot be applied to other species without modification.

Interroute extrapolation.

The models are designed to simulate intravenous or oral exposures to radioiodine and cannot be applied to other routes of exposure without modification.

3. HEALTH EFFECTS

Berkovski (2002) Iodine Biokinetics Model**Description of the model.**

Berkovski (1999a, 1999b) developed compartmental models of the biokinetics of iodine in the pregnant and lactating human female (Figure 3-12). The most recent description of the models (Berkovski 2002) is the basis for the ICRP (2002) iodine model. The models simulate the transfer of iodine from the pregnant woman to the fetus and to breast milk, during lactation. The maternal model simulates the gastrointestinal cycling of iodine, including absorption to blood from the stomach (slow) and small intestine (fast), secretion into the stomach, secretion into salivary glands (the latter transfers to the stomach), and secretion of organic iodine from other tissues into the large intestine (e.g., biliary transfer; the latter transfers to feces). Iodide in the central blood compartment distributes to the breasts, kidney (to urinary bladder), ovaries, thyroid gland, and other tissues. The model includes pathways for cycling of iodine into and out of the organic iodine (e.g., thyroid hormones) pool. This includes the thyroid gland, which has subcompartments for iodide and organic iodine (e.g., thyroid hormone and precursors). The thyroidal iodide compartment exchanges with the blood compartment; the organic iodine compartment receives input from blood and delivers organic iodine to the other tissue compartment. In the other tissue compartment, organic iodine is deiodinated and the resulting iodide pool exchanges with the iodide in the blood compartment. The model predicts, for a euthyroid adult who ingests 150 μg iodide/day, equilibrium contents of approximately 21 μg iodide in blood, 30 μg iodide and 8,000 μg organic iodine in the thyroid gland, 57 μg iodide and 1,350 μg organic iodine in other tissues, and 21 μg iodide in blood. The resulting ratio of total iodine in thyroid to that in blood is approximately 400.

The pregnancy model extends the maternal model with additional compartments representing the uterus and placenta, amniotic fluid compartment, and fetus. Iodide in the maternal blood compartment exchanges with iodide in the placental/uterine and amniotic fluid compartments. Organic iodine in the maternal other tissues compartment exchanges with organic iodine in the placental and amniotic fluid compartments. The fetal compartment includes three subcompartments representing cycling of fetal iodide into thyroid and extra-thyroidal iodine pools. Iodide can enter the fetal compartment from exchange with iodide in the placental/uterine compartments or from transfer from the amniotic fluid (i.e., fetal ingestion of amniotic fluid). Transfer coefficients vary through gestation to account for changes in maternal and fetal iodine biokinetics associated with growth of the placenta and fetus, initiation of fetal thyroid iodine accumulation and hormone production (approximately 12 weeks of gestation), and increased maternal renal clearance of iodide.

3. HEALTH EFFECTS

Figure 3-12. Berkovski (2002) Metabolic Model for Iodine

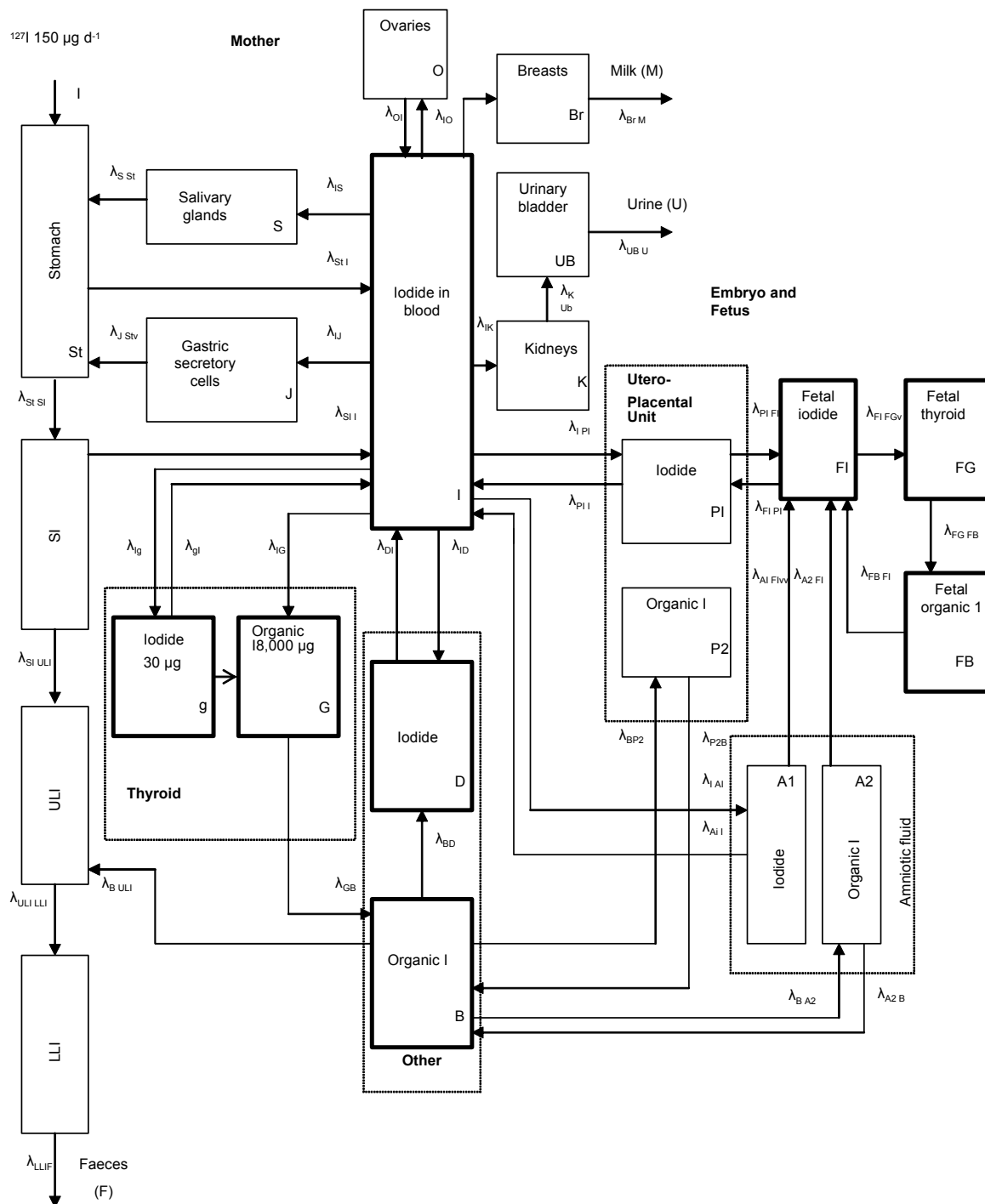

Adapted from Berkovski 1999a

3. HEALTH EFFECTS

The lactation model includes an additional compartment for breast milk, which receives iodide from the breast compartment.

Validation of the model.

Berkovski (1999a, 1999b, 2002) presents comparisons of model predictions and observations made in humans. The model predictions agree well with the observed kinetics of elimination of ^{131}I from amniotic fluid after intravenous injection of ^{131}I . The model also simulates, with good agreement, observed fetal thyroid radioiodine uptakes and elimination at various stages of gestation.

Risk assessment.

The Berkovski (2002) model is the basis for the ICRP (2002) model, which is used to establish radiation dose equivalents (Sv/Bq) of various ingested radioactive isotopes of iodine.

Target tissues.

The model is designed to calculate radioiodine intake limits based on radiation dose to all major organs that concentrate iodine (relative to blood), including the thyroid gland, salivary glands, ovaries, and fetus.

Species extrapolation.

The model is designed for applications to human dosimetry and cannot be applied to other species without modification.

Interroute extrapolation.

The model is designed to simulate oral exposures to radioiodine; however, it has been applied to simulating the biokinetics of intravenous injections of iodide and could be applied other routes of exposure with modification to include simulations of the absorption from these routes to blood.

ICRP (1989) Iodine Biokinetics Model

Description of the model.

ICRP (1989) developed a compartmental model of the kinetics of ingested iodine in humans with parameter values that are applicable to infants, children, adolescents, and adults. The model is a

3. HEALTH EFFECTS

modification and expansion of a similar model described in ICRP (1979; Riggs 1952). Ingested iodine is assumed to be completely absorbed. Absorbed iodine is assumed to distribute to three compartments: blood, thyroid gland, and extrathyroid tissues (Figure 3-13). Of the iodine entering the transfer compartment, 30% is assumed to be transferred to the thyroid gland; the remaining 70% is excreted in urine. All iodine eliminated from the thyroid gland is assumed to be transferred to the extrathyroidal tissues compartment as organic iodine (e.g., iodothyronines). Twenty percent of the iodine eliminated from extrathyroidal tissues is assumed to be excreted in feces; the remaining 80% is transferred to blood. Elimination half-times of iodine from thyroid, and extrathyroidal tissues are age-dependent, while that from blood is independent of age (Figure 3-13). The modifications made in this model from ICRP (1979) include: (1) 20%, rather than 10% of the of iodine eliminated from extrathyroidal tissues is assumed to be excreted in feces; (2) age-dependent elimination half-times for iodine, which allows the model to be applied to infants, children, adolescents, and adults; and (3) the extrathyroidal iodine pool is assumed to be 0.1 of the thyroid pool and the thyroid iodine pool is allowed to be variable, reflecting geographic variation or other sources of variation in intake.

Validation of the model.

The extent to which the ICRP model has been validated is not described in ICRP (1989).

Risk assessment.

The model has been used to establish radiation dose equivalents (Sv/Bq) of ingested various radioactive isotopes of iodine (ICRP 1989, 1993).

Target tissues.

The model is designed to calculate radioiodine intake limits based on radiation dose to all major organs, including the thyroid gland.

Species extrapolation.

The model is designed for applications to human dosimetry and cannot be applied to other species without modification.

3. HEALTH EFFECTS

Figure 3-13. International Commission on Radiological Protection (ICRP) (1989) Metabolic Model for Iodine

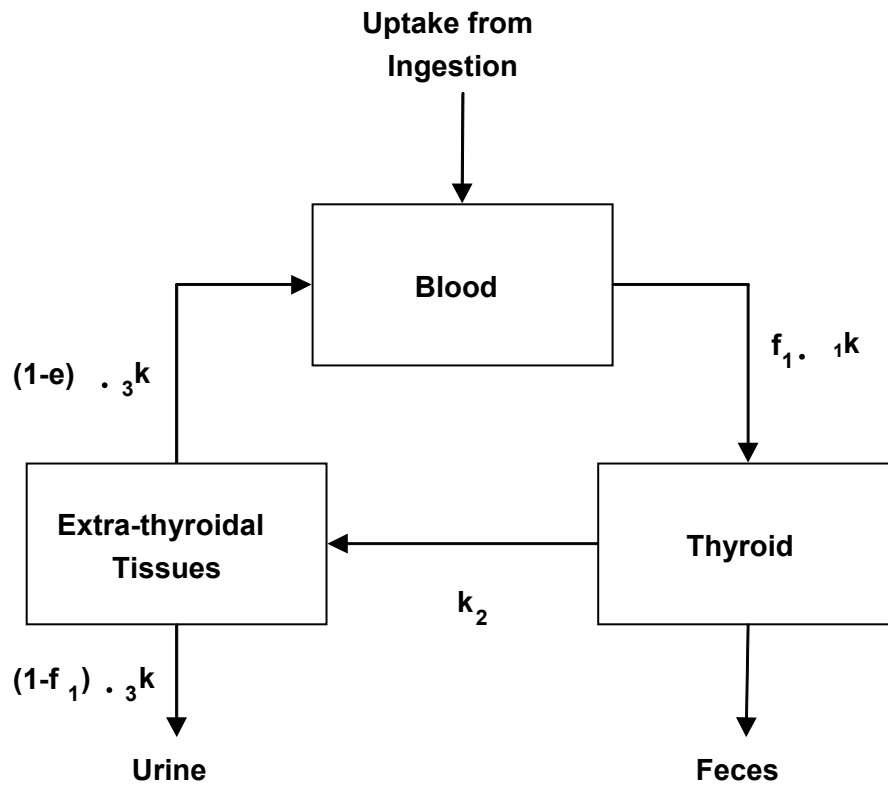

ICRP (1989) Metabolic Model for Iodine							
Age	f_1	Thyroid uptake (%)	Fecal excretion (%)	Biological half-time ^a (d)			Apparent half-time ^b (d)
				Blood T_1	Thyroid T_2	Extrathyroidal T_3	Thyroid
3 months	1	30	20	0.25	11.2	1.12	15
1 year	1	30	20	0.25	15	1.5	20
5 years	1	30	20	0.25	23	2.3	30
10 years	1	30	20	0.25	58	5.8	70
15 years	1	30	20	0.25	67	6.7	80
Adult	1	30	20	0.25	80	12	91

^a $\ln 2/k_i$
^b2–16 days after uptake

3. HEALTH EFFECTS

Interroute extrapolation.

The model is designed to simulate oral exposures to radioiodine and cannot be applied to other routes of exposure without modification.

Killough and Eckerman (1986) Iodine Biokinetics Model**Description of the model.**

Killough and Eckerman (1986) developed a 2-compartment modification of the 3-compartment model as described by Riggs (1952, the basis for the ICRP 1979 model). In the Killough and Eckerman (1986) model, the compartment representing the extrathyroidal organic iodine pool in Riggs (1952) has been eliminated and transfer into the thyroid gland is represented with a first-order rate constant (rather than a deposition fraction). This change provides for simulation of the short-term kinetics of uptake of iodine into the thyroid (rather than only maximal uptakes), enabling such observations to be incorporated into model calibration efforts (Killough and Eckerman 1986). Values for the transfers of iodine into and out of the thyroid are age-dependent, which is the basis for age-dependence of the biokinetics simulated in the model.

Validation of the model.

The extent to which the Killough and Eckerman model has been validated is not described in Killough and Eckerman (1986).

Risk assessment.

The model has been used to establish radiation doses to the thyroid for 4,216 patients administered ^{131}I for clinical diagnostic purposes (Killough and Eckerman 1986).

Target tissues.

The model is designed to calculate thyroid gland radiation doses associated with administered activities of radioiodine.

3. HEALTH EFFECTS

Species extrapolation.

The model is designed for applications to human dosimetry and cannot be applied to other species without modification.

Interroute extrapolation.

The model is designed to simulate biokinetics of iodine after the delivery of iodine to the central *transfer compartment* (irrespective of the route of absorption). Oral, inhalation, or other routes exposures to radioiodine could be simulated with modification to include simulations of the absorption from these routes.

NRPB-UK Model**Description of the model.**

The National Radiological Protection Board of the United Kingdom (NRPB-UK) developed a compartmental model of ingested iodine in human adults and children (Stather and Greenhalgh 1983). The model has three compartments representing the thyroid gland, an inorganic iodide pool that includes all inorganic iodide in the body with the exception of that in the thyroid gland, and an organic iodine pool, exclusive of organic iodine in the thyroid gland (Figure 3-14). Iodide that enters the gastrointestinal tract from ingestion is assumed to be completely absorbed into the inorganic iodide pool. Of the iodine entering the inorganic iodide pool, 25% is transferred to the thyroid gland where it resides with an elimination half-time of 79 days; the rest is excreted in urine. The thyroid gland is assumed to have a steady state iodine content of 8 mg. All iodine eliminated from the thyroid gland is assumed to be transferred to the organic iodine pool where it resides with an elimination half-time of 8 days. Twenty percent of the iodine eliminated from the organic iodine pool is assumed to be excreted in feces; the remaining 80% enters the inorganic iodide pool.

Models for 1-year-old infants and 10-year-old children are also described in Stather and Greenhalgh (1983). The models are essentially the same as the adult model with one change; the elimination half-time for iodine in the thyroid gland is assumed to be 17 days for 1-year-old infants and 72 days for 10-year-old children.

3. HEALTH EFFECTS

**Figure 3-14. National Radiological Protection Board of the United Kingdom
Metabolic Model for Iodine**

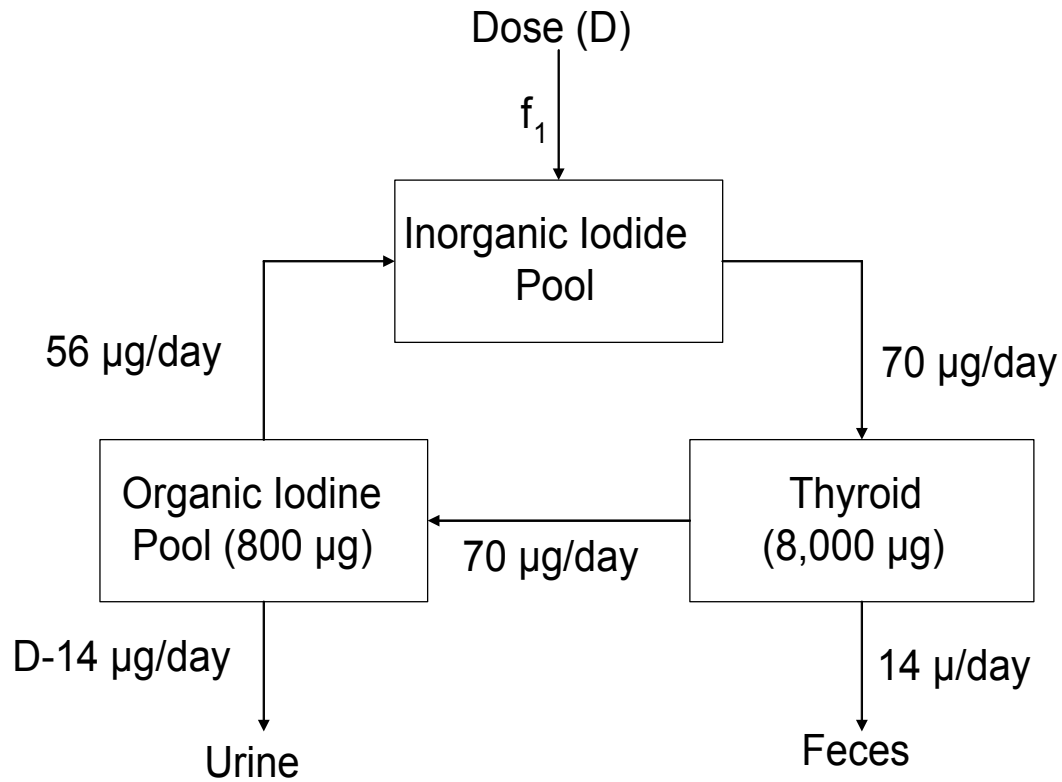

Source: Stather and Greenhalgh 1983

3. HEALTH EFFECTS

Validation of the model.

The extent to which the NRPB-UK model has been validated is not described in Stather and Greenhalgh (1983).

Risk assessment.

The model was developed for calculating radiation doses to populations in the United Kingdom following release of iodine isotopes into the environment. The extent to which the model has been used for this purpose is not described in Stather and Greenhalgh (1983).

Target tissues.

The model is designed to calculate intake and exposure limits, based on radiation dose to the NRPB-UK model thyroid gland.

Species extrapolation.

The model is designed for applications to human dosimetry and cannot be applied to other species without modification.

Interroute extrapolation.

The model is designed to simulate oral exposures to radioiodine and cannot be applied to other routes of exposure without modification.

Johnson (1982) Model

Description of the model.

Johnson (1982, 1986) described a compartmental model of iodine biokinetics in humans that included parameters for simulating pregnancy. The structure of the maternal model is similar to the Stather and Greenhalgh (1983) model in that it has three compartments representing the thyroid gland, an extra-thyroidal inorganic iodide pool, and an organic iodine pool, exclusive of organic iodine in the thyroid gland (Figure 3-15). Iodide that enters the gastrointestinal tract from ingestion or the lungs from inhalation is assumed to be absorbed into the inorganic iodide pool. From the inorganic iodide pool, iodide is transferred to the thyroid gland (at a rate equal to loss of thyroidal iodine to the organic iodine

3. HEALTH EFFECTS

Figure 3-15. Johnson (1982) Metabolic Model for Iodine

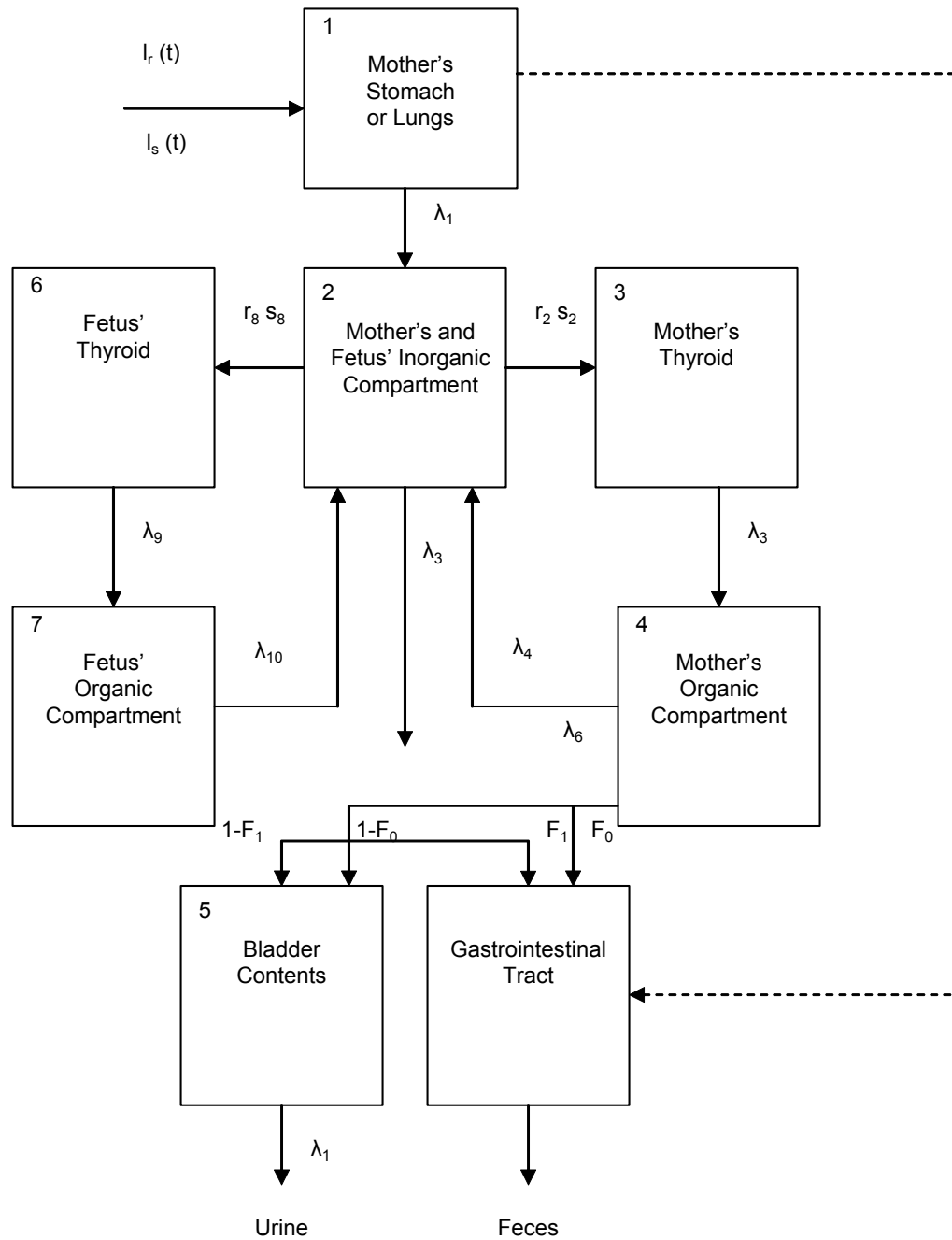

Adapted from Johnson 1986

3. HEALTH EFFECTS

pool), or is excreted in urine and feces. All iodine eliminated from the thyroid gland is assumed to be transferred to the organic iodine pool, from which it can reenter the extra-thyroidal inorganic iodine pool. Daily thyroid iodide uptakes vary with thyroid gland mass. Thyroid gland growth and mass are age- and gender-dependent, which are the bases for age- and gender dependence of the biokinetics in the model.

The pregnancy model includes fetal thyroid and fetal organic iodine compartments. Iodide cycles from the maternal extrathyroidal iodide pool, to the fetal thyroid pool, to the fetal organic iodine pool, from where it can return to the maternal extrathyroidal iodide pool.

Validation of the model.

The extent to which the Johnson (1982, 1986) model has been validated is not described in either publication.

Risk assessment.

The model was developed for calculating radiation doses to populations following release of iodine isotopes into the environment. The extent to which the model has been used for this purpose is not described in Johnson (1982, 1986).

Target tissues.

The model is designed to calculate intake and exposure limits, based on radiation dose to the thyroid gland.

Species extrapolation.

The model is designed for applications to human dosimetry and cannot be applied to other species without modification.

Interroute extrapolation.

The model is designed to simulate oral and inhalation exposures to radioiodine; however, it could be applied to other routes of exposure with modifications to include simulations of the absorption from these routes to the extrathyroidal inorganic iodide pool.

3. HEALTH EFFECTS

Oddie et al. Model**Description of the model.**

Oddie et al. (1955) described a compartmental model of absorbed iodine human adults and infants (Fisher et al. 1962) for predicting 24-hour radioiodine uptake by the thyroid gland in clinical procedures. The model has two compartments representing the thyroid gland and a central iodide pool that includes all inorganic iodide in the body with the exception of that in the thyroid gland. An organic iodine pool is not included in the model. Although this would preclude the model from accurately simulating radioiodide levels in extrathyroidal tissues, including blood, it was not considered necessary for simulating the initial uptake of iodide by the thyroid following a single dose of radioiodine, prior to significant release of organic iodine from the thyroid gland. Iodide that enters the inorganic iodide pool is assumed to be transferred either to the thyroid gland, represented as a first order rate constant k_1 , or to the kidney for urinary excretion, represented by a rate constant k_2 , usually corrected for loss of iodide in sweat, feces, and uncollected urine (Oddie and Fisher 1967). In a study of 20 healthy adults, k_1 was estimated to be 60×10^{-5} /minute in subjects who ingested a tracer dose of radioiodine (Fisher et al. 1965). In this same study, the value of k_1 was 49×10^{-5} after 13 weeks of daily ingestion of 252 μg iodide/day and 35×10^{-5} , after 13 weeks of daily ingestion of 1,000 μg iodide/day. The estimate of k_2 from this study was 300×10^{-5} minute^{-1} . Values for k_1 estimated in various populations have ranged from 67 to 134×10^{-5} minute^{-1} (Oddie and Fisher 1967). The volume of the iodide space was estimated to be 2.1 L (Fisher et al. 1965).

The same model has been used to predict thyroid uptakes of iodine in infants. Values for k_1 and k_2 were estimated from studies in which 24-hour thyroid uptakes of iodine were measured in 26 euthyroid newborn infants (Fisher et al. 1962). The values for k_1 and k_2 were 2.4×10^{-3} minute^{-1} and 1.1×10^{-3} minute^{-1} , respectively. The iodide space was estimated to be approximately 0.4 L in newborn infants.

Validation of the model.

The model has been shown to predict 24-hour iodine uptakes in the thyroid in adults who received single doses of radioiodine. Predicted 24-hour thyroid uptakes of radioiodine were compared to observed estimates in 1,573 euthyroid subjects reported from various studies; the difference between observed and predicted estimated for eight studies ranged from 0.7 to 2.1%, with the observed uptakes ranging from 21 to 37% (Oddie and Fisher 1967).

3. HEALTH EFFECTS

Risk assessment.

The model was developed for predicting the 24-hour uptake of radioiodine in the thyroid after single doses of radioiodine are given in the clinical setting for assessing thyroid function. It has been evaluated in terms of its predictive value in detecting abnormal thyroid conditions that affect iodide uptake into the gland (Oddie et al. 1960). The extent to which the model has been used for risk assessment could not be ascertained from the available literature.

Target tissues.

The model is designed to predict 24-hour uptakes of radioiodine into the thyroid gland.

Species extrapolation.

The model is designed for applications to humans and cannot be applied to other species without modification.

Interoute extrapolation.

The model is designed to simulate oral ingestion or parenteral injection (e.g., intramuscular in infants) of radioiodine and cannot be applied to other routes of exposure without modification.

3.6 MECHANISMS OF ACTION

3.6.1 Pharmacokinetic Mechanisms

Absorption. The mechanism(s) by which iodide is absorbed from the gastrointestinal tract is not known. Based on the study conducted by Small et al. (1961), absorption appears to occur primarily in the small intestine in humans. This study measured iodine in the saliva of healthy human subjects who ingested 0.25 g of potassium iodide (0.19 g iodide) together with a radioopaque suspension of barium sulfate that allowed the emptying of the stomach to be imaged with a fluoroscope. In five subjects, iodine was not detected in saliva until 2–3 minutes after the first appearance of the barium sulfate in the duodenum; the actual time of appearance relative to the oral dose of iodide ranged from 15 to 40 minutes. An intravenous dose of proanthine, which delays gastric emptying time, given just prior to the oral dose of potassium iodide, substantially delayed the time of appearance of iodine in saliva to 114–133 minutes;

3. HEALTH EFFECTS

however, in each of three subjects, iodine was detected in saliva 3–4 minutes after the first appearance of the radioopaque marker in the duodenum. When iodide was instilled directly into the duodenum together with the radioopaque marker (two subjects), iodine was detected in saliva 3–4 minutes after the dose was administered. These observations suggest that the absorption of iodide in humans occurs primarily in the small intestine and that the stomach may play a minor role in iodide absorption. The mechanisms by which iodide is transported across the intestinal epithelium are not known. Iodide may be transported by mechanisms that also transport chloride such as the $\text{Cl}^-/\text{HCO}_3^-$ antiport (Dalmark 1976; Lambert and Lowe 1978) or Cl^- channels (Katayama and Widdicombe 1991).

While the above studies implicate the small intestine as the major site of absorption of iodide in humans, studies in rats and dogs indicate that 14–30% of an oral dose of iodide may be absorbed in the stomach in these species (Small et al. 1961; Cohn 1932)

Distribution.

Iodide Transport. Uptake of iodide into the thyroid is facilitated by a membrane carrier in the basolateral membrane of the thyroid follicle cell (Carrasco 1993; Levy et al. 1998a; Shen et al. 2001). The carrier, or NIS, catalyzes the simultaneous transfer Na^+ and I^- across the basolateral membrane (Chambard et al. 1983; Iff and Wilbrandt 1963; Nilsson et al. 1990). The stoichiometry of transfer reaction is $(2)\text{Na}^+/(1)\text{I}^-$, which confers to the NIS a net positive charge and, therefore, a sensitivity to transmembrane voltage (Eskandari et al. 1997; O'Neill et al. 1987). In the presence of an inward-directed electrochemical gradient for Na^+ , the NIS can transfer I^- into the cell against a pronounced outward-directed electrochemical gradient for I^- (Takasu et al. 1984; Williams 1969; Woodbury and Woodbury 1963). This enables the follicle cell to achieve intracellular/extracellular concentration ratios of 10–50 for iodide (Andros and Wollman 1991; Bagchi and Fawcett 1973; Shimura et al. 1997; Vroye et al. 1998; Weiss et al. 1984b; Wolff 1964).

The NIS has been studied extensively in several *in vitro* preparations, including isolated plasma membrane vesicles of mammalian thyroid (O'Neill et al. 1987), FRTL-5 cells, a cell line derived from normal rat thyroid (Weiss et al. 1984b), *Xenopus laevis* oocytes transformed by intracellular injection of FRTL-5 RNA to express NIS (Eskandari et al. 1997), and other mammalian cells cultures transformed to express NIS (Levy et al. 1997; Nakamura et al. 1990; Smanik et al. 1996; Yoshida et al. 1997). The apparent K_m for I^- transport in cell systems is approximately 30–40 μM , which is considerably higher than the serum iodide concentration of 0.04–0.08 μM (5–10 $\mu\text{g/L}$) (Eskandari et al. 1997; Weiss et al. 1984b). The relatively high K_m enables the iodide transport rate to be highly sensitive to changes in plasma I^-

3. HEALTH EFFECTS

concentration. Iodide transport by the NIS is inhibited by other anions, most notably, thiocyanate (SCN^-) and perchlorate (ClO_4^-) (Carrasco 1993; Wolff 1964). Thiocyanate is one of several anions other than I^- that can be transported by the NIS, including SeCN^- , NO_3^- , ClO_3^- , Br^- , BF_4^- , IO_4^- , and BrO_3^- (Eskandari et al. 1997). Perchlorate, on the other hand, does not appear to be transported by NIS (Eskandari et al. 1997; Yoshida et al. 1997). Thus, thiocyanate and perchlorate, which both inhibit iodide uptake in thyroid *in vivo*, do so by different mechanisms; thiocyanate is a competitive substrate for transport, whereas perchlorate appears to block I^- binding to the NIS.

Synthesis of NIS is regulated by the pituitary hormone, TSH, which stimulates iodide uptake into the thyroid. The mechanism involves both increased transcription of the NIS gene and increased translation of mRNA for NIS (Kogai et al. 1997; Levy et al. 1997; Ohno et al. 1999; Pekary et al. 1998). Both responses to TSH follow binding of TSH to a receptor on the basolateral membrane and activation of the enzyme adenylate cyclase by GTP binding protein G_α (Akamizu et al. 1990; Chazenbalk et al. 1990; Kogai et al. 1997; Parmentier et al. 1989; Perret et al. 1990; Raspe and Dumont 1995). In FRTL-5 cells grown in the absence of TSH, NIS activity declines to a minimum level and can be restored by the addition of TSH to the medium or by treating the cells with dibutryl-cAMP or other agents that increase the intracellular concentration of cAMP (Pekary et al. 1998; Weiss et al. 1984a, 1984b). Thus, the actions of TSH appear to involve the activation of adenylate cyclase and subsequent increase in the intracellular concentration of cAMP. TSH also appears to mediate post-transcriptional regulation of NIS, including increasing the intracellular elimination half-time of the NIS protein and stimulating the incorporation of the NIS protein into the thyrocyte cell membrane (Riedel et al. 2001).

Synthesis of NIS also appears to be regulated by plasma iodide concentration through a mechanism that does not directly involve TSH. In rats exposed to drinking water containing 500 mg/L I as sodium iodide, expression of mRNA for the NIS in the thyroid decreased by 45% after 1 day of exposure and 60% after 6 days of exposure compared to controls that ingested water without added iodide. Serum iodide concentrations were 150–200-fold higher in the exposed rats compared to controls, whereas the serum TSH concentrations were not different between control and treated groups (Eng et al. 1999). A similar observation was made in dogs made hypothyroid by treatment with propylthiouracil (an inhibitor of iodination of thyroglobulin) and perchlorate (Uyttersprot et al. 1997). The hypothyroid state elevated TSH concentrations in serum; nevertheless, a single injection of 0.3 mg potassium iodide (0.23 mg I) resulted in decreased expression of NIS in the thyroid within 24–48 hours after the dose, without a change in TSH concentrations in serum. Both iodide and T_3 depress the expression of NIS mRNA and iodide uptakes in rat thyroid follicle cells grown in culture (Sptizweg et al. 1999).

3. HEALTH EFFECTS

The exact mechanisms by which the NIS gene transcription is regulated have not been determined. The gene in humans and rats has been sequenced, enabling studies of the mechanisms of gene transcription regulation (Dai et al. 1996; Smanik et al. 1996). The human gene resides on chromosome 19 (Smanik et al. 1997). Mutations in the gene sequence have been associated with hypothyroidism, goiter, and abnormally low thyroid uptake of injected iodide (Fujiwara et al. 1997, 1998, 2000; Kosugi et al. 1998, 2002; Levy et al. 1998c; Pohlenz and Refetoff 1999; Pohlenz et al. 1997). The 5'-flanking region of the rat NIS gene has been shown to contain one or more promoter regions; however, their role in regulation of the NIS transcription is not completely understood (Endo et al. 1997; Kogai et al. 2001; Ohno et al. 1999; Schmitt et al. 2000, 2001; Tong et al. 1997). A promoter region in the rat NIS gene appears to respond to a rise in intracellular cAMP, most likely by binding a cAMP-inducible or cAMP-activated transcription factor (Chun and Di Lauro 2001; Ohno et al. 1999). NIS expression in FRTL-5 cells is increased in response to extracellular adenosine, possibly through a mechanism that is independent of cAMP (Harii et al. 1999). A promoter region in the rat NIS gene responsive to thyroid transcription factor 1 (TTF-1) has also been described (Endo et al. 1997). Tong et al. (1997) found evidence for a promoter region in the rat NIS gene that could be suppressed in cell cultures that were transformed with the oncogene PTC1. This may provide a mechanism for the decreased expression of the NIS gene in thyroid papillary carcinomas and the decreased iodide uptake of some thyroid carcinomas (Smanik et al. 1996, 1997).

Several tissues in humans, other than thyroid, actively express NIS and accumulate iodide; these include the mammary gland, salivary glands, and gastric mucosa (Brown-Gant 1961; Lacroix et al., 2001; Smanik et al. 1997; Spitzweg et al. 1998, 1999; Wolff 1983). These tissues can achieve intracellular/extracellular and/or transepithelial concentration ratios for I⁻ concentrations of 20–40. Transport of iodide in these tissues is inhibited by thiocyanate and perchlorate; however, transport activity is not responsive to TSH. Clinical cases of genetic absence or impaired iodide uptake in the thyroid coupled with low uptakes in saliva and gastric fluid suggest an involvement of an NIS mechanism in these tissues (Fujiwara et al. 1997, 1998; Kosugi et al. 1998; Leger et al. 1987; Pohlenz and Refetoff 1999; Pohlenz et al. 1997; Wolff 1983). Further evidence for extrathyroidal NIS comes from studies of mammary gland. The NIS gene is expressed in the mammary gland of the human, rat, and many strains of mice (Levy et al. 1997; Perron et al. 2001; Rillema et al. 2000b; Smanik et al. 1997; Spitzweg et al. 1998; Tazebay et al. 2000). In the rat, expression of the NIS, or a structurally similar membrane protein, increases during nursing and decreases after weaning (Cho et al. 2000; Levy et al. 1998a). In the mouse and rat, the induction of NIS appears to

3. HEALTH EFFECTS

be stimulated by prolactin (Cho et al. 2000; Rillema and Rowady 1997; Rillema et al. 2000b). The NIS gene is also expressed in human kidney and placenta (Bidart et al. 2000; Spitzweg et al. 2001).

Studies in animals have revealed other tissues that actively secrete or accumulate iodide transport by a mechanism that is inhibited by perchlorate and thiocyanate, suggestive of an active NIS. These include choroid plexus, ciliary body of the eye, small intestine (ileum), ovary, placenta, and skin in mammals; and avian salt gland in marine birds (Brown-Grant 1961). In humans, the NIS gene is expressed in mammary gland, salivary glands, and gastric mucosa (Lacroix et al. 2001; Smanik et al. 1997; Spitzweg et al. 1998).

An iodide transporter that is distinct from NIS has been characterized in the apical membrane of the thyroid follicle cell (Royaux et al. 2000; Taylor et al. 2002; Yoshida et al. 2002). This transporter may function in the facilitated transfer of iodide from the follicle cell in the follicle lumen. Mutations in the gene coding for the apical transporter occur in Pendred syndrome, an autosomal recessive disorder characterized by hearing loss, thyroid iodide organification deficits goiter (Scott et al. 2000).

Iodothyronine Transport. Uptake of T_4 and T_3 into tissues occurs by a saturable, energy-dependent carrier transport system. Evidence for active transport derives from a variety of observations. The rate of uptake of T_3 into the perfused rat liver is proportional to the concentration of free T_3 in the perfusate and is not related to the total concentration or bound concentration (Mendel et al. 1988). The free cytosolic concentration of T_3 in the *in vivo* rat liver and heart muscle exceeds that of the simultaneous free concentration in plasma, suggesting uptake of T_3 into these tissues against a chemical gradient for T_3 (Oppenheimer and Schwartz 1985). T_3 uptake into confluent cultures of human or rat hepatoma cells is saturable, stereoselective for the active L enantiomer, temperature dependent, and inhibited by metabolic and membrane transport inhibitors, including phloretin (Movius et al. 1989; Topliss et al. 1989). Saturable, stereoselective, temperature-dependent, and energy-dependent uptake of T_3 and T_4 has also been observed in cultures of human fibroblasts and of T_3 in *in vitro* preparations of rat skeletal muscle (Centanni and Robbins 1987; Docter et al. 1987).

Metabolism.

Iodination in the Thyroid Gland. Iodination of thyroglobulin is catalyzed by thyroid peroxidase, a hemoprotein in the apical (luminal) membrane of thyroid follicle cells (Dunn and Dunn 2001). Thyroid peroxidase catalyzes both the iodination of tyrosine residues in thyroglobulin and the coupling of the iodinated residues to form the thyroid hormones, T_4 and T_3 , and diiodotyrosine. The iodination reaction involves the oxidation of iodide (I^-) to a reactive species having a sufficiently high oxidation potential to

3. HEALTH EFFECTS

iodinate the aromatic ring of tyrosine. The oxidizing agent in the reaction is hydrogen peroxide, which is generated at the apical membrane of follicle cells by an NADPH oxidase (Deme et al. 1994; Dupuy et al. 1991). Although the exact mechanism of the iodination reaction is not completely understood, three species are suspected as being candidates for the reactive iodinating species: a free radical ($I\cdot$), iodinium (I^+), or an enzyme-bound hypoiodite ($[EOI]^-$) (Taurog 1996). Human thyroglobulin contains 134 tyrosyl residues, of which approximately 20 undergo iodination to yield approximately 2–4 molecules of T_4 or T_3 per molecule of thyroglobulin. The coupling reaction occurs within thyroglobulin, rather than as a reaction between free iodinated tyrosines. In the formation of T_4 , two molecules of diiodotyrosine are coupled, whereas the formation of T_3 is a coupling of monoiodotyrosine and diiodotyrosine residues. The reaction is catalyzed by thyroid peroxidase with hydrogen peroxide serving as the oxidizing agent in the formation of a reactive intermediate of the contributing diiodotyrosine residue, possibly a free radical species (Taurog et al. 1994). Specificity of iodination and coupling of tyrosine residues within thyroglobulin is conferred, in part, by the specificity of thyroid peroxidase and, in part, by the structure of thyroglobulin (Taurog 1996).

The gene for human thyroid peroxidase has been isolated and sequenced (Kimura et al. 1987; Libert et al. 1987; Magnusson et al. 1987). Transcription of the gene is stimulated by TSH, possibly through a mechanism involving cAMP (McLachlan and Rapoport 1992).

Deiodination of Iodothyrones in Peripheral Tissues. Deiodination serves both as an important mechanism for the production of extrathyroidal T_3 and for the deactivation of the thyroid hormones, T_4 and T_3 . The deiodination reactions are catalyzed by selenium-dependent deiodinase enzymes (selenodeiodinases). Three selenodeiodinases have been described that differ in substrate preference, reaction products, response to inhibitors (propylthiouracil, gold), and response to T_3 (Table 3-8). Full activity of each enzyme requires selenocysteine in the amino acid sequence of the active site, which is the basis for deiodination activity being responsive to nutritional selenium status (Larsen and Berry 1994; see Section 3.10).

Excretion.

Urinary Excretion of Iodide. Urinary excretion normally accounts for >97% of the elimination of absorbed iodine. The renal plasma clearance of iodine has been measured in human subjects during continuous intravenous infusions of radioiodide (Bricker and Hlad 1955). Under these conditions, only a negligible amount of radioiodine in the plasma was associated with protein and >98% was ultrafilterable; thus, the renal clearance of radioiodine can be assumed to reflect that of radioiodide (Bricker and Hlad

3. HEALTH EFFECTS

Table 3-8. Properties of Human Iodothyronine Selenodeiodinases

Parameter	Type 1	Type 2	Type 3
Physiological role	Plasma T ₃ production, deactivate T ₃ and T ₄ , degrade rT ₃	Plasma and intracellular T ₃ production	Deactivate T ₃ and T ₄
Tissue location	Liver, kidney, thyroid, central nervous system, pituitary	Central nervous system, pituitary, brown fat, placenta, thyroid, skeletal muscle, heart	Central nervous system, placenta, skin
Substrate preference	rT ₃ >> T ₄ > T ₃	T ₄ > rT ₃	T ₃ > T ₄
Molecular weight (D) ^a	29,000	35,000	31,500
Apparent K _m (M)	~10 ⁻⁷ (rT ₃) ~10 ⁻⁶ (T ₄)	10 ⁻⁹ (T ₄) ~10 ⁻⁸ (rT ₃)	~10 ⁻⁹ (T ₃) ~10 ⁻⁸ (T ₄)
Deiodination site	Outer and inner ring	Outer ring	Inner ring
Apparent K _i (M)			
Propylthiouracil	2x10 ⁻⁷	4x10 ⁻³	10 ⁻³
Gold	~5x10 ⁻⁹	~2x10 ⁻⁶	5x10 ⁻⁶
Response to T ₃	Increase	Decrease	Increase

^aMonomerT₃ = 3,5,3Ntriodo-L-thyronine; T₄ = 3,5,3N5Ntetraiodo-L-thyronine (thyroxine); rT₃ = reverse T₃

Source: Larsen et al. 1998

3. HEALTH EFFECTS

1955; Walser and Rahill 1965). Under steady-state conditions with respect to the serum radioiodine concentration, the renal plasma clearance of radioiodine was approximately 30% of the glomerular filtration rate, suggesting that filtered iodide is reabsorbed in the renal tubule (Vadstrup 1993). Measurements of the steady-state renal clearance of radioiodide in dogs have provided additional evidence for tubular reabsorption of iodide (Beyer et al. 1981; Walser and Rahill 1965). The mechanism of renal tubular reabsorption of iodide has not been elucidated, although studies to examine mechanisms have been largely limited to clearance studies. NIS mRNA is expressed in human kidney and NIS immunoreactivity has been observed in the human kidney proximal and distal tubules; however, its role in iodine transport in the kidney has not been elucidated (Spitzweg et al. 2001). In humans, iodide clearance as a fraction of the glomerular filtration rate (C_I/GFR) increases in response to an acute increase in GFR and decreases in response to an acute decrease in GFR; however, C_I/GFR is relatively unaffected by large acute increases in the plasma concentration of radioiodine at a constant GFR (Bricker and Hlad 1955). This suggests a sensitivity of tubular reabsorption to both filtered load of iodide and tubular flow rate. C_I/GFR can be increased to near unity during mannitol-induced diuresis (Bricker and Hlad 1955). Although the inability to detect an apparent saturation of tubular reabsorption at high filtered loads of iodide and the sensitivity of tubular reabsorption to tubular flow rate are consistent with a passive, paracellular, component to iodide reabsorption, these observations do not rule out the existence of facilitated transport of iodide in the nephron. In humans, C_I/GFR , whole body clearance of radioiodine is increased during diuresis induced by furosemide and hydrochlorothiazide, two clinical diuretics that decrease sodium and chloride reabsorption in the in the loop of Henle and distal convoluted tubule, suggesting the possibility of reabsorption of iodide in distal segments of the nephron (Seabold et al. 1993). This observation is further supported by steady-state clearance measurements in dogs, in which C_I/GFR was found to increase in response to hydrochlorothiazide-induced diuresis, and to be lower, near that of C_{Cl}/GFR , in dogs that had been maintained on a sodium deprivation diet (Beyer et al. 1981; Walser and Rahill 1965). The latter observation would suggest that adaptations to sodium deprivation that result in greater reabsorption of sodium in the late distal nephron also give rise to increased reabsorption of iodide.

3.6.2 Mechanisms of Toxicity

The mechanism by which excess iodide produces hypothyroidism is not completely understood. Iodide excess inhibits the iodination of thyroglobulin in the thyroid gland and inhibits the release of T_4 and T_3 from the gland (Pisarev and Gärtner 2000). Both effects could contribute to stimulation of release of TSH from the pituitary gland and to the increase in serum concentration of TSH and hypertrophy of the thyroid

3. HEALTH EFFECTS

gland that has been shown to accompany iodide-induced thyroid gland suppression (see Section 3.2.2.2, Endocrine). The mechanism by which iodide suppresses iodination and thyroid hormone release appears to involve inhibition of adenylate cyclase. The stimulatory actions of TSH on the thyroid gland, which include increased iodide transport and increased iodination of thyroglobulin and production and release of T_4 and T_3 , occur in response to a rise in intracellular cAMP levels that follow binding of TSH to TSH receptors on thyroid gland follicle cells. Iodide inhibits adenylate cyclase in thyroid gland follicle cells and decreases the TSH-induced rise in intracellular cAMP. However, the effect of iodide on adenylate cyclase can be prevented by inhibitors of iodination, such as propylthiouracil. This has led to the suggestion that the ultimate active inhibitor is an endogenous iodinated species that is produced in a reaction requiring thyroid peroxidase. Candidates for the endogenous inhibitor are one or more iodinated lipids (Filetti and Rapoport 1983; Pereira et al. 1990; Pisarev and Gärtner 2000). The synthesis of NIS also appears to be regulated by plasma iodide concentration, through a mechanism that does not directly involve TSH. In rats and dogs, expression of mRNA for the NIS in the thyroid decreased when serum iodide concentrations were increased by ingestion or injection of iodide, even when serum TSH concentrations were unchanged (Eng et al. 1999; Uyttensprot et al. 1997).

Excess iodide intake may be a contributing factor in the development of autoimmune thyroiditis in people who are susceptible (Brown and Bagchi 1992; Foley 1992; Rose et al. 1997; Safran et al. 1987). In certain inbred strains of rats and mice, exposure to iodide has been shown to increase the incidence of lymphocytic thyroiditis (Allen and Braverman 1990; Allen et al. 1986; Noble et al. 1976; Rasooly et al. 1996). The mechanism by which iodide stimulates autoimmunity is not completely understood. In the inbred mouse strain, NODh^{2h4}, both CD4⁺ and CD8⁺ T cells are required for iodine-induced acceleration of autoimmunity (Hutchings et al. 1999). Highly iodinated thyroglobulin may be an antigen in susceptible animals (or humans) (Dai et al. 2002; Rose et al. 1997; Saboori et al. 1998a, 1998b, 1999; Sundick et al. 1987). Other proposed mechanisms include effects of iodine on the regulation of major histocompatibility complex class I and increased expression of thyroid gland TNF- α (Schuppert et al. 2000; Roti and Vagenakis 2000; Ruwhof and Drexhage 2001; Verma et al. 2000). Thyroid autoimmunity may produce hypothyroidism by stimulating thyroid cell apoptosis (Huang and Kukes 1999; Phelps et al. 2000; Stassi et al. 2000).

Excess iodide can, under certain circumstances, induce hyperthyroidism and thyrotoxicosis; this has been observed most often after iodine supplementation of iodine-deficient populations (Braverman and Roti 1996; Fradkin and Wolff 1983; Leger et al. 1984; Paschke et al. 1994). The mechanism by which iodide induces hyperthyroidism is not completely understood. Chronic iodine deficiency results in thyroid gland

3. HEALTH EFFECTS

proliferation, which may increase the fixation of mutations in the gland and promote the development of autonomous nodules that are less responsive or unresponsive to regulation in response to serum TSH concentrations. Iodine excess, under these conditions, could result in increased and unregulated thyroid hormone production (Corvilain et al. 1998; Dremier et al. 1996; Roti and Uberti 2001).

Extremely high acute doses of iodine in the form of tinctures containing iodine and sodium triiodide have resulted in deaths (Finkelstein and Jacobi 1937). The mechanism of toxicity is not understood, although direct chemical injury to the gastrointestinal tract and related secondary consequences, including fluid and electrolyte loss, massive acute extracellular fluid volume contraction, and cardiovascular shock, may contribute to the widespread systemic effects that have been observed in lethal or near-lethal poisonings.

3.6.3 Animal-to-Human Extrapolations

The principal health effects of iodine in humans have been characterized in experimental, clinical, and epidemiological studies of humans. Animal models remain useful for exploring mechanisms, and where relevant, these studies have been described; for example, the use of inbred rat strains to study iodine-induced autoimmune thyroiditis (see Section 3.2.2.2, Endocrine). The major features of the toxicokinetics of iodine in humans, particularly following oral exposures, have been characterized in experimental and clinical studies of humans. A substantial amount of experience exists in the application of biomarkers for assessing human exposures to iodine (e.g., urinary iodine excretion and thyroid scintillation scan) and health effects in humans (e.g., serum thyroid hormone, TSH, and thyroid antibodies). Thus, the assessment of health effects and health risks associated with exposures to iodine or radioiodine can be based soundly on human studies rather than on extrapolations from animal studies.

3.7 TOXICITIES MEDIATED THROUGH THE NEUROENDOCRINE AXIS

Recently, attention has focused on the potential hazardous effects of certain chemicals on the endocrine system because of the ability of these chemicals to mimic or block endogenous hormones. Chemicals with this type of activity are most commonly referred to as endocrine disruptors. However, appropriate terminology to describe such effects remains controversial. The terminology endocrine disruptors, initially used by Colborn and Clement (1992), was also used in 1996 when Congress mandated the Environmental Protection Agency (EPA) to develop a screening program for “...certain substances [which] may have an effect produced by a naturally occurring estrogen, or other such endocrine effect[s]...”. To meet this mandate, EPA convened a panel called the Endocrine Disruptors Screening and

3. HEALTH EFFECTS

Testing Advisory Committee (EDSTAC), which in 1998 completed its deliberations and made recommendations to EPA concerning endocrine disruptors. In 1999, the National Academy of Sciences released a report that referred to these same types of chemicals as hormonally active agents. The terminology endocrine modulators has also been used to convey the fact that effects caused by such chemicals may not necessarily be adverse. Many scientists agree that chemicals with the ability to disrupt or modulate the endocrine system are a potential threat to the health of humans, aquatic animals, and wildlife. However, others think that endocrine-active chemicals do not pose a significant health risk, particularly in view of the fact that hormone mimics exist in the natural environment. Examples of natural hormone mimics are the isoflavonoid phytoestrogens (Adlercreutz 1995; Livingston 1978; Mayr et al. 1992). These chemicals are derived from plants and are similar in structure and action to endogenous estrogen. Although the public health significance and descriptive terminology of substances capable of affecting the endocrine system remains controversial, scientists agree that these chemicals may affect the synthesis, secretion, transport, binding, action, or elimination of natural hormones in the body responsible for maintaining homeostasis, reproduction, development, and/or behavior (EPA 1997). Stated differently, such compounds may cause toxicities that are mediated through the neuroendocrine axis. As a result, these chemicals may play a role in altering, for example, metabolic, sexual, immune, and neurobehavioral function. Such chemicals are also thought to be involved in inducing breast, testicular, and prostate cancers, as well as endometriosis (Berger 1994; Giwercman et al. 1993; Hoel et al. 1992).

Iodine is an endocrine disruptor in that the principal direct effects of excessive iodine ingestion are on the thyroid gland and on the regulation of thyroid hormone production and secretion. As discussed in Section 3.2.2.2, Endocrine Effects, the effects of iodine on the thyroid gland include hypothyroidism, hyperthyroidism, and thyroiditis. The above three types of effects can occur in children and adults, and in infants exposed *in utero* or during lactation. Adverse effects on the pituitary and adrenal glands derive secondarily from disorders of the thyroid gland. A wide variety of effects on other organ systems can result from disorders of the thyroid gland, including disturbances of the skin, cardiovascular system, pulmonary system, kidneys, gastrointestinal tract, liver, blood, neuromuscular system, central nervous system, skeleton, male and female reproductive systems, and numerous endocrine organs, including the pituitary and adrenal glands (Braverman and Utiger 2000).

3.8 CHILDREN'S SUSCEPTIBILITY

This section discusses potential health effects from exposures during the period from conception to maturity at 18 years of age in humans, when all biological systems will have fully developed. Potential

3. HEALTH EFFECTS

effects on offspring resulting from exposures of parental germ cells are considered, as well as any indirect effects on the fetus and neonate resulting from maternal exposure during gestation and lactation.

Relevant animal and in vitro models are also discussed.

Children are not small adults. They differ from adults in their exposures and may differ in their susceptibility to hazardous chemicals. Children's unique physiology and behavior can influence the extent of their exposure. Exposures of children are discussed in Section 6.6 Exposures of Children.

Children sometimes differ from adults in their susceptibility to hazardous chemicals, but whether there is a difference depends on the chemical (Guzelian et al. 1992; NRC 1993). Children may be more or less susceptible than adults to health effects, and the relationship may change with developmental age (Guzelian et al. 1992; NRC 1993). Vulnerability often depends on developmental stage. There are critical periods of structural and functional development during both prenatal and postnatal life and a particular structure or function will be most sensitive to disruption during its critical period(s). Damage may not be evident until a later stage of development. There are often differences in pharmacokinetics and metabolism between children and adults. For example, absorption may be different in neonates because of the immaturity of their gastrointestinal tract and their larger skin surface area in proportion to body weight (Morselli et al. 1980; NRC 1993); the gastrointestinal absorption of lead is greatest in infants and young children (Ziegler et al. 1978). Distribution of xenobiotics may be different; for example, infants have a larger proportion of their bodies as extracellular water and their brains and livers are proportionately larger (Altman and Dittmer 1974; Fomon 1966; Fomon et al. 1982; Owen and Brozek 1966; Widdowson and Dickerson 1964). The infant also has an immature blood-brain barrier (Adinolfi 1985; Johanson 1980) and probably an immature blood-testis barrier (Setchell and Waites 1975). Many xenobiotic metabolizing enzymes have distinctive developmental patterns. At various stages of growth and development, levels of particular enzymes may be higher or lower than those of adults, and sometimes unique enzymes may exist at particular developmental stages (Komori et al. 1990; Leeder and Kearns 1997; NRC 1993; Vieira et al. 1996). Whether differences in xenobiotic metabolism make the child more or less susceptible also depends on whether the relevant enzymes are involved in activation of the parent compound to its toxic form or in detoxification. There may also be differences in excretion, particularly in newborns who all have a low glomerular filtration rate and have not developed efficient tubular secretion and resorption capacities (Altman and Dittmer 1974; NRC 1993; West et al. 1948). Children and adults may differ in their capacity to repair damage from chemical insults. Children also have a longer remaining lifetime in which to express damage from chemicals; this potential is particularly relevant to cancer.

3. HEALTH EFFECTS

Certain characteristics of the developing human may increase exposure or susceptibility, whereas others may decrease susceptibility to the same chemical. For example, although infants breathe more air per kilogram of body weight than adults breathe, this difference might be somewhat counterbalanced by their alveoli being less developed, which results in a disproportionately smaller surface area for alveolar absorption (NRC 1993).

Children are highly vulnerable to radioiodine toxicity and related thyroid cancers (NRC 1999).

Radioiodine is secreted into milk in humans, cows, and goats, and infants and children ingest a larger amount of milk per unit of body mass than adults; they also absorb ingested iodine as avidly as adults. As a result, children exposed to milk that has been contaminated with radioiodine may receive a larger internal dose of radioiodine than similarly exposed adults. This larger absorbed iodine dose per unit of body mass is concentrated in a smaller thyroid mass in infants and children (Aboul-Khair et al. 1966; Kay et al. 1966; Mochizuki et al. 1963), which can result in a higher radiation dose per unit of thyroid mass.

In addition to a smaller thyroid mass, thyroid iodine uptakes, expressed as a fraction of absorbed dose, are 3–4 times higher during the first 10 days of postnatal life compared to adult uptakes and decline to adult levels after approximately age 10–14 days (Fisher et al. 1962; Kearns and Phillipsborn 1962; Morrison et al. 1963; Ogborn et al. 1960; Van Middlesworth 1954). As a result, newborn infants will be particularly vulnerable to high radiation doses from internal exposure to radioiodine. NCI (1997) estimated that the radiation dose (rad) to the thyroid gland resulting from ingestion of 1 μCi of ^{131}I activity would increase with decreasing age in children from approximately 1.5 rad/ μCi in adults, to approximately 6.6 rad/ μCi at 5 years, 12 rad at 1 year, and 33 rad in newborn infants. Another important factor that contributes to higher vulnerability of children is that children under 15 years of age appear to be more susceptible to developing thyroid tumors from thyroid irradiation (Wong et al. 1996). Studies of thyroid cancers and external radiation exposure have found a strong age-dependence between thyroid radiation dose and thyroid cancer. Risk is substantially greater for radiation doses received prior to age 15 years when compared to risks for doses received at older ages (Ron et al. 1995). An age-dependence has been found for solid tumors of other organs and external radiation dose (Thompson et al. 1994). This same general trend in age-dependence would be expected for internal exposures to radioiodine; thus, studies of adult exposures to radioiodine may not be directly applicable to predicting outcomes from exposures to children.

3. HEALTH EFFECTS

Evidence for vulnerability of infants and children to radioiodine toxicity derive from studies of populations that have been exposed to radioiodine fall-out as a result of thermonuclear bomb tests and nuclear reactor accidents. Several epidemiological studies have examined thyroid gland disorders in residents of the Marshall Islands who were exposed to radioiodine from atmospheric fallout after an atmospheric nuclear bomb test (so-called BRAVO test, see Section 3.3.2 for a more detailed discussion of exposures from the Marshall Islands BRAVO test). The exposures occurred as a result of an unexpected change in the wind direction after the bomb detonation. Residents of several islands near and downwind from the test site on Bikini Atoll (e.g., Ailingnae, Rongelap, Utrik) were exposed to both internal radioiodine and external gamma radiation from fallout during the 2 days prior to their evacuation. The estimated gamma radiation dose on these islands ranged from 69 to 175 rad (0.7–1.75 Gy) or approximately 10–50% of the estimated thyroid dose (Conard 1984; Hamilton et al. 1987; Howard et al. 1997; Takahashi et al. 1999). Cases of thyroid gland disorders began to be detected in the exposed population in approximately 10 years after the exposure, particularly in persons who were exposed as children; these included cases of apparent growth retardation, myxedema, and thyroid gland nodules and neoplasms (Conard et al. 1970). In 1981, health screening of children on Rongelap revealed an 83% prevalence of elevated serum concentrations of TSH (>5 mU/L) among exposed children who were ≤ 1 year old at the time of the BRAVO test and who received an estimated thyroid radiation dose exceeding 1,500 rad (15 Gy). Prevalence of elevated serum TSH decreased with exposure age and/or thyroid dose: 25% for ages 2–10 years (800–1,500 rad, 8–15 Gy) and 9% for ages ≤ 10 years (335–800 rad, 3.3–8 Gy). A similar age-related prevalence of thyroid abnormalities occurred after radioiodine release from the fire at the Chernobyl nuclear power plant in the Ukraine. Clinical records from the Republics of Belarus and Ukraine show an increase in the incidence of thyroid nodules and thyroid cancers in children and adolescents, which became apparent approximately 4 years after the release of radioactive materials from the Chernobyl nuclear power plant in April 1986 (Astakhova et al. 1998; Cherstvoy et al. 1996; Drobysheskaya et al. 1996; Tronko et al. 1996) (see Section 3.3.2 for a more detailed discussion of exposures from the Chernobyl accident). A comparison of thyroid cancers diagnosed in children in the Belarus-Ukraine region after the Chernobyl fire with thyroid cancers diagnosed in children in France and Italy during the same period revealed a striking age difference (Pacini et al. 1997). Most the Belarus-Ukraine cancers were diagnosed at age ≤ 5 years, whereas most of the cases in France and Italy were diagnosed after age 14 years. This observation is consistent with a radioiodine contribution to the Belarus-Ukraine cancers and a higher vulnerability of infants to radioiodine toxicity.

3. HEALTH EFFECTS

Nutritional factors can affect the toxicokinetics of iodine in children and adults. The most important factor is dietary iodine. Chronic iodine deficiency triggers homeostatic mechanisms to increase iodide uptake into the thyroid gland in order to sustain adequate thyroid hormone levels to regulate metabolism (Delange and Ermans 1996). These mechanisms include induction of iodide transport activity and iodination activity in the thyroid gland, as well as hypertrophy of the gland (i.e., goiter). As a result, exposures to radioiodine that occur during a state of deficiency can be expected to result in a larger fraction of the radioiodine dose being deposited in the thyroid gland, which could result in a higher radiation dose and risk.

Another nutritional factor that could potentially affect iodine biokinetics in infants and children is selenium deficiency. Selenium is a cofactor in the iodothyronine deiodinases that are important for the synthesis of the thyroid hormone, T_3 , in extrathyroidal tissues. Iodine deficiency, in conjunction with selenium deficiency, has been associated with goiter and cretinism, a developmental impairment related to prenatal hypothyroidism (Goyens et al. 1987; Vanderpas et al. 1990). In this state, in which the thyroid gland is responding to a deficiency in T_3 production by increasing iodide transport and iodination activity in the thyroid gland, infants and children (as well as adults) may experience a higher thyroid uptake of absorbed iodine, and possibly a higher radiation dose to the thyroid when exposed to radioiodine.

As previously discussed in Section 3.5.2.2, exposure to iodine can begin *in utero* with maternal exposure and, as a result, the fetus is vulnerable to the potential toxic effects of maternal iodine exposures that occur during pregnancy. Maternal exposures to excess iodine have been shown to produce thyroid enlargement and hypothyroidism in neonates (Coakley et al. 1989; Hassan et al. 1968; Iancu et al. 1974; Martin and Reno 1962; Penfold et al. 1978; Vicens-Colvet et al. 1998). Deaths have occurred in neonates as a result of tracheal compression from thyroid gland enlargement (Galina et al. 1962). The vulnerability of the fetal thyroid gland has a toxicokinetic basis. Radioiodine uptake in the fetal thyroid commences in humans at approximately 70–80 days of gestation and precedes the development of thyroid follicles and follicle colloid, which are generally detectable at approximately 100–120 days of gestation (Book and Goldman 1975; Evans et al. 1967). Fetal iodide uptake activity increases with the development of the fetal thyroid and reaches its peak at approximately 6 months of gestation, at which point, the highest concentrations in the thyroid are achieved, approximately 5% of the maternal dose/g fetal thyroid (approximately 1% of the maternal dose) (Aboul-Khair et al. 1966; Evans et al. 1967). Fetal radioiodine concentrations 1–2 days following a single oral maternal dose of radioiodine generally exceed the concurrent maternal thyroid concentration by a factor of 2–8, with the highest fetal/maternal ratios occurring at approximately 6 months of gestation (Book and Goldman 1975). Following exposure to ^{131}I

3. HEALTH EFFECTS

from maternal ingestion of medically administered radioiodine or from repeated exposure to radioactive fallout, the fetal/maternal ratio for thyroid radioiodine concentration has been estimated to be approximately 2–3 (Beierwaltes et al. 1963; Book and Goldman 1975; Eisenbud et al. 1963).

Dermal exposures to iodine, in particular topical antiseptics containing povidone-iodine, can expose the fetus to iodine. For example, increases in iodine concentration in maternal urine and umbilical cord blood have been observed in pregnant women who received dermal or vaginal applications of povidone-iodine prior to delivery for disinfection of the skin and fetal scalp electrodes, suggesting that absorption of iodine occurs with these uses of povidone-iodine as well (l'Allemand et al. 1983; Bachrach et al. 1984).

Consistent with this are observations that topical application of iodine preparations (i.e., povidone-iodine) during labor has produced thyroid gland suppression in newborns (l'Allemand et al. 1983; Novaes et al. 1994). Infants can also absorb iodine when such iodine preparations are applied topically. Use of povidone-iodine for topical and surgical wound disinfection in infants has been shown to induce transient hypothyroidism or hyperthyroidism (Brown et al. 1997; Chabrolle and Rossier 1978a, 1978b).

Nursing infants can be exposed to iodine in breast milk (Dydek and Blue 1988; Hedrick et al. 1986; Lawes 1992; Morita et al. 1998; Robinson et al. 1994; Rubow et al. 1994; Spencer et al. 1986). The level of exposure will depend not only on the maternal exposure, but also on the physiologic status of the maternal thyroid. A larger fraction of the absorbed dose is excreted in breast milk in the hypothyroid state compared to the hyperthyroid state; in the hypothyroid state, excretion of radioiodine into breast milk can be 10 times higher (e.g., 25% of the dose) than in euthyroid or hyperthyroid states (Hedrick et al. 1986; Morita et al. 1998; Robinson et al. 1994).

Iodine is not stored in skeletal tissue or fat to any significant degree and thus, mobilization of these tissues during pregnancy, for production of the fetal skeleton or breast milk, would not be expected to contribute to fetal or infant exposure. There is no evidence that iodine metabolism would be appreciably different in children compared to adults. It is possible that the conjugation of iodothyronines with glucuronic acid could be limited in newborns as a result of the normal development of glucuronyltransferase activity in the newborn and infant; however, there is no evidence for an effect on iodine toxicokinetics. In the Gunn rat, which is a strain of rat that is deficient in glucuronyltransferase activity, glucuronic acid conjugates of iodothyronines are formed and biliary excretion of iodothyronines is impaired; however, normal circulating levels iodothyronine appear to be maintained (Curran and DeGroot 1991). This would suggest that the thyroid gland may not increase uptake of iodine in response to an impairment in glucuronyltransferase activity.

3. HEALTH EFFECTS

Models of the biokinetics of iodine in infants, children, adolescents, and adults have been developed by ICRP (1989, 1994a, 1995). Models have also been developed that predict, with reasonably high accuracy, the accumulation of radioiodide in the thyroid gland of infants and children exposed to single doses of radioiodine for clinical procedures (Fisher et al. 1962).

3.9 BIOMARKERS OF EXPOSURE AND EFFECT

Biomarkers are broadly defined as indicators signaling events in biologic systems or samples. They have been classified as markers of exposure, markers of effect, and markers of susceptibility (NAS/NRC 1989).

Due to a nascent understanding of the use and interpretation of biomarkers, implementation of biomarkers as tools of exposure in the general population is very limited. A biomarker of exposure is a xenobiotic substance or its metabolite(s) or the product of an interaction between a xenobiotic agent and some target molecule(s) or cell(s) that is measured within a compartment of an organism (NAS/NRC 1989). The preferred biomarkers of exposure are generally the substance itself or substance-specific metabolites in readily obtainable body fluid(s), or excreta. However, several factors can confound the use and interpretation of biomarkers of exposure. The body burden of a substance may be the result of exposures from more than one source. The substance being measured may be a metabolite of another xenobiotic substance (e.g., high urinary levels of phenol can result from exposure to several different aromatic compounds). Depending on the properties of the substance (e.g., biologic half-life) and environmental conditions (e.g., duration and route of exposure), the substance and all of its metabolites may have left the body by the time samples can be taken. It may be difficult to identify individuals exposed to hazardous substances that are commonly found in body tissues and fluids (e.g., essential mineral nutrients such as copper, zinc, and selenium). Biomarkers of exposure to iodine are discussed in Section 3.9.1.

Biomarkers of effect are defined as any measurable biochemical, physiologic, or other alteration within an organism that, depending on magnitude, can be recognized as an established or potential health impairment or disease (NAS/NRC 1989). This definition encompasses biochemical or cellular signals of tissue dysfunction (e.g., increased liver enzyme activity or pathologic changes in female genital epithelial cells), as well as physiologic signs of dysfunction such as increased blood pressure or decreased lung capacity. Note that these markers are not often substance specific. They also may not be directly

3. HEALTH EFFECTS

adverse, but can indicate potential health impairment (e.g., DNA adducts). Biomarkers of effects caused by iodine are discussed in Section 3.9.2.

A biomarker of susceptibility is an indicator of an inherent or acquired limitation of an organism's ability to respond to the challenge of exposure to a specific xenobiotic substance. It can be an intrinsic genetic or other characteristic or a preexisting disease that results in an increase in absorbed dose, a decrease in the biologically effective dose, or a target tissue response. If biomarkers of susceptibility exist, they are discussed in Section 3.11 "Populations That Are Unusually Susceptible".

3.9.1 Biomarkers Used to Identify or Quantify Exposure to Iodine

Urinary iodine excretion provides a reliable biomarker of steady state iodine intake. Under steady state conditions, in which exposure to iodine has been reasonably constant for at least 6 months, daily iodine will approximate the 24-hour urinary iodine excretion. The basis for this relationship is that ingested iodide is nearly completely absorbed in the gastrointestinal tract and that urine is the principal route of excretion of the absorbed iodide (see Sections 3.5.1.2 and 3.5.4.2). The use of urinary iodide as a biomarker of iodide exposure is supported by studies in which 24-hour urinary iodide was measured before and after supplementation. For example, 31 patients received oral supplements of 382 µg I/day for 6 months. Prior to the supplementation, the mean 24-hour urinary iodide excretion rate was 36 µg/day (range, 13–69), whereas after 6 months of iodide supplementation, the mean 24-hour urinary iodide excretion rate was 415 µg/day (Kahaly et al. 1998). The difference between these two values, 379 µg/day, is nearly identical to the supplemental dose of 382 µg/day.

Exposure to ^{123}I , ^{124}I , and ^{131}I can be detected directly from external measurements of gamma radiation emanating from the thyroid gland. The basis for this is that approximately 90% of the iodine in the body is in the thyroid gland and absorbed iodine is rapidly taken up into the thyroid gland. The measurement procedure is known as a thyroid scintillation scan. A scintillation detector device usually consists of a shielded sodium iodide crystal connected to a collimator and spectrometer. The detector is placed over the thyroid gland and the spectrometer is tuned to collect gamma emissions having peak energies of the target isotope (e.g., 0.159, 0.511, or 0.364 MeV for ^{123}I , ^{124}I , or ^{131}I , respectively). Events are corrected for attenuation by overlying tissue by counting a neck phantom containing a gamma source of known activity. Because of the relatively short radioactive decay half-times of ^{123}I (13 hours), ^{124}I (4.2 days), and ^{131}I (8 days), thyroid scans must be conducted soon after exposure in order to detect the iodine in the thyroid gland.

3. HEALTH EFFECTS

The thyroid scintillation scan is also used in medical practice to identify disease of the thyroid, and can reflect either iodine excess or deficiency.

3.9.2 Biomarkers Used to Characterize Effects Caused by Iodine

The thyroid gland is the primary and most sensitive target for both chemical and radioiodine toxicity. As a result, biomarkers of iodine effects are those that allow the detection of preclinical and clinical suppression or stimulation of the thyroid gland. Effects on the thyroid gland can be classified into three types: hypothyroidism, hyperthyroidism, and thyroiditis. Hypothyroidism refers to a state of diminished production of thyroid hormones leading to clinical manifestations of thyroid insufficiency and can occur with or without goiter, a functional hypertrophy of the gland in response to suppressed hormone production and elevated serum thyroid stimulating hormone (TSH, also known as thyrotropin) concentrations. Typical biomarkers of hypothyroidism are depressions in the circulating levels of thyroxine (T_4) and/or triiodothyronine (T_3) below their normal ranges. This is always accompanied by an elevation of the pituitary hormone, TSH, above the normal range. Typical normal ranges for hormone levels are shown in Table 3-9. Hyperthyroidism is an excessive production and/or secretion of thyroid hormones. The clinical manifestation of abnormally elevated circulating levels of T_4 and/or T_3 is thyrotoxicosis. Thyroiditis refers to an inflammation of the gland, which is often secondary to thyroid gland autoimmunity. Thyroid autoimmunity can be detected as a presence of IgG antibodies to thyroglobulin and thyroid peroxidase in serum antibodies (Table 3-9). In addition to the above measurements, physical examination, ultrasound and thyroid scintillation scanning can reveal nodules and other normal or abnormal variations in thyroid gland structure and function. Examples of the use of these measurements in assessing iodine-induced effects on the thyroid gland are presented in Section 3.2 of the profile.

3. HEALTH EFFECTS

Table 3-9. Typical Reference Ranges for Serum Thyroid Hormones and TSH in Humans

Hormone	Reference range	
	Metric	SI unit
Total T ₄	4–11 µg/dL	60–140 nM ^a
Free T ₄	0.7–2.1 ng/dL	10–25 pM ^a
Total T ₃	75–175 ng/dL	1.1–2.7 nM ^a
Free T ₃	0.2–0.5 ng/dL	3–8 pM
Reverse T ₃	15–45 ng/dL	0.2–0.7 nM
TSH	0.3–4.0 mU/L ^{b,c}	1–15 pM
Thyroid peroxidase antibodies (TPA)	<10 IU/mL	No data
Thyroglobulin autoantibodies (Tg-ab)	<10 IU/mL	No data

^aChildren may be higher

^bAssumes a biologic potency of 7–15 mU/mg

^cHigher in neonates (de Zegher et al. 1994)

T₃ = 3,5,3Ntriodo-L-thyronine; T₄ = 3,5,3N5Ntetraiodo-L-thyronine (thyroxine); TSH = thyroid stimulating hormone

Source: Stockigt (2000) and Marcocci and Chiovato (2000)

3. HEALTH EFFECTS

3.10 INTERACTIONS WITH OTHER CHEMICALS

Thioureylenes and Thionamides. Several of thionamide compounds that contain a thioureylene chemical group have been shown to increase the accumulation of iodide in the thyroid gland and to decrease the production of iodothyronines (Green 1996):

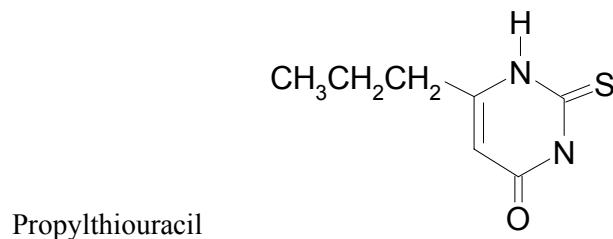

These include several drugs used in the treatment of thyrotoxicosis and other hyperthyroid states, (carbimazole, methimazole, and propylthiouracil); as well as the antibiotic, ethionamide; the cancer chemotherapy agent, 6-mercaptopurine; and goitrin, a natural constituent of the plant genus Brassicaceae (rutabaga, turnip, and cabbage). The thionamides exert their effects by inhibiting the iodination of tyrosine and monoiodotyrosine in the thyroid gland and the coupling of iodotyrosines to form iodothyronines. The mechanisms for these effects are not completely understood; however, at least two mechanisms are needed to explain the reversible and irreversible inhibition of iodothyronine production that is characteristic of these agents. Thionamides agents may act reversibly by reducing I⁺ or some other reactive intermediate of iodine required in the iodination reaction, and also through a mechanism that involves a direct, irreversible reaction with thyroid peroxidase.

Thiouracil and propylthiouracil, and related thioureylenes, are also inhibitors of iodothyronine deiodinase (Leonard and Koehrlé 1996). The mechanism of inhibition involves the formation of a covalent complex with deiodinase enzymes. Inhibitory potency is highest for Type 1 deiodinase (Table 3-8). The result of inhibition is a decreased metabolic clearance of iodothyronines.

Aniline Derivatives. As a class, para-substituted aminobenzenes have activity similar to that of the thionamides in that they increase the accumulation of iodide in the thyroid gland and decrease production of iodothyronines, although possibly not through the same mechanisms (Green 1996). The group

3. HEALTH EFFECTS

includes several drugs (and drug classes), amphenone B, carbutamide, amino-glutethimide, p-aminosalicylic acid, and the sulfonamides.

Substituted Phenols. Various substituted phenols that have hydroxyl groups in the meta positions have been shown to increase thyroid iodide accumulation and to inhibit iodothyronine production in the thyroid. These include resorcinol, 2,4-dihydroxybenzoic acid, and 2,4-dihydroxyphenol. These compounds exert their activity by producing an irreversible inhibition of thyroid peroxidase (Green 1996).

Hydroxypyridines. Hydroxypyridines, including 3-hydroxypyridine and 3,4-dihydroxypyridine, have been shown to increase thyroid iodide accumulation and to inhibit iodothyronine production in the thyroid (Green 1996).

Perchlorate and Related Complex Anions. A variety of complex inorganic anions have been shown to decrease the uptake of iodide in the thyroid gland. When given at high enough dosages, these agents can induce hypothyroidism and goiter (Green 1996). The complex anions include, in order of potency: perchlorate (ClO_4^-), perrhenate (ReO_4^-), pertechnetate (TcO_4^-), and tetrafluoroborate (BF_4^-). The mechanism for their activity is competitive inhibition of the NIS (Carrasco 1993; Eskandari et al. 1997; Wolf 1964). These agents may also be transported by the NIS to varying degrees. Perchlorate does not appear to be transported by NIS (Eskandari et al. 1997; Yoshida et al. 1997). These anions can also affect accumulation and/or secretion of iodide in other tissues that have an active iodide transporter, including the choroid plexus, gastric mucosa, mammary gland, placenta, salivary gland, and sweat gland (Brown-Gant 1961).

Thiocyanate. Thiocyanate (SCN^-) is a potent inhibitor of iodide uptake in the thyroid gland and iodination of thyroglobulin. The mechanism for the effect on iodide uptake is primarily related to competitive inhibition of iodide transport by the Na^+/I^- symport in thyroid gland; however, thiocyanate may also accelerate iodide efflux from the thyroid by being a substrate with iodide for an anion exchange mechanism on the basolateral membrane of thyroid follicle cells (Eskandari et al. 1997; Yoshida et al. 1997). Thiocyanate inhibits iodination, apparently by its actions as a competitive oxidation substrate for thyroid peroxidase (Virion et al. 1980). Unlike other complex anion inhibitors of iodide transport, thiocyanate is not accumulated in the thyroid gland.

Thiocyanate is a product of the metabolism of cyanide (ATSDR 1997) to which humans are exposed when they smoke cigarettes, which has prompted interest in the potential effects of smoking on thyroid

3. HEALTH EFFECTS

iodine metabolism and thyroid disease (Bertelsen and Hegedus 1994). Thiocyanate is a metabolite of nitroprusside, a drug used in the treatment of acute hypertensive emergencies and cardiac failure. Impairment of thyroid function in patients on nitroprusside has been reported (Bodigheimer et al. 1979; Nourok et al. 1964).

Microsomal Enzyme Inducers. Agents that induce hepatic microsomal enzymes increase the activity of phenolic glucuronyl transferases that catalyze the conjugation of iodothyronines with glucuronic acid (Curran and DeGroot 1991; Visser 1990). Induction of glucuronyltransferase increases the metabolic clearance of iodothyronines and, if sufficiently accelerated, can stimulate TSH release and goiter. Such effects have been observed in rats and other experimental animal models in response to exposures to 2,4-benzopyrene, chlordane, DDT and DDD, 3-methylcholanthrene, PCBs, chlorinated dibenzodioxins (CDDs), and toxaphene. A variety of drugs have also been shown to exert effects on glucuronide conjugation of iodothyronines, including the sedative, phenobarbital; the anticonvulsants, phenytoin and carbamazepine; and the antibiotic, rifampin.

Polychlorinated Biphenyls (PCBs). Depending on dose and duration, PCBs can disrupt the production and disposition of thyroid hormones at a variety of levels and thereby may potentially interact with iodine in impairing the thyroid gland. The major findings include (1) histological changes in the thyroid gland indicative of both stimulation of the gland (e.g., similar to that induced by TSH or a hypothyroid state) and disruption of the processing of follicular colloid needed for normal production and secretion thyroid hormone; (2) depression of serum T_4 and T_3 levels, which may effectively create a hypothyroid state (in some studies, low doses resulted in elevated serum T_4 levels while depressed levels occurred at higher PCB doses); (3) increased rates of elimination of T_4 and T_3 from serum; (4) increased activities of T_4 -UDP-glucuronyl transferase (UDP-GT) in liver, which is an important metabolic elimination pathway for T_4 and T_3 ; (5) decreased activity of iodothyronine sulfotransferases in the liver, which are also important in the metabolic elimination of iodothyronines; (6) decreased activity of iodothyronine deiodinases, including brain Type-2 deiodinase, which provide the major pathways for the production of the active thyroid hormone, T_3 ; and (7) decreased binding of T_4 to transthyretin, an important transport protein for both T_4 and T_3 (ATSDR 2000b).

Selenium. Selenium is essential for the activity of the glutathione peroxidases and iodothyronine deiodinases. In humans, concurrent selenium and iodine deficiency have been associated with goiter and cretinism, a developmental impairment related to prenatal hypothyroidism (Goyens et al. 1987; Vanderpas et al. 1990). Supplementation of individuals deficient in both iodine and selenium with

3. HEALTH EFFECTS

selenium produces a further decrease in thyroid function, but if selenium supplementation is preceded by normalization of iodine levels, then normal thyroid function is restored (Contempré et al. 1991, 1992). Selenium intake has been reported to affect thyroid hormone levels in humans; these effects include decreases in serum T₃ and T₄ levels and increases in serum TSH levels, suggesting suppression of thyroid hormone production (Brätter and Negretti De Brätter 1996; Duffield et al. 1999; Hagmar et al. 1998; Hawkes and Keim 1995). In experimental animals, selenium deficiency produces a decreased metabolic clearance of iodothyronines and decreased extrathyroidal production of T₃, as a result of decreased iodothyronine deiodinase activity, which can be restored to normal by selenium repletion (Arthur and Beckett 1994; Behne and Kyriakopoulos 1993). Selenium deficiency also results in decreases in thyroid iodine concentrations. The latter effect is thought to involve direct and indirect effects on thyroid hormone production and secretion. The direct effect is thought to result from decreased activity of glutathione peroxidase in the thyroid and increased availability of hydrogen peroxide for utilization in the production of iodothyronines in the thyroid, which can then be exported from the gland. The indirect effect may involve increased release of TSH from the pituitary gland in response to a decrease in plasma concentration of T₃, resulting from inhibition of deiodination of T₄.

Amiodarone. The more serious side effects of the use of the antiarrhythmia drug, amiodarone, are effects on the thyroid, including hypothyroidism, hyperthyroidism, and thyroiditis (Bogazzi et al. 2001; Meier and Burger 1996). Although the exact mechanisms for these effects are not completely understood, amiodarone contains a large quantity of iodine and has been shown to inhibit the deiodination of iodothyronines; in particular, the production of T₃ from T₄, most likely as a result of inhibition of Type 1 deiodinase (Table 3-8). A metabolite of amiodarone, desethyamiodarone, has been shown to inhibit binding of T₃ to thyroid hormone receptors in a variety of tissues (Green 1996). As a thyroid receptor antagonist, amiodarone (or its metabolite) also stimulates the release of TSH from the pituitary gland.

Lithium. Hypothyroidism and goiter have been associated with chronic therapy with lithium carbonate for management of bipolar disease (Green 1996; Spaulding et al. 1972). The mechanism for these effects is not understood, although it has been suggested that lithium may inhibit the coupling reaction in the synthesis of iodothyronines and may inhibit thyroid hormone secretion.

Propranolol. Propranolol is a drug used in the treatment of hypertension, angina, and other cardiovascular disorders as well as for the symptomatic treatment of thyrotoxicosis. Although the basis for its use in treatment of thyrotoxicosis is to counteract the cardiovascular symptoms of the disorder, the drug is also an inhibitor of iodothyronine deiodination (Meier and Burger 1996). The effect is unrelated

3. HEALTH EFFECTS

to its activity as a β -adrenergic receptor antagonist, as both the L- and D-isomer (devoid of β -receptor antagonist activity) inhibit the deiodination of T_4 . The mechanism for this action is not understood.

Dexamethasone. Although the corticosteroids exert multiple effects on the physiological regulation of thyroid hormone release (e.g., decreased TSH release from the pituitary), these agents also have appreciable activity as inhibitors of iodothyronine deiodinase and can decrease the metabolic clearance of iodothyronines (Meier and Burger 1996).

Iodinated Drugs. A variety of iodine-containing drugs have been shown to inhibit iodothyronine deiodination and thereby decrease the metabolic clearance of iodothyronines. These include the antiarrhythmic agent, amiodarone (previously discussed), and several radiographic contrast agents used for cholecystography such as iopanoic acid, sodium ipodate, and tyropanoate (Meier and Burger 1996).

3.11 POPULATIONS THAT ARE UNUSUALLY SUSCEPTIBLE

A susceptible population will exhibit a different or enhanced response to iodine than will most persons exposed to the same level of iodine in the environment. Reasons may include genetic makeup, age, health and nutritional status, and exposure to other toxic substances (e.g., cigarette smoke). These parameters result in reduced detoxification or excretion of iodine, or compromised function of organs affected by iodine. Populations who are at greater risk due to their unusually high exposure to iodine are discussed in Section 6.7, Populations With Potentially High Exposures.

People who consume diets deficient in iodine may be more vulnerable to the toxic effects of exposure to radioiodine. At very low intakes, representing iodine deficiency (e.g., 20 $\mu\text{g}/\text{day}$), uptake of iodide into the thyroid gland is increased (Delange and Ermans 1996). This response is mediated by TSH, which stimulates iodide transport and iodothyronine production in the thyroid gland (see Section 3.6.1). If exposure to radioiodine was to occur in an individual who is iodine-deficient, a larger fraction of the absorbed radioiodine may be taken up by the thyroid gland and a larger radiation dose to the thyroid gland may be received. Iodine deficiency has been suggested to be a possible contributing factor to the increase in thyroid cancer incidence observed in Belarus after the Chernobyl reactor accident (Gembicki et al. 1997; Robbins et al. 2001).

People who have multinodular goiter or thyroid gland adenomas can have foci of thyroid gland tissues that produce and secrete thyroid hormone autonomously from control of the gland by TSH. The

3. HEALTH EFFECTS

mechanisms for thyroid tissue autonomy appear to involve clonal expansion of follicle cells that have either a modified TSH receptor or receptor coupling mechanism, or that overexpress growth factors (Corvilain et al. 2000; Derwahl and Studer, 2001; Krohn et al. 2000). Autonomous nodules can give rise to hyperthyroidism (e.g., toxic nodular goiter, toxic adenoma). Iodine deficiency and goiter appear to be risk factors in the development of autonomous nodules (Aghini-Lombardi et al. 1999). People who have the autonomous nodules appear to be more vulnerable to iodide-induced hyperthyroidism (Braverman and Roti 1996; Ermans and Camus 1972). This may, in part, explain the increased incidence of hyperthyroidism that sometimes accompanies the introduction of iodide supplements into the diet of iodine-deficient populations (Connolly 1971b; Corvilain et al. 1998; Delange et al. 1999). In experimental studies, supplemental doses of 75–150 µg I/day for 1–2 weeks have induced hyperthyroidism in euthyroid patients who had autonomous thyroid adenoma (Livadas et al. 1977). Patients with certain types of thyroid autoimmunity may be more susceptible to developing hyperthyroidism when exposed to excess iodine (Braverman and Roti 1996; Braverman et al. 1971a; Roti and Uberti 2001).

Populations with diets that are deficient in selenium may be more susceptible to iodine toxicity. Selenium is a cofactor in the iodothyronine deiodinases that are important for the synthesis of the thyroid hormone, T₃, in extrathyroidal tissues. Iodine deficiency, in conjunction with selenium deficiency, has been associated with goiter and cretinism, a developmental impairment related to prenatal hypothyroidism (Goyens et al. 1987; Vanderpas et al. 1990). In this state, in which the thyroid gland is responding to a deficiency in T₃ production by increasing iodide transport and iodination activity in the thyroid gland, infants and children (as well as adults) may experience a higher thyroid uptake of absorbed iodine and possibly a higher radiation dose to the thyroid when exposed to radioiodine.

People who have δ -thalassemia, an inherited disorder of hemoglobin production that can lead to anemia, may be more sensitive to developing hypothyroidism when exposed to excess iodide (Alezandrides et al. 2000).

3.12 METHODS FOR REDUCING TOXIC EFFECTS

This section will describe clinical practice and research concerning methods for reducing toxic effects of exposure to iodine. However, because some of the treatments discussed may be experimental and unproven, this section should not be used as a guide for treatment of exposures to iodine. When specific exposures have occurred, poison control centers and medical toxicologists should be consulted for

3. HEALTH EFFECTS

medical advice. The following text provides specific information about treatment following exposures to iodine:

Braverman LE, Utiger RD. 2000. *Werner and Ingbar's The thyroid: A Fundamental and Clinical Text*. Philadelphia, PA: Lippincott-Raven.

Treatment of toxicity from exposure to excess iodine is directed at lowering exposure and, if clinical hypothyroidism or hyperthyroidism persists, correcting the thyroid dysfunction. Treatment of clinical hypothyroidism includes the administration of thyroid hormone. Treatment of hyperthyroidism involves administering thyroid hormone synthesis inhibitors.

Treatment of toxicity from exposure to radioiodine is also directed at lowering thyroid gland uptakes of absorbed iodine, for example, by administration of potassium iodide (see Section 3.12.2). If the exposure produces persistent hypothyroidism or hyperthyroidism, the treatment strategies for the clinical abnormalities are the same as those for exposure for nonradioactive iodine.

3.12.1 Reducing Peak Absorption Following Exposure

No information was located on methods to reduce peak absorption following exposure. Mitigation of toxic effects following exposure to radioiodine is directed at reducing the uptake of absorbed iodine in the thyroid gland (see Section 3.12.2).

3.12.2 Reducing Body Burden

Approximately 90% of the iodine in the human body is contained in the thyroid gland. The thyroid gland is also the major toxicity target of radioiodine. Therefore, methods for reducing the uptake and accumulation of radioiodine in the thyroid gland can reduce the radioiodine body burden, the absorbed radiation dose to the thyroid gland and body, and the toxic effects of exposure to radioiodine. Iodine uptake into the thyroid gland is highly sensitive to the iodide intake. At very high intakes of iodine, representing an intake excess (e.g., >1 mg/day), iodine uptake into the thyroid gland decreases, primarily as a result of decreased iodothyronine synthesis (Wolff-Chaikoff effect) and iodide transport into the gland (Nagataki and Yokoyama 1996; Saller et al. 1998). A single oral dose of 30 mg iodide (as sodium iodide) decreases the 24-hour thyroid uptake of radioiodine by approximately 90% in healthy adults (Ramsden et al. 1967; Sternthal et al. 1980). The inhibition of uptake was sustained with repeated oral

3. HEALTH EFFECTS

doses of sodium iodide for 12 days, with complete recovery to control (presodium iodide) uptake levels within 6 weeks after the last sodium iodide dose (Sternthal et al. 1980), or within 8 days after a single dose (Ramsden et al. 1967). Repeated oral doses of 1.5–2.0 mg iodide/m³ of surface area produced an 80% decrease in thyroid uptake of radioiodine in children (Saxena et al. 1962). Inhibition of radioiodine uptake by the thyroid gland that occurs when large doses of iodide are administered results in more rapid urinary excretion of radioiodine and decreased iodine body burden (Ramsden et al. 1967). The administration of iodide as prophylaxis for reducing thyroid uptake of radioiodine after accidental releases of radioiodine has been recommended by the FDA and NCRP (FDA 1978, 2001b; NCRP 1977). Recommendations regarding the distribution and administration of potassium iodide in the event of a nuclear accident have been provided by the National Research Council (NRC 2004). Doses of 50 mg (infants <1 year of age) or 100 mg (adults) I, as potassium iodide, just before or at the time of exposure, have been found to be effective for blocking (>90%) thyroid uptake of radioiodine (Verger et al. 2001). The dose of potassium iodide that is effective for achieving this level radioiodine uptake block will depend on the time of dosing, relative to the exposure, as well as the dietary iodide status; higher doses of potassium iodide may be needed under conditions of low dietary iodide intake (Zanzonico and Becker 2000). The FDA (2001b) has recommended that potassium iodide be administered at the following doses, daily doses, until the risk of exposure from inhalation or ingestion no longer exists:

Receptor (years)	Predicted thyroid radiation dose (cGy, rad)	Dose (mg KI/day)	Dose (mg I/day)
Adults >40 years	\$500		
Adults >18–40 years	\$10	130	100
Pregnant or lactating women	\$5		
Adolescents >12–18 years*		65	50
Children >3–12 years	\$5		
Infants <1 month–3 years		32	24
Infants <1 month		16	12

* Adolescents \$70 kg should receive adult dose (130 mg/day)

3.12.3 Interfering with the Mechanism of Action for Toxic Effects

The mechanisms of action of excess iodine in producing goiter, hypothyroidism, hyperthyroidism, or thyroiditis involve direct interactions between iodide and physiological elements involved in thyroid hormone synthesis and release, and iodine transport. Therefore, the principal strategy for reducing toxic effects is to decrease iodine intake or uptake into the thyroid gland (see Section 3.12.2). Numerous cases of reversal of iodine-induced hypothyroidism or hyperthyroidism after reduction of iodide intake have been reported and are described in this profile (see Section 3.2.2.2, Endocrine Effects). The principal

3. HEALTH EFFECTS

clinical strategy for managing permanent hypothyroidism is the administration of T4 (Brent and Larsen 2000). The principal clinical strategies for managing permanent hyperthyroidism is the administration of agents that inhibit iodination of thyroglobulin, such as propylthiouracil or methimazole, or that inhibit thyroid uptake of iodine, such as perchlorate, or the destruction of the thyroid gland with radiation. The latter is usually accomplished by administering a cytotoxic dose of ^{131}I . β -Adrenergic antagonists are also used to manage some of the symptoms of thyrotoxicosis (Cooper 2000). Cases of massive acute, near-lethal poisoning from ingestion of tinctures of iodine (mixtures of molecular iodine and sodium triiodide) have included fluid and electrolyte replacement to manage cardiovascular shock (Finkelstein and Jacobi 1937).

The sulfhydryl compound, amifostine, has been found to reduce the toxic effects of high exposures to ^{131}I in patients who undergo ablative therapy with ^{131}I for thyroid cancers (Bohuslavizki et al. 1996, 1998a, 1998b, 1999). The mechanism for the protective effect appears to be accumulation of amifostine in the salivary gland and scavenging of free radicals formed as a result of interactions of ionizing radiation from ^{131}I with tissues.

3.13 ADEQUACY OF THE DATABASE

Section 104(i)(5) of CERCLA, as amended, directs the Administrator of ATSDR (in consultation with the Administrator of EPA and agencies and programs of the Public Health Service) to assess whether adequate information on the health effects of iodine is available. Where adequate information is not available, ATSDR, in conjunction with the National Toxicology Program (NTP), is required to assure the initiation of a program of research designed to determine the health effects (and techniques for developing methods to determine such health effects) of iodine.

The following categories of possible data needs have been identified by a joint team of scientists from ATSDR, NTP, and EPA. They are defined as substance-specific informational needs that if met would reduce the uncertainties of human health assessment. This definition should not be interpreted to mean that all data needs discussed in this section must be filled. In the future, the identified data needs will be evaluated and prioritized, and a substance-specific research agenda will be proposed.

3. HEALTH EFFECTS

3.13.1 Existing Information on Health Effects of Iodine

The existing data on health effects of inhalation, oral, and dermal exposure of humans and animals to iodine are summarized in Figures 3-16 and 3-17. The purpose of this figure is to illustrate the existing information concerning the health effects of iodine. Each dot in the figure indicates that one or more studies provide information associated with that particular effect. The dot does not necessarily imply anything about the quality of the study or studies, nor should missing information in this figure be interpreted as a “data need”. A data need, as defined in ATSDR’s Decision Guide for Identifying Substance-Specific Data Needs Related to Toxicological Profiles (Agency for Toxic Substances and Disease Registry 1989), is substance-specific information necessary to conduct comprehensive public health assessments. Generally, ATSDR defines a data gap more broadly as any substance-specific information missing from the scientific literature.

3.13.2 Identification of Data Needs

Acute-Duration Exposure. The primary effect of acute exposures to excess iodine in humans is hypothyroidism. This effect has been studied extensively in experimental studies of humans and is also well documented in the clinical case literature. Reported NOAELs for iodine-induced hypothyroidism in humans vary widely for reasons that are not completely understood. Acute exposures to excess iodine produce allergic reactions in people. The mechanisms for sensitivity and the reactions are not completely understood.

The effects of acute exposures to radioiodine (primarily ^{131}I) have been extensively studied in humans. An enormous amount of epidemiological and case literature derives from the clinical use of ^{131}I in diagnostic procedures and in treatment of thyroid gland enlargement and thyrotoxicosis. Epidemiology studies have also examined health effects resulting from accidental environmental exposures due to nuclear bomb detonations (e.g., Marshall Islands) and releases from nuclear power plants (e.g., Chernobyl). These studies collectively and convincingly identify the thyroid gland as the primary target of radioiodine. Other tissues that are either near the thyroid gland, such as the parathyroid gland, or that accumulate iodine, such as the salivary gland, also are affected by exposures to ^{131}I ; however, these effects occur at absorbed radiation doses that are clearly cytotoxic to the thyroid gland. Breast tissue expresses NIS and appears capable of accumulating ^{131}I and transferring it to mammary milk; therefore, it is a potential target of ^{131}I . However, epidemiology studies reported to date have not found a significant risk of breast cancer even after cytotoxic exposures to ^{131}I .

3. HEALTH EFFECTS

Figure 3-16. Existing Information on Health Effects of Stable Iodine

	Systemic									
	Death	Acute	Intermediate	Chronic	Immunologic/Lymphoretic	Neurologic	Reproductive	Developmental	Genotoxic	Cancer
Inhalation										
Oral	●	●	●	●	●	●		●	●	●
Dermal		●	●	●	●			●		

Human

	Systemic									
	Death	Acute	Intermediate	Chronic	Immunologic/Lymphoretic	Neurologic	Reproductive	Developmental	Genotoxic	Cancer
Inhalation										
Oral		●	●	●	●				●	
Dermal										

Animal

● Existing Studies

3. HEALTH EFFECTS

Figure 3-17. Existing Information on Health Effects of Radioactive Iodine

	Death	Acute	Intermediate	Chronic	Systemic	Immunologic/Lymphoretic	Neurologic	Reproductive	Developmental	Genotoxic	Cancer
Inhalation											
Oral		●		●	●	●	●	●	●	●	●
Dermal											
External											

Human

	Death	Acute	Intermediate	Chronic	Systemic	Immunologic/Lymphoretic	Neurologic	Reproductive	Developmental	Genotoxic	Cancer
Inhalation											
Oral		●							●	●	
Dermal											
External											

Animal

● Existing Studies

3. HEALTH EFFECTS

Intermediate-Duration Exposure. The primary effect of intermediate-duration exposures to excess iodine in humans is hypothyroidism. This effect has been studied extensively in humans and is well documented in the clinical case literature. Reported LOAELs for iodine-induced hypothyroidism in euthyroid humans, without goiter, fall within a reasonably narrow range, and are higher than those for people who are iodine deficient, suggesting a higher sensitivity in these subjects. The mechanisms for this are not completely understood. Intermediate-duration exposure has also been shown to induce hyperthyroidism in people who have nontoxic goiter. Here again, the mechanisms are not completely understood, although clonal expansion of autonomous follicle cells and autoimmunity are suspected contributors. Intermediate-duration exposures to excess iodine produce allergic reactions in people. The mechanisms for sensitivity and the reactions are not completely understood.

Chronic-Duration Exposure and Cancer. Epidemiological studies and clinical case literature identify the thyroid gland as the principal target of chronic exposure to excess iodine. Goiter, hypothyroidism, hyperthyroidism, and/or thyroid autoimmunity are the main outcomes of chronic exposure to excess iodine. Which effect occurs appears to be related to the pre-existing iodine intake (e.g., deficient or replete) and the presence or absence of possibly pre-existing autoimmunity and/or thyroid gland enlargement (or nodularity).

Genotoxicity. Stable iodine has been tested for genotoxicity in a variety of eukaryotic cell systems and has been found to be without mutagenic activity. The genotoxicity of radioactive iodine (^{131}I) has been extensively studied in clinical studies of patients who received ^{131}I for therapy of thyroid cancer and thyrotoxicosis and in people who were exposed to radioiodine from nuclear power plant accidents (e.g., Chernobyl).

Reproductive Toxicity. Several studies of reproductive effects of exposures to ^{131}I have been reported. These studies indicate that relatively high exposures to radioiodine (i.e., that are cytotoxic to the thyroid gland) can produce impairment of testicular function. The mechanism for this is not understood, but the observation of these effects suggests a possible exposure of the testes to ^{131}I . The testis is not presently known to express NIS; however, studies of the uptake of radioiodine in testes were not located.

Developmental Toxicity. Developmental toxicity of iodine and radioiodine related to effects on the fetal/neonatal thyroid gland has been well documented in the clinical case literature. The primary effect is congenital hypothyroidism and associated sequelae.

3. HEALTH EFFECTS

Immunotoxicity. The epidemiological and clinical case literature has identified thyroid autoimmunity and allergic reactions as the primary immunologic effects of exposure to excess iodine. Thyroid autoimmunity is an extremely important mechanism of thyroid gland disease. The mechanisms by which iodine induces thyroid autoimmunity are not completely understood. The production of antibodies to highly iodinated thyroglobulin has been proposed as a possible contributor.

Neurotoxicity. The primary target of iodine toxicity is the thyroid gland. A large amount of clinical literature exists on the neurological sequelae of thyroid gland disorders.

Epidemiological and Human Dosimetry Studies. The epidemiological literature on iodine- and radioiodine-related health effects is very substantial and provides information on exposures associated with the primary effect, thyroid gland dysfunction. There remain certain complications in the interpretation of the major epidemiology studies of environmental exposures to iodine and radioiodine. These relate to the magnitude of the contribution of iodine deficiency and autoimmunity in the observed thyroid gland outcomes (e.g., hypothyroidism, hyperthyroidism, thyroid gland nodularity, and cancers).

Studies of human dosimetry of ^{131}I are extensive, in large part, because of the extensive use of ^{131}I in diagnostic and treatment procedures that require highly certain estimates of the radiation dose delivered to the thyroid gland. The clinical information has been incorporated into reconstructions of thyroid doses experienced by the general public.

Biomarkers of Exposure and Effect.

Exposure. The use of urinary iodide for assessing steady state iodine intakes is well substantiated in the clinical and epidemiological literature and is supported by toxicokinetics studies in humans. Similarly, the use of external scintillation spectrometry to estimate radioiodine doses to the thyroid gland also has a substantial clinical history.

Effect. The clinical literature on thyroid gland disorders extensively documents the major biomarkers of thyroid gland dysfunction that are relevant to iodine toxicity.

Absorption, Distribution, Metabolism, and Excretion. The toxicokinetics of iodine in humans has been substantially explored and characterized in experimental studies and clinical cases. Radioiodine toxicity is most likely in tissues that can transport and accumulate iodide. Studies of the expression of

3. HEALTH EFFECTS

NIS and factors that alter expression of NIS can further advance our understanding of which tissues are at risk and what factors, including genetic factors, might affect sensitivity to radioiodine in humans.

Comparative Toxicokinetics. The extensive information on the toxicokinetics of iodine in humans makes extrapolations from animals less important in assessing the health effects of iodine in humans. Studies of interindividual variability in humans are valuable for identifying sensitive subpopulations.

Methods for Reducing Toxic Effects. The principal method for preventing the toxic effects of radioiodine is dosing with stable iodine, which decreases the thyroid gland uptake of radioiodine and the absorbed radiation dose to the gland. The mechanistic basis and effectiveness of this approach is well established from experimental and clinical studies.

Children's Susceptibility. Higher susceptibility of the fetus and infants to iodine and radioiodine toxicity is substantiated by the epidemiological and clinical case studies. The toxicokinetic basis for the susceptibility of infants and children to iodine exposure is understood. Uncertainties in assessing the potential health effect of iodine exposures are largely related to estimating exposures, in particular, the pathways by which environmental releases result in radioiodine uptake into the fetal or infant thyroid gland (see Section 6.8.1).

Child health data needs relating to exposure are discussed in 6.8.1 Identification of Data Needs:
Exposures of Children.

3.13.3 Ongoing Studies

Ongoing studies pertaining to iodine have been identified and are shown in Table 3-10.

3. HEALTH EFFECTS

Table 3-10. Ongoing Studies on Health Effects of Radioactive Iodine

Investigator	Affiliation	Title	Sponsor
Baker JR	University of Michigan at Ann Arbor	Characterization of thyroid autoantibodies and antigens	NCRR
Brent GA	University of California, Los Angeles	Regulation of the sodium/iodine symporter in breast	NCI
Burek CL	John Hopkins University	Immunotoxic effects of iodine	NIH—National Institute of Diabetes and Digestive and Kidney Diseases
Burek CL	John Hopkins University	Nod h2h4 mice as a sentinel model for autoimmune thyroid	NIEHS
Carrasco N	Yeshiva University	Characterization of the thyroid Na +/I-symporter	NIH—National Institute of Diabetes and Digestive and Kidney Diseases
Degroot LJ	University of Chicago	Pathogenesis and therapy of autoimmune thyroid disease	NIH—National Institute of Diabetes and Digestive and Kidney Diseases
Kong Y-CM	Wayne State University	T cell recognition—repertoire in autoimmune thyroiditis	NIH—National Institute of Diabetes and Digestive and Kidney Diseases
Naylor EW	Neo Gen Screening, Inc.	Simplified population screening for adult hypothyroidism	NIH—National Institute of Diabetes and Digestive and Kidney Diseases
Refetoff SS	University of Chicago	Regulation and mechanisms of hormone action	NIH—National Institute of Diabetes and Digestive and Kidney Diseases
Refetoff SS	University of Chicago	Screening for inherited thyroid defects	NCRR
Sgouros G	Sloan-Kettering Institute for Cancer	Modeling and dosimetry for radiolabeled antibody therapy	NCI
St Germain DL	Dartmouth College	Regulation of thyroid hormone metabolism	NIH—National Institute of Diabetes and Digestive and Kidney Diseases
St Germain DL	Dartmouth College	The role of the Type 3 deiodinase in development	NIH—National Institute of Diabetes and Digestive and Kidney Diseases

3. HEALTH EFFECTS

Table 3-10. Ongoing Studies on Health Effects of Radioactive Iodine

Investigator	Affiliation	Title	Sponsor
Weintraub BD	University of Maryland, Baltimore Professional School	Structure/function relationships of human thyrotrophin	NIH—National Institute of Diabetes and Digestive and Kidney Diseases

NCI = National Cancer Institute; NCRR = National Center for Research Resources; NIEHS = National Institute of Environmental Health Sciences; NIH = National Institute of Health/National Institute of General Medical Sciences

Source: CRISP 2001; National Institutes of Health; Central Repository of Incidents, Solutions, and Problems

