

NASA HISTORICAL DATA BOOK

Volume II

Programs and Projects 1958-1968

Linda Neuman Ezell

The NASA Historical Series



Library of Congress Cataloging-in-Publication Data
(Revised for vols. 2 and 3)

Van Nimmen, Jane, 1937-

NASA historical data book, 1958-1968.

(The NASA historical series) (NASA SP ; 4012)

Includes bibliographical references and indexes.

Vols. 2 and 3 by Linda Neuman Ezell.

Contents: v. 1. NASA resources -- v. 2. Programs and projects, 1958-1968 -- v. 3. Programs and projects, 1969-1978.

I. United States. National Aeronautics and Space Administration. I. Bruno, Leonard C., joint author.

II. Ezell, Linda Neuman. III. Title. IV. Series.

V. Series: The NASA historical series.

TL521.312.V36 629.4'0973 74-600126

PREFACE

The first two volumes of this series provide a statistical summary of the first decade of the National Aeronautics and Space Administration (NASA). It was a pioneering decade, characterized by public and congressional support, growth, and adventure. While Volume I introduces the researcher to NASA finances, personnel, and installations, the second volume contains information on the agency's major programs and projects—the *raison d'être* for the “dollars, people, and things” previously measured.

Established by the National Aeronautics and Space Act of July 1958, NASA, a civilian organization, was charged with managing those aeronautics and space activities sponsored by the United States that fell outside the purview of the Department of Defense. Included in the space act were eight general objectives for the new agency: (1) to expand man's knowledge of phenomena in the atmosphere and space; (2) to improve the usefulness and performance of aeronautical and space vehicles; (3) to send instrumented vehicles into space that could support life; (4) to study the long-range benefits that might result from utilizing space; (5) to preserve the role of the U.S. as a technological leader; (6) to support national defense by providing other agencies with information on new discoveries; (7) to cooperate with other countries in the peaceful utilization and exploration of space; and (8) to utilize existing scientific and engineering facilities and personnel. To meet these objectives, NASA channeled its resources into five programs: space science and applications, manned spaceflight, launch vehicle development, tracking and data acquisition, and advanced research and technology.

The procurement and development of launch vehicles was a critical first step for NASA. Chapter 1 discusses the military vehicles used by the agency in its early years and the stable of launchers designed and developed by NASA and its contractors. Saturn V, the largest and most powerful of these vehicles, was built for a specific purpose—manned expeditions to the moon. Chapter 2 outlines for the reader NASA's manned spaceflight program. Project Mercury proved that one man could safely orbit the earth and return. Pairs of astronauts in larger vehicles performed larger, more sophisticated missions during Project Gemini. But it was the ambitious Apollo program that captured the attention and the purse of the nation. In 1961 in answer to Yuri A. Gagarin's successful orbital flight, which preceded John H. Glenn, Jr.'s orbital mission by 10 months, President John F. Kennedy declared that before the end of the decade the U.S. would send a man to the moon. At the close of NASA's first decade, three Americans circled earth's natural satellite aboard *Apollo*

8; in July 1969 the first of six Apollo lunar landers touched down safely on the moon. Although it received less fiscal support, the space science and applications program brought the agency its first and steadiest supply of results.

Chapter 3 explores the disciplines NASA's space scientists sought to study and describes the many vehicles they used—from small sounding rockets and the Explorer family of satellites to large orbiting-laboratory satellites. In addition to supporting "pure" scientific research, NASA specialists also developed satellites of a more "practical" nature that contributed to such fields as meteorology and communications. NASA also applied its expertise to aeronautical research, continuing a practice begun by the National Advisory Committee for Aeronautics in 1915. Also included in the advanced research and technology program, described in Chapter 4, were investigations in the fields of space vehicle systems, electronics and control, human factor systems, and space power and propulsion. Scientific satellites, manned spacecraft, and experimental aircraft all demanded accurate tracking procedures and sophisticated data acquisition and analysis equipment, which is discussed in Chapter 5. During the first 10 years, the agency's tracking and data acquisition program supported three networks: the Space Tracking and Data Acquisition Network (satellites), the Manned Space Flight Network, and the Deep Space Network.

Each of the five chapters is divided into three sections. The narrative introduction to each chapter includes information on the changing management of the program offices at NASA Headquarters. In the budget sections, tables provide a fiscal history of each program and the many flight and research projects sponsored by NASA. The bulk of the book is devoted to describing these projects, including data on the projects' origins. For example, in Chapter 3, the material is divided among six broad categories: physics and astronomy, lunar and planetary, life sciences, meteorology, communications, and applications (including geodesy). In turn, the physics and astronomy section is organized by project: Explorer, Orbiting Solar Observatory, Orbiting Astronomical Observatory, Orbiting Geophysical Observatory, sounding rockets, Vanguard, and miscellaneous projects (including several international ventures). For each flight, a data sheet gives a physical description of the spacecraft and information on objectives, results, and participants. Throughout the book, the reader will find material that is duplicative. This is necessary to give the researcher who is interested in only one program or one project a more complete story.

The authors of the NASA Historical Data Book series have made no attempts to interpret or judge the events they describe; instead they have provided only the facts, figures, and background. Such an approach does not lend itself to volumes that are read from cover to cover, but it does provide students, writers, and others—especially those without ready access to primary documentation—objective material with which to begin their research. The second volume also gives historians, managers, engineers, and scientists working in the field quick answers to specific questions such as: Who initiated the Explorer series of satellites? How large was the Ranger spacecraft? When did the Space Task Group become the Manned Spacecraft Center? How many NASA pilots flew the X-15? What steps did the agency take to expand its research abilities in the field of electronics in the 1960s? Taken as a unit, each chapter will give the more serious reader a complete look at a program, its pre-NASA origins, objectives, constituents, and results.

Volume II was prepared under contract, sponsored by the NASA Historical Office. The author is indebted to the staff of that office for their assistance, criticisms, and moral support.

Linda Neuman Ezell
Spring 1982

CONTENTS

Preface	iii
Chapter One: Launch Vehicles	1
Chapter Two: Manned Spaceflight	89
Chapter Three: Space Science and Applications	195
Chapter Four: Advanced Research and Technology	401
Chapter Five: Tracking and Data Acquisition	519
Notes	597
Notes on Sources	605
Appendix: NASA Organization Charts	609
Index	619

CHAPTER ONE
LAUNCH VEHICLES



CHAPTER ONE

LAUNCH VEHICLES

Before the National Aeronautics and Space Act was signed on July 29, 1958, the art of launch vehicle development was the exclusive concern of the Department of Defense (DoD). With the passage of the act, the National Aeronautics and Space Administration (NASA), the new civilian agency charged with managing the country's space program was given the authority to initiate its own launch vehicle program. From an amalgam of civilian and military groups and organizations, NASA's managers began to gather the expertise and hardware they required, but for several years NASA would depend largely on DoD-developed missiles to launch its civilian payloads.

When NASA was organized, DoD's Scientific Satellite Project, which included the Naval Research Laboratory's Vanguard Division and its upper atmosphere sounding rocket team, was transferred to the new agency. In addition to several satellite and probe projects, NASA acquired the F-1 engine development project from the Air Force. On December 3, 1958, the facilities and 2300 employees of the Jet Propulsion Laboratory (JPL) in Pasadena, California, were transferred to NASA from the Army. For 22 years, this research group had been studying liquid and solid propellant rockets and recently had been supporting the Army Ballistic Missile Agency's work on *Explorer 1*, America's first successful artificial satellite. At NASA's Langley Research Center, a facility inherited from the National Advisory Committee for Aeronautics, the Scout solid propellant rocket was being developed. Scout, the agency's first launch vehicle program of its own, was an assembly of existing components gathered from the Navy's Polaris missile project, JPL's Sergeant missile, and the Vanguard satellite launcher. In October 1959, the decision was made to transfer to NASA the Army Ballistic Missile Agency's important Development Operations Division, the Wernher von Braun team. This group was developing a large clustered-engine rocket called Saturn (formerly known as Juno V), which agency planners had identified as a potential booster for advanced manned vehicles. NASA had been seeking to acquire the competence of the von Braun team since its founding and on July 1, 1960 officially assumed responsibility for some 4000 personnel and part of the division's facilities near Huntsville, Alabama, which were renamed the George C. Marshall Space Flight Center. The civilian agency also had been given authority to develop the Thor-Delta vehicle and the Vega upper stage and in 1960 took over from the Air Force the Centaur high-energy upper stage, which could be used with either the Atlas or the Titan booster. With the acquisition of the Missile Firing Laboratory at Cape Canaveral, Florida, in 1960, NASA possessed the

experienced people and the specialized facilities it needed to develop a successful family of launch vehicles.*¹

To develop a "national" launch vehicle program, the Department of Defense and NASA had to coordinate their efforts to assist one another and to avoid unnecessary and costly duplication. Responsibility for this coordination was assumed by the Launch Vehicle Panel of the Aeronautics and Astronautics Coordinating Board, a NASA-DoD organization established in September 1960 to replace the ineffectual Civilian-Military Liaison Committee. Since NASA-DoD relations and the prudent management of funds was also a frequent concern of Congress, the space agency's managers and designers took special care in the late 1950s and early 1960s to use military boosters already developed, to continue propulsion research initiated by the services, and to phase out any vehicle that was no longer suitable. NASA made immediate use of Juno and Vanguard vehicles and the Thor intermediate range missile with modified military upper stages; the agency began borrowing the Atlas intercontinental ballistic missile in 1959, Redstone in 1960, and Titan in 1964. However, NASA's plans for advanced missions called for larger and more specialized boosters than the military had to offer.² In designing these new vehicles, NASA's specialists made every effort to develop the minimum number of different vehicles with which to accommodate the wide range of missions that the agency was planning, and it became standard policy to use the same vehicle configurations repeatedly to improve their reliability.³ Cost effectiveness, reliability and versatility were characteristics the agency's managers and engineers sought in their launchers.

NASA's first decade saw the successful conclusion of the manned Mercury and Gemini projects, which employed Redstone, Atlas, and Titan boosters, and the development of the Saturn family of launch vehicles for manned spaceflight. *Apollo 8* was sent to orbit the moon with a crew of three by a Saturn V in December 1968, the first manned mission launched by the large booster. For NASA's unmanned programs, the Thor-Delta launch vehicle proved to be a workhorse. It was used 63 times in 1960-1968 to orbit geophysical, astronomical, biological, meteorological, communications-navigation, and interplanetary payloads. The dependable Atlas booster was employed successfully in several configurations, including the Atlas-Centaur, which at the end of the agency's first 10 years promised to be a valuable combination for large space science projects. NASA and the military were still depending on and improving the Scout launcher for small-payload tasks at the end of the decade (see fig. 1-1).

Until December 1959, all launch vehicle development was managed at NASA Headquarters by the director of spaceflight development, Abe Silverstein. Abraham Hyatt, assistant director for propulsion, reported to Silverstein, and several chiefs

*For further information on NASA facilities, see Jane Van Nimmen and Leonard C. Bruno with Robert L. Rosholt, *NASA Historical Data Book, 1958-1968*; *NASA Resources*, vol. 1, NASA SP-4012 (Washington, 1976), pp. 13-50. Also useful are Charles D. Benson and William B. Faherty, *Moonport: A History of Apollo Launch Facilities and Operations*, NASA SP-4204 (Washington, 1978); Manned Spacecraft Center, White Sands Test Facility, "MSC White Sands Test Facility History, July 1965-December 1967," MSC rep. [no number], Dec. 1967; Kennedy Space Center Public Affairs Off., "The Kennedy Space Center Story," Jan. 1968; NASA, "Wallops Station Handbook; General Information," vol. 1, April 3, 1961; and NASA Hq., Off. of Facilities, *National Aeronautics and Space Administration Facilities Data* (Washington, 1974).

responsible for such areas as solid rocket development and nuclear engines answered to Hyatt. In late 1959, a Launch Vehicle Programs Office was established, with Director Ron R. Ostrander reporting to the agency's associate administrator. A November 1961 reorganization divided launch vehicle management among the Office of Advanced Research and Technology (OART), the Office of Manned Space Flight (OMSF), and the Office of Space Science (OSS), later the Office of Space Science and Applications (OSSA). Managed in this fashion, nuclear and other advanced power systems were the responsibility of OART (see also chapter 4 for more on OART). Launch vehicles intended for use in unmanned space science projects were under the purview of Director of Launch Vehicles and Propulsion Programs Donald H. Heaton (replaced by Richard B. Morrison in 1962). As director of launch vehicles and propulsion in OMSF, Milton W. Rosen oversaw those vehicles that would boost men into space. In 1963, because NASA in general and the Apollo lunar exploration program in particular had become so very large, a major restructuring of the organization took place. The management of launch vehicles for unmanned projects was not affected. Project managers for the various vehicles continued to report to the director of launch vehicles and propulsion programs (Vincent L. Johnson replaced Morrison in 1964; Joseph B. Mahon assumed the role in 1967). Management of the manned vehicles, however, underwent a change. Instead of individuals assuming responsibility for specific components of the Apollo space vehicle and the Saturn launcher, Associate Administrator for Manned Space Flight George E. Mueller divided the authority for Apollo five ways: program control, systems engineering, testing, flight operations, and reliability and quality. For example, the director for systems engineering would be concerned with the Apollo command module, the launch vehicle, the lunar module, and any other component of Apollo for which systems engineering was required. There was no longer a launch vehicle manager per se in OMSF. (See table 1-1 for more information on the organization of the several offices concerned with the management of launch vehicle development and operations.)

Table 1-1.
Four Phases of Launch Vehicle Management, NASA Headquarters

Phase I

Oct. 1958-Dec. 1959

Administrator/Deputy Administrator

Associate Administrator

- Director, Space Flight Development (Abe Silverstein)
- Assistant Director, Propulsion (Abraham Hyatt)
 - Chief, Rocket Vehicle Development (Milton W. Rosen)
 - Chief, Solid Rocket Development (Elliot Mitchell)
 - Chief, Liquid Fuel Rocket Engines (Adelbert O. Tischler)
 - Chief, Space Propulsion and Auxiliary Power Units (William Cooley)
 - Chief, Analysis and Requirements (Eldon W. Hall)

Phase II

Dec. 1959-Nov. 1961

Administrator/Deputy Administrator

Associate Administrator

- Director, Launch Vehicle Programs (Don R. Ostrander)
- Deputy Director (Hyatt; Rosen, Jan. 1961)
 - Assistant Director, Vehicles (Rosen; Donald H. Heaton, Jan. 1961)
 - Assistant Director, Propulsion (Mitchell)
 - Assistant Director, Launch Operations (Samuel Snyder)
 - Assistant Director, Nuclear Propulsion (Harold B. Finger)

Phase III

Nov. 1961-Oct. 1963

Administrator/Deputy Administrator

Associate Administrator

- Director, Office of Advanced Research and Technology (Ira H. Abbott; Raymond L. Bisplinghoff, Aug. 1962)
- Director, Nuclear Systems (Finger)
- Director, Propulsion and Power Generation (William H. Woodward; John L. Sloop, Feb. 1962); office combined with Nuclear Systems in 1963
- Director, Office of Space Science (Homer E. Newell)
- Director, Launch Vehicles and Propulsion Programs (Heaton; Richard B. Morrison, June 1962)
 - Deputy Director, Launch Vehicles and Propulsion Programs (Sloop); office dropped in early 1962
 - Coordinator, Launch Operations (John W. Rosenberry); office dropped in 1963
 - Head, Small Vehicles and International Projects (Vincent L. Johnson; Roll D. Ginter, July 1962)
 - Head, Centaur (W. Schubert; Johnson, 1962)
 - Head, Agena (Dixon L. Forsythe; Joseph B. Mahon, 1963)
 - Program Manager, Scout (Ginter; Warren A. Guild, July 1962)
 - Program Manager, Delta (Johnson; Theodrick B. Norris, 1962)
 - Program Manager, San Marco (Ginter); office added in late 1962
 - Head, Advanced Projects (Alfred M. Nelson; J. A. Salmanson, 1963)
- Director, Office of Manned Space Flight (D. Brainerd Holmes; George E. Mueller, Sept. 1963)
 - Director, Launch Vehicles and Propulsion (Rosen; Robert F. Freitag, April 1963); office dropped in 1963 (see discussion above)
 - Assistant Director, Vehicle Engineering (Hall; Rosen, acting, late 1962); office dropped in 1963 (see discussion above)

Table 1-1.
Four Phases of Launch Vehicle Management, NASA Headquarters (Continued)

Assistant Director, Vehicles (Richard B. Canright; Stanley M. Smolensky, acting, late 1962); office dropped in 1963 (see discussion above)
Assistant Director, Propulsion (Tischler); functions transferred to OART
Assistant Director, Launch Operations (Gus A. D'Onofrio, acting; John K. Holcomb, June 1962); office dropped in 1963 (see discussion above)

Phase IV
Nov. 1963–Dec. 1968

Administrator/Deputy Administrator

Associate Administrator

Associate Administrator, Office of Advanced Research and Technology (Bisplinghoff; Mac C. Adams, Oct. 1965; James M. Beggs, June 1968)

Division Director, Chemical Propulsion (Tischler)

Division Director, Nuclear Systems and Space Power (Finger; Woodward, April 1967); office renamed Space Power and Electric Propulsion in April 1967

Associate Administrator, Office of Space Science and Applications (Newell)

Director, Launch Vehicles and Propulsion Programs (Morrison; Johnson, June 1964; Mahon, Dec. 1967)

Program Manager, Centaur (Johnson; Ginter, 1964; Norris, 1967)

Program Manager, Small Vehicles and International Projects (Ginter); office dropped in 1964 but reestablished in 1967 (R. W. Manville)

Program Manager, San Marco (Ginter); office dropped in 1964

Program Manager, Delta (Norris; Manville, 1966; I. T. Gillam, 1967)

Program Manager, Scout (Guild; R. K. Sherburne, 1966; Paul E. Goozh, 1967)

Program Manager, Agena (Mahon; W. L. Lovejoy, 1968)

Program Manager, Advanced Programs and Technology Support (Salmanson, acting; Joseph E. McGolrick, 1964)

Program Manager, Medium Launch Vehicles (Norris); office added in 1968

Associate Administrator, Office of Manned Space Flight (Mueller)

Director, Apollo Program (Samuel C. Phillips) (see discussion above)

Director, Program Control (Phillips, acting; Milo L. Seccomb, 1965; Jerald R. Kubat, 1967; James B. Skaggs, 1968)

Director, Systems Engineering (Thomas H. Thompson; Robert L. Wagner, 1967)

Director, Testing (John H. Disher; Melvin Savage, 1965; LeRoy E. Day, 1966)

Director, Flight Operations (Walter C. Williams, acting; Holcomb, 1963)

Director, Reliability and Quality (James Turnock; George A. Lemke, 1964; George C. White, Jr., 1966)

BUDGET

NASA's budget process, from requests for funds to programming the funds granted, was a complex one involving the agency, the Bureau of the Budget (BoB), and Congress. The agency was always considering three budgets simultaneously: the current operating budget, the budget for the ensuing fiscal year, and the preliminary budget for the following fiscal year (the fiscal year beginning July 1). In addition to asking for specific dollar amounts in each year's request, NASA's managers also had to explain and justify each budget category.

Table 1-2.
Simplified Steps of the Budget Process

-
1. Program Operating Plans submitted quarterly to NASA Headquarters program offices by the field installations.
 2. First draft of preliminary budget prepared by Office of Programming.
 3. First internal NASA semiannual budget review (March).
 4. Preliminary budget review by BoB, which leads to NASA-BoB negotiations and BoB targets (summer).
 5. Second internal NASA semiannual budget review (fall).
 6. Formal submission of requests to BoB (Sept. 30).
 7. Requests readied and justified for review by congressional authorization and appropriation committees (by Jan.).
 8. Initial hearings before House and Senate authorization committees, followed by reporting out of an authorization bill.
 9. Similar review by House and Senate appropriations subcommittees.
 10. Conference committees resolve any differences.
 11. Debate on floor of House and Senate, followed by passage of NASA authorization and appropriation acts.
-

From fiscal years 1963 through 1969, NASA's budget was divided into three accounts: Research and Development (R&D), Administrative Operations (AO), and Construction of Facilities (CoF).^{*} R&D and AO were funded on a no-year basis; that is, the funds were made available over an undefined multiyear period and did not have to be spent in one particular fiscal year. NASA was also permitted to reprogram internally among the three accounts (as of 1965, transfer authority was reduced from 3% to 0.5% of the total R&D authorization). This volume will only be concerned with R&D funds. For budget purposes, R&D was defined loosely to include more than pure research and development. For example, R&D funds were used not only to develop but also to procure launch vehicles and spacecraft after they were being produced in quantity. Severable equipment (equipment not permanently attached to a structure) could be financed with R&D funds, and non-NASA personnel supporting or working directly on an agency project could be paid from R&D accounts.

The Bureau of the Budget was responsible for most of the cuts suffered by NASA budgets months before Congress acted on the requests. In the tables that follow, the "request" column represents the amounts agreed to by NASA and BoB. Data on submissions (requests) for this volume are taken from the yearly budget estimates prepared by NASA's Office of Administration, Budget Operations Division, and from chronological histories prepared for each fiscal year by the same office. In Congress, the authorization committees and their several subcommittees intensely examined NASA's requests and the programs for which the funds would be spent. The House committee, for example, was divided into subcommittees corresponding to each NASA program office. NASA managers reported regularly to these subcommittees to keep them informed, because they had the authority to in-

^{*}R&D and AO were combined in FY 1963-1964 and called Research, Development, and Operations (RDO).

crease or decrease the agency's budget requests. The authorization committees set a maximum over which funds could not be appropriated; they imposed limitations or preconditions on how funds could be spent; they determined how the agency could reprogram or transfer its monies among accounts.

The "authorization" column in the following charts is the ceiling set by the authorization committees. Authorizations were not always listed for individual projects in the chronological histories, especially in the early 1960s. To determine the amount authorized for the general category or program under which a certain project fell, consult the chronological histories. The appropriations committees had the power to restore funds cut by the authorization committees or make further adjustments to the requests. Generally, however, the appropriations committees did not scrutinize NASA's budgets as closely as did the authorization subcommittees. Also, funds were not appropriated by "line item," an individual listing in the request, as they were authorized; for example, a sum would be appropriated for launch vehicle development, but the amount would not be itemized for each launch vehicle. Therefore, there are no appropriations columns in the tables to follow (however, see table 1-3 for a summary of appropriations for the three accounts).

Data on authorizations and appropriations for this volume are taken from the annual chronological histories mentioned above. The last column, "programmed," represents the funds spent during the fiscal year as reported in the NASA budget estimates (for example, funds programmed in FY 1964 were reported in the FY 1966 estimate). However, to account for all the funds expended for a major NASA

Table 1-3
NASA Appropriations, 1959-1968 (in millions of dollars)

Fiscal Year	Salaries & Expenses/ Administrative Operations ^a	Research & Development	Construction & Equipment Construction of Facilities ^b	Total
1959 ^c	86.3 ^a	196.6	48.0	330.9
1960	91.4	347.6	84.6	523.6
1961	170.8	670.4	122.8	964.0
1962	206.8	1302.5	316.0	1825.3
1963	----	2897.9 ^d	776.2	3674.1
1964	494.0	3926.0	680.0	5100.0
1965	623.5	4363.6	262.9	5250.0
1966	584.0	4531.0	60.0	5175.0
1967	640.0	4245.0	83.0	4968.0
1968	628.0	3925.0	35.9	4588.9
Total	3524.8 ^e	26 405.6 ^f	2469.4	32 399.8

^aS&E, 1959-1962; AO, 1963-1968.

^bC&E, 1959-1961; CoF, 1962-1968.

^cFY 1959 funds came from NACA and NASA appropriations and from a transfer from DoD.

^dDuring FY 1963, AO and R&D funds were combined to form Research, Development, and Operations.

^eBecause of the change in how the accounts were managed in FY 1963, this total is understated by about \$440 000 000 (see note d above).

^fBecause of the change in how the accounts were managed in FY 1963, this total is overstated by about \$440 000 000 (see note d above).

From Jane Van Nimmen and Leonard C. Bruno with Robert L. Rosholt, *NASA Historical Data Book, 1958-1968; NASA Resources*, Vol. 1, NASA SP-4012 (Washington, 1976), p. 115.

research and development project, one would also have to consider such things as funds reprogrammed from other accounts, special facilities built to support a particular project, salaries for NASA employees, and support activities.*⁴

To review the budgets of various launch vehicle programs, consult such obvious budget categories in the tables to follow as the name of the vehicle in which you are interested (arranged alphabetically), but do not overlook the miscellaneous categories included in table 1-31. Summary information can be found in tables 1-3 through 1-5. Valuable information is provided in the following tables in the bottom notes. For example, prior to FY 1966, portions of individual spacecraft project budgets were earmarked for launch vehicles. Of the FY 1964 request for Mariner (\$100 000 000), \$15 600 000 was requested for Atlas-Agena and \$9 700 000 for Centaur. But the requests were not always written so precisely. In the FY 1965 request for Mariner (\$54 100 000), \$10 900 000 was requested for launch vehicles, which would be divided between Atlas-Agena and Centaur; the request did not specify the amount to be budgeted for each vehicle. In using these tables, carefully review the bottom notes before making conclusions about totals for any particular vehicle or year.

*For further information on NASA's budget process, see Arnold Levine, *Managing NASA in the Apollo Era* (1963-1969), NASA SP-4102 (Washington, 1982).

Table 1-4
NASA Research and Development Funds, 1959-1968
(in millions of dollars)

Fiscal Year	Request	Authorization	Programmed
1959	237.6 ^a	237.6 ^b	175.7
1960	345.3	333.1	307.9
1961	671.0	671.4	644.1
1962	1380.5	1305.5	1261.3
1963	2968.3 ^c	2957.9 ^c	2878.6
1964	4351.7	4119.6	3824.4
1965	4523.0 ^d	4341.1	4358.6
1966	4575.9	4537.0	4468.9
1967	4246.6	4248.6	4249.3
1968	4352.0	4147.6	3881.3
Total	27 651.9 ^e	26 899.4	26 050.1

^aOf the total, \$146 619 532 was transferred to NASA.

^bActual authorization for NASA was \$20 750 000; the remainder was transferred to the agency.

^cIncludes administrative operations money and is thus overstated.

^dIncludes \$141 000 000 supplemental request for FY 1964 R&D program.

^eOverstated as per note c above.

From Jane Van Nimmen and Leonard C. Bruno with Robert L. Rosholt, *NASA Historical Data Book, 1958-1968; NASA Resources*, NASA SP-4012, Vol. 1 (Washington, 1976), p. 120.

Table 1-5.
Programmed Costs by Launch Vehicle, FY 1959-1968
(in thousands of dollars)

Vehicle	1959	1960	1961	1962	1963	1964	1965	1966	1967	1968
Atlas	8760	11 390	---	---	---	---	---	---	---	---
Atlas-Able	4097	18 349	5975	---	---	---	---	---	---	---
Atlas-Agena B & D	3500	7706	16 670	53 500	58 874	---	---	---	---	---
Atlas-Antares	---	---	---	---	4000	1786	8972	3602	---	---
Atlas-Centaur	---	---	---	---	---	---	---	---	---	---
Procurement	---	---	---	2309	13 900	32 000	44 814	65 000	55 019	68 305
Development	---	---	---	---	---	---	---	---	---	---
(Centaur)	---	---	---	---	---	---	---	---	---	---
(Total)	4000	36 644	64 673	73 791	90 600	108 100	89 400	53 790	27 200	---
(Atlas-Agena B & D)	(4000)	(36 644)	(64 673)	(76 100)	(104 500)	(140 100)	(134 214)	(118 790)	(82 219)	(68 305)
Juno II	10 690	34 833	2848	---	---	---	---	---	---	---
Jupiter	2740	---	---	---	---	---	---	---	---	---
Little Joe	2850	---	---	---	---	---	---	---	---	---
Nova	---	---	297	---	---	---	---	---	---	---
Redstone	6490	4477	---	---	---	---	---	---	---	---
Saturn I	---	---	---	950	---	---	---	---	---	---
Procurement	---	9450	173 908	193 326	256 887	187 077	40 265	---	---	---
Development	19 325 ^h	(9450)	(173 908)	(194 276)	(256 887)	(187 077)	(40 265)	---	---	---
(Total)	(19 325)	---	---	---	---	---	---	---	---	---
Saturn IB	---	---	---	---	---	---	---	1000	21 900	---
Procurement	---	---	---	---	---	---	---	274 786	225 626	101 100
Development	---	---	---	---	21 271	146 817	262 690	(275 786)	(247 526)	(101 100)
(Total)	---	---	---	---	(21 271)	(146 817)	(262 690)	---	---	---
Saturn V	---	---	---	---	---	---	---	---	1300	---
Procurement	---	---	---	---	---	---	---	1 135 081	1 098 154	853 965
Development	---	---	623	57 375	343 442	763 382	964 924	(1 135 081)	(1 099 454)	(853 965)
(Total)	---	---	(623)	(57 375)	(343 442)	(763 382)	(964 924)	---	---	---
Scout	---	---	---	---	4954	11 500	13 287	11 700	9400	10 200
Procurement	---	---	2202	---	---	---	---	---	---	---
Development	6048	3000	9652	4700	3648	---	---	---	---	---
(Total)	(6048)	(3000)	(11 854)	(4700)	(8602)	(11 500)	(13 287)	(11 700)	(9400)	(10 200)
Thor	---	---	3200	1000	---	---	---	---	---	---
Thor-Able	4963	---	---	---	---	---	---	---	---	---
Thor-Agena B & D	---	---	8302	12 100 ^j	7166	---	---	---	---	---
Thor-Delta	---	---	---	---	---	---	---	---	---	---
Procurement	---	34	8000	2500 ^m	31 589	30 101	32 374	27 729	23 835	33 696

Table 1-5.
Programmed Costs by Launch Vehicle, FY 1959-1968
(in thousands of dollars) (Continued)

Vehicle	1959	1960	1961	1962	1963	1964	1965	1966	1967	1968
Development										
(Delta)	12 927	12 476	10 479	5255	2183	---	---	---	---	---
(Total)	(12 927)	(125 101)	(18 479)	(7755) ^m	(33 772)	(30 101)	(32 374)	(27 729)	(23 835)	(33 696)
Titan II	---	---	---	22 391	63 709	---	o	---	---	---
Vega	14 291	4000	---	---	---	---	---	---	---	---
Totals	100 681	142 359	337 665	444 147	902 223	1 458 062	1 627 166	1 643 357	1 491 830	1 075 265

^a The total programmed for all Mercury launch vehicles (Atlas, Redstone, and Little Joe I) was \$30 836 000 (included in the total for 1961).
^b In addition, \$5 100 000 was programmed for the combined procurement of Atlas-Agena and Thor-Agena from the OGO budget, plus \$2 500 000 for the combined procurement of Atlas-Agena and Delta from the OSO budget (included in the total for 1962).
^c OSSA programmed \$54 599 000 for the combined procurement of Atlas-Agena and Thor-Agena; OMSF programmed \$122 700 000 for Gemini launch vehicles, which included Atlas-Agena D and Titan II (included in the total for 1964).
^d OSSA programmed \$55 040 000 for the combined procurement of Atlas-Agena and Thor-Agena; OMSF programmed \$115 400 000 for Gemini launch vehicles, which included Atlas-Agena D and Titan II (included in the total for 1965).
^e OSSA programmed \$70 669 000 for the combined procurement of Atlas-Agena and Thor-Agena (included in the total for 1966).
^f OSSA programmed \$29 396 000 for the combined procurement of Atlas-Agena and Thor-Agena (included in the total for 1967).
^g OSSA programmed \$7 999 000 for the combined procurement of Atlas-Agena and Thor-Agena (included in the total for 1968).
^h Funded by DoD.
ⁱ Combined amount programmed for procurement of Scout, Delta, and Thor-Agena from the international satellite budget (geophysics-astronomy) was \$7 350 000 (included in the total for 1962).
^j In addition, \$5 100 000 was programmed from the OGO budget for the combined procurement of Atlas-Agena and Thor-Agena, and \$7 350 000 from the international satellite budget (geophysics-astronomy) for the combined procurement of Delta, Thor-Agena, and Scout (included in the total for 1962).
^k OSSA programmed \$54 599 000 for the combined procurement of Atlas-Agena and Thor-Agena (included in the total for 1964).
^l OSSA programmed \$55 040 000 for the combined procurement of Atlas-Agena and Thor-Agena (included in the total for 1965).
^m In addition, \$2 500 000 was programmed for the combined procurement of Delta and Atlas-Agena from the OSO budget, and \$7 350 000 was programmed for the combined procurement of Delta, Thor-Agena, and Scout from the international satellite budget (geophysics-astronomy) (included in the total for 1962).
ⁿ OMSF programmed \$122 700 000 for Gemini launch vehicles, which included Atlas-Agena D and Titan II (included in the total for 1964).
^o OMSF programmed \$115 400 000 for Gemini launch vehicles, which included Atlas-Agena D and Titan II (included in the total for 1965).

Table 1-6.
Atlas Funding History,^a
(in thousands of dollars)

Year	Request	Programmed
1959	---	8760 ^b
1960	---	11 390 ^b
1961	24 900 ^b	--- ^c
1962	39 000 ^d	---

^aSee also Atlas-Able, Atlas-Agena/Thor-Agena, Atlas-Antares, and Atlas-Centaur.

^bFrom the manned spaceflight (Mercury) budget.

^cTotal programmed for all Mercury launch vehicles (Atlas, Redstone, and Little Joe I) was \$30 836 000.

^dIncludes \$11 500 000 from the Mercury request, \$22 000 000 from the Apollo orbital flight tests request, and \$5 500 000 from the Apollo biomedical flight research request.

Table 1-7.
Atlas-Able Funding History
(in thousands of dollars)^a

Year	Request	Programmed
1959	---	4097
1960	---	18 349 ^b
1961	---	5975 ^b

^aFrom the lunar and planetary exploration (Pioneer) budget.

^bIncludes funds for the Pioneer payload.

Table 1-8.
Atlas-Agena B and D Funding History
(in thousands of dollars)^a

Year	Request	Programmed
1959	---	3500 ^b
1960	---	7706 ^c
1961	16 500 ^d	16 670 ^e
1962	113 675 ^f	53 500 ^g
1963	93 581 ^h	58 874 ⁱ
1964	132 800 ^j	---
1965	97 300 ^k	---
1966	---	---
1967	---	---
1968	---	---

^aSee also Thor-Agena.

^bFrom the lunar and planetary budget.

^cIncludes \$346 000 from the astronomical observatories budget, and \$7 360 000 from the Ranger budget.

^dIncludes \$3 000 000 from the scientific satellite request, and \$9 500 000 from the lunar and planetary request, plus two FY 1961 supplementary requests: \$200 000 from the Rebound request and \$3 800 000 from a transitional communications system request.

^eFrom the Ranger budget.

^fIncludes funds from the following project requests: astronomical observatories (\$22 775 000), geophysical observatories (\$3 700 000), Ranger (\$32 800 000), Rebound (\$8 100 000), a transitional communications system (\$27 300 000), and Apollo for high-speed reentry tests (\$19 000 000).

^gIncludes funds from the following project budgets: Gemini (\$2 000 000), Ranger (\$30 900 000), Mariner (\$17 000 000), advanced Syncom (\$200 000), and OAO (\$3 400 000). In addition, \$5 100 000 was programmed for the combined procurement of Atlas-Agena and Thor-Agena from the OGO budget, plus \$2 500 000 for the combined procurement of Atlas-Agena and Delta from the OSO budget.

^hIncludes funds from the following project requests: Rebound (\$11 828 000), intermediate-altitude satellite (\$10 215 000), advanced Syncom (\$6 236 000), OGO (\$17 565 000), advanced OSO (\$3 600 000), Ranger (\$20 900 000), Mariner R (\$6 240 000), and OAO (\$16 997 000).

ⁱIncludes funds from the following project budgets: Mariner (\$4 812 000), OAO (\$1 356 000), Gemini (\$15 400 000), geophysics observatories (\$4 890 000), and Ranger (\$32 416 000).

^jIncludes funds from the following project requests: OAO (\$15 100 000), advanced Syncom (\$12 500 000), Gemini (\$47 900 000), Ranger (\$41 700 000), and Mariner (\$15 600 000). In addition, \$22 200 000 was requested for the combined procurement of Atlas-Agena and Thor-Agena from the OGO budget, plus \$4 800 00 for the combined procurement of Atlas-Agena and Delta from the OSO budget.

^kOSSA programmed \$54 599 000 for the combined procurement of Atlas-Agena and Thor-Agena. OMSF programmed \$122 700 000 for Gemini launch vehicles, which included Atlas-Agena D and Titan II.

^lIncludes funds from the following project requests: geophysical observatories (\$5 200 000), Ranger (\$2 000 000), Lunar Orbiter (\$15 500 000), Mariner (\$10 900 000), OAO (\$13 400 000), ATS (\$5 900 000), and Gemini (\$44 400 000).

^mOSSA programmed \$55 040 000 for the combined procurement of Atlas-Agena and Thor-Agena. OMSF programmed \$115 400 000 for Gemini launch vehicles, which included Atlas-Agena D and Titan II.

ⁿOSSA requested \$82 300 000 for the combined procurement of Atlas-Agena and Thor-Agena. OMSF requested \$88 600 000 for Gemini launch vehicles, which included Atlas-Agena D and Titan II.

^oOSSA programmed \$70 669 000 for the combined procurement of Atlas-Agena and Thor-Agena.

^pOSSA requested \$54 700 000 for the combined procurement of Atlas-Agena and Thor-Agena. OMSF requested \$8 500 000 for Gemini launch vehicles, which included Atlas-Agena D and Titan II.

^qOSSA programmed \$29 396 000 for the combined procurement of Atlas-Agena and Thor-Agena.

^rOSSA requested \$24 700 000 for the combined procurement of Atlas-Agena and Thor-Agena.

^sOSSA programmed \$7 999 000 for the combined procurement of Atlas-Agena and Thor-Agena.

Table 1-9.
Atlas-Antares Funding History
(in thousands of dollars)

Year	Request	Programmed
1963	---	4000 ^a
1964	---	1786 ^b
1965	1110 ^a	8972 ^b
1966	---	3602 ^b

^aFunds provided by the Project FIRE Budget.

^bOSSA Atlas procurement for Project FIRE.

Table 1-10.
Atlas-Centaur Funding History
(in thousands of dollars)

Year	Request		Authorization		Programmed	
	Procurement	Development (Centaur)	Procurement	Development (Centaur)	Procurement	Development (Centaur)
1959	---	---	---	---	---	4000
1960	---	41 000	---	41 000	---	36 644
1961	---	47 000	---	47 000	---	64 673
1962	12 070 ^a	65 400 ^b	---	56 400	2309 ^c	73 791
1963	34 400 ^d	66 664	---	66 664	13 900 ^c	90 600
1964	51 700 ^e	110 700	---	110 700	32 000	108 100
1965	54 000 ^c	92 000	---	92 000	44 814	89 400
1966	69 800	59 600	---	59 600	65 000	53 790
1967	64 000	29 700	60 000 ^g	29 700	55 019	27 200
1968	87 000	---	85 000	---	68 305	---

^aIncludes \$6 700 000 from the Surveyor request, and \$5 370 000 from the Mariner request.

^bIncludes a \$9 000 000 supplementary request.

^cFrom the Surveyor budget.

^dIncludes \$17 300 000 from the Surveyor request, and \$17 100 000 from the Mariner request.

^eIncludes \$42 000 000 from the Surveyor request, and \$9 700 000 from the Mariner request.

^fTotal 1966 request for launch vehicle procurement was \$194 500 000; total authorized was \$178 700 000 (authorizations were not itemized by launch vehicle).

^gIt was noted by the Conference Committee that \$4 000 000 of the \$9 250 000 reduction in the launch vehicle procurement budget was against Centaur, bringing the authorization to \$60 000 000.

Table 1-11.
Juno II Funding History
(in thousands of dollars)

Year	Request	Programmed
1959	---	10 690 ^a
1960	---	3483 ^b
1961	---	2848 ^c

^aIncludes \$8 540 000 from the scientific satellites budget, and \$2 150 000 from the communications budget.

^bIncludes funds from the following scientific satellite budgets: gamma ray astronomy satellite (\$870 837), ionosphere direct measurements satellite (\$870 837), and ionosphere beacon satellite (\$1 741 672).

^cIncludes funds from the following scientific satellite budgets: ionospheric air measurements (\$730 000), gamma ray satellite (\$705 000), and ionospheric beacon satellite (\$1 413 000).

Table 1-12.
Jupiter (Juno I) Funding History
(in thousands of dollars)^a

Year	Request	Programmed
1959	---	2740
1960	---	--- ^b

^aFrom the manned spaceflight budget (Mercury).

^bIt was estimated in the FY 1961 budget estimate that \$40 000 would be programmed for Jupiter vehicles in FY 1960. Plans for using this launch vehicle were cancelled, and no hardware was procured.

Table 1-13.
Little Joe I Funding History
(in thousands of dollars)

Year	Request	Programmed
1959	---	2850 ^a
1960	---	--- ^b
1961	---	--- ^c

^aFrom the manned spaceflight budget. In addition, \$1 170 000 was programmed for Little Joe I special purpose test apparatus and airframe development.

^bIt was estimated in the FY 1961 budget estimate that \$1 300 000 would be programmed for Little Joe I special purpose test apparatus and airframe development.

^cTotal programmed for all Mercury launch vehicles (Little Joe I, Atlas, and Redstone) was \$30 836 000.

Table 1-14.
Little Joe II Funding History
(in thousands of dollars)

Year	Request	Programmed
1962	1900 ^a	1250 ^a
1963	8800 ^b	--- ^c
1964	5000 ^a	--- ^d
1965	--- ^e	--- ^f
1966	--- ^g	--- ^h
1967	--- ⁱ	--- ^j

^aFrom the manned spacecraft systems (Apollo) budget.

^bFrom the Apollo (advanced manned spaceflight) request for a "solid, suborbital" launch vehicle.

^cTotal programmed for Apollo spacecraft support, of which Little Joe II was a part, was \$47 286 000.

^dTotal programmed for Apollo spacecraft support, of which Little Joe II was a part, was \$43 503 000.

^eTotal requested for Apollo spacecraft support, of which Little Joe II was a part, was \$144 000 000.

^fTotal programmed for Apollo spacecraft support, of which Little Joe II was a part, was \$83 663 000.

^gTotal requested for Apollo spacecraft support, of which Little Joe II was a part, was \$120 840 000.

^hTotal programmed for Apollo spacecraft support, of which Little Joe II was a part, was \$120 840 000.

ⁱTotal requested for Apollo spacecraft support, of which Little Joe II was a part, was \$96 500 000.

^jTotal programmed for Apollo spacecraft support, of which Little Joe II was a part, was \$119 937 000.

Table 1-15.
Nova Funding History
(in thousands of dollars)

Year	Request	Authorization	Programmed
1961	---	---	297
1962	48 500	48 500	--- ^a
1963	163 574	163 574	---

^aNASA's adoption of the Saturn C-5 in July 1962 effectively cancelled Nova. In the FY 1963 request, it was estimated that \$6 322 000 would be programmed for Nova in FY 1962.

Table 1-16.
Redstone Funding History
(in thousands of dollars)^a

Year	Request	Programmed
1959	---	6490
1960	---	4477
1961	750	--- ^b

^aFrom the manned spaceflight (Mercury) budget.

^bTotal programmed for all Mercury launch vehicles (Redstone, Atlas, and Little Joe I) was \$30 836 000. It was estimated in the FY 1962 budget request that \$2 450 000 would be programmed for Redstone in FY 1961.

Table 1-17.
Saturn I Funding History
(in thousands of dollars)^a

Year	Request		Authorization		Programmed	
	Procurement	Development	Procurement	Development	Procurement	Development
1959	---	---	---	---	---	19 325 ^b
1960	---	---	---	---	---	9450 ^c
1961	---	134 309	---	134 308	---	173 908
1962	---	224 160 ^d	---	224 160	950 ^e	193 326
1963	90 864 ^e	249 237	---	249 237	---	256 887
1964	75 000 ^e	93 800	---	93 800	---	187 077
1965	---	120 600	---	120 600	---	40 265
1966	---	4 400	---	4 400	---	---

^aFunded as a separate launch vehicle project in the FY 1959-1963 requests, as part of the OMSF launch vehicle and propulsion systems project in the FY 1964 request, and as part of Project Apollo in the FY 1965-1966 requests (funds for procuring Saturn vehicles were also included in the FY 1964 request as part of Apollo).

^bFunded by DoD.

^cAn additional \$47 870 000 was programmed for the development of the Saturn family by DoD. NASA programmed its funds for Saturn vehicle development, of which the Saturn I was the first step.

^dRequested for Saturn vehicle development, of which the Saturn I was the first step; however, some of these funds were being requested for work on advanced Saturn hardware.

^eDistinctions between procurement and development were not usually made in the Saturn launch vehicle budget (as they were for the launch vehicles used by OSSA). The procurement figures for 1962 and 1964 are exceptions; the procurement figure for 1963 is from the advanced manned spaceflight budget.

Table 1-18.
Saturn IB Funding History
(in thousands of dollars)^a

Year	Request		Authorization		Programmed	
	Procurement	Development	Procurement	Development	Procurement	Development
1963	---	---	---	---	---	21 271
1964	55 000 ^b	68 600	---	68 600	---	146 817
1965	---	260 100	---	260 100	---	262 690
1966	---	274 700	---	274 700	1000 ^b	274 786
1967	---	216 400	---	216 400	21 900 ^b	225 626
1968	78 500 ^b	156 200	---	---	---	101 100

^aIncluded as part of the OMSF launch vehicle and propulsion systems program and Project Apollo in the FY 1964 request, as part of Project Apollo in the FY 1965-1967 and 1970 requests, and as part of Project Apollo and Apollo applications in the FY 1968-1969 requests.

^bDistinctions between procurement and development were not usually made in the Saturn launch vehicle budget (as they were for OSSA launch vehicles). The procurement figure shown for FY 1964 (from the Apollo request) was an exception; the procurement figures shown for FY 1966-1968 are from the Apollo applications budget.

Table 1-19.
Saturn V Funding History
(in thousands of dollars)^a

Year	Request		Authorization		Programmed	
	Procurement	Development	Procurement	Development	Procurement	Development
1961	---	---	---	---	---	623
1962	---	50 000 ^b	---	---	---	57 375
1963	---	335 172	---	335 172	---	343 442
1964	---	843 000 ^c	---	733 000	---	763 382
1965	---	988 400	---	988 400	---	964 924
1966	---	1 236 500	---	1 236 500	---	1 135 081 ^d
1967	---	1 191 000	---	1 191 000	1300 ^e	1 098 154
1968	45 600 ^e	1 110 000 ^f	---	---	---	853 965

^aFunded as a separate launch vehicle program in the FY 1963 request, as part of the OMSF launch vehicle and propulsion systems program in the FY 1964 request, as part of Project Apollo in the FY 1965-1967 and 1970 requests, and as part of Project Apollo and Apollo applications in the FY 1968-1969 requests.

^bSupplementary request.

^cIncludes a supplementary request of \$110 000 000.

^dIncludes \$210 000 for Voyager studies of a Saturn V launch vehicle system.

^eDistinctions between procurement and development were not usually made in the Saturn launch vehicle budget (as they were for OSA launch vehicles). The procurement figures shown for FY 1967-1968 are for Apollo applications.

^fIncludes \$1 500 000 for Voyager studies of a Saturn V launch vehicle system.

^gThe authorization was not itemized by individual items; the total authorization for Project Apollo was \$2 521 500 000.

Table 1-20.
Scout Funding History
(in thousands of dollars)

Year	Request		Authorization		Programmed	
	Procurement	Development	Procurement	Development	Procurement	Development
1959	---	---	---	---	---	6048
1960	---	2000	---	2000	---	3000
1961	3500 ^a	---	---	---	2202 ^b	9652
1962	3000 ^c	3675	---	3675	---	4700
1963	4176 ^e	8947	---	8947	4954 ^f	3648
1964	---	---	---	---	11 500	---
1965	5300 ^h	---	---	---	13 287	---
1966	11 700	---	---	---	11 700	---
1967	10 400	---	---	---	9400	---
1968	16 800	---	14 300	---	10 200	---

^a From the scientific satellites budget.

^b Includes funds from the budgets of the following scientific satellites: topside sounder (\$52 000), U.K. ionosphere satellite (\$1 200 000), and electron density profile probe (\$950 000).

^c Includes funds from the budgets of the following scientific satellites: recoverable nuclear emulsions probe (\$1 000 000), topside sounder (\$1 000 000) and U.K. ionosphere satellite (\$1 000 000).

^d Combined amount programmed for procurement of Scout, Delta, and Thor-Agena from the international satellite budget (geophysics-astronomy) was \$7 350 000.

^e Includes funds from the budgets of the following scientific satellites: topside sounder (\$326 000), geoprobos (\$1 000 000), and U.K. international satellite (\$2 850 000).

^f From the Explorer budget.

^g \$8 800 000 was requested for the combined procurement of Scout and Delta for Explorer and Monitor; \$5 500 000 was requested for the combined procurement of Scout, Delta, and Thor-Agena for several international satellite projects.

^h Includes \$4 300 000 from the Explorer budget, and \$1 000 000 from the Soviet reentry heating experiment budget.

ⁱ Total request for launch vehicle procurement was \$194 500 000; total authorized was \$178 700 000 (authorizations were not broken down by individual vehicle).

^j Total request for launch vehicle procurement was \$152 000 000; total authorized was \$142 750 000 (authorizations were not broken down by individual vehicle).

Table 1-21.
Thor Funding History,^a
(in thousands of dollars)

Year	Request	Programmed
1961	2400 ^b	3200 ^c
1962	---	1000 ^c

^a See also Atlas-Agena/Thor-Agena, Thor-Able, and Thor-Delta.

^b FY 1961 supplementary request for Echo suborbital tests.

^c For ballistic tests of the Echo (rigid) satellite; no upper stage was used.

Table 1-22.
Thor-Able Funding History
(in thousands of dollars)

Year	Request	Programmed
1959	---	4963 ^a
1960	---	--- ^b

^aIncludes \$2 120 000 from the scientific satellites budget, and \$2 843 000 from the lunar and planetary budget.

^bAs reported in the FY 1961 request, it was estimated that \$727 000 of the scientific satellites budget would be programmed for Thor-Able.

Table 1-23.
Thor-Agena B & B Funding History FY 1959-1968
(in thousands of dollars)^a

Year	Request	Programmed
1961	10 600 ^b	8 302 ^c
1962	24 400 ^d	12 100 ^e
1963	13 059 ^f	7 166 ^g
1964	8 200 ^h	--- ⁱ
1965	10 100 ^j	--- ^k
1966	--- ^l	--- ^m
1967	--- ⁿ	--- ^o
1968	--- ^p	--- ^q

^aSee also Atlas-Agena B and D.

^bIncludes \$3 000 000 from the scientific satellites request, and \$5 700 000 from the Tiros request, plus \$1 900 000 from a supplementary request for Echo.

^cIncludes funds programmed for the following projects: Nimbus (\$2 802 000), Echo (\$2 200 000), and topside sounder (\$3 300 000).

^dIncludes funds from the following requests: OSO (\$1 000 000), topside sounder (\$8 300 000), Nimbus (\$10 900 000), and Echo (\$4 200 000).

^eIncludes funds programmed for the following projects: Echo (\$4 800 000) and Nimbus (\$7 300 000). In addition, \$5 100 000 was programmed from the OGO budget for the combined procurement of Atlas-Agena and Thor-Agena, and \$7 350 000 from the international satellites budget (geophysics-astronomy) for the combined procurement of Delta, Thor-Agena, and Scout.

^fIncludes funds from the following requests: Nimbus (\$91 517 000) and OGO (\$3 908 000).

^gIncludes funds programmed for the following projects: geophysical observatories (\$2 366 000), Explorer (\$3 100 000), Nimbus (\$1 200 000), and Echo II (\$500 000).

^hFrom the Nimbus request. In addition, \$22 200 000 was requested for the combined procurement of Atlas-Agena and Thor-Agena for OGO; and \$5 500 000 for the combined procurement of Delta, Thor-Agena, and Scout for several international satellite projects (geophysics-astronomy).

ⁱOSSA programmed \$54 599 000 for the combined procurement of Atlas-Agena and Thor-Agena.

^jIncludes funds from the following requests: geophysical observatories (\$5 700 000), Explorer (\$1 000 000), and Nimbus (\$3 400 000).

^kOSSA programmed \$55 040 000 for the combined procurement of Atlas-Agena and Thor-Agena.

^lOSSA requested \$82 300 000 for the combined procurement of Atlas-Agena and Thor-Agena.

^mOSSA programmed \$70 669 000 for the combined procurement of Atlas-Agena and Thor-Agena.

ⁿOSSA requested \$54 700 000 for the combined procurement of Atlas-Agena and Thor-Agena.

^oOSSA programmed \$29 396 000 for the combined procurement of Atlas-Agena and Thor-Agena.

^pOSSA requested \$24 700 000 for the combined procurement of Atlas-Agena and Thor-Agena.

^qOSSA programmed \$7 999 000 for the combined procurement of Atlas-Agena and Thor-Agena.

Table 1-24.
Thor-Delta Funding History
(in thousands of dollars)

Year	Request		Authorization		Programmed	
	Procurement	Development	Procurement	Development	Procurement	Development
1959	---	---	---	---	---	12 927
1960	---	13 300	---	13 300	34 ^a	12 476
1961	---	20 000 ^b	---	12 500	8000 ^c	10 479
1962	20 000 ^d	2900	---	2900	2500 ^e	5255
1963	6500 ^f	268	---	268	31 589 ^g	2183
1964	10 100 ^h	---	---	---	30 101	---
1965	28 100 ⁱ	---	---	---	32 374	---
1966	30 700	---	---	---	27 729	---
1967	22 900	---	---	---	23 835	---
1968	32 600	---	31 100	---	33 696	---

^aFrom the Project Echo budget for third-stage hardware.

^bIncludes a supplementary request of \$7 500 000.

^aFrom the Project Relay budget.

^dIncludes \$7 500 000 from the Project Relay request, and \$2 500 000 from the Tiros request.

^cFrom the Syncom budget. In addition, \$2 500 000 was programmed for the combined procurement of Delta and Atlas-Agena from the OSO budget, and \$7 350 000 was programmed for the combined procurement of Delta, Thor-Agena, and Scout from the international satellites (geophysics-astronomy) budget.

^fFrom the Project Relay request.

^gIncludes funds from the following projects: OSO (\$2 289 000), Explorer (\$14 100 000), Tiros (\$10 200 000), Relay (\$1 000 000), and Syncom (\$4 000 000).

^hIncludes funds from the following requests: Pioneer (\$5 000 000), geodesy (\$2 800 000) and Tiros (\$2 300 000). In addition, \$8 800 000 was requested for the combined procurement of Delta and Scout from the Explorer and Monitor request, \$4 800 000 for the combined procurement of Delta and Atlas-Agena from the OSO request, and \$5 500 000 for the combined procurement of Delta, Thor-Agena, and Scout from the international satellites request (geophysics-astronomy).

ⁱIncludes funds from the following requests: OSO (\$2 700 000), Explorer (\$7 500 000), Pioneer (\$8 100 000), Biosatellite (\$6 500 000), and Tiros (\$3 300 000).

^jTotal request for launch vehicle procurement was \$194 500 000; total authorized was \$178 700 000 (authorizations were not broken down for individual launch vehicles).

^kTotal request for launch vehicle procurement was \$152 000 000; total authorized was \$142 750 000 (authorizations were not broken down for individual launch vehicles).

Table 1-25.
Titan II Funding History
(in thousands of dollars)^a

Year	Request	Authorization	Programmed
1962	---	---	22 391
1963	50 000	---	63 709
1964	46 900	---	--- ^b
1965	66 900	66 900	--- ^c
1966	--- ^d	--- ^d	---
1967	--- ^e	--- ^c	---

^aFrom the manned spaceflight budget (Gemini).

^bCombined total programmed for both Gemini launch vehicles (Titan II and Atlas-Agena D) was \$122 700 000.

^cCombined total programmed for both Gemini launch vehicles (Titan II and Atlas-Agena D) was \$115 400 000.

^dCombined total requested and authorized for both Gemini launch vehicles (Titan II and Atlas-Agena D) was \$88 600 000.

^eCombined total requested and authorized for both Gemini launch vehicles (Titan II and Atlas-Agena D) was \$8 500 000.

Table 1-26.
Vega Funding History
(in thousands of dollars)

Year	Request	Authorization	Programmed
1959	---	---	14 291
1960	42 800	42 800	4000

Table 1-27.
F-1 Engine Development Funding History
(in thousands of dollars)^a

Year	Request	Authorization	Programmed
1961	---	---	50 849
1962	---	---	48 320
1963	55 316	55 316	53 703
1964	54 100	54 100	61 954
1965	64 100	64 100	62 396
1966	52 500	---	--- ^b
1967	41 000	---	--- ^c
1968	--- ^d	---	--- ^e

^aFunded as part of the liquid propulsion program in the FY 1963 request, as part of the OMSF launch vehicle and propulsion systems program in the FY 1964 request, and as part of Project Apollo in the FY 1965-1968 requests.

^bThe amount programmed for Apollo engine development (F-1, H-1, and J-2) was \$133 200 000.

^cThe amount programmed for Apollo engine development (F-1, H-1, and J-2) was \$49 800 000.

^dFY 1968 was the last year NASA requested funds for Apollo engine development. The request of \$24 500 000 was for the F-1, H-1, and J-2. The procurement of engines for the Saturn launch vehicles was charged to the appropriate Saturn account.

^eThe amount programmed for Apollo engine development (F-1, H-1, and J-2) was \$20 500 000.

Table 1-28.
H-1 Engine Development Funding History
(in thousands of dollars)^a

Year	Request	Authorization	Programmed
1962	---	---	5662
1963	---	---	6260
1964	5200	5200	11 531
1965	9800	9800	6550
1966	4800	---	--- ^b
1967	5500	---	--- ^c
1968	--- ^d	---	--- ^e

^a Funded as part of the OMSF launch vehicle and propulsion systems program in the FY 1964 request and as part of Project Apollo in the FY 1965-1968 requests.

^b The amount programmed for Apollo engine development (F-1, H-1, and J-2) was \$133 200 000.

^c The amount programmed for Apollo engine development (F-1, H-1, and J-2) was \$49 800 000.

^d FY 1968 was the last year NASA requested funds for Apollo engine development. The request of \$24 500 000 was for the F-1, H-1, and J-2. The procurement of engines for the Saturn launch vehicles was charged to the appropriate Saturn account.

^e The amount programmed for Apollo engine development (F-1, H-1, and J-2) was \$20 500 000.

Table 1-29.
J-2 Engine Development Funding History
(in thousands of dollars)^a

Year	Request	Authorization	Programmed
1961	---	---	18 574
1962	---	---	33 635
1963	38 732	38 732	46 769
1964	48 200	48 200	48 284
1965	61 600	61 600	49 102
1966	45 500	---	--- ^b
1967	37 900	---	--- ^c
1968	--- ^d	---	--- ^e

^a Funded as part of the liquid propulsion program in the FY 1963 request, as part of OMSF launch vehicle and propulsion systems program in the FY 1964 request, and as part of Project Apollo in the FY 1965-1968 requests.

^b The amount programmed for Apollo engine development (F-1, H-1, and J-2) was \$133 200 000.

^c The amount programmed for Apollo engine development (F-1, H-1, and J-2) was \$49 800 000.

^d FY 1968 was the last year NASA requested funds for Apollo engine development. The request of \$24 500 000 was for the F-1, H-1, and J-2. The procurement of engines for the Saturn launch vehicles was charged to the appropriate Saturn account.

^e The amount programmed for Apollo engine development (F-1, H-1, and J-2) was \$20 500 000.

Table 1-30.
 RL-10 Engine Development Funding History
 (in thousands of dollars)^a

Year	Request	Authorization	Programmed
1962	---	---	16 332
1963	---	---	29 645
1964	32 600	32 600	18 521
1965	17 900	17 900	14 970
1966	20 400	---	---
1967	12 000	---	---
1968	---	---	---

^aFunded as part of the OMSF launch vehicle and propulsion systems program in the FY 1964 request, as part of Project Apollo in the FY 1965 request, and as part of Project Apollo and the Centaur development project in the FY 1966-1967 requests. The procurement of RL-10 engines was charged to the appropriate launch vehicle accounts.

CHARACTERISTICS

The launch vehicles utilized by NASA during the agency's first 10 years are described in the following tables. Two boosters borrowed from the military, Atlas and Thor, were used with several different upper stages. Atlas was paired with Able, Agena, Antares, and Centaur; it also stood alone as the standard Mercury launch vehicle for orbital missions. Able, Agena, and Delta were added to Thor to increase that missile's range and versatility. Juno and Vanguard vehicles contributed to NASA's early space science program. Redstone missiles were man-rated to boost the first Mercury astronauts onto ballistic trajectories, and Gemini astronauts rode modified Titan IIs into orbit. Two distinct vehicles, Little Joe I and Little Joe II, were used to test and qualify launch techniques and hardware for the Mercury and Apollo programs. The Saturn family of launch vehicles was developed specifically to support the Apollo lunar exploration venture. And Scout, which changed over time as its engines were upgraded and its reliability improved, was NASA's first contribution to the launch vehicle stable. Two proposed vehicles, Vega and Nova, are also discussed.⁵

In some cases, finding the "official" figures for the height, weight, or thrust of a particular launch vehicle was not possible. It was not uncommon to find several NASA sources with conflicting data on the same vehicle. Measurements, therefore, may be approximate. Height may be measured several different ways, and there was some disagreement in the source material over where an upper stage begins and ends for measuring purposes. The height of a launch vehicle stack does not usually include the payload (spacecraft); weight, however, does. Weight of the individual stages includes propellant (wet weight). Diameter does not take into consideration the base of the booster stage, which is often much wider than the rest of the cylindrical vehicle due to the addition of fins or strap-on engines.

Table 1-31.
Other Budget Categories Related to Launch Vehicle Research and Development
(in thousands of dollars)

Item	59	60	61	62	63	64	65	66	67	68
Space Propulsion technology ^a :										
Solid propulsion	616	1720	1899	---	---	---	---	---	---	---
Liquid propulsion	15 979	27 217	72 726	---	---	---	---	---	---	---
Chemical propulsion	---	---	---	7003	49 722	46 000	76 502	39 700	33 638	37 037
Space power	---	3514	8913	12 256	8335	---	---	---	---	---
Electric propulsion	---	1300	7164	---	---	---	---	---	---	---
Space power and electric systems	---	---	---	---	---	---	58 220	45 200	46 440	43 735
Nuclear-electric systems	3810	5613	25 050	20 458	39 893	45 963	---	---	---	---
Nuclear rockets	---	---	---	26 776	69 465	79 176	57 000	58 000	53 000	54 000
OMSF Launch Vehicle & propulsion systems:										
Supporting technology	---	---	---	12 588	---	---	---	---	---	---
Range Support	---	---	---	2210	---	---	---	---	---	---
OSSA launch vehicle development:										
Supporting technology	---	---	---	---	1598	3800	7100	4000	4000	---
Operational support	---	---	---	1915	7700	---	---	---	---	---
Launch operations development	---	---	100	---	---	---	---	---	---	---
Launch vehicle technology/space vehicle systems ^a	1904	---	13 851 ^c	20 762	43 990	45 714	44 193	35 000	33 909	34 100

^a See also chapter 4.

^b See also table 4-11. Funds were programmed for spacecraft technology only.

^c See also table 4-11. Funds were programmed for spacecraft technology and launch vehicle technology.

Engine number changes may not always be noted if only minor modifications of the engines precipitated the changes. The following abbreviations for propellants were used throughout the following tables:

IRFNA = inhibited red fuming nitric acid
 LH₂ = liquid hydrogen
 LOX = liquid oxygen
 N₂O₄ = nitrogen tetroxide
 RP-1 = kerosene
 UDMH = unsymmetrical dimethylhydrazine
 WFNA = white fuming nitric acid

Thrust was measured in newtons (pounds of thrust multiplied by 4.448 equals newtons). Payload capacity was expressed in the number of kilograms that could be boosted to a specific ballistic height or to a certain orbit (measured in nautical miles converted to kilometers).

When available for major vehicles, a listing by launch vehicle number (serial number or production number) has been provided, with information on how each vehicle was used and its rate of success. Consult table 1-32 and figure 1-2 for a summary of the success rates of NASA's launch vehicles.

A chronology of each vehicle's development and operation has also been included. Development of many of the launch vehicles often preceded the founding of the space agency, but these early highlights of the vehicle's history have been provided. Launch dates and time were based on local time at the launch site.

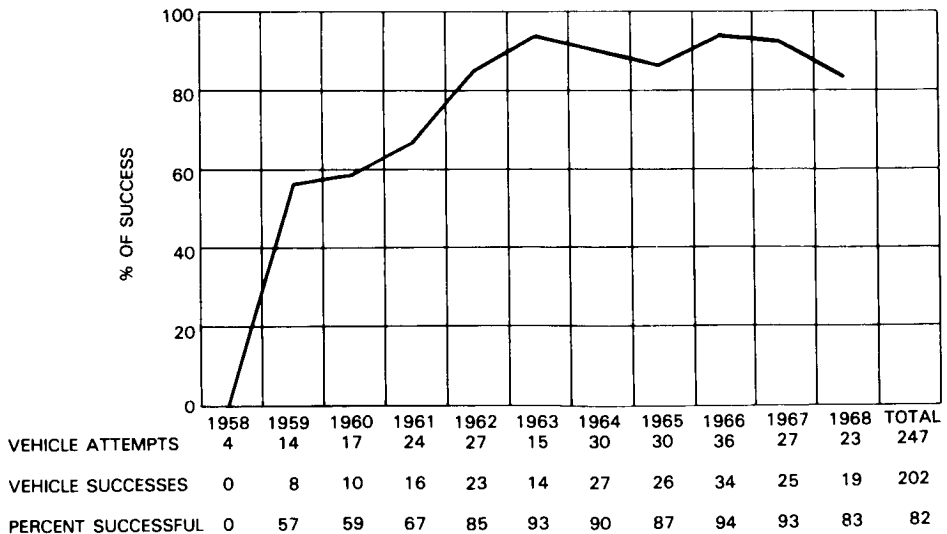

Figure 4-2. Launch Vehicle Success

Table 1-32.
Launch Vehicle Summary Including
Vehicle Development Missions (successes/attempts)

VEHICLE	1958	1959	1960	1961	1962	1963	1964	1965	1966	1967	1968	Total	%*
Thor-Able	0/2	1/1	2/2	---	---	---	---	---	---	---	---	3/5	60
Juno II	0/1	2/4	1/2	1/3	---	---	---	---	---	---	---	4/10	40
Jupiter C	---	---	---	---	---	---	---	---	---	---	---	0/1	0*
Little Joe	---	3/3	2/2	2/2	---	---	---	---	---	---	---	7/7	100
Vanguard	---	1/4	---	---	---	---	---	---	---	---	---	1/4	25
Atlas-Able	---	0/1	0/2	---	---	---	---	---	---	---	---	0/3	0
Atlas ††	---	1/1	0/1	3/4	3/3	1/1	---	1/1	---	---	---	9/11	82
Redstone	---	---	1/1	4/4	---	---	---	---	---	---	---	5/5	100
Scout **	---	---	2/3	2/4	3/4	3/4	4/4	2/2	2/2	2/3	6/6	33/39#	85
Scout X ***	---	---	0/1	---	---	---	---	---	---	---	---	0/1	0
Thor-Delta (includes TADs)	---	---	2/3	3/3	9/9	7/7	3/5	7/8	8/8	12/12	7/8	58/63	92
AF 609A †	---	---	---	0/1	---	---	---	---	---	---	---	0/1	0
Saturn I	---	---	---	1/1	2/2	1/1	3/3	3/3	---	---	---	10/10	100
Atlas-Agena	---	---	---	0/2	3/5	---	4/5	2/2	5/5	5/6	1/1	20/26	77
Thor-Agena (includes TATs)	---	---	---	---	1/1	---	2/2	2/2	2/2	1/1	0/1	8/9	89
Atlas-Centaur †	---	---	---	---	0/1	1/1	2/2	1/2	3/4	4/4	2/3	13/17†	77
Thor	---	---	---	---	2/2	---	---	---	---	---	---	2/2	100
Little Joe II	---	---	---	---	---	1/1	2/2	0/1	1/1	---	---	4/5	80
Titan II	---	---	---	---	---	---	1/1	6/6	5/5	---	---	12/12	100
Atlas-X259	---	---	---	---	---	---	1/1	1/1	---	---	---	2/2	100

Table 1-32.
Launch Vehicle Summary Including
Vehicle Development Missions (successes/attempts) (Continued)

VEHICLE	1958	1959	1960	1961	1962	1963	1964	1965	1966	1967	1968	Total	%*
Gemini Atlas-Agena	---	---	---	---	---	---	---	0/1	4/5	---	---	4/6	67
Saturn IB	---	---	---	---	---	---	---	---	3/3	---	2/2	5/5	100
Saturn V	---	---	---	---	---	---	---	---	---	1/1	1/2	2/3	67
TOTAL	0/4	8/14	10/17	16/24	23/27	14/15	27/30	26/30	34/36	25/27	19/23	202/247	

% of vehicle success

0 57 59 67 85 85 93 90 87 94 93 83 82

* Successful launches with this vehicle prior to creation of NASA by projects transferred to NASA not included.

*** Not a complete test vehicle; excluded from Scout Performance totals. † Mercury (Blue) Scout

†† Includes Atlas vehicles for Gemini mission and Mercury Big Joe mission. #Does not include 25 Scouts (18 successful)

** Does not include successful San Marco II launch in 1967 by an Italian launch crew. † Not a NASA launch responsibility.

¶ Includes all vehicle development missions, e.g., eight Atlas-Centaur developmental missions of which five succeeded. Of the nine operational launches, eight were successful.

The Atlas Family

When engineers at NACA's Langley laboratory began seriously studying manned spacecraft designs in early 1958, they identified the Atlas intercontinental ballistic missile as a candidate for orbiting a small blunt-shaped craft. Under development at Consolidated Vultee Aircraft Corporation (Convair, later a division of General Dynamics) since 1946, Atlas flew its designed range for the first time in November 1958. NASA, the new civilian space agency, put Atlas to work the next year. Four Mercury astronauts were boosted into orbit by the Atlas D (also designated Atlas SLV-3) in 1962-1963 (see tables 1-33, 1-34). This reliable booster was also put to use during the second phase of the manned program as the Gemini target launch vehicle. But Atlas played an even larger role in the agency's space science and applications program.

Atlas was first paired with the Able upper stage, which was derived from the Vanguard launch vehicle. This unsuccessful configuration failed in its attempts to send a Pioneer probe to the moon in 1959-1960 (see tables 1-37, 1-38). The Atlas-Agena combination fared better. First with Agena B and later with the upgraded Agena D (manufactured by Lockheed Missiles and Space Company for the Air Force and NASA), Atlas-Agena launched Mariner, Ranger, Lunar Orbiter, Orbiting Geophysical Observatory, and Applications Technology Satellite payloads (see tables 1-39 through 1-43). Teamed with the Antares, a modified solid motor from the Scout third stage, Atlas was used to hurl reentry experiments (Project FIRE) onto ballistic trajectories at speeds that simulated lunar spacecraft reentry in 1964-1965 (see tables 1-44, 1-45). Atlas-Centaur was the most promising configuration of the Atlas family. The high-energy Centaur, made by General Dynamics, was the first American vehicle to use liquid hydrogen as a propellant. During 1966-1968, Atlas-Centaur launched the Surveyor lunar probe series and one Orbiting Astronomical Observatory (see tables 1-46 through 1-48). NASA officials seriously considered one other Atlas-upper stage combination. Vega was being planned by NASA and General Dynamics as an interim vehicle to be used while Centaur was undergoing lengthy research and development phases. In 1959, however, the Department of Defense revealed its work on the Agena B stage; Atlas-Vega was dropped in favor of the military's proposed vehicle (see tables 1-49, 1-50).

The Atlas booster was unique in that it had 1.5 stages. In addition to its primary booster engines, Atlas carried a sustainer engine system, which was jettisoned shortly after launch. The Atlas MA-5 propulsion system was manufactured by Rocketdyne Division of North American Aviation. In the mid-1960s, NASA funded a "stretch-out" program for Atlas. By increasing its length, engineers were able to increase the vehicle's propellant capacity. The Atlas SLV-3X (or SLV-3C) was first used by NASA in 1966.⁶

Table 1-33.
Atlas D/Atlas SLV-3 (Standard
Launch Vehicle-3) Characteristics

<i>Height (m):</i>	23.2 (24.1 including the Centaur interstage adapter)
<i>Diameter (m):</i>	3 (4.9 at the base)
<i>Launch weight (kg):</i>	128 879
<i>Propulsion system</i>	
<i>Stages:</i>	1.5
<i>Powerplant:</i>	Rocketdyne MA-5 propulsion system (see table 1-33)
<i>Thrust (newtons):</i>	1 752 512
<i>Propellant:</i>	LOX/RP-1
<i>Payload capacity:</i>	With Centaur, 1133 kg to a parking orbit trajectory to the moon
<i>Origin:</i>	Funds were spent in FY 1965 and 1966 to "stretch out" the standard Atlas, thereby increasing its propellant capacity.
<i>Contractors:</i>	Consolidated Vultee Aircraft Corp. (Convair/General Dynamics), prime Rocketdyne Div., North American Aviation, Inc., engines
<i>How utilized:</i>	With Centaur and Agena D upper stages to launch unmanned payloads, from 1966.
<i>Remarks:</i>	First used on Oct. 26, 1966 for an Atlas-Centaur R&D launch.
<i>See also:</i>	Atlas D/Atlas SLV-3, Atlas-Agena D, and Atlas-Centaur.

Table 1-34.
Atlas SLV-3X/Atlas SLV-3C Characteristics

<i>Height (m):</i>	21.9
<i>Diameter (m):</i>	3 (4.9 at base)
<i>Launch weight (kg):</i>	117 979
<i>Propulsion system</i>	
<i>Stages:</i>	1.5
<i>Powerplant:</i>	MA-5 propulsion system, consisting of one sustainer engine (Rocketdyne YLR-105) producing 266 880 newtons of thrust and two booster engines (Rocketdyne YLR-89) producing 667 200 newtons of thrust each.
<i>Thrust (newtons):</i>	1 601 280
<i>Propellant:</i>	LOX/RP-1
<i>Payload capacity:</i>	1224.7 kg to 555 km earth orbit
<i>Origin:</i>	ICBM developed by Convair under contract to U.S. Air Force.
<i>Contractors:</i>	Consolidated Vultee Aircraft Corp. (Convair/General Dynamics), prime Rocketdyne Div., North American Aviation, Inc., engines
<i>How utilized:</i>	Project Mercury, 1959-1963 With Able, Agena B, Agena D, and Centaur upper stages to launch unmanned payloads, 1959-1966. Project Gemini to launch Agena target vehicles, 1966
<i>Remarks:</i>	There were six versions of the Atlas, A to F. NASA used only the D model, which differed from the military versions in the following ways: modified spacecraft-launch vehicle adapter section, stronger upper neck, and inclusion of an emergency system for manned Mercury spacecraft. The Atlas is said to have 1.5 stages. The half-stage consisted of the sustainer engine plus some supporting structure, which was jettisoned to reduce weight after the initial boost phase. During 1964-1965, NASA and Rocketdyne explored the possibility of adding fluorine to the propellant's oxidizer to increase Atlas booster performance. The "FLOX Atlas" project was dropped in 1965 in favor of improving Centaur's performance.
<i>See also:</i>	Atlas SLV-3X/Atlas SLV-3C, Atlas-Able, Atlas-Agena A, Atlas-Agena B, Atlas-Agena D, Atlas-Antares, Atlas-Centaur, and Atlas-Vega.

Table 1-35.
Listing of Atlas D Boosters

Vehicle Serial #	Date	Mission	Atlas Stage Successful*
10	Sept. 9, 1959	Mercury boilerplate test	No (electrical failure)
--	Sept. 24, 1959	Pioneer (Atlas-Able)	Yes
20	Nov. 26, 1959	Pioneer (Atlas-Able)	Yes
50	July 29, 1960	Mercury MA-1	No (airframe failure)
67	Feb. 21, 1961	Mercury MA-2	Yes
77		Mercury (flight cancelled)	
80	Sept. 25, 1960	Pioneer (Atlas-Able)	Yes
88	Sept. 13, 1961	Mercury MA-4	Yes
91	Dec. 15, 1960	Pioneer (Atlas-Able)	No (airframe failure)
93	Nov. 29, 1961	Mercury MA-5	Yes
100	April 25, 1961	Mercury MA-3	No (flight control failure)
103		Mercury (flight cancelled)	
104	May 8, 1962	R&D launch with Centaur (AC-1)	Yes
107	May 24, 1962	Mercury MA-7	Yes
109	Feb 20, 1962	Mercury MA-6	Yes
111	Aug. 23, 1961	Ranger 1 (Atlas-Agena B)	Yes
113	Oct. 3, 1962	Mercury MA-8	Yes
117	Nov. 18, 1961	Ranger 2 (Atlas Agena B)	Yes
121	Jan. 26, 1962	Ranger 3 (Atlas Agena B)	No (guidance system failure)
126	Nov. 27, 1963	R&D launch with Centaur (AC-2)	Yes
130	May 15, 1963	Mercury MA-9	Yes
133	April 23, 1962	Ranger 4 (Atlas-Agena B)	Yes
135	June 30, 1964	R&D launch with Centaur (AC-3)	Yes
144		Mercury MA-10 (cancelled)	
145	July 22, 1962	Mariner 1 (Atlas-Agena B)	No (ground guidance failure)
146	Dec. 11, 1964	R&D launch with Centaur (AC-4)	Yes
151	Aug. 11, 1965	R&D launch with Centaur (AC-6)	Yes
152		Mercury (unassigned)	
156	March 2, 1965	R&D launch with Centaur (AC-5)	No (propellant feed failure)
167		Mercury (flight cancelled)	
174	Oct. 26, 1966	R&D launch with Centaur (AC-9)	Yes
179	Aug. 27, 1962	Mariner 2 (Atlas-Agena B)	Yes
184	April 7, 1966	R&D launch with Centaur (AC-8)	Yes
194	Sept. 20, 1966	Surveyor 2 (Atlas-Centaur)	Yes
195	Sept. 4, 1964	OGO 1 (Atlas-Agena B)	Yes

Table 1-35.
Listing of Atlas D Boosters (Continued)

Vehicle Serial #	Date	Mission	Atlas Stage Successful*
196	Feb. 17, 1965	Ranger 8 (Atlas-Agena B)	Yes
199	Jan. 30, 1964	Ranger 6 (Atlas-Agena B)	Yes
204	March 21, 1965	Ranger 9 (Atlas-Agena B)	Yes
215	Oct. 18, 1962	Ranger 5 (Atlas-Agena B)	Yes
250	July 28, 1964	Ranger 7 (Atlas-Agena B)	Yes
263	April 14, 1964	FIRE I suborbital (Atlas-Antares)	Yes
264	May 22, 1965	FIRE II suborbital (Atlas-Antares)	Yes
288	Nov. 28, 1964	Mariner 4 (Atlas-Agena D)	Yes
289	Nov. 5, 1964	Mariner 3 (Atlas-Agena D)	Yes
290	May 30, 1966	Surveyor 1 (Atlas-Centaur)	Yes
291	July 14, 1967	Surveyor 4 (Atlas-Centaur)	Yes
292	April 17, 1967	Surveyor 3 (Atlas-Centaur)	Yes
5001	April 8, 1966	OAO 1 (Atlas-Agena D)	Yes
5002C	Dec. 7, 1968	OAO 2 (Atlas-Centaur)	Yes
5101	Dec. 6, 1966	ATS 1 (Atlas-Agena D)	Yes
5102	April 5, 1967	ATS 2 (Atlas-Agena D)	Yes
5103	Nov. 5, 1967	ATS 3 (Atlas-Agena D)	Yes
5104	Aug. 10, 1968	ATS 4 (Atlas-Centaur)	Yes
5301	Oct. 25, 1965	Gemini target (Agena D)	Yes**
5302	March 16, 1966	Gemini target (Agena D)	Yes
5303	May 17, 1966	Gemini target (Agena D)	No (flight control failure)
5304	June 1, 1966	Gemini target (Agena D)	Yes
5305	July 18, 1966	Gemini target (Agena D)	Yes
5306	Sept. 12, 1966	Gemini target (Agena D)	Yes
5307	Nov. 11, 1966	Gemini target (Agena D)	Yes
5401	June 14, 1967	Mariner 5 (Atlas-Agena D)	Yes
5601	June 6, 1966	OGO 3 (Atlas-Agena B)	Yes
5602A	March 4, 1968	OGO 5 (Atlas-Agena D)	Yes
5801	Aug. 10, 1966	Lunar Orbiter 1 (Atlas-Agena D)	Yes
5802	Nov. 6, 1966	Lunar Orbiter 2 (Atlas-Agena D)	Yes
5803	Feb. 4, 1967	Lunar Orbiter 3 (Atlas-Agena D)	Yes
5804	May 4, 1967	Lunar Orbiter 4 (Atlas-Agena D)	Yes
5805	Aug. 1, 1967	Lunar Orbiter 5 (Atlas-Agena D)	Yes
5901C	Sept. 8, 1967	Surveyor 5 (Atlas-Centaur)	Yes
5902C	Nov. 7, 1967	Surveyor 6 (Atlas-Centaur)	Yes
5903C	Jan. 7, 1968	Surveyor 7 (Atlas-Centaur)	Yes

*8 failures out of 67 attempts (88% successful).

†The Agena stage, however, malfunctioned shortly after separation.

Table 1-36.
Chronology of Atlas Development and Operations

Date	Event
1946	Contract awarded by U.S. Air Force to Consolidated Vultee Aircraft Corporation (Convair) to develop a long-range missile, the MX-774.
1947	Contract with Convair cancelled due to budget restraints; Convair continued research on its own.
1950	Air Force reestablished missile program.
Jan. 1951	Convair contract with Air Force reinstated (Project MX-1953); proposed missile named Atlas.
1953	Essentials of Atlas design were developed by 1953.
June 11, 1957	Atlas flight testing began.
March 1958	NACA Langley designers considered Atlas for the first U.S. manned spaceflight program.
Oct. 17-18, 1958	Langley personnel opened negotiations with the Air Force Ballistic Missile Division to procure Atlas vehicles.
Nov. 24, 1958	Atlas flew its designed range for the first time.
Dec. 18, 1958	First orbital launch of entire vehicle (Air Force Project Score).
Sept. 9, 1959	NASA successfully conducted Mercury Big Joe boilerplate test with Atlas 10-D (the Atlas, however, suffered an electrical failure).
Nov. 26, 1959	Unsuccessful launch of Atlas-Able with a Pioneer lunar probe; failure due to upper stage malfunctions; first time Atlas was used with an upper stage.
June 18, 1960	Atlas 50-D delivered to Cape Canaveral for first Mercury-Atlas mission (MA-1).
July 29, 1960	MA-1 launch was unsuccessful because of launch vehicle and adapter structural failure.
Feb. 21, 1961	MA-2 launch was successful.
April 25, 1961	MA-3 launch was unsuccessful because of launch vehicle failure to assume proper trajectory.
Sept. 13, 1961	MA-4 launch was successful; Atlas declared safe for manned launch.
Nov. 29, 1961	MA-5 launch was successful with chimpanzee aboard.
Feb. 20, 1962	MA-6 launch was successful; first manned flight using Atlas launch vehicle.
May 24, 1962	MA-7 launch was successful.
Oct. 3, 1962	MA-8 launch was successful.
May 15, 1963	MA-9 launch was successful.
1965-1966	Funds were spent to modify the Atlas; by stretching out the vehicle's tanks its propellant capacity was increased; work was accomplished by Convair.
Oct. 26, 1966	First launch of stretched-out Atlas with Centaur upper stage (R&D launch) was successful.

Table 1-37.
Atlas-Able Characteristics

	1st stage (Atlas)	2d stage	3d stage	4th stage (w/payload)	Total
<i>Height (m):</i>	21.9	5.3	1.9	0.7	29.8
<i>Diameter (m):</i>	3				
<i>Launch weight (kg):</i>	117 780	2265	390	154	120 589
<i>Propulsion system</i>					
<i>Stages:</i>					4
<i>Powerplant:</i>	MA-5 propulsion system	AJ10-101	Altair X-248	injection rocket	
<i>Thrust (newtons):</i>	1 601 280	33 360	13 344	1930	1 649 914
<i>Propellant:</i>	LOX/RP-1	WFNA/UDMH	Solid	hydrazine	
<i>Payload capacity:</i>	680 kg to 555 km earth orbit 227 kg to lunar impact 136 kg to escape trajectory for interplanetary mission				
<i>Origin:</i>	Able stages derived from the Vanguard launch vehicle.				
<i>Contractors:</i>	Space Technology Laboratories, Able assembly, instrumentation, checkout, and Pioneer payload (4th stage) Consolidated Vultee Aircraft Corp. (Convair/General Dynamics), Atlas Rocketdyne Div., North American Aviation, Inc., Atlas engines Aerojet-General, 2d-stage engine Alleghany Ballistics Laboratory, Hercules Powder Co., 3d stage engine				
<i>How utilized:</i>	Pioneer lunar probe (with Atlas booster stage).				
<i>Remarks:</i>	Failed due to upper stage malfunctions in all three attempts to launch the Pioneer lunar probe; retired in 1960.				
<i>See also:</i>	First configuration in which the Atlas was mated with an upper stage. Atlas D/Atlas SLV-3, Thor-Able, and Vanguard.				

Table 1-38.
Chronology of Atlas-Able Development and Operations

Date	Event
1955	Aerojet-General received an Air Force contract to design and produce a second-stage propulsion system for Vanguard derived from the Aerobee-Hi sounding rocket engine.
Dec. 6, 1957	First Vanguard test vehicle launch with live second stage (TV-3); vehicle exploded due to first stage malfunction.
Late 1957	Air Force requested Aerojet-General to modify stage for use in ICBM nose cone reentry tests. Two months later the first Able upper stage was delivered. It was used with the Thor booster as the Thor-Able RTV (reentry test vehicle).
March 17, 1958	First successful Vanguard launch; second stage performed as expected. Vanguard was used through 1959.
March 27, 1958	NACA directed the Air Force Ballistic Missile Division to proceed with the procurement of two Able probes, Able 3 and 4.
April 23, 1958	First Thor-Able RTV launch.
Aug. 17, 1958	Thor-Able 1 exploded due to first stage malfunction.
Fall 1958	Atlas-Able combination suggested to NASA by Abe Silverstein, director, Office of Space Flight Development, to launch small probes to the moon.
Nov. 1958	Work was begun on Atlas-Able probe project under agreement between NASA and Air Force Ballistic Missile Division. Space Technology Laboratories began constructing Able 3 and 4.
Sept. 24, 1959	Atlas-Able vehicle exploded on pad during ground tests.
Nov. 26, 1959	Unsuccessful launch of Pioneer lunar probe with Atlas-Able.
Sept. 25, 1960	Second unsuccessful launch of Pioneer lunar probe with Atlas-Able.
Dec. 15, 1960	Third unsuccessful launch of Pioneer lunar probe with Atlas-Able. Atlas-Able vehicle retired without a successful launch.

Table 1-39.
Atlas-Agena A Characteristics

	1st stage (Atlas)	2d stage (Agena A)	Total (w/adaptor)
<i>Height (m):</i>	21.9	5.9	29
<i>Diameter (m):</i>	3	1.5	
<i>Launch weight (kg):</i>	117 780	3851	121 631
<i>Propulsion system</i>			
<i>Stages:</i>			2
<i>Powerplant:</i>	MA-5 propulsion system	Bell XLR-81 (model 8001; upgraded to model 8048)	
<i>Thrust (newtons):</i>	1 601 280	67 610	1 668 890
<i>Propellant:</i>	LOX/RP-1	IRFNA/UDMH	
<i>Payload capacity:</i>	2265 kg to 555 km earth orbit		
<i>Origin:</i>	Derived from the proposed Atlas-Hustler, a configuration proposed to the Air Force in the late 1950s.		
<i>Contractors:</i>	Consolidated Vultee Aircraft Corp. (Convair/General Dynamics), Atlas Rocketdyne Div., North American Aviation, Inc., Atlas engines Lockheed Missiles and Space Co., Agena Bell Aerospace, Textron, 2d-stage engine		
<i>How utilized:</i>	Proposed for launching unmanned satellites into earth orbit.		
<i>Remarks:</i>	Tailor-made to requirements for each mission. Because the improved Agena B became available, the Agena A was never used by NASA. The Bell engine was also called the "Hustler"; the first model used JP4 fuel, the second IRNA/UDMH.		
<i>See also:</i>	Atlas D/Atlas SLV-3, Atlas-Agena B, and Atlas-Agena D.		

Table 1-40.
Atlas-Agena B Characteristics

	1st stage (Atlas)	2d stage (Agena B)	Total (w/adaptor)
<i>Height (m):</i>	21.9	7.2	30.6
<i>Diameter (m):</i>	3	1.5	
<i>Launch weight (kg):</i>	117 780	7022	124 802
<i>Propulsion system</i>			
<i>Stages:</i>			2
<i>Powerplant:</i>	MA-5 propulsion system	Bell XLR-81-Ba-9 (model 8081; upgraded to 8096)	
<i>Thrust (newtons):</i>	1 601 280	71 168	1 672 448
<i>Propellant:</i>	LOX/RP-1	IRFNA/UDMH	
<i>Payload capacity:</i>	2627 kg to 555 km earth orbit 340 kg to escape trajectory 204 kg to Mars or Venus		
<i>Origin:</i>	Up-rated Atlas-Agena A.		
<i>Contractors:</i>	Consolidated Vultee Aircraft Corp. (Convair/General Dynamics), Atlas Rocketdyne Div., North American Aviation, Inc., Atlas engines Lockheed Missiles and Space Co., Agena Bell Aerospace, Textron, 2d-stage engine		
<i>How utilized:</i>	To launch the Mariner and Ranger series and two OGO satellites.		
<i>Remarks:</i>	Capable of engine restart.		
<i>See also:</i>	Atlas D/Atlas SLV-3, Atlas-Agena A, Thor-Agena B, Atlas-Agena D, and Thrust-Augmented Thor-Agena B and D.		

Table 1-41.
Atlas-Agena D Characteristics

	1st stage (Atlas)	2d stage (Agena D)	Total (w/adaptor)
<i>Height (m):</i>	21.9 23.2 (SLV-3C)	7.2	30.6 32.1 (w/SLV-3C)
<i>Diameter (m):</i>	3	1.5	
<i>Launch weight (kg):</i>	117 780 128 879 (SLV-3C)	7248	125 028 136 127 (w/SLV-3C)
<i>Propulsion system</i>			
<i>Stages:</i>			2
<i>Powerplant:</i>	MA-5 propulsion system	Bell XLR-81-Ba-9 (model 8247)	
<i>Thrust (newtons):</i>	1 601 280 1 752 512 (SLV-3C)	71 168	1 672 448 1 823 680 (w/SLV-3C)
<i>Propellant:</i>	LOX/RP-1	N ₂ O ₄ /UDMH	
<i>Payload capacity:</i>	2718 kg to 555 km earth orbit 385 kg to escape trajectory 250 kg to Mars or Venus		
<i>Origin:</i>	Up-rated Atlas-Agena B.		
<i>Contractors:</i>	Consolidated Vultee Aircraft Corp. (Convair/General Dynamics), Atlas Rocketdyne Div., North American Aviation, Inc., Atlas engines Lockheed Missiles and Space Co., Agena Bell Aerospace, Textron, 2d-stage engine		
<i>How utilized:</i>	Target vehicle for Project Gemini, 1966. To launch Mariner, OAO, Lunar Orbiter, and ATS unmanned payloads.		
<i>Remarks:</i>	The Agena D model could accept a greater variety of payloads than could the B model.		
<i>See also:</i>	Work was underway in 1967 for an up-rated Agena D Bell engine, model 8533. Atlas D/Atlas SLV-3, Atlas SLV-3C, Atlas-Agena A, Atlas-Agena B, and Thrust- Augmented Thor-Agena B and D.		

Table 1-42.
Listing of Agena B and D Stages

Vehicle Serial #	Date of Launch	B or D Model	Mission	Agena Stage Successful*
6001	Aug. 23, 1961	B	Ranger 1 (Atlas-Agena)	No (failed to restart)
6002	Nov. 18, 1961	B	Ranger 2 (Atlas-Agena)	No (attitude control system failed)
6003	Jan. 26, 1962	B	Ranger 3 (Atlas-Agena)	Yes
6004	Apr. 23, 1962	B	Ranger 4 (Atlas-Agena)	Yes
6005	Oct. 18, 1962	B	Ranger 5 (Atlas-Agena)	Yes
6006	Feb. 17, 1965	B	Ranger 8 (Atlas-Agena)	Yes
6007	March 21, 1965	B	Ranger 9 (Atlas-Agena)	Yes
6008	Jan. 30, 1964	B	Ranger 6 (Atlas-Agena)	Yes
6009	July 28, 1964	B	Ranger 7 (Atlas-Agena)	Yes
6101	Sept. 28, 1962	B	Alouette 1 (Thor-Agena)	Yes
6102	Nov. 28, 1965	B	Explorer 31 and Alouette 2 (Thor-Agena)	Yes
6201	Aug. 28, 1964	B	Nimbus 1 (Thor-Agena)	Yes
6202	May 14, 1966	B	Nimbus 2 (Thor-Agena)	Yes
6301	Jan. 25, 1964	B	Echo 2 (Thor-Agena)	Yes
6501	Sept. 5, 1964	B	OGO 1 (Atlas-Agena)	Yes
6502	Oct. 14, 1965	D	OGO 2 (Thor-Agena)	Yes
6901	July 22, 1962	B	Mariner 1 (Atlas-Agena)	N/A (Atlas stage failed)
6902	Aug. 27, 1962	B	Mariner 2 (Atlas-Agena)	Yes
AD71/5001	Nov. 11, 1966	D	GATV 5001, Gemini 12 (Atlas-Agena)	Yes
AD82/5002	Oct. 25, 1965	D	GATV 5002, Gemini 6A	No (probable hard start)
AD108/5003	March 16, 1966	D	GATV 5003, Gemini 8 (Atlas- Agena)	Yes
AD109/5004	May 17, 1966	D	GATV 5004, Gemini 9A (Atlas-Agena)	N/A (Atlas stage failed)
AD129/5005	July 18, 1966	D	GATV 5005, Gemini 10 (Atlas-Agena)	Yes
AD130/5006	Sept. 12, 1966	D	GATV 5006, Gemini 11 (Atlas-Agena)	Yes
AD136/6151	Dec. 6, 1966	D	ATS 1 (Atlas-Agena)	Yes
AD137/6152	Apr. 5, 1967	D	ATS 2 (Atlas-Agena)	No (failed to restart)
AD140/6153	Nov. 5, 1967	D	ATS 3 (Atlas-Agena)	Yes
AD165/6221	May 18, 1968	D	Nimbus B (Thor-Agena)	N/A (Thor stage failed)
AD123/6311	June 23, 1966	D	PAEGOS 1 (Thor-Agena)	Yes
AD171/6503	March 4, 1968	D	OGO 5 (Atlas-Agena)	Yes

Table 1-42.
Listing of Agena B and D Stages (Continued)

Vehicle Serial #	Date of Launch	B or D Model	Mission	Agena Stage Successful*
AD121/6630	Sept. 12, 1966	D	Lunar Orbiter 1 (Atlas-Agena)	Yes
AD122/6631	Nov. 6, 1966	D	Lunar Orbiter 2 (Atlas-Agena)	Yes
AD128/6632	Feb. 4, 1967	D	Lunar Orbiter 3 (Atlas-Agena)	Yes
AD131/6633	May 4, 1967	D	Lunar Orbiter 4 (Atlas-Agena)	Yes
AD159/6634	Aug. 1, 1967	D	Lunar Orbiter 5 (Atlas-Agena)	Yes
AD99/6703	Apr. 8, 1966	D	OAD 1 (Atlas-Agena)	Yes
AD74/6801	June 6, 1966	B	OGO 3 (Atlas-Agena)	Yes
AD133/6802	July 28, 1967	D	OGO 4 (Thor-Agena)	Yes
AD68/6931	Nov. 5, 1964	D	Mariner 3 (Atlas-Agena)	Yes
AD69/6932	Nov. 28, 1964	D	Mariner 4 (Atlas-Agena)	Yes
AD157/6933	June 14, 1967	D	Mariner 5 (Atlas-Agena)	Yes

*4 failures out of 38 attempts (89% successful).

Table 1-43.
Chronology of Agena Development and Operations

Date	Event
Oct. 1956	Development began at Lockheed under contract to the Air Force Ballistic Missile Division to develop an advanced military satellite system (WS 117L) and its associated upper stage vehicle, which would be capable of in-orbit propulsion and control. The upper stage was called Hustler after its Bell engine, and later renamed Agena. The Hustler engine had been under Bell Aerospace's purview since 1956. It was designed to provide 66 720 newtons of thrust for an air-to-surface missile which would be carried by a B-58 bomber. When requirements for the missile were dropped, the engine was transferred to the Agena project.
1957	The Air Force Ballistic Missile Division contracted with Lockheed for the Agena.
Jan. 1959	NASA had plans for using Agena with Thor and Atlas boosters.
Feb. 28, 1959	First Air Force launch of an Agena with a Thor first stage. Used by the Air Force to launch the Discoverer satellite series from Feb. 28, 1959 through Sept. 13, 1960.
April 24, 1959	Air Force issued a contract amendment to Lockheed for the development of an advanced Agena, to be known as Agena B.
Dec. 11, 1959	NASA's Vega launch vehicle program was cancelled in favor of the Air Force Atlas-Agena B. An Agena B Coordinating Board was established to assist the Air Force and NASA in coordinating the development and utilization of the new Agena.
Early 1960	NASA's Marshall Space Flight Center, Huntsville, AL, was given authority to supervise procurement of Agena B vehicles for NASA from the Air Force Ballistic Missile Division, who would acquire them directly from Lockheed.
April 1960	Agreement was reached between NASA and Lockheed for the purchase of 16 Agena B vehicles over the next three years.

Table 1-43.
Chronology of Agena Development and Operations (Continued)

Date	Event
May 1960	First successful launch of Atlas-Agena A, carrying the Midas 2 satellite.
Oct. 26, 1960	Unsuccessful launch of Air Force Thor-Agena B with Discoverer satellite; failure due to stage separation malfunction.
Nov. 12, 1960	First Air Force launch of Agena B on an Atlas booster.
1961	Atlas-Agena A discontinued by the Air Force in favor of follow-on Atlas-Agena B.
Feb. 1961	Agreement signed between NASA and Air Force regarding procurement of Agena B vehicles.
Aug. 23, 1961	NASA's first launch of Atlas-Agena B with <i>Ranger 1</i> , a lunar probe, as the payload. The Agena stage failed to restart, and the probe was injected into low earth orbit.
1961-1966	Atlas-Agena B combination used to launch <i>Ranger 1</i> through <i>9</i> , with <i>Ranger 4</i> being the first mission during which the two-stage launch vehicle performed satisfactorily. Atlas-Agena B was also used with <i>Mariner 1</i> and <i>2</i> and <i>OGO 1</i> and <i>3</i> , with the last launch of an Agena B taking place on June 6, 1966. (NASA used a total of 18 Agena B stages; 5 of these were used with the Thor booster.)
May 29, 1962	NASA memorandum of agreement was issued stating that the adoption of an improved Agena model, the Agena D, was desirable.
June 1962	Air Force successfully flight tested the Agena D.
Dec. 12, 1962	Atlas-Agena program authority transferred from Marshall Space Flight Center to Lewis Research Center, Cleveland.
Sept. 1963	New agreement between Air Force and NASA was reached regarding procurement of Agena vehicles and cooperation between the two organizations.
1964-1968	From Nov. 5, 1964 through 1968, Atlas-Agena D was used 20 times to launch 6 Project Gemini targets, <i>PAEGOS 1</i> , <i>Mariner 3</i> through <i>5</i> , <i>Lunar Orbiter 1</i> through <i>5</i> , <i>ATS 1</i> through <i>3</i> , and <i>OGO 5</i> . The March 4, 1968 launch of <i>OGO 5</i> utilized the stretched-out Atlas SLV-3C. (NASA also used the Thor-Agena D configuration four times in 1965-1968.)

Table 1-44.
Atlas-Antares Characteristics

	1st stage (Atlas)	2d stage (Antares)	Total (w/adaptor)
<i>Height (m):</i>	21.9	2.9	25.6
<i>Diameter (m):</i>	3	0.7	
<i>Launch weight (kg):</i>	117 780	1258	122 310
<i>Propulsion system</i>			
<i>Stages:</i>			
<i>Powerplant:</i>	MA-5 propulsion system	ABL X-259	2.5
<i>Thrust (newtons):</i>	1 601 280	106 752	1 708 032
<i>Propellant:</i>	LOX/RP-1	solid	
<i>Payload capacity:</i>	90 kg on a 9260 km ballistic trajectory		
<i>Origin:</i>	The Antares upper stage was a modified Antares solid motor from the 3d stage of the Scout launch vehicle.		
<i>Contractors:</i>	Consolidated Vultee Aircraft Corp. (Convair/General Dynamics), Atlas Rocketdyne Div., North American Aviation, Inc., Atlas engines Alleghany Ballistics Laboratory, Hercules Powder Co., 2d stage		
<i>How utilized:</i>	Project FIRE (Flight Investigation Reentry Environment).		
<i>Remarks:</i>	Special test launch vehicle used to obtain direct measurements of reentry heating at a speed in excess of 40 225 kilometers per hour to simulate lunar spacecraft and interplanetary probe reentry.		
<i>See also:</i>	Atlas D/Atlas SLV-3 and Scout.		

Table 1-45.
Chronology of Atlas-Antares Operations

Date	Event
April 14, 1964	Launch of <i>FIRE 1</i> (Flight Investigation Reentry Environment) was successful.
May 22, 1965	Launch of <i>FIRE 2</i> was successful.

Table 1-46.
Atlas-Centaur Characteristics

<i>Height (m):</i>	23.2	13	34
		14.6 w/payload fairing	
<i>Diameter (m):</i>	3	3	
<i>Launch weight (kg):</i>	128 879	17 145	146 024
<i>Propulsion system</i>			
<i>Stages:</i>			2.5
<i>Powerplant:</i>	MA-5	2 RL-10s	
	propulsion system		
<i>Thrust (newtons):</i>	1 752 512	66 720 × 2 = 133 440	1 885 952
<i>Propellant:</i>	LOX/RP-1	LOX/LH ₂	
<i>Payload capacity:</i>	3857 kg to 555 km earth orbit		
	1225 kg to escape trajectory		
	815 kg to Venus or Mars		
<i>Origin:</i>	General Dynamics studies for a high-energy second stage.		
<i>Contractors:</i>	Consolidated Vultee Aircraft Corp. (Convair/General Dynamics), Atlas Rocketdyne Div., North American Aviation, Inc., Atlas engines General Dynamics, Centaur Pratt & Whitney, 2d-stage engines		
<i>How utilized:</i>	Originally planned to boost 1962-1965-era Mars and Venus spacecraft, but due to development problems with Centaur it was not used until 1966 to launch the Surveyor lunar probe series (1966-1968) and other scientific satellites.		
<i>Remarks:</i>	First American launch vehicle to utilize liquid hydrogen as a propellant. One of the serious problems with the vehicle's development was hydrogen loss; heat transfer between the oxygen and hydrogen fuel tanks caused the liquid hydrogen to evaporate. Early R&D launches used the standard Atlas; the stretched-out Atlas was first used on Oct. 26, 1966 with AC-9.		
<i>See also:</i>	Atlas D/Atlas SLV-3 and Atlas SLV-3C.		

Table 1-47.
Listing of Centaur Vehicles

Vehicle Serial #	Date	Mission	Centaur Stage Successful*
F-1	May 8, 1962	R&D launch	No (fairing malfunction)
AC-2	Nov. 27, 1963	R&D launch	Yes
AC-3	June 30, 1964	R&D launch	No (premature engine shutdown)
AC-4	Dec. 11, 1964	R&D launch	Yes
AC-5	March 2, 1965	R&D launch	No trial (Atlas stage shut down prematurely)
AC-6	Aug. 11, 1965	R&D launch	Yes
AC-7	Sept. 20, 1966	Surveyor 2	Yes
AC-8	April 7, 1966	R&D launch	No (failed 2d burn)
AC-9	Oct. 26, 1966	R&D launch	Yes
AC-10	May 30, 1966	Surveyor 1	Yes
AC-11	July 14, 1967	Surveyor 4	Yes
AC-12	April 17, 1967	Surveyor 3	Yes
AC-13	Sept. 8, 1967	Surveyor 5	Yes
AC-14	Nov. 7, 1967	Surveyor 6	Yes
AC-15	Jan. 7, 1968	Surveyor 7	Yes
AC-16	Dec. 7, 1968	OAO 2	Yes
AC-17	Aug. 10, 1968	ATS 4	No (failure to ignite)

*4 failures out of 16 attempts (75% successful).

Table 1-48.
Chronology of Atlas-Centaur Development and Operations

Date	Event
1956	Convair/General Dynamics began to study high-energy second stages that could be used with the Atlas booster.
Oct. 1957	Studies for a Centaur prototype were completed; General Dynamics began discussions with the Advanced Research Projects Agency (ARPA).
Aug. 28, 1958	ARPA requested the Air Force Research and Development Command to oversee a contract with General Dynamics for the development of an upper stage for Atlas to be propelled by liquid oxygen and liquid hydrogen (contract executed on Nov. 14). Pratt & Whitney received a contract for the stage's engine development.
July 1, 1959	Responsibility for Centaur was transferred to NASA.
July 1960	NASA proposed to utilize Centaur, which was being managed by the new Marshall Space Flight Center, for 1962 Venus and Mars missions.
Jan. 1961	The Centaur launch schedule was revised due to problems with engine development; first mission rescheduled for 1964.
Oct. 30, 1961	First flight vehicle shipped to Cape Canaveral by General Dynamics.
May 8, 1962	First Atlas-Centaur test launch (AC-1) was unsuccessful due to Centaur fairing failure. Launch schedule revised again with first mission set for 1965.
Sept. 1962	Marshall recommended cancelling Centaur; management responsibility for Centaur was transferred to Lewis Research Center, Cleveland.
Nov. 27, 1963	AC-2 R&D launch was successful.
June 30, 1964	AC-3 R&D launch achieved majority of objectives, but experienced premature Centaur engine shutdown.
Dec. 11, 1964	AC-4 R&D launch with model of Surveyor lunar probe was successful, but secondary two-burn inflight experiment was not completed.
March 2, 1965	AC-5 R&D launch was unsuccessful due to premature shutdown of Atlas stage.
Mid-1965	Centaur declared operational.
Aug. 11, 1965	AC-6 R&D launch with new propellant utilization system was successful (simulated Surveyor launch).
April 7, 1966	AC-8 R&D launch was unsuccessful; the dummy payload was not put into the planned parking orbit.
May 30, 1966	Launch of <i>Surveyor 1</i> lunar probe was successful.
Sept. 20, 1966	Launch of <i>Surveyor 2</i> lunar probe was successful.
Oct. 26, 1966	AC-9 R&D launch with stretched-out Atlas SLV-3C was successful.
Dec. 1966	NASA decided to launch OAO and ATS satellites with Atlas-Centaur rather than Atlas-Agena D.
April 17, 1967- Dec. 7, 1968	Atlas-Centaur successfully launched <i>Surveyor 3</i> through <i>7</i> and <i>OAO 2</i> . The attempt to launch <i>ATS 4</i> on Aug. 10, 1968 failed when Centaur ignition did not occur and the spacecraft and second stage did not separate.

Table 1-49.
Proposed Atlas-Vega Characteristics

	1st stage (modified Atlas)	2d stage	3d stage (optional)	Total
<i>Height (m):</i>	18.6	4.8	6.4	29.9
<i>Diameter (m):</i>	3	3	3	
<i>Launch weight (kg):</i>	117 910	14 512	2268	134 690
<i>Propulsion system</i>				
<i>Stages:</i>				2.5 or 3.5
<i>Powerplant:</i>	MA-5 propulsion system	GE 405H-2	JPL design	
<i>Thrust (newtons):</i>	1 601 280	155 680	26 688	1 783 648
<i>Propellant:</i>	LOX/RP-1	LOX/RP-1	solid	
<i>Payload capacity:</i>	2177 kg to 555 km earth orbit 476 kg to escape trajectory (with 3d stage) 227 kg to lunar orbit (with 3d stage)			
<i>Origin:</i>	NASA design			
<i>Contractors:</i>	Consolidated Vultee Aircraft Corp. (Convair/General Dynamics), Atlas Rocketdyne Div., North American Aviation, Inc., Atlas engines, Consolidated Vultee Aircraft Corp., (Convair/General Dynamics), Vega General Electric, 2d-stage engine Jet Propulsion Laboratory, 3d-stage engine			
<i>How utilized:</i>	General purpose "interim" launch vehicle to be used for a variety of missions until Atlas-Centaur became operational.			
<i>Remarks:</i>	Dropped in favor of DoD-sponsored Atlas-Agena B.			
<i>See also:</i>	Atlas D/Atlas SLV-3.			

Table 1-50.
Chronology of Atlas-Vega Development

Date	Event
Fall 1958	Vega design was conceived by NASA engineers as an interim upper stage to be used with Atlas booster for a variety of unmanned and manned missions until Atlas-Centaur was available.
Dec. 15, 1958	Atlas-Vega design was proposed by NASA in an interagency meeting on U.S. launch vehicles; it was described as a three-stage vehicle with a thrust of nearly two million newtons.
Jan. 30, 1959	Funds were made available to the Jet Propulsion Laboratory for third stage development.
March 18, 1959	Convair, General Dynamics Corp., was awarded the prime contract for Atlas-Vega development and production.
March 18, 1959	General Electric Co. was awarded a contract for the second stage engine.
April 4, 1959	Launch schedule plan was adopted for Vega, with the first flight set for Aug. 1960.
Oct. 13, 1959	Civilian-Military Liaison Committee recommended that the Vega stage be dropped in favor of the DoD-sponsored Agena B.
Dec. 11, 1959	Vega was cancelled in favor of Agena B, which had a similar payload capacity and development schedule.

Juno I and II

NASA adopted the Juno I and Juno II military vehicles to launch its early Explorer satellites and probes. Juno I, made from a modified Jupiter C, successfully launched the first American satellite, *Explorer 1*, for the Army in 1957. Juno I was transferred to NASA shortly after the civilian agency was established and was used only once unsuccessfully before it was replaced by Juno II. An extended Jupiter intermediate ballistic missile served as Juno II's booster stage. NASA used Juno II in 1958-1961 with poor results: only 3 successful missions in 10 attempts. NASA's own Scout launch vehicle replaced Juno as the primary launcher for the Explorer series.⁷

Table 1-51.
Juno I Characteristics

	1st stage (modified Redstone)	2d stage	3d stage	4th stage (w/payload)	Total
<i>Height (m):</i>	17.1	approx. 1.2	approx. 1.2	approx. 1.5	21
<i>Diameter (m):</i>	1.8				
<i>Launch weight (kg):</i>	28 828	575	244	varied with payload	approx. 30 000
<i>Propulsion system</i>					
<i>Stages:</i>					4
<i>Powerplant:</i>	Rocketdyne A-7	11 scaled-down Sergeants, clustered	3 scaled-down Sergeants, clustered	1 scaled-down Sergeant	
<i>Thrust (newtons):</i>	369 184	73 392	24 019	8006	474 601
<i>Propellant:</i>	LOX/ hydrazine	solid	solid	solid	
<i>Payload capacity:</i>	18 kg to 555 km earth orbit				
<i>Origin:</i>	Developed by the Army Ballistic Missile Agency and the Jet Propulsion Laboratory.				
<i>Contractors:</i>	Chrysler, prime Rocketdyne Div., North American Aviation, Inc., 1st-stage engine Jet Propulsion Laboratory, upper-stage engines				
<i>How utilized:</i>	To launch early Explorer satellites.				
<i>Remarks:</i>	Juno I is sometimes incorrectly referred to as Jupiter C, which was a three-stage launch vehicle used by the Army for reentry nose cone tests. Juno I is an adaptation of Jupiter C.				
<i>See also:</i>	Mercury-Redstone and Juno II.				

Table 1-52.
Chronology of Juno I Development and Operations

Date	Event
Sept. 20, 1956	The Army conducted the first long-range firing of Jupiter C, a three-stage vehicle (Redstone, plus two solid-fuel upper stages). Jupiter C was used for missile nose cone reentry tests by the Army.
Nov. 8, 1957	The Army was directed to launch a scientific satellite for the International Geophysical Year with a modified Jupiter C with an added fourth stage, a single Sergeant motor. This launch vehicle became known as Juno.
Jan. 31, 1958	Launch of <i>Explorer 1</i> , the first American satellite, by the Army Ballistic Missile Agency was successful.
March 5, 1958	Launch of <i>Explorer 2</i> was unsuccessful due to fourth-stage malfunction.
March 26, 1958	Launch of <i>Explorer 3</i> was successful.
July 26, 1958	Launch of <i>Explorer 4</i> was successful.
Aug. 24, 1958	Launch of <i>Explorer 5</i> was unsuccessful; satellite failed to achieve orbit.
Oct. 21, 1958	Juno was transferred to NASA.
Oct. 22, 1958	Launch of <i>Beacon 1</i> , a suborbital atmospheric physics test developed by Langley Research Center, was unsuccessful due to premature upper stage separation.

Table 1-53.
Juno II Characteristics

	1st stage (extended Jupiter)	2d stage	3d stage	4th stage (w/payload)	Total
<i>Height (m):</i>	19.6	approx. 1.2	approx. 1.2	approx. 1.5	23.5
<i>Diameter (m):</i>	2.7				
<i>Launch weight (kg):</i>	49 000	575	244	varied	50 111
<i>Propulsion system</i>					
<i>Stages:</i>					4
<i>Powerplant:</i>	Rocketdyne 5-30	11 scaled-down Sergeants, clustered	3 scaled-down Sergeants, clustered	1 scaled-down Sergeant	
<i>Thrust (newtons):</i>	667 200	66 720	17 792	7117	758 829
<i>Propellant:</i>	LOX/ RP-1	solid	solid	solid	
<i>Payload capacity:</i>	45 kg to 555 km earth orbit 20 kg to escape trajectory				
<i>Origin:</i>	Upgraded Juno I, which was developed by the Army.				
<i>Contractors:</i>	Chrysler, prime Rocketdyne Div., North American Aviation, Inc., 1st-stage engine Jet Propulsion Laboratory, upper-stage engines				
<i>How utilized:</i>	To launch Explorer scientific satellites.				
<i>Remarks:</i>	Jupiter IRBM propellant capacity was increased by extending the booster section and fuel tanks by 0.9 meter.				
<i>See also:</i>	Juno I.				

Table 1-54.
Chronology of Juno II Development and Operations

Date	Event
1955	Work began on the Jupiter intermediate range ballistic missile by the Army Ballistic Missile Agency.
March 1957	First Jupiter IRBM flight tests.
Sept. 1958	Chrysler delivered first flight qualification missile to Army Ballistic Missile Agency. Jupiter was named as the new booster stage for the Juno launch vehicle, which was redesignated Juno II.
Oct. 21, 1958	NASA adopted the Juno II vehicle.
Dec. 6, 1958	Launch of <i>Pioneer 3</i> lunar probe was unsuccessful due to several launch vehicle malfunctions that prevented the spacecraft from escaping earth orbit.
March 3, 1959	Launch of <i>Pioneer 4</i> was unsuccessful; the probe was put into heliocentric rather than lunar orbit when the second stage fired too long.
July 16, 1959	Launch of Explorer probe was unsuccessful; the vehicle was destroyed shortly after launch when it deviated sharply from its course.
Aug. 14, 1959	Launch of <i>Beacon 2</i> was unsuccessful due to booster and attitude control system malfunctions.
Oct. 13, 1959	Launch of <i>Explorer 7</i> was successful.
March 23, 1960	Launch of Explorer probe was unsuccessful due to upper stage malfunction.
Aug. 1960	Marshall Space Flight Center assumed overall responsibility for Juno II; prior to this time JPL had shared the authority with Marshall.
Nov. 3, 1960	Launch of <i>Explorer 8</i> was successful.
Feb. 24, 1961	Launch of Explorer probe was unsuccessful; the probe did not achieve proper orbit.
April 27, 1961	Launch of <i>Explorer 11</i> was successful.
May 24, 1961	Launch of Explorer probe was unsuccessful due to second-stage failure.

Little Joe I and Little Joe II

NASA engineers designed Little Joe I and Little Joe II to serve as test vehicles for two manned spacecraft projects. The two vehicles are not related, but were both used to verify spacecraft abort systems and to simulate other mission phases.

Little Joe I, the airframes for which were manufactured by North American Aviation, was first put on the launch pad at Wallops Island in August 1959 with a boilerplate model of the Mercury capsule. In the event of a malfunctioning Redstone or Atlas booster, Mercury astronauts would need an escape system. With Little Joe I, this system was verified under a variety of conditions. Two of the eight payloads carried biological payloads, as well. The last test took place in April 1961. For more information see table 2-29.

Little Joe II served the Apollo program. Built by Convair/General Dynamics, Little Joe II demonstrated the Apollo abort system at transonic, high-altitude, and intermediate-altitude phases of launch. Four Apollo boilerplate models were launched by the test vehicle in 1964-1966 at White Sands. (For more information see table 2-51).⁸

Table 1-55.
Little Joe I Characteristics

<i>Height (m):</i>	16.8
<i>Diameter (m):</i>	2
<i>Launch weight (kg):</i>	18 140
<i>Propulsion system</i>	
<i>Stages:</i>	1
<i>Powerplant:</i>	4 Thiokol Castors + 4 Thiokol Recruits
<i>Thrust (newtons):</i>	1 023 040
<i>Propellant:</i>	solid
<i>Payload capacity:</i>	1814 kg on a 160 km ballistic path
<i>Origin:</i>	NASA design
<i>Contractors:</i>	North American Aviation, prime Thiokol Chemical Corp., propulsion system
<i>How utilized:</i>	Project Mercury manned capsule qualification tests (matched altitude that could be reached with the Mercury-Redstone). Capsule escape system was tested at maximum dynamic pressure; parachute system was qualified; search and retrieval methods were verified.
<i>Remarks:</i>	Designed exclusively for Project Mercury tests.

Table 1-56.
Chronology of Little Joe I Development and Operations

Date	Event
Aug. 1958	NACA's Langley Research Center Pilotless Aircraft Research Division was requested to prepare specifications for a vehicle capable of launching full-scale and full-weight manned spacecraft for tests to a maximum altitude of 160 kilometers.
Nov. 1958	Twelve companies responded to NASA's invitation for bids to construct Little Joe airframes.
Dec. 29, 1958	North American Aviation was assigned the prime contract.
Aug. 21, 1959	Thirty minutes before the first Little Joe scheduled launch (LJ-1), the rocket fired prematurely. Capsule and tower combination were launched on an off-the-pad abort trajectory.
Sept. 25, 1959	North American completed shipment of the airframes.
Oct. 4, 1959	Little Joe 6 (also called LJ-1) launch was successful with a Mercury boilerplate model.
Nov. 4, 1959	Little Joe 1A (also called LJ-2) launch was successful with a Mercury boilerplate model.
Dec. 4, 1959	Little Joe 2 (also called LJ-3) launch was successful with a Mercury boilerplate model and a biological payload (a rhesus monkey).
Jan. 21, 1960	Little Joe 1B (also called LJ-4) launch was successful with a Mercury boilerplate model and a biological payload (a rhesus monkey).
Nov. 8, 1960	Little Joe 5 launch with Mercury production capsule was unsuccessful; escape rocket and tower jettison rocket ignited prematurely; booster, capsule, and tower did not separate.
March 18, 1961	Little Joe 5A (also called LJ-6) launch with a production capsule was a partial success; the escape rocket fired prematurely.
April 28, 1961	Little Joe 5B (also called LJ-7) launch with a production capsule was successful; two of the Castor motors carried ballast rather than propellant.

Table 1-57.
Little Joe II Characteristics

<i>Height (m):</i>	10
<i>Diameter (m):</i>	3.9
<i>Launch weight (kg):</i>	25 924—63 368
<i>Propulsion system</i>	
<i>Stages:</i>	1
<i>Powerplant:</i>	1 Aerojet-General Algot 1D + 6 Thiokol Recruit TE-29s
<i>Thrust (newtons):</i>	459 034 + (148 563 × 6 = 891 379) = 1 350 413
<i>Propellant:</i>	solid
<i>Payload capacity:</i>	12 698 kg to an altitude of 35 km on a ballistic path
<i>Origin:</i>	NASA design
<i>Contractors:</i>	General Dynamics/Convair, prime Aerojet General, propulsion system Thiokol Chemical Corp., propulsion system
<i>How utilized:</i>	Simulations of flight conditions to be experienced during Apollo missions. Structural design and escape system of Apollo command module was tested under maximum aerodynamic conditions.
<i>Remarks:</i>	Completely different design from Mercury's Little Joe I, but used for the same kind of program—testing of a spacecraft abort system and simulation of mission characteristics. First U.S. launch vehicle to utilize a corrugated skin.

Table 1-58.
Chronology of Little Joe II Development and Operations

Date	Event
June 1961	Apollo engineers suggested using a fin-stabilized, clustered-rocket, solid propellant booster for boilerplate flight tests of Apollo.
April 6, 1962	A request for proposals was issued for the production of an Apollo test launch vehicle.
May 11, 1962	Convair/General Dynamics was selected to develop the Little Joe vehicle; a letter contract was awarded.
Feb. 18, 1963	A definitive contract was negotiated with Convair/General Dynamics.
July 16, 1963	Convair delivered the first flight vehicle to the White Sands test facility.
Aug. 28, 1963	The first launch of Little Joe II demonstrated the overall capability of the vehicle for Apollo simulations.
May 13, 1964	Launch of A-001 (Apollo Transonic Abort) with Apollo boilerplate was successful.
Dec. 8, 1964	Launch of A-002 (Apollo Max q Abort) with Apollo boilerplate was successful.
May 19, 1965	Launch of A-003 (Apollo High Altitude Abort) with Apollo boilerplate was unsuccessful. However, the launch escape system took the boilerplate safely away from the malfunctioning launch vehicle, which was what the mission was designed to accomplish.
Jan. 20, 1966	Launch of A-004 (Intermediate Altitude Abort) with Apollo boilerplate was successful.

Mercury-Redstone

Project Mercury, the first step in the NASA manned spaceflight program, was undertaken to prove that one man could safely orbit earth and return to a predetermined point. The Atlas missile was being modified to boost astronauts to orbit, but a less powerful, less expensive vehicle was required for the manned ballistic tests that would precede orbital flight. Two of the Army's missiles became candidates for the role.

In October 1958, days after the space agency was officially opened for business, NASA requested eight Redstone and three Jupiter missiles from the Army for Project Mercury. In the interest of simplifying launch operations, the requirement for Jupiter was soon dropped. Redstone was modified for manned use by Chrysler Corporation, its manufacturer, and was ready for verification tests by late 1960. A chimpanzee was Mercury-Redstone's first passenger. In 1961, two missions were launched successfully with astronauts on board. (For more information see chapter 2 under Mercury.)⁹

Table 1-59.
Mercury-Redstone Characteristics

<i>Height (m):</i>	18 (25.3 w/spacecraft)
<i>Diameter (m):</i>	1.8
<i>Launch weight (kg):</i>	29 931
<i>Propulsion system</i>	
<i>Stages:</i>	1
<i>Powerplant:</i>	Rocketdyne A-7
<i>Thrust (newtons):</i>	346 944
<i>Propellant:</i>	LOX/RP-1
<i>Payload capacity:</i>	1814 kg to an altitude of 189 km on a ballistic path.
<i>Origin:</i>	Army ballistic missile.
<i>Contractors:</i>	Chrysler Corp., prime Rocketdyne Div., North American Aviation, Inc., engine
<i>How utilized:</i>	Project Mercury launch vehicle for ballistic shots.
<i>Remarks:</i>	First large ballistic missile developed by the U.S. Redstone propellant tanks elongated for Mercury.
<i>See also:</i>	Juno I.

Table 1-60.
Chronology of Mercury-Redstone Development and Operations

Date	Event
1950	The Army's Guided Missile Center recommended further development of the proposed Hermes C1 surface-to-surface missile and the North American XLR43-NA-1 engine to meet Department of the Army's requirements for a tactical missile system.
March 27, 1951	Contract was awarded to North American to modify their engine for the missile system.
May 1, 1951	A development program was begun for a new missile.
April 8, 1952	The new missile was assigned the name Redstone.
Oct. 28, 1952	Chrysler was issued a letter contract as prime contractor for Redstone production.
Aug. 20, 1953	First R&D flight test.
June 18, 1958	First operational deployment.
Oct. 6, 1958	Tentative agreement was reached between NASA and the Army Ordnance Missile Command whereby the Army would supply 10 Redstones and 3 Jupiters for NASA's manned program.
Jan. 8, 1959	NASA supplied funds to the Army Ordnance Missile Command for 8 Redstones; the Army Ballistic Missile Agency began production planning of Mercury-Redstone.
Jan. 1960	First Mercury-Redstone static test firing.
July 1, 1960	Authority for the Mercury-Redstone was transferred from the Army Ballistic Missile Agency to Marshall Space Flight Center.
Aug. 3, 1960	Mercury-Redstone 1 arrived at Cape Canaveral.
Nov. 21, 1960	Launch of MR-1 was unsuccessful due to premature booster cutoff.
Dec. 19, 1960	Launch of MR-1A to qualify abort system and spacecraft-launch vehicle combination was successful.
Jan. 31, 1961	Launch of MR-2 with a biological payload (chimpanzee) was successful, but a malfunction caused the engine to operate at a higher thrust level, which caused the capsule to impact beyond the target area.
March 24, 1961	Launch of MR-BD (Booster Development) was successful.
May 5, 1961	Launch of MR-3 with a man aboard was successful.
July 21, 1961	Launch of MR-4 with a man aboard was successful.
June 1964	Redstone missile program was deactivated.

Nova

Nova was proposed by early NASA advanced planners as a "super booster," capable of sending large spacecraft directly to the moon and beyond. Ten powerful F-1 engines would make up its first stage; a nuclear engine was being considered for the third stage. Four major aerospace companies were studying designs for the giant launcher in the early 1960s.

Also under development at this time was the Saturn family of vehicles. Managers at NASA Headquarters and at the Marshall Space Flight Center recognized that the agency could not afford both. In July 1962, NASA chose the lunar rendezvous mode for Apollo, the agency's manned lunar program, over direct ascent, cancelling any immediate need for Nova. Saturn would serve Apollo's needs. Although studies of possible Nova configurations and missions continued for two more years, hardware design and development were never commenced.¹⁰

Table 1-61.
Proposed Nova Characteristics

	1st stage	2d stage	3d stage	Total
<i>Height (m):</i>	35			107-114
<i>Diameter (m):</i>	15-18			
<i>Launch weight (kg):</i>				4 530 000- 5 436 000
<i>Propulsion system:</i>	Several configurations were proposed that would use F-1, M-1, J-2, solid-propellant, or nuclear engines.			
<i>Stages:</i>				3
<i>Powerplant (example A):</i>	8-10 Rocketdyne F-1s	1-2 Aerojet General M-1s	1 Rocketdyne J-2	
<i>Thrust (newtons):</i>	53 376 000- 66 720 000	5 337 600- 10 675 200	889 600	59 603 200- 78 284 800
<i>Powerplant (example B):</i>	10-12 Rocketdyne F-1s	10 Rocketdyne J-2s	or nuclear engine	
<i>Thrust (newtons):</i>	66 720 000- 80 064 000	8 896 000	undefined	undefined
<i>Propellant:</i>	LOX/RP-1	LOX/LH ₂	LOX/LH ₂ or nuclear	
<i>Origin:</i>	NASA design			
<i>Contractors for design study:</i>	General Dynamics, Martin Marietta, Boeing, and Douglas			
<i>How utilized:</i>	Proposed for manned missions to the moon and for planetary flights.			
<i>Remarks:</i>	Operational target for this super-boosters was 1970.			

Table 1-62.
Chronology of Nova Development

Date	Event
Jan. 1959	Nova was officially proposed by NASA to serve as a "super rocket" more powerful than the Saturn; it would utilize a 6 700 000-newton thrust single-chamber engine under development by the Air Force. Nova would be capable of direct ascent to the moon. Rocketdyne was awarded a contract by NASA for F-1 engine development.
Aug. 1959	Launch vehicle managers at NASA Headquarters recognized the possibility of conflicts between Saturn and Nova proponents.
Early 1961	The von Braun team indicated that NASA would be overextended if it pursued development of both Saturn C-2 and Nova.
Aug. 1961	First open test firing of the F-1 engine.
Jan. 24, 1962	NASA awarded a contract for M-1 engine development to Aerojet-General.
March 28, 1962	Marshall Space Flight Center issued a request for proposals for Nova systems definition and preliminary design.
July 1962	General Dynamics and Martin Marietta were chosen for Nova study contracts.
July 11, 1962	NASA endorsed the Saturn C-5 and the lunar rendezvous mode for its first lunar program, thereby cancelling an immediate need for Nova.
Oct. 1, 1962	Martin Marietta was awarded a Nova launch facilities study contract.
1963-1964	Nova studies were continued as part of post-Saturn planning funded by Marshall's Future Projects Office, but no large booster beyond the Saturn class was seriously considered by NASA.

The Saturn Family

Wernher von Braun's earliest proposals to the U.S. Army were for large clustered-engine rockets. With such a vehicle, heavy payloads could be put into orbit or spacecraft could reach the moon. The Advanced Research Projects Agency approved plans for an Army Ballistic Missile Agency clustered-engine booster in August 1958. Von Braun's multistage vehicle was called Juno.

The first contracts let for Juno were to the engine maker. Rocketdyne (later a division of North American Aviation) set to work uprating its Thor-Jupiter engine (H-1) and developing an even larger powerplant, the F-1 (also being considered for the proposed Nova vehicle). In November 1959, NASA assumed management responsibility for the large booster program, which had been redesignated Saturn. The agency soon recommended that long-range development include a family of Saturn launch vehicles. By the summer of 1962, Saturn had a firm assignment: it would boost Apollo astronauts to the moon.

The first member of the family was the two-stage Saturn I (originally called Saturn C-1). Powered by engines made at Rocketdyne and Pratt & Whitney, both stages were flight tested in a 1964 launch. Five Apollo boilerplate models were launched by Saturn I in 1964-1965 as a step toward qualifying the spacecraft for manned flight.

Saturn IB (also called C-1B and Uprated Saturn) was a step closer to the vehicle required for lunar missions. Used to perform the earth-orbital phase of Apollo, it depended on nine Rocketdyne engines in its two stages. Saturn IB helped qualify the Apollo spacecraft three times in 1966 and 1968. On October 11, 1968, it boosted *Apollo 7* with a crew of three astronauts into orbit.

Plans for Saturn V (also called Saturn C-5), NASA's largest launch vehicle, were officially approved in January 1962. Powered by 11 Rocketdyne engines, its first launch took place in 1967. Saturn V's three stages sent an Apollo spacecraft to lunar orbit for the first time in December 1968 (*Apollo 8*). This reliable vehicle would be used in the next decade of NASA's operations for lunar exploration and Apollo applications (Skylab) missions.

The Marshall Space Flight Center oversaw the work of many Saturn contractors. The major ones were Rocketdyne Division of North American Aviation (Saturn I first-stage propulsion, Saturn IB first- and second-stage propulsion, and Saturn V first-, second-, and third-stage propulsion, plus Saturn V second-stage airframe), Chrysler Corporation (Saturn I first-stage airframe, Saturn IB first-stage airframe), Pratt & Whitney Aircraft Company (Saturn I second-stage propulsion), Douglas Aircraft Corporation (Saturn I second-stage airframe, Saturn IB second-stage airframe, Saturn V third-stage airframe), and Boeing Company (Saturn V first-stage airframe).¹¹

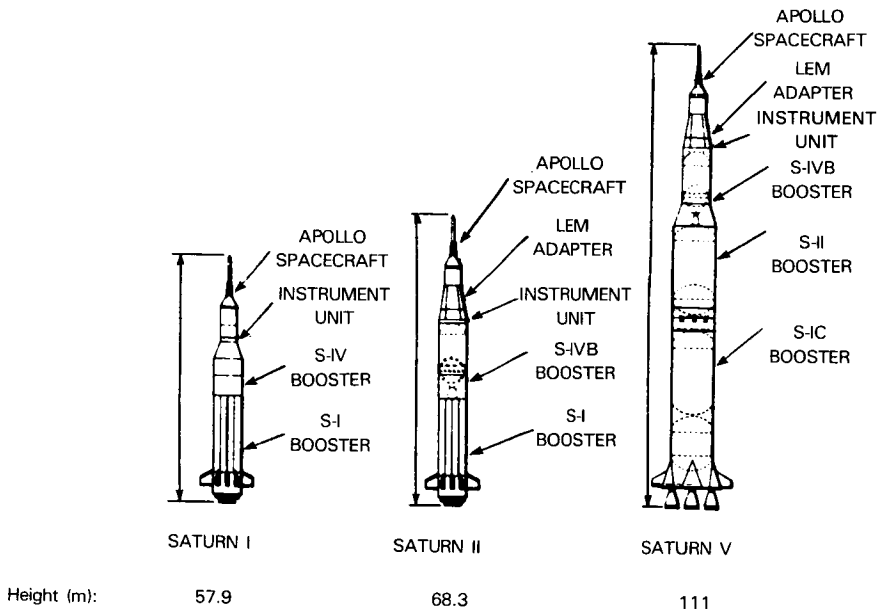

Figure 1-3. Comparison of Three Saturn Launch Vehicles

Source: From Courtney G. Brooks, James M. Grimwood, and Loyd S. Swenson, *Chariots for Apollo; A History of Manned Lunar Spacecraft*, NASA SP-4205 (Washington, 1979), p. 93.

Table 1-63.
Saturn I Characteristics

	1st stage (S-I)	2d stage (S-IV)	Instrument Unit	Total w/ spacecraft & tower
<i>Height (m):</i>	25	12	0.86	57.9
<i>Diameter (m):</i>	6.5	5.6	4	
<i>Launch weight (kg):</i>	385 475	45 350	1179	453 500
<i>Propulsion system</i>				
<i>Stages:</i>				2
<i>Powerplant:</i>	8 Rocketdyne H-1s	6 Pratt & Whitney RL-10A3s		
<i>Thrust (newtons):</i>	6 672 000	400 320		7 072 320
<i>Propellant:</i>	LOX/RP-1	LOX/LH ₂		
<i>Payload capacity:</i>	9070 kg in 555 km earth orbit			
<i>Origin:</i>	Army Ballistic Missile Agency (von Braun team) design			
<i>Contractors:</i>	North American Aviation, first-stage propulsion Chrysler, first stage Pratt & Whitney, second-stage propulsion Douglas, second stage			
<i>How utilized:</i>	First step toward perfecting the Saturn V vehicle for lunar missions. Used in qualification tests of the Apollo spacecraft.			
<i>Remarks:</i>	Briefly referred to as Juno V.			
<i>See also:</i>	Saturn IB and Saturn V.			

Table 1-64.
Chronology of Saturn I Development and Operations

Date	Event
April 1957	Studies were begun by the Army's von Braun team at Redstone Arsenal on large boosters capable of launching 9070 to 18 140 kilograms into orbit or 2721 to 5442 kilograms to an escape trajectory.
Dec. 1957	The Army Ballistic Missile Agency proposed to DoD a booster capable of 6 672 000 newtons of thrust with a cluster of four Rocketdyne engines.
Aug. 15, 1958	The Advanced Research Projects Agency (ARPA) authorized the Army Ballistic Missile Agency to conduct an R&D program at Redstone for a 6 672 000-newton booster (unofficially known as Juno V).
Sept. 11, 1958	Contract was awarded to Rocketdyne to update the Thor-Jupiter engine, which became the H-1.
Oct. 1958	ARPA tentatively identified the advanced multistage launch vehicle as Juno V.
Dec. 1958	First full-power H-1 engine firing.
Jan. 9, 1959	Rocketdyne was awarded a contract to develop a larger single-chamber engine, the F-1.
Feb. 3, 1959	ARPA officially named the project Saturn.
April 28, 1959	First production H-1 engine was delivered to the Army Ballistic Missile Agency.
Nov. 18, 1959	NASA assumed technical direction of Saturn.
Dec. 1959	ARPA and NASA requested an engineering study for a three-stage Saturn from the Army Ordnance Missile Command.

Table 1-64.
Chronology of Saturn I Development and Operations (Continued)

Date	Event
Dec. 15, 1959	Saturn Vehicle Evaluation Committee recommended a long-range development program for a family of Saturn launch vehicles, the first to be called C-1.
Jan. 18, 1960	The Saturn project was formally approved and given the highest national priority.
March 16, 1960	Saturn transfer to NASA became official.
March 28, 1960	First live firing of Saturn test booster.
April 26, 1960	NASA awarded Douglas Aircraft Co. a contract to develop the Saturn second stage (S-IV).
July 1, 1960	Program was formally transferred to the Marshall Space Flight Center.
Aug. 10, 1960	NASA awarded a contract to Pratt & Whitney to develop the LR-119 engine for the S-IV and S-V stages of the C-1 vehicle.
Oct. 21, 1960	NASA awarded a study contract to Convair for the S-V upper stage, but the requirement for an S-V stage on the C-1 was dropped in Jan. 1961.
Feb. 1961	First horizontal assembly of a complete C-1 vehicle.
March 1961	Marshall redirected Pratt & Whitney's development of the LR-119; instead, the RL 10-A-1 would be used for Centaur and the S-IV stage.
April 29, 1961	First flight qualification test of SA-1 booster was successful.
June 1961	Contract was awarded to Chrysler for the management of the quality and reliability testing program required to qualify the various Saturn booster components.
July 1961	Rocketdyne static fired the F-1 engine. Contracts were awarded to General Dynamics, Douglas, Lockheed, and Martin Marietta to study a nuclear-powered upper stage for Saturn.
Sept. 15, 1961	SA-1 vehicle was completely assembled on the launch pedestal at launch complex 34, Cape Canaveral.
Oct. 27, 1961	SA-1 launch was almost flawless (first stage test only; dummy second stage).
Nov. 6, 1961	S-II stage was redesigned to incorporate five J-2 engines.
Nov. 17, 1961	Chrysler Corp. was selected to build 20 S-I boosters.
Nov. 19, 1961	RL-10 engine was successfully tested (first U.S. liquid hydrogen engine).
April 25, 1962	SA-2 launch was successful (first-stage test only; second stage was filled with water—called Project Highwater).
May 1962	S-II stage was lengthened from 22.9 meters to 24.8 meters; S-IC stage was shortened from 43 meters to 42 meters.
Aug. 6, 1962	Chrysler was awarded a contract to produce 21 C-1 boosters.
Nov. 16, 1962	SA-3 launch was successful (first-stage test only).
Feb. 1963	Saturn C-1 was renamed Saturn I.
March 28, 1963	SA-4 launch was successful (first-stage test only).
June 1963	Dynamics test of S-IV stage with Apollo boilerplate and launch escape system was completed.
Oct. 30, 1963	Saturn I manned missions were dropped from NASA's plans, thereby deleting the need for six Saturn I vehicles. Later that winter a third Pegasus meteoroid detector satellite mission was planned for the 10th Saturn I launch.

Table 1-64.
Chronology of Saturn I Development and Operations (Continued)

Date	Event
Oct. 31, 1963	Marshall received the first production model F-1 engine.
Jan. 29, 1964	SA-5 launch was successful with live first and second stages.
May 28, 1964	SA-6 launch was successful with the guidance system active for the first time and an Apollo boilerplate model included in the configuration.
Sept. 18, 1964	SA-7 launch with Apollo boilerplate command and service modules was successful. Saturn I was declared operational.
Feb. 16, 1965	SA-9 launch with Apollo boilerplate and <i>Pegasus 1</i> meteoroid detection satellite was successful.
May 25, 1965	SA-8 launch with Apollo boilerplate and <i>Pegasus 2</i> was successful (first contractor-built S-1 stage).
July 30, 1965	SA-10 launch with Apollo boilerplate and <i>Pegasus 3</i> was successful; this marked the conclusion of the Saturn I program.

Table 1-65.
Saturn IB Characteristics

	1st stage (S-1B)	2d stage (S-1VB)	Instrument Unit	Total w/ spacecraft & tower
<i>Height (m):</i>	24.5	17.8	0.9	68.3
<i>Diameter (m):</i>	6.5	6.6	6.6	
<i>Launch weight (kg):</i>	401 348	103 852	1859	589 550
<i>Propulsion system</i>				
<i>Stages:</i>			2	
<i>Powerplant:</i>	8 Rocketdyne H-1s	1 Rocketdyne J-2		
<i>Thrust (newtons):</i>	7 116 800	1 000 800		8 117 600
<i>Propellant:</i>	LOX/RP-1	LOX/LH ₂		
<i>Payload capacity:</i>	16 598 kg to 195 km earth orbit			
<i>Origin:</i>	Uprated Saturn I.			
<i>Contractors:</i>	North American Aviation, first-stage propulsion Chrysler, first stage North American, second-stage propulsion Douglas, second stage			
<i>How utilized:</i>	To further qualify the Apollo spacecraft and the Saturn stages required for the lunar missions; also used for astronaut training.			
<i>Remarks:</i>	Called Uprated Saturn I from May 1966 through 1967.			
<i>See also:</i>	Saturn I and Saturn V.			

Table 1-66.
Chronology of Saturn IB Development and Operations

Date	Event
March 31, 1961	NASA approved the accelerated development of the Saturn C-2 vehicle.
May 1961	Reexamination of the C-2 configuration to support lunar circumnavigation indicated a need for a Saturn with greater performance capability.
June 23, 1961	Design work on C-2 was discontinued in favor of C-3 and Nova concepts.
Dec. 21, 1961	Douglas was selected to modify the second stage (S-IVB) by installing a single J-2 engine capable of 889 600 newtons thrust.
July 11, 1962	NASA announced the need for a new two-stage Saturn for manned earth-orbital missions with full-scale Apollo spacecraft.
Feb. 1963	Saturn C-IB was renamed Saturn IB.
Aug. 1963	Contracts were awarded to Chrysler for the S-IB stage and to Douglas for the S-IVB stage.
Oct. 30, 1963	Speedup of Saturn IB development was approved.
Nov. 8, 1963	Marshall Space Flight Center directed Rocketdyne to develop an uprated H-1 engine.
Nov. 27, 1963	First extended-duration firing test of J-2 engine.
June 1964	Rocketdyne delivered the first four uprated H-1 engines.
April 1, 1965	First stage was successfully static-fired for the first time; Rocketdyne was authorized to increase the H-1's capability to 911 840 newtons.
July 1965	Rocketdyne initiated a development program to uprate the thrust capability of the J-2 engine to 1 023 040 newtons.
Aug. 9, 1965	Chrysler shipped the first IB booster to Kennedy Space Center.
Sept. 19, 1965	First IVB stage arrived at Kennedy.
Oct. 1, 1965	Stages were mated at launch complex 34.
Oct. 28, 1965	Rocketdyne delivered to Chrysler the first two H-1 uprated engines.
Dec. 26, 1965	An Apollo spacecraft was added to the launch vehicle; together they were designated AS-201.
Feb. 26, 1966	Launch of AS-201 was successful (suborbital test of Apollo command module heat shield).
May 6, 1966	First uprated J-2 engine arrived at Marshall.
May 19, 1966	Saturn IB was renamed Uprated Saturn I.
July 5, 1966	Launch of AS-203 without a spacecraft was successful (observation of liquid hydrogen in zero gravity).
Aug. 25, 1966	Launch of AS-202 was successful (test of command module heat shield).
Jan. 22, 1968	Launch of <i>Apollo 5</i> (AS-204) with lunar module was successful.
Jan. 1968	Uprated Saturn I was officially designated Saturn IB.
Oct. 11, 1968	Launch of <i>Apollo 7</i> (AS-205) with crew of three was successful.

Table 1-67.
Saturn V Characteristics

	1st stage (S-IC)	2d stage (S-II)	3d stage (S-IVB)	Instrument Unit	Total w/ spacecraft & tower
<i>Height (m):</i>	42.1	24.9	17.9	0.9	111
<i>Diameter (m):</i>	10.1	10.1	6.6	6.6	
<i>Launch weight (kg):</i>	2 076 123	437 628	105 212	2041	2 621 004
<i>Propulsion system</i>					
<i>Stages:</i>					3
<i>Powerplant:</i>	5	5	1		
	Rocketdyne F-1s	Rocketdyne J-2s	Rocketdyne J-2		
<i>Thrust (newtons):</i>	33 360 000	5 004 000	1 023 040		39 387 040
<i>Propellant:</i>	LOX/RP-1	LOX/LH ₂	LOX/LH ₂		
<i>Payload capacity:</i>	129 248 kg to 195 km earth orbit 45 350 kg to escape trajectory				
<i>Origin:</i>	Up-rated Saturn IB.				
<i>Contractors:</i>	North American, 1st-, 2d-, and 3d-stage propulsion and 2d stage Boeing, 1st stage, Douglas, 3d stage				
<i>How utilized:</i>	To launch Apollo lunar missions.				
<i>Remarks:</i>	Called Saturn C-5 in 1961-1962.				
<i>See also:</i>	Saturn I and Saturn IB.				

Table 1-68.
Chronology of Saturn V Development and Operations

Date	Event
Sept. 11, 1961	NASA selected North American to develop and build the S-II stage for an advanced Saturn.
Nov. 10, 1961	NASA received proposals from five firms for the development and production of advanced Saturn boosters.
Dec. 15, 1961	Boeing was selected as the most likely candidate for prime contractor of the S-IC stage of advanced Saturn.
Dec. 21, 1961	Douglas was selected to modify the second stage of Saturn IB by installing a single J-2 engine of 889 600 newtons thrust. Called the S-IVB stage, it would be used as the third stage in the advanced Saturn.
Jan. 25, 1962	NASA approved the development of the three-stage Saturn C-5 for the manned lunar program.
Feb. 9, 1962	Preliminary contract was awarded to North American to design and fabricate the S-II stage of C-5.
Mid-May 1962	Marshall Space Flight Center directed Douglas to increase the diameter of the S-IVB stage to 6.6 meters.
Aug. 6, 1962	Boeing was awarded a contract for the development of the C-5 booster.
Aug. 8, 1962	Douglas was awarded a contract for 11 S-IVB stages.
Aug. 15, 1962	Rocketdyne was awarded a contract to continue H-1 engine R&D.
Feb. 1963	Saturn C-5 was renamed Saturn V.
May 1963	The J-2 engine was successfully fired for the first time.
April 23, 1966	First captive firing of Saturn V second stage test vehicle, which developed more than 4 million newtons of thrust.
Aug. 26, 1966	First Saturn V flight booster was shipped to Kennedy Space Center.
Jan. 21, 1967	First S-II stage arrived at Kennedy.
Jan. 27, 1967	Jet Propulsion Laboratory issued a request for proposals for preliminary design studies of unmanned Voyager missions to Mars to be launched by Saturn V.
April 27, 1967	Saturn upper stage model outfitted as a manned orbital workshop arrived at Marshall.
May 1967	S-IVB orbital workshop design review was held at Marshall.
June 1967	AS-501 was erected.
July 11, 1967	First and second stages of AS-502 were mated.
Aug. 3, 1967	Successful completion of Apollo-Saturn V dynamic test program.
Aug. 26, 1967	Rollout of first Saturn V vehicle, the AS-501, at Kennedy.
Nov. 9, 1967	Launch of <i>Apollo 4</i> (AS-501) was successful.
April 4, 1968	Launch of <i>Apollo 6</i> (AS-502) was partially successful (premature second-stage engine shutdown and third-stage failure to restart).
Dec. 21, 1968	Launch of <i>Apollo 8</i> (AS-504) with crew of three was successful; the spacecraft orbited the moon.

Scout

Scout was NASA's most frequently used small launch vehicle. A product of the Langley Research Center, its development was initiated in 1957 when the laboratory was part of the National Advisory Committee for Aeronautics. Scout's designers created a vehicle that depended on off-the-shelf components and a small budget; accordingly, it was dubbed the "poor man's rocket." Both NASA and the Air Force recognized the importance of the solid-fuel Scout for launching small payloads and pushed for its early completion. Vought Astronautics of Chance Vought Aircraft

(later Ling-Temco-Vought, Incorporated), the prime contractor, delivered the first four-stage Scout to Wallops Island in 1960.

NASA used Scout to launch more than a score of Explorer-class satellites and probes, small payloads with scientific objectives, in 1961-1968. But Scout's design was not static. In 1962, its first and third stages were upgraded with new engines, as was the fourth stage in 1963. In response to requests from the military for more reliability and in anticipation of an increased demand for a small-satellite launcher, NASA further improved the second and fourth stages in 1965. Scout's payload capacity had more than doubled by 1965¹²

Table 1-69.
Scout Characteristics (as of 1968)

	1st stage (Algol IIB)	2d stage (Castor II)	3d stage (Antares II)	4th stage (Altair III)	Total
<i>Height (m):</i>	9.1	6.2	2.9	1.5	21.9
<i>Diameter (m):</i>	1	0.8	0.7	0.5	
<i>Launch weight (kg):</i>	10 771	4429	1260	300	16 780
<i>Propulsion system</i>					
<i>Stages:</i>					4
<i>Powerplant:</i>	Aerojet- General	Thiokol TX 354	Hercules ABL X-259	UTC FW-4S	
<i>Thrust (newtons):</i>	449 248	271 328	93 408	25 798	839 782
<i>Propellant:</i>	solid	solid	solid	solid	
<i>Payload capacity:</i>	145 kg to 555 km earth orbit 45 kg to an altitude of 8000-9600 km				
<i>Origin:</i>	Pilotless Aircraft Research Division, Langley Memorial Aeronautical Laboratory, National Advisory Committee for Aeronautics				
<i>Contractors:</i>	Vought Astronautics Div., Chance Vought Aircraft (Ling-Temco-Vought, Inc.), prime Aerojet-General, first-stage propulsion Thiokol Chemical Corp., second-stage propulsion Alleghany Ballistics Laboratory, Hercules Powder Co., third- and fourth-stage pro- pulsion United Technology Center, fourth-stage propulsion				
<i>How utilized:</i>	To launch Explorer and other small scientific satellites, including a number of inter- national payloads.				
<i>Remarks:</i>	As NASA's first launch vehicle program of its own, the emphasis was on off-the- shelf components; Scout was thus dubbed the "poor man's rocket." Scout was upgraded several times from 1960 to 1968 (see table 1-70).				

Table 1-70.
Scout Stage Development, 1960-1968

	1960	1961	1962	1963	1964	1965	1966	1967	1968
Stage 1st	Algol I (Aerojet- General)		Algol IIB (Aerojet- General)						
2d	Castor I (Thiokol TX-33)					Castor II (Thiokol TX-354 3)			
3d	Antares I (ABL X-254)		Antares II (ABL X 259)						
4th	Altair I (ABL X-248)			Altair II (ABL X-258)		Altair III (UTC FW-4S)			
Total weight (kg)	16 329					16 780			
Height w/payload (m)	21.7					22.4			
Payload capacity	59 kg					145 kg			
to						to			
	555 km					555 km			

Table 1-71.
Listing of Scout Vehicles

Vehicle Serial #	Date	Mission	Successful Launch*
ST-1	July 1, 1960	R&D launch	Partial (4th-stage separation incomplete)
ST-2	Oct. 4, 1960	R&D launch	Yes
ST-3	Dec. 4, 1960	Beacon satellite	No (2d-stage failure)
ST-4	Feb. 16, 1961	Explorer 9	Yes
ST-5	June 30, 1961	S-55 satellite	No (3d-stage failure)
ST-6	Aug. 25, 1961	Explorer 13	Partial (orbit life of satellite reduced by 4th-stage malfunction)
ST-7	Oct. 19, 1961	P-21 probe	Yes
ST-8	March 1, 1962	R&D launch (plus Reentry Heating Experiment 1)	Yes
ST-9	March 29, 1962	P-21A P-21A probe	Yes
S-110	July 20, 1963	Reentry Heating Experiment 3	No (1st-stage failure)
S-113	June 28, 1963	NASA launch of Air Force geophysics research payload	Yes
S-114	Aug. 31, 1962	R&D launch (plus Reentry Heating Experiment 2)	No (3d-stage failure)
S-115	Dec. 16, 1962	Explorer 16	Yes
S-116	May 22, 1963	RFD-1 (Reentry Flight Demonstration) for AEC	Yes
S-122R	Dec. 19, 1963	Explorer 19	Yes
S-123RR	Oct. 9, 1964	Explorer 22	Yes
S-124R	July 20, 1964	SERT I	Yes
S-127	March 27, 1964	Ariel 2	Yes
S-129R	Aug. 18, 1964	Reentry Heating Experiment 4	Yes
S-130R	Oct. 9, 1964	RFD-2 for AEC	Yes
S-131R	Aug. 10, 1965	R&D launch	Yes
S-133R	Nov. 6, 1964	Explorer 23	Yes
S-134R	Aug. 25, 1964	Explorer 20	Yes
S-135R	Nov. 21, 1964	Explorer 24 and 25	Yes
S-136R	April 29, 1965	Explorer 27	Yes
S-137R	Dec. 15, 1964	San Marco 1	Yes
S-138R	Nov. 18, 1965	Explorer 30	Yes
S-139R	Dec. 6, 1965	FR-1 French satellite	Yes

Table 1-71.
Listing of Scout Vehicles (Continued)

Vehicle Serial #	Date	Mission	Successful Launch
S-141C	Feb. 9, 1966	Reentry Heating Experiment 5	Yes
S-147C	June 10, 1966	NASA launch of Air Force OV3-IV research satellite	Yes
S-152C	May 29, 1967	ESRO 2A	No (4th-stage failure; payload did not achieve orbit)
S-155C	May 5, 1967	Ariel 3	Yes
S-159C	Oct. 19, 1967	RAM C-1	Yes
S-160C	March 5, 1968	Explorer 37	Yes
S-161C	May 16, 1968	ESRO 2B (IRIS)	Yes
S-164C	April 27, 1968	Reentry Heating Experiment 6	Yes
S-165C	Aug. 8, 1968	Explorer 39 and 40	Yes
S-167C	Oct. 3, 1968	ESRO 1 (Aurorae)	Yes
S-168C	Aug. 22, 1968	RAM C-2	Yes

*5 failures out of 39 attempts (87% successful).

Table 1-72.
Chronology of Scout Development and Operations

Date	Event
July 1957	The Pilotless Aircraft Research Division (PARAD) at NACA's Langley center recognized the need to extend the performance capabilities of existing research rockets.
Summer 1958	A design for a new rocket was conceived by PARAD.
Aug. 11, 1958	Specifications for the rocket were drafted.
Oct. 1958	NASA assumed responsibility for Scout development.
Oct.-Dec. 1958	Contracts were let for propulsion development.
Feb. 27, 1959	Memorandum of understanding between NASA and the Air Force, which was also developing a small all-solid-fueled launch vehicle was signed to avoid duplication. NASA would have responsibility for Scout development while the Air Force would make the necessary modifications it required to Scout for military payloads.
March 1959	Contracts with Minneapolis-Honeywell Regulator Co. and Aerojet-General were announced by NASA.
March 1, 1959	NASA and the Air Force officially announced their joint Scout program; the Air Force's version of the vehicle would be called Blue Scout.
April 1959	Vought was awarded a contract for the airframes and the launch tower.
April 18, 1960	During a component test to analyze first- and third-stage performance, the vehicle broke up after first-stage burnout.
July 1, 1960	First complete Scout launch from Wallops Station; fourth-stage separation was not accomplished.
Oct. 4, 1960	Scout R&D launch was successful.
Dec. 4, 1960	Beacon satellite launch was unsuccessful due to second-stage failure.
Feb. 16, 1961	<i>Explorer 9</i> launch was successful (first satellite launch with Scout).
March 1961	Decision was announced to increase the performance of Scout's third and fourth stages, the work to be funded jointly by NASA and the Navy.
June 30, 1961- Oct. 3, 1968	Scout was used by NASA to launch 18 orbital payloads and 7 ballistic experiments, plus 11 non-NASA payloads.
Nov. 1, 1961	Launch of <i>Mercury-Scout 1</i> (Mercury Network Test Vehicle or MNTV), a small communications payload to verify the Project Mercury tracking network, was unsuccessful due to a technician's error; the vehicle was destroyed 43 seconds after launch.
1962	First and third stages of Scout were upgraded.
March 29, 1962	Launch of P-21A probe was successful (first flight with X-259 engine).
Aug. 31, 1962	Scout R&D launch to test an improved first stage (Algol IIB) was unsuccessful due to a third-stage electrical malfunction.

Table 1-72.
Chronology of Scout Development and Operations (Continued)

Date	Event
1963	Fourth stage was upgraded.
June 28, 1963	Launch of an Air Force research payload was successful (first flight of ABL X-258 engine on fourth stage).
Nov. 1963	The Air Force and the Navy urged NASA to improve the reliability of Scout.
Nov. 21, 1964	Two Explorer satellites were successfully launched with a single Scout.
1965	Second and fourth stages were upgraded.
Aug. 10, 1965	R&D launch to evaluate upgraded second and fourth stages was successful.

The Thor Family

Thor was developed in 1956 by Douglas Aircraft Company as an intermediate range ballistic missile for the Air Force, but it also proved to be a most useful booster for launching Air Force and NASA unmanned payloads to earth orbit. Not a year went by during NASA's first decade that the agency did not make use of Thor with either the Able, Agena, or Delta upper stage.

NASA used the Thor-Able combination only five times in 1958-1960, with three successful launches. The Able stage was derived from the Vanguard vehicle by the Air Force (see tables 1-76, 1-77). More successful was the Thor-Agena configuration, also initiated by the Air Force. NASA put Thor to work with Lockheed's Agena B in 1962, replacing the upper stage with the improved restartable Agena D in 1966 (see tables 1-78 through 1-83). But Thor was most frequently launched with Delta, a two-part vehicle designed by NASA engineers and produced by Douglas. Together Thor and Delta went through 12 configuration changes over nine years (see table 1-84). Delta's two stages were steadily improved; strap-on engines were added to Thor (Thrust-Augmented Delta, or TAD); Thor was lengthened (Thorad); Delta's second stage was omitted in two models. Thor-Delta, often called simply Delta, was highly successful in launching Echo, Explorer, Tiros, Syncom, Orbiting Solar Observatory, Intelsat, and other scientific and applications satellites: only 5 failures in 63 attempts in 1960-1968 (see tables 1-85, 1-86).

Thor's powerplant was augmented by the addition of three strap-on solid-fuel Thiokol engines, almost doubling the booster's thrust. This version of Thor was used with Agena B, Agena D, and Delta. By stretching the Thor booster from 17 to 21.6 meters in length, Douglas gave the vehicle more propellant, increasing its burn time. The thrust-augmented Thorad, as the lengthened Thor was called, was paired with Agena D and Delta. The improved Thor-Delta was able to put Intelsat 3 communications satellites (286.7 kilograms) into geosynchronous orbit (approximately 35 000 kilometers) in 1968.¹³

Table 1-73.
Thor Characteristics

<i>Height (m):</i>	17
<i>Diameter (m):</i>	2.4
<i>Launch weight (kg):</i>	48 978
<i>Propulsion system</i>	
<i>Stages:</i>	1
<i>Powerplant:</i>	Rocketdyne MB-1 Basic LR79-NA-9
<i>Thrust (newtons):</i>	676 096
<i>Propellant:</i>	LOX/RP-1
<i>Payload capacity:</i>	243 kg to an altitude of 463 km on a ballistic path
<i>Origin:</i>	Air Force IRBM.
<i>Contractors:</i>	Douglas Aircraft Co., Inc. (McDonnell Douglas), prime Rocketdyne Div., North American, propulsion system
<i>How utilized:</i>	To launch inflation tests for Echo. With Able, Agena B, Agena D, and Delta upper stages to launch a variety of un- manned payloads.
<i>Remarks:</i>	Echo inflation test launch vehicles used an MB-3 propulsion system capable of 733 920 newtons of thrust. The standard model Thor used was the DM-18. Thor was upgraded in some configurations with the addition of strap-on engines and by the elongation of its tanks. See following tables.
<i>See also:</i>	Thor-Able, Thor-Agena B, Thrust-Augmented Thor-Agena B and D, Long-Tank, Thrust-Augmented Thor-Agena D, and Thor-Delta.

Table 1-74.
Listing of Thor Stages

Vehicle Manufactur- ing no./Model no.	Date	Mission	Thor Stage Successful*
129/DM-1812-6	Nov. 8, 1958	Pioneer 2 (Thor-Able I)	Yes
130/DM-1812-6	Oct. 11, 1958	Pioneer 1 (Thor-Able I)	Yes
134/DM-1812-6	Aug. 7, 1959	Explorer 6 (Thor-Able III)	Yes
144/DM-19	May 13, 1960	Echo (Thor-Delta)	Yes
148/DM-1812-2	April 1, 1960	Tiros 1 (Thor-Able II)	Yes
219/DM-1812-6A	March 11, 1960	Pioneer 5 (Thor-Able IV)	Yes
245/DM-19	Nov. 23, 1960	Tiros 2 (Thor-Delta)	Yes
270/DM-19	Aug. 12, 1960	Echo 1 (Thor-Delta)	Yes
286/DM-19	July 12, 1961	Tiros 3 (Thor-Delta)	Yes
295/DM-19	March 25, 1961	Explorer 10 (Thor-Delta)	Yes
301/DM-19	March 7, 1962	OSO 1 (Thor-Delta)	Yes
312/DM-19	Aug. 15, 1961	Explorer 12 (Thor-Delta)	Yes
316/DM-19	July 10, 1962	Telstar 1 (Thor-Delta)	Yes
317/DM-19	Feb. 8, 1962	Tiros 4 (Thor-Delta)	Yes
318/DM-19	Sept. 18, 1962	Tiros 6 (Thor-Delta)	Yes
320/DM-19	April 26, 1962	Ariel 1 (Thor-Delta)	Yes

Table 1-74.
Listing of Thor Stages (Continued)

Vehicle Manufacturing no./Model no.	Date	Mission	Thor Stage Successful*
321/DM-19	June 19, 1962	Tiros 5 (Thor-Delta)	Yes
337/DSV-2D	Jan. 15, 1962	Echo (Big Shot 1) (booster only)	Yes
338/DSV-20	July 18, 1962	Echo (Big Shot 2) (booster only)	Yes
341/DM-21	Sept. 29, 1962	Alouette 1 (Thor-Agena B)	Yes
345/DSV-3A	Oct. 2, 1962	Explorer 14 (Thor-Delta)	Yes
346/DSV-3A	Oct. 27, 1962	Explorer 15 (Thor-Delta)	Yes
355/DSV-3B	Dec. 13, 1962	Relay 1 (Thor-Delta)	Yes
357/DSV-3B	April 2, 1963	Explorer 17 (Thor-Delta)	Yes
358/DSV-3B	Feb 14, 1963	Syncom 1 (Thor-Delta)	Yes
359/DSV-3B	June 19, 1963	Tiros 7 (Thor-Delta)	Yes
363/DSV-3B	May 7, 1963	Telstar 2 (Thor-Delta)	Yes
370/DSV-3B	July 26, 1963	Syncom 2 (Thor-Delta)	Yes
371/DSV-3B	Dec. 21, 1963	Tiros 8 (Thor-Delta)	Yes
373/DSV-3B	Jan. 21, 1964	Relay 2 (Thor-Delta)	Yes
374/DSV-3C	Jan. 22, 1965	Tiros 9 (Thor-Delta)	Yes
387/DSV-3C	Nov. 26, 1963	Explorer 18 (Thor-Delta)	Yes
391/DSV-3B	March 19, 1964	Beacon Explorer A (Thor-Delta)	Yes
392/DSV-3C	Oct. 4, 1964	Explorer 21 (Thor-Delta)	Yes
393/DSV-3C	Dec. 21, 1964	Explorer 26 (Thor-Delta)	Yes
397/DSV-2A	Jan. 25, 1964	Echo 2 (Thor-Agena B)	Yes
399/DSV-2A	Aug. 28, 1964	Nimbus 1 (Thor-Agena B)	Yes
411/DSV-3C	Feb. 3, 1965	OSO 2 (Thor-Delta)	Yes
415/DSV-3C	July 2, 1965	Tiros 10 (Thor-Delta)	Yes
417/DSV-3D	Aug. 19, 1964	Syncom 3 (Thor-Delta)	Yes
426/DSV-3D	April 6, 1965	Intelsat I (Early Bird) (Thor-Delta)	Yes
431/DSV-3C	March 8, 1967	OSO 3 (Thor-Delta)	Yes
434/DSV-3C	Aug. 25, 1965	OSO C (Thor-Delta)	Yes
435/DSV-2C	Oct. 14, 1965	OGO 2 (Thor-Agena D)	Yes
436/DSV-3C	May 25, 1966	Explorer 32 (Thor-Delta)	Yes
441/DSV-3C	May 29, 1965	Explorer 28 (Thor-Delta)	Yes
442/DSV-3E	Sept. 27, 1967	Intelsat II-D (Thor-Delta)	Yes
445/DSV-3C	Feb. 3, 1966	ESSA 1 (Thor-Delta)	Yes
453/DSV-2A	Nov. 29, 1965	Explorer 31 and Alouette 2 (Thor-Agena B)	Yes
454/DSV-3E	Jan. 11, 1968	Explorer 36 (Thor-Delta)	Yes
456/DSV-2C	May 15, 1966	Nimbus 2 (Thor-Agena D)	Yes
457/DSV-3E	Nov. 6, 1965	Explorer 29 (Thor-Delta)	Yes

Table 1-74.
Listing of Thor Stages (Continued)

Vehicle Manufacturing no./Model no.	Date	Mission	Thor Stage Successful*
460/DSV-3E	Dec. 16, 1965	Pioneer 6 (Thor-Delta)	Yes
461/DSV-3E	Feb. 28, 1966	ESSA 2 (Thor-Delta)	Yes
462/DSV-3E	Aug. 17, 1966	Pioneer 7 (Thor-Delta)	Yes
463/DSV-3E	Oct. 2, 1966	ESSA 3 (Thor-Delta)	Yes
464/DSV-3E	Oct. 26, 1966	Intelsat II-A (Thor-Delta)	Yes
467/DSV-3E	July 1, 1966	Explorer 33 (Thor-Delta)	Yes
468/DSV-3E	Jan. 11, 1967	Intelsat II-B (Thor-Delta)	Yes
470/DSV-3E	March 22, 1967	Intelsat II-C (Thor-Delta)	Yes
471/DSV-3G	Dec. 14, 1966	Biosatellite 1 (Thor-Delta)	Yes
472/DSV-3E	Jan. 26, 1967	ESSA 4 (Thor-Delta)	Yes
473/DSV-2C	June 23, 1966	PAGEOS 1 (Thor-Agena D)	Yes
474/DSV-3E	July 28, 1967	OGO 4 (Thor-Delta)	Yes
475/DSV-3G	Sept. 7, 1967	Biosatellite 2 (Thor-Delta)	Yes
476/DSV-3E	July 4, 1968	Explorer 38 (Thor-Delta)	Yes
479/DSV-3E	Nov. 8, 1968	Pioneer 9 (Thor-Delta)	Yes
480/DSV-3E	Nov. 10, 1967	ESSA 6 (Thor-Delta)	Yes
481/DSV-3E	Dec. 5, 1968	HEOS 1 (Thor-Delta)	Yes
484/DSV-3E	April 20, 1967	ESSA 5 (Thor-Delta)	Yes
486/DSV-3E	May 24, 1967	Explorer 34 (Thor-Delta)	Yes
488/DSV-3E	July 19, 1967	Explorer 35 (Thor-Delta)	Yes
489/DSV-3E	Dec. 13, 1967	Pioneer 8 (Thor-Delta)	Yes
490/DSV-3C	Oct. 18, 1967	OSO 4 (Thor-Delta)	Yes
520/DSV-2L	May 18, 1968	Nimbus B (Thor-Agena D)	No (control system malfunction)
528/DSV-3L	Aug. 16, 1968	ESSA 7 (Thor-Delta)	Yes
529/DSV-3L	Sept. 18, 1968	Intelsat III F-1 (Thor-Delta)	No (control system malfunction)
534/DSV-3L	Dec. 15, 1968	ESSA 8 (Thor-Delta)	Yes
536/DSV-3L	Dec. 18, 1968	Intelsat III F-2 (Thor-Delta)	Yes

*2 failures out of 79 attempts (97% successful).

Table 1-75.
Chronology of Thor Development and Operations

Date	Event
Dec. 27, 1955	Ballistic Missile Office, Air Materiel Command, awarded a contract to the Douglas Aircraft Company for the development of Weapon System 315A, an intermediate range ballistic missile.
Oct. 26, 1956	Douglas delivered the first WS-315A missile, which became known as Thor.
Jan. 25, 1957	Missile 101 launch was unsuccessful due to the rupture of the liquid oxygen tank.
Sept. 20, 1957	Missile 105 launch was the first completely successful Thor launch.
Oct. 24, 1957	Missile 109 launch proved that the vehicle could fly its required 3200-kilometer range.
1958	The Thor booster was used with the Able upper stage by the Air Force and by NASA (NASA had responsibility for the October 11 and November 8 launch attempts of <i>Pioneer 1</i> and 2 lunar probes; in both cases the launch vehicles' upper stages malfunctioned).
1959	The Thor booster was mated with the Agena upper stage by the Air Force.
May 13, 1960	The Thor booster was used with the Delta upper stage by NASA in the attempted launch of an Echo satellite; the Delta stage malfunctioned.
Aug. 12, 1960	First successful Thor-Delta launch by NASA (<i>Echo 1</i>) took place. Thor-Delta proved to be a highly successful configuration (used 61 times by NASA in 1960-1968).
Sept. 29, 1962	The Thor-Agena B configuration was used by NASA for the first time in the launch of <i>OGO 2</i> ; this configuration was used four times by NASA in 1965-1968.

Table 1-76.
Thor-Able Characteristics

	1st stage (Thor)	2d stage	3d stage	4th stage	Total (w/payload)
<i>Height (m):</i>	17	5.3	1.9	0.7	27
<i>Diameter (m):</i>	2.4				
<i>Launch weight (kg):</i>	48 978	2100	390	154	51 622
<i>Propulsion system</i>					
<i>Stages:</i>					4
<i>Powerplant:</i>	Rocketdyne MB-1 Basic LR79-NA-9	AJ10-41 or AJ10-42	Altair ABL X 248	ARC 1 KS 420	
<i>Thrust (newtons):</i>	676 096	34 000	13 650	1930	725 676
<i>Propellant:</i>	LOX/ RP-1	WFNA/UDMH	solid	solid	
<i>Payload capacity:</i>	122 kg to 850 km earth orbit				
<i>Origin:</i>	Able stages derived from the Vanguard launch vehicle; Thor was an Air Force IRBM.				
<i>Contractors:</i>	Douglas Aircraft Co., (McDonnell Douglas), Thor prime Rocketdyne Div., North American, Thor propulsion system Space Technology Laboratories, Able prime Aerojet-General, second stage propulsion Alleghany Ballistics Laboratory, Hercules Powder Co., third-stage propulsion Atlantic Research Corp., fourth-stage propulsion				
<i>How utilized:</i>	To launch small probes and satellites.				
<i>Remarks:</i>	NASA briefly used this configuration in four variations (Able I, II, III, and IV). The four Ables were basically the same vehicle, but there were some slight variations in weight, thrust, and engine numbers. The figures shown above are an average for the different variations. The Thor model used in this configuration was the DM1812-2, the DM1812-6, or the DM1812-6A.				
<i>See also:</i>	Atlas-Able and Thor.				

Table 1-77.
Chronology of Thor-Able Development and Operations

Date	Event
1955	Aerojet-General was awarded an Air Force contract to design and produce a second-stage propulsion system based on the Aerobee-Hi sounding rocket for the Vanguard launch vehicle.
Dec. 6, 1957	Vanguard with live second stage (TV-3) exploded due to a first-stage malfunction.
Late 1957	Air Force requested Aerojet-General to modify the stage for use in ICBM nose cone reentry tests; the Able stage was the result of those modifications. Air Force established a space probe program that would utilize the Able upper stage.
March 17, 1958	First successful launch of Vanguard; second stage performed as programmed.
April 23, 1958	Attempted launch of Thor-Able combination by the Air Force was unsuccessful.
July 9, 1958	Successful launch of Thor-Able; first test of a full-scale ICBM nose cone at ICBM ranges and velocities.
Aug. 17, 1958	Thor-Able I, an Air Force attempt to launch a lunar probe, was unsuccessful; the first-stage engine exploded 77 seconds after liftoff; there was also uneven separation of the second and third stages.
Oct. 11, 1958	NASA's attempt to launch the <i>Pioneer 1</i> lunar probe was unsuccessful.
Nov. 8, 1958	NASA's attempt to launch the <i>Pioneer 2</i> lunar probe was unsuccessful; the third stage failed to ignite.
Aug. 7, 1959	Thor-Able III successfully launched <i>Explorer 6</i> .
March 11, 1960	Thor-Able IV successfully launched <i>Pioneer 5</i> .
April 1, 1960	Thor-Able II successfully launched <i>Tiros 1</i> .

Table 1-78.
Thor-Agena B Characteristics

	1st stage (Thor)	2d stage (Agena B)	Total
Height (m):	17	7.2	23
Diameter (m):	2.4	1.5	
Launch weight (kg):	48 978	7000	55 978
<i>Propulsion system</i>			
<i>Stages:</i>			
<i>Powerplant:</i>	Rocketdyne MB-3 Basic LR79-NA-13	Bell XLR-81-Ba-11	2
<i>Thrust (newtons):</i>	765 056	66 720	831 776
<i>Propellant:</i>	LOX/RP-1	IRFNA/UDMH	
<i>Payload capacity:</i>	1380 kg to 185 km earth orbit 34 kg to synchronous altitude transfer ellipse		
<i>Origin:</i>	Agena developed by Lockheed under contract to the Air Force; Thor was an Air Force IRBM.		
<i>Contractors:</i>	Douglas Aircraft Co., Inc. (McDonnell Douglas), Thor prime Rocketdyne Div., North American, Thor propulsion system Lockheed Missiles and Space Co., Agena prime Bell Aerospace, Textron, second-stage propulsion		
<i>How utilized:</i>	To launch earth-orbital scientific satellites.		
<i>Remarks:</i>	Agena stage capable of engine restart.		
<i>See also:</i>	Atlas-Agena B and Thor		

Table 1-79.
Chronology of Thor-Agena B Development and Operations

Date	Event
Oct. 1956	Development began at Lockheed under contract with the Air Force for an advanced military satellite system and its associated upper stage vehicle; this upper stage became the Agena.
1957	The Air Force contracted with Lockheed for production of the Agena upper stage.
Jan. 1959	NASA announced plans to use the Agena with Atlas and Thor.
April 24, 1959	The Air Force issued a contract amendment to Lockheed for the development of an advanced Agena, to be known as Agena B.
Dec. 11, 1959	NASA cancelled its Vega upper-stage development program in favor of the Agena B.
Oct. 26, 1960	The Air Force failed in its attempt to launch a Thor-Agena A; failure was due to stage-separation malfunction.
Feb. 1961	An agreement was signed between NASA and the Air Force regarding NASA's procurement of Agena B vehicles.
Sept. 29, 1962	NASA successfully launched <i>Alouette 1</i> with a Thor-Agena B (first NASA launch from the Western Test Range).
Jan. 25, 1964	Thor-Agena B launch of <i>Echo 2</i> passive communications satellite was successful.
Aug. 28, 1964	Thor-Agena B launch of <i>Nimbus 1</i> meteorological satellite was successful.
Nov. 29, 1965	Thor-Agena B dual launch of <i>Alouette 2</i> and <i>Explorer 31</i> was successful.
1966	Agena B was discontinued in favor of Agena D.

Table 1-80.
Thrust-Augmented Thor-Agena B and D Characteristics

	1st stage (Thor)	2d stage (Agena B)	or	2d stage (Agena D)	Total
<i>Height (m):</i>	17	7.2		7.2	23
<i>Diameter (m):</i>	2.4	1.5		1.5	
	3.4 (w/strap-ons)				
<i>Launch weight (kg):</i>	48 777	7000		7250	69 000
	12 653 (strap-ons)				
<i>Propulsion system</i>					
<i>Stages:</i>					
<i>Powerplant:</i>	Rocketdyne	+ 3 Thiokol		Bell XLR-81-	2
	MB-3 Basic	TX-33-52 strap-ons		BA-11	Bell XLR-81Ba-11
<i>Thrust (newtons):</i>	765 056	719 775		71 168	1 555 999
<i>Propellant:</i>	LOX/RP-1	solid		IRFNA/UDMH	N ₂ O ₄ /UDMH
<i>Payload capacity:</i>	57 kg to 4284 km earth orbit				
<i>Origin:</i>	Agena developed by Lockheed under contract to the Air Force; Thor was an Air Force IRBM.				
<i>Contractors:</i>	Douglas Aircraft Co., Inc. (McDonnell Douglas), Thor prime Rocketdyne Div., North American, Thor propulsion system Thiokol Chemical Corp., Thor strap-ons Lockheed Missiles and Space Co., Agena prime Bell Aerospace, Textron, second-stage propulsion				
<i>How utilized:</i>	To launch earth-orbital scientific satellites.				
<i>Remarks:</i>	Thor used was Douglas Model DSV-2C.				
<i>See also:</i>	Thor, Thor-Agena B, Atlas-Agena B, Atlas-Agena D, and Long-Tank, Thrust-Augmented Thor-Agena D				

Table 1-81.
Chronology of Thrust-Augmented Thor-Agena B & D
Development and Operations

Date	Event
1962	Air Force ordered the Thrust-Augmented Thor from Lockheed; the vehicle consisted of a standard Thor with three strap-on solid-propellant Castor I motors.
Feb. 28, 1963	First Air Force launch of a Thrust-Augmented Thor was unsuccessful; the vehicle was destroyed when it veered off course.
March 18, 1963	The Air Force launched a payload into polar orbit with a Thrust-Augmented Thor-Agena D.
Oct. 14, 1965	NASA launch of <i>OGO 2</i> was successful with Thrust-Augmented Thor-Agena D.
May 15, 1966	NASA launch of <i>Nimbus 2</i> was successful with Thrust-Augmented Thor-Agena B.
June 23, 1966	NASA launch of <i>PAGEOS 1</i> was successful with Thrust-Augmented Thor-Agena D.
July 28, 1967	NASA launch of <i>OGO 4</i> was successful with Thrust-Augmented Thor-Agena D.

Table 1-82.
 Long-Tank, Thrust-Augmented Thor-Agena D
 (Thorad-Agena D) Characteristics

	1st stage (Thorad)	2d stage (Agena D)	Total
<i>Height (m):</i>	21.6	6.2	27.8
<i>Diameter (m):</i>	2.4	1.5	
<i>Launch weight (kg):</i>	70 000	7250	90 000
	12 653 (strap-ons)		
<i>Propulsion system</i>			
<i>Stages:</i>			2
<i>Powerplant:</i>	Rocketdyne	+ 3 Thiokol TX-33-52	
	MB-3 Basic	strap-ons	Bell XLR-81-Ba-11
<i>Thrust (newtons):</i>	765 056	719 775	71 168
<i>Propellant:</i>	LOX/RP-1	solid	N ₂ O ₄ /UDMH
<i>Payload capacity:</i>	1360 kg to 185 km earth orbit		
<i>Origin:</i>	Agena developed by Lockheed under contract to the Air Force; Thor was an Air Force IRBM.		
<i>Contractors:</i>	Douglas Aircraft Co., Inc. (McDonnell Douglas), Thor prime Rocketdyne Div., North American, Thor propulsion system Thiokol Chemical Corp., Thor strap-ons Lockheed Missiles and Space Co., Agena prime Bell Aerospace, Textron, second-stage propulsion		
<i>How utilized:</i>	Used once by NASA in an unsuccessful attempt to launch two earth-orbital scientific satellites.		
<i>Remarks:</i>	The long-tank Thor became the standard model Thor; the thrust capability remained the same as the short-tank Thor, but the burn time was increased by 65 seconds. The Thorad-Agena D combination was dropped in favor of Thorad-Delta after only one attempted launch.		
<i>See also:</i>	Thor, Thrust-Augmented Thor-Agena B & D, Atlas-Agena D, and Thor-Delta.		

Table 1-83.
Chronology of Long-Tank, Thrust-Augmented
Thor-Agena D (Thorad-Agena D) Development and Operations

Date	Event
1966	The Thor booster was uprated by stretching the stage; the result was the Long-Tank Thor, or Thorad. The liquid oxygen and RP-1 tanks were lengthened, giving the booster 65 more seconds of burn time and the capability to lift 20 percent more payload.
Jan. 5, 1966	21 Thorad boosters were purchased from Douglas by the Air Force; all subsequent new-production Thors were the Thorad version.
May 18, 1968	NASA attempted to launch Nimbus B and Secor satellites on a simple Thorad-Agena D vehicle; the vehicle was destroyed at launch when it malfunctioned.

Table 1-84.
Thor-Delta Characteristics

<i>Thor-Delta</i>	1st stage (Thor)	2d stage (Delta)	3d stage (Delta)	Total w/ adapters
<i>Height (m):</i>	17	5.2	1.5	27.4
<i>Diameter (m):</i>	2.4	1.3	0.5	
<i>Launch weight (kg):</i>	48 978	3149	268	52 395
<i>Propulsion system</i>				
<i>Stages:</i>				
<i>Powerplant:</i>	Rocketdyne MB-3 Basic LR79-NA-9	AJ10-142	Altair X-248-A7	3
<i>Thrust (newtons):</i>	676 096	33 360	13 344	722 800
<i>Propellant:</i>	LOX/RP-1	WIFNA/UDMH	solid	
<i>Payload capacity:</i>	272 kg to 185-km earth orbit			
<hr/>				
<i>Thor-Delta A</i>				
<i>Height (m):</i>	15.9	5.2	1.5	27.4
<i>Diameter (m):</i>	2.4	0.8	0.5	
<i>Launch weight (kg):</i>	48 978	2268	268	51 509
<i>Propulsion system</i>				
<i>Stages:</i>				
<i>Powerplant:</i>	Rocketdyne MB-3 Basic LR-79-NA-11	AJ10-118	Altair X-248-A5D	3
<i>Thrust (newtons):</i>	742 816	33 360	13 344	789 520
<i>Propellant:</i>	LOX/RP-1	WIFNA/UDMH	solid	
<i>Payload capacity:</i>	272 kg to 185 km earth orbit			
<i>Height (m):</i>	15.9	5.2	1.5	27.4
<i>Diameter (m):</i>	2.4	0.8	0.5	
<i>Launch weight (kg):</i>	48 978	2721	239	51 938
<i>Propulsion system</i>				
<i>Stages:</i>				
<i>Powerplant:</i>	Rocketdyne MB-3 Basic LR79-NA-11	AJ10-118A	Altair X-248-A5DM	3

Table 1-84.
Thor-Delta Characteristics (Continued)

Thor-Delta B (Operational Delta)

	1st stage (Thor)	2d stage (Delta)	3d stage (Delta)	Total w/ adapters
<i>Thrust</i> (newtons):	742 816	34 250	13 344	790 410
<i>Propellant</i> :	LOX/RP-1	IRFNA/UDMH	solid	
<i>Payload capacity</i> :	272 kg to 185 km earth orbit			

Thor-Delta C (Standard Delta)

<i>Height</i> (m):	15.9	5.2	0.9	27.4
<i>Diameter</i> (m):	2.4	0.8	0.5	
<i>Launch weight</i> (kg):	48 978	2721	259	51 958
<i>Propulsion system</i>				
<i>Stages</i> :				3
<i>Powerplant</i> :	Rocketdyne MB-3 Basic LR79-NA-11	AJ10-118D	Altair A-258	
<i>Thrust</i> (newtons):	742 816	34 472	25 576	802 864
<i>Propellant</i> :	LOX/RP-1	IRFNA/UDMH	solid	
<i>Payload capacity</i> :	272 kg to 185 km earth orbit			

Thor-Delta C-1 (Standard Delta)

<i>Height</i> (m):	15.9	5.2	1.5	27.4
<i>Diameter</i> (m):	2.4	0.8	0.5	
<i>Launch weight</i> (kg):	48 978	2721	259	51 958
<i>Propulsion system</i>				
<i>Stages</i> :				3
<i>Powerplant</i> :	Rocketdyne MB-3 Basic LR79-NA-11	AJ10-118D	UTC FW-4	
<i>Thrust</i> (newtons):	742 816	34 472	24 909	802 197
<i>Propellant</i> :	LOX/RP-1	IRFNA/UDMH	solid	
<i>Payload capacity</i> :	272 kg to 185 km earth orbit			

Thor-Delta D (Thrust-Augmented Delta, TAD)

<i>Height</i> (m):	15.9	5.8	1.6	28.0
<i>Diameter</i> (m):	2.4	0.8	0.5	
<i>Launch weight</i> (kg):	48 978	2721	270	64 622
	12 653 (strap- ons)			
<i>Propulsion system</i>				
<i>Stages</i> :				3
<i>Powerplant</i> :	Rocketdyne + MB-3 Basic LR79-NA-13	3 Thiokol TX-33-52 strap- ons	AJ10-118D	Altair X-258
<i>Thrust</i> (newtons):	765 056	719 775	34 694	25 576
<i>Propellant</i> :	LOX/RP-1	solid	IRFNA/ UDMH	solid
<i>Payload capacity</i> :	590 kg to 185 km earth orbit			

Table 1-84.
Listing of Thor Stages (Continued)

Thor-Delta G (Thrust-Augmented Improved Delta)

	1st stage (Thor)	2d stage (Delta)	3d stage (Delta)	Total (w/adaptor)
Height (m):	15.9	5.2	--	27.4
Diameter (m):	2.4	1.4	--	
Launch weight (kg):	48 978	6167	--	67 798
	12 653 (strap-ons)			
<i>Propulsion system</i>				
Stages:				2
Powerplant:	Rocketdyne + MB-3 Basic LR79-NA-13	3 Thiokol TX-33-52 strap-ons	AJ10-118E	--
Thrust (newtons):	765 056	719 775	34 694	1 519 525
Propellant:	LOX/RP-1	solid	IRFNA/UDMH	
Payload capacity:	500 kg to 265 km earth orbit			

Delta J (Thrust-Augmented Improved Delta)

Height (m):	15.9	5.2	1.4	27.4
Diameter (m):	2.4	1.4	0.9	
Launch weight (kg):	48 978	6167	301	68 099-
	12 653 (TX-33-52) strap-ons			68 779
	13 333 (TX-354-3) strap-ons			
<i>Propulsion system</i>				
Stages:				3
Powerplant:	Same as for Delta E	AJ10-118E	Thiokol TE-364-3	
Thrust (newtons):	765 056 719 775	34 694	44 480	1 564 005
Propellant:	LOX/RP-1 solid	IRFNA/UDMH	solid	
Payload capacity:	190 kg to 6900 km earth orbit			

Delta M (Long-Tank, Thrust-Augmented Delta)

Height (m):	21.6	5.2	1.4	32.0
Diameter (m):	2.4	1.4	0.9	
Launch weight (kg):	70 000	6167	301	89 801
	13 333 (strap-ons)			
<i>Propulsion system</i>				
Stages:				3
Powerplant:	Rocketdyne + MB-3 Basic LR79-NA-13	3 Thiokol TX-354-5 strap-ons	AJ10-118E	Thiokol TE-364-3

Table 1-84.
Listing of Thor Stages (Continued)

	1st stage (Thorad)	2d stage (Delta)	3d stage (Delta)	Total (w/adapters)	
<i>Thrust</i> (newtons):	765 056	719 775	34 694	42 256	1 561 781
<i>Propellant</i> :	LOX/RP-1	solid	IRFNA/ UDMH	solid	
<i>Payload capacity</i> :	1180 kg to 185 km earth orbit 372 kg to synchronous altitude transfer ellipse				

<i>Thor-Delta N (Long-Tank, Thrust-Augmented Delta)</i>					
<i>Height</i> (m):	21.6	5.2	--	--	32.0
<i>Diameter</i> (m):	2.4	1.4	--	--	
<i>Launch weight</i> (kg):	70 000	6167	--	--	89 500
	13 333 (strap-ons)				
<i>Propulsion system</i>					
<i>Stages</i> :					2
<i>Powerplant</i> :	Same as for Delta M		AJ10-118E	--	
<i>Thrust</i> (newtons):	765 056	719 775	34 694		1 519 525
<i>Propellant</i> :	LOX/RP-1	solid	IRFNA/UDMH		
<i>Payload capacity</i> :	1180 kg to 185 km earth orbit 372 kg to synchronous altitude transfer ellipse				
<i>Origin</i> :	NASA design produced by Douglas Aircraft to extend usefulness of Thor booster.				
<i>Contractors</i> :	Douglas Aircraft Co., Inc. (McDonnell Douglas), Thor prime and Delta prime Rocketdyne Div., North American, Thor propulsion system Thiokol Chemical Corp., Thor strap-ons and third stage Aerojet-General, Delta stage propulsion system Alleghany Ballistics Laboratory, Hercules Powder Co., third stage United Technology Center, third stage				
<i>How utilized</i> :	With the Thor booster in a variety of configurations to boost many different classes of satellites to several kinds of orbits; included in the payloads launched by Delta combinations were Echo, Tiros, Relay, Explorer, Intelsat, OSO, HEOS, and ESSA satellites.				
<i>Remarks</i> :	The Thor-Delta configurations were often referred to only as "Delta." Thor-Delta was often called the workhorse of NASA's unmanned program.				
<i>See also</i> :	Thor, Thrust-Augmented Thor-Agena B & D, and Long-Tank, Thrust-Augmented Thor-Agena D.				

Table 1-85.
Listing of Delta Vehicles

Vehicle Serial #/ Delta Model #	Date	Mission	Delta Stages Successful*
1/DM-19	May 13, 1960	Echo	No (2d-stage failure)
2/DM-19	Aug. 12, 1960	Echo 1	Yes
3/DM-19	Nov. 23, 1960	Tiros 2	Yes
4/DM-19	March 25, 1961	Explorer 10	Yes
5/DM-19	July 12, 1961	Tiros 3	Yes
6/DM-19	Aug. 15, 1961	Explorer 12	Yes
7/DM-19	Feb. 8, 1962	Tiros 4	Yes
8/DM-19	March 7, 1962	OSO 1	Yes
9/DM-19	April 26, 1962	Ariel 1	Yes
10/DM-19	June 19, 1962	Tiros 5	Partial (spacecraft did not enter planned orbit)
11/DM-19	July 10, 1962	Telstar 1	Yes
12/DM-19	Sept. 18, 1962	Tiros 6	Yes
13/A	Oct. 2, 1962	Explorer 14	Yes
14/A	Oct. 27, 1962	Explorer 15	Yes
15/B	Dec. 13, 1962	Relay 1	Yes
16/B	Feb. 14, 1963	Syncom 1	Yes
17/B	April 2, 1963	Explorer 17	Yes
18/B	May 7, 1963	Telstar 2	Yes
19/B	June 19, 1963	Tiros 7	Yes
20/B	July 26, 1963	Syncom 2	Yes
21/C	Nov. 26, 1963	Explorer 18	Yes
22/B	Dec. 21, 1963	Tiros 8	Yes
23/B	Jan. 21, 1964	Relay 2	Yes
24/B	March 19, 1964	Beacon Explorer A	No (3d-stage malfunction)
25/B	Aug. 19, 1964	Syncom 3	Yes
26/C	Oct. 4, 1964	Explorer 21	Yes
27/C	Dec. 21, 1964	Explorer 26	Yes
28/C	Jan. 22, 1965	Tiros 9	Yes
29/C	Feb. 3, 1965	OSO 2	Yes
30/D	April 6, 1965	Early Bird (Intelsat I)	Yes
31/C	May 29, 1965	Explorer 28	Yes
32/C	July 2, 1965	Tiros 10	Yes
33/C	Aug. 25, 1965	OSO C	No (3d-stage failure)
34/E	Nov. 6, 1965	Explorer 29	Yes

Table 1-85.
Listing of Delta Vehicles (Continued)

Vehicle Serial #/ Delta Model #	Date	Mission	Delta Stages Successful*
35/E	Dec. 16, 1965	Pioneer 6	Yes
36/C	Feb. 3, 1966	ESSA 1	Yes
37/E	Feb. 28, 1966	ESSA 2	Yes
38/C-1	May 25, 1966	Explorer 32	Yes
39/E-1	July 1, 1966	Explorer 33	Yes
40/E-1	Aug. 17, 1966	Pioneer 7	Yes
41/E	Oct. 2, 1966	ESSA 3	Yes
42/E-1	Oct. 26, 1966	Intelsat II-A	No (apogee motor malfunction)
43/G	Dec. 14, 1966	Biosatellite 1	Yes
44/E-1	Jan. 11, 1967	Intelsat II-B	Yes
45/E	Jan. 26, 1967	ESSA 4	Yes
46/C	March 8, 1967	OSO 3	Yes
47/E-1	March 22, 1967	Intelsat II-C	Yes
48/E	April 20, 1967	ESSA 5	Yes
49/E-1	May 24, 1967	Explorer 34	Yes
50/E-1	July 19, 1967	Explorer 35	Yes
51/G	Sept. 7, 1967	Biosatellite 2	Yes
52/E-1	Sept. 27, 1967	Intelsat II-D	Yes
53/C	Oct. 18, 1967	OSO 4	Yes
54/E-1	Nov. 10, 1967	ESSA 6	Yes
55/E-1	Dec. 13, 1967	Pioneer 8	Yes
56/E-1	Jan. 11, 1968	Explorer 36	Yes
57/J	July 4, 1968	Explorer 38	Yes
58/N	Aug. 16, 1968	ESSA 7	Yes
59/M	Sept. 18, 1968	Intelsat III F-1	No (3d-stage malfunction)
60/E-1	Nov. 8, 1968	Pioneer 9	Yes
61/E-1	Dec. 5, 1968	HEOS 1	Yes
62/N	Dec. 15, 1968	ESSA 8	Yes
63/M	Dec. 18, 1968	Intelsat III F-2	Yes

*5 failures out of 63 attempts (92% successful).

Table 1-86.
Chronology of Thor-Delta Development and Operations

Date	Event
Feb. 3, 1959	Douglas Aircraft responded to a NASA request for proposals to develop a modified launch vehicle based on the Thor booster. NASA wanted to extend the usefulness of the Thors the agency had purchased from the Air Force by creating a vehicle based on the Thor-Able. The second stage was a modified Vanguard second stage with an improved guidance and attitude control system. It was redesignated Delta. A Vanguard X-248 third stage would serve as Thor-Delta's third stage.
April 1, 1959	Douglas was awarded a contract by NASA to produce the Delta, which was defined as an "interim" launch vehicle. It was intended to be used only as a temporary vehicle, with Scout and Vega serving as the primary launch vehicles of the future.
May 13, 1960	First launch of Thor-Delta with an Echo passive communications satellite was unsuccessful due to a second-stage failure.
Aug. 13, 1960	First successful launch of Thor-Delta with <i>Echo 1</i> .
Nov. 23, 1960	Thor-Delta configurations were used successfully to launch many different payloads to a variety of orbits.
Dec. 18, 1968	
Oct. 2, 1962	Thor-Delta A model was used for the first time successfully.
Dec. 13, 1962	Thor-Delta B model was used for the first time successfully.
Nov. 26, 1963	Thor-Delta C model was used for the first time successfully.
April 6, 1965	Thor-Delta D model with thrust augmentation was used for the first time successfully.
Dec. 11, 1959	NASA's Vega second-stage project was cancelled in favor of the Agena B, and the agency continued to use Thor-Delta as a standard launch vehicle.
Nov. 6, 1965	Thor-Delta E model with improved Delta stage was used for the first time successfully.
May 25, 1966	Thor-Delta C-1 model was used for the first time successfully.
July 1, 1966	Thor-Delta E-1 model was used for the first time successfully.
July 4, 1968	Thor-Delta J model was used for the first time successfully.
Aug. 16, 1968	Thor-Delta N model was used for the first time successfully.
Sept. 18, 1968	Thor-Delta M model with Thorad was used for the first time; the attempt to launch a dual payload was unsuccessful because Delta's third stage malfunctioned.

Titan II (Gemini Launch Vehicle)

The Titan II is another example of a missile borrowed by NASA for a non-military purpose. Built for the Air Force by the Martin Company, the Titan II intercontinental ballistic missile was adapted for use in Gemini, the second phase of NASA's manned spaceflight program, in 1963.

Titan, with its two stages, was more powerful than Atlas and safer because it used a storable hypergolic liquid propellant. Titan did not require the complex abort

system necessary for the potentially explosive Redstone, Atlas, and Saturn boosters. The vehicle was not without its difficulties, however. Problems with second-stage combustion stability and a tendency for the entire vehicle to oscillate during launch forced a delay in scheduling the first two-man Gemini mission to earth orbit.

The Gemini Launch Vehicle (GLV) was qualified in a test launch in April 1964. Less than a year later, it boosted the first of 10 crews to orbit. NASA put Titan II on the launch pad 12 times in 1964-1966; all the launches were successful. For more information see also chapter 2 under Gemini.¹⁴

Table 1-87.
Titan II (Gemini Launch Vehicle, GLV) Characteristics

	1st stage	2d stage	Total
<i>Height (m):</i>	21.6	8.2 (5.8 forward of stage separation plane)	27.4
<i>Diameter (m):</i>	3	3	
<i>Launch weight (kg):</i>	122 445	27 210	150 000
<i>Propulsion system</i>			
<i>Stages:</i>			2
<i>Powerplant:</i>	2 Aerojet-General YLR-87-AJ-7	Aerojet-General YLR-91-AJ-7	
<i>Thrust (newtons):</i>	1 912 640	444 800	2 357 440
<i>Propellant:</i>	UDMH/N ₂ O ₄	UDMH/N ₂ O ₄	
<i>Payload capacity:</i>	3200 kg in 185 km earth orbit		
<i>Origin:</i>	Air Force ICBM		
<i>Contractors:</i>	Martin Co., Martin Marietta Corp., prime Aerojet-General Corp., propulsion		
<i>How utilized:</i>	To launch Gemini spacecraft to qualify rendezvous and docking techniques, and to observe astronauts' reactions to long-duration earth-orbital missions.		
<i>Remarks:</i>	Man-rating the Titan ICBM required minimal changes to the basic Titan II. Changes were made in the interest of pilot safety (e.g., system redundancies); some modifications were also necessary to ready the basic ICBM to accept the Gemini payload.		

Table 1-88.
Chronology of Titan II (Gemini Launch Vehicle, GLV)
Development and Operations

Date	Event
May 2, 1955	The Air Force approved the development of an ICBM airframe, which became the Titan missile.
Feb. 6, 1959	First Titan ICBM test launch.
June 1960	The Air Force awarded a contract to the Martin Co. (later Martin Marietta) for the development of a Titan II; the primary difference between the two missiles was Titan II's ability to use a storable hypergolic liquid propellant that would not require liquid oxygen.
Spring 1961	NASA engineers considered Titan II for launching an improved Mercury (Gemini) manned spacecraft.
Fall 1961	Air Force Titan II was officially selected by NASA as the Project Gemini launch vehicle.
Dec. 28, 1961	First successful captive firing of Titan II.
March 1962	First operational launch of Titan I ICBM by the Air Force, preceded by 51 R&D and test launches.
March 16, 1962	First R&D launch of Air Force Titan II.
Spring 1963	Together NASA and the Air Force solved second-stage combustion instability and vehicle vibration-oscillation (called the Pogo effect) problems with Titan II; these problems had to be corrected before the missile could be manned. Gemini's schedule was delayed because of launch vehicle difficulties.
Fall-Winter 1963	NASA considered substituting the Saturn I for Titan II as the Gemini launch vehicle. However, problems with Titan were solved during the various test flights (Nov. 1963 to April 1964).
Oct. 26, 1963	GT-1 was airlifted to Cape Kennedy.
April 8, 1964	Launch of <i>Gemini 1</i> to qualify the launch vehicle was successful.
Jan. 19, 1965	Launch of <i>Gemini 2</i> to qualify the spacecraft was successful.
March 23, 1965	Launch of <i>Gemini 3</i> with crew of two was successful.
June 3, 1965	Launch of <i>Gemini 4</i> with crew was successful.
Aug. 21, 1965	Launch of <i>Gemini 5</i> with crew was successful.
Dec. 4, 1965	Launch of <i>Gemini 7</i> with crew to act as a rendezvous target for <i>Gemini 6A</i> was successful.
Dec. 15, 1968	Launch of <i>Gemini 6A</i> with crew was successful.
March 16, 1966	Launch of <i>Gemini 8</i> with crew was successful.
June 3, 1966	Launch of <i>Gemini 9A</i> with crew was successful.
July 18, 1966	Launch of <i>Gemini 10</i> with crew was successful.
Sept. 12, 1966	Launch of <i>Gemini 11</i> with crew was successful.
Nov. 11, 1966	Launch of <i>Gemini 12</i> with crew was successful.

Vanguard

Vanguard, the launch vehicle and the satellite, was the product of the Naval Research Laboratory (NRL). The Navy team, which had experience with sounding rocket research, began in 1955 to design a small vehicle capable of orbiting a satellite for the American committee of the International Geophysical Year (IGY). NRL received official approval for the project from the Department of Defense (DoD) in August 1955. In less than a month, they had awarded the prime contract for the three-stage launcher to the Martin Company.

Table 1-89.
Vanguard Characteristics

	1st stage	2d stage	3d stage	o r	3d stage	Total
<i>Height (m):</i>	13.4	5.8	1.5		1.5	21.9 (w/cone and aerodynamic spike)
<i>Diameter (m):</i>	1.1	0.8	0.8		0.8	
<i>Launch weight (kg):</i>	8181	1977	194		227	10 385
<i>Propulsion system</i>						
<i>Stages:</i>						3
<i>Powerplant:</i>	GE X-405	Aerojet-General AJ-10	Grand Central Rocket Co. 133-KS-2800		ABL X-248	
<i>Thrust (newtons):</i>	124 544	33 360	10 230		10 675	168 134-168 579
<i>Propellant:</i>	LOX/RP-1	WIFNA/ UDMH			solid	solid
<i>Payload capacity:</i>	11.3 kg to 555 km earth orbit 24 kg to 555 km earth orbit with ABL third stage					
<i>Origin:</i>	Naval Research Laboratory design.					
<i>Contractors:</i>	Martin Co., prime General Electric Co., first-stage propulsion Aerojet-General, second-stage propulsion Grand Central Rocket Co., third-stage propulsion Alleghany Ballistics Laboratory, Hercules Powder Co., third-stage propulsion					
<i>How utilized:</i>	To launch small geodetic satellites as part of the United States' earliest satellite program (part of the International Geophysical Year).					
<i>Remarks:</i>	Many later launch vehicles would be built on the technology developed during the Vanguard program. The first stage was derived from the Viking sounding rocket, the second from the Aerobee sounding rocket. Vanguard was the designation for both the launch vehicle and the satellite.					

Because NRL suffered delays in the development of the Vanguard launch vehicle, DoD gave the Army Ballistic Missile Agency, which had also submitted an IGY satellite proposal, approval to participate. *Explorer 1*, launched by a Juno I, became the first American satellite to orbit earth on January 31, 1958. *Vanguard 1* followed less than two months later. When NASA was established in October 1958, Vanguard and the group at NRL responsible for the project were transferred to the new civilian agency. NASA tried four times in 1959 to orbit scientific payloads with Vanguard; only one was successful. For more information see also chapter 3 under Vanguard.¹⁵

Table 1-90.
Chronology of Vanguard Development and Operations

Date	Event
1955	Early in the year, Naval Research Laboratory (NRL) scientists and engineers started working on the design of a three-stage vehicle capable of launching a small satellite, in reply to interest expressed by the international scientific community and the military in orbiting artificial satellites.
July 6, 1955	The Committee on Special Capabilities (the Steward Committee within DoD) heard NRL's proposal for a scientific satellite program.
Aug. 24, 1955	The Steward Committee approved NRL's proposal for launching an International Geophysical Year satellite with a three-stage vehicle (Viking first stage, Aerobee second stage, new third stage).
Sept. 9, 1955	NRL was authorized to proceed with its proposal for Project Vanguard.
Sept. 23, 1955	The Martin Co. was awarded the prime contract for development and production of Vanguard; Martin subcontracted with General Electric for the first-stage engine.
Nov. 1955	Aerojet-General was awarded a contract for the second stage.
March 1956	Grand Central Rocket Co. and Alleghany Ballistics Laboratory were awarded contracts for third stages.
Dec. 6, 1957	TV-3 launch was the first complete Vanguard launch with three live stages.
March 17, 1958	TV-4 launched <i>Vanguard 1</i> scientific satellite successfully.
Oct. 1, 1958	Project Vanguard was transferred to NASA.
Feb. 17, 1959	SLV-4 launch <i>Vanguard 2</i> into orbit, but the third stage reignited and bumped the payload, impairing the scientific value of the satellite.
Feb. 13, 1959	SLV-5 Vanguard launch with a magnetometer satellite was unsuccessful because of second-stage malfunction.
June 22, 1959	SLV-6 Vanguard launch with a scientific satellite was unsuccessful because tank pressure dropped after second-stage ignition.
Sept. 18, 1959	TV-4BU, with ABL third stage, successfully launched <i>Vanguard 3</i> scientific satellite into orbit.

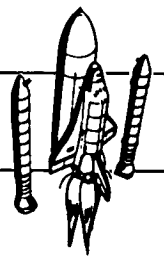
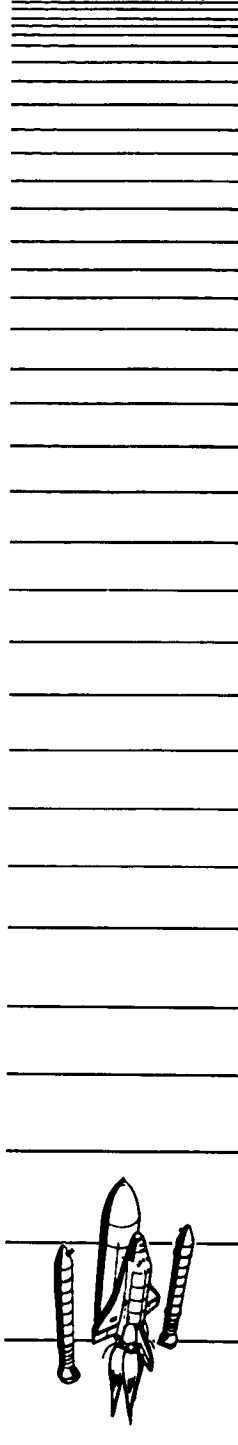

CHAPTER TWO

MANNED SPACEFLIGHT

CHAPTER TWO

MANNED SPACEFLIGHT

Wartime research in the fields of aeronautics and rocketry guaranteed that the 1950s would be a promising decade for American engineers and pilots who sought aircraft that would fly faster and higher, and for military specialists and scientists who recognized the rocket's potential. Private industry, the military, and one of the country's chief civilian research organizations, the National Advisory Committee for Aeronautics (NACA), sought to apply the new technology spawned by the crises of a world war to more nationalistic goals. Improved radar and radio interferometry equipment on missile ranges allowed the military to evaluate captured German rockets and their own sounding rockets and fledgling missiles more effectively. Specially-instrumented aircraft proved out new design concepts and operational procedures over California deserts. On the Atlantic coast, engineers used small rockets to conduct materials testing at high speeds. Frontier beyond the atmosphere was the goal of these and other exercises. By mid-decade, the Navy, Army, and Air Force were all exploring different paths by which to reach that frontier.

Rivalry among the services to become the leader of an American "space program" almost swept aside NACA. This advisory-research body was traditionally committed to methodical investigations that would assist the user agency (usually the military) in its mission; space spectaculars and quantum overnight leaps in the state of the art were not its way of doing business. But it was an age of rapid acceleration, and there were pockets of enthusiasm for the new pace even within the conservative NACA.

Sending biological payloads, animal and later human, into space was seemingly a logical extension of two ongoing activities: the scientific satellite-sounding rocket program being conducted by the Naval Research Laboratory, the Army, and others, and the Air Force-NACA hypervelocity research aircraft program.* If intercon-

*During the postwar years, the Army experimented with animals (monkeys and mice) as part of the V-2 program at White Sands Missile Range, while the Air Force conducted similar investigations with Aerobee sounding rockets at Holloman Air Force Base. From 1953 through 1957, however, medical experimentation with animals was discontinued as the military ballistic missile project monopolized flight opportunities and funds. Investigators had to be content with aircraft-borne experiments. In the USSR during the 1950s, researchers sent numerous biological payloads on rocket flights, with dogs being frequent test subjects. For more information, see Loyd S. Swenson, Jr., James M. Grimwood, and Charles C. Alexander, *This New Ocean; A History of Project Mercury*, NASA SP-4201 (Washington, 1966), pp. 37-38; Edward C. Ezell and Linda N. Ezell, *The Partnership; A History of the Apollo-Soyuz Test Project*, NASA SP-4209 (Washington, 1978); and Joel Powell, "Animal Precursors to Manned Space Flight," *Spaceflight 22* (Sept.-Oct. 1980), pp. 315-18.

tinental ballistic missiles could be augmented to boost instruments into orbit, why could they not carry men? If pilots could fly to the fringes of the atmosphere, why could they not go beyond? Except to the enthusiastic believers, the "whys" were obvious. Boosters under development in the mid-1950s by the Air Force and the Army were still experimental and could not be expected to carry large spaceships. Although the mysteries of the sound barrier had been solved with the XS-1 research aircraft, hypervelocity flight above Mach 4 was still challenging the Air Force-NACA team; escape velocities were far out of reach. Medical evidence that man could survive the rigors of spaceflight was sketchy and based on experiments with rocket-powered impact sleds, centrifuges, sounding rockets, and parabolic aircraft flights. Experts could not even agree on the optimum design for a manned spacecraft that would provide the pilot protection from the environment of space as well as withstand the intense heating that was expected during atmospheric reentry. There were enough challenges to keep all interested parties, military and civilian, busy for many years.

Military Proposals for Man-in-Space

A view popular with the Air Force was that the skies belonged to it, and this branch of the military was not going to allow the absence of an atmosphere to restrict its domain. With the Atlas intercontinental ballistic missile, under development at Convair since 1946, the Air Force sought to defer "Soviet aggression." In increasingly sophisticated aircraft, Air Force test pilots in the mid-1950s were flying three times the speed of sound and approaching altitudes of 20 000 meters. Space medicine proved to be a natural extension of aviation medicine, and the Air Force established several special facilities for human factors research as it related to space travel. NACA supported these Air Force programs with research in the fields of aerodynamics, propulsion, structures, and materials. Protection of a warhead during reentry was one critical problem that NACA specialists at the Ames and Langley aeronautical laboratories tackled. Since 1954, the Air Force and NACA, along with the Navy, had also been formally involved in a joint hypersonic research aircraft project that the Air Force labeled X-15.* Flying at speeds in excess of Mach 1 had been "round one." The X-15 with a design speed of Mach 6 at 76 000 meters was "round two." The third round would hopefully take the Air Force into space.

The Soviet Union's unexpected success in orbiting two satellites in 1957, the second one with a biological payload, interfered with the Air Force's incremental plans. The U.S. desperately needed to get into space soon, and with a manned mission, warned military leaders. The Air Force could not hope to launch its weighty X-20 Dyna-Soar (round three, based on a delta-wing flat-bottom glider design favored at NACA's Langley Memorial Aeronautical Laboratory) in the near future, but there was a more feasible alternative: send a man into orbit in a ballistic-shaped capsule

* See chapter 1, pp. 44-51, for more information on the Atlas missile and chapter 4, pp. 202-24, for more on the joint hypervelocity research aircraft program.

atop an ICBM.* NACA engineers at Langley had been studying this possibility, and they agreed that a conical spacecraft with a blunt reentry surface could be launched by missiles currently available. Abandoning for the present a scheme for a mission launched by a two-stage vehicle under development, the Air Force proposed to NACA in January 1958 that the Committee join them in supporting a two-phase manned program. First they would get "Man-in-Space-Soonest" using the ballistic missile (Atlas) approach; then they would proceed with their boost-glide vehicle.¹ Before NACA and the Air Force could formalize any agreement, events in Washington of a more political nature overtook them. President Dwight D. Eisenhower, personally committed to keeping space a peaceful frontier, submitted a bill to Congress in April in which he recommended establishing a new civilian agency based on the National Advisory Committee for Aeronautics that would manage this country's space program. NACA waited for Congress to act before committing itself to the Air Force's proposal.

The Army Ballistic Missile Agency (ABMA) at Redstone Arsenal, Huntsville, Alabama, was also anxious to expand its ongoing intermediate range ballistic missile projects into a program involving spaceflight. Under the leadership of Wernher von Braun and other German rocket specialists brought to the U.S. after World War II, ABMA had successfully developed several tactical missiles for the Army. The Redstone missile was sent on its first test flight in 1953. Building on this reliable booster, von Braun's team added two upper stages with which to conduct their own nose cone reentry tests (Jupiter C). Adding to the stack again, ABMA offered the Juno I to the American International Geophysical Year (IGY) committee in 1955 as the best vehicle for launching this country's first artificial satellite. In competition with a project sponsored by the Naval Research Laboratory, the Army orbited the first American satellite (Explorer) in January 1958. With success on their side, von Braun angled for a manned spaceflight assignment, using proposals for a huge clustered-engine rocket as bait. According to specialists in Alabama, not only was orbital manned flight possible, it was a first step to manned lunar bases and space stations. The Advanced Research Projects Agency (ARPA), established in February 1958 to oversee the various space projects and proposals, approved ABMA's scheme for the powerful rocket in August.† The Army, however, was not destined to manage its own manned space program. In Washington, planners of the new civilian space agency were assessing the possible value of von Braun's rocket.²

The Naval Research Laboratory (NRL) near Washington had been the home of sounding rocket research in the U.S. since 1945. Refinements of these small rockets during the postwar years inspired a group of engineers and scientists to respond to the IGY call for a satellite. Although the Army, not NRL, launched the first orbiting payload, Project Vanguard did add to the country's growing pool of knowledge

*Chap. 4, pp. 112-13, discusses Project Dyna-Soar. This glider design, which had been promoted by experts at Langley, was a lifting body-type vehicle. It was designated X-20 in 1962.

†During 1958, the Army was also suggesting that the Redstone missile could be used to launch a man along a steep suborbital trajectory, after which he would splash down in the Atlantic. When Air Force officials declined to get involved in Project Man Very High, the Army renamed their plan Project Adam. The proposal was not considered a practical one by the Department of Defense or ARPA and was not funded.

about space. Within the Navy, there were other groups, the missile contingent among them, who were interested in even more ambitious programs. With the Air Force and NACA, the Navy contributed to the X-15 project, and the service supported aerospace medicine research.³ In 1958, the Navy added to the growing number of proposals for manned spaceflight. Their study of a "Manned Earth Reconnaissance" mission included plans for a cylindrical spacecraft with spherical ends, which could be transformed into a delta-wing inflated glider once in orbit. Project MER was not funded beyond a feasibility study.

NACA's Response to the Space Age

The National Advisory Committee for Aeronautics met the space age introspectively. It had changed since its birth in 1915 from a strictly advisory group to a research organization and policy maker, but it was little known outside the military and the aircraft industry. The NACA laboratories' engineers conducted studies, carried out research, and delivered their reports, but it was not their job to apply the results. The Committee's leaders of the 1940s had been reluctant to commit the organization to a role in rocket propulsion research or the risky new field of astronautics, and it was not until 1952 that a move was made to seriously study flight in the upper atmosphere and space. One small group at the Langley laboratory, the Pilotless Aircraft Research Division (PARAD), was already using rockets as a research tool on nearby Wallops Island, Virginia. Since 1945, PARAD (originally the Auxiliary Flight Division) had been measuring the effects of hypervelocity flight and the resultant heating on models launched by small rockets.⁴ In California at the Ames Research Laboratory, aerodynamicists working with H. Julian Allen conducted wind tunnel experiments with missile nose cone models for the Air Force. They discovered that a blunt-bodied configuration rather than the sharp-nosed one being considered at Convair for Atlas would survive atmospheric reentry. These nose cone studies led Allen and his colleagues Alfred J. Eggers, Jr., and Stanford E. Neise to speculate on designs suitable for manned spacecraft of the future. In an important paper, the three men discussed ballistic, skip, and glide vehicles.⁵

As the Air Force Air Research and Defense Command's interest in manned spaceflight grew, so did the amount of spaceflight-related research at NACA, although it still remained low priority relative to aeronautics work. By 1957, however, an estimated 40 to 50 percent of NACA's assignments involved space research. Supporters of all three of the proposed general designs for a manned spacecraft existed at NACA, with the early favorite, especially at Langley, being a delta-wing flat-bottom glider. Eggers borrowed from this configuration and the ballistic shape to design what came to be called a lifting body—a semiballistic vehicle with a certain amount of aerodynamic lift with a nearly flat top and a round bottom (the M-1). This design was further refined, and models were built and flight-tested at the Flight Research Center near Edwards Air Force Base, California.* PARAD engineers led by Maxime A. Faget and Paul E. Purser stuck by their original studies,

* See chapter 4, pp. 110-24, for more on NASA's lifting body program.

which favored the ballistic shape. While the Langley researchers worked in their spare time on refining their suggestions for a manned spaceflight, the Soviets orbited the first two artificial satellites. NACA Headquarters in Washington reacted to Sputnik with a new committee: the Special Committee on Space Technology; its members were charged with finding ways in which NACA could participate more aggressively in upper atmosphere and space research.

NACA was not the only body to form investigating committees in response to the Soviet Union's mechanical moons. A U.S. Senate committee chaired by Lyndon B. Johnson met to review America's prospects for a national space program. The Secretary of Defense established ARPA. And President Eisenhower instructed his new President's Scientific Advisory Committee (PSAC) to study the legality and feasibility of a federally funded space program. In mid-April, the president sent his proposed space bill to Congress, which reflected the advice of his scientific committee and a White House Advisory Committee on Government Organization. It did not take the lawmakers long to revise and approve the National Aeronautics and Space Act of 1958. Passed on July 16, the act was signed into law on the 29th, but it took another month for the White House to assign the important manned spaceflight task to the new civilian National Aeronautics and Space Administration (NASA). Robert R. Gilruth, the first chief of PARD and Langley's assistant director when the space act was passed, was named to chair a NASA-ARPA Manned Satellite Panel in September. These experts, who met for the first time in late September 1958, would provide specific recommendations and a basic procedural plan for NASA's manned program.

Table 2-1.
Events that Influenced NASA's Manned Spaceflight Program prior to the Agency's Establishment

Date	Event
May 7, 1945	The Langley Memorial Aeronautical Laboratory of the National Advisory Committee on Aeronautics (NACA) created an Auxiliary Flight Division, with an operational Research Station located at Wallops Island, Virginia. In 1946, this group, which carried out materials testing and other investigations by means of small rocket launchings, was renamed the Pilotless Aircraft Research Division (PARAD). Robert R. Gilruth was chief of this division until 1952.
1946	The Air Force awarded a contract to Convair to develop a long-range missile, the MX774. Although the Air Force's missile program was cancelled the next year, Convair continued its research in-house.
Nov. 1948	At Randolph Air Force Base, a panel under the direction of Harry G. Armstrong discussed "Aeromedical Problems of Space Travel." Three months later Armstrong established a Department of Space Medicine at Randolph under the direction of Hubertus Strughold.
Jan. 1951	With the reestablishment of the Air Force missile program, the Convair contract was reinstated; the proposed missile was named Atlas.
Sept. 1951	The first successful recovery of rocket-launched animals by an American team took place at Holloman AFB; a monkey and 11 mice survived a sounding rocket flight (The first attempt at this experiment had been made in June 1948.)
Summer 1952	In response to proposals to study hypersonic-class research aircraft, NACA's Committee on Aerodynamics moved to expand its research program to include altitudes of 19 to 80 kilometers at speeds of Mach 4 to 10 and to devote a modest effort to studying escape-velocity flights. Specialists at NACA's Ames Aeronautical Laboratory under the leadership of H. Julian Allen conducted wind tunnel experiments with several configurations that were considered feasible for missile nose cones and spacecraft. Allen's team concluded that a blunt-bodied vehicle would survive atmospheric reentry better than a sharp-nosed one.
Summer 1953	In August, the Army fired its first research and development model of the Redstone missile and began to study nose cone reentry thermodynamics at Redstone Arsenal. At Holloman AFB, the Space Biology Branch of the Aeromedical Field Laboratory began a program that would last more than five years to study weightlessness during parabolic flights. (Other groups interested in weightlessness studies at this time included the Department of Space Medicine, Randolph AFB; the Wright Air Development Center, Wright-Patterson AFB; the Navy School of Aviation Medicine; and NACA's Lewis Flight Propulsion Laboratory.)
1954-1955	At Ames, studies were conducted on the impact of reentry heating on hypervelocity missiles. In a paper, Allen, Alfred J. Eggers, Jr., and Stanford E. Neise discussed the three basic designs they considered appropriate for future space vehicles: ballistic, skip, and glide ("A Comparative Analysis of the Performance of Long-Range Hypervelocity Vehicles," 1954.)
Dec. 23, 1954	Representatives from NACA, the Air Force, and the Navy signed a memorandum of understanding establishing a joint hypersonic research aircraft program. A design for the aircraft proposed at Langley had been accepted earlier in the year. The project was designated X-15 by the Air Force.
1955-1956	At the request of the Air Force, Army, and Navy, NACA tested materials suitable for use as heat sinks and ablatives. The PARAD group studied the heat

Table 2-1.
Events that Influenced NASA's Manned Spaceflight Program prior to the Agency's
Establishment (Continued)

Date	Event
Early 1956	transfer characteristics on variations of a basic blunt heat shield as suggested by Allen of Ames.
Early 1956	The Air Force began letting contracts for feasibility studies of manned satellites; specifically, the Air Force was looking for a project that would take them beyond the X-15. In March, the Air Research and Development Command (ARDC) established two research projects, one to investigate a manned glide rocket research system and another to study a manned ballistic rocket (the final stage of an ICBM). The Command also promoted extensive human factors research at the School of Aviation Medicine, the Aeromedical Field Laboratory, and the Aeromedical Laboratory.
1956-1957	In cooperation with the ARDC, NACA engineers at Langley, Lewis, and Ames conducted manned spacecraft feasibility and design studies. The design most favored was a flat-top round-bottom configuration. At Ames, Eggers compared ballistic, skip, and glide vehicles in his search for a suitable design. Because of its great weight, he revised his original optimum glider design to include features from the ballistic and glider concepts, the result being a semiballistic vehicle, blunt, but with a certain amount of aerodynamic lift and a nearly flat top and round bottom (the M-1 lifting body design). Meanwhile, at Redstone Arsenal, the Army extended its studies of nose cone reentry by modifying and adding to the Redstone missile. The resulting multistage vehicle was called Jupiter C by designer Wernher von Braun and his colleagues in Alabama. In conjunction with its nose cone manufacturers, the Air Force was also investigating reentry heating. The ARDC's Division of Human Factors had concluded that from a medical standpoint, sufficient knowledge and expertise existed to support a manned space mission.
April 1957	The Army Ballistic Missile Agency (ABMA) began studies of a large clustered-engine booster capable of generating 6 672 000 newtons of thrust.
June 11, 1957	Atlas missile flight testing was begun.
Oct. 4, 1957	The USSR successfully orbited <i>Sputnik 1</i> , the first manmade satellite.
Oct. 9, 1957	An ad hoc committee of the Air Force Scientific Advisory Board urged the development of a second generation of ICBM's that could be used as boosters for spacecraft, proposed a manned lunar mission, and recommended that the Air Force launch reconnaissance, weather, and communications satellites as soon as possible.
Oct. 15-21, 1957	At a NACA conference at Ames, the three leading candidate configurations for manned spacecraft were discussed: (1) a delta-wing flat-bottom glider (favored by many at Langley); (2) a ballistic capsule (considered by PARD to be the quickest solution to finding a workable design); and (3) Eggers' M-1, which would weigh from 1800 to 3400 kilograms (still too heavy for existing boosters).
Winter 1957-1958	The American Rocket Society called for a civilian space agency, and the National Academy of Sciences endorsed a plan for a National Space Establishment. At Langley, Maxime A. Faget, Paul E. Purser, and other members of PARD worked on refining a ballistic manned spacecraft design. Additionally, they started exploring the possibility of using a solid-fuel rocket for the research and development phase of a manned program.
Nov. 3, 1957	The USSR successfully orbited <i>Sputnik 2</i> with a dog onboard. The ARDC was charged with preparing a comprehensive astronautics program for the Air Force. At a December 18-20 meeting of NACA's Committee on

Table 2-1.
Events that Influenced NASA's Manned Spaceflight Program prior to the Agency's
Establishment (Continued)

Date	Event
	Aerodynamics, the members called for increased, aggressive NACA participation in upper atmosphere and spaceflight research. On the 22nd, a NACA Special Committee on Space Technology was formed with H. Guyford Stever as chairman.
Jan. 23, 1958	Senator Lyndon B. Johnson summarized the findings of the Senate Preparedness Investigating Committee formed to review the U.S. space program. Their 17 recommendations included establishing an independent space agency.
Jan. 24, 1958	The ARDC's plan for astronautics called for reconnaissance, communications, and weather satellites, recoverable data capsules, manned capsules, manned stations, and eventually a manned lunar base.
Jan. 29-31, 1958	At a closed conference, 11 aircraft and missile companies outlined for the Air Force and NACA their various proposals for manned satellite vehicles.
Jan. 31, 1958	The Air Force formally invited NACA to participate in its man-in-space program. The Committee was asked to support both a one-orbit manned flight and a boost-glide research airplane (Project Dyna-Soar, a design based on Langley's delta-wing flat-bottom glider).
Feb. 1958	The Secretary of Defense created the Advanced Research Projects Agency (ARPA) to manage all existing space projects. President Dwight D. Eisenhower instructed the President's Scientific Advisory Committee (PSAC) to study the feasibility of government-financed astronautical ventures and a national space science program. Late in the month, a PSAC subcommittee suggested establishing a new civilian space agency to be built around NACA. Also during February, the NACA Committee on Aerodynamics was renamed the Committee on Aircraft, Missile, and Spacecraft Aerodynamics.
March 1958	ARPA recognized the Air Force's responsibility to accomplish manned satellite flight as soon as the technology permitted, and the Department of Defense authorized the Air Force to develop a liquid propellant upper stage (Agena) to be used with Atlas or Thor. The ABMA also proposed a manned spaceflight program, which included von Braun's ideas for a clustered-engine booster. On March 10-12, ARDC held a conference in Los Angeles for Air Force, NACA, and industry specialists who were working in the fields of rocketry, aeronautics, or biotechnology. Most attendees agreed that a simple ballistic capsule would offer the quickest means for getting man into orbit. On the 14th, NACA officially informed the Air Force that it would cooperate in drawing up a detailed manned satellite development plan. Also on the 14th, a NACA Conference on High-Speed Aerodynamics began at Ames, at which Faget (PARC) presented a paper favoring the wingless nonlifting ballistic configuration for manned spaceflight. (The paper was coauthored by Faget, Benjamin J. Garland, and James J. Buglia).
Winter-Spring 1958	At Langley, PARC and other research divisions devoted their time to working out the details of a manned mission that would utilize the ballistic-type spacecraft and the Atlas missile. On another front, working to determine the human body's tolerance to increased gravity, it was discovered at Holloman AFB on a rocket-driven impact sled that 83g represented the limit of human tolerance for deceleration. Using centrifuges at the Navy's Aviation Medical Acceleration Laboratory and at the Air Force's Aeromedical Laboratory, specialists determined that 8g represented the acceleration safety limit.
April 1958	When the Air Force refused to participate in the Army's plans for an inter-service "Man Very High" spaceflight project, the ABMA devised an Army-

Table 2-1.
 Events that Influenced NASA's Manned Spaceflight Program prior to the Agency's
 Establishment (Continued)

Date	Event
April 14, 1958	Navy proposal called Project Adam. Using a modified Redstone, von Braun and his colleagues wanted to launch a man in a sealed capsule along a steep ballistic trajectory, after which the capsule would land in the ocean and be recovered.
May 2, 1958	President Eisenhower sent his proposed space bill (based largely on PSAC's advice and the White House Advisory Committee on Government Organization's suggestions) to Congress; special committees began hearings on the bill.
Mid-May 1958	Air Force Headquarters was sent detailed designs and procedures for the ARDC Ballistic Missile Division's "Man-in-Space-Soonest" scheme.
June 16, 1958	NACA and the Air Force tabled their agreement to work together on a ballistic manned spacecraft project.
July 11, 1958	ARPA approved a revised Air Force Man-in-Space-Soonest proposal that called for using the Atlas rather than a proposed two-stage vehicle. However, only funds for life support system studies were granted.
July 16, 1958	ARPA rejected the Army's Project Adam.
Aug. 1958	Congress passed the National Aeronautics and Space Act of 1958, creating the National Aeronautics and Space Administration; Eisenhower signed the act into law on the 29th.
Sept. 1958	Eisenhower assigned the new space administration specific responsibility for developing and carrying out the mission of manned spaceflight. The Air Force Man-in-Space-Soonest project was cancelled, money earmarked for it being transferred to NASA. But the Air Force was allowed to proceed with development of Dyna-Soar in conjunction with NASA. On the 15th, ARPA provided the Army Ordnance Missile Command with the authority to develop the Juno V launch vehicle based on von Braun's plans for a large clustered-engine rocket.
Oct. 1, 1958	A NASA-ARPA Manned Satellite Panel (Gilruth of Langley, chairman) was formed to generate specific recommendations and a basic procedural plan for NASA's manned satellite project. The panel began holding meetings during the last week of the month.
Oct. 1, 1958	NASA officially began operations.

Manned Spaceflight, 1958-1968

From the Langley engineers' studies of reentry configurations grew Project Mercury, NASA's first entry in the manned space program.* Project Mercury would prove that one man could be safely launched into earth orbit in a ballistic-shaped spacecraft, that he could survive increasing lengths of time in the weightlessness of space, that his progress could be monitored by a global network of ground stations, and that he could return safely to a predetermined splash-down point where crews waited to recover him. Beyond earth orbit was the moon, orbiting space stations, perhaps manned exploration of the planets. Mercury was only a simple first step.⁶

NASA officials were working steadily toward manned orbital flight in the spring of 1961, anticipating the first suborbital piloted missions that were scheduled to take place soon, when the USSR launched another "space first." Yuri A. Gagarin in *Vostok 1* circled the earth on April 12. The U.S. was still 10 months away from its first orbital manned mission. NASA had tested full-scale models of the Mercury spacecraft during suborbital flights, had a team of astronauts in training, and had successfully flight-tested the Redstone and Atlas boosters, but a Russian astronaut had earned the title "first man in space." An American president would once again react to Soviet space feats with a countermove. The United States was the technological leader of the world, President John F. Kennedy asserted just weeks after the Gagarin flight, and NASA would prove it by landing a man on the moon and returning him safely by the end of the decade—an ambitious goal for the young agency.⁷ Project Apollo, NASA's proposed lunar enterprise, was thus given the administration's highest priority. Apollo would require great sums of money and most of the agency's attention during its first decade. Before John Glenn could make the first U.S. orbital flight aboard his Mercury *Friendship 7* spacecraft in February 1962, NASA had already reorganized its headquarters management to reflect the increased commitment it had given Apollo.

However, NASA did not leap from Mercury to Apollo. Project Gemini, the intermediate step, called for a spacecraft larger than Mercury to accommodate two passengers for longer missions. With more control over their spacecraft, Gemini astronauts would demonstrate rendezvous and docking with other vehicles while in orbit. These second-generation spacecraft circled earth in 1965 and 1966 on missions lasting from 4 hours to 13 days. The highly successful project gave NASA's operations people experience with tracking and supporting two manned spacecraft simultaneously and an appreciation for the mechanics of orbital rendezvous and extravehicular activity. It also gave von Braun's team in Alabama and the engineers at the Manned Spacecraft Center in Houston the time they needed to develop the powerful Saturn V launch vehicle and the complex Apollo spacecraft.

*At an important meeting at Ames in March 1958, Faget delivered a formal paper defining the ballistic-shaped manned spacecraft (Maxime A. Faget, Benjamin J. Garland, and James J. Buglia, "Preliminary Studies of Manned Satellites—Wingless Configuration: Nonlifting," in "NACA Conference on High-Speed Aerodynamics, Ames Aeronautical Laboratory, Moffett Field, Calif., Mar. 18, 19, and 20, 1958: A Compilation of Papers Presented," pp. 9-34, reissued as NASA Technical Note D-1254, Langley Research Center, 1962).

Apollo with its crew of three would not be boosted directly to the moon. From earth orbit, Apollo and the final stage of the launch vehicle would begin the trip to the moon. Along the way, the command and service module would pull away from the Saturn stage, turn around and return to dock with a lunar module, and then continue the journey. From lunar orbit, the lunar module would make the landing with two of the men. After the astronauts had completed their lunar tasks, the module would return to the orbiting ship. At the close of NASA's first decade, the agency was near its lunar goal. In November 1967, a Saturn V successfully orbited an unmanned spacecraft (*Apollo 4*). In December 1968, three Americans orbited the moon aboard *Apollo 8*.⁸ NASA was no longer in a contest with the Soviet Union to reach earth's natural satellite; its race was with the calendar.*

Managing the Manned Program at NASA

Under NASA Headquarters's first organizational plan, manned spaceflight was assigned to Abe Silverstein's Office of Space Flight Development as part of the Advanced Technology Program (Newell D. Sanders, assistant director). Even before President Kennedy's decision in May 1961 to assign NASA the task of sending astronauts to the moon before 1970, agency managers had been moving to reorganize the Washington offices to correspond with four broad program areas: applications, advanced research and technology, space sciences, and manned spaceflight. It quickly became apparent that the Office of Manned Space Flight (OMSF) under Director D. Brainerd Holmes would be responsible for NASA's major project of the decade, Apollo, to which Project Mercury and Project Gemini were stepping stones. Reporting to Holmes were directors for launch vehicles, propulsion, spaceflight, and flight missions, systems engineering, aerospace medicine, program review and resources management, and integration and checkout. In the spring of 1963, Holmes added to his network of managers. Two deputy directors, one for programs and one for systems, joined the team, along with a director for systems studies and a representative from the Air Force Systems Command. Holmes, who had been with RCA before joining NASA in November 1961, was totally committed to achieving the lunar landing goal. He was so committed that he and Administrator James E. Webb often disagreed over policy and budget matters, especially when Webb believed that OMSF's demands threatened the agency's other programs. In March 1963, Holmes testified that the administration's refusal to seek supplemental funds for Apollo and Gemini had led to delays in Gemini's schedule. NASA's director of manned spaceflight returned to industry soon thereafter. When

*The existence of an actual race to the moon with the Soviets is still under debate. Most experts believe that any early discussions by Soviet spokesmen of manned flights to the moon and beyond were political in nature or at least premature and not based on the actual hardware under development. The Soviets relied on automatic spacecraft to explore the moon and the planets, devoting their manned program to increasingly sophisticated earth-orbital activities. During the early 1960s, however, it was the firm conviction of many Americans that success with Project Apollo would prove the technological, and thus the military, superiority of the U.S.

George E. Mueller became associate administrator for manned spaceflight on September 1, 1963, the management responsibilities of the program had grown considerably. To assist him, Mueller often had up to four deputies plus a manned spaceflight experiments board secretary on his staff. Also reporting to Mueller were a representative from the Air Force Systems Command and directors for field center development, program control, operations, space medicine, Gemini (until 1968), Apollo, advanced manned missions, mission operations (added in 1965), Apollo applications (added in 1965), and safety (added in 1967). This large management structure was operating at the close of the agency's first decade (see table 2-2 for details on OMSF's changing organization.⁹

When President Eisenhower delegated authority for the country's manned space program to the National Aeronautics and Space Administration, Administrator T. Keith Glennan assigned the working level responsibility to Robert Gilruth. As assistant director of the Langley center, Gilruth had encouraged the small group of designer-engineers from the Pilotless Aircraft Research Division in their studies of the ballistic-shaped spacecraft. On November 5, 1958, Gilruth borrowed heavily from PARD to build a Space Task Group (STG) with which to manage Project Mercury, the first phase of the agency's manned program.* Charles J. Donlan was appointed assistant program manager. In addition to his duties as program manager, Gilruth was also assistant director for a new NASA center to be built near Greenbelt, Maryland. Until their new home was ready, the Space Task Group would stay at Langley. Gilruth's team reported directly to NASA Headquarters through George M. Low, chief of manned spaceflight.¹⁰

STG's size grew as Project Mercury matured. As specialists finished mission definition studies and began the advanced engineering work, the group's ranks reached 400 during the summer of 1959. One small cadre relocated in Florida at the Atlantic Missile Range to ready NASA's manned launch site, while another went to the midwest to oversee the work of the spacecraft prime contractor, McDonnell Aircraft Corporation, in St. Louis. In Virginia, Gilruth divided his organization into three divisions: flight systems under Faget, engineering under James A. Chamberlin, and operations under Charles Mathews. This three-directorate system was intact in late 1960 when the manned spaceflight team learned they would not be moving to the Goddard Space Flight Center along with the unmanned space projects group. Instead, the STG was declared an autonomous organization. The events of the spring of 1961—Gagarin's orbital flight and Kennedy's declaration concerning a lunar

*Of the 36 original members of the STG from Langley, 14 were drawn from PARD (William M. Bland, Jr., Aleck C. Bond, Maxime A. Faget, Edison M. Fields, Jack C. Heberlig, Clairborne R. Hicks, Jr., Alan B. Kehlet, Ronald Kolenkiewicz, John B. Lee, Betsy F. Magin, Paul E. Purser, Herbert G. Patterson, Frank C. Robert, and Julia R. Watkins); 5 from the Flight Research Division (Robert G. Chilton, Jerome B. Hammack, Christopher C. Kraft, Jr., Charles W. Mathews, and John P. Mayer); 2 from the Instrument Research Division (William J. Bayer and Harry H. Ricker, Jr.), 2 from the Office of the Assistant Director (Charles J. Donlan and Robert R. Gilruth), 2 from the Stability Research Division (George F. MacDougall, Jr., and Charles H. Zimmerman), 1 from the Structures Research Division (Melvin S. Anderson), 1 from the Full-Scale Tunnel Research Division (Paul D. Taylor), 1 from the Dynamic Loads Division (William T. Lauten, Jr.), plus 1 each from the planning and fiscal offices (William C. Muhly and Ronelda F. Sartor), and 3 stenographers and 3 file clerks. Ten other specialists from the Lewis Research Center brought the total number of scientist-engineers to 38.

landing—prompted NASA officials to find a permanent center for Gilruth's growing family. From a group of 20 prospective locations for the Manned Spacecraft Center, NASA chose Houston, Texas, and Gilruth began moving his people south into temporary quarters in October.* The relocation was completed by mid-1962.

Gilruth's management plan for MSC was not unlike the STG style: directorates for administrative, engineering, and operations activities; program offices for Mercury, Gemini, and Apollo. Engineering and development (Faget), flight crew operations (Donald K. Slayton), and general operations (Christopher Kraft) were joined by two new directorates in 1966: science and applications and medical operations. Program offices were dropped when their objectives were met; new ones were added to manage future flight projects: Apollo applications (1966) and advanced missions (1968). (See table 2-3 for a summary of STG and MSC organizational changes.)

*During August 1961, a site selection team led by John F. Parsons (Ames Research Center) evaluated 20 cities in their search for a location that met 10 specific requirements for the new manned spaceflight center. These requirements included available facilities for advanced scientific study, power facilities and utilities, water supply, mild climate, adequate housing, at least 1000 acres of land, available industrial facilities, transportation, including water for shipping by barge, jet service airport, and local cultural and recreational facilities. Sites considered were Tampa and Jacksonville, Florida; New Orleans, Baton Rouge, Shreveport, and Bogalusa, Louisiana; Houston, Beaumont, Corpus Christi, Victoria, Liberty, and Harlingen, Texas; St. Louis, Missouri; Los Angeles, Berkeley, San Diego, Richmond, Moffett Field, and San Francisco, California; and Boston, Massachusetts. On September 19, it was announced that MSC would be constructed on 1000 acres donated by Rice University southeast of Houston. On November 1, the STG was officially redesignated the Manned Spacecraft Center, with Gilruth as director.

Table 2-2.
Four Phases of Manned Spaceflight
Management, NASA Headquarters*

Phase I
Oct. 1958-Oct. 1961

Administrator/Deputy Administrator/Associate Administrator

Director, Space Flight Development (Abe Silverstein); office renamed Space Flight Programs in 1960

Assistant Director, Advanced Technology (Newell D. Sanders); office renamed Applications and Manned Flight Programs in 1960

Chief, Manned Space Flight (George M. Low)

Chief, Manned Satellites (Warren J. North)

Chief, Advanced Manned Systems (John H. Disher)

Chief, Biotechnology (G. Dale Smith); office dropped in 1960

Staff Scientist (Richard J. Wisniewski); office dropped in 1961

Chief, Plans and Evaluation (Merle G. Waugh); office added in 1961

Phase II
Nov. 1961-Winter 1962-1963

Administrator/Deputy Administrator

Associate Administrator

Director, Manned Space Flight (D. Brainerd Holmes)

Executive Assistant (Clyde Bothmer)

Director, Launch Vehicles and Propulsion (Milton W. Rosen)

Deputy Director, Launch Vehicles and Propulsion (Stanley M. Smolensky); office added Aug. 1962

Executive Assistant (John R. Schaibley; William T. Ashley, 1962)

Technical Assistant (Harvey Hall)

Assistant Director, Launch Vehicle Engineering (Eldon W. Hall; Rosen, acting, 1962)

Assistant Director, Vehicles (Richard B. Canright; Smolensky, acting, 1962)

Assistant Director, Propulsion (Adelbert O. Tischler)

Assistant Director, Launch Operations (Gus A. D'Onofrio; John K. Holcomb, June 1962)

Director, Spacecraft and Flight Missions (Low)

Executive Assistant (Paul E. Cotton)

Assistant Director, Apollo Spacecraft Development (Disher)

Assistant Director, Manned Satellite Programs (North; Daniel D. McKee, 1962)

Assistant Director, Manned Spaceflight Operations (Harper E. Van Ness)

Assistant Director, Human Engineering (Fred Ireland)

Chief, Future Projects, Plans, and Evaluations (Waugh, 1962); office dropped in 1962

Deputy Director, Systems Engineering (Joseph F. Shea)

Executive Assistant (Joseph R. Quinn)

Director, Systems Engineering (John A. Gautraud)

Assistant Director, Systems Engineering, Vehicle and Spacecraft (Eldon W. Hall); office renamed Design and Performance in 1962

Assistant Director, Flight Systems (Michael Yarymovych); office added in Oct. 1962

Assistant Director, Communications and Tracking (James H. Turnock, Jr.)

Table 2-2.
Four Phases of Manned Spaceflight
Management, NASA Headquarters* (Continued)

Assistant Director, Design Practices and Reliability (James E. O'Neill)
 Director, Systems Studies (William A. Lee)
 Assistant Director, Evaluation Studies (Douglas R. Lord); office renamed Systems Studies
 Mission Planning in early 1962 and then Program Planning later in 1962
 Assistant Director, Engineering Studies (William B. Taylor)
 Assistant Director, Human Factors (William A. Lee)
 Assistant Director, Space Science Studies (vacant)
 Director, Aerospace Medicine (Charles H. Roadman)
 Deputy Director, Aerospace Medicine (George M. Knauf); office added in Jan. 1962
 Executive Assistant (J. Robert Brown)
 Technical Assistant, Program Control and Systems (Alfred M. Mayo); office dropped in 1962
 Assistant Director, Analysis (James P. Nolan, Jr.); office renamed Plans and Programs in 1962
 Assistant Director, Medical Operations (W. R. Turner; David H. Stoddard, 1962)
 Assistant Director, Advanced Technical Development (Frank B. Voris; Joseph Connor, 1962);
 office renamed Test and Evaluation in 1962
 Director, Program Review and Resources Management (William E. Lilly)
 Assistants, Program Management (Secret L. Berry and Juanita Hathcock)
 Assistant Director, Plans and Resources (William P. Risso)
 Assistant Director, Facilities (Rodolfo A. Diaz)
 Chief, Program Management Support (Alex P. Nagy)
 Director, Integration and Checkout (James E. Sloan; directorate added in Feb. 1962)
 Executive Assistant (Schaibley)
 Assistant Director, Checkout (Jack F. Underwood)
 Assistant Director, Reliability Assessment (Richard H. Myers)
 Assistant Director, Integration (vacant)

Phase III

Spring 1963-Aug. 1963

Administrator/Deputy

Associate Administrator

Director, Manned Space Flight (D. Brainerd Holmes)
 Executive Assistant (Bothmer)
 Deputy Director (Programs) (Low)
 Executive Assistant (Cotton)
 Deputy Director (Systems) (Shea)
 Special Assistant (Systems) (Bert A. Denicke)
 Deputy to Commander, Air Force Systems Command (Osmond J. Ritland)
 Assistant Deputy to Commander, Air Force Systems Command (Harvey W. C. Shelton)
 Executive Officer (John B. Chickering)
 Director, Space Medicine (John M. Talbot)
 Director, Launch Vehicles and Propulsion (Donald H. Heaton)

Table 2-2.
Four Phases of Manned Spaceflight
Management, NASA Headquarters* (Continued)

Phase III (Continued)

Spring 1963-Aug. 1963

- Director, Program Review and Resources Management (C. C. Lutman)
- Director, Launch Vehicles and Propulsion (Robert F. Freitag)
 - Executive Assistants (Ashley and Harvey Hall)
 - Deputy Director, Launch Vehicles and Propulsion (Smolensky)
 - Assistant Director, Vehicles (Smolensky, acting)
 - Assistant Director, Propulsion (Tischler)
 - Assistant Director, Launch Operations (John K. Holcomb)
- Director, Spacecraft and Flight Missions (Low, acting)
 - Executive Assistant (Cotton, acting)
 - Assistant Director, Apollo Spacecraft Development (Disher)
 - Assistant Director, Information and Control Systems and Human Factors (Ireland)
 - Assistant Director, Manned Spaceflight Operations (Van Ness)
 - Assistant Director, Manned Satellites (McKee)
- Director, Systems Engineering (Gautraud)
 - Assistant Director, Communications and Tracking (Turnock)
 - Assistant Director, Design and Performance (Eldon W. Hall)
 - Assistant Director, Flight Systems (Yarymovych)
- Director, Systems Support Group (Cole)
- Director, Systems Studies (William A. Lee)
 - Assistant Director, Engineering Studies (Taylor)
 - Assistant Director, Human Factor Studies (vacant)
 - Assistant Director, Program Planning (Lord)
 - Assistant Director, Exploration Studies (vacant)
- Director, Aerospace Medicine (Roadman)
 - Deputy Director, Aerospace Medicine (Knauf)
 - Executive Assistant (J. Robert Brown)
 - Assistant Director, Development Test and Evaluation (Connor)
 - Assistant Director, Medical Operations (Stoddard)
 - Assistant Director, Plans and Programs (Nolan)
- Director, Program Review and Resources Management (Lilly)
 - Assistants, Program Management (Berry and Hathcock)
 - Assistant Director, Plans and Resources (Risso)
 - Assistant Director, Facilities (Diaz)
 - Chief, Program Management Support (vacant)
- Director, Integration and Checkout (vacant)
 - Executive Assistant (Schaibley)
 - Assistant Director, Checkout (Underwood)
 - Assistant Director, Reliability Assessment (O'Neill)
 - Assistant Director, Integration (Philip S. Selvaggi)

Table 2-2.
Four Phases of Manned Spaceflight
Management, NASA Headquarters* (Continued)

Phase IV

Sept. 1963-1968

Administrator/Deputy Administrator

Associate Administrator

Associate Administrator, Manned Space Flight (George E. Mueller)

Deputy Associate Administrator, Manned Space Flight (Low, Nov. 1963-May 1964; James C. Elms, Sept. 1965-Sept. 1966; Edgar M. Cortright, Oct. 1967-Apr. 1968; Charles W. Mathews, May 1968)

Executive Assistant (Cotton); office dropped in 1964

Special Assistants (Everett E. Christiansen and Joe T. Dickerson); office added in 1964 and dropped in 1965

Deputy Associate Administrator (Management) (William B. Rieke, Nov. 1964-June 1965; Frank A. Bogart, Sept. 1965)

Deputy Associate Administrator (Programs) (David M. Jones, Nov. 1964); office dropped in May 1967

Deputy Associate Administrator (Technical) (Shea, Apr.-July 1967; Harold T. Luskin, March-Apr. 1968; Charles J. Donlan, May 1968)

Deputy Associate Administrator, Manned Space Flight Operations (Walter C. Williams, Nov. 1963-Apr. 1964); office dropped in Apr. 1964

Executive Secretary, Manned Space Flight Experiments Board (Denicke; William O. Armstrong, 1967); briefly during 1965 this function was assigned to the Advanced Manned Mission Program Office

Deputy to Commander for Space, Manned Space Flight, Air Force Systems Command (AFSC) (Ritland; Harry L. Evans, 1966), directorate reduced in size in early 1967 and dropped later that year

Assistant Deputy to Commander for Space, Manned Space Flight, AFSC (Shelton); office dropped in 1964 but reactivated as Assistant Deputy to Commander for Space Systems in early 1967 to oversee reduced operations (Walter R. Hedrick)

Executive Officer (Chickering); office dropped in 1964

Director, AFSC Directorate, NASA Program Support (John M. Coulter, 1964; Harry B. Allen, 1964); office added in 1964; redesignated Chief, NASA Programs Support Division in early 1967

Director, Gemini Program Support (M. P. Yopchick; W. J. Fry, 1965; Herman Dorfman, 1966); office dropped in early 1967

Director, Apollo and MOL Program Support (Dorfman, 1965; James E. Miller, 1967); office changed to Systems Officer, Apollo and MOL, in 1967

Director, Advanced Manned Mission Support (Coulter, 1964; Allen, 1964; John R. Burke, 1965; James E. Miller, 1966)

Director, Program Support (Lutman; Yopchick, 1965; James E. Miller, 1965); office redesignated Systems Officer, Program Support, in 1967

Director, Biomedical Support (Donald C. Almy, 1964; H. Grady Wise, 1965); office redesignated Systems Officer, Biomedical Support, in 1967

Director, Procurement Processes Support (Alvin E. Greenhorn); office added in 1965 and dropped in 1966

Director, Manned Space Flight Field Center Development (Freitag)

Table 2-2.
Four Phases of Manned Spaceflight
Management, NASA Headquarters* (Continued)

- Deputy Director, Manned Space Flight Field Center Development (Smolensky; Freitag, acting, 1968; V. John Lyle, Aug. 1968); office added in Nov. 1963
- Director, Technical Staff (William F. Moore); position called Executive Assistant in 1964-1965, and Chief, Technical Staff, in 1965-1967
- Director, Logistics (Smolensky; office renamed Center Development Planning in 1964 and dropped in 1965)
- Director, Manpower (Freitag, acting, 1964-1965; Smolensky, acting, 1966; William J. Bolce, 1967); office renamed Special Operations in 1964 and Special Staff in 1965
- Director, Resources (Van Ness); office dropped in 1964
- Director, Manned Space Flight Program Control (Lilly; Bogart, acting, March 1967; Maynard E. White, June 1967; Jerald R. Kubat, Jan. 1968)
- Executive Assistant (Albert P. Little, 1963-1965; Anthony Cannetti, 1968)
- Director, Facilities Management (Diaz; Maynard E. White, acting, 1967; Harry Mitchell, 1968); office known as Facilities Programming Construction in 1964-1967; office dropped in 1968
- Director, Plans and Analysis (Norman Rafel)
- Director, Programming Operations (Lilly, acting; Bernard L. Johnson, June 1964)
- Director, Test Systems Requirements (Lilly, acting, 1965); office operated only briefly in 1965
- Director, Resources Analysis (Charles E. Koenig); office added in Nov. 1968
- Director, Manned Space Flight Management Operations (Bothmer; Bogart, Feb. 1965; Cotton, Sept. 1965; White, Jan. 1968)
- Executive Assistant (Harold E. Pryor); office dropped in 1965
- Director, Management Assistant and Personnel (William R. Sweeney; C. C. Coyne, 1965); office added in 1964
- Director, Procurement Management (M. J. Barkdull Kahao; Charles J. Bingman, July 1966; Cotton, acting, June 1967; William P. Davis, 1968)
- Chief, Special Services (Jay Holmes); office dropped in 1964
- Director, Space Medicine (Knauf, acting; W. Randolph Lovelace, II, Apr. 1964; Jack Bollerud, acting, Feb. 1966; James W. Humphreys, June 1967)
- Deputy Director, Space Medicine (Knauf, Apr.-Dec. 1964; Bollerud, June 1965-June 1967); office dropped in 1967
- Assistant, Program Coordination (Herbert S. Brownstein)
- Director, Medical Science and Technology (Sherman P. Vinograd); office called Professional Services in 1963-1964
- Director, Medical Operations (Knauf, acting; vacant, 1965-1966); office dropped in 1966
- Director, Lunar Receiving Operations (John Pickering); office added in 1966; earlier that year Pickering held the post Special Assistant to Director, Space Medicine
- Director, Gemini Program (Low, acting; Mueller, acting, 1965-1968); directorate was downgraded in early 1967 and disbanded entirely in 1968
- Special Assistant (Samuel H. Hubbard); Hubbard continued in this post until the directorate was disbanded in 1968
- Deputy Director, Gemini Program (William E. Schneider; LeRoy E. Day, acting, Oct. 1965; John A. Edwards, July 1966)
- Director, Program Control (Richard C. Henry; Anthony L. Liccardi, acting, 1964; J. Pemble Field, 1965; William A. Summerfelt, acting, 1965)
- Director, Systems Engineering (Eldon W. Hall, Dec. 1963-Nov. 1966)

Table 2-2.
Four Phases of Manned Spaceflight
Management, NASA Headquarters* (Continued)

Director, Test (Day; Charles W. McGuire, acting 1965-1966; Clarence C. Gay, Jr., 1966)
Director, Flight Operations (Edwards; Hubbard, July 1966)
Director, Reliability and Quality (Dwight C. Cain; Schneider, acting, 1965; Day, 1965-1966; Edwards, July 1966)
Director, Apollo Program (Mueller, acting; Samuel C. Phillips, Oct. 1964)
Deputy Director, Apollo Program (Phillips, Jan.-Oct. 1964; Lee B. James, Feb. 1967; George H. Hage, Jan. 1968)
Executive Assistant (Schaibley; Gilbert L. Roth, 1967; Schaibley, 1967)
Deputy Director (Programs) (Turnock); office added in 1966 and dropped in 1968
Deputy Director (Engineering) (Hage, Oct. 1967-Jan. 1968; William E. Stoney, Sept. 1968); office added in 1967
Special Assistant (Operational Readiness) (Harold G. Russell); office added in 1966 and dropped in 1967
Special Assistant (Allen Jones); office operated only briefly in 1967
Assistant Director (Management) (Thomas E. Jenkins); office added in Feb. 1968
Mission Director (Schneider); office added in July 1967
Assistant Mission Directors (Chester M. Lee, Aug. 1966-1968; and Thomas H. McMullen, 1968); both men served as assistant directors in 1968
Director, Program Control (Phillips, acting, 1964; Milo L. Seccomb, 1965; Kubat, July 1967; James B. Skaggs, Jan. 1968)
Director, Test (Disher; Melvyn Savage, Aug. 1965; Day, July 1966)
Director, Flight Operations (Williams, acting; Holcomb, Nov. 1963)
Director, Reliability and Quality Control (Turnock; George A. Lemke, 1964; George C. White, Jr., Nov. 1966)
Director, Apollo Lunar Exploration (Lee R. Scherer); directorate added in Dec. 1967; the several assistant directorships were added during 1968
Assistant Director, Flight Systems Development (William T. O'Bryant)
Assistant Director, Lunar Science (R. J. Allenby)
Assistant Director, Lunar Sample Program (Benjamin Milwitsky)
Assistant Director, Lunar Sample Program (Verl R. Wilmarth)
Director, Systems Engineering (Bellcomm) (Thomas H. Thompson, 1964; Robert L. Wagner, 1967)
Vice President, General Manager (Boeing) (George Stoner; C. A. Wilkinson, 1968); office added in 1967; Wilkinson's title was Assistant Division Manager (Boeing)
Washington Office (General Electric) (Jack E. Vessely); office added in 1968
Director, Advanced Manned Missions Program (Edward Z. Gray; George S. Trimble, Apr. 1967; Lord, acting, Oct. 1967; Cortright, acting, early 1968; Donlan, acting, May 1968)
Executive Assistant (William A. LaRue)
Deputy Director, Advanced Manned Missions Program (Lord); office added in Nov. 1966
NASA-USAF Technical Director, MOL (Yarymovych); office added in 1965 and dropped in 1968
NASA DoD Technical Advisor (Hubbard); office added in 1968
Director, Program Control (Gray, acting, 1964; Walter C. Beckwith, 1965; Waugh, 1967)
Director, Special Manned Space Flight Studies (Taylor); office dropped in 1965

Table 2-2.
Four Phases of Manned Spaceflight
Management, NASA Headquarters* (Continued)

- Director, Systems Engineering (Lord, Eldon W. Hall, Nov. 1966; Brian T. Howard, Dec. 1967)
- Director, Manned Space Flight Advanced Technology (William D. Greene); office dropped in 1965
- Director, Vehicle Studies (Lester K. Fero; A. Daniel Schnyer, March 1965); office renamed Transportation Systems in 1968
- Director, Earth Orbital Mission Studies (Yarymovych, acting; Maurice J. Raffensperger, 1974); office dropped in March 1968
- Director, Lunar Mission Studies (Thomas C. Evans, acting; Franklin P. Dixon, acting, Feb. 1965; Thomas E. Hanes, spring 1965; Philip E. Culbertson, Sept. 1965; P. Grosz, May 1967); office dropped in March 1968
- Director, Planetary Mission Studies (Lord, acting; Dixon, June 1964); office dropped in March 1968
- Director, Experiments (Lord, acting; Armstrong, 1967); office added in 1965 and renamed Payloads in March 1968
- Executive Secretary, Manned Space Flight Experiments Board (Denicke); office added in summer 1965, but by year's end it was moved back to the direct purview of the Associate Administrator for Manned Space Flight
- Director, Supporting Development (Eldon W. Hall); office added in Dec. 1967
- Director, Mission Planning and Operations (Raffensperger; Lord, acting, Apr. 1968; Jack W. Wild, winter 1968); office added in March 1968
- Director, Manned Spacecraft (Dixon); office added in March 1968
- Director, Mission Operations (Christensen; John D. Stevenson, Feb. 1967); directorate added in Jan. 1965
- Executive Assistant (Joseph W. Cover; L. K. Abernethy, acting, winter 1967; Archer W. Kinny, 1968)
- Deputy Directors, Mission Operations (Carroll H. Bolender, Schneider, and Roderick O. Middleton); office added in 1966 and dropped in mid-1967
- Mission Directors (Bolender, Jan. 1965-early 1966; and Robert Thompson, June 1965-early 1966); this office was dropped in early 1966 and the mission director function transferred to the various program offices
- Assistant Mission Director (Apollo) (Chester M. Lee); this office was briefly part of Mission Operations in 1967; function was assumed by the Apollo Program Office
- Director, Operations Support Requirements (B. Porter Brown)
- Chief, Ground Operations Support Systems (William E. Miller); office renamed Information and Control Systems in 1967
- Chief, Flight Crew Support (Reuben P. Prochard, Jr.; Thomas U. McElmurry, 1965; John Prodan, 1967)
- Director, Systems Analysis (Bellcomm) (John Hibbert); office added in 1967
- Chief, Operations Planning (Chester M. Lee, Aug. 1965-July 1966; Nolan, mid-1967 to mid-1968); office added in Aug. 1965
- Chief, Program Control (Abernethy); office added in mid-1967
- Director, Saturn/ Apollo Applications (Harold G. Russell; David M. Jones, acting, mid-1965; Mathews, Dec. 1966; Luskin, May 1968); directorate added in Apr. 1965 as the Saturn IB/Centaur Program; it was renamed and expanded later in 1965 and then renamed again in late 1967 to Apollo Applications Program
- Deputy Director, Saturn/Apollo Applications (Fero; Disher, Aug. 1965)

Table 2-2.
Four Phases of Manned Spaceflight
Management, NASA Headquarters* (Continued)

Executive Assistant (Stephan S. Levenson); office added in mid-1966
Assistant (Programs) (Hubbard); office operated only briefly in 1968
Director, Saturn IB/Centaur (Russell); office operated only briefly in 1968
Director, Program Control (Field)
Director, Test (Disher, acting, 1965; Savage, July 1966)
Director, Flight Operations (Taylor, acting; Edwards, Dec. 1966)
Director, Reliability, Quality, and Safety (Field, acting; Haggai Cohen, Sept. 1966)
Director, Apollo Extension Systems (Taylor; Culbertson, May 1967); office renamed Project Integration in mid-1967
Director, Systems Engineering (Bellcomm) (P. L. Havenstein; George M. Anderson, acting, 1966; Donald R. Hagner, 1967)
Director, Manned Space Flight Safety (Jerome Lederer); directorate added in June 1967
Deputy Director, Manned Space Flight Safety (Philip H. Bolger); office added in Nov. 1967

*These four phases represent composites for each time period. Refer to Appendix A and other NASA historical publications for complete organization charts. Phase four (Sept. 1963-1968) includes many offices whose existence was short-lived within the 11 OMSF directorates; extra information has been included to indicate when these offices were added or dropped.

Table 2-3.

Six Phases of Space Task Group-
Manned Spacecraft Center Organization, 1959-1968

Phase I
1959-Oct. 1961

Director (Robert R. Gilruth)

Associate Director, Development (Charles J. Donlan)

Associate Director, Operations (Walter C. Williams)

Special Assistant (Paul E. Purser)

Technical Assistant (James A. Chamberlin); office dropped in 1960

Executive Assistant (Raymond L. Zavasky)

Chief, Flight Systems Division (Maxime A. Faget)

Assistant Chief, Flight Systems (Robert O. Piland); Piland's title was changed to Assistant Chief, Advanced Projects in 1960

Executive Engineer, Flight Systems (J. T. Markley); office dropped in 1960

Assistant Chief, Mercury Support (Alec C. Bond); office added in early 1960

Chief, Engineering and Contract Administration Division (Chamberlin); office renamed Engineering Division in 1960

Assistant Chief, Engineering and Contract Administration (André J. Meyer, Jr.; and William M. Bland, Jr., 1960)

Executive Engineer (Norman F. Smith); office dropped in 1960

Chief, Operations Division (Charles W. Mathews)

Assistant Chief, Implementation (G. Merritt Preston)

Assistant Chief, Plans and Arrangements (Christopher C. Kraft, Jr.)

Executive Engineer (Chris C. Critzos); office dropped in 1960

Head, Astronauts and Training (Keith G. Lindell)

Flight Surgeon (William K. Douglas)

Training Officer (Robert B. Voas)

Important points regarding Phase I: The first organization chart drawn up for the Space Task Group was dated Sept. 1959, but it was functioning as an organization by Oct. 7, 1958. The third chart (Sept. 1960) gave Faget's flight systems division responsibility for Mercury and Apollo. Astronaut activities were directly under the office of the director. Reporting to the Flight Systems Division were the following branches: electrical systems, flight dynamics, life systems, systems engineering, and structures. Reporting to the Engineering and Contract Administration Division were branches for contracts and scheduling and project engineering. Four branches added to the Operations Division in 1960 managed mission analysis, flight control, recovery operations, and launch operations. Although an Apollo office was established in Sept. 1960, a manager for that office was not selected until the next major reorganization.

Table 2-3.
Six Phases of Space Task Group-
Manned Spacecraft Center Organization, 1959-1968

Phase II

Nov. 1961-1962

Director (Gilruth)

Associate Director (Williams)

Special Assistant (Purser)

Executive Assistant (Zavasky)

Technical Assistant (Don T. Gregory)

Assistant, Human Factors (Voas)

Special Assistant, Astronaut Affairs (Ford Eastman); office added in June 1962

Manager, Mercury Program Office (Kenneth S. Kleinknecht)

Manager, Gemini Project Office (Chamberlin)

Manager, Apollo Program Office (Charles W. Frick)

Assistant Director, Administration (Wesley L. Hjernevik)

Assistant Director, Research and Development (Faget)

Chief, Spacecraft Research Division (Mathews)

Chief, Life Systems Division (White)

Chief, Systems Evaluation and Development Division (Bond)

Chief, Space Physics Division (vacant)

Assistant Director, Operations (Mathews; vacant, Jan. 1962)

Chief, Aerospace Medical Operations (Charles A. Berry)

Chief, Preflight Operations (Preston)

Chief, Flight Operations Division (Kraft)

Chief, Flight Crew Operations (Warren J. North)

Important points regarding Phase II: This phase represents the Space Task Group's reorganization as the Manned Spacecraft Center. Offices for the three flight programs stood alone outside the directorates. During this period, Kraft's Flight Operations Division in the operations directorate grew dramatically as the center readied for Mercury's first orbital missions. Astronaut training was part of flight crew operations in the operations directorate. An assistant director for engineering support with four chiefs assigned to him was carried on the operations directorate's organization chart during this period, but the positions were not filled.

Table 2-3.
Six Phases of Space Task Group-
Manned Spacecraft Center Organization, 1959-1968 (Continued)

Phase III

Spring-Fall 1963

Director (Gilruth)

Deputy Director, Development and Programs (James C. Elms)

Deputy Director, Mission Requirements and Flight Operations (Williams)

Special Assistant (Purser)

Engineering Advisor (Chamberlin)

Assistant, Human Factors (Voas)

Executive Assistant (Zavasky)

Technical Assistant (Gregory)

Manager, Mercury Program Office (Kleinknecht)

Deputy Manager, Mercury Program Office (Bland)

Manager, Gemini Project Office (Mathews)

Manager, Apollo Program Office (Robert Piland, acting; Joseph F. Shea, Oct. 1963)

Deputy Manager, Spacecraft (Robert Piland)

Deputy Manager, Lunar Module (James L. Decker)

Assistant Director, Administration (Hjornevik)

Assistant Director, Engineering and Development (Faget)

Chief, Spacecraft Technology (William E. Stoney)

Chief, Crew Systems (Richard Johnston)

Chief, Systems Evaluation and Development (Bond)

Chief, Space Environment (Faget, acting)

Assistant Director, Information and Control Systems (G. Barry Graves)

Chief, Instrumentation and Electronic Systems (Graves, acting)

Chief, Computation and Data Reduction (Brock)

Manager, Ground Systems Project Office (Paul H. Vavra)

Chief, Flight Crew Operations (North)

Chief, Flight Operations (Kraft)

Chief, Preflight Operations (Preston)

Chief, Center Medical Operations (Berry)

Coordinator, Astronaut Activities (Donald K. Slayton)

Important points regarding Phase III: The spring 1963 reorganization was an attempt to divide MSC's operational activities from its developmental work. Crew, flight, preflight, and medical operations all fell under the supervision of the director.

Table 2-3.
Six Phases of Space Task Group-
Manned Spacecraft Center Organization, 1959-1968 (Continued)

Phase IV

Nov. 1963-1965

Director (Gilruth)

Deputy Director (Elms; George M. Low, Feb. 1964)

Special Assistant (Purser)

Senior Engineering Advisor (Chamberlin); office dropped in late 1964

Executive Assistant (Zavasky, Nov. 1963-late 1964; Stanley P. Weiss, acting, 1965); office dropped in 1965

Technical Assistant (Gregory, Nov. 1963-late 1964; Weiss, 1965); office dropped in 1965

Manager, Gemini Program Office (Mathews)

Deputy Manager (Kleinknecht)

Manager, Apollo Spacecraft Program Office (Shea)

Deputy Manager, Apollo Spacecraft Program Office (Robert Piland; William A. Lee, 1965); position renamed Assistant Manager in 1965

Chief, Ground Systems Engineering (Rolf W. Lanzkron); office replaced by Flight Projects Division in 1965

Chief, Operations Planning (Lee)

Chief, Program Control (J. Thomas Markley)

Chief, Reliability and Quality Assurance (vacant; Owen G. Morris, 1964)

Chief, Systems Engineering (Owen E. Maynard)

Chief, Checkout and Test (Bland)

Assistant Director, Administration (Hjornevik)

Assistant Director, Engineering and Development (Faget)

Deputy Assistant Director, Engineering and Development (Graves); office dropped in 1965

Manager, Systems Test and Evaluation (Bond); office added in 1965

Manager, Special Design Efforts (Chamberlin); office added in 1965

Manager, Engineering and Development Experiments (Robert Piland); office added in 1965

Chief, Long-Range Planning (Thomas W. Briggs); office added in 1965

Chief, Information Systems (Vavra)

Chief, Crew Systems (Johnston)

Chief, Instrumentation and Electronic Systems (Ralph S. Sawyer)

Chief, Guidance and Control (Robert C. Duncan)

Chief, Propulsion and Power (Joseph G. Thibodaux, Jr.)

Chief, Structures and Mechanics (Joseph N. Kotanchik)

Chief, Advanced Spacecraft Technology (Stoney)

Chief, Experiments Program Office (Robert Piland); office added in 1966

Assistant Director, Flight Crew Operations (Slayton)

Chief, Astronaut Office (Slayton, acting; Alan B. Shepard, July 1964)

Chief, Aircraft Operations (Joseph S. Algranti)

Chief, Flight Crew Support (North)

Assistant Director, Operations (Kraft)

Table 2-3.
Six Phases of Space Task Group-
Manned Spacecraft Center Organization, 1959-1968 (Continued)

Manager, Operations Planning and Development (Sigurd A. Sjoberg)
 Chief, Flight Control (John D. Hodge)
 Chief, Landing and Recovery (Robert F. Thompson)
 Chief, Mission Planning and Analysis (John P. Mayer)
 Chief, Flight Support (Henry E. Clements); office added in 1965
 Chief, Center Medical Programs (Berry)
 Chief, Center Medical Office (D. Owen Coons)
 Manager, MSC Florida Operations (Preston); office dropped in Dec. 1964 when the Kennedy Space Center assumed the duties
 Manager, MSC White Sands Missile Range Operations (Martin L. Raines)

Important points regarding Phase IV: With a Nov. 1963 reorganization, MSC settled back into the three-directorate pattern (plus the administrative directorate). Mercury personnel were reassigned elsewhere (primarily to Gemini and Apollo). The engineering and development directorate expanded noticeably. Astronaut Slayton became assistant director for a new flight crew operations directorate, and Kraft, with his growing flight operations team, assumed leadership of the operations directorate. Two separate offices were established to handle life sciences matters: center medical programs and center medical office. Two offices directed off-site operations at the Cape and at White Sands.

Phase V

1966-1967

Director (Gilruth)

Deputy Director (Low, George S. Trimble, Oct. 1967)
 Special Assistant (Purser)
 Special Assistant, Long-Range Planning (Julian M. West); office briefly called Advanced Spacecraft Planning in early 1966
 Technical Assistant (Robert Piland); office added in Dec. 1967
 Executive Assistant (M. Scott Carpenter; vacant, May 1966); office dropped in mid-1966
 Manager, Gemini Program Office (Mathews); program concluded in Nov. 1966
 Deputy Manager (Kleinknecht)
 Manager, Apollo Spacecraft Program Office (Shea; Low, Apr. 1967)
 Assistant Manager(s), Apollo Spacecraft Program Office (Lee, Jan. 1966-spring 1967; Kotanchik, Jan.-mid-1966; Markley, spring 1967; Kleinknecht, spring-summer 1967)
 Manager, Lunar Module (Lee; C. H. Bolender, fall 1967); office added in spring 1967
 Manager, Command and Service Module (Kleinknecht); office added in Feb. 1967
 Chief, Flight Projects Division (Lanzkron); office dropped in spring 1966
 Chief, Systems Engineering (Maynard; Robert W. Williams, spring 1966; Maynard, fall 1967)
 Chief, Reliability, Quality, and Test (Morris; Bland, spring 1966; Donald D. Arabian, late 1967); called Reliability and Test in early 1966, while a separate office attended to Checkout and Test (Bland); the two were combined in spring 1966 under Bland
 Chief, Program Control (Markley; McClintock, spring 1967)
 Chief, Lunar Module Project Engineering and Checkout (Morris); office added in spring 1966

Table 2-3.
Six Phases of Space Task Group-
Manned Spacecraft Center Organization, 1959-1968 (Continued)

-
- Chief, Command and Service Module Project Engineering and Checkout (Lanzkron); office added in spring 1966
 - Chief, Mission Operations (Maynard); office added in spring 1966
 - Chief, Mission Support (A.D. Mardel); office added in 1967
 - Chief, Test Division (Mardel); office added in fall 1967 in addition to Reliability, Quality, and Test under Bland
 - Manager, Apollo Applications Program Office (Low, acting; vacant, Apr.-Nov. 1967; Thompson, Dec. 1967); office added in July 1966 and expanded in early 1967
 - Deputy Manager, Apollo Applications Program Office (Thompson)
 - Head, Future Missions (Harold E. Gartrell)
 - Head, Mission Operations (Wyendell B. Evans)
 - Head, Program Control (vacant)
 - Head, Systems Engineering (Homer W. Dotts)
 - Head, Test Operations (W. Harry Douglas)
 - Head, Orbital Workshop Project (Kenneth F. Hecht)
 - Director, Administration (Hjornevik)
 - Director, Engineering and Development (Faget)
 - Manager, Systems Test and Evaluation (Bond); office combined with Special Design and Analysis to form the Design and Analysis Office in fall 1967
 - Manager, Special Design and Analysis (Chamberlin); office combined with Systems Test and Evaluation to form the Design and Analysis Office under Chamberlin in fall 1967
 - Manager, Engineering and Development Experiments (Robert Piland); office dropped in spring 1967
 - Chief, Advanced Spacecraft Technology (Stoney)
 - Chief, Crew Systems (Johnston)
 - Chief, Instrumentation and Electronics (Sawyer)
 - Chief, Information Systems (Vavra)
 - Chief, Power and Propulsion (Thibodaux)
 - Chief, Computation and Analysis (Brock)
 - Chief, Guidance and Control (Robert C. Duncan; vacant, spring 1967; Robert A. Gardiner, mid-1967)
 - Chief, Structures and Mechanics (Kotanchik)
 - Chief, Long-Range Planning (Thomas W. Briggs); office dropped in mid-1966
 - Chief, Experiments Program (Robert Piland); office dropped and incorporated into the new Science and Applications directorate in Jan. 1967
 - Chief, Space Science (Robert Piland, acting; Kotanchik, fall 1966); office added in spring 1966 and dropped and incorporated into the new Science and Applications directorate in Jan. 1967
 - Director, Science and Applications (Robert Piland, acting; Wilmot N. Hess, spring 1967); directorate established in Jan. 1967 and expanded in mid-1967
 - Deputy Director, Science and Applications (Robert Piland)
 - Manager, Flight Projects (Robert E. Vale)
 - Manager, Management Operations (Paul R. Penrod)
 - Manager, Reliability and Quality Assurance (Earl K. Smith)

Table 2-3.

Six Phases of Space Task Group-
Manned Spacecraft Center Organization, 1959-1968 (Continued)

- Chief, Space Physics Division (Jerry Modisette)
- Chief, Lunar Surface Project Office (John W. Small)
- Chief, Lunar and Earth Sciences Division (vacant; Persa R. Bell, fall 1967)
- Chief, Test and Operations Office (Norman G. Foster)
- Chief, Applications Project Office (Bruce G. Jackson)
- Chief, Advanced Systems Office (Fred T. Pearce, Jr.)
- Chief, Applications Plans and Analysis Office (vacant)
- Director, Medical Research and Operations (Berry); office established in May 1966 (Berry was Chief, Center Medical Programs for the first four months of 1966)
 - Chief, Occupational and Environmental Medicine Office (Coons, acting; Edward L. Beckman, mid-1966)
 - Chief, Biomedical Research Office (Lawrence F. Dietlein)
 - Chief, Medical Operations Office (Coons; Willard R. Hawkins, fall 1967)
- Director, Flight Crew Operations (Kraft)
 - Deputy Director, Flight Crew Operations (Sjoberg)
 - Chief, Flight Support (Clements; Lynwood C. Dunseith, mid-1967)
 - Chief, Mission Planning and Analysis (Mayer)
 - Chief, Flight Control (Hodge)
 - Chief, Landing and Recovery (Thompson; Hammock, July 1966)
- Manager, MSC White Sands Missile Range Operations (Raines)
- Manager, Lunar Receiving Laboratory Program (Joseph V. Piland, fall 1966); office dropped in 1967; the laboratory was briefly part of the engineering and development directorate when it was established in spring 1966 (James C. McLane, Jr., acting manager)

Important points regarding Phase V: The 1966-1967 period brought several important changes to MSC. Management of Project Apollo was assumed by George Low in 1967, who instituted some organizational changes in the program office. Project Gemini met its final objectives in Nov. 1966. An Apollo applications office was established to investigate how the agency might use the Apollo spacecraft in the future. Charles Berry became the assistant director of a new medical research and operations directorate, which centralized the center's several life sciences interests in one office.

Phase VI

1968

- Director (Gilruth)
 - Deputy Director (Trimble)
 - Special Assistant (Purser; Johnston, mid-1968)
 - Special Assistant, Long-Range Planning (West)
 - Technical Assistant (Robert Piland)
 - Associate Director (Hjornevik)
 - Director, Administration (Philip H. Whitbeck)
 - Director, Program Control and Contracts (Dave W. Lang)
 - Manager, Apollo Spacecraft Program Office (Low)

Table 2-3.

Six Phases of Space Task Group-
Manned Spacecraft Center Organization, 1959-1968 (Continued)

- Manager, Lunar Module (Bolender)
- Manager, Command and Service Module (Kleinknecht)
 - Chief, Systems Engineering (Maynard)
 - Chief, Lunar Module Project Engineering (Morris)
 - Chief, Command and Service Module Project Engineering (Lanzkron; Aaron Cohen, mid-1968)
 - Chief, Program Control (J. G. McClintock)
 - Chief, Test (Arabian)
 - Chief, Mission Operations (Maynard); office dropped in mid-1968
 - Chief, Mission Support (Mardel); office dropped in mid-1968
- Manager, Apollo Applications Program (Thompson)
 - Head, Future Missions Project Office (Gartrell)
 - Deputy, Lunar Module (Reginald M. Machell)
 - Deputy, Command and Service Module (James C. Shows)
 - Head, Mission Operations Office (Evans)
 - Head, Program Control (vacant)
 - Head, Systems Engineering Office (Dotts)
 - Head, Test Operations Office (Douglas)
 - Head, Orbital Workshop Project Office (Hecht)
- Manager, Advanced Missions Program (Hodge)
 - Chief, Project Engineering (Joseph P. Loftus, Jr.)
 - Chief, Lunar Exploration (Meyer)
 - Chief, Advanced Projects (Rene A. Berglund)
 - Chief, Program Planning (Dennis E. Fielder)
- Director, Engineering and Development (Faget); directorate reorganized April 1968 to include three assistant directors
- Manager, Design and Analysis (Chamberlin)
- Assistant Director, Chemical and Mechanical Systems (Bond)
 - Chief, Crew Systems (Robert E. Smylie)
 - Chief, Propulsion and Power (Thibodaux)
 - Chief, Structures and Mechanics (Kotanchik)
 - Chief, Space Environment Test (James C. McLane, Jr.)
- Assistant Director, Spacecraft Integration (Faget, acting)
- Assistant Director, Electronic Systems (Robert A. Gardiner)
 - Chief, Information Systems (Vavra)
 - Chief, Guidance and Control (Gardiner, acting)
 - Chief, Computation and Analysis (Brock)
 - Chief, Space Electronic Systems (Sawyer)
- Director, Science and Applications (Hess)
 - Deputy Director, Science and Applications (Anthony J. Calio)
 - Manager, Lunar Surface Project Office (Small)
 - Chief, Space Physics (Modisette; S. Freden, mid-1968)

Table 2-3.

Six Phases of Space Task Group-
Manned Spacecraft Center Organization, 1959-1968 (Continued)

- Manager, Earth Resources Group (Robert Piland)
- Manger, Applications Project Office (Jackson); office dropped in mid-1968
- Chief, Lunar and Earth Sciences Division (Bell)
- Manager, Advanced Systems (Pearce; Jackson, mid-1968); office dropped in late 1968
- Manager, Mapping Sciences Laboratory (James H. Sasser, acting)
- Director, Medical Research and Operations (Berry)
 - Deputy Director, Medical Research and Operations (A. D. Catterson)
 - Deputy Director, Medical Requirements (Coons)
 - Assistant Director, Research (Dietlein)
 - Chief, Biomedical Research (Dietlein; Beckman, mid-1968)
 - Chief, Preventive Medicine (John J. Dreoscher, Jr.; Walter K. Kemmerer, Jr., mid-1968)
 - Chief, Medical Operations (Hawkins)
 - Head, Biomedical Technology Group (George G. Armstrong, Jr.)
- Director, Flight Crew Operations (Slayton)
 - Chief, Astronaut Office (Shepard)
 - Chief, Aircraft Operations Office (Algranti)
 - Chief, Flight Crew Support Division (North)
- Director, Flight Operations (Kraft)
 - Deputy Director, Flight Operations (Sjoberg)
 - Chief, Flight Control Division (Eugene F. Kranz, acting)
 - Chief, Landing and Receiving Division (Hammock)
 - Chief, Mission Planning and Analysis Division (Mayer)
 - Chief, Flight Support Division (Dunseith)
- Director, Lunar Exploration Working Group (Hodge); office added in Sept. 1968
- Manager, MSC White Sands Test Facility Operations (Raines)

Important points regarding Phase VI: During 1968, Gilruth reorganized the center's administrative staff arm. Wesley J. Hjernevik, long-time assistant director for administration at MSC, became associate director, with directors for administration and program control reporting to him. An advanced program office was added to explore mission possibilities beyond the Apollo era. Faget got the help of three assistant directors in managing the multifaceted engineering and development directorate.

* These six phases represent composites for each time period. Refer to appendix A and other NASA historical publications for complete organization charts (especially helpful for the early years is "Key Management Progression involving Project Mercury," app. 8, James M. Grimwood, *Project Mercury: A Chronology*, NASA SP-4001 (Washington, 1963), pp. 215-21). These six phases emphasize operational and developmental activities rather than administrative and staff activities. See the notes following each phase for a summary of the important changes for each time period.

BUDGET

For general information on the NASA budget and the budget charts in this book, consult chapter 1, pages 7 to 11. Other charts that may assist the researcher interested in the cost of NASA's manned spaceflight program include budget tables in chapter 1 for Atlas, Atlas-Agena, Jupiter, Little Joe I, Little Joe II, Redstone, Saturn I, Saturn IB, Saturn V, and Titan II; see chapter 4 for budget tables for Scout Reentry Heating Project, Project FIRE, lifting bodies, Project RAM, human factor systems, and X-15; chapter 5 provides budget information for manned flight tracking network operations and manned network equipment and components. For a more detailed breakdown of the flight project budgets, consult the NASA annual budget estimates. Review the bottom notes of the following charts carefully before making conclusions about totals for any particular project or year.

The total cost of NASA's manned spaceflight programs and in particular the cost of the lunar landing, is a figure sought frequently by friends and foes of the agency. Because it was such a huge undertaking with a fixed deadline and because it demanded quantum state-of-the-art leaps in several fields (especially computerization and miniaturization), the costs were high. Totals for any one program are hard to determine, but NASA issued the following figures for its major manned ventures: Mercury, \$392.6 million; Gemini, \$1.283 billion; and Apollo, \$25 billion (\$21.35 billion through the first lunar landing in July 1969). If we add another \$2.6 billion for Skylab and \$250 million for the Apollo-Soyuz Test Project, the grand total for the "expendable-generation" manned spaceflight program was \$29.5 billion.¹¹ These totals include facilities, salaries, research and development, operations, and hardware (spacecraft and launch vehicles) expenditures. The following charts are concerned with only OMSF research and development monies (spacecraft, some launch vehicle costs, and supporting development).

Table 2-4.
Total Manned Spaceflight Costs
(in thousands of dollars)

Year	Request	Authorization	Programmed
1959	---	---	46 416
1960	---	---	84 428
1961	107 750	---	130 596 ^a
1962	234 245	---	563 050
1963	876 887 ^b	---	1 483 446
1964	2 931 800 ^c	2 817 100 ^c	2 713 052
1965	3 011 900	3 011 900	2 949 019
1966	3 249 485	3 219 485	3 002 232
1967	3 022 800	3 022 800	3 024 000
1968	3 009 200	2 871 700	2 809 230

^aIncludes \$124 330 000 for Project Mercury, and \$6 266 000 for advanced manned spaceflight.

^bIncludes \$13 259 000 for Project Mercury, and \$863 628 000 for advanced spaceflight.

^cThe OMSF budget for FY 1964 was divided among manned spacecraft systems (see following charts), launch vehicle and propulsion systems (see chapter 1), aerospace medicine (request, \$16 700 000; authorization, \$11 000 000), integration and checkout (request, \$153 000 000; authorization, \$125 000 000); and systems engineering (request and authorization, \$37 000 000). The budget was usually divided among the various flight projects (Mercury, Gemini, Apollo, and advanced programs).

Table 2-5.
 Programmed Costs of Manned Spaceflight Programs
 (in thousands of dollars)

Program	1959	1960	1961	1962	1963	1964	1965	1966	1967	1968
Mercury	46 416	84 328	124 330	31 060	---	---	---	---	---	---
Gemini	---	---	---	54 959	288 090	418 900	308 400	---	---	---
Apollo	---	100	---	75 618	1 183 965	2 272 952	2 614 619	2 940 985	2 922 600	2 556 030
Apollo Applications	---	---	---	---	---	---	---	51 247	80 000	---
Advanced Missions	---	---	---	---	11 391	21 200	26 000	10 000	6 200	---
Other Costs	---	---	6 266 ^a	401 413 ^b	---	---	---	---	---	---

^a Includes \$2 020 000 for manned spacecraft systems supporting research and technology, and \$4 246 000 for aerospace medicine.

^b Includes \$5 164 000 for manned spacecraft systems supporting research and technology, \$386 153 000 for launch vehicles and propulsion systems, \$7 854 000 for aerospace medicine, \$1 250 000 for integration and checkout, and \$992 000 for systems engineering.

Table 2-6.
Total Mercury Funding History
(in thousands of dollars)

Year	Request	Authorization	Programmed
1959	---	---	46 416 ^a
1960	---	---	84 328 ^a
1961	107 750 ^a	107 750 ^a	124 330
1962	74 245 ^a	---	31,060 ^b
1963	25 439 ^c	13 259	--- ^d

^aIn the FY 1961 and FY 1962 budget estimates, the Mercury budget was in two parts: advanced technical development and flight research.

^bIncludes \$16 460 000 for a "one-day mission," a Mercury mission of longer duration than the initial flights. At one time, four such missions were planned for 1963. *MA-9*, lasting more than 34 hours, was considered the Mercury one-day mission, but the designation was not widely used.

^cIncludes \$12 180 000 for the "one-day mission" from the advanced manned spaceflight budget; see note "b" above.

^dNot included as an item in the FY 1965 budget estimate, however, it was estimated in the FY 1964 budget estimate that \$3 342 000 and \$17 957 000 would be programmed in FY 1963 for Mercury and a "one-day mission," respectively. No funds were programmed after FY 1963.

Table 2-7.
Mercury—Spacecraft Funding History
(in thousands of dollars)

Year	Request	Authorization	Programmed
1959	---	---	22 299
1960	---	---	61 850
1961	35 290	---	60 474
1962	32 000	---	--- ^a
1963	12 069	7569 ^c	--- ^d

^aThe Mercury budget was not itemized in the FY 1964 budget estimate; total programmed was \$31 060 000, which included funds for a "one-day mission."

^bIncludes \$4 500 000 from the advanced manned spaceflight budget for a "one-day mission."

^cDoes not include funds for a "one-day mission."

^dMercury was not included as an item in the FY 1965 budget estimate. It was estimated in the FY 1964 budget estimate that \$21 299 000 would be programmed for Mercury for FY 1963, which included funds for a "one-day mission." No funds were programmed after FY 1963.

Table 2-8.
Mercury—Operations Funding History
(in thousands of dollars)

Year	Request	Authorization	Programmed
1959	---	---	7 ^a
1960	---	---	3193 ^b
1961	39 670 ^c	---	30 283 ^d
1962	28 235 ^e	---	--- ^f
1963	13 370 ^g	5690 ^h	--- ⁱ

^aFor tracking network operations and equipment.

^bIncludes \$7 850 000 for recovery operations, \$19 635 000 for network operations, and \$750 000 for network operational implementation.

^cIncludes \$24 670 000 for tracking network operations and equipment, and \$15 000 000 for recovery operations.

^dIncludes \$25 254 000 for tracking network, and \$5 029 000 for recovery operations.

^eIncludes \$353 000 for recovery operations, \$145 000 for network operations, and \$2 695 000 for network operational implementation.

^fThe Mercury budget was not itemized in the FY 1964 budget estimate; total programmed was \$31 060 000, which included funds for a "one-day mission."

^gIncludes \$2 490 000 for flight operations, and \$3 200 000 for recovery operations, plus \$7 680 000 from the advanced manned spaceflight budget to support a "one-day mission."

^hDoes not include funds to support a "one-day mission."

ⁱMercury was not included as an item in the FY 1965 budget estimate. It was estimated in the FY 1964 budget estimate that \$21 299 000 would be programmed for Mercury for FY 1963, which included funds for a "one-day mission." No funds were programmed after FY 1963.

Table 2-9.
Mercury—Supporting Development Funding History
(in thousands of dollars)

Year	Request	Programmed
1959	---	3270 ^a
1960	---	3419 ^b
1961	7140 ^c	2737 ^b
1962	2510 ^b	--- ^d

^aIncludes \$170 000 for biological and human engineering studies, and \$3 100 000 for a Mercury development program.

^bFor advanced technical development.

^cIncludes \$2 090 000 for biological and human engineering studies, \$4 050 000 for a Mercury development project, \$800 000 for advanced reentry configuration development, and \$200 000 for reentry guidance and control system technical development.

^dThe Mercury budget was not itemized in the FY 1964 budget estimate. Total programmed was \$31 060 000, which included funds for a "one-day mission." No funds were programmed after FY 1962.

Table 2-10.
Mercury—Launch Vehicles Funding History
(in thousands of dollars)

Year	Request	Programmed
1959	---	20 840
1960	---	15 867
1961	25 650	30 836
1962	11 500	--- ^a

^aThe Mercury budget was not itemized in the FY 1964 budget estimate. Total programmed was \$31 060 000, which included funds for a "one-day mission." No funds were programmed after FY 1962.

Table 2-11.
Total Gemini Funding History
(in thousands of dollars)

Year	Request	Authorization	Programmed
1962	---	---	54 959
1963	203 200 ^a	---	288 090
1964	306 300	306 300	418 900
1965	308 400	308 400	308 400
1966	242 100	242 100	--- ^b
1967	40 600	40 600	--- ^c

^aFrom the advanced manned spaceflight budget.

^bNot included as an item in the FY 1968 budget estimate. However, it was estimated in the FY 1967 budget estimate that \$226 611 000 would be programmed for Gemini in FY 1966.

^cNot included as an item in the FY 1969 budget estimate. No funds were programmed after FY 1967.

Table 2-12.
Gemini—Spacecraft Funding History
(in thousands of dollars)

Year	Request	Authorization	Programmed
1962	---	---	30 329
1963	131 350 ^a	---	205 045
1964	196 206	---	280 520
1965	168 900	168 900	165 300
1966	122 700	122 700	--- ^b
1967	19 100	19 100	--- ^c

^aFrom the advanced manned spaceflight budget.

^bIt was estimated in the FY 1967 budget estimate that \$107 211 000 would be programmed in FY 1966 for Gemini spacecraft.

^cNo funds were programmed after FY 1967.

Table 2-13.
Gemini—Operations and Support Funding History
(in thousands of dollars)

Year	Request	Authorization	Programmed
1962	---	---	239 ^a
1963	---	---	3936
1964	15 300 ^b	---	15 680
1965	28 200	28 200	27 700
1966	30 800	30 800	--- ^c
1967	13 000	13 000	--- ^d

^a For supporting development.

^b Includes \$700 000 for supporting development.

^c It was estimated in the FY 1967 budget estimate that \$30 800 000 would be programmed in FY 1966 for Gemini support.

^d No funds were programmed after FY 1967.

Table 2-14.
Gemini—Launch Vehicles Funding History
(in thousands of dollars)

Year	Request	Authorization	Programmed
1962	---	---	24 391
1963	71 850 ^a	---	79 109
1964	94 800	---	122 700
1965	111 300	111 300	115 400
1966	88 600	88 600	--- ^b
1967	8500	8500	--- ^c

^a From the advanced manned spaceflight budget.

^b It was estimated in the FY 1967 budget estimate that \$88 600 000 would be programmed in FY 1966 for Gemini launch vehicles.

^c No funds were programmed after FY 1967.

Table 2-15.
Total Apollo Funding History
(in thousands of dollars)

Year	Request	Authorization	Programmed
1960	---	---	100
1961	---	---	--- ^b
1962	160 000 ^a	---	75 618
1963	617 164 ^b	---	1 183 965
1964	1 207 400	1 147 400	2 272 952
1965	2 677 500	2 677 500	2 614 619
1966	2 997 385	2 967 385	2 940 985
1967	2 974 200	2 974 200	2 922 600
1968	2 606 500 ^c	2 521 500 ^d	2 556 030

^aThe first request for Apollo submitted to Congress was for \$29 500 000; the request was increased in response to the presidential mandate that NASA land a man on the moon by the end of the 1960s.

^bFrom the advanced manned spaceflight budget; there was no item labeled "Apollo" in the FY 1963 budget estimate.

^c\$60 000 000 was available in unobligated funds to finance Apollo, bringing the actual request to \$2 546 500 000.

^dThe sum was further reduced to \$2 496 000 000 by the Appropriations Conference Committee on Oct. 25, 1967.

Table 2-16.
Apollo—Spacecraft, Command and Service Module Funding History
(in thousands of dollars)

Year	Request	Programmed
1960	---	100 ^a
1961	---	---
1962	47 000	60 000
1963	345 000 ^b	269 450
1964	661 200	545 874
1965	520 500	577 834
1966	550 000	612 799
1967	586 900	532 815
1968	494 000	393 023

^aFor general spacecraft design and engineering.

^bFrom the advanced manned spaceflight budget.

Table 2-17.
Apollo—Spacecraft, Lunar Module Funding History
(in thousands of dollars)

Year	Request	Programmed
1962	5000 ^a	---
1963	123 100 ^b	13 000
1964	230 000	135 000
1965	189 000	242 600
1966	270 000	362 615
1967	388 300	539 272
1968	373 100	402 688

^a For lunar landing propulsion system development.

^b From the advanced manned spaceflight budget.

Table 2-18.
Apollo—Spacecraft, Other Costs, Funding History
(in thousands of dollars)

Year	Request	Programmed
1962	---	9869
1963	49 400 ^a	81 512
1964	140 200	195 701
1965	235 400	189 464
1966	298 840	258 386
1967	225 400	238 513
1968	169 200	238 989

^a From the advanced manned spaceflight budget.

Table 2-19.
Apollo—Operations Funding History
(in thousands of dollars)

Year	Request	Programmed
1963	---	8042 ^a
1964	16 000	26 422 ^a
1965	72 900 ^a	96 717
1966	74 245 ^a	112 928
1967	154 405	184 120
1968	229 000	545 765

^a Includes launch and space operations.

Table 2-20.
Apollo—Supporting Development Funding History
(in thousands of dollars)

Year	Request	Programmed
1962	108 000 ^a	1257
1963	---	53 984 ^b
1964	27 292 ^c	106 679 ^b
1965	136 300 ^b	73 825 ^d
1966	148 000 ^b	51 400 ^d
1967	58 895 ^d	54 300 ^d
1968	52 000 ^d	---

^a Includes \$63 900 000 for orbital flight tests, \$16 550 000 for biomedical flight research, and \$27 550 000 for high-speed reentry tests.

^b For systems engineering, mission control systems, and supporting technology and development.

^c Includes \$25 000 000 for supporting development, and \$2 292 000 for research and development facilities.

^d Includes systems engineering and supporting development.

Table 2-21.
Apollo—Launch Vehicles and Engine Development Funding History
(in thousands of dollars)

Year	Request	Programmed
1962	---	2200 ^a
1963	99 664 ^b	757 977
1964	135 000 ^a	1 263 276
1965	1 522 500	1 434 179
1966	1 656 300	1 542 857
1967	1 518 400	1 373 580
1968	1 289 200	975 565

^a Most of the OMSF launch vehicle and propulsion systems budget in the FY 1964 estimate was devoted to Apollo launch vehicle and engine development.

^b From the advanced manned spaceflight budget.

Table 2-22.
Total Apollo Applications Funding History
(in thousands of dollars)

Year	Request	Authorization	Programmed
1966	---	---	51 247
1967	41 900 ^a	---	80 000
1968	454 700	347 700	--- ^b

^aFrom the Apollo mission support request.

^bNot included as an item in the FY 1970 budget estimate. However, it was estimated in the FY 1969 budget estimate that \$253 200 000 would be programmed for Apollo applications in FY 1968.

Table 2-23.
Apollo Applications—Space Vehicles Funding History
(in thousands of dollars)

Year	Request	Programmed
1966	---	8500
1967	---	37 700
1968	263 700	--- ^a

^aIt was estimated in the FY 1969 budget estimate that \$86 000 000 would be programmed for Apollo applications space vehicles in FY 1968.

Table 2-24.
Apollo Applications—Mission Support Funding History
(in thousands of dollars)

Year	Request	Programmed
1966	---	2400
1967	---	4700
1968	50 300	--- ^a

^aIt was estimated in the FY 1969 budget estimate that \$28 200 000 would be programmed for Apollo applications mission support in FY 1968.

Table 2-25.
Apollo Applications—Experiments Funding History
(in thousands of dollars)

Year	Request	Programmed
1966	---	40 347
1967	---	37 600
1968	140 700	--- ^a

^a It was estimated in the FY 1969 budget estimate that \$139 000 000 would be programmed for Apollo applications experiments in FY 1968.

Table 2-26.
Total Advanced Missions Funding History
(in thousands of dollars)

Year	Request	Authorization	Programmed
1963	---	---	11 391
1964	---	---	21 200
1965	26 000	26 000	26 000
1966	10 000	10 000	10 000
1967	8000	8000	6200
1968	8000	2500	--- ^a

^a Not included as a line item in the FY 1970 budget estimate. It was estimated in the FY 1969 budget estimate that no funds would be programmed for the advanced missions program in FY 1968.

Table 2-27.
Manned Spaceflight—Other Costs Funding History
(in thousands of dollars)

Year	Request	Authorization	Programmed
1961	---	---	6266 ^a
1962	---	---	401 413 ^b
1963	31 084 ^c	---	--- ^d
1964	1 418 100 ^e	1 363 400 ^f	--- ^g

^aFrom the advanced manned spaceflight budget: \$2 020 000 for manned spaceflight technology, and \$4 246 000 for aerospace medicine.

^bIncludes \$5 164 000 for manned spacecraft systems supporting research and technology, \$386 153 000 for launch vehicle and propulsion systems, \$7 854 000 for aerospace medicine, \$1 250 000 for integration and checkout, and \$992 000 for systems engineering.

^cFrom the advanced manned spaceflight budget: \$11 764 000 for manned spacecraft technology, and \$19 320 000 for aerospace medicine.

^dThe following are estimates as per the FY 1964 budget estimate (these categories did not appear as items in the FY 1965 estimate): aerospace medicine, \$7 000 000; integration and checkout, \$38 500 000; systems engineering, \$26 500 000; mission control center operations, \$10 500 000; supporting research and technology, \$8 100 000; and launch vehicle and propulsion systems, \$734 057 000.

^eIncludes \$21 100 000 for manned spacecraft systems research and technology, \$21 800 000 for mission control center operations, \$1 168 500 000 for launch vehicle and propulsion systems, \$153 000 000 for integration and checkout, \$37 000 000 for systems engineering, and \$16 700 000 for aerospace medicine.

^fThe authorization for launch vehicle and propulsion systems was \$1 147 500, for aerospace medicine \$11 000 000, and for integration and checkout \$125 000 000. For other categories the authorizations were the same as the request (as per note "e" above).

^gThese several categories were assumed by the Gemini and Apollo budgets as per the FY 1965 budget estimate.

CHARACTERISTICS—PROJECT MERCURY

Project Mercury's goals were simply stated in 1958 when it was officially chosen as this country's first step toward manned spaceflight: (1) launch a manned spacecraft into earth orbit; (2) assess man's performance capabilities and his ability to function in the space environment; and (3) recover the pilot and spacecraft safely. In developing the ballistic-shaped spacecraft, NASA proposed to rely on existing technology and off-the-shelf equipment when practical and to follow the simplest, most reliable approach to system design.¹² These guidelines, of course, echoed the advice of engineers at the Langley Research Center who had been studying the feasibility of sending man into orbit in a nose cone-type spacecraft months prior to NASA's organization in October 1958 (see discussion above). Designer Maxime Faget and his colleagues favored the Air Force's Atlas missile for a Mercury launch vehicle, and suggested a test program for both the spacecraft and the booster that would guarantee that the hardware was "man-rated."

Mercury was not the sleek, sophisticated-looking craft that most dreamers of manned flight would have designed. It was small (1 cubic meter in the crew compartment), a blunt cone with zero lift (2.1 meters at its widest, 3.4 meters nose to retrorocket), and at launch it perched atop a modified ICBM. If some thought it an ignoble way to fly—"the man in the can"—those same critics probably paled at the thought of reentering earth's atmosphere on their backs protected by a heat shield in preparation for a splash-down in the ocean (see figs. 2-1 and 2-2). But it was the only approach to manned flight that could be supported by existing launch vehicles. Boosters powerful enough to send "space planes" into orbit were still decades away. (See table 2-28 for a chronology of key Project Mercury events.)

To prepare for the first orbital mission, originally scheduled for 1960, NASA personnel in the Space Task Group (redesignated the Manned Spacecraft Center in 1961 and moved from Langley Research Center in Virginia to Houston, Texas) devised a hardware test plan that called for ground simulations and flight tests. Mercury's heat shield and basic reentry attitude had to be proved, as did its environmental control system and other critical subsystems. In addition to evaluating changes made to the basic Atlas missile, propulsion experts were charged with designing a launch escape system that would carry the manned capsule away from a malfunctioning launch vehicle and a retrorocket system capable of supplying the impulse necessary to bring the spacecraft out of orbit for return to earth. Beyond laboratory and wind tunnel tests of these Mercury features conducted at the Langley, Ames, and Lewis centers, the Space Task Group relied on ballistic flights to qualify hardware. Rather than depend exclusively on the more expensive Atlas for test flights, NASA procured eight Redstone missiles from the Army Ballistic Missile Agency and awarded North American Aviation a contract to build airframes for a new Mercury test launcher, the Little Joe I.* Suborbital launches of Mercury spacecraft boilerplate models using Little Joe began in 1959 at Wallops Island. The spacecraft abort system was not qualified under maximum dynamic pressure with Little Joe un-

*NASA had originally planned to also include the Army's Jupiter missile in the Mercury test flight scheme but dropped the requirement in favor of exclusive use of Redstone for suborbital missions. The solid propellant Little Joe was used primarily to test the spacecraft abort system. (See chap. 1 for more information on the Mercury launch vehicles.)

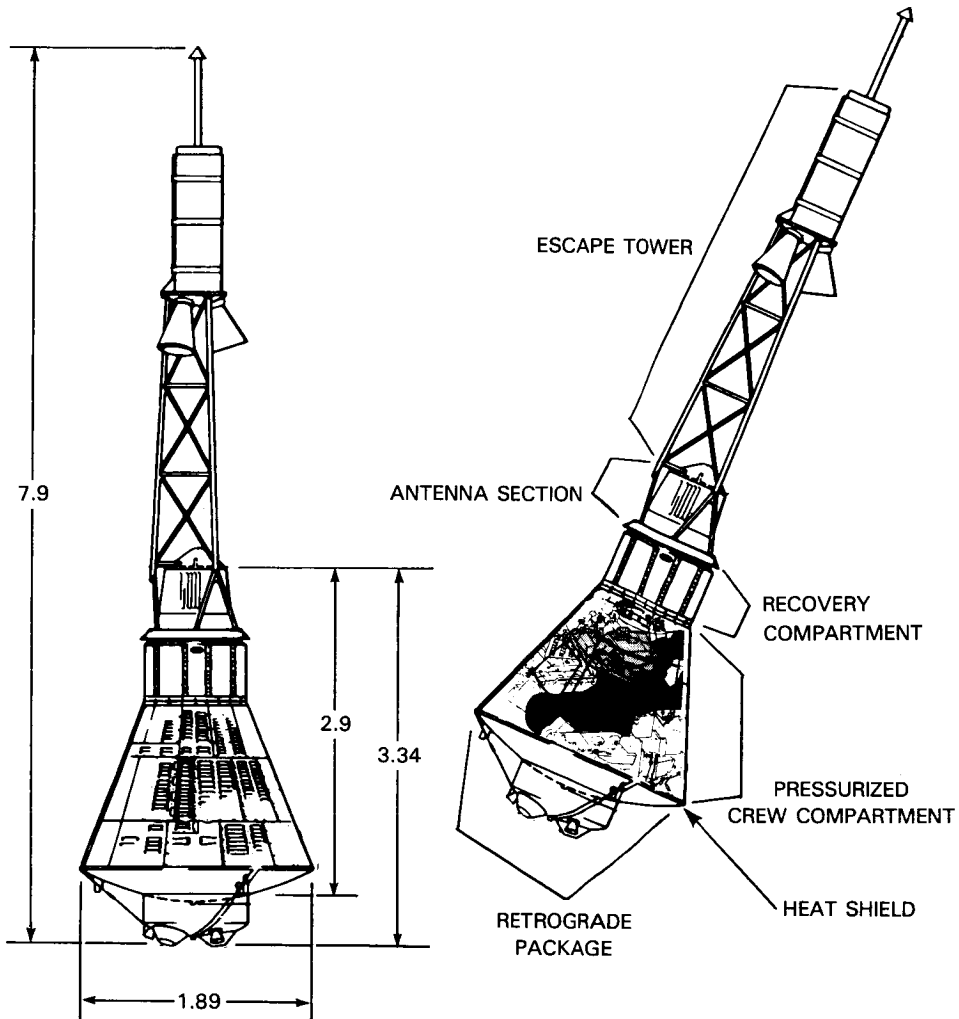

Figure 2-1. Mercury Spacecraft (dimensions in meters). The exterior shape of the Mercury spacecraft was conical, with a segment of a sphere for the heatshield and a cylindrical afterbody at the apex of the cone. Two crew access hatches were included, one for entrance and egress on the side of the spacecraft and the other for exit through the cylindrical section. A large window and an instrument panel were provided for crew monitoring of flight events and systems operation. Thermal protection was provided by an ablative heatshield on the blunt face and radioactive-type shingles on the afterbody. Environmental control was made possible in part by evaporative cooling in two separate circuits, one for the cabin and one for the astronaut's suit. A stabilization and control system with a three-axis gyro package erected by horizon scanners provided attitude references for the displays and the two automatic control modes. Attitude changes were effected through a redundant system of hydrogen peroxide-fueled reaction control engines. Three silver-zinc batteries were the source of electrical power. Reentry retrofire maneuvers were accomplished by three solid-fuel rockets. (See also tables 2-54 and 2-55 for more information on the spacecraft and its major subsystems.)

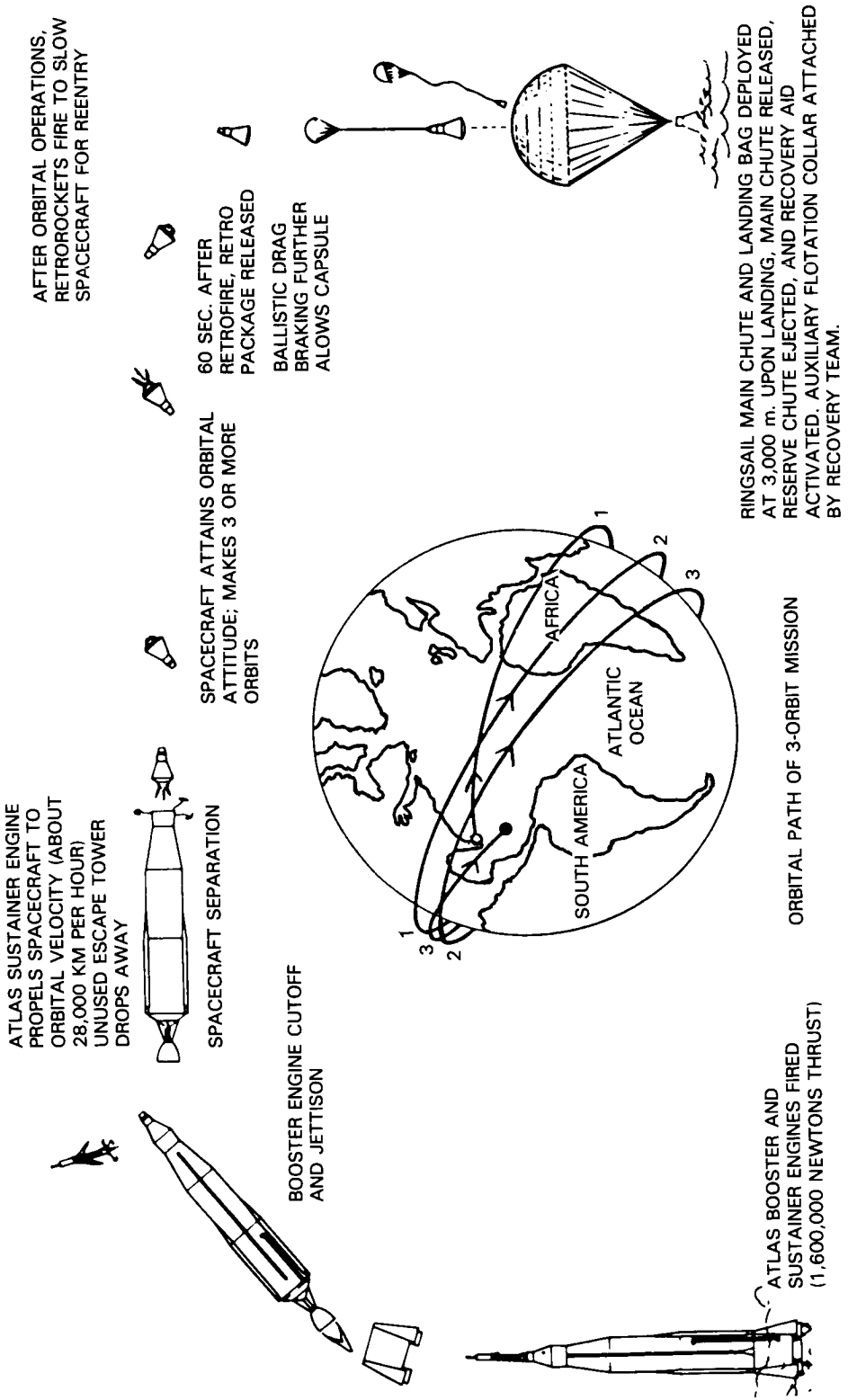

Figure 2-2. Sequence of Events during a Mercury Orbital Flight

til April 1961 (*Lj-5B*).¹³ From the Eastern Test Range (formerly the Atlantic Missile Range) in Florida, the first attempt to launch a Mercury production capsule in a qualification flight ended in a malfunction of the Atlas vehicle in February 1961 (*MA-2*). The first successful orbital test took place seven months later in September (*MA-4*), followed by an all-systems two-orbit test flight in November (*MA-5*). Redstone also malfunctioned during its first Mercury test in November 1960 (*MR-1*), but performed more satisfactorily one month later (*MR-1A*). Redstone boosters would send NASA's first astronauts into space on suborbital missions in 1961. (See table 2-29 for a list of Mercury development flights.)

Manufacture of the spacecraft was assigned to McDonnell Aircraft Corporation in January 1959, one of 11 firms to submit proposals to NASA (see table 2-56 for a list of major contractors). STG personnel were assigned to the contractor's facilities in St. Louis, where they worked together to produce 20 Mercury spacecraft. The builders of the spacecraft had to allow for the incorporation of a life support system (100 percent oxygen supplied as a gas at a pressure of 258 mm mercury, with removal of carbon dioxide and humidity by lithium hydroxide canisters) and flight couches that conformed to each astronaut's body. The inclusion of redundant systems and manual as well as automatic controls where possible was another important requirement.¹⁴ McDonnell delivered the last spacecraft to the launch complex in April 1963.*

Qualifications for astronauts to man Mercury spacecraft were first established in January 1959: a candidate had to be under 40 years of age, less than 180 centimeters (5'11") tall, in excellent physical condition, holder of a bachelor's degree or its equivalent, a graduate of test pilot school, and a qualified jet pilot with 1500 hours of flight time. From the files of 508 military test pilots, a NASA committee found 110 apparently qualified candidates, of which 69 were interviewed. Of these, 56 took a battery of written exams; 32 were left in March to undergo mental and physical testing. By April, the field had been narrowed to 7 men, who reported to the Space Task Group at Langley for training.† The astronaut training program in-

*This capsule was to have been used for MA-10, which was cancelled in June 1963.

†The NASA astronaut candidate evaluation committee was led by Charles Donlan, assistant director of the STG. He was assisted by Warren North, a test pilot-engineer, Stanley C. White and William S. Augerson, flight surgeons, Allen O. Gamble and Robert B. Voas, psychologists, and George E. Ruff and Edwin Z. Levy, psychiatrists. The Lovelace Foundation for Medical Education and Research, Albuquerque, New Mexico, and the Aeromedical Laboratory, Wright Air Development Center, Dayton, Ohio, were used to conduct many of the physical tests during the evaluations; NASA specialists were supported by military medical personnel. STG Director Gilruth endorsed the final list of seven candidates and passed it to Abe Silverstein, director of space flight development, and Administrator Keith Glennan for final review in April 1959. The Mercury astronauts named later that month were M. Scott Carpenter (Lt., Navy), L. Gordon Cooper (Cpt., USAF), John H. Glenn, Jr. (Lt. Col., USMC), Virgil I. Grissom (Cpt., USAF), Walter M. Schirra, Jr. (Lt. Com., Navy), Alan B. Shepard, Jr. (Lt. Com., Navy), and Donald K. Slayton (Cpt., USAF).

¹ Medical personnel played an important part during astronaut training. They measured, monitored, or tested every bodily function, component, and product. To monitor the astronaut's body temperature (with a rectal thermistor), respirations (with a pneumograph on *MA-8* and *MA-9*), heart action (with electrocardiographic electrodes), and blood pressure (with a unidirectional microphone and cuff during *MA-7*, *MA-8*, and *MA-9*) during flight, new biomedical sensors were developed. To supplement this data, the flight surgeon could also evaluate the astronaut's actions, his voice quality, and his answers to specific questions. Scientists and doctors were especially interested in determining man's physiological responses to weightlessness, acceleration and deceleration forces, radiation, and stress.

cluded classroom studies in rocket propulsion, space physics, and other astronomical sciences, briefings on spacecraft systems, time on fixed and moving simulators and trainers, sessions on a centrifuge, and egress and survival exercises.¹⁵ Approximately three months before each flight, the designated pilot and his backup began specific preparations for the mission. Crew members also were assigned to mission control and tracking network stations to serve as capsule communicators (cap coms), the voice links with the spacecraft. In addition, the astronauts worked with technicians from McDonnell Aircraft to ensure that the spacecrafts' form-fitting flight couches were suitable and with B. F. Goodrich, maker of the Mercury pressure suits. Systems, procedures, and equipment were evaluated continuously by the engineers, astronauts, and manufacturers during training sessions. One other important aspect of the astronaut's life was medical maintenance and monitoring. Flight crew surgeons determined the astronaut's readiness for flight, monitored his health during the mission, and evaluated his condition upon recovery.¹⁶

The Department of Defense cooperated with NASA during Project Mercury on several fronts. Their most visible role was as supplier of the launch vehicles (Atlas from the Air Force and Redstone from ABMA). The agency was totally dependent on military launchers for its early manned program. Launch operations and communications was another area in which the Air Force shared its expertise and facilities at Cape Canaveral. NASA's Mercury network was supplemented by military tracking stations and equipment. Recovery of the astronaut and his craft from the Atlantic was largely the Navy's assignment. Astronaut selection and training was also accomplished with the assistance of medical experts from the services. To coordinate the many operational activities that required Department of Defense support, the commander of the Atlantic Missile Range Test Center was designated DoD representative for Project Mercury operations by the Secretary of Defense. A Mercury Support Planning Office was staffed by officers from the services participating in Mercury.¹⁷

Before committing the Mercury spacecraft to a manned orbital mission, NASA further qualified the capsule with two manned suborbital flights. Sent on a ballistic trajectory by a Redstone launch vehicle on May 5, 1961, Alan Shepard became the first American space traveler. *MR-3* was followed by Virgil Grissom in *MR-4* in July. With this second successful Mercury-Redstone mission, Gilruth and his STG advisors decided against any further suborbital tests; they were ready for orbital operations. After three postponements due to bad weather, *MA-6* took John Glenn to earth orbit on February 20, 1962. In a little less than five hours, Glenn accomplished the "standard" three-orbit Mercury mission. With *MA-6*, Project Mercury met its basic objectives—the hardware had functioned properly and Glenn had suffered no harmful effects from his flight. Scott Carpenter completed another three-orbit mission (*MA-7*) in May, followed by a six-orbit shot (*MA-8*) by Walter Schirra in October. The last Mercury flight, *MA-9*, was also referred to as the "one-day mission."¹⁸ Gordon Cooper, surpassing the one-day goal with a 34-hour flight (22 orbits) in May 1963, brought the Mercury project to a close. (See tables 2-30 through 2-35 for mission details.) Relying on experiences with each successive flight, the manned spaceflight team had improved spacecraft systems and the biomedical equipment, modified the astronaut's suit and couch, and augmented the tracking net to cover *MA-9*'s extra orbits. Procedures and hardware were evolving toward the next step in NASA's manned program, Gemini.

As discussed above, the Space Task Group was established in 1958 to manage Project Mercury. Even though the team was located at Langley Research Center, Robert Gilruth, leader of the group, reported directly to NASA Headquarters. The STG was declared an independent operation in January 1961 and was assigned a new name and a permanent home in November, the Manned Spacecraft Center, in Houston, Texas. James Chamberlin as engineering chief and chair of the Capsule Coordination Committee assumed a large share of the project's management in 1959. In a reorganization in November 1961, Kenneth Kleinknecht became manager of the Mercury Program Office. He was assisted by chiefs for engineering operations, project engineering, and engineering data and measurement (see also table 2-3 for information on the changing organization of STG-MSC).

Three useful sources for the reader interested in Project Mercury are the following NASA publications: Loyd S. Swenson, Jr., James M. Grimwood, and Charles C. Alexander, *This New Ocean; A History of Project Mercury*, NASA SP-4201 (Washington, 1966); Grimwood, *Project Mercury; A Chronology*, NASA SP-4001 (Washington, 1963); and NASA, *Mercury Project Summary including Results of the Fourth Manned Orbital Flight, May 15 and 16, 1963*, NASA SP-45 (Washington, 1963). The summary volume is a compilation of papers given at the October 3-4, 1963, Mercury conference held in Houston.

Table 2-28.
Chronology of Key Project Mercury Events*

Date	Event
Oct. 6, 1958	Langley Research Center personnel opened negotiations with the Army Ballistic Missile Agency (ABMA) to procure Redstone and Jupiter launch vehicles for a manned satellite project; on the 17th they began discussions with the Air Force Ballistic Missile Division regarding procurement of Atlas vehicles.
Oct. 7, 1958	NASA Administrator T. Keith Glennan approved plans for a manned satellite project.
Oct. 21, 1958	A bidders conference was held concerning a Little Joe launch vehicle to be used for development testing of the manned capsule. Design work was completed by December 1.
Oct. 23, 1958	Preliminary specifications for a manned spacecraft were distributed to industry. Another set of specifications was mailed on Nov. 14 to 20 firms that wanted to be considered bidders. Deadline for proposal submission was December 11.
Nov. 5, 1958	The Space Task Group (STG) was officially formed at Langley to manage the manned program.
Nov. 14, 1958	NASA requested DX priority procurement rating for the manned spacecraft project, which was accorded on April 27, 1959.
Nov. 24, 1958	The STG ordered one Atlas launch vehicle for a development launch of a boilerplate spacecraft model (Big Joe); nine Atlas vehicles would be required according to a December 8 memo. A total of 15 had been approved by FY 1962.
Nov. 26, 1958	The name "Mercury" was agreed on for the manned project.
Dec. 11, 1958	Eleven firms submitted proposals for a manned spacecraft. STG members began assessing them on the 12th; they forwarded their findings to NASA Headquarters on the 30th.

Table 2-28.

Chronology of Key Project Mercury Events* (Continued)

Date	Event
Dec. 29, 1958	NASA awarded a contract to North American Aviation for the design and construction of the Little Joe I airframe (letter of intent dated December 31, 1958). The first two airframes were delivered on May 28, 1959.
Jan. 5, 1959	Guidelines were established for choosing astronaut candidates.
Jan. 9, 1959	McDonnell Aircraft Corporation's proposal for developing and producing the Mercury spacecraft was chosen as the winning bid. Preliminary negotiations began on the 14th, with a contract being signed on February 6. By FY 1962, 26 spacecraft had been ordered. Also on the 9th, NASA and Department of Defense (DoD) officials met to coordinate requirements for spacecraft tracking.
Jan. 16, 1959	NASA ordered eight Redstones and two Jupiters for Mercury from the Army; the requirement for the Jupiters was dropped on July 1, 1959.
Jan. 29, 1959	The Little Joe test program was drafted; it was updated on April 14, 1959.
Feb. 12, 1959	NASA and Navy officials met to discuss Mercury recovery needs; a NASA-Navy committee met formally for the first time on the 17th.
March 8, 1959	The first abort test of a full-scale model of the Mercury spacecraft was conducted at Wallops Island. On the 11th, a full-scale pad-abort test took place.
March 31, 1959	STG officials met with Atlantic Missile Range (AMR) personnel to discuss launch requirements.
Apr. 2, 1959	NASA held a preliminary briefing for prospective bidders on the Mercury tracking network.† Also on the 2d, it was announced that the selection of seven Mercury astronauts had been made; the candidates were announced publicly on the 9th. Training began on the 27th.
Apr. 12, 1959	A second full-scale beach abort was successful.
Apr. 19, 1959	The STG organized a Mercury Capsule Coordination Office under James A. Chamberlin; a Capsule Review Board, Paul E. Purser, chairman, was also formed.
July 22, 1959	NASA selected B. F. Goodrich Company as contractor for the Mercury pressure suit. Specifications were issued on October 2, 1959, and production began in May 1960. Also on the 22d, another successful pad-abort test took place using an escape rocket made by Grand Central Rocket Company.
Aug. 21, 1959	Little Joe 1 (LJ-1) beach-abort was unsuccessful.**
Sept. 9, 1959	Big Joe 1 was successful.
Oct. 4, 1959	LJ-6 was successful.
Nov. 1959-Jan. 1960	The general design work on the Mercury couch was completed.
Nov. 4, 1959	LJ-1A was unsuccessful.
Nov. 8-Dec. 5, 1959	Tentative design and layout of the Mercury control center was completed.
Dec. 4, 1959	LJ-2 was successful.
Jan. 15, 1960	NASA approved an "Overall Plan for Department of Defense Support for Project Mercury Operations"; DoD approval came in March.
May 9, 1960	A beach-abort test was successful.
June 20, 1960	Tests of the spacecraft environmental control system were begun.
July 29, 1960	<i>Mercury-Atlas 1 (MA-1)</i> was unsuccessful.
Sept. 1960	Pressure suits were tested to determine final adjustments; a number of improvements had been suggested and changes made by April 1963. The suit evolved with the program.
Nov. 8, 1960	LJ-5 was unsuccessful.
Nov. 21, 1960	<i>Mercury-Redstone 1 (MR-1)</i> was unsuccessful.
Dec. 19, 1960	<i>MR-1A</i> was successful.
Jan. 3, 1961	The STG was declared a separate NASA field element.
Jan. 31, 1961	<i>MR-2</i> was successful.

Table 2-28.

Chronology of Key Project Mercury Events* (Continued)

Date	Event
Feb. 21, 1961	<i>MA-2</i> was successful. Also on the 21st, astronauts John H. Glenn, Jr., Virgil I. Grisson, and Alan B. Shepard, Jr., were selected to begin training for the first manned flight.
March 18, 1961	<i>LJ-5A</i> was unsuccessful.
March 24, 1961	A Mercury Redstone-Booster Development (MR-BD) test was successful.
Apr. 12, 1961	Soviet cosmonaut Yuri A. Gagarin made an orbital flight on <i>Vostok 1</i> .
Apr. 25, 1961	<i>MA-3</i> was unsuccessful.
Apr. 28, 1961	<i>LJ-5B</i> was successful.
May 5, 1961	<i>MR-3</i> , piloted by Shepard, successfully completed NASA's first manned suborbital mission (see table 2-30).
May 25, 1961	President John F. Kennedy called for an accelerated space program, leading to a manned lunar landing before the end of the decade.
July 21, 1961	<i>MR-4</i> , manned by Grissom, successfully completed a suborbital mission (see table 2-31).
Aug. 1961	A site selection team evaluated locations for a Manned Spacecraft Center; Houston was chosen as the best site in September.
Sept. 13, 1961	<i>MA-4</i> was successful.
Nov. 1, 1961	The STG was redesignated the Manned Spacecraft Center (MSC); Robert R. Gilruth was retained as director.
Nov. 29, 1961	<i>MA-5</i> , the last unmanned development test, was successful. Also on the 29th, Glenn was selected as pilot of the first orbital mission.
Jan. 15, 1962	Organization of MSC was completed.
Feb. 1962	Kenneth S. Kleinknecht was appointed Project Mercury manager.††
Feb. 20, 1962	<i>MA-6</i> , manned by Glenn, successfully completed NASA's first manned orbital mission (see table 2-32).
May 24, 1962	<i>MA-7</i> , with M. Scott Carpenter onboard, successfully completed an orbital mission (see table 2-33).
July 1, 1962	Relocation of the MSC group from Langley Research Center to the Houston site was completed.
Sept. 18, 1962	Donald K. Slayton was designated coordinator of astronaut activities at MSC.
Oct. 3, 1962	<i>MA-8</i> , manned by Walter M. Schirra, Jr., successfully completed an orbital mission (see table 2-34)
May 15-16, 1963	<i>MA-9</i> , manned by L. Gordon Cooper, Jr., successfully completed an orbital mission lasting more than 34 hours, concluding the Mercury flight program (see table 2-35).
June 12, 1963	NASA Administrator James E. Webb announced that because Mercury had accomplished its goals, <i>MA-10</i> would not be flown. McDonnell's Mercury spacecraft contract was terminated the next day.
Oct. 3-4, 1963	A Project Mercury summary conference was held in Houston.

*For a more detailed calendar of events, see James M. Grimwood, *Project Mercury: A Chronology*, NASA SP-4001 (Washington, 1963).

†For further details on events that led to the establishment of the Manned Space Flight Network, see table 5-24.

**For further details on this and other developmental flights, consult table 2-29.

††Kleinknecht replaced James Chamberlin, who was reassigned to the new Project Gemini office as manager. Chamberlin's STG titles had been chief of the engineering division and chairman of the Capsule Coordination Committee, effectively making him "project manager" of Mercury.

Table 2-29.
Developmental Tests/Flights, Project Mercury

Launch Date (location)	Test/ Flight	Objectives/Results
Aug. 21, 1959 (Wallops)	LJ-1	Unsuccessful beach abort test. When the escape rocket fired prematurely during the countdown, the vehicle rose to an altitude of 600 m and landed some 600 m from the launch site.
Sept. 9, 1959 (ETR)	Big Joe 1	Successful launch (suborbital) of a full-scale instrumented Mercury boilerplate spacecraft to an altitude of 160 km; capsule survived reentry heat of more than 5800° K.
Oct. 4, 1959 (Wallops)	LJ-6	Successful launch of a boilerplate Mercury (suborbital) to check the integrity of the launch vehicle airframe and motor, to verify launch operations, and to test the destruct system.
Nov. 4, 1959 (Wallops)	LJ-1A	Suborbital test of the abort maneuver under high aerodynamic load conditions (repeat of LJ-1). Maneuver was not accomplished at the desired pressure.
Dec. 4, 1959 (Wallops)	LJ-2	Successful suborbital test of spacecraft-escape tower during high-altitude abort. Entry dynamics and the effects of acceleration on a rhesus monkey (Sam) were also studied.
Jan. 21, 1969 (Wallops)	LJ-1B	Successful beach abort test (repeat of LJ-1) with a rhesus monkey (Miss Sam) onboard. The Mercury helicopter recovery system was also exercised.
May 9, 1960 (Wallops)	Beach abort (Mercury spacecraft 1)	Successful performance evaluation of the escape system, parachute-landing system, and recovery operations in an off-the-pad abort. McDonnell's first production spacecraft was used in the test.
July 29, 1960 (ETR)	MA-1 (spacecraft 4)	Launch of a Mercury production capsule was unsuccessful due to launch vehicle failure.
Nov. 8, 1960 (Wallops)	LJ-5 (spacecraft 3)	Unsuccessful test of spacecraft abort under most severe launch conditions. The escape rocket ignited prematurely, and the spacecraft did not detach from the vehicle until impact.
Nov. 21, 1960 (ETR)	MR-1 (spacecraft 2)	Premature booster cutoff caused the vehicle to settle back down on the pad after barely leaving the ground. The Mercury capsule was reused in MR-1A.
Dec. 19, 1960 (ETR)	MR-1A (spacecraft 2)	Successful suborbital reentry test (repeat of MR-1).
Jan. 3, 1961 (ETR)	MR-2 (spacecraft 5)	Suborbital flight of fully operational Mercury with chimpanzee (Ham) onboard. Although excessive booster velocity carried the spacecraft higher and farther than programmed, the capsule and passenger were recovered after their 16-min. flight.
Feb. 21, 1961 (ETR)	MA-2 (spacecraft 6)	Successful suborbital test of Mercury-Atlas configuration.
March 18, 1961 (Wallops)	LJ-5A (spacecraft 14)	Second unsuccessful attempt to test spacecraft abort system under most severe conditions. Premature escape rocket ignition was again the cause of the failure.
March 24, 1961 (ETR)	MR-BD	Successful booster development test flight of the Redstone, qualifying the vehicle for manned missions.
Apr. 25, 1961 (ETR)	MA-3 (spacecraft 8)	Orbital capsule test was unsuccessful due to launch vehicle failure; the abort and recovery system was proved.
Apr. 28, 1961 (Wallops)	LJ-5B (spacecraft 14A)	Successful test of abort system under maximum dynamic pressure (reuse capsule from LJ-5A).
Sept. 13, 1961	MA-4	Successful one-orbit test of the tracking network (reused

Table 2-29.
Developmental Tests/Flights, Project Mercury

Launch Date (location)	Test/ Flight	Objectives/Results
(ETR) Nov. 2, 1961	(spacecraft 8A) MA-5	spacecraft from MA-3). Successful two-orbit flight to test all Mercury systems; a third orbit was not completed due to an abnormal roll rate. A chimpanzee (Enos) passenger was recovered in good condition.
(ETR)	(spacecraft 9)*	

*Spacecraft 10 was used at McDonnell's St. Louis facility in an environmental test; 12B had been scheduled for a manned one-day mission which was cancelled (12B was not delivered); 15B had been scheduled for a manned one-day mission also, which was cancelled after the successful MA-9 (15B not delivered); 17 was delivered to Cape Canaveral in April 1963 to be used as parts support for planned one-day missions; 19 was not delivered when the manned orbital mission for which it was scheduled was cancelled after the successful MA-8.

Table 2-30.
Mercury-Redstone 3 (MR-3) Characteristics

Date of launch (ETR pad #):	May 5, 1961 (5)	
Spacecraft designation:	Mercury capsule 7	
Unofficial spacecraft designation:	Freedom 7	
Launch vehicle designation:	Mercury-Redstone 7	
Spacecraft weight (kg):	1832.5	
Spacecraft shape, dimensions (m):	conical width at base, 2.1 length, 3.4	
Crew:	Alan B. Shepard, Jr.	
Backup crew:	John H. Glenn, Jr.	
Cap com:	Donald K. Slayton (Mercury Control Ctr.)	
Max. alt. (km):	187.42	
Range (km):	487.26	
No. of orbits:	suborbital	
Length of mission:	00:15:22	
Mission events (date, time, ground elapsed time):		
launch	May 5 9:34:13 a.m., EST	
main engine shutoff	9:36:35	00:02:22
capsule separation	9:36:45.5	00:02:32.5
initiation of retrofire	9:38:57	00:04:44
splashdown	9:49:35	00:15:22
Distance traveled (km):	1006	
Time in weightlessness:	approx. 00:04:00	
Landing point:	27°13.7'N, 75°53'W (5.6 km from target)	
Recovery ship:	USS <i>Champlain</i> (crew onboard in 15 min.)	
Mission objectives:	During a suborbital flight, evaluate Mercury astronaut's performance and advance the qualities of the capsule and its systems.	
Results:	Mission was performed as planned.	

Table 2-31.
Mercury-Redstone 4 (MR-4) Characteristics

Date of launch (ETR pad #):	July 21, 1961 (5)
Spacecraft designation:	Mercury capsule 11
Unofficial spacecraft designation:	Liberty Bell 7
Launch vehicle designation:	Mercury-Redstone 8
Spacecraft weight (kg):	1824.4
Spacecraft shape, dimensions (m):	see table 2-30
Crew:	Virgil I. Grissom
Backup crew:	Glenn
Cap com:	Shepard (Mercury Control Ctr.)
Max. alt. (km):	190.76
Range (km):	487.08
No. of orbits:	suborbital
Length of mission:	00:15:37
Mission events (date, time, ground elapsed time):	
launch	July 21 7:20 a.m., EST
main engine shutoff	7:22:22 00:02:22
capsule separation	7:22:32.4 00:02:32.4
initiation of retrofire	7:24:45.8 00:04:45.8
splashdown	7:35:37 00:15:37
Distance traveled (km):	1014
Time in weightlessness:	00:04:54
Landing point:	27°32'N, 75°44'W (9.3 km from target)
Recovery ship:	<i>USS Randolph</i> (crew onboard in 20 min.)
Mission objectives:	Evaluate pilot's reaction to spaceflight and his performance as an integral part of the flight system.
Results:	The only event that marred the flight was the loss of the capsule during recovery operations when the explosive side egress hatch activated prematurely while Grissom was waiting for the recovery helicopter. The spacecraft sank after Grissom left it. He was recovered after being in the water 3 or 4 minutes. Two attempts to launch the mission on July 18 and 19 were scrubbed due to inclement weather.
Reference:	STG, "Postlaunch Memorandum Report for Mercury-Redstone No. 4 (MR-4)," Aug. 6, 1961.

Table 2-32.
Mercury-Atlas 6 (MA-6) Characteristics

Date of launch (ETR pad #):	Feb. 20, 1962 (14)	
Spacecraft designation:	Mercury capsule 13	
Unofficial spacecraft designation:	Friendship 7	
Launch vehicle designation:	Atlas 109-D	
Spacecraft weight (kg):	1934.7	
Spacecraft shape, dimensions (m):	see table 2-30	
Crew:	Glenn	
Backup crew:	M. Scott Carpenter	
Cap coms:	Shepard (Mercury Mission Ctr.), Grissom (Bermuda), Walter M. Schirra, Jr. (California), L. Gordon Cooper, Jr. (Mucnea)	
Apogee/perigee (km):	261.14/161	
No. of orbits:	3	
Period:	01:28:29	
Length of mission:	04:55:23	
Mission events (date, time, ground elapsed time):		
launch	Feb. 20 9:47 a.m., EST	
main engine shutoff	9:48:09.6	00:02:09.6
spacecraft separation	9:51:03.6	00:15:13.6
initiation of retrofire	2:20:08 p.m.	04:33:08
splashdown	2:42:23	04:55:23
Distance traveled (km):	130 355	
Time in weightlessness:	04:38:00	
Landing point:	21°26'N, 68°41'W (74 km from target)	
Recovery ship:	<i>USS Noa</i> (crew onboard in 20 min.)	
Mission objectives:	Evaluate performance of man-spacecraft system in a three-orbit mission, evaluate effects of spaceflight on astronaut, obtain astronaut's evaluation of spacecraft's operational suitability.	
Results:	Three launch attempts were cancelled because of inclement weather on Jan. 27 and 30 and Feb. 14. Only two mechanical problems bothered Glenn on <i>MA-6</i> ; a yaw attitude control jet apparently clogged, forcing him to use the manual system; and a faulty switch indicated that the heat shield had been prematurely released when it had not.	
Reference:	MSC, "Postlaunch Memorandum Report for Mercury-Atlas No. 6 (MA-6), Part I—Mission Analysis," March 5, 1962.	

Table 2-33.
Mercury-Atlas 7 (MA-7) Characteristics

Date of launch (ETR pad #):	May 24, 1962 (14)	
Spacecraft designation:	Mercury capsule 18	
Unofficial spacecraft designation:	Aurora 7	
Launch vehicle designation:	Atlas 107-D	
Spacecraft weight (kg):	1925.1	
Spacecraft shape, dimensions (m):	see table 2-30	
Crew:	Carpenter	
Backup crew:	Schirra	
Cap coms:	Grissom (Mercury Control Ctr.), Shepard (California), Slayton (Muchea), Cooper (Guaymas)	
Apogee/perigee (km):	268.55/160.84	
No. of orbits:	3	
Period:	01:28:32	
Length of mission:	04:56:04.8	
Mission events (date, time, ground elapsed time):		
launch	May 24 7:45 a.m., EST	
main engine shutoff	7:47:06.6	00:02:06.6
spacecraft separation	7:50:09.9	00:05:09.9
initiation of retrofire	12:17:36.5	04:32:36.5
splashdown	12:41:04.8	04:56:04.8
Distance traveled (km):	130 933	
Time in weightlessness:	approx. 04:30:00	
Landing point:	19°27'N, 63°59'W (400 km from primary target)	
Recovery ship:	<i>USS Pierce</i> (crew onboard in 3 hr.)	
Mission objectives:	Same as for <i>MA-6</i> , plus further exercise and evaluate performance of the Mercury tracking net (see table 3-32).	
Results:	Launch of <i>MA-7</i> met with three postponements on: May 7 (checkout problems with Atlas), May 17 (modifications were found to be necessary to the parachute deployment system), and May 19 (irregularities with the heater temperature control device in the Atlas flight control system). Three anomalies were experienced during the flight: random failure of the circuitry associated with the pitch horizon scanner, excessive fuel usage, and a landing 400 km beyond the predicted point.	
Reference:	MSC, "Postlaunch Memorandum Report for Mercury-Atlas No. 7 (MA-7), Part I—Mission Analysis," June 15, 1962.	

Table 2-34.
Mercury-Atlas 8 (MA-8) Characteristics

Date of launch (ETR pad #):	Oct. 3, 1962 (14)	
Spacecraft designation:	Mercury capsule 16	
Unofficial spacecraft designation:	Sigma 7	
Launch vehicle designation:	Atlas 113-D	
Spacecraft weight (kg):	1961.6	
Spacecraft shape, dimension (m):	see table 2-30	
Crew:	Schirra	
Backup crew:	Cooper	
Cap coms:	Slayton (Mercury Mission Ctr.), Grissom (Hawaii), Glenn (California), Shepard (<i>Coastal Sentry</i> Quebec), Carpenter (Guaymas)	
Apogee/perigee (km):	283.04/161	
No. of orbits:	6	
Period:	01:28:55	
Length of mission:	09:13:11	
Mission events (date, time, ground elapsed time):		
launch	Oct. 3 7:15 a.m., EST	
main engine shutoff	7:17:08.6	00:02:08.6
spacecraft separation	7:20:17.9	00:05:17.9
initiation of retrofire	4:06:30 p.m.	08:51:30
splashdown	4:28:11	09:13:11
Distance traveled (km):	247 748	
Time in weightlessness:	approx. 09:30:00	
Landing point:	32°06'N, 174°28'W (7.4 km from target)	
Recovery ship:	<i>USS Kearsarge</i> (crew onboard in 45 min.)	
Mission objectives:	Evaluate performance of man-spacecraft system during a 6-orbit mission; evaluate effects of extended orbital spaceflight on astronaut; obtain additional astronaut evaluation of capsule and its systems; evaluate network and support forces, and establish their suitability for extended orbital flight.	
Results:	The only difficulty experienced during the mission was in attaining the correct pressure suit temperature adjustment. The <i>MA-8</i> spacecraft was modified slightly to allow for the use of low-thrust reaction control jets only during manual operations; two high-frequency antennas also were mounted to improve communications.	
Reference:	MSC, "Postlaunch Memorandum Report for Mercury-Atlas No. 8 (MA-8), Part I—Mission Analysis," Oct. 23, 1962.	

Table 2-35.
Mercury-Atlas 9 (MA-9) Characteristics

Date of launch (ETR pad #):	May 15, 1963 (14)	
Spacecraft designation:	Mercury capsule 20	
Unofficial spacecraft designation:	Faith 7	
Launch vehicle designation:	Atlas 130-D	
Spacecraft weight (kg):	1964.4	
Spacecraft shape, dimension (m):	see table 2-30	
Crew:	Cooper	
Backup crew:	Shepard	
Cap coms:	Schirra (Mercury Control Ctr.), Grissom (Guaymas), Glenn (<i>Coastal Sentry</i> Quebec), Carpenter (Hawaii)	
Apogee/perigee (km):	267.1/161.48	
No. of orbits:	22	
Period:	01:28:45	
Length of mission:	34:19:49	
Mission events (date, time, ground elapsed time):		
launch	May 15 8:04 a.m., EST	
main engine shutoff	8:06:12.4	00:02:12.4
spacecraft separation	8:09:05.3	00:05:05.3
initiation of retrofire	May 16 6:02:59 p.m.	33:58:59
splashdown	6:23:49	34:19:49
Distance traveled (km):	939 385	
Time in weightlessness:	approx. 34:00:00	
landing point:	27°20'N, 176°26'W (8.1 km from target)	
recovery ship:	<i>USS Kearsarge</i> (crew onboard in 45 min.)	
Mission objectives:	Evaluate effects of 1-day orbital flight on astronaut; evaluate modifications made to spacecraft for mission; obtain astronaut's evaluation of suitability of spacecraft; assess effectiveness of net.	
Results:	There was one previous attempt to launch <i>MA-9</i> on May 14; a ground support problem and a computer anomaly at the Bermuda tracking station led to postponement. Because of a possible short circuit, Cooper reentered the atmosphere using manual controls, the first astronaut to do so; he landed 6400 meters from the prime recovery ship.	
Reference:	MSC, "Postlaunch Memorandum Report for Mercury-Atlas No. 9 (MA-9), Part I—Mission Analysis," June 24, 1963.	

Table 2-36.
Project Mercury Flight Experiments

Experiment	Mercury-Atlas			
	6	7	8	9
Astronaut observations	x			
Light visibility observations				
Ground flare visibility			x	x
Air glow observations		x		
Flashing light experiment		x		
Photography studies				x
Infrared weather photography	x	x	x	
Dim-light photography				x
Horizon definition photography				x
Zero g liquid behavior		x		
Tethered inflatable balloon		x		
Radiation studies			x	x
Ablative materials investigation			x	

CHARACTERISTICS—PROJECT GEMINI

Long before the first American astronaut was boosted into orbit, engineers at the Space Task Group and at McDonnell Aircraft Corporation were making changes on paper to the Mercury design that would lend it to longer, more useful missions. In late 1961, these engineers were given the opportunity to fit their "improvements in the abstract" to a set of specific mission goals. President Kennedy's decision to exhibit American technical prowess through a manned expedition to the moon had given NASA a revised timetable for finding answers to a broad range of questions. What effect would several days of weightlessness have on a crew? If a spacecraft were not sent to the moon directly but relied on maneuvers in earth orbit to prepare it for a translunar trajectory, how complicated would rendezvous and docking in space be?^{*19} Could an astronaut perform tasks outside his spacecraft? Gemini would be NASA's vehicle for investigating these and other unknowns. (See table 2-37 for a chronology of key events.)

At McDonnell Aircraft, contractor to NASA for the Mercury spacecraft, designers had two advanced craft in mind. One would require a minimum number of changes to the basic Mercury spacecraft, which would extend its mission lifetime. The second called for major modifications that would provide space for a second crewman, more consumables, and experiment hardware. Mercury Mark II, as this upgraded design was called, would also be a more controllable spacecraft during reentry, although it would retain its predecessor's ballistic shape. When NASA

*Besides direct ascent and earth orbit rendezvous modes for reaching the moon, one other possibility, lunar orbit rendezvous, gained wide support among NASA personnel in 1962 and was later chosen as the best solution. See the discussion of the Apollo program elsewhere in this chapter for more information.

Headquarters approved a development plan for Mercury Mark II in December 1961, the scheme had expanded to include subsystems that would allow the spacecraft to rendezvous and dock with a target vehicle and perform a controlled touchdown on land rather than on water. Perhaps the most significant change, however, was the modular approach to spacecraft subsystems. To save weight and space in Mercury, hardware had been fit into the spacecraft as best as it could be, with components of one subsystem often interspersed among others. Removing or testing one component could lead to the removal and retesting of many. In the new design, a system could be dismantled, changed, or verified as a distinct part without disturbing its neighbors. McDonnell's new contract with NASA called for 13 spacecraft (see fig. 2-3 for spacecraft details).

To launch the larger, heavier (3500-kilogram class) "Gemini," the new spacecraft's name as of January 1962, the Air Force would contribute its Titan missile. More powerful than Mercury's Atlas launch vehicle, Titan used hypergolic fuel, which was less dangerous on the pad, precluding the need for an escape rocket (instead, ejection

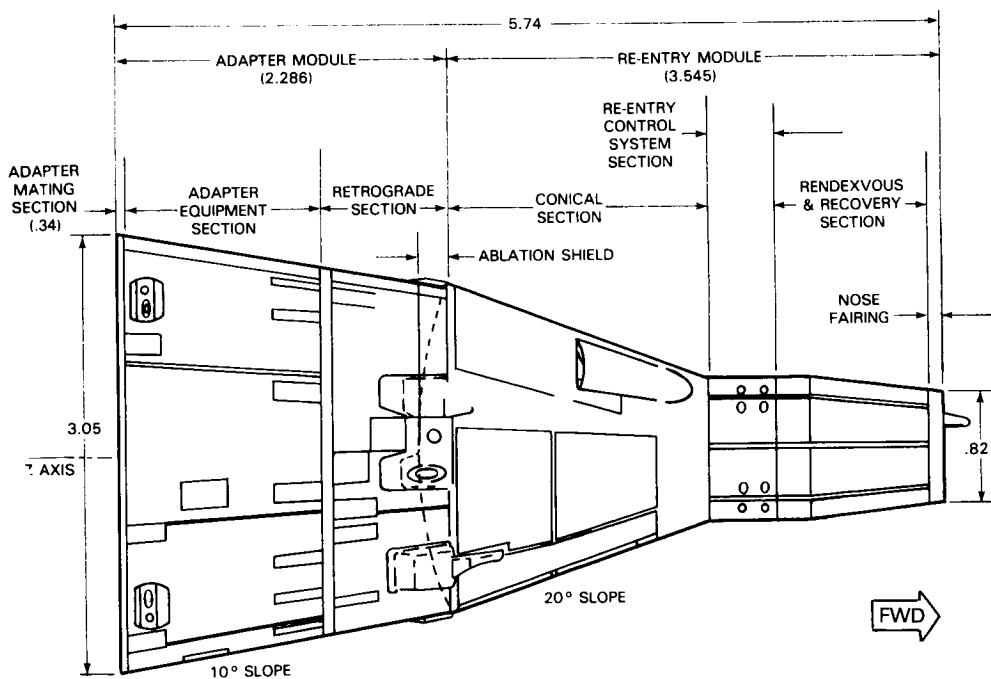

Figure 2-. General Arrangement of the Gemini Spacecraft (dimensions in meters). The conical Gemini spacecraft had two major assemblies: the adapter module, which was jettisoned in two parts before reentry; and a reentry module. Heat resistant titanium and magnesium were used to fabricate the spacecraft, with externally-mounted shingles (Rene 41 on the conical section; beryllium on the small end) giving extra protection. The vehicle's primary protector during reentry was a silicone elastomer ablative heatshield on the large blunt end of the reentry module. Two access hatches were provided in the cabin section (reentry module), each fitted with windows. Spacecraft attitude was controlled with eight 111-newton thrusters and translation along any axis by six 445-newton thrusters and two 378-newton thrusters. Four retrograde rockets for reentry deceleration were located in the retrograde section of the adapter module. Electrical power was provided by silver-oxide batteries and a fuel cell built by General Electric (see also tables 2-54 and 2-55 for more information on major spacecraft systems). From P.W. Malik and G.A. Souris, Project Gemini; A Technical Summary, NASA CR-1106 (Washington, 1968), p. 5.

tion seats and parachutes would take Gemini crews away from malfunctioning boosters). The Titan II ICBM, however, was still in the development stage, with the first of 33 research and development flights taking place in March 1962. The Air Force and the Martin Company, prime contractor for the Titan, spent months massaging the design to rid it of its problems. Its tendency to oscillate longitudinally (called the pogo effect) made the missile unsafe for manned use, as did its potential second-state combustion instability and a number of other minor design flaws. Troubles with the launch vehicle forced mission planners to substitute unmanned flights for the first two missions to verify further the Gemini launch vehicle.* By the spring of 1964, Titan was ready.²⁰

The mechanics of rendezvous and docking became Gemini's most important objective when lunar orbit rendezvous was chosen over direct ascent or earth orbit rendezvous for the Apollo mission mode. One rendezvous and docking maneuver would take place shortly after leaving earth orbit enroute to the moon; a second would be required in lunar orbit. NASA chose another Air Force vehicle to serve as Gemini's target in orbital exercises. Agena, a second stage manufactured by Lockheed Missiles and Space Company for the Air Force, would be launched into orbit where it would be available for maneuvers. Agena was considered especially suitable because it had the capability to restart its engines (NASA required five restarts for Gemini); its propulsion system could thus be used to maneuver the two vehicles while they were docked (see fig. 2-4 for spacecraft details). Gemini was pro-

*For more information on the Titan vehicle, see chap. 1.

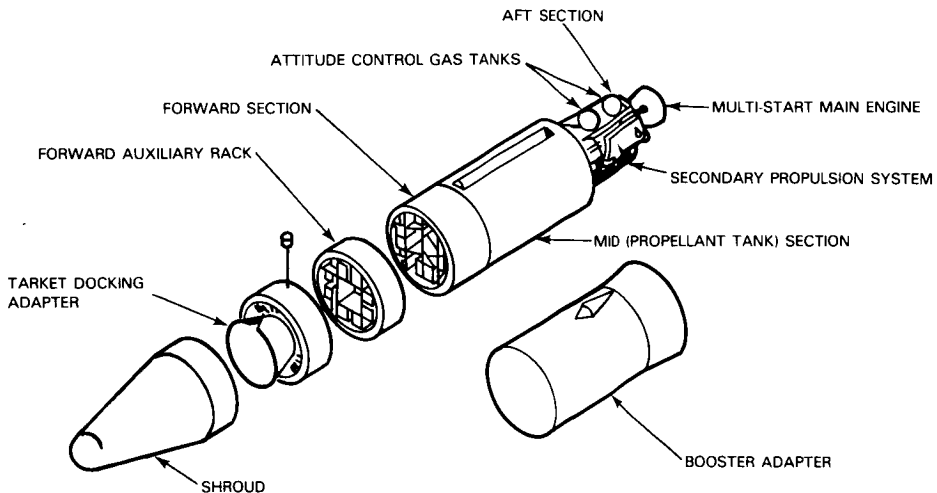

Figure 2-4. Gemini Agena Target Vehicle. The Gemini Agena Target Vehicle (GATV) was 10.28 meters long with launch shroud and booster adapter intact, 7.92 meters long in orbit. Its diameter was 1.52 meters. Total thrust from its primary propulsion system and two secondary engines was 73,000 newtons. Equipment added to the standard Agena D upper stage for the Gemini program included a docking collar, compatible radar transponder, strobe lights, secondary propulsion system, ground control equipment, and a multi-restartable engine (see also chap. 1 for more information on the Agena vehicle as an upper stage).

vided with an orbital attitude and maneuvering system (OAMS), a series of thrusters, by which the crew could adjust its attitude and orbit. Agena and the spacecraft maneuvering system were the source of many problems; they were over budget and late. And difficulties with target vehicles continued throughout most of the operational phase of the program.²¹

Land landings were a goal Gemini officials had to abandon. Paraglider, a stowable, flexible wing (similar in shape to a hang glider), presented too many design problems. It was a totally new concept for which Gemini did not have the necessary time and money. North American Aviation, the contractor for paraglider, was instructed to downgrade its development plan for the wing in February 1964. Gemini would rely on a system of parachutes for water landings as had Mercury.

The extravehicular activity (EVA) planned for Gemini astronauts was applicable to Apollo operations and to any advanced orbital program that NASA might consider for the future. Astronauts could be asked to retrieve experiment packages from other vehicles or be forced to make inspections or repairs to their craft. And biotechnicians assigned to Apollo needed more data on the environmental control requirements for space suits and portable life support systems. Because of hardware delays, EVA was not conducted until the second Gemini flight (*GT-4*). Astronauts found this activity more fatiguing than experts had predicted, and throughout the program hardware improvements were affected to make EVA easier.*²²

The final Gemini program plan included 10 manned missions, two crewmen per flight. To supplement the seven original Mercury astronauts, NASA added nine men to the corps in September 1962 and another 14 in October 1963.† Training exercises for the missions included classroom studies and many sessions in the dynamic crew procedures simulator, which provided crew members with high-fidelity simulations of the several phases of the missions (launch, rendezvous, experiments activity, reentry). Crew training for EVA was conducted in a one-g environment in mockups of the spacecraft, in altitude chambers, and on air-bearing platforms. NASA astronauts also trained in Air Force zero-g test aircraft. Limited use was made of underwater neutral buoyancy training for the last Gemini crews. As was the case with Mercury, Gemini astronauts worked closely with engineers, technicians, operations people, and physicians during the program.²³

Gemini manned operations filled two years. Following two unmanned flights (see table 2-38) to prove the integrity of the launch vehicle and spacecraft, the first two Gemini pilots took part in *Gemini-Titan 3 (GT-3)* in March 1965. Virgil Grissom and John W. Young piloted their craft on a short three-orbit mission. The new spacecraft was judged fit. On *GT-4* in June, James A. McDivitt and Edward H.

*There were two classes of EVA. One was called "standup" and did not involve leaving the spacecraft. The crew member opened the hatch and performed various tasks while still in the cabin. "Umbilical" EVA involved leaving the spacecraft, tethered to it by a life line. One modification to Gemini that made EVA easier was the addition of more restraint straps and handholds outside the spacecraft. Handheld maneuvering units were tested on *GT-4* and *GT-10*. These gas-expulsion devices could produce up to 8.89 newtons of thrust. An astronaut maneuvering unit devised by the Air Force was carried on *GT-9A* but not evaluated because the crew member conducting EVA was bothered by visor-fogging and overheating. This backpack unit had pitch, roll, and yaw controls, with 20 newtons of thrust.

† See the section on the Apollo program for more on astronaut selection.

White, II, spent four days in orbit and conducted the first extravehicular activity. They were followed two months later by Gordon Cooper and Charles Conrad, Jr., in a seven-day mission. The first attempt to conduct a mission with the Agena target vehicle failed when the target did not go into orbit in October 1965. In its place, a dual manned spacecraft mission was performed in December. *GT-7* with Frank Borman and James A. Lovell, Jr., aboard rendezvoused with *GT-6A* manned by Walter M. Schirra, Jr., and Thomas P. Stafford. In addition to their successful joint exercise, the *GT-7* crew set an endurance record of more than 13 days in space. The docking of *GT-8* and an Agena target vehicle in March 1966 was marred by a spacecraft thruster malfunction. Astronauts Neil A. Armstrong and David R. Scott had to undock and use their reentry thrusters to control their rolling spacecraft; this led to an early return to a secondary landing area. In May, another Agena failure led to a backup mission plan. Stafford and Eugene A. Cernan in *GT-9* attempted to dock with a contingency target (an Augmented Docking Target Adapter built by McDonnell and launched by an Atlas), but its launch shroud failed to jettison, leaving the docking cone covered. Cernan performed tasks outside the spacecraft for more than two hours, and *GT-9* accomplished rendezvous maneuvers. Crewmen Young and Michael Collins conducted the first completely successful docking mission aboard *GT-10* in July 1966. During the next mission two months later, *GT-11* and an Agena target docked during Gemini's first orbit. Conrad and Richard F. Gordon, Jr., then maneuvered the docked vehicle into a high-altitude orbit. The last crew, Lovell and Edwin E. Aldrin, Jr., in *GT-12*, also docked successfully with their target.* Gemini missions became almost routine for the press and public; for the launch and test teams at Cape Kennedy and for the mission controllers in Houston it never became routine, but it did become operational (see tables 2-39 through 2-48 for mission details).

The lengthy missions planned for Gemini and the spacecraft's increased payload capacity prompted NASA officials to sponsor an experiments program for manned spaceflight missions. The agency solicited proposals for investigations that required crew participation from universities, other government agencies, private research groups, and its own field centers. Once the Gemini Experiments Office (part of the Gemini Project Office, later called the Experiments Program Office and moved to the science and applications directorate at MSC) had determined an experiment's suitability and had identified missions that could accommodate it, the Manned Space Flight Experiments Board at NASA Headquarters made a specific flight assignment.† Implementing approved experiments into the mission plan and into the spacecraft hardware was MSC's task. A total of 52 different experiments was flown on Gemini, many on more than one mission. Of the 52, 17 were classified scientific, 27 technological (in support of spacecraft development or operational techniques), and 8 medical (in addition to routine medical monitoring). The Department of

* Gemini crews completed 10 rendezvous maneuvers using 7 different rendezvous modes. They completed 9 docking exercises.

† The Manned Space Flight Experiments Board, organized in January 1964 to support Gemini and Apollo, also collected proposals submitted by MSC, the Office of Space Science and Applications, the Space Medicine Office, and the Office of Advanced Research and Technology and transmitted them to the Gemini Experiments Office. In turn, the Gemini Experiments Office consulted recovery operations, flight crew support, medical, and flight operations to determine a proposal's feasibility.

Defense was the largest contributor outside NASA with 15 investigations, all in the technological category. *GT-12* carried the largest number of experiments, and the crew spent 30 percent of its flight time performing them. The various photography experiments, of which at least one was flown on all missions but the first, provided investigators and the public with the extensive series of "space photographs," more than 2400 images.²⁴ (See table 2-49.)

Because of Project Gemini's use of two Air Force launch vehicles, the Air Force played a larger part in project management than the service had in Mercury. In addition, the Navy and the Air Force supported launch, tracking, and recovery operations. After several months of dispute over DoD's role in Gemini, a January 1963 joint agreement established a NASA-DoD Gemini Program Planning Board to coordinate the two groups' activities.²⁵

At NASA Headquarters for most of the project's lifetime, George E. Mueller, associate administrator for manned spaceflight, also acted as Gemini program director. Mueller was assisted by Special Assistant Samuel H. Hubbard and by directors for program control, systems engineering, test, flight operations, and reliability and quality. At the Manned Spacecraft Center in Houston, James Chamberlin served as Gemini's first manager. Chamberlin had worked with the technical people at McDonnell in St. Louis when NASA first considered upgrading the Mercury design. In 1964, when Gemini, plagued by several major hardware problems, started running over budget and behind schedule, Charles Mathews took over the manager's job and reorganized the program office. Personnel from MSC monitored progress at the Martin Company in Baltimore (Titan II), at Lockheed in California (Agena target vehicle), at McDonnell in St. Louis (Gemini spacecraft), and at the Cape. Kenneth Kleinknecht, Mathews' deputy in the Gemini Project Office, was supported by managers for program control, spacecraft management, and vehicles and missions. (See also tables 2-2 and 2-3.)

Table 2-37.
Chronology of Key Project Gemini Events*

Date	Event
May 25-26, 1959	During its first meeting, a NASA committee chaired by Harry J. Goett (Ames Research Ctr.) considered possibilities for a post-Mercury manned spaceflight project. Ideas included an enlarged Mercury craft that could support a crew of two for three days.
Aug. 12, 1959	The Space Task Group's (STG) New Projects Panel instructed the Flight Systems Division of STG to initiate a program that would lead to a second-generation spacecraft with advances over the Mercury vehicle. The Mercury spacecraft contractor, McDonnell Aircraft Corporation, was also studying possible modifications that would improve the vehicle.
Apr. 5, 1960	The STG issued specifications by which to modify the Mercury spacecraft (e.g., the addition of a reentry control navigation system). Besides reentry control, designers also wanted to include orbital controls so that orbital rendezvous techniques would be possible. (Rendezvous was later seen as a necessary requirement for a lunar mission and included as an objective for Gemini.)
Apr. 14, 1961	Following discussions between NASA and McDonnell personnel in February regarding an advanced Mercury design, NASA issued a study contract to McDonnell for improving the Mercury. Their work would be concentrated on two versions of an advanced spacecraft: one with minor changes that would sustain one man for 18 orbits; and a second that would be capable of more advanced missions with two men, requiring more radical modifications. The improved Mercury concept came to be called Mercury Mark II.
May 8, 1961	Personnel from the Martin Company, manufacturer of the Titan missile system for the Air Force, briefed NASA officials on the Titan and its possible applications to the future manned program. During July, Martin submitted a proposal for a Titan-boosted Mercury-type vehicle.
May 17, 1961	To allow for a controlled descent on land of a manned spacecraft, the STG issued a statement of work for a design study of a "paraglider" landing system. The design study (conducted at Goodyear Aircraft Corp., North American Aviation, Inc., and Ryan Aeronautical Co.) became phase one of a paraglider development program.
Nov. 1, 1961	STG was redesignated the Manned Spacecraft Center (MSC).
Nov. 21, 1961	NASA issued a letter contract to North American to proceed with phase II-A of the paraglider development program; the final contract was awarded on February 9, 1962.
Dec. 7, 1961	NASA Associate Administrator Robert C. Seamans approved a Mercury Mark II development plan prepared by the STG in October. The plan called for a two-man version of the Mercury spacecraft capable of longer missions to be launched by a modified Titan II; the spacecraft would conduct orbital rendezvous and docking maneuvers with an Agena B target vehicle placed in orbit by an Atlas booster. A controlled land landing of the returning spacecraft was an additional project objective. Flights would begin in 1963.
Dec. 15, 1961	NASA awarded McDonnell a letter contract for the development of 12 Mark II spacecraft. The final contract was not signed until April 2, 1963 (it called for 13 spacecraft, one of which would be used for ground testing).
Dec. 26, 1961	MSC directed the Air Force Space Systems Division to authorize its launch vehicle contractors (primarily Martin) to begin the work necessary to modify the Titan II for the Mercury Mark II program. A letter contract with Martin for 15 launch vehicles was issued on January 19, 1962.
Jan. 3, 1962	"Gemini" became the official designation of the Mercury Mark II program. On the 15th, a Gemini Project Office was established at MSC, with James Chamberlin as manager.
Jan. 31, 1962	MSC notified the Marshall Space Flight Center that it should procure through the Air Force 11 Agena B target vehicles and Atlas boosters for Gemini. The Air Force Space Systems Division awarded a letter contract to Lockheed Missiles and

Table 2-37. (Continued)
Chronology of Key Project Gemini Events*

Date	Event
March 16, 1962	Space Company for 8 modified Agenas on May 1. Marshall was actively involved in the Atlas-Agena procurement cycle until January 1963, when MSC assumed the responsibility. The Air Force successfully conducted the first full-scale test launch of a Titan II ICBM. In all, 33 Titan research and development flights took place, the last on April 9, 1964. From the standpoint of a Gemini mission, 22 would be judged successful.
March 27, 1962	Air Force and NASA officials signed a Gemini Operational and Management Plan that outlined the roles NASA and DoD would play in the program. DoD was responsible for the Titan II and Atlas-Agena B launch vehicles from development through launch and for range and recovery support.
March 31, 1962	The Gemini spacecraft configuration was formally frozen.
April 4, 1962	MSC awarded B. F. Goodrich a contract for the development of prototype Gemini pressure suits. The first suit was delivered on November 6.
May 1962	Tests began at Ames Research Center to evaluate a half-scale paraglider wing. Tests ran through July. North American also began drop tests of the emergency parachute system for their half-scale paraglider. North American was authorized to begin phase II-B of the paraglider program on June 20.
July 1962	During Gemini launches, ejection seats rather than escape rockets would be used to carry astronauts away from a malfunctioning booster. Simulated off-the-pad ejection tests began in July at the Naval Ordnance Test Station.
Aug. 2, 1962	NASA and Air Force officials decided to substitute the updated, more versatile Agena D stage for use as the Gemini target vehicle.
Aug. 14, 1962	North American began flight tests of the half-scale paraglider test vehicle.
Aug. 15-16, 1962	A formal review of McDonnell's engineering mockup of the Gemini spacecraft was held in St. Louis.
Sept. 17, 1962	MSC announced the selection of nine more astronauts to supplement the original group of seven. The flight crew training program for Gemini and Apollo, the lunar exploration program, would be managed at MSC in Houston.
Oct. 15, 1962	NASA awarded a contract to International Business Machines to provide the ground-based computer system for Gemini and Apollo. The computing center and mission control for Gemini and Apollo would be at Houston.
Dec. 1962	Deployment flight tests of the half-scale paraglider test vehicle were unsuccessful. A NASA team inspected the full-scale test model and requested 24 modifications. An advanced paraglider trainer was also under development at North American.
Dec. 17, 1962	A newly formed Scientific Experiments Panel met to solicit proposals for experiments to be performed during Gemini and Apollo. The first Gemini experiments were approved in February 1964.
Jan. 17, 1963	NASA and DoD officials signed a second agreement defining Gemini responsibilities and establishing a NASA-DoD Gemini Program Planning Board (first meeting, Feb. 8). While NASA would continue to manage the program, the agreement gave DoD a part in spacecraft development, pilot training, preflight checkout, launch, and flight operations, in addition to its role as launch vehicle provider.
March 1963	Because of budget problems and a series of failures with the paraglider test vehicle, the paraglider development plan was revised: paraglider would not be used until the 10th rather than the 7th mission. Some officials favored dropping the concept completely and relying exclusively on the water-landing method.
March 21, 1963	Guidelines were established for conducting extravehicular activity during certain Gemini missions; an operations plan was readied in January 1964.
May 1963	Under a new contract for a paraglider landing system, North American began testing a half-scale tow test vehicle. Additional ground-tow activity and helicopter-tow tests took place at the Flight Research Center in California in

Table 2-37. (Continued)
Chronology of Key Project Gemini Events*

Date	Event
	August, September, and October. At Ames, wind tunnel tests of a half-scale vehicle were conducted in July and August to verify design changes. In a design engineering inspection in August, North American was requested to make 30 modifications to the full-scale test vehicle.
June 13, 1963	The contract for the Gemini spacesuit was awarded to the David Clark Company. A prototype suit was delivered in July.
Aug. 25, 1963	McDonnell completed the first Gemini spacecraft. It arrived at Cape Canaveral on October 4.
Oct. 1963	North American completed the first full-scale prototype paraglider wing and sent it to Ames for wind tunnel tests.
Oct. 18, 1963	Another 14 astronauts were added to the team at MSC.
Oct. 26, 1963	The first Titan launch vehicle for Gemini arrived at the Cape; spacecraft and launch vehicle were mechanically mated on March 5, 1964.
Dec. 22, 1963	Charles Mathews was appointed manager of the Gemini Project Office, having been acting manager since March 19 when Chamberlin became an advisor to the MSC director.
Jan. 1964	North American began development flights of the full-scale paraglider test vehicle; only 6 of the 25 tests were completely satisfactory. In February, NASA eliminated all plans for paraglider from the Gemini schedule; Gemini would rely on water landings. While the concept was still judged a sound one, paraglider hardware development and qualification could apparently not be completed in time for Gemini.
Apr 8, 1964	A successful unmanned orbital test (<i>Gemini-Titan 1</i>) of the launch vehicle and spacecraft was conducted from the Eastern Test Range (ETR). No recovery was planned (see table 2-38 for details on this and other developmental flights).
Apr. 13, 1964	It was announced that Virgil Grissom and John Young would make the first manned Gemini flight.
Oct. 1964	The manned spaceflight tracking network as configured for Gemini was exercised.
Jan. 19, 1965	A successful unmanned suborbital test (<i>GT-2</i>) of the reentry systems was launched from ETR. The spacecraft was recovered from the Atlantic.
March 23, 1965	<i>GT-3</i> , manned by Grissom and Young, successfully demonstrated the integrity of the spacecraft in a three-orbit mission (see table 3-39).
June 3, 1965	James A. McDivitt and Edward H. White, II, in <i>GT-4</i> conducted the first long-duration mission. White demonstrated extravehicular activity (EVA). After four days of activities, the crew splashed down in the Atlantic (see table 2-40).
Aug. 21, 1965	The next mission, <i>GT-5</i> , with Gordon Cooper and Charles Conrad, Jr., lasted twice as long. The crew evaluated the rendezvous guidance and navigation system; landing was on the 29th (see table 2-41).
Oct. 25, 1965	An attempt to orbit a Gemini-Agena D target vehicle as part of the <i>GT-6</i> mission was unsuccessful because of an engine malfunction shortly after stage separation. The launch of <i>GT-6</i> was postponed and a review board formed to investigate the failure.
Dec. 4, 1965	In addition to further demonstrating long-duration flight, <i>GT-7</i> , with Frank Borman and James A. Lovell, Jr., at the controls, acted as a substitute target vehicle for <i>GT-6A</i> . After 14 days, the spacecraft made its landing (see table 2-42).
Dec. 15, 1965	Walter M. Schirra, Jr., and Thomas P. Stafford on <i>GT-6A</i> accomplished rendezvous and stationkeeping maneuvers with <i>GT-7</i> . The mission ended on the 16th (see table 2-43).
Feb. 23-24, 1966	A mid-program conference was held at MSC.
Feb. 28, 1966	Elliott M. See, Jr., and Charles A. Bassett, II, the two astronauts chosen for the ninth mission, were killed when their T-38 jet trainer crashed in the fog near St. Louis.

Table 2-37.
Chronology of Key Project Gemini Events*

Date	Event
March 16, 1966	In the first mission to successfully utilize the Agena target vehicle, Neil A. Armstrong and David R. Scott docked their <i>GT-8</i> spacecraft to the Agena D stage. Because of a spacecraft thruster malfunction, however, the crew was forced to undock after 27 minutes and use the reentry control system to control their spacecraft. The mission was terminated early; landing took place in the Pacific some 10 hours into the flight (see table 2-44).
May 17, 1966	Because of a short in the servo control circuit, the target vehicle planned for use with <i>GT-9</i> did not achieve orbit. In its place, NASA decided to launch an augmented target docking adapter, a backup to the Agena vehicle, which was built by McDonnell.
June 1, 1966	The alternative docking target was launched successfully, but the launch of <i>GT-9A</i> was postponed by a ground equipment failure.
June 3, 1966	In <i>GT-9A</i> , Stafford and Eugene A. Cernan began their rendezvous mission. Because the launch shroud was still attached to the docking adapter when the crew reached it, they could not dock. Several secondary rendezvous objectives and an EVA exercise were accomplished. Landing took place on the 6th (see table 2-45).
July 18, 1966	An Atlas-Agena target vehicle and <i>GT-10</i> were both successfully launched from ETR. Pilots Young and Michael Collins docked their spacecraft with the Agena about six hours later. The mission ended on the 21st (see table 2-46).
Sept. 12, 1966	An Atlas-Agena D and <i>GT-11</i> were launched successfully. Astronauts Conrad and Richard F. Gordon, Jr., docked their spacecraft with the target vehicle and met all mission objectives. The mission ended on the 15th (see table 2-47).
Nov. 11, 1966	In the last Gemini mission, an Atlas-Agena target vehicle and <i>GT-12</i> with Lovell and Edwin E. Aldrin, Jr., aboard were launched during the afternoon. Rendezvous, docking, and EVA were accomplished. Splashdown took place on the 15th (see table 2-48).
Feb. 1-2, 1967	The Gemini Project Office was abolished on the 1st, and a two-day summary conference was held at MSC.

*For a more detailed calendar of events, see James M. Grimwood and Barton C. Hacker with Peter J. Vorzimmer, *Project Gemini Technology and Operations; A Chronology*, NASA SP-4002 (Washington, 1969).

Table 2-38.
Developmental Flights, Project Gemini

Launch Date (location)	Flight	Objectives/Results
April 8, 1964 (ETR)	GT-1 (Gemini spacecraft 1) (Gemini launch vehicle 1)	Successful orbital test of the Titan II launch vehicle, spacecraft structural integrity, and launch vehicle-spacecraft compatibility (no recovery operations planned; reentry and disintegration 3½ days after launch).
Jan. 19, 1965 (ETR)	GT-2 (spacecraft 2) (GLV 2)	Successful suborbital reentry test at maximum heating rate; spacecraft was recovered after parachute landing in the Atlantic.

Table 2-39.
Gemini-Titan 3 (GT-3)

Date of launch (ETR pad #):	March 23, 1965 (19)	
Spacecraft designation:	Gemini 3	
Unofficial spacecraft designation:	Molly Brown	
Launch vehicle designation:	GLV-3	
Spacecraft weight (kg):	3225	
Spacecraft shape, dimensions (m):	conical with a cylindrical rendezvous-recovery section fitted to the nose of the cone and a trapezoidal retrorocket-equipment section fitted to the cone's base	
	max. width, 3.05	
	min. width, 0.82	
	length, 5.74	
Crew:	Virgil I. Grissom, John W. Young	
Backup crew:	Walter M. Schirra, Jr., Thomas P. Stafford	
Cap coms:	L. Gordon Cooper (Cape), Roger B. Chaffee (Houston)	
Apogee/perigee at insertion (km):	225.8/161.3	
No. of orbits:	3	
Period:	01:28:12	
Length of mission:	04:52:31	
Mission events (date, time, ground elapsed time):		
launch	March 23 9:24 a.m., EST	
main engine shutoff	9:26:32	00:02:32
orbital insertion	9:29:54	00:05:54
initiation of retrofire	1:57:23 p.m.	04:33:23
splashdown	2:16:31	04:52:31
Distance traveled (km):	128 748	
Landing point:	22°26'N, 70°51'W (111 km from target)	
Recovery ship:	<i>USS Intrepid</i> (crew onboard in 70 min.)	
Mission objective:	Evaluate ability of Gemini spacecraft to support crew of two; conduct orbital maneuvers; manually control reentry; execute three experiments.	
Results:	There was one brief hold on the day of launch while a sensor on an oxidizer line was adjusted. The mission was carried out as planned.	
Reference:	Gemini Mission Evaluation Team, "Gemini Program Mission Report GT-3," MSC-G-R-65-2, Apr. 1965.	

Table 2-40.
Gemini-Titan 4 (GT-4) Characteristics

Date of launch (ETR pad #):	June 3, 1965 (19)	
Spacecraft designation:	Gemini 4	
Launch vehicle designation:	GLV-4	
Spacecraft weight (kg):	3574	
Spacecraft shape, dimension (m):	see table 2-39	
Crew:	James A. McDivitt, Edward H. White II	
Backup crew:	Frank Borman, James A. Lovell, Jr.	
Cap coms:	Clifton C. Williams, Jr. (Cape), Grissom (Houston)	
Apogee/perigee at insertion (km):	281.9/162.2	
No. of orbits:	62	
Period:	01:20:54	
Length of mission:	97:56:12 (4 + days)	
Mission events (date, time, ground elapsed time):		
launch	June 3 10:15:59 a.m., EST	
main engine shutoff	10:18:31	00:02:32
orbital insertion	10:22:05	00:06:06
initiation of retrofire	June 7 11:56:00 a.m.	97:40:01
splashdown	12:12:11	97:56:12
Distance traveled (km):	2 590 561	
EVA time:	00:36:00	
Landing point:	27°44'N, 74°11'W (81 km from target)	
Recovery ship:	<i>USS Wasp</i> (crew onboard in 57 min.)	
Mission objective:	Demonstrate and evaluate spacecraft systems for a period of approximately four days; evaluate effects of prolonged exposure of crew to space environment; demonstrate EVA; conduct stationkeeping and rendezvous with second stage of launch vehicle; demonstrate capability of orbital attitude and maneuvering system to operate as backup to retrograde rocket system; execute 11 experiments.	
Results:	One 76-minute hold was experienced during launch while a problem with the launch vehicle erector tower was investigated. No attempt was made to rendezvous because of a fuel shortage after the stationkeeping exercise. Also, a computer-controlled reentry was not made because of an inadvertent alteration of the computer's memory (a rolling entry was performed). The EVA was performed by White.	
Reference:	Gemini Mission Evaluation Team, "Gemini Program Mission Report Gemini IV," MSC-G-R-65-3, July 1965.	

Table 2-41.
Gemini-Titan 5 (GT-5) Characteristics

Date of launch (ETR pad #):	Aug. 21, 1965 (19)	
Spacecraft designation:	Gemini 5	
Launch vehicle		
designation:	GLV-5	
Spacecraft weight (kg):	3605	
Spacecraft shape,		
dimension (m):	see table 2-39	
Crew:	Cooper, Charles Conrad, Jr.	
Backup crew:	Neil A. Armstrong, Elliot M. See, Jr.	
Cap coms:	Grissom (Cape); McDivitt, Edwin E. Aldrin, Jr., Armstrong (Houston)	
Apogee/perigee at		
insertion (km):	349.8/161.9	
No. of orbits:	120	
Period:	01:29:35	
Length of mission:	190:55:14 (7 + days)	
Mission events (date, time, ground elapsed time):		
launch	Aug. 21 8:59:59 a.m., EST	
main engine shutoff	9:02:33	00:02:34
orbital insertion	9:05:55	00:05:56
initiation of retrofire	Aug. 29 7:27:42 a.m.	190:27:43
splashdown	7:55:13	190:55:14
Distance traveled (km):	5 371 990	
Landing point:	29°44'N, 69°45'W (270 km from target)	
Recovery ship:	<i>USS Champlain</i> (crew onboard in 89 min.)	
Mission objectives:	Demonstrate and evaluate performance of spacecraft for a period of eight days; evaluate rendezvous guidance and navigation system with radar evaluation pod; evaluate effects of prolonged exposure of crew to space environment; execute 17 experiments.	
Results:	A launch attempt on August 19 was postponed due to weather conditions and problems with loading cryogenic fuel for the fuel cell. During the mission, problems developed with the fuel cell that precluded rendezvous with the radar evaluation pod; instead the crew rendezvoused with a "phantom" target vehicle. Otherwise, the mission was successful.	
Reference:	Gemini Mission Evaluation Team, "Gemini Program Mission Report Gemini V," MSC-G-R-65-4, Oct. 1965.	

Table 2-42.
Gemini-Titan 7 (GT-7) Characteristics

Date of launch (ETR pad #):	Dec. 4, 1965 (19)	
Spacecraft designation:	Gemini 7	
Launch vehicle		
designation:	GLV-7	
Spacecraft weight (kg):	3663	
Spacecraft shape,		
dimension (m):	see table 2-39	
Crew:	Borman, Lovell	
Backup crew:	White, Michael Collins	
Cap coms:	Alan L. Bean (Cape); See, Eugene A. Cernan, Charles A. Bassett II (Houston)	
Apogee/perigee at		
insertion (km):	328/161.5	
No. of orbits:	206	
Period:	01:29:23	
Length of mission:	330:35:01 (13 + days)	
Mission events (date, time, ground elapsed time):		
launch	Dec. 4 2:30:03 p.m., EST	
main engine shutoff	2:32:39	00:02:36
orbital insertion	2:36:11	00:06:08
initiation of retrofire	Dec. 18 8:28:07 a.m.	329:58:04
splashdown	9:05:04	330:35:01
Distance traveled (km):	9 200 459	
Landing point:	25°25'N, 70°7'W (12 km from target)	
Recovery ship:	<i>USS Wasp</i> (crew onboard in 33 min.)	
Mission objective:	Conduct a long-duration flight of 14 days, evaluating spacecraft and crew performance; execute 20 experiments; serve as a target for <i>GT-6A</i> rendezvous and stationkeeping maneuvers.	
Results:	Rendezvous with <i>GT-6A</i> took place on December 15-16. The crew experienced a number of minor hardware problems on this long-duration flight, including difficulty with the fuel cell, an onboard tape recorder failure, trouble with two attitude thrusters, and difficulty with experiment equipment. (See also table 2-43.)	
Reference:	Gemini Mission Evaluation Team, "Gemini Program Mission Report Gemini VII," MSC-G-R-66-1, Jan. 1966.	

Table 2-43.
Gemini-Titan 6A (GT-6A) Characteristics

Date of launch (ETR pad #):	Dec. 15, 1965 (19)	
Spacecraft designation:	Gemini 6	
Launch vehicle		
designation:	GLV-6	
Spacecraft weight (kg):	3546	
Spacecraft shape,		
dimension (m):	see table 2-39	
Crew:	Schirra, Stafford	
Backup crew:	Grissom, Young	
Cap coms:	see table 2-42	
Apogee/perigee at		
insertion (km):	260/161.5	
No. of orbits:	16	
Period:	01:28:42	
Length of mission:	25:51:24 (1 + day)	
Mission events (date, time, ground elapsed time):		
launch	Dec. 15 8:37:26 a.m., EST	
main engine shutoff	8:40:03	00:02:37
orbital insertion	8:43:25	00:05:59
initiation of retrofire	Dec. 16 9:53:24 a.m.	25:15:58
splashdown	10:28:50	25:51:24
Distance traveled (km):	723 883	
Landing point:	23°35'N, 67°50'W (13 km from target)	
Recovery ship:	<i>USS Wasp</i> (crew onboard in 66 min.)	
Mission objectives:	Rendezvous with <i>GT-7</i> , performing a number of orbital maneuvers; execute three experiments.	
Results:	On October 25, the launch of <i>GT-6</i> was cancelled when the Agena target vehicle (GATV 5002 and TLV 5301) with which the spacecraft was to rendezvous and dock failed to go into orbit. NASA officials revised their plans for the spacecraft and elected to use it in conjunction with <i>GT-7</i> , a long-duration mission scheduled for December. <i>GT-7</i> would act as a target for <i>GT-6A</i> rendezvous maneuvers. A launch attempt on December 12 failed because of a minor launch vehicle hardware problem. The next attempt on the 15th was successful. Rendezvous with <i>GT-7</i> began about 6 hours after launch (at one point the two spacecraft were within .3 meters of one another). The crew remained inside the spacecraft during recovery operations.	
Reference:	Gemini Mission Evaluation Team, "Gemini Program Mission Report Gemini VI-A," MSC-G-R-66-2, Jan. 1966.	

Table 2-44.
Gemini-Titan 8 (GT-8) Characteristics

Date of launch (ETR pad #):	March 16, 1966 (19)	GATV: March 16, 1966 (14)
Spacecraft designation:	Gemini 8	GATV-5003
Launch vehicle designation:	GLV-8	TLV-5302
Spacecraft weight (kg):	3788	8097
Spacecraft shape, dimensions (m):	see table 2-39	cylindrical diam., 1.52 length in orbit, 7.92
Crew:	Armstrong, David R. Scott	
Backup crew:	Conrad, Richard F. Gordon, Jr.	
Cap coms:	R. Walter Cunningham (Cape), Lovell (Houston)	
Apogee/perigee at insertion (km):	271.7/159.8	
No. of orbits:	7	
Period:	01:28:50	
Length of mission:	10:41:26	
Mission events (date, time, ground elapsed time):		
GATV launch	March 16 10:00:03 a.m., EST	
launch	11:41:02	
main engine shutdown	11:43:36	00:02:34
orbital insertion	11:47:36	00:06:06
initiation of retrofire	9:45:49 p.m.	10:04:47
splashdown	10:22:28	10:41:26
Distance traveled (km):	292 015	
Landing point:	25°14'N, 136°0'E (2 km from secondary target)	
Recovery ship:	<i>USS Mason</i> (crew onboard in 3 hr.)	
Mission objectives:	Rendezvous and dock with Agena target vehicle; execute 10 experiments during a three-day mission; conduct EVA.	
Results:	There was a one-day delay in launching the spacecraft due to minor problems with spacecraft and launch vehicle hardware. <i>GT-8</i> successfully docked with the GATV 6 hours, 34 minutes after Gemini liftoff. Because of problems with the spacecraft control system, the crew was forced to undock after approximately 30 minutes. The spacecraft-target vehicle combination had begun to encounter increasing yaw and roll rates. The crew regained control of their spacecraft by using the reentry control system, which prompted an early landing in a secondary landing area in the Pacific. No EVA was performed.	
Reference:	Gemini Mission Evaluation Team, "Gemini Program Mission Report Gemini VIII," MSC-G-R-66-4, Apr. 1966.	

Table 2-45.
Gemini-Titan 9A (GT-9A) Characteristics

Date of launch (ETR pad #):	June 3, 1966 (19)	ATDA: June 1, 1966 (14)
Spacecraft designation:	Gemini 9	ATDA
Launch vehicle		
designation:	GLV-9	TLV-5304
Spacecraft weight (kg):	3750	1088
Spacecraft shape,		
dimensions (m):	see table 2-39	cylindrical diam., 1.52 length in orbit, 3.41
Crew:	Stafford, Cernan	
Backup crew:	Lovell, Aldrin	
Cap coms:	Aldrin (Cape, Houston); Armstrong, Lovell, Gordon (Houston)	
Apogee/perigee at		
insertion (km):	266.7/158.7	
No. of orbits:	45	
Period:	01:28:47	
Length of mission:	72:20:50 (3 + days)	
Mission events (date, time, ground elapsed time):		
ATDA launch	June 1	10:00:02 a.m., EST
launch	June 3	8:39:33 a.m.
main engine shutoff		8:42:05 00:02:32
orbital insertion		8:45:40 00:06:07
initiation of retrofire	June 6	8:26:17 a.m. 71:46:44
splashdown		9:00:23 72:20:50
Distance traveled (km):	2 020 741	
EVA time:	02:07:00	
Landing point:	27°52'N, 75°0'W (.7 km from target)	
Recovery ship:	<i>USS Wasp</i> (crew onboard in 52 min.)	
Mission objectives:	Rendezvous and dock with a target vehicle; conduct EVA; execute seven experiments; test the Air Force astronaut maneuvering unit.	
Results:	GT-9 was postponed when TLV 5303 with GATV 5004 malfunctioned on May 17. In its place, a substitute target was used for <i>GT-9A</i> ; the Augmented Target Docking Adapter (ATDA) was launched by an Atlas on June 1; however, <i>GT-9A</i> was not launched on the same day as planned due to a guidance system computer problem. After a brief hold, the spacecraft was launched on the 3d. Upon maneuvering with the target, the crew discovered that the launch shroud protecting the ATDA had not been jettisoned, precluding any attempts to dock. Instead <i>GT-9A</i> performed a number of rendezvous maneuvers, including a simulation of lunar module rendezvous (Apollo). During EVA maneuvers, Cernan's visor became fogged, and he was unable to test the Air Force maneuvering unit. The crew remained inside their spacecraft during recovery operations. The original crew for GT-9, Elliott M. See and Charles Bassett, were killed in an airplane crash on February 28, 1966. The backup crew was named to the prime crew positions.	
Reference:	Gemini Mission Evaluation Team, "Gemini Program Mission Report Gemini IX-A," MSC-G-R-66-6, July 1966.	

Table 2-46.
Gemini-Titan 10 (GT-10) Characteristics

Date of launch (ETR pad #):	July 18, 1966 (19)	GATV: July 18, 1966 (14)
Spacecraft designation:	Gemini 10	GATV-5005
Launch vehicle		
designation:	GLV-10	TLV-5305
Spacecraft weight (kg):	3763	8097
Spacecraft shape, dimension (m):	see tables 2-39 and 2-44	
Crew:	Young, Collins	
Backup crew:	Bean, Williams	
Cap coms:	Cooper (Cape, Houston), Aldrin (Houston)	
Apogee/perigee at insertion (km):	268.7/159.8	
No. of orbits:	43	
Period:	01:28:47	
Length of mission:	70:46:39 (2+ days)	
Mission events (date, time, ground elapsed time):		
GATV launch	July 18 3:39:46 p.m., EST	
launch	5:20:26 a.m.	
main engine shutoff	5:22:59	00:02:33
orbital insertion	5:26:38	00:06:12
initiation of retrofire	July 21 3:30:50 p.m.	70:10:24
splashdown	4:07:05	70:46:39
Distance traveled (km):	1 968 823	
EVA time:	01:29:00 (umbilical, 00:39:00; standup, 00:50:00)	
Landing point:	26°45'N, 71°57'W (6 km from target)	
Recovery ship:	<i>USS Guadalcanal</i> (crew onboard in 28 min.)	
Mission objectives:	Rendezvous and dock with an Agena target vehicle; conduct dual rendezvous maneuvers using the target vehicle's propulsion systems; conduct EVA; practice docking maneuvers; execute 15 experiments; evaluate various docked spacecraft systems.	
Results:	Docking took place about 6 hours after <i>GT-10</i> liftoff. Because more fuel was used than planned during the first rendezvous exercise the spacecraft remained docked with the GATV for 39 hours so that it could take advantage of the target vehicle's propulsion system for docked maneuvers. The spacecraft also rendezvoused with GATV 5003 from the <i>GT-8</i> mission, which had been in orbit since March 1966. During umbilical EVA, Collins retrieved an experiments package from GATV 5003.	
Reference:	Gemini Mission Evaluation Team, "Gemini Program Mission Report Gemini X," MSC-G-R-66-7, Aug. 1966.	

Table 2-47.
Gemini-Titan II (GT-II) Characteristics

Date of launch (ETR pad #):	Sept. 12, 1966 (19)	GATV: Sept. 12, 1966 (14)
Spacecraft designation:	Gemini 11	GATV-5006
Launch vehicle		
designation:	GLV-11	TLV-5306
Spacecraft weight (kg):	3798	8097
Spacecraft shape,		
dimension (m):	see tables 2-39 and 2-44	
Crew:	Conrad, Gordon	
Backup crew:	Armstrong, William A. Anders	
Cap coms:	Williams (Cape), Young, Bean (Houston)	
Apogee/perigee at		
insertion (km):	276.3/159.6	
No. of orbits:	44	
Period:	01:28:59	
Length of mission:	71:17:08 (2 + days)	
Mission events (date, time, ground elapsed time):		
GATV launch	Sept. 12 8:05:01 a.m., EST	
launch	9:42:27	
main engine shutoff	9:45:00	00:02:33
orbital insertion	9:48:28	00:06:01
initiation of retrofire	Sept. 15 8:24:03 a.m.	70:41:36
splashdown	8:59:35	71:17:08
Distance traveled (km):	1 983 565	
EVA time:	02:43:00 (umbilical, 00:33:00; standup, 02:10:00)	
Landing point:	24°15'N, 70°0'W (5 km from target)	
Recovery ship:	<i>USS Guam</i> (crew onboard in 24 min.)	
Mission objectives:	Rendezvous and dock with an Agena target vehicle during the first orbit; conduct docking practice, including docked maneuvers at a high altitude; conduct a tethered-vehicle test during EVA; execute 11 experiments; demonstrate automatic reentry.	
Results:	The mission was postponed twice; on September 9 due to a small leak in the first-stage oxidizer tank of the GLV; and on the 10th due to a suspected malfunction of the autopilot on the GLV. On the day of launch, there was a 16-minute hold due to a suspected leak around the command pilot's hatch. Once under way, the mission went as planned with a successful first-orbit docking. The GATV propulsion system put the two spacecraft into a high-altitude orbit (1373.3/289.5 km) 40½ hours into the mission. During EVA, astronaut Gordon tethered the two spacecraft together with a 30-meter line. Automatic reentry was successful.	
Reference:	Gemini Mission Evaluation Team, "Gemini Program Mission Report Gemini XI," MSC-G-R-66-8, Oct. 1966.	

Table 2-48.
Gemini-Titan 12 (GT-12) Characteristics

Date of launch (ETR pad #):	Nov. 11, 1966 (19)	GATV: Nov. 11, 1966 (14)
Spacecraft designation:	Gemini 12	GATV-5001
Launch vehicle designation:	GLV-12	TLV-5307
Spacecraft weight (kg):	3763	8097
Spacecraft shape, dimension (m):	see tables 2-39 and 2-44	
Crew:	Lovell, Aldrin	
Backup crew:	Cooper, Cernan	
Cap coms:	Stuart A. Roosa (Cape); Conrad, Anders (Houston)	
Apogee/perigee at insertion (km):	270.6/160.8	
No. of orbits:	59	
Period:	01:28:52	
Length of mission:	94:34:31 (3+ days)	
Mission events (date, time, ground elapsed time):		
GATV launch	Nov. 11 2:07:58 p.m., EST	
launch	3:46:33	
main engine shutoff	3:49:08	00:02:35
orbital insertion	3:52:40	00:06:07
initiation of retrofire	Nov. 15 1:46:31 p.m.	93:59:58
splashdown	2:21:04	94:34:31
Distance traveled (km):	2 574 950	
EVA time:	05:30:00 (umbilical, 02:06:00; standup, 03:24:00)	
Landing point:	24°35'N, 69°57'W (5 km from target)	
Recovery ship:	<i>USS Wasp</i> (crew onboard in 30 min.)	
Mission objectives:	Rendezvous and dock with an Agena target vehicle; conduct EVA three times; practice docking; accomplish tethered-vehicle stationkeeping; perform docked exercises with the GATV propulsion system, including high-altitude maneuvers; use controlled reentry technique.	
Results:	Initial docking took place about 4¼ hours into the mission. High-altitude docked maneuvers were cancelled when flight controllers noted fluctuations in GATV's primary propulsion system; instead an eclipse of the sun was photographed on the 10th orbit. The crew experienced problems with the fuel cell and the orbital attitude and maneuvering system. Aldrin's EVA went as planned, as did reentry.	
Reference:	Gemini Mission Evaluation Team, "Gemini Program Mission Report Gemini XII," MSC-G-R-67-1, Jan. 1967.	

Table 2-49.

Project Gemini Flight Experiments

No*	Experiment	Results†									
		Gemini-Titan									
		3	4	5	6A	7	8	9A	10	11	12
M-1	Cardiovascular conditioning			X		X					
M-3	Inflight exercise		X	X		X					
M-4	Inflight phonocardiogram		X	X		X					
M-5	Body fluid bioassays		X			X	P	X			
M-6	Bone demineralization			X		X					
M-7	Calcium balance study					X					
M-8	Inflight sleep analysis					P					
M-9	Human otolith function			X		X					
MSC-1	Electrostatic charge		X	X							
MSC-2	Proton electron spectrometer		X			P					
MSC-3	Triaxis magnetometer		X			X			X		X
MSC-4	Optical communication					P					
MSC-5	Lunar UV spectral reflectance								N		
MSC-6	Beta spectrometer								X		P
MSC-7	Bremsstrahlung spectrometer								X		X
MSC-8	Color patch photography								X		
MSC-10	2-color earth's limb photography		X								
MSC-12	Landmark contrast measurement					N		N			
T-1	Reentry communications		X								
T-2	Manual navigation sightings										X
D-1	Basic object photography		X								
D-2	Nearby object photography			N							
D-3	Mass determination							N		X	
D-4	Celestial radiometry					X		X			
D-5	Star occultation navigation							N		X	
D-6	Surface photography			X							
D-7	Space object radiometry			X		X					
D-8	Radiation in spacecraft		X		X						
D-9	Simple navigation		N			X					
D-10	Ion-sensing attitude control								X		X
D-12	Astronaut maneuvering unit							P			
D-13	Astronaut visibility			N				X			
D-14	UHF-VHF polarization							N	P		
D-15	Night image intensification							N		X	
D-16	Power tool evaluation							N		N	
S-1	Zodiacal light photography			X		N	X	X			

Table 2-49.
Project Gemini Flight Experiments (Continued)

No*	Experiment	Results*										
		3	4	5	6A	7	8	9A	10	11	12	
S-2	Sea urchin egg growth	P										
S-3	Frog egg growth						P					X
S-4	Radiation and zero-g on blood	X									X	
S-5	Synoptic terrain photography		X	X	X	X				X	X	X
S-6	Synoptic weather photography		X	X	X	X				X	X	X
S-7	Cloud top spectrometer			X			N					
S-8	Visual acuity			X		X						
S-9	Nuclear emulsion						N				X	
S-10	Agema micrometeorite collection						N	N	X			X
S-11	Airglow horizon photography							X		P		X
S-12	Micrometeorite collection							X	N			X
S-13	UV astronomical camera									X	X	P
S-26	Ion wake measurement									X	X	
S-29	Librations region photography											X
S-51	Sodium vapor cloud											N
S-30	Dim light photography/orthicon						N				X	
S-64	Sunrise UV photography											N
N/A	Eclipse photography (contingency experiment added by crew)											P

*The letter prefixes to the experiment numbers correspond to the following: M=manned spaceflight; MSC=Manned Spacecraft Center; T=technological; D=Department of Defense; and S=scientific.

†X=experiment performed successfully

P=experiment performed partially

N=experiment not performed

Characteristics – The Apollo Program

NASA's first 10-year plan, drawn up by the headquarters Program Planning Office in late 1959, scheduled manned circumlunar missions and permanent earth-orbiting space stations for the late 1960s. Manned exploration of the moon's surface was reserved for the next decade, when the "super boosters" considered necessary for lunar landing missions would be operational. Advanced planners forecast that a direct-ascent flight from earth to the moon would require more than 50 million newtons of thrust; Atlas, which was being readied for Project Mercury, was capable of only 1.6 million newtons (see the discussion of Project Mercury elsewhere in this chapter). Furthering the development of large rocket engines and establishing a national space vehicle program that would provide increasingly powerful boosters were critical first steps to the moon.²⁶ In 1959, NASA proposed to develop four boosters that would fulfill all the agency's heavy-payload needs during the coming years. Nova, the most powerful and the least defined of the four, would boost man directly to the moon.* From the Army Ballistic Missile Agency came another scheme for lunar missions that did not require a vehicle in the Nova class. Instead of launching the lunar spacecraft in one package in a direct ascent to the moon, Wernher von Braun suggested assembling a vehicle in earth orbit from propulsion and spacecraft components put there by boosters much smaller than the proposed Nova. From orbit (in zero gravity), it would require far less thrust to send a spacecraft on its way to the moon. The clustered-engine booster von Braun had in mind was Juno V. Working in-house with proponents of both lunar mission modes, NASA designers began conceptualizing an advanced spacecraft that would take man beyond earth.† (See table 2-50 for a listing of key program events.)

In July 1960, manned spaceflight officials held the first of several conferences at which they acquainted industry with NASA's plans for circumlunar missions and "Apollo," the designation given the agency's advanced spacecraft. Apollo would be designed to support three astronauts for up to 14 days on a lunar reconnaissance mission. Three contractors were chosen that fall to prepare feasibility studies for such a spacecraft. Meanwhile in Alabama, von Braun's rocket team was transferred to NASA and instructed to continue development of its family of clustered-engine rockets, which had been redesignated Saturn. New studies suggested that multistage Saturns might be powerful enough for NASA's lunar program. Judged by some to be an unnecessary complication, a third method for reaching the moon had surfaced that year at the agency's Langley Research Center. Direct ascent and earth orbit rendezvous both assumed landing the entire spacecraft package on the moon, along with the large amount of propellant that would be required to lift the returning spacecraft off the moon. Rather than fly this very heavy configuration, Langley researchers suggested a much smaller two-part spacecraft. From orbit around the moon, crewmen in a lunar module would separate from the main spacecraft and land on the moon; when surface operations were completed they would return to the

* The four vehicles were Vega and Centaur, which were upper stages, and Saturn and Nova, which were multistage launchers. For more information, see chap. 1.

† STG engineers were led by Mercury designer Maxime Faget. Jack Heberlig drafted the first hardware guidelines for the Apollo command center spaceflight.

orbiting ship, leaving behind the craft's landing legs. Before their return to earth, the crew would jettison the module. While such a scenario would require a more modest launch vehicle than Nova and only one launch rather than the multiple launches characteristic of earth orbit rendezvous, it also demanded the precise coordination of two vehicles far from earth. If the crew should miss in their attempt to rendezvous, the returning lunar module could just drift off into space, warned the opponents of lunar orbit rendezvous.*²⁷

Days after the Martin Company, General Electric, and the Convair/Astronautics Division of General Dynamics submitted Apollo feasibility studies to NASA, President John Kennedy made a speech that dramatically affected the agency's plans for lunar missions.²⁸ Before Congress on May 25, 1961, the president called for an accelerated space program that would land a man on the moon before the end of the decade, a program that would prove America's technical prowess to the world. NASA was still nine months away from orbiting a man about earth, and Apollo was in its earliest stages of definition. To accomplish a manned landing by 1969 would require an enormous effort and a huge purse.

Reacting to Kennedy's challenge, NASA assigned several new committees and working groups the task of evaluating the three mission modes proposed for a lunar landing.²⁹ Although the agency went ahead with its plans to invite 12 firms to bid for the Apollo spacecraft contract, the vehicle's final configuration would depend on what route it would take to its destination and by what means.† It was quickly determined that NASA would not have time to develop a Nova-class launch vehicle. Apollo would have to depend on a three- or four-stage version of Saturn. As for mission mode, this left earth orbit rendezvous as the clear favorite at NASA Headquarters and the Marshall Space Flight Center in Alabama, while the Manned Spacecraft Center in Houston, the new home and designation of the Space Task Group, began to see the practicality of lunar orbit rendezvous. Of the five teams that submitted proposals to design and manufacture the Apollo command and service modules, NASA chose the Space and Information Systems Division of North American Aviation.** The day before the decision was announced on November 27, 1961, the manned spacecraft team had expanded the Apollo contract statement of work considerably to include all major spacecraft subsystems. North American would have to employ a small army of subcontractors to provide many of Apollo's 2 million functional parts (see fig. 2-5 for a description of the Apollo spacecraft and table 2-56 for a list of contractors).

On January 15, 1962, two new offices were opened at the Manned Spacecraft Center. In addition to the Apollo Spacecraft Project Office (ASPO), NASA

* A fourth mission mode suggested by personnel at the Jet Propulsion Laboratory involved assembling on the moon an earth-return vehicle from components deposited there by unmanned landers. Lunar surface rendezvous was not seriously considered for Apollo.

† The first contract NASA let for Apollo was to the Instrumentation Laboratory of MIT (Aug. 1961) for the development of a guidance and navigation system. It was recognized that this system was a long lead-time item that would be required regardless of which mission mode was chosen.

** The definitive contract with North American, signed on Aug. 14, 1963, called for 11 mockups of the CSM, 15 boilerplate models, and 11 spacecraft.

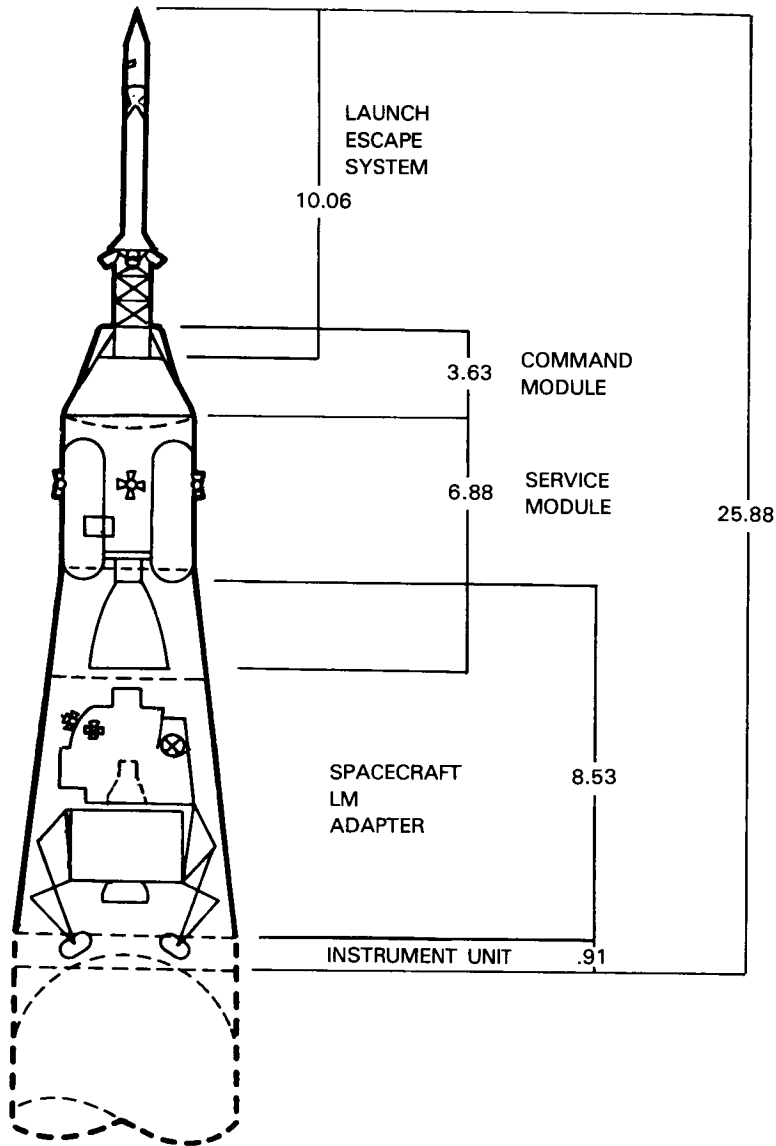

Figure 2-5. Apollo Spacecraft (dimensions in meters). This drawing represents the Apollo stack at launch. The launch escape system (3 solid-propellant motors) was included to propel the command module to safety in the event of an aborted launch. If it were not required, the LES was jettisoned shortly after launch. The command module, equipped with 3 couches, served as the crew compartment and control center. A forward docking ring and hatch allowed the spacecraft to dock with the lunar module (stowed in the spacecraft LM adapter during launch). The command module was capable of attitude control about 3 axes (with its 10 reaction control system engines) and some lateral lift translation in the atmosphere. Made from aluminum, the command module had 2 hatches and 5 windows. Thermal protection during reentry was provided by ablative heatshields of varying thicknesses. The service module provided the primary propulsion and maneuvering capability for the spacecraft. Most of the consumables (oxygen, hydrogen, propellant) was also stored in this module. Prior to reentry, the crew jettisoned the service module. Inside the spacecraft LM adapter, the lunar module was stowed. The instrument unit, part of the launch vehicle, contained guidance, navigation, and control equipment. (See also tables 2-54 and 2-55 for more information on major spacecraft subsystems and spacecraft characteristics.)

established a Gemini Project Office in Houston to manage a Mercury follow-on program that would prove useful to Apollo (see discussion of Gemini elsewhere in this chapter). The two-man Gemini flights scheduled to begin the next year would demonstrate that man could tolerate lengthy stays in a weightless environment and that two spacecraft could rendezvous and dock. Having abandoned direct ascent as a method for reaching the moon, NASA would have to rely on rendezvous, either in earth orbit or lunar orbit, and it was an unproven operation. Much of Apollo's hardware would represent a new generation of spacecraft components, but many of Apollo's operations—in space and on the ground—would be tested during Gemini.

Although work on many of the Apollo CSM's subsystems was under way in early 1962, the spacecraft builders had to wait until that summer to finalize the vehicle's external configuration. After months of campaigning by John C. Houbolt and others from the Langley Research Center, Apollo managers were finally convinced that lunar orbit rendezvous offered them the best chance of meeting the 1969 deadline for a landing.* One Saturn V (a three-stage vehicle previously designated Saturn C-5) would boost the Apollo stack, including a lunar module (LM, pronounced lem) stowed aft of the CSM (see fig. 2-6 for a description of the LM). Early along the translunar path, the CSM would separate from the adapter section that held the lunar craft, turn around, and dock nose first with the LM. They would travel to the moon in this docked position. From lunar orbit, the LM with two crewmembers would make the trip to the surface, while the remaining astronaut continued to orbit in the CSM waiting for the LM's return. The LM's ascent stage would bring the two lunar explorers back to the CSM. Before entering a trans-earth trajectory, the crew would jettison the lander module. The service module would be abandoned before reentry, and the three would make a water landing in the command module. In July, the Manned Spacecraft Center invited 12 companies to submit plans for the Apollo lunar module. Grumman Aircraft Engineering Corporation was judged the winner in November.

Research and development flights for Apollo and its Saturn launcher stretched from October 1961 to April 1968 (see table 2-51). Little Joe II, a booster designed specifically for the Apollo test program, was used to evaluate the launch escape and abort system. Scout and Atlas-Antares launch vehicles put payloads into suborbital trajectories to test Apollo's reentry configuration and its heatshield. In July 1966, the two-stage Saturn IB, suitable for launching earth-orbit missions, was judged acceptable. Saturn V's first test came in November 1967, when it orbited an unmanned CSM (*Apollo 4*). Apollo mission plans in 1967 called for incremental steps beyond the research and development flights. In low earth orbit, a crew would first assess the CSM's performance (C mission), then the combined performance of the CSM and the LM (D mission). In high earth orbit, a crew would again put the CSM and the LM through their paces (E mission). Only then would Apollo astronauts journey to the moon in a circumlunar mission (F mission). Lunar landing was the last goal (G mission). Such a scheme would demand near-capacity operations during 1968 and 1969 at NASA's new launch facilities on Merritt Island at the Kennedy Space Center.

*MSC engineers favored lunar orbit rendezvous because it promised the highest payload efficiency, the smallest size for the landing module, and the least compromise on spacecraft design. Headquarters determined that this mode would cost 10 to 15 percent less than direct ascent or earth orbit rendezvous.

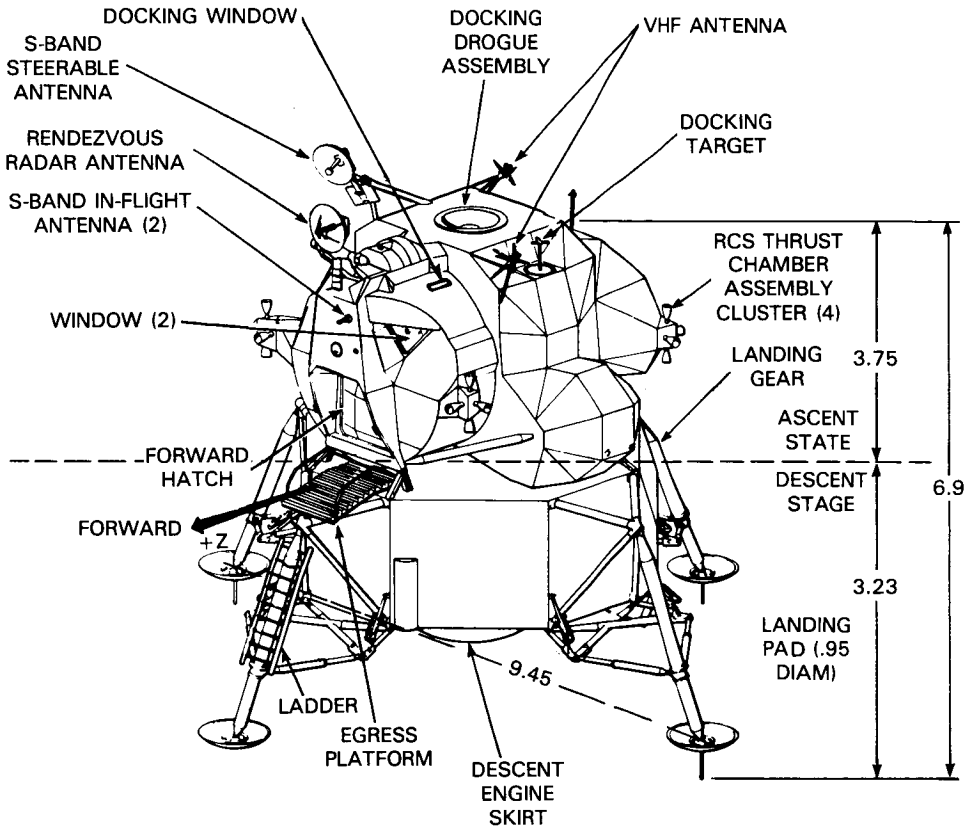

Figure 2-6. Apollo Lunar Module (dimensions in meters). Because the lunar module (LM) would operate only in space, its designers could ignore the aerodynamic streamlining demanded by vehicles that flew in Earth's atmosphere. Un gainfully looking vehicle was the result. The two-stage spacecraft carried to the vicinity of the moon by the Apollo command and service module (CSM)—the points of interface being the apex of the conical command module and the top surface of the LM ascent stage—was designed to land two of the three Apollo crewmen on the surface in a controlled fashion. From lunar orbit where it was released by the CSM, the LM's descent and ascent stages functioned as a unit. During surface operations, the ascent stage served as a home for the astronauts, when it was time to return to the orbiting CSM the descent stage provided a launch platform for the ascent stage. It took more than two years to design the LM, with its makers fighting weight gain long after a configuration was approved. The most troublesome, critical, and heavy of the LM's components were its engines—18 of them (1 large engine for each stage: descent propulsion system at 43,900 newtons thrust, ascent propulsion system at 15,500 newtons; and 16 small attitude control engines clustered in quads around the ascent stage). Propellant for these systems accounted for more than 70 percent of the LM's total weight of 1,500 kilograms (propulsion for the variable-thrust descent engine alone came to nearly 55 percent). The ascent stage was basically cylindrical (4.29-meter diameter) but with angular faces; its aluminum skin was encased by a mylar thermal-micrometeorite shield. The cruciform structure of the descent stage supported the descent engine and 4 propellant tanks. Four legs, the struts of which were filled with crushable aluminum honeycomb for absorbing the shock of landing, were capped by footpads. The descent stage was also constructed of aluminum alloy. A ladder attached to one of the legs gave the crew access to the surface. A docking tunnel (0.81-meter diameter) was provided for crew transfer between the command module and the LM ascent stage. After the surface operations were completed and the crew returned via the ascent stage to the CSM, the LM was jettisoned. A LM was included on a manned Apollo mission for the first time in March 1969 (Apollo 9); the first manned lunar landing took place in July 1969 (Apollo 11). For more information on spacecraft systems, see table 2-55.

At North American, work was under way on two versions of the command and service module: Block I for earth-orbit operations and Block II for lunar missions. The prime contractor's greatest problem was ensuring the compatibility of thousands of interfaces, those points at which two or more components were joined. Grumman's greatest difficulty was weight gain on the lunar module. Development of propulsion units for the CSM and the LM was another stumbling block. When schedules started to slip and hardware problems failed to disappear, NASA expressed its dissatisfaction with North American. In early 1966, the agency converted both North American and Grumman's contracts from cost-plus-fixed-fee to cost-plus-incentive-fee in an attempt to improve performance at the firms.

By early 1967, hardware and software schedules were keeping better pace with NASA's mission plans. Ground personnel and astronaut training had begun; the new mission control center in Houston was in operation. Long-duration missions and rendezvous and docking had been proved during Gemini flights. Unmanned Surveyor and Lunar Orbiter spacecraft were sending much needed data on the lunar surface to Apollo technicians and scientists. Apollo's first crew, Virgil I. Grissom, Edward H. White, and Roger B. Chaffee, was due to fly an earth-orbital mission in February. Tragically, however, a fire claimed the lives of these astronauts and forced the agency to review its lunar exploration program meticulously. In a simulated countdown of CSM 204 on January 27, 1967, arcs from electrical wiring in an equipment bay on the command module started a fire (no single ignition point was identified); in the 100 percent oxygen atmosphere the crew died in minutes of asphyxia. Faced with its first tragedy, the agency convened an Apollo 204 Review Board to investigate, which in turn established 21 task panels to scrutinize every aspect of the accident, from the configuration of spacecraft during the test to the disposition of the surviving service module. Led by Floyd L. Thompson, the board in its final report, submitted in April, called for a number of significant hardware design, test operations, and flight plan changes. Redefinition of the Block II CSM was also demanded. Tests in 100 percent oxygen environments had already been forbidden.* Specific recommendations included the restriction of combustible materials in the command module, simplifying crew egress procedures, testing for fire safety on full-scale mockups of a reconfigured CSM, and an in-depth review of the environmental control system. For five months, a NASA team oversaw Block II work at North American.³⁰

Apollo began to fly in November 1967 with the first "all-up" orbital test of the Saturn V (*Apollo 4*), followed by an equally successful orbital trial of the lunar module (*Apollo 5*). The second Saturn V-launched mission (*Apollo 6*) did not meet its objectives, however, because of several launch vehicle malfunctions. Apollo 7, now slated to carry the first crew into earth orbit, passed its flight readiness review in early October 1968. Walter Schirra, Donn F. Eisele, and R. Walter Cunningham were at the controls of the Block II CSM on October 11 when it was put into orbit by a Saturn IB. During the 11-day mission, the spacecraft performed admirably, allowing the crew to complete all their test objectives (see table 2-52). Months before this first flight, George Low, Apollo spacecraft project manager at MSC, made a deci-

* Future tests would be performed at 60 percent oxygen-40 percent nitrogen levels; launch operations would also be conducted using this ratio; 100 percent oxygen would be reserved for flight operations.

sion to accelerate the schedule if the first flight were successful. If NASA wanted to reach the moon before 1970, it would have to sacrifice some of the intermediate steps. Apollo 8, the second manned mission, would orbit the moon.

On December 21, 1960, *Apollo 8* with Frank Borman, James Lovell, and William A. Anders aboard, was boosted along its translunar path. After 69 hours of flight, the crew reached their destination, the first men to travel to the vicinity of the moon. After some 20 hours in lunar orbit, *Apollo 8* returned to earth for a December 27 splashdown in the Pacific (see fig. 2-7 and table 2-53). *Apollo 8*, a milestone mission, was the last flight in NASA's first decade.

NASA's corps of astronauts grew considerably during the Apollo years. The first addition to the original seven Mercury pilots was on September 17, 1962, when nine men joined the group to fly Gemini and Apollo missions. They were supplemented by another 13 on October, 18, 1963. Prompted by the scientific community, four scientist-astronauts (two physicists, one physician, and one geologist) were signed on in June 1965 for lunar landing flights. The largest single group of pilot-astronauts (18) joined NASA on April 4, 1966. Another seven were chosen on August 4, 1967 to fill support and backup crew slots.*³¹ There were three Apollo crew positions for each mission: commander, command module pilot, and lunar module pilot. The prime and backup crews followed the one spacecraft that had been assigned for their flight through its testing program at the factory and through preparations at the launch site. This kept the crew up to date on modifications that were made to spacecraft hardware. In addition to "living with their spacecraft," the astronauts had to train for their specific missions on simulators and trainers, keep physically fit, and maintain proficiency in flying jet aircraft. To help them coordinate these many activities, each crew had a support crew assigned to it. As they had during Mercury and Gemini, Apollo astronauts acted as "capsule communicators" at mission control during the flights, serving as voice links between spacecraft and ground control.

In a 1962 summer study conference sponsored by NASA and the National Academy of Sciences, scientists concluded that the most important tasks that would face Apollo astronauts once they reached the moon would involve educated observations of natural phenomena, the collection of samples, and the installation of monitoring instruments. From these general guidelines, an Ad Hoc Working Group on Apollo Experiments built its recommendations for Apollo science: (1) the examination of physical and geological properties in the area near the spacecraft; (2) geological mapping; (3) investigation of the moon's interior; (4) studies of the lunar atmosphere; and (5) radio astronomy from the surface. Evaluating proposals for experiments, developing an Apollo lunar surface experiments package, integrating experiments with spacecraft hardware, and preparing special facilities on earth in which to examine lunar samples kept a cadre of scientists and engineers busy for years before the first Apollo landing. *Apollo 7* and *8*, which were basically engineering missions, did not carry scientific equipment, with the exception of biomedical

* On August 13, 1969, a final group of four astronauts was added to the NASA team as Apollo support crew members. These men transferred from the USAF Manned Orbiting Laboratory (MOL) program, which had been cancelled.

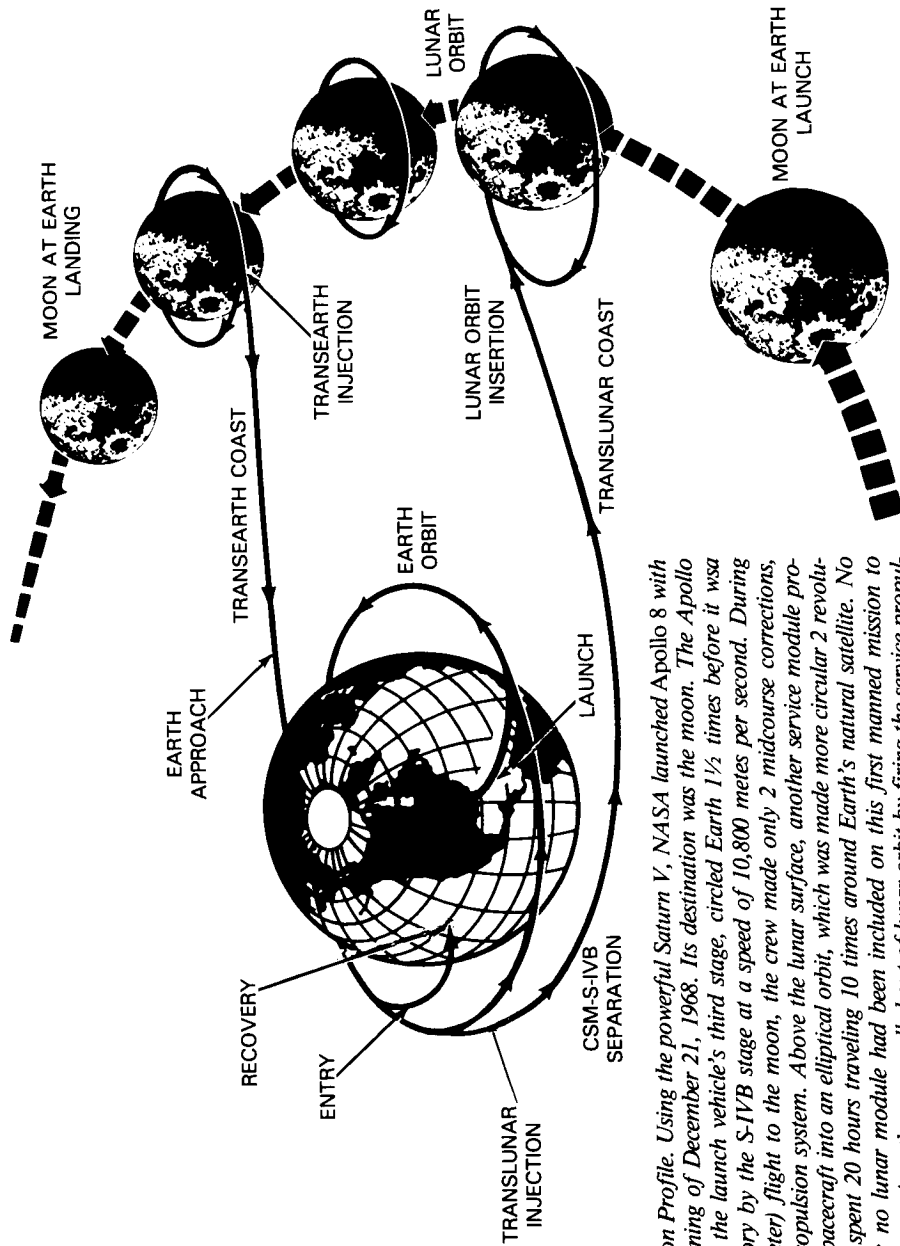

Figure 2-7. Apollo 8 Mission Profile. Using the powerful Saturn V, NASA launched Apollo 8 with a crew of three on the morning of December 21, 1968. Its destination was the moon. The Apollo spacecraft, still attached to the launch vehicle's third stage, circled Earth $1\frac{1}{2}$ times before it was thrust onto a lunar trajectory by the S-IVB stage at a speed of 10,800 metres per second. During their 3-day (365,000-kilometer) flight to the moon, the crew made only 2 midcourse corrections, using the service module propulsion system. Above the lunar surface, another service module propulsion maneuver put the spacecraft into an elliptical orbit, which was made more circular 2 revolutions later. The astronauts spent 20 hours traveling 10 times around Earth's natural satellite. No attempt was made to land; no lunar module had been included on this first manned mission to the moon. Early Christmas morning, the crew pulled out of lunar orbit by firing the service propulsion unit to increase their speed. The 57-hour trip home with only 1 course correction ended with reentry into Earth's atmosphere at 9,700 metres per second. The crew jettisoned the service module prior to reentry and deployed 2 drogue and 3 main parachutes at 7,300 and 3,000 metres above the surface. Apollo 8's command module splashed down in the Pacific Ocean only 2 kilometers from the target point on December 27.

sensors and cameras.* In fact, until the first landing and return were accomplished, enthusiasm for mission science took a decided second place to concerns for engineering and operational matters. The success of the post-1968 missions, however, "stimulated a more vigorous interest in the solar system and established the study of the moon as a modern interdisciplinary science."³²

A November 1961 agency-wide reorganization put George Low in charge of spacecraft and flight missions in the NASA Headquarters Office of Manned Space Flight (OMSF). Reporting to Low was John H. Disher, assistant director for Apollo spacecraft development. When George Mueller took over as associate administrator of manned spaceflight in 1963, he kept hold of the Apollo program reins until its growth demanded a full-time program director. General Samuel C. Phillips was chosen as director in October 1964, a post he would keep for many years (see table 2-2). Houston's Manned Spacecraft Center was responsible for executing the program. The Apollo Project Office added in September 1960 grew in importance with a 1961 reorganization (see table 2-3). Charles W. Frick was MSC's first Apollo manager. Joseph F. Shea, assisted by Robert Piland and William A. Lee, saw the program through its formative years (1963-1966). When George Low took over as manager of the Apollo Spacecraft Program Office at MSC in April 1967, he faced the aftermath of the Apollo 204 accident and a compromised flight schedule. Apollo's circumlunar mission in 1968 was testimony to Low's ability to make bold decisions.

Every NASA center made some contribution to Apollo, but MSC, the Marshall Space Flight Center, and the Kennedy Space Center were the major participants (see also chapter 5 for a discussion of the roles the Goddard Space Flight Center and the Jet Propulsion Laboratory played in Apollo tracking and data acquisition). In late 1964, MSC's Florida Operations Office was absorbed in a reorganization of KSC; Kurt H. Debus as director of launch operations managed Apollo's activity at the Cape.† Marshall, provider of the launch vehicle, was directed by von Braun, who as leader of the Saturn team, had a very personal interest in Apollo.†³³ Apollo managers geared their activities to correspond with a series of reviews, inspections, and certifications that served as key checkpoints for spacecraft design and hardware production. The six steps were preliminary and critical design reviews, flight article configuration inspection, certification of flight worthiness, design certification review, and flight readiness review. This last two-part review confirmed the readiness of hardware and facilities for each mission.³⁴ Cooperating with NASA officials at each of these checkpoints was a legion of contractor and subcontractor employees whose job it was to ready the spacecraft for launch. North American Aviation (later called North American Rockwell) led the command and service module team, Grumman the lunar module team (see table 2-56 for a listing of contractors).

**Apollo 7* carried experiments S-005, synoptic terrain photography, and S-006, synoptic weather photography; *Apollo 8* carried S-151, cosmic ray detector, and the crew conducted lunar mission photography.

†Other launch sites that were used during the Apollo testing program were Wallops Station and White Sands Test Facility.

**Marshall also supervised Apollo support activities at the Michoud Assembly Facility in New Orleans, the Mississippi Test Facility at Bay St. Louis, and the Slidell Computer Facility, Slidell, Louisiana.

Table 2-50.

Chronology of Key Apollo Program Events*

Date	Event
Dec. 3, 1958	An Army-NASA agreement established that the Army Ordnance Missile Command (AOMC), of which Wernher von Braun's rocket team was a part, was to be responsive to NASA requirements for launch vehicles.
Jan. 19, 1959	NASA awarded North American Aviation, Inc., a contract to develop a large-class single-chamber rocket engine, called the F-1 (to be used in the proposed Nova launcher). The F-1 was static-fired for the first time on March 3.
Feb. 5, 1959	A Working Group of Lunar Exploration was established by NASA.
Apr. 1959	A Research Steering Committee on Manned Space Flight was organized to assist with long-range planning and basic research. Chaired by Harry J. Goett of Ames Research Center, the group met for the first time on May 25-26.
June 8, 1959	The Army, in developing a plan for establishing manned lunar outposts (Project Horizon), predicted that the first landing could take place in 1965.
June 18, 1959	NASA authorized the AOMC to study possibilities for using the proposed Saturn launch vehicle for lunar missions. These studies were discussed at a meeting of NASA's Research Steering Committee on Manned Space Flight later that month.
Aug. 12, 1959	The Space Task Group's (STG) New Projects Panel, chaired by H. Kurt Strass, met for the first time to discuss future manned programs. The panel recommended that work start immediately on an advanced capsule and assigned panel member Alan B. Kehlet to begin a program that would lead to a second-generation three-man capsule with a potential for near-lunar return velocities. Kehlet presented his initial findings at a meeting of the panel on September 28.
Dec. 31, 1959	A Saturn Vehicle Team led by Abe Silverstein recommended that NASA pursue development of the Saturn C-1.
March 15, 1960	The Army Ballistic Missile Agency's Development Operations Division (von Braun's group) and the Saturn program were transferred to NASA; the facility was named the George C. Marshall Space Flight Center (MSFC).
Apr.-May 1960	STG personnel wrote guidelines for the design of an advanced spacecraft.
May 25, 1960	STG formed an Advanced Vehicle Team with Robert O. Piland as leader. This team would make preliminary design studies for an advanced vehicle capable of carrying several crew members.
July 25, 1960	"Apollo" was chosen as the name for NASA's advanced manned spaceflight program, which included plans for a manned lunar landing and a permanent space station.
July 28-29, 1960	The first of a series of NASA-Industry Program Plans Conferences was held to acquaint industry with the agency's plans for advanced spacecraft and circumlunar missions.
Oct. 17, 1960	At NASA Headquarters, a small working group was formed by George M. Low, chief of manned spaceflight, to establish ground rules for manned lunar landings, determine spacecraft weights, specify launch vehicle requirements, and prepare a development plan.
Oct. 25, 1960	NASA selected three contractors—Convair/Astronautics Division of General Dynamics Corporation, General Electric Company, and Martin Company—to prepare feasibility studies of an advanced manned spacecraft. These companies were chosen from 14 who submitted proposals on October 9

Table 2-50.
Chronology of Key Apollo Program Events* (Continued)

Date	Event
	in answer to a request for proposals issued on September 13. Technical assessment panels and an evaluation board judged the proposals.
Nov. 1960	Technical Liaison Groups were established by STG to coordinate work and discussions among center employees involved with advanced spacecraft design. Nine groups were formed.
Dec. 10, 1960	Personnel at Langley Research Center briefed STG members on an alternative to direct ascent to the moon: lunar orbit rendezvous. (Other mission modes under discussion were earth orbit rendezvous and direct ascent.) The lunar orbit rendezvous mode reduced launch vehicle power requirements. Later that month Grumman Aircraft Engineering Corporation funded an in-house study of lunar orbit rendezvous. Langley and STG personnel met again to discuss this mode on January 10.
Jan. 9, 1961	A newly formed Manned Lunar Landing Task Group led by Low met for the first time to consider how the objective of a lunar landing fit into the agency's future plans and to prepare a position paper on the subject for FY 1962 budget hearings. Their report, submitted on February 7, suggested that a manned lunar landing could be accomplished during the 1960s using direct ascent or earth orbit rendezvous (Saturn C-2, three or four stages).
Jan. 19, 1961	MSFC awarded contracts to Douglas Aircraft Company and Chance Vought Corporation to study the earth orbit rendezvous mode for manned lunar and interplanetary missions.
May 5, 1961	STG completed its first draft of general requirements for the Apollo spacecraft.
May 15-17, 1961	The Martin Company, GE, and Convair/Astronautics submitted their final feasibility studies of an advanced spacecraft.
May 25, 1961	In a speech before Congress, President Kennedy called for new long-range goals for the space program, including a lunar landing before the end of the decade.
June 10, 1961	The Lundin Committee, established by NASA the day of Kennedy's speech, completed a study of vehicle systems that could support manned lunar landings. The committee preferred earth orbit rendezvous as a means for putting together a lunar vehicle package, using two or three Saturn C-3 launches. Another study group, the Fleming Committee, appointed on May 2, concluded that a lunar landing was feasible before 1970.
July 18-20, 1961	A NASA-Industry Apollo Technical Conference was held for representatives of 300 potential Apollo contractors.
July 20, 1961	A NASA-Department of Defense (DoD) Large Vehicle Planning Group, directed by Nicholas E. Golovin, was established to study large vehicle systems such as those needed for a direct ascent mission to the moon.
July 28, 1961	NASA invited 12 companies to submit proposals due on October 9 for the Apollo spacecraft prime contract.
Aug. 1961	An Ad Hoc Task Group for Study of Manned Lunar Landing by Rendezvous Techniques reported that the earth orbit rendezvous mode offered the earliest possibility for a lunar landing. Meanwhile, John C. Houbolt of Langley made another presentation on lunar orbit rendezvous to STG.

Table 2-50.
Chronology of Key Apollo Program Events* (Continued)

Date	Event
Oct. 27, 1961	Saturn SA-1 (first stage with a dummy second stage) was launched successfully. The booster was a cluster of eight H-1 engines. (See table 2-51 for details on this and other Apollo-Saturn developmental flights.)
Nov. 15, 1961	In a letter to NASA Associate Administrator Robert C. Seamans, Houbolt made his case for the lunar orbit rendezvous mode for Apollo.
Nov. 20, 1961	A working group led by Milton W. Rosen, director of launch vehicles and propulsion in the Office of Manned Space Flight (OMSF), reported that the direct ascent mode for a lunar landing was the most promising, using the proposed Nova.
Nov. 28, 1961	NASA chose the Space and Information Systems Division of North American Aviation to design and build the two-module Apollo spacecraft. North America's proposal had been selected by technical assessment panels and a source evaluation board over those submitted by four other teams: General Dynamics/Astronautics Avco Corporation; General Electric Missile and Space Vehicle Department-Douglas-Grumman-Space Technology Laboratories; McDonnell Aircraft Corporation-Lockheed Aircraft Corporation-Hughes Aircraft Company-Chance Vought; and the Martin Company. On the previous day, the Apollo spacecraft statement of work had been expanded substantially. North American's letter contract was signed on December 12, the definitive contract on August 14, 1963.
Jan. 15, 1962	An Apollo Spacecraft Project Office (ASPO) was established at the Manned Spacecraft Center (MSC), STG's new designation, with Charles W. Frick as manager.
Jan.-June 1962	Grumman conducted another in-house study of lunar orbit rendezvous techniques.
Feb. 6, 1962	Houbolt and Charles W. Mathews of MSC made a presentation on lunar orbit rendezvous to the Manned Space Flight Management Council.
March 1962	NASA Headquarters approved plans for the development of a Little Joe II test launch vehicle with which to verify various Apollo spacecraft systems. General Dynamics/Convair was awarded a contract to design and manufacture the vehicle on May 11.
March 2-3, 1962	At a meeting at NASA Headquarters, lunar orbit rendezvous was reviewed as a possible mission mode for Apollo. It would require a single Saturn C-5 (three stages).
Apr. 11, 1962	Kennedy assigned the Apollo program the highest national priority category (DX) for procurement action.
Apr. 16, 1962	MSC representatives made a lunar orbit rendezvous presentation at MSFC; additional presentations were made at Headquarters in May.
Apr. 25, 1962	Saturn SA-2 with a water-filled second stage was launched successfully.
June 7, 1962	MSFC's von Braun recommended that the lunar orbit rendezvous mode be adopted for Apollo.
June 22, 1962	The Manned Space Flight Management Council announced that it favored lunar orbit rendezvous. Other NASA officials agreed, and on July 11 the agency announced that this mode had been selected for Apollo. A lunar module capable of landing two men on the moon's surface and returning them to the orbiting command and service module would be required.

Table 2-50.
Chronology of Key Apollo Program Events* (Continued)

Date	Event
July 25, 1962	MSC invited 11 firms to submit proposals due on September 4 for an Apollo lunar excursion module.
Sept. 17, 1962	Nine new astronauts were added to NASA's flight team.
Sept. 26, 1962	NASA announced plans for constructing the Mississippi Test Facility for testing the Saturn stages.
Nov. 7, 1962	NASA selected Grumman to build the lunar module. Grumman was chosen over eight other firms. A definitive contract was signed on March 11, 1963.
Nov. 16, 1962	Saturn SA-3 with a water-filled second stage was launched successfully.
Feb.-March 1963	The MSC Lunar Surface Experiments Panel, formed to study and evaluate proposals for lunar surface investigations, met for the first time.
Feb. 27, 1963	NASA established an Apollo Mission Planning Panel to develop mission design, coordinate trajectory analyses, and produce contingency plans for all manned missions.
March 28, 1963	Saturn SA-4 was launched successfully (last first-stage test of Saturn I).
Sept. 4, 1963	At MSC, a Manned Spacecraft Criteria Board was established to determine engineering, design, and procedural standards for spacecraft systems.
Sept. 16-18, 1963	The first lunar module mockup review was held at Grumman.
Oct. 18, 1963	NASA selected another 14 astronauts for training for Gemini and Apollo.
Oct. 30, 1963	NASA cancelled plans for four manned earth orbital missions launched by Saturn I vehicles. The first manned Apollo test flight would be powered by a Saturn IB.
Nov. 1, 1963	Apollo's launch escape system was successfully tested at White Sands (<i>Pad Abort-1</i>).
Jan. 29, 1964	Saturn SA-5 with a powered second stage was launched successfully (second stage put into orbit).
Feb. 3, 1964	NASA selected 14 more astronauts for Gemini and Apollo.
Apr. 14, 1964	FIRE 1, a reentry heating test of an Apollo-shaped vehicle, was carried out successfully.
Apr. 28-30, 1964	A mockup review of the Block I (earth orbital) Apollo command and service module (CSM) was held at North American; a second review followed on July 8-9.
May 28, 1964	The first orbital flight of an Apollo boilerplate model with a Saturn I (<i>A-101</i>) took place successfully.
Sept. 18, 1964	Test <i>A-102</i> took place successfully.
Sept. 30, 1964	A review of a Block II (lunar mission) Apollo CSM mockup was held. NASA gave North American a formal go-ahead for manufacture on November 23.
Jan. 6-8, 1965	NASA held a preliminary design review of the Block II CSM.
June 29, 1965	NASA announced the selection of six additional astronauts for Apollo; these newest astronauts were chosen because of their academic training in the sciences (only four became active).
Nov. 1965-Jan. 1966	The critical design review of the lunar module was conducted by five teams: structures and properties; communications, instrumentation and electrical power; stabilization and control, navigation and guidance, and radar; crew systems; and mission compatibility and operations.

Table 2-50.
Chronology of Key Apollo Program Events* (Continued)

Date	Event
Nov. 30, 1965	The first of two Apollo mission simulators was shipped from the Link Group of General Precision to MSC.
Dec. 6-17, 1965	The critical design review of the Block II CSM (mockup 27A) was held.
Dec. 15, 1965	In a letter to North American President J. L. Atwood, Apollo Program Director Samuel C. Phillips expressed NASA's dissatisfaction with the firm's progress with the manufacture of the Apollo spacecraft and the Saturn S-II stage.
Jan. 14, 1966	Grumman's lunar module contract was converted from cost-plus-fixed-fee to cost-plus-incentive-fee; North American's contract was likewise changed on the 21st.
Feb. 26, 1966	A suborbital launch vehicle development test of the Saturn IB was carried out; an Apollo CSM served as payload (AS-201).
July 5, 1966	A successful orbital launch vehicle development test of the Saturn IB (for a time called Uprated Saturn I) was conducted (AS-203).
Aug. 25, 1966	A second suborbital test of the Saturn IB was launched successfully (AS-202).
Oct. 19, 1966	It was announced that the crew of the first manned Apollo mission, AS-204, would be Virgil I. Grissom, Edward H. White, II, and Roger B. Chaffee. The earth-orbital flight was scheduled for February 12, 1967.
Jan. 23, 1967	A Lunar Mission Planning Board established at MSC met for the first time.
Jan. 27, 1967	During a pre-launch test of AS-204 at Launch Complex 34 at the Kennedy Space Center, fire swept through the command module, killing all three crew members (Grissom, White, and Chaffee). The next day a review board was formed to investigate the accident; Floyd L. Thompson, director of Langley, was appointed chairman. On February 1, MSC instructed contractors and other government agencies to stop all MSC-related manned testing in high-oxygen environments.
Feb. 5, 1967	The Apollo 204 Review Board submitted its final report. Arcs from electrical wiring in an equipment bay on the command module had started the fire; in the 100 percent oxygen atmosphere the crew had died of asphyxia due to inhalation of toxic gases. The board's report included a number of significant suggestions for hardware and operational changes.
Apr.-Aug. 1967	A NASA task team charged with overseeing Block II CSM redefinition worked at North American to provide input on detail design, overall quality and reliability testing, and scheduling. Astronaut Frank Borman led the group.
Nov. 9, 1967	Apollo 4, the first "all-up" orbital test of the Saturn V vehicle, was conducted successfully. The command module's reentry simulated the most severe conditions that were expected on a lunar-return trajectory.
Jan. 22, 1968	Apollo 5, the first development test flight that included a lunar module in the payload, was launched successfully with a Saturn IB. The lunar module, S-IVB stage, and launch vehicle instrument unit were put into orbit. A second unmanned lunar module flight was cancelled.
March 6-7, 1968	Design certification reviews of CSM 101 (to be flown on the first manned Apollo flight) and LM-3 were held at MSC.

Table 2-50.
Chronology of Key Apollo Program Events* (Continued)

Date	Event
Apr. 4, 1966	The Saturn V-launched <i>Apollo 6</i> mission did not meet its primary objectives because of launch vehicle malfunctions. The CSM was put into orbit and recovered from the Pacific.
Aug. 9-17, 1968	In a series of top-level meetings initiated by ASPO Manager George Low, it was decided that the second manned Apollo mission (Apollo 8) would be a lunar-orbit mission if all went well on the Apollo 7 earth orbital flight. Plans made in late 1967 did not call for a lunar mission until the fourth manned flight, but Low and others argued that if they were to meet the end-of-the-decade deadline they would have to seek as soon as possible firsthand knowledge of communications, navigation, and thermal control in deep space. The decision for a December 1968 lunar orbit mission was not made public until November 12.
Oct. 3, 1968	The flight readiness review for Apollo 7 was held at KSC, with crew and vehicle being declared ready for the mission.
Oct. 11-22, 1968	<i>Apollo 7</i> , the first manned Apollo flight, was conducted successfully with Astronauts Walter Schirra, Donn F. Eisele, and R. Walter Cunningham at the controls (before the 204 fire and the death of the crew, these three men had been scheduled to pilot the second flight). During their nearly 11 days in orbit, the crew made a live television broadcast from their spacecraft and performed all their test objectives. The Block II CSM was launched by a Saturn IB (see table 2-52).
Dec. 21-27, 1968	<i>Apollo 8</i> became the first manned spacecraft to circle the moon. Frank Borman, James Lovell, and William Anders reached the moon in 69 hours and orbited the satellite for 20 hours. Splashdown was in the Pacific (see table 2-53).

Table 2-51.
Developmental Tests and Flights, the Apollo Program

Launch Date	Flight/Test	Objectives/Results
Oct. 27, 1961 (ETR)	SA-1	Successful launch vehicle development test (Saturn C-1); dummy second stage.
Apr. 25, 1962 (ETR)	SA-2	Successful launch vehicle development test (Saturn C-1); water in dummy second stage was released into the ionosphere (Project Highwater).
Nov. 16, 1962 (ETR)	SA-3	Successful launch vehicle development test (Saturn C-1); water in dummy second stage was released (Project Highwater).
March 28, 1963 (ETR)	SA-4	Successful launch vehicle development test (Saturn I) final test of the Saturn I booster stage.
July 20, 1963 (Wallops)	Scout Reentry Heating Experiment (R-3)	Unsuccessful suborbital reentry test of Apollo heatshield material; the failure was due to launch vehicle malfunction.
Aug. 28, 1963 (White Sands)	Little Joe II (LJ-II)	Successful flight qualification test of Little Joe II booster; it carried a dummy payload that simulated an Apollo spacecraft; plans called for using the LJ-II as an Apollo test vehicle.
Nov. 7, 1963 (White Sands)	Pad Abort-1 (boilerplate spacecraft 6)	Successful test of Apollo launch escape system (LES) with a boilerplate model of the spacecraft (no launch vehicle was required).
Jan. 29, 1964 (ETR)	SA-5	Successful launch vehicle development test of Block I vehicle (Saturn I); a powered second stage was put into orbit.
Apr. 14, 1964 (ETR)	FIRE 1	Successful suborbital reentry test of an Apollo-shaped reentry vehicle at speeds of 40 000 km/hr; an Atlas-Antares vehicle launched <i>FIRE 1</i> .
May 13, 1964 (White Sands)	Apollo A-001 (BP-12)	Successful suborbital LES test, using the LJ-II and a CSM boilerplate model.
May 28, 1964 (ETR)	Apollo A-101 (SA-6) (BP-13)	Orbital compatibility test of an Apollo boilerplate model and a Saturn I; reentry took place on June 1 after 54 orbits.
Aug. 18, 1964 (Wallops)	R-4	Successful suborbital reentry test of Apollo heatshield materials.
Sept. 18, 1964 (ETR)	Apollo A-102 (SA-7) (BP-15)	Successful orbital compatibility test of an Apollo boilerplate model and Saturn I; the LES was also demonstrated; reentry took place on Sept. 22 after 59 orbits.
Dec. 8, 1964 (White Sands)	Apollo A-002 (BP-23)	Successful test of the Apollo LES using LJ-II.
May 19, 1965 (White Sands)	Apollo A-003 (BP-22)	During a planned high-altitude test of the Apollo abort system, the LJ-II vehicle malfunctioned; the LES functioned and lifted the spacecraft clear of the defective launcher.
May 22, 1965 (ETR)	FIRE 2	Successful suborbital reentry test of an Apollo-shaped reentry vehicle at speeds of 40 000 km/hr.

Table 2-51.
Developmental Tests and Flights, the Apollo Program (Continued)

Launch Date	Flight/Test	Objectives/Results
June 29, 1965 (White Sands)	Pad Abort-2 (BP-23A)	Successful test of the LES to function from the launch pad; no launch vehicle was required.
Jan. 20, 1966 (White Sands)	Apollo A-004	Successful medium-altitude test of the Apollo LES, using an LJ-II.
Feb. 9, 1966 (ETR)	R-5	Successful suborbital reentry test of heatshield materials.
Feb. 26, 1966 (ETR)	AS-201 (CSM-009)	Successful suborbital launch vehicle development (Saturn IB); the command module was recovered.
July 5, 1966 (ETR)	AS-203	Successful orbital launch vehicle development test (Saturn IB, or Uprated Saturn I); data were returned on the S-IVB stage and the instrument unit; engine restart capability was demonstrated; the S-IVB stage fragmented during a 4th-orbit pressure differential test of the bulkhead.
Aug. 25, 1966 (ETR)	AS-202 (CSM-011)	Successful suborbital launch vehicle development test (Saturn IB); the Apollo heatshield and the spacecraft rapid restart capability were also evaluated; the command module was recovered.
Nov. 9, 1967 (ETR)	Apollo 4 (AS-501) (CSM-017)	Successful orbital launch vehicle development test (Saturn V); the reentry simulated the most severe conditions expected during a lunar return trajectory; the command module was recovered on Nov. 9.
Jan. 22, 1968 (ETR)	Apollo 5 (AS-204) (LM-1)	Successful orbital launch vehicle development test (Saturn IB) and spacecraft development test; the LM was tested for the first time and recovered on Jan. 24.
Apr. 4, 1968 (ETR)	Apollo 6 (AS-502) (CSM-020)	Unsuccessful attempt to perform a launch vehicle development test (Saturn V); failure was due to severe up-and-down vibrations of the vehicle during first-stage thrust, early shutdown of second-stage engines, and failure of the third-stage engine to restart; the command module was recovered on Apr. 4.

Table 2-52.
Apollo 7 Characteristics

Date of launch (ETR complex #):	Oct. 11, 1968 (34)		
Official mission designation:	AS-205		
Spacecraft designation:	CSM-101		
Launch vehicle designation:	Saturn IB 205		
Spacecraft weight (kg):	20 553		
Spacecraft shape, dimension (m):			
command module:	truncated cone length, 3.63 diameter of base, 3.9	service module:	cylindrical with extended engine nozzle length, 6.88 diameter, 3.9
Crew:	Walter M. Schirra, Jr., commander; Donn F. Eisele, CM pilot; R. Walter Cunningham, LM pilot		
Backup crew:	Thomas P. Stafford, John W. Young, and Eugene A. Cernan		
Cam coms:	Stafford, Ronald E. Evans, William R. Pogue, John L. Swigert, Young, Cernan		
Apogee/perigee at insertion (km):	285/227		
No. of orbits:	163		
Period:	01:29:08		
Length of mission:	260:09:03 (10+ days)		
Mission events (date, time, ground elapsed time):			
launch	Oct. 11 11:02:45 a.m., EST		
S-IB cutoff (inboard)	11:05:05.7	00:02:20.7	
S-IB cutoff (outboard)	11:05:09.3	00:02:24.3	
S-IVB cutoff	11:13:01.8	00:10:16.8	
orbital insertion	11:13:11.8	00:10:26.8	
S-IVB-CSM separation	1:57:47 p.m.	02:55:02	
deorbit maneuver initiated	Oct. 22 6:42:01.3 a.m.	259:39:16.3	
CM-SM separation	6:46:18.8	259:43:33.8	
splashdown	7:11:48	260:09:03	
Distance traveled (km):	7 323 000		
Landing point:	27°32'N, 64°04'W (3 km from target)		
Recovery ship:	USS Essex (crew onboard in 60 min.)		
Mission objectives:	Demonstrate CSM-crew performance; demonstrate crew-space vehicle-mission support facilities performance during a manned CSM mission; demonstrate CSM rendezvous capability; execute two experiments.		
Results:	All primary mission objectives were achieved.		
Reference:	MSC, "Apollo 7 Mission Report," MSC-PA-R-68-15, Dec. 1968.		

Table 2-53.
Apollo 8 Characteristics

Date of launch (ETR complex #):	Dec. 21, 1968 (39A)	
Official mission designation:	AS-503	
Spacecraft designation:	CSM-103	
Launch vehicle designation:	Saturn V 503	
Spacecraft weight (kg):	43 663 (includes LM Test Article)	
Spacecraft shape, dimension (m):	see table 2-52	
Crew:	Frank Borman, commander; James A. Lovell, CM pilot; William A. Anders, LM pilot	
Backup crew:	Neil A. Armstrong, Edwin E. Aldrin, Jr., Fred W. Haise, Jr.	
Cam coms:	Michael Collins, Thomas K. Mattingly, II, Gerald P. Carr, Armstrong, Aldrin, Vance D. Brand, Haise	
Apogee/perigee at insertion (km):	190/180	
No. of orbits:	1.5	
Lunar orbit parameters (km):	312/111 (initial), 112/111 (orbits 3-10)	
Period (average):	02:01:06	
No. of orbits:	10	
Length of mission:	147:00:42 (6+ days)	
Mission events (date, time, ground elapsed time):		
launch	Dec. 21	7:51:00 a.m., EST
S-IC cutoff (center)	7:53:05.9	00:02:05.9
S-IC cutoff (outboard)	7:53:33.8	00:02:33.8
S-II cutoff	7:59:44	00:08:44
S-IVB cutoff	8:02:25	00:11:25
earth orbital insertion	8:02:35	00:11:35
translunar injection ignition	10:41:37.1	02:50:37.1
S-IVB-CSM separation	11:11:59.3	03:20:59.3
lunar orbit insertion ignition	Dec. 24 4:59:20.4 a.m.	69:08:20.4
transearth injection ignition	Dec. 25 1:10:16.6 a.m.	89:19:16.6
CM-SM separation	Dec. 27 10:19:48 a.m.	146:28:48
splashdown	10:51:42	147:00:42
Distance traveled (km):	933 000	
Landing point:	8°7.5'N, 165°1.2'W (2 km from target)	
Recovery ship:	USS <i>Yorktown</i> (crew onboard in 80 min.)	
Mission objectives:	Demonstrate crew-vehicle-support facilities performance during a manned Saturn V mission with CSM; demonstrate performance of nominal and selected backup lunar orbit rendezvous mission activities; execute two experiments.	
Results:	All primary mission objectives were achieved, and the crew became the first to travel to the vicinity of the moon.	
Reference:	MSC, "Apollo 8 Mission Report," MSC-PA-R-69-1, Feb. 1969.	

Table 2-54.
Size and Performance Comparisons of Mercury, Gemini, and Apollo

	Mercury	Gemini	Apollo CSM	Apollo LM
Weight at reentry (kg)	1208	2165	566.8	NA
Volume, habitable (m ³)	1.02	1.56	5.94	4.53
Mission duration, max. (days)	1½	13¼	12½	3
Crew size	1	2	3	2
Cabin atmosphere	100% O ₂	100% O ₂	100% O ₂	100% O ₂
Suit usage	cabin backup	cabin backup ejection EVA	cabin backup EVA crew transfer	cabin backup crew transfer surface
Propulsion, main maneuvering and retro, ΔV (m/sec)	solid retro 98.8	solid retro 99.1	service propulsion system 1951	descent propulsion system 2135 ascent propulsion system 1850
Propulsion, reaction control system for auxiliary maneuvers and attitude control, total impulse (newtons/sec)	30 967	entry vehicle 90 478 orbital maneuvering 1 077 524	command module 256 714 service module 1 653 828	782 483
Lift/drag, entry	ballistic	0.17-0.09 (Mach 24-6)	0.28-0.38 (Mach 36-6)	NA

From Maxime A. Fagnet, "An Overview of United States Manned Spaceflight from Mercury to the Shuttle," paper, 32d Congress, International Astronautical Federation, Rome, Sept. 6-12, 1981.

Table 2-55.
Major Subsystem Comparison for Mercury, Gemini, and Apollo

	Mercury	Gemini	Apollo CSM	Apollo LM
Entry shape	blunt cone w/ cylindrical afterbody	same as Mercury	blunt cone (CM)	NA
Thermal protection	fiberglass ablator on blunt face; high-temperature shingles elsewhere	silicone elastomer ablator (otherwise same as Mercury)	ablator like Gemini's of varying thickness around CM	multilayer reflective insulation
Launch escape system	solid-fuel rocket mounted on tower	ejection seats	same as Mercury	NA
Life support	100% O ₂ ; water evaporators for cooling	100% O ₂ ; radiator and evaporators for cooling	same as Gemini	100% O ₂ ; water sublimators for cooling
Attitude control	hydrogen peroxide monopropellant; redundant systems	hypergolic propellants; ablatively cooled engines; redundant entry systems	same as Gemini, but radiatively cooled engines in coast system	same as SM coast system
Maneuver propulsion (Newtons)	NA	thrusters using same fuel as for attitude control (423)	SM propulsion, pressure-fed hypergolics (91 184)	ascent propulsion (15 568) 10 throttleable descent engines (2224 each)
Retrograde propulsion	3 solid-fuel rockets	4 solid-fuel rockets	(maneuver propulsion used)	NA
Onboard control	body-mounted gyro stabilization; horizon scanner reference	4-gimbal inertial platform; horizon scanners; digital computer; rendezvous radar	3-gimbal inertial platform digital autopilot and computer; optical alignment; VHF ranging	same as CM, but w/rendezvous and landing radars
Electrical power	3 silver-zinc batteries	fuel cells w/ backup batteries	same as Gemini	4 descent and 2 ascent batteries
Communications	UHF, VHF voice and PAM telemetry; C- and S-band tracking; command link	same as Mercury, except PCM telemetry	unified S-band; VHF voice	same as CM, plus extra-vehicular

Table 2-55.
Major Subsystem Comparison for Mercury, Gemini, and Apollo (Continued)

	Mercury	Gemini	Apollo CSM	Apollo LM
Landing system	1 drogue, 1 main, 1 reserve chutes; landing bag	1 drogue, 1 main chutes; crushable structure	2 drogue, 3 main chutes; crushable structure; stroke couch	4-leg landing gear w/ crushable honeycomb
Pressure suit	backup to cabin atmosphere control	EVA-type w/ umbilical	EVA-type w/ umbilical	EVA-type w/ independent life support

From John H. Boynton and Kenneth S. Kleinknecht, "Systems Design Experience from Three Manned Space Programs," paper 69-1077, AIAA 6th Annual Meeting, Anaheim, CA, Oct. 20-24, 1969.

Table 2-56.
Major Contractors for Mercury, Gemini, and Apollo Spacecraft

Contractor	Mercury	Gemini	Apollo
Aerojet-General Corp., Space Propulsion Div.			SM engine
Atlantic Research Corp.	escape tower rocket, posigrade rocket		
Avco Corp., Space Systems Div.			CM heatshield
Bell Aerospace Corp., Bell Aerosystems Co.	reaction control system	(Agena propulsion)	LM ascent stage engine
Bellcomm, Inc.			systems engineering and analysis support to Hq
Bendix Corp.		instrumentation	lunar surface experiments package, CSM instrumentation
Boeing Co.			technical integration and evaluation
David Clark Co., Inc.		space suits	
Collins Radio Co.	communications hardware	voice communications	communications and data subsystem
Eagle-Picher Co.	batteries	batteries	post-entry and storage batteries
Electro-Mechanical Research, Inc.		data transmission system	
Garrett Corp., AiResearch Manufacturing Co.	environmental control system (ECS)	ECS	ECS
General Electric Co.		fuel cell, engineering services	reliability and quality assurance

Table 2-56
Major Contractors for Mercury, Gemini, and Apollo Spacecraft – (Continued)

Contractor	Mercury	Gemini	Apollo
General Motors Corp. AC Electronics Div.			guidance and navigation system
B. F. Goodrich Co.	space suits		
Grumman Aircraft Engineering Corp.			LM (prime)
Hexcel Products, Inc.		core assembly honeycomb shield	
Honeywell, Inc. Minneapolis-Honeywell Regulator Co.	stabilization system	rate gyros, attitude and control electronics	stabilization and attitude control system
International Business Machine Corp.		onboard computer [mission control center]	[instrument unit 6, mission control center]
International Latex Corp./ILC Industries			space suits
Lockheed Propulsion Co./Lockheed Missiles & Space Co.	escape tower motor	(Agena target vehicle)	launch escape motor, pitch control motor
McDonnell Aircraft Corp./McDonnell Astronautics Co., McDonnell Douglas Corp.	spacecraft (prime)	spacecraft (prime)	
Marquardt Corp.			LM reaction control system SM reaction control system
Massachusetts Institute of Technology, Instrumentation Laboratory			CSM guidance and navigation system design
J. A. Maurer, Inc.		cameras	
D. B. Milliken Co.	camera		
Motorola, Inc.	command receivers	digital command system	digital command system
North American Aviation, Inc., Rocketdyne Div.		reentry control system, orbit attitude and maneuvering system	
North American Aviation, Inc., Space & Information Systems Div.			CSM (prime)
Northrop Corp., Ventura Div.	landing and recovery system	landing system	landing system

Table 2-56.
Major contractors for Mercury, Gemini, and Apollo Spacecraft (Continued)

Contractor	Mercury	Gemini	Apollo
Radio Corporation of America, Aerospace Communications and Controls Div.		pulse code modulator recorder	television equipment, LM guidance system, communications hardware
Raytheon Co.			CSM guidance and navigation digital computer
Space Technology Laboratories, Inc.			LM descent stage engine
Studebaker-Packard Corp., Cincinnati Testing and Research Laboratory	heatshield		
Thiokol Chemical Corp.	retrograde rocket	retrograde rockets	launch escape tower motor
TRW Systems Inc.			trajectory analysis
United Aircraft Corp., Hamilton Standard Div.			LM ECS
United Aircraft Corp., Pratt & Whitney Aircraft Div.			CSM fuel cell powerplants
Weber Aircraft Corp.		ejection seat system	
Westinghouse Electric Corp.		rendezvous radar and transponder	

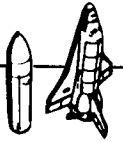
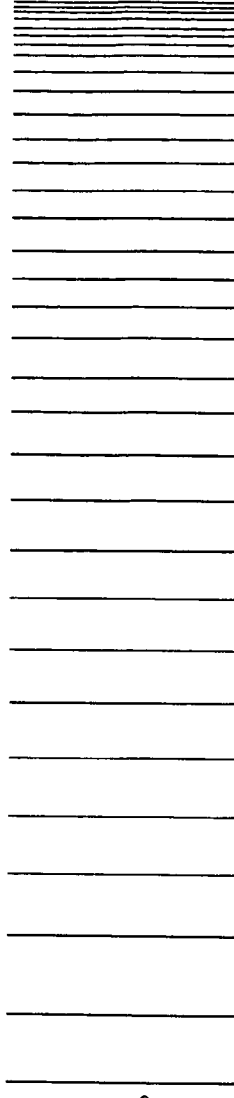

CHAPTER THREE
**SPACE SCIENCE
AND APPLICATIONS**

CHAPTER THREE

SPACE SCIENCE AND APPLICATIONS

With the launching of small sounding rockets in the 1940s, scientists were able to extend their observations and measurements into the upper atmosphere. When larger rockets became available, they were put to work carrying sophisticated instrument packages to even higher altitudes. Rockets and spacecraft were "revolutionary tools," which were used on a large scale by the National Aeronautics and Space Administration (NASA) when the agency was established in 1958.¹ Taking advantage of the momentum inspired by the International Geophysical Year, which saw the launching of the first Explorer and Vanguard satellites, NASA managers organized a space science program around the several disciplines that would benefit from sounding rocket, satellite, probe, and manned spaceflight projects. The agency made a conscious effort to build its scientific programs along the guidelines suggested by the nation's leading scientists, and continued throughout its first 10 years to seek outside advice and support. Applying this new wealth of scientific return to practical uses was another part of NASA's mandate as a body supported by public funds.

The legislation that called for the establishment of a civilian space agency directed the new administration to expand the body "of human knowledge of phenomena in the atmosphere and space," a broad dictum.² Most of the scientists and engineers who hoped to achieve this goal came to NASA from other government agencies, namely the Naval Research Laboratory, the Jet Propulsion Laboratory, and the National Advisory Committee for Aeronautics. Members of the Naval Research Laboratory's Vanguard division and the upper atmosphere sounding rocket team formed the nucleus around which the Goddard Space Flight Center (originally called the Beltsville Space Center) in Maryland was built. Goddard's personnel were responsible for many of NASA's unmanned spacecraft projects and sounding rocket experiments, in addition to operating a satellite tracking network. Besides working in the field of propulsion, specialists at the Jet Propulsion Laboratory (JPL) in Pasadena, California, were also involved with the Army's early satellite program. When JPL was assigned to NASA in 1958 as a contractor facility, its scientists became part of the agency's unmanned lunar and planetary exploration team. JPL also found a network for communicating with lunar and planetary spacecraft. The Langley Research Center, which had been part of the National Advisory Committee for Aeronautics, also played a role in the unmanned space program when its personnel began taking part in NASA's lunar and planetary projects

in the 1960s. Unmanned space science payloads were launched from Wallops Station, the Eastern Test Range, and the Western Test Range.*

Along with facilities and personnel, NASA inherited some ongoing space science projects—the Vanguard satellite, various sounding rocket investigations, and the Air Force's Pioneer deep space probe. Building on these activities, NASA's managers and scientists were able to shape a space science program that embraced many areas of research: geodesy, meteorology, atmospheric and ionospheric physics, magnetospheric research, lunar and planetary science, solar studies, galactic astronomy, and bioscience. For management purposes, NASA throughout its reorganizations of the space science and applications program grouped these disciplines and their related flight projects into several divisions—physics and astronomy, lunar and planetary, life sciences, meteorology, communications, and applications. Thus organized and funded, “NASA proceeded to attack the scientific problems of the atmosphere and space that the scientists . . . deemed most important and most likely to produce significant new information,” with the approval of Congress.³

To ensure that NASA's space science program reflected the interests and concerns of the nation's scientists, the agency's managers invited several advisory groups to take part in program planning. The National Academy of Science's Space Science Board was an important and influential source of input, but NASA also established a series of advisory committees that involved a broader segment of the scientific community. The subcommittees of the Space Science and Applications Steering Committee were highly specialized groups that could furnish advice in a number of particular fields, while an Astronomy Missions Board and a Lunar and Planetary Missions Board offered broader commentary on NASA's programs. Working relations between NASA and its various advisory bodies were not always smooth, and friction among those bodies was not unknown. But, it is generally agreed that the content of NASA's science programs accurately mirrored the priorities and objectives of most American space scientists. In addition to the scrutiny given them by advisory groups, NASA's space activities were analyzed by the president's science adviser, the Space Science and Technology Panel of the President's Science Advisory Committee, the Subcommittee on Space Science and Applications of the House Committee on Science and Astronautics, and the Senate Committee on Aeronautical and Space Sciences.

“Pure scientists” do not always concern themselves with the practical applications of their research, but NASA managers in justifying the budgets for their science programs often were forced to explain to Congress what the public could expect in return for tax dollars spent on space science. As funds for the space program and other large government programs not directly related to defense or public welfare became harder to obtain in the late 1960s and as the Apollo lunar expeditions took more and more of the agency's budget, it became increasingly important to realize some practical benefits from scientific projects. NASA had to balance the desirability of basic research, which could answer fundamental questions about the nature of matter and the forces of the universe and which might have some unforeseen practical benefits, and the need for applied research, which could be geared toward a planned application. Both were critical components of the agency's scien-

* See chapter 1 for details on the launch vehicles used for space science and applications missions.

tific program.⁴ Meteorology and communications are two obvious fields to which NASA's scientific research was applied that benefited the public. Land and water management, cartography, forestry, and aircraft design are other examples. NASA, a research and development organization, relied on other government agencies, industry, and universities for the actual application of its work to products or services.

Space science was always an integral part of NASA's organization. Until late 1961, space science was part of the Office of Space Flight Development, becoming a directorate by itself in a November 1961 reorganization of the agency. Homer E. Newell, Jr., led the space science team from 1958 until October 1967. In March 1960, life sciences was organized as a separate directorate, but in November 1961 it became part of the space science program. There were separate directors for space science and for applications from November 1961 until June 1963, when the two interests were combined into one office. Directors and division directors were responsible to Associate Administrator Newell for their various program areas and flight projects. In October 1967, John E. Naugle became responsible for the management of space science and applications as the associate administrator.⁵ (See table 3-1 for details on how the organization of space science and applications evolved through 1968.)

NASA's space science missions experienced their share of failures during the late 1950s, but by the end of the next decade the agency saw 80.8 percent of its scientific and applications experiments to successful or partially successful conclusions (this figure does not include sounding rocket projects). However, there was more to the success story than perfect launches and the operation of complex equipment. Beyond the tally of successful flights were the many discoveries made in several areas of study as a result of new data returned from scientific satellites and probes and the practical applications of these discoveries that have made new products and services possible. Add to this the overall progress made in the earth and planetary sciences that have advanced man's knowledge and understanding of the universe and opened new fields for investigation. While scientific and applications missions consistently took second place to manned spaceflight in NASA's search for funds, for most of the agency's first 10 years it was the science and applications program that provided the larger return on the nation's investment in space.⁶

Table 3-1.
Five Phases of Space

Science and Applications Management,
NASA Headquarters

Phase I
Oct. 1958-Jan. 1960

Administrator/Deputy Administrator/Associate Administrator
 Director, Space Flight Development (Abe Silverstein)
 Assistant Director, Space Science(s) (Homer E. Newell, Jr.)
 Chief, Space Science Programs (Morton J. Stoller)
 Chief, Planetary Science Program (John F. Clark)
 Chief, Science Program Analysis (Nicholas E. Manos)
 Chief, Astronomy and Astrophysics (Gerhard F. Schilling)

Phase II
Feb. 1960-Oct. 1961

Administrator/Deputy Administrator/Associate Administrator
 Director, Space Flight Programs (Silverstein)
 Deputy Director, Space Flight Programs (Newell)
 Assistant Director, Program Planning and Coordination (D. D. Wyatt; Edgar M. Cortright, acting, June 1961)
 Assistant Director, Applications and Manned Flight Programs (Newell D. Sanders); office dropped in 1961 and replaced by Advanced Technology Programs (Sanders) and Manned Space Flight Programs (George M. Low)
 Assistant Director, Space Flight Operations (Edmond C. Buckley)
 Assistant Director, Satellite and Sounding Rocket Programs (Stoller)
 Assistant Director, Lunar and Planetary Programs (Cortright)
 Director, Life Sciences Program (Clark T. Randt); established March 1960
 Assistant Director, Bioengineering (Alfred M. Mayo); office dropped in mid-1961 (Mayo became acting director for life sciences)
 Assistant Director, Grants and Contracts (Freeman H. Quimby); office dropped in mid-1961
 Assistant Director, Space Biology (Quimby); established in mid-1961
 Assistant Director, Program Planning and Coordination (G. Dale Smith); established in mid-1961
 Assistant Director, Aerospace Medicine (Frank Voris); established in mid-1961

Phase III
Nov. 1961-Oct. 1963

Administrator/Deputy Administrator
 Associate Administrator
 Director, Space Sciences (Newell)
 Deputy Director, Space Sciences (Cortright)
 Director, Grants and Research Contracts (Thomas L. K. Smull)
 Director, Launch Vehicles and Propulsion (Donald H. Heaton; Richard B. Morrison, June 1962)

Table 3-1.
Five Phases of Space (Continued)

Director, Geophysics and Astronomy Programs (John F. Clark; John E. Naugle, May 1962)
 Director, Program Review and Resources Management (John D. Nicolaides)
 Director, Lunar and Planetary Programs (Oran W. Nicks)
 Director, Bioscience Programs (Orr E. Reynolds)
 Director, Applications (Stoller)
 Director, Meteorological Systems (Morris Tepper)
 Director, Communications Systems (Leonard Jaffe)
 Director, Program Review and Resources Management (Carl Freedman)
 Director, Future Applications (vacant); office dropped in Nov. 1962
 Director, Industrial Applications (Louis B. C. Fong, Nov. 1962); office dropped in April 1963

Phase IV
Nov. 1963-Sept. 1967

Administrator/Deputy Administrator

Associate Administrator

Associate Administrator, Space Science and Applications (Newell)

Deputy Associate Administrator, Space Science and Applications (Cortright)

Deputy Associate Administrator (Sciences), Space Science and Applications (Naugle); office established in May 1966

Director, Sciences (Clark; Naugle, acting, July 1965); office dropped in May 1966

Director, Applications (Robert F. Garbarini); office replaced in 1964 (Garbarini became director of engineering)

Division Director, Bioscience Programs (Reynolds)

Division Director, Communications and Navigation Programs (Jaffe); office dropped in 1966

Director, Physics and Astronomy (Naugle; Jesse Mitchell, May 1966)

Director, Grants and Research Contracts (Smull); office dropped in 1967

Director, Launch Vehicles and Propulsion Programs (Morrison; Vincent L. Johnson, Aug. 1964)

Director, Lunar and Planetary Programs (Nicks)

Division Director, Manned Space Science (Willis B. Foster); office dropped in 1967

Division Director, Meteorological Programs (Tepper); office dropped in 1966

Division Director, Program Review and Resources Management (Eldon D. Taylor)

Director, Voyager Program (Nicks); office established in mid-1967

Phase V
Oct. 1967-Dec. 1968

Administrator/Director Administrator

Associate Administrator

Associate Administrator, Space Science and Applications (Naugle)

Deputy Associate Administrator, Space Science and Applications (Nicks)

Deputy Associate Administrator (Sciences), Space Science and Applications (Naugle; Henry J. Smith, April 1968)

Table 3-1.
Five Phases of Space (Continued)

Deputy Associate Administrator (Engineering), Space Science and Applications (Johnson)
 Assistant Associate Administrator (Manned Flight Experiments), Space Science and Applications (Foster); office dropped in mid-1968

Director, Advanced Programs (Pitt Thome)
 Director, Program Review and Resources Management (Taylor)
 Director, Bioscience Programs (Reynolds)
 Director, Space Applications (Jaffe)
 Director, Launch Vehicles and Propulsion Programs (Joseph B. Mahon)
 Director, Voyager Program (Donald P. Hearth); office dropped in late 1968
 Director, Lunar and Planetary Programs (Hearth)
 Director, Physics and Astronomy Programs (Mitchell)

Table 3-2.
Science and Applications
Satellites and Probes, 1958-1968

Mission Type	Successful ^a	Number of Missions		Total
		Partially Successful ^a	Unsuccessful ^a	
Geophysics and astronomy ^b	53	2	14	69
Lunar and planetary	22	4	12	38
Communications ^c	13	2	2	17
Meteorology	20	0	1	21
Bioscience	1	1	0	2
Applications Technology	2	2	0	4
Total	111	11	29	151

^aAs reported in Kennedy Space Center, *A Summary of Major NASA Launchings*, KSC Historical, report 1 (Kennedy Space Center, rev. 1970).

^bIncludes a number of international missions.

^cIncludes Telstar and INTELSAT.

BUDGET

Each year, NASA's managers confronted the Bureau of the Budget and members of Congress with their wish list of scientific projects.* They needed funds for basic research, for the development of spacecraft and experiment hardware, and for launch vehicles. President John F. Kennedy's decision in May 1961 to assign NASA the task of landing a man on the moon before the end of the decade pushed science projects that did not directly support the lunar landing into a decidedly second place in the budget queue. For most of the agency's first decade, Apollo, the manned lunar venture, would have priority. However, NASA's scientists still managed to assemble a respectable program in several fields of research. For each of these disciplines, budget tables are provided in this chapter, along with tables for individual flight projects (e.g., in the discipline of lunar and planetary studies, Ranger was a flight project.)† For a more detailed breakdown of flight projects budgets consult the NASA annual budget. In addition to funds for flight projects, each discipline was also granted money for supporting research and advanced studies. The following categories represent the changing organization of NASA's space science and applications program. Review the many bottom notes of the budget tables carefully before making conclusions about totals for any particular project or fiscal year. Summary information can be found in tables 3-3 and 3-4.

* It would be useful to review the introduction to the budget section in chap. 1 for general information on NASA's budget and on the sources and format used for the budget tables in this book.

† If a project's activity were limited to two years, it is included in a miscellaneous category for the appropriate discipline.

Table 3-3.
Total Space Science and Applications Funding History^a
(in thousands of dollars)

Year	Request	Authorization	Programmed
1959	---	---	87 246 ^b
1960	62 244	62 244	95 767 ^c
1961	131 000 ^d	131 000 ^d	216 190 ^e
1962	414 619 ^f	414 619 ^f	429 067
1963	604 444	594 044	615 345
1964	857 200	767 075	615 922
1965	776 900	745 650	732 362
1966	797 515	773 015	759 093
1967	661 400	663 650	607 100
1968	694 600	638 400 ^g	562 850

^a For those years before there was an Office of Space Science and Applications, totals have been figured by adding together the funds requested, authorized, or programmed for the various space science, applications, and research projects; see following notes for details.

^b Includes \$3 995 000 for research grants and contracts, which was used for "the conduct of fundamental and applied research necessary for advancing aeronautical and space technology." Research grants and contracts were replaced in part by the sustaining university program in the FY 1965 budget estimate. In the FY 1963 and 1964 estimates, there was no corresponding budget item. The total also includes \$21 944 000 for Vanguard, which in 1959 was funded as a program separate from scientific satellites.

^c Includes \$4 869 370 for research grants and contracts; see further note b above.

^d Includes \$10 000 000 for research grants and contracts; see further note b above. After the Authorization Conference Committee approved the \$131 000 000 budget for FY 1961, the appropriation conference committee awarded an additional \$29 000 000 in a supplemental appropriation in June 1960.

^e Includes \$5 000 000 for research grants and contracts; see further note b above; this was the amount established in the FY 1962 budget estimate; by the FY 1963 budget estimate this category had been dropped.

^f Includes \$7 600 000 for research grants and contracts; see further note b above.

^g Total reduced to \$538 000 000 by the appropriation conference committee in October 1967.

Table 3-4.
 Programmed Costs by Space Science and Applications Flight Projects, FY 1959-1968
 (in thousands of dollars)

Project	1959	1960	1961	1962	1963	1964	1965	1966	1967	1968	Total
Physics & astronomy											
Explorer class ^a	6252	12 965	19 925	4483	32 811	15 526	21 565	18 592	18 224	17 532	167 875
Orbiting Solar Observatories	250	1863	3917	5742	10 000	20 005	16 597	19 052	10 106	11 332	99 764
Orbiting Astronomical Observatories	---	346	7472	38 221	39 250	35 608	32 644	22 300	27 700	44 768	248 309
Orbiting Geophysical Observatories	---	401	5358	25 729	39 634	42 868	30 352	28 215	24 770	20 064	217 391
Soundings	---	---	---	7765	11 513	16 950	867	19 300	20 000	20 000	112 395
Misc.	23 412 ^b	654 ^c	4560 ^d	10 635 ^e	---	---	---	---	---	---	---
Lunar & planetary											
Pioneer lunar probes	6237 ^f	18 349	5975	---	---	---	---	---	---	---	61 074
Ranger	---	19 542	45 066	63 430	88 816	30 306	11 037	1000	---	---	259 197
Surveyor	---	---	7054	39 134	66 386	70 704	81 814	104 634	79 942	33 000	482 668
Lunar Orbiter	---	---	---	---	004	20 000	49 500	58 081	26 000	9500	163 085
Prospector	---	---	575	---	---	---	---	---	---	---	575
Pioneer planetary probes	---	3798	462	---	2614	13 600	15 000	12 700	6900	6000	61 074
Mariner	---	---	14 785	48 377	42 777	49 152	17 368	17 585	43 188	66 250	299 482
Voyager ^g	---	---	---	---	---	---	7168	17 097	12 670	350	37 285
Misc.	17 543 ^h	---	---	---	---	---	---	---	---	---	17-543
Meteorology											
TIROS/TOS	818	3091	3013	6675	19 176	11 506	4100	2500	1292	9100	61 271
Nimbus	---	1802	12 722	23 881	28 561	41 673	16 000	22 560	24 410	33 700	205 309
Soundings	---	---	---	441	1437	2244	2380	2730	2855	3000	15 087
Meteorological Flight Experiments	---	---	---	---	---	---	1200	---	---	---	1200
Cooperative Applications Satellite	---	---	---	---	---	---	---	---	100	100	200
Communications											
Echo	1140	1528	8928	6103	2299	1675	325	---	---	---	21 998
Relay	---	---	20 650	6912	13 751	2590	462	---	---	---	44 365 ⁱ
Rebound	---	---	325	---	---	---	---	---	---	---	325 ^k
Syncom	---	---	---	12 612	13 013	2511	168	---	---	---	28 304 ^l
Misc.	---	---	1890 ^m	---	---	---	5000 ⁿ	---	---	---	11 890 ^m

Table 3-4.
Programmed Costs by Space Science and Applications Flight Projects, FY 1959-1968
(in thousands of dollars) (Continued)

Project	1959	1960	1961	1962	1963	1964	1965	1966	1967	1968	Total
Applications Technology Satellite	---	---	---	---	---	15 377	22 695	34 431	30 013	25 600	128 116
Geodetic satellites	---	---	---	---	---	---	---	4993	1600	3400	9993
Misc. applications flight projects	---	---	---	---	---	---	---	---	---	5300 ^o	5300
Biosatellite	---	---	165	133	1959	8500	16 000	23 300	31 950	30 000	112 007
Sounding rockets ^p	2916	8428	10524 ^q	---	---	---	---	---	---	---	21 868

^a See the explanatory notes for table 3-10.

^b Includes \$1 468 000 for general payload instrumentation and \$21 944 000 for Vanguard, which in 1959 was funded as a program separate from scientific satellites.

^c Includes \$2000 for Jupiter nuclear emulsions project, \$10 000 for integration of emulsion package, \$445 000 for a recoverable nuclear emulsions probe, and \$197 000 for electron density profile probe.

^d Includes \$89 000 for modifying an X-15 for an astronomy payload, \$167 000 for *Vanguard 2*, \$2 673 000 for international ionospheric satellite (UK-1), \$60 000 for international project satellite (UK-2), and \$1 571 000 for electron density profile probes.

^e For international satellites.

^f Includes funds for launch vehicles; see the explanatory notes for table 3-19.

^g See table 3-26 for explanatory notes regarding FY 1962-1964.

^h Includes \$2 843 000 for Thor-Able, \$3 500 000 for Atlas-Agena, and \$11 200 000 for unspecified payloads.

ⁱ It was estimated in the FY 1965 budget estimate that \$4 200 000 would be programmed for manned space science in FY 1964; by the FY 1966 estimate this item had been dropped. The manned space science project dealt with the engineering and operational development of manned spacecraft systems that would benefit the manned satellite program and lunar science.

^j It was estimated that \$200 000 would be programmed for Relay in FY 1966; see table 3-41 for explanatory note.

^k It was estimated that \$13 500 000 would be programmed for Rebound in FY 1962; see table 3-42 for explanatory note.

^l It was estimated that \$100 000 would be programmed for Syncom in FY 1966; see table 3-43 for explanatory note.

^m For a radiation measurements satellite. It was estimated that \$5 000 000 would be programmed for a transitional system.

ⁿ For early gravity gradient experiment.

^o For earth resources survey satellite.

^p See also physics and astronomy soundings and meteorological soundings (FY 1962-1968).

^q Includes funds for launch vehicles; see table 3-60 for explanatory notes.

Table 3-5.
Research Grants and Contracts Funding History^a
(in thousands of dollars)

Year	Request	Programmed
1959	---	3995 ^b
1960	---	4869
1961	10 000	--- ^c
1962	7600	---

^aTo utilize the capabilities of nongovernment organizations in carrying out research; dropped as a category by FY 1963.

^bIncludes \$966 510 provided under salaries and expenses.

^cIt was estimated in the FY 1962 budget estimate that \$5 000 000 would be programmed in FY 1961 for research grants and contracts; this category had been dropped by the FY 1963 estimate.

Table 3-6.
Physics and Astronomy (Scientific Satellites) Funding History^a
(in thousands of dollars)

Year	Request	Authorization	Programmed
1959	---	---	43 249 ^b
1960	22 800	22 800	20 241
1961	41 700	41 700	54 398
1962	72 700	72 700	97 775
1963	175 165	175 165	147 689
1964	194 400	194 400	148 623
1965	190 200	177 450	139 082
1966	172 100	165 900	142 753
1967	131 400	129 900	129 800
1968	147 500	145 500 ^c	139 500

^aIn the FY 1961-63 budget estimates, this program was called scientific satellites; in the FY 1964-65 estimates it was renamed geophysics and astronomy; it was changed to physics and astronomy in the FY 1966 estimate.

^bIncludes \$21 944 000 for Vanguard, which in 1959 was funded as a program separate from scientific satellites.

^cFY 1960 appropriation reduced to \$130 000 000 by the appropriations conference committee in October 1967.

Table 3-7.
 Physics and Astronomy Supporting Research and
 Technology and Advanced Studies Funding History^a
 (in thousands of dollars)

Year	Request	Authorization	Programmed
1959	---	---	2675 ^b
1960	---	---	4012 ^c
1961	8000 ^d	---	13 001 ^e
1962	12 369 ^f	---	5200
1963	33 679 ^g	33 679 ^g	13 581
1964	15 200	15 200	17 666
1965	14 800	14 800	21 057
1966	25 200	25 200	20 594
1967	22 900	22 900	20 365
1968	19 900	19 900	22 904

^aPrior to the FY 1964 budget estimate, supporting research was budgeted as advanced research (FY 1962-63), development of advanced instrumentation/advanced technical development (FY 1961-63), and scientific and technical studies (FY 1961).

^bIncludes \$1 520 000 for development of advanced instrumentation/advanced technical development, and \$1 155 00 for scientific and technical studies.

^cIncludes \$2 332 000 for development of advanced instrumentation/advanced technical development, and \$1 680 000 for advanced research.

^dIncludes \$6 000 000 for development of advanced instrumentation/advanced technical development, and \$2 000 000 for scientific and technical studies.

^eIncludes \$6 207 000 for development of advanced instrumentation/advanced technical development, and \$6 794 000 for advanced research.

^fIncludes \$8 326 000 for development of advanced instrumentation/advanced technical development, and \$4 043 000 for advanced research.

^gIncludes \$16 261 000 for development of advanced instrumentation/advanced technical development, and \$17 418 000 for advanced research.

Table 3-8.
Total Physics and Astronomy Flight Projects Funding History^a
(in thousands of dollars)

Year	Request	Authorization	Programmed
1959	---	---	40 574 ^b
1960	---	---	16 228
1961	33 700 ^c	---	41 397
1962	60 331	---	92 575
1963	141 486	141 486	134 108
1964	179 200	179 200	130 957
1965	175 400	162 650 ^d	118 025
1966	143 900	137 700 ^e	120 159
1967	106 500	105 000	107 700
1968	125 600	123 600	113 696

^a In the scientific satellites program, a flight project was defined as a payload.

^b Includes \$8 540 000 for Juno II vehicles and \$2 120 000 for Thor-Able vehicles as part of the flight research program and \$21 944 000 for Vanguard, which in 1959 was funded as a program separate from scientific satellites.

^c Includes \$3 000 000 for Atlas-Agena B vehicles, \$3 000 000 for Thor-Agena B vehicles, and \$3 500 000 for Scout vehicles as part of the flight research program.

^d The House authorization committee suggested that NASA was requesting funds for FY 1965 for projects that were scheduled too far in the future to warrant immediate monies. Included in this category were Orbiting Solar Observatories, Orbiting Astronomical Observatories, and Orbiting Geophysical Observatories.

^e The House authorization committee suggested that NASA was requesting funds for FY 1966 for projects that were scheduled too far in the future to warrant immediate monies. Included in this category were Orbiting Astronomical Observatories and Orbiting Geophysical Observatories. The Senate authorization committee, however, restored funds for the Orbiting Geophysical Observatories.

^f The House authorization committee suggested that failures with the Orbiting Astronomical Observatories and Orbiting Geophysical Observatories warranted a decrease in the funds requested. The Senate authorization committee, however, restored the funds.

Table 3-9.
Physics and Astronomy Soundings Funding History^a
(in thousands of dollars)

Year	Request	Authorization	Programmed
1962	---	---	7765
1963	---	---	11 513
1964	13 300	13 300	16 950
1965	15 000	15 000	16 867
1966	17 000	17 000	19 300
1967	19 000	19 000	20 000
1968	22 000	22 000	20 000

^a Before the FY 1964 estimate, physics and astronomy soundings were budgeted under the general category sounding rocket program (see table 3-57).

Table 3-10.
Explorer-Class Satellites Funding History^a
(in thousands of dollars)

Year	Request	Authorization	Programmed
1959	---	---	6 252 ^b
1960	---	---	12 965 ^c
1961	13 735 ^d	---	19 925 ^e
1962	10 698 ^f	---	4 483 ^g
1963	4729 ^h	---	32 811
1964	20 600 ^g	20 600 ^g	15 526
1965	31 900	31 900	21 565
1966	25 700	25 700	18 592
1967	23 000	23 000	18 224
1968	21 600	21 600	17 532

^aIncluded in this category, in addition to Explorer satellites, are funds spent from FY 1959-1963 on satellite projects that were listed in the budget estimates under names other than Explorer but that subsequently were flown as Explorers, and some projects that were not flown but were in the Explorer class.

^bIncludes \$5 000 000 for *Explorer 6*, \$557 000 for an ionospheric beacon satellite, \$220 000 for an ionospheric direct measurements satellite, \$180 000 for an advanced radiation belt satellite, \$145 000 for an atmospheric structures satellite, and \$150 000 for a radiation belt satellite.

^cIncludes \$2 267 000 for *Explorer 6*, \$1 420 000 for *Explorer 7*, \$51 000 for a 3.66-meter sphere, \$565,000 for a radiation balance experiment, \$829 000 for an energetic particles satellite, \$2 487 000 for an ionospheric beacon satellite, \$1 942 000 for an ionospheric direct measurements satellite, \$565 000 for an atmospheric structures satellite, \$2 185 000 for a gamma ray astronomy satellite, \$225 000 for a Scout micrometeoroid satellite, \$125 000 for an air density drag measurements satellite, and \$304 000 for a fixed-frequency topside sounder.

^dIncludes \$270 000 for an ionospheric beacon satellite, \$256 000 for an ionospheric direct measurements satellite, \$712 000 for an advanced radiation belt satellite, \$765 000 for an atmospheric structures satellite, \$100 000 for a radiation belt satellite, \$520 000 for a gamma ray astronomy satellite, \$1 690 000 for a polar geophysical satellite, \$912 000 for a topside sounder, and \$8 510 000 for seven unspecified Scout payloads.

^eIncludes \$3 142 000 for an energetic particles satellite, \$2 052 000 for an ionospheric beacon satellite, \$1 954 000 for an ionospheric direct measurements satellite, \$3 506 000 for a gamma ray astronomy satellite, \$2 854 000 for a Scout micrometeoroid satellite, and \$4 794 000 for topside sounders.

^fIncludes \$496 000 for an energetic particles satellite, \$50 000 for an ionospheric direct measurements satellite, \$463 000 for an atmospheric structures satellite, \$80 000 for a Scout micrometeoroid satellite, and \$9 609 000 for topside sounders.

^gIn the FY 1964 budget estimate, all projects in this class were under the heading "Explorers and Monitors."

^hIncludes \$336 000 for an energetic particles satellite, \$558 000 for an atmospheric structures satellite, \$2 983 000 for an ionospheric monitor, and \$852 000 for topside sounders.

Table 3-11.
Orbiting Solar Observatories Funding History
(in thousands of dollars)

Year	Request	Authorization	Programmed
1959	---	---	250
1960	---	---	1863
1961	2480 ^a	---	3917
1962	4167	---	5742
1963	15 506 ^b	---	10 900
1964	17 400	17 400	20 005
1965	22 100	19 600	16 597
1966	37 000	37 000	19 052
1967	11 900	11 900	10 106
1968	11 900	11 900	11 332

^a Included \$550 000 for a solar observatory satellite, and \$1 930 000 for a solar geophysical satellite.

^b Includes \$11 687 000 for an advanced solar observatory.

Table 3-12.
Orbiting Astronomical Observatories Funding History
(in thousands of dollars)

Year	Request	Authorization	Programmed
1960	---	---	346
1961	4445	---	7472
1962	22 775	---	38 221
1963	45 668	---	39 250
1964	52 900	52 900	35 608
1965	51 000	44 000	32 644
1966	32 500	26 300	22 300
1967	29 200	27 700	27 700
1968	40 600	40 600	44 768

Table 3-13.
Orbiting Geophysical Observatories Funding History
(in thousands of dollars)

Year	Request	Authorization	Programmed
1960	---	---	401
1961	1580	---	5358
1962	18 517	---	25 729
1963	58 595	---	39 634
1964	61 800	61 800	42 868
1965	55 400	52 150	30 352
1966	31 700	31 700	28 215
1967	23 400	23 400	24 770
1968	20 000	20 000	20 064

Table 3-14.
Miscellaneous Physics and Astronomy Projects Funding History
(in thousands of dollars)

Year	Request	Authorization	Programmed
1959	---	---	23 412 ^a
1960	---	---	654 ^b
1961	1480 ^c	---	4560 ^d
1962	4174 ^e	---	10 635 ^f
1963	13 355 ^g	---	---
1964	13 200 ^h	13 200 ^h	---
1965	---	---	---
1966	---	---	---
1967	---	---	---
1968	2000 ⁱ	---	---

^a Included \$1 468 000 for general payload instrumentation and \$21 944 000 for Vanguard, which in 1959 was funded as a program separate from scientific satellites.

^b Includes \$2000 for a Jupiter nuclear emulsions project, \$10 000 for integration of the emulsion package, \$445 000 for a recoverable nuclear emulsions probe, and \$197 000 for electron density profile probes.

^c Includes \$260 000 for general payload instrumentation and \$1 220 000 for a geodetic satellite.

^d Includes \$89 000 for modifying an X-15 for an astronomy payload, \$167 000 for *Vanguard 3*, \$2 673 000 for international ionospheric satellite UK-1, \$60 000 for international project satellite UK-2, and \$4 571 000 for electron density profile probes.

^e Includes \$1 231 000 for international ionospheric satellite UK 1, \$1 000 000 for international project satellite UK-2, \$420 000 for international project satellite UK-3, \$1 330 000 for a recoverable nuclear emulsions probe, and \$193 000 for electron density profile probes.

^f For international satellite projects.

^g Includes \$338 000 for international ionospheric satellite UK-1, \$5 247 000 for international project satellite UK-2, \$1 654 000 for international project satellite UK-3, \$1 719 000 for international satellite no. 4, and \$4 397 000 for geoprobes.

^h Includes \$7 000 000 for international satellite projects and \$6 200 000 for geodesy projects.

ⁱ For Sunblazer, a small interplanetary probe project that was not authorized for budgetary reasons.

Table 3-15.
Physics and Astronomy Data Analysis Funding History
(in thousands of dollars)

Year	Request	Authorization	Programmed
1966	3000	3000	2000
1967	2000	2000	1735
1968	2000	2000	2900

Table 3-16.
Total Lunar and Planetary Funding History
(in thousands of dollars)

Year	Request	Authorization	Programmed
1959	---	---	31 883
1960	---	---	49 996
1961	45 000	45 000 ^a	91 019
1962	159 899	159 899	161 784
1963	273 560	263 160	222 802
1964	322 600	274 400	205 762
1965	300 400	283 100	206 027
1966	215 615	213 115	204 300
1967	197 900	210 900	184 150
1968	142 000	131 900 ^b	147 500

^aAfter the authorization conference committee approved the \$45 000 000 budget for FY 1961, the appropriation conference committee awarded an additional \$5 000 000 in a supplemental appropriation in June 1960.

^bFY 1968 appropriation was reduced to \$125 000 000 by the appropriation conference committee in October 1967.

Table 3-17.
Lunar and Planetary Supporting Research and
Technology and Advanced Studies Funding History^a
(in thousands of dollars)

Year	Request	Authorization	Programmed
1959	---	---	8103 ^b
1960	---	---	8307 ^c
1961	9000 ^d	---	17 102 ^e
1962	18 103 ^f	---	10 843
1963	32 000 ^g	32 000 ^g	22 205
1964	20 000	20 000	22 000
1965	18 100	18 100	24 140
1966	36 800	36 800	23 000
1967	40 100	40 100	22 350
1968	20 900	20 900	31 800 ^h

^cPrior to the FY 1964 budget estimate, supporting research was budgeted as advanced technical development (FY 1959-63) and advanced research (FY 1960-63).

^bFor advanced technical development.

^cIncludes \$6 449 000 for advanced technical development and \$1 858 000 for advanced research.

^dFor advanced technical development.

^eIncludes \$11 670 000 for advanced technical development and \$4 432 000 for advanced research.

^fIncludes \$12 080 000 for advanced technical development and \$6 023 000 for advanced research.

^gIncludes \$17 000 000 for advanced technical development and \$15 000 000 for advanced research.

^hIncludes \$12 000 000 budgeted for advanced planetary missions technology, a budget item introduced in the FY 1970 estimate.

Table 3-18.
Total Lunar and Planetary Flight Projects Funding History
(in thousands of dollars)

Year	Request	Authorization	Programmed
1959	---	---	23 780 ^a
1960	---	---	41 690
1961	36 000 ^a	---	73 917
1962	141 796	---	150 941
1963	241 560	231 160	200 597
1964	302 600	254 400	183 762
1965	282 300	265 000 ^b	181 887
1966	178 815	176 315 ^c	181 300
1967	157 800	170 800	161 800
1968	121 100	111 000	127 000

^a Listed as "Flight Research Program" in the FY 1962 estimate.

^b The House authorization committee suggested that NASA was requesting funds for FY 1965 for projects that were scheduled too far in the future to warrant immediate monies. Included in this category were Surveyor and Lunar Orbiter.

^c The House and Senate authorization committee suggested that NASA reexamine its immediate need for funds for future Surveyor and Lunar Orbiter projects.

Table 3-19.
Pioneer Lunar Probes (Atlas-Able) Funding History
(in thousands of dollars)

Year	Request	Authorization	Programmed
1959	---	---	6237 ^a
1960	7140 ^b	7140 ^b	18 349 ^c
1961	---	---	5975 ^c

^a Includes \$4 097 000 for the Atlas-Able launch vehicle.

^b Amount requested and authorized for unspecified lunar probes.

^c Includes funds for the launch vehicle.

Table 3-20.
Ranger Funding History
(in thousands of dollars)

Year	Request	Authorization	Programmed
1960	---	---	19 542
1961	---	---	45 066
1962	64 754	---	63 430
1963	44 022	---	88 816
1964	90 000	65 000	30 306
1965	10 800	10 800	11 037
1966	1415	1415	1000

Table 3-21.
Surveyor Funding History
(in thousands of dollars)

Year	Request	Authorization	Programmed
1961	---	---	7054
1962	53 134	--	39 134
1963	97 378	---	66 386
1964	97 500	89 300	70 704
1965	136 000	123 700	81 814
1966	85 600	84 100	104 634
1967	90 400	90 400	79 942
1968	42 200	42 200	33 000

Table 3-22.
Lunar Orbiter Funding History
(in thousands of dollars)

Year	Request	Authorization	Programmed
1963	---	---	4
1964	---	---	20 000
1965	49 300	44 300	49 500
1966	37 000	36 000	58 081
1967	24 600	24 600	26 000
1968	10 000	10 000	9500

Table 3-23.
Prospector Funding History
(in thousands of dollars)

Year	Request	Authorization	Programmed
1961	---	---	575
1962	24 000	---	---
1963	10 400	--- ^a	---

^a During the authorization process, funds for Prospector, a proposed heavy lunar lander, were denied because of its high cost and because the proposed launch vehicle, Saturn, would not be ready for some time.

Table 3-24.
Pioneer Probes Funding History
(in thousands of dollars)

Year	Request	Authorization	Programmed
1960	6804 ^a	6804 ^a	3798 ^b
1961	---	---	462 ^c
1962	---	---	---
1963	---	---	2614
1964	15 000	15 000	13 600
1965	21 100	21 100	15 000
1966	8000	8000	12 700 ^d
1967	6700	6700	6900 ^d
1968	7500 ^d	7500 ^d	6000

^a Funds were requested and authorized for unspecified deep space probes.

^b For *Pioneer 5* a precursor to the later Pioneer probe series.

^c For a magnetometer probe, *Explorer 10*, the program's second interplanetary probe.

^d Funded by the physics and astronomy budget in FY 1968-1969 estimates.

Table 3-25.
Mariner Funding History
(in thousands of dollars)

Year	Request	Authorization	Programmed
1961	---	---	14 785
1962	21 159	---	48 377
1963	82 960	---	42 777
1964	100 100	85 100	49 152
1965	54 100	54 100	17 368
1966	3800	3800	17 585
1967	26 100	26 100	43 188
1968	68 900	58 800 ^a	66 250

^a \$10 100 000 for two Mariner Mars flyby probe projects was not authorized because current funding already provided for a 1969 Mariner Mars project and because the Voyager program would also provide for the detailed exploration of Mars.

Table 3-26.
Voyager Funding History^a
(in thousands of dollars)

Year	Request	Authorization	Programmed
1962	349	---	--- ^b
1963	6800	---	--- ^c
1964	--- ^d	---	--- ^e
1965	--- ^f	---	7168
1966	43 000	43 000	17 097 ^g
1967	10 000	23 000	12 670
1968	71 500 ^g	42 000 ^h	350

^aNot to be confused with the Voyager interplanetary probe series of the 1980s; these funds were budgeted for a large Mars lander project, which was replaced by the Viking project in 1969.

^b\$330 000 from supporting research and technology funds was programmed for a Voyager study, but no funds were programmed for a Voyager flight project.

^c\$3 069 000 from supporting research and technology funds was programmed for advanced studies, which included a Voyager study; this category was not broken down further in the estimate.

^d\$900 000 of the supporting research and technology request was for a Voyager study; no funds were requested for a flight project.

^e\$2 236 000 from supporting research and technology funds was programmed for advanced studies, which included a Voyager study; this category was not broken down further in the estimate.

^fAlthough no funds were requested for a Voyager flight project, funds from the supporting research and technology budget were designated for a Voyager study and for sterilization studies; this category was not broken down further.

^gVoyager was listed as a separate program in the FY 1968-1970 budget estimates rather than as a lunar and planetary flight project.

^hThe Senate authorization committee initially declined any funds for Voyager because of the large-scale expenditures it would require over the next several years, but in response to the House authorization committee's reasoning that the exploration of the nearby planets was one of the most significant objectives of the space program the Senate committee agreed to an authorization of \$42 000 000. Subsequently, the House appropriations committee in August 1967 denied funds for Voyager, recognizing the financial burdens of the Vietnam conflict and other domestic needs; but the Senate appropriations committee in October 1967 restored \$36 000 000 to the appropriation. Later in October, the appropriations conference committee denied funding, thereby terminating the program.

Table 3-27.
Miscellaneous Lunar and Planetary Flight Projects Funding History
(in thousands of dollars)

Year	Request	Authorization	Programmed
1959	---	---	17 543 ^a
1960	---	---	---
1961	36 000 ^b	---	---
1962	---	---	---
1963	---	---	---
1964	---	---	4200 ^c
1965	11 000 ^d	11 000 ^d	---

^aIncludes \$2 843 000 for Thor-Able, \$3 500 000 for Atlas-Agena, and \$11 200 000 for unspecified payloads.

^bIncludes \$9 500 000 for Atlas-Agena and \$26 500 000 for unspecified payloads.

^cThis is the estimated amount programmed for FY 1964 as found in the FY 1965 budget estimate for manned space science; by the FY 1966 estimate this item had been dropped. The manned space science project dealt with the engineering and operational development of manned spacecraft systems.

^dFor manned space science.

Table 3-28.
Lunar and Planetary Data Analysis Funding History
(in thousands of dollars)

Year	Request	Authorization	Programmed
1968	---	---	600

Table 3-29.
Total Meteorology Funding History^a
(in thousands of dollars)

Year	Request	Authorization	Programmed
1959	---	---	988
1960	10 800	10 800	7930
1961	20 700	20 700	19 610
1962	50 200	50 200	34 433
1963	51 185	51 185	54 051
1964	63 700	63 700	63 177
1965	37 500	37 500	30 991
1966	42 700	42 700	35 260 ^b
1967	43 600	43 600	34 418 ^b
1968	50 400 ^b	45 400 ^b	51 063 ^b

^aFrom FY 1959 to 1967, meteorology was funded as a program with research and flight project funds as part of the Office of Applications or the Office of Space Science and Applications. In the FY 1968-1970 budget estimates, meteorology flight projects were funded as part of OSSA's space applications program. Research funds for meteorology came from the space application program's supporting research and technology budget.

^bFrom the space applications budget; see note a below.

Table 3-30.
 Meteorology Supporting Research and Technology and Advanced Studies Funding History
 (in thousands of dollars)

Year	Request	Authorization	Programmed
1959	---	---	170 ^b
1960	---	---	3037 ^c
1961	5800 ^d	---	3875 ^e
1962	4650 ^f	---	3436
1963	11 413 ^g	11 413 ^g	4877
1964	10 200	10 200	7754
1965	6600	6600	7311
1966	8200	8200	7470 ^h
1967	9100	9100	5761 ^h
1968	5300	---	5163 ^h

^a Prior to the FY 1964 budget estimate, supporting research was budgeted as advanced technical development (FY 1959-63) and advanced research (FY 1960-63).

^b For advanced technical development.

^c Includes \$1 706 000 for advanced technical development and \$1 331 000 for advanced research.

^d For advanced technical development.

^e Includes \$3 350 000 for advanced technical development and \$1 870 000 for advanced research.

^f Includes \$3 350 000 for advanced technical development and \$1 300 000 for advanced research.

^g Includes \$9 605 000 for advanced technical development and \$1 808 000 for advanced research.

^h As of the FY 1968 budget estimate, funds for meteorology research came from the space applications program's supporting research and technology budget.

ⁱ Authorized as space applications supporting research and technology, of which meteorology was a part.

Table 3-31.
 Total Meteorology Flight Projects Funding History
 (in thousands of dollars)

Year	Request	Authorization	Programmed
1959	---	---	818
1960	---	---	4893
1961	14 900 ^a	---	15 735
1962	45 550	---	30 997
1963	39 772	39 772	49 174
1964	53 500	53 500	55 423
1965	30 900	30 900	23 680
1966	34 500	34 500	27 790 ^b
1967	34 500	34 500	28 657 ^b
1968	45 100 ^b	40 100 ^b	45 900 ^b

^a Includes \$5 700 000 for launch vehicles for the flight research program.

^b In the FY 1968-1970 budget estimates, meteorology flight projects were funded as part of OSSA's space applications program.

Table 3-32.
 Soundings (Meteorology) Funding History^a
 (in thousands of dollars)

Year	Request	Authorization	Programmed
1962	---	---	441
1963	1468	---	1437
1964	2500	2500	2244
1965	3000	3000	2380
1966	3000	3000	2730
1967	3000	3000	2855
1968	3000	3000	3000

^aSee also the meteorology projects funded under the sounding rocket program, FY 1959-1963 (table 3-67).

Table 3-33.
 TIROS-TOS Funding History
 (in thousands of dollars)

Year	Request	Authorization	Programmed
1959	---	---	818
1960	---	---	3091
1961	1600	---	3013
1962	23 300	---	6675
1963	3390	---	19 176
1964	7200	7200	11 506
1965	5800	5800	4100
1966	4800	4800	2500
1967	2600	2600	1292
1968	7500	7500	9100

Table 3-34.
 Nimbus Funding History
 (in thousands of dollars)

Year	Request	Authorization	Programmed
1960	---	---	1802
1961	7600	---	12 722
1962	22 250	---	23 881
1963	34 914	---	28 561
1964	43 800	43 800	41 673
1965	18 900	18 900	16 000
1966	22 700	22 700	22 560
1967	23 400	23 400	24 420
1968	34 500	29 500	33 700

Table 3-35.
Flight Experiments (Meteorology) Funding History
(in thousands of dollars)

Year	Request	Authorization	Programmed
1965	3200	3200	1200
1966	4000	4000	---
1967	5500	5500	---

Table 3-36.
Cooperative Applications Satellite (French Satellite FR-2) Funding History^a
(in thousands of dollars)

Year	Request	Authorization	Programmed
1967	---	---	100
1968	100	100	100

^a A joint American-French project that culminated in the launching of the French meteorology satellite *CAS-1 (Eole)* in 1971.

Table 3-37.
Communications Total^a
(in thousands of dollars)

Year	Request	Authorization	Programmed
1959	---	---	3575
1960	4700	4700	3050
1961	5600	5600 ^b	33 833
1962	94 600	94 600	33 105
1963	85 377	85 377	32 075
1964	51 100	42 175	8413
1965	12 600	11 400	8079 ^c
1966	2800	2800	2019 ^d
1967	4600 ^c	4600 ^c	3595 ^d
1968	4100 ^d	--- ^e	3897 ^d

^a From FY 1959 to 1966, the communications program (with research and flight project funds) was part of the Office of Applications or the Office of Space Science and Applications. As of FY 1967, meteorology and Applications Technology Satellite (ATS) projects were combined into a single OSSA program called space applications; in the FY 1968-1970 budget estimates, communications was also part of this program.

^b After the authorization conference committee approved the \$5 600 000 budget for FY 1961, the appropriations conference committee awarded an additional \$24 000 000 in a supplemental appropriation in June 1960.

^c Includes research funds for communications and the Applications Technology Satellite.

^d From the space applications budget.

^e Authorized as space applications, of which communications was a part.

Table 3-38.
 Communications Supporting Research and Technology and
 Advanced Studies Funding History^a
 (in thousands of dollars)

Year	Request	Authorization	Programmed
1959	---	---	285 ^b
1960	---	---	1522 ^c
1961	1450 ^d	---	2040 ^e
1962	4450 ^f	---	7478
1963	5161 ^g	5161 ^g	3012
1964	5000	3075	1637
1965	3500	2300	2124 ^h
1966	2500	2500	2019 ⁱ
1967	4600 ^h	4600 ^h	3593 ⁱ
1968	4100 ^j	---	3897

^a Prior to the FY 1964 budget estimate, supporting research was budgeted as advanced technical development (FY 1959-63) and advanced research (FY 1960-63).

^b For advanced technical development.

^c Includes \$705 000 for advanced technical development and \$817 000 for advanced research.

^d For advanced technical development.

^e Includes \$790 000 for advanced technical development and \$1 250 000 for advanced research.

^f Includes \$3 650 000 for advanced technical development and \$800 000 for advanced research.

^g Includes \$2 473 000 for advanced technical development and \$2 688 000 for advanced research.

^h For communications and applications technology satellite.

ⁱ As of the FY 1968 budget estimate, funds for supporting research for communications and navigation came from the space applications program's supporting research and technology budget.

^j Authorized as space applications supporting research and technology, of which communications was a part.

Table 3-39.
 Total Communications Flight Projects Funding History
 (in thousands of dollars)

Year	Request	Authorization	Programmed
1959	---	---	3290 ^a
1960	---	---	1528
1961	4150 ^b	---	31 793
1962	90 150	---	25 627
1963	80 216	80 216	29 063
1964	46 100	39 100	6776
1965	9100	9100	5955
1966	300	300	---

^a Includes \$2 150 000 for boosters and \$46 000 for tracking and communications for the flight research program.

^b Includes \$1 300 000 for tracking and communications for the flight research program.

^c As of the FY 1968 budget estimate, communications flight projects were a part of the space applications program.

Table 3-40.
Echo Funding History
(in thousands of dollars)

Year	Request	Authorization	Programmed
1959	---	---	1140
1960	---	---	1528
1961	4150	---	8928 ^a
1962	4400 ^b	---	6103 ^c
1963	135	---	2299 ^d
1964	200	200	1675
1965	300	300	325

^aIncludes \$3 200 000 for Thor and \$2 200 000 for Thor-Agena launch vehicles.

^bIncludes \$400 000 for Thor launch vehicle.

^cIncludes \$1 000 000 for Thor and \$4 800 000 for Thor-Agena launch vehicles.

^dIncludes \$500 000 for Thor-Agena launch vehicle.

Table 3-41.
Relay Funding History
(in thousands of dollars)

Year	Request	Authorization	Programmed
1961	---	---	20 650
1962	16 350	---	6912
1963	19 141	---	13 751
1964	1900	1900	2590
1965	1800	1800	462
1966	200	200	--- ^a

^aIt was estimated in the FY 1967 budget estimate that \$200 000 would be programmed in FY 1966 for Relay; by the FY 1968 estimate this item had been dropped.

Table 3-42.
Rebound Funding History
(in thousands of dollars)

Year	Request	Programmed
1961	1650 ^a	325
1962	13 250 ^b	--- ^c
1963	16 747 ^d	---

^aSupplemental request, of which \$1 400 000 was for Atlas-Agena B launch vehicle.

^bIncludes \$5 700 000 for Atlas-Agena B and \$3 500 000 for Centaur launch vehicles.

^cIt was estimated in the FY 1963 budget request that \$13 500 000 would be programmed for Rebound in FY 1962; by the FY 1964 request this item had been dropped.

^dIncludes \$11 828 000 for Atlas-Agena launch vehicles.

Table 3-43.
Syncom Funding History
(in thousands of dollars)

Year	Request	Authorization	Programmed
1962	---	---	12 612 ^a
1963	22 688 ^b	---	13 013
1964	44 000 ^c	37 000 ^d	2511
1965	2000	2000	168
1966	100	100	--- ^e

^aIncludes \$200 000 for an Advanced Syncom study.

^bIncludes \$18 601 000 for Advanced Syncom.

^cIncludes \$40 000 000 for Advanced Syncom.

^dIncludes \$33 000 000 for Advanced Syncom.

^eIt was estimated in the FY 1967 budget estimate that \$1 000 000 would be programmed in FY 1966 for Syncom; by the FY 1968 estimate this item had been dropped.

Table 3-44.
Miscellaneous Communications Flight Projects Funding History
(in thousands of dollars)

Year	Request	Authorization	Programmed
1961	---	---	1890 ^a
1962	54 300 ^b	---	---
1963	21 505 ^c	---	---
1964	---	---	---
1965	5000 ^d	5000 ^d	5000 ^d

^aFor a radiation measurement satellite. It was estimated in the FY 1962 budget that \$5 000 000 would be programmed for a transitional satellite system; by the FY 1963 estimate this item had been dropped.

^bFor a transitional satellite system.

^cFor an intermediate-altitude satellite.

^dFor an early gravity gradient experiment.

Table 3-45.
Total Applications Technology Satellite Funding History^a
(in thousands of dollars)

Year	Request	Authorization	Programmed
1963	---	---	8668
1964	1000	000	17 539
1965	31 000	31 000	24 819 ^b
1966	28 700	28 700	35 781 ^c
1967	26 400 ^b	26 400 ^b	31 239 ^c
1968	36 800 ^c	--- ^d	26 330 ^c

^aAlso called Advanced Applications Satellite and Advanced Technological Satellite.

^bIncludes supporting research and technology funds for Applications Technology Satellites and communications.

^cIn the FY 1968-1970 budget estimates, Applications Technology Satellites were funded as part of OSSA's space applications program.

^dAuthorized as space applications, of which the Applications Technology Satellite project was a part.

Table 3-46.
Applications Technology Satellite Supporting Research and
Technology and Advanced Studies Funding History
(in thousands of dollars)

Year	Request	Authorization	Programmed
1963	---	---	8668
1964	---	---	2162
1965	1100	1100	2124 ^a
1966	2000	2000	1350 ^b
1967	4600 ^a	4600 ^a	1226 ^b
1968	1300 ^b	--- ^c	730 ^b

^aSupporting research funds for Applications Technology Satellites and communications.

^bAs of the FY 1968 budget estimate, funds for supporting research for Applications Technology Satellites came from the space applications program's supporting research and technology budget.

^cAuthorized as space applications supporting research and technology, of which the Applications Technology Satellite project was a part.

Table 3-47.
Applications Technology Satellite Flight Program Funding History
(in thousands of dollars)

Year	Request	Authorization	Programmed
1964	---	---	15 377
1965	29 900	29 900	22 695
1966	26 700	26 700	34 431
1967	21 800	21 800	30 013
1968	35 500	35 500	25 600

Table 3-48.
Total Space Applications Funding History^a
(in thousands of dollars)

Year	Request	Authorization	Programmed
1962	---	---	300 ^b
1963	---	---	--- ^c
1964	3500 ^b	3500 ^b	---
1965	---	---	---
1966	---	---	78 053
1967	---	---	71 300
1968	104 200	99 500 ^d	99 500

^aAs of the FY 1968 budget estimate, the space applications program replaced the separate meteorology, communications, and Applications Technology Satellite programs.

^bFor industrial applications.

^cIt was estimated in the FY 1964 budget estimate that \$2 370 000 would be programmed for space applications in FY 1963; by the FY 1965 estimate this item had been dropped.

^dTotal reduced to \$88 000 000 by the appropriations conference committee in October 1967.

Table 3-49.
Space Applications Supporting Research and
Technology and Advanced Studies Funding History
(in thousands of dollars)

Year	Request	Authorization	Programmed
1966	---	---	10 839
1967	---	---	11 030 ^a
1968	16 600 ^b	16 600 ^b	19 300 ^c

^a Includes \$450 000 for geodesy.

^b Includes \$900 000 for geodesy and \$5 000 000 for earth resources.

^c Includes \$7 361 000 for interdisciplinary applications.

Table 3-50.
Total Space Applications Flight Projects Funding History^a
(in thousands of dollars)

Year	Request	Authorization	Programmed
1966	---	---	67 214
1967	---	---	60 270
1968	87 600	75 600 ^b	80 200

^a See also meteorology (table 3-31), communications (table 3-39), and Applications Technology Satellite (table 3-47).

^b \$5 000 000 for Nimbus and \$4 700 000 for geodetic satellites was undistributed in the authorization.

Table 3-51.
Geodetic Satellites Funding History^a
(in thousands of dollars)

Year	Request	Authorization	Programmed
1966	---	---	4993
1967	---	---	1600
1968	4700	--- ^b	3400

^a Before FY 1966, this flight project was included in the Explorer class of satellites funded by the physics and astronomy program.

^b Funds not distributed in the authorization.

Table 3-52.
Miscellaneous Space Applications Flight Project Funding History
(in thousands of dollars)

Year	Request	Authorization	Programmed
1968	2300 ^a	--- ^a	5300 ^b

^a For a voice broadcasting satellite, which was not authorized because the authorization committee believed that such a venture should be commercially funded since the project obviously had commercial applications.

^b For an earth resources survey satellite.

Table 3-53.
Total Bioscience (Life Sciences) Funding History
(in thousands of dollars)

Year	Request	Authorization	Programmed
1960	---	---	917 ^a
1961	2000 ^a	---	360 ^b
1962	20 620 ^c	---	3048
1963	4747 ^b	---	13 731
1964	35 200	21 200	21 479
1965	31 000	31 000	28 501
1966	31 500	31 500	34 400
1967	35 400	35 400	42 000
1968	44 300	41 800 ^d	41 800

^aFunded under research grants and contracts.

^bFunded under scientific satellites (physics and astronomy).

^cFunded as a separate life sciences program.

^dTotal reduced to \$40 000 000 by the appropriations conference committee in October 1967.

Table 3-54.
Bioscience Supporting Research and Technology and
Advanced Studies Funding History^a
(in thousands of dollars)

Year	Request	Authorization	Programmed
1961	---	---	195 ^b
1962	11 200 ^c	---	2915
1963	1114 ^b	---	11 772
1964	10 800	---	12 979
1965	11 800	11 800	12 501
1966	15 500	15 500	11 100
1967	14 700	14 700	10 050
1968	14 300	14 300	10 122

^a Before the FY 1964 budget estimate, supporting research was budgeted as advanced technical development (FY 1961-62) and advanced research (FY 1961-62).

^bFunded under scientific satellites (physics and astronomy).

^cIncludes \$6 330 000 for advanced research and \$4 870 000 for advanced technical development.

Table 3-55.
Biosatellite Funding History
(in thousands of dollars)

Year	Request	Authorization	Programmed
1961	---	---	165 ^a
1962	2070	---	133
1963	3633 ^a	---	1959
1964	24 400	---	8500
1965	19 200	19 200	16 000
1966	16 000	16 000	23 300
1967	20 700	20 700	31 950
1968	30 000	27 500 ^b	30 000

^aFunded under scientific satellites (physics and astronomy).

^bBecause of delays and cost overruns, \$2 500 000 of the funds requested for the continuation of this project were denied.

Table 3-56.
Planetary Quarantine Funding History
(in thousands of dollars)

Year	Request	Programmed
1968	---	1678

Table 3-57.
Total Sounding Rockets Funding History^a
(in thousands of dollars)

Year	Request	Authorization	Programmed
1959	---	---	3556
1960	10 000	10 000	9681
1961	8000	8000	12 330
1962	9000	9000	---
1963	19 157	19 157	---

^aAs of the FY 1964 budget estimate, sounding rockets as a separate program was dropped. For FY 1964-1968, see physics and astronomy soundings (table 3-10) and meteorological soundings (table 3-32).

Table 3-58.
Sounding Rocket Advanced Technical Development Funding History
(in thousands of dollars)

Year	Request	Authorization	Programmed
1959	---	---	640
1960	---	---	835
1961	1800	---	1387
1962	420	---	---
1963	1658	1685	---

Table 3-59.
Sounding Rocket Advanced Research Funding History
(in thousands of dollars)

Year	Request	Authorization	Programmed
1960	---	---	419
1961	---	---	419
1962	320	---	---
1963	784	784	---

Table 3-60.
Total Sounding Rockets Flight Program Funding History
(in thousands of dollars)

Year	Request	Authorization	Programmed
1959	---	---	2916 ^a
1960	---	---	8428
1961	6200 ^b	---	10 524 ^c
1962	8260	---	---
1963	16 688 ^d	16 688	---

^aIncludes \$1 380 000 for launch vehicles.

^bIncludes \$3 200 000 for launch vehicles.

^cIncludes \$2 254 000 for launch vehicles.

^dIncludes \$3 768 000 for launch vehicles.

Table 3-61.
Solar Physics and Astronomy Soundings Funding History
(in thousands of dollars)

Year	Request	Programmed
1959	---	108
1960	---	323
1961	1046	491
1962	450	---
1963	592	---

Table 3-62.
Energetic Particles and Magnetic Field Soundings Funding History
(in thousands of dollars)

Year	Request	Programmed
1959	---	367
1960	---	687
1961	460	631
1962	350	---
1963	412	---

Table 3-63.
Ionosphere-Plasma and Ionospheric Physics Soundings Funding History
(in thousands of dollars)

Year	Request	Programmed
1959	---	168
1960	---	335
1961	157	505
1962	420	---
1963	1050	---

Table 3-64.
Aeronomy Soundings Funding History
(in thousands of dollars)

Year	Request	Programmed
1960	---	745
1961	---	1077
1962	980	---
1963	1329	---

Table 3-65.
Galactic Astronomy Soundings Funding History
(in thousands of dollars)

Year	Request	Programmed
1960	---	720
1961	---	719
1962	500	---
1963	911	---

Table 3-66.
Meteorite-Micrometeorite Soundings Funding History
(in thousands of dollars)

Year	Request	Programmed
1960	---	83
1961	---	---
1962	94	---
1963	115	---

Table 3-67.
Miscellaneous Sounding Rocket Flight Projects Funding History
(in thousands of dollars)

Year	Request	Programmed
1960	---	--- ^a
1961	226 ^b	365 ^c
1962	---	---
1963	1946 ^d	---

^a It was estimated in the FY 1961 budget estimate that \$115 000 would be programmed for atmospheric soundings for FY 1960; by the FY 1962 estimate this item had been dropped.

^b For atmospheric soundings.

^c Includes \$146 000 for a meteorology probe, \$49 000 for magnetodynamics, and \$170 000 for space chemistry studies.

^d Includes \$40 000 for a meteorology probe, \$405 000 for magnetodynamics, \$1 386 000 for space chemistry, and \$115 000 for astrophysics studies.

Table 3-68.
Sounding Rocket Support-Analysis Funding History^a
(in thousands of dollars)

Year	Request	Programmed
1959	---	894
1960	---	5536
1961	1111	4483
1962	5466	---
1963	6565	---

^aFunded from flight project monies.

Table 3-69.
OSSA Launch Vehicle Development^a
(in thousands of dollars)

Year	Request	Authorization	Programmed
1962	---	---	85 661
1963	---	---	105 729
1964	130 700	127 700	111 900
1965	128 200	128 200	96 500
1966	63 600	63 600	57 790
1967	33 700	33 700	31 200

^aFor more information on launch vehicles, see chapter 1.

Table 3-70.
OSSA Launch Vehicle Procurement Funding History^a
(in thousands of dollars)

Year	Request	Authorization	Programmed
1964	---	---	129 986
1965	---	---	154 487
1966	194 500	178 700	178 700
1967	152 000	142 750	117 650
1968	165 100	157 700 ^b	124 550

^aFor more information on launch vehicle procurement, see chapter 1, table 1-21).

^bTotal reduced to \$145 000 000 by the appropriations conference committee in October 1967.

DESCRIPTION—PHYSICS AND ASTRONOMY PROGRAM

The goals of the physics and astronomy program during NASA's first 10 years were broad: "to increase our knowledge of the environment of the earth and interplanetary space; to study the sun and to determine its influence in interplanetary space and on the environment of the earth; to expand our knowledge of the structure and history of the universe through astronomical observations; and to extend our knowledge of astrophysical laws through the conduct of experiments in space."⁷ In accomplishing these goals, the program embraced several scientific disciplines—astronomy and geodesy, solar physics, particles and fields, ionospheric physics, and radio physics among others. Generally, NASA physics and astronomy projects were designed to obtain new information about the stars, interplanetary space, and the sun that was not obtainable with ground-based instruments. Supplemented by balloons and aircraft-borne experiments, the physics and astronomy flight projects included sounding rockets, small scientific satellites (Explorers), Pioneer probes, and geophysical, astronomical, and solar orbiting observatories (platforms).

NASA's scientific investigations revealed a space environment full of surprises. In 1958, the model of earth's environment as generally envisioned had an atmosphere and an ionosphere limited to low altitudes with a dipole-like magnetic field in which the field lines presumably extended without limit into the vacuum of space. But scientists discovered a very active region above earth containing highly energetic particles controlled by earth's magnetic field. The solar wind, an ionized gas, was found to be blowing in interplanetary space, which reacts with earth's magnetic field limiting that field's extension in all directions. Observations of the sun gave researchers new information about ultraviolet rays and x-rays and their effect on earth's environment. By sending instruments above this planet's obscuring atmosphere, astronomers gathered new data on the sun, other stars and planets, and the interplanetary medium. Supporting research and technology funds also made possible theoretical work and laboratory developments not specifically related to a given flight project. Funds for data analysis ensured that scientific returns would be studied and the findings distributed to the scientific community.

In an agency-wide reorganization in November 1961, a director for geophysics and astronomy programs was added to the space science directorate. John F. Clark was director until May 1961, when John E. Naugle took the post, which he held until May 1966 (the program was renamed physics and astronomy in June 1963). Jesse Mitchell saw the program through the remainder of the agency's first decade. Reporting to the director were chiefs of the various disciplines (e.g., astronomy and particles and fields) and as of June 1963 managers of flight programs (e.g., interplanetary and solar probes and solar observatories).

Explorer

The Explorer program was already under way when NASA was established in 1958. Of the five launches attempted by the Army Ballistic Missile Agency, three had returned valuable scientific data. Used for investigations of the earth's environ-

ment and terrestrial-solar-interplanetary relationships and for astronomical observations, the Explorers were the smallest of NASA's scientific satellites. Launched primarily by Scout and Thor-Delta vehicles, 33 Explorer spacecraft successfully performed their missions from 1959 through 1968.

The design of the spacecraft (ranging from inflatable spheres to windmill-shaped satellites) and its instrumentation (ranging from a single radio beacon to a dozen complex scientific experiments) depended on the mission, and there were several different classes of missions: energetic particles Explorers (6, 7, 10, 12, 14, 15, 26), atmospheric studies Explorers (9, 17, 19, 32), ionospheric studies Explorers (8, 20, 22, 27, 31), micrometeoroid Explorers (13, 16, 23), interplanetary monitoring platform Explorers (18, 21, 28, 33, 34, 45), air density-Injun Explorers (24, 25, 39, 40), radio astronomy Explorers (38), geodesy Explorers, part of the U.S. Geodetic Satellite Program (29, 36), gamma ray astronomy Explorers (11), and solar Explorers (30, 37) (see fig. 3-1).

A single program manager oversaw both the Explorers and the sounding rocket program within the physics and astronomy office at NASA Headquarters. From mid-1963 until mid-1966, Marcel T. Aucremanne held this post, with John R. Holtz taking over in May 1966. The individual projects were managed at either Goddard Space Flight Center or Langley Research Center (see following tables for project managers and scientists), with the launches taking place at Wallops Island, the Eastern Test Range, or the Western Test Range.

Many of the early Explorer spacecraft were designed and built in-house at Goddard or Langley, with some of the instruments and experiments coming from university or industry participants. Two Explorer missions were jointly managed by NASA and the Naval Research Laboratory (30, 37); the two Injun Explorers were built at the State University of Iowa (25, 40); and one Explorer mission was part of a joint NASA-Canadian Defense Research Board project (31). When contractors were hired to fabricate the spacecraft or their various components, the cognizant center oversaw the work.

The Explorers were simpler, smaller, and less expensive than the orbiting observatories also used in the physics and astronomy program. As such, they often performed preliminary surveys and gathered basic data as precursors to the more sophisticated missions, sometimes opening new areas of scientific investigation in the process. Many discoveries in the fields of astronomy and physics were attributed to instruments carried by the efficient, economical Explorers.

The following tables briefly describe each Explorer mission. For more information, especially on the instruments and experiments, consult Alfred Rosenthal and William R. Corliss, *Encyclopedia of Satellites and Sounding Rockets, August 1959 to December 1969* (Beltsville, MD: GSFC (1970); Henry L. Richter, Jr., ed., *Space Measurements Survey: Instruments and Spacecraft, October 1957-March 1965*, NASA SP-3028 (Washington, 1966); and Corliss *Scientific Satellites*, NASA SP-133 (Washington, 1967) For the early history of Explorer and how it was related to the Vanguard program and the International Geophysical Year, see Constance M. Green and Milton Lomask, *Vanguard: A History*, NASA SP-4202 (Washington, 1970).



Figure 3-1. Explorers 1965-1966

Table 3-71.
Chronology of Explorer Development and Operations

Date	Event
1954	American participants in the International Geophysical Year (IGY) suggested using a satellite for obtaining scientific information during the 1957-1958 activities.
July 1, 1955	The Army Ballistic Missile Agency (ABMA) and the Jet Propulsion Laboratory (JPL) proposed a plan for launching a small satellite with Sergeant solid-fuel rockets (2d, 3d, 4th stages) atop a Redstone booster.
July 28, 1955	U.S. officially announced plans to launch a satellite as part of the IGY.
Aug. 3, 1955	The Department of Defense (DoD) Advisory Group on Special Capabilities (Stewart Committee), in choosing an IGY satellite, selected the Naval Research Laboratory's (NRL) Vanguard project over the Army's proposal, called Orbiter.
1956	Both the Army and Navy continued to develop their launch vehicles, the Navy's booster being based on the Viking missile and the Army's on Redstone (see also chapter 1).
Nov. 1957	After delays with its Vanguard launch vehicle, NRL transferred one of its satellite experiments to ABMA for use in their satellite project, now called Explorer. The experiment, sponsored by James Van Allen, State University of Iowa, was integrated into a fourth-stage Sergeant motor by JPL in three months.
Nov. 8, 1957	DoD officially directed the Army to proceed with their Explorer program to launch a satellite for the IGY; the modified Jupiter C launch vehicle (Redstone Booster) would be called Juno I.
Jan. 31, 1958	<i>Explorer 1</i> , the first successful U.S. satellite (13.6 kg, torpedo-shaped), was launched by the Army with a Juno I vehicle.
March 5, 1958	A second Explorer failed to achieve orbit when the launch vehicle malfunctioned (ABMA).
March 26, 1958	<i>Explorer 3</i> was launched by Juno I (ABMA).
July 26, 1958	<i>Explorer 4</i> was launched by Juno I (ABMA).
Aug. 24, 1958	The fifth Explorer failed to achieve orbit because it collided with the booster after separation.
July 16, 1959	Explorer S-1, an energetic particles Explorer, failed when the launch vehicle malfunctioned (ABMA).
Aug. 7, 1959	<i>Explorer 6</i> was launched, the first NASA Explorer put into orbit.
Oct. 13, 1959	<i>Explorer 7</i> was launched.
March 23, 1960	Explorer S-46, an energetic particles Explorer, failed when the launch vehicle malfunctioned.
Nov. 3, 1960	<i>Explorer 8</i> was launched.
Feb. 16, 1961	<i>Explorer 9</i> was launched.
Feb. 24, 1961	Explorer S-45, an ionospheric beacon Explorer, failed because of malfunction after separation from the booster.
Feb. 25, 1961	<i>Explorer 10</i> was launched.
April 27, 1961	<i>Explorer 11</i> was launched.
May 24, 1961	Explorer S-45A, an ionospheric beacon satellite, failed when the launch vehicle malfunctioned.
Aug. 16, 1961	<i>Explorer 12</i> was launched.

Table 3-71.
Chronology of Explorer Development and Operations (Continued)

Date	Event
Aug. 25, 1961	<i>Explorer 13</i> was launched.
Oct. 2, 1962	<i>Explorer 14</i> was launched.
Oct. 27, 1962	<i>Explorer 15</i> was launched as part of Project SERB (Study of the Enhanced Radiation Belt)
Dec. 16, 1962	<i>Explorer 16</i> was launched.
April 3, 1963	<i>Explorer 17</i> was launched.
Nov. 26, 1963	<i>Explorer 18</i> was launched (first interplanetary monitoring platform).
Dec. 19, 1963	<i>Explorer 19</i> was launched.
March 19, 1964	Explorer S-66, an ionospheric measurements Explorer, failed when the launch vehicle malfunctioned.
Aug. 25, 1964	<i>Explorer 20</i> was launched.
Oct. 4, 1964	<i>Explorer 21</i> was launched.
Oct. 9, 1964	<i>Explorer 22</i> was launched.
Nov. 6, 1964	<i>Explorer 23</i> was launched.
Nov. 21, 1964	<i>Explorer 24</i> and <i>25</i> were launched together (first successful dual launch by NASA). This was a joint NASA-State University of Iowa project.
Dec. 21, 1964	<i>Explorer 26</i> was launched.
April 29, 1965	<i>Explorer 27</i> was launched.
May 29, 1965	<i>Explorer 28</i> was launched.
Nov. 6, 1965	<i>Explorer 29</i> was launched (part of the U.S. Geodetic Satellite Program).
Nov. 19, 1965	<i>Explorer 30</i> was launched (joint NASA-NRL project).
Nov. 29, 1965	<i>Explorer 31</i> was launched with a Canadian satellite in a dual launch (joint NASA-Canadian Defense Research Board project).
May 25, 1966	<i>Explorer 32</i> was launched.
July 1, 1966	<i>Explorer 33</i> was launched.
May 24, 1967	<i>Explorer 34</i> was launched.
July 19, 1967	<i>Explorer 35</i> was launched.
Jan. 11, 1968	<i>Explorer 36</i> was launched (part of the U.S. Geodetic Satellite Program).
March 5, 1968	<i>Explorer 37</i> was launched (joint NASA-NRL project).
July 4, 1968	<i>Explorer 38</i> was launched.
Aug. 8, 1968	<i>Explorer 39</i> and <i>40</i> were launched together (joint NASA-State University of Iowa project).

Table 3-72.
Explorer 6 (S-2) Characteristics

Date of launch (location):	Aug. 7, 1959 (ETR)
Launch vehicle:	Thor-Able
Weight (kg):	64.4
Shape	Irregular but symmetrical spheroid with 4 solar cell paddles extended on arms from waste of spacecraft
Dimensions (m):	spheroid diameter, .66 diameter w/paddles extended, 2.18 height, .74 paddles, .5 × .56
Power source:	NiCd batteries plus solar cells
Date of reentry:	Prior to July 1961
Cognizant NASA center:	GSFC
Project manager, scientists:	J. C. Lindsay
Contractor:	Space Technology Laboratories, Inc. (STL), spacecraft
Class of Explorer :	Energetic particles
Objectives:	Measure Van Allen belt and cosmic radiation; map earth's magnetic field; acquire data on micrometeorites; determine effect of ionosphere on radio wave propagation; provide crude television image of cloud cover.
Experiments, responsible institution:	Total of 12 experiments from the University of Chicago, STL, the University of Minnesota, Cambridge Research Laboratories, and Stanford University.
Results:	All experiments performed satisfactorily; returned first televised cloud cover picture; first detailed study of the Van Allen belts.
Remarks:	Also designated <i>Able 3</i> .

Table 3-73.
Explorer 7 (S-1a) Characteristics

Date of launch (location):	Oct. 13, 1959 (ETR)
Launch vehicle:	Juno II
Weight (kg):	41.5
Shape:	Truncated cones joined at bases
Dimensions (m):	.76 × .76
Power source:	NiCd batteries plus solar cells
Date of reentry:	In orbit
Cognizant NASA center:	GSFC
Project manager:	H. E. La Gow
Contractor:	Army Ballistic Missile Agency, spacecraft and launch vehicle
Class of Explorer:	Energetic particles
Objectives:	Measure sun's radiation, intensity of x-rays, and ultraviolet rays, heavy cosmic rays, intensity of charged particles; study ionospheric composition, micrometeorite impacts, solar cell erosion; measure temperatures.
Experiments, responsible institution:	Thermal radiation balance, University of Wisconsin Solar x-ray, NRL et al. Cosmic ray ion chamber, Martin Co. et al. Geiger counters, State University of Iowa et al. Ground-based observations, University of Iowa et al. Micrometeoroid penetration sensor, GSFC
Results:	Provided significant geophysical information on radiation and magnetic storms.
Remarks:	Spacecraft designed, fabricated, and tested under the direction of Ernst Stuhlinger and Joseph Boehm, ABMA (later MSFC).

Table 3-74.
Explorer 8 (S-30) Characteristics

Date of launch (location):	Nov. 3, 1960 (ETR)
Launch vehicle:	Juno II
Weight (kg):	40.8
Shape:	2 truncated cones joined at bases
Dimensions (m):	.76 × .76
Power source:	Hg batteries
Date of reentry:	In orbit
Cognizant NASA center:	GSFC
Project manager, scientist:	R. E. Bourdeau
Class of Explorer:	Ionospheric studies
Objectives:	Take measurements in the ionosphere; study ionospheric properties and micrometeorite impacts.
Experiments, responsible institution:	RF impedance probe, ion traps, Langmuir probe, rotating shutter electric field meter, micrometeoroid detector, and micrometeoroid microphones, all GSFC experiments
Results:	Micrometeoroid influx rate measured; layers of helium discovered in upper atmosphere.
Remarks:	Spacecraft was built at the Marshall Space Flight Center (MSFC).

Table 3-75.
Explorer 9 (S-56a) Characteristics

Date of launch (location):	Feb. 16, 1961 (Wallops)
Launch vehicle:	Scout
Weight (kg):	36.3
Shape:	Sphere (inflated with nitrogen)
Dimensions(m):	Diameter, 3.66
Power source:	Batteries plus solar cells
Date of reentry:	Before July 1961
Cognizant NASA center:	LaRC-GSFC joint project
Project scientist:	William J. O'Sullivan, LaRc
Contractor:	G. T. Schjeldahl
Class of Explorer :	Atmospheric studies
Objectives:	Determine density of atmosphere by measuring air drag on an inflatable sphere; test launch for the Scout vehicle.
Experiments:	Radio beacon only, no instrumentation (passive)
Results:	Balloon and fourth stage of launch vehicle achieved orbit, but the radio beacon failed; the satellite was tracked optically and useful data were obtained.
Remarks:	See also Echo communications satellite for background information on the spacecraft's design.

Table 3-76.
Explorer 10 (P-14) Characteristics

Date of launch (location):	March 25, 1961 (ETR)
Launch vehicle:	Thor-Delta
Weight (kg):	35.4
Shape:	Sphere atop a supporting tube joined to a drum
Dimensions:	Sphere diameter, .33 Drum diameter, .49 Total height, 1.32
Power source:	Batteries
Date of reentry:	June 1968
Cognizant NASA center:	GSFC
Project manager, scientist:	James P. Heppner
Contractors:	Varian Associates, rubidium vapor magnetometer Schonstedt Engineering Co., fluxgate magnetometers
Class of Explorer:	Energetic particles (also called Magnetometer-Plasma Probe)
Objectives:	Gather information on earth's magnetic field and interplanetary magnetic fields and on the way these fields interact with electrically charged particles thrown outward by the sun.
Experiments, responsible institution:	Rubidium vapor magnetometer, GSFC Fluxgate magnetometers, GSFC Plasma probe, MIT
Results:	Data transmitted for 52 hours; demonstrated existence of geomagnetic cavity in solar wind and existence of solar proton streams.

Table 3-77.
Explorer 11 (S-15) Characteristics

Date of launch (location):	April 27, 1961 (ETR)
Launch vehicle:	Juno II
Weight (kg):	43.1, including 5.8-kg 4th-stage rocket
Shape:	3-sectional octagonal box with .43-meter plate on top and instrument column attached to 1.12-meter-long 4th-stage Sergeant rocket
Dimensions (m):	Overall length, 2.26 Box, .3 × .6 × .43 Instrument column, .52 × .15
Power source:	NiCd batteries
Date of reentry:	In orbit
Cognizant NASA center:	GSFC-MSFC joint project
Project manager:	John Coogan, GSFC Bill Greever, MSFC
Project scientist:	J. E. Kupperian, Jr., GSFC
Contractors:	MIT, gamma ray telescope Raymond Engineering Laboratory, tape recorder
Class of Explorer:	Gamma ray astronomy
Objectives:	Detect and map extraterrestrial high-energy gamma rays; measure high-energy gamma ray albedo of atmosphere.
Experiments, responsible institution:	Gamma ray telescope, MIT
Results:	Detected first gamma rays from space.

Table 3-78.
Explorer 12 (S-3) Characteristics

Date of launch (location):	Aug. 15, 1961 (ETR)
Launch vehicle:	Thor-Delta
Weight (kg):	37.6
Shape:	Octagonal platform atop a truncated cone with 4 solar panels extending from sides
Dimensions (m):	.43 × .7 × .7
Power source:	AgCd batteries plus solar cells
Date of reentry:	Sept. 1963
Cognizant NASA center:	GSFC
Project manager:	Paul Butler
Project scientist:	F. B. McDonald
Contractor:	Raymond Engineering Laboratory, Inc., spacecraft structure
Class of Explorer:	Energetic particles
Objectives:	Study physics of fields and energetic particles by observing solar wind, interplanetary magnetic field, and particle population of interplanetary space, and trapped radiation regions.
Experiments responsible institution:	Proton analyzer, ARC Fluxgate magnetometer, University of New Hampshire Cosmic ray instruments, State University of Iowa Geiger and scintillation counters, GSFC Ion-electron detectors, GSFC
Results:	Normal operation; 2568 hours of data received and significant geophysical data on radiation and magnetic fields provided.

Table 3-79.
Explorer 13 (S-55a) Characteristics

Date of launch (location):	Aug. 25, 1961 (Wallops)
Launch vehicle:	Scout
Weight (kg):	83.9, including 22.7-kg spent motor case
Shape	Cylindrical, with instruments in nose
Dimensions	.61 × 1.9
Power source:	NiCd batteries plus solar cells
Date of reentry:	Aug. 28, 1961
Cognizant center:	LaRC Charles T. D'Aiutolo
Project manager:	
Class of Explorer :	Micrometeoroid
Objectives:	Gather information on micrometeoroids 385-965 kilometers above earth; study dust particles; test Scout vehicle.
Experiments responsible institution:	Cadmium sulphide cell detector, GSFC Wire grid detector, GSFC Piezoelectric detector, LeRC Pressurized cell detectors, LaRC Foil-type detectors, LeRC
Results:	Orbit lower than planned; no significant data returned.

Table 3-80.
Explorer 14 (S-3a) Characteristics

Date of launch (location):	Oct. 2, 1962 (ETR)
Launch vehicle:	Thor-Delta
Weight (kg):	40.4
Shape:	Octagonal platform atop a truncated cone with 4 solar panels
Dimensions (m):	.43 × .7 × .7
Power source:	AgCd batteries plus solar cells
Date of reentry:	July 1, 1966
Cognizant NASA center:	GSFC
Project manager:	Paul G. Marcotte
Project scientists:	F. B. McDonald
Contractor:	Raymond Engineering Laboratory, Inc., spacecraft structure
Class of Explorer :	Energetic particles
Objectives:	Continuation of <i>Explorer 12's</i> mission; gather information on radiation, solar particles, and the solar wind.
Experiments, responsible institution:	Proton analyzer, ARC Fluxgate magnetometer, University of New Hampshire Trapped particle radiation study, State University of Iowa Various radiation detectors, GSFC
Results:	Studied earth's radiation belt as planned.

Table 3-81.
Explorer 15 (S-3b) Characteristics

Date of launch (location):	Oct. 27, 1962 (ETR)
Launch vehicle:	Thor-Delta
Weight (kg):	45.4
Shape:	Octagonal platform atop a truncated cone with 4 solar panels
Dimensions (m):	.43 × .7 × .7
Power source:	AgCd batteries plus solar cells
Date of reentry:	In orbit
Cognizant NASA center:	GSFC
Project manager:	John W. Townsend, Jr.
Project scientist:	W. Hess
Contractor:	Raymond Engineering Laboratory, Inc., spacecraft structure
Class of Explorer :	Energetic particles
Objectives:	Make detailed measurements of artificial radiation belt created by Starfish high-altitude nuclear test of July 9, 1962; determine effects of radiation on solar cells.
Experiments, responsible institution:	Electron energy distribution, GSFC, Bell Telephone Laboratories (BTL) Electron angular distribution, BTL Omnidirectional electron-proton detector, University of California, San Diego Directional electron-proton detector, UCSD Ion-electron detector, GSFC Fluxgate magnetometer, University of New Hampshire Solar cell damage, BTL
Results:	Good data on artificial radiation belt obtained although spacecraft's despin system failed to operate.
Remarks:	Fabricated from <i>Explorer 14</i> spare parts; part of Project SERB (Study of Enhanced Radiation Belt).

Table 3-82.
Explorer 16 (S-55b) Characteristics

Date of launch (location):	Dec. 16, 1962 (Wallops)
Launch vehicle:	Scout
Weight (kg):	100.7
Shape:	Cylindrical
Dimensions (m):	1.93 × .58
Power source:	NiCd batteries plus solar cells
Date of reentry:	In orbit
Cognizant NASA center:	LaRC
Project manager:	Earl Hastings
Class of Explorer :	Micrometeoroid
Objectives:	Determine micrometeoroid puncture hazards to spacecraft skin samples; gather information on dust particles; compare performance of protected and unprotected solar cells.
Experiments, responsible institution:	Foil gauge detectors, LeRC Cadmium sulphide cells, GSFC Impact detectors, LaRC Wire grids, GSFC
Results:	All experiments functioned as planned; 16 micrometeoroid penetrations were registered during the first 29 days of flight.

Table 3-83.
Explorer 17 (S-6) Characteristics

Date of launch (location):	April 2, 1963 (ETR)
Launch vehicle:	Thor-Delta
Weight (kg):	185.5
Shape:	Spherical
Dimensions (m):	Diameter, .89
Power source:	AgZn batteries
Date of reentry:	Nov. 24, 1966
Cognizant NASA center:	GSFC
Project managers:	N. W. Spencer, J. E. Cooley
Contractor:	Budd Co., spacecraft structure
Class of Explorer:	Atmospheric studies (also called Aeronomy Satellite)
Objectives:	Determine diurnal and spatial variations of electron density and temperature; determine the neutral parameters—density, composition, pressure, temperature—in the regions between 250 and 900 km.
Experiments, responsible institution:	Mass spectrometers, GSFC Pressure gauges, GSFC Langmuir probes, GSFC
Results:	Confirmed that earth is surrounded by a belt of neutral helium at an altitude of 250-900 km.

Table 3-84.
Explorer 18 (IMP-A) Characteristics

Date of launch (location):	Nov. 26, 1963 (ETR)
Launch vehicle:	Thor-Delta
Weight (kg):	62.6
Shape:	Octagonal platform with solar panels
Dimensions (m):	.3 × .71 × .71
Power source:	NiCd batteries plus solar cells
Date of reentry:	Dec. 30, 1965
Cognizant NASA center:	GSFC
Project manager:	Paul Butler
Project scientist:	F. B. McDonald
Class of Explorer :	Interplanetary monitoring platform
Objectives:	Study magnetic fields, solar wind, and cosmic rays beyond the influence of earth's magnetic field; obtain information about space radiation intensities and distribution.
Experiments, responsible institution:	Ion and electron probes, GSFC Fluxgate magnetometers, GSFC Cosmic ray telescope, University of Chicago Geiger counter and ion chamber, University of California Plasma probe, MIT Scintillator and geiger telescopes, GSFC Radium vapor magnetometer, GSFC Plasma analyzer, ARC
Results:	First accurate measurements of the interplanetary magnetic field and shock front.

Table 3-85.
Explorer 19 (AD-A) Characteristics

Date of launch (location):	Dec. 20, 1963 (WTR)
Launch vehicle:	Scout
Weight (kg):	43.1
Shape:	Spherical (inflatable)
Dimensions (m):	Diameter, 3.66
Power source:	NiCd batteries plus solar cells
Date of reentry:	May 10, 1981
Cognizant NASA center:	LaRC
Project manager:	Claude W. Coffee, Jr.
Project scientist:	William J. O'Sullivan
Contractor:	G. T. Schjeldahl
Class of Explorer :	Atmospheric studies (also called Atmospheric Density Satellite)
Objectives:	Determine air density of upper atmosphere; study heating effects in upper atmosphere due to influx of energetic particles and ultraviolet radiation.
Experiments, responsible institution:	Radio beacon only, no instrumentation (passive)
Results:	Achieved desired orbit but lost ability to transmit; first sighted in Australia on Dec. 20; some data obtained through optical tracking.
Remarks:	See also Echo communications satellite for background information on the spacecraft's design.

Table 3-86.
Explorer 20 (S-48) Characteristics

Date of launch (location):	Aug. 25, 1964 (ETR)
Launch vehicle:	Scout
Weight (kg):	44.5
Shape:	Conical main body with .1-meter ball-shaped ion mass spectrometer and .25-meter tapered boom
Dimensions:	Main body, .83 × .66 Overall length, 1.18
Power source:	NiCd batteries plus solar cells
Date of reentry:	In orbit
Cognizant NASA center:	GSFC
Project manager	John J. Jackson
Contractor:	Airborne Instruments Lab., Cutler-Hammer, Inc., spacecraft
Class of Explorer:	Ionospheric studies
Objectives:	Measure irregularities in the topside of earth's ionosphere.
Experiments, responsible institution:	Fixed frequency sounder, Central Radio Propagation Laboratory, National Bureau of Standards Ion probe, University College, London Galactic radio noise receiver, GSFC
Results:	Helped to map the topside of the ionosphere.

Table 3-87.
Explorer 21 (IMP-B) Characteristics

Date of launch (location):	Oct. 4, 1964 (ETR)
Launch vehicle:	Thor-Delta
Weight (kg):	61.7
Shape:	Octagonal platform with 4 solar panels
Dimensions (m):	.3 × .71 × .71 Solar panels, .66 × .46
Power source:	AgCd batteries plus solar cells
Date of reentry:	Jan. 30, 1966
Cognizant NASA center:	GSFC
Project manager:	P. Butler
Project scientist:	F. B. McDonald
Class of Explorer:	Interplanetary monitoring platform
Objectives:	Study magnetic fields, solar wind, and cosmic rays beyond the influence of earth's magnetic field; study magnetic field interactions with solar plasma; obtain information regarding space radiation intensities and distribution.
Experiments, responsible institution:	Same as for <i>Explorer 18</i> (table 3-84).
Results:	Useful data obtained, but spacecraft failed to achieve required orbit.

Table 3-88.
Explorer 22 (BE-B) Characteristics

Date of launch (location):	Oct. 9, 1964 (WTR)
Launch vehicle:	Scout
Weight (kg):	52.2
Shape:	Octagonal with 4 solar panels extending from sides
Dimensions (m):	Shell diameter, .46 Shell height, .3 Solar panels, .25 × 1.68
Power source:	NiCd batteries plus solar cells
Date of reentry:	In orbit
Cognizant NASA center:	GSFC
Project manager:	F. T. Martin
Project scientist:	R. E. Bourdeau
Contractor:	Applied Physics Laboratory, Johns Hopkins, spacecraft
Class of Explorer:	Ionospheric studies (also called Beacon-Explorer)
Objectives:	Conduct ionospheric and geodetic research for a minimum of 1 year.
Experiments, responsible institution:	Ionospheric beacon, University of Illinois, et al. Electron density, GSFC Laser tracking, GSFC
Results:	More than 80 international observing stations participated; successful.

Table 3-89.
Explorer 23 (S-55c) Characteristics

Date of launch (location):	Nov. 6, 1964 (Wallops)
Launch vehicle:	Scout
Weight (kg):	133.8 (including spent 4th-stage motor)
Shape	Cylindrical
Dimensions (m):	2.34 × .61
Power source:	NiCd batteries plus solar cells
Date of reentry:	June 29, 1983
Cognizant NASA center:	LaRC
Project manager:	Earl Hastings, Jr.
Class of Explorer:	Micrometeoroid
Objectives:	Measure micrometeoroid penetration
Experiments, responsible institution:	Pressurized cells, LaRC Impact detectors, LaRC Capacitor detectors, LaRC Cadmium sulphide cells, GSFC
Results:	Obtained data on penetrations as planned.

Table 3-90.
Explorer 24 and 25 (AD-Injun B) Characteristics

Date of launch (location):	Nov. 21, 1964 (WTR)
Launch vehicle:	Scout
Weight (kg):	<i>Explorer 24</i> , 8.6 <i>Explorer 25</i> , 40.8
Shape:	<i>Explorer 24</i> , spherical (inflatable) <i>Explorer 25</i> , roughly spherical with 40 flat surfaces
Dimensions (m):	<i>Explorer 24</i> , diameter, 3.66 <i>Explorer 25</i> , diameter, .61
Power source:	NiCd batteries plus solar cells
Date of reentry:	<i>Explorer 24</i> , Oct. 18, 1968 <i>Explorer 25</i> , in orbit
Cognizant NASA center:	LaRC
Project manager:	Claude W. Coffee, Jr.
Project scientist:	Gerald M. Keating
Contractor:	<i>Explorer 24</i> , G. T. Schjeldahl <i>Explorer 25</i> , State University of Iowa
Class of Explorer:	Air density-Injun
Objectives:	Provide information on complex radiation-air density relationships in the upper atmosphere.
Experiments, responsible institution:	<i>Explorer 24</i> , radio beacon only, no instrumentation (passive). <i>Explorer 25</i> , 16 radiation sensors, State University of Iowa
Results:	First successful dual launch; all instruments performed as planned.
Remarks:	Joint NASA-State University of Iowa project; see also Echo communications satellite for background information on <i>Explorer 24's</i> design.

Table 3-91.
Explorer 26 (EPE-D) Characteristics

Date of launch (location):	Dec. 21, 1964 (ETR)
Launch vehicle:	Thor-Delta
Weight (kg):	45.8
Shape:	Octagonal platform atop a truncated cone with 4 solar panels extending from sides; .86-meter tube mounted on top to support magnetometer
Dimensions (m):	.43 × .7 × .7
Power source:	AgCd batteries plus solar cells
Date of reentry:	In orbit
Cognizant NASA center:	GSFC
Project manager:	Gerald W. Longanecker
Project scientist:	Leo R. Davis
Contractor:	Electro-Mechanical Research, Inc., electrical integration
Class of Explorer:	Energetic particles
Objectives:	Determine how high-energy particles are injected, trapped, and lost in the Van Allen Belt; determine penetration depth of high-energy solar protons into the geomagnetic field.
Experiments, responsible institution:	Electron-proton angular distribution and energy spectra, BTL, GSFC Electron-proton directional-omnidirectional detector, University of California, San Diego Magnetic field measurements, University of New Hampshire Ion-electron detector, GSFC Solar cell damage, BTL
Results:	Experiments performed as planned, continuing the work of earlier satellites in the energetic particles series.

Table 3-92.
Explorer 27 (BE-C) Characteristics

Date of launch (location):	April 29, 1965 (Wallops)
Launch vehicle:	Scout
Weight (kg):	60.8
Shape:	Octagonal with 4 solar panels extending from sides
Dimensions (m):	.46 × .3 Solar panels, .25 × 1.68
Power source:	NiCd batteries plus solar cells
Date of reentry:	In orbit
Cognizant NASA center:	GSFC
Project manager:	Frank T. Martin
Project scientists:	Robert E. Bourdeau, R. Newton
Contractor:	Applied Physics Laboratory, Johns Hopkins, spacecraft
Class of Explorer:	Ionospheric studies (also called Beacon-Explorer)
Objectives:	Study for a minimum of 1 year variations of electron density and orbital perturbations in order to deduce the size and shape of earth and the nature of its gravitational field.
Experiments, responsible institution:	Same as for <i>Explorer 22</i> (table 3-88).
Results:	Experiments functioned as planned.

Table 3-93.
Explorer 28 (IMP-C) Characteristics

Date of launch (location):	May 29, 1965 (ETR)
Launch vehicle:	Thor-Delta
Weight (kg):	59
Shape:	Octagonal with 4 solar panels
Dimensions (m):	.71 × .71 × .2 Solar panels, .7 × .51
Power source:	NiCd batteries plus solar cells
Date of reentry:	July 4, 1968
Cognizant NASA center:	GSFC
Project manager:	Paul Bulter
Project scientist:	Frank B. McDonald
Contractor:	Electro-Mechanical Research, Inc., electrical integration
Class of Explorer:	Interplanetary monitoring platform
Objectives:	Study radiation environment of cislunar space and quiescent properties of interplanetary magnetic field; develop solar flare prediction capability for Apollo.
Experiments, responsible institution:	Same as for <i>Explorer 18</i> (table 3-84).
Results:	Placed in a highly eccentric orbit, the spacecraft returned data on earth's magnetosphere.

Table 3-94.
Explorer 29 (GEOS-A) Characteristics

Date of launch (location):	Nov. 6, 1965 (ETR)
Launch vehicle:	Thrust-augmented Thor-Delta (TAD)
Weight (kg):	174.6
Shape:	Octahedron topped by a truncated pyramid with 18-meter extendable boom
Dimensions (m):	1.22 × .81
Power source:	NiCd batteries plus solar cells
Date of reentry:	In orbit
Cognizant NASA center:	GSFC
Project manager:	C. H. Looney
Contractor:	Applied Physics Laboratory, Johns Hopkins, spacecraft
Class of Explorer:	Geodesy
Objectives:	Compare tracking system accuracies; study gravitational field; improve geodetic datum accuracies.
Experiments, responsible institution:	Flashing-light beacon, corner cube quartz reflector, radio transmitters for doppler shift detector, radio range transponder, range and range-rate transponder, all GSFC experiments
Results:	All systems functioned with good data returned.
Remarks:	Also called <i>GEOS I</i> ; part of the U.S. Geodetic Satellite Program, with coordinated tracking accomplished by NASA, DoD, and the Department of Commerce.

Table 3-95.
Explorer 30 (SE-A) Characteristics

Date of launch (location):	Nov. 19, 1965 (Wallops)
Launch vehicle:	Scout
Weight (kg):	56.7
Shape:	2 hemispheres separated by a .089-meter equatorial band
Dimensions (m):	Diameter of each hemisphere, .61
Power source:	NiCd batteries plus solar cells
Date of reentry:	In orbit
Cognizant NASA center:	NASA Hq.
Project manager:	Marcel T. Aucremanne
Project scientist:	R. W. Kreplin, Naval Research Laboratory
Contractor:	NRL
Class of Explorer:	Solar
Objectives:	Monitor solar x-rays during the International Quiet Sun Year.
Experiments, responsible institution:	X-ray ion chamber photometer, NRL X-ray geiger counters, NRL Lyman-alpha ion chamber, NRL
Results:	Successful return of data on solar x-rays and ultraviolet rays.
Remarks:	Joint NASA-Naval Research Laboratory Project.

Table 3-96.
Explorer 31 (DME-A) Characteristics

Date of launch (location):	Nov. 29, 1965 (WTR)
Launch vehicle:	Thor-Agena B
Weight (kg):	98.9 (plus 146.5-kg Alouette)
Shape:	<i>Explorer 31</i> , octagonal with a spherical ion mass spectrometer Alouette 2, roughly spherical
Dimensions (m):	<i>Explorer 31</i> , .76 × .64; overall height, 1.17 Alouette 2, diameter, 1.07; height, .86
Power source:	Solar cells
Date of reentry:	In orbit
Cognizant NASA center:	GSFC
Project manager:	Evert D. Nelson
Project scientist:	J. E. Jackson
Contractor:	Explorer 31, Applied Physics Laboratory, Johns Hopkins, spacecraft
Class of Explorer:	Ionospheric studies (also called Direct Measurements Satellite)
Objectives:	Sound the topside of the ionosphere using topside sounder and measurement techniques.
Experiments, responsible institution:	<i>Explorer 31</i> , Thermal ion and electron probes, GSFC Electrostatic probe, GSFC Electron probe, University College, London Spherical ion mass spectrometer, University College Magnetic ion mass spectrometer, NRL Energetic current monitor, GSFC
Results:	Functioned as planned, with the Alouette still in orbit and available for use in 1970.
Remarks:	Joint NASA-Canadian Defense Research Board project; dual mission called ISIS-X (International Satellite for Ionospheric Studies); see also table 3-126.

Table 3-97.
Explorer 32 (AE-B) Characteristics

Date of launch (location):	May 25, 1966 (ETR)
Launch vehicle:	Thor-Delta
Weight (kg):	220
Shape:	Spherical
Dimensions (m):	Diameter, .89
Power source:	AgZn batteries plus solar cells
Date of reentry:	In orbit
Cognizant NASA center:	GSFC
Project manager:	N. W. Spencer
Project scientist:	L. H. Brace
Class of Explorer:	Atmospheric studies
Objectives:	Study structure and physics of upper atmosphere (220-1050 km).
Experiments:	Redhead ion gauges, ion gauges, electrostatic probes, ion mass spectrometer, all GSFC experiments.
Results:	Experiments performed well, but spacecraft achieved a higher apogee than planned due to a long second-stage burn.

Table 3-98.
Explorer 33 (IMP-D) Characteristics

Date of launch (location):	July 1, 1966 (ETR)
Launch vehicle:	Thrust-augmented Improved Thor-Delta (TAID)
Weight (kg):	93.4
Shape:	2-piece axial-thrust tube with a Delta attach-flange on one end and a retromotor flange on the other connected to an octagonal equipment deck with 4 solar cell paddles and 2 booms for magnetometers
Dimensions (m):	Width with paddles extended, 2.78 Height, 1.12
Power source:	Battery plus solar cells
Date of reentry:	In orbit
Cognizant NASA center:	GSFC
Project manager:	P. G. Marcotte
Project scientist:	N. F. Ness
Class of Explorer:	Interplanetary monitoring platform (anchored)
Objectives:	Anchor satellite in orbit about moon; measure solar plasma flux, energetic particles, magnetic fields, and cosmic dust; explore variations of moon's gravity field.
Experiments, responsible institution:	Fluxgate magnetometers, GSFC, ARC Thermal ion probe, GSFC Ion chamber, UCLA Tubes plus p-on-n junction, State University of Iowa Faraday-cup probe, MIT
Results:	Spacecraft failed to achieve lunar orbit, but the highly eccentric earth orbit into which it was injected allowed for the return of data on solar plasma, energetic particles, and magnetic fields.

Table 3-99.
Explorer 34 (IMP-F) Characteristics

Date of launch (location):	May 24, 1967 (WTR)
Launch vehicle:	Thrust-augmented Improved Thor-Delta (TAID)
Weight (kg):	73.9
Shape:	Octagonal platform with 4 solar cell paddles and 2 booms for magnetometers
Dimensions (m):	Diameter, .71
Power source:	AgCd battery plus solar cells
Date of reentry:	May 3, 1969
Cognizant NASA center:	GSFC
Project manager:	Paul Butler
Project scientist:	Frank B. McDonald
Class of Explorer:	Interplanetary monitoring platform
Objectives:	Study solar and galactic cosmic radiation, solar plasma, and energetic particles within the magnetosphere and interplanetary magnetic field.
Experiments, responsible institution:	Total of 11 experiments from Bell Telephone Laboratories, Southwest Center for Advanced Studies, GSFC, University of Maryland, State University of Iowa, and TRW.
Results:	Returned 170 000 hours of data; launched during class three period of bright solar flares.

Table 3-100.
Explorer 35 (IMP-E) Characteristics

Date of launch (location):	July 19, 1967 (ETR)
Launch vehicle:	Thrust-augmented Improved Thor-Delta
Weight (kg):	104.3
Shape:	Octagonal with 4 solar panels
Dimensions (m):	.71 × .71 × .86
Power source:	AgCd battery plus solar cells
Date of reentry:	In lunar orbit
Cognizant NASA center:	GSFC
Project manager:	Paul G. Marcotte
Project scientist:	Norman F. Ness
Contractor:	Aerospace Div., Westinghouse Electric Corp., integration
Class of Explorer:	Interplanetary monitoring platform (anchored)
Objectives:	Anchor satellite in orbit around moon; measure solar plasma flux, energetic particles, magnetic fields, and cosmic dust.
Experiments, responsible institution:	Magnetometers, GSFC, ARC Thermal ion detector, GSFC Ion chambers and geiger tubes, UCLA Geiger tubes and p-on-n junction, State University of Iowa Micrometeoroid detector, Temple University Faraday cup, MIT
Results:	Inserted into lunar orbit on July 22; no detectable lunar magnetic field discovered.

Table 3-101.
Explorer 36 (GEOS-B) Characteristics

Date of launch (location):	Jan. 11, 1968 (WTR)
Launch vehicle:	Thrust-augmented Improved Thor-Delta
Weight (kg):	208.7
Shape:	Octahedron topped by a truncated pyramid with a 9-meter extendable boom
Dimensions (m):	1.22 × 1.22 × .81
Power source:	NiCd batteries plus solar cells
Date of reentry:	In orbit
Cognizant NASA center:	NASA Hq.
Project manager:	J. D. Rosenberg
Program scientist:	Nancy Roman
Contractor:	Applied Physics Laboratory, Johns Hopkins, spacecraft
Class of Explorer:	Geodesy
Objectives:	Compare tracking system accuracies; study earth's gravitational field; improve geodetic datum accuracies.
Experiments, responsible institution:	Optical beacon, radio doppler, range transponder, range and range-rate transponder, C-band transponder, and laser corner reflector, all GSFC experiments
Results:	All experiments returned data as planned.
Remarks:	Also called <i>GEOS 2</i> ; part of the U.S. Geodetic Satellite Program.

Table 3-102.
Explorer 37 (SE-B) Characteristics

Date of launch (location):	March 5, 1968 (Wallops)
Launch vehicle:	Scout
Weight (kg):	88.5
Shape:	12-sided cylinder
Dimensions (m):	.76 × .69
Power source:	NiCd batteries plus solar cells
Date of reentry:	In orbit
Cognizant NASA center:	NASA Hq.
Project manager:	J. Holtz
Program scientist:	H. Glaser, NASA Hq.; R. W. Kreplin, Naval Research Laboratory
Contractors:	NRL
Class of Explorer:	Solar
Objectives:	Monitor the sun's x-ray emissions.
Experiments, responsible institution:	Scintillation counter, x-ray photometer, geiger counters, and ultraviolet photometers, all NRL experiments
Results:	Experiments returned data as planned.
Remarks:	Joint NASA-NRL project.

Table 3-103.
Explorer 38 (RAE-A) Characteristics

Date of launch (location):	July 4, 1968 (WTR)
Launch vehicle:	Thrust-augmented Improved Thor-Delta
Weight (kg):	275.3 (including 79.4-kg apogee kick motor)
Shape:	Cylindrical with 4 solar paddles and 4 228-meter antennas
Dimensions (m):	.91 × .79
Power source:	NiCd batteries plus solar cells
Date of reentry:	In orbit
Cognizant NASA center:	GSFC
Project manager:	John T. Shea
Program scientists:	Robert G. Stone
Contractor:	Space and Electronics Div., Fairchild Hiller Corp., spacecraft structure and antenna assemblies
Class of Explorer:	Radio astronomy
Objectives:	Monitor low-frequency cosmic radio noise using large deployable antennas; monitor radio noise emitted by sun, Jupiter, and Earth.
Experiments, responsible institution:	Nine-step receivers, burst receivers, electron trap, impedance probe, and capacitance probe, all GSFC experiments
Results:	Successfully deployed antennas and damper boom on Oct. 8; deleted sharply beamed sporadic low-frequency radio signal from Jupiter.

Table 3-104.
Explorer 39 and 40 (AD-Injun E) Characteristics

Date of launch (location):	Aug. 8, 1968 (WTR)
Launch vehicle:	Scout
Weight (kg):	<i>Explorer 39</i> , 9.4 <i>Explorer 40</i> , 71.2
Shape:	<i>Explorer 39</i> , spherical (inflatable) <i>Explorer 40</i> , 6-sided cylinder
Dimensions (m):	<i>Explorer 39</i> , diameter, 3.66 <i>Explorer 40</i> , .74 × .76
Power source:	NiCd batteries plus solar cells
Date of reentry:	<i>Explorer 39</i> , June 22, 1981 <i>Explorer 40</i> , in orbit
Cognizant NASA center:	LaRC
Project manager:	Claude W. Coffee, Jr.
Program scientist:	William A. Whelpley, State University of Iowa
Contractor:	<i>Explorer 39</i> , G. T. Schjeldahl <i>Explorer 40</i> , State University of Iowa
Class of Explorer:	Air density-Injun
Objectives:	Study complex radiation-air density relationships in upper atmosphere in polar regions.
Experiments, responsible institution:	<i>Explorer 39</i> , radio beacon only, no instrumentation (passive) <i>Explorer 40</i> , particle differential energy analyzer, solid-state detector, VLF receiver, and spherical particle analyzers, all State University of Iowa experiments
Results:	Dual launch; studied interaction of solar radiation with the atmosphere during the solar maximum.
Remarks:	Joint NASA-State University of Iowa project; see also Echo communications satellite for background information of <i>Explorer 39's</i> design.

Orbiting Solar Observatories

The dominant position of the sun in our solar system and its profound effect on earth's atmosphere has made it the subject of extensive examinations by space agency scientists. To study the sun, NASA planned an earth-orbiting platform—smaller and less sophisticated than the proposed Orbiting Astronomical Observatories (see elsewhere in this chapter)—equipped with instruments to measure solar radiation, x-rays, gamma rays, and dust particles.⁸

Called a “streetcar” satellite because it could carry interchangeable scientific instruments aboard as passengers, the Orbiting Solar Observatory (OSO) consisted of two main sections. The lower wheel-like structure was composed of nine wedge-shaped compartments, five of which housed scientific apparatus. Three spheres on extended arms held pressurized nitrogen for stabilization. The top part of the spacecraft was a stable fan-shaped array to which silicon solar cells were attached. Experiments that required a fixed orientation with respect to the sun could be housed in this section. In 1962, 1965, and 1967, four OSOs were orbited successfully by Thor-Delta launchers, sending back a wealth of data about the sun and sun-earth relationships.

Managed at NASA headquarters by the physics and astronomy directorate, *OSO 1* was the responsibility of Irwin Cherrick, program manager. From June 1963 through 1965, Richard E. Halpern was OSO program manager, and Dixon L. Forsythe was solar observatories manager from January 1965 until mid-1967, when C. Dixon Ashworth assumed these duties (Ashworth managed both astronomical and solar observatory programs from December 1967). The Goddard Space Flight Center was responsible for the individual flight projects (see the following tables for project managers), with the launches taking place at the Eastern Test Range. Ball Brothers Research Corporation of Boulder, Colorado, designer of the spacecraft, was the prime contractor. The firm has worked with Goddard on the design even before the first OSO contract was awarded in October 1959. The experimenters involved with the program were from Goddard, NASA's Ames Research Center, the University of Rochester, the University of California at San Diego, Harvard, the Naval Research Laboratory, the University of Minnesota, the University of New Mexico, the Air Force Cambridge Research Laboratory, MIT, the University of Michigan, University College (London), and American Science and Engineering, Inc.

The Orbiting Solar Observatories opened a new era in solar astronomy, but the spacecraft had its limitations. To carry larger instruments with high spectral and spatial resolution, NASA proposed in 1962 an advanced OSO to carry on observations beyond the eight planned OSOs. After Goddard specialists had completed negotiations with Republic Aviation Corp. for such an advanced spacecraft, the project was cancelled because of budget cuts in late 1965. However, each succeeding OSO flight offered investigators new opportunities to confirm their data and improve their instruments. In addition, *OSO 4* was able to carry 90 kilograms more payload than *OSO 1*.

For more information, consult GSFC, *Orbiting Solar Observatory Satellite, OSO 1, the Project Summary*, NASA SP-57 (Washington, 1965); [Alfred Rosenthal and William R. Corliss], *Encyclopedia of Satellites and Sounding Rockets, August 1959 to December 1969* (Beltsville, MD: GSFC [1970]); and Corliss, *Scientific Satellites*, NASA SP-133 (Washington, 1967).

Table 1-105.
Chronology of Orbiting Solar Observatory (OSO)

Date	Event
April 16, 1959	Measurements of the sun from a spacecraft with pointing controls were included among NASA's immediate space science flight program objectives.
Aug. 17, 1959	An Orbiting Solar Observatory (OSO) was included in an "Office of Space Sciences Ten Year Program" document (pp. VII-15 through 17, table VII-8) as one of the solar physics projects underway at the Goddard Space Flight Center (GSFC), with Ball Brothers Research Corp. being considered a potential prime contractor; the first launch was tentatively scheduled for December 1960.
By Sept. 30, 1959	Goddard and Ball Brothers had completed part of the preliminary engineering for an OSO to weigh about 136 kilograms.
Oct. 1959	The first contract with Ball Brothers for OSO instrumentation was signed (\$250 000, initial funding); additional contracts were awarded in 1961.
March 7, 1962	<i>OSO 1</i> was launched successfully.
Aug. 15, 1962	NASA awarded three study contracts for the design of a new series of spacecraft with which to study the sun (Ball Brothers, Republic Aviation, and Space Technology Laboratories, \$100 000 each).
Oct. 22, 1962	NASA and Republic initiated discussions for a development studies contract for an advanced OSO (\$1.9 million estimated contract).
Feb. 6, 1964	The General Accounting Office reported to Congress that NASA had incurred \$799 000 in unnecessary costs on OSO because of mismanagement.
April 14, 1964	OSO-B's third-stage launch vehicle motor (X-248) ignited accidentally while mated to the spacecraft at Goddard; three men were killed. Some parts were salvaged for OSO-B2.
Feb. 3, 1965	<i>OSO 2</i> was launched successfully.
April 16, 1965	NASA signed a contract with Ball Brothers to build two more OSOs (\$9.6 million).
Aug. 25, 1965	OSO-C failed to achieve orbit due to launch vehicle malfunction.
Aug. 30, 1965	NASA negotiated with Ball Brothers to purchase three more OSOs, bringing the total to eight.
Oct. 1, 1965	Goddard and Republic completed negotiations for an advanced OSO (\$58.4 million, estimated contract).
Dec. 15, 1965	An advanced OSO development program was cancelled because of budgetary considerations.
March 8, 1967	<i>OSO 3</i> was launched successfully.
Oct. 18, 1967	<i>OSO 4</i> was launched successfully.
April 10, 1968	A request for proposals for OSO-H was issued by Goddard.

Table 3-106.
OSO 1 (OSO-A) Characteristics

Date of launch (location):	March 7, 1962 (ETR)
Launch vehicle:	Thor-Delta
Weight (kg):	199.6
Shape:	2 main sections, each capable of movement; fan-shaped sail with solar cells atop a lower wheel-like structure composed of 9 wedge-shaped compartments; 3 stabilization arms
Dimensions (m):	Upper Section, diameter, 1.12 Lower section, diameter, 1.12; height, .23 Overall height, .95
Power source:	NiCd batteries plus solar cells
Date of reentry:	Oct. 8, 1981
Cognizant NASA center:	GSFC
Project manager, scientist:	John C. Lindsay
Contractor:	Ball Brothers Research Corp., spacecraft and integration
Objectives:	Measure solar electromagnetic radiation in ultraviolet, x-ray, and gamma ray regions; investigate dust particles in space; improve future spacecraft design.
Experiments, responsible institution:	X-ray spectrometer, GSFC Gamma ray monitor, GSFC X-ray monitors, GSFC Dust particle experiment, GSFC Emissivity stability, ARC Photoelectric error sensor stability, Ball Brothers Solar radiation, GSFC Solar ultraviolet radiation, GSFC Solar gamma ray radiation, GSFC Earth horizon sensor, GSFC High-energy gamma ray, University of Rochester Neutron flux, University of California at San Diego Proton-electron flux, University of California at San Diego
Results:	Collected 2000 hours of data; detected rapid fluctuations in the x-ray flux emitted by the sun and a correlation between the temperature of earth's upper atmosphere and the intensity of ultraviolet radiation from the sun striking the atmosphere. Tracking and data operations for the spacecraft ceased on August 6, 1963.

Table 3-107.
OSO 2 (OSO-B2) Characteristics

Date of launch (location):	Feb. 3, 1965 (ETR)
Launch vehicle:	Thor-Delta
Weight (kg):	247.2
Shape:	2 main sections, each capable of movement; fan-shaped sail with solar cells atop a lower wheel-like structure composed of 9 wedge-shaped compartments; 3 stabilization arms
Dimensions (m):	Upper section, diameter, 1.12 Lower section, diameter, 1.12; height, .23 Overall height, .95
Power source:	NiCd batteries plus solar cells
Date of reentry:	In orbit
Cognizant NASA center:	GSFC
Project manager:	L. T. Hogarth
Project scientist:	John C. Lindsay
Contractor:	Ball Brothers Research Corp., spacecraft and integration
Objectives:	Continue studies of solar x-ray, gamma ray, and ultraviolet emissions, with added capability to scan entire solar disc and part of the corona.
Experiments, responsible institution:	Ultraviolet spectrometer, Harvard Solar x-ray and ultraviolet imaging, NRL White light coronagraph, NRL Zodiacal light, University of Minnesota High-energy gamma ray, University of New Mexico Low-energy gamma ray, GSFC Astronomical ultraviolet spectrometer, GSFC Emissivity stability, ARC
Results:	Successful return of data from 4100 orbits; placed in coasting mode on November 29, 1965 after exceeding its operating life expectancy by 50 percent.

Table 3-108.
OSO-3 (OSO-E) Characteristics

Date of launch (location):	March 8, 1967 (ETR)
Launch vehicle:	Thor-Delta
Weight (kg):	284.4
Shape:	2 main sections, each capable of movement; fan-shaped sail with solar cells atop a lower wheel-like structure composed of 9 wedge-shaped compartments; 3 stabilization arms
Dimensions (m):	Upper section, diameter, 1.12 Lower section, diameter, 1.12; height, .23 Overall height, .95
Power source:	NiCd batteries plus solar cells
Date of reentry:	Apr. 4, 1982
Cognizant NASA center:	GSFC
Project manager:	L. T. Hogarth
Project scientist:	W. E. Behring
Contractor:	Ball Brothers Research Corp., spacecraft and integration
Objectives:	Obtain high-resolution spectral data
Experiments, responsible institution:	X-ray spectrometer, GSFC Ultraviolet spectrometer, Air Force Cambridge Research Lab Gamma ray telescope, MIT Particle detector and gamma ray telescope, University of Rochester X-ray telescope, University of California, San Diego Solar x-ray detector, University of Michigan Technological instrumentation, ARC
Results:	Observed changes in the ultraviolet spectrum during solar flares; collected data significant for aeronomy; still transmitting scientific data on command.

Table 3-109.
OSO 4 (OSO-B2) Characteristics

Date of launch (location):	Oct. 18, 1967 (ETR)
Launch vehicle:	Thor-Delta
Weight (kg):	276.7
Shape:	2 main sections, each capable of movement; fan-shaped sail with solar cells atop a lower wheel-like structure composed of 9 wedge-shaped compartments; 3 stabilization arms
Dimensions (m):	Upper section, diameter, 1.12 Lower section, diameter, 1.12; height, .23 Overall height, .95
Power source:	NiCd batteries plus solar cells
Date of reentry:	June 15, 1982
Cognizant NASA center:	GSFC
Project manager:	L. T. Hogarth
Project scientists:	W. E. Behring
Contractor:	Ball Brothers Research Corp., spacecraft and integration
Objectives:	Obtain high-resolution spectral data
Experiments, responsible institution:	Ultraviolet spectrometer-spectroheliograph, Harvard Solar x-ray spectroheliograph, ASE (?) Solar x-ray spectrometers, NRL; University College (London) Geocorona hydrogen Lyman alpha telescope, NRL X-ray monitor, NRL Earth proton-electron telescope, University of California Solar monochromator, University College (London)
Results:	Returned the first photographs of the corona over the whole face of the solar disc; still provides data on command.

Orbiting Astronomical Observatories

Since Galileo began telescopic observations in the mid-17th century, observers have been monitoring and measuring atmospheric phenomena. With the advent of rocket-launched observatories, scientists were able to enhance the quality of their results by placing their instruments above earth's obscuring atmosphere. Experiments borne by balloons, sounding rockets, and high-flying aircraft gave investigators brief glimpses above the atmosphere, but what was needed was a large stable orbiting platform on which they could place their telescopes, photometers, and other measuring devices. The Orbiting Astronomical Observatory (OAO) was one of the first long-range projects planned by NASA's Office of Space Sciences.

Octagonal in shape with solar paddles, the aluminum OAO spacecraft was precisely stabilized and had a hollow cylindrical central tube in which experiments could be housed. The spacecraft was designed to point in any direction with an accuracy of 1 minute of arc during the observation of an individual star, with the accuracy being increased to 0.1 second of arc using sensors associated with the experiment instrumentation. Of the two OAOs launched during NASA's first 10 years, the first failed one and a half days into the mission because of a power system malfunction. The loss of this complex, expensive observatory without any data having been

returned led to an extensive review of the spacecraft's design and some systems modifications. *OAO 2* was a highly successful spacecraft, providing an abundance of information on ultraviolet, gamma ray, x-ray, and infrared radiation, on the structure of stars, and on the distribution and density of the interstellar medium.

A physics and astronomy project, the Orbiting Astronomical Observatory was managed at NASA Headquarters by Allan H. Sures from June 1963 until early 1966, when C. Dixon Ashworth took this position (Ashworth managed both OAO and OSO from December 1967). While personnel at Ames Research Center prepared the preliminary engineering specifications for OAO, technical management of the flight projects was assigned to the Goddard Space Flight Center in February 1960 (see the following tables for project managers). Grumman Aircraft Engineering Corp., Bethpage, New York, was the prime contractor for OAO. Major subsystem contractors included General Electric, Radio Corporation of America, IBM, Westinghouse, and Kollsman Instrument Corp. The scientific investigators were recruited from Goddard, Lockheed, MIT, the University of Wisconsin, and the Smithsonian Astrophysical Observatory.

For more information, see Alfred Rosenthal and William R. Corliss, *Encyclopedia of Satellites and Sounding Rockets, August 1959 to December 1969* (Beltsville, MD: GSFC, 1970); Corliss, *Scientific Satellites*, NASA SP-133 (Washington, 1967); Robert S. Rudney, "A Preliminary History of the OAO Program (1966-1968)," NASA HHN-115, Sept. 1971, prepared for NASA Historical Off.; GSFC, *The Observatory Generation of Satellites, Session II of a Special Astronautics Symposium Held at the Franklin Institute, Philadelphia, December 27, 1962, during the 129th Annual Meeting of the American Association for the Advancement of Science* (Washington, 1963); and James E. Kupperian, Jr., and Robert R. Zeimer, "Satellite Astronomy," *International Science and Technology* (March 1962): 48-56.

Table 3-110.
Chronology of Orbiting Astronomical Observatories (OAO) Development and Operations

Date	Event
May 15, 1958	In a preliminary study, the staff at the Langley Memorial Aeronautical Laboratory (National Advisory Committee for Aeronautics) suggested that the new civilian space agency consider stabilized and oriented astronomical observatories as a long-range goal with practical equipment being provided by 1960.
Oct. 1958 March 1959	NASA established a working group under Nancy Roman to study the feasibility of launching large orbiting astronomical observatories.
April 1959	Stable orbiting platforms with telescopes to make observations in the infrared, optical, ultraviolet, and x-ray regions of the spectrum beyond earth's obscuring atmosphere were proposed as part of the space sciences long-range flight program.
Dec. 1, 1959	An OAO project briefing was held at NASA Hq. for potential industry participants to provide further information on requirements and planning (150 attendees).
Feb. 1960	Technical management of OAO was assigned to the Goddard Space Flight Center.
Apr. 1960- Sept. 1960	Having circulated OAO design specifications, NASA evaluated the 11 proposals received for an OAO spacecraft. Experiments suitable for an OAO were under way at Goddard, Princeton, the University of Wisconsin, Smithsonian Astrophysical Observatory, and the University of Michigan Observatory.
Oct. 10, 1960	NASA announced plans to negotiate with Grumman Aircraft Engineering Corp. for a contract for a 1360-kilogram OAO (\$23 million contract estimate).
Oct. 1960- June 1961	Grumman negotiated four subsystem development contracts: General Electric, spacecraft stabilization and control; Radio Corp. of America, television scanner; IBM, data processing; and Westinghouse Electric Corp., ground operating equipment.
April 1961	Booz-Allen Company was awarded a contract for a study of an independent NASA reliability control program for OAO.
Jan. 1962	Kollsman Instrument Div. was awarded a contract for the primary mirror for the OAO telescope.
Aug. 7, 1962	GE announced that the control system for OAO had completed its first simulated flight tests.
Oct. 29, 1962	Three photometers developed for OAO were flight-tested on an Aerobee sounding rocket launched from Wallops Island.
Feb. 24, 1964	General Dynamics/Astronautics was awarded a contract for the OAO shroud system.
June 16, 1964	NASA ordered a third OAO from Grumman and took an option for two more (\$20 million, estimated contract for one spacecraft; \$50 million for three).
April 9, 1965	Grumman was given the go-ahead to convert its prototype OAO into a flight-ready spacecraft to be called OAO-A2.
May 12, 1965	Grumman was awarded a contract for a fourth OAO.

Table 3-110.
Chronology of Orbiting Astronomical Observatories (OAO) Development and Operations
(Continued)

Date	Event
April 8, 1966	<i>OAO 1</i> was launched successfully and placed in circular orbit. After 1½ days (22 orbits), the spacecraft power system failed when the battery overheated. No data were returned.
April 21, 1966	A NASA review board was established to examine observatory-class satellites.
Dec. 23, 1966	NASA announced that Atlas-Centaur would replace Atlas-Agena D as the launch vehicle for future OAO missions; it would be capable of boosting 40 percent more payload.
Jan.-June 1967	OAO-A2 underwent extensive systems redesign to prepare it for flight; the launch date was slipped from 1967 to late 1968.
April 30, 1968	NASA ordered two additional Centaur rockets from General Dynamics Astronautics for OAO.
Dec. 7, 1968	OAO-2 was launched successfully and placed in orbit. All systems and experiments functioned as planned.

Table 3-111.
OAO 1 (OAO-A1) Characteristics

Date of launch (location):	April 8, 1966 (ETR)
Launch vehicle:	Atlas-Agena D
Weight (kg):	1769
Shape:	Octagonal with 6 solar panels
Dimensions (m):	3.1 × 5.2 Width with solar panels extended, 6.4
Power source:	NiCd batteries plus solar cells
Date of reentry:	In orbit
Cognizant NASA center:	GSFC
Project manager:	Robert R. Ziemer
Project scientist:	James E. Kupperian
Contractors:	Grumman Aircraft Engineering Corp., prime General Electric Co., stabilization and control subsystem Radio Corp. of America, TV scanner IBM, data processing Westinghouse Electric Corp., ground operating equipment Kollsman Instrument Corp., primary mirror in OAO telescope
Objectives:	Make precise telescopic observations above the atmosphere; of special interest were emission and absorption characteristics of the sun, stars, planets, nebulae, and interplanetary and interstellar media in the infrared, ultraviolet, x-ray, and gamma ray regions of the spectrum.
Experiments, responsible institution:	Broad-band photometric studies of ultraviolet, University of Wisconsin Gamma ray telescope, MIT X-ray proportional counter, Lockheed Gamma ray telescope, GSFC

Table 3-111.
OAO 1 (OAO-A1) Characteristics (Continued)

Results:	Spacecraft failed after 1½ days (22 orbits) because of battery malfunction; when the battery overheated the power supply system would not respond to ground commands to switch over to the two backup batteries; no data received.
Remarks:	As a result of this failure, <i>OAO 2</i> 's power system was redesigned. <i>OAO 1</i> 's loss forced NASA's managers to function as a review team as they scrutinized and reworked a design they had previously judged to be satisfactory.

Table 3-112.
OAO 2 (OAO-A2) Characteristics

Date of launch (location):	Dec. 7, 1968 (ETR)
Launch vehicle:	Atlas-Centaur
Weight (kg):	1995.8
Shape:	Octagonal with 8 solar panels
Dimensions (m):	3.1 × 5.2 Width with solar panels extended, 6.4
Power source:	NiCd batteries plus solar cells
Date of reentry:	In orbit
Cognizant NASA center:	GSFC
Contractors:	Grumman Aircraft Engineering Corp., prime For subsystem contractors, see <i>OAO 1</i> (table 3-111).
Objectives:	Survey ultraviolet spectra and helium content of hot, young stars; study ultraviolet spectra of giant stars; study distribution and density of interstellar gas.
Experiments, responsible institution:	Ultraviolet photometer package, University of Wisconsin, Smithsonian Astrophysical Observatory Telescope (4305mm telescopes with TV imaging photometers)
Results:	All systems and experiments functioned as planned, providing among other things a detailed map of a significant portion of the celestial sphere; spacecraft was turned off on February 13, 1973, after the experiments' power system failed, but the spacecraft had far exceeded its expected lifetime.
Remarks:	Changes in the design resulted in less dependence on ground commands, better experiment efficiency, and an ability to work around component failures.

Orbiting Geophysical Observatories

NASA's early scientific satellites were necessarily tailor-made to suit the available launch vehicles and the scientific instruments required for the specific investigations. Besides leading to a variety of configurations, this practice was not a particularly economic way to build spacecraft. Engineers at the Goddard Space Flight Center in 1959-1960 suggested a standardized satellite design into which many experiments could be incorporated (called the "streetcar" principle); the same basic satellite could be used for several different missions. Since the satellites could be fabricated independently of the scientific instruments and on more of a mass-production scale, it would save time and money. As geophysical studies covered such a broad range of investigations (atmospheric composition, solar emissions, radio astronomy) and required many different measurements, this field would be well served by such a versatile spacecraft.

Called the Orbiting Geophysical Observatory (OGO), the large spacecraft could house 20 or more experiments. Scientists also had their choice of orbits—polar (POGO), or highly eccentric, or elliptic (EGO). This made observations possible near earth or in cislunar space. Three-axis stabilization of the $.9 \times .9 \times 1.8$ -meter OGO could accommodate investigations that demanded precise orientation for long periods. Several booms and antennas added to the craft's versatility. Unfortunately, all five OGO spacecraft flown in the agency's first decade encountered attitude control problems, and the spacecraft spun about their axes instead of orbiting in a stable manner. This seriously degraded or reduced to zero the data available from many of the experiments. *OGO 6* flown in 1969, however, was highly successful. Despite their technical problems, *OGO 1* through *5* sent back over a million hours of data that helped scientists gain a broader understanding of earth and earth-sun relationships and made precise measurements of magnetic and electric fields, cosmic rays, and solar particles.

OGO, a physics and astronomy program, was managed at NASA Headquarters by C. Dixon Ashworth from mid-1963 until mid-1966, by Marcel T. Aucremanne until September 1968, and then by Thomas L. Fischetti, who acted as manager through the remainder of the agency's first 10 years. Goddard monitored the prime contractor, TRW of Redondo Beach, California, and the scientific investigators, in addition to integrating the many scientific instruments into the spacecraft (see following tables for project managers). Major subcontractors included Gulton Industries, battery cells; Minneapolis-Honeywell, gyroscopes; American Standard, Advanced Technology Div., horizon scanners; ITT Industrial Products Div., power converters; Bendix Eclipse Pioneer Div., reaction wheels; Hoffman Electronics, solar cells; Kinetics, static inverters; RCA, Astro-Electronics Div., tape recorders; and Ampex, tape transporters.

Although the Orbiting Geophysical Observatory program was not as successful nor as efficient as its initiators had planned, it rewarded most of the scientists involved with a steady stream of significant measurements and observations. OGO also represented a significant step in the evolution of satellites—from tailor-made one-instrument packages to automated orbiting laboratories.

The best single source on OGO, especially concerning the scientific instruments, is John E. Jackson and James I. Vette, *OGO Program Summary*, NASA SP-7601 (Washington, 1975). It has an extensive bibliography.

Table 3-113.
Chronology of Orbiting Geophysical Observatory (OGO)
Development and Operations

Date	Event
May 15, 1958	In a preliminary study, the staff at the Langley Memorial Aeronautical Laboratory (National Advisory Committee for Aeronautics) suggested that the new civilian space agency consider a large satellite-platform with stable orientation for geophysical measurements as a long-range goal.
April 1959	An orbiting observatory was recognized as a long-range flight project by NASA's Office of Space Science for measuring particle flux, solar radiation, and magnetic and electric fields.
Mid-1959- mid-1960	Personnel at the Goddard Space Flight Center did preliminary design work on a new-generation satellite with a standard structure into which many experiments could be integrated from mission to mission.
July 1960	Eccentric and polar orbit missions were considered for ionospheric physics investigations.
Aug. 30, 1960	A bidder's conference was held at Goddard for 17 companies interested in constructing an Orbiting Geophysical Observatory, a 450-kilogram-class satellite.
Dec. 21, 1960	NASA issued a letter contract to Space Technology Laboratories, Inc. (later a division of TRW) to proceed with preliminary analytical and design studies for three OGOS (\$15 million).
April 1961	NASA and STL agreed on a 400-kilogram box-like structure for OGO with movable solar panels and extendable booms.
Dec. 19, 1961	NASA selected 19 experiments for OGO-A.
Aug. 3, 1962	TRW received a definitive contract for OGO.
Dec. 1963	Experiments installed in the first spacecraft underwent environmental testing.
April 1964	NASA began negotiations with TRW to provide a fourth and fifth OGO.
June 1964	OGO-A was transported to the Kennedy Space Center for final assembly, checkout, and integration with the launch vehicle.
Sept. 5, 1964	OGO 1 was launched into eccentric orbit, but an attitude control system failure left the spacecraft in a fixed position.
Oct. 14, 1965	OGO 2 was launched into polar orbit.
Oct. 24, 1965	OGO 2 ceased operations after its attitude control system gas supply was depleted; the spacecraft was put into a spin mode with some of its experiments still working.
Jan. 24, 1966	NASA began contract negotiations with TRW for a sixth OGO.
April 1966	OGO 1's batteries failed, leaving three experiments operational.
June 6, 1966	OGO 3 was launched into eccentric orbit.
July 27, 1966	OGO 3 was placed into a fixed spin mode after its attitude control system failed.
Aug. 1966	The House Science and Astronautics Committee on NASA Oversight began inquiries into spacecraft failures, including OGO 1, 2, and 3.
July 28, 1967	OGO 4 was launched into polar orbit; attitude control problems detected after orbital insertion were corrected by ground control.

Table 3-113.
Chronology of Orbiting Geophysical Observatory (OGO)
Development and Operations (Continued)

Date	Event
Aug. 8, 1967	NASA modified TRW's fixed-price contract to a fixed-price-incentive contract.
Sept. 19, 1967	All four OGOS transmitted data simultaneously for the first time.
Nov. 1967	OGO 2 was shut down and put into a standby mode.
Jan. 29, 1968	Funds were approved for one additional OGO; after a proposed sixth mission the program would be phased out.
March 4, 1968	OGO 5 was launched into eccentric orbit.

Table 3-114.
OGO 1 (OGO-A) Characteristics

Date of launch (location):	Sept. 5, 1964 (ETR)
Launch vehicle:	Atlas-Agena B
Weight (kg):	487
Shape:	Rectangular parallelepiped with 2 6.7-meter and 4 1.8-meter booms for experiment sensors, plus several antennas and 2 solar paddles
Dimensions (m):	.9 × .9 × 1.8 Length with booms extended, 18 Width with solar panels extended and experiment booms, 15 Solar panels, 1.83 × 2.29
Power source:	NiCd batteries plus solar cells
Type of orbit:	Eccentric (EGO)
Date of reentry:	In orbit
Cognizant NASA center:	GSFC
Project manager:	Wilfred E. Scull
Project scientist:	George H. Ludwig
Contractor:	Space Technology Laboratories (later a div. of TRW), prime, plus 10 major subcontractors
Objectives:	In a highly eccentric orbit, make measurements and observations in earth's atmosphere and magnetosphere and in interplanetary space beyond earth's magnetic field.
Areas of investigation:	Cosmic rays, radio astronomy, solar emissions, and composition of interplanetary medium
Number of experiments:	20
Results:	The immediate failure of 2 booms to deploy properly caused the unscheduled use of attitude control gas, leaving the spacecraft in a fixed position. Because of this orientation, solar aspect was periodically unfavorable, resulting in a regular low-power period of 6 weeks every 4½ months. Although 6 of the 20 experiments could not function as planned, the data returned were judged to be valuable. Experiments were turned off November 25, 1969.

Table 3-115.
OGO 2 (OGO-C) Characteristics

Date of launch (location):	Oct. 14, 1965 (ETR)
Launch vehicle:	Thrust-augmented Thor-Agena D (TAT)
Weight (kg):	520
Shape:	Rectangular parallelepiped with 2 6.7-meter and 4 1.8-meter booms for experiment sensors, plus several antennas and 2 solar paddles
Dimensions (m):	.9 × .9 × 1.8 Length with booms extended, 18 Width with solar panels extended and experiment booms, 15 Solar panels, 1.83 × 2.29
Power source:	AgCd batteries plus solar cells
Type of orbit:	Polar (POGO)
Date of reentry:	Sept. 17, 1981
Cognizant NASA center:	GSFC
Project manager:	Wilfred E. Scull
Project scientist:	N. W. Spencer
Contractor:	TRW, prime, plus 10 major subcontractors
Objectives:	Take geophysical measurements of the near-earth environment during a period of low solar activity to study earth-sun relationships.
Areas of investigation:	Particles and fields, solar emissions, and magnetic field measurements (as part of International Quiet Sun Year World Magnetic Survey)
Number of experiments:	20
Results:	Because of difficulties in maintaining earth-lock with the horizon scanners, the attitude control gas supply was exhausted by October 23, and the spacecraft began to spin, rendering five experiments useless and degrading six others. Two experiments had failed soon after launch. Battery failure occurred by April 1966, leaving eight experiments operational. Before the spacecraft was shut down and put on standby in November 1967, it had produced more than 72 000 hours of data. Operations were terminated on November 1, 1971.

Table 3-116.
OGO 3 (OGO-B) Characteristics

Date of launch	June 6, 1966 (ETR)
(location):	
Launch vehicle:	Atlas-Agena B
Weight (kg):	515
Shape:	Rectangular parallelepiped with 2 6.7-meter and 4 1.8-meter booms for experiment sources, plus several antennas and 2 solar paddles
Dimensions (m):	.9 × .9 × 1.8
	Length with booms extended, 18
	Width with solar panels extended and experiment booms, 15
	Solar panels, 1.83 × 2.29
Power source:	AgCd batteries plus solar cells
Type of orbit:	Eccentric (EGO)
Date of reentry:	In orbit
Cognizant NASA center:	GSFC
Project manager:	Wilfred E. Scull
Project scientist:	G. H. Ludwig
Contractor:	TRW, prime, plus 10 major subcontractors
Objectives:	Make correlated measurements within the magnetosphere and interplanetary space.
Areas of investigation:	Micrometeorites, optical and radio emissions, ionosphere, magnetic fields, trapped radiation, plasma, and cosmic rays
Number of experiments:	21
Results:	Maintained planned 3-axis stabilization for 46 days; a failure in the attitude control system in July 1966 forced the spacecraft into a permanent spin mode. By June 1969, data acquisition was limited to half of the orbit. Before operations were suspended in December 1969, 15 of the 21 experiments were still operating with more than 375 000 hours of data returned. Operations were terminated on February 29, 1972.

Table 3-117.
OGO 4 (OGO-D) Characteristics

Date of launch (location):	July 27, 1967 (WTR)
Launch vehicle:	Thrust-augmented Thor-Agena D (TAT)
Weight (kg):	562
Shape:	Rectangular parallelepiped with 2 6.7-meter and 4 1.8-meter booms for experiment sensors, plus several antennas and 2 solar paddles
Dimensions (m):	.9 × .9 × 1.8 Length with booms extended, 18 Width with solar panels extended and experiment booms, 15 Solar panels, 1.83 × 2.29
Power source:	AgCd batteries plus solar cells
Type of orbit:	Polar (POGO)
Date of reentry:	Aug. 16, 1972
Cognizant NASA center:	GSFC
Project manager:	Wilfred E. Scull
Project scientist:	N. W. Spencer
Contractor:	TRW, prime, plus 10 major subcontractors
Objectives:	Take geophysical measurements in the near-earth environment and study earth-sun relationships during a period of increased solar activity.
Areas of investigation:	Cosmic rays, magnetic field, radio measurements, and the atmosphere-ionosphere
Number of experiments:	20
Results:	An attitude control problem detected after orbital insertion was corrected by ground control, and 3-axis stabilization was maintained for 18 months, after which the tape recorder failed. The spacecraft was placed in a spin-stabilized mode in January 1969 and put on standby status in October 1969 with 3 reactivations in 1970 and 1971. Operations were terminated on September 27, 1971.

Table 3-118.
OGO 5 (OGO-EB) Characteristics

Date of launch (location):	March 4, 1968 (ETR)
Launch vehicle:	Atlas-Agena D
Weight (kg):	611
Shape:	Rectangular parallelepiped with 2 6.7-meter and 4 1.8-meter booms for experiment sensors, plus several antennas and 2 solar paddles
Dimensions (m):	.9 × .9 × 1.8 Length with booms extended, 18 Width with solar panels extended and experiment booms, 15 Solar panels, 1.83 × 2.29
Power source:	AgCd batteries plus solar cells
Type of orbit:	Eccentric (EGO)
Date of reentry:	In orbit
Cognizant NASA center:	GSFC
Project manager:	Wilfred E. Scull
Project scientist:	J. P. Heppner
Contractor:	TRW, prime, with 10 major subcontractors
Objectives:	Conduct many diversified geophysical experiments to obtain a better understanding of earth as a planet; study earth-sun relationships.
Areas of investigation:	Particles and fields, radio astronomy, and solar emissions
Number of experiments:	25
Results:	All systems operated normally for 41 months. The attitude control system failed in August 1971, and the spacecraft was placed on standby mode the following October, with a period of reactivation in 1972. Provided first observations of the hydrogen cloud surrounding earth and first detailed measurements of electric fields at the shock and magnetosphere boundaries. Most successful OGO to date. Operations were terminated on July 14, 1972.

Sounding Rockets

The sounding rocket story begins long before NASA's organization in 1958. As early as July 1929, Robert H. Goddard included two measuring instruments on one of his test rockets, and in 1933 Mikhail K. Tikhonoravov, a Russian, launched a liquid-fuel sounding rocket. At last, scientists could send their instruments into and above earth's atmosphere to make *in situ* measurements. Early investigators had taken their measuring devices to high mountains and exploited high-flying balloons when they became available, but this still limited their area of study to about 40 kilometers, the maximum balloon altitude. But rockets, which could surpass that altitude several times, could be instrumented and fired along a vertical or nearly vertical trajectory, taking measurements on the way up and again as the rocket fell back to earth (a vertical profile).

The further refinement of small rockets after World War II offered scientists vehicles that could carry a few hundred kilograms of instruments to altitudes exceeding 250 kilometers for several minutes of observation time above the atmosphere.

As scientists learned to build compact, sturdy instruments, rocket designers further improved vehicle control systems and extended the altitudes rockets could reach by increasing their power. Hundreds of rocket soundings gave specialists clues about the composition of the ever-changing upper atmosphere and ionosphere, and crude pictures of weather patterns taken of high altitudes hinted at the practical value these vehicles would have. But it was during the International Geophysical Year (IGY), July 1957 to December 1958, that the first "concerted systematic application of sounding rockets to upper atmosphere and space research" took place. The U.S. alone launched 200, with other countries firing hundreds more. High-altitude wind patterns were measured, along with pressure, density, and other parameters of the atmosphere. Regions of electron densities were mapped and new theories about earth's magnetic field established. Several kinds of solar emissions were studied, and some limited micrometeoroid influx data were obtained. But this explosion of scientific information obtained from soundings was overshadowed by the introduction of earth-orbiting satellites flown by the Soviet Union and the United States during the IGY.

The advantages of satellites were obvious. They could stay in orbit for long periods of time, reaching higher altitudes and giving investigators a look at the geographical "big picture." But sounding rockets, though not as glamorous as satellites or manned flights, continued to be popular, useful research tools. Sounding rockets were simpler than most satellites with fewer mechanical interfaces to match. Because they could be mass produced and launched without lengthy preparations, there was a shorter lead time for the experimenter; he did not have to plan years ahead for a sounding rocket flight as was often required for satellite payloads. And sounding rockets were much less costly, allowing universities, private research laboratories, and industries who could not afford multimillion-dollar satellites to take advantage of space research. Finally, some investigations could be adapted more easily to the brief flights of sounding rockets; also, satellites could not operate below 250 kilometers, leaving this region to be investigated and measured by soundings.

When NASA came into being in 1958, some members of the Naval Research Laboratory Rocket-Sonde Research Branch, formed in 1945 to develop small rockets that could carry scientific instruments, were transferred to NASA and assigned to the new Beltsville Space Center (called Goddard Space Flight Center after 1959) in Maryland. This group formed the core of the agency's sounding rocket team, and management of sounding projects became a permanent Goddard assignment. Within the space and satellite applications directorate at Goddard, sounding rockets were part of the Spacecraft Integration and Sounding Rocket Division, which was led by Robert C. Baumann (formerly part of NRL's Project Vanguard team) during the center's first decade. He was assisted by Karl R. Medrow, head of the sounding rocket branch. At NASA Headquarters from 1958 through 1961, sounding rockets were under the purview of the Office of Space Flight Programs. Morton J. Stoller was assistant director for satellites and sounding rocket programs in 1960-1962. In a 1962 reorganization, William C. Spreen became chief of meteorological soundings within the Office of Applications, and Spreen continued to manage this part of the sounding program through various Headquarters reorganizations. The scientific soundings were managed by the physics and astronomy director. In mid-1963, John R. Holtz became program manager for Explorer and sounding rockets and remained in this post through 1968.

Sounding rocket data contributed to many fields of investigation (see table 3-119), including aeronomy, biology, fields and particles, ionospheric and solar physics, and astronomy. The investigators and their instruments came from a great many places in the U.S. and from several foreign countries. Universities were well represented, as were private and corporate laboratories that could make use of high-altitude research data. Japan, New Zealand, Australia, India, Pakistan, Israel, Germany, France, Argentina, and Brazil sponsored or participated in sounding rocket experiments with NASA. Scientists at Goddard, of course, were the most frequent users of small instrumented rockets. Besides soundings for scientific purposes, the vehicles were also used to flight-test experiments or components that were due to fly on satellites. And measurements of radiation taken by soundings supported Mercury and Apollo manned missions. As rockets and instruments became more and more sophisticated, the number of soundings increased—from 16 in 1959, to 93 in 1963, to 174 in 1968.

The rockets NASA used for soundings from 1959 to 1968 were relatively simple and very small when compared to standard launch vehicles used to boost satellites and manned spacecraft. The Aerobee family, developed by Aerojet in the late 1940s, was used extensively to carry a variety of payloads weighing up to 227 kilograms to a maximum altitude of 483 kilometers. A series of all-solid-propellant sounding rocket configurations using the Nike booster paired with an Apache, Asp, Cajun, or Tomahawk upper stage sent hundreds of scientific payloads of up to 45 kilograms to an altitude up to 322 kilometers. Other vehicles flown by NASA included the small Arcas (meteorological soundings), the Astrobe 1500, the Canadian-built Black Brant IV, the large Javelin and Journeyman (also called the Argo series), and the British Skylark (see following tables for more information). All the slender rockets had three or four stabilizing fins, but attitude control, telemetry, and recovery systems varied from vehicle to vehicle.

Many sounding rockets were small and could be launched from any number of ranges without long lead times or elaborate preparations. Some could even be launched from ships, and the tiny Arcas was tube-launched. Launch facilities at Wallops Island, Virginia, Fort Churchill (Canada), and White Sands, New Mexico, were used most often by NASA; however, many soundings were launched from other American ranges and from Puerto Rico, Brazil, Australia, Norway, Pakistan, and Sweden. Rail launching was the method of firing required by most sounding rockets.

For more information on the early history of American sounding rockets, see Homer E. Newell, Jr., *High Altitude Rocket Research* (New York: Academic Press, 1953); and Newell, ed., *Sounding Rockets* (New York: McGraw-Hill, 1959). For a look at NASA's sounding rocket program, see William R. Corliss, *NASA Sounding Rockets, 1958-1968: A Historical Summary*, NASA SP-4401 (Washington, 1971); Alfred Rosenthal and William R. Corliss, *Encyclopedia of Satellites and Sounding Rockets, August 1959 to December 1969* (Beltsville, MD: GSFC [1970]); and Rosenthal, *Venture into Space: Early Years of Goddard Space Flight Center*, NASA SP-4301 (Washington, 1968), pp. 121-30, 181-202. (These three books have comprehensive lists of NASA sounding rocket missions.) For information on sounding rocket launches at Wallops, see Joseph A. Shortal, *A New Dimension; Wallops Island Flight Test Range: The First Fifteen Years*, NASA Ref. Pub. 1028 (Washington, 1978), pp. 541-614.

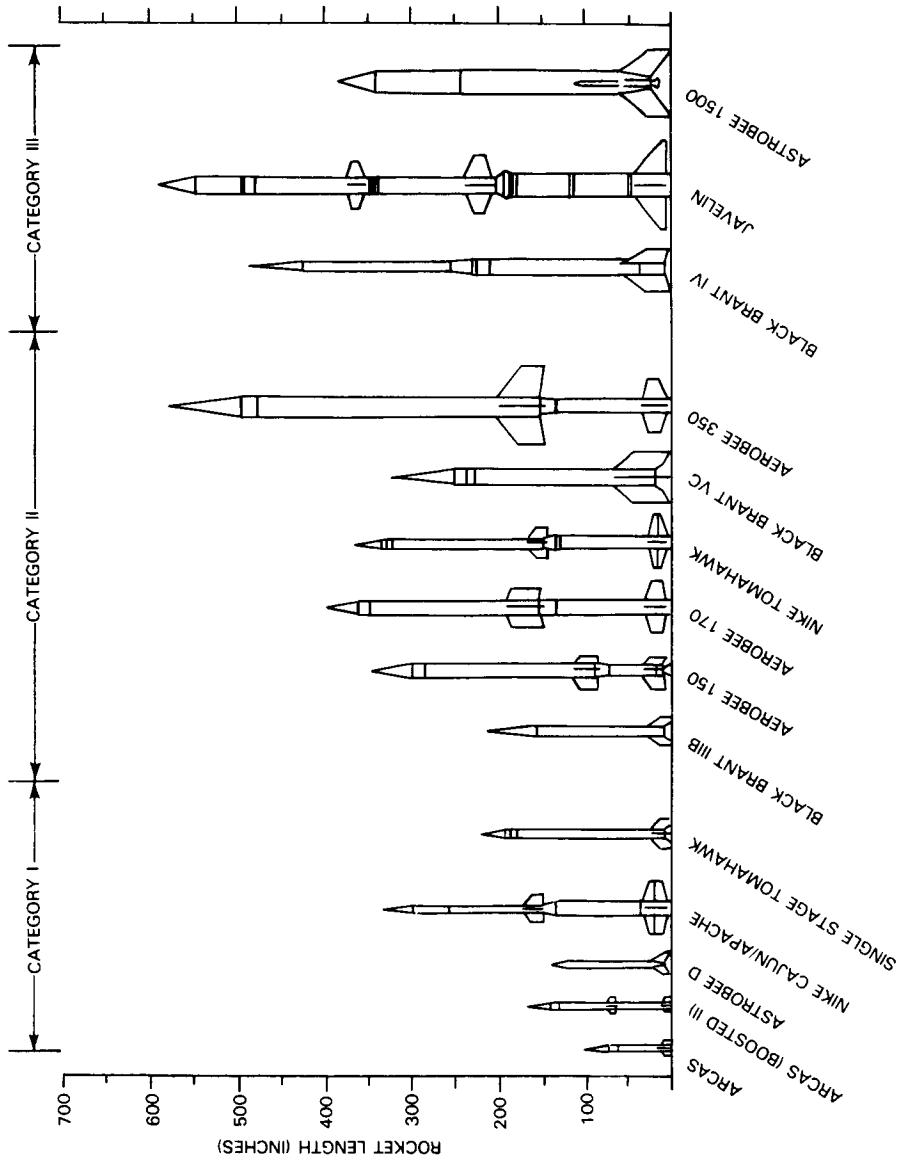

Figure 3-2. NASA Sounding Rockets

Table 3-119.
Number of Soundings by Field of Investigation

Discipline	Year										10-year total
	1959	1960	1961	1962	1963	1964	1965	1966	1967	1968	
Aeronomy	5	10	21	30	35	51	45	31	28	31	287
Biology	0	0	2	0	0	0	0	0	1	2	5
Energetic particles	0	16	1	0	2	16	15	14	11	21	96
Fields	0	2	3	0	1	9	13	5	12	12	57
Galactic astronomy	0	4	5	4	5	11	10	11	16	19	85
Ionospheric physics	4	8	10	14	27	22	46	25	20	21	197
Meteorology	0	5	13	14	11	34	53	59	57	48	294
Radio astronomy	0	0	0	1	0	1	2	1	1	1	7
Solar physics	0	4	1	2	6	1	5	9	10	12	50
Test and miscellaneous	7	11	14	13	6	7	2	3	6	7	76
Total	16	60	70	78	93	152	191	158	162	174	1154

From William R. Corliss, *NASA Sounding Rockets, 1958-1968: A Historical Summary*, NASA SP-4401 (Washington, 1971), p. 146.

Table 3-120.
Sounding Rocket Projects Summary, 1959-1968

	1959	1960	1961	1962	1963	1964	1965	1966	1967	1968	10-yr Total	Success (%)
Aerobee		4	8	2							14	92
Aerobee 150/150A	4	11	8	20	30	26	29	29	35	37	229	94
Aerobee 300/300A		3	2	1	2	2	1				11	100
Aerobee 350							1	1			2	100
Arcas							13	9	16	6	44	95
Arcon	6										6	100
Astrobee 1500					1	1			2	1	5	80
Black Brant IV										2	2	100
Iris		2	1	1							4	75
Javelin	1	5	8	2	2	7	7	6	9	4	51	94
Journeyman		1	2	1	1		2				7	100
Nike-Apache			5	11	36	76	92	57	48	50	375	98
Nike-Asp	5	10	8	3	1						27	63
Nike-Cajun		24	23	37	20	38	43	43	35	38	301	97
Nike-Tomahawk							3	12	15	30	60	98
Skylark			4								4	100
Special (other)			1			2		1	2	6	12	83
Totals	16	60	70	78	93	152	191	158	162	174	1154	

From Alfred Rosenthal and William R. Corliss, *Encyclopedia of Satellites and Sounding Rockets, August 1959 to December 1969* (Beltsville, MD: GSFC [1970]), p. 320.

Table 3-121.
Chronology of Sounding Rockets Development and Operations

Date	Event
1919	Robert H. Goddard suggested in <i>A Method of Reaching Extreme Altitudes</i> that rockets could be used for upper atmosphere research.
July 17, 1929	An aneroid barometer and a thermometer were included on a test of one of Goddard's rockets, which attained an altitude of 52.1 meters.
1933	Mikhail K. Tikhonoravov launched an instrumented liquid-fueled sounding rocket in the Soviet Union.
Dec. 1934	The A-2 rocket, a predecessor to the V-2, was launched by the German Army.
1935	Russian F. A. Tsander designed an instrumented rocket that reached an altitude of 11 kilometers.
Jan. 1944	The U.S. Army Signal Corps expressed a need for a high-altitude sounding rocket that could carry 11.3 kilograms of meteorological instruments.
1944-1945	Germany used the V-2 (A-4) rocket as a weapon during World War II; it could carry 907 kilograms of explosives to an altitude of about 322 kilometers.
July 1945	Live tests of the Baby Wac (Corporal) being designed by the Jet Propulsion Laboratory for upper atmosphere research were performed.
Sept. 26, 1945	The first launch of a Wac Corporal was successful; it reached an altitude of 70 kilometers.
Dec. 17, 1945	The Naval Research Laboratory (NRL) Rocket-Sonde Research Branch was formed to develop a sounding rocket to carry scientific instruments.
Jan. 16, 1946	An informal meeting was held at NRL to discuss the possibility of working with the Army Ordnance Department in implementing a scientific research program to use with the captured German V-2s, which the Army would launch from White Sands, New Mexico. After agreeing to cooperate with the Army, the group established a V-2 Upper Atmosphere Research Panel on February 27, which would include representatives from government, industry, and universities.
Feb. 22, 1946	Aerojet Engineering submitted a proposal to the Applied Physics Laboratory of Johns Hopkins to develop a sounding rocket capable of carrying a payload weighing from 136 to 680 kilograms to an altitude of 182 880 meters.
April 16, 1946	First U.S. launch of a V-2. A total of 67 V-2s were fired from White Sands as part of the Hermes program.
May 17, 1946	Aerojet was awarded a contract for 20 liquid-fuel rockets; 15 would go to the Applied Physics Laboratory and 5 to NRL; the Aerojet rocket was called Aerobee.
Aug. 1946	The Navy awarded contracts to Glenn L. Martin Co. and Reaction Motors for the construction of a rocket called Viking designed by NRL; NRL's rocket was capable of launching a payload larger than Aerobee's. The original contract called for 10 Vikings.
Nov. 24, 1947	First full-scale Aerobee launch took place.
May 3, 1949	Launch of Viking 1 from White Sands.
1952-1953	Aerojet developed an improved rocket, the Aerobee-Hi, for the Air Force and Navy.

Table 3-121.
Chronology of Sounding Rockets Development and Operations (Continued)

Date	Event
1953	NACA's Pilotless Aircraft Research Division mated a Nike I guided missile to the Deacon motor to form the Nike-Deacon configuration, which could launch 23 kilograms to an altitude of 111 kilometers.
Nov. 19, 1953	First firing of a Nike-Deacon took place.
1954	The University of Michigan's Aeronautical Engineering Department was funded by the Air Force to convert the Nike-Deacon into a sounding rocket.
April 8, 1955	First launch of a Nike-Deacon took place.
June 20, 1956	First firing of the Cajun motor took place. When the Cajun was combined with the Nike I guided missile, the resulting rocket could lift 23 kilograms to 167 kilometers.
July 6, 1956	First launch of a Nike-Cajun took place.
July 1957- Dec. 1958	During the International Geophysical Year (IGY), the U.S. launched 210 sounding rockets (mainly Aerobee His—the improved version of the Aerobee 150—and Nike-Cajuns).
Feb. 18, 1958	First firing of the improved Aerobee (Aerobee 150) took place. It was capable of launching 18 kilograms to 160 kilometers.
Oct. 25, 1958	First firing of the Aerobee 300 took place, an Aerobee 150 with a motor from the Sparrow missile.
Dec. 28, 1958	Some members of NRL's Rocket-Sonde Branch were transferred to NASA and assigned to the Beltsville Space Center (later called the Goddard Space Flight Center).
July 1959	First firings of the Arcas rocket developed by the Army and the Navy took place.
July 22, 1960	First firing of the Iris rocket designed by NRL (pre-NASA design) took place. It could send 45 kilograms to 320 kilometers.
March 1, 1965	NASA launched its first small Arcas rocket.
June 18, 1965	First launch of the Aerobee 350 sounding rocket took place.
Dec. 10, 1967	NASA launched a sounding rocket (an Aerobee 150) equipped with the solar pointing Aerobee rocket control system (SPARCS) developed at Ames Research Center.
May 7, 1968	NASA launched its first British Black Brant IV.

Table 3-122.
 Characteristics of NASA Sounding Rockets, 1977-1968

Rocket	Max. body diam. (m)	Length w./ payload (m)	Total weight (kg)	Thrust (newtons)	No. of stages	Booster- upper stages	Nominal payload/ alt. (kg/km)	Primary launching facility (method)	Manufacture	Remarks
Aerobee 100 (Aerobee Junior)	.381	8.71	706	94 297	2	Aerojet General-Nike	18/160	Ft. Churchill (tower)	Aerojet-General	Used 14 times by NASA in 1960-62, the Aerobee 100 was the smallest in this series of sounding rockets. Aerojet-General began developing its liquid-fueled Aerobee in 1946 with the support of the Applied Physics Laboratory of Johns Hopkins. The first successful flight test of the three-finned 100 took place in 1958. Except for two west coast launches, all firings took place at the Canadian range. The rocket was used primarily for aeronomy and ionospheric physics experiments.
Aerobee 150/150A (Aerobee-Hi)	.381	9.66	1065	100 969.6	2	Aerojet 2.5KS-Aerojet 2d stage	68/274	White Sands, Wallops (rail, tower)	Aerojet-General	The improved Aerobee 150/150A, the so-called "stand-ard Aerobee," was first used by NASA in 1959, with 229 launches by the end of 1968. The 150A had four fins rather than three and could be kept loaded with propellant in a launch-ready mode longer than the 150. Many slightly different versions of this solid booster-liquid propellant upper stage rocket exist, along with Navy and Air Force models. It was used for a variety of upper atmospheric research tasks.

Table 3-122. (Continued)
 Characteristics of NASA Sounding Rockets, 1977-1968

Rocket	Max. body diam. (m)	Length w./ payload (m)	Total weight (kg)	Thrust (newtons)	No. of stages	Booster-upper stages	Nominal payload/ alt. (kg/km)	Primary launching facility (method)	Manufacture	Remarks
Aerobee 300/300A (Spaerobee)	.381	9.72	3485	135 664	3	Aerobet 2.5KS-Aerobee 150 2d stage-Douglas Sparrow	23/483	White Sands, Wallops (tower)	Aerobet-General	Used 11 times by NASA in 1960-65, the Aerobee 300/300A could reach a higher altitude than the 170 (not used by NASA until 1969) or the 150/150A. Basically, the 300/300A is a 150/150A with a Douglas Sparrow solid-fuel 3d stage. It was developed with Navy funds under the technical direction of NRL. First used by NASA in 1960, the 300A model had four fins like the 150A and could be loaded well ahead of launch.
Aerobee 350	.559	15	3040	286 451	4	Nike-4 Aerobee 150 upper stages	227/338	White Sands, Wallops (tower)	Space-General (Aerobet-General)	The most powerful of the Aerobee series used by NASA during its first decade, the 350 was actually four 150s clustered atop a Nike solid booster. It was designed by Goddard personnel and built by Space-General. Used twice in 1965-66.
Arcas	.1143	2.31	32.2	1495	1	Arcas booster	5.4/65	White Sands, Wallops (tube)	Atlantic Research Corp.	Arcas (All-purpose Rocket for Collecting Atmospheric Soundings) was developed by Atlantic Research for the Office of Naval Research with the support of the Navy Bureau of Aeronautics and the Air Force Cambridge Research Center. Its first firing was in 1958, and it was used by

Table 3-122.
 Characteristics of NASA Sounding Rockets, 197?-1968 (Continued)

Rocket	Max. body diam. (m)	Length w./ payload (m)	Total weight (kg)	Thrust (Newtons)	No. of stages	Booster-upper stages	Nominal payload/ alt. (kg/km)	Primary launching facility (method)	Manufacturer	Remarks
Arcon	.152	3.35	113	4204	1	Arcon	18/113	(tower)	Atlantic Research Corp.	Developed by Atlantic Research for NRL, this solid rocket was first flight-tested in 1958. Except for six flights to test the rocket in 1959, Arcon was not used by NASA.
Astrobee 1500	.787	10.13	5262	600 480	2	Aerojet Jr. + 2 Thiokol Recruits-Aerojet Alcor IB	34/2414	Wallops (tower, boom launcher)	Space-General (Aerojet-General)	First test-fired in August 1961, the Astrobee 1500 was developed for the Air Force. It was used sparingly by NASA for heavy payloads or for very high altitudes. The Astrobee 100 stage was teamed with a solid second stage. NASA's first launch, a failure, took place in April 1963; it was used four more times through 1968.
Black Brant IV	.438	11.33	1426	160 128	2	Bristol Aerospace 15KS-Bristol Aerospace 9KS	39/925	Wallops (rail)	Bristol Aerospace	The Black Brant family of sounding rockets was developed by the Canadian firm Bristol Aerospace, with the first Black Brant launch during the IGY in September 1959. The improved

Table 3-122.
 Characteristics of NASA Sounding Rockets, 19??-1968 (Continued)

Rocket	Max. body diam. (m)	Length w./ payload (m)	Total weight (kg)	Thrust (Newtons)	No. of stages	Booster-upper stages	Nominal payload/ alt. (kg/ km)	Primary launching facility (method)	Manufacturer	Remarks
Iris	.3048	7.18	600.6	103 082	3	Iris-IHS upper motors	45/320	Wallops (rail, tower)	Atlantic Research Corp.	Black Brant IIIB was launched by NASA for testing purposes in December 1962 in a cooperative venture with Canada. With a more powerful engine than its predecessors, the IVA model was first tested in 1964. NASA used the all-solid IVA twice in 1968 to conduct an ionospheric physics experiment and a radiation investigation in support of Apollo.
Javelin (Argo D-4)	.582	14.85	3377	811 982	4	Thiokol Honest John M6-Nike M5-E1-Nike MS-E1-ABL X-248-A6	45/800	Wallops (zero length launcher)	Aerolab Corp.	Designed by NRL and built by Atlantic Research, this small all-solid rocket was first fired by NASA in 1960 and was launched four times through 1962. Its last flight carried an atmospheric structures experiment. The Argo vehicles built by Aerolab were derived from a NACA Pilotless Aircraft Research Div. design. NASA used the all-solid Javelin 51 times from 1959 through 1968 for a variety of scientific soundings.

Table 3-122. (Continued)
 Characteristics of NASA Sounding Rockets, 197?-1968

Rocket	Max. body diam. (m)	Length w./ payload (m)	Total weight (kg)	Thrust (newtons)	No. of stages	Booster-upper stages	Nominal payload/alt. (kg/km)	Primary launching facility (method)	Manufacture	Remarks
Journeyman (Argo D-8)	.787	18.92	6502	787 518	4	Pollux TX20-6 + 2	68/1600	Pacific Missile Range Wallops (tower)	Aerolab Corp.	Another of the Argo vehicles, the Journeyman was large for a sounding rocket. Used seven times in 1960-65 by NASA to carry two biology experiments, two radio astronomy packages, and three particles and fields investigations. It supported the Mercury program by gathering radiation data prior to the manned missions.
Nike-Apache	.419	8.39	727	237 746	2	Nike M5-E1-Thiokol Apache TE 307-2	45/160	White Sands, Wallops (rail, zero length launcher)	McDonnell Douglas Thiokol	NACA's Pilotless Aircraft Research Div. first mated the Army's Nike guided missile to an upper stage motor in 1953. Since then, the booster has been used in a variety of sounding rocket configurations. The Apache, developed by Thiokol, was mated to the Nike in 1960. This all-solid rocket has been used extensively (375 times, 1961-68) by NASA for meteorology, aeronomy, particles and fields, and ionospheric physics experiments.

Table 3-122.
 Characteristics of NASA Sounding Rockets, 19??-1968 (Continued)

Rocket	Max. body diam. (m)	Length w./ payload (m)	Total weight (kg)	Thrust (Newtons)	No. of stages	Booster-upper stages	Nominal payload/ alt. (kg/km)	Primary launching facility (method)	Manufacturer	Remarks
Nike-Asp	.419	8.23	680	242 638	2	Nike M5-E1-Asp 1	27/260	Wallops (zero length launcher, rail)	Hercules, Cooper Development Corp.	Development of the Asp upper stage was sponsored by the Naval Radiological Defense Lab. The all-solid sounding rocket was first flight-tested in 1956 and first used by NASA in 1959. Through 1963, the agency launched 27 Nike-Asps with aeronomy, solar physics, and ionospheric physics payloads.
Nike-Cajun	.419	8.39	720	251 534	2	Nike M5-E1-Cajun TE-82 mod. 2	34/160	Ft. Churchill, White Sands, Pt. Barrow, Natal, Brazil (rail, zero length launcher)	Hercules, Thiokol	This sounding rocket was developed by NACA in conjunction with the University of Michigan, sponsored by the Air Force Cambridge Research Center. First tested in 1956, it was used during the IGY and from 1960 through 1968 301 times by NASA. The all-solid rocket was the workhorse for low-level synoptic observations (aeronomy, particles and fields, ionospheric physics, and meteorology).

Table 3-122.
 Characteristics of NASA Sounding Rockets, 19??-1968 (Continued)

Rocket	Max. body diam. (m)	Length payload (m)	Total weight (kg)	Trust (Newtons)	No. of stages	Booster-upper stages	Nominal payload/alt. (kg/km)	Primary launching facility (method)	Manufacturer	Remarks
Nike-Tomahawk	.419	9.30	839	265 546	2	Nike-Tomahawk	45/322	Wallops, zero length launcher (rail, zero length launcher)	Hercules, Thiokol	Originally developed by Sandia Corp. for nuclear weapons work, the Nike-Tomahawk has been used as a sounding rocket since 1956 and by NASA since 1965 (60 launches in 1965-68). The all-solid Nike-Tomahawk was utilized by NASA primarily for launching aeronomy and paratides and fields experiments.
Skylark	.43	9.39	3195	53 376	2	Cuckoo-Raven II	140/200	Woomera, Australia (tower)	Royal Aircraft Establishment	NASA used the British Skylark four times in 1961 in Australia to launch galactic astronomy packages. Originally called the Gassiot High Altitude Vehicle, the three-finned all-solid Skylark was used by the British during the IGY.

Table 3-123.
Representative NASA Sounding Rocket Missions

Field of investigation	Rocket type (vehicle #)	Launch date	Launch site	Objective and instrumentation	Preliminary experiments results	Rocket performance	Approx. peak alt. (km)	Experimenter, location	NASA Projects scientist, location
Aeronomy	Aerobee 150 (4.217 U/A)	Feb. 9, 1968	Ft. Churchill	To perform a group of coordinated aural experiments using an ion mass spectrometer, a primary electron spectrometer, a secondary spectrometer, a UV photometer for measuring the emission in both the up and down direction, a far UV photometer, and a 3-barrel visible photometer.	Every experiment performed almost perfectly throughout the flight. The aurora faded badly after firing, but all experiments had sufficient dynamic range to acquire good data. Telemetry, radar, and Dovap were very good.	Satisfactory	155	T. M. Donahue, Univ. of Pittsburgh; W. G. Fastie, Johns Hopkins	M. Dubin, Hq.
Aeronomy	Arcas (15.40 DA)	Oct. 22, 1967	Barking Sands, HI	To provide measurements of the incident solar UV irradiance in direct support of OGO 4 UV monochromator measurement of earth backscattered radiation. Also, ozone altitude profiles were to be measured for comparison with OGO 4 measurements.	All experimental objectives were attained. Data were obtained at a time coincident with OGO 4 overpass.	Satisfactory	59	A. Krueger, Naval Ordnance Test Station	R. Horowitz, Hq.
Galactic astronomy	Aerobee 150 (4.268 UG)	Nov. 15, 1968	White Sands	To obtain UV radiation of the star Cas with 1 Å resolution using a gyrostabilized spectrograph, IACS, and recovery system.	ACS stabilized rocket on target of Cas Spectra were obtained on 3 exposures. Payload recovered in excellent condition.	Satisfactory	174	D. C. Morton, Princeton	N. G. Roman, Hq.
Ionospheric physics	Javelin (8.35 UI)	Dec. 8, 1967	Ft. Churchill	To make an attempt to understand the ionosphere-protonosphere transition region at L values beyond the plasma pause, using a magnetic mass spectrometer, planar and hemispherical ion traps, a pair of Langmuir probes, and other sensors.	Payload operated 100% successfully, but was unstable and caused weak telemetry reception with occasional dropouts.	Satisfactory	805	W. B. Hanson, Southwest Center for Advanced Studies	E. R. Scherling, Hq.
Ionospheric physics	Nike-Apache (14.268 UI)	May 5, 1967	Ft. Churchill	To provide a test of the instrumentation, prove out the feasibility of payload recovery and reuse, and provide geophysical observations under either quiet or disturbed conditions; payload is designed to provide a comprehensive investigation of auroral zone disturbance.	All objectives met with the exception of payload recovery; parachute system did not function.	Satisfactory	136	W. J. Heikkila, Southwest Center for Advanced Studies	E. R. Scherling, Hq.

Table 3-123. (Continued)
Representative NASA Sounding Rocket Missions

Field of investigation	Rocket type (vehicle #)	Launch date	Launch site	Objective and instrumentation	Preliminary experiments results	Rocket performance	Aprox. peak alt. (km)	Experimenter, location	NASA Projects scientist, location
Meteorology	Nike-Cajun (10.248 GM)	Oct. 14, 1967	Natal, Brazil	To provide a data point in an overall series of 15 firings in series of 3 each between June 21, 1967, and Dec. 18, 1967. The series objective was to isolate the effect of sun angle on the mesospheric temperature structure over a 6-month period.	Experiment was successful and expected to yield good data.	Satisfactory	N/A	W. S. Smith, GSFC	W. S. Smith, GSFC
Particles and fields	Black Brant IV (19.01 NE)	June 11, 1968	Natal, Brazil	Provide a fast response capability for measuring radiation dose and dose rate at orbital altitude in South Atlantic anomaly region, using a geiger tube spectrometer, ion chambers, heavy ion detector, and diagnostic instruments.	Obtained almost 100% of expected data; boundary of region defined as predicted.	Satisfactory	806	G. Brandon, MSC	G. Brandon, MSC
Particles and fields	Nike-Tomahawk	Mar. 21, 1968	Ft. Churchill	To study dissipation process	Energy spectra of auroral electrons taken by 3 of the 4 electron experiments; 4th appears to have produced some data, but its actions are not yet fully understood; clamshell nose cone failed to deploy.	Satisfactory	N/A	D. L. Mathews, T. D. Wilkerson, Univ. of MD	A. G. Oppenheim, Hq.
Solar physics	Astrobee I500 (16.05 US)	Feb. 25, 1967	Wallops	To obtain accurate spectral observations from 0.25-4 MHz within the near-earth environment. Certain critical elements of the discrete and swept frequency radiometer system were to be flown prior to their use on the proposed Pilgrim satellite. To obtain flight performance data on revised Astrobee I500.	Improper antenna deployment due to early de-spin caused loss of most of desired scientific data.	Above Predicted	2380	G. R. Hugenin, Harvard	H. J. Smith, Hq.

Vanguard

Project Vanguard was initiated in the mid-1950s by the Naval Research Laboratory (NRL) in response to interest in orbiting an artificial satellite, as expressed by the international scientific community and the military. In September 1955, NRL was given official authorization by the Department of Defense to build a satellite and launch vehicle, both to be called Vanguard, for use during the International Geophysical Year (IGY), July 1957 through December 1958. At that early date, before the final configuration of the Vanguard satellite had been determined, James Van Allen, George Ludwig, and others at the State University of Iowa submitted a plan for a cosmic ray observation experiment weighing about 23 kilograms for an IGY satellite.

In November 1955, NRL announced that its 10-kilogram spherical satellite could accommodate only a 1-kilogram scientific package. NRL scientists proposed to conduct basic environmental studies with instruments capable of measuring surface and internal temperatures, surface erosion, and internal pressures with the first Vanguards. Another prospective investigator wanted to determine the variation in the intensity of solar Lyman-alpha radiation during each revolution of the satellite. In February 1957, a panel of scientists led by Van Allen suggested that the first of the four Vanguards planned for the IGY carry the equipment for the environmental studies and the radiation experiment. The second would house a scaled-down version of Van Allen's cosmic ray observer and one other experiment. There were many worthwhile proposals for investigations from which to choose.

Delays in perfecting the Vanguard launch vehicle forced NRL to readjust the launch schedule for the first mission several times. The Soviet Union in the meantime, orbited its first Sputnik satellite on October 4, 1957. In response to *Sputnik 1* and Vanguard's delays, the Department of Defense gave the Army authority to proceed with all haste in launching its proposed satellite (see table 3-71). On January 3, 1958, the Army Ballistic Missile Agency launched *Explorer 1* with a modified Redstone missile. Less than two months later on March 17, the 1.8-kilogram *Vanguard 1* also was successfully boosted into orbit.

In October 1958, Project Vanguard and the NRL team responsible for the satellite and launch vehicle were transferred to NASA. The new agency oversaw the launch of *Vanguard 2* on February 17, 1959, which did not achieve the desired orbit but transmitted data for 18 days, the unsuccessful launches of two Vanguards in April and May 1959, and the successful *Vanguard 3*, a 23.7-kilogram scientific payload orbited on September 18, 1959.

When Project Vanguard and the NRL team were transferred en masse to NASA, the project was assigned to the new Beltsville Space Center (later called Goddard Space Flight Center) in Maryland. John P. Hagen, head of the project at NRL since 1955, continued in this position as project director at Goddard.

For a chronology of events, see table 1-90, which deals primarily with the development of the Vanguard launch vehicle. *Vanguard 2* and *3* are described in the following tables. The Minitrack tracking network devised for Vanguard is discussed in chapter 5. For further information, see Constance M. Green and Milton Lomask, *Vanguard: A History*, NASA SP-4202 (Washington, 1970).

Table 3-124.
Vanguard 2 Characteristics

Date of launch (location):	Feb. 17, 1959 (ETR)
Launch vehicle:	Vanguard
Weight (kg):	9.75
Shape:	Spherical
Dimensions (m):	Diameter, .51
Power source:	Hg batteries
Date of reentry:	In orbit
Cognizant NASA center:	GSFC
Project director:	John P. Hagen
Objectives:	Record cloud formations over the surface of earth by means of photo cells.
Experiments, responsible institution:	Cloud cover, U.S. Army Signal R&D Lab.
Results:	A wobbling motion of the satellite initiated by the launch vehicle's third stage, which reignited and bumped the satellite, made it impossible to interpret the cloud cover data returned. Transmissions stopped on March 7, 1959.

Table 3-125.
Vanguard 3 Characteristics

Date of launch (location):	Sept. 18, 1959 (ETR)
Launch vehicle:	Vanguard
Weight (kg):	22.7
Shape:	Spherical
Dimensions (m):	Diameter, .51
Power source:	AgZn batteries
Date of reentry:	In orbit
Cognizant NASA center:	GSFC
Project director:	John P. Hagen
Objectives:	Measure earth's magnetic field, x-rays from the sun, and environmental conditions in space.
Experiments, responsible institution:	Magnetometer, GSFC Solar x-ray, NRL Environmental measurements, GSFC Micrometeoroid detectors, GSFC
Results:	Transmitted data for 85 days, providing a comprehensive survey of magnetic fields, a detailed location of the lower edges of the Van Allen Belt, and an accurate count of micrometeorite impacts; the satellite was put into orbit with the third stage.

Other Physics and Astronomy Projects

In addition to Explorer, OAO, OSO, OGO, Vanguard, and sounding rockets, NASA sponsored several other small physics and astronomy projects.

The agency attempted to orbit two Beacon 3.66-meter inflatable spheres to study atmospheric density in 1958 and 1959. A cylindrical shell housed the folded Mylar satellite before it was to be released and filled with nitrogen. An October 22, 1958, launch was attempted by a Juno I, but failed when the upper stages of the vehicle separated prematurely, and an August 14, 1959, try with a Juno II was met with booster and attitude control system malfunctions. A third Beacon (S-66), of another configuration, also failed in 1964 (table 3-138). The early Beacons were under the project direction of Langley Research Center, with support from the Jet Propulsion Laboratory; the 1964 attempt was sponsored by Goddard Space Flight Center. NASA did orbit four balloon-like satellites as *Explorer 9, 19, 24, and 39* (tables 3-75, 3-85, 3-90, 3-104). The two successful Beacon-Explorers (*Explorer 22* and *27*) were ionospheric investigations; they were not balloon-shaped (tables 3-88, 3-92). (See also Echo communications satellite.)

In 1961, the Scout launch vehicle boosted two probes, P-21 and P-21A, into suborbital trajectories. They provided data on the densities of the electron field and radiowave propagation (tables 3-135, 3-136).

Geodetic earth-orbiting satellites (GEOS) were also part of the physics and astronomy program. See *Explorer 29* and *36* (tables 3-94, 3-101) for information on *GEOS 1* and *2*. For *PAGEOS 1*, a 30.5-meter balloon satellite was used as a tracking beacon for geodesy experiments, see table 3-137. For a discussion on geodetic satellites, see elsewhere in this chapter.

During its first 10 years of operation, NASA cooperated with the governments of many foreign countries—setting up NASA tracking stations around the world, launching scientific or applications payloads for countries that did not have the technology or adequate vehicles and launching facilities, incorporating the experiments of foreign scientists on NASA flights, collaborating on sounding rocket programs, and sharing the data returned from American experiments. Another area of cooperation was the international satellite program. The first joint project culminated in the launching of *Ariel 1* in April 1962, a United States-United Kingdom venture, followed by *Ariel 2* and *3* in 1964 and 1967 (tables 3-128, 3-129, 3-130). The Canadian *Alouette 1* and *2* were launched by NASA in 1962 and 1965 (tables 3-126, 3-127). *San Marco 1* and *2* were put into orbit for Italy in 1964 and 1967 (tables 3-139, 3-140). NASA orbited *FR-1* for France in 1965 (table 3-133). In May 1967, NASA attempted to launch the first satellite designed and built by the European Space Research Organization (ESRO),* but the solar astronomy-cosmic ray investigator (*ESRO 2A*) failed to achieve orbit because the Scout vehicle's third stage malfunctioned. A second attempt was successful. *ESRO 2B* (also called *IRIS*) was orbited in May 1968 (table 3-132). A third European satellite, *ESRO 1* (also called *Aurorae*), was launched by NASA in October 1968, and a fourth, *HEOS 1*, capable of sampling the interplanetary medium, was sent to its eccentric orbit by the United States in December 1968 (tables 3-131, 3-134).

*The 10 members of ESRO were Belgium, Denmark, France, the Federal Republic of Germany, Italy, the Netherlands, Spain, Switzerland, and the United Kingdom.

Table 3-126.
Alouette 1 Characteristics

Date of launch (location):	Sept. 28, 1962 (WTR)
Launch vehicle:	Thor-Agena B
Weight (kg):	144.7
Shape:	Oblate spheroid
Dimensions (m):	Diameter, 1.1 Height, .86
Power source:	NiCd batteries plus solar cells
Date of reentry:	In orbit
Cognizant NASA center:	GSFC
Project manager, scientist:	John E. Jackson
Contractor:	De Haviland Aircraft Co., spacecraft design and fabrication (contract with Canadian Defence Research Board)
Objectives:	Measure electron density distribution in the ionosphere and study for one year the variations of electron density distribution with time of day and latitude under varying magnetic auroral conditions; obtain galactic noise measurements; study flux of energetic particles and investigate whistlers (VLF).
Experiments, responsible institution:	Topside sounder, Defence Research Telecon Establishment (Can.) Energetic particle counters, Defence Research Telecon Estab. VLF receiver, National Research Council (Can.) Cosmic noise receiver, Defence Research Telecon Estab.
Results:	All experiments operated as planned with excellent data return; still available for use in 1970.
Remarks:	Joint NASA-Canadian Defence Research Board project; first spacecraft designed and built by a country other than the U.S. or USSR.

Table 3-127.
Alouette 2 Characteristics

Date of launch (location):	Nov. 29, 1965 (WTR)
Launch vehicle:	Thor-Agena B
Weight (kg):	146.5
Shape:	Oblate spheroid
Dimensions (m):	Diameter, 1.07 Height, .86
Power source:	NiCd batteries plus solar cells
Date of reentry:	In orbit
Cognizant NASA center:	GSFC
Project manager:	Evert D. Nelson
Project scientist:	John E. Jackson
Contractor:	De Haviland Aircraft Co., spacecraft design and fabrication (contract with Canadian Defense Research Board)
Objectives:	To sound the topside of the ionosphere; continuation of the mission started by <i>Alouette 1</i> .
Experiments, responsible institution:	Topside sounder, Defence Research Telecon Establishment (Can.) Galactic and solar radio noise receiver, Defence Research Telecon Estab. VLF receiver, Defence Research Telecon Estab. Energetic particle detectors, Naval Research Laboratory Electrostatic probe, GSFC
Results:	Excellent data return; still available for use in 1970.
Remarks:	Joint NASA-Canadian Defence Research Board project (known as ISIS—International Satellites for Ionospheric Studies). <i>Alouette 2</i> was launched with <i>Explorer 31</i> (table 3-96).

Table 3-128.
Ariel 1 (UK-1) Characteristics

Date of launch (location):	April 26, 1962 (ETR)
Launch vehicle:	Thor-Delta
Weight (kg):	59.9
Shape:	Cylindrical with a spherical section at each end, plus 4 solar paddles and 2 1.22-meter booms
Dimensions (m):	Cylinder, .27 × .58 Spheres, .14 × .13
Power source:	NiCd batteries plus solar cells
Date of reentry:	May 24, 1976
Cognizant NASA center:	GSFC
Project manager:	R. C. Baumann
Project scientists:	R. E. Bourdeau
UK project manager:	M. O. Robbins
Contractor:	Washington Technological Associates, spacecraft structure
Objectives:	Ionospheric investigations; measure electron density and temperature and the composition of positive ions; monitor ultraviolet radiation and x-rays; measure cosmic rays.
Experiments, responsible institution:	Cosmic ray detector, Imperial College Electron density plasma probe, University of Birmingham Ionospheric composition probe, University College Solar emissions measurement, University College Electron temperature density probe, University College X-ray counters and gages, University of Leicester
Results:	Much useful data on the ionosphere were returned, including information on a new ion layer at an altitude of 725-800 kilometers; satellite was damaged by an American atomic test in September 1962 but transmissions continued until June 1964; restarted in August 1964 for two months.
Remarks:	Joint NASA-U.K. project; first international satellite.

Table 3-129.
Ariel 2 (UK-C) Characteristics

Date of launch (location):	Nov. 18, 1967 (Wallops)
Launch vehicle:	Scout
Weight (kg):	59.9
Shape:	Cylindrical with a spherical section at each end, plus 4 solar paddles and 2 1.22-meter booms
Dimensions (m):	Cylinder, .27 × .58 Spheres, .14 × .13
Power source:	NiCd batteries plus solar cells
Date of reentry:	Nov. 18, 1967
Cognizant NASA center:	GSFC
Project manager:	Emil Hymoqitz
Project scientist:	Lawrence Dunkelman
UK project manager:	M. O. Robbins
Contractors:	Washington Technological Associates, spacecraft structure Westinghouse Electric Corp., several satellite subsystems and integration
Objectives:	Measure vertical distribution of the ozone; study galactic radio noise; measure micrometeoroid flux.
Experiments, responsible institution:	Galactic radio noise receiver, University of Cambridge Ozone photometers and spectrometer, Air Ministry Micrometeoroid detectors, University of Manchester, Jodrell Bank
Results:	Made a global survey of the ozone; designed for a longer life than <i>Ariel 1</i> .
Remarks:	Joint NASA-U.K. project

Table 3-130.
Ariel 3 (UK-E) Characteristics

Date of launch (location):	May 5, 1967 (WTR)
Launch vehicle:	Scout
Weight (kg):	89.8
Shape:	Cylindrical main body with a dome on top, plus 4 honeycomb vanes attached to the bottom of the main structure
Dimensions (m):	Diameter, .58 Height, .89
Power source:	NiCd batteries plus solar cells
Date of reentry:	Dec. 14, 1970
Cognizant NASA center:	GSFC
Project manager:	R. C. Baumann
Project scientist:	Siegfried Bauer
Contractors:	Space Research Management Unit, UK Science Research Council assigned spacecraft design and fabrication to Royal Aircraft Establishment
Objectives:	Measure vertical distribution of molecular oxygen in earth's atmosphere; map large-scale R-F noise sources; investigate VLF radiation; measure ionization density and temperature above the F ₂ maximum; investigate terrestrial radio noise.
Experiments, responsible institution:	Ion chamber, Meteorological Office Radio receivers, University of Manchester, University of Sheffield, and Radio Research Station R-F plasma probe, University of Birmingham
Results:	Much useful data on the upper atmosphere were returned; transmitter was turned off after 28 months.
Remarks:	Joint NASA-U.K. project.

Table 3-131.
ESRO 1 (Aurorae) Characteristics

Date of launch (location):	Oct. 3, 1968 (WTR)
Launch vehicle:	Scout
Weight (kg):	85.8
Shape:	Cylindrical with truncated cones at each end
Dimensions (m):	Diameter, .76 Overall height, 1.5 Span with booms extended, 2.4
Power source:	Battery plus solar cells
Date of reentry:	June 26, 1970
Cognizant NASA center:	GSFC
Project director:	H. L. Eaker
Project scientist:	L. H. Meredith
Project coordinator:	J. Talentino
Objectives:	To study the aurora borealis and other related phenomena of the polar ionosphere.
Experiments responsible institution:	High-altitude particle experiments (5), Radio and Space Research Station (England), Kiruna Geophysical Observatory (Sweden), Technical University of Denmark, University of Bergen (Norway), Norwegian Space Committee Auroral photometry, Norwegian Institute of Cosmic Physics Ionospheric experiments (2), University College (England)
Results:	Returned data as planned; outlived its expected lifetime of six months.
Remarks:	Satellite designed and built by ESRO (European Space Research Organization) and launched by NASA. <i>ESRO 2B (IRIS)</i> was launched before <i>ESRO 1</i> (table 3-132).

Table 3-132.
ESRO 2B (IRIS) Characteristics

Date of launch (location):	May 16, 1968 (WTR)
Launch vehicle:	Scout
Weight (kg):	74.2 (plus 14.9-kg separation system)
Shape:	Cylindrical, 12-sided
Dimensions (m):	Diameter, .76 Height, .85
Power source:	NiCd battery plus solar cells
Date of reentry:	May 8, 1971
Cognizant NASA center:	GSFC
Project manager:	H. L. Eaker
Project scientists:	L. H. Meredith
Project coordinator:	J. Talentino
Objectives:	To conduct solar astronomy and cosmic ray studies.
Experiments responsible institution:	Monitor of energetic particle flux, Imperial College (England) Solar and Van Allen Belt protons, Imperial College Solar and galactic alphas particles and protons, Imperial College Primary cosmic ray electrons, University of Leeds (England) Hard solar x-rays, University of Leicester, University of London (England) Soft solar x-rays, University of Utrecht (the Netherlands) Flux and energy spectrum of solar and galactic cosmic ray particles, Centre d'Études Nucleaires de Saclay (France)
Results:	Returned data as planned.
Remarks:	First launch of an ESRO-(European Space Research Organization-) designed-and-built spacecraft. The launch was accomplished by NASA for ESRO. <i>IRIS</i> , the ESRO designation for the payload, stands for International Radiation Investigation Satellite. <i>ESRO 2B</i> was launched before <i>ESRO 1</i> (table 3-131). A previous attempt on May 29, 1967 to launch a similar payload (<i>ESRO 2A</i>) failed when the Scout's third stage malfunctioned.

Table 3-133.
FR-1 Characteristics

Date of launch (location):	Dec. 6, 1965 (WTR)
Launch vehicle:	Scout
Weight (kg):	61
Shape:	2 truncated octagonal cones joined by an octagonal central section
Dimensions (m):	Diameter from corner to corner, .69 Height, 1.3
Power source:	NiCd batteries plus solar cells
Date of reentry:	In Orbit
Cognizant NASA center:	GSFC
Project director:	Samuel R. Stevens
Project scientist:	R. W. Rochelle
Project director, CNES:	Jean-Pierre Causse
Project director, CNES:	Xavier Namy
Objectives:	To investigate the characteristics of very low frequency (VLF) electromagnetic wave propagation in the ionosphere and to study irregularities in the distribution of ionization in the magnetosphere.
Experiments responsible institution:	VLF experiment, electron density probe, rendezvous experiment with <i>OGO 2</i> and the Canadian <i>Alouette</i> satellites, Centre National d'Études des Telecommunications
Results:	Returned data as planned.
Remarks:	Satellite designed and built by the French Centre National D'Études Spatiales (CNES) and launched by NASA.

Table 3-134.
HEOS 1 Characteristics

Date of launch (location):	Dec. 5, 1968 (ETR)
Launch vehicle:	Thor-Delta
Weight (kg):	109
Shape:	Flat cylinder with an axial boom
Dimensions (m):	.75 × .13
Power source:	AgCd batteries plus solar cells
Date of reentry:	Oct. 28, 1975
Cognizant NASA center:	GSFC
Project manager:	R. J. Gross
Project scientists:	B. Taylor
Contractor:	Junkers Flugzeug- und Motorenwerke GmbH (Munich), prime contractor to ESRO
Objectives:	Study interplanetary radiation, solar wind, and magnetic fields outside the magnetosphere during the period of maximum solar activity.
Experiments responsible institution:	Fluxgate magnetometer, Imperial College, University of London Barium-copper oxide release, Max Plank Institute Cerenkov scintillator telescope, Imperial College Solid-state telescope, Imperial College and Centre D'Études Nuclaires de Saclay Electrostatic analyzer, University of Brussels Radio telescope and Cerenkov counter, University of Milan and Centre D' Études Nuclaires de Saclay
Results:	Good data returned until October 1975; barium cloud experiment performed on March 18, 1969.
Remarks:	HEOS stands for Highly Eccentric Orbit Satellite; launched for ESRO (European Space Research Organization) by NASA.

Table 3-135.
P-21 Characteristics

Date of launch (location):	Oct. 19, 1961 (Wallops)
Launch vehicle:	Scout
Weight (kg):	42.6
Shape:	8-sided frustrum
Dimensions (m):	.38 × .84
Power source:	NiCd batteries
Date of reentry:	Oct. 19, 1961
Cognizant NASA center:	GSFC
Project manager:	John E. Jackson
Project scientist:	Siegfried J. Bauer
Objectives:	Measure electron densities; investigate radio wave propagation under daytime conditions.
Experiments responsible institution:	Radio frequency probe, GSFC Radio wave propagation, GSFC
Results:	Probe achieved altitude of 7891 kilometers and transmitted good data; electron density information was collected to about 2778 kilometers.
Remarks:	Also considered a sounding.

Table 3-136.
P-21A Characteristics

Date of launch (location):	March 29, 1962 (Wallops)
Launch vehicle:	Scout
Weight (kg):	42.6
Shape:	8-sided frustrum
Dimensions (m):	.38 × .84
Power source:	NiCd batteries
Date of reentry:	March 29, 1962
Cognizant NASA center:	GSFC
Project manager:	John E. Jackson
Project scientist:	Siegfried J. Bauer
Objectives:	Measure electron density profile and ion density and intensity in the atmosphere under nighttime conditions.
Experiments responsible institution:	Radio wave propagation, GSFC Radio frequency probe, GSFC Ion trap, GSFC
Results:	Probe achieved altitude of 7241 kilometers; determined that characteristics of the ionosphere differ sharply from daytime when the temperature of the ionosphere is much cooler.
Remarks:	Also considered a sounding.

Table 3-137.
PAGEOS I (PAGEOS-A) Characteristics

Date of launch (location):	June 23, 1966 (WTR)
Launch vehicle:	Thor-Agena D
Weight (kg):	56.7 (110.7 with canister)
Shape:	Spherical (inflatable)
Dimensions (m):	Diameter, 30.48
Power source:	None (passive)
Date of reentry:	In orbit
Cognizant NASA center:	LaRC
Project manager:	D. L. Clummons, Jr.
Contractor:	G. T. Schjeldahl, sphere Goodyear Aerospace Corp., canister
Objectives:	In support of the National Geodetic Satellites Program, serve as a passive point source of light for a worldwide network of optical observation stations (56); stations then would provide geometric geodesy measurements for defining the precise shape of the planet and for preparing maps.
Experiments responsible institution:	No active payload.
Results:	Successfully served as a target for optical tracking; still being used in 1972 for experiments.
Remarks:	See also Echo communications satellite for information on the background of the spacecraft's design.

Table 3-138.
S-66 Polar Ionosphere Beacon Characteristics

Date of launch (location):	March 19, 1964 (ETR)
Launch vehicle:	Thor-Delta
Weight (kg):	54.4
Shape:	Octagonal with 4 solar panels
Dimensions (m):	Body diameter, .457 Height, .305 Panels, .254 x 1.676
Power source:	NiCd battery plus solar cells
Date of reentry:	Did not achieve orbit
Cognizant NASA center:	GSFC
Project manager:	Frank T. Martin
Program scientist:	Robert E. Bourdeau
Contractor:	Johns Hopkins Applied Physics Laboratory
Objectives:	Survey earth's ionosphere; observations would be made by 81 ground stations in 32 countries; other experiments were designed to measure electron density and temperatures and to provide geodetic information.
Experiments responsible institution:	Laser and doppler tracking, GSFC and NASA Hq. (OART) Electron measurement, GSFC
Results:	Failed to orbit because of a launch vehicle (third-stage) failure.
Remarks:	Would have been called Explorer 20 had the mission been successful. First Delta failure in 23 consecutive launches.

Table 3-139.
San Marco 1 Characteristics

Date of launch (location):	Dec. 15, 1964 (Wallops)
Launch vehicle:	Scout
Weight (kg):	113.4
Shape:	Spherical
Dimensions (m):	Diameter, .66
Power source:	Hg batteries
Date of reentry:	Sept. 13, 1965
Cognizant NASA center:	GSFC
Project manager:	A. J. Caporale, Hq.
Contractor:	Centro Ricerche Aerospaziale, University of Rome, spacecraft design and fabrication (Italian contract)
Objectives:	Measure air and electron density of upper atmosphere; study radio wave propagation.
Experiments responsible institution:	Accelerometer, University of Rome, Faraday rotation, University of Florence
Results:	All systems performed as expected.
Remarks:	Italian satellite launched by NASA.

Table 3-140.
San Marco 2 Characteristics

Date of launch (location):	April 26, 1967 (Formosa Bay, Indian Ocean; near coast of Kenya)
Launch vehicle:	Thrust-augmented Improved Thor-Delta (TAID)
Weight (kg):	129.3
Shape:	Spherical
Dimensions (m):	Diameter, .66
Power source:	Batteries
Date of reentry:	Oct. 14, 1967
Cognizant NASA center:	GSFC
Project manager:	A. J. Caporale, Hq.
Contractor:	Centro Richere Aerospaziale, University of Rome, spacecraft design and fabrication (Italian contract)
Objectives:	Measure upper atmosphere air density, electron density; study radio wave propagation.
Experiments responsible institution:	Air density triaxial balance, University of Rome, Electron content and wave propagation, University of Florence
Results:	All experiments returned data as expected.
Remarks:	Italian satellite launched by NASA; first satellite to be launched from a sea platform.

DESCRIPTION—LUNAR AND PLANETARY PROGRAM

Beyond the examination of our own planet's upper atmosphere, the unmanned exploration of earth's moon and the other planets was an especially attractive goal for NASA's space scientists. Telescopes and other instruments sent into orbit around earth had relayed clearer, improved images of these distant bodies and new information about the interplanetary medium. This wealth of new data, plus increasingly powerful launch vehicles and improved telemetry systems, recording devices, and scientific instruments, made it possible for man's machines to explore new worlds. The Soviet Union's success with Sputnik and Luna spacecraft added an extra sense of urgency to NASA's early plans for lunar and interplanetary investigation.

Schemes for sending automated spacecraft to the vicinity of the moon certainly predate NASA. The moon was one of the goals military launch vehicle specialists and civilian scientists alike had in mind when it became apparent that powerful boosters capable of launching large payloads could be perfected over time. In the spring of 1958, advanced planners at the Langley Memorial Aeronautical Laboratory, part of the National Advisory Committee for Aeronautics were suggesting that the new civilian space agency being organized launch a 34-kilogram probe to the vicinity of the moon to acquire "scientific information on the characteristics of space between the earth and the moon, and on the physical, biological, and chemical characteristics of the moon itself." Probes would be followed by orbiters and then landers. A secondary benefit from these scientific investigations, of course, would be data that could also be applied to manned

spaceflight. There were many unknowns. How many meteorites would a spacecraft encounter during its trip to the moon? Precisely what was the moon's mass? What was the radioactivity level at the surface? What were the constituents of the atmosphere? Would the crust be made of volcanic rock or dust? For many participants and bystanders, unmanned exploration and the search for answers to scientific questions were overshadowed by the glamor of manned expeditions. As early as the summer of 1959, the Office of Space Science recognized this: "If one goal were to be selected which would most influence the overall NASA program during the next decade it would be manned flight to the moon. The manned space flight program, the program of unmanned lunar exploration and the booster development program are all oriented toward this goal." The Langley people believed that NASA could take its first steps in this direction by late 1959, with landers reaching the moon "within a few years."⁹

NASA's early attempts to send a probe to the moon were unsuccessful. From the Department of Defense's Advanced Research Projects Agency, NASA had inherited a lunar probe program called Pioneer. Launch vehicle malfunctions in 1958 prevented three Pioneer probes from obtaining the velocity necessary to escape earth's gravity, and *Pioneer 4* in early 1959 did not pass close enough to the moon for its photoelectric scanner to operate. Three more attempts in 1959 and 1960 with Atlas-Able vehicles also were failures. It was 1964 before NASA had an unqualified success. *Ranger 7* orbited the moon sending back good-quality photographs and impacted on the lunar surface on command. Two other Ranger missions were carried out successfully, followed by five lunar Orbiters, also successful. Five of the seven Surveyor spacecraft soft-landed on the moon in 1966-1968. Much of the lunar surface was photographed, and millions of bits of scientific data were telemetered to earth, the sheer bulk of which led to the establishment of the Lunar Science Institute in 1968 to serve as a center for the analysis and study of data being generated by unmanned and manned lunar programs.

Beyond the moon were more unknowns: the other planets, our sun, the medium surrounding them. The first thing scientists wanted to determine was the astronomical unit, the semi-major axis of earth's orbit about the sun, so that interplanetary trajectories could be plotted precisely. The size of the planets, the composition of their atmospheres, and their physical, biological, and chemical properties were other subjects for investigation. The early planners again suggested a three-tiered approach: trackable spacecraft that would escape earth's gravitational field but remain in a nearby orbit of the sun, followed by planetary orbiters of the nearby planets, and finally by landers.¹⁰ This was basically the approach NASA followed. Five very successful Pioneer interplanetary probes were sent on a variety of missions from 1960 through 1968. A Mariner spacecraft passed by Venus in 1962 and another took 22 photographs of Mars as it passed by that planet in 1964. Another Mariner flew by Venus in 1967. NASA's plans for a Mars Voyager lander were cancelled in 1967 by a budget cut demanded by Congress, but it was replaced by Project Viking, which would send two orbiter-landers to the Red Planet in the 1970s.

NASA in its initial organization had a chief of planetary science programs, John F. Clark. In an early 1960 reorganization, Edgar M. Cortright was named assistant director for lunar and planetary programs. In November 1961, Oran W. Nicks assumed this position, managing the programs until late 1967. With the growing importance of the Apollo Program and the conclusion of the automated lunar exploration program, lunar science was assigned to the Office of Manned Space Flight in

December 1967. R. J. Allenby became assistant director for lunar science under Lee R. Scherer, director for Apollo lunar exploration, both of whom were formerly of the Office of Space Science and Applications. Donald P. Heath was named director of planetary programs. Managers of the various flight programs reported to him. Project managers were named at the appropriate centers—the Jet Propulsion Laboratory, Langley Research Center, and Ames Research Center.

Pioneer

There were two separate Pioneer programs—lunar and interplanetary. The former started before NASA was established when President Dwight D. Eisenhower approved Department of Defense plans for a lunar probe program in March 1958. The Air Force Ballistic Missile Division and the Army Ballistic Missile Agency were assigned three and two probes, respectively. The prime objective was to place a payload in the vicinity of the moon with scientific instruments designed to measure radiation, temperature, and micrometeorite distribution. Space Technology Laboratories joined with the Air Force in designing the Thor-Able launch vehicle and its lunar-bound payloads (the payloads were incorporated in Able fourth stages and were sometimes referred to as the Able series of lunar probes). The Air Force failed to place any of its three probes in a lunar trajectory during 1958. On October 1, 1959, the new civilian space agency was assigned the management responsibility for the lunar probe program, but NASA delegated authority back to the Air Force and Army. The Army-Jet Propulsion Laboratory team also failed to put its first small conical probe into a lunar trajectory in 1958, and its second probe in 1959 did not pass close enough to the moon for its instruments to record any data on the near-lunar environment.

In 1960, a spherical probe with a NASA Goddard Space Flight Center experiment package was sent to explore interplanetary space. Aboard were instruments that would measure radiation, magnetic fields, cosmic dust, and solar phenomena. *Pioneer 5* was a success. Even before it began its journey around the sun, specialists at NASA's Ames Research Center, Moffett Field, California, were exploring the possibilities of a new series of solar probes. In November 1962 NASA Headquarters approved a series of five interplanetary Pioneer probes and assigned their management to Ames. Built by TRW (formerly Space Technology Laboratories) and equipped with scientific instruments from universities and other NASA centers, four Pioneers were launched successfully from 1965 through 1968 (the fifth in the series failed when the booster malfunctioned in 1969), returning valuable data on solar plasma, solar and galactic cosmic radiation, magnetic and electric fields, and cosmic dust. Because of the Pioneers' unexpectedly long lives, they returned information beneficial to scientists studying the solar minimum as part of the International Quiet Sun Year (1964-1965) and the solar maximum (1969-1970).

Although NASA had formal authority for the early lunar probes, they essentially were managed by the Army and the Air Force, since their development was already well under way before NASA came into being. During 1960 when *Pioneer 5* was launched, Roger C. Moore was in charge of planetary science in the NASA Headquarters Lunar and Planetary Program Office, and the project was managed at Goddard. Glenn A. Reiff became Mariner-Pioneer program manager at Head-

quarters in 1963 for the second Pioneer series. In 1966 and 1967, however, Reiff devoted all his energies to *Mariner 4* and *5*, and management of Pioneer was assigned to the physics and astronomy program under Marcel T. Aucremanne's direction. Reiff resumed authority for Pioneer in 1968. Charles F. Hall led the Ames Pioneer team from its first informal study of solar probes in 1960. TRW was the prime contractor for the design and fabrication of the interplanetary Pioneers (Herbert Lasser of TRW was responsible for the spacecraft's configuration).

For more information on the interplanetary Pioneers, see William R. Corliss, *The Interplanetary Pioneers*, 3 vols., NASA SP-278, 279, and 280 (Washington, 1972); and TRW Systems Group, *Pioneer Handbook, 1965-1969* (Ames Research Center, 1968).

Table 3-141.
Chronology of Pioneer Development and Operations

Date	Event
March 27, 1958	The Secretary of Defense announced that the Advanced Research Projects Agency of the Department of Defense would proceed with several programs for launching unmanned spacecraft. One of these programs, which called for three lunar probes, was assigned to the Air Force Ballistic Missile Division; two other probes were assigned to the Army. The Air Force planned to use a Thor-Vanguard launch vehicle for the lunar probes, which would be launched during the International Geophysical Year.
1958	Space Technology Laboratories was awarded a contract by the Air Force for designing and building the probe and modifying the second and third stages of the launch vehicle, which came to be called Thor-Able.
July 9, 1958	First successful test launch of Thor-Able.
Aug. 17, 1958	Attempted launch of a small lunar probe failed when the Thor-Able I vehicle exploded 77 seconds after liftoff.
Oct. 1, 1958	The lunar probe program was assigned to NASA, which delegated authority back to the Army and the Air Force.
Oct. 11, 1958	<i>Pioneer 1</i> was launched on an Air Force Thor-Able I; because the second and third stages of the vehicle did not separate evenly, the probe did not reach the velocity required for a lunar trajectory. The lunar probe program was officially called Pioneer by this time, but the individual spacecraft were still sometimes referred to as Ables.
Fall 1958	The Atlas-Able launch vehicle combination was suggested as a possible launcher for NASA's lunar probe.
Nov. 8, 1958	<i>Pioneer 2</i> launch by an Air Force Thor-Able I was unsuccessful; the third stage of the vehicle failed to ignite, and the probe did not reach the required altitude.
Dec. 6, 1958	<i>Pioneer 3</i> launch by an Army Juno II was unsuccessful; the first stage of the vehicle cut off prematurely, and the probe did not reach the required altitude.
Feb. 1959	Negotiations were conducted between the Air Force-NASA team and Space Technology Laboratories for two Able stages and payloads.
March 3, 1959	<i>Pioneer 4</i> launch by an Army Juno II was successful, but the probe did not pass close enough to the moon for its instruments to function.

Table 3-141.
Chronology of Pioneer Development and Operations (Continued)

Date	Event
Nov. 26, 1959	An attempt to launch a lunar orbiter with an Atlas-Able was unsuccessful; the payload shroud broke away 45 seconds after liftoff (Able 4).
May 1960	Ames Research Center begun an informal study of solar probes.
Sept. 14, 1960	Ames Solar Probe Team was formed.
Sept. 25, 1960	An attempt to launch a lunar orbiter with an Atlas-Able was unsuccessful; the second stage of the vehicle malfunctioned (Able 5A).
Dec. 15, 1960	An attempt to launch a lunar orbiter with an Atlas-Able was unsuccessful; the first stage of the vehicle malfunctioned (Able 5B).
March 11, 1960	<i>Pioneer 5</i> launch was successful (interplanetary probe).
April 1962	TRW completed a feasibility study for Ames on designing an interplanetary Pioneer.
Nov. 6, 1962	NASA approved a new series of interplanetary Pioneers and assigned management responsibility to Ames.
Nov. 9, 1962	Project approval document for the Pioneer series was signed.
Jan. 29, 1963	A request for proposals for building the spacecraft was issued.
Feb. 1, 1963	A request for proposals for experiments to be carried on the Pioneer missions was issued.
July 23, 1963	An initial set of experiments for Pioneer was selected.
Aug. 5, 1963	TRW received a letter contract for the fabrication of five Pioneer spacecraft (\$1.5 million, maximum contract value).
April 1964	The final spacecraft design review was held.
July 30, 1964	A definitive contract with TRW was approved.
Dec. 5, 1965	The first of the Pioneer spacecraft arrived at the Kennedy Space Center.
Dec. 15, 1965	<i>Pioneer 6</i> launch was successful.
Feb. 22, 1966	The fifth spacecraft was eliminated from TRW's contract due to budget cuts.
April 28, 1966	TRW's contract was amended further; a fifth spacecraft would be constructed from spare parts.
Aug. 17, 1966	<i>Pioneer 7</i> launch was successful.
Dec. 13, 1967	<i>Pioneer 8</i> launch was successful.
Nov. 8, 1968	<i>Pioneer 9</i> launch was successful.

Table 3-142.
Pioneer 1 Characteristics

Date of launch (location):	Oct. 11, 1958 (ETR)
Launch vehicle:	Thor-Able
Weight (kg):	38.3
Shape:	2 truncated cones joined by a cylindrical midsection
Dimensions (m):	.74 × .46
Power source:	Batteries
Date of reentry:	Oct. 12, 1958
Cognizant NASA center:	NASA Hq.
Contractor:	Space Technology Laboratories, under contract to the Air Force Ballistic Missile Division
Type of Pioneer:	Lunar (also known as <i>Able 2</i>)
Objectives:	Place a probe with instrumented payload in orbit around the moon; measure radiation, micrometeorite flux, and magnetic fields.
Experiments, responsible institution:	Ion chamber, magnetometer, temperature sensor, TV scanner, micrometeorite sensor, all AFBMD experiments.
Results:	Did not achieve required velocity for a lunar trajectory because of launch vehicle malfunction (second and third stages did not separate evenly); some data returned on the Van Allen Belt and other phenomena before reentering 43 hours after launch.
Remarks:	NASA had delegated authority for this lunar probe mission back to the Air Force.

Table 3-143.
Pioneer 2 Characteristics

Date of launch (location):	Nov. 8, 1958 (ETR)
Launch vehicle:	Thor-Able
Weight (kg):	39.2
Shape:	2 truncated cones joined by a cylindrical midsection
Dimensions (m):	.74 × .46
Power source:	Batteries
Date of reentry:	Nov. 8, 1958
Cognizant NASA center:	NASA Hq.
Contractor:	Space Technology Laboratories, under contract to the Air Force Ballistics Missile Division
Type of Pioneer:	Lunar (also known as <i>Able 3</i>)
Objectives:	Place a probe with instrumented payload in orbit around the moon; measure radiation, micrometeorite flux, and magnetic fields.
Experiments, responsible institution:	Ion chamber, magnetometer, temperature sensor, micrometeorite sensor, proportional counter, all AFBMD experiments, plus image scanning TV, STL.
Results:	Did not achieve required velocity for a lunar trajectory because of launch vehicle malfunction (third stage failed to ignite); briefly returned data that indicated that earth's equatorial region has higher flux and energy levels than previously believed.
Remarks:	NASA had delegated authority for this lunar probe mission back to the Air Force.

Table 3-144.
Pioneer 3 Characteristics

Date of launch (location):	Dec. 6, 1958 (ETR)
Launch vehicle:	Juno II
Weight (kg):	5.9
Shape:	Conical
Dimensions (m):	.51 × .23
Power source:	Hg batteries
Date of reentry:	Dec. 7, 1958
Cognizant NASA center:	NASA Hq.
Contractor:	Jet Propulsion Laboratory for Army Ballistic Missile Agency, spacecraft
Type of Pioneer:	Lunar
Objectives:	Place a probe with instrumented payload in the vicinity of the moon and obtain data on Van Allen radiation belts.
Experiments, responsible institution:	Geiger counters, photoelectric sensor trigger, ABMA experiments.
Results:	Did not achieve required velocity for a lunar trajectory because of launch vehicle malfunction (premature cutoff of first stage); transmitted data on dual bands of radiation around earth; reached an altitude of 102 322 kilometers; reentered after 36 hours.
Remarks:	NASA had delegated authority for this Pioneer lunar probe mission back to the Army.

Table 3-145.
Pioneer 4 Characteristics

Date of launch (location):	March 3, 1959
Launch vehicle:	Juno II
Weight (kg):	6.1
Shape:	Conical
Dimensions (m):	.51 × .23
Power source:	Hg batteries
Date of reentry:	In orbit around the sun
Cognizant NASA center:	NASA Hq.
Contractor:	Jet Propulsion Laboratory for Army Ballistic Missile Agency, spacecraft
Type of Pioneer:	Lunar
Objectives:	Place a probe with instrumented payload in the vicinity of the moon; obtain data on the Van Allen radiation belts; determine extent of radiation in the vicinity of the moon; test a photoelectric sensor.
Experiments, responsible institution:	Geiger counters, photoelectric sensor trigger, ABMA experiments.
Results:	Passed within 59 500 kilometers of the moon, not close enough for its photoelectric scanner to be effective; sent back excellent data on radiation; was tracked for 82 hours to a distance of 655 000 kilometers.
Remarks:	NASA had delegated authority for this Pioneer lunar probe mission back to the Army.

Table 3-146.
Pioneer 5 Characteristics

Date of launch (location):	March 11, 1960 (ETR)
Launch vehicle:	Thor-Able
Weight (kg):	43
Shape:	Spherical with 4 solar panels
Dimensions (m):	Diameter, .66 With solar panels extended, diameter, 1.4
Power source:	NiCd batteries plus solar cells
Date of reentry:	In orbit around the sun
Cognizant NASA center:	GSFC
Project director, scientist:	J. C. Lindsay
Contractor:	Space Technology Laboratories, under contract to NASA and the Air Force Ballistic Missile Division
Type of Pioneer:	Interplanetary (also known as <i>Able 6</i>)
Objectives:	Place probe in orbit around the sun between Earth and Venus; transmit data on radiation, magnetic fields, cosmic dust distribution, and solar phenomena in interplanetary space.
Experiments, responsible institution:	Cosmic ray telescopes, magnetometer, ionization chamber and geiger-Mueller tube, micrometeorite counter, thermistors, and photoelectric cell aspect indicator, all GSFC experiments
Results:	Sent back excellent data on interplanetary space.

Table 3-147.
Pioneer 6 Characteristics

Date of launch (location):	Dec. 16, 1965 (ETR)
Launch vehicle:	Thrust-augmented Improved Thor-Delta (TAID)
Weight (kg):	62.14
Shape:	Cylindrical with 3 2.09-meter booms and 2 antennas
Dimensions (m):	.95 × .89
Power source:	Battery plus solar cells
Date of reentry:	In orbit around sun
Cognizant NASA center:	Ames Research Center (ARC)
Project manager:	Charles F. Hall
Contractor:	TRW, spacecraft fabrication
Type of Pioneer:	Interplanetary, first of the new series
Objectives:	Make synoptic measurements of the interplanetary milieu as it was affected by the sun; record solar occultation of the spacecraft as seen by earth tracking stations; explore area ahead of earth as it orbits around the sun.
Experiments, responsible institution:	Single-axis fluxgate magnetometer, GSFC Faraday-cup plasma probe, MIT Plasma analyzer, ARC Cosmic ray telescope, University of Chicago Cosmic ray-anisotropy detector, Graduate Research Center of the Southwest Radio wave propagation, Stanford University Celestial mechanics, JPL
Results:	All experiments returned good data.

Table 3-148.
Pioneer 7 Characteristics

Date of launch (location):	Aug. 17, 1966 (ETR)
Launch vehicle:	Thrust-augmented Improved Thor-Delta (TAID)
Weight (kg):	62.75
Shape:	Cylindrical with 3 2.09-meter booms and 2 antennas
Dimensions (m):	.95 × .89
Power source:	Battery plus solar cells
Date of reentry:	In orbit around the sun
Cognizant NASA center:	ARC
Project manager:	Charles F. Hall
Contractor:	TRW, spacecraft fabrication
Type of Pioneer:	Interplanetary
Objectives:	Make synoptic measurements of the interplanetary milieu as it was affected by the sun; analyze geomagnetospheric tail and lunar occultation.
Experiments, responsible institution:	Same as for <i>Pioneer 6</i> (table 3-146).
Results:	All experiments returned good data; tail of earth's magnetosphere was detected 5.25 million kilometers from earth.

Table 3-149.
Pioneer 8 Characteristics

Date of launch (location):	Dec. 13, 1967 (ETR)
Launch vehicle:	Thrust-augmented Improved Thor-Delta (TAID)
Weight (kg):	65.36
Shape:	Cylindrical with 3 2.09-meter booms and 2 antennas
Dimensions (m):	.95 × .89
Power source:	Battery plus solar cells
Date of reentry:	In orbit around sun
Cognizant NASA center:	ARC
Project manager:	Charles F. Hall
Contractor:	TRW, spacecraft fabrication
Type of Pioneer:	Interplanetary
Objectives:	Make synoptic measurements of the interplanetary milieu as it was affected by the sun; analyze geomagnetospheric tail and lunar occultation.
Experiments, responsible institution:	Single-axis fluxgate magnetometer, GSFC Plasma analyzer, ARC Cosmic ray telescope, Graduate Research Center of the Southwest Radio wave propagation, Stanford University Cosmic ray gradient detector, University of Minnesota Electric field detector, TRW Cosmic dust detector, GSFC Celestial mechanics, JPL
Results:	All experiments returned good data; generally the experiment instrumentation was improved on this mission and two new experiments were added. A <i>TETR 1</i> satellite designed to serve as a target for the new Apollo tracking network also was launched with <i>Pioneer 8</i> .

Table 3-150.
Pioneer 9 Characteristics

Date of launch (location):	Nov. 8, 1968 (ETR)
Launch vehicle:	Thrust-augmented Improved Thor-Delta (TAID)
Weight (kg):	65.36
Shape:	Cylindrical with 3 2.09-meter booms and 2 antennas
Dimensions (m):	.95 × .89
Power source:	Battery plus solar cells
Date of reentry:	In orbit around the sun
Cognizant NASA center:	ARC
Project manager:	Charles F. Hall
Contractor:	TRW, spacecraft fabrication
Type of Pioneer:	Interplanetary
Objectives:	Make synoptic measurements of the interplanetary milieu as it was affected by the sun; record solar occultation of the spacecraft as seen by earth tracking stations; explore area ahead of earth as it orbits around the sun.
Experiments, responsible institution:	Triaxial fluxgate magnetometer, ARC Plasma analyzer, University of Chicago Cosmic ray anisotropy detector, Graduate Research Center of the Southwest Cosmic ray gradient detector, University of Minnesota Radio wave propagation, Stanford University Electric field detector, TRW Cosmic dust detector, GSFC Celestial mechanics, JPL
Results:	All experiments returned good data. A <i>TETR 2</i> satellite designed to serve as a target for the new Apollo tracking network was also launched with <i>Pioneer 9</i> .

Ranger

Project Ranger, like the early Pioneers, was established in response to increasing scientific interest in the moon and to the successful lunar flight program of the Soviet Union. The design of the spacecraft was first suggested during studies done at the Jet Propulsion Laboratory (JPL) when advanced planners were considering Vega-launched lunar and planetary missions. After the Vega launch vehicle program was cancelled (see chapter 1) in favor of the Air Force Atlas-Agena B in December 1959, the design group at JPL was directed to adapt its Vega lunar spacecraft and experiment packages to an Atlas-Agena B mission. Lunar photography was considered a prime objective since it would support future manned lunar landings and provide a valuable scientific data base.

The lunar program, tentatively named Ranger in 1960 and assigned to JPL, called for two lunar near-misses, or probes (called Block I), and three impact missions (Block II). *Ranger 1* and *2* were to be launched in highly elliptical earth orbits that would take them near the moon so that their eight scientific instruments could measure radiation, solar emissions, and magnetic fields in the cis-lunar environment and serve as a test for the new hexagonally-shaped solar-powered spacecraft. Because of launch vehicle failures, the first two Rangers (1961) were boosted only

into low earth orbit, to reenter shortly thereafter. The next three Rangers, the capsules for which were built by the Aeronautics Division of Ford Motor Company, also failed. Equipped with television camera systems provided by RCA, *Ranger 3* and *4* impacted the moon, but without the ability to transmit telemetry. *Ranger 5* missed the moon by 725 kilometers. Block III spacecraft carried only a television system – no other onboard experiments – in an effort to simplify the mission and ensure a successful lunar impact with photographs. Even before *Ranger 6*, too, failed to return any data, NASA Headquarters directed JPL to terminate its follow-on Ranger activities, which had called for Block IV and V spacecraft that could survive a hard landing. The failures of all six Rangers led to investigations by Congress, JPL, and independent boards appointed by NASA. With an increased number of design and hardware reviews, revised schedules, closer monitoring of the subcontractors, and more intense participation by NASA Headquarters personnel, *Ranger 7*, *8*, and *9* were all highly successful missions. They returned over 17 000 high-quality images of the lunar surface, which were studied by hundreds of scientists and by manned spaceflight specialists looking for their first Apollo lunar landing site. Early program failures, budget cuts, and plans for Lunar Orbiter and Surveyor programs forced NASA to terminate Ranger after the third successful mission.

Newton W. Cunningham led the NASA management of Ranger as program manager within the Office of Lunar and Planetary Programs. At JPL, J. D. Burke, who had been deputy director of the Vega program, was Ranger project manager from October 1960 until December 1962, when Harris M. Schurmeier took the post. JPL not only oversaw the work of many subcontractors, but also performed most of the spacecraft integration and testing in-house and established a deep space tracking network with which to communicate with the spacecraft.

For more information, see R. Cargill Hall, *Lunar Impact: A History of Project Ranger*, NASA SP-4210 (Washington, 1977); and Hall, *Project Ranger: A Chronology*, JPL HR-2 (Pasadena, CA: JPL, 1971).

Table 3-151.
Chronology of Ranger Development and Operations

Date	Event
April 1958	JPL's Functional Design Group was established to study possibilities for a 160-kilogram spacecraft capable of a Mars mission.
Feb. 6-7, 1959	NASA Headquarters and JPL officials established management responsibilities for Vega and proposed payloads for lunar and deep space missions. Lunar probes would be followed by lunar orbiters and then lunar landers, with the first probe mission tentatively scheduled for August 1960.
Dec. 11, 1959	The Vega launch vehicle program was cancelled in favor of Atlas-Agena B.
Dec. 21, 1959	JPL was directed to establish a post-Vega lunar and interplanetary flight program with missions through 1962. High-resolution photography was judged the most urgent goal of this new program. Five Atlas-Agena B-launched lunar reconnaissance missions were suggested for 1961-1962.
Jan. 12, 1960	NASA chose eight experiments for the first two near-lunar missions.
Jan. 21, 1960	The first of two lunar near-misses (Block I) was scheduled for February 1961, with the first of three impact missions (Block II) scheduled for August 1961.
Jan. 26, 1960	The lunar spacecraft was tentatively designated Ranger. C. I. Cummings and J. D. Burke were named program director and deputy director of JPL's new Lunar Program Office.
Feb. 5, 1960	NASA Headquarters officially approved the Agena B program and gave JPL permission to proceed with Ranger.
March 1, 1960	JPL awarded study contracts for Ranger design to North American Aviation, Hughes Aircraft, and the Aeronautics Div. of Ford Motor Co.; reports were due on April 15.
March 8, 1960	Sterilization guidelines were established.
March 25, 1960	A letter contract was awarded to RCA for a lunar impact TV camera system.
April 27, 1960	JPL awarded a contract to Ford for the development of five rough-landing capsules (\$4.8 million, contract value).
May 7, 1960	The first mission was slipped to July 1961.
June 30, 1961	JPL plans for Ranger follow-on missions, the first flight of which was scheduled for January 1963, were delivered to Headquarters; included were four Ranger missions (Block III) with emphasis on lunar photography. Headquarters approved these follow-on plans in August.
July 12, 1961	First launch of an Atlas-Agena B was successful.
Aug. 23, 1961	Ranger 1 was launched on the fifth countdown; the spacecraft did not achieve its planned orbit.
Nov. 18, 1961	Ranger 2 was launched on the fourth countdown; the spacecraft did not achieve its planned orbit.
Dec. 1, 1961	Final approval was given for four experiments for the Block II Rangers.
Jan. 26, 1962	Ranger 3 was launched; lunar impact was not achieved.
April 23, 1962	Ranger 4 was launched; telemetry transmissions before impact failed.
June 1962	Initial planning was started for a Block IV series. Northrop contributed a preliminary design study for a soft-landing capsule. Tentative launch dates (1964) were released in October; by late fall as many as 20 flights were being considered.

Table 3-151.
Chronology of Ranger Development and Operations (Continued)

Date	Event
Oct. 18, 1962	<i>Ranger 5</i> was launched; it did not impact on the moon.
Oct. 29, 1962	Headquarters established a Ranger board of inquiry, who submitted its final report on November 30.
Dec. 7, 1962	H. M. Schurmeier was named JPL project manager, replacing Burke.
Feb. 12-13, 1963	At a Ranger reprogramming meeting, it was decided that Block III and IV spacecraft would be impacting-photography missions, with additional experiments incorporated into IV only; planning for Block V (12 hard landers) was approved.
March 8, 1963	Northrop was selected to provide support for Block III and V and to fabricate Block V spacecraft.
July 12, 1963	Headquarters directed JPL to terminate all its efforts on impact missions beyond Block III. While Block V—redesignated Block IV—landers were not eliminated, JPL was asked to study the possibility.
Dec. 13, 1963	Headquarters directed JPL to cancel all activities beyond Block III.
Jan. 30, 1964	<i>Ranger 6</i> was launched successfully, but it transmitted no telemetry before impact.
Feb. 2-3, 1964	JPL and independent <i>Ranger 6</i> review boards were established. The independent board's final report was issued in March.
Feb. 16, 1964	A TV subsystem for the next Ranger spacecraft was returned to RCA for reexamination.
April-May 1964	The House of Representatives Committee on Science and Astronautics Subcommittee on NASA Oversight investigated Project Ranger.
July 28, 1964	<i>Ranger 7</i> was launched successfully with good data return.
Feb. 17, 1965	<i>Ranger 8</i> was launched successfully with good data return.
March 21, 1965	<i>Ranger 9</i> was launched successfully with good data return.

Table 3-152.
Ranger 1 Characteristics

Date of launch (location):	Aug. 23, 1961 (ETR)
Launch vehicle:	Atlas-Agena B
Weight (kg):	306.18
Shape:	Hexagonal base with 2 trapezoidal solar panels and 1 pointable high-gain antenna
Dimensions (m):	Diameter, 1.5 Overall height, 3.6 Full span, 5.2
Power source:	AgZn batteries plus solar cells
Date of reentry:	Aug. 29, 1961
Cognizant NASA center:	JPL
Project manager:	J. D. Burke
Type of Ranger:	Block I
Objectives:	Test spacecraft systems for a lunar probe; collect data on solar plasma, particles, magnetic fields, and cosmic rays near the moon and in deep space.
Experiments, responsible institution:	Electrostatic analyzer for solar plasma, JPL Photoconductive particle detectors, State University of Iowa Rubidium vapor magnetometer, GSFC Triple coincidence cosmic ray telescope, University of Chicago Cosmic ray integrating ionization chamber, California Institute of Technology and JPL X-ray scintillation detectors, Sandia Corp. Micrometeorite dust particle detectors, GSFC Lyman alpha scanning telescope, Naval Research Laboratory
Results:	Injected into low earth orbit rather than highly eccentric orbit because of launch vehicle malfunction (Agena stage failed to restart); some spacecraft systems were checked out successfully and some data returned before reentry.

Table 3-153.
Ranger 2 Characteristics

Date of launch (location):	Nov. 18, 1961 (ETR)
Launch vehicle:	Atlas-Agena B
Weight (kg):	306.18
Shape:	Hexagonal base with 2 trapezoidal solar panels and 1 pointable high-gain antenna
Dimensions (m):	Diameter, 1.5 Overall height, 3.6 Full span, 5.2
Power source:	AgZn batteries plus solar cells
Cognizant NASA center:	JPL
Project manager:	J. D. Burke
Type of Ranger:	Block I
Objectives:	Test spacecraft systems for a lunar probe; collect data on solar plasma, particles, magnetic fields, and cosmic rays near the moon and in deep space.
Experiments responsible institution:	Same as for <i>Ranger 1</i> (table 3-152).
Results:	Injected into low-earth orbit rather than highly eccentric orbit because of launch vehicle malfunction (Agena stage altitude control system failed); little significant data received.

Table 3-154.
Ranger 3 Characteristics

Date of launch (location):	Jan. 26, 1962 (ETR)
Launch vehicle:	Atlas-Agena B
Shape:	Hexagonal base with 2 trapezoidal solar panels, 1 pointable high-gain antenna, a radar altimeter antenna, and a landing capsule
Dimensions (m):	Diameter, 1.5 Overall height, 3.6 Full span, 5.2
Power source:	AgZn batteries plus solar cells
Date of reentry:	In orbit around the sun
Cognizant NASA center:	JPL
Project manager:	J. D. Burke
Contractors:	Aeronutronic Div., Ford Motor Co., lunar capsule subsystem Radio Corporation of America-Astro-Electronics Div., TV camera subsystem
Type of Ranger:	Block II
Objectives:	Collect in-flight data on gamma rays; make a rough landing on the moon at a predetermined sight; transmit data on seismic activity and temperature and TV pictures prior to impact.
Experiments, responsible institution:	TV cameras, JPL et al. Gamma ray spectrometer, University of California at San Diego et al. Single-axis seismometer, California Institute of Technology and Columbia University
Results:	Surface scanning pulse radio, JPL Injected into lunar trajectory at excessive velocity because of launch vehicle malfunction (Atlas guidance system failed); missed the moon by 37 000 kilometers; a failure in the spacecraft central computer and sequencer caused the high-gain antenna to lose its earth orientation so the signals were too weak for proper transmission; useful spectrometer data on radiation were received on January 27-28.

Table 3-155.
Ranger 4 Characteristics

Date of launch (location):	April 23, 1962 (ETR)
Launch vehicle:	Atlas-Agena B
Weight (kg):	331.12
Shape:	Hexagonal base with 2 trapezoidal solar panels, 1 pointable high-gain antenna, a radar altimeter antenna, and a landing capsule
Dimensions (m):	Diameter, 1.5 Overall height, 3.6 Full span, 5.2
Power source:	AgZn batteries plus solar cells
Date of reentry:	Impacted on moon
Cognizant NASA center:	JPL
Project manager:	J. D. Burke
Contractors:	Aeronutronic Div., Ford Motor Co., lunar capsule subsystem, Radio Corp. of America-Astro-Electronics Div., TV camera subsystem
Type of Ranger:	Block II
Objectives:	Collect in-flight data on gamma rays; make a rough landing on the moon at a predetermined sight; transmit data on seismic activity and temperature and TV pictures prior to impact.
Experiments responsible institution:	Same as for <i>Ranger 3</i> (table 3-154).
Results:	The spacecraft impacted the backside of the moon on April 26; a possible failure of the spacecraft central computer and sequencer caused the master clock to stop; no telemetry was received.

Table 3-156.
Ranger 5 Characteristics

Date of launch (location):	Oct. 18, 1962 (ETR)
Launch vehicle:	Atlas-Agena B
Weight (kg):	342.46
Shape:	Hexagonal base with 2 trapezoidal solar panels, 1 pointable high-gain antenna, a radar altimeter antenna, and a landing capsule
Dimensions (m):	Diameter, 1.5 Overall height, 3.6 Full span, 5.2
Power source:	AgZn batteries plus solar cells
Date of reentry:	In orbit around the sun
Cognizant NASA center:	JPL
Project manager:	J. D. Burke
Contractors:	Aeronutronic Div., Ford Motor Co., lunar capsule subsystem Radio Corp. of America-Astro-Electronics Div., TV camera subsystem
Type of Ranger:	Block II
Objectives:	Collect in-flight data on gamma rays; make a rough landing on the moon at a predetermined sight; transmit data on seismic activity and temperature and TV pictures before impact.
Experiments, responsible institution:	Same as for <i>Ranger 3</i> (table 3-154).
Results:	Ranger power failure rendered all systems and experiments useless; spacecraft passed within 725 kilometers of the moon; four hours of data were received from the gamma ray experiment before battery depletion.

Table 3-157.
Ranger 6 Characteristics

Date of launch (location):	Jan. 30, 1964 (ETR)
Launch vehicle:	Atlas-Agena B
Weight (kg):	364.69
Shape:	Hexagonal base with 2 rectangular solar panels, pointable high-gain antenna, and omnidirectional low-gain antenna
Dimensions (m):	Diameter, 1.5 Overall height, 3.6 Full span, 4.6
Power source:	AgZn batteries plus solar cells
Date of reentry:	Impacted on moon
Cognizant NASA center:	JPL
Project manager:	H. M. Schurmeier
Contractors:	Radio Corp. of America-Astro-Electronics Div., TV camera subsystem
Type of Ranger:	Block III
Objectives:	Obtain television pictures of the lunar surface before impact for scientific study and for the support of Apollo.
Experiments, responsible institution:	TV cameras, University of Arizona, U.S. Geological Survey, University of California at San Diego, JPL
Results:	Ranger TV cameras failed; spacecraft impacted in Sea of Tranquility area on February 2, 1964; no data were returned.

Table 3-158.
Ranger 7 Characteristics

Date of launch (location):	July 28, 1964 (ETR)
Launch vehicle:	Atlas-Agena B
Weight (kg):	365.6
Shape:	Hexagonal base with 2 rectangular solar panels, pointable high-gain antenna, and omnidirectional low-gain antenna
Dimensions (m):	Diameter, 1.5 Overall height, 3.6 Full span, 4.6
Power source:	AgZn batteries plus solar cells
Date of reentry:	Impacted on moon
Cognizant NASA center:	JPL
Project manager:	H. M. Schurmeier
Contractor:	Radio Corp. of America-Astro-Electronics Div., TV camera subsystem
Type of Ranger:	Block III
Objectives:	Obtain television pictures of the lunar surface before impact for scientific study and for the support of Apollo.
Experiments, responsible institution:	TV cameras, University of Arizona, U.S. Geological Survey, University of California at San Diego, JPL
Results:	Spacecraft transmitted 4316 high-quality photographs of the moon; impacted Sea of Clouds area on July 31; findings indicated that the lunar surface would be suitable for a manned landing.

Table 3-159.
Ranger 8 Characteristics

Date of launch (location):	Feb. 17, 1965 (ETR)
Launch vehicle:	Atlas-Agena B
Weight (kg):	366.87
Shape:	Hexagonal base with 2 rectangular solar panels, pointable high-gain antenna, and omnidirectional low-gain antenna
Dimensions (m):	Diameter, 1.5 Overall height, 3.6 Full span, 4.6
Power source:	AgZn batteries plus solar cells
Date of reentry:	Impacted on moon
Cognizant NASA center:	JPL
Project manager:	H. M. Schurmeier
Contractor:	Radio Corp. of America-Astro-Electronics Div., TV camera subsystem
Type of Ranger:	Block III
Objectives:	Obtain television pictures of the lunar surface before impact for scientific study and for the support of Apollo.
Experiments, responsible institution:	TV cameras, University of Arizona, U.S. Geological Survey, University of California at San Diego, JPL
Results:	Spacecraft transmitted 7137 photographs of the moon; impacted in Sea of Tranquility area on Feb. 20, 1965.

Table 3-160.
Ranger 9 Characteristics

Date of launch (location):	March 21, 1965 (ETR)
Launch vehicle:	Atlas-Agena B
Weight (kg):	366.87
Shape:	Hexagonal base with 2 rectangular solar panels, pointable high-gain antenna, and omnidirectional low-gain antenna
Dimensions (m):	Diameter, 1.5 Overall height, 3.6 Full span, 4.6
Power source:	AgZn batteries plus solar cells
Date of reentry:	Impacted on moon
Cognizant NASA center:	JPL
Project manager:	H. M. Schurmeier
Contractor:	Radio Corp. of America-Astro-Electronics Div., TV camera subsystem
Type of Ranger:	Block III
Objectives:	Obtain television pictures of the lunar surface before impact for scientific study and for the support of Apollo.
Experiments, responsible institution:	TV cameras, University of Arizona, U.S. Geological Survey, University of California at San Diego, JPL
Results:	Spacecraft transmitted 5814 photographs; impacted in crater of Alphonsus on March 24, 1965.
Remarks:	Final mission of Project Ranger.

Lunar Orbiter

The Surveyor lunar orbiter project as approved in 1960 was a two-part undertaking. An orbiter would be used for lunar reconnaissance and a lander for surface exploration. However, development problems with the Centaur launch vehicle, early failures with Project Ranger, and increasing demands from the Office of Manned Space Flight for information on the lunar surface that would assist them in finding landing sites for Apollo, led Office of Space Sciences personnel to look for an alternative to the Surveyor orbiter. In 1962 and 1963, working groups at Headquarters and NASA's Langley Research Center were formed to study the requirements of an orbiter mission and suggest a center to manage its development and operations, and by March 1963 designers at Langley had completed plans for a lightweight orbiter.

This was the Virginia center's first major spaceflight project, and the personnel at Langley were especially anxious for it to be a successful one. Proposals from five companies for an orbiter were studied during 1963, with a contract being awarded to the Boeing Company in May 1964. This also was Boeing's first spacecraft venture. The 385-kilogram orbiter constructed by Boeing carried a photography system developed by Eastman Kodak and three scientific experiments sponsored by Langley and JPL—selenodesy (the lunar equivalent to geodesy), meteoroid detection, and radiation measurement. While the scientific and photographic returns of the Lunar Orbiter missions would, of course, be of high interest to scientists, the data would contribute to the Surveyor lander project and to the Apollo lunar landings, the agency's most popular and visible program. *Lunar Orbiter 1* through *5* were all successful, returning hundreds of high- and medium-resolution orbital photographs of the moon that were orders of magnitude better than those returned by Ranger or Surveyor. By the end of the third mission, the manned program's requirements of Lunar Orbiter had been met. In addition to prospective landing sites, other areas of the moon were photographed, and by the end of the project a broad systematic survey had been accomplished, including the moon's dark side. Scientists and designers of lunar landers received much useful data on radiation, gravity, and micrometeorites, and the manned program's tracking network had several opportunities to practice tracking a spacecraft in the vicinity of the moon.

The highly successful Lunar Orbiter was managed at NASA Headquarters by the Office of Lunar and Planetary Programs, with Lee R. Scherer as program manager. At Langley, C. H. Nelson served as project manager. The Boeing Company was the prime spacecraft contractor, with Eastman Kodak supplying the essential photographic subsystem and RCA providing the communications subsystem.

For more information on Lunar Orbiter, see Bruce K. Byers, *Destination Moon: A History of the Lunar Orbiter Program*, NASA TM X-3487 (Washington, 1977).

Table 3-161.
Chronology of Lunar Orbiter Development and Operations

Date	Event
May 1958	Long-range planners at the National Advisory Committee for Aeronautics suggested that the new civilian space agency being formed should send orbiters to the moon to gather data on its mass, magnetic field, and radioactivity and general information on its surface, with the first mission taking place by 1960.
May 1960	NASA approved the Surveyor lunar program, to consist of an orbiter and a lander for photographic coverage and surface exploration. JPL was assigned responsibility for the project (see table 3-167).
Sept. 1962	Because of problems with Ranger at JPL, demands from the Apollo program for more detailed information on the lunar surface, and delays in the development of the Centaur launch vehicle on which the Surveyor orbiter would be launched, the Office of Space Sciences (OSS) was examining alternate hardware and launch vehicles for a lunar orbiter mission. An OSS working group was formed to study the problem.
Oct. 1962	A joint Office of Manned Space Flight-Office of Space Sciences working group was formed to study the requirements for an Agena-class orbiter. The OSS group recommended giving Space Technology Laboratories (STL) a study contract for an orbiter, which NASA did.
Jan. 1963	Langley Research Center personnel were asked to study the feasibility of that center managing a lunar orbiter project.
Feb. 1963	STL's study was reviewed at a major planning meeting at Langley.
March 1963	Langley formulated a project approval document for a lightweight orbiter mission; five companies began to develop proposals.
Aug. 30, 1963	A request for proposals for an orbiter mission and spacecraft was released to industry, and a Lunar Orbiter Project Office was established at Langley under the direction of Clifford H. Nelson.
Sept.-Nov. 1963	A Langley Source Evaluation Board studied proposals from Hughes Aircraft, Boeing, TRW (of which STL was now a division), Martin Co., and Lockheed for orbiters and from Eastman Kodak for a photographic system to be used with the proposed Boeing orbiter. The board favored Boeing's proposal and recommended it to Headquarters.
Dec. 20, 1963	Boeing was selected as prime contractor for the Lunar Orbiter and the launch shroud.
May 7, 1964	Boeing's contract was signed by NASA's administrator (\$75.8 million, contract value).
Oct. 1964	A subcontract was awarded to Eastman Kodak for the photographic subsystem. A Lunar Orbiter preliminary spacecraft design review was held.
Feb. 1965	A subcontract was awarded to RCA for the communications subsystem.
July 25, 1966	A flight readiness review for the first spacecraft was held at the Kennedy Space Center.
Aug. 10, 1966	<i>Lunar Orbiter 1</i> was launched successfully with good data return.
Nov. 6, 1966	<i>Lunar Orbiter 2</i> was launched successfully with good data return.
Feb. 4, 1967	<i>Lunar Orbiter 3</i> was launched successfully with good data return.
May 4, 1967	<i>Lunar Orbiter 4</i> was launched successfully with good data return.
July 24, 1967	Plans for a possible sixth mission were not approved by Headquarters.
Aug. 1, 1967	<i>Lunar Orbiter 5</i> was launched successfully with good data return.

Table 3-162.
Lunar Orbiter 1 Characteristics

Date of launch (location):	Aug. 10, 1966 (ETR)
Launch vehicle:	Atlas-Agena D
Weight (kg):	385.6
Shape:	Truncated cone with 4 solar panels projecting from base 2-part primary structure—main equipment mounting deck, and an upper module supported by trusses and an arch)
Dimensions (m):	Stowed, 1.64×1.67 With Antennas and panels deployed, 5.6×3.7
Power source:	NiCd battery plus solar cells
Date of reentry:	Impacted on moon
Cognizant NASA center:	Langley Research Center (LaRC)
Project manager:	Clifford H. Nelson
Contractors:	Boeing Co., prime Eastman Kodak, TV camera subsystem Radio Corp., of America, communications subsystem
Objectives:	In lunar orbit, obtain high- and medium-resolution photographs of various types of lunar terrain suitable for Surveyor and Apollo landing sites; provide information on gravitational field through tracking exercises; measure radiation and detect micrometeorites.
Experiments, responsible institution:	610-mm Panoramic and 80-mm Xenotar lenses, LaRC Selenodesy, LaRC, JPL Meteoroid detection, LaRC Radiation measurement, LaRC
Results:	Transmitted 207 images of the lunar surface covering 41 000 square kilometers of candidate Apollo sites and 4.9 million kilometers of the far side of the moon; high-resolution images were smeared, medium-resolution excellent. Mission was terminated by crashing the spacecraft onto the surface on October 29 (perilune, 58 kilometers).
Remarks:	First U.S. spacecraft to enter lunar orbit.

Table 3-163.
Lunar Orbiter 2 Characteristics

<i>Date of launch (location):</i>	Nov. 6, 1966 (ETR)
<i>Launch vehicle:</i>	Atlas-Agena D
<i>Weight (kg):</i>	385.6
<i>Shape:</i>	Truncated cone with 4 solar panels projecting from base (2-part primary structure—main equipment mounting deck, and an upper module supported by trusses and an arch)
<i>Dimensions (m):</i>	Stowed, 1.64 × 1.67 With antennas and panels deployed, 5.6 × 3.7
<i>Power source:</i>	NiCd battery plus solar cells
<i>Date of reentry:</i>	Impacted on moon
<i>Cognizant NASA center:</i>	LaRC
<i>Project manager:</i>	Clifford H. Nelson
<i>Contractors:</i>	Boeing Co., prime Eastman Kodak, TV camera subsystem Radio Corp. of America, communications subsystem
<i>Objectives:</i>	In lunar orbit, obtain high- and medium-resolution images of various types of lunar terrain suitable for Surveyor and Apollo landing sites; provide information of gravitational field through tracking exercises; measure radiation and detect micrometeorites.
<i>Experiments, responsible institution:</i>	Same as for <i>Lunar Orbiter 1</i> (table 3-162).
<i>Results:</i>	Transmitted 211 high- and medium-resolution photographs and monitored radiation in the lunar environment; photographed 13 primary Apollo target sites (36 000 square kilometers). Mission was terminated by crashing the spacecraft onto the lunar surface on October 11, 1967 (perilune, 196 kilometers).

Table 3-164.
Lunar Orbiter 3 Characteristics

<i>Date of launch</i> (location):	Feb. 4, 1967 (ETR)
<i>Launch vehicle:</i>	Atlas-Agena D
<i>Weight (kg):</i>	385.6
<i>Shape:</i>	Truncated cone with 4 solar panels projecting from base (2-part primary structure—main equipment mounting deck, and an upper module supported by trusses and an arch)
<i>Dimensions (m):</i>	Stowed, 1.64 × 1.67 With antennas and panels deployed, 5.6 × 3.7
<i>Power source:</i>	NiCd battery plus solar cells
<i>Date of reentry:</i>	Impacted on moon
<i>Cognizant NASA center:</i>	LaRC
<i>Project manager:</i>	Clifford H. Nelson
<i>Contractors:</i>	Boeing Co., prime Eastman Kodak, TV camera subsystem Radio Corp. of America, communications subsystem
<i>Objectives:</i>	In lunar orbit, obtain high- and medium-resolution photographs of various types of lunar terrain suitable for Surveyor and Apollo landing sites; provide information on gravitational field through tracking exercises; measure radiation and detect micrometeorites; provide target for tracking network.
<i>Experiments, responsible institution:</i>	Same as for <i>Lunar Orbiter 1</i> (table 3-162).
<i>Results:</i>	Transmitted 211 medium- and high-resolution images of Apollo and Surveyor landing sites; only 72% of the total planned images were taken due to malfunction in readout system on February 24. Mission was terminated by crashing the spacecraft onto the surface on October 9 (perilune, 55 kilometers).

Table 3-165.
Lunar Orbiter 4 Characteristics

<i>Date of launch</i> (location):	May 4, 1967 (ETR)
<i>Launch vehicle:</i>	Atlas-Agena D
<i>Weight (kg):</i>	385.6
<i>Shape:</i>	Truncated cone with 4 solar panels projecting from base (2-part primary structure—main equipment mounting deck, and an upper module supported by trusses and an arch)
<i>Dimensions (m):</i>	Stowed, 1.64 × 1.67 With antennas and panels deployed, 5.6 × 3.7
<i>Power source:</i>	NiCd battery plus solar cells
<i>Date of reentry:</i>	Impacted on moon
<i>Cognizant NASA center:</i>	LaRC
<i>Project manager:</i>	Clifford H. Nelson
<i>Contractors:</i>	Boeing Co., prime Eastman Kodak, TV camera subsystem Radio Corp. of America, communications subsystem
<i>Objectives:</i>	Obtain a broad systematic photographic survey of the moon, assessing various surface features; gather data on gravity, micrometeorites, and radiation.
<i>Experiments, responsible institution:</i>	Same as for <i>Lunar Orbiter 1</i> (table 3-162).
<i>Results:</i>	Transmitted 193 medium- and high-resolution images, 99% of the planned number by June 1; southern polar region photographed for the first time. Mission was terminated by crashing the spacecraft onto the surface on October 6 (perilune, 2705 kilometers).

Table 3-166.
Lunar Orbiter 5 Characteristics

<i>Date of launch (location):</i>	Aug. 1, 1967 (ETR)
<i>Launch vehicle:</i>	Atlas-Agena D
<i>Weight (kg):</i>	385.6
<i>Shape:</i>	Truncated cone with 4 solar panels projecting from base (2-part primary structure—main equipment mounting deck, and an upper module supported by trusses and an arch)
<i>Dimensions (m):</i>	Stowed, 1.64 × 1.67 With antennas and panels deployed, 5.6 × 3.7
<i>Power source:</i>	NiCd battery plus solar cells
<i>Date of reentry:</i>	Impacted on moon
<i>Cognizant NASA center:</i>	LaRC
<i>Project manager:</i>	Clifford H. Nelson
<i>Contractors:</i>	Boeing Co., prime Eastman Kodak, TV camera subsystem Radio Corp. of America, communications subsystem
<i>Objectives:</i>	Obtain photographs of scientifically interesting areas on both sides of the moon; gather data on gravity, micrometeorites, radiation; provide a target for tracking exercises.
<i>Experiments, responsible institution:</i>	Same as for <i>Lunar Orbiter 1</i> (table 3-162).
<i>Results:</i>	Transmitted 212 medium- and high-resolution images of lunar surface until August 28; these images completed coverage of the far side. Mission was terminated by crashing the spacecraft into the surface on January 31, 1968 (perilune, 194 kilometers).
<i>Remarks:</i>	Last mission of the Lunar Orbiter series.

Surveyor

Originally perceived in 1960 as an orbiter-lander project that would yield photographs of the lunar surface and scientific information on the moon's environment and its structure, Surveyor as flown was a lunar lander project that supported NASA's manned Apollo missions. Langley Research Center's Lunar Orbiter replaced the Surveyor orbiter (see table 3-161). In its initial configuration, the Surveyor soft-lander would have carried several scientific instruments to the moon, but weight constraints and the growing importance of Apollo eliminated most of Surveyor's scientific objectives. Before men could be sent on a lunar expedition, spacecraft designers needed information on the moon's crust and its bearing limits, its soil, magnetic properties, and radar and thermal reflectivity. Equipped with a television camera, sampling scoop, magnetic footpads, and an alpha-scattering instrument, Surveyor would supply the designers with these critical data.

In early 1961, NASA chose Hughes Aircraft's proposal for a Surveyor lander and began mission planning at the Jet Propulsion Laboratory (JPL) for seven lunar

flights, the first of which was planned for launch on Atlas-Centaur in 1963. Unfortunately, the new Centaur stage did not cooperate, and repeated schedule delays with the launch vehicle forced Surveyor managers to postpone the lander's first mission. Surveyor's designers also had to pare down the spacecraft's size so that it was compatible with Centaur's more limited lifting capabilities—from an original 1134 kilograms with a 156-kilogram payload to a 953-kilogram spacecraft with 52 kilograms of instruments. It was 1966 before Atlas-Centaur was operational, but the new booster launched all seven Surveyors into the proper trajectories.

Surveyor lander was roughly triangular in shape with two equipment compartments and a vertical mast to hold a solar panel and several antennas. The three-meter-high craft was supported on three landing legs with shock absorbers and footpads. Its controlled landing was accomplished by three vernier engines and a retrorocket. The first two landers were equipped with only a television camera (capable of both 25- and 6-degree fields of view) for taking post-landing photographs. *Surveyor 1* landed on the moon on June 2, 1966, three days after it started its journey from the Eastern Test Range. Transmitting more than 10 000 high-quality images, it remained operational until the following January. Trouble with the vernier engines caused the second lander to crash into the moon, but *Surveyor 3* with added features returned an abundance of data. Besides 6315 photographs, the earth-bound specialists received information on the composition and surface-bearing strength of the lunar crust as the television camera focused on a surface sampler as it dug trenches in the soil and on thermal and radar reflectivity. *Surveyor 4* failed; minutes before it was due to land something went wrong, and the spacecraft either exploded or crashed onto the moon's surface. The last three missions all returned thousands of photographs and supplied data on chemical elements in the soil, touchdown dynamics, and the surface's magnetic properties. Mission specialists had a great deal of control over the Surveyor spacecraft and could correct its trajectory if needed and otherwise maneuver it. *Surveyor 6* was even restarted and moved three meters on the surface. Apollo designers had met all their objectives with Surveyor by the end of the sixth flight, and NASA managers cancelled any follow-on Block II or III missions. Scientists, too, especially geologists, benefitted from the vast photographic archives made possible by Surveyor (some of the photographs were in color). *Surveyor 7* landed in an area of high scientific interest outside the Apollo target area.

Surveyor was managed by the NASA Headquarters Office of Lunar and Planetary Programs within the Office of Space Science and Applications (OSSA). Benjamin Milwitzky served as program manager. At JPL, Walker E. Gibberson led the Surveyor team in its early days, with Robert J. Parks taking over in 1965. Howard H. Haglund assumed the role in late 1966. Hughes Aircraft Company was the prime spacecraft contractor.

No single source can be suggested for further reading, but several volumes published by NASA record the results of the project. Among them, the following is perhaps the most useful: NASA, Office of Space Science and Applications, comp., *Surveyor Program Results*, NASA SP-184 (Washington, 1969).

Table 3-167.
Chronology of Surveyor Development and Operations

Date	Event
May 1960	NASA approved the Surveyor launch program to consist of two parts—an orbiter for photographic coverage and a lander for surface exploration. The Jet Propulsion Laboratory (JPL) was assigned project responsibility for Surveyor and for Ranger.
July 1960	Four Surveyor study contracts were awarded to Hughes Aircraft, North American, Space Technology Laboratories, and McDonnell Aircraft, with JPL providing design requirements. Eight study contracts for experiment proposals also were let.
Jan. 19, 1961	Hughes was selected as contractor to build seven Surveyor landers; a letter contract was issued on March 1. The first launch was scheduled for August 1963 on an Atlas-Centaur.
March 6, 1962	Martin-Marietta Corporation was selected to build a thermoelectric generator for use on Surveyor.
May 8, 1962	The first Atlas-Centaur test launch was unsuccessful.
Mid-1962	Because of Centaur development problems, early failures with Ranger, and increasing demands for information on the lunar surface for Apollo, the orbiter portion of Surveyor was dropped and replaced by Lunar Orbiter, to be managed at Langley Research Center. Problems with the Centaur stage forced the postponement of the first Surveyor launch.
Early 1963	Initial testing of the first proof test model was completed.
Nov. 27, 1963	The second Atlas-Centaur test launch was successful.
Dec. 11, 1964	Atlas-Centaur launched a Surveyor model successfully.
Aug. 11, 1965	Atlas-Centaur launched a Surveyor model successfully, putting the dummy spacecraft into a highly elliptical orbit to simulate lunar transfer orbit.
Feb. 1, 1966	A soft-landing retrorocket system was tested successfully by Hughes and JPL.
April 7, 1966	Atlas-Centaur launched a Surveyor model, but the vehicle failed to achieve double ignition, and the dummy spacecraft remained in earth orbit.
May 11, 1966	The Surveyor spacecraft accomplished a soft-landing test under its own power.
May 30 1966	<i>Surveyor 1</i> was launched successfully, landing on the moon on June 2.
June 1, 1966	A General Accounting Office report charged NASA with spending \$2.5 million on Surveyor experiments it had not required.
Sept. 20, 1966	<i>Surveyor 2</i> was launched successfully, but the spacecraft crashed into the lunar surface on September 22 due to vernier engine failure.
Dec. 13, 1966	NASA dropped plans for three additional Surveyors (Block II) and a possible Surveyor rover because of good results with later Ranger spacecraft, Lunar Orbiters, and <i>Surveyor 1</i> and because of budgetary considerations.
April 17, 1967	<i>Surveyor 3</i> was launched successfully, landing on the moon on April 19.
July 14, 1967	<i>Surveyor 4</i> was launched successfully, but the spacecraft failed minutes before its scheduled landing.
Sept. 8, 1967	<i>Surveyor 5</i> was launched successfully, landing on the moon on September 10.
Nov. 7, 1967	<i>Surveyor 6</i> was launched successfully, landing on the moon on November 9.
Jan. 7, 1968	<i>Surveyor 7</i> was launched successfully, landing on the moon on January 9.
June 28, 1968	JPL's Surveyor project office was closed.

Table 3-168.
Surveyor 1 (Surveyor-A) Characteristics

<i>Date of launch (location):</i>	May 30, 1966 (ETR)
<i>Launch vehicle:</i>	Atlas-Centaur
<i>Weight (kg):</i>	995.2
<i>Shape:</i>	Triangular aluminum frame containing 2 equipment compartments supported by 3 landing legs with footpads; a vertical mast supported a solar panel and antennas
<i>Dimensions (m):</i>	Height, 3 Width with legs extended, 4.2
<i>Power source:</i>	AgZn batteries plus solar cells
<i>Date of reentry:</i>	Landed on the moon June 2, 1966
<i>Cognizant NASA center:</i>	JPL
<i>Project manager:</i>	Robert J. Parks
<i>Contractor:</i>	Hughes Aircraft Co., prime
<i>Objectives:</i>	Demonstrate spacecraft capability to maneuver, communicate, and soft-land on the moon; photograph surface.
<i>Experiments responsible institution:</i>	TV cameras, GSFC, LaRC, JPL, U.S. Geological Survey, Lamont Geological Observatory, University of Chicago
<i>Results:</i>	Soft-landed on the moon June 2 in the Ocean of Storms area; returned more than 10 000 high-quality images and selenological data; completed primary mission July 13 with communications reestablished periodically through January 1967.
<i>Remarks:</i>	First spacecraft to soft-land on the moon.

Table 3-169.
Surveyor 2 (Surveyor-B) Characteristics

<i>Date of launch (location):</i>	Sept. 20, 1966 (ETR)
<i>Launch vehicle:</i>	Atlas-Centaur
<i>Weight (kg):</i>	995.2
<i>Shape:</i>	Triangular aluminum frame containing 2 equipment compartments supported by 3 landing legs with footpads; a vertical mast supported a solar panel and antennas
<i>Dimensions (m):</i>	Height, 3 Width with legs extended, 4.2
<i>Power source:</i>	AgZn batteries plus solar cells
<i>Date of reentry:</i>	Impacted onto the moon Sept. 22, 1966
<i>Cognizant NASA center:</i>	JPL
<i>Project manager:</i>	Robert J. Parks
<i>Contractor:</i>	Hughes Aircraft Co., prime
<i>Objectives:</i>	Demonstrate spacecraft capability to maneuver, communicate, and soft-land on the moon; photograph surface.
<i>Experiments, responsible institution:</i>	TV cameras, GSFC et al.
<i>Results:</i>	Spacecraft crashed onto the lunar surface on September 22 when one of its three vernier engines failed to ignite during a mid-course maneuver.

Table 3-170.
Surveyor 3 (Surveyor-C) Characteristics

<i>Date of launch</i> (location):	April 17, 1967 (ETR)
<i>Launch vehicle:</i>	Atlas-Centaur
<i>Weight (kg):</i>	997.9
<i>Shape:</i>	Triangular aluminum frame containing 2 equipment compartments supported by 3 landing legs with footpads; a vertical mast supported a solar panel and antennas
<i>Dimensions (m):</i>	Height, 3 Width with legs extended, 4.2
<i>Power source:</i>	AgZn batteries plus solar cells
<i>Date of reentry:</i>	Landed on the moon April 19, 1967
<i>Cognizant NASA center:</i>	JPL
<i>Project manager:</i>	H. H. Haglund
<i>Contractor:</i>	Hughes Aircraft Co., prime
<i>Experiments, responsible institution:</i>	TV cameras, U.S. Geological Survey Surface sampler, California Institute of Technology
<i>Results:</i>	Soft-landed on the moon April 19, 1967, within an Apollo landing area; returned 6315 images and data on a soil sample; experiments functioned until early May when lunar night began. The visual range of the TV cameras was extended by the use of two flat mirrors.

Table 3-171.
Surveyor 4 (Surveyor-D) Characteristics

<i>Date of launch</i> (location):	July 14, 1967 (ETR)
<i>Launch vehicle:</i>	Atlas-Centaur
<i>Weight (kg):</i>	1037.4
<i>Shape:</i>	Triangular aluminum frame containing 2 equipment compartments supported by 3 landing legs with footpads; a vertical mast supported a solar panel and antennas
<i>Dimensions (m):</i>	Height, 3 Width with legs extended, 4.2
<i>Power source:</i>	AgZn batteries plus solar cells
<i>Date of reentry:</i>	Impacted onto the lunar surface July 16, 1967
<i>Cognizant NASA center:</i>	JPL
<i>Project manager:</i>	H. H. Haglund
<i>Contractor:</i>	Hughes Aircraft Co., prime
<i>Objectives:</i>	Soft-land on the moon in Sinus Medii; obtain photographs of surface; conduct vernier engine experiment; manipulate surface with scoop and observe with TV camera; obtain touchdown dynamics information and thermal and radar reflectivity data.
<i>Experiments, responsible institution:</i>	TV cameras, U.S. Geological Survey Surface sampler, California Institute of Technology
<i>Results:</i>	Flight was successful until two seconds before retrorocket burnout, two and one-half minutes before scheduled landing; spacecraft impacted the moon, possibly after an explosion.

Table 3-172.
Surveyor 5 (Surveyor-E) Characteristics

<i>Date of launch</i> (location):	Sept. 8, 1967 (ETR)
<i>Launch vehicle:</i>	Atlas-Centaur
<i>Weight</i> (kg):	1006
<i>Shape:</i>	Triangular aluminum frame containing 2 equipment compartments supported by 3 landing legs with footpads; a vertical mast supported a solar panel and antennas
<i>Dimensions</i> (m):	Height, 3 Width with legs extended, 4.2
<i>Power source:</i>	AgZn batteries plus solar cells
<i>Date of reentry:</i>	Landed on the moon Sept. 10, 1967
<i>Cognizant NASA center:</i>	JPL
<i>Project manager:</i>	H. H. Haglund
<i>Contractor:</i>	Hughes Aircraft Co., prime
<i>Objectives:</i>	Soft-land on moon; obtain TV photos of the surface; conduct vernier engine experiment; determine abundance of chemical elements in soil; obtain touchdown dynamics information and thermal and radar reflectivity data.
<i>Experiments, responsible institution:</i>	TV cameras, U.S. Geological Survey Alpha-scattering instrument, University of Chicago Surface sampler, California Institute of Technology Magnetic footpads, JPL
<i>Results:</i>	Soft-landed on the moon in Sea of Tranquility area on September 10; returned 18 000 images, some converted to color; obtained data on lunar surface radar and thermal reflectivity; performed other investigations as planned. Complete signal was lost on December 16, 1967.

Table 3-173.
Surveyor 6 (Surveyor-F) Characteristics

<i>Date of launch</i> (location):	Nov. 7, 1967 (ETR)
<i>Launch vehicle:</i>	Atlas-Centaur
<i>Weight</i> (kg):	1008.3
<i>Shape:</i>	Triangular aluminum frame containing 2 equipment compartments supported by 3 landing legs with footpads; a vertical mast supported a solar panel and antennas
<i>Dimensions</i> (m):	Height, 3 Width with legs extended, 4.2
<i>Power source:</i>	AgZn batteries plus solar cells
<i>Date of reentry:</i>	Landed on the moon Nov. 9, 1967
<i>Cognizant NASA center:</i>	JPL
<i>Project manager:</i>	H. H. Haglund
<i>Contractor:</i>	Hughes Aircraft Co., prime
<i>Objectives:</i>	Soft-land on moon; obtain TV photos of the surface; conduct vernier engine experiment; determine abundance of chemical elements in soil; obtain touchdown dynamics information and thermal and radar reflectivity data.
<i>Experiments, responsible institution:</i>	Same as for <i>Surveyor 5</i> (table 3-172)
<i>Results:</i>	Soft-landed in Sinus Medii area on November 9; returned 29 500 images of the lunar surface, Earth, Jupiter, and several stars; obtained data on touchdown dynamics and surface characteristics; on November 17 the spacecraft was restarted and moved about 3 meters. Signals were lost on December 14, 1967.

Table 3-174.
Surveyor 7 (Surveyor-G) Characteristics

<i>Date of launch</i> (location):	Jan. 7, 1968 (ETR)
<i>Launch vehicle:</i>	Atlas-Centaur
<i>Weight</i> (kg):	1040.1
<i>Shape:</i>	Triangular aluminum frame containing 2 equipment compartments supported by 3 landing legs with footpads; a vertical mast supported a solar panel and antennas
<i>Dimensions</i> (m):	Height, 3 Width with legs extended, 4.2
<i>Power source:</i>	AgZn batteries plus solar cells
<i>Date of reentry:</i>	Landed on the moon Jan. 9, 1968
<i>Cognizant NASA center:</i>	JPL
<i>Project manager:</i>	H. H. Haglund
<i>Contractor:</i>	Hughes Aircraft Co., prime
<i>Objectives:</i>	Soft-land on moon; obtain TV photos of the surface; manipulate lunar material with the surface sampler; obtain touchdown dynamics information and thermal and radar reflectivity data.
<i>Experiments, responsible institution:</i>	Same as for <i>Surveyor 5</i> (table 3-172).
<i>Results:</i>	Landed near lunar crater Tycho on January 9; returned 21 274 images, including some stereo pictures of the surface and of rocks that were of special interest; light-scattering experiment failed to contact surface, but the sampling arm manipulated it into position. Signal was lost on February 20, 1968.
<i>Remarks:</i>	Last mission of the Surveyor series.

Mariner

Exploration of earth's nearest planetary neighbors was a goal entertained by NASA scientists from the agency's earliest days. Missions to Venus and Mars would require more sophisticated spacecraft than the Explorers sent into orbit around earth or the sun to measure and observe the phenomena of interplanetary space. Spacecraft directed toward earth's moon and the other planets would require complex communications, data storage, and guidance and control equipment, computers, and scientific instruments with which to sound distant atmospheres. The weight of this new hardware would require a launch vehicle more powerful than those available to NASA in the early 1960s. From the first preliminary studies, space agency planners built their designs for Mariner planetary explorers around the powerful Centaur upper stage under development at General Dynamics. And it was Centaur's availability, or lack of it, that determined the direction the first 10 years of planetary mission planning would take.

From 1960 through 1968, 10 distinct Mariner projects were approved, but troubles with Centaur and the budget caused the cancellation of four of them. The first Mariners—"A," a Venus flyby mission, and "B," instrumented Mars and Venus landings—were proposed in 1960, but they never became flight projects. Proposals for Mariner-Venus 1962 (also called Mariner R) led to the launches of *Mariner 1* and 2, Venus flyby projects. Only *Mariner 2* reached its target, returning 42 minutes of

data about the atmosphere and surface of the planet. *Mariner 3* and *4*, flyby missions, were approved in late 1962 as Mariner-Mars 1964. Again, only one of the pair was successful. *Mariner 4* reached Mars in 228 days, sending back 21½ photographs of the Red Planet's surface and information about its atmosphere. Mission planners and scientists, anxious to send orbit-landers to Mars and Venus, designed a heavy, sophisticated spacecraft called Voyager in 1962, but Voyager plans were never translated into flight hardware. Money and launch vehicles were once again the problems. The proposals or cancellations of Mariner-Mars 1966 (flyby), Advanced Mariner 1969 (Mars orbiter-lander), Mariner-Venus 1967 (flyby), Mariner-Mars 1969 (flyby), Mariner-Mars 1971 (orbiter), and Mariner Venus-Mercury 1973 (flyby) were all affected in some way by Voyager's postponements and cancellation. The one other Mariner launched during NASA's first decade was *Mariner 5*, which took advantage of the 1967 Venus launch windows. The spacecraft flew by this cloud-shrouded planet on October 19, 1967 and reported on its atmosphere, mass, and solar wind interaction.

The first five Mariners were in the 200-260-kilogram class and were launched by Atlas-Agena B or D vehicles. Their hexagonal or octagonal frame bases held scientific instruments designed by personnel from NASA's centers and from American universities. Solar panels provided spacecraft powers, and the Deep Space Network at the Jet Propulsion Laboratory (JPL) was responsible for tracking and communications. Many companies contributed components to the Mariners, acting as subcontractors to the Jet Propulsion Laboratory, where the spacecraft were assembled and tested.

At NASA Headquarters, the Mariner program was managed by Fred D. Kochendorfer of the Office of Lunar and Planetary Programs until 1963, when Donald P. Heath began acting as Pioneer and Mariner manager. Glenn A. Reiff took over in 1965. In mid-1967, Reiff took responsibility for Mariner-Mars 1967 only, and Newton W. Cunningham managed Mariner-Mars 1969, with Earl W. Glahn becoming manager of Mariner-Mars 1971 in late 1968. At JPL, Jack N. James was Mariner project manager until January 1965, when Dan Schneiderman assumed the job.

For an overall look at Mariner history, see chapters 2, 3, 6, and 9 of Edward C. and Linda N. Ezell, *On Mars: Exploration of the Red Planet, 1958-1978*, NASA SP-4212 (Washington, 1984). Many NASA publications have been issued on the Mariner projects and their results; three useful ones are JPL, *Mariner-Venus 1962 Final Project Report*, NASA SP-59 (Washington, 1965); JPL, *Mariner-Mars 1964 Final Project Report*, NASA SP-139 (Washington, 1967); and JPL, *Mariner-Venus 1967 Final Project Report*, NASA SP-190 (Washington, 1971).

Table 3-175.
Mariner Proposals, 1960-1968

Proposal	Year Proposed*	Mission	Results
Mariner A	1960	Venus flyby (1962, 1964, 1965)	Cancelled in 1961 because of the unavailability of Centaur.
Mariner B	1960	Mars or Venus lander (1964)	Replaced by Mariner-Mars 1966 proposal.
Mariner-Venus 1962 (also called Mariner R)	1961	Venus flyby (1962)	Led to the launches of <i>Mariner 1</i> and <i>2</i> in 1962.
Mariner-Mars 1964	1962	Mars flyby (1964)	Led to the launches of <i>Mariner 3</i> and <i>4</i> in 1964.
Mariner-Mars 1966 (to replace Mariner B)	1963	Mars flyby (1966)	Cancelled in 1966 and replaced by a proposal for Advanced Mariner 1969.
Advanced Mariner 1969 (to replace Mariner-Mars 1966)	1964	Mars orbiter-lander (1969)	Cancelled in 1964 for budgetary reasons.
Mariner-Mars 1969 (in answer to Voyager postponement)	1965	Mars flyby (1969)	Led to the launches of <i>Mariner 6</i> and <i>7</i> in 1969.
Mariner-Venus 1967 (in answer to Voyager postponement)	1965	Venus flyby (1967)	Led to the launch of <i>Mariner 5</i> in 1967.
Mariner-Mars 1971 (in answer to Voyager cancellation)	1967	Mars orbiter (1971)	Led to the launches of <i>Mariner 8</i> and <i>9</i> in 1971.
Mariner Venus-Mercury 1973 (proposed by the Space Science Board)	1968	Venus and Mercury flybys (1973)	Led to the launch of <i>Mariner 10</i> in 1973.

*Does not necessarily indicate official proposal; for further details see table 3-176.

Table 3-176.
Chronology of Mariner Development and Operations

Date	Event
1958-1959	Several feasibility studies for unmanned lunar and planetary missions resulted in conceptual designs for spacecraft using the planned Atlas-Centaur launch vehicle; the earliest mission was scheduled for 1962 to Venus.
May 19, 1960	NASA's planetary program was named Mariner.
July 1960	A study was begun at the Jet Propulsion Laboratory (JPL) for a Mariner A mission that would fly by Venus in 1962 and a Mariner B mission for an instrumented landing on Venus or Mars in 1964.
July 15, 1960	Mariner A and B were approved by NASA Headquarters.
Nov. 1960	JPL completed the preliminary design of Mariner A.
Feb. 1961	Revised plans for Mariner A called for missions to Venus in 1962, 1964, and 1965; revised plans for Mariner B dropped the Venus landing from consideration.
Aug. 1961	A study was begun at JPL for a Mariner-Venus 1962 flyby mission (also called Mariner R), which led to <i>Mariner 1</i> and 2.
Aug. 30, 1961	Mariner A was cancelled due to the projected unavailability of the Atlas-Centaur; Mariner-Venus 1962 was approved.
Early 1962	JPL began a design study for a Mariner-Mars 1964 craft for a flyby mission to Mars, which led to <i>Mariner 3</i> and 4.
April 9, 1962	Mariner B's Mars landing option was dropped and the Venus landing reconsidered.
May 1962	Mariner-Venus 1962 spacecraft were delivered to KSC.
July 22, 1962	<i>Mariner 1</i> launch was unsuccessful when the launch vehicle malfunctioned.
Aug. 27, 1962	<i>Mariner 2</i> launch was successful; the spacecraft passed by Venus on December 14.
Nov. 1962	The Mariner-Mars 1964 project was tentatively approved.
March 1, 1963	A project approval document for Mariner-Mars 1964 was signed; the Atlas-Agena launch vehicle was substituted for Atlas-Centaur, which was still behind schedule.
March 14, 1963	The Mariner B mission was changed to a pre-Voyager checkout flight to Mars with a lander.
April 11, 1963	The selection of 10 experiments for Mariner-Mars 1964 was announced.
May 6, 1963	A Mariner-Mars 1966 flyby project was proposed, which took the place of Mariner B.
June-Dec. 1963	A Mariner-Mars 1964 spacecraft proof-test model was assembled and testing begun.
Dec. 19, 1963	Mariner-Mars 1966 was approved.
Jan. 1964	Initial plans for an Advanced Mariner 1969 orbiter-lander mission to Mars were formulated.
July 28, 1964	Mariner-Mars 1966 was effectively cancelled, with official termination coming on September 4; it would be replaced by Advanced Mariner 1969.
Aug. 2, 1964	A project approval document for Advanced Mars 1969 was signed.
Sept. 11, 1964	Mariner-Mars 1964 spacecraft arrived at the Kennedy Space Center.
Nov. 5, 1964	<i>Mariner 3</i> launch was unsuccessful due to the failure of the shroud to jettison properly.
Nov. 19, 1964	Lewis Research Center undertook the supervision of Lockheed's design and development of a metal shroud for the next Mariner launch; the metal shroud would replace the fiberglass one that had failed on <i>Mariner 3</i> .

Table 3-176.
Chronology of Mariner Development and Operations (Continued)

Date	Event
Nov. 20, 1964	Advanced Mariner 1969 was cancelled because of budgetary considerations.
Nov. 28, 1964	<i>Mariner 4</i> was launched successfully; the spacecraft passed by Mars on July 14, 1965.
Dec. 22, 1965	A Mariner-Mars 1969 flyby project was tentatively approved when the Voyager Venus-Mars project was postponed (this led to <i>Mariner 6</i> and <i>7</i>).
Dec. 25, 1965	A Mariner-Venus 1967 flyby project was approved when the Voyager Venus-Mars project was postponed (this led to <i>Mariner 5</i>).
March 28, 1966	A project approval document for Mariner-Mars 1969 was signed.
June 14, 1967	<i>Mariner 5</i> launch was successful; the spacecraft passed by Venus on October 19.
Nov. 1967	Mariner-Mars 1971 was proposed after cancellation of Voyager (this led to <i>Mariner 8</i> and <i>9</i>).
June 1968	Mariner Venus-Mercury 1973 was proposed by the Space Science Board (this led to <i>Mariner 10</i>). The first Mariner-Mars 1969 spacecraft was assembled.
Aug. 23, 1968	A project approval document for Mariner-Mars 1971 was signed.
Nov. 14, 1968	JPL was authorized to begin work on Mariner-Mars 1971.

Table 3-177.
Mariner 1 (Mariner R-1) Characteristics

<i>Date of launch</i> (location):	July 22, 1962 (ETR)
<i>Launch vehicle:</i>	Atlas-Agena B
<i>Weight</i> (kg):	202.8
<i>Shape:</i>	Hexagonal frame base with 2 solar panels; antennas mounted atop the base
<i>Dimensions</i> (m):	Base, 1.04 × .36 Overall height, 3.66 Span with panels deployed, 5.05
<i>Power source:</i>	AgZn battery plus solar cells
<i>Date of reentry:</i>	Destroyed on range
<i>Cognizant NASA center:</i>	JPL
<i>Project manager:</i>	Jack N. James
<i>Contractor:</i>	In-house (JPL) construction and testing of components built by many subcontractors.
<i>Objectives:</i>	Send spacecraft to near-vicinity of Venus; establish and maintain two-way communications with the spacecraft throughout flight; obtain data on the environment in interplanetary space and near Venus; survey the planet's surface characteristics.
<i>Experiments, responsible institution:</i>	Microwave radiometer, JPL et al. Infrared radiometer, JPL et al. Fluxgate magnetometer, JPL, California Institute of Technology Energetic particle detectors, JPL, CalTech, State University of Iowa Cosmic dust detector, GSFC Solar plasma spectrometer, JPL
<i>Results:</i>	Booster deviated from course and was destroyed by range safety officer 290 seconds after liftoff.

Table 3-178.
Mariner 2 (Mariner R-2) Characteristics

<i>Date of launch (location):</i>	Aug. 27, 1962 (ETR)
<i>Launch vehicle:</i>	Atlas-Agena B
<i>Weight (kg):</i>	202.8
<i>Shape:</i>	Hexagonal frame base with 2 solar panels; antennas mounted atop the base
<i>Dimensions (m):</i>	Base, 1.04 × .36 Overall height, 3.66 Span with panels deployed, 5.05
<i>Power source:</i>	AgZn battery plus solar cells
<i>Date of reentry:</i>	In orbit around sun
<i>Cognizant NASA center:</i>	JPL
<i>Project manager:</i>	Jack N. James
<i>Contractor:</i>	In-house (JPL) construction and testing of components built by many subcontractors.
<i>Objectives:</i>	Send spacecraft to near-vicinity of Venus; establish and maintain two-way communications with the spacecraft throughout flight; obtain data on the environment in interplanetary space and near Venus; survey the planet's surface characteristics.
<i>Experiments, responsible institution:</i>	Same as for <i>Mariner 1</i> (table 3-177).
<i>Results:</i>	Passed within 34 762 kilometers of Venus on December 14 and made a 42-minute instrument survey of the atmosphere and surface of the planet before going into heliocentric orbit; made comprehensive measurements of the solar wind; transmissions received until January 4, 1963, from a maximum distance of 87.4 million kilometers.
<i>Remarks:</i>	First spacecraft to scan another planet.

Table 3-179.
Mariner 3 (Mariner C, Mariner-Mars 1964) Characteristics

<i>Date of launch (location):</i>	Nov. 5, 1964 (ETR)
<i>Launch vehicle:</i>	Atlas-Agena D
<i>Weight (kg):</i>	260.8
<i>Shape:</i>	Octagonal base with 4 solar panels
<i>Dimensions (m):</i>	Base, 1.27 × .46 Overall height, 2.89 Span with panels deployed, 6.88
<i>Power source:</i>	AgZn battery plus solar cells
<i>Date of reentry:</i>	In orbit around sun
<i>Cognizant NASA center:</i>	JPL
<i>Project manager:</i>	Jack N. James
<i>Contractor:</i>	In-house (JPL) construction and testing of components built by many subcontractors.
<i>Objectives:</i>	Fly by Mars and study the planet's atmosphere and surface; develop operational techniques for interplanetary missions; take measurements of the interplanetary environment; provide engineering experience in spacecraft operations during long-duration flights away from the sun.
<i>Experiments, responsible institution:</i>	Cosmic dust detector, GSFC, Temple University Cosmic ray telescope, University of Chicago TV system, California Institute of Technology Plasma probe, MIT, JPL Magnetometer, JPL, UCLA Trapped radiation detector, State University of Iowa Ionization chamber, California Institute of Technology, JPL Occultation, JPL, Cornell, Stanford University
<i>Results:</i>	Spacecraft failed to jettison and battery power dropped; there was no indication that the solar panels were able to open and replenish power supply, and communications were lost; spacecraft in permanent heliocentric orbit.

Table 3-180.
Mariner 4 (Mariner D, Mariner-Mars 1964) Characteristics

<i>Date of launch</i> (location):	Nov. 28, 1964 (ETR)
<i>Launch vehicle:</i>	Atlas-Agena D
<i>Weight</i> (kg):	260.8
<i>Shape:</i>	Octagonal base with 4 solar panels
<i>Dimensions</i> (m):	Base, 1.27 × .46
	Overall height, 2.89
	Span with panels deployed, 6.88
<i>Power source:</i>	AgZn battery plus solar cells
<i>Date of reentry:</i>	In orbit around sun
<i>Cognizant NASA center:</i>	JPL
<i>Project manager:</i>	Jack N. James
<i>Contractor:</i>	In-house (JPL) construction and testing of components built by many subcontractors.
<i>Objectives:</i>	Fly by Mars and study the planet's atmosphere and surface; develop operational techniques for interplanetary missions; take measurements of the interplanetary environment; provide engineering experience in spacecraft operations during long-duration flights away from the sun.
<i>Experiments, responsible institution:</i>	Same as for <i>Mariner 3</i> (table 3-179).
<i>Results:</i>	Spacecraft flew by Mars on July 14, 1965, with 9844 kilometers being the closest approach; dense-packed lunar-type impact carriers discovered on the 1% of Mars visible in the 22½ photographs received; ionosphere and atmosphere measured somewhat less dense than expected; carbon dioxide thought to be a major constituent of the atmosphere; solar plasma probe ceased working after 8 days. Mission was terminated in December 1967.
<i>Remarks:</i>	First close-up images of Mars.

Other Lunar and Planetary Projects

Two other lunar and planetary projects were funded during the 1960s by NASA's space science and applications program, but not beyond the paper study phase. At one time, the unmanned lunar program called for three vehicles—Ranger, Surveyor, and Prospector. Prospector, first funded in 1961, was the next step beyond a Surveyor soft-lander. Launched by Saturn and weighing some 2270 kilograms, Prospector would “rove across the land, pick samples, deposit instrumented packages, take many close looks at the surface, detonate explosive charges at various points for seismic measurements, and report all its findings back to Earth.”¹¹ Prospector's designers at the Jet Propulsion Laboratory (JPL) even had plans for a sample return task for the craft, and by 1963 Apollo planners wanted to use the large spacecraft to store equipment that the astronauts would require when landing on the moon. The first Prospectors were scheduled for launch in 1965-1966. When Congress cut more than \$23.5 million from the FY 1963 lunar and planetary budget, this third class of unmanned lunar spacecraft was eliminated from the roster.

Table 3-181.
Mariner 5 (Mariner E, Mariner-Venus 1967) Characteristics

<i>Date of launch</i> (location):	June 14, 1967 (ETR)
<i>Launch vehicle:</i>	Atlas-Agena D
<i>Weight (kg):</i>	244.9
<i>Shape:</i>	Octagonal frame base with 4 solar panels and antennas
<i>Dimensions (m):</i>	Base, 1.27 × .46 Overall height, 2.89 Span with panels deployed, 5.48
<i>Power source:</i>	AgZn battery plus solar cells
<i>Date of reentry:</i>	In orbit around sun
<i>Cognizant NASA center:</i>	JPL
<i>Project manager:</i>	Dan Schneiderman
<i>Contractor:</i>	In-house (JPL) construction and testing of components built by many subcontractors.
<i>Objectives:</i>	Fly by Venus within 3218 kilometers to provide data on atmosphere, radiation, and magnetic field; return data on interplanetary environment before encounter with Venus; provide first exercise of turnaround ranging technique of planetary distance.
<i>Experiments, responsible institution:</i>	Ultraviolet photometer, University of Colorado et al. S-ban occultation, JPL, GSFC, Stanford University Dual frequency occultation, Stanford University Magnetometer, JPL et al. Plasma probe, MIT, JPL Trapped radiation detector, State University of Iowa Celestial mechanics, JPL
<i>Results:</i>	Spacecraft passed within 4000 kilometers of Venus providing data on atmospheric structure, radiation, and magnetic field; mass of Venus was further defined by processing flyby trajectory data; solar wind interaction with Venus shown to be different from earth interaction. Mission was terminated in December 1967.

Voyager, as an advanced mission concept for planetary exploration, was first considered in the spring of 1960. It was proposed that as early as 1967 this 1100-kilogram spacecraft orbit Mars or Venus and drop a landing capsule to the planet's surface. Delays with developing the Saturn launch vehicle, the growing importance and cost of Apollo, and an ever-tightening federal budget stood in Voyager's way. Supporting research and technology funds were used to pay for preliminary design studies in FY 1962-1963, but for FY 1966 NASA had requested \$43 million for Voyager. By FY 1968, the price had risen to \$71.5 million, the sum needed to start full-scale design and development for Voyager's first flight to Mars, rescheduled for 1973. Congress balked. With an expensive manned lunar project under way that was as yet unproved, Congress would not allow NASA to undertake another large venture. And Voyager promised to be large; so large, in fact, that a separate program office had been established to manage it.

Before Voyager was cancelled on August 29, 1967, thousands of man-hours of work and millions of dollars had been spent at JPL on defining the best approaches for a combination orbiter-lander investigation of Mars (the Venus mission had been dropped from consideration). The data generated did not go to waste, however. Project Viking personnel who would oversee two Viking orbiter-lander missions to

Mars in 1976 would make use of the many mission design studies, hardware and scientific evaluations, and landing site surveys conducted in Pasadena. At NASA Headquarters, Donald P. Heath acted briefly as Voyager program manager before Oran W. Nicks was named to that position in 1968. Donald P. Burcham led the effort at JPL, where Voyager design studies prepared by General Electric, Avco, and others were evaluated.

For further information on Voyager, see chapter 4 of Edward C. and Linda N. Ezell, *On Mars: Exploration of the Red Planet, 1958-1978*, NASA SP-4212 (Washington, 1984).

DESCRIPTION -- LIFE SCIENCES PROGRAM

Except for a brief time (March 1960 to October 1961) during NASA's first 10 years, the life sciences was not centrally organized as a program on par with manned spaceflight or space science, but was variously divided among the Office of Space Science and Applications (OSSA), the Office of Manned Space Flight (OMSF), and the Office of Advanced Research and Technology (OART). Life sciences meant many things at NASA, and it was this multitude of different interpretations that kept it from becoming a strong program in its own right. For the team charged with sending man into space and eventually to the moon, life science investigations could help answer many questions: What kind of environment would man require inside his spacecraft? What were the effects of prolonged weightlessness on the cardiovascular system? What were the maximum acceleration forces he could withstand during launch and reentry?* Crew training and selection would also require a medical doctor's expertise, as would monitoring the health of a crew in flight. Management of "aerospace medicine" was assumed by NASA's manned spaceflight experts. The designers of flight garments, spacecraft systems, and hardware with which astronauts and pilots would work also needed the advice of specialists who understood the physical and psychological needs and limits of man. Such "bioengineering" projects were sponsored by OMSF and the advanced research and technology office. The study of terrestrial life forms exposed to the conditions of space (space biology) and the search for extraterrestrial life (exobiology) was left to the agency's space scientists.

As most of the space biologist's work was done in laboratories under controlled conditions that simulated the environment of space, not many flight projects were totally devoted to biological payloads. Some experiments were performed on sounding rockets (e.g., *BIOS 1*, a 1961 Journeyman-launched reentry experiment sponsored by the Goddard Space Flight Center) and on high-altitude balloon flights (with monkeys, hamsters, insects, and microscopic specimens being sent aloft). The one spaceflight project funded exclusively by the life sciences program, Biosatellite, was

*Long before NASA was established, the Air Force had set up several aviation and aerospace medicine institutions committed to answering the same kind of questions. For more information on Air Force programs in this field and how the existence of Air Force medical research centers affected NASA's organization in the early 1960s, see John A. Pitts, *The Human Factor: Biomedicine in the Manned Space Program to 1980*, NASA SP-4213 (Washington, 1985), chapters 1 and 2.

judged only a partial success (see following tables). Scientists attempted to observe the effects of prolonged weightlessness and radiation on the growth of plants and animals carried on small satellites, but a retrorocket failure terminated the first mission, and bad weather and hardware problems contributed to the second spacecraft's early return. Much of the data that was generated by the space biology program in laboratories and with other small flight experiments was directly applicable to the design of manned spacecraft and life support equipment and to aerospace medicine.

Exobiology was a more "purely" scientific endeavor, and it did not contribute to the manned spaceflight program. But finding life elsewhere in the solar system would most certainly have had a profound impact on scientists concerned with discovering the origins and composition of earth-based life forms. Exobiologists studied data returned by lunar and interplanetary spacecraft and pored over photographs of the moon, Venus, and Mars for clues, chemical or geological, that might lead them to some extraterrestrial life or to an environment that seemed conducive to harboring carbon-based life. With the increasing sophistication of interplanetary spacecraft capable of long-duration flights, scientists began designing hardware for life-detecting instruments that could be sent near or to Venus and Mars. Project Voyager would have been the exobiologists' first opportunity for a lander mission on another planet, but its cancellation in 1967 put a temporary end to years of work on Mars- and Venus-bound experiments. Most of this activity, however, was redirected to Project Viking in the 1970s.

Before March 1960, biology and biotechnology was the exclusive concern of manned spaceflight and advanced technology directorates, but in the spring of 1960 Administrator T. Keith Glennan took the advice of his Bioscience Advisory Committee and established a separate Office of Life Sciences, with Clark T. Randt as director (see table 3-1). Five assistant directors (for bioengineering, grants and contracts, space biology, program planning, and aerospace medicine) were assigned to Randt. This office would supplant the Special Committee on Life Sciences, which had been formed by Glennan in 1958 to serve as an advisory body to Project Mercury personnel. The Bioscience Advisory Committee also recommended that NASA establish a central laboratory for life sciences research. Ames Research Center in California was chosen as the most likely site for such a facility, and Richard S. Young was assigned to Ames in early 1961 to establish more formal life sciences activities there. However, the first new facilities at Ames were not constructed until 1963-1964. These new laboratories were equipped with the tools required by space biologists and exobiologists, including a large animal shelter (vivarium) to house the thousands of laboratory animals required for research.

With the change of administrations in Washington in November 1961 came a change in NASA's organization. The new administrator, James E. Webb, abolished the Office of Life Sciences Programs and reassigned the personnel throughout the agency, mainly to the new Office of Manned Space Flight. A director of bioscience programs, Orr E. Reynolds, was named in the space sciences directorate, but his staff and budget were small. Reynolds served as the head of NASA Headquarters' bioscience program throughout the remainder of NASA's first decade and beyond. Reporting to Reynolds were chiefs of exobiology, environmental biology, physical biology, behavioral biology, and planetary quarantine.

For further reading, see the following: on how life sciences fit into NASA's space science and applications program, Homer E. Newell, Jr., *Beyond the Atmosphere: Early Years of Space Science*, NASA SP-4211 (Washington, 1980), chap.

16; on Ames Research Center's role in the life sciences, Edwin P. Hartman, *Adventures in Research: A History of Ames Research Center*, NASA SP-4302 (Washington, 1970), pp. 321-23, 325, 426-28, 478-87, 496-502; and Elizabeth A. Muenger, *Searching the Horizon: A History of Ames Research Center, 1940-1976*, NASA SP-4304 (Washington, 1985), chap. 5; and on space medicine, John A. Pitts, *The Human Factor: Biomedicine in the Manned Space Program to 1980*, NASA SP-4213 (Washington, 1985); on exobiology, Edward C. and Linda N. Ezell *On Mars: Exploration of the Red Planet, 1958-1978*, NASA SP-4212 (Washington, 1984), chap. 3; and on NASA's changing organization, Robert L. Rosholt, *An Administrative History of NASA, 1958-1963*, NASA SP-4101 (Washington, 1966).

Biosatellite

First with balloons and later with sounding rockets and airplanes, biologists and physicians had been observing the effects of high altitudes on living specimens for many years before NASA was organized. In an environmentally controlled spacecraft, scientists could study phenomena that were relative to their laboratory investigations but often impossible to simulate on earth (for example, prolonged weightlessness). Internal discussions among NASA personnel concerning a recoverable biological probe or satellite mission date from early 1959, with a National Academy of Sciences Space Science Board summer study group endorsing the suggestion in 1961. During such a mission, specialists could observe the effects of radiation and weightlessness on plants, insects, and small animals and study how living systems react to being deprived from their normal day-night cycle.

Six Biosatellite flights were approved by NASA in 1962 and the project assigned to Ames Research Center, Moffett Field, California.* The missions would become increasingly complex over time, progressing from two 3-day flights with a payload of plant and insect matter, to two 21-day flights with a more sophisticated general biology package, and culminating in two 30-day flights with a primate on board. The response from the scientific community for experiments was enthusiastic, with some 170 proposals being submitted for consideration. The 3-day missions could accommodate 14 relatively simple experiments (13 were actually flown); 4 investigations could be selected for the 21-day missions; and 4 areas of investigation were allowed for the 30-day primate mission. In January 1964 after more than a year's evaluation, the Bioscience Program Office at NASA Headquarters recommended 22 experiments to be included in the Biosatellite program.

Experiments on the first two flights would be exposed to one of two environments: radiation and weightlessness, or weightlessness only with no radiation. Provisions were made in the capsule for an essentially radiation-free area to house control experiments or those that did not require exposure to radiation, for an area where radiation exposures were to be precisely timed (1 rad/day), and for an area

*For more on this project's management and the conflict it raised between the Office of Space Science and Applications and the Office of Advanced Research and Technology, see John Pitts, *The Human Factor: Biomedicine in the Manned Space Program to 1980*, NASA SP-4213 (Washington, 1985), pp. 82-84.

that would be constantly irradiated by a gamma matter. Wasps, flour beetles, drosophilae, spiderwort plants, bread mold, and lysogenic bacteria were used for the radiation-weightlessness experiments. General biology investigations (no radiation) were accomplished with frog eggs, amoebae, wheat seedlings, and pepper plants.

The 21-day missions were not flown, but a great deal of work was done on readying their experiment payloads before they were cancelled. The investigators had planned to study the effects of subgravity on mammal body (white rats) composition and biorhythms, a higher plant (arabidopsis) life cycle, and the growth and development of human tissue cells (liver and respiratory).

Only one of the 30-day primate missions (*Biosatellite 3*) was launched, and that took place in the post-1968 period. Like all complex missions, it required a long lead time during which to prepare the payload. *Biosatellite 3*'s objectives were to determine the physiological effects of orbital flight on a subhuman primate (Macaque nemestrina), to provide information about possible hazards to manned flight, and to observe basic physiological phenomena. Of special interest were neurophysiological, cardiovascular, and metabolic functions.

A request for proposals for the design and development of the Biosatellite spacecraft was issued to industry in March 1963, with three firms (General Electric, Northrop Aircraft Corporation, and Lockheed Aircraft Corporation) being awarded preliminary design study contracts the next month. GE's plans for a two-section craft were approved that summer and a letter contract awarded in March 1964. A reentry vehicle carrying the experiment capsule, equipped with retrorocket and heat shield, would return the payload to earth, while an adapter section housing the bulk of the spacecraft's systems would remain in orbit. A parachute-aerial recovery system was adapted for Biosatellite from an existing Air Force capability. Recoveries were targeted for the Pacific with a post-recovery laboratory available at Hickam Air Force Base, Hawaii. The capsule had to be delivered to the investigators waiting at Hickam within six hours of the deorbit maneuver. General Electric's initial cost projection of \$24 million had been grossly miscalculated. While the basic spacecraft did not pose many unforeseen design problems or expenses, the development and integration of so many experiments from so many different organizations led to ever-increasing costs and delays. Biologists and engineers were not accustomed to working together and did not communicate well, and biologists were not familiar with the complexities and restrictions of spaceflight hardware. *Biosatellite 1* was not sent on its way until September 1967, nearly two years late. Both 21-day missions were eliminated because of money and time problems and an increasingly critical Congress. And funds for only one primate mission were made available.

The launch and orbital phases of the *Biosatellite 1* mission were successful, but the retrorocket system failed, and the capsule did not reenter as planned. Although teams searched the area of Australia and the Tasman Sea where the spacecraft should have reentered when its orbit decayed in January 1967 (Operation Lost Ball), nothing was found and no data were returned from the flight. The next year, *Biosatellite 2* was more successful, but the spacecraft did not complete all its required orbits. During its second day of flight, *Biosatellite 2* frequently refused to accept commands, and meteorologists reported that a tropical storm was due to hit the prime recovery area soon. Fearing that they might lose all contact with the satellite, the flight control team commanded the recovery vehicle to deorbit one day early. Recovery was complete on September 9, 1967. The *Biosatellite 3* mission, launched

in 1969, did not go according to plan either. On the eighth day of flight, the primate appeared unresponsive, and the team called the spacecraft down.

Management of the Biosatellite project was static during its seven years. At Headquarters, Thomas P. Dallow was Biosatellite chief, reporting to Director of Bioscience Programs Orr Reynolds. Charles A. Wilson, taking over for retiring Carlton Bioletti, led the team at Ames Research Center as project manager from March 1965 until the project's termination. Project Biosatellite was under the direction of Ames's assistant director for development rather than the assistant director for life sciences.

The best single source for further information is J. W. Dyer, ed., *Biosatellite Project Historical Summary Report* (Moffett Field, CA: Ames Research Center, 1969).

Table 3-182.
Chronology of Biosatellite Development and Operations

Date	Event
April 1959	NASA's Office of Space Science included among its goals a recoverable payload mission that would subject living things to the environment of space.
Nov. 1960	In a planning document, the Office of Space Flight Programs suggested a flight project with biological experiments to study the effects of space environment on living things (frog eggs, germinating seeds, bacteria, algae). Several contracts were let for studies.
Summer 1962	The Space Science Board of the National Academy of Sciences considered methods by which NASA could help solve basic biological problems and suggested the study of the effects of weightlessness, disassociation of living systems from day-night cycles, and radiation on various living things.
July 1962	NASA announced that specialists at its centers were studying plans for a biological project of three to six flights.
Oct. 1962	Ames Research Center was assigned the management of a biological satellite project, unofficially called Biosatellite.
Dec. 1962	Six Biosatellite flights (3-, 21-, and 30-day missions) launched by Thor-Delta vehicles were approved by NASA Headquarters, with the first launch scheduled for late 1965. The Bioscience Subcommittee of NASA's Space Science Steering Committee reviewed preliminary proposals for experiments.
Jan. 1963	The name Biosatellite was officially reserved for the project.
March 1, 1963	A request for proposals was issued for design and development studies of a Biosatellite spacecraft.
April 11, 1963	General Electric, Northrop Aircraft Corp., and Lockheed Aircraft Corp. were awarded eight-week preliminary design study contracts.
May 1963	Panels of specialists convened to evaluate further proposals for experiments to be carried on Biosatellite missions.
Aug 21, 1963	GE was selected for negotiations for a Biosatellite contract.
Jan. 16, 1964	The Bioscience Programs Office recommended 22 experiments for the three classes of missions.
Feb. 1964	Payload selection was made by the Office of Space Science and Applications.
March 19, 1964	GE was awarded a letter contract for design and fabrication of six spacecraft.

Table 3-182.
Chronology of Biosatellite Development and Operations (Continued)

Date	Event
Dec. 14, 1966	<i>Biosatellite 1</i> was launched successfully, but controlled reentry was not achieved three days later because a retrorocket failed.
Jan. 1967	A failure analysis review board was established.
Spring 1967	Publicity was generated over Biosatellite cost overruns.
Sept. 7, 1967	<i>Biosatellite 2</i> was launched successfully; the payload was recovered on September 9, one day ahead of schedule because the spacecraft was not responding satisfactorily to commands and because inclement weather threatened the recovery area.
July 30, 1968	GE's contract was modified to cover continuation of work on four remaining spacecraft.
July-Aug. 1968	A month-long laboratory test of systems designed to maintain a primate for a 30-day mission was completed.
Dec. 16, 1968	NASA terminated plans for Biosatellite C and D 21-day missions.

Table 3-183.
Biosatellite 1 (Biosatellite-A) Characteristics

<i>Date of launch</i> (location):	Dec. 14, 1966 (ETR)
<i>Launch vehicle:</i>	Thrust-augmented Thor-Delta (TAD)
<i>Weight (kg):</i>	381 (reentry vehicle, 199.6; adapter section, 181.4)
<i>Shape:</i>	Cylindrical cone adapter and instruments section, plus a blunt-cone reentry vehicle with heat shield
<i>Dimensions (m):</i>	Adapter section, length, 2.06; diameter, 1.02-1.45 Reentry vehicle, length, 1.22; diameter at base, 1.02 Total length, 2.44 Diameter at point of mating with Delta, 1.37
<i>Power source:</i>	AgZn batteries
<i>Date of reentry:</i>	Feb. 15, 1967
<i>Cognizant NASA center:</i>	Ames Research Center (ARC)
<i>Project manager:</i>	Charles A. Wilson
<i>Project scientist:</i>	C. M. Wignet
<i>Contractor:</i>	General Electric, prime
<i>Objectives:</i>	Observe the effects of weightlessness and gamma radiation on the growth of plants and animals over a three-day period; recover payload.
<i>Experiments, responsible institution:</i>	Total of 13 experiments using pepper plants, spiderworts, corn and wheat seedlings, amoeba, frog eggs, mold, flour beetles, wasps, bacteria, and fruit flies; the experiments came from several universities, private labs, and ARC
<i>Results:</i>	No useful data were obtained because a retrorocket failure prevented the controlled return of the payload.

Table 3-184.
Biosatellite 2 (Biosatellite-B) Characteristics

<i>Date of launch</i>	Sept. 7, 1967 (ETR)
(location):	
<i>Launch vehicle:</i>	Thrust-augmented Thor-Delta (TAD)
<i>Weight (kg):</i>	381 (reentry vehicle, 199.6; adapter section, 181.4)
<i>Shape:</i>	Cylindrical cone adapter and instruments section, plus a blunt-cone reentry vehicle with heat shield
<i>Dimensions (m):</i>	Adapter section, length, 2.06; diameter, 1.02-1.45
	Reentry vehicle, length, 1.22; diameter at base, 1.02
	Total length, 2.44
	Diameter at point of mating with Delta, 1.37
<i>Power source:</i>	AgZn batteries
<i>Date of reentry:</i>	Oct. 4, 1967
<i>Cognizant NASA center:</i>	ARC
<i>Project manager:</i>	Charles A. Wilson
<i>Project scientist:</i>	C. M. Wignet
<i>Contractor:</i>	General Electric, prime
<i>Objectives:</i>	Observe the effects of weightlessness and gamma radiation on the growth of plants and animals over a three-day period; recover payload.
<i>Experiments responsible institution:</i>	Same as for <i>Biosatellite 1</i> (table 3-183).
<i>Results:</i>	Because of decreasing communications reception and bad weather in the recovery area, the capsule was deorbited ahead of schedule; the capsule was recovered on September 9, with all specimens surviving. Some specimens did show the effects of being submitted to prolonged weightlessness, apparently related to the rapidity of cell processes; both enhancing and antagonistic effects were shown on various specimens from radiation exposure experiments.

DESCRIPTION—METEOROLOGY PROGRAM

Meteorology is a field to which space science has been conspicuously applied. As defined by Morris Tepper, leader of NASA's meteorology program during the agency's first decade, meteorology is "concerned with the observation, description, explanation and prediction of the atmosphere, specifically its state and its motion."¹² Early observers used ground readings, kites, and balloons (radiosondes) to gather information on wind, temperature, barometric pressure, precipitation, and other factors that affected local weather conditions and coordinated their findings as best they could. But it was obviously necessary to collect data from larger areas and from greater altitudes to generate more accurate forecasts. With the development of airplanes and then rockets, plus improved global communications networks, the meteorologist had new tools. Weather-sensing instruments carried on aircraft could be sent expeditiously over long distances, and sounding rockets could take measurements above 30 kilometers and photograph the cloud cover (first accomplished in 1947). But the greatest boon to meteorology was the satellite, a plat-

form high above earth that could record continuously and over a large area cloud cover and other critical readings.

A weather satellite had been proposed as a possible project for the International Geophysical Year (1957-1958), and the Naval Research Laboratory flew a cloud cover experiment on its *Vanguard 2* satellite in 1959. Interested in reliable weather forecasts and the reconnaissance abilities of satellites, the military community had been studying the feasibility and effectiveness of television-equipped weather satellites since the late 1940s and had contracted with several private firms for preliminary hardware and mission studies. Having been awarded such a contract by the Air Force in 1951, the Radio Corporation of America (RCA) went on to perform independent research that led to the development of an orbital camera system. Their efforts attracted the attention of the Army Ballistic Missile Agency (ABMA). A joint RCA-ABMA project led to the construction of the prototype satellite Janus, the forerunner of the Tiros satellite. When NASA was established in 1958, it inherited this weather satellite project.

Project Tiros (Television Infra-Red Observation Satellite) was highly successful, from its first research and development flight in 1960 through its operational use as a Weather Bureau-Environmental Science Services Administration (ESSA) satellite in 1965-1969. Nimbus, a second-generation meteorology observatory, was first orbited in 1964 (see also Applications Technology Satellite). The other half of NASA's meteorology flight program was sounding rockets. Being primarily concerned with the region below 105 kilometers for temperature and other readings, some NASA scientists benefited from the frequent use of small, inexpensive Arcas rockets for the bulk of their soundings. Satellites could not provide data about the upper stratosphere or the mesosphere since their orbits exceeded approximately 100 kilometers. Small sounding rockets carried balloon payloads aloft, which were ejected, inflated, and then tracked by radar. Density of the air and wind velocity were determined by the balloon's rate of descent and motion. Sensors carried by small rockets recorded temperature and other characteristics during their flights up and down, giving investigators vertical profiles of a particular area. In 1965, NASA's small meteorology sounding rockets were launched from 14 different sites around the world—from Point Barrow to McMurdo Sound, and from Midway Island to Ascension Island. With larger sounding rockets such as the Nike-Cajun, experimental techniques were improved, new hardware tested, and readings taken in the upper atmosphere. By listening to acoustic grenades ejected from rockets, specialists computed the wind and the temperature of the intervening air. In another experiment, rockets released trails of sodium vapor that were tracked by ground observers and recorded on film, yielding data on wind speed and direction. Air density and pressure circulation systems, the influence of tidal forces on the atmosphere, and geographical and seasonal variations in the atmospheric structure were other areas of research to which the meteorology sounding rocket was applied.

The NASA Headquarters meteorology program was variously organized during the 1958-1968 period, but Morris Tepper was its only director. Until mid-1961, the program was part of the Applications and Manned Flights Programs Office, under the Office of Space Flight Programs. In 1971, meteorology was one of the elements of the satellite and sounding rocket program, part of the Office of Space Flight Programs. From late 1961 until May 1963, Tepper's people were a division of the new Office of Applications, and with the organization of the Office of Space Science and Applications (OSSA) in mid-1963 meteorology was assigned to it until 1966. The

program finished out the decade as part of the Space Applications Programs Office of OSSA. William K. Widger was in charge of meteorological satellites until 1962; Michael L. Garbacz assumed these duties in 1963. William C. Spreen was the meteorology sounding rockets manager for most of the decade. Richard L. Haley worked as advanced technology and projects manager or as Nimbus program manager from 1964. Meteorology flight projects were assigned to the Goddard Space Flight Center, where they were managed first by the aeronomy and meteorology division, part of the Office of Space Science and Satellite Applications (William G. Stroud, chief), and then from 1965 on by the projects directorate.

Since the data returned by the meteorology satellites were of immediate use to many parties, NASA worked with various agencies to ensure that the information was disseminated through the National Weather Satellite Center to the proper authorities and users and that the agency met the needs of the Department of Defense, ESSA (formerly the Department of Commerce Weather Bureau), and other groups. Interagency coordination committees further oversaw and reviewed the government's requirements. Since weather forecasting was by necessity a global undertaking, NASA also worked with private international meteorological organizations and foreign government agencies in setting up workshops, establishing sounding rocket launch facilities and recovery operations, and developing direct data readout capabilities.

Tiros/TOS/ESSA

The development of weather reconnaissance satellites was initiated several years before NASA was established in 1958. In 1956, the Army Ballistic Missile Agency (ABMA) awarded a contract to the Radio Corporation of America (RCA) that would allow the company to continue the development and fabrication of a weather satellite it had been studying since 1951. With the creation of the Advanced Research Projects Agency (ARPA) by the Department of Defense in early 1958, authority for RCA's Project Janus was transferred to this new group. By the time NASA assumed responsibility for the nation's weather satellite programs in April 1959, RCA's satellite had advanced through several design configurations—from a rod-shaped 9-kilogram payload that would be boosted by a Jupiter C missile, to a 39-kilogram spin-stabilized disk (Janus II) that would be launched by a Juno II, to a much heavier disk-shaped satellite (the Tiros configuration). This last design was slated at first for launch by a Juno IV vehicle (development of which was dropped) and then by a Thor-Able. Less than a year after NASA started managing the Tiros (Television Infra-Red Observation Satellite) project, *Tiros 1* was launched successfully from the Eastern Test Range. Nine more research and development flights followed (1961-1965), culminating in the first Tiros Operational System (TOS) launch in 1966 (*ESSA 1*). But even by the 1962 flight of *Tiros 4*, the U.S. Weather Bureau was able to send daily transmissions of cloud cover maps provided by NASA to weather services around the world, and by April 1965 had issued more than 2100 storm bulletins to some 50 countries based on Tiros data. Early fears voiced by the Soviet Union that Tiros was no more than a "spy in the sky" were clearly unfounded since the images sent to earth by the weather satellite showed only the largest of geographical features beneath the weather systems.

The basic configuration of the Tiros satellite changed little over the years. It was an 18-sided hatbox-shaped cylinder with a diameter of 1.07 meters and a height of .48 to .57 meter, weighing 120 to 147 kilograms. Tiros was covered with solar cells that charged nickel cadmium batteries, which powered the critical two-camera television system. On the first eight missions, the cameras were mounted on the bottom of the spacecraft, but on *Tiros 9* the two cameras were positioned on the satellite's curved outer ring pointing in opposite directions; as the spacecraft turned on its side it rolled through space like a slow-turning wheel on an imaginary track (the so-called cartwheel mode). Early Tiros satellites were launched in east-west orbits, but later weather satellites were put into polar north-south paths, which provided more ideal photographic lighting conditions and better coverage. The television system became more sophisticated, too, with the addition of an automatic picture transmission (APT) system on *Tiros 8*, which allowed for the transmission of real-time cloud cover pictures to any APT ground receiver within audio range of the satellite in a fashion similar to radio photograph transmissions. An advanced vidicon camera system (AVCS) could take 6 or 12 pictures per orbit at 260-second intervals, each image covering an area 3160 by 3160 kilometers, thereby obtaining global coverage. Images were stored in an onboard tape recorder for transmission to the National Environmental Satellite Center. In addition to the television cameras, some Tiros spacecraft carried infrared-scanning and temperature-probing instruments.

The Weather Bureau (later the Environmental Science Services Administration) participated in the Tiros project from its beginnings in the late 1950s, and this Department of Commerce agency was responsible for disseminating data returned by satellites to weather services and scientists. A formal agreement on an operational satellite system was first reached by NASA and the Weather Bureau in March 1964. Once Tiros became operational, the Bureau assumed its management, while NASA was charged with spacecraft-launch vehicle development and procurement on a cost-reimbursable basis. Tiros Operational System missions (*ESSA 1* through *9*) were all successful, providing daily information on cloud cover, upper winds, pressure, and precipitation on a global scale. This kind of data made possible daily weather forecasts, storm and marine advisories, gale and hurricane warnings, cloud analyses, and polar and Great Lakes navigational information.

At NASA Headquarters, Morris Tepper as chief of meteorology programs was in charge of Tiros management, sharing the responsibilities with William K. Widger in 1962. In mid-1963, Michael L. Garbacz was named flight project program manager and led the Tiros-TOS team at Headquarters for the remainder of the decade. Tiros, assigned to the Goddard Space Flight Center, was managed by William G. Stroud (*Tiros 1*), Rudolf A. Stampfl (*Tiros 2*), Robert M. Rados (*Tiros 3* through *ESSA 1*), and William W. Jones (*ESSA 2* through *8*). RCA served as prime spacecraft contractor.

For further reading on the early history of Tiros, see John H. Ashby, "A Preliminary History of the Evolution of the TIROS Weather Satellite Program," NASA HHN-45, Aug. 1964; and GSFC and U.S. Weather Bureau, *Final Report on the Tiros I Meteorological Satellite System*, NASA TR-R-131 (Washington, 1962).

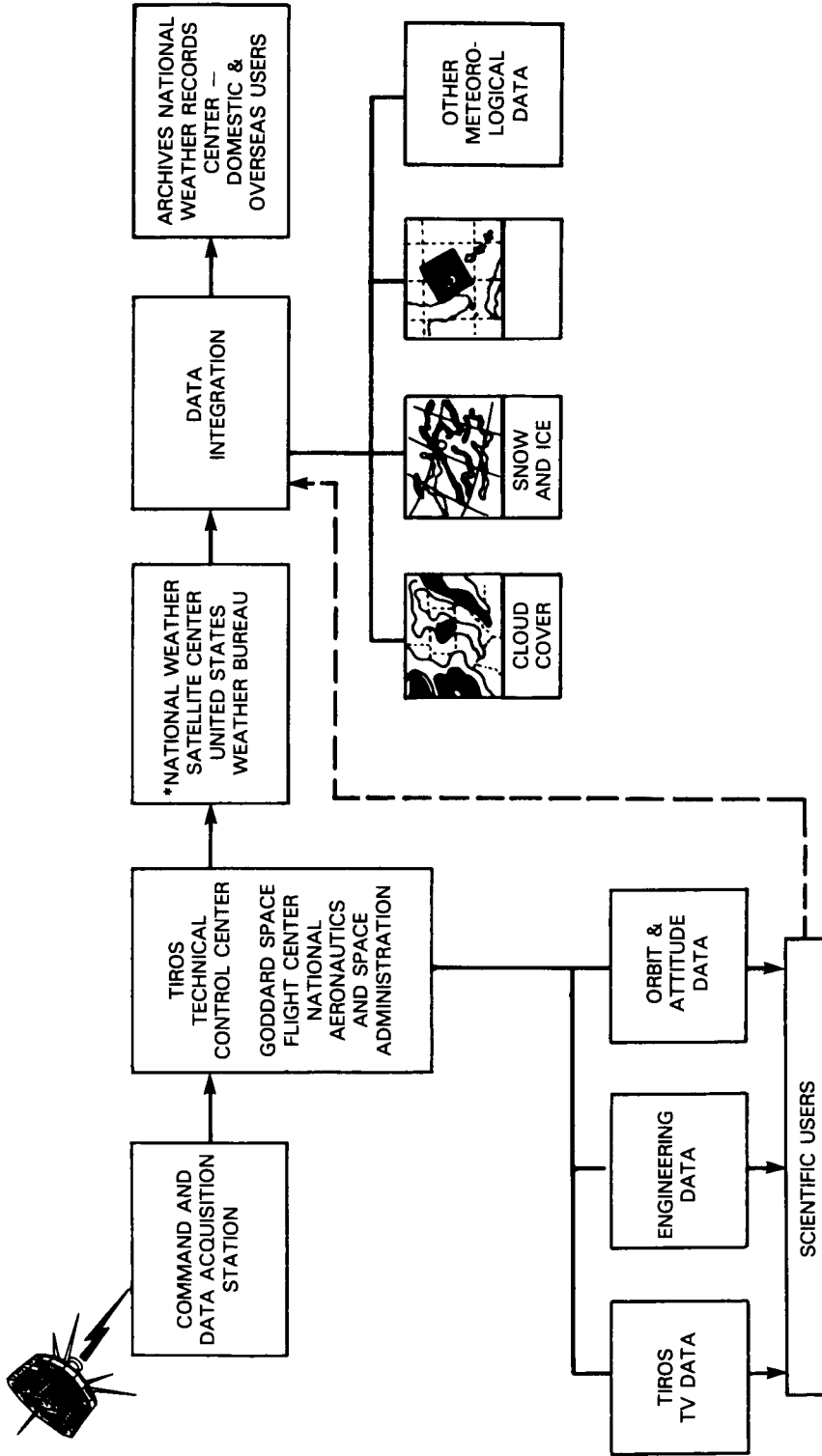

Figure 3-3. TIROS 9 data flow diagram

* Later called the National Environmental Satellite Center, Environmental Science Services Administration.

Table 3-185.
Chronology of Tiros/TOS/ESSA
Development and Operations

Date	Event
1946	In a report for the Air Force, Douglas Aircraft (Project RAND) suggested that weather forecasting could be one of the uses to which orbiting satellites could be put.
1951	RAND contracted with the Radio Corporation of America (RCA) to study the feasibility of using cameras on orbiting satellites.
1956	RCA, acting on its own, submitted proposals to the Department of Commerce Weather Bureau and the military for a television-equipped weather reconnaissance satellite. The Army Ballistic Missile Agency (ABMA) contracted with RCA for work on such a spacecraft (called Janus), to be launched with Jupiter C in the spring of 1958.
Feb. 1958	The Advanced Research Projects Agency (ARPA) assumed responsibility for the television satellite project, with new emphasis being placed on its use as a meteorology satellite.
March 1958	RCA redesigned Janus for use with the Juno II launch vehicle (Army Ordnance Missile Command); the satellite effort as redirected toward a meteorology mission was called Tiros (Television Infra-Red Observation Satellite).
Summer-Winter 1958	Tiros was assigned a new more powerful launch vehicle—first Juno IV, which was cancelled, and then Thor-Able. RCA's contract with ARPA called for the manufacture of 10 satellites.
April 13, 1959	Project Tiros was transferred to NASA, with Goddard Space Flight Center being assigned project management responsibility.
Sept. 26, 1969	The first flight model of Tiros was readied for systems integration.
March 7, 1960	Tiros A-1 was shipped to the launch facility in Florida.
April 1, 1960	<i>Tiros 1</i> was launched successfully.
Oct. 10, 1960	An interagency meeting was held on the establishment of an operational meteorology satellite system.
Nov. 23, 1960	<i>Tiros 2</i> was launched successfully.
June 1961	NASA awarded a letter contract to RCA for four Tiros satellites.
July 12, 1961	<i>Tiros 3</i> was launched successfully.
April 15, 1962	The U.S. Weather Bureau began daily international transmissions of cloud cover maps based on <i>Tiros 4</i> photographs.
June 19, 1962	<i>Tiros 5</i> was launched successfully.
Sept. 18, 1962	<i>Tiros 6</i> was launched successfully; for the first time two Tiros satellites were in operation simultaneously.
Feb. 12, 1963	RCA was awarded a letter contract for seven Tiros satellites.
June 19, 1963	<i>Tiros 7</i> was launched successfully.
Dec. 21, 1963	<i>Tiros 8</i> was launched successfully.
March 20, 1964	NASA and the Weather Bureau reached an agreement on an operational satellite system, utilizing an improved Tiros.
July 15, 1964	RCA was awarded a contract for the Tiros Operational Satellite (TOS) program.
Jan. 22, 1964	<i>Tiros 9</i> was launched successfully (first of the cartwheel-mode spacecraft).
July 2, 1965	<i>Tiros 10</i> was launched successfully (funded by the Weather Bureau).

Table 3-185.
Chronology of Tiros/TOS/ESSA
Development and Operations (Continued)

Date	Event
Feb. 3, 1966	<i>ESSA 1</i> was launched successfully (first satellite of the TOS system, all of which would be funded by the Environmental Science Services Administration, formerly the Weather Bureau).
Feb. 28, 1966	<i>ESSA 2</i> was launched successfully.
May 11, 1966	NASA announced that it would negotiate with RCA for a design study of an improved Tiros.
Oct. 2, 1966	<i>ESSA 3</i> was launched successfully.
Jan. 26, 1967	<i>ESSA 4</i> was launched successfully.
April 20, 1967	<i>ESSA 5</i> was launched successfully.
Nov. 10, 1967	<i>ESSA 6</i> was launched successfully.
Aug. 16, 1968	<i>ESSA 7</i> was launched successfully.
Dec. 15, 1968	<i>ESSA 8</i> was launched successfully.

Table 3-186.
Tiros 1 (Tiros-A-1) Characteristics

<i>Date of launch</i>	April 1, 1960 (ETR)
<i>(location):</i>	
<i>Launch vehicle:</i>	Thor-Able
<i>Weight (kg):</i>	122.5
<i>Shape:</i>	18-sided polyhedron
<i>Dimensions (m):</i>	1.07 × .48
<i>Power source:</i>	NiCd batteries plus solar cells
<i>Date of reentry:</i>	In orbit
<i>Cognizant NASA center:</i>	GSFC
<i>Project manager:</i>	W. G. Stroud
<i>Project scientist:</i>	H. I. Butler
<i>Contractor:</i>	RCA-Astro-Electronic Products Div., prime spacecraft and TV cameras
<i>Objectives:</i>	Test experimental TV techniques leading to an eventual worldwide meteorological information system.
<i>Experiments, responsible institution:</i>	2-camera TV system
<i>Results:</i>	Transmitted 22 952 images over 89 days April 1-June 17; provided first global cloud cover images from near-circular orbit.

Table 3-187.
Tiros 2 (Tiros-B, -A-2) Characteristics

<i>Date of launch (location):</i>	Nov. 23, 1960 (ETR)
<i>Launch vehicle:</i>	Thor-Delta
<i>Weight (kg):</i>	127
<i>Shape:</i>	18-sided polyhedron
<i>Dimensions (m):</i>	1.07 × .48
<i>Power source:</i>	NiCd batteries plus solar cells
<i>Date of reentry:</i>	In orbit
<i>Cognizant NASA center:</i>	GSFC
<i>Project manager:</i>	Rudolf A. Stampfl
<i>Contractor:</i>	RCA, prime spacecraft and TV cameras
<i>Objectives:</i>	Test experimental TV techniques and infrared equipment leading to an eventual worldwide meteorological information system
<i>Experiments, responsible institution:</i>	2-camera TV system Wide-field radiometer, GSFC Scanning radiometer, GSFC
<i>Results:</i>	Transmitted 36 156 images over 376 days; (November 23, 1960–December 4, 1961); combined infrared and photographic measurements; wide-angle photography substandard, but useful cloud pictures received.

Table 3-188.
Tiros 3 (Tiros-C, -A-3) Characteristics

<i>Date of launch (location):</i>	July 12, 1961 (ETR)
<i>Launch vehicle:</i>	Thor-Delta
<i>Weight (kg):</i>	129.3
<i>Shape:</i>	18-sided polyhedron
<i>Dimensions (m):</i>	1.07 × .48
<i>Power source:</i>	NiCd batteries plus solar cells
<i>Date of reentry:</i>	In orbit
<i>Cognizant NASA center:</i>	GSFC
<i>Project manager:</i>	Robert M. Rados
<i>Contractor:</i>	RCA, prime spacecraft and TV cameras
<i>Objectives:</i>	Develop satellite weather observation system; obtain photographs of earth's cloud cover for weather analysis; determine amounts of solar energy absorbed and emitted by earth.
<i>Experiments, responsible institution:</i>	2-camera TV system Omnidirectional radiometer, University of Wisconsin Wide-field radiometer, GSFC Scanning radiometer, GSFC
<i>Results:</i>	Transmitted 35 033 images over 230 days (July 12, 1961–February 1962); one camera failed, but the other worked until February 1962; spotted 50 tropical storms during hurricane season 1961.

Table 3-189.
Tiros 4 (Tiros-D, -A-9) Characteristics

<i>Date of launch</i> (location):	Feb. 8, 1962 (ETR)
<i>Launch vehicle:</i>	Thor-Delta
<i>Weight (kg):</i>	129.3
<i>Shape:</i>	18-sided polyhedron
<i>Dimensions (m):</i>	1.07 × .48
<i>Power source:</i>	NiCd batteries plus solar cells
<i>Date of reentry:</i>	In orbit
<i>Cognizant NASA center:</i>	GSFC
<i>Project manager:</i>	Robert M. Rados
<i>Contractor:</i>	RCA, prime spacecraft and TV cameras
<i>Objectives:</i>	Develop principles of a weather satellite system; obtain cloud cover and radiation data for use in meteorology.
<i>Experiments, responsible institution:</i>	2-camera TV system Omnidirectional radiometer, University of Wisconsin Wide-field radiometer, GSFC Scanning radiometer, GSFC
<i>Results:</i>	Transmitted 32 593 images over 161 days; early photos excellent because of new wide-angle lens, but images became less clear after June 14, 1962; photos used in weather analyses in support of Project Mercury; data also used in a joint U.S. Weather Bureau-Canadian Department of Transportation ice reconnaissance of the St. Lawrence River.

Table 3-190.
Tiros 5 (Tiros-E, -A-50) Characteristics

<i>Date of launch</i> (location):	June 19, 1962 (ETR)
<i>Launch vehicle:</i>	Thor-Delta
<i>Weight (kg):</i>	129.7
<i>Shape:</i>	18-sided polyhedron
<i>Dimensions (m):</i>	1.07 × .56
<i>Power source:</i>	NiCd batteries plus solar cells
<i>Date of reentry:</i>	In orbit
<i>Cognizant NASA center:</i>	GSFC
<i>Project manager:</i>	Robert M. Rados
<i>Contractor:</i>	RCA, prime spacecraft and TV cameras
<i>Objectives:</i>	Develop principles of a weather satellite system; obtain cloud cover data for use in meteorology.
<i>Experiments, responsible institution:</i>	2-camera TV system Omnidirectional radiometer, University of Wisconsin Wide-field radiometer, GSFC Scanning radiometer, GSFC
<i>Results:</i>	Transmitted 58 226 images over 321 days; spotted 5 tropical storms worldwide during August; launched at a higher inclination than previous Tiros satellites to provide greater coverage of the August-September hurricane season.

Table 3-191.
Tiros 6 (Tiros-F, -A-51) Characteristics

<i>Date of launch</i> (location):	Sept. 18, 1962 (ETR)
<i>Launch vehicle:</i>	Thor-Delta
<i>Weight (kg):</i>	127.5
<i>Shape:</i>	18-sided polyhedron
<i>Dimensions (m):</i>	1.07 × .56
<i>Power source:</i>	NiCd batteries plus solar cells
<i>Date of reentry:</i>	In orbit
<i>Cognizant NASA center:</i>	GSFC
<i>Project manager:</i>	Robert M. Rados
<i>Contractor:</i>	RCA, prime spacecraft and TV cameras
<i>Objectives:</i>	Develop principles of a weather satellite system; obtain cloud cover data for use in meteorology.
<i>Experiments, responsible institution:</i>	2-camera TV system
<i>Results:</i>	Transmitted 68 557 images over 389 days; one camera failed December 1, 1962; provided data for hurricane season; provided operational support for the Army's Project Swift Stride cold regions study, for Columbia University and Texas A&M projects, and for Project Mercury.

Table 3-192.
Tiros 7 (Tiros-G, -A-52) Characteristics

<i>Date of launch</i> (location):	June 19, 1963 (ETR)
<i>Launch vehicle:</i>	Thor-Delta
<i>Weight (kg):</i>	134.7
<i>Shape:</i>	18-sided polyhedron
<i>Dimensions (m):</i>	1.07 × .56
<i>Power source:</i>	NiCd batteries plus solar cells
<i>Date of reentry:</i>	In orbit
<i>Cognizant NASA center:</i>	GSFC
<i>Project manager:</i>	Robert M. Rados
<i>Contractor:</i>	RCA, prime spacecraft and TV cameras
<i>Objectives:</i>	Launch satellite capable of viewing earth's surface, cloud cover, and atmosphere by TV cameras and radiation sensors; control satellite attitude by magnetic means; acquire and process collected data.
<i>Experiments, responsible institution:</i>	2-camera TV system Omnidirectional radiometer, University of Wisconsin Electron temperature probe, GSFC
<i>Results:</i>	Transmitted 125 331 pictures over 1809 days; coverage extended to 65 degrees N and 65 degrees S latitudes; launch date selected to provide maximum coverage during the hurricane season in the northern hemisphere; electron temperature probe malfunctioned after 26 days; tracked hurricanes in 1963, 1964, and 1965; provided support for Ranger, Mariner, and Gemini missions.

Table 3-193.

Tiros 8 (Tiros-H, -A-53) Characteristics

<i>Date of launch (location):</i>	Dec. 21, 1963 (ETR)
<i>Launch vehicle:</i>	Thor-Delta
<i>Weight (kg):</i>	120.2
<i>Shape:</i>	18-sided polyhedron
<i>Dimensions (m):</i>	1.07 × .56
<i>Power source:</i>	NiCd batteries plus solar cells
<i>Date of reentry:</i>	In orbit
<i>Cognizant NASA center:</i>	GSFC
<i>Project manager:</i>	Robert M. Rados
<i>Contractor:</i>	RCA, prime spacecraft and TV cameras
<i>Objectives:</i>	Launch satellite capable of viewing cloud cover and atmosphere by TV cameras; acquire and process collected data from satellite and control its attitude by magnetic means; evaluate automatic picture transmission (APT) system.
<i>Experiments, responsible institution:</i>	2-camera TV system and APT system
<i>Results:</i>	Transmitted 102 463 images over 1287 days; first of the series to carry real-time experimental camera subsystem (APT), which could be queried by multiple local ground stations with APT receivers.

Table 3-194.

Tiros 9 (Tiros-I, -A-54) Characteristics

<i>Date of launch (location):</i>	Jan. 22, 1965 (ETR)
<i>Launch vehicle:</i>	Thor-Delta
<i>Weight (kg):</i>	138.3
<i>Shape:</i>	18-sided polyhedron
<i>Dimensions (m):</i>	1.07 × .48
<i>Power source:</i>	NiCd batteries plus solar cells
<i>Date of reentry:</i>	In orbit
<i>Cognizant NASA center:</i>	GSFC
<i>Project manager:</i>	Robert M. Rados
<i>Contractor:</i>	RCA, prime spacecraft and TV cameras
<i>Objectives:</i>	Evaluate new cartwheel configuration Tiros spacecraft; explore the use of sun-synchronous orbits.
<i>Experiments, responsible institution:</i>	2-camera TV system
<i>Results:</i>	Transmitted 88 892 images over 1238 days; increased coverage; ejected into elliptical polar orbit.

Table 3-195.
Tiros 10 (OT-1) Characteristics

<i>Date of launch (location):</i>	July 2, 1965 (ETR)
<i>Launch vehicle:</i>	Thor-Delta
<i>Weight (kg):</i>	131.5
<i>Shape:</i>	18-sided polyhedron
<i>Dimensions (m):</i>	1.07 × .48
<i>Power source:</i>	NiCd batteries plus solar cells
<i>Date of reentry:</i>	In orbit
<i>Cognizant NASA center:</i>	GSFC
<i>Contractor:</i>	RCA, prime spacecraft and TV cameras
<i>Objectives:</i>	Provide additional operational data for Weather Bureau requirements; prove out Tiros Operational System.
<i>Experiments, responsible institution:</i>	2-camera TV system
<i>Results:</i>	Transmitted 79 874 pictures over 730 days; more daily data on typhoon and hurricane breeding areas.
<i>Remarks:</i>	First Weather Bureau-funded Tiros spacecraft.

Table 3-196.
ESSA I (OT-3) Characteristics

<i>Date of launch (location):</i>	Feb. 3, 1966 (ETR)
<i>Launch vehicle:</i>	Thor-Delta
<i>Weight (kg):</i>	138.3
<i>Shape:</i>	18-sided polyhedron
<i>Dimensions (m):</i>	1.07 × .56
<i>Power source:</i>	NiCd batteries plus solar cells
<i>Date of reentry:</i>	In orbit
<i>Cognizant NASA center:</i>	GSFC
<i>Project manager:</i>	Robert M. Rados
<i>Contractor:</i>	RCA, prime spacecraft and TV cameras
<i>Objectives:</i>	ESSA operational satellite.
<i>Experiments, responsible institution:</i>	2-camera APT TV system
<i>Results:</i>	Transmitted 111 144 images over 861 days.
<i>Remarks:</i>	Funded and managed by ESSA.

Table 3-197.
ESSA 2 (OT-2) Characteristics

<i>Date of launch</i>	Feb. 28, 1966 (ETR)
(location):	
<i>Launch vehicle:</i>	Thrust-augmented Improved Thor-Delta (TAID)
<i>Weight (kg):</i>	131.5
<i>Dimensions (m):</i>	1.07 × .57
<i>Date of reentry:</i>	In orbit
<i>Project manager:</i>	William W. Jones
<i>Objectives:</i>	ESSA operational satellite.
<i>Results:</i>	All systems operated as planned.
<i>Remarks:</i>	See table 3-196 for spacecraft description.

Table 3-198.
ESSA 3 (TOS-A) Characteristics

<i>Date of launch</i>	Oct. 2, 1966 (ETR)
(location):	
<i>Launch vehicle:</i>	Thrust-augmented Improved Thor-Delta (TAID)
<i>Weight (kg):</i>	147.4
<i>Dimensions (m):</i>	1.07 × .57
<i>Date of reentry:</i>	In orbit
<i>Objectives:</i>	ESSA operational satellite; included advanced vidicon camera system (AVCS); replace <i>ESSA 1</i> .
<i>Results:</i>	All systems operated as planned; transmitted 97 076 images over 241 days.
<i>Remarks:</i>	See tables 3-196, 3-197 for spacecraft description.

Table 3-199.
ESSA 4 (TOS-B)

<i>Date of launch</i>	Jan. 26, 1967 (WTR)
(location):	
<i>Launch vehicle:</i>	Thrust-augmented Improved Thor-Delta (TAID)
<i>Weight (kg):</i>	131.5
<i>Dimensions (m):</i>	1.07 × .57
<i>Date of reentry:</i>	In orbit
<i>Objectives:</i>	ESSA operational satellite; two ATP camera systems; replace <i>ESSA 2</i> .
<i>Results:</i>	All systems operated as planned, but one camera system became inoperable on January 29, 1967; transmitted 27 129 images over 110 days.
<i>Remarks:</i>	See tables 3-196, 3-197 for spacecraft description.

Table 3-200.
ESSA 5 (TOC-C) Characteristics

<i>Date of launch</i> (location):	April 20, 1967 (WTR)
<i>Launch vehicle:</i>	Thrust-augmented Improved Thor-Delta (TAID)
<i>Weight (kg):</i>	147.4
<i>Dimensions (m):</i>	1.07 × .57
<i>Date of reentry:</i>	In orbit
<i>Objectives:</i>	ESSA operational satellite; two AVCS; replace ESSA 3.
<i>Results:</i>	All systems operated as planned.
<i>Remarks:</i>	See tables 3-196, 3-197 for spacecraft description.

Table 3-201.
ESSA 6 (TOS-D) Characteristics

<i>Date of launch</i> (location):	Nov. 10, 1967 (WTR)
<i>Launch vehicle:</i>	Thrust-augmented Improved Thor-Delta (TAID)
<i>Weight (kg):</i>	129.7
<i>Dimensions (m):</i>	1.07 × .57
<i>Date of reentry:</i>	In orbit
<i>Objectives:</i>	ESSA operational satellite; two APT camera systems.
<i>Results:</i>	All systems operated as planned.
<i>Remarks:</i>	See table 3-196, 3-197 for spacecraft description.

Table 3-202.
ESSA 7 (TOS-E) Characteristics

<i>Date of launch</i> (location):	Aug. 16, 1968 (WTR)
<i>Launch vehicle:</i>	Long-tank Thrust-augmented Thor-Delta
<i>Weight (kg):</i>	147.4
<i>Dimensions (m):</i>	1.07 × .57
<i>Date of reentry:</i>	In orbit
<i>Objectives:</i>	ESSA operational satellite; two AVCS; take readings with a flat-plate radiometer; replace ESSA 5.
<i>Results:</i>	All systems operated as planned.
<i>Remarks:</i>	See tables 3-196, 3-197 for spacecraft description.

Table 3-203.
ESSA 8 (TOS-F) Characteristics

<i>Date of launch</i> (location):	Dec. 15, 1968 (WTR)
<i>Launch vehicle:</i>	Long-tank Thrust-augmented Thor-Delta
<i>Weight (kg):</i>	136.1
<i>Dimensions (m):</i>	1.07 × .57
<i>Date of reentry:</i>	In orbit
<i>Objectives:</i>	ESSA operational satellite; two ATP camera systems.
<i>Results:</i>	All systems operated as planned.
<i>Remarks:</i>	See tables 3-196, 3-197 for spacecraft description.

Nimbus

Shortly after the launch of the first Tiros weather satellite in the spring of 1959, NASA officials informed Congress of their plans for a second-generation meteorology payload that would orbit earth on a near-polar trajectory. This new satellite would provide sophisticated global coverage for an extended lifetime.¹³ The spacecraft's stabilization system would be designed to give the flight team greater control over the spacecraft's position and, thereby, over the readings and photographs Nimbus would take. In addition to automatic picture transmission and advanced vidicon camera systems that could produce very high-quality cloud cover photographs, Nimbus spacecraft would be equipped with high-resolution and medium-resolution radiometers for nighttime infrared readings, which would give meteorologists information on heat retention on a global scale. Mapping water vapor and stratospheric temperature patterns also would be made possible with data returned by Nimbus.

Project Nimbus, approved by NASA Headquarters officials in the summer of 1959, fell behind schedule and overran its budget, which prompted the scrutiny of Congress. A horizon scanner, which would allow the spacecraft to be operated in a sun-synchronous orbit, and overall hardware weight gains were the spacecraft's major problems. The butterfly-shaped Nimbus (360-410 kilograms) was developed and fabricated by General Electric's Spacecraft Department under the direction of the Goddard Space Flight Center. Rotating solar paddles, although they malfunctioned on *Nimbus 1*, provided enough storable energy to power the spacecraft's instruments for nighttime use. By using Nimbus cloud cover photographs, which covered almost 2 million kilometers per sequence, NASA and the Weather Bureau (and additionally the Department of Defense) hoped to establish an operational weather observation system. Because of early setbacks with the development of hardware and reported plans for reducing the expected lifetime of the spacecraft, the Weather Bureau abandoned its plans and its funding support for a Nimbus Operational System (NOS) in September 1963. NASA, however, continued Nimbus as a research and development project aimed at developing an observatory system that would meet the future needs of the nation's atmospheric and earth scientists.

The first Nimbus spacecraft was orbited in August 1964. The images received from *Nimbus 1* were remarkably clear and much better than Tiros images, but a hardware problem forced the mission's premature termination on orbit 371, in the second month of operations. By using the more powerful Thrust-augmented Thor-Agena B, NASA was able to design a heavier payload for *Nimbus 2*. This second spacecraft returned data for more than 32 months (1966-1969), including the "satellite pictures" that became a popular feature on television news and weather programs. Because a Thor engine malfunctioned on the long-tank Thorad-Agena D during the launch of the third Nimbus, the entire vehicle was destroyed 121 seconds after liftoff on May 18, 1968. The Nimbus B mission, repeated in 1969, was more sophisticated than the first two, having two infrared spectrometers, an interrogation and location system for determining the position of other man-made objects in space, two radiometers, an ultraviolet radiation flux experiment, and an image dissector camera system system capable of taking daytime pictures of the entire earth with a resolution of 3.2 kilometers at picture center. The 570-kilogram satellite was powered by a new radioisotope thermoelectric generator (SNAP-19) augmented

by solar cells.* The seven-mission Nimbus program (1964-1978) contributed widely to the development of experiment hardware and image systems, provided scientists with a variety of data on cloud cover, temperature, and other weather-related phenomena, and became the nation's principal satellite program for remote-sensing research.

Richard L. Haley, advanced technology and projects program manager since early 1964, was named Nimbus program manager in early 1965. He saw the program through the agency's first decade. At the Goddard Space Flight Center, William G. Stroud was Nimbus project manager from February 1960 to August 1961, when Harry Press took the job. General Electric was the prime contractor.

*For more on the SNAP-19 RTG and sources for nuclear onboard electric power, see chapter 4.

Table 3-204.
Chronology of Nimbus Development and Operations

Date	Event
April 1959	An advanced meteorology satellite research and development project was described by NASA at FY 1960 authorization hearings before the House of Representatives and at FY 1959 supplementary appropriations hearings.
Aug. 1959	A Nimbus research and development program was approved by NASA Headquarters.
March 8, 1960	The Weather Bureau solicited proposals for an engineering design study of an infrared spectrometer for a weather satellite.
June 1960	The Weather Bureau Panel on Observations over Space Data Regions issued a report suggesting the need for a research and development satellite beyond Tiros.
Fall 1960	NASA issued a request for proposals for Nimbus spacecraft design.
Dec. 1960	The Radio Corporation of America (RCA) was awarded a contract for development and fabrication of an advanced vidicon camera system (AVCS) for Nimbus.
Feb. 3, 1961	General Electric (GE) was selected as contractor for spacecraft fabrication and subsystems integration for two Nimbus satellites. GE was chosen over Temco, RCA, Grumman Aircraft Engineering Corp., Bendix, and Republic Aviation Corp.
April 1961	The Panel on Operation Meteorological Satellites, an interagency group, recommended expanding the Nimbus research and development project into a Nimbus Operation System (NOS); this would be a joint undertaking (NASA and the Weather Bureau).
Nov. 1961	A preliminary project development plan was prepared at NASA's Goddard Space Flight Center.
Jan. 1962	The Nimbus spacecraft underwent a rigorous test program at GE. NASA and the Weather Bureau signed an agreement providing for implementation of NOS. The Weather Bureau approved the preliminary project development plan.
Aug-Sept. 1962	The House of Representatives Science and Astronautics Applications Subcommittee held hearings on the effects of postponing the first Nimbus launch.

Table 3-204.
Chronology of Echo Development and Operations (Continued)

Date	Event
Dec. 1962	The Weather Bureau reprogrammed funds from NOS to the Tiros Operational System (TOS).
Jan. 1963	AVCS was qualified as a subsystem. The Department of Defense (DoD) questioned the adequacy of Nimbus for military requirements.
June 1963	The Weather Bureau provided NASA with DoD-Weather Bureau requirements for Nimbus.
July 1963	The project development plan was revised to incorporate DoD-Weather Bureau recommendations.
Sept. 1963	DoD and the Weather Bureau advised the Bureau of the Budget that NASA's research and development program for meteorology satellites should be placed under their control; the Weather Bureau advised NASA that it was withdrawing from NOS as of October 4.
Sept. 18, 1963	GE was awarded a contract for developing operating procedures for the Nimbus control center.
Oct. 1963	NASA advised the Weather Bureau of its intentions of continuing a Nimbus research and development project; a revised project development plan was approved by NASA Headquarters on October 10.
Aug. 11, 1964	A faulty relay box in the Thor-Agena B launch vehicle postponed the first Nimbus launch.
Aug. 28, 1964	<i>Nimbus 1</i> was launched successfully, but the spacecraft ceased operating on September 23, 1964, because of malfunctions.
Jan. 29, 1965	A General Accounting Office report accused NASA of spending \$1.2 million unnecessarily on Nimbus by failing to react to new spacecraft weight design goals.
June 1965	The project development plan was revised to reflect the cancellation of NOS and operation of a second Nimbus mission.
May 15, 1966	<i>Nimbus 2</i> was launched successfully.
Aug. 13, 1966	A NASA review board and the House of Representatives Science and Astronautics Committee NASA Oversight Subcommittee began inquiries into OGO, OAO, and Nimbus (<i>Nimbus 1</i>) failures.
May 18, 1968	An attempted Nimbus launch using a long-tank Thorad-Agena D failed because the Thor malfunctioned; the entire vehicle was destroyed 121 seconds after liftoff.
June 28, 1968	<i>Nimbus 2's</i> tape recorder became inoperable.
Dec. 1968	Hittan Associates, Inc., was chosen to evaluate the SNAP-19 nuclear power system for the Nimbus B spacecraft.

Table 3-205.
Nimbus 1 (Nimbus-A) Characteristics

<i>Date of launch</i> (location):	Aug. 28, 1964 (WTR)
<i>Launch vehicle:</i>	Thor-Agena B
<i>Weight (kg):</i>	376.5
<i>Shape:</i>	Hexagonal upper section with solar array paddles connected by a truss to a lower housing sensory ring
<i>Dimensions (m):</i>	Height, 2.9 Width with paddles extended, 3.4 Ring diameter, 1.52
<i>Power source:</i>	NiCd batteries plus solar cells
<i>Date of reentry:</i>	May 16, 1974
<i>Cognizant NASA center:</i>	GSFC
<i>Project manager:</i>	Harry Press
<i>Contractor:</i>	General Electric Co., Spacecraft Dept., prime
<i>Objectives:</i>	Prove basic spacecraft design; obtain high-resolution TV cloud mapping images; demonstrate APT role; obtain nighttime infrared radiometer readings on a global scale.
<i>Experiments, responsible institution:</i>	APT and AVCS camera systems High-resolution infrared radiometer, GSFC
<i>Results:</i>	Transmitted 27 000 pictures over 27 days; data returned from all sensors as expected; mission was terminated on September 23, 1964, orbit 371, when the solar array paddles were unable to continue tracking the sun.

Table 3-206.
Nimbus 2 (Nimbus-C) Characteristics

<i>Date of launch</i> (location):	May 15, 1966 (WTR)
<i>Launch vehicle:</i>	Thrust-augmented Thor-Agena B
<i>Weight (kg):</i>	413.68
<i>Shape:</i>	Hexagonal upper section with solar array paddles connected by a truss to a lower housing sensory ring
<i>Dimensions (m):</i>	Height, 2.9 Width with paddles extended, 3.4 Ring diameter, 1.52
<i>Power source:</i>	NiCd batteries plus solar cells
<i>Date of reentry:</i>	In orbit
<i>Cognizant NASA center:</i>	GSFC
<i>Project manager:</i>	Harry Press
<i>Contractor:</i>	GE, prime
<i>Objectives:</i>	Demonstrate long lifetime meteorology satellite observatory; demonstrate role of direct readout of infrared nighttime cloud cover to APT ground stations; map water vapor and stratospheric temperature patterns.
<i>Experiments, responsible institution:</i>	APT and AVCS camera systems High-resolution infrared radiometer, GSFC Medium-resolution infrared radiometer, GSFC
<i>Results:</i>	Transmitted 210 000 images over 978 days; all systems operated as expected.

DESCRIPTION – COMMUNICATIONS PROGRAM

As early as 1945, writer-scientist Arthur C. Clarke proposed that an active communications satellite be developed to assist with the relaying of long-distance transmissions, and by the early 1960s the need for such high-altitude relays could not be ignored. Because of its elevation, a satellite could offer a simultaneous line-of-sight connection between two points that are shielded from one another by the curvature of the earth. Two kinds of satellites were possible: passive satellites that would act as mirrors, retransmitting no more than they intercepted, and active satellites that would receive and amplify a signal before retransmitting it to the ground.¹⁴ During the 1950s, the Navy established a communications system that used the moon as a passive reflector for radar waves (Communication by Moon Relay), and the Air Force launched an Army-built active communications satellite experiment (Project Score, 1958), by which President Dwight D. Eisenhower sent taped Christmas greetings. Advanced planners at the National Advisory Committee for Aeronautics (NACA) recommended in the spring of 1958 that the new space agency take an active part in satellite communications research with studies of channel requirements, reflector and active relays, and radio wave propagation. They thought that a passive reflector could be launched by NASA as early as FY 1959.¹⁵

Project Echo was NASA's first flight experiment in the communications field. The first launch of a large reflector balloon took place in 1960. NASA's Relay and Syncom satellites began providing active relay capabilities in 1962 and 1963. Also in 1962, the agency launched two Telstar satellites for the American Telephone & Telegraph Company (AT&T). Like weather satellites, orbiting communications relays were directly and immediately applicable to the general public's welfare. Demonstrations of what this new technology could accomplish were a popular part of the program; these included television, teletype facsimile, and voice operations. On television sets around the world, viewers watched as astronaut L. Gordon Cooper was recovered from his Mercury capsule after orbiting the earth (1963, via *Relay 1*), as Pope Paul VI visited the Middle East (1964, via *Relay 1*), as Khrushchev toured Poland (1964, via *Relay 2*), and as Olympic athletes competed in Tokyo (1964, via *Syncom 3*). Special demonstrations soon gave way to daily routine service. NASA launched six INTELSATS for the Communications Satellite Corporation (COMSAT) in 1965-1968, establishing a global operational network of communications satellites capable of voice (240 channels), television, and teletype facsimile transmissions.

COMSAT, which served as the operational arm of the International Telecommunications Satellite Organization (INTELSAT), was authorized by Congress in August 1962 to exploit the commercial possibilities of the new communications satellite field. Allocating frequencies for space communications was the responsibility of the Federal Communications Commission (FCC). NASA was assigned the task of launching these commercial spacecraft, furnishing technical assistance, and cooperation with COMSAT on research and development projects. Within NASA, the International Affairs Office interacted with the State Department in arranging for the many ground stations required around the world for various communications satellite projects. The National Communications System coordinated U.S. government needs (see table 3-208). As shown in the organizational chart (fig. 3-5), all these groups had to work together to deliver an operational communications system.

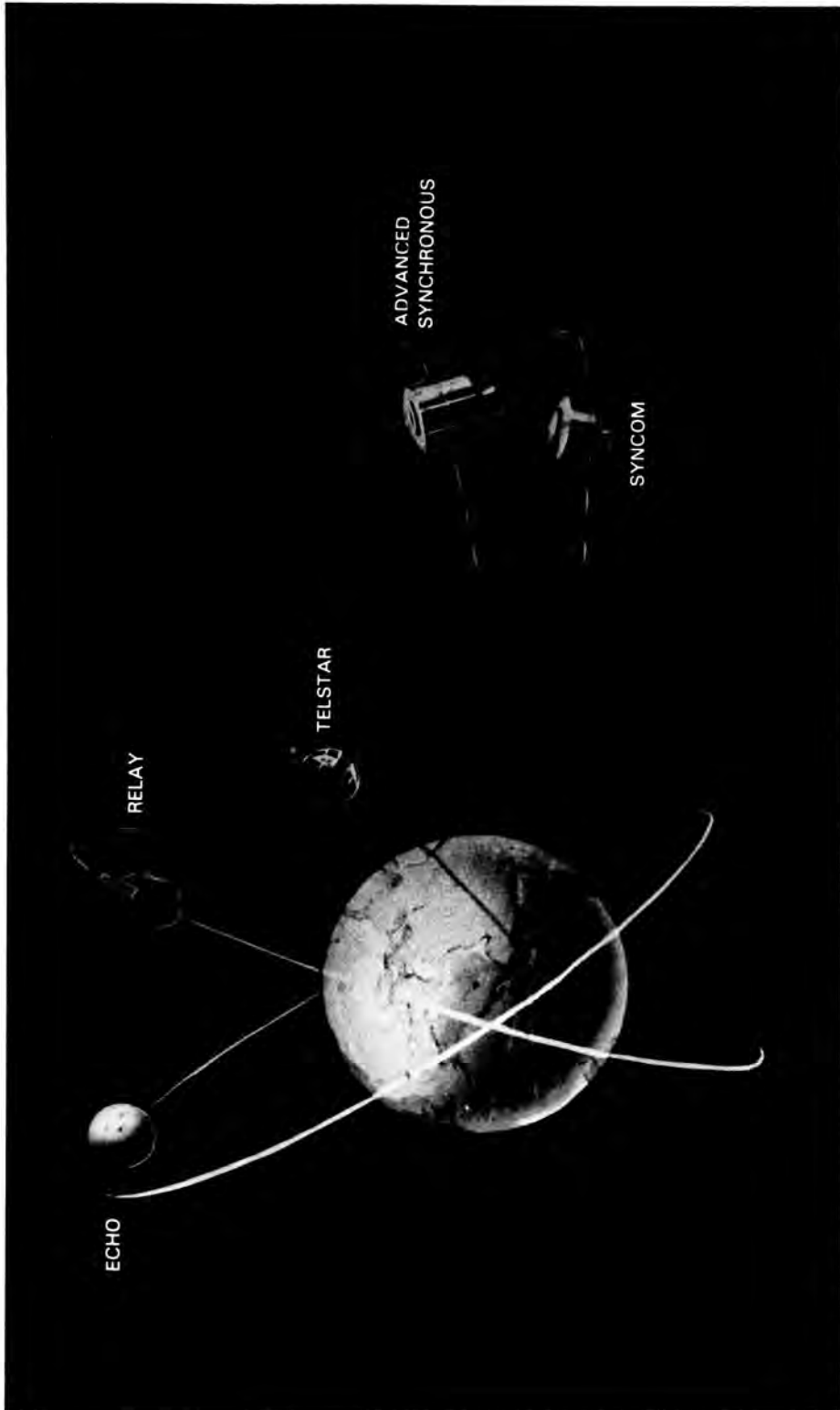

Figure 3-4. NASA's communications satellites.

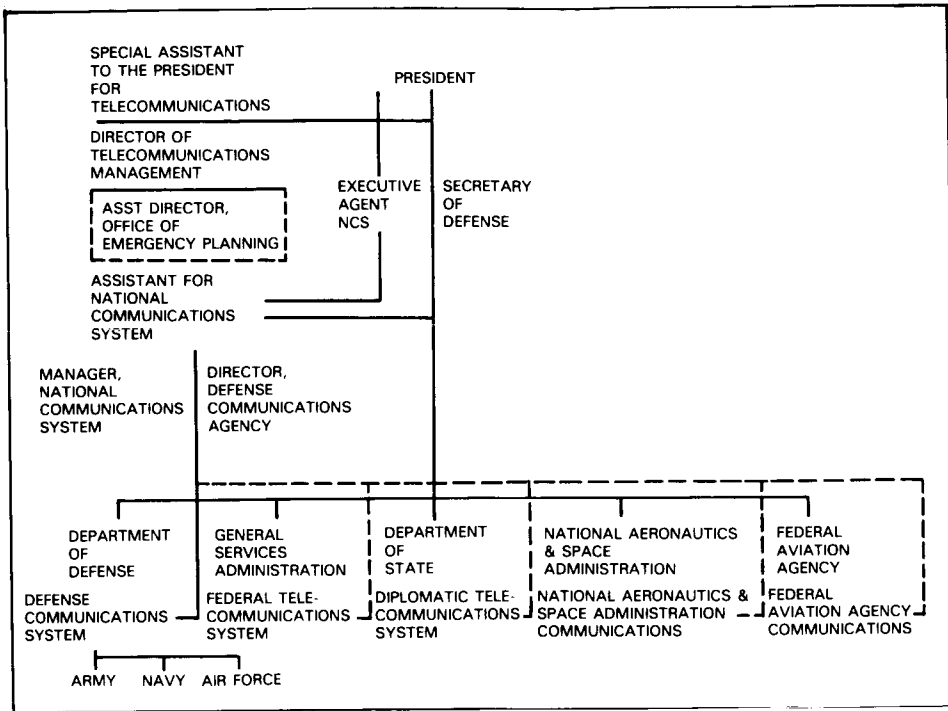

Figure 3-5. The National Communications Systems encompasses total Federal assets.

At NASA Headquarters, communications satellites were the concern of the Office of Space Flight Development until a reorganization in 1962 placed them under the purview of the Office of Applications. In June 1963, communications and navigation programs became a directorate of the new Office of Space Science and Applications (OSSA). In a 1966 reorganization of OSSA, communications programs became part of the Space Applications Programs Office. Until January 1966, Leonard Jaffe led the Headquarters communications team through its various management reassignments. A. Marion Andrus, associated with advanced communications systems since the early 1960s, was named program chief in 1966. Joseph R. Burke was satellite projects program manager from 1963 through 1965; from 1966 through 1969 Wayne C. Mathews, John Kelleher, and Jerome Friebaum all took a turn as manager. A separate navigation satellite manager, Eugene Ehrlich, assumed responsibility for this special class of communications satellites in late 1965 (by March 1966 this office had been expanded to include traffic control activities). Goddard Space Flight Center was assigned the hardware development and program management of the various communications satellites. Goddard's Office of Space Science and Satellite Applications oversaw the communications satellite projects until 1965, when the projects directorate assumed the task. Goddard had responsibility for launching the INTELSAT series and providing related services, while COMSAT controlled operations.

In 1963, OSSA combined the responsibility for navigation and communications satellites, their technical requirements being very similar. With increasing traffic in the air and on the sea, it was becoming necessary to develop a system by which a central body could monitor and control traffic in congested areas and respond to emergency situations. Plans called for an operational system by the early 1970s. Large direct broadcast (real-time) satellites made up another class of communications satellites under study at NASA in the 1960s. Advanced planners were calling for flight projects to begin in the 1970s.

A general introduction to communications satellites can be found in J. R. Pierce, *The Beginnings of Satellite Communications* (San Francisco: San Francisco Press, Inc., 1968).

Table 3-207.
Comparison, Relay, Telstar, Syncom

Item	Relay	Telstar	Syncom
Orbit	Elliptical	Elliptical	Circular, 22 300 mi.
Attitude	Magnetic coil	Magnetic coil	Nitrogen jets
Control			
Output Power	10 Watts, TWT	3 Watts, TWT	2 Watts, TWT
Baseband	3 MCS, wideband	3 MCS	4 KC per channel
Width	96 KCS 2-way telephone		
Channel Disposition	Two identical transponders only one usable at a time, each having one wideband (TV) and two narrow-band (12 telephone) channels, one for each direction	One wideband (TV) channel; for 2-way phone, signal strength at satellite is equalized by adjusting transmitter power	Two telephone channels, one for each direction
Operating Modes	TV 1-way or, 300 data channel 1-way or, 12 telephone circuits 2-way	TV 1-way or, wideband data 1-way or, 60 telephone circuits 2-way	One 2-way telephone circuit
Frequencies (MCS)	1725 Up 4170 Down	4390 Up 4170 Down	7363 Up 1815 Down

Table 3-208.
Organizational Interactions
Communication & Navigation Satellite Programs

	NASA Flight Programs				NAV PROGRAM	CSC PROGRAM	ITU PARTICI- PATION
	ECHO	RELAY	SYNCOM	ATS			
DOD	X	X	X	X	X		
STATE						X	X
TREASURY					X		
INTERIOR					X		
COMMERCE					X		
FAA			X		X		X
USIA		X	X	X			
FOC				X		X	X
BROADCASTERS		X	X	X			
COM SAT CORP			X			X	
FOREIGN PARTICIPANTS	X	X	X	X			
SCIENTIFIC COMMUNITY	X	X	X	X			
NAT'L SPACE COUNCIL	X	X	X	X	X	X	X
DIR. TELECOMM'S.							
MGMT.	X	X	X	X	X	X	X

NAV = Joint Navigation Satellite Committee

CSC = Communications Satellite Corp.

ITU = International Telecommunication Union

From NASA Hq., "Program Review Document, Communication & Navigation Programs," Sept. 22, 1964, p. 21.

Echo

Echo was NASA's first communications satellite flight project. The balloon-like passive reflector was initially sponsored by the National Advisory Committee for Aeronautics (NACA) as an International Geophysical Year (IGY) air density experiment. In 1956 at NACA's Langley research facility, William J. O'Sullivan, after assessing the value of prospective IGY experiments designed to measure the density of earth's atmosphere, proposed that a low-density inflatable structure that could be tracked optically would serve as a good measure of aerodynamic drag. Twice attempts were made to launch O'Sullivan's spheres along with IGY payloads, but launch vehicle malfunctions with Juno I and Vanguard thwarted the Langley team's efforts.*

If a satellite of the type O'Sullivan envisioned were equipped with small radio beacons, it could be followed by radar and optical means, significantly increasing

*An attempt on August 14, 1959, to launch a Beacon inflatable satellite also failed because Juno II's fuel supply was depleted prematurely. The air density experiment was finally realized as *Explorer 9* (February 16, 1961), *Explorer 19* (December 19, 1963), and *Explorer 39* (August 8, 1968).

the period during each orbit it could be tracked. And if the satellite carried a reflector or acted as a reflector as a whole, sending back radar signals to a specific point, it could be tracked day or night. According to O'Sullivan, "it was a simple next step" to consider using the satellite for communications purposes.¹⁷ As early as April 1958, NACA Director Hugh L. Dryden had told Congress that such a passive satellite could be orbited and inflated in space. To be sure, Langley's air density balloon would have to grow considerably in size to provide the maximum surface from which to bounce signals, and the surface would have to possess increased reflectivity characteristics. John R. Pierce of Bell Telephone Laboratories had been contemplating such a communications experiment since 1955, and by 1959 Bell and the new civilian space agency, which had inherited NACA's balloon project, were working together on a passive communications satellite project called Echo.

Technicians at Langley (now a part of NASA) had three major requirements in designing a balloon satellite that measured 30.48 meters in diameter and would inflate in orbit into a perfectly smooth surface: a suitable material for the sphere, an inflation system, and a canister in which to launch the folded-up balloon. And since there was no way to run ground tests that simulated the space environment on such a large sphere, NASA would have to rely on suborbital flight tests. The G. T. Schjeldahl Company fitted and cemented together 82 separate flat gores of aluminized Mylar film (.5 millimeter thick) supplied by E. I. Dupont to form the Echo sphere. Benzoic acid was selected as the sublimating agent (i.e., going from a solid to a gaseous state without liquifying) that would be used to inflate the structure. Kaiser-Fleetwing manufactured a spherical metal canister impregnated with plastic to contain the deflated satellite. The Langley crew assembled the first Echo test model by the fall of 1959. In October, it was launched to an altitude of 400 kilometers (Project Shotput), where the sphere ruptured. On the fourth try (April 1960), the balloon inflated successfully at 375 kilometers. After a first launch attempt failed, *Echo 1* was placed in orbit and inflated on August 12, 1960. For the next four and a half months, it was utilized for experiments by Bell Telephone Laboratories in New Jersey and the Jet Propulsion Laboratory in California. Even after the balloon's skin had been damaged repeatedly by micrometeoroids and its orbit affected by solar wind, *Echo 1* was used to reflect a variety of communications signals to and from ground stations around the globe.* As it was visible from the ground, it also served as a popular symbol of the peaceful and practical uses of space research.

The second-generation Echo was larger (41.15-meter diameter), heavier, and more durable. Fabricated from 106 gores of Mylar three layers thick bonded between two sheets of soft aluminum foil, the improved Echo maintained its rigidity for a longer time. Pyrazol was used as the inflating medium, and a new canister was made by the Grumman Aircraft Company from magnesium forgings. First test-inflated in a dirigible hanger, the new Echo was tested several times under suborbital conditions (Project Big Shot). *Echo 2* was put into orbit on January 25, 1964, and used successfully for more than a year by a number of groups for communications

*The *Echo 1* configuration was also used for *PAGEOS 1*, launched on June 23, 1966. It served as a point source of light for a tracking network; the resulting data were used for mapping and other geodetic purposes (table 3-137).

tests, including a cooperative investigation by American, Soviet, and British specialists.

In early 1963, NASA managers cancelled plans for an advanced passive communications satellite* when it learned that the Department of Defense had dropped its active satellite project, Advent. Since an active repeater satellite powered by solar cells in synchronous orbit clearly had more potential as a commercial communications system, NASA would direct its research to that area.

At NASA Headquarters, Echo was managed by Leonard Jaffe's office, with Joseph R. Burke as satellite projects program manager. Overall project management was assigned to Goddard Space Flight Center, with Langley Research Center being responsible for the payload.

*NASA had let several feasibility study contracts to determine the best shape, structure, and materials for a future passive communications satellite. The agency briefly contemplated a three-balloon experiment dubbed Rebound.

Table 3-209.
Chronology of Echo Development and Operations

Date	Event
Jan. 26, 1956	William J. O'Sullivan of NACA's Langley Memorial Aeronautical Laboratory considered a low-density inflatable structure to measure aerodynamic drag as a possible experiment for the International Geophysical Year (IGY).
April 22, 1958	NASA Director Hugh Dryden in testimony before the House Select Committee on Astronautics and Space Exploration said that large aluminized balloons could be inflated after being placed in orbit and used for communications tests.
April 15, 1958	Launched by a Nike-Cajun, a 3.66-meter inflatable sphere was successfully erected.
May 1958	NACA launched a 4.1-kilogram inflatable sphere to an altitude of 80 kilometers.
Oct. 22, 1958	An attempt to launch a 3.66-meter inflatable sphere (called <i>Explorer 6</i> , but not the same spacecraft that was launched in August 1959) failed when the required orbit was not achieved.
April 13, 1959	Because of Vanguard launch vehicle malfunctions, an attempt to place a .76-meter inflatable sphere into orbit failed.
April-Sept. 1959	Personnel at NASA's Langley Research Center constructed a 30.48-meter inflatable sphere satellite.
Oct. 28, 1959	NASA launched a 30.48-meter inflatable sphere to an altitude of 400 kilometers with a Sergeant-Delta; the sphere ruptured (Project Shotput).
Jan. 16, 1960	NASA launched a 30.48-meter inflatable sphere to an altitude of 400 kilometers with a Sergeant-Delta; the sphere ruptured (Project Shotput).
Feb. 27, 1960	NASA launched a 30.48-meter inflatable sphere to an altitude of 400 kilometers; radio transmissions were reflected via the sphere from Holmdel, New Jersey, to Round Hill, Massachusetts, before it ruptured (Project Shotput).

Table 3-209.
Chronology of Echo Development and Operations (Continued)

Date	Event
April 1, 1960	A 30.48-meter inflatable sphere was launched and inflated successfully by NASA at 380 kilometers (Project Shotput).
May 13, 1960	An attempt to launch an Echo satellite failed when the Thor-Delta vehicle malfunctioned.
July 15, 1960	Hughes Aircraft Co. was awarded a seven-month contract for developing techniques to rigidize structures so that they would maintain their reflectivity in sunlight or shadow.
Aug. 12, 1960	<i>Echo 1</i> was launched successfully; experiments were performed on August 18.
Feb. 21, 1961	NASA awarded a contract to the G. T. Schjeldahl Co. for nine inflatable spheres for Project Echo.
May 18, 1961	The first test inflation of an improved Echo balloon was conducted in a dirigible hanger.
Jan. 15, 1962	A suborbital test of a modified Echo inflation system was launched by a Thor-Agena from the Western Test Range (Project Big Shot).
Sept. 28, 1962	Plans were announced for launching two Echo-type helium balloons to determine skin smoothness characteristics for an advanced Echo.
Oct. 20, 1962	A 30.48-meter <i>Echo 1</i> -type balloon was launched; it ruptured at 35 kilometers.
Dec. 5, 1962	The U.S. and the USSR agreed to cooperate in the coming year's experiments with Echo.
Feb. 25, 1963	NASA announced that in light of the formation of the Communications Satellite Corporation (COMSAT) and the cancellation of the Department of Defense Advent active communications satellite project, the agency would focus its efforts on synchronous-orbit active satellites. NASA cancelled advanced passive and intermediate-altitude communications satellite projects.
May 13, 1963	Langley issued a request for proposals for a feasibility study for an inflatable lenticular passive communications satellite.
Aug. 12, 1963	Schjeldahl was selected to build three second-generation Echo satellites, a project which was cancelled.
Jan. 25, 1964	<i>Echo 2</i> was launched successfully.

Table 3-210.
Echo 1 (Echo A-11) Characteristics

<i>Date of launch</i> (location):	August 12, 1960 (ETR)
<i>Launch vehicle:</i>	Thor-Delta
<i>Weight</i> (kg):	75.9 (plus 10.9-kilogram canister)
<i>Shape:</i>	Spherical (inflatable)
<i>Dimensions</i> (m):	Diameter, 30.48
<i>Power source:</i>	Beacon transmitters powered by NiCd batteries plus solar cells
<i>Date of reentry:</i>	May 24, 1968
<i>Cognizant NASA centers:</i>	GSFC, project management LaRC, payload
<i>Project manager:</i>	Robert J. Mackey, Jr.
<i>Contractors:</i>	E. I. Dupont, aluminized Mylar polyester film G. T. Schjeldahl Co., fabrication Kaiser-Fleetwings, Inc., canister Radio Corporation of America, tracking beacons
<i>Objectives:</i>	Inject a passive communications reflector into circular orbit; test feasibility of using passive satellites as passive reflectors of radio and television signals for long-range transmissions.
<i>Experiments responsible institution:</i>	Communications experiments were conducted between Bell Telephone Laboratories and the Jet Propulsion Laboratory.
<i>Results:</i>	Demonstrated use of radio reflector for global communications; numerous successful transmissions; visible to the naked eye; orbit characteristics perturbed by solar pressure due to high area-to-mass ratio. It remained 100% useful for 4½ months, but some experiments were conducted after that time even though the satellite's skin had begun to deteriorate and it had lost some of its shape.

Table 3-211.
Echo 2 (Echo C) Characteristics

<i>Date of launch</i> (location):	Jan. 25, 1964 (WTR)
<i>Launch vehicle:</i>	Thor-Agena B
<i>Weight</i> (kg):	243.6 (plus 348.4-kilogram canister, beacons, and other equipment)
<i>Shape:</i>	Spherical (inflatable)
<i>Dimensions</i> (m):	Diameter, 41.15
<i>Power source:</i>	NiCd batteries plus solar cells
<i>Date of reentry:</i>	June 8, 1969
<i>Cognizant NASA center:</i>	GSFC, project management LaRC, payload
<i>Project manager:</i>	Herbert L. Ecker
<i>Contractors:</i>	E. I. Dupont, aluminized Mylar polyester film G. T. Schjeldahl Co., fabrication Viron Div., Geophysics Corp. of America, inflation system Aero Geo Astro Corp., beacons Grumman Aircraft Co., canister
<i>Objectives:</i>	Demonstrate rigidization technique applicable to passive communications satellites; advance the state of the art represented by <i>Echo 1</i> .
<i>Experiments, responsible institution:</i>	Communications experiments were conducted by Bell Telephone Laboratories, Collins Radio Co., Naval Research Laboratory, Lincoln Laboratory, U.S. Air Force, and the Naval Electronics Laboratory.
<i>Results:</i>	Successfully inflated and used for many communications experiments; tracking also provided data on the upper atmosphere; joint experiments with the Soviet Union and the United Kingdom took place in 1964.

Telstar

In October 1960, American Telephone & Telegraph Company (AT&T) asked the Federal Communications Commission (FCC) for approval of its plans for an active communications satellite experiment. The following January, the FCC allocated AT&T the frequencies it had requested, and in July NASA announced that it would launch and track two Bell Telephone Laboratories-designed satellites (Telstars) for AT&T on a reimbursable basis. With Telstar, AT&T hoped to demonstrate the transmission of multichannel two-way telephone, television data, and facsimile signals via satellite and gain experience with very large ground station antennas. In addition to its microwave repeater and other communications-related instruments, Telstar was equipped with an array of sensors and measuring devices by which to study the characteristics and intensity of radiation in the Van Allen Belt. Bell built a large ground antenna in Maine, and communications agencies in England, France, and Germany constructed ground stations that would operate with Telstar and with the experimental active communications satellite (Relay) NASA was planning to launch in the near future. NASA stations that were being built in Brazil, Italy, and elsewhere for Relay also could be used for Telstar.

From its first day in operation, July 10, 1962, *Telstar 1* was used successfully for a variety of experiments and tests. In November, the satellite's command channel began acting erratically and on the 23d ceased responding. The following January, however, transmissions resumed unexpectedly for a few weeks; it was theorized that radiation had affected Telstar's performance. *Telstar 2* was launched on May 7, 1963. Specialists immediately began a series of tests and demonstrations involving ground stations in England, France, Italy, Japan and the U.S. Although affected periodically by radiation damage, the satellite remained operational for two years.

Telstar was a commercially financed project. NASA provided only the support requested by AT&T. At NASA Headquarters, Telstar was managed by Satellite Projects Program Manager Joseph R. Burke. Charles P. Smith was the project manager at the Goddard Space Flight Center, where NASA's Minitrack network was used for Telstar tracking operations.

Table 3-212.
Chronology of Telstar Development and Operations

Date	Event
1959	An ad hoc group was formed at Bell Telephone Laboratories to study the feasibility of developing an active communications satellite.
Aug. 24, 1959	A Bell company memorandum outlined plans for an active repeater communications satellite experiment.
1960	Bell experimented with and tested many of the components for the active satellite that would become Telstar.
Oct. 21, 1960	The Federal Communications Commission (FCC) was asked to approve plans for an American Telephone & Telegraph (AT&T) satellite experiment, which would use the Bell satellite.
Jan. 19, 1961	FCC authorized the AT&T experiment and allocated it frequencies for one year.
July 27, 1961	NASA announced that it would launch and test two AT&T active communications satellites on a reimbursable basis.
Aug. 23-24, 1961	The Senate Commerce Committee heard testimony from NASA officials and the assistant attorney general on Telstar costs.
Oct. 18, 1961	The AT&T satellite was officially designated Telstar.
Dec. 1961	The West German Post Office announced that it would construct a ground station near Munich that could be used with Telstar and NASA's Relay communications satellite.
June 5, 1962	NASA announced plans for a cooperative program for testing Relay and Telstar.
July 10, 1962	<i>Telstar 1</i> was launched successfully; demonstrations of television transmissions began shortly after launch.
Dec. 30, 1962	AT&T announced plans to launch a second satellite in the spring of 1963.
May 7, 1963	<i>Telstar 2</i> was launched successfully.

Table 3-213.
Telstar 1 Characteristics

<i>Date of launch (location):</i>	July 10, 1962 (ETR)
<i>Launch vehicle:</i>	Thor-Delta
<i>Weight (kg):</i>	77.1
<i>Shape:</i>	Roughly spherical with 72 flat faces
<i>Dimensions (m):</i>	Diameter, .88
<i>Power source:</i>	NiCd batteries plus solar cells
<i>Date of reentry:</i>	In orbit
<i>Cognizant NASA center:</i>	GSFC
<i>Project manager:</i>	Charles P. Smith
<i>Contractor:</i>	Bell Telephone Laboratories built the spacecraft for American Telephone & Telegraph Co.
<i>Objectives:</i>	Advance the art of long-range communications by satellite; measure radiation in and near the inner Van Allen Belt; measure radiation damage to transistors.
<i>Experiments responsible institution:</i>	Proton-electron detectors, solar aspect sensor, silicon transistors, all Bell Telephone Laboratories experiments.
<i>Results:</i>	Part of the communications system suffered radiation damage from the July 9, 1962, high-altitude Starfish nuclear test and was silent from November 23, 1962, to January 3, 1963; more than 300 technical tests and over 400 demonstrations were conducted successfully.
<i>Remarks:</i>	First commercial satellite launched by NASA.

Table 3-214.
Telstar 2 Characteristics

<i>Date of launch (location):</i>	May 7, 1963 (ETR)
<i>Launch vehicle:</i>	Thor-Delta
<i>Weight (kg):</i>	79.4
<i>Shape:</i>	Roughly spherical with 72 flat faces
<i>Dimensions (m):</i>	Diameter, .88
<i>Power source:</i>	NiCd batteries plus solar cells
<i>Date of reentry:</i>	In orbit
<i>Cognizant NASA center:</i>	GSFC
<i>Project manager:</i>	Charles P. Smith
<i>Contractor:</i>	Bell Telephone Laboratories built the spacecraft for American Telephone & Telegraph Co.
<i>Objectives:</i>	Continuation of first mission; study effects of radiation and means of extending the useful life of an active communications satellite; check new ground equipment
<i>Experiments responsible institution:</i>	Proton-electron detectors, Bell Telephone Laboratories
<i>Results:</i>	Transmitted black and white and color television and voice signals between stations in the U.S., France and England; used until May 1965 although radiation periodically affected the satellite's performance.

Relay

Along with passive communications satellite experiments (Echo), NASA planned a modest low-altitude active satellite project for the early 1960s. The Department of Defense had responsibility for a synchronous-orbit satellite system (Advent), so the space agency confined its research and development activities to low- and medium-altitude communications satellites. In November 1960, NASA awarded a contract to Space Technology Laboratories for a feasibility design study for an active communications satellite, and by the following January officials were briefing industry on the agency's requirements for Project Relay. As a result of the Soviet Union's "space spectaculars" of 1961 and President John F. Kennedy's subsequent support of a strong U.S. space program, NASA's communications satellite program received supplementary funds that made it feasible to support active satellite research. In May 1961, the Radio Corporation of America (RCA) was awarded a contract to fabricate three Relay satellites.

Relay was designed with three objectives in mind: to test transoceanic communications, to measure radiation in its orbital path, and to determine to what extent these high- and low-energy electrons and protons would damage the satellite's solar cells and diodes (8.6 of *Relay 1*'s 78 kilograms were devoted to radiation-measuring devices and solid-state component testing equipment). The roughly spherical Relay satellites were built with redundancy as a major feature; they carried two sets of every major system of circuits. Relay's most important component, the microwave repeater, received frequency-modulated signals from one or two ground stations, amplified these signals, tripled their deviation, and retransmitted them. Test stations for sending and receiving transmissions were in the U.S. (Andover, Maine; Mojave, California; and Nutley, New Jersey); Fucino, Italy; Goonhilly Downs, England; Pleumeur-Bodou, France; Rio de Janeiro, Brazil; Raisting, Germany; and Isbaraki Prefecture, Japan. To coordinate and define the main international experiments and demonstrations that would be performed via Relay, an International Ground Station Committee was formed.

Thor-Delta vehicles launched *Relay 1* (December 13, 1962) and *Relay 2* (January 21, 1964) into elliptical orbits, from which they successfully retransmitted television, telephone, and digital signals. *Relay 1* did not function properly at first because of an abnormal power drain on its storage batteries, but the problem was traced to the voltage regulator in a transponder. A second transponder was used as a backup, and the mission went on as planned. By March 1963, *Relay 1* had fulfilled its mission objectives and went on to transmit the first transpacific television signals between Japan and the U.S. in November. In fact, *Relay 1* worked too well. It would not respond to commands to turn itself off in December 1963 and continued relaying signals until February 1965. *Relay 2* was equipped with upgraded solar cells designed to extend the satellite's power supply, and its traveling wave tubes, power regulation system, and radiation shielding were also of an improved design. The second Relay's initial public demonstration took place on January 29, 1964, when a portion of the winter Olympics at Innsbruck, Austria, was televised and transmitted to the U.S. via Relay and ground stations in France and Maine. After a successful demonstration career, *Relay 2* was retired in the fall of 1965.

Relay was managed at NASA Headquarters by Joseph R. Burke (*Relay 1*) and Donald P. Rogers (*Relay 2*), working in Leonard Jaffe's Office of Communications

and Navigations Programs. At Goddard Space Flight Center, Joseph Berliner and Wendell S. Sunderlin were project managers for *Relay 1* and *2*, respectively.

For further reading, see GSFC, *Final Report on the Relay I Program*, NASA SP-76 (Washington, 1965); and GSFC, *Relay Program Final Report*, NASA SP-151 (Washington, 1968).

Table 3-215.
Chronology of Relay Development and Operations

Date	Event
Nov. 21, 1960	The Unmanned Spacecraft Panel of the Aeronautics and Astronautics Coordinating Board, an interagency body, issued a "Statement on NASA Program Philosophy on Communications Satellites," in which NASA expressed its intentions to develop low-altitude active repeater satellites.
Late Nov. 1960	NASA awarded a contract to Space Technology Laboratories for a spacecraft design study of an active communications satellite system that would lead to a commercial communications satellite system.
Jan. 13, 1961	Preliminary specifications for a low-altitude communications satellite (<i>Relay</i>) were drawn up at the Goddard Space Flight Center.
Jan. 25, 1961	Industry was briefed on the requirements for Project <i>Relay</i> , and a request for quotations was issued. The project was officially named <i>Relay</i> .
Feb. 1961	NASA signed agreements with the U.K. and France to establish government programs for testing communications satellites in 1962 and 1963 (<i>Relay</i> and <i>Rebound</i>).
May 18, 1961	NASA awarded a contract to the Radio Corporation of America (RCA), Astro-Electronics Division, for the development of three <i>Relay</i> spacecraft.
Dec. 1961	The West German Post Office announced that it would construct a ground station near Munich to be used with AT&T's <i>Telstar</i> and <i>Relay</i> .
June 5, 1962	NASA announced a cooperative program for testing <i>Relay</i> and <i>Telstar</i> .
Dec. 13, 1962	<i>Relay 1</i> was launched successfully.
Jan. 21, 1964	<i>Relay 2</i> was launched successfully.
Feb. 25, 1964	Goddard recommended not launching a third <i>Relay</i> (the backup satellite); since <i>Relay 1</i> and <i>2</i> and Project <i>Syncom</i> were meeting their schedules and objectives there was no need for a third <i>Relay</i> mission.

Table 3-216.
Relay 1 (Relay A-15) Characteristics

<i>Date of launch (location):</i>	Dec. 13, 1962 (ETR)
<i>Launch vehicle:</i>	Thor-Delta
<i>Weight (kg):</i>	78
<i>Shape:</i>	8-sided prism topped by an octagonal truncated pyramid with a .46-meter mast on one end
<i>Dimensions (m):</i>	Prism maximum diameter, .74; height, .43 Pyramid height, .41 Overall height, 1.3
<i>Power source:</i>	NiCd batteries plus solar cells
<i>Date of reentry:</i>	In orbit
<i>Cognizant NASA center:</i>	GSFC
<i>Project manager:</i>	Joseph Berliner
<i>Contractor:</i>	Radio Corp. of America, Astro-Electronics Div., spacecraft fabrication
<i>Objectives:</i>	Investigate wide-band communications between intercontinental stations; develop operational experience in using active satellite communications system; measure energy particles; determine effects of energy particles and radiation on selected electronic components.
<i>Experiments, responsible institution:</i>	In addition to the microwave communications experiments: Radiation monitor, Bell Telephone Laboratories, State University of Iowa Diode damage, Bell, GSFC Solar cell damage, GSFC
<i>Results:</i>	Proved that a satellite can be used successfully as a microwave repeater; some mapping of the electron and proton fields was accomplished; conducted 2000 technical tests and 172 successful demonstrations; tests were terminated in February 1965; an initial power drain problem was overcome by ground control.

Syncom

Specialists in communications at Hughes Aircraft Company, as elsewhere, agreed that an active repeater satellite in geostationary orbit, where it was always visible to its ground stations, was highly desirable. But the California-based experts thought it could be done with the satellite technology and launch vehicles available in the early 1960s. Since the Army's large 450-kilogram Advent satellite (under development at General Electric) had already been chosen as the nation's synchronous-orbit communications satellite project, NASA officials could only listen politely to Hughes' proposal for its Syncom project in early 1960.

A task group at Hughes led by Harold A. Rosen and Donald Williams had been working on the design of Syncom since late 1958. Having sold their ambitious project to the management at Hughes, they informally approached NASA for the first time with their proposal in November 1959, and during the next two years they made repeated presentations to the civilian space agency, the Department of Defense (DoD), the President's Committee on Science, Bell Telephone Laboratories, the Stanford Research Institute, and others in an effort to gain support for their satellite. The people at Hughes believed so strongly in their proposal that they even made plans at one time to buy a Scout launch vehicle from NASA and launch their

Table 3-217.
Relay 2 (Relay-B) Characteristics

<i>Date of launch</i>	Jan. 21, 1964 (ETR)
(location):	
<i>Launch vehicle:</i>	Thor-Delta
<i>Weight (kg):</i>	85.3
<i>Shape:</i>	8-sided prism topped by an octagonal truncated pyramid with a .46-meter mast on one end
<i>Dimensions (m):</i>	Prism maximum diameter, .74; height, .43 Pyramid height, .41 Overall height, 1.3
<i>Power source:</i>	NiCd batteries plus solar cells
<i>Date of reentry:</i>	In orbit
<i>Cognizant NASA center:</i>	GSFC
<i>Project manager:</i>	Wendell S. Sunderlin
<i>Contractor:</i>	Radio Corp. of America, Astro-Electronics Div., spacecraft fabrication
<i>Objectives:</i>	Investigate wide-band communications between ground stations by means of low-altitude orbiting spacecraft; measure the effects of the space environment on the system.
<i>Experiments, responsible institution:</i>	In addition to the microwave communications experiments: Radiation damage, GSFC Proton and electron detectors, Bell Telephone Laboratories Directional and omnidirectional electron and proton detectors, University of California at La Jolla
<i>Results:</i>	Television, teletype facsimile, and digital data transmissions were made with satisfactory results; conducted more than 1500 technical tests and 95 demonstrations; retired in September 1965.

own payload from a Pacific island near the equator. By the spring of 1961, it was becoming clear to the Army that Advent was still several years away from being ready, partly due to delays with the Centaur stage of the launch vehicle, and already over budget. Meanwhile, NASA's Leonard Jaffe had become convinced that Syncom was the logical next step for the agency's communications satellite program. With President John F. Kennedy's mandate to accelerate the communications satellite program and DoD support of a NASA synchronous-orbit project, the path was cleared for Hughes. By August 1961, NASA had named Hughes its contractor for Project Syncom.

At an altitude of about 35 800 kilometers above the equator, the Syncom satellite could orbit at the same relative speed of earth, appearing to be always in one location. In this position, a single satellite could give communications coverage to approximately one-third of the globe. This altitude also would ensure that the satellite's solar cells received the sun's rays continuously. Precise spacecraft attitude control, a necessity, was achieved by spin stabilization and two attitude control jets. Another activity critical to Syncom was the development of a lightweight traveling wave tube. J. T. Mendel at Hughes was charged with designing this component, which had to weigh less than half a kilogram. DoD, taking advantage of those systems that were already being readied for Advent, offered to provide and pay for the entire ground station complex, the stations, crews, and the control center

necessary for conducting experiments with Syncom. Two 9.14-meter parabolic antennas at Lakehurst, New Jersey, and aboard the USNS *Kingsport* would intercept signals. The NASA-Hughes-DoD team was given 13 months to prepare for the first launch.

Syncom 1 with its many redundant systems was launched on February 14, 1963, by a Thor-Delta launch vehicle. The orbit planned for the first Syncom was not a truly synchronous one. Since NASA still did not have a stable of powerful launchers, the angle of orbit injection would be influenced by the location of the Eastern Test Range launch site, 30 degrees north of the equator. The satellite would appear to move about 30 degrees north, then 30 degrees south, swinging every 24 hours in a huge figure eight, the center of which would remain approximately stationary over the equator. As part of the ground station complex, the USNS *Kingsport* would be able to track the satellite through this figure-eight configuration. But the ground crew lost all contact with *Syncom 1* seconds after the satellite's apogee motor fired. Apparently, the kick of the apogee rocket knocked out the onboard electronics equipment. Consequently, NASA directed that a number of changes be made to the second spacecraft, including measures to maintain radio contact in case of main power failure. *Syncom 2*, launched in July 1963, transmitted excellent telephone, teletype, and facsimile signals, as well as video signals, even though the satellite was not designed for this particular capability. The third Syncom, the last in the series, was put into a true geostationary orbit by the more powerful Thrust-augmented Thor-Delta. It, too, operated perfectly.

By late 1964, NASA had completed its slate of tests and demonstrations with the Syncom system. Since the Army had cancelled its Project Advent in 1963, the military was interested in using Syncom for its operations in Asia. DoD communications specialists were impressed by the reliability of the system and the high-quality transmissions over long distances that a relay at synchronous altitude allowed. If the ground station complex were supplemented with highly transportable stations that could be rushed to remote isolated areas, Syncom could be very useful during military activities. On April 1, 1965, the Syncom was officially transferred to the Department of Defense.¹⁸

At NASA Headquarters, Syncom was managed from Leonard Jaffe's office by Robert E. Warren (*Syncom 1*), Joseph R. Burke (*Syncom 2*), and Henry N. Stafford (*Syncom 3*). Alton E. Jones led the Goddard Space Flight Center team during the first two missions, with Robert J. Darcey managing the third.

For more information on the background of the project, see Edgar W. Morse, "Preliminary History of the Origins of Project Syncom," NASA HNN-40, Sept. 1, 1964.

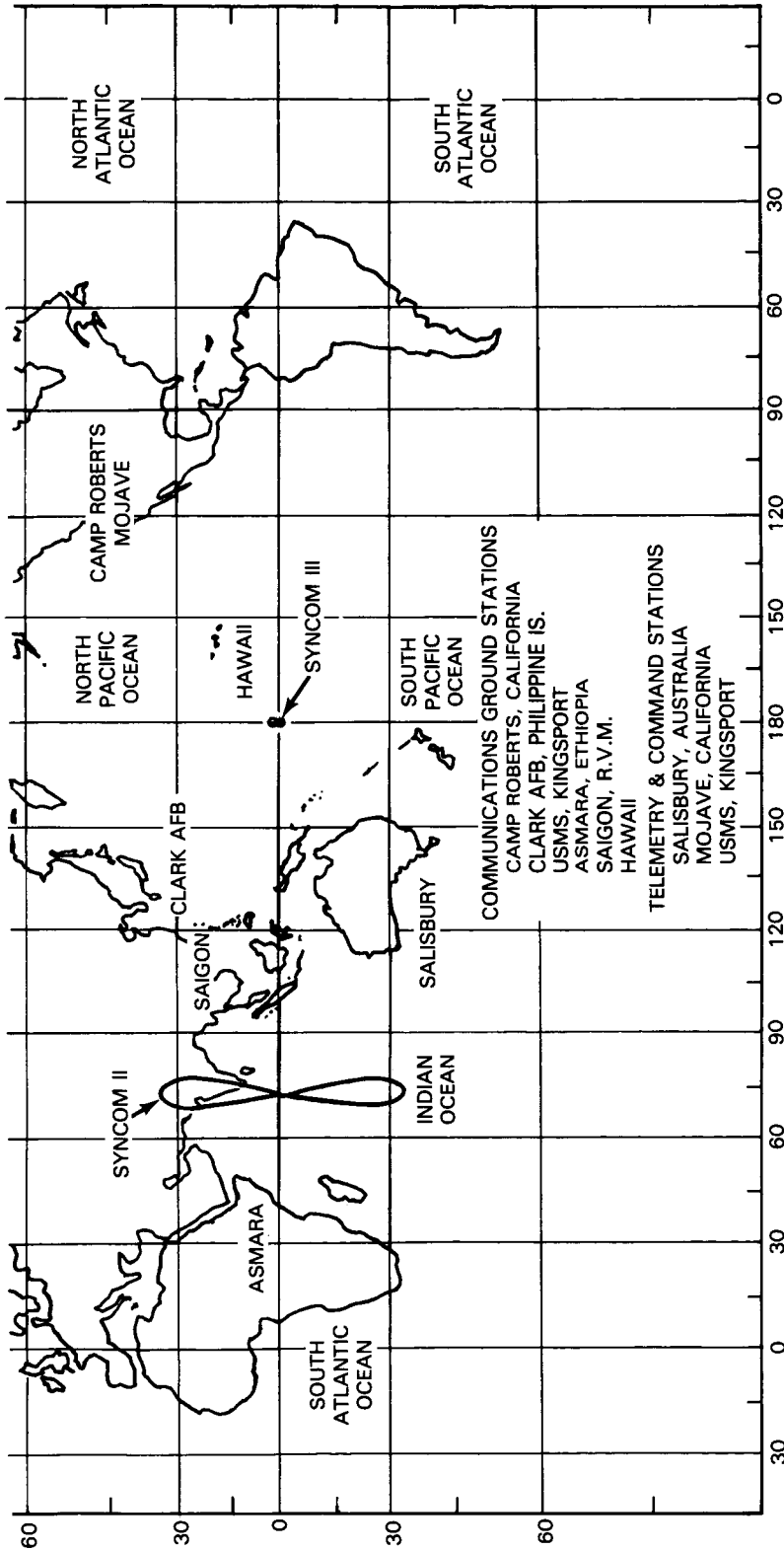

Figure 3-6. Deployment of Syncom 2 & 3 and Ground Stations

Table 3-218.
Chronology of Syncom Development and Operations

Date	Event
Late 1958	A task group led by Harold A. Rosen was established at Hughes Aircraft Company to investigate communications satellite experiments beyond the company's work on advanced radar.
1959	Rosen and Donald Williams at Hughes studied the problems associated with a synchronous-orbit active communications satellite.
Sept. 25, 1959	Hughes informally proposed its Syncom to NASA.
Feb. 4, 17, 1960	Hughes made formal presentations to NASA.
March 1, 1960	Hughes authorized its engineers to proceed with the development of Syncom without NASA's support.
April-May 1960	Hughes made Syncom presentations to the Department of Defense (DoD).
July 11, 1960	Hughes made Syncom presentations to the President's Science Advisory Committee.
Aug. 16, 1960	Hughes made another presentation to NASA, and Administrator T. Keith Glennan suggested that Hughes apply its activities to a low-altitude satellite project.
Oct.-Dec. 1960	Hughes made Syncom presentations to GT&E, Bell Telephone Laboratories, IT&T, Stanford Research Institute, Aerospace Corporation, the U.S. Air Force, and to British military and civilian delegations.
Spring 1961	Leonard Jaffe at NASA Headquarters urged agency managers to adopt a synchronous-orbit satellite.
June 23, 1961	DoD announced its support of a NASA synchronous-orbit communications satellite project.
Aug. 10, 1961	Goddard Space Flight Center personnel prepared a preliminary project development plan in coordination with the U.S. Army Advent Management Agency for a Syncom project.
Aug. 21, 1961	Hughes was named NASA contractor for Syncom.
March 1, 1962	In Senate hearings, Hughes advocated that any future public communications satellite corporation should adopt Syncom as its primary system.
Nov. 9, 1962	Hughes reported that the final assembly of the first Syncom spacecraft had been completed.
Dec. 1962	A simulated Syncom training mission was undertaken.
Jan. 1963	NASA announced that the first launch of Syncom would take place the next month.
Feb. 14, 1963	<i>Syncom 1</i> was launched successfully, but contact with the spacecraft was lost when the apogee motor was fired to place the satellite in the required orbit.
Feb. 25, 1963	NASA announced that in light of the formation of the Communications Satellite Corporation (COMSAT) and DoD's cancellation of Advent, the agency would focus its efforts on synchronous active communications satellites and cancel passive and intermediate-altitude projects.
July 26, 1963	<i>Syncom 2</i> was launched successfully.
Aug. 19, 1964	<i>Syncom 3</i> was launched successfully.
Dec. 31, 1964	NASA began the transfer of the Syncom system to DoD for use in Asia and the Indian Ocean; the transfer was completed by April 1, 1965.

Table 3-219.
Syncom 1 (Syncom-A) Characteristics

<i>Date of launch (location):</i>	Feb. 14, 1963 (ETR)
<i>Launch vehicle:</i>	Thor-Delta
<i>Weight (kg):</i>	68 (at apogee motor burnout, 39)
<i>Shape:</i>	Cylindrical (2 concentric cylinders), with an apogee motor nozzle protruding at one end
<i>Dimensions (m):</i>	.74 × .66
<i>Power source:</i>	NiCd batteries plus solar cells
<i>Date of reentry:</i>	In orbit
<i>Cognizant NASA center:</i>	GSFC
<i>Project manager:</i>	Alton Jones
<i>Contractor:</i>	Hughes Aircraft Co., spacecraft design and fabrication
<i>Objectives:</i>	Obtain experience using communications satellites in a 24-hour synchronous orbit; flight-test new techniques for satellite attitude and control; develop transportable ground facilities.
<i>Experiments, responsible institution:</i>	No scientific experiments.
<i>Results:</i>	Communication with the satellite was lost 20 seconds after the firing of the apogee rocket; it was sighted traveling in a near-synchronous orbit.

Table 3-220.
Syncom 2 (Syncom-B) Characteristics

<i>Date of launch (location):</i>	July 26, 1963 (ETR)
<i>Launch vehicle:</i>	Thor-Delta
<i>Weight (kg):</i>	66.7 (at apogee motor burnout, 39)
<i>Shape:</i>	Cylindrical (2 concentric cylinders), with an apogee motor nozzle protruding at one end
<i>Dimensions (m):</i>	.74 × .66
<i>Power source:</i>	NiCd batteries plus solar cells
<i>Date of reentry:</i>	In orbit
<i>Cognizant NASA center:</i>	GSFC
<i>Project manager:</i>	Alton Jones
<i>Contractor:</i>	Hughes Aircraft Co., spacecraft design and fabrication
<i>Objectives:</i>	Continuation of the <i>Syncom 1</i> mission.
<i>Experiments, responsible institution:</i>	No scientific experiments.
<i>Results:</i>	Orbit and attitude control achieved; data, telephone, and facsimile transmissions excellent; television video signals were also transmitted although the satellite was not designed for this capability.
<i>Remarks:</i>	Operation assumed by the Department of Defense in April 1965.

Table 3-221.
Syncom 3 (Syncom-C) Characteristics

<i>Date of launch</i> (location):	Aug. 19, 1964 (ETR)
<i>Launch vehicle:</i>	Thrust-augmented Thor-Delta
<i>Weight (kg):</i>	65.8 (at apogee motor burnout, 37.6)
<i>Shape:</i>	Cylindrical (2 concentric cylinders), with an apogee motor nozzle protruding from one end
<i>Power source:</i>	NiCd batteries plus solar cells
<i>Date of reentry:</i>	In orbit
<i>Cognizant NASA center:</i>	GSFC
<i>Project manager:</i>	Robert J. Darcey
<i>Contractor:</i>	Hughes Aircraft Co., spacecraft design and fabrication
<i>Objectives:</i>	Continuation of <i>Syncom 2</i> mission; with the added goal of placing the spacecraft into a true synchronous orbit; provide an experimental communications link between the U.S. and the Far East, as requested by DoD.
<i>Experiments, responsible institution:</i>	No scientific experiments.
<i>Results:</i>	Orbit and attitude control were achieved; the satellite was put into near-equatorial synchronous orbit; data, telephone, and facsimile transmissions were excellent; television video signals were transmitted through wide-band transponder, including coverage of the 1964 Olympic games in Tokyo.
<i>Remarks:</i>	Last of the series. Operations assumed by the Department of Defense in April 1965. See also INTELSAT and Applications Technology Satellite (ATS).

INTELSAT

In August 1962, Congress authorized the formation of the Communications Satellite Corporation (COMSAT) to manage the commercial applications of the nation's communications satellite program. By late 1963, COMSAT had issued a request for proposals to industry for an engineering design for a commercial communications satellite system. Radio Corporation of America (RCA) and Bell Telephone Laboratories were funded to study random medium-altitude satellites, TRW and ITT phased medium-altitude satellites, and Hughes Aircraft Company synchronous-orbit satellites.¹⁹

Since global communications necessarily involved many countries, the International Telecommunications Satellite Consortium (INTELSAT) was established in August 1964 to develop, implement, and operate an international communications satellite system (see fig. 3-7). Each member nation (63 members in September 1968) of INTELSAT owned an investment share of the consortium proportional to its international traffic in a global satellite system. Individual nations owned and operated their own ground stations. COMSAT, as the management and operations arm of INTELSAT, continued with its plans for a family of commercial satellites. NASA's part in this scheme was a critical but limited one: the agency would launch the communications payloads on a reimbursable basis.

As a result of its work on the NASA-managed Project Syncom, Hughes was able to submit a sophisticated proposal for COMSAT's first synchronous-orbit spacecraft. Called *INTELSAT I* (also *Early Bird*), the 38-kilogram satellite could maintain 240 two-way telephone circuits, but from only two stations at a time. *INTELSAT I*, launched on April 6, 1965, was used for over 3½ years (spacecraft estimated lifetime had been 18 months). The next step in the INTELSAT series called for a larger, more powerful spacecraft with a wider band width capable of providing coverage over a greater area. Multiple-access capability was also introduced; each spacecraft transponder carried four 6-watt traveling wave tubes that could operate simultaneously. The first of four INTELSAT II satellites was launched in October 1966. A third series, built by TRW, was even larger. Each of three INTELSAT III satellites had a nominal capability of 1200 telephone circuits, obtained by using a new antenna system. While the spacecraft body was spinning, its antenna was despun to point always at earth. The first of this series was launched in September 1968. With three spacecraft operating above the Pacific, the Atlantic, and the Indian Oceans, a truly global communications system was an accomplished fact by 1969 (see fig. 3-8). A fourth model of the INTELSAT spacecraft was being planned for the 1970s (see fig. 3-9 for a comparison of the different INTELSAT spacecraft).²⁰

NASA's activities were limited to launching and initial tracking operations. J. J. Kelleher managed the *Early Bird* launch for NASA Headquarters, and Wayne C. Mathews served as program manager for the INTELSAT II series. Jerome Friebaum assumed this post in June 1968. At the Goddard Space Flight Center, Charles P. Smith was project manager.

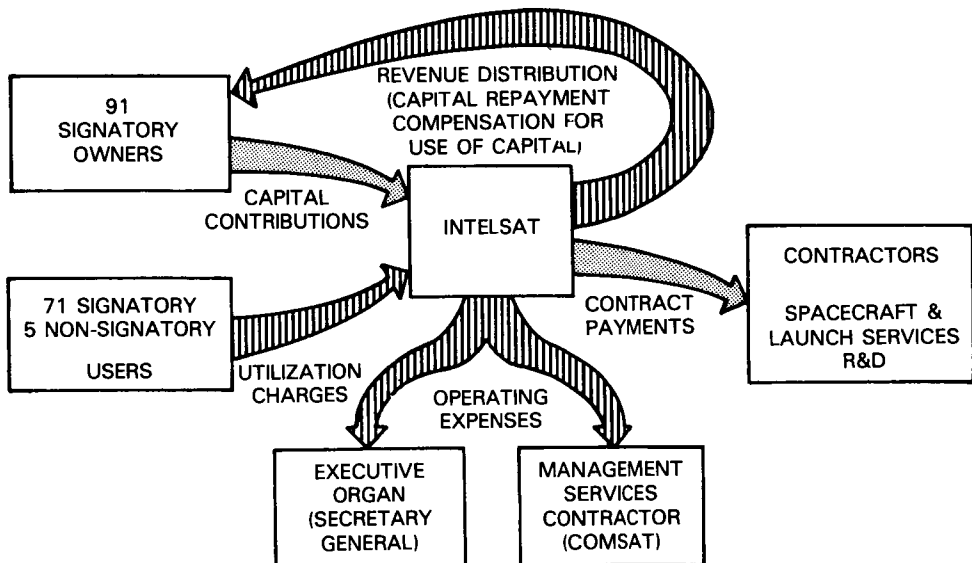

Figure 3-7. International Telecommunications Satellite Organization (INTELSAT) financial arrangements, simplified cash flow diagram, as of 1975.

APPENDIX B
THE INTELSAT SYSTEM

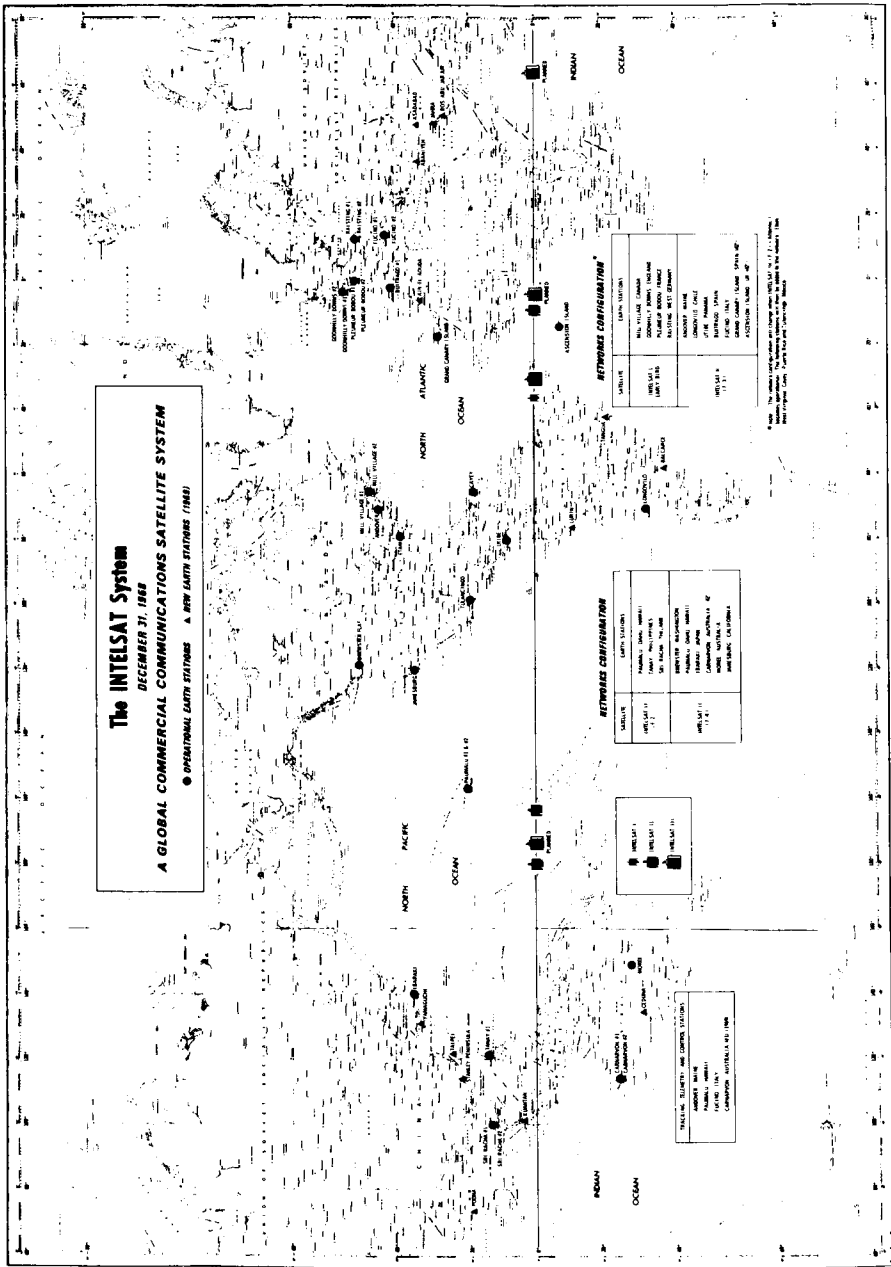

Figure 3-8. The Intelsat System





		INTELSAT I	INTELSAT II	INTELSAT III	INTELSAT IV	INTELSAT IVA
						
YR OF 1st LAUNCH		1965	1967	1968	1971	1975
DIMENSIONS (cm)	DIA	72.1	142	142	238	238
	HGHT	59.6	67.3	104	282 (DRUM)	282 (DRUM)
					528 (OVERALL)	590 (OVERALL)
MASS (kg)	AT LAUNCH	68	162	293	1385	1469
	IN ORBIT	38	86	152	700	790
LAUNCH VEHICLE		THOR-DELTA	IMPROVED THOR-DELTA	LONG-TANK THOR-DELTA	ATLAS/CENTAUR	ATLAS/CENTAUR
PRIMARY POWER (W)		40	75	120	400	500
TRANSPONDERS		2	1	2	12	20
BW/TRANSPONDER (MHz)		25	130	225	36	32-26
ANTENNA		OMNI-SQUINTED	OMNI	DESPUN	DESPUN	DESPUN
COVERAGE		N. HEMISPHERE	GLOBAL	GLOBAL	GLOBAL & SPOT BEAMS	GLOBAL & HEMI BEAMS
e.i.r.p./BEAM (dBW)		11.5	15.5	23	22.5 (GLOBAL)	22 (GLOBAL)
					33.7 (SPOT BEAM)	29 (HEMI BEAM)
NO. OF TEL. CIRCUITS		240 (NO MULT. ACCESS)	240	1200	4000	6000
DESIGN LIFETIME (YR)		1.5	3	5	7	7
COST/CIRCUIT YEAR (\$000)		30	10	2	1	1

Figure 3-9. Evolution of the INTELSAT family of communications satellites.

From B.I. Edelson, H.W. Wood, and C.J. Reber, "Cost Effectiveness in Global Satellite Communications," paper, International Astronautical Federation 26th Congress, Sept. 21-27, 1975, p. 3.

Table 3-222.
Chronology of INTELSAT Development and Operations

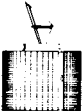
Date	Event
Aug. 31, 1962	The Communications Satellite Corporation (COMSAT) was authorized by Congress.
Feb. 1, 1963	COMSAT Corp. was incorporated.
Dec. 22, 1963	COMSAT issued a request for proposals for an engineering design study for a commercial communications satellite system.
Dec. 1963	Hughes Aircraft Co. submitted a proposal to COMSAT for the development of an initial communications satellite for commercial use (synchronous orbit).
March 1964	COMSAT awarded Hughes a contract for the development and fabrication of the proposed Early Bird experimental operational communications satellite.
July 1964	Satellite design studies were begun by the Radio Corporation of America (RCA) and Bell Telephone Laboratories (random medium-altitude satellites), TRW and ITT (phased medium-altitude satellites), and Hughes (synchronous-orbit satellites) for COMSAT; reports were due on March 1, 1965.
Aug. 20, 1964	The International Telecommunications Satellite Consortium (INTELSAT) was established, of which COMSAT was the management services-operations arm.
Nov. 1964	Six companies submitted proposals for COMSAT ground stations.
Dec. 1964	NASA and COMSAT signed a formal agreement outlining their cooperation on a satellite project, with an initial launch planned for March 1965.
April 6, 1965	<i>INTELSAT I (Early Bird)</i> was launched successfully.
Sept. 30, 1965	COMSAT asked the Federal Communications Commission for authority to fund four new satellites to provide private communications services and to support NASA's Project Apollo.
Dec. 16, 1965	COMSAT and TRW opened negotiations for a contract that called for the development and fabrication of a second-generation satellite to be used in a global communications satellite system.
Dec. 29, 1965	COMSAT issued a request for design study proposals for a multipurpose communications-navigation satellite.
July 1966	NASA and COMSAT reached an agreement on the launching of two more INTELSAT satellites.
Oct. 22, 1966	<i>INTELSAT II-A</i> was launched, but it failed to achieve synchronous orbit, limiting the spacecraft's usefulness.
Jan. 11, 1967	<i>INTELSAT II-B</i> was launched successfully.
March 22, 1967	<i>INTELSAT II-C</i> was launched successfully.
Sept. 27, 1967	<i>INTELSAT II-D</i> was launched successfully.

Table 3-222.
Chronology of INTELSAT Development and Operations (Continued)

Date	Event
Feb. 1968	COMSAT opened bids for the design of INTELSATS III, IV, and V.
April 1968	COMSAT reopened bidding on a proposed INTELSAT III½, designed to supplement the INTELSAT III system until the advanced INTELSAT IV was ready. Hughes, Lockheed, and TRW bid on INTELSAT IV.
Sept. 18, 1968	The launch of <i>INTELSAT III F-1</i> was unsuccessful because the launch vehicle failed; the spacecraft and launch vehicle were destroyed.
Oct. 4, 1968	A contract between COMSAT and Hughes for the INTELSAT IV series was approved by INTELSAT.
Dec. 18, 1968	<i>INTELSAT III F-2</i> was launched successfully.

Table 3-223.
INTELSAT I Characteristics

<i>Date of launch (location):</i>	April 6, 1965 (ETR)
<i>Launch vehicle:</i>	Thrust-augmented Thor-Delta
<i>Weight (kg):</i>	68 in orbit
<i>Shape:</i>	Cylindrical
<i>Dimensions (m):</i>	.72 × .6
<i>Power source:</i>	NiCd batteries plus solar cells
<i>Date of reentry:</i>	In orbit
<i>Cognizant NASA center:</i>	GSFC
<i>Project manager:</i>	Charles P. Smith
<i>Contractor:</i>	Hughes Aircraft Co. for COMSAT (who represented INTELSAT)
<i>Objectives:</i>	Establish a commercial communications system.
<i>Experiments, responsible institution:</i>	No scientific experiments.
<i>Results:</i>	Went into commercial operation on June 28, linking North America and Europe; transmitted telephone, color and black and white television, teletype, and facsimile signals; used for four years.
<i>Remarks:</i>	NASA provided launching, initial tracking, and associated services on a reimbursable basis; satellite operation was the responsibility of COMSAT. Also called <i>Early Bird</i> .

Table 3-224.
INTELSAT II-A Characteristics

<i>Date of launch</i>	Oct. 26, 1966 (ETR)
(location):	
<i>Launch vehicle:</i>	Thrust-augmented Improved Thor-Delta (TAID)
<i>Weight (kg):</i>	87.1 in orbit (162.2 at launch)
<i>Shape:</i>	Cylindrical
<i>Dimensions (m):</i>	1.42 × .67
<i>Power source:</i>	NiCd batteries plus solar cells
<i>Date of reentry:</i>	In orbit
<i>Cognizant NASA center:</i>	GSFC
<i>Project manager:</i>	Charles P. Smith
<i>Contractor:</i>	Hughes Aircraft Co. for COMSAT (who represented INTELSAT)
<i>Objectives:</i>	Commercial communications; Pacific link.
<i>Experiments, responsible institution:</i>	No scientific experiments.
<i>Results:</i>	Satellite failed to achieve synchronous orbit due to a malfunction of the apogee kick motor, which limited use to approximately 8 hours daily. Capable of handling television data transmissions or up to 240 voice channels; part of its capacity was purchased by NASA for Apollo support.
<i>Remarks:</i>	NASA provided launching, initial tracking, and associated services on a reimbursable basis; satellite operation was the responsibility of COMSAT. Also called <i>Lani Bird</i> .

Table 3-225.
INTELSAT II-B Characteristics

<i>Date of launch</i>	Jan. 11, 1967 (ETR)
(location):	
<i>Date of reentry:</i>	In orbit
<i>Objectives:</i>	Commercial communications; Pacific link.
<i>Results:</i>	Placed in geosynchronous orbit over the Pacific; used for Apollo support.
<i>Remarks:</i>	NASA provided launching, initial tracking, and associated services on a reimbursable basis. See table 3-224 for spacecraft description.

Table 3-226.
INTELSAT II-C Characteristics

<i>Date of launch</i>	March 22, 1967 (ETR)
(location):	
<i>Date of reentry:</i>	In orbit
<i>Objectives:</i>	Commercial communications; Atlantic link.
<i>Results:</i>	Placed in geosynchronous orbit over Atlantic.
<i>Remarks:</i>	NASA provided launching, initial tracking, and associated services on a reimbursable basis. Also called <i>Atlantic 2</i> . See table 3-224 for spacecraft description.

Table 3-227.
INTELSAT II-D Characteristics

<i>Date of launch</i> (location):	Sept. 27, 1967 (ETR)
<i>Date of reentry:</i>	In orbit
<i>Objectives:</i>	Commercial communications; Pacific link.
<i>Results:</i>	Placed in geosynchronous orbit over Pacific.
<i>Remarks:</i>	NASA provided launching, initial tracking, and associated services on a reimbursable basis. Also called <i>Pacific 2</i> . See table 3-224 for spacecraft description.

Table 3-228.
INTELSAT III F-1 Characteristics

<i>Date of launch</i> (location):	Sept. 18, 1968 (ETR)
<i>Launch vehicle:</i>	Long-tank Thrust-augmented Thor-Delta
<i>Weight (kg):</i>	146.1 in orbit (286.7 at launch)
<i>Shape:</i>	Cylindrical
<i>Dimensions (m):</i>	1.42 × 1.04 Overall height with antennas, 1.98
<i>Power source:</i>	NiCd batteries plus solar cells
<i>Date of reentry:</i>	Spacecraft destroyed
<i>Cognizant NASA center:</i>	GSFC
<i>Project manager:</i>	Charles P. Smith
<i>Contractor:</i>	TRW Systems Group, TRW, Inc., for COMSAT (who represented INTELSAT)
<i>Objectives:</i>	Commercial communications; Atlantic link.
<i>Experiments responsible institution:</i>	No scientific experiments.
<i>Results:</i>	When the launch vehicle control system malfunctioned, the entire vehicle was destroyed by the range officer.
<i>Remarks:</i>	NASA provided launching and associated services on a reimbursable basis. An earlier designation for this satellite was INTELSAT III-A.

Table 3-229.
INTELSAT III F-2 Characteristics

<i>Date of launch</i> (location):	Dec. 18, 1968 (ETR)
<i>Date of reentry:</i>	In orbit
<i>Objectives:</i>	Commercial communications; Atlantic link.
<i>Results:</i>	Placed in geosynchronous orbit over Atlantic; capacity of 1200 telephone circuits.
<i>Remarks:</i>	NASA provided launching, initial tracking, and associated services on a reimbursable basis. See table 3-228 for spacecraft description.

DESCRIPTION – APPLICATIONS TECHNOLOGY SATELLITE (ATS) PROGRAM

Shortly after the Syncom project was approved by NASA, designers at Hughes Aircraft Company began investigating ways in which the basic configuration might be exploited in the future. Officials at Goddard Space Flight Center were enthusiastic about expanding the capabilities of this yet-to-be-tried synchronous-orbit satellite to include a multiple communications access capability between fixed points and a phased-array antenna. NASA Headquarters approved a feasibility study for such a spacecraft in 1962. Early the following year, Hughes personnel were anxious for the agency to sanction an Advanced Syncom flight project, but their proposals were poorly timed. Heated debates were raging in Congress during FY 1964 budget appropriations hearings over NASA's relations with the newly organized Communications Satellite Corporation (COMSAT), which had been charged by Congress to establish a commercial operational communications network. Some members of Congress believed that the privately-run COMSAT, which seemingly had a monopoly in the communications satellite field, would be the sole benefactor of NASA's advanced research and development communications projects; as they saw it the government space agency would be subsidizing a private corporation. NASA countered that its mandate was to further the state of the art; the agency had no intentions of getting into the "communications satellite business." NASA's authorization for Advanced Syncom was \$7 million less than the request, and managers at Headquarters decided to avoid future open criticism by dropping their plans for an advanced communications flight project.

Advanced Syncom, however, was a sound design, and specialists at Hughes, Goddard, and NASA Headquarters sought ways to integrate their ideas for communications, meteorology, and navigation-traffic control satellites into a single package that could be carried on one spacecraft. In February 1964, NASA officials signed off on a project approval document for an Advanced Technological Satellite, which was renamed Applications Technology Satellite (ATS) that spring. The Department of Defense (DOD) also played a part in influencing NASA to redirect its plans from a synchronous-orbit communications satellite to a multipurpose project. Military officials had become convinced that Syncom, while highly useful, was also very vulnerable; feasibly it could be maneuvered, interfered with, or put out of commission by an enemy ground station. For more secure communications, the military planned some 60 randomly spaced medium-altitude satellites. DoD specialists also were interested in an experimental gravity-gradient stabilized spacecraft, one plane of which would always face earth; and the military suggested that NASA explore this area of spacecraft design.*

In May 1964, Hughes was instructed to build five Applications Technology Satellites, which would accommodate a variety of communications, meteorology, and

*A gravity-gradient stabilized spacecraft required long booms attached to a main body that would respond to earth's gravitational pull. Those booms nearest earth would tend to remain pointed at earth since the gravity exerted on them would be slightly greater than that exerted on the booms most distant from earth. This would keep the spacecraft fixed with one plane always facing earth, another always facing away.

scientific experiments. General Electric set to work designing a gravity-gradient system, and NASA sent letters to over 1000 prospective investigators explaining the multiple opportunities afforded them by ATS. The next two years saw the first spacecraft readied for launch, more than 60 investigations chosen for flight (see table 3-230), and the fabrication of experiment hardware by Control Data Corporation, Philco, and Bell Aerospace. NASA's Lewis Research Center was contributing a small ion engine that was to be tested for stationkeeping maneuvers, and the Jet Propulsion Laboratory was supplying the apogee motors for ATS as it had for the Syncom satellites. Ground stations were readied at Rosman, North Carolina, and in California's Mojave Desert. Sylvania was chosen to build a transportable ground system, which would be used in Toowoomba, Australia.²¹

ATS 1, launched in December 1966, was put into synchronous orbit over the equator (Pacific). Equipped with a collection of environmental measurement devices, communications hardware (VHF, FM, and microwave), and cameras for collecting weather data (including a joint NASA-Environmental Science Services Administration experiment), the first ATS performed all its operations successfully. More than 10 years later, it and *ATS 3* were still being used for a variety of applications tasks, including transmitting medical data for isolated patients, supporting manned spaceflight activities (in the late 1960s), and providing communications links in emergency situations. *ATS 3*, launched in November 1967, carried a payload similar to that of *ATS 1* into synchronous orbit over the Atlantic. It returned excellent high-resolution photographs along with other data. A gravity-gradient stabilization system and an experiment sponsored by DoD to measure albedo and electromagnetic radiation were first included on *ATS 2*, but a launch vehicle malfunction prevented that spacecraft from obtaining the proper orbit. *ATS 4*, similarly configured, likewise suffered launch vehicle failure and did not achieve orbit. Ground controllers were able to test-fire the new ion engine included in a payload for the first time on *ATS 4* before the spacecraft reentered the atmosphere. Unexpectedly during the 1969 flight of *ATS 5*, large amounts of spacecraft fuel were expended to stabilize the satellite in its parking orbit. Fearing they would have trouble controlling the satellite, the flight team inserted it into synchronous orbit at the very first opportunity, rather than waiting for the planned orbit insertion. The spacecraft continued to tumble, however, jeopardizing some of the primary experiments. Although the first series of five Application Technology Satellites was fraught with launch vehicle and attitude control problems, the spacecraft itself was judged highly successful. *ATS 1* and *3* outlasted their planned operations schedule several times and, as noted above, were used for a number of purposes that were not anticipated at the time of the project's initiation. *ATS 1* and *3* also have been moved many times to provide services to several areas of the globe. A second-generation ATS was on the drawing boards as early as 1964.

When Joseph R. Burke joined NASA Headquarters in 1961, he was assigned to the Syncom and advanced Syncom projects. He was a natural candidate for ATS program manager and served in that position through the first ATS flight series. At the Goddard Space Flight Center, Robert J. Darcey, a member of the center's Syncom team, was project manager for the first three missions. By the time *ATS 4* was launched, he had become chief of Goddard's ATS office; Don V. Fordyce was project manager for ATS-D and ATS-E.

The first series of Applications Technology Satellites made it clear to Govern-

ment agencies and private concerns that funding space research and development projects could be a wise investment. Benefits more immediately tangible than national prestige and scientific discoveries could be realized in several fields from a multipurpose satellite. Accurate weather forecasting, studies of water resources, forests and land use, precise positioning of air and water vessels for navigation and traffic control, television broadcasting, point-to-point communications, geodesy, cartography—all these areas would gain from NASA's early experiences with the Applications Technology Satellite.

Table 3-230.
Applications Technology Satellite Experiments

EXPERIMENT	SPACECRAFT				
	A	B	C	D	E
Microwave Communications	X	X	X	X	X
VHF Communications		X	X		
WEFAX (see also meteorology experiments)					
Ground to Aircraft					
Propagational Effect of VHF					
Navigational Systems					
STADAN Calibration					
Millimeter Wave Communications					X
Meteorological Experiments					
Spin Scan Cloud Cover Experiment (SSCCE)					
Black and White		X			
Color			X		
Advanced Videcon Camera System (AVCS)	X				
WEFAX		X	X		
Image Dissector Camera System (IDCS)			X		
OMEGA Position Location Experiment (OPLE)			X		
Image Orthicon Day/Night Camera				X	
Gravity Gradient	X			X	X
Antenna					
Phased Array		X			
Mechanically Despun			X		
Nutation Sensor		X	X		
Subliming Solid Jet	X			X	X
Hydrazine Rocket			X	X	X
Resistojet		X	X	X	X
Ion Engine				X	X
Reflectometer			X		
Self-Contained Navigation System			X		
Environmental Measurements Experiments					
Omnidirectional Particle Telescope (UCSD)	X				X
Omnidirectional Particle Telescope (Aerospace)		X			
Particle Detector (BTL)	X				
Proton/Electron Spectrometer (U. of Minn.)	X				
Solar Cell Damage (GSFC—Dr. Waddel)	X	X			
Thermal Coatings (GSFC—J. Triolo)	X	X			
Ion Detector (Rice Univ.)		X			
Magnetometer (UCLA)		X			
VLF Detector (BTL)	X				
Cosmic Radio Noise (GSFC—Dr. Stone)	X				X
Electric Field Measuremet (GSFC—Dr. Aggson)	X				X
Trapped Radiation Detector (UCB)					X
Proton/Electron Detector (Lockheed)					X
Spacecraft Charge Measurement (GSFC—Dr. Aggson)				X	X

From Gilbert D. Bullock, comp. and ed., "ATS Program Summary," rev. April 1968, p. 12.

BTL = Bell Telephone Laboratories
 STADAN = Satellite Tracking and Data Acquisition Network
 UCB = University of California at Berkeley
 UCSD = University of California at San Diego
 WEFAX = Weather facsimile

Table 3-231.
Chronology of Applications Technology
Satellite (ATS) Development and Operations

Date	Event
Oct.-Nov. 1961	Hughes Aircraft Company personnel began investigating ways to improve the existing configuration of Syncom.
Feb. 1962	Hughes proposed an advanced Syncom to NASA Headquarters and Goddard Space Flight Center personnel.
June 1962	A project development plan for an advanced stationary communications satellite was prepared at Goddard.
June 18, 1962	A project approval document was issued for the study of an advanced synchronous-orbit satellite. Hughes was selected to prepare a feasibility study for an advanced Syncom.
Feb. 14, 1963	<i>Syncom 1</i> went silent shortly after its apogee motor was fired.
March 8, 1963	Hughes presented plans to NASA Headquarters for an advanced Syncom flight program, with the first launch scheduled for the second half of 1964.
Spring 1963	Congressional debates took place over the relationship between NASA's communications research and development program and the Communications Satellite Corp. (COMSAT).
April 1, 1963	Leonard Jaffe testified at congressional hearings that NASA was interested in using an advanced synchronous-orbit satellite to accomplish communications and meteorology tasks.
May 1963	Hughes's design study contract for advanced Syncom was extended through August; in June it was extended again until October.
June 27, 1963	Hughes proposed an intermediate Syncom.
July 26, 1963	<i>Syncom 2</i> was launched successfully, and the feasibility of the basic spacecraft demonstrated.
Sept. 1963	Goddard supported an advanced Syncom in recommendations to Headquarters.
Fall 1963	NASA terminated its plans for an advanced Syncom flight project, and personnel at Goddard, Headquarters, and Hughes studied ways to reorient the advanced Syncom design to include more areas of research.
Nov. 1, 1963	A four-month feasibility study for integrating requirements for several areas of research into one flight program was started at Hughes; advanced Syncom came to be called Advanced Technological Satellite.
Feb. 13, 1964	A project approval document for Advanced Technological Satellite was issued.
May 1964	The program was unofficially renamed Applications Technology Satellite (ATS).
May 13, 1964	A NASA letter contract was issued to Hughes for development and fabrication of the ATS spacecraft.
May 14, 1964	General Electric was selected to design and build a gravity-gradient stabilization system for ATS.
June 26, 1964	NASA issued a request for proposals from scientists for experiments to be carried on five ATS spacecraft (a second request to industry was issued in September).
Aug. 19, 1964	<i>Syncom 3</i> was launched successfully.
Aug. 1964	Goddard personnel submitted a proposed procurement plan for an advanced ATS to NASA Headquarters.
Oct. 4, 1964	The name Applications Technology Satellite was officially approved.
Aug. 11, 1965	Control Data Corp., Philco, Bell Aerospace, and Electro-Optical Systems, Inc., were selected by NASA to prepare feasibility studies for ATS experiment hardware.
Aug. 25, 1965	Sylvania was chosen to build a transportable ground system for ATS.
Sept. 1965	NASA issued a request for proposals for a second-generation ATS.

Table 3-231.
Chronology of Applications Technology
Satellite (ATS) Development and Operations (Continued)

Date	Event
March 1, 1966	GE, Fairchild-Hiller, and Lockheed were selected to receive six-month feasibility design study contracts for a second-generation ATS. Studies were to be completed in December.
Dec. 6, 1966	<i>ATS 1</i> was launched successfully.
April 5, 1967	The launch of <i>ATS 2</i> was unsuccessful because the second stage of the launch vehicle malfunctioned; the satellite was not put into the correct orbit.
Nov. 5, 1967	<i>ATS 3</i> was launched successfully.
May 22, 1968	NASA selected Fairchild-Hiller, GE, and Lockheed for competitive contract negotiations to develop spacecraft designs for ATS-F and ATS-G.
Aug. 10, 1968	The launch of <i>ATS 4</i> was unsuccessful because the Centaur stage of the launch vehicle failed; the satellite was not injected into the required orbit.
Aug. 12, 1968	An <i>ATS 4</i> failure review board was established by NASA's Office of Space Science and Applications.
Summer 1968	The National Academy of Sciences-National Research Council conducted a space applications summer study.

Table 3-232.
ATS 1 (ATS-B) Characteristics

<i>Date of launch (location):</i>	Dec. 6, 1966 (ETR)
<i>Launch vehicle:</i>	Atlas-Agena D
<i>Weight (kg):</i>	351.5 in orbit (737.1 at launch including adapter)
<i>Shape:</i>	Cylindrical
<i>Dimensions (m):</i>	1.47 × 1.52
<i>Power source:</i>	NiCd batteries plus solar cells
<i>Date of reentry:</i>	In orbit
<i>Cognizant NASA center:</i>	GSFC
<i>Project manager:</i>	Robert J. Darcey
<i>Contractor:</i>	Hughes Aircraft Co., spacecraft design and fabrication
<i>Objectives:</i>	Conduct a variety of experiments on a spin-stabilized spacecraft in geostationary orbit.
<i>Experiments responsible institution:</i>	See table 3-230.
<i>Results:</i>	Placed into synchronous orbit over the equator (Pacific); the 15 experiments (meteorology, communications, and control technology) all operated successfully; still in operation more than 10 years later.

Table 3-233.
 ATS 2 (ATS-A) Characteristics

<i>Date of launch (location):</i>	April 5, 1967 (ETR)
<i>Launch vehicle:</i>	Atlas-Agena D
<i>Weight (kg):</i>	323.4 in orbit (369.9 at launch)
<i>Shape:</i>	Cylindrical with 2 long booms and 2 solar panels
<i>Dimensions (m):</i>	1.83 × 1.42
	Overall length with booms extended, 76.81
<i>Power source:</i>	NiCd batteries plus solar cells
<i>Date of reentry:</i>	Sept. 2, 1968
<i>Cognizant NASA center:</i>	GSFC
<i>Project manager:</i>	Robert J. Darcey
<i>Contractor:</i>	Hughes Aircraft Co., spacecraft design and fabrication
<i>Objectives:</i>	Evaluate gravity-gradient system for spacecraft stabilization; evaluate simultaneous transmission of voice, television, telegraph, and digital data; evaluate using gravity-gradient satellite for meteorology applications; obtain data on earth's albedo and electromagnetic radiation in space (DoD).
<i>Experiments responsible institution:</i>	See table 3-230.
<i>Results:</i>	Because the launch vehicle's second stage engine malfunctioned, the spacecraft was not inserted into a circular orbit; some experiments returned data, but the mission was judged unsuccessful.

Table 3-234.
 ATS 3 (ATS-C) Characteristics

<i>Date of launch (location):</i>	Nov. 5, 1967 (ETR)
<i>Launch vehicle:</i>	Atlas-Agena D
<i>Weight (kg):</i>	362 in orbit (714 at launch)
<i>Shape:</i>	Cylindrical
<i>Dimensions (m):</i>	1.47 × 1.37
<i>Power source:</i>	NiCd batteries plus solar cells
<i>Date of reentry:</i>	In orbit
<i>Cognizant NASA center:</i>	GSFC
<i>Project manager:</i>	Robert J. Darcey
<i>Contractor:</i>	Hughes Aircraft Co., spacecraft design and fabrication
<i>Objectives:</i>	In near-stationary equatorial orbit, perform communications, meteorology, stabilization and pointing technology, orbital technology, and space environmental degradation experiments.
<i>Experiments responsible institution:</i>	See table 3-230.
<i>Results:</i>	Transmitted excellent high-resolution photographs and other data as planned; put into synchronous orbit over the Atlantic; still in use more than 10 years later.

Table 3-235.
ATS 4 (ATS-D) Characteristics

<i>Date of launch</i> (location):	Aug. 10, 1968 (ETR)
<i>Launch vehicle:</i>	Atlas-Centaur
<i>Weight (kg):</i>	385.4 in orbit (834.6 at launch with adapter)
<i>Shape:</i>	Cylindrical with 2 long booms and 2 solar panels
<i>Dimensions (m):</i>	1.83 × 1.42 Overall length with booms extended, 76.81
<i>Power source:</i>	NiCd batteries plus solar cells
<i>Date of reentry:</i>	Oct. 17, 1968
<i>Cognizant NASA center:</i>	GSFC
<i>Project manager:</i>	Don V. Fordyce
<i>Contractor:</i>	Hughes Aircraft Co., spacecraft design and fabrication
<i>Objectives:</i>	Evaluate gravity-gradient stabilization system; evaluate a day-night camera system for meteorology; transmit simultaneous voice, television (black and white and color), telegraph, and digital signals; test ion engine for in-orbit stationkeeping maneuvers; evaluate additional ground station at the Radio Research Laboratory, Kashima, Japan.
<i>Experiments, responsible institution:</i>	See table 3-230.
<i>Results:</i>	Because the Centaur stage failed to ignite, the spacecraft did not reach the desired orbit; the cesium propellant ion engines were tested successfully.

DESCRIPTION – GEODETIC INVESTIGATIONS

Satellites are also a useful research tool for geodesists. By coordinating tracking data collected on a global scale, specialists can determine the exact positions of particular points on earth's surface, the exact shape of the planet, and the locations where the gravitational field is anomalous. This information gives cartographers the many reference points required to prepare a 1:25 000 scale map of the planet. Such precise measurements also are necessary to calculate launch trajectories. In addition, geologists can profit from information on deviations from the normal pull of gravity; such anomalies hint at what kind of materials lay beneath the earth's crust.

In 1965, NASA established a National Geodetic Satellite Program to coordinate the activities of those government agencies (namely NASA, the Department of Defense, and the Department of Commerce) that required geodetic data and the several groups working in the field (the National Geodetic Survey, Ohio State University, the Smithsonian Astrophysical Observatory, and the European Satellite Triangulation Network among others). NASA's Goddard Space Flight Center with its tracking and data acquisition facilities was assigned a major responsibility for the agency's part in the national program. Jerome D. Rosenberg, who directed the national effort, was also geodetic satellites program manager at NASA Headquarters.

Vanguard 1 provided the first geodetic data for investigators in the U.S., when analysis of its orbit indicated that earth's equatorial bulge was not quite as large as previously calculated and that the southern hemisphere was flatter than the northern half. This gives earth its pear shape. Although tracking data from all orbital

spaceflights are applicable to the geodesist's mission, NASA devoted three flight projects exclusively to geodesy investigations—two Explorers and a passive balloon project. *Explorer 29* and *Explorer 36* (also called *GEOS 1* and *GEOS 2*) were equipped with flashing light beacons and radio equipment by which to track them (see tables 3-94, 3-101). *PAGEOS 1*, passive like the Echo balloons, was tracked optically by stations around the world (table 3-137). The Explorer satellites helped geodesists define earth's gravity and pinpoint the magnitude and location of significant irregularities, improve tracking capabilities, and more accurately determine datum points. By simultaneously photographing the light source provided by the passive *PAGEOS 1* with two or more widely separated ground-based cameras, specialists determined the relative spatial coordinates of each camera position. It took five years to collect enough data to provide a purely geometric determination of the planet's shape. In addition to geometric and gravimetric applications, information gathered by geodetic satellites was also useful to scientists working in the fields of earth geophysics and geology, meteorology and aeronomy, space dynamics and astronomy, and oceanography. For example, such data were helpful in determining continental drift, ice motion in Antarctica and Greenland, and snow and ice accumulation. Additionally, the findings were used to select the best sites for deep-space-probe tracking stations.

For a detailed report on the subject, see S. W. Henriksen, ed., *National Geodetic Satellite Program: A Report Compiled and Edited for NASA by the American Geophysical Union*, 2 pts., NASA SP-365 (Washington, 1977).



CHAPTER FOUR

**ADVANCED RESEARCH
AND TECHNOLOGY**

CHAPTER FOUR

ADVANCED RESEARCH AND TECHNOLOGY

More than any other directorate, NASA's advanced research and technology arm was tailored after a pattern established by the National Advisory Committee for Aeronautics (NACA). Although NASA's research agenda necessarily emphasized those problems posed by spaceflight, the agency also was charged with continuing the role NACA had played for 43 years in the field of aeronautics. Congress had approved NACA's formation in 1915 to address a variety of problems that the airplane and its new technology had brought to the military, the fledgling aviation industry, and the increasing number of civilian users of aircraft. From an advisory body that was limited to proffering opinions on such policy matters as licensing agreements and civil aviation legislation and to coordinating the research efforts and requirements of others, NACA had evolved into a national research organization with its own aeronautical laboratory by 1920. Sharing the fundamental work of "uncovering the basic, underlying, scientific principles applicable to all kinds of aviation" with the National Bureau of Standards, subcommittees within NACA claimed responsibility for various research topics—powerplants for aircraft, aerodynamics, materials and structures, aircraft construction, and operating problems—with aerodynamics and wind tunnel research being NACA's major field of interest for several decades.¹ In the mid-1940s, the Pilotless Aircraft Research Division at NACA's Langley Memorial Aeronautical Laboratory expanded its duties to include the study of guided missiles and rockets.* By the time its functions were assumed by the National Aeronautics and Space Administration in 1958, NACA was conducting a wide variety of research at four centers across the country.†

Certainly harder to define and usually less visible than the activities of NASA's manned program or of the space science and applications program, the basic and applied research conducted under the auspices of the agency's Office of Advanced Research and Technology (OART) was equally important. Without it, NASA specialists could not have provided in a timely fashion the advanced electronic equipment, engines, attitude control devices, and related items for the sophisticated missions NASA conducted during its first decade. Basic research (that which had no application to any specific mission and ranged from very fundamental studies into

*Through its Research and Development Board, the military assumed major responsibility for the new field of missiles and rockets and for nuclear propulsion and supersonic flight.

† For more information on NACA, see Alex Roland, *Model Research: A History of the National Advisory Committee for Aeronautics, 1915-1958*, NASA SP-4103 (Washington, 1985).

the nature and properties of atoms to the analysis of different metals suitable for the wings of supersonic aircraft) and applied research (mission oriented) necessarily preceded the construction of hardware and the detailed planning of missions, often by many years. Or perhaps it did not lead to hardware development at all, but to solving some problem in applied mathematics or physics. In 1967, some 80 percent of OART's budget went to future mission support, 15 percent to proposed mission extension and new starts, and 5 percent to current mission support. In addition to OART's own research projects, this office also reviewed and coordinated the supporting research and technology (SRT) work being done by project offices in other directorates. SRT funds paid for fundamental scientific studies, supporting technology tasks "intended to meet particular technological objectives . . . in a given time-frame, in anticipation of the needs of future NASA missions," and advanced development projects that required long lead times.²

Broadly speaking, OART managers were charged with achieving four goals: (1) understanding the general phenomena underlying aeronautical and space vehicle technology; (2) reducing this understanding to design methods or procedures; (3) testing vehicle components to obtain new data; and (4) using these data to develop advanced subsystems.³ Specifically, OART's various divisions addressed such topics as basic research, nuclear propulsion, aeronautics, chemical propulsion, electronics and control systems, space power, and human factor research.

The organization of the Office of Advanced Research and Technology* was relatively static from 1963 through 1968. John W. Crowley, former NACA associate director of research, served as NASA's first research director. Upon his retirement in less than a year, Ira Abbott,† who had also been with NACA Headquarters (since 1947), became director. In August 1962, Raymond L. Bisplinghoff took the post of OART director, to be succeeded by Mac C. Adams in October 1965 and James M. Beggs in June 1968 (see table 4-1).

Beginning in 1968, several changes were initiated within OART to simplify working procedures and to coordinate more efficiently NASA's many diverse research projects. The number of OART congressional budget line items was reduced from 8 to 3; the number of work units—the basis for OART reporting by the centers—was reduced from 5000 to 500; a research council was established to ensure a more balanced overall program; and program division directors were delegated increasing authority to issue instructions. These changes were intended to give OART programs a focus and a consistency they had sometimes lacked.⁴

Along with the NACA personnel based in Washington, the new space administration inherited the NACA employees and facilities of four research centers. Because of their nature, many of the projects being conducted at these centers in 1958 when NASA assumed authority for them were assigned to the research directorate. Langley Memorial Aeronautical Laboratory near Hampton, Virginia, had been NACA's first field station. Renamed Langley Research Center by NASA, the

*Before the Office of Advanced Research and Technology was established in the November 1961 agencywide reorganization, research tasks had been assigned to the Office of Aeronautical and Space Research, renamed the Office of Advanced Research Programs in 1959.

†Abbott chaired the NACA Ad Hoc Committee on NASA Organization, commonly called the Abbott Committee, from April to August 1958. This committee's suggestions contributed to the new agency's initial structure.

center was involved with basic research in a number of areas.* Moffett Field, California, was the site of NACA's second laboratory, named Ames Aeronautical Laboratory in 1944 (formerly called Moffett Field Laboratory). Ames Research Center became NASA's facility for basic and applied research in the physical and life sciences. NACA's Aircraft Engine Research Laboratory (renamed Lewis Flight Propulsion Laboratory in 1948) began operations in Cleveland, Ohio, in 1942. As the Lewis Research Center, the facility continued to specialize in advanced propulsion and space power systems for NASA. NACA employees were first assigned to the Air Force facility at Muroc, California (later called Edwards Air Force Base) in 1946, when a group from Langley went west to assist with the rocket-powered X-1 flight research program. The High-Speed Flight Station became NASA's Flight Research Center.† Investigators at the Flight Research Center were concerned with special problems encountered during aeronautical flight, vehicle reentry and landing, and manned spaceflight within and beyond the atmosphere. In addition to these older research facilities, in 1964 NASA formally opened its Electronics Research Center in Cambridge, Massachusetts, to strengthen the agency's capabilities in this important field.**‡

Planning a balanced, useful advanced research and technology program demanded more than the internal coordination and evaluation of NASA's many advanced missions requirements and the identification of problem areas where improvements in technological capabilities could enhance mission performance or decrease costs. OART managers also had to look to the military††, to other government agencies (particularly the Federal Aviation Agency, the Department of Transportation, which absorbed the FAA in 1967, and the Atomic Energy Commission), to such organizations as the National Academy of Sciences and the President's Science Advisory Committee***, and to universities and private companies active in aerospace research to determine their research requirements and to solicit their support. To establish a smooth working relationship among the many external groups that could influence OART's program, several research advisory committees were formed to provide technical advice and assistance in many subject areas such as fluid mechanics, aircraft aerodynamics, chemical propulsion systems, materials, and aircraft operating problems.††† As did the Office of Manned Space Flight and the Office of Space Science and Applications, OART did not rely exclusively on in-house personnel and facilities to do its work, but let contracts to qualified industrial concerns and research organizations.

Quantitative assessment of the first 10 years of NASA's advanced research and technology program is impossible. We have no tally of flight projects, unless we

*Wallops Station (renamed Wallops Flight Center in 1974) was established as a Langley subsidiary in 1945. Used primarily as a launching center by NASA, Wallops was also responsible for some advanced aeronautical research projects.

†The Flight Research Center was renamed the Hugh L. Dryden Flight Research Center in 1976.

**Budget reductions forced NASA to close the Electronics Research Center in 1969.

††For example, NASA was a nonvoting member of the Interservice Group for Flight Vehicle Power.

***For example, in 1967 PSAC recommended that NASA's advanced research and technology program be maintained at a higher level.

††† In 1968, Raymond L. Bisplinghoff, former director of OART, was named to chair a new Research and Technology Advisory Council. Work of the group was divided among seven committees, which functioned much as the research advisory committees had.

counted every airplane, helicopter, launch vehicle, and spacecraft that benefited in some way from an OART research project—and the benefits would range from improved ailerons and flight couches to new rocket motors to concepts for landing on the surface of Mars. This chapter will discuss the major research projects that were under way during 1958-1968 and indicate how this research was used to develop new flight subsystems or hardware or how it contributed to the solution of flight problems.

Table 4-1.
Three Phases of Advanced Research and
Technology Management, NASA Headquarters

Phase I
Oct. 1958–Oct. 1961

Administrator/Deputy Administrator/Associate Administrator

Director, Aeronautical and Space Research (John W. Crowley; Ira H. Abbott, July 1959); office renamed Advanced Research Programs in 1959

Assistant Director, Aerodynamics and Flight Mechanics (Milton B. Ames; Herman H. Kurzweg, Sept. 1960)

Assistant Director, Power Plants (Emerson W. Conlon)

Assistant Director, Structures and Materials and Aircraft Operating Problems (Richard V. Rhode)

Chief, University Research (Lloyd A. Wood); office renamed Research Grants and Contracts in mid-1959 and dropped in 1961

Phase II
Nov. 1961–Oct. 1963

Administrator/Deputy Administrator

Associate Administrator

Director, Advanced Research and Technology (Abbott; Raymond L. Bisplinghoff, Aug. 1962)

Director, Nuclear Systems (Harold B. Finger)

Director, Aeronautical Research (John P. Stack; Charles H. Zimmerman, June 1962)

Director, Propulsion and Power Generation (William H. Woodward; John L. Sloop, Feb. 1962)

Director, Program Review and Resources Management (Boyd Myers II)

Director, Space Vehicles (Ames)

Director, Electronics and Control (Albert J. Kelley)

Director, Biotechnology and Human Research (E. B. Konecni); office added in July 1962*

Director, Research (Kurzweg)

Manager, AEC-NASA Space Nuclear Propulsion Office (Finger)

Table 4-1.
Three Phases of Advanced Research and
Technology Management, NASA Headquarters (Continued)

Phase III

Nov. 1963-Dec. 1968

Administrator/Deputy Administrator

Associate Administrator

Associate Administrator, Advanced Research and Technology (Bisplinghoff; Mac C. Adams, Oct. 1965; James M. Beggs, June 1968)

Deputy Associate Administrator (Operations) (Myers)

Deputy Associate Administrator (Aeronautics) (Charles W. Harper); office added in May 1967

Division Director, Aeronautical Research (Albert J. Evans, acting; Harper, Oct. 1964; Evans, May 1967)

Division Director, Biotechnology and Human Research (Konecci; Walton L. Jones, Oct. 1964)

Division Director, Chemical Propulsion (Adelbert Tischler); office added in Jan. 1964

Division Director, Electronics and Control (Kelley; Francis J. Sullivan, May 1965)

Division Director, Nuclear Systems and Space Power (Finger; Woodward, April 1967); office renamed Space Power and Electric Propulsion in April 1967

Division Director, Programming and Resources Management (Powell M. Lovell; Merrill H. Mead, 1964; Walter C. Scott, 1965; William E. Hanna, Jr., 1967; Paul E. Cotton, 1968)

Division Director, Research (Kurzweg)

Division Director, Space Vehicle Research and Technology (Ames)

Division Director, Mission Analysis (Leonard Roberts); office added in 1967**

Manager, AEC-NASA Space Nuclear Propulsion Office (Finger; Milton Klein, March 1967)

Division Director, Space Flight Programs (R. D. Ginter); office added in 1967 and renamed Special Programs in 1968

Director, Research and Technology Support (Clarence R. Morrison); office added in 1967 and dropped in 1968

*Prior to July 1962, Alfred M. Mayo was serving as a special assistant to the director of OART to activate an Office of Bioresearch.

**As of February 1965, many advanced planning and mission analysis tasks were assigned to the Mission Analysis Division at Ames Research Center. This group identified options for future planning and estimated the time in which a certain technology would be needed.

BUDGET

For general information on the NASA budget and the budget charts in this chapter, consult chapter 1. For a more detailed breakdown of flight project budgets, consult the NASA annual budget estimates. Review the bottom notes of the following charts carefully before making conclusions about the totals for any specific project or area of research.

Advanced research and technology funds were divided among broad disciplines; for example, basic research, space vehicle systems, and aeronautics. The budget was further broken down by research field or research project; for example, fluid physics, lifting bodies, and hypersonic aircraft. For each discipline, a total budget chart is provided, along with individual project charts. The following categories represent the changing organization of OART. For instance, space power was combined with nuclear-electric systems as of the FY 1966 budget estimate (consult table 4-3).

As explained above, projects in other directorates also were awarded supporting research and technology funds. For these figures, see the budget charts under the appropriate discipline; for example, table 3-46 deals with Applications Technology Satellite supporting research and technology and advanced studies.

Table 4-2.
Advanced Research and Technology Funding History
(in thousands of dollars)

Year	Request	Authorization	Programmed
1959	---	---	2528 ^a
1960	---	---	36 650 ^b
1961	61 345 ^a	61 345 ^a	64 983 ^c
1962	107 070 ^d	107 070 ^d	91 592
1963	106 672 ^e	106 672 ^e	271 560
1964	331 200	317 200	317 201
1965	320 300	316 900	331 328
1966	277 700	297 400	288 596
1967	278 300	286 300	268 150
1968	345 500	342 465 ^f	315 022

^aTotal for aeronautical and space research (support of NASA plant and research grants and contracts); see also table 1-31 for research related to launch vehicles.

^bTotal for aeronautical and space research (support of NASA plant and research grants and contracts) plus spacecraft technology; see also table 1-31 for research related to launch vehicles.

^cTotal for spacecraft technology and aircraft and missile technology; see also table 1-31 for research related to launch vehicles.

^dTotal for support of NASA plant, research grants and contracts, and spacecraft technology.

^eTotal for spacecraft technology and aircraft and missile technology.

^fThe appropriations conference committee reduced the final total to \$301 500 000 on October 25, 1967.

Table 4-3.
 Programmed Costs by Advanced Research and Technology Project
 (in thousands of dollars)

Project	1959	1960	1961	1962	1963	1964	1965	1966	1967	1968
Support of NASA Plant	2271	27 762	---	---	---	---	---	---	---	---
Basic Research										
Research grants and contracts	257	4869	---	---	---	---	---	---	---	---
Fluid physics	---	---	---	---	6716	7887	7803	7538	4875	4957
Electrophysics	---	---	---	---	3160	3986	4039	4726	7290	7245
Materials Applied	---	---	---	---	7080	9582	8034	8438	7811	7819
mathematics	---	---	---	---	740	1198	1355	1298	1425	1444
Space Vehicle Systems										
SRT	---	4019 ^b	25 376 ^b	12 620	20 226	24 951	25 707	26 450	26 777	34 100
Scout reentry heating	---	---	500	3000 ^c	1383	305	400	3000	1800	---
FIRE	---	---	---	3969 ^e	13 912 ^f	7037	1811	---	---	---
Scout-launched meteoroid experiments	---	---	---	878 ^g	3940	362	175	---	---	---
Pegasus	---	---	---	---	3940	9900	13 690	70	---	---
Small flight experiments	---	---	750	295	1724	1959	1010	3000	4262	---
Lifting body tests	---	---	---	---	---	1200	1400	1000	1000	---
Electronic Systems										
SRT	---	---	---	4933	15 535	26 380	23 222	29 848	32 302	37 557
RAM	---	---	---	---	1305	450	900	1300	1000	500
Scanner	---	---	---	---	110	1800	1500	1152	295	---
SOCS	---	---	---	---	121	---	---	---	---	---
Gemini optical communications	---	---	---	---	---	70	---	---	---	---
Human Factor										
Systems SRT	---	---	---	1984	9678	13 200	12 160	13 000	14 765	18 228
Small flight projects	---	---	---	420	112	000	1160	1900	1500	1600
Nuclear-Electric										
Systems SRT	---	---	---	8210	19 463	26 749	36 770	38 200	34 940	42 385
SNAP-8	---	---	---	6103	15 994	15 465	19 150	4000	5500	---
MECCA	---	---	---	---	1248	---	---	---	---	---
Electric engine development	---	---	---	2575	---	---	---	---	---	---
SERT	---	---	---	3570 ^o	3188 ^p	3467	2300	3000	---	1350
Space Power SRT	---	---	---	6302	8335	---	---	---	---	---
Solar and Chemical Power										
SRT	---	---	---	---	1400	---	---	---	---	---
Nuclear Rockets										
SRT	---	---	---	1791	12 878	21 261	20 891	20 644	16 506	12 500
Kiwi	---	---	---	4669	3856	1700	---	---	---	---
NERVA	---	---	---	19 316	41 884	48 820	35 370	35 356	34 162	37 500
RIFT	---	---	---	1000	10 847	6645	---	---	---	---
NRDS	---	---	---	---	---	750	739	2000	2332	4000
Chemical Propulsion										
SRT	---	---	---	7003	14 392	21 970	24 762	32 950	30 688	33 537
Small flight project	---	---	---	---	330	30	30	---	---	---
M-1 engine	---	---	---	16 705 ^s	35 000	24 000	24 910	2000	---	---
Large solid motor	---	---	---	---	---	---	26 800	4750	2950	3500
Aeronautics										
SRT	---	---	30 000 ^u	996	6580	9195	8163	10 186	35 900	66 800
X-15	---	---	7000 ^v	---	5580	900	1425	883	---	---
Hypersonic ramjet	---	---	---	---	---	---	2712	5000	---	---

Table 4-3.
 Programmed Costs by Advanced Research and Technology Project
 (in thousands of dollars) (Continued)

Project	1959	1960	1961	1962	1963	1964	1965	1966	1967	1978
Supersonic transport	---	---	100	1958	2513	8821	19 953	12 331	---z	---aa
XB-70A	---	---	---	---	---	---	---	9896	---z	---bb
V/STOL	---	---	757	---cc	925	2879	2987	3200	---dd	---ee

^a Estimate as per the FY 1962 budget estimate was \$48 203 000; by the FY 1963 estimate this category was dropped.

^b For spacecraft technology.

^c For launch vehicles.

^d \$2 206 000 was programmed for Scout-launched reentry technology flight experiments from the space vehicle aerothermodynamics budget.

^e Included \$2 400 000 for the Atlas-Antares launch vehicle.

^f Included \$4 000 000 for the Atlas-Antares launch vehicle.

^g Included \$800 000 for the launch vehicle.

^h \$1 336 000 was programmed for small flight experiments from the space vehicle aerothermodynamics budget.

ⁱ \$1 200 000 was programmed for lifting body tests from the space vehicle aerothermodynamics budget.

^j Funded as a small space vehicle flight experiment.

^k \$1 635 000 was programmed for RAM from operation of installation funds.

^l \$7 500 000 was programmed for SNAP-8 technology in the SRT budget.

^m It was estimated in the FY 1965 budget estimate that \$600 000 would be programmed for small nuclear-electric propulsion and power flight projects (MECCA); this category was dropped in the FY 1966 budget.

ⁿ It was estimated in the FY 1964 budget estimate that \$5 500 000 would be programmed for electric engine development projects; this category was dropped in the FY 1965 budget estimate.

^o Included \$1 500 000 for the Scout launch vehicle.

^p Included \$6 700 000 for the Scout launch vehicle.

^q Included with nuclear-electric systems.

^r Included with space power and electric propulsion systems.

^s Included as part of the liquid propulsion program in the FY 1963 request, as part of the OMSF launch vehicle and propulsion systems program in the FY 1964 request, and as part of the OART chemical propulsion program in the FY 1965-1968 requests.

^t Funded by the U.S. Air Force.

^u For aircraft and missile technology.

^v For X-15 hypersonic environmental studies.

^w \$539 000 was programmed for X-15A research from the operation of installations budget.

^x \$6 280 000 was programmed for hypersonic aircraft technology supporting research from the research and technology budget (formerly SRT).

^y \$3 448 000 was programmed for the X-15 from the hypersonic aircraft research and technology budget (formerly SRT).

^z \$14 040 000 was programmed for supersonic aircraft technology supporting research from the aeronautics research and technology budget (formerly SRT).

^{aa} \$24 050 000 was programmed for supersonic aircraft technology supporting research from the aeronautics research and technology budget (formerly SRT).

^{bb} Of the \$24 050 000 programmed for supersonic aircraft technology supporting research from the aeronautics research and technology budget (formerly SRT), \$10 000 000 was for the XB-70A.

^{cc} \$182 000 was programmed for V/STOL from the operation of installations budget.

^{dd} \$4 440 000 was programmed for V/STOL from the aeronautics research and technology budget (formerly SRT).

^{ee} \$7 057 000 was programmed for V/STOL from aeronautics research and technology funds (formerly SRT).

Table 4-4.
Support of NASA Plant Funding History
(in thousands of dollars)^a

Year	Request	Authorization	Programmed
1959	---	---	2271
1960	---	---	27 762
1961	51 345	51 345	--- ^b
1962	89 110	89 110	---

^a Includes the following categories: transportation, communications services, other contractual services, supplies and materials, and equipment. These funds were distributed among all NASA installations and were used for a wide variety of expenses.

^b Estimate as per the FY 1962 budget was \$48 203 000; by the FY 1963 estimate this category had been dropped.

Table 4-5.
Total Basic Research Funding History
(in thousands of dollars)

Year	Request	Authorization	Programmed
1959	---	---	257 ^a
1960	---	---	4869 ^a
1961	10 000 ^a	10 000 ^a	--- ^b
1962	7600 ^a	7600 ^a	--- ^c
1963	--- ^c	--- ^c	17 696
1964	--- ^c	--- ^c	22 653
1965	21 000	21 000	21 231
1966	22 000	22 000	22 000
1967	23 000	23 000	21 401
1968	23 500	21 465 ^d	21 465

^a For research grants and contracts in the following fields: physical science, cosmological science, bioscience, engineering science, socioeconomic studies, propulsion science, and miscellaneous.

^b Estimate as per the FY 1962 budget estimate was \$5 000 000; by the FY 1963 estimate this category had been dropped.

^c No corresponding line item.

^d Final total was decreased to \$20 000 000 by the appropriations conference committee on October 25, 1967.

Table 4-6.
Basic Research Supporting Research and Technology Funding History
(in thousands of dollars)

Year	Request	Authorization	Programmed
1963	---	---	17 696
1964	---	---	22 653
1965	21 000	21 000	21 231
1966	22 000	22 000	22 000
1967	23 000	23 000	21 401
1968	23 500	21 465	21 465

Table 4-7.
Basic Research Supporting Research and Technology—Fluid Physics Funding History
(in thousands of dollars)

Year	Request	Authorization	Programmed
1963	---	---	6716
1964	---	---	7887
1965	7800	7800	7803
1966	8000	8000	7538
1967	8200	8200	4875
1968	8615	--- ^a	4957

^a Authorization not broken down by individual supporting research and technology project.

Table 4-8.
Basic Research Supporting Research and Technology—Electrophysics Funding History
(in thousands of dollars)

Year	Request	Authorization	Programmed
1963	---	---	3160
1964	---	---	3986
1965	4000	4000	4039
1966	4100	4100	4726
1967	4800	4800	7290
1968	4740	--- ^a	7245

^a Authorization not broken down by individual supporting research and technology projects.

Table 4-9.
Basic Research Supporting Research and Technology—Materials Funding History
(in thousands of dollars)

Year	Request	Authorization	Programmed
1963	---	---	7080
1964	---	---	9582
1965	8000	8000	8034
1966	8600	8600	8438
1967	8500	8500	7811
1968	8655	--- ^a	7819

^a Authorization not broken down by individual supporting research and technology projects.

Table 4-10.
Basic Research Supporting Research and Technology—Applied Mathematics
Funding History
(in thousands of dollars)

Year	Request	Authorization	Programmed
1963	---	---	740
1964	---	---	1198
1965	1200	1200	1355
1966	1300	1300	1298
1967	1500	1500	1425
1958	1490	--- ^a	1444

^a Authorization not broken down by individual supporting research and technology projects.

Table 4-11.
Total Space Vehicle Systems Funding History
(in thousands of dollars)

Year	Request	Authorization	Programmed
1959	---	---	1904 ^a
1960	5000 ^b	5000 ^b	4019 ^c
1961	21 200 ^a	21 200 ^a	27 126 ^c
1962	10 360 ^c	10 360 ^c	20 762
1963	54 084 ^c	54 084 ^c	43 990
1964	61 962	53 462	45 714
1965	38 800	37 000 ^d	44 193
1966	35 000	35 000	35 000
1967	36 000	36 000	33 909
1968	37 000	36 000 ^e	34 100

^a For vehicle systems technology.

^b For space systems technology.

^c For spacecraft technology.

^d Authorization not broken down by line item to indicate from what projects the \$1 800 000 was subtracted. All line items are noted to be undistributed.

^e Total was reduced further to \$35 000 000 by the appropriations conference committee on October 25, 1967.

Table 4-12.
Space Vehicle Systems Supporting Research and Technology Funding History
(in thousands of dollars)^a

Year	Request	Authorization	Programmed
1959	---	---	1904 ^b
1960	5000 ^c	5000 ^c	4019 ^d
1961	21 200 ^b	21 200 ^b	25 376 ^d
1962	10 360 ^d	10 360 ^d	12 620
1963	30 894 ^d	30 894 ^d	20 226
1964	37 762	37 762	24 951
1965	26 300	--- ^e	25 707
1966	24 000	24 000	26 450
1967	28 700	28 700	26 777
1968	29 000	--- ^e	34 100 ^f

^a SRT funds supported work in several fields: spacecraft and launch vehicle aerothermodynamics, spacecraft and launch vehicle loads and structures, space vehicle environmental factors, advanced space vehicle concepts, and space vehicle design criteria.

^b For vehicle systems technology.

^c For space systems technology.

^d For spacecraft technology advanced research.

^e Authorization not broken down by line item.

^f All items were described as research and technology projects (there were no flight project categories): space vehicle aerothermodynamics, \$11 815 000; space vehicle structures, \$9 779 000; space environmental protection and control, \$10 754 000; and space vehicle design criteria, \$1 752 000.

Table 4-13.
Space Vehicle Systems Flight Projects Funding History
(in thousands of dollars)

Year	Request	Authorization	Programmed
1961	---	---	1750
1962	---	---	8142
1963	23 190 ^a	23 190 ^a	23 764
1964	24 200	15 700	20 763
1965	12 500	--- ^b	18 486
1966	11 000	11 000	8550
1967	7300	7300	7132
1968	8000	--- ^b	--- ^c

^a For spacecraft technology flight projects.

^b Authorization not broken down by line item.

^c All items in the budget were described as research and technology projects rather than flight projects (see table 4-12, note f).

Table 4-14.
Space Vehicle Systems Flight Projects—Scout Reentry Heating Funding History
(in thousands of dollars)

Year	Request	Authorization	Programmed
1961	---	---	500
1962	---	---	3000 ^a
1963	2500 ^b	---	1383
1964	1500 ^c	1500 ^c	305
1965	2000 ^c	--- ^d	400
1966	5000	5000	3000
1967	4800	4800	1800
1968	4500	--- ^d	--- ^e

^a For launch vehicle.

^b Includes \$2 000 000 for launch vehicle.

^c Includes \$1 000 000 for launch vehicle.

^d Authorization not broken down by line item.

^e \$2 206 000 was programmed for Scout-launched reentry technology flight experiments in the space vehicle aerothermodynamics SRT budget.

Table 4-15.
Space Vehicle Systems Flight Projects—FIRE Funding History
(in thousands of dollars)

Year	Request	Authorization	Programmed
1962	---	---	3969 ^a
1963	10 200 ^b	---	13 912 ^c
1964	12 500 ^d	4000	7037
1965	3000 ^e	--- ^f	1811
1966	500	500	---

^a Includes \$2 400 000 for Atlas-Antares launch vehicle.

^b For flight-reentry-at-hyperbolic-velocities project, of which \$4 000 000 was for an Atlas launch vehicle.

^c Includes \$4 000 000 for Atlas-Antares launch vehicle.

^d For an Advanced FIRE, of which \$1 700 000 was for an Atlas-Agena launch vehicle. Advanced FIRE was not approved by Congress.

^e Includes \$1 110 000 for Atlas-Antares launch vehicle.

^f Authorization not broken down by line item.

Table 4-16.
Space Vehicle Systems Flight Projects—Scout-Launched Meteoroid Experiments
Funding History
(in thousands of dollars)^a

Year	Request	Authorization	Programmed
1962	---	---	878 ^b
1963	3500 ^c	---	2805
1964	950 ^d	950	362
1965	---	---	175

^aSee also table 3-10. These funds were for *Explorer 23*.

^bIncludes \$800 000 for the launch vehicle.

^cIncludes \$2 000 000 for launch vehicle.

^dIncludes \$500 000 for the launch vehicle.

Table 4-17.
Space Vehicle Systems Flight Projects—Project Pegasus Funding History
(in thousands of dollars)^a

Year	Request	Authorization	Programmed
1963	---	---	3940
1964	4250	4250	9900
1965	2600	--- ^b	13 690
1966	2500	2500	70

^aAlso listed as "Saturn-Launched Meteoroid Experiments" in the budget estimates.

^bAuthorization not broken down by line item.

Table 4-18.
Space Vehicle Systems Flight Projects—Lifting Bodies Funding History
(in thousands of dollars)

Year	Request	Authorization	Programmed
1964	950 ^a	950 ^a	1200
1965	1900	--- ^b	1400
1966	1000	1000	1000
1967	1000	1000	1000
1968	1000	--- ^b	--- ^c

^aFor space vehicle recovery.

^bAuthorization not broken down by line item.

^c\$1 200 000 was programmed for lifting body flight research from the space vehicle aerothermodynamics technology research budget.

Table 4-19.
Space Vehicle Systems Flight Projects—Other Small Projects Funding History
(in thousands of dollars)

Year	Request	Authorization	Programmed
1961	---	---	750 ^a
1962	---	---	295 ^b
1963	6990 ^c	---	1724 ^d
1964	4050 ^e	4050 ^e	1959 ^f
1965	3000 ^g	--- ^h	1010 ⁱ
1966	2000 ^j	2000 ^j	3000 ^j
1967	1500 ^j	1500 ^j	4262 ^j
1968	2500 ^j	--- ^h	--- ^k

^a Includes \$500 000 for radio attenuation measurements, \$50 000 for Trailblazer reentry project, and \$700 000 for horizon sensors.

^b Includes \$719 000 for experiments dealing with behavior and handling of cryogenic propellants, \$113 000 for wind shear measurements, \$535 000 for a meteorology simulation experiment, \$84 000 for a reentry detection experiment, and \$273 000 for a meteoroid penetration probe.

^c Includes \$4 000 000 for environmental experiments (of which \$2 000 000 was for a Scout launch vehicle), \$1 950 000 for engineering test flight experiments, \$140 000 for a recoverable micrometeoroid probe, \$700 000 for horizon sensors, and \$200 000 for a Trailblazer reentry project.

^d For a meteoroid penetration probe. In addition, \$925 000 was provided from operation of installations funds.

^e Includes \$550 000 for environmental experiments, \$1 650 000 for experiments dealing with the behavior of cryogenic propellants, \$600 000 for wind shear measurements, \$600 000 for a meteor simulation experiment, \$200 000 for a Trailblazer reentry project, and \$450 000 for a meteoroid penetration probe.

^f Includes \$1 050 000 for experiments dealing with the behavior of cryogenic propellants, \$117 000 for wind shear measurements, \$640 000 for a meteor simulation experiment, \$63 000 for reentry detection, and \$89 000 for a meteoroid penetration probe.

^g Includes \$640 000 for experiments dealing with the behavior of cryogenic propellants, \$200 000 for wind shear measurements, \$610 000 for a meteor simulation experiment, \$150 000 for reentry detection, and \$1 400 000 for secondary environmental experiments.

^h Authorization not broken down by line item.

ⁱ For planetary entry technology and heat shield materials technology.

^j Includes \$95 000 for wind shear measurements, \$325 000 for meteor simulation experiment, and \$1 580 000 for materials and structures tests.

^k \$1 336 000 was programmed for parachute-decelerator flight experiments from the space vehicle aerothermodynamics technology research budget.

Table 4-20.
Total Electronic Systems Funding History
(in thousands of dollars)

Year	Request	Authorization	Programmed
1962	---	---	4933
1963	---	---	17 071
1964	30 362	30 362	28 700
1965	28 400	27 000 ^a	25 622
1966	34 400	34 400	32 300
1967	36 800	36 800	33 597
1968	40 200	39 200 ^b	38 057

^aThe authorization was not broken down by line item to indicate from what projects the \$1 400 000 was subtracted.

^bThe authorization was not broken down by line item to indicate from what projects the \$1 000 000 was subtracted. The total was reduced further to \$35 000 000 by the appropriations conference committee on October 25, 1967.

Table 4-21.
Electronic Systems Supporting Research and Technology Funding History
(in thousands of dollars)

Year	Request	Authorization	Programmed
1962	---	---	4933
1963	---	---	15 535
1964	26 612	26 612	26 380
1965	25 400	--- ^a	23 222
1966	30 000	30 000	29 848
1967	34 000	34 000	32 302
1968	39 200	--- ^a	37 557

^aAuthorization not broken down by line item.

Table 4-22.
Electronic Systems Flight Projects Funding History
(in thousands of dollars)

Year	Request	Authorization	Programmed
1961	---	---	--- ^a
1962	---	---	---
1963	--- ^a	---	1536
1964	3750	3750	2320
1965	3000	--- ^b	2400
1966	4400	4400	2452
1967	2800	2800	1295
1968	1000	--- ^b	500

^aSee table 4-19.

^bAuthorization not broken down by line item.

Table 4-23.
Electronic Systems Flight Projects—Project RAM Funding History
(in thousands of dollars)

Year	Request	Authorization	Programmed
1961	---	---	--- ^a
1962	---	---	--- ^b
1963	---	---	1305
1964	2000	--- ^c	450
1965	2000	--- ^c	900
1966	3400	3400	1300
1967	1300	1300	1000
1968	400	--- ^c	500

^a See also table 4-19.

^b \$1 635 000 was programmed for Project RAM from operation of installations funds.

^c Authorization not broken down by line item.

Table 4-24.
Electronic Systems Flight Projects—Project SCANNER Funding History
(in thousands of dollars)

Year	Request	Authorization	Programmed
1961	---	---	--- ^a
1962	---	---	---
1963	--- ^a	---	110
1964	1750	--- ^b	1800
1965	1000	--- ^b	1500
1966	1000	1000	1152
1967	1000 ^c	1000 ^c	295
1968	600 ^c	--- ^b	--- ^d

^a See also table 4-19.

^b Authorization not broken down by line item.

^c For earth coverage horizon measurements.

^d No corresponding line item.

Table 4-25.
Electronic Systems Flight Projects—Other Small Projects Funding History
(in thousands of dollars)

Year	Request	Programmed
1963	---	121 ^a
1964	---	70 ^b

^a For spacecraft orientation control system (SOCS) project.

^b For Gemini optical communications experiment.

Table 4-26.
Total Human Factor Systems Funding History
(in thousands of dollars)

Year	Request	Authorization	Programmed
1960	---	---	--- ^a
1961	--- ^b	---	---
1962	---	---	2404
1963	---	---	9790
1964	18 200	13 200	13 200
1965	16 200	15 500	13 320
1966	14 900	14 900	14 900
1967	17 000	17 000	16 265
1968	21 000	21 000	19 828

^a\$917 000 was programmed for biosciences, which included some human factors research, in the research and grants budget.

^b\$2 000 000 was requested for biosciences, which included some human factors research, in the grants and contracts budget.

Table 4-27.
Human Factor Systems Supporting Research and Technology Funding History
(in thousands of dollars)

Year	Request	Authorization	Programmed
1962	---	---	1984
1963	---	---	9678
1964	18 200	13 200	13 200
1965	13 200	--- ^a	12 160
1966	13 000	13 000	13 000
1967	15 500	15 500	14 765
1968	19 500	19 500	18 228

^a Authorization not broken down by line item.

Table 4-28.
Human Factor Systems Small Flight Projects Funding History
(in thousands of dollars)

Year	Request	Authorization	Programmed
1962	---	---	420
1963	---	---	112
1964	---	---	---
1965	3000	--- ^a	1160
1966	1900	1900	1900
1967	1500	1500	1500
1968	1500	1500	1600

^a Authorization not broken down by line item.

Table 4-29.
Total Space Power and Electric Propulsion Funding History
(in thousands of dollars)

Year	Request	Authorization	Programmed
1962	---	---	20 458
1963	---	---	39 893
1964	68 768	68 768	45 963
1965	48 100	47 100 ^b	58 220
1966	27 000	33 000	45 200
1967	42 500	44 500	40 440
1968	45 000	44 000	43 735

^aThis category was called nuclear-electric systems until the FY 1967 budget estimate. As of the FY 1966 estimate, funds for space power were added to the nuclear-electric systems budget. As of the FY 1967 estimate, funds for solar and chemical power were added to this category. See also table 1-31.

^bThe authorization was not broken down by line item to indicate from what projects the \$1 000 000 was subtracted.

Table 4-30.
Space Power and Electric Propulsion Supporting Research and Technology Funding History
(in thousands of dollars)

Year	Request	Authorization	Programmed
1962	---	---	8210
1963	---	---	19 463
1964	20 018	20 018	26 749
1965	25 000	--- ^a	36 770
1966	24 000	24 000	38 200
1967	37 000	37 000	34 940
1968	34 200	--- ^a	42 385

^aAuthorization not broken down by line item.

Table 4-31.
Space Power and Electric Propulsion Flight Projects Funding History
(in thousands of dollars)

Year	Request	Authorization	Programmed
1962	---	---	12 248
1963	---	---	20 430
1964	48 750	48 750	19 214
1965	23 100	--- ^a	21 450
1966	3000	9000	7000
1967	5500	7500	5500
1968	10 800	--- ^b	1350

^aAuthorization was not broken down by line item.

^bThere was no line authorization for SERT; \$9 700 000 was authorized for SNAP-8.

Table 4-32.
Space Power and Electric Propulsion Flight Projects—SNAP-8 Funding History
(in thousands of dollars)

Year	Request	Authorization	Programmed
1962	---	---	6103
1963	---	---	15 994
1964	24 000 ^a	24 000 ^a	15 465
1965	18 000	--- ^b	19 150
1966	000	6000	4000
1967	5500	7500	5500
1968	9700	9700	--- ^c

^a\$9 000 000 of the total was set aside specifically for flight evaluation, of which \$500 000 was for a Thor launch vehicle.

^bAuthorization not broken down by line item.

^c\$7 500 000 was programmed for SNAP-8 technology in the supporting research and technology budget.

Table 4-33.
Space Power and Electric Propulsion Flight Projects—Project SERT Funding History
(in thousands of dollars)

Year	Request	Authorization	Programmed
1962	---	---	3570 ^a
1963	---	---	3188 ^b
1964	15 350 ^c	15 350 ^c	3467
1965	5100	--- ^d	2300
1966	3000	3000	3000
1967	000	---	000
1968	1100	--- ^d	1350

^aTotal includes \$1 500 000 for Scout launch vehicles.

^bTotal includes \$6 700 000 for Scout launch vehicles.

^cTotal includes \$600 000 for Scout launch vehicles.

^dAuthorization not broken down by line item.

Table 4-34.
Space Power and Electric Propulsion Flight Projects—Other Small Projects Funding History
(in thousands of dollars)

Year	Request	Authorization	Programmed
1962	---	---	2575 ^a
1963	---	---	1248 ^b
1964	9400 ^c	9400 ^c	--- ^d

^aFor electric engine development.

^bFor Project MECCA. In addition, it was estimated in the FY 1964 budget estimate that \$5 500 000 would be programmed for electric engine development projects; this category was dropped in the FY 1965 budget estimate.

^cIncludes \$8 000 000 for electric engine development and \$1 400 000 for Project MECCA.

^dIt was estimated in the FY 1965 budget estimate that \$600 000 000 would be programmed for small nuclear-electric propulsion and power flight projects (MECCA); this category was dropped in the FY 1966 budget estimate.

Table 4-35.
Total Space Power Funding History
(in thousands of dollars)^a

Year	Request	Authorization	Programmed
1962	---	---	6302
1963	---	---	8335
1964	16 524	16 524	--- ^b
1965	13 000	12 500	--- ^b

^a Combined with the nuclear-electric systems budget as of the FY 1966 budget estimate. See also table 1-31.

^b See table 4-29.

Table 4-36.
Space Power Supporting Research and Technology Funding History
(in thousands of dollars)

Year	Request	Authorization	Programmed
1962	---	---	6302
1963	---	---	8335
1964	16 524	16 524	--- ^a
1965	13 000	12 500	--- ^a

^a See table 4-30.

Table 4-37.
Total Solar and Chemical Power Funding History
(in thousands of dollars)^a

Year	Request	Authorization	Programmed
1964	---	---	14 000
1965	---	---	---
1966	14 200	14 200	--- ^b

^a As of the FY 1967 budget estimate, this category was combined with the nuclear-electric systems budget.

^b See table 4-29.

Table 4-38.
Solar and Chemical Power Supporting Research and Technology Funding History
(in thousands of dollars)

Year	Request	Authorization	Programmed
1964	---	---	14 000
1965	---	---	---
1966	14 200	14 200	--- ^a

^a See table 4-30.

Table 4-39.
Total Nuclear Rockets Funding History
(in thousands of dollars)^a

Year	Request	Authorization	Programmed
1962	---	---	26 776
1963	---	---	69 465
1964	96 687	94 187	79 176
1965	58 000	57 000 ^b	57 000
1966	58 000	58 000	58 000
1967	53 000	53 000	53 000
1968	74 000 ^c	73 000 ^d	54 000

^a See also table 1-31.

^b The authorization was not broken down to indicate from what projects the \$1 000 000 was subtracted.

^c NASA's original request for nuclear rockets was \$46 500 000. Because the NERVA rocket engine was considered to be an especially important item by the administration, the request was increased.

^d The authorization was not broken down to indicate from what projects the \$1 000 000 was subtracted. The total was reduced further to \$46 500 000 by the appropriations conference committee on October 25, 1967. See note c above.

Table 4-40.
Nuclear Rockets Supporting Research and Technology Funding History
(in thousands of dollars)

Year	Request	Authorization	Programmed
1962	---	---	1791
1963	---	---	12 878
1964	22 687	22 687	21 261
1965	23 000	--- ^a	20 891
1966	22 000	22 000	20 644
1967	16 900	16 900	16 506
1968	23 000 ^b	--- ^a	12 500

^a Authorization not broken down by line item.

^b NASA's original request was \$16 500 000. Because the nuclear rocket program was considered to be an especially important item by the administration, the request was increased.

Table 4-41.
Nuclear Rockets Flight Projects Funding History
(in thousands of dollars)

Year	Request	Authorization	Programmed
1962	---	---	24 985
1963	---	---	56 587
1964	74 000	71 500	57 915
1965	35 000	--- ^a	36 109
1966	36 000	36 000	37 356
1967	36 100	36 100	36 494
1968	51 000	--- ^a	41 500

^a Authorization was not broken down by line item.

^b NASA's original request was \$30 000 000. Because the NERVA rocket engine program was considered to be an especially important item by the administration, the request was increased.

Table 4-42.
Nuclear Rockets Flight Projects—Kiwi Funding History
(in thousands of dollars)

Year	Request	Programmed
1962	---	4669
1963	---	3856
1964	1000	1700

Table 4-43.
Nuclear Rockets Flight Projects—RIFT Funding History
(in thousands of dollars)

Year	Request	Programmed
1962	---	1000
1963	---	10 847
1964	12 000	6645

Table 4-44.
Nuclear Rockets Flight Projects—NERVA Funding History
(in thousands of dollars)

Year	Request	Authorization	Programmed
1962	---	---	19 316
1963	---	---	41 884
1964	60 000	--- ^a	48 820
1965	34 500	--- ^a	35 370
1966	35 000	35 000	35 356
1967	33 100	33 100	34 162
1968	47 000 ^b	--- ^a	37 500

^a Authorization not broken down by line item.

^b NASA's original request for NERVA was \$26 000 000. Because the NERVA rocket engine program was considered to be an especially important item by the administration, the request was increased.

Table 4-45.
Nuclear Rockets Flight Projects—Nuclear Rocket Development Station Funding History
(in thousands of dollars)

Year	Request	Authorization	Programmed
1964	1000	--- ^a	750
1965	500	--- ^a	739
1966	1000	1000	2000
1967	3000	3000	2332
1968	4000	--- ^a	4000

^a Authorization not broken down by line item.

Table 4-46.
Total Chemical Propulsion Funding History
(in thousands of dollars)^a

Year	Request	Authorization	Programmed
1962	---	---	7003
1963	---	---	49 722
1964	22 497	24 497	46 000
1965	59 800	62 800	76 502
1966	30 000	43 700	39 700
1967	37 000	41 000	33 638
1968	38 000	41 000 ^b	37 037

^aSee also table 1-31.

^bThe total was subsequently reduced to \$35 000 000 by the appropriations conference committee on October 25, 1967.

Table 4-47.
Chemical Propulsion Supporting Research and Technology Funding History
(in thousands of dollars)

Year	Request	Authorization	Programmed
1962	---	---	7003
1963	---	---	14 392
1964	22 497	24 497	21 970
1965	21 800	25 800	24 762
1966	30 000	30 000	32 950
1967	33 500	33 500	30 688
1968	38 000	38 000	33 537

Table 4-48.
Chemical Propulsion Flight Projects Funding History
(in thousands of dollars)

Year	Request	Authorization	Programmed
1963	---	---	35 330
1964	---	---	24 030
1965	38 000	37 000	51 740
1966	---	13 700	6750
1967	3500	7500	2950
1968	---	3000	3500

Table 4-49.
Chemical Propulsion Flight Projects—M-1 Engine Funding History
(in thousands of dollars)^a

Year	Request	Authorization	Programmed
1962	26 000 ^b	---	16 705
1963	55 316	---	35 000 ^c
1964	45 000	---	24 000
1965	25 000 ^d	--- ^e	24 910
1966	--- ^f	7500	2000

^aIncluded as part of the liquid propulsion program in the FY 1963 request, as part of the OMSF launch vehicle and propulsion systems program in the FY 1964 request, and as part of the OART chemical propulsion program in the FY 1965-1968 requests.

^bSupplementary request.

^cThis amount was programmed for experimental engines, of which the M-1 was the major project.

^dThe total amount requested for experimental engines, of which the M-1 was the major program, was \$38 000 000.

^eThe total amount authorized for experimental engines, of which the M-1 was the major project, was \$37 000 000. There is no indication in the chronological budget history for FY 1965 from which project the \$1 000 000 was subtracted. See also table 4-50.

^fAlthough NASA did not request funds in FY 1968 for the M-1, Congress authorized \$7 500 000 for the project.

Table 4-50.
Chemical Propulsion Flight Projects—Large Solid Motor Funding History
(in thousands of dollars)

Year	Request	Authorization	Programmed
1964	---	---	--- ^a
1965	13 000 ^b	--- ^c	26 800
1966	000	6200	4750
1967	3500	7500	2950
1968	000	3000	3500

^aFunded previously by the U.S. Air Force.

^bThe total amount requested for experimental engines, of which the large solid motor was one project, was \$38 000 000.

^cThe total amount authorized for experimental engines, of which the large solid motor was one project, was \$37 000 000. There is no indication in the chronological budget history for FY 1965 from which project the \$1 000 000 was subtracted. See also table 4-49.

Table 4-51.
Chemical Propulsion Flight Projects—Other Small Projects Funding History
(in thousands of dollars)

Year	Request	Programmed
1963	---	330
1964	---	30
1965	---	30

Table 4-52.
Total Aeronautics Funding History
(in thousands of dollars)

Year	Request	Authorization	Programmed
1961	---	---	37 857 ^a
1962	---	---	2954
1963	52 588 ^a	52 588 ^a	15 598
1964	16 200	--- ^b	21 795
1965	37 000	37 000	35 240
1966	42 400	42 200	41 496
1967	33 000	35 000	35 900
1968	66 800	66 800 ^c	66 800

^aFor aircraft and missile technology.

^bAuthorization not broken down by line item.

^cTotal was reduced to \$65 000 000 by the appropriation conference committee on October 25, 1967.

Table 4-53.
Aeronautics Supporting Research and Technology Funding History
(in thousands of dollars)

Year	Request	Authorization	Programmed
1961	---	---	30 000 ^a
1962	---	---	996
1963	39 500 ^b	39 500 ^b	6580
1964	9910	9910	9195
1965	9400	9400	8163
1966	8300	8300	10 186
1967	9000	11 000 ^c	35 900 ^d
1968	18 600	18 600	66 800 ^e

^aFor aircraft and missile technology advanced research (\$15 200 000 for supersonic commercial transport, \$2 300 000 for V/STOL aircraft, \$3 500 000 for multicapability aircraft, and \$1 000 000 for hypersonic aircraft) and advanced technical development (\$8 000 000).

^bFor aircraft and missile technology advanced research (\$18 000 for supersonic commercial transport, \$4 500 000 for V/STOL aircraft, \$4 500 000 for multicapability aircraft, and \$3 000 000 for hypersonic aircraft) and advanced technical development (\$9 500 000).

^cThe increase was to fund supporting research for the SST, V/STOL, and hypersonic ramjet projects.

^dAll line items are described as research and technology projects (there are no flight project monies): advanced research and technology, \$3 730 000; general aircraft technology supporting research, \$200 000; V/STOL aircraft technology supporting research, \$5 550 000; subsonic aircraft technology supporting research, \$6 100 000; supersonic aircraft technology supporting research, \$14 040 000; and hypersonic aircraft technology supporting research, \$6 280 000.

^eAll line items are described as research and technology projects (there are no flight project monies): advanced research and technology, \$12 800 000; general aviation aircraft technology, \$450 000; V/STOL aircraft technology, \$7 057 000; subsonic aircraft technology, \$7 905 000; supersonic aircraft technology, \$24 050 000; and hypersonic aircraft technology, \$14 538 000.

Table 4-54.
Aeronautics Flight Projects Funding History
(in thousands of dollars)

Year	Request	Authorization	Programmed
1961	---	---	7857 ^a
1962	---	---	1958
1963	13 088 ^a	13 088 ^a	9018
1964	6290	6290	12 600
1965	27 600	27 600	27 077
1966	33 900	33 900	31 310
1967	24 000	26 000 ^b	--- ^c
1968	48 200	48 200	--- ^c

^aFor aircraft and missile technology flight projects.

^bThe increase was to fund the SST, V/STOL, and hypersonic ramjet projects.

^cAll line items are described as research and technology projects; there are no flight project monies.

See table 4-53, notes d and e.

Table 4-55.
Aeronautics Flight Projects—X-15 Funding History
(in thousands of dollars)

Year	Request	Authorization	Programmed
1961	---	---	7000 ^a
1962	---	---	--- ^b
1963	8000 ^a	8000 ^a	5580
1964	900	900	900
1965	900	900	1425
1966	900	900	883
1967	900	900	--- ^c
1968	5000 ^d	5000 ^d	--- ^e

^aFor X-15 hypersonic environmental studies.

^b\$539 000 from the operation of installations budget was programmed for the X-15.

^c\$6 280 000 was programmed for hypersonic aircraft technology supporting research; see table 4-53, note d.

^dIncludes \$1 000 000 for a Delta X-15.

^eOf the \$14 538 000 programmed for hypersonic aircraft technology supporting research, \$4 338 000 was for the X-15; see table 4-53, note e.

Table 4-56.
Aeronautics Flight Projects—Supersonic Transport Funding History
(in thousands of dollars)

Year	Request	Authorization	Programmed
1961	---	---	100 ^a
1962	---	---	1958 ^b
1963	1600 ^a	1600 ^a	2513
1964	3790	3790	8821
1965	24 700	24 700	19 953
1966	16 000	16 000	12 331
1967	14 100	--- ^c	--- ^d
1968	11 100	11 100	--- ^e

^aFor B-58 flight simulation of supersonic transport operation.

^b\$299 000 from the operation of installations budget was also programmed for the SST.

^cAn increase in the authorization (\$2 000 000) was to be used for the SST, V/STOL, and hypersonic ramjet projects.

^d\$14 040 000 was programmed for supersonic aircraft technology supporting research; see table 4-53, note d.

^e\$24 050 000 was programmed for supersonic aircraft technology supporting research; see table 4-53, note e.

Table 4-57.
Aeronautics Flight Projects—V/STOL Funding History
(in thousands of dollars)

Year	Request	Authorization	Programmed
1961	---	---	757
1962	---	---	--- ^a
1963	1988	1988	925
1964	1600	1600	2879
1965	2000	2000	2987
1966	2000	2000	3200
1967	5000	--- ^b	--- ^c
1968	7100	7100	--- ^d

^a\$182 000 from the operation of installations budget was programmed for V/STOL.

^bAn increase in the authorization (\$2 000 000) was to be used for the SST, V/STOL, and hypersonic ramjet projects.

^c\$5 550 000 was programmed for V/STOL technology supporting research; see table 4-53, note d.

^d\$7 057 000 was programmed for V/STOL technology supporting research; see table 4-53, note e.

Table 4-58.
Aeronautics Flight Projects—Hypersonic Ramjet Funding History
(in thousands of dollars)

Year	Request	Authorization	Programmed
1965	---	---	2712
1966	5000	5000	5000
1967	2000	--- ^a	--- ^b
1968	7000	7000	--- ^b

^aAn increase in the authorization (\$2 000 000) was to be used for the SST, V/STOL, and hypersonic ramjet projects.

^bSee table 4-53, notes d and e.

Table 4-59.
Aeronautics Flight Projects—XB-70 Funding History
(in thousands of dollars)

Year	Request	Authorization	Programmed
1966	10 000	10 000	9896
1967	2000	2000	--- ^a
1968	10 000	10 000	--- ^b

^a\$14 040 000 was programmed for supersonic aircraft technology supporting research; see table 4-53, note d.

^bOf the \$24 050 000 programmed for supersonic aircraft technology supporting research, \$10 000 000 was for the XB-70; see table 4-53, note e.

Table 4-60.
Aeronautics Flight Projects—Other Small Projects Funding History
(in thousands of dollars)

Year	Request	Authorization	Programmed
1967	---	---	--- ^a
1968	8000 ^b	8000 ^b	--- ^c

^aOf the \$6 100 000 programmed for subsonic aircraft supporting research, \$4 400 000 was for aircraft noise reduction and \$1 716 000 was for quiet engine research; see table 4-53, note d.

^bIncludes \$3 500 000 for aircraft noise reduction, \$2 000 000 for quiet engine development, \$2 000 000 for the F-106, and \$500 000 for the F-111.

^cSee table 4-53, note e.

DESCRIPTION—BASIC RESEARCH PROGRAM

In the early 1960s, basic research tasks were often the responsibility of applied research divisions within the Office of Advanced Research and Technology; for example, research in fluid physics was supported by the spacecraft technology budget. But the FY 1963–1968 budgets provided funds for four distinct categories of basic research—fluid physics, electrophysics, materials, and applied mathematics. The overall purpose of basic research was not to contribute to some specific mission or discipline, but to “institute and administer” fundamental research with the aim that the increase and distribution of scientific knowledge would lead to a better understanding of the physical and mathematical laws that governed all NASA’s projects.⁶

With the November 1961 agencywide reorganization, Hermann H. Kurzweg was named OART’s director of research at NASA Headquarters. He was still serving in this capacity in 1968. Although it was never a heavily funded program, various basic research projects were supported at all NASA’s research centers and by a large number of contractors.

Fluid Physics

Providing fundamental information and understanding of the many different flow processes of liquid and gas mixtures involved in aircraft, spacecraft, and propulsion systems operation (especially during entry or reentry into an atmosphere) was the research objective in the field of fluid physics. Work in this area often cut across the conventional disciplinary lines of fluid mechanics, chemistry, and physics. Researchers at Ames, Langley, and Lewis Research Centers and at the Jet Propulsion Laboratory contributed to solving a variety of aircraft and spacecraft design problems.

The measurement of radiation characteristics, heat, viscous and electrical conductivities, and chemical reaction rates of different planetary gas mixtures at very high temperatures (as with the interaction of air and a fast-moving vehicle) gave scientists and engineers data that proved useful in determining the stresses a vehicle would have to overcome during reentry into earth's atmosphere or entry into some extraterrestrial atmosphere. Information on convective and radiant heat transfer was used by designers to select the best configuration for spacecraft entry cones and protective heat shields and the ablative materials from which they were made. The application of fluid physics principles gave propulsion experts clues by which to understand the mechanism of combustion instability in liquid-fuel rocket engines. A knowledge of high-temperature ionized gases (plasmas) was essential to the design of electromagnetic gas accelerators and certain energy converters (this subfield of fluid physics is called plasma physics).

Turbulent boundary layer behavior was another field under investigation; using new data, researchers contributed to a more reliable design for hypersonic aircraft and engine inlets and nozzles. Measuring the energy and momentum transferred by a particle to a surface during impact produced information critical to a number of design issues, such as determining the orbital lifetime of satellites and predicting heating and thrust loss from attitude control rockets. NASA researchers at the field centers and their contractors completed many studies, measurements, and observations by using theoretical models and by conducting laboratory experiments in wind tunnels and shock tubes and with other sophisticated equipment.⁷

Alfred Gessow (formerly with NACA since 1944) was the long-time chief of fluid physics research within OART's basic research program (he served the aerodynamics and flight mechanics program in the same capacity in NASA's early years). In January 1967, Gessow became assistant director for physics and mathematics in the same program office. James E. Danberg took the position of chief of fluid dynamics research until mid-1967, when John T. Howe assumed the job.

Electrophysics

The electrophysics program was concerned with theoretical and experimental basic physics research devoted to exploring and explaining the macroscopic and atomic electric behavior of solids, liquids, and magnetic force fields, either static or dynamic. Information from this kind of research was generally applicable to

engineering advances in such fields as space power, radiation effects, and electronic communications. Laboratory work in electrophysics was conducted at the Lewis, Langley, Ames, and Electronics Research Centers and at the Jet Propulsion Laboratory, and at the facilities of many contractors. The University of Chicago, the Johns Hopkins University, University of Michigan, Stanford University, Virginia Polytechnic Institute, William and Mary College, University of Virginia, Massachusetts Institute of Technology, and Columbia University were major participants.

Research into the mechanisms of energy transfer in the atomic levels of solids and gases led investigators to new sources for the stimulated emission of coherent electromagnetic waves (lasers) in the region from gamma ray to millimeter wavelengths. In turn, this led to the development of new signal sources for electronic communications and spacecraft navigation devices. Superconductors (zero electrical resistance at very low temperatures) made of niobium-tin were scrutinized by NASA and contractor scientists to determine the precise relationship of the current and the magnetic field. It was believed that the magnetic fields produced by superconducting coils could be used to shield spacecraft from solar particle radiation; other potential applications for superconductors included their use on electric power lines, rotating electrical motors and generators, and gyroscopes. Electron movement through titanium dioxide placed between aluminum films also was being studied to determine if a device capable of detecting long wavelength infrared radiation could be developed. Many other research tasks with possible applications to space science and vehicle design were conducted during the decade, including the study of antimatter, high-frequency acoustic waves, lasers, and the fission-electron cell. Another area of research that caught the attention of NASA electrophysicists concerned the electrical forces responsible for the high velocity of tornado clouds.

One man, Harry Harrison, led the electrophysics research team during NASA's first 10 years. He held the position of chief for electrophysics in OART's basic research program office.

Materials

Developing lightweight materials that could withstand extreme temperatures, stresses, corrosion, and radiation was a critical task facing NASA during the 1958-1968 period. OART's basic research program contributed to this effort by supporting materials research, which ranged from very basic studies associated with the ways in which atoms were arranged to investigations of the failure of a particular material and how that failure was influenced by the environment in which it operated. Of the basic research programs, materials research could be most directly applied to hardware development. Personnel at the Lewis, Langley, Ames, and Electronics Research Centers, the Jet Propulsion Laboratory, Goddard Space Flight Center, and Marshall Space Flight Center worked in the field of materials research. Contractors that assisted them included the University of Washington, Michigan State University, Massachusetts Institute of Technology, Case Institute of Technology, Naval Ordnance Test Station, and the Martin Company.

Aircraft, spacecraft, and launch vehicles were exposed to harsh and unique environments that demanded the special attention of designers and engineers: extreme

heat and cold, high speeds, weightlessness and great accelerations of gravity, ultraviolet radiation and other kinds of emissions, and collisions with meteorites. Not only was the outer surface or skin affected, but internal components (engine nozzles, turbine blades, fuel tanks, and electronic equipment) were subject to damage as well. One of the most basic things a researcher in this field could do was determine how a material's atomic and molecular arrangement affected the properties of that material, whether it be a polymer, alloy, crystalline, or ceramic. Under stress or exposure to radiation, how did the arrangement change? How did different materials interact when melded or when other fibers were introduced to strengthen the material? All manner of laboratory experiments were conducted on a variety of sample materials to observe their reactions to specific conditions. By examining the arrangement of atoms in crystals of unlubricated solids, researchers could suggest methods by which to cut down on wear and friction. Materials experts discovered that coating objects with foamed ceramics insulated them from intense heat and vibration. By using a very sensitive microphone that could detect the sound of cracking metal, scientists developed a method for determining exactly when a crack starts to develop in a piece of metal under stress. New superalloys that resist heat and corrosion were the products of NASA researchers looking for new materials with which to make engines for supersonic transports and vertical takeoff and landing aircraft. Fundamental research of the electronic properties of materials for circuitry in communications devices was another area of study.

A formal materials research office was first established as part of the structures and operating problems program of the Office of Advanced Research Programs. George C. Deutsch, who had been part of the refractory materials branch at Lewis Research Center, was named chief. When OART was formed in November 1961, Deutsch became chief of materials research in the basic research program. In January 1967 in a program reorganization, Deutsch became assistant director for materials sciences and engineering, with Ralph Nash assuming the job of materials sciences chief and James J. Gangler becoming materials engineering chief.

Applied Mathematics

Research in applied mathematics was concerned with the development of improved mathematical techniques for the solution of physical problems, such as determining launch trajectories or the optimum shape of an aircraft wing. NASA's basic research program in applied mathematics included investigations in ordinary and partial differential equations, numerical analysis, celestial mechanics, and statistics, with mathematicians at the Jet Propulsion Laboratory, Marshall Space Flight Center, and the Ames, Lewis, and Langley Research Centers participating. As with other area of research, contracts and grants were awarded to universities and research organizations to assist the agency with this work.

Specialists in gravitational and orbital mathematics addressed the complex theories necessary for predicting the motion of any object moving under the influence of gravitational or other forces. This research led to the ability to predict the time required for a spacecraft to orbit some particular body or to travel a specific distance, and was necessary in determining the most efficient and accurate launch trajectories for lunar and interplanetary missions. Using mathematical procedures,

experts also could calculate energy requirements, determine the distortion and bending of vehicles that could be expected during launch, and assess how the spinning rate of spacecraft in orbit would affect tracking maneuvers or how heat flow would affect the path of a reentering spacecraft. Researchers at the Marshall Space Flight Center developed a numerical technique called the Runge-Kutta transformation method that was especially applicable to solving celestial mechanics problems. Ames Research Center mathematicians developed a numerical integration technique for solving systems of ordinary differential equations that was applied to the calculation of flows behind normal shock waves at very high speeds and low density. Mathematical analyses also aided aircraft and spacecraft designers. Using mathematical formulas, engineers could determine, for instance, the optimum aerodynamic shape for the wings of supersonic or hypersonic aircraft. Tracking and data processing mathematics research was devoted to such problems as numerical error analysis of tracking systems and data reduction.

Applied mathematics research had one chief during the November 1961-December 1968 period—Raymond H. Wilson, Jr.

DESCRIPTION—SPACE VEHICLE SYSTEMS

Milton B. Ames and his space vehicle systems team were responsible for a broad spectrum of applied research tasks designed to identify and solve problems that launch vehicles and spacecraft might experience during launch and ascent through the atmosphere, flight in space, entry into the atmosphere of earth or other planets, and landing. In addition to theoretical studies and laboratory work, this group also conducted several flight projects and participated as investigators on three Explorer satellite missions. Through the examination of problems with existing vehicles, these specialists also advanced the state of the art of future space vehicle design. The program was divided into three broad areas—advanced design criteria, environmental factors and aerodynamics (which included aerothermodynamics), and structures.

To ensure that the latest information from NASA's many research projects could be applied to the design of future space vehicles, it was translated into space vehicle design criteria, an organized set of engineering guides. The advanced design criteria division was responsible for evaluating new data applicable to design problems and making that data available to engineers and designers.

The bulk of the work performed by the space vehicle systems group was in the field of environmental factors and aerodynamics. Aerothermodynamics specialists investigated the special problems associated with spacecraft high-speed entry into a planet's atmosphere, which led to research with recovery systems (parachutes, paragliders, and flexible wings), reusable vehicles (lifting bodies), and special reentry heating spacecraft (Project FIRE and the Scout Reentry Heating Project). Studies in this area also dealt with launch vehicle exhaust and acoustics problems. The broad goal of the environmental factors group was to gain a detailed understanding of the space environment in which vehicles would travel. Vehicles would have to be protected from radiation and extreme temperatures (research with special shielding and materials) and meteoroids (Project Pegasus meteoroid studies).

Because weightlessness influenced the behavior of fluids, specialists were prompted to study liquid propellant management.

Space-vehicle structures research was necessary to maintain the weight of spacecraft and launch vehicles at reasonable levels and to ensure reliability under complex stress and loading conditions. Component testing under simulated flight conditions was the research method used most often by this OART branch.

A fourth area of responsibility, added to the space vehicle program in 1968, was aerospace safety. Plans called for a comprehensive research effort aimed at safety considerations related to aeronautical and space vehicle operations and systems. This work was assigned to the NASA Safety Research and Data Institute at Lewis Research Center.⁸

Before the organization of OART, space vehicles research was assigned to the aerodynamics and flight mechanics division and the structures and materials and operating problems division of the Office of Aeronautics and Space Research, later called the Office of Advanced Research Programs. With the establishment of the Office of Advanced Research and Technology in November 1961, Milton Ames (with NACA from 1936) became director of space vehicle systems and continued in this position through the remainder of the agency's first decade. Richard V. Rhode was Ames's long-time assistant director for advanced design criteria; Ernest O. Pearson, Jr., headed the environmental factors and aerodynamics office* until he became deputy director at Ames in 1966, at which time Ralph W. May assumed the post; Melvin G. Rosche led the space vehicle structures group; and H. Kurt Strass became chief of aerospace safety in May 1968.

Advanced Design Criteria

Many of the space vehicle failures that occurred during the agency's early years were traced to the application of inadequate or inappropriate design conditions or procedures. To prevent structural failures, the advanced design criteria group, part of OART's space vehicle systems program, provided designers and project managers with a continual stream of new technical information suitably filtered from the total mass of data available and arranged in a useful form for uniform application to design studies. These design criteria (engineering guides) took the form of monographs. Representative topics included solar electromagnetic radiation, buckling of thin-walled cylinders, and aerodynamic and ground-wind loads. It was the responsibility of the advanced design criteria team to identify design problems, formulate existing technical information bearing on the problems into authoritative guides, distribute the guides to NASA and industry users, and update them as required. This work usually fell into four broad categories: environmental factors, structures, propulsion, and stability, guidance, and control.

Personnel at all of NASA's centers prepared advanced design criteria, with three of the centers functioning as lead centers: Langley (structures), Lewis (propulsion),

*For a time in 1962-1963, there was an assistant director for aerodynamics (Pearson) and an assistant director for environmental effects (May); when the two research fields were combined Pearson was named assistant director and May programs chief.

and Electronics Research Center (guidance and control). The U.S. Weather Bureau and several industry and university groups prepared design criteria under contract to NASA. This activity was financed by space vehicle systems supporting research and technology (SRT) funds. Richard V. Rhode was assistant director for advanced design criteria until 1967, when Thomas V. Cooney took the job. William J. Underwood served as the assistant director's deputy.

Environmental Factors and Aerodynamics

Of the three major divisions of space vehicle systems, the environmental factors and aerodynamics group had the broadest range of responsibilities. These specialists were concerned with every aspect of flight from launch to landing, with particular emphasis on understanding the environment of space and protecting the vehicle from that environment and on reentry (or entry) and recovery. Environmental factors research included many topics—determination of the meteoroid environment and means for protecting the vehicle against penetration, the effects of high-energy charged-particle radiation and shielding against it, thermal vacuum effects on spacecraft temperature control, storage of cryogenic liquids for long periods, behavior and control of fluids under reduced gravity conditions, and structural concepts that take advantage of the very low gravitational and aerodynamic forces in space.

Penetration of a vehicle by meteoroids was one of the early fears expressed by spacecraft designers. While data on the velocity, density, and composition of large meteoroids were obtained by ground-based photography and radar (Harvard College Observatory had contracts to study meteors by optical and radio reflection techniques), more information was needed on possible meteoroid hazards in space. While micrometeoroid detectors were included on many astronomy and physics satellites (Vanguard, Explorer, OGO, Ariel),* three Explorers were devoted exclusively to this investigation (*Explorer 13, 16, and 23*; see table 3-79, 3-82, and 3-89). They carried piezoelectric, wire-grid, cadmium sulphide-cell, foil-gauge, and impact detectors to record the size, frequency, and velocity of micrometeoroids. To provide long-term meteorite data applicable to future manned and scientific satellite missions, OART funded Project Pegasus, three large meteorite detection satellites. Saturn I launch vehicles orbited the Pegasus series in 1965, with data being returned for 13 to 15 months on meteorites in the zone 480 to 725 kilometers above earth. Meteoroids were discovered to pose no real threat to earth-orbiting satellites, and even less danger was expected in cislunar space. Specialists at Ames Research Center, Marshall Space Flight Center, and Langley Research Center supported these activities (for more information see space vehicle systems flight projects).

Since high-energy radiation is detrimental to sensitive equipment and hazardous to humans, engineers sought to protect spacecraft from the radiation they would encounter in space. Research into high-energy proton and electron radiation effects was one of the responsibilities of the OART environmental factors team, which

*Some experiments were also performed using sounding rockets and simulated meteors to determine the heating and entry phenomena of natural meteors.

utilized the radiation facility at the Goddard Space Flight Center and the Space Radiation Effects Laboratory (operated by the Virginia Associated Research Center under contract) at Langley Research Center. Researchers in industry and at the Oak Ridge National Laboratory (Atomic Energy Commission) also were included in this study under contract. Specialists conducted radiation environmental tests, evaluated simulation techniques, correlated damage data, tested shielding materials, and investigated electromagnetic shielding concepts.

Another field of research funded with environmental factors and aerodynamics monies was zero-gravity fluid behavior, specifically the effect of weightlessness on the static and dynamic behavior of fluids and on heat transfer phenomena of liquids and vapor. This research was applicable to problems of storing, separating, and positioning liquids and vapors, liquid pumping systems, and venting vapors in space vehicle propellant tanks and water supply tanks. Although most of this work was done at Lewis Research Center's drop towers, several flight experiments with cryogenic propellants (experiments with liquid hydrogen were of particular interest) were conducted with sounding rockets.

Testing vehicle components and materials in a vacuum that simulated the conditions of spaceflight was also assigned to the environmental factors people. The creation, maintenance, and measurement of a vacuum under laboratory conditions was under study in FY 1967 and 1968. Related to this field was the study of heat transfer by thermal radiation. Because the radiative characteristics of spacecraft surfaces are altered by ultraviolet and other radiations in combination with a vacuum, quantitative temperature predictions for long-duration flight were difficult to obtain. In the late 1960s, specialists were seeking ways to simulate the solar spectrum in the laboratory so that thermal control coating materials could be tested (a half-scale thermal model of the *Mariner 4* spacecraft was used to evaluate scale modeling techniques).

Several other secondary areas of investigation interested members of the environmental factors team, which they pursued by contributing to or evaluating the results of scientific experiments conducted by the Office of Space Science and Applications or by sponsoring sounding rocket projects. One sounding rocket experiment took wind shear measurements in the vicinity of launching areas with Nike rockets equipped with smoke-producing nose cones.

The other half of the environmental factors and aerodynamics story was aerothermodynamics and aerodynamics research — primarily studies of the problems associated with high-speed reentry into earth's atmosphere or entry into the atmosphere of Mars or Venus and the soft-landing of the spacecraft. In addition, work on launch vehicle heating (nozzle clustering, exhaust plumes) and rocket engine noise was carried out by this group of OART specialists.

Two Langley Research Center-managed flight research projects contributed to aerodynamic heating technology during the 1958–1968 period. A series of six Scout Reentry Heating Projects flights was launched in 1962–1968 (one failed because of launch vehicle malfunctions) to measure aerodynamic heat transfer to the nose cap of a blunt-nosed reentry payload and to evaluate specific heat shield materials. The reentry speeds of the Scout-launched payloads (ballistic trajectories only) reached about 32 000 kilometers per hour. To obtain information applicable to shielding spacecraft against the heat generated at reentry speeds of 40 000 kilometers per hour or more, two reentry packages similar in shape to the Apollo command module were launched into a ballistic trajectory by Atlas-Antares launch vehicles in 1964 and

1965. Project FIRE was designed to gather data on total and radiant heating and radio signal attenuation and to evaluate a beryllium heat shield. (For more information, see under space vehicle systems flight projects).

In addition to looking at protective shielding for blunt-nosed cone-shaped nonlifting spacecraft, NASA designers also investigated other possible configurations for future spacecraft that would give the vehicle improved maneuvering capabilities during reentry plus protection from reentry heating. NASA joined the Air Force in testing a class of vehicles called lifting bodies (or medium lift-drag-ratio maneuvering vehicles). Included in this testing program were NASA's M-2 and HL-10 and the Air Force's X-24A. Personnel at Ames and Langley Research Centers participated in design and engineering studies and wind tunnel tests, with flight test landings taking place at the Flight Research Center (for more information see under space vehicle systems flight projects).

To assist with the final landing and recovery sequences of conventional truncated-cone-shaped spacecraft, NASA designers and contractors looked at several parachute configurations. Cooperating with specialists from the manned spaceflight program, OART personnel tested large drogue parachutes capable of handling 13 600 kilograms during a water landing. But more steerable devices would be required for manned spacecraft touchdowns on land, and OART specialists studied several kinds of controllable, gliding-type parachutes called paragliders or parawings. Langley Research Center* was the site of paraglider research and wind tunnel testing, with flight testing being conducted at Houston's Manned Spacecraft Center, Flight Research Center, and the Joint Parachute Test Facility at El Centro, California. Since the paraglider made feasible a controlled descent in a shallow glide, manned spaceflight personnel seriously considered it for Project Gemini. Several contractors, Northrop Ventura and B. F. Goodrich among them, also participated in paraglider research and fabrication.⁹ Designing a parachute system that would operate in the thin atmosphere of Mars was another task that held OART's attention. The deployment of large lightweight parachutes at relatively high speeds would be required for the large Voyager Mars lander. Small-scale and full-scale tests of parachute concepts for a terminal descent on Mars were conducted in 1966-1968. Nike sounding rockets and balloons were used to carry these parachutes aloft where they were deployed. Specialists at Ames and Langley participated in this research.

Until Ernest O. Pearson, Jr., became Milton Ames's deputy in 1966, he led the environmental factors and aerodynamics office within OART's space vehicle systems group at NASA Headquarters. Ralph W. May, programs chief, was assisted for many years by Clotaire Wood (vehicle technology flight experiments), Fred J. DeMerritte (aerothermodynamics), and J. Warren Keller (environmental factors).

Space Vehicle Structures

As with other research fields, the space vehicle structures program had many parts. Its broad objective was to identify and solve critical spacecraft and launch

*Francis M. Rogallo of Langley originated the stowable flexible-wing paraglider concept in the 1950s.

vehicle structural problems through analytical and experimental research. Major elements of the program included advanced structural concepts and materials applications, protection against entry heating and environmental hazards, determination of critical loads and structural responses, protection against excessive vibration and impacts, and prolonged storage of cryogenic fluids in space. Anticipating future requirements (such as inflatable lunar structures and very long extendable boom antennas on spacecraft) was also the responsibility of this program.

Reusable spacecraft whose critical structure could be refurbished after entry and landing was one problem area this team investigated during NASA's first decade. In conjunction with plans the Office of Space Science and Applications had for lander missions to Mars and Venus, specialists also studied designs for strong, lightweight spacecraft that could survive terminal descent into the low atmospheric pressure environment of Mars. Other topics of interest were high-frequency vibrations and long-term storages of liquid propellants aboard spacecraft. Improved air locks, gas-tight liners, and reflective outer coatings are examples of the practical applications to which this research led.

With launch vehicles, one of the big problems facing engineers was the influence of ground winds and winds above the launching area. By experimenting with models in wind tunnels, researchers developed methods for predicting loads on vehicles. Thrust vectoring, fuel slosh, and aerodynamic flow instability were also studied under laboratory conditions. Dynamic modeling technology was perhaps one of this team's most important contributions to the space program.

Most of NASA's centers participated to some extent in space vehicle structures research. Melvin G. Rosche directed the program from headquarters with the assistance of Norman J. Mayer (advanced structures and materials applications), Douglas Michel (dynamics), Douglas A. Gilstead (loads), and Howard S. Wolko (high-temperature structures and structural mechanics).

Space Vehicle Systems Flight Projects

Pegasus. Personnel at the Marshall Space Flight Center, physicist Ernst Stuhlinger among them, proposed a Saturn-launched meteoroid detection satellite to NASA planners in late 1962. The original proposal called for exposing to possible meteoroid penetrations large areas of aluminum of different thicknesses (meteoroids range in size from microscopic particles to huge fragments). By December 1962, NASA had requested proposals from industry for designing and constructing two large satellites with expandable wings, which would provide more than 185 square meters for detection equipment. *Explorer 16*, a meteoroid detection experiment launched in 1962, had had only 2.3 square meters available for detectors. NASA scientists and designers needed more data on the quantity, size, and velocity of meteoroids so they could protect from possible hazards scientific satellites and probes being planned for increasingly long lifetimes and manned spacecraft destined for earth orbit and cislunar space.

Fairchild Stratos Corporation (later known as Fairchild-Hiller) was awarded a contract to build two flight models of a Micrometeoroid Detection Satellite (MDS) in early 1963. The satellite's wings would consist of 208 panels, each about 0.5 by 1

meter, made of two aluminum target sheets separated by 25 millimeters of plastic foam. A polymer plastic sheet coated with a thin layer of copper was bonded to each aluminum sheet, forming a capacitor that stored an electric charge. On penetration by a meteoroid, the material removed by the impact was vaporized, which formed a conducting gas that discharged the capacitor—registering a “hit.” On each satellite, 8 panels had aluminum sheets 0.381 millimeter thick, 17 panels 0.2032 millimeter, and 183 panels 0.4064 millimeter. The satellite’s center section, protected during launch in an Apollo boiler plate capsule, was connected by an adapter to the spent second stage of the Saturn launch vehicle, and in launch configuration the payload was topped by a dummy Apollo command module.

Designated Pegasus* in July 1964, the satellites also served as part of the Saturn I launch vehicle test flight program (see tables 1-63 and 1-64). When plans for using the Saturn I for manned flights were dropped in late 1963, mission planners at the Marshall Space Flight Center proposed that a third Pegasus satellite be launched by the last existing Saturn I vehicle. The three launches took place successfully in February, May, and July 1965, with the satellites recording meteoroid penetrations in orbits that ranged from 480 to 725 kilometers above earth. To overcome a problem with the capacitors shorting out, an improved capacitor fusing arrangement was used on *Pegasus 2*; a single malfunctioning capacitor could be disconnected, leaving the others in that group of panels operable. An extra experiment was included on *Pegasus 3*: 48 recoverable subpanels mounted to 8 detector panels positioned symmetrically on each wing, 4 to a side. The subpanels (called coupons), made of aluminum in three thicknesses and variously coated, could have been removed and returned to earth for analysis by Gemini astronauts rendezvousing with the satellite. However, it was determined later in 1965 that a rendezvous with Pegasus by a Gemini crew was not possible. The extravehicular activity required was too complicated; the necessary stationkeeping operation demanded more propellant than the spacecraft carried, and a tethering operation was ruled out because this was a maneuver that the Gemini team had not planned or trained for; and *Pegasus 3*’s altitude was too high—additional retrorockets would be needed for the manned spacecraft, equipment that the project could not afford. All three satellites outlasted their one-year life expectancies, with *Pegasus 2* still recording hits in October 1967. In addition to data on meteoroids, the three spacecraft also relayed information on thermal measurements and radiation. After the detection systems ceased operating, specialists used the engineering data still being sent by Pegasus to determine the survival rates of certain materials and equipment on the spacecraft. The satellites were shut down in August 1968.

Concurrent with planning for the Pegasus missions were proposals from Langley Research Center for a follow-on project to extend the measurements of meteoroid penetrations into cislunar space. Using Saturn IB-Centaur (a launch vehicle configuration that was never flown), the researchers wanted to send two winged spacecraft to the vicinity of the moon in 1968 and even beyond the moon into interplanetary space at a later date (the Martin Company proposed an advanced Pegasus with four z-shaped trapezoidal panels that could be sent as far out as the asteroid belt, some 160 million kilometers away). Budget cuts and the belief that the

*Pegasus represents a deviation from the usual practice of designating a satellite of this class one of the Explorer series.

flux of small particles decreased rapidly with distances from earth combined to cut short plans for any advanced meteoroid detection satellite.

Fairchild Stratos (Fairchild-Hiller) was the prime contractor; G. T. Schjeldahl fabricated the detector panels. Marshall Space Flight Center monitored these contracts, with William G. Johnson acting as project manager. OART funded the project.

Table 4-61.
Chronology of Pegasus Development and Operations

Date	Event
1962	Personnel at the Marshall Space Flight Center proposed using the Saturn vehicle to launch a micrometeoroid detection experiment.
Dec. 30, 1962	NASA issued a request for proposals for the design and construction of a large-surfaced micrometeoroid detection satellite.
Feb. 5, 1963	NASA announced it would negotiate with Fairchild Stratos Corp. to build two flight models of a micrometeoroid detection satellite.
March 4, 1963	NASA awarded Fairchild a contract for the construction of such a satellite, unofficially called Pegasus.
Dec. 1963	Marshall personnel considered using the SA-10 vehicle for a third Pegasus satellite.
April 1964	NASA Headquarters approved a third Pegasus. The Martin Co. was awarded a contract by Langley Research Center for a design study of an advanced Pegasus that would be launched by a Saturn IB-Centaur to investigate cislunar and interplanetary space.
July 21, 1964	The name Pegasus was officially approved by NASA for the micrometeoroid satellite project.
Feb. 16, 1965	Launch of <i>Pegasus 1</i> was successful.
May 1965	NASA awarded a phase two contract to Martin for an advanced Pegasus study.
May 27, 1965	Launch of <i>Pegasus 2</i> was successful.
July 30, 1965	Launch of <i>Pegasus 3</i> was successful.
March 1, 1966	The last hit was recorded on <i>Pegasus 1</i> ; only engineering data were recorded thereafter.
July 21, 1966	Marshall let a contract to Emerson Electric to study the feasibility of Gemini astronauts visiting Pegasus to retrieve panels for return and analysis.
Aug. 16, 1967	The last hit was recorded on <i>Pegasus 3</i> ; only engineering data were recorded thereafter.
Oct. 31, 1967	The last hit was recorded on <i>Pegasus 2</i> ; only engineering data were recorded thereafter.
Aug. 1968	All Pegasus satellites were turned off.

Table 4-62.
Pegasus Characteristics

	Pegasus 1	Pegasus 2	Pegasus 3
Date of launch (location):	Feb. 16, 1965 (ETR)	May 25, 1965 (ETR)	July 30, 1965 (ETR)
Launch vehicle:	Saturn I (SA-9)	Saturn I (SA-8)	Saturn I (SA-10)
Weight (kg):	2675 plus: Attached second stage, 6575 Instrument unit, 1180 Boiler plate Apollo module, 1435 Propellant, 700		
Shape:	Fuselage-shaped center section with 2 wings, which were folded and stowed during launch		
Dimensions (m):	Length of center stage and attached second stage, 22 Width, wing tip to wing tip, 29 Width of wing, 4.3		
Power source:	NiCd batteries plus solar cells		
Date of reentry:	Sept. 17, 1978	Nov. 3, 1979	Aug. 4, 1969
Cognizant NASA center:	MSFC		
Project manager:	William G. Johnson		
Contractor:	Fairchild Stratos (later known as Fairchild-Hiller), prime G. T. Schjeldahl, detector panels		
Objectives:	Detect the frequency, velocity and size of meteoroids at an altitude of 480-725 kilometers.		
Experiments:	Capacitor detectors		
Results:	All three satellites returned information on meteoroid penetrations, plus data on the Van Allen radiation belts, earth albedo, and thermal control systems. The satellites were silenced in Aug. 1968.		
Remarks:	Through October 1967, a total of 2265 hits had been recorded. <i>Pegasus 1</i> started sending signals again intermittently in June and July 1977.		

Scout Reentry Heating Project. The effects of high-velocity reentry heating and the search for materials that could withstand reentry had long been a concern of specialists at Langley Research Center, even before the facility became part of NASA. It was an even more crucial concern for manned spaceflight. Speeds in excess of 33 800 kilometers per hour had been reached under laboratory conditions in the early 1960s, but actual flight experiments would be necessary to duplicate the conditions a manned crew might face on their return from earth orbit or the moon. In 1961, space vehicle systems engineers and manned spacecraft designers perceived a four-stage program for gathering pertinent data on reentry heating and the ability of specific materials to withstand the reentry environment. First and already under way were experiments in wind tunnels and laboratories. Second was a Scout-launched* reentry project scheduled for December 1961 to September 1962, followed by an Atlas-Agena B-launched Project FIARE (Flight Investigation of Apollo

*Plans called for a five-stage Scout; the vehicle as developed included only four stages. However, the designers might have been considering a velocity package that would have given the reentry payload increased speed as a "fifth stage."

Reentry Environment) in 1963. With FIARE, velocities approaching those of a returning lunar spacecraft would be examined. The last step called for Saturn C-1s to launch boilerplate models of the Apollo spacecraft as a final test of the heat shield.

Taking advantage of the Langley-developed Scout launcher, a team at the Virginia center proceeded with the second step of the program. They sent five reentry heating experiments into ballistic trajectories in 1962-1968 to measure heat transfer and to test heat shield materials and configurations. Funds were first programmed for the Scout Reentry Heating Project (sometimes called the Supercircular Reentry Research Project) in FY 1961. The first of five planned flights was launched on March 1, 1962, from Wallops Island.* In approximately 4 minutes the reentry vehicle reached apogee altitude, at which time the third stage ignited. About 5½ minutes later, Scout's fourth stage ignited, followed shortly by the firing of the reentry vehicle's rocket (sometimes called the Scout's fifth stage). This spherical .43-meter rocket motor developed by the Naval Ordnance Test Station, China Lake, California, gave the payload its final burst of speed as it reentered the atmosphere 1290 kilometers from Wallops at 30 500 kilometers per hour. Thermocouples mounted on R-1 and R-2 (launched on August 31, 1962) measured the aerodynamic heat transfer to the nose cap of the small blunt-nosed conical reentry payload during the brief reentry heating period. Real-time and recorded telemetry were received at stations on Wallops Island and Bermuda and aboard a range telemetry ship. Radar and optical coverage also were used to gather information. The flights lasted only about 8 minutes, with 90 seconds of telemetry. No attempt was made to recover the payloads, which splashed down in the Atlantic near Bermuda. To assist in evaluating the results of the experiments, a series of six Arcas sounding rockets was launched from Bermuda before and after the flights of R-1 and R-2 to measure air temperature and density in the reentry area.

In addition to 24 temperature-measuring thermocouples, the next three reentry payloads were equipped with ablation sensors. Ablation is a physical and chemical reaction that takes place during reentry in which part of the heat shield material protecting the spacecraft is lost. The materials used for the heat shield on R-3, R-4, and R-5 were of the charring ablator type, a plastic resin material with added substances such as fiberglass. Charring ablator heat shields protect a spacecraft in several ways. When exposed to extreme heat, the material begins to decompose chemically, absorbing some heat in the process. During decomposition, gases form that act as an insulating blanket. At the surface of the shield, a charred layer of coke-like material develops, capable of operating at very high temperatures to radiate heat away from the spacecraft. The uncharred layers provide another layer of insulation. R-3, along with its four-stage Scout launcher, was destroyed when the launch vehicle malfunctioned seconds after liftoff on July 20, 1963. Launched on August 18, 1964, R-4 reached a maximum speed of 31 400 kilometers per hour during its 11-minute flight. The low-density charring ablator material (AVCOAT 5026-39 H/G) used to protect this spacecraft was being considered for the Apollo spacecraft. Telemetered data were received by Wallops Island, Langley Research Center, Bermuda, and ships and aircraft operated by the Air Force and NASA. Radar and optical coverage were also

*The first reentry experiment, R-1, was a secondary experiment on this eighth Scout development flight; proving the launch vehicle was the primary mission goal.

employed. Reaching a speed of 29 600 kilometers per hour, R-5 took an 8-minute flight on February 9, 1966. Thermocouples and various ablation sensors sent information on the low-density phenolic-nylon charring ablator used for the heat shield to several telemetry stations. As with R-1 and R-2, sounding rocket data were obtained at the reentry area near Bermuda. A secondary radio attenuation effects experiment on R-4 and R-5 monitored the voltage standing wave ratio during the reentry blackout period.

The sixth reentry payload was quite different from the others. Built by General Electric for Langley, the pointed conical spacecraft was 4 meters long and similar in shape to missiles, reentry vehicles, and hypersonic aircraft being considered for the future. Labeled the Turbulent Heating Experiment Project, R-6 was used to establish baseline (or anchor-point) data on boundary layer transition and turbulent heating rates during the reentry of a sleek needle-nosed vehicle. The data from this experiment were used to correlate and extend ground test results. R-6 carried thermocouples, pressure ports, and accelerometers. The primary data period began at an altitude of 36 600 meters at a velocity of 22 000 kilometers per hour, 1000 kilometers downrange; it was over at 15 000 meters. All data were telemetered in real time. Information collected by Arcas sounding rockets and high-altitude and standard weather balloons supplemented R-6's findings.

With laboratory, wind tunnel, and flight project data, designers in the 1958-1968 period were able to choose the material best suited for the Apollo reentry heat shield and were beginning to analyze ways to dispense heat from more advanced spacecraft and aircraft configurations. The Scout Reentry Heating Project was managed at Langley Research Center. Andrew G. Swanson was project manager for R-1 and R-2; Joseph M. Hallissy managed R-3, R-4, and R-5, while E. C. Hastings led the R-6 team. For the first five payloads, Langley Research Center provided the spacecraft; General Electric fabricated the sixth. Serving the NASA Headquarters Office of Advanced Research and Technology as the first project officer for this series of experiments was Charles D'Aiutolo, followed by B. E. Quass (R-3, R-4, R-5) and J. Levine (R-6).

Table 4-63.
Chronology of Scout Reentry Heating
Project Development and Operations

Date	Event
Aug. 1961	A preliminary project development plan for Project FIARE (Flight Investigation of Apollo Reentry Environment) included a series of Scout-launched reentry experiments in 1963, to precede the higher-velocity Atlas-launched experiments.
Fall 1961	NASA Headquarters approved the Scout Reentry Heating Project and assigned project management to Langley Research Center.
March 1, 1962	Launch of R-1 was successful.
Aug. 31, 1962	Launch of R-2 was successful.
July 20, 1963	An attempt to launch R-3 was unsuccessful because the launch vehicle malfunctioned; the entire vehicle was destroyed.
Aug. 18, 1964	Launch of R-4 was successful.
Spring-Summer 1965	Studies were under way at Langley that were designed to investigate the usefulness of extending the project to include two more flights; two more flights were approved that fall.
Dec. 16, 1965	NASA issued a request for proposals for the design and fabrication of a sixth reentry experiment to be housed in a slender cone.
Feb. 9, 1966	Launch of R-5 was successful.
March 8, 1966	NASA selected the Missiles and Space Division of General Electric to build the R-6 spacecraft, one prototype, and one backup.
April 27, 1968	Launch of R-6 was successful.
Dec. 1968	Langley officials investigated the possibility of using the R-6 backup for a seventh reentry experiment.

Table 4-64.
Scout Reentry Heating Project

	R-1	R-2	R-3	R-4	R-5
Date of launch (location):	March 1, 1962 (WI)	Aug. 31, 1962 (WI)	July 20, 1963 (WI)	Aug. 18, 1964 (WI)	Feb. 9, 1966 (WI)
Launch vehicle:	Scout (ST-8)	Scout (S-114)	Scout (S-110)	Scout (S-129R)	Scout (S-141C)
Weight (kg):					
Reentry experiment:	70.4	70.4	77	82.6	95.3
With rocket motor:	158.8	158.8	170.1	145.1	156.5
Shape:	Blunt-nosed cone				
Dimensions (m):					
Length:	0.94				
Base diameter:	0.514				
Nose diameter:	0.29				
Date of reentry:	Ballistic trajectories				
Cognizant NASA center:	LaRC				
Project manager:	Andrew G. Swanson		Joseph M. Hallissy		
Contractor:	Naval Ordnance Test Station, payload rocket motor (LaRC) provided the reentry payload.)				
Objectives:	To gather information on heat transfer during high-velocity reentry and to evaluate various heat shield materials.				
Experiments:	Temperature-measuring thermocouples (R-1 through R-5) Springwire ablation sensors (R-3 through R-5) Lightpipe ablation sensors (R-5)				
Results:	R-1 and R-2 were successful in returning heat transfer data; R-3 failed because the launch vehicle malfunctioned; R-4 and R-5 successfully tested various heat shield materials.				

Table 4-65.
Scout Reentry Heating Project (R-6) Characteristics

<i>Date of launch</i>	April 27, 1968 (WI)
(location):	
<i>Launch vehicle:</i>	Scout (S-164C)*
<i>Weight (kg):</i>	272.2
<i>Shape:</i>	Slender pointed cone with 10 degrees total angle
<i>Dimensions (m):</i>	
Length:	3.96
Base diameter:	0.69
Nose tip radius	2.54
(mm):	
<i>Date of reentry:</i>	Ballistic trajectory
<i>Cognizant NASA center:</i>	LaRC
<i>Project manager:</i>	E. C. Hastings
<i>Contractor:</i>	General Electric Missile and Space Division, prime
<i>Objectives:</i>	To gather information on heat transfer during high-velocity reentry of a slender-shaped configuration that resembled designs being considered for future aircraft and spacecraft.
<i>Experiments:</i>	Temperature-measuring thermocouples Pressure ports Accelerometers
<i>Results:</i>	Returned data as planned.

*A three-stage Scout launched R-6 (four stages was the standard configuration).

Project FIRE (Flight Investigation Reentry Environment). In 1960, advanced planners proposed using the Atlas-Agena B launch vehicle to send a recoverable reentry package on a ballistic path to gather information on reentry heating at near-escape velocities. The reentry capsule would be made of Mercury spacecraft components, and the experiments would give Project Mercury personnel extra experience with tracking and data acquisition procedures. This idea was abandoned in 1961 in favor of an experiment dubbed Flight Investigation of Apollo Reentry Environment, Project FIARE (also briefly called Project Calorie). Plans called for four Atlas-Agena B-launched flights in 1963. The recoverable payload would resemble a small Apollo command module (a truncated cone) and be fitted with a beryllium calorimeter-heat shield. By early 1962, the project had been redesignated Project FIARE, the launch vehicle had been changed to Atlas-Antares,* and the number of missions had been reduced to two. Funds were first programmed for FIRE in FY 1962.

Project FIRE reentry payloads reached speeds in excess of 40 000 kilometers per hour, the velocity a spacecraft returning from the moon was expected to reach. Outfitted with multilayer heat shield-calorimeters, the FIRE vehicles measured radiative and conductive heat transfer and returned data on the radiant energy and spectral

*The Antares stage was an ABL X-259 motor, also used as Scout's third stage. FIRE was the only NASA project that utilized the Atlas-Antares configuration. The ballistic trajectory called for did not require the more powerful Atlas-Agena B, and the Antares stage could be procured more inexpensively than the Agena B.

content of the hot gas cap, that area just ahead of a reentering body that is heated by energy transferred from the vehicle. Secondary objectives included measuring the response of heat shield materials to the reentry environment and monitoring radio attenuation effects during the reentry blackout period. The blunt end of the truncated cone consisted of three beryllium calorimeters, which were instrumented with thermocouples interleaved with three phenolic asbestos ablative heat shields. All but the last two layers were designed to burn away or be jettisoned during the 45-second high-heating reentry period. By periodically jettisoning heat shield layers to expose fresh calorimeters to the reentry environment, readings on the heating phenomena were taken during the earliest portion of reentry, at the peak, and near the end of the heating period. Two radiometers measured total radiant energy, and a spectral radiometer relayed data on reentry heating caused by radiation from the hot gases and the chemical content of the gases. Each FIRE reentry vehicle carried 258 thermocouples.

At launch, the Antares velocity package was connected to the Atlas stage by an adapter, and the reentry vehicle was fitted to the cylindrical Antares. The Antares stage separated from the Atlas booster about 5 minutes after launch, with ignition of the second stage taking place at about 26 minutes; separation of the reentry vehicle from the Antares stage came about 1 minute later. Traveling at 40 000 kilometers per hour, the spacecraft headed for splashdown near Ascension Island in the south Atlantic. In addition to the onboard sensors, information also was gathered from Ascension Island with a telespectrograph, a light-gathering telescope equipped with a slitless spectrograph. This instrument measured the spectrum of light generated during reentry in the visible and near-infrared wavelength ranges, defining the chemical constituents of the incandescent gas.

FIRE 1 was launched on April 14, 1964, from the Eastern Test Range. The 32½-minute flight was successful, and a Nike-Apache sounding rocket launched from Ascension Island gathered supplementary data on weather conditions near the reentry area after splashdown. *FIRE 2*, on May 22, 1965, validated the findings of the first mission during its 32-minute flight. Heat shield ejection times were revised slightly on *FIRE 2*, and the reentry vehicle was instrumented with additional pressure sensors. After the successful flight, another Nike-Apache was launched from Ascension to measure density, temperature, pressure, and wind conditions. The two FIRE experiments provided data that indicated that the radiation and the temperatures that would be experienced during an Apollo spacecraft reentry were less severe than had been expected. Spacecraft engineers made use of this information in designing and qualifying Apollo's heat shield. FY 1964 funds for an advanced FIRE that would have duplicated the reentry of spacecraft from interplanetary missions at an even greater velocity were not approved by Congress.

Project FIRE was managed by Langley Research Center. Herbert A. Wilson, Jr., was project manager for *FIRE 1*, David G. Stone for *FIRE 2*. Under contract to Langley, Chance Vought Corporation of Ling-Temco-Vought, Inc., fabricated the velocity package; Republic Aviation built the reentry vehicle; General Dynamics/Astronautics served as integration manager. At NASA Headquarters in the Office of Advanced Research and Technology, Ralph W. May, Jr., was FIRE program manager.

Table 4-66.
Chronology of FIRE
Development and Operations

Date	Event
Sept. 1960	An entry test vehicle project was proposed by NASA personnel. Mercury-like payloads, launched into ballistic trajectories by Atlas-Agena B vehicles, would reenter the atmosphere at near-escape speeds, allowing researchers to investigate reentry heating.
Aug. 1961	Langley Research Center personnel prepared a preliminary development plan for Project FIARE (Flight Investigation of Apollo Reentry Environment). The plan called for four small recoverable reentry payloads that resembled Apollo command modules in shape. A beryllium calorimeter-heat shield would be tested and temperature measurements taken at velocities reaching 11 000 meters per second.
Sept. 13, 1961	NASA Headquarters proposed designating the Apollo reentry environment experiments Project Calorie, a name which was not adopted.
Feb. 18, 1962	NASA announced plans for Project FIRE (Flight Investigation Reentry Environment), as the reentry experiment had been renamed. Atlas D boosters would launch two reentry vehicles into ballistic trajectories in 1963-1964.
March 29, 1962	Republic Aviation was named prime contractor for FIRE reentry vehicles and Chance Vought contractor for the FIRE velocity package (Antares second stage).
Nov. 20, 1962	General Dynamics/Astronautics was named contractor for FIRE systems integration.
April 14, 1964	Launch of <i>FIRE 1</i> was successful.
Summer 1964	Republic Aviation and Chance Vought were given the go-ahead to begin work on the second FIRE velocity reentry vehicle and velocity package.
May 22, 1965	Launch of <i>FIRE 2</i> was successful.

Lifting Bodies. When considering designs for hypersonic aircraft, NACA aeronautical engineers in the early 1950s studied the lifting body-glider configuration along with other more conventional aircraft designs. Lifting bodies are wingless vehicles that obtain aerodynamic lift from their shape alone. When designers turned to the problems spacecraft would face as they returned through earth's atmosphere at high speeds, a gliding, maneuverable spacecraft was one of the three basic designs that seemed promising. Although the relatively simple ballistic configuration, which could take advantage of existing missiles for launching, won the contest for the Mercury design over the skip and glider designs, many specialists at NASA's Ames and Langley Research Centers continued to study the reentry glider concept. Combining the best features of the ballistic and glider shapes, Alfred J. Eggers, Jr. at Ames designed a new lifting body configuration in 1957 that he believed could serve as a second-generation spacecraft—a blunt-nosed, flat-topped, deep-bottomed vehicle he called the M-1. Unlike the Mercury, Gemini, and Apollo spacecraft (blunt, nonlifting, high-drag vehicles that entered the atmosphere like projectiles without aerodynamic controls), an M-1-class spacecraft could glide through the reentry environment at a lower speed with greater pilot control, landing more like an aircraft.

Table 4-67.
Project FIRE Characteristics

	FIRE 1	FIRE 2
Date of launch (location):	Apr. 14, 1964 (ETR)	May 22, 1965 (ETR)
Launch vehicle:	Atlas-Antares (Atlas 263D)	Atlas-Antares (Atlas 264D)
Weight (kg):		
Reentry vehicle:	90.7	86.2
With velocity package:	1995.8	2005.8
Shape:	Cylindrical velocity package with a truncated-cone reentry package	
Dimensions (m):		
Length with velocity package:	3.66	
Diameter of base of cone:	0.658	
Length of cone:	0.53	
Date of reentry:	Ballistic trajectories	
Cognizant NASA center:	LaRC	
Project manager:	Herbert A. Wilson, Jr.	David G. Stone
Contractor:	Republic Aviation, reentry vehicle Chance Vought, velocity package General Dynamics/Astronautics, systems integration	
Objectives:	To obtain research data on total and radiative heating, radio signal attenuation, and material behavior of an Apollo-shaped reentry vehicle at speeds of 40 000 kilometers per hour.	
Experiments:	Temperature-measuring thermocouples (258) Radiometers Pressure sensors Telespectrograph (ground-based)	
Results:	Data were obtained from both flights are planned.	

During the late 1950s and early 1960s, specialists at Langley and Ames conducted studies independent of one another of several lifting body designs and ran wind tunnel tests on various scale models.

Egger's design for a reentry vehicle caught the attention of engineer Robert Dale Reed at NASA's Flight Research Center (FRC) in California. Reed built several small models of this lifting body and suggested that the design could be flown in a towed fashion for testing.* In turn, Reed's models intrigued several of the Air Force and NASA test pilots stationed at Edwards Air Force Base.† By the fall of 1962, FRC Director Paul F. Bilke had approved the construction of a lightweight full-scale lifting body to be designated the M2-F1 (*M* for manned; *F* for flight model). With the assistance of a local glider manufacturer, Sailplane Corporation of America, engineers built the M2-F1 in-house at FRC from plywood and tubular steel and sent it to Ames for wind tunnel verification tests. The first successful ground-towed experiments, which used an uprated Pontiac convertible as the towing vehicle, were

*Ground-towing had been used successfully at FRC to test out steerable parachute concepts.

†The Air Force Flight Test Center was at Edwards Air Force Base.

carried out in April 1963, with the first air-towed flight via a C-47 taking place the following August. Equipped with an ejection seat, the half-coned M2-F1 was towed to an altitude of 3048 meters and released for about 3 minutes of free flight, using its tricycle landing gear to set down on the dry lake beds of Edwards. Over two years, five pilots flew the vehicle (labeled the "flying bathtub") during hundreds of flight experiments (ground- and air-towed).

The next step in FRC's lifting body program called for the construction of an M-2 flight vehicle of heavier all-metal construction. Norair Division of Northrop built the 2300-kilogram M2-F2 lifting body in 1964-1965, and specialists at Ames conducted a series of wind tunnel tests on the new vehicle in early 1966. In July, the M2-F2 was carried aloft under the wing of a B-52 and released at 14 000 meters for a successful first flight. The amount of free flight time was still very limited, but with rudder and flaps and the vehicle's high-lift body four test pilots maneuvered the M2-F2 for landings at Edwards. On the 16th flight experiment on May 10, 1967, the pilot crash-landed without his landing gear down, after an unusually low flare maneuver executed to recover from a lateral oscillation. The vehicle turned over several times, injuring the pilot and the craft. In the spring of 1968, NASA Headquarters authorized a Northrop-FRC team to restore the damaged M2-F2. Redesignated the M2-F3, the lifting body was repaired and flown again in 1970-1972.

From their studies of lifting body designs at NASA's Langley Research Center, advanced researchers had come up with a configuration they called HL-10 (*HL* for horizontal landing); it was the 10th design they examined in the spring of 1962. Though similar in general shape, size, and weight to the M2-F2, Langley's vehicle was round on top and flat on the bottom (the opposite of the M2), plus it had a third vertical tail fin (in the center) and more of a delta-wing shape overall. It did not have the M2's bubble-type cockpit canopy. Northrop built the HL-10 and the M2-F2 under the same contract, completing the HL-10 in early 1966. The test-flight phase of the Virginia center's lifting body project also was conducted at FRC, with the first successful flight on December 22, 1966. Nearly 15 months went by before the second experiment took place, while engineers ground-tested the vehicle further and modified the design somewhat to increase its stability. From 1966 to 1970, the HL-10 (sometimes called a "flying flatiron") was flown 37 times by 5 test pilots. As with the M2, the HL-10 was launched from under the wing of a B-52. To test the lifting body concept at greater speeds and altitudes, the HL-10 and M2-F2 were both designed to accommodate a jet engine. In November 1968 on the vehicle's 13th flight, HL-10 experiments were expanded to include powered flight. Augmented by an XLR-11 jet engine, the HL-10 could travel at 1915 kilometers per hour at 24 000 meters.

The Air Force also was interested in the lifting body concept as it applied to future spacecraft designs. Project Dyna-Soar (for dynamic soaring), the Air Force's first entry in the manned lifting body program, had been designed around a Titan-launched vehicle to be built by Boeing. Designated the X-20 in the summer of 1962, the first launch of Dyna-Soar was to have taken place in 1966, but this project was cancelled in December 1963 because it had become too expensive and overly complex. The Air Force redirected its energies to Project START (Spacecraft Technology and Advanced Reentry Test), whose first product was the SV-5D PRIME (Precision Recovery Including Maneuvering Entry). Later called the X-23A, this lifting body was made by Martin Marietta and test launched (unmanned) on an

Atlas launch vehicle in 1967. The wedge-shaped X-24A, a modified and enlarged X-23A, was ready for manned flight tests in 1969. NASA and the Air Force had been officially coordinating their manned lifting body programs since early 1964, sharing testing facilities, pilots, and test results. An agreement between NASA and the Air Force on testing NASA's M2-F2 and HL-10 was reached in April 1965, and it was extended to include the Air Force X-24A in November 1967. NASA's Flight Research Center had responsibility for maintenance, instrumentation, and ground support of its craft, while the Air Force Flight Test Center assumed responsibility for the launch aircraft, support aircraft, medical assistance, the rocket power plant, and the pilot's personal equipment. The two organizations shared management of the overall flight operations, flight data analysis, test range support, and advanced planning.

The many theoretical studies, wind tunnel tests, and lifting body flights that NASA conducted or sponsored in 1958-1968 proved the feasibility of an advanced reusable spacecraft (or space transportation system, as it was being called in the late 1960s) based on the gliding reentry mode. Feasibility studies initiated by several NASA centers looked at such refinements of the lifting body concept as increasing its size to accommodate a larger crew and payload. Although NASA Headquarters officials decided in 1966 not to approve an orbital flight test of the lifting body configuration,* the extensive flight test program with the M2, HL-10, and X-24 series of vehicles gave pilots and designers experience with developing improved procedures and mechanical controls for reentry and landing maneuvers that some future-generation spacecraft would surely require.

At NASA Headquarters, Milton B. Ames, director of OART's space vehicle systems directorate, had overall responsibility for the lifting body program. Langley's Eugene S. Love and Ames's Alfred Eggers and Clarence A. Syverston played key roles in designing and testing lifting body configurations. The team at the Flight Research Center, always a small group, was led by John McTigue. NASA pilot Milton O. Thompson played an important role throughout the program as pilot, researcher, and manager.¹⁰

*It was not clear at this time what direction the post-Apollo manned program would take, and agency officials were hesitant to invest in costly manned projects beyond the use of available Apollo hardware and technology.

Table 4-68.
Chronology of Lifting Body Development and Operations

Date	Event
Summer 1952	NACA engineers at Ames Aeronautical Laboratory began wind tunnel experiments with several possible configurations for spacecraft, including a gliding craft. Their conclusion was that a blunt-bodied vehicle rather than a sharp-nosed one would survive the heat of atmospheric reentry.
1954-1955	Specialists at Ames conducted theoretical analysis and wind tunnel research on the impact of reentry heating on hypervelocity missiles.
1955	Langley engineers conducted basic studies of flat-bottomed vehicles in the mid- and high-angle-of-attack reentry regimes.
1956-1957	NACA engineers at the Langley, Lewis, and Ames laboratories carried out feasibility and design studies in cooperation with the Air Force Air Research and Development Command. The spacecraft design most favored was a flat-top round-bottom configuration. (In a January 1957 summary report in which the Ames people described this configuration, a minority report from Langley favoring a nonlifting spherical capsule was included.)
June 10-13, 1957	At an American Rocket Society meeting, Alfred J. Eggers, Jr., a research scientist at Ames, compared ballistic, skip, and glide vehicles, concluding that a blunt-nosed slender vehicle with low-aspect-ratio delta wings (highly swept, blunt leading edges) and a vertical tail would be most suited for manned spaceflight.
Mid-late 1957	Realizing the glider configuration would be too heavy for existing launch vehicles, Eggers revised his design to combine features of the ballistic and glider crafts. The result was a semiballistic vehicle, blunt but with a certain amount of aerodynamic lift, with a nearly flat top and a round bottom for heat protection. This design was known as the M-1.
Oct. 15, 1957	At a NACA conference at Ames, three schools of thought were evident regarding the shape a manned spacecraft should take: (1) a delta-wing flat-bottom glider (favored by many at Langley)*; (2) a ballistic capsule (considered by the Pilotless Aircraft Research Division of Langley to be the quickest solution to finding a workable—launchable—configuration);† and (3) a compact low lift-to-drag vehicle with little or no wings and a blunt nose (Eggers's M-1 design).
1958-1960	Specialists at Ames continued testing models of lifting bodies in wind tunnels and in the atmosphere entry simulator, continually refining the designs.
April 11-14, 1960	An Air Force-NASA Joint Conference on Lifting Manned Hypervelocity and Reentry Vehicles was held at Langley Research Center.
1961-1962	Robert Dale Reed at NASA's Flight Research Center (FRC) built small models of the M-1 design and demonstrated the possibility of towing a lightweight lifting body for testing purposes.
Spring 1962	Personnel at Langley began to study a lifting body configuration they called HL-10.
Summer 1962	FRC was planning to construct several lightweight full-scale glider vehicles for a lifting body flight test program.
Oct. 1962	FRC management approved the construction of a test-flight model of the M-1; it was designated the M2-F1. Fabrication began in-house with the assistance of Sailplane Corporation of America.
March 1, 1963	An attempt to ground-tow the M2-F1 was unsuccessful because of its poor lateral control.
March 1963	The Air Force proposed to NASA that the two agencies jointly manage the Air Force X-20 program.

Table 4-68.
Chronology of Lifting Body Development and Operations (Continued)

Date	Event
April 5, 1963	The M2-F1 was ground-towed successfully for the first time.
Aug. 16, 1963	The M2-F1 was carried aloft to 4000 meters on a C-47 and released for its first glide to a controlled landing.
Dec. 18, 1963	Langley personnel suggested that the center sponsor a study of hypersonic lifting vehicles with propulsion systems.
Jan. 7, 1964	NASA established an Ad Hoc Committee on Hypersonic Lifting Vehicle with Propulsion.
Feb. 19, 1964	FRC issued a request for proposals for developing two advanced lifting bodies.
April 14, 1964	A subpanel for coordinating manned lifting reentry vehicle studies was established by the Manned Space Flight Panel of the Aeronautics and Astronautics Coordinating Board (AACB).
April 20, 1964	A project approval document for the lifting body program was signed by NASA Headquarters officials.
April 21, 1964	Northrop Division of Northrop was chosen by NASA to build two advanced lifting bodies—one M2 and one HL-10—for a flight test program (contract awarded on June 2, 1964).
Summer 1964	NASA engineers conducted design studies for incorporating the XLR-11 jet engine into the lifting bodies being constructed.
June 18, 1964	The AACB ad hoc committee on lifting reentry vehicles submitted their final report.
Nov. 11, 1964	Ames Research Center issued a request for proposals for a feasibility study of lifting body "space shuttle" vehicles with emphasis on aerodynamic characteristics.
Feb. 1, 1965	FRC issued a request for proposals for two preliminary feasibility studies for a manned lifting reentry vehicle.
March 26, 1965	Ames issued a request for proposals for a study of the protective equipment required on a "space shuttle" lifting body.
April 19, 1965	A NASA-Air Force agreement on testing the M2-F2 and HL-10 was signed.
April 30, 1965	FRC awarded McDonnell Aircraft Company and Northrop contracts for feasibility studies for a manned lifting body flight program.
June 15, 1965	A roll-out ceremony was held at Northrop for the M2-F2.
Jan. 1966	Langley issued a request for proposals for a study on how the size of a lifting body would influence research potential and project costs.
Jan. 18, 1966	Northrop delivered the HL-10 to FRC.
March 23, 1966	The first captive flight with the M2-F2 attached to a B-52 took place at FRC.
April 8, 1966	NASA selected the Martin Company to study the costs, crew size, and complexity of a flight research program that used a manned lifting body.
April 18, 1966	NASA Headquarters decided not to proceed with plans for an orbital flight test of a lifting body configuration, as had been suggested by the project personnel.
July 12, 1966	The M2-F2 successfully performed its first flight; it was released from a B-52 at 14 000 meters.**
Dec. 22, 1966	The HL-10 successfully performed its first flight at FRC. By this time, the M2-F2 had been flown 14 times.

Table 4-68.
Chronology of Lifting Body Development and Operations (Continued)

Date	Event
May 10, 1967	During the 16th M2-F2 test flight, the pilot was forced to make a 350-kilometer-per-hour landing with the landing gear up; the craft rolled over six times, injuring the pilot. The vehicle was subsequently rebuilt as the M2-F3.
July 11, 1967	Martin Company's X-24 (SV5-P) lifting body sponsored by the Air Force was rolled out for inspection. NASA was to participate in flight tests at FRC.
Nov. 7, 1967	The NASA-Air Force agreement was extended to include testing of the X-24A.
March 1968	NASA Headquarters gave its authorization to restore the damaged M2-F2.
Feb.-April 1968	The X-24A underwent wind tunnel tests at Ames.
March 15, 1968	Flights resumed with the HL-10 after the craft had been modified to improve its stability.**
Oct. 23, 1968	First attempt to fly a powered HL-10 failed because the XLR engine shut down prematurely.
Nov. 13, 1968	First successful powered flight of the HL-10 took place at FRC.
Dec. 9, 1968	The HL-10 took its 14th flight.

*This design would become the Air Force X-20 lifting body. Northrop was interested in pursuing this concept. The Martin Company was the firm finally selected to build the lifting body configuration.

†With modifications, this design became the Mercury truncated cone flown by NASA.

**See table 4-72 for a flight log of M2-F2 and HL-10 activity.

Table 4-69.
M2-F1 Lifting Body Characteristics

<i>Shape:</i>	130-degree half-cone body with a blunt nose and vertical tail fins
<i>Dimensions (m):</i>	
Length:	6.1
Width:	3.96
Height:	3
<i>Weight (kg):</i>	513
<i>Construction:</i>	Plywood, tubular steel, fiberglass
<i>Controls:</i>	2 vertical rudders for yaw; 2 trailing-edge flaps for pitch; 2 elevons working in synchronization for pitch and in opposition for roll
<i>First Flight:</i>	
Ground-tow:	April 5, 1963
Air-tow:	Aug. 16, 1963
<i>Times flown:*</i>	
Ground-tow:	400
Air-tow:	100
<i>Test pilots:</i>	Milton O. Thompson, Charles Yeager, William H. Dana, Fred Haise, Bruce A. Peterson, Tom Millick
<i>Cognizant</i>	ARC (design)
<i>NASA Center:</i>	FRC (flight testing)
<i>Program manager:</i>	Robert Dale Reed
<i>Project leader:</i>	Vic Horton
<i>Contractor:</i>	Sailplane Corporation of America, hull
<i>Mode of operation:</i>	Ground-towed or air-towed (C-47)

*Approximate number of experiments.

Table 4-70.
M2-F2 Lifting Body Characteristics

<i>Shape:</i>	Half-cone body (flat top, round bottom) with blunt nose and vertical tail fins
<i>Dimensions (m):</i>	
Length:	6.75
Width:	2.92
Height:	2.69
<i>Weight (kg):</i>	2300 (with water ballast test tanks full, 4100)
<i>Construction:</i>	Aluminum
<i>Controls:</i>	Rudder on outer face of each fin for yaw; upper flaps for roll control and pitch trim; full-length pitch flap on lower surface of tail
<i>First flight:</i>	July 12, 1966
<i>Last flight:</i>	May 10, 1967
<i>Times flown:</i>	16
<i>Test pilots:</i>	Milton O. Thompson, Bruce A. Peterson, Donald Sorlie, Jerauld R. Gentry
<i>Cognizant</i>	ARC (design)
<i>NASA Center:</i>	FRC (flight testing)
<i>Program manager:</i>	John McTigue
<i>Contractor:</i>	Northrop Corporation, prime
<i>Remarks:</i>	Repaired after a crash-landing in May 1967 damaged the vehicle: it was redesignated the M2-F3; flights were resumed in mid-1970.
<i>Mode of operation:</i>	Released in mid-air from under the wing of B-52

Table 4-71.
HL-10 Lifting Body Characteristics

<i>Shape:</i>	Half-cone body (round top, flat bottom) with blunt nose and three vertical tail fins
<i>Dimensions (m):</i>	
Length:	6.75
Width:	4.597
Height:	3.48
<i>Weight (kg):</i>	2400 (with water ballast test tanks full, 4100)
<i>Construction:</i>	Aluminum
<i>Controls:</i>	Thick elevon between each fin and center fin for pitch and roll; split rudder on center fin for yaw and speed brake
<i>First flight:</i>	Dec. 22, 1966
<i>Last flight:</i>	July 17, 1970
<i>Times flown:</i>	37
<i>Test pilots:</i>	Bruce A. Peterson, Jerauld R. Gentry, John A. Manke, William H. Dana, Peter Hoag
<i>Cognizant</i>	LaRC (design)
<i>NASA Center:</i>	FRC (flight testing)
<i>Program manager:</i>	John McTigue, FRC
<i>Contractor:</i>	Northrop Corporation, prime
<i>Remarks:</i>	In the fall of 1968, an XLR-11 engine was installed to give the HL-10 the capability of powered flight (it was still launched from a B-52, however); the first powered flight took place on October 23, 1968, but the attempt failed because the engine shut down prematurely; a second attempt on November 13, 1968 was successful.
<i>Mode of operation:</i>	Released in mid-air from under the wing of a B-52

Table 4-72.
MS-F2 and HL-10 Flight Log, 1966-1968

No.	Date	Flight no.*	Pilot	Max. alt. (m)†	Max. speed (km/hr)	Max. Mach	Flight time (sec.)	Remarks
<i>1966</i>								
1	July 12	M-1-8	Milton O. Thompson (NASA)	13 700	727	0.64	216	First M2-F2 flight
2	July 19	M-2-9	Thompson	13 700	634	0.59	245	
3	Aug. 12	M-3-10	Thompson	13 700	655	0.61	278	
4	Aug. 24	M-4-11	Thompson	13 700	716	0.67	241	
5	Sept. 2	M-5-12	Thompson	13 700	748	0.70	226	First 360° approach
6	Sept. 16	M-6-13	Bruce A. Peterson (NASA)	13 700	750	0.71	210	
7	Sept. 20	M-7-14	Donald Sorlie (USAF)	13 700	678	0.63	211	
8	Sept. 22	M-8-15	Peterson	13 700	702	0.66	233	
9	Sept. 28	M-9-16	Sorlie	13 700	713	0.67	225	
10	Oct. 5	M-10-17	Sorlie	13 700	690	0.61	234	
11	Oct. 12	M-11-18	Jerauld R. Gentry (USAF)	13 700	702	0.66	226	
12	Oct. 26	M-12-19	Gentry	13 700	641	0.60	260	
13	Nov. 14	M-13-20	Gentry	13 700	714	0.68	229	
14	Nov. 21	M-14-21	Gentry	13 700	735	0.69	235	
15	Dec. 22	H-1-3	Peterson	13 700	734	0.69	186	First HL-10 flight
<i>1967</i>								
16	May 2	M-15-23	Peterson	13 700	660	0.62	231	
17	May 10	M-16-24	Peterson	13 700	649	0.61	222	Crash landing injured pilot and craft
<i>1968</i>								
18	March 15	H-2-5	Gentry	13 700	682	0.60	242	
19	April 3	H-3-6	Gentry	13 700	732	0.68	241	
20	April 25	H-4-8	Gentry	13 700	739	0.69	257	
21	May 3	H-5-9	Gentry	13 700	732	0.68	245	
22	May 16	H-6-10	Gentry	13 700	719	0.67	264	
23	May 28	H-7-11	John A. Manke (NASA)	13 700	697	0.65	245	
24	June 11	H-8-12	Manke	13 700	697	0.65	245	
25	June 21	H-9-13	Gentry	13 700	679	0.63	271	
26	Sept. 24	H-10-17	Gentry	13 700	723	0.68	245	First flight with XLR-11 engine (engine not activated)

Table 4-72. (Continued)
MS-F2 and HL-10 Flight Log, 1966-1968

No.	Date	Flight no.*	Pilot	Max. alt. (m)†	Max. speed (km/hr)	Max. Mach	Flight time (sec.)	Remarks
27	Oct. 3	H-11-18	Manke	13 700	758	0.71	242	
28	Oct. 23	H-12-20	Gentry	12 100	723	0.66	188	First powered flight attempt; premature shut-down of engine
29	Nov. 13	H-13-21	Manke	13 000	842	0.84	385	First successful powered flight; (2 chambers ran 186 sec.)
30	Dec. 9	H-14-24	Gentry	14 450	871	0.87	393	Powered flight

*Vehicle letter code plus flight number of that particular vehicle plus B-52 carrier flight number (M = M2-F2 and H = HL-10).

†The altitude at which the lifting body was released from the B-52 carrier.

DESCRIPTION—ELECTRONICS AND CONTROL PROGRAM

When the Office of Advanced Research and Technology was organized in November 1961, one of the research areas given emphasis for the first time was electronics. NASA had inherited expertise in many fields when it was formed in 1958, but electronics was not one of them. To be sure, there were specialists working on propulsion, guidance systems, and other critical areas who were experts when it came to electronics, but their primary concern was with the larger system, not with its particular electronic components. It was estimated that some 40 percent of the cost of launch vehicles, 70 percent of the cost of satellites, and 90 percent of the cost of tracking and data acquisition equipment was for electronic components, and unfortunately most of NASA's early hardware failures could be traced in part to some electronic malfunction. Early flight experience indicated that there were significant differences between the reliability requirements of electronic instruments used on earth and those used in space. The agency needed some in-house, centrally-located expertise in this field, which affected guidance and navigation equipment, communications and tracking, instrumentation and data processing, and vehicle control and stabilization.

NASA was, of course, committed to contracting with industry and universities for research in all fields, including electronics, but the agency needed to develop some level of competence by which to direct this work and to evaluate the end products. In the early years of space vehicle development, electronics technology borrowed from aeronautics and missile programs was sufficient, but with demands for increasingly sophisticated hardware the old equipment—as adapted by specialists at NASA's centers—could only be used as a stopgap. NASA engineers often needed unique items, often in small quantities, that would survive the rigors of launch, ex-

posure to the harsh environment of space, and atmospheric reentry. Private companies were seldom interested in making one-of-a-kind or extremely-limited-production items, and university research in electronics was not expanding at a fast enough rate. When Albert J. Kelley was appointed NASA's first director of electronics and control, he was charged with assessing the agency's needs and capabilities in basic electronics research and then proposing whatever steps would be necessary to ensure that all elements of the space program could be satisfied by in-house competence.

Not surprisingly, Kelley's fall 1962 report called for a significant increase in electronics research within NASA. Rather than step up electronics research at the several NASA centers that had requirements in this field or assign a particular center the role of coordinator of electronics research in addition to its other functions, Kelley recommended that a new research facility be established that would be dedicated to electronics. Electronics was too important to become an appendage to some existing center, and many specialists — managers and technical people — agreed that electronics work would be most successful if it were centralized in one location. This new center would be capable of providing agencywide leadership and act as an information channel for new requirements and new data. Administrator James E. Webb agreed with Kelley's analysis, but also was acutely aware of the possible political problems that a proposal for a new NASA center might bring. NASA did not immediately request funds for the new facility in the FY 1964 budget (which was being prepared in the fall of 1962), but planned to reprogram from other sources the money it might need in the early phases of the new center's development (estimated at \$5 million for the first year). Selecting a prime site for the research center was not difficult, but getting the site approved was a long, often unpleasant affair. Webb, Kelley, and others agreed that Boston offered the best environment for an electronics center. MIT, Harvard, and many industrial concerns that also conducted electronics research would be close by, which would contribute to a productive research and development atmosphere. Members of Congress, however, heatedly argued for other sites and delayed approval for NASA's new center until spring 1964.¹¹ The Electronics Research Center (ERC) was formally activated on September 1, 1964 in Cambridge, Massachusetts.*

The Electronics Research Center, with Winston E. Kock as director and Albert Kelley as deputy director, parceled the research tasks into several logical divisions: systems, components, guidance and control, instrumentation and data processing, and electromagnetic research. At headquarters, Francis J. Sullivan became OART's director for electronics and control. Reporting to the director were chiefs for guidance and navigation (later guidance and control), control and stabilization (later requirements and systems), communications and tracking (later microwaves and optics), and instrumentation and data processing; electronics technology and components was a fifth division added in 1968.

All NASA centers participated to some extent in electronics research or component testing, with ERC serving as the prime investigator, coordinator, and clearinghouse.† ERC worked closely with its many contractors as new components were

* ERC absorbed NASA's North Eastern Office, which since August 14, 1962, had acted as the agency's liaison with industry in the northeastern states.

† Because of post-Apollo budget reductions, NASA was forced to close ERC in 1970. The facilities were transferred to the Department of Transportation.

developed and tested to meet specific project needs and as basic research was expanded to include such new fields as microwaves and optics. When test conditions could not be adequately simulated in the laboratory, OART funded flight projects to verify new hardware or theories. These included Project RAM (Radio Attenuation Measurements), with two flights in the 1958-1968 period, SCANNER, and other small experiments sent aloft on sounding rockets or incorporated into satellite payloads on a noninterfering basis. Most of the research conducted in the electronics and control program was funded by supporting research and technology monies.

Guidance and Control

From the initial planning for manned lunar missions and long-life scientific satellites, it was obvious that launch vehicles and spacecraft would have to be equipped with instruments that would stabilize them during all phases of flight and guide them, either automatically or manually, to their destinations. Guidance systems research was directed toward designing simple, lightweight, reliable sensors, reference elements, and associated components that made up an onboard guidance system. By studying sensors and control mechanisms, control systems researchers sought to optimize flight stabilization techniques, improve visual displays, and develop adaptive automatic controls. Personnel at several NASA centers worked in this area of research. At the Electronics Research Center two laboratories supported guidance and control studies: the Guidance Laboratory and the Control and Information Systems Laboratory.

Work on guidance systems was generally divided among four categories: inertial reference sensors and systems, navigation techniques and displays, electromagnetic sensors, and guidance theory and trajectory analysis. Work on developing improved gyroscopes (cryogenic and electrostatic) was going on at Marshall Space Flight Center and at the Jet Propulsion Laboratory before the projects were transferred to ERC. The electrostatic gyro was flight-tested in aircraft in 1968. The sun, stars, and planets, primary targets for space navigation and reference systems, are located automatically by onboard electromagnetic sensors or electro-optical star trackers or manually with hand-held sextants. Finding the simplest and most reliable systems for navigation on a manned flight was a major goal of the 1960s. In addition, several experiments were performed that measured the radiance characteristics of earth's horizon to serve as a basis for developing highly accurate navigation and attitude control sensors.

Three major tasks faced control systems specialists: research into very high-performance automatic control systems necessary to achieve the precise pointing characteristics required of communication satellites, development of manual control systems in which the crew played an active part, and furthering the study of control and information theory. One important development in this area was the control moment gyro, a momentum storage device used to stabilize the Apollo telescope mount (which became a major experiment and structural element on Skylab) or other large spacecraft. Gravity gradient stabilization (as employed by some Application Technology Satellites) also was investigated, at the Air Force's suggestion. Mathematical modeling was used by researchers in their analysis of pilot performance with different manual control systems and various information display devices.

Communications and Tracking and Data Acquisition

Long-life, lightweight communications systems capable of handling ever increasing loads were of concern to all NASA centers. At Goddard Space Flight Center, researchers incorporated OART-funded experiments into satellites to test communications and tracking systems for advanced scientific satellites (*S-66*, *Explorer 22*, and *Explorer 27* are examples; see tables 3-138, 3-88, and 3-92). Concern over the blackout period caused by ionized plasmas during vehicle reentry led OART to fund a series of radio attenuation measurements (Project RAM), with several launches in the pre-1969 period (for more information see electronics and control flight projects). Optical and microwave communications devices were under study at Goddard, MIT, IBM, and General Electric. When the Electronics Research Center was built, two special facilities—the Microwave Radiation Laboratory and the Space Optics Laboratory—took over many of these research tasks. Research on deep space communications and tracking was a special concern of the Jet Propulsion Laboratory. Researchers at JPL and ERC were particularly interested in managing the very high data rates required for the real-time transmission of high-resolution images and scientific experiments data. High-power microwave tubes and electro-optical systems were two possible answers. JPL researchers perfected a video film converter and associated digital computer equipment for recovering high-quality image data from the noisy and distorted television signals received from spacecraft (a prototype of this image enhancement system was used in Project Ranger; an improved version was carried on *Mariner 4*). Other areas of research included the search for improved computer processing and data transmissions, more efficient on-board telemetry techniques, new microminiaturized instruments, and the development of thin-film laminated ferrite materials for use in computer memories.

Building larger (or longer) antennas for spacecraft and ground stations was particularly important to tracking specialists, once the initial problems of real-time optical tracking and the accurate determination of spacecraft orbital parameters had been solved. Multiple array antennas and microwave antennas were studied at Langley Research Center, Goddard, and JPL. Researchers were studying the feasibility of 64-meter ground antennas and 9-meter spacecraft antennas.

Instrumentation and Data Processing

Scientists and engineers both required reliable instruments with which to measure the environment in which the spacecraft was operating and to monitor the vehicle's performance. Electronics researchers were continually searching for ways to increase the accuracy of these many and varied instruments, extend their measurement range, improve energy and signal conversion, reduce their size and power consumption, and ensure component compatibility. Some products of this research include miniaturized self-contained biomedical sensors, compact mass spectrometers and gas chromatographs, miniature accelerometers, and small solid-state television cameras. All NASA's centers were participants in this research or the application of the resulting new technology. ERC established an Instrumentation Research Laboratory with several advanced simulators with which to test new components.

NASA's computer specialists constantly reviewed the agency's growing needs

for data handling and processing, on the ground and onboard spacecraft. Computer technology was forced to advance rapidly with the space program. In the early 1960s, NASA specialists used computers to calculate trajectories or to control a launch, but by the end of the decade they required a system that could process and store the millions of bits of information per second that a television camera could produce. In addition to lightweight high-performance computers, the agency needed high-capacity onboard data storage devices. Researchers also looked for ways to compress data mathematically so that it could be transmitted in less time. A long-range research task in this field was the development of optical techniques for spacecraft computer memories. Automated flight-failure warning systems for aircraft also were under study. Another group of experts monitored man-computer interactions. In addition to work at NASA's other centers, ERC set up a Computer Laboratory to conduct basic and applied research to meet computer and data processing requirements of future NASA missions.

Electronic Techniques and Components

Reliability was the chief concern of researchers working in the techniques and components field. The technology of microelectronics and the materials and processes used to fabricate the components of a microelectronic system were of special interest. These specialists also developed test procedures for inspecting parts made by contractors and methods for analyzing electrical failures. Research to extend the reliable lifetime of parts was under way, as well. Work at ERC's Electronics Components Laboratory was divided into four branches: solid-state, materials, vacuum devices, and electromechanical.

Electronics and Control Flight Projects

Improved and new electronic components were tested on almost every NASA flight project, as were new techniques for tracking, communications, and data processing. However, proving some minor new electrical part or system was hardly ever listed as a prime mission objective. But in addition to early tracking experiments designed for Beacon-Explorer satellites (*S-66*, *Explorer 22*, and *Explorer 27*), three flight experiments in the 1958-1968 era were linked to the electronics and control program.

Project SCANNER. The objective of Project SCANNER (also called Horizon Definition Research Project) was to make detailed measurements of earth's horizon radiation profile and to determine the existence of relatively stable gradients in the profile that could be used to design precise horizon sensors. Project SCANNER was undertaken as an extension of laboratory research on horizon characteristics to verify theoretical predictions of the existence and nature of radiation gradients. Two ballistic flights, launched from Wallops Island in 1966 by modified Scout launchers, measured the energy radiated from the horizon.* The data collected allowed re-

*The Air Force was conducting similar experiments with the support of the Ohio State University Research Foundation. The Air Force planned six Trailblazer (Air Force designation for its Scout launch vehicle and the same vehicle used by NASA for SCANNER) flights for 1966-1967.

searchers to draw an accurate correlation between theoretical predictions and experiments. Project management came from Langley Research Center (see table 4-73).

Earth Coverage Horizon Measurement. This project was designed to extend the limited measurements attained with Project SCANNER and with X-15 borne instruments. The investigators wanted to make a comprehensive measurement of earth's horizon radiance profile over a broad range of seasonal and latitudinal variations. Project definition studies were under way in 1967-1968.

Project RAM (Radio Attenuation Measurement). During atmospheric reentry, a spacecraft experiences a brief period of communications blackout when the gas surrounding the vehicle becomes ionized because of intense heating. The attenuation suffered by radio signals (electromagnetic waves) traversing this plasma sheath is due to the free electrons in the plasma, which collide with other gas particles. The density of the electrons determines the degree of radio energy absorption and reflection. Speed and the angle of reentry also affect the length of the blackout period. A manned spacecraft returning from a lunar mission would reenter at such high speeds and at such a shallow angle that the crew could be out of contact with the recovery team for several (7-11) critical minutes. To study the blackout problem, the Office of Advanced Research and Technology initiated Project RAM in FY 1961.

The first two series of ballistic flight experiments obtained data on the plasma sheath at reentry velocities in the 5500-meter-per-second range and demonstrated the utility of techniques such as varying the aerodynamic shape of the body, using higher radio frequencies, and injecting water around the reentering vehicle. To support RAM A and B flights (1961-1964), specialists at Langley Research Center explored the transmission of microwave signals through ionized plasma under conditions that simulated reentry. In addition, on *Gemini 3*, the first manned Gemini

Table 4-73.
Project SCANNER Characteristics

	Flight 1	Flight 2
Date of launch	Aug. 16, 1966	Dec. 9, 1966
(location):	(WI)	(WI)
Launch vehicle:	Trailblazer (USAF Scout)	Trailblazer (USAF Scout)
Weight (kg):	250	250
Shape:	Cylindrical with a conical nose	
Dimensions (m):		
Length:	3.05	3.05
Diameter at base of cone:	0.76	0.76
Date of reentry:	Ballistic trajectories	
Cognizant NASA center:	LaRC	
Project manager:	Howard J. Curfman, Jr.	
Contractor:	Honeywell Systems & Research Division, prime	
Objective:	To obtain data during a ballistic flight needed to design and develop improved horizon-scanning instrumentation for future spacecraft stabilization systems.	
Experiments:	2-channel radiometer Star mapper telescope Infrared horizon sensors	
Results:	Both flights were successful and returned data as planned.	

flight (March 23, 1965), a RAM experiment was conducted. Water was sprayed in extremely brief, timed pulses at different flow rates in the hot gas envelope surrounding the spacecraft on its reentry. This increased the strength of C-band and UHF telemetry signals, but the results of the experiment were inconclusive. OART called for a third series of RAM reentry flights at increasing velocities. Approval for RAM C was granted in late 1964.

In addition to ground experiments and theoretical analyses, plans called for two ballistic reentry flights. Launched by Scout vehicles, the RAM reentry payloads traveled at the medium-velocity range (7600-8200 meters per second). The first experiment (October 19, 1967) again attempted to measure the effectiveness of injecting water into the plasma (it used X-band radio frequency instead of S-band). RAM C-2 (August 22, 1968) measured electron and ion concentrations in the flow field at various points along the reentry path with microwave reflectometers. Approval for a third flight experiment came in mid-1969. RAM C-3 carried freon and water injection experiments on September 30, 1970. All RAM flight experiments were performed successfully and the results compared to similar Department of Defense experiment data. With this information, specialists could more accurately predict high-altitude flow field characteristics and work on the design of a practical liquid injection system to help future spacecraft overcome the blackout problem.

RAM was a Langley project, with Theo E. Sims serving as project manager. The spacecraft were assembled in-house. Funds came initially from OART's space vehicle systems budget, but after the electronics and control program was established RAM was funded from its budget. Jack Levine was OART's project officer for RAM at NASA Headquarters (see tables 4-74 and 4-75).

Table 4-74.
Project RAM A and B Characteristics

	RAM A-1	RAM A-2	RAM B-1	RAM B-2	RAM B-3
Date of launch (location):	Aug. 30, 1961 (WI)	Feb. 21, 1962 (WI)	Sept. 21, 1962 (WI)	May 28, 1963 (WI)	April 10, 1964 (WI)
Launch vehicle:	Hybrid vehicle sometimes called RAM A*		hybrid vehicle sometimes called RAM B†		
Weight (kg):	approx. 34	approx. 34	80	112	112
Shape:	hemispherically blunted 9 degree half-angle cone		blunt-cone cylinder		
Dimensions (m):	Length: 3.7 (with the 4th stage)		1.7		
Date of reentry:	Ballistic trajectories				
Cognizant NASA center:	LaRC				
Project manager:	Theo E. Sims				
Objective:	To explore the communications blackout problem experienced during spacecraft reentry at velocities up to 5500 meters per second.				
Results:	All experiments except B-1 returned data as expected; RAM B-1 was unsuccessful because the launch vehicle's second stage malfunctioned.				

*This four-stage vehicle consisted of a Castor XM 33E3 first stage with two auxiliary Recruit XM 19 engines, two XM 45 stages, and another Recruit XM 19 as the fourth stage. It was 19.8 meters tall and weighed 6500 kilograms.

†The Ram B vehicle had three stages: a Castor E-8 first stage, an Antares (X-254-A1) second stage, and an Alcor (AJ-10) third stage. Launched by the rail method, the vehicle was 12.8 meters tall and weighed 6000 kilograms. It was similar to the Air Force Blue Scout.

Table 4-75.
Project RAM C Characteristics

	RAM C-1	RAM C-2
Date of launch (location):	Oct. 19, 1967 (WI)	Aug. 22, 1968 (WI)
Launch vehicle:	Scout (S-159C)	Scout (?)
Weight (kg):	117	120
Shape:	hemispherical cone	
Dimensions (m):		
Length:	13.9	
Largest diameter:	0.66	
Smallest diameter:	0.3	
Date of reentry:	Ballistic trajectories	
Cognizant NASA center:	LaRC	
Project manager:	Theo E. Sims	
Contractor:	Ling-Temco-Vought, systems integration	
Objective:	To explore the communications blackout problem experienced during spacecraft reentry at velocities up to 8200 meters per second.	
Experiments:	VHF telemetry transmissions X-band transmissions L-, S-, and K _a -band transmissions (C-2 only) water injection (C-1 only) Langmuir probe	
Results:	All experiments returned data as planned.	

DESCRIPTION—HUMAN FACTOR SYSTEMS PROGRAM

The establishment in mid-1962 of OART's human factor systems program—a catchall title for research in the fields of man-system integration, biotechnology, the human body, and advanced concepts for manned spacecraft systems—was only one aspect of NASA's participation in life sciences activities. How the life sciences came to be divided among the Office of Manned Space Flight (aerospace medicine), the Office of Space Science and Applications (bioscience), and the Office of Advanced Research and Technology is a complicated story. When NASA was formed in 1958, its most immediate and obvious need in the life sciences field was medical specialists who could help engineers design a Mercury spacecraft that would support an astronaut and who could help choose, train, and monitor the health of the agency's pilots and astronauts. Man, a critical component of the total engineering configuration and the overall operational plan, had to be integrated into a man-machine system, a system designed with man's needs, capabilities, and limitations considered as critical engineering constraints. Obviously, this was the responsibility of the Space Task Group, an organization at Langley Research Center charged with NASA's first manned project (this group later became the nucleus of the Manned Spacecraft Center in Houston). A biomedical team, the Aeromedical Consultants Staff, was organized as part of the Space Task Group in November 1958 to under-

take the medical and human factors work that was required.* In the late 1950s, NASA managers had no precise idea as to what the future held for the manned program and, therefore, had given little thought to the advanced research that would be needed for future manned systems; emphasis was on Mercury and today's requirements.

Faced with the need to coordinate the Space Task Group's biomedical activities with NASA Headquarters program planning and prompted by advice from his staff and special advisory groups (and charges from academia that basic research in biology was being ignored), NASA Administrator T. Keith Glennan sought to centralize and strengthen the agency's life sciences program by creating an Office of Life Sciences Programs in March 1960 (on par with the Office of Space Flight Programs). But the experiment was short-lived. The office was abolished in August 1961 for several reasons: lack of support, financial and managerial; unclear lines of authority; and no precise goals for the future. An agencywide reorganization in November 1961 in response to a major expansion in the scope of the manned program gave bioscience a more secure niche as part of the Office of Space Sciences.† The Office of Manned Space Flight (OMSF) was given authority for aerospace medicine. Advanced human factor research, however, was not given a place in OART until July 1962 (see fig. 4-1). This tripartite organization of the life sciences would survive through the rest of the agency's first decade, but not without a great deal of destructive competition between bioscience (OSSA) and human factor systems (OART) for limited funds and managerial support. And relations between the human factor researchers and OMSF's biomedical people was seldom an easy one. To make matters worse, some members of Congress always suspected that NASA's research in advanced human factor systems only duplicated that being conducted by the Air Force, while the Air Force felt it was competing with the civilian agency for dwindling research dollars. It was a difficult set of circumstances under which to work, but NASA's advanced human factor specialists did manage to contribute to the lunar exploration program and to the design of advanced systems for spacecraft and aircraft.

The basic premise assumed by researchers in OART's human factor systems program was that man was a critical component of the spacecraft; together they were a man-machine system. Research activities fell into four categories. (1) Man-

*The Air Force had long been interested in aerospace medicine and human engineering. A department of space medicine was established in 1950 at the USAF School of Aviation Medicine, Wright Air Force Base. In the early 1950s at the Aviation (later Aerospace) Medical Laboratory at Wright-Patterson, researchers were investigating the possible effects of spaceflight on man. At the Aeromedical Field Laboratory at Holloman Air Force Base in 1948, specialists began their investigations of the effects that the space environment would have on subhuman organisms. Although the Navy had little interest in spaceflight before 1957, three Navy institutions were conducting research that would prove applicable to the space program. The Naval School of Aviation Medicine, the Navy's center for flight surgeon training, sponsored studies of the effects of high stress and extreme environments on pilots. Biomedical research and development work was conducted at the Aviation Medical Acceleration Laboratory (human research) and at the Naval Equipment Center (biotechnology).

† See also chapter 3, pages 252-62, for more information on the OSSA biosciences program.

machine integration studies were concerned with "critical points of contact of man with his vehicle," that is, the interfaces that "involve man's health, comfort, survival, observation, decision-making, integrative and manipulative skills," and the ways "in which man's limitations may affect this system." Of particular interest were studies of how well an astronaut could perform "routine" tasks outside the spacecraft and on the lunar surface. At Langley, specialists simulated a one-sixth gravity environment to evaluate man's ability to work and use tools on the moon. At the Manned Spacecraft Center, neutral buoyancy simulators were used in training to determine the possible impacts of weightlessness on crew activity. Requirements for long-term interplanetary and lunar bases was another topic of interest, as was aircraft safety. (2) Biotechnology, the design and engineering of life support systems, protective equipment, information displays, communications devices, and controls for manual operations, was an area in which the engineer and the medical specialist worked closely. These experts determined what effect man's needs would have on spacecraft design. Space suits also came under this group's purview, along with portable life support systems for extravehicular activity. The most visible of

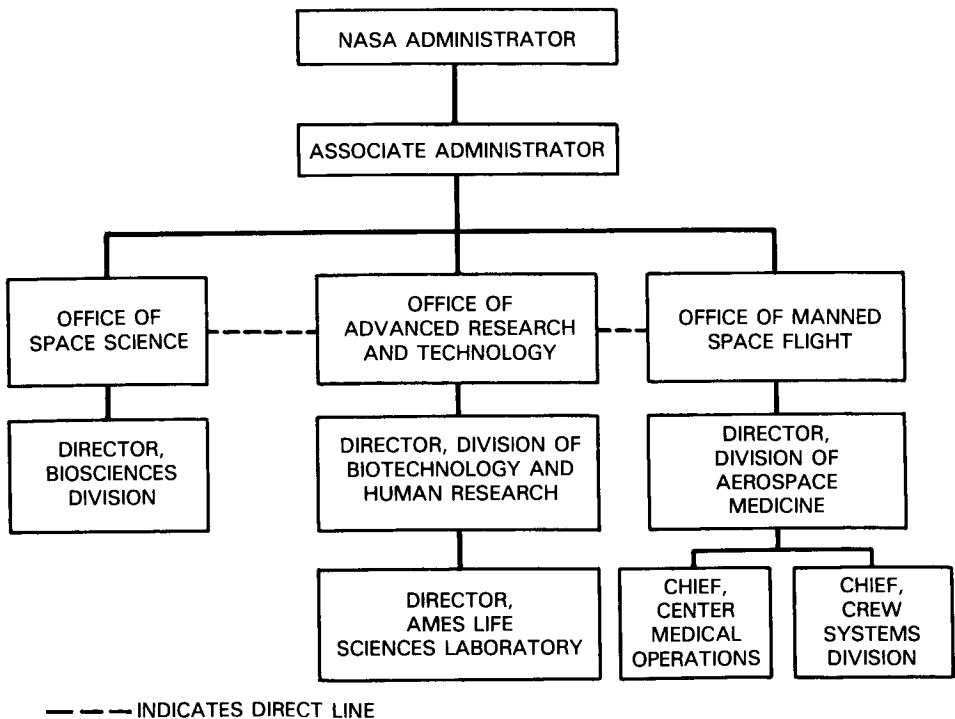

Figure 4-1. NASA Life Sciences Elements, August 1962.* The reorganization of 1961-1962 created three separate, functionally independent life sciences components and placed them under the management jurisdiction of three different program office administrators.

* From John Pitts, *The Human Factor: Biomedicine in the Manned Space Program to 1980*, NASA Sp-4213 (Washington, 1985), p. 79.

biotechnology projects was the search for a regenerative life support system. Langley personnel were testing a closed regenerative system built by General Dynamics/Astronautics in the late 1960s capable of housing a crew of four for 100 days. (3) Human research was perhaps the most general category of the four. The objective here was to understand the physiological and psychological reactions of man to long-term exposure to the hostile environment of space and the rigors of flight, and to predict how these reactions would affect his performance and well being. The phenomena under examination were many: zero gravity, extreme acceleration forces, vibration, solitary confinement, radiation, artificially-produced atmospheres. Radiobiology and acceleration research were of special importance. Researchers also investigated how lengthy space missions would affect metabolism, nutritional needs, and the cardiovascular system. (4) The final area of research was called advanced concepts, but as all OART's work was "advanced" we can take this title to mean research on systems that would require even greater advances in the state of the art. Bionics and cybernetics were among the fields studied in the search for new ways to further integrate man into the operational systems of spacecraft and aircraft. Inflatable space suits and direct eye or nerve-impulse control over spacecraft instruments are examples of futuristic concepts under study in 1964-1968.

The human factor systems team did not sponsor any major flight projects, but it did have funds for small biotechnology flight experiments to supplement the laboratory work conducted at Ames, Langley, the Manned Spacecraft Center, and elsewhere.* These experiments (testing new components, observing the effects of a particular environment on a subhuman organism, evaluating some new material) were flown by sounding rockets, balloons, and high-speed aircraft or on satellites and manned flights where the configuration allowed. One project involved the collection of physiological data from a large number of individuals who spent long periods of time under stressful conditions representative of those encountered during spaceflight. For several months, students at the Air Force Aerospace Test Pilots School at Edwards Air Force Base wore special instruments that monitored certain body systems. With these data, specialists developed new standards for "normal" heartbeat, blood pressure, and respiration for astronauts functioning for prolonged periods under stress.

Eugene B. Konecci was OART's first director for human factor systems research, taking the job in July 1962. He strongly favored the systems approach to solving the life sciences problems of manned spaceflight. He viewed man and the vehicle as individual total systems made up of numerous subsystems. The ultimate object of life sciences research and development, as Konecci saw it, was to optimize the integration of man and spacecraft in terms of their subsystems. Orr Reynolds, director of OSSA's bioscience program, saw life sciences research on a more general and purely scientific scale. These two men, with their basic academic disagreements, competed for funds and facilities; there was little cooperation between the two groups. Walton L. Jones took over the human factor systems post in October 1964. Answering to the director were chiefs for man-system integration, biotechnology, human research, and advanced concepts.

*John Pitts in *The Human Factor* argues that Ames Research Center with its special life sciences facilities more directly supported bioscience investigations than human factor research.

DESCRIPTION—SPACE POWER AND PROPULSION PROGRAM

In the 1960s, NASA's advanced planners were predicting that future spaceflight projects would send increasingly heavy payloads on lengthy interplanetary and lunar missions. To send manned spacecraft to the outer reaches of our solar system and to support lunar and orbital laboratories, NASA would require boosters much more powerful than the 1960s-era chemical rockets plus lightweight onboard power systems that produced megawatts of electricity. Research leading to advanced power and propulsion systems, originally under the direction of NASA's radioisotope vehicle offices (see chap. 1), was assigned to OART in 1961. Larger chemical rockets, more efficient solar cells, solid- and liquid-core nuclear reactors, generators, and spacecraft stationkeeping propulsion devices were among the topics investigated by several OART divisions. Most of these projects were expensive, long-term, and complex. They often required close coordination with other government agencies, and usually the technology under development was not applicable to any ongoing flight projects. The great expense and the lack of specific requirements for the new systems made this field difficult to defend against the scrutiny of budget conscious managers and members of Congress. But if the U.S. wished to continue its role as a peaceful space-exploring and space-exploiting nation, NASA would have to initiate in the 1960s research that would lead to the development of new technology it would require in the 1970s and 1980s. As NASA managers and mission planners had discovered with the Centaur upper stage, propulsion systems required particularly long development lead times.

The changing management structure of OART's power and propulsion divisions reflected the agency's changing attitude toward different energy sources. After OART was established in 1961, Harold B. Finger became director of nuclear systems (in addition to being manager of the joint Atomic Energy Commission-NASA Space Nuclear Propulsion Office, which he had headed since August 1960), and W.H. Woodward became director of propulsion and power generation. In 1963, Finger and Woodward's offices joined forces in a new nuclear systems and space power division, while authority for advanced chemical propulsion went to the Adelbert O. Tischler in a new chemical propulsion division. The next year Finger and Woodward's operation was streamlined somewhat, and in 1967 the division name was changed to space power and electric propulsion (see table 4-76). Finger, Woodward, and Tischler were all former NACA propulsion specialists who had spent their early careers at the Lewis Flight Propulsion Laboratory before coming to Washington as headquarters managers.

Advanced propulsion experts were looking to three fields for systems that would provide power to boost spacecraft weighing up to 4500 kilograms to escape velocity. In addition to operating lunar ferries that could transport some 1.8 million kilograms of payloads over a six-year period between earth and the moon, NASA wanted to send orbiters to all the planets in the solar system and heavy landers to Mercury, Venus, Mars, Jupiter's moons, and Pluto, and eventually men to Mars (see table 4-77). Electric upper stages offered one solution for sending these large payloads on their way. Teamed with conventional chemical or advanced nuclear boosters, an electric propulsion system could be used very efficiently in a zero gravity environment. Electric propulsion was also being considered for spacecraft onboard propulsion (for stationkeeping and attitude con-

Table 4-76.
Changing Organization of OART Advanced Propulsion and
Power Systems Divisions, 1961-1968

Nov. 1961-1962

Director, Advanced Research and Technology

Director, Nuclear Systems (Harold B. Finger)

Deputy Director, Nuclear Systems (W. H. Woodward, 1962)

Assistant Director, Electric Thrust Systems (I. R. Schwartz)

Assistant Director, Electric Power Systems (Fred Shulman)

Assistant Director, Flight Test Systems (C. H. Seaton)

Assistant Director, Electrical Rocket Flight Systems (James Lazar)

Assistant Director, Nuclear Rocket Flight Systems (David Novik)

Assistant Director, Nuclear Flight Safety Program (Thomas B. Kerr)

Technical Assistant, Electric Propulsion and Power Systems (Harold P. Hipsher)

Director, Propulsion and Power Generation (Woodward; John L. Sloop, 1962)

Assistant Director, Liquid Propulsion Systems (Henry Burlage)

Assistant Director, Space Power Technology (Walter C. Scott)

Assistant Director, Solid Power Technology (Robert W. Ziem)

1963-1968

Administrator, Advanced Research and Technology

Director, Nuclear Systems and Space Power (Finger; Woodward, 1967); office renamed Space Power and Electric Propulsion in 1967

Deputy Director, Nuclear Systems and Space Power (Woodward); office dropped in 1968

Assistant Director, Nuclear Power Systems (Shulman)

Assistant Director, Electric Thrusters Systems (Lazar)

Assistant Director, Vehicle Technology (Nuclear and Space Power Systems) (Novik); office dropped in 1967

Assistant Director, Nuclear Flight Safety Evaluation (Kerr)

Assistant Director, Solar and Chemical Power Systems (Scott; Arvin H. Smith, 1964)

Director, Chemical Propulsion (Adelbert O. Tischler)

Assistant Director, Liquid Propulsion Technology Program (Burlage; Robert S. Levine, 1966)

Assistant Director, Liquid Propulsion Engineering Systems (James R. Flannagan; Ward W. Wilcox, 1966)

Assistant Director, Solid Propulsion Technology Program (Ziem)

Assistant Director, Solid Propulsion Engineering Systems (William Cohen)

1961-1968

Director/Administrator, Advanced Research and Technology

Manager, AEC-NASA Nuclear Programs Office (Finger; Milton S. Klein, 1967)

Facilities Officer (Edwin G. Johnson)

Safety Officer (Ralph S. Decker)

Chief, NERVA Engine Branch (H. R. Schmidt; Walter S. Scheib, 1962; William R. Slivka, 1963)

Chief, Advanced Engine Branch (F. C. Schwenk)

Technology Utilization Officer (Samuel Snyder); office added in 1967

trol maneuver). During NASA's first decade, electric systems such as these moved beyond theoretical and laboratory studies to rudimentary hardware tests with Project SERT (Space Electric Rocket Test). Experimental electric thrusters were carried on Applications Technology Satellites (ATS) payloads. Electric systems, researchers believed, could be highly reliable and lightweight. A hybrid system that combined solar cells with electric propulsion hardware was also being studied in the late 1960s.

Table 4-77.
Booster Requirements for Advanced Missions

Target	Type of Rocket								
	Electric			Nuclear			Chemical		
	No. of Boosters		Length of mission (days)	No. of Boosters		Length of mission (days)	No. of Boosters		
	IB	V		IB	V		IB	V	
A. Lunar ferries									
(1 800 000 kg total in 6 yr.)									
Moon	—	35	—	—	56	—	—	100	—
B. 900-kg orbiters									
Mercury	1	—	165	—	1	60	—	1	65
Venus	1	—	130	—	1	30	1	—	55
Mars	1	—	170	—	1	80	1	—	125
Jupiter, Ganymede	1	—	590	—	1	250	1	—	500
Jupiter	1	—	1100	No mission			No mission		
Saturn, Titan	1	—	850	—	1	600	1	—	1100
Saturn, outer ring	1	—	1000	—	1	900	—	1	1200
Uranus, Titania	1	—	1270	—	1	2000	—	1	2000
Uranus	1	—	1490	—	1	2000	No mission		
Neptune, Triton	1	—	1850	No mission			No mission		
Neptune	1	—	2170	No mission			No mission		
Pluto	1	—	2160	No mission			No mission		
C. 4500-kg landers									
Mercury	1	—	410	—	1	75	—	2	90
Venus	1	—	280	—	1	30	—	1	40
Mars	1	—	260	—	1	90	—	1	120
Ganymede	—	1	550	—	1	250	—	1	300
Titan	—	1	780	—	1	700	—	1	850
Titania	—	1	1200	—	1	2000	—	1	2000
Triton	—	1	1740	No mission			No mission		
Pluto	—	1	2030	No mission			No mission		
D. Manned Mars roundtrips									
Earth reentry									
37 000 m/sec	—	3	420	—	4	420	—	9	420
25 000 m/sec	—	5	450	—	14	420	—	123	420

A second field under investigation by propulsion specialists was nuclear systems. Graphite solid-core reactors and engines seemed the most likely nuclear technology on which to base an extremely powerful launcher. NASA began participating in the Atomic Energy Commission's (AEC) Project Rover in 1960 when the two government agencies established a joint nuclear rocket program. NASA supported the AEC's Kiwi reactor tests, hoping to fly a nuclear stage in Project RIFT (Reactor-in-Flight-Test) to evaluate the engine around which the NERVA (Nuclear Engine for Rocket Vehicle Applications) launcher would be built. The space agency assumed responsibility for the nonreactor components these projects would demand, for combining the reactor and other hardware into engine systems, for total vehicle development, and for providing the required propellants. The AEC was charged with the nuclear reactor research and engineering work.

A third area of advanced propulsion research was chemical, increasing the size and power of conventional solid- and liquid-fuel engines. Two important chemical propulsion projects of interest to NASA advanced planners were the M-1 engine (liquid hydrogen-liquid oxygen) and a large solid-fuel motor (the "260-inch" engine). With new chemical systems, specialists also planned to uprate existing launch vehicles with strap-on engines and assist motors and improve onboard spacecraft propulsion systems. Enriching liquid hydrogen and kerosene with fluorine (creating FLOX) was another OART project, but this technology was turned over to the Office of Space Science and Applications for possible use with Centaur.

Onboard spacecraft electric power was the other half of the advanced propulsion and power story. There was an immediate need for improved solar cell-battery systems, as scientific and applications payloads became increasingly sophisticated and large, requiring more and more power. Approximately one-third of the payload weight of a satellite was normally devoted to the power system, so the growth of the size of chemical batteries and solar panels was necessarily limited. Also, solar cells could be used only when sunlight was available (the battery was charged by solar energy for use when the spacecraft was in darkness or needed extra power). Advanced planners were thinking in terms of missions that would take interplanetary craft further and further from the sun, and the equipment required for such advanced missions would demand megawatts of electricity (in the 1960s spacecraft designers had to be content with a few hundred watts of onboard power). Besides improved solar and solar-battery systems, researchers were investigating the use of nuclear-generated electricity. There were two options: radioisotope generators (RTG) and reactors. In an RTG, radioisotopes such as plutonium decay and produce heat, which is converted to electrical energy; a reactor generates heat by splitting the nuclei of uranium or plutonium. AEC researchers had been investigating these two kinds of energy conversion since the 1950s, calling their power systems SNAPs (Systems for Nuclear Auxiliary Power). In their search for high-power lightweight electricity producers, OART personnel turned to the AEC for both RTGs and reactors. Working together, NASA and the Atomic Energy Commission studied SNAPs for Nimbus weather satellites and the Apollo lunar sample package (SNAP 19 and 27), as well as systems for future-generation spacecraft (SNAP 50).

These advanced propulsion-power research and development projects were complex, expensive undertakings that demanded the participation of most of NASA's research centers. Lewis Research Center in Cleveland took the lead role in the advanced propulsion field. Although many of OART's chemical propulsion projects had originally been assigned to the Marshall Space Flight Center, the

development of the large Saturn family of launch vehicles for Apollo forced that center's attention away from the bulk of future-systems research in 1961. Nuclear propulsion testing was carried out in Nevada at AEC facilities and at NASA's specially built Nuclear Rocket Development Station (NRDS). Nuclear systems contracts were let and managed by the AEC-NASA Space Nuclear Propulsion Office (SNPO). Lewis was also the primary center for electric power and propulsion research.

Electric Propulsion

Since it takes considerably less thrust to put a mass in motion once it is in zero gravity, advanced researchers at NASA considered developing relatively low-power electric propulsion systems for spacecraft. As an upper stage of a launch vehicle (prime propulsion), an electric propulsion unit could boost a payload out of earth orbit, and an onboard electric propulsion system could "fine-tune" spacecraft during maneuvers or lift satellites to higher orbits (auxiliary propulsion). Prime and auxiliary propulsion systems are based on the same operating principle: electric power generated by a solar or nuclear device is fed to a thruster system, of which there are three kinds—electrothermal, electrostatic, and electromagnetic.* Electrothermal thrusters, of which resistojets were the most highly developed example in the 1960s, could produce specific impulses of thrust lasting 150 to 850 seconds. Electrostatic and electromagnetic thrusters produced impulses lasting 3000 to 10 000 seconds. A small resistojet was included on *ATS 1* in December 1967, but it was damaged during the mission. Evaluation of the system was inconclusive. Resistojets were tested successfully in 1968 on later *ATS* flights, and a cesium propellant contact ion thruster was carried on *ATS 4*. Because the gravity-gradient-stabilized *ATS* spacecraft had two very long booms, stationkeeping maneuvers were accomplished with extremely low thrust (4.448×10^{-5} newtons) to minimize torque disturbances to the booms.

OART specialists were suggesting in 1967 that the addition of a solar-electric stage capable of 4 to 28 kilowatts of power to an Atlas-Centaur, a Titan IIIC, or a Saturn IB-Centaur would greatly increase the payload capacity of these configurations without adding much weight to the vehicle. In this concept, lightweight solar arrays were the power source for the electric propulsion system, teamed with either a resistojet or an electron-bombardment thruster. As with ion thrusters, electron-bombardment thrusters develop thrust by accelerating charged particles. Although the resultant thrust is not enough to lift the engine's own weight on earth, it is sufficient in weightless, frictionless space to propel large payloads over vast distances at high speeds. In the late 1960s, researchers were striving for low specific impulses †

*Electrothermal thrusters produce heat by passing the propellant over a hot metal surface and expanding it through a nozzle. Electrostatic and electromagnetic thrusters produce heat by accelerating the propellant by means of electrical forces and reactions.

† Specific impulse is defined as the velocity imparted to the propellant divided by gravitational acceleration.

and high efficiency. But electric propulsion was also recognized for its growth potential. For example, a launch vehicle consisting of a nuclear booster and a megawatt-class electric upper stage would reduce both mission time and launch vehicle weight on some future manned voyage to Mars. At Lewis Research Center, 30-kilowatt and 150-kilowatt thrusters were being evaluated to determine if more powerful electric propulsion systems were feasible. At the Jet Propulsion Laboratory in California, specialists established a program in 1968 they called Solar Electric Propulsion Systems Technology (SEPST) to find the best propulsion system for unmanned planetary flyby spacecraft.¹³

Project SERT (Space Electric Rocket Test). SERT was an integral part of the electric propulsion team's technology development program. SERT 1's basic goal was to prove that an ion beam could be neutralized by injecting electrons, thereby producing thrust. Because researchers could not duplicate in the laboratory the exact conditions of spaceflight that this test demanded, NASA Headquarters approved a flight test of an electric propulsion engine, with the first launch scheduled for late 1962. With the transfer of the project from Marshall Space Flight Center to Lewis Research Center in November 1961, the first mission was slipped to 1964, giving engineers at Lewis and Hughes Research Laboratories more time to build the two kinds of ion thrusters that would be tested. Lewis specialists constructed a mercury electron bombardment thruster, and Hughes was responsible for a cesium contact ion thruster. The summer 1964 ballistic test, which lasted 47 minutes, proved the Lewis electron bombardment design; the cesium thruster, however, failed to operate.* *SERT 1* demonstrated that the ion thruster concept would work. Plans for repeat tests were dropped, but Lewis set *SERT 2* into motion shortly thereafter, with official approval coming in the fall of 1966. *SERT 2*, originally scheduled for a later 1968 launch, would demonstrate the long-term operation of electric thrusters in space (two 1-kilowatt mercury bombardment ion engines powered by a 1.5-kilowatt solar array) and provide information on how the propulsion system interacted with other spacecraft systems. This earth orbital mission was launched on February 3, 1970.

Nuclear Propulsion

NASA's search for a nuclear-powered launch vehicle was one of the agency's most controversial undertakings. It met both ardent support and disapproval in Congress and was the subject of many debates in congressional committees, at the Bureau of the Budget, and within NASA itself. The agency's managers recognized that they should investigate how advances in atomic research would affect space power and propulsion systems and how new atomic hardware could be applied to NASA missions. In August 1960, NASA joined with the Atomic Energy Commission to form the joint Space Nuclear Propulsion Office to serve as an interface between the two agencies (see fig. 4-2). Thereby, NASA could monitor, evaluate, test,

*Subsequently, the Air Force flew a cesium contact ion thruster in a hardware development test, which functioned as predicted.

and eventually adopt new propulsion and power technology developed by AEC. Advanced planners believed that for the post-Apollo period the agency would need powerful boosters for manned interplanetary and solar system escape missions. Nuclear propulsion systems, they reasoned, could provide 890 000 to 1 100 000 newtons of thrust.

The Air Force and AEC had long been interested in developing a nuclear rocket. Calling their effort Project Rover, research was well under way on various nuclear reactors at Los Alamos Scientific Laboratory and Livermore Radiation Laboratory when NASA was established. In 1958, the civilian agency inherited the Air Force's role in Rover, basically assuming responsibility for every aspect of the nuclear rocket program except reactor research and engineering, which was AEC's domain. The grand plan (see table 4-65) called for the development and ground-testing of increasingly sophisticated reactors (Kiwi and Phoebus), a flight test of a nuclear upper stage (RIFT), and the launch of a nuclear vehicle (NERVA). For several reasons—expense, complexity, safety questions, lack of specific applications—funds for nuclear propulsion were cut from the agency's budget request several times, slimm-

Table 4-78.
Chronology of SERT Development and Operations

Date	Event
July 17, 1961	Marshall Space Flight Center announced the selection of RCA's Astro-Electronics Division as contractor for developing a payload capsule for flight testing electric propulsion engines. Four flights were planned, with the first to be launched in late 1962. Hughes Research Laboratories and Lewis Research Center were developing engines to be tested on the spacecraft.
Nov. 1961	The electric propulsion project was transferred from Marshall to Lewis.
Summer 1962	NASA Headquarters officials signed the project approval document for Project SERT (Space Electric Rocket Test).
Aug. 1962	Lewis issued a request for proposals for a 12-month research program to develop and test an ion rocket engine system of the electron bombardment ionization type.
Dec. 1962	The Air Force attempted to test an ion engine during a ballistic flight test; the engine failed to start (engine built by Electro-Optical Systems, Inc.).
July 20, 1964	Launch of <i>SERT 1</i> was successful; the Lewis engine performed as planned, but the Hughes engine failed to respond to commands to start.
Oct. 16, 1964	A second <i>SERT 1</i> -class flight was cancelled because the July experiment had accomplished the program's basic goal.
Dec. 23, 1964	The Air Force successfully tested a cesium thruster in a ballistic test.
Oct. 4, 1966	Lewis was authorized to proceed with a <i>SERT 2</i> project, an orbital ion engine test to last six months (1968). Lewis was assigned the task of designing two engines for <i>SERT 2</i> .
July 18, 1967	Lewis awarded various <i>SERT 2</i> systems contracts to Fairchild-Hiller Corp., Hughes Aircraft Corp., Westinghouse Electric Corp.'s Aerospace Electrical Div., and Cutler-Hammer Corp.'s Airborne Instruments Div.
Feb. 1968	Lockheed Missiles and Space was awarded a contract for adapting the Agena stage for use in <i>SERT 2</i> .

ing the venture down from a flight hardware program to a technology research and development project.

The reactor is the key component of a nuclear rocket propulsion system. The nucleus of an atom is composed of particles held together by tremendous bonds of energy, and when these bonds are broken the nucleus splits apart, or fissions. Great quantities of heat and radiation are released when elements such as uranium or plutonium are fissioned. When this activity takes place within a confined space—such as rods within a graphite-lined container, a reactor*—the resultant heat energy can be controlled and used to heat a propellant. The propellant, liquid hydrogen, for example, is pumped through the reactor. Heated, the propellant expands and exits at a high velocity through a nozzle. During the 1960s, atomic researchers searched for heat-resistant materials from which to construct the reactor and sought to design a pumping system that could handle the very cold liquid-hydrogen propellant. Other reactor configurations were considered, such as a gaseous-core reactor and a tungsten solid-core reactor, but it was the graphite solid-core reactor that captured most of the AEC and NASA's attention.

The Lewis Research Center in Cleveland, a participant in nuclear research as it related to possible applications to aeronautics since the 1940s (as part of the National Advisory Committee for Aeronautics), had acquired the Army's Plum Brook nuclear research reactor. In 1958 when NASA began participating in the nuclear rocket program, the AEC was building a reactor and the complex facilities needed to test it in the deserts of Nevada on Jackass Flats. Plum Brook, therefore, did not play a major role in the nuclear rocket program.

*Graphite, inexpensive and easy to fabricate, has the unique quality of gaining strength as the temperature increases. However, hydrogen can erode the carbon from the graphite, causing it to collapse. The graphite in a reactor would have to be covered by a coating of some protective material.

Table 4-79.
SERT 1 Characteristics

<i>Date of launch</i>	July 20, 1964 (WI)
<i>(location):</i>	
<i>Launch vehicle:</i>	Scout (ABL X-258 4th stage)
<i>Weight (kg):</i>	170
<i>Shape:</i>	Experimental equipment was mounted on both sides of a circular baseplate
<i>Dimensions (m):</i>	
Diameter of baseplate:	0.762
<i>Date of reentry:</i>	Ballistic trajectory
<i>Cognizant NASA center:</i>	LeRC
<i>Project manager:</i>	Harold Gold
<i>Contractors:</i>	RCA, Astro-Electronics Div., spacecraft assembly Hughes Research Laboratories, cesium contact ion thruster
<i>Objective:</i>	To determine the feasibility of ion beam neutralization in space.
<i>Experiments:</i>	Mercury electron bombardment thruster (LeRC) Cesium contact ion thruster (Hughes)
<i>Results:</i>	The mercury electron bombardment thruster produced thrust as predicted, operating for 30 minutes during the 47-minute ballistic flight; the cesium contact ion thruster failed to respond to commands.

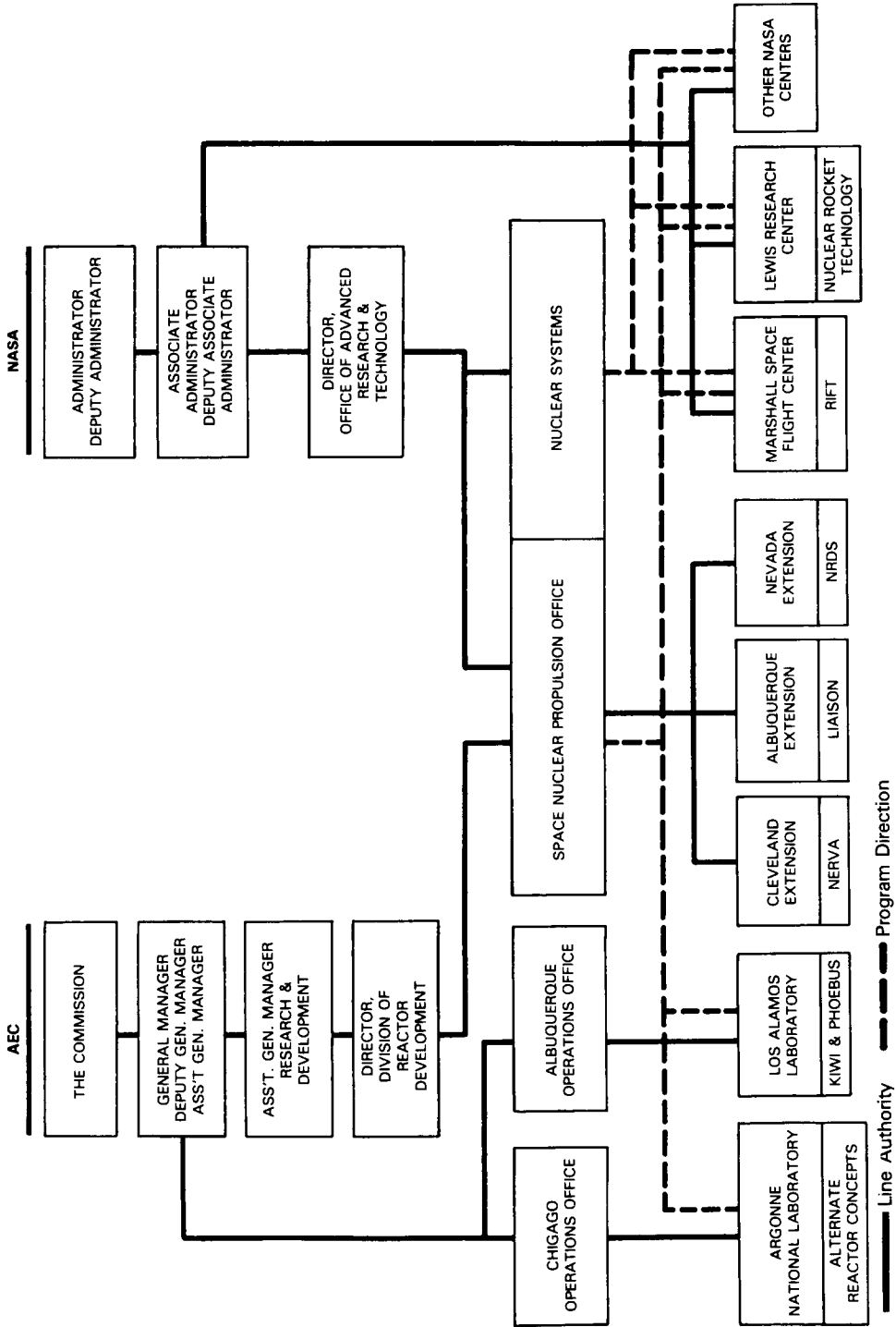

Figure 4-2. AEC-NASA Management of Nuclear Projects of Mutual Interest, 1960s.

Kiwi A, the first step in AEC's reactor test program, was designed to demonstrate that a high-power reactor could heat a propellant quickly and stably to high temperatures, to establish basic testing procedures, and to determine the basics of graphite-hydrogen interaction. Kiwi A (100-megawatt power level) passed its first hot test* in the summer of 1959, convincing many that a nuclear rocket was possible. During the two years that it took to develop and test Kiwi A, work was being conducted simultaneously on the larger Kiwi B (1000-megawatt power level), which would utilize liquid hydrogen as a propellant. A Kiwi B-class reactor would be suitable for use in the upper stage of a launch vehicle.† AEC-NASA specialists saw the development of a structurally sound reactor core to be their most urgent task and pursued three new core concepts in 1960: Kiwi B1, B2, and B4.** NASA's first hardware task associated with the Kiwi B reactor was providing a turbopump that could deliver liquid hydrogen to the reactor quickly and in great quantities without increasing the temperature of the propellant through friction before it entered the reactor. Before it gave up its part in Rover, the Air Force had assigned the development of a pumping system to the Rocketdyne Division of North American Aviation, but NASA favored assigning the pump to personnel at Lewis Research Center. At AEC's request, however, NASA funded Rocketdyne's effort as a backup.

At this juncture, still smarting from the Soviet Union's early successes with Sputnik, lawmakers, policy advisers, and technical specialists were closely examining the country's launch vehicle technology. Project Rover†† with its promise of great power—but very long lead time and high price tag—was considered less critical to the immediate success of the U.S. space program than the development of large chemical rockets. Rover's most visible supporter was Senator Clinton P. Anderson, who came to the defense of the nuclear rocket program many times, capturing funds for NASA's part in it when the budget situation looked bleakest. Chemical rockets were a priority item for the 1960s, but many experts believed that future vehicles would be powered by nuclear means. It was agreed in 1960 that NASA and AEC should proceed with an incremental program leading to the development of a nuclear rocket engine.*** Harold B. Finger, of Lewis' compressor and turbine division and a leader of that center's nuclear rocket study group, went to Washington to manage the joint venture. In August 1960, the agencies signed a memorandum of understanding establishing the Space Nuclear Propulsion Office. The next year

*"Hot" tests were conducted with the fuel cell in the reactor; "cold" tests were run without the fuel cell to evaluate the nonnuclear components of the reactor.

†NASA planners reasoned it would be safer to use a nuclear reactor in an upper stage; an accident with a nuclear booster on the launch pad would contaminate the area and endanger launch operations personnel.

**The B4 was also called Phoebus for a time, a name that was adopted for an advanced graphite-core reactor program (AEC) in the mid-1960s.

†† This designation was not used widely by OART; instead the program was referred to by the several stepping stones that would lead to a nuclear rocket—Kiwi, RIFT, and NERVA.

***AEC would continue to favor a higher priority program with operational capability by the late 1960s.

brought the Kennedy administration's even more ambitious drive to surpass the Soviets in space. Besides landing a man on the moon by 1969, NASA was directed by the young president to ready a flight-rated nuclear rocket by 1965. This goal would demand testing of Kiwi B in 1963, a prototype vehicle in 1964, and a flight vehicle in 1965, a schedule that left little time for incremental, reiterative testing.

To meet the flight goal, Finger and his colleagues set to work finding an industry group that could build the large number of reactors and engines the AEC-NASA team would require. AEC's Los Alamos laboratory did not have the manpower or the facilities for such a large-scale undertaking. SNPO field offices in Cleveland, Albuquerque, and near Jackass Flats were put into operation to manage industry contracts and to coordinate the intense activities the managers expected on several fronts. A phase-one contract was let for the NERVA (Nuclear Engine for Rocket Applications) engine in July 1961 to Aerojet General Corporation and Westinghouse Electric Company. NASA funded Aerojet, which had responsibility for the overall engine and nonnuclear components of the flight engine; AEC supported Westinghouse, who would build the reactor to AEC's specifications. Together these concerns worked toward a 1966-1967 flight date.

Ideas, plans, and schedules for Kiwi B were modified many times. In addition to testing the reactors, the 1961-1962 timetable called for evaluating the nozzles, pumps, and controls that would be incorporated onto a Kiwi C. Labor problems at the contractors' plants and hardware difficulties with the pump and nozzles prompted AEC officials to perform the Kiwi B1 test with gaseous rather than liquid hydrogen at a lower power level. An explosion during a pretest checkout of the B1A reactor in November 1961 put the team behind schedule, but the next month found them running the first test. A leak led to a large hydrogen fire and forced a premature shutdown after only 30 seconds of operation. NERVA contractors, finished with the first phase of their development plan, were waiting for AEC to determine what reactor configuration would be flown on the nuclear rocket, but problems with test facilities and structural difficulties with B2 threw the program behind again. The specialists turned briefly to the B4 configuration, which had greater power potential, but problems with its assembly forced them back to B1. The Kiwi B1B reactor, not a serious contender for the nuclear engine, was put through a hot test with liquid hydrogen in September 1962, from which the propellant experts gained confidence in the nonnuclear components of the reactor—the turbopump, the drive system, and the nozzles—and in the test facility. In the midst of another debate in Washington over funding for Project Rover, the B4A reactor failed during its November 1962 test run. More than 90 percent of the reactor's parts had been broken, mostly at the core's hot end. President Kennedy agreed to fund an abbreviated flight test program pending the results of B4B's test score in 1963. This decision left RIFT (Reactor-In-Flight-Test), the test flight of a nuclear stage, without funds for hardware development.

With so much hinging on a successful hot test, Finger and his fellow managers moved to introduce a new, more cautious testing scheme. Although specialists at Los Alamos argued against it, the revised program would include extensive component testing and cold flow tests, leading to a hot test of B4D and B4E—which proved to be the last reactors of the Kiwi series. From cold test results, the engineers designed an improved hot-end seal to combat vibration, which had caused many of their earlier problems. B4D reached and maintained full power in May 1964; B4E was even more successful three months later. It was now Aerojet and

Westinghouse's turn to incorporate the basic Kiwi B4 core design into the complex NERVA system. But NERVA had been downgraded in December 1963 by the budget cutters on the east coast from a flight-rated engine project to a research project. There would be no Kiwi C. RIFT had been cancelled altogether.

The Reactor-In-Flight-Test was to have included four flights of the nuclear stage with a Saturn booster. Lockheed Missiles and Space Company, studying nuclear rocket design since 1957, had been awarded a contract for RIFT's airframe in June 1962. Convair, Lockheed, the Martin Company, and Douglas Aircraft Company, with funds from NASA, had conducted preliminary studies of a nuclear flight test program in 1960; Lockheed and Convair did further work in 1961 for the Marshall Space Flight Center's new Nuclear Vehicle Project Office. Marshall would manage the development of the RIFT stage and integrate it into a Saturn vehicle. During the first phase of their contract, Lockheed employees produced an engineering analysis development plan and test facilities definition that they hoped would lead to the manufacture of 10 RIFT stages.* One of Lockheed's major objectives in its early work was to determine how radiation might affect critical electronic instruments and vehicle materials. As with Kiwi, these tests would require special facilities that would add greatly to the budget. An extensive, expensive complex designated the Nuclear Rocket Development Station (NRDS) was proposed for RIFT and NERVA in 1962. Its operation would boost NASA's nuclear rocket budget request even higher. RIFT did not get beyond the paper and preliminary component test phase; the construction of the development station, however, was approved and built. Kiwi's failure and Washington's doubts that the country needed this expensive nuclear rocket project brought about RIFT's cancellation in late 1963. Lockheed's contract was terminated in February 1964.

NERVA faced the same doubters and its own unique technical problems. The nuclear engine would require massive engine test stands, which were difficult to construct and required a long lead time—like everything else connected with the nuclear propulsion program. Because the NERVA contractors' pace was dictated by the Kiwi team's success with finding a suitable reactor, Westinghouse and Aerojet never got beyond preliminary studies for a flight-rated NERVA. When Lyndon B. Johnson assumed the presidency, he was faced with balancing many demands on the nation's treasury—an escalating war in Indochina, urban strife and racial unrest, the Apollo lunar landing. Protecting South Vietnam from the communists of the north, salving the cities' wounds, and getting an American astronaut to the moon were all goals to which this country was committed. It was clearly not the time for ambitious post-Apollo projects such as lunar bases and manned Mars landings that would require nuclear rockets. If NASA wanted to continue with a nuclear propulsion program, it would have to be a modest one.

During the next several years, the AEC and NASA continued their experiments with nuclear reactors, albeit at a much lower funding level. The two agencies' advanced propulsion experts made slow but sure progress in defining a nuclear system that might be used some day to launch large payloads to Mars and beyond. This steady, if plodding, pace was more to the liking of many NASA specialists (especially at Lewis) who had been disquieted by the brief but costly flurry of Project Rover.

*The RIFT stage was to be 24.4 meters long and 11.1 meters in diameter.

Westinghouse and Aerojet-General stayed on board, pursuing the technology that a nuclear rocket engine would require, with tests being performed at the Nuclear Rocket Development Station.* Kiwi technology was used at Los Alamos to build the larger Phoebus reactors, which would be capable of 5000 megawatts of power.¹⁴ Supporting research and technology funds from OART were programmed for rocket reactor and engine component research, flight safety analyses, and vehicle technology studies. Personnel at Lewis continued their research into other possible reactor designs. By the end of the agency's first decade, advanced planners were predicting that the agency would require a NERVA I engine capable of 289 000 newtons (an even larger NERVA II concept had been axed by Congress in 1967). The nuclear rocket program suffered a cut in 1971 after another brief resurgence of support in Washington. Its termination came in 1973.

*Ground testing of NERVA experimental reactors and engines was completed in August 1969.

Table 4-80.
Chronology of Nuclear Propulsion Program
(Kiwi, RIFT, NERVA) Research and Development

Date	Event
1945	At the suggestion of Manhattan Project participants, the Air Force Scientific Advisory Board studied the possible use of nuclear propulsion for rocket systems. No action was recommended.
June 1946	The Atomic Energy Commission's (AEC) Division of Reactor Development requested the Applied Physics Laboratory (APL) of Johns Hopkins to study the feasibility of nuclear propulsion.
July 1, 1946	North American Aviation Corp. prepared "A Preliminary Study on the Use of Nuclear Power in Rocket Missiles."
Jan. 14, 1947	APL's report concluded that a nuclear rocket was feasible, but expressed concern over the associated technological problems and expense.
Feb. 7, 1947	An Air Force report investigated the "Feasibility of Nuclear Powered Rockets and Ramjets" for the USAF MX-770 missile project. In preparing the report, the authors investigated almost every major problem that would arise in Project Rover.
Sept. 1948	An Air Force report recommended pursuing the development of a turbojet rather than a nuclear rocket.
July 1953	R. W. Bussard of AEC's Oak Ridge National Laboratory authored a study on "Nuclear Energy for Rocket Propulsion," rekindling Air Force interest in the subject.
July-Dec. 1954	A series of meetings was held by the Weapons Div. of AEC's Los Alamos Scientific Laboratory on the feasibility of developing nuclear rockets. The laboratory's Reactor Division was also interested in the subject. A committee was formed in October to look at proposals for utilizing nuclear energy for rockets. The committee came to be known as the Condor Committee.
Oct. 18, 1954	The Air Force Scientific Advisory Board Ad Hoc Committee on Nuclear Missile Propulsion convened to study application of nuclear reactors to space propulsion. Presentations were made by industry on the design of turbojets, ramjets, and nuclear rockets.

Table 4-80.
Chronology of Nuclear Propulsion Program
(Kiwi, RIFT, NERVA) Research and Development (Continued)

Date	Event
Fall 1954	H. F. Bunze of the USAF Wright Air Development Center and Frank Rom* of the National Advisory Committee for Aeronautics's (NACA) Lewis laboratory briefed the Air Force Air Research and Development Command on the design of a nuclear-powered ICBM, after which the Air Force requested the AEC to study the subject. The AEC authorized a six-month nuclear rocket propulsion study at Los Alamos and the Livermore Radiation Laboratory.
March 1955	The Los Alamos and Livermore studies were presented at the Air Force Scientific Advisory Board ad hoc committee's second meeting (studies published in April 1955 as "The Feasibility of Nuclear-Powered Long Range Ballistic Missiles," by Los Alamos, report LAMS 1870, and as "Nuclear Rockets," by Livermore, report UCRL 4499).
April 15, 1955	Nuclear rocket divisions were formed at Los Alamos and Livermore.
Oct. 18, 1955	In their final report, the Air Force Scientific Advisory Board ad hoc committee reaffirmed its recommendation that development work begin on a nuclear rocket.
Nov. 2, 1955	AEC approved programs at Los Alamos and Livermore to demonstrate the feasibility of nuclear rocket propulsion. This effort became Project Rover. The two laboratories pursued independent preliminary research on reactor designs. The Air Force was considered the prospective "user agency" of any hardware that was developed as a result of this project (Air Force management of Rover was assigned to the Propulsion Laboratory at Wright Air Development Center).
April 1956	The Department of Defense (DoD) Armed Forces Special Weapons Project group conducted a two-week study to set 1959 as a target date for the development of a nuclear rocket.
Spring 1956	The Air Force assigned property it owned in Nevada to the AEC for reactor testing; Los Alamos chose a site on Jackass Flats, Livermore at Cain Springs.
May 18, 1956	The Air Force awarded a contract to Aerojet-General Corp. to provide non-nuclear component support to Rover at Los Alamos.
July 15, 1956	The Air Force awarded a contract to the Rocketdyne Div. of North American Aviation to provide nonnuclear component support to Rover.
Dec. 28, 1956	At DoD's request, the Armed Forces Special Weapons Project group conducted a study to determine if the military advantages of a nuclear-powered ICBM were commensurate with the great expense involved in its development. The group's report indicated that there was no immediate application for a nuclear ICBM but that the project should be continued for its possible future applications. The feasibility of a reactor for nuclear propulsion could be demonstrated by 1960-1961, according to this study.
Jan. 12, 1957	DoD suggested that it reduce the level of its support of the nuclear rocket program. The group at Los Alamos began defining their first nuclear propulsion reactor, Kiwi A.
March 18, 1957	The AEC assigned Project Rover to Los Alamos and the nuclear ramjet project to Livermore.
May 1957	Construction of reactor test facilities (Test Cell A) began in Nevada.

Table 4-80.
Chronology of Nuclear Propulsion Program
(Kiwi, RIFT, NERVA) Research and Development (Continued)

Date	Event
Sept. 1957	Los Alamos held the first of a series of meetings to determine goals beyond Kiwi A.
Winter 1957-1958	A Rover Coordination Group was formed representing the Wright Air Development Center, Los Alamos, AEC's Albuquerque Operations Office, Aerojet-General, and Rocketdyne. This group began planning for technical support of Kiwi B in early 1958 at its first meeting.
Jan. 22, 1958	The Joint Committee on Atomic Energy of the Congress held hearings to review Project Rover.
June 11, 1958	The AEC requested that the Air Force increase its support of the development of Kiwi B's turbopump and flow control system, which were to be built by Aerojet-General and Rocketdyne.
Oct. 1, 1958	The executive order that created NASA also transferred responsibility for the nonnuclear aspects of Project Rover from the Air Force to the new civilian agency. NASA managers were of the opinion that Rover should be supported as fast as the technology would allow. The AEC would continue to provide technical direction of the reactor program within a broad framework of guidance from NASA.
Late 1958	Fabrication of Kiwi A was near completion at Los Alamos; it was shipped to Nevada and assembled there for testing.
April 1959	During a checkout test of Kiwi A's flow control system, the bellows pumping the gaseous hydrogen ruptured, causing a fire. The testing schedule was delayed.
July 1, 1959	Kiwi A passed its first hot test successfully (5 minutes at 78 megawatts), after which it was disassembled and inspected.
Fall 1959	Because of the expense involved in developing it, a reactor called Dumbo with a tungsten core was dropped from the test program. In its place, Los Alamos introduced Kiwi A Prime (sometimes written Kiwi A'), which would test Kiwi B's core design and protected fuel elements, and Kiwi A3, which incorporated some further design changes in the coating and core.
April 29, 1960	NASA awarded Rocketdyne a contract for a regeneratively-cooled nozzle for Kiwi B.
Spring 1960	Assembly and checkout of Kiwi A Prime was begun in Test Cell A.
July 8, 1960	Kiwi A Prime was hot-tested (3 minutes at 85 megawatts). The results indicated that the core design was not structurally sound.
Aug. 15, 1960	Martin, Douglas, Convair, and Lockheed began work on RIFT (Reactor-In-Flight-Test) studies for Marshall Space Flight Center.
Aug. 29, 1960	NASA and AEC signed a memorandum of understanding establishing the joint Space Nuclear Propulsion Office (SNPO).
Oct. 10, 1960	Kiwi A3 underwent a hot test (5 minutes at 100 megawatts) with results similar to Kiwi A Prime's.
Feb. 2, 1961	NASA and AEC issued a request for proposals for the development of a NERVA (Nuclear Engine for Rocket Applications) engine.
March 5, 1961	Several contractors completed preliminary RIFT studies.

Table 4-80.
Chronology of Nuclear Propulsion Program
(Kiwi, RIFT, NERVA) Research and Development (Continued)

Date	Event
May 25, 1961	President John F. Kennedy in a special message to Congress recommended a supplement for Rover to be added to the FY 1962 budget (the development of a nuclear rocket as part of an accelerated space and Atoms for Peace program had been a plank in the Democratic platform during Kennedy's campaign).
June 9, 1961	NASA and AEC selected Aerojet-General and Westinghouse as the builders of the NERVA engine (the contract was effective on July 10). Aerojet-General was the prime contractor, Westinghouse the reactor subcontractor.
July 1, 1961	Follow-on RIFT studies to determine a preliminary design were begun by Martin, Douglas, Convair, and Lockheed for Marshall.
Summer 1961	SNPO field offices in Cleveland, Albuquerque, and Nevada were staffed. Two Kiwi B1 reactors were under construction. Designs for the cores of Kiwi B2 and B4 were being studied.
Nov. 1961	During the final checkout of Kiwi B1A, a leak of hydrogen gas caused an explosion.
Dec. 1961	Kiwi B1A underwent a hot test (30 seconds at 300 megawatts). A leak of hydrogen caused a large fire. The NERVA phase-one contract was completed. A structural weakness was found in Kiwi B2's hot-end graphite disc.
March 1962	After Kiwi B2 failed a preassembly test, it was redesigned. AEC personnel began assembling Kiwi B4, but they encountered problems with this configuration, too.
May 1962	The assembly of Kiwi B1B was begun.
June 28, 1962	NASA awarded a contract to Lockheed to design and develop the RIFT stage.
July 1962	A Kiwi B1B cold test was conducted successfully.
Sept. 1962	A Kiwi B1B hot test was run (a few seconds at 900 megawatts), during which the core failed. Nonnuclear components of the reactor performed satisfactorily. Checkout of Kiwi B4A and assembly of B4B were begun.
Nov. 30, 1962	A Kiwi B4A hot test was conducted (a few seconds at 600 megawatts), during which extensive core damage was suffered.
Dec. 7-8, 1962	President Kennedy was briefed on the nuclear propulsion program at Los Alamos. As a result, he agreed to continue funding a test program, albeit an abbreviated one, pending the results of the next reactor hot test. RIFT was not to go beyond the study stage.
Jan. 1963	Because of the reactor failures and the importance given the next reactor hot test by the president, SNPO reoriented the reactor test program. More emphasis was placed on component evaluation and cold tests, postponing further hot tests until later in the year.
March 1963	Assembly of Kiwi B4A cold flow reactor was begun.
May 15, 1963	Kiwi B4A cold test was conducted, confirming that vibration had been the cause of earlier core failures. Corrective redesign of B4B was initiated immediately.
July 1963	Marshall awarded a study contract to Space Technology Laboratories to define requirements for an operative nuclear propulsion system. Contracts were also awarded to Douglas Aircraft and General Dynamics/Astronautics for design studies of chemical-nuclear rockets.

Table 4-80.
Chronology of Nuclear Propulsion Program
(Kiwi, RIFT, NERVA) Research and Development (Continued)

Date	Event
Aug. 1963	A Kiwi B4B cold test was conducted, proving out the improved hot-end seal. SNPO approved the resumption of hot testing.
Nov. 1963	Lewis Research Center (NASA) specialists began cold tests on another reactor design at the Plum Brook Nuclear Rocket Dynamics Test Facility.
Dec. 1963	As a result of budget problems and the complex problems that were associated with developing a nuclear rocket, Project Rover was downgraded from a flight project to a technology development project. RIFT was cancelled (Lockheed's contract was terminated in February 1964).
Jan. 1964	Assembly of Kiwi B4D commenced.
Feb. 13, 1964 March 12, 1964	Kiwi B4D was cold tested successfully. Marshall awarded a contract to Lockheed to continue research of reactor in-flight testing at a more modest level.
April 16, 1964	NRX-AL (NERVA Reactor Experiment A1), a reactor built by Westinghouse, was cold tested, reconfirming that the improved hot-end gas seal had eliminated the vibration anomaly experienced with the earlier Kiwis.
May 13, 1964	Kiwi B4D hot test was conducted (1 minute at 1000 megawatts). The only failure experienced was with the nozzle.
Aug. 28, 1964 Sept. 10, 1964	Kiwi B4E hot test was conducted (10.5 minutes at 1000 megawatts). Kiwi B4E was restarted and run for 2½ minutes at full power to gather additional data on reactor reliability.
Sept. 21, 1964 Sept. 24, 1964	Cold flow tests were conducted on Lewis's reactor at Plum Brook. NRX-A2 reactor was tested at high power for 6 minutes; gaseous hydrogen was used as the propellant.
Oct. 15, 1964 Dec. 1964	NRX-A2 was restarted successfully. There was some discussion in Congress on reviving RIFT, but it did not lead to any policy changes.
Jan. 12, 1965	The Kiwi Transient Nuclear Test was completed; this was a safety test designed to verify the behavior of a graphite-core reactor during power excursion.
April 23, 1965 May 20, 1965 May 28, 1965	NRX-A3 reactor was tested for 3½ minutes at full power. NRX-A3 reactor was restarted and operated at full power for 13 minutes. NRX-A3 reactor was restarted and operated at low to medium power for 45 minutes.
June 25, 1965	A Phoebus 1A reactor built by AEC was tested for 10½ minutes at full power. The test was conducted to evaluate design improvements that were to be incorporated into the larger Phoebus 2 reactor.
Summer 1965	Lewis began an in-house study of nuclear powered aircraft concepts to determine what progress had been made in this field since 1961. The Air Force had expressed interest in such aircraft.
Dec. 8, 1965- March 25, 1966	NRX/EST (NERVA Reactor Experiment/Engine System Test) breadboard test was conducted. NRX-A4 was used in this combination reactor-system test.
March 4, 1966	The NERVA breadboard engine system was ground-tested at full power.
May 26- June 23, 1966	NRX-A5 reactor was tested; it maintained full power (1100 megawatts) for 30 minutes.
Feb. 1967	The Phoebus 1B reactor was tested; it maintained full power (1500 megawatts) for 30 minutes.

Table 4-80.
Chronology of Nuclear Propulsion Program
(Kiwi, RIFT, NERVA) Research and Development (Continued)

Date	Event
Spring 1967	President Lyndon B. Johnson and the congressional Joint Committee on Atomic Energy supported increased funds for Rover, but the full Congress did not approve them. The extra funds were not appropriated.
June 1967	DoD declared that it had no plans for using a NERVA engine in its space program.
July 12-19, 1967	Phoebus 2 was cold-tested.
Dec. 1967	NRX-A6 reactor was tested for 60 minutes at full power (1100 megawatts).
Spring 1968	NERVA test engines XE-1 and XE-2 were being assembled for testing (testing was scheduled to begin in 1969).
June 26, 1968	Phoebus 2A was tested for 32 minutes (12 minutes at 4000 + megawatts).

*Harold B. Finger, manager of the NASA-AEC joint Space Nuclear Propulsion Office, had been Rom's protegee.

Table 4-81.
Reactors Evaluated by AEC-NASA in Their Search for a
Reactor Suitable for NERVA, 1959-1968

Reactor	Power (max. megawatts)	When Tested	Remarks
Kiwi A	78	July 1959	Successful.
Kiwi A Prime ^a	85	July 1960	Core design found structurally unsound.
Kiwi A3 ^b	100	Oct. 1960	Core design found structurally unsound.
Kiwi B1A	300	Dec. 1961	Hydrogen leak caused a fire; reactor shut down after 30 sec.
Kiwi B1B	cold ^c	July 1962	Successful.
Kiwi B1B	900	Sept. 1962	Core failed but nonnuclear components checked out satisfactorily.
Kiwi B4A ^d	600	Nov. 1962	Extensive core damage was suffered; reactor shut down after a few seconds.
Kiwi B4A	cold	May 1963	Confirmed that vibration was the cause of earlier core failures.
Kiwi B4B	cold	Aug. 1963	Proved out an improved hot-end seal.
Kiwi B4D	cold	Feb. 1964	Successful.
Kiwi B4D	1000	May 1964	Successful except for a problem with the nozzle.
Kiwi B4E	1000	Aug.-Sept. 1964	Successful.

NRX-A1	cold	April 1964	Reconfirmed improved hot-end gas seal.
NRX-A2	ca. 900-1000	Sept.-Oct. 1964	Tests run with gaseous hydrogen.
NRX-A3	1000	April-May 1965	Successful; restarted several times.
NRX-A4	1100	Dec. 1965-March 1966	Part of the breadboard NRX/EST test.
NRX-A5	1100	May-June 1966	Successful.
NRX-A6	1100	Dec. 1967	Successful; run for 60 minutes at full power.

Table 4-81.
Reactors Evaluated by AEC-NASA in Their Search for a
Reactor Suitable for NERVA, 1959-1968 (Continued)

Reactor	Power (max. megawatts)	When Tested	Remarks
Phoebus 1A	1000 +	June 1965	Tested design improvements to be incorporated into Phoebus 2.
Phoebus 1B	1500	Feb. 1967	Tested design improvements to be incorporated into Phoebus 2.
Phoebus 2	cold	July-Aug. 1967	Successful.
Phoebus 2A	4200	July-July 1968	Successful; run at 4000+ megawatts for 12 min.

^a Actually a test of the Kiwi B core design and protected fuel elements; also written as Kiwi A'.

^b Actually a test of Kiwi B design improvements.

^c Tested without fuel cells installed.

^d After extensive damage to the reactor during hot tests, a Kiwi B4A cold-flow reactor was built and tested to determine why the reactor had failed during the earlier tests.

Chemical Propulsion

Chemical propulsion systems, the "conventional" means for delivering payloads into space, were also the subject of studies being conducted by NASA's advanced researchers. How could the packaging of solid and liquid propellants be improved, their costs reduced, their durability and efficiency increased? How much longer could the solid-fuel motors be built? How durable could the turbopumps that feed liquid propellants into the combustion chambers be made? What kinds of insulation and material would make better propellant storage tanks? These and many other questions were fed to OART's chemical propulsion group, which was divided into four teams: liquid propulsion research and technology, liquid propulsion engineering, solid propulsion research and technology, and solid propulsion engineering. The research teams, after experimenting with a new concept or grappling with some specific component difficulty, passed on their findings to the engineering people, who translated the research into hardware and tested it. This scheme helped bridge the gap between developmental and operational systems. Because research and engineering tasks often overlapped, as did concerns with developmental and operational systems, a strong line of communications was required among the many parties concerned with improving launch vehicles. Since uprated chemical rockets were likely to be put into use in the near rather than the distant future, it was especially important for NASA to coordinate its research and engineering program with the Department of Defense, as the Air Force shared the agency's interest in a number of chemical-propellant launchers. This coordination was achieved by the Aeronautics and Astronautics Coordinating Board, and the Interagency Chemical Rocket Propulsion Group served this function.

Solid Propulsion Systems. Solid fuels were the mainstay of the military's missile programs and NASA's small launch vehicle and sounding rocket efforts. Solid fuel,

a mixture of propellant and oxidizer cast into the desired shape, was storable and easy to handle. Its weakness was controllability. Researchers sought to improve the solid rocket in several ways: by altering the propellant compound (e.g., adding powdered metal fuels), by increasing the size and structural reliability of the motor (e.g., the "260-inch" motor), and by developing a restart capability for solid systems. NASA used solid propulsion units not only for primary boosters, but also for small strap-on engines, capsule escape systems, and auxiliary propulsion systems. These small motors, often used in multiples, had to be very reliable and safe. Each burned for only a short time. OART specialists worked to perfect small propulsion units for manned and unmanned vehicles during the 1960s at the Lewis Research Center, the Marshall Space Flight Center, and the Jet Propulsion Laboratory. The large solid motor, the "260-inch" (6.6-meter), was the solid propulsion group's most visible project.

When considering the future of the nation's launch vehicle program in the early 1960s, NASA and military planners looked to larger high-performance liquid-propellant rockets to boost heavy payloads to the moon and beyond. But in addition to the development of these liquid-fuel motors that NASA, in particular, required, the Air Force Space Systems Division pursued a comprehensive technology program to demonstrate the feasibility of solid motors in the 4-meter and 6.6-meter-diameter classes. The larger of these two would be capable of a thrust level of 33.36 million newtons, comparable to the five F-1s of the Saturn IC stage. Starting in March 1965 at the Air Force's request, NASA took over the management and funding of the 6.6-meter motor, assigning it to Lewis, while the Air Force continued the 4-meter project.* That September, the large motor was test fired successfully for the first time by Aerojet-General, one of two contractors originally assigned to the project by the Air Force (a contract with Thiokol had been terminated earlier in 1965). A maximum thrust of nearly 16 million newtons was attained as the motor burned for 2 minutes. But neither NASA nor the military had a specific requirement for the powerful motor. It was, however, a project popular with Congress, and for FY 1966, 1967, and 1968 the lawmakers authorized more funds for it than NASA requested. The large motor test-firing program was completed by FY 1967, but still no mission for it had been found.† The agency continued to fund it at a "sustaining" level to preserve it as a competitive option for the booster stage of some future launch vehicle.

Liquid Propulsion Systems. Early rocketeers were experimenting with liquid fuels many years before America had an organized launch vehicle program. Kerosene (RP-1) or liquid hydrogen (LH₂), sprayed into a combustion chamber along with liquid oxygen (LOX) and then ignited, is a very controllable power source. But liquid oxygen and especially liquid hydrogen (in the cryogenic class) has to be kept extremely cold in specially insulated tanks. It will evaporate (boil off) if it becomes warm. NASA used RP-1/LOX engines in its early years (Atlas, Juno II,

*The Air Force called the "260-inch" motor the S-10. It was 49.38 meters long and weighed nearly 2 million kilograms loaded with its monolithic propellant grain.

†Different roles considered for the motor included use as a strap-on to Saturn, as a booster stage for the manned lunar project, or in a half-length configuration as the first stage of the Saturn IB. None of these possibilities proved practical because of the extra weight the large motor would have added to the configuration.

Table 4-82.
Chronology of Large Solid-Rocket Motor Research and Development

Date	Event
June 1961	NASA and the Air Force agreed that the Air Force Space Systems Division would develop any large solid motors that NASA might require for Apollo.
Winter 1961	The Air Force initiated a technology development program for two solid motors (6.6 meters and 4 meters in diameter).
May 4, 1962	A joint NASA-Air Force meeting was held to review the proposed specifications for the two motors.
Summer 1962	The Marshall Space Flight Center intensified its study of using large solid motors on future launch vehicles.
Nov. 9, 1962	NASA and the Department of Defense (DoD) formally defined the general scope of their solid-motor program.
Nov. 19, 1962	NASA and DoD agreed that two contractors would be selected to build and test-fire two half-length 6.6-meter motors each, followed by selection of one of the contractors to proceed with a full-length motor program.
Jan. 15, 1963	A request for proposals was sent to industry for the development of a large solid motor.
April 1963	Aerojet-General and Thiokol were selected for the 6.6-meter project, Lockheed and Thiokol for the 4-meter (6.6-meter project contracts were signed in June).
Nov. 1963	DoD requested that NASA fund the 6.6-meter project starting in FY 1965. NASA assigned the project to OART.
May 1964	Aerojet-General and Thiokol dedicated their 6.6-meter motor facilities.
July 1964	Thiokol tested its motor igniter system for the 6.6-meter motor.
Sept. 10, 1964	Lewis Research Center was assigned project management of the 6.6-meter motor project.
Winter 1964-1965	The Bureau of the Budget (BoB) eliminated NASA's FY 1966 budget request for the large motor project, but Congress subsequently authorized the agency more funds than it had requested originally.
April 1965	During a hydrotest of Thiokol's 6.6-meter motor, the motor case burst after reaching 60 percent pressure.
June 1965	NASA decided to terminate Thiokol's contract because the firm could not meet project milestones within budget.
Aug. 1965	A hydrotest of the 6.6-meter motor by Aerojet-General was successful.
Sept. 25, 1965	The first successful firing of the 6.6-meter motor was conducted by Aerojet-General. A maximum thrust of 15.88 million newtons was attained as the motor burned 2 minutes.
Nov. 1965	BoB again deleted the large solid motor project from NASA's budget (FY 1967), and again Congress restored the funds.
Dec. 1965	The Air Force and NASA jointly endorsed continuing the 6.6-meter and 4-meter solid-motor projects so the technology would be available for future missions.
Jan. 1966	NASA decided to fund a third motor firing test, using a shortened motor (test officially approved as SL-3 on March 4).
Feb. 23, 1966	The second 6.6-meter solid motor was successfully fired by Aerojet-General.
March 10, 1966	A 90-day transition contract was initiated with Aerojet-General (the original contract had been completed). A contract for the third test was signed on August 29, 1966 to cover the period through June 1967.
Sept. 1966	Aerojet-General successfully hydrotested the SL-3 motor case.
Dec. 1966	OART proposed deleting the large solid motor from the FY 1968 budget so that the office could fund other projects likely to be cut by BoB.
June 17, 1967	The SL-3 motor was fired successfully by Aerojet-General for 80 seconds. The motor developed 25.4 million newtons thrust and burned 726 thousand kilograms of propellant.
1968	The large solid-motor project was funded on a "sustaining" basis to keep it alive as an option for future missions.

Mercury Redstone, Vanguard, and Thor) for missions that would require precise burn times, but it took propulsion specialists many years to perfect the next step up in liquid rockets—the high-energy Centaur stage (LH₂/LOX). Centaur's super-cooled liquid hydrogen was difficult to handle, and the components of the RL-10 engines that would come into contact with the propellants were hard to qualify. As were all NASA launchers, the large engines included in the various Saturn stages and in Centaur (H-1 and F-1 used RP-1/LOX; RL-10 and J-2 used LH₂/LOX) were developed and procured by the launch vehicle development office, the launch vehicle procurement office, and the user (usually the Office of Manned Space Flight or the Office of Space Science and Applications). But improving the state of the art of liquid propulsion systems was the task of OART's two liquid propulsion teams assigned to the Chemical Propulsion Office.

Specialists evaluated the efficiency of various propellants and oxidizers (e.g., adding fluorine to liquid oxygen—FLOX—promised to add considerably to an engine's power; so much so that OSSA assumed management of the FLOX project in FY 1964 for Atlas-Centaur), searched for better insulators for propellant tanks, tested multichambered engines and improved turbopumps and nozzles, investigated the desirability of very high-pressure engines, and sought safer handling procedures for liquid fuels. The single project that attracted the most attention in this field was the M-1 engine, a huge motor that was slated to produce 6.67 million newtons of thrust (the equivalent of the Saturn F-1 engine) as an upper stage. But in addition to the M-1, the liquid propulsion experts also contributed to the development of auxiliary engines and small-motor technology.

The M-1 engine, 8 meters long and 5 meters in diameter at the nozzle exit, was initiated in 1961 by the Launch Vehicle Programs Office and transferred to OART in 1964. Aerojet-General was on board as contractor for the large engine by January 1962, and later that year Lewis Research Center assumed management responsibility of the project from the Marshall Space Flight Center. Constructing a large engine test stand and the complicated propellant pumping and storage system that would be required for test firings was a key milestone that the contractor failed to meet. A test stand failure in June 1964, the month during which hardware for the M-1 was to have undergone its first hot firing, prompted NASA officials to demand that Aerojet-General make some changes in how it was managing the test program.

Because the M-1 was another advanced propulsion project without a mission but with an escalating budget, the agency began phasing it out in August 1965.* NASA's budget allowed Lewis and the contractor to conduct a number of small-scale tests, leading to a full-scale thrust chamber test in August 1966, the closeout event of the project. The M-1 was not incorporated into a launch vehicle configuration, because the agency did not have any clear post-Apollo plans that called for such increased power.

*Advanced planners had originally considered using the M-1 in an upper stage with the Nova booster, which was not developed, or with Saturn.

Table 4-83.
Chronology of M-1 Engine Research and Development

Date	Event
Fall 1961	The Office of Propulsion in the Launch Vehicle Programs Office initiated the development of a "one million-pound [thrust]" liquid hydrogen-liquid oxygen engine. The engine was called the M-1.
Jan. 24, 1962	NASA selected Aerojet-General as the contractor for the development and fabrication of the M-1 (a letter contract was issued in April).
Nov. 1962	Project management of the M-1 was transferred from the Marshall Space Flight Center to the Lewis Research Center.
Jan. 1964	NASA Headquarters management of the M-1 was transferred from the Office of Manned Space Flight to OART.
March 25, 1964	NASA awarded contracts to Aerojet-General for the building of test facilities and preliminary flight-rate testing of the M-1. Tests were scheduled to begin in April 1967.
June 20, 1964	Development hardware for the M-1 was ready to undergo its first hot test when a malfunction in the liquid oxygen delivery system at the engine test stand stopped the test midway. NASA's dismay at this failure led to management changes at Aerojet-General.
Summer 1964	Headquarters managers started to question the need for the M-1 as a flight hardware project. It was suggested that it be downgraded to a technology development project.
Feb. 4, 1965	Headquarters advised Lewis to suspend the construction of major facilities that were being planned exclusively for the M-1 project.
Aug. 6, 1965	NASA executed a project approval document to phase out the M-1 project. Funds were authorized in FY 1966 that would support tests.
March 24, 1966	Initial tests of the M-1 turbopumps, the largest ever built for handling propellants, were conducted successfully at Lewis.
April 18, 1966	Aerojet-General successfully tested the M-1 turbopumps.
Aug. 1966	A gaseous fluorine ignition system was used in the first full-scale thrust chamber tests of the M-1. The test firings, held at Lewis, were successful.

Electric Power

Along with propulsion, onboard spacecraft power was one of the critical systems that paced the development of early space vehicles. Telemetry systems, scientific experiments, spacecraft control apparatus could be only as sophisticated as the power supply would allow. Spacecraft designers could look to three sources for electricity: chemical, solar, and nuclear (see table 4-84).

Batteries alone, the chemical source, offered a short-term supply of electricity, but their weight and short lifespan spoke against carrying a bank of batteries on an orbiting vehicle. However, teamed with solar cells, attached directly to the spacecraft or on extendable panels, the battery could offer a reliable energy source for lengthy missions. When an orbiting spacecraft was in earth's shadow, it would depend on energy that had been stored in the battery during each revolution. Alone, the solar cells could supply only direct power intermittently, while in the sun. The chemical-solar system, often tailor-made for each spacecraft, was used successfully throughout the 1960s in numerous configurations. Some spacecraft resembled windmills with several solar paddles; others had fixed pairs of solar panels; some were

studded on all sides with solar cells. Batteries were of three types: nickel-cadmium, silver-cadmium, and silver-zinc. In 1968, this kind of system was producing 500 to 1000 watts of electrical power, enough to operate a weather satellite or a physical properties Explorer but hardly enough to provide a crew of astronauts en route to Mars with the power they would need to keep life support equipment running for months or powerful enough to operate a direct broadcast satellite. To produce megawatts of electricity, NASA would need either very improved solar-chemical systems or nuclear power generating systems or a combination of some kind. Two nuclear power sources were available to the agency from the Atomic Energy Commission: radioisotope generators and reactors.

Solar cells, made from a semiconductor material (most often silicone) into which impurities have been introduced that alter its crystalline structure, convert sunlight directly into electricity. To improve this photovoltaic system, NASA researchers experimented with altering the shape and construction of solar cells, sought to protect the system from radiation to lengthen its operational life, and increased the efficiency of solar cells while decreasing their mass. (In 1966, one of OART's projects in this field was a 20-watt-per-45-kilogram solar array.) The space agency was also working on a cell that would operate at both great distances from the sun and very close to it (solar cells are heat sensitive). Lowering the manufacturing cost of solar cells was another important goal.

To improve batteries for spacecraft use, NASA and contractor personnel decreased their weight and increased their operating life, magnetic compatibility, stability at high and low temperatures, and ability to dissipate heat. Late in the agency's first decade, OART was assigned the development of a rechargeable battery with a three-to five-year cycling capability. In addition, the agency would need batteries that would operate on the cold moon and very close to the sun. Besides developing nondestructive test methods, the power specialists were concerned with sterilization techniques, electrode corrosion, and component ruggedness.

The AEC-NASA partnership extended to cover spacecraft power systems research as well as propulsion research. AEC had begun its SNAP (Systems for Nuclear Auxiliary Power) program in the 1950s, and the Air Force had been quick to incorporate a SNAP-1A-class RTG on a satellite in 1955. In 1960 and 1961, NASA expressed its interest in SNAP-8, a reactor system, for future spacecraft applications and in the SNAP-11 RTG for the Surveyor lunar orbiter. Rather than depend on nuclear systems for immediate full-power systems, OART personnel emphasized development of components and subsystems.¹⁵

Working with AEC and Aerojet-General, one group of experts at Lewis Research Center spent most of 1958-1968 trying to produce an acceptable SNAP-8 prototype. While AEC worked on the reactor, NASA was responsible for the mercury Rankine converter. In July 1968, SNAP-8DR sustained a nuclear reaction for the first time. The only other reactor-class SNAP NASA advanced researchers investigated in any depth was SNAP-50, an advanced reactor power unit capable of 300 kilowatts to 1 megawatt. NASA's support of this ambitious project, which was of special interest to the military, was limited to the early 1960s.

NASA found the relatively less powerful RTG system (whereby heat is created by decaying isotopes) more suitable to its needs than reactor SNAPs. Although the agency was forced to drop its plans for a Surveyor orbiter and the SNAP-11 that would have powered it, OART was quick to request AEC's assistance with an RTG for the Nimbus weather satellite. SNAP-19 would contribute supplementary power

for Nimbus B. The Nuclear Division of the Martin Company built the RTG unit for AEC and, with the assistance of personnel from the commission, installed it on NASA's spacecraft in early 1968. Unfortunately, the launch went awry, and SNAP-19 sank to the bottom of the Santa Barbara, California, channel along with pieces of the spacecraft. Another SNAP-19, built by Isotopes, Incorporated, was launched aboard *Nimbus 3* the next year. This successful RTG would also be incorporated into the Viking Mars spacecraft in the 1970s. The Manned Spacecraft Center was interested in an RTG for its Apollo Lunar Surface Experiments Package (ALSEP) and negotiated with General Electric to provide the center with four units. In 1968, the first flight-ready SNAP-27 was delivered for integration into the ALSEP; it would go to the moon with the *Apollo 12* crew in 1969.

Lewis Research Center assumed technical direction for most spacecraft power research. Goddard Space Flight Center, the Jet Propulsion Laboratory, and the Manned Spacecraft Center were interested in specific applications of new power systems to spacecraft or experiments they had under development. Research was conducted at numerous contractor facilities and in-house at NASA centers. Lewis personnel made use of the Plum Brook nuclear test center.

DESCRIPTION – AERONAUTICS

Advanced aeronautics had been the major research field of the National Advisory Committee for Aeronautics (NACA), its only field for decades. But for NACA's predecessor, it was of decidedly lesser importance. The ambitious "space goals" that NASA was expected to achieve during the 1960s were given first priority. When the Office of Advanced Research and Technology was organized in 1961, aeronautics was assigned to it.

Table 4-84.
Power Conversion Systems under Investigation, 1958-1968

With each of the three energy sources under investigation—chemical, solar and nuclear—there were several different means for converting the source energy to electrical energy:

CHEMICAL

Primary batteries*
Secondary batteries*
Fuel cells*
Engines

SOLAR

Photovoltaic*
Brayton
Thermionic

NUCLEAR

RADIOISOTOPE

Thermoelectric*
Brayton
Thermionic
Rankine

REACTOR

Brayton
Rankine
Thermionic
Magnetohydrodynamic conversion (MHD)

*Operational systems.

The laboratories at Langley and Ames with their wind tunnels and other special facilities had been NACA's major aeronautical research sites; personnel at Lewis in Cleveland had worked on aircraft propulsion problems; crews at Muroc, California, had flight-tested new rocket-powered aircraft. With the call for orbiting manned spacecraft and lunar landings, Langley, Ames, and Lewis, along with NASA's new centers, turned most of their energies to solving the many problems of spaceflight. Little time and money were left for aeronautics. As the agency's first decade was coming to a close, members of Congress began echoing the accusations of earlier, more farsighted proponents of aeronautical research, who in the early 1960s had predicted that if the U.S. diverted all its support to astronautics and space science the country would start lagging behind in the competitive field of aeronautics. Some experts believe this is exactly what happened in both military and commercial aviation¹⁶ However, NASA did contribute significantly to several areas of aeronautical research in 1958-1968, although this work took on an increasingly applied, as opposed to a basic research, flavor (see fig. 4-3).

Table 4-85.
SNAP Systems Used or Investigated by NASA, 1958-1968

Designation ^a	RTG or reactor	Isotope ^b	Core type	Electrical power (w)	Weight (g)	Remarks
SNAP-8	reactor		hydride	35 000	4460	Developed for use in orbital labs, lunar bases, communications satellites, and deep space probes. NASA was interested in pursuing the development of this system for future applications.
SNAP-11	RTG	Ce-242		21-25	13.6	Engineers at JPL wanted to incorporate this system on the Surveyor orbiter, a project that was dropped in 1962.
SNAP-19B	RTG	Pu-238		30	13.6	Used on 1968-1969 Nimbus weather satellites. Another variation of the SNAP-19 would be used on the Viking Mars lander in the 1970s.
SNAP-27	RTG	Pu-238		63.5	30.9	Used to power the Apollo Lunar Surface Experiments Packages (ALSEPs), the first of which was being readied for <i>Apollo 12</i> in 1968.
SNAP-29	RTG	Po-210		500	180	An advanced system being investigated by NASA for possible Apollo applications missions.
SNAP-50	reactor		fast nitride	100 000- 1 000 000	2700- 9000	Investigated briefly by NASA for possible future applications.

^a Even numbers indicate a reactor-type SNAP, odd numbers an RTG-type.

^b Ce = cerium; Pu = plutonium; Po = polonium.

NASA's aeronautics teams were interested in pursuing problems in every regime of flight, from the hovering of helicopters to the hypersonic capabilities of advanced military rocket-planes. And the civilian specialists investigated topics as diverse as aircraft structures and materials, operating problems, air traffic controller work loads, pilot response to complex instrumentation, and possible designs for supersonic transports and military fighters. Some employees at Langley and Ames continued their work on aircraft design and testing, especially with V/STOL aircraft (vertical/takeoff and landing craft). The Flight Research Center (FRC) at Edwards Air Force Base, formerly NACA's Muroc High-Speed Test Flight Station, grew from a small contingent of less than 300 specialists working in makeshift quarters in October 1958 to a major research and test-flight facility in the mid-1960s. Over the decade, FRC pilots and ground crews saw increasingly sophisticated aircraft on the desert runways. Aircraft became sleeker and high-flying. They progressed from subsonic speeds, through transonic, to supersonic, and then to hypersonic. The 1960s was an exciting, pioneering decade for spaceflight enthusiasts, but it was also a time of advancement in the field of aeronautics.

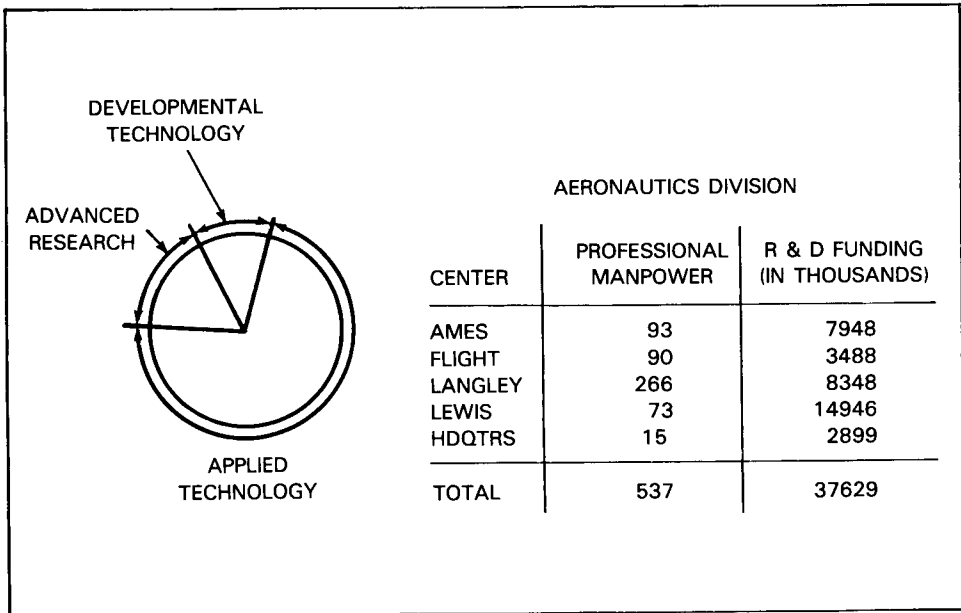

advanced research = exploration of new ideas not related to specific aircraft

applied technology = study of new vehicle concepts, a definition phase useful to industry to indicate the feasibility of a design

developmental technology = support to a user agency in testing and analyzing new technology

Figure 4-3. Typical Distribution of Aeronautics Resources (CY 1965)

Most of the OART managers that served the aeronautics research directorate at NASA Headquarters during the first 10 years began their careers with NACA. John Stack and Charles H. Zimmerman, the first two directors, were old Langley hands. From Ames came Charles W. Harper, who was NASA's director of aeronautics from October 1964 through April 1967, when he assumed the new post of deputy associate administrator for aeronautics, reporting directly to the OART associate administrator. Albert J. Evans, who had served as acting director in 1963-1964 and later as deputy director, took the director's job again when Harper moved to his new post. Membership in the headquarters aeronautics group was stable, with the same chiefs leading the branches offices for many years. William S. Aiken, Jr. (NACA, Langley) headed the operating problems office; John B. Parkinson (NACA, Langley) oversaw the management of aerodynamics research; Harvey H. Brown was the loads and structures man; Nelson F. Rekos represented propulsion; and James A. Martin (NACA, Muroc) oversaw the various flight systems projects (a super-sonics systems manager, Leonard Sternfield, was added in 1967). (See table 4-71 for more information on the management structure of this directorate.) Adding a deputy associate administrator for aeronautics in 1967 was recognized as a symbol of a renewed and greater interest in this area of research by NASA.

By mandate, NASA's primary goal in aeronautics research was to provide the aviation community—civilian and military—with data that would lead to advanced aircraft and safer operating procedures. To do this, the agency had to work closely with the Department of Defense and the Federal Aviation Administration. Many aeronautics projects, because of their great expense and their possible applications to several parties, were joint projects. The NASA-FAA-DoD-industry team members did not always agree among themselves as to priorities and research techniques, but the nature of the enterprise required them to work together and share their expertise. Throughout the first decade, there were numerous joint panels, investigative boards, and committees (technical and managerial) to coordinate the projects that demanded group action.

Of the many projects the NASA aeronautics team contributed to, the best known are probably the flight tests at the Flight Research Center of high-speed research aircraft such as the X-15. But the bulk of the work was accomplished less dramatically in wind tunnels, on drawing boards, and with computers. Langley Research Center absorbed most of the aeronautics research and development budget during the decade, and it was there that most of the general aviation studies took place. NASA pilots were assigned to Langley, Ames, and FRC, and they flew experimental and specially instrumented aircraft of all classes. They worked closely with aeronautical engineers who tested designs in wind tunnels under simulated flight conditions before they trusted their ideas and the ideas of others to actual flying hardware. The work was unglamorous and tedious for the most part; it often led nowhere; but it was undeniably important to a country that depended on aircraft for transportation and defense.¹⁷

Table 4-86.
Changing Organization of the OART
Aeronautics Office, 1961-1968

Nov. 1961–Oct. 1964

Director, Office of Advanced Research and Technology

Director, Aeronautics Research (John Stack; Charles H. Zimmerman, June 1962; Albert J. Evans, acting, June 1963)

Chief, Aerodynamics (John B. Parkinson)

Chief, Special Projects (Evans, 1962; James A. Martin, June 1963)

Chief, Operations Research (William S. Aiken); office renamed Operating Problems in 1963

Chief, Loads and Structures (Harvey H. Brown, 1962)

Chief, Propulsion and Vehicle Projects (Evans; Nelson F. Rekos, 1962); office renamed Propulsion in 1963

Oct. 1964–April 1967

Director, Office of Advanced Research and Technology

Director, Aeronautics (Charles W. Harper)

Deputy Director, Aeronautics (Evans)

Chief, Aerodynamics (Parkinson)

Manager, Flight Systems (Martin)

Chief, Loads and Structures (Brown)

Chief, Operating Problems (Aiken); office renamed Operating Environment and System Dynamics in 1966

Chief, Propulsion (Rekos)

May 1967–Dec. 1968

Administrator, Office of Advanced Research and Technology

Deputy Associate Administrator for Aeronautics (Harper)

Director, Aeronautical Vehicles (Evans)

Deputy Director, Aeronautical Vehicles (Aiken, Aug. 1967)

Chief, Aerodynamics (Parkinson)

Manager, Flight Systems (Martin)

Chief, Loads and Structures (Brown)

Chief, Operating Environment and System Dynamics (Aiken)

Chief, Propulsion (Rekos)

Manager, Supersonic Systems (Leonard Sternfield); office added fall 1967

General Aviation

Much of NASA's aeronautical research could be applied to nonmilitary aircraft in the general aviation class. With the increasing numbers of commercial and privately owned and operated aircraft came problems with pilot readiness, airport crowding, and midair accidents. In 1965-1966, NASA participated in a national program to improve flight safety by conducting a broad-scale evaluation of the handling qualities of light personal aircraft. In the area of pilot readiness, researchers devised improved simulators for training exercises. The computer-driven Movingbase Landing-Approach Simulator in operation at Ames in the late 1960s was one example of this kind of teaching aid developed by NASA. The many accidents involving small planes, especially near airports, led the agency to search for a low-cost collision-avoidance system. In 1968, research on such a device was underway at Langley, Ames, and the Electronics Research Center.

Research into aircraft operating problems at the NASA centers benefited all classes of flyers. Advanced researchers at Ames and Langley studied runways under various conditions, and their findings led to the redesign of runways to make them safer when wet or covered with slush or snow. Aircraft engine noise was an operating problem that gained national attention in 1966 when President Johnson called for a solution to the noisy conditions present at large air terminals. NASA participated in this multiagency project (Interagency Aircraft Noise Abatement Program) by studying improvements that could be made to the terminals themselves to combat noise and to the aircraft engines. In 1968, Lewis Research Center was requesting proposals from industry as part of its quiet engine project. Engine noise can be reduced from two sources: the interaction of the jet exhaust with the outside air, and the fan. Langley, too, was soliciting proposals for developing, fabricating, and testing modified engine nacelles for commercial aircraft.¹⁸

Besides looking for the answers to specific problems, specialists at Ames and Langley conducted research in the fields of aerodynamics and loads and structures that was more basic in nature. Aerodynamicists studied a variety of situations and conditions—high winds during V/STOL landings, hypervelocity flight, reentry heating. Others analyzed the integrity of various new materials and their suitability to various design roles. More visible than basic research or applied technology studies was the developmental technology work that the NASA aeronautics team did—the actual testing and analyzing of new hardware.*

V/STOL

Aircraft capable of landing and taking off vertically or with a relatively short ground-run showed promise as military vehicles and as short-haul commercial or civil transports. The armed conflicts in Korea and later in Indochina alerted the

*NACA had played a leading role in the military's testing program. NACA pilots flew prototypes of new military aircraft and worked with the services and the manufacturers in improving (or rejecting) designs. This tradition was being revived by NASA in the late 1960s.

Department of Defense to the need for aircraft that could operate from widely dispersed, relatively unprepared sites close to the front. Large metropolitan areas with inadequate highway systems needed a way to transport emergency crews and commuters and goods. Experts at Langley and Ames Research Centers studied many V/STOL (vertical/short takeoff and landing) concepts during 1958-1968, rejecting many of the designs but steadily contributing to the state of the art. In the search for advanced designs, specialists also found ways to improve the conventional helicopter (for example, by introducing nonarticulated rotors).

V/STOL concepts took many forms (see fig. 4-4). Some resembled helicopters, some bent-winged airplanes. Others sat on their tails. One way of classifying the possible types was by comparing their methods of converting from vertical or near

V/STOL TESTBEDS

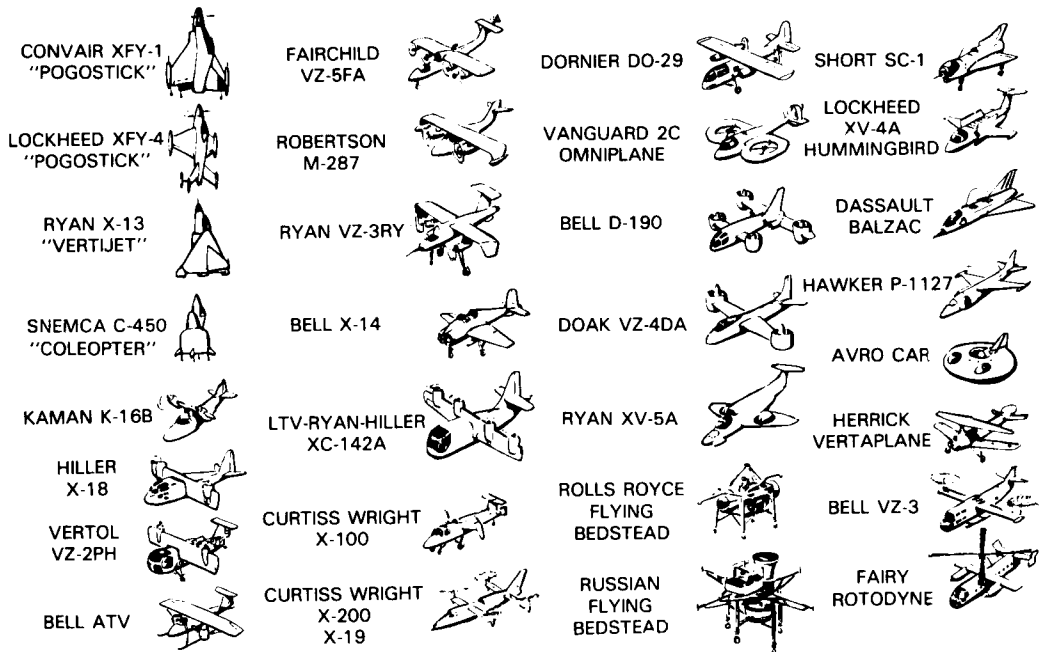

Figure 4-4. V/STOL Testbeds Analyzed by NASA

From "Program Review, Aeronautics Program," March 21, 1966, p. 11.

vertical flight to horizontal flight—tilting the entire craft; tilting only the rotors, propellers, or other source of thrust; deflecting the thrust; or using dual propulsion (one set of engines for lifting-lowering, another for driving horizontally). Possible sources of thrust were rotors, propellers, ducted fans, jet exhausts, or some combination of these. The goal with an STOL was a steep climb out of a congested area; a VTOL might be required to hover for long periods of time. With wind tunnels and computers, NASA employees analyzed the various designs. The promising ones were translated to flight prototypes and equipped with extra instrumentation for a rigorous test flight program. NASA's investigations of V/STOLs covered aerodynamic design, materials and structures, the power plant, handling, and operating costs.¹⁹

Supersonic/Hypersonic Research

Traveling faster than the speed of sound had been a goal of flyers and aircraft designers since the early 1940s, and NACA and the services had jointly pursued that goal with an instrumented research aircraft program. The Army-sponsored Bell XS-1 was the first of these specially built air-launched X-series aircraft to be approved.* With the Army, Air Force, and Navy supporting them, Bell Aircraft, Reaction Motors, Douglas Aircraft, and others became involved with designing faster and higher-flying aircraft. NACA's part in this activity increased as the builders entered the detail design phases of their projects and when flight-testing began. One of the committee's major contributions in the search for high-speed aircraft was the concept of variable swept wings (1946–1947). If an aircraft's wings could be made to move, changing their angle (sweep), the aircraft could adapt itself to different regimes of flight.

In October 1947, pilot Charles E. Yeager broke the sound barrier. In the XS-1, he traveled at more than the speed of sound—Mach 1.06 at 13,000 meters.† By the next year, the scope of the research aircraft program had increased greatly to include several types of aircraft, operational or under development. To manage this growing activity, NACA established a Research Airplane Projects Panel that would serve as coordinator for the committee's high-speed aircraft program and as an interface between NACA and the military. The 1950s saw NACA engineers and pilots working

*It was NACA's participation in the testing of the XS-1 in 1946 in Muroc, California, that prompted a contingent of specialists from Langley to move to this land of dry lake beds so suitable for test flights. They became the nucleus around which NASA's Ames Flight Research Center was built in the 1960s.

†As an airplane's speed increases, it piles up a mass of air ahead of it, formed from constantly emitted pressure disturbances that move outward from the plane. These disturbance waves move at the speed of sound, approximately 1220 kilometers per hour at sea level, dropping to 1060 kilometers per hour at about 12,000 meters. As an airplane approaches the speed of sound, it begins to catch up with its own forward-moving pressure wave fronts. When flying well below the speed of sound, a plane is said to be moving at subsonic speed; flight at velocities around the speed of sound is termed transonic; flight faster than sound is supersonic. Hypersonic flight is generally defined as five times the speed of sound. The common unit of measurement for the speed of sound is Mach number, the ratio of an object's speed to the speed of sound (Mach 1.0 = the speed of sound).

with X-1, X-3, X-4, X-5, D-558-1, and D-558-2 research craft, plus a number of advanced military bombers and fighters.* When NASA assumed authority over Langley and the Muroc station, the last of the first-generation X-series studies (aerodynamics, flight loads, stability and control, operations) had been completed. The X-2 had reached Mach 3; the delta wing configuration had been flown; pilots had ventured beyond the 30 000-meter ceiling; the X-5 with its variable swept wings had been proved; hypervelocity (Mach 5+) flight was under study at Langley. NASA had inherited round two of the X-series program, the X-15 hypervelocity research aircraft.†

X-15. As early as 1951, Robert J. Woods of Bell Aircraft suggested that NACA sponsor a hypervelocity-class research aircraft. The next year, the committee expanded its research program to investigate the possibility of flight at altitudes of 19 to 80 kilometers, at speeds of Mach 4 to 10. Langley's first studies of hypervelocity flight coincided with the Air Force's interest in this class of advanced aircraft. By the end of 1954, NACA and the military services had jointly defined the specifications for the first hypersonic aircraft and had invited 12 firms to bid on its manufacture. The X-15 was to be capable of flight at 76 000 meters at 2000 meters per second. Of the four companies (Bell, Douglas Aircraft, North American Aviation and Republic Aviation) who submitted proposals, North American's package was judged to be the best. The firm signed a contract with the Air Force for three X-15s in December 1955. Reaction Motors (later absorbed by Thiokol) would build the power plant. By October 1958 when NASA was established, the first X-15 was ready for roll-out, but not with its liquid oxygen-ammonia XLR-99 engine. North American had had relatively little trouble fabricating the X-15's airframe, but the powerful new engine had proved to be a stumbling block. In its place for the interim, two XLR-11 engines would power the new craft. NASA's team at Edwards Air Force Base was fortified for the coming test flights by 80 new employees, bringing its force to near 300.

During the spring of 1959, the first X-15 was flown captively under the wing of a B-52 to check out its onboard systems before its first glide flight in June. The first powered flight took place in September with the second X-15.** Because of its large fuel consumption, the X-15 was air-launched from a B-52 at 13 000 meters at about 800 kilometers per hour.†† The X-15 reached Mach 2.15 on its second powered flight, but the third flight was not as successful. When an engine caught fire, the pilot made an emergency landing, and it took three months to repair the resulting damage. Meanwhile, the first aircraft was checked out satisfactorily and turned over to NASA. NASA pilot Joe Walker took X-15 number one to Mach 2 on March 25, 1960, during the first true X-15 research flight. For the rest of the year, NASA and

*For details on these aircraft, see Langley Research Center, *Progress in Aircraft Design since 1903* (Hampton, VA, 1974); and Flight Research Center, "Experimental Research Aircraft," n.d.

† Round three was to have been the Air Force Dyna-Soar (X-20) orbital lifting reentry vehicle. This project was cancelled in 1963 because of rising costs.

**North American pilot A. Scott Crossfield flew the initial checkout flights before the aircraft were officially turned over to NASA and the Air Force.

†† Depending on the mission, the X-15's rocket engine provided 80-120 seconds of thrust; the remainder of the 10 to 11-minute flight was powerless, ending with a 300-kilometer-per-hour glide landing. One of two flight profiles was normally used: a high-altitude plan that called for the pilot to maintain a steep rate of climb, or a speed profile that called for the pilot to maintain a level altitude.

Air Force pilots flew the two vehicles regularly, exceeding Mach 3 even before the XLR-99 engines were installed.* The third aircraft had meanwhile been forced back to the factory already, after it exploded in its test stand at FRC in June. It was not ready for its first flight until December 1961.

NASA's test objectives with the X-15 were many.²⁰ Instruments monitored closely by ground crews at FRC measured the aircraft's stability, its ability to withstand heating and loads, and its controllability. Of special interest were the conditions experienced during atmospheric exit and reentry; the data collected on reentry were used by spacecraft designers struggling with the definition of a future-generation reusable vehicle. In addition to the mechanics of hypersonic flight and the performance of the X-15, however, NASA and Air Force specialists closely observed the pilots. Operating such a sophisticated machine at six times the speed of sound in a near-space environment was a demanding task. By studying the research pilots' reactions to commands, their vital signs while under stress, and their overall performance records, manned spaceflight experts collected data that influenced astronaut training and spacecraft systems engineering. By late 1961, NASA researchers had completed their original test objectives. With two aircraft operational and a modified and improved third X-15 on the way, the research aircraft team broadened the X-15 program to include scientific and engineering experiments. The joint X-15 Research Airplane Committee approved 28 experiments, ranging from astronomy investigations with stellar photography to micrometeorite collection.

The next several years of X-15 operations saw success and tragedy. In November 1962, X-15 number two crash-landed, injuring the pilot and extensively damaging the plane. In the rebuilding, NASA and Air Force personnel modified the design, adding external fuel tanks and a hypersonic ramjet engine. The improved X-15 was expected to reach Mach 7+. In 1963, speed and altitude records were broken. Air Force pilot Robert M. White earned his astronaut's wings in July when he took X-15 number three to 95 936 meters, an altitude topped by NASA pilot Joseph A. Walker the next month. X-15 number one went beyond Mach 6 in December 1963. The modified, rebuilt second X-15, redesignated X-15A-2, went into operation in 1964, and with its external tanks and ramjet broke the latest speed records. In November 1966, X-15A-2 reached Mach 6.33; less than a year later it hit Mach 6.72, its last speed record and one that cost the aircraft its new ablative coating. Heating also caused unforeseen problems with the ramjet. X-15A-2 did not reach the Mach 7+ speeds that its designers had predicted. Tragedy came to the program in November 1967 when X-15 number 3 went into a spin at Mach 5+ and then into a steep dive during reentry. Pilot Michael J. Adams (Air Force) did not regain control of his aircraft; it broke up and the pilot was killed. NASA engineers had hoped to convert X-15 number three into a delta-wing aircraft with a ramjet to evaluate a second hypersonic aircraft design, but the agency cancelled these plans after the fatal accident. Number two was grounded permanently, as well, in June 1968. NASA Headquarters had decided that the Langley-FRC research team had nearly exhausted the X-15's potential. The \$600 000 it cost per flight to operate the aircraft could be used elsewhere. X-15 number one took its last flight on October 24,

*See table 4-88 for a log of X-15 flights.

1968. For many weeks thereafter, the group at FRC tried for one more flight, the 200th, but minor mechanical problems and inclement weather thwarted their efforts. On their last attempt in December, it snowed on the desert runways.²¹

LENGTH:	15.24 m
WING SPAN:	6.7 m
WEIGHT, EMPTY:	22,500 kg
WEIGHT, AT LAUNCH:	54,700 kg
THRUST:	267,000 newtons

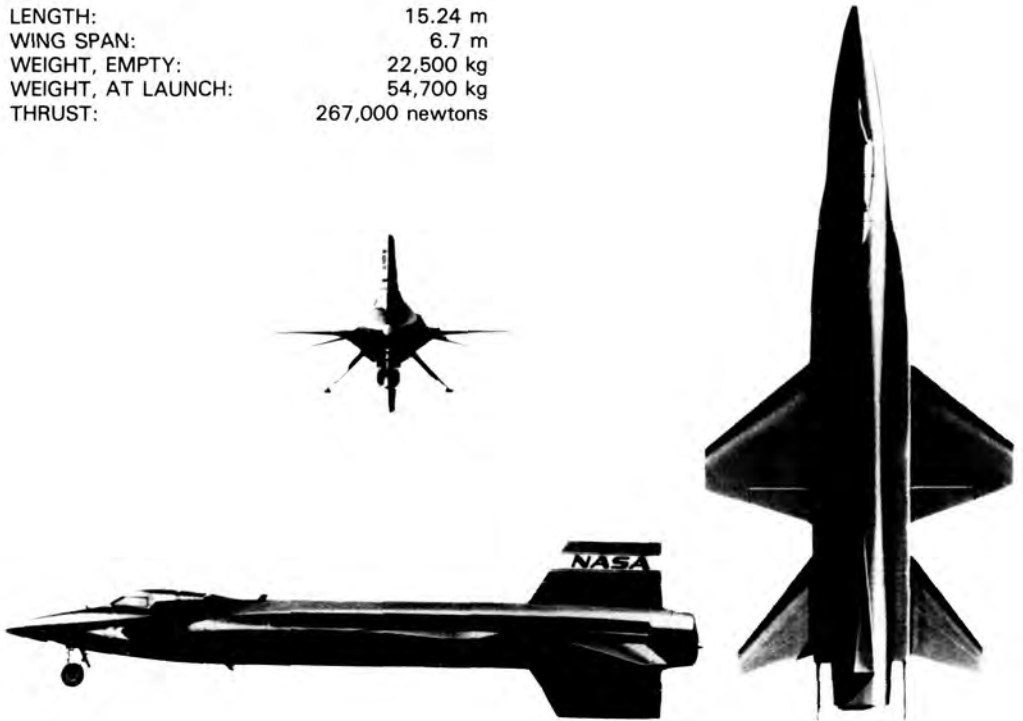

Figure 4-5. Configuration of the X-15 Research Aircraft

Table 4-87.
Chronology of X-15 Development and Operations

Date	Event
Aug. 1944	A report by German scientists Eugen Sänger and Irene Bredt supported the design of a hypersonic rocket-propelled ground-launched global aircraft also capable of spaceflight. It would reenter in a semi-ballistic skip trajectory. The iron-shaped aircraft would weigh 91 000 kilograms. (This report influenced hypersonic research conducted later by the National Advisory Committee for Aeronautics [NACA]. After World War II, Walter Dornberger [war-time director at Peenemünde] of Bell Aircraft proposed a boost-glide vehicle based on the Sänger-Bredt design.)
Oct. 4, 1951	Robert J. Woods of Bell suggested that NACA build a hypersonic-class research aircraft.
Jan. 30, 1952	Woods recommended that NACA establish a group to study Mach 5† manned winged aircraft designs.
June 24, 1952	NACA's Committee of Aerodynamics voted to expand its research aircraft program to include flight at altitudes of 19 to 80 kilometers at Mach 4-10 and to devote a modest effort to studying escape-velocity flights.
Aug. 1952	NACA appointed a hypersonic research aircraft study group at the Langley Memorial Aeronautical Laboratory (Clinton Brown, W. J. O'Sullivan, Charles Zimmerman).
June 1953	The hypersonic aircraft study group submitted a report recommending that NACA investigate aerodynamic heating problems and undertake rocket-propelled hypersonic aircraft model tests.
Aug. 1953	Specialists at NACA's test-flight facility at Muroc, California, submitted a proposal for a very futuristic hypersonic piggyback research aircraft.
Oct. 1953	The Air Force Scientific Advisory Board's Aircraft Panel advocated a hypersonic research aircraft program.
Fall 1953	Douglas Aircraft Corporation's El Segundo Division was awarded a contract by the Office of Naval Research for a feasibility study of a hypersonic research aircraft capable of Mach 7 at 200 000 meters.
Feb. 1954	NACA's Research Airplane Projects Panel concluded that an entirely new research aircraft capable of hypersonic speeds was desirable.
March 9, 1954	NACA directed its laboratories to submit their views on hypersonic aircraft to headquarters.
March 15, 1954	Langley created a hypersonic research airplane study group (John V. Baker, Maxime Faget, Thomas Toll, N. F. Dow, J. B. Whitten). Their work led to the design that would later be adopted for the X-15.
June 1954	NACA invited the military services to join them in forming a joint hypersonic research aircraft program.
July 9, 1954	Becker submitted the Langley study group's design proposal at a joint NACA-Air Force-Navy meeting.
Sept. 13, 1954	The Air Force, through Wright Air Development Center, endorsed NACA's proposal for a hypersonic aircraft, but cautioned that selection of a power plant should be deferred until propulsion requirements were more adequately defined. The Air Force wanted "executive responsibility" for the project.
Oct. 18, 1954	NACA, the Air Force, and the Navy created a committee to define the specifications for a hypersonic research aircraft (Hartley Soulé, NACA; R. M. Wray, Air Force; Abraham Hyatt, Navy).

Table 4-87.
Chronology of X-15 Development and Operations (Continued)

Date	Event
Winter 1954	NACA, Air Force, and Navy participants worked out the management responsibilities for the project; the Air Force and the Navy would jointly fund the design and development phases of the aircraft; NACA would have responsibility for the technical aspects of the project. A Research Airplane Committee would advise NACA.
Dec. 23, 1954	A memorandum of understanding was signed by NACA, Air Force, and Navy participants.
Dec. 30, 1954	The Air Force Air Materiel Command Aircraft Division released an invitation to bid to 12 firms; the deadline for reply was May 9, 1955. The aircraft was to be capable of speeds of 2000 meters per second and an altitude of 76 000 meters.
Jan. 17, 1955	The Air Force designated the hypersonic research aircraft project the X-15. NACA selected Arthur Vogely of Langley as project officer; the Air Force chose Chester McCollough as project engineer.
Jan. 18, 1955	A briefing on the X-15 project was held for industry.
May 9, 1955	Bell, Douglas, North American Aviation, and Republic Aviation submitted proposals for an X-15.
May 17, 1955	The X-15 Research Airplane Committee decided that the Air Force would build and equip the new test-flight range that would be required for the X-15 and that NACA would operate it.
Aug. 5, 1955	North American's proposal was judged to be the best package, with Douglas's proposal a close second.
Dec. 9, 1955	North American signed a letter contract with the Air Force that called for the development and fabrication of three X-15 aircraft.
Feb. 15, 1956	The Air Force awarded Reaction Motors, Inc., a contract for the X-15 power plant, a liquid oxygen-ammonia engine designated the XLR-99.
June 11, 1956	The Air Force awarded North American a definitive contract for the X-15.
Dec. 11, 1956	North American held an X-15 mockup inspection.
Sept. 1957	Construction of the first X-15 began at North American.
Feb. 1958	Because of delays with the XLR-99 engine, the project office authorized the use of two XLR-11 engines in place of the 99 for the X-15's initial flights. NACA, the Air Force, and the Navy's Bureau of Aeronautics set up a technical advisory group to monitor the new engine's development. The Air Force secured the cooperation of North American's Rocketdyne Div. to assist Reaction Motors.
April 1958	Thiokol Chemical Corp. absorbed Reaction Motors.
Aug. 1958	The XLR-99 engine was operating close to specifications.
Oct. 1958	The Air Force cancelled Rocketdyne's backup engine program. At NASA's facility at the flight-test site, 80 personnel were added to the X-15 group.
Oct. 15, 1958	Rollout of the first X-15 took place at North American's Los Angeles Div.; the aircraft was delivered to Edwards Air Force Base the next day.
March 10, 1959	Carried under the wing of a B-52, the first X-15 was flown captively to check out onboard systems. An electrical generator malfunctioned, terminating the test prematurely.
April 1, 1959	A second captive flight revealed problems with the pilot's pressure suit.

Table 4-87.
Chronology of X-15 Development and Operations (Continued)

Date	Event
April 10, 1959	The second X-15 was delivered to Edwards.
April 18, 1959	The XLR-99 engine completed acceptance tests.
May 1959	Flight Research Center (FRC, NASA) engineer Hubert Drake suggested using the X-15 to carry scientific and engineering experiments.
June 8, 1959	X-15 number one performed its first glide flight (no power); North American pilot A. Scott Crossfield was at the controls. The pilot had some difficulty with the landing, but the problems were easily solved.
June 30, 1959	North American completed the third aircraft.
July 1959	The X-15 High Range was ready for operations (three radar tracking facilities).
Sept. 17, 1959	X-15 number two performed the first powered flight with the interim engines; Crossfield reached Mach 2.11 and 15 954 meters.
Nov. 5, 1959	An engine fire on X-15 number two led to an emergency landing with a partial propellant load, breaking the plane's "back." The aircraft was grounded for repairs for three months.
Jan. 23, 1960	X-15 number one took its first powered flight; after the mission NASA took official delivery of the aircraft.
May 1960	The XLR-99 engine was installed in the third X-15, and the aircraft was shipped to FRC.
June 1960	North American installed the XLR-99 in X-15 number two.
June 8, 1960	X-15 number three exploded in its test stand when a pressure regulator in the ammonia tank malfunctioned. The aircraft's midsection and tail were destroyed.
Feb. 1961	X-15 number one was returned to North American for its XLR-99 engine.
Feb. 8, 1961	NASA accepted X-15 number two from North American.
June 10, 1961	X-15 number one was returned to FRC with its XLR-99 engine.
Aug. 1961	NASA and the Air Force established an X-15 Joint Program Coordinating Committee to plan X-15 follow-on experiments; their report was readied by September.
Sept. 1961	North American delivered the repaired X-15 number three to FRC; it was equipped with a unique stability augmentation system (Honeywell MH-96 Adaptive Flight Control System), which would enable the craft to reach higher altitudes.
Oct. 4, 1961	The lower half of the ventral vertical fin was removed to improve pilot control of the aircraft and to allow for angles of attack greater than 20 degrees to simulate spacecraft reentry.
Nov. 1961	NASA and the Air Force approved using the X-15 as an experiments carrier.
Nov. 9, 1961	X-15 number two reached its design speed of Mach 6+.
Dec. 20, 1961	X-15 number three took its first powered flight.
March 23, 1962	The X-15 Research Airplane Committee approved the follow-on research program.
Nov. 9, 1962	X-15 number two crash-landed, injuring the pilot. The plane had to be totally rebuilt. Its design was modified by the addition of external fuel tanks and a hypersonic ramjet engine. The damaged aircraft was delivered to North American on December 7.

Table 4-87.
Chronology of X-15 Development and Operations (Continued)

Date	Event
March 25, 1963	North American was notified to proceed with the modifications that would transform number two into a Mach 8 aircraft.
May 9, 1963	North American received a letter contract for modifications to number two.
Feb. 17, 1964	Modified number two (X-15A-2) was delivered to FRC.
Feb. 18, 1964	The X-15 Research Airplane Committee held its last formal meeting, approving the Langley hypersonic ramjet experiment for X-15A-2.
June 25, 1964	X-15A-2 took its first flight.
Jan. 1966	NASA negotiated a contract with the Martin Company for the design and testing of an ablative coating for X-15A-2 that would protect it at speeds above Mach 6.
Oct. 3, 1967	X-15A-2 with the ramjet set an official world speed record of Mach 6.72. The heating experienced at that speed caused problems with the ramjet, and the spray-on ablative coating proved unsatisfactory. The aircraft was returned to North American Rockwell for general maintenance and repairs, but this was the aircraft's last flight.
Nov. 15, 1967	Due to probable distraction and misinterpretation of instrument displays and possible vertigo, pilot Michael J. Adams in X-15 number three went into a spin at Mach 5+ and then into a steep dive at Mach 4.7+ during atmospheric reentry. The plane broke up, and the pilot was killed. An accident board was convened to investigate.
June 27, 1968	X-15A-2 was returned to FRC but not flown again.
Dec. 1968	NASA decided to cancel the X-15 program. The flight team at FRC tried to accomplish the 200th X-15 flight with number one, but minor mechanical problems and unfavorable weather conditions prevented them from attaining this symbolic goal.

Table 4-88.
X-15 Flight Log

No.	Date	Flight no.*	Pilot	Max. Mach	Max. alt. (meters)	Remarks
<i>1959</i>						
1	June 8	1-1-5	A. Scott Crossfield, North American	.79	11 445	First glide flight.
2	Sept. 17	2-1-3	Crossfield	2.11	15 954	First powered flight (XLR-11 engines).
3	Oct. 17	2-2-6	Crossfield	2.15	18 831	
4	Nov. 5	2-3-9	Crossfield	1.00	13 857	Engine fire forced landing with partial propellant load; some damage on landing.
<i>1960</i>						
5	Jan. 23	1-2-7	Crossfield	2.53	20 374	NASA took delivery after this flight.
6	Feb. 11	2-4-11	Crossfield	2.22	26 858	
7	Feb. 17	2-5-12	Crossfield	1.57	16 045	
8	March 17	2-6-13	Crossfield	2.15	16 045	
9	March 25	1-3-8	Joseph A. Walker, NASA	2.00	14 822	NASA's first research flight.
10	March 29	2-7-15	Crossfield	1.96	15 235	
11	March 31	2-8-16	Crossfield	2.03	15 653	
12	April 13	1-4-9	Robert M. White, Air Force	1.94	14 630	First Air Force flight.
13	April 19	1-5-10	Walker	2.56	18 134	
14	May 6	1-6-11	White	2.20	15 631	
15	May 12	1-7-12	Walker	3.19	23 738	
16	May 19	1-8-13	White	2.31	33 222	
<i>1960</i>						
17	May 26	2-9-18	Crossfield	2.20	15 631	Reaction control system used in flight for the first time.
18	Aug. 4	1-9-17	Walker	3.31	23 809	
19	Aug. 12	1-10-19	White	2.52	41 605	
20	Aug. 19	1-11-21	Walker	3.13	23 159	
21	Sept. 10	1-12-23	White	3.23	24 343	
22	Sept. 23	1-13-25	Forrest S. Petersen, Navy	1.68	16 168	
23	Oct. 20	1-14-27	Petersen	1.94	16 398	
24	Oct. 28	1-15-28	John B. McKay, NASA	2.02	15 453	
25	Nov. 4	1-16-29	Robert A. Rushworth, Air Force	1.95	14 905	
26	Nov. 15	2-10-21	Crossfield	2.97	24 750	First flight with XLR-99 engine.
27	Nov. 17	1-17-30	Rushworth	1.90	16 688	
28	Nov. 22	2-11-22	Crossfield	2.51	18 867	First engine restart with the XLR-99.

Table 4-88.
X-15 Flight Log (Continued)

No.	Date	Flight no.*	Pilot	Max. Mach	Max. alt. (meters)	Remarks
29	Nov. 30	1-18-31	Neil A. Armstrong,	1.75	14 886	
30	Dec. 6	2-12-23	NASA Crossfield	2.85	18 268	This flight concluded North American's part of the test flight program.
31	Dec. 9	1-19-32	Armstrong	1.80	15 269	
<i>1961</i>						
32	Feb. 1	1-20-35	McKay	1.88	15 173	Last flight with XLR-11 engines.
33	Feb. 7	1-21-36	White	3.50	23 820	
34	March 7	2-13-26	White	4.43	23 607	
35	March 30	2-14-28	Walker	3.95	51 694	
36	April 21	2-15-29	White	4.62	32 004	
37	May 25	2-16-31	Walker	4.95	32 766	
38	June 23	2-17-33	White	5.27	32 827	
39	Aug. 10	1-22-37	Petersen	4.11	23 835	
40	Sept. 12	2-18-34	Walker	5.21	34 839	
41	Sept. 28	2-19-35	Petersen	5.30	31 029	
42	Oct. 4	1-23-39	Rushworth	4.30	23 774	Flight made without lower ventral. Outer panel of left windshield cracked.
43	Nov. 11	2-20-36	White	5.21	66 142	
44	Oct. 17	1-24-40	Walker	5.74	33 101	Design speed reached.
45	Nov. 9	2-21-37	White	6.04	30 968	
46	Dec. 20	3-1-2	Armstrong	3.76	24 689	

<i>1962</i>						
47	Jan. 10	1-25-44	Petersen	.97	13 640	Emergency landing; engine malfunction.
48	Jan. 17	3-2-3	Armstrong	5.51	40 691	
49	April 5	3-3-7	Armstrong	4.12	54 864	Design altitude reached.
50	April 19	1-26-46	Walker	5.69	46 939	
51	April 20	3-4-8	Armstrong	5.31	63 246	
52	April 30	1-27-48	Walker	4.94	75 194	
53	May 8	2-22-40	Rushworth	5.34	21 458	
54	May 22	1-28-49	Rushworth	5.03	30 602	
55	June 1	2-23-43	White	5.42	40 416	
56	June 7	1-29-50	Walker	5.39	31 577	
57	June 12	3-5-9	White	5.02	56 266	
58	June 21	3-6-10	White	5.08	75 194	
59	June 27	1-30-51	Walker	5.92	37 704	Unofficial world speed record.
60	June 29	2-24-44	McKay	4.95	25 359	

Table 4-88.
X-15 Flight Log (Continued)

No.	Date	Flight no.*	Pilot	Max. Mach	Max. alt. (meters)	Remarks
<i>1959</i>						
61	July 16	1-31-52	Walker	5.37	32 675	
62	July 17	3-7-14	White	5.45	95 936	Official world altitude record.
63	July 19	2-25-45	McKay	5.18	25 984	
64	July 26	1-32-53	Armstrong	5.74	30 145	
65	Aug. 2	3-8-16	Walker	5.07	44 044	
66	Aug. 8	2-26-46	Rushworth	4.40	27 699	
67	Aug. 14	3-9-18	Walker	5.25	59 009	
68	Aug. 20	2-27-47	Rushworth	5.24	27 097	
69	Aug. 29	2-28-48	Rushworth	5.12	29 627	
70	Sept. 28	2-29-50	McKay	4.22	20 787	This and all following flights without lower ventral.
71	Oct. 4	3-10-19	Rushworth	5.17	34 199	
72	Oct. 9	2-30-51	McKay	5.46	39 685	
73	Oct. 23	3-11-20	Rushworth	5.47	40 996	
74	Nov. 9	2-31-52	McKay	1.49	16 444	Emergency landing; injured pilot and damaged aircraft.
75	Dec. 14	3-12-22	White	5.65	43 098	
76	Dec. 20	3-13-23	Walker	5.73	48 890	

<i>1963</i>						
77	Jan. 17	3-14-24	Walker	5.47	82 814	First flight of a civilian above 80 km.
78	April 11	1-33-54	Rushworth	4.25	22 677	
79	April 18	3-15-25	Walker	5.51	28 194	
80	April 25	1-34-55	McKay	5.32	32 156	
81	May 2	3-16-26	Walker	4.73	63 825	
82	May 14	3-17-28	Rushworth	5.20	29 139	
83	May 15	1-35-56	McKay	5.57	37 856	
84	May 29	3-18-29	Walker	5.52	28 042	Inner panel of left windshield cracked.
85	June 18	3-19-30	Rushworth	4.97	68 184	
86	June 25	1-36-57	Walker	5.51	34 077	
87	June 27	3-20-31	Rushworth	4.89	86 868	
88	July 9	1-37-59	Walker	5.07	69 007	
89	July 18	1-38-61	Rushworth	5.63	31 943	
90	July 19	3-21-32	Walker	5.50	106 009	
91	Aug. 22	3-22-36	Walker	5.58	107 960	Unofficial world altitude record.
92	Oct. 7	1-39-63	Joe H. Engle	4.21	23 713	
93	Oct. 29	1-40-64	Air Force Milton O. Thompson, NASA	4.10	22 677	

Table 4-88.
X-15 Flight Log (Continued)

No.	Date	Flight no.*	Pilot	Max. Mach	Max. alt. (meters)	Remarks
94	Nov. 7	3-23-39	Rushworth	4.40	25 085	
95	Nov. 14	1-41-65	Engle	4.75	27 676	
96	Nov. 27	3-24-41	Thompson	4.94	27 371	
97	Dec. 5	1-42-67	Rushworth	6.06	30 785	

<i>1959</i>						
<i>1964</i>						
98	Jan. 8	1-43-69	Engle	5.32	42 642	
99	Jan. 16	3-25-42	Thompson	4.92	21 641	
100	Jan. 28	1-44-70	Rushworth	5.34	32 736	
101	Feb. 19	3-26-43	Thompson	5.29	23 957	
102	March 13	3-27-44	McKay	5.11	23 165	
103	March 27	1-45-72	Rushworth	5.63	30 937	
104	April 8	1-46-73	Engle	5.01	53 340	
105	April 29	1-47-74	Rushworth	5.72	30 968	
106	May 12	3-28-47	McKay	4.66	22 189	
107	May 19	1-48-75	Engle	5.02	59 680	
108	May 21	3-29-48	Thompson	2.90	19 568	Premature engine shut-down.
109	June 25	2-32-55	Rushworth	4.59	25 390	First flight of the modified X-15A-2.
110	June 30	1-49-77	McKay	4.96	30 358	
111	July 8	3-30-50	Engle	5.05	51 938	
112	July 29	3-31-52	Engle	5.38	23 774	
113	Aug. 12	3-32-53	Thompson	5.24	24 750	
114	Aug. 14	2-33-56	Rushworth	5.23	31 486	
115	Aug. 26	3-33-54	McKay	5.65	27 737	
116	Sept. 3	3-34-55	Thompson	5.35	23 957	
117	Sept. 28	3-35-57	Engle	5.59	29 566	
118	Sept. 29	2-34-57	Rushworth	5.20	29 809	
119	Oct. 15	1-50-79	McKay	4.56	25 878	
120	Oct. 30	3-36-59	Thompson	4.66	25 786	
121	Nov. 30	2-35-60	McKay	4.66	26 579	
122	Dec. 9	3-37-60	Thompson	5.42	28 164	
123	Dec. 10	1-51-81	Engle	5.35	33 670	
124	Dec. 22	3-38-61	Rushworth	5.55	24 750	

<i>1965</i>						
125	Jan. 13	3-39-62	Thompson	5.48	30 297	
126	Feb. 2	3-40-63	Engle	5.71	29 931	
127	Feb. 17	2-36-63	Rushworth	5.27	28 986	
128	Feb. 26	1-53-85	McKay	5.40	46 817	
129	March 26	1-53-86	Rushworth	5.17	31 059	
130	April 23	3-41-64	Engle	5.48	24 293	
131	April 28	2-37-64	McKay	4.80	28 224	
132	May 18	2-38-66	McKay	5.17	31 120	
133	May 25	1-54-88	Thompson	4.87	54 803	
134	May 28	3-42-65	Engle	5.17	63 886	
135	June 16	3-43-66	Engle	4.69	74 585	
136	June 17	1-55-89	Thompson	5.14	33 071	
137	June 22	2-39-70	McKay	5.64	47 518	

Table 4-88.
X-15 Flight Log (Continued)

No.	Date	Flight no.*	Pilot	Max. Mach	Mal. alt. (meters)	Remarks
138	June 29	3-44-67	Engle	4.94	85 527	
139	July 8	2-40-72	McKay	5.19	64 800	
140	July 20	3-45-65	Rushworth	5.40	32 126	
141	Aug. 3	2-41-73	Rushworth	5.16	63 612	
142	Aug. 6	1-56-93	Thompson	5.15	31 455	
143	Aug. 10	3-46-70	Engle	5.20	82 601	
144	Aug. 25	1-57-96	Thompson	5.11	65 258	
145	Aug. 26	3-47-71	Rushworth	4.79	73 030	
146	Sept. 2	2-42-74	McKay	5.16	73 091	
147	Sept. 9	1-58-97	Rushworth	5.25	29 627	
148	Sept. 14	3-48-72	McKay	5.03	72 847	
149	Sept. 22	1-59-98	Rushworth	5.18	30 571	
150	Sept. 28	3-49-73	McKay	5.33	90 099	
151	Sept. 30	1-60-99	William J. Knight, USAF	4.06	23 348	
152	Oct. 12	3-50-74	Knight	4.62	28 773	
153	Oct. 14	1-61-101	Engle	5.08	81 229	
154	Oct. 27	3-51-75	McKay	5.06	72 207	
155	Nov. 3	2-43-75	Rushworth	2.31	21 519	First flight with external tanks (empty).
156	Nov. 4	1-62-103	William H. Dana, NASA	4.22	24 445	

<i>1966</i>						
157	May 6	1-63-104	McKay	2.21	20 848	Premature engine shutdown.
158	May 18	2-44-79	Rushworth	5.43	30 175	
159	July 1	2-45-81	Rushworth	1.54	13 716	First flight with external tanks loaded; premature engine shutdown.
160	July 12	1-64-107	Knight	5.34	39 624	
161	July 18	3-52-78	Dana	4.71	29 291	
162	July 21	2-46-83	Knight	5.12	58 613	
163	July 28	1-65-108	McKay	5.19	73 701	
164	Aug. 3	2-47-84	Knight	5.03	75 895	
165	Aug. 4	3-53-79	Dana	5.34	40 447	
166	Aug. 11	1-66-111	McKay	5.21	76 505	
167	Aug. 12	2-48-85	Knight	5.02	70 439	
168	Aug. 19	3-54-80	Dana	5.20	54 254	
169	Aug. 25	1-67-112	McKay	5.11	78 486	
170	Aug. 30	2-49-86	Knight	5.21	30 541	
171	Sept. 8	1-68-113	McKay	2.44	22 311	Premature engine shutdown.
172	Sept. 14	3-55-82	Dana	5.12	77 480	
173	Oct. 6	1-69-116	Michael J. Adams, Air Force	3.00	22 982	
174	Nov. 1	3-56-83	Dana	5.46	93 543	
175	Nov. 18	2-50-89	Knight	6.33	30 145	Unofficial world speed record.

Table 4-88.
X-15 Flight Log (Continued)

No.	Date	Flight no.*	Pilot	Max. Mach	Max. alt. (meters)	Remarks
176	Nov. 29	3-57-86	Adams	4.65	28 042	
177	March 22	1-70-119	Adams	5.59	40 569	
178	April 26	3-58-87	Dana	1.80	16 276	
179	April 28	1-71-121	Adams	5.44	50 902	
180	May 8	2-51-92	Knight	4.75	29 748	
181	May 17	3-59-89	Dana	4.80	21 671	
182	June 15	1-72-125	Adams	5.12	69 891	
183	June 22	3-60-90	Dana	5.44	25 055	
184	June 29	1-73-126	Knight	4.17	52 730	Electrical failure; emergency landing.
185	July 20	3-61-91	Dana	5.44	25 725	
186	Aug. 21	2-52-96	Knight	4.94	27 737	Protected by an ablative coating.
187	Aug. 25	3-62-92	Adams	4.63	25 725	
188	Oct. 3	2-53-97	Knight	6.70	31 120	Unofficial world speed record; last flight of X-15A-2.
189	Oct. 4	3-63-94	Dana	5.53	76 535	
190	Oct. 17	3-64-95	Knight	5.53	85 496	
191	Nov. 15	3-65-97	Adams	5.20	81 077	Fatal accident; aircraft destroyed.

<i>1968</i>						
192	March 1	1-74-130	Dana	4.36	31 852	
193	April 4	1-75-133	Dana	5.27	57 150	
194	April 26	1-76-134	Knight	5.00	63 094	
195	May 11	1-77-136	Dana	5.15	67 086	
196	July 16	1-78-138	Knight	4.79	67 513	
197	Aug. 21	1-79-139	Dana	5.01	81 534	
198	Sept. 13	1-80-140	Knight	5.37	77 450	
199	Oct. 24	1-81-141	Dana	5.38	77 724	

*The three numbers stand for: X-15 number, free flight number, and B-52 number.

Supersonic Transport. Did supersonic aircraft have any practical applications beyond research and defense? Was a commercial supersonic transport feasible? It would take a national effort and many years to answer these questions. During the mid-1960s, a supersonic transport certainly seemed possible technically, but could one be designed, manufactured, and operated cost effectively? In March 1961, President Kennedy had requested a position paper on the country's aeronautical goals from Federal Aviation Agency (FAA) Administrator Najeeb E. Halaby. A Mach 3 supersonic transport was high on the FAA's list, and the agency moved quickly to create an SST Advisory Board to pursue this ambitious goal. But the search for an SST also required the participation of NASA, the Department of Defense, and industry. It was NASA's role to provide the research data and

technical support that industry needed to design and build a reliable, economical, safe, and publicly acceptable SST.

In their studies of supersonic and hypersonic flight, engineers and designers at NASA's Langley, Ames, and Lewis Research Centers had amassed a wealth of data on aircraft design and high-performance power plants. At the Flight Research Center, specialists had had firsthand experience with operating high-speed aircraft, as had Air Force personnel at Edwards Air Force Base. NASA's advanced researchers suggested investigating three configurations for the supersonic transport: a slender delta, a variable swept-wing craft, and a canard (horizontal stabilizing and control surfaces located in front of the main supporting surfaces). By 1963, Ames's and Langley's wind tunnels were being used extensively to evaluate various designs based on these three possibilities. The FAA, meanwhile, solicited industry for SST proposals, and in January 1964 Boeing, North American, and Lockheed submitted their ideas. Interestingly enough, each firm had followed a different design route: Boeing submitted a variable-sweep proposal, North American a canard based on their XB-70, and Lockheed a double delta. It took nearly three years to evaluate these packages. Langley participants contributed reports on what they called SCAT (Supersonic Commercial Air Transport) configuration studies.

To complement the theoretical work, pilots at FRC flew high-speed military aircraft to get some understanding of problems that a commercial supersonic transport might have with landings, terminal approaches, air traffic control procedures, and handling. A General Purpose Airborne Simulator developed for NASA by Cornell Aeronautical Laboratory also was put to use simulating flight patterns and emergency situations. One aircraft flown at FRC as part of this study program captured the public's attention: the XB-70, a futuristic-looking strategic bomber prototype built by North American for the Air Force (see fig. 4-6).^{*} Designed as a replacement for the B-52, the XB-70 proved very costly and of questionable military value. Only two were manufactured, and they were turned over to NASA to use as research aircraft in the late 1960s. They were flown as part of a joint Air Force-NASA research project in support of the SST as early as June 1966.[†]

Boeing's variable swept-wing SST was named the winning design in December 1966 by the FAA (General Electric would build the engine), but this decision did not mean that the aircraft had been precisely defined. Two years later, behind schedule and over-budget, Boeing was still making major changes to the configuration. The FAA announced in early 1968 that the SST design required still more development work before a prototype could be constructed. In fact, Boeing engineers had changed their minds about the variable sweep wing; they wanted to go with a fixed-

^{*} Other aircraft flown in SST studies at FRC were the Douglas F5D-1 Skylancer (landing studies), the F-100C Super Sabre (handling quality studies), the North American A-5A Vigilante (approach and landing studies), and the Lockheed YF-12A Blackbird.

[†] XB-70-1's first flight took place on September 21, 1964, and for two years both aircraft participated in flight worthiness demonstrations. At Mach 3, the aircraft tended to lose their outer skin, which led to extensive maintenance to keep them flight-ready. On June 8, 1966, XB-70-2 was involved in a mid-air collision, killing the co-pilot Carl S. Cross, USAF, and destroying the aircraft. (Joseph A. Walker, NASA, piloting an F-104 was also killed). The remaining aircraft was not as well-suited for the research role (it never flew beyond Mach 2.57). It was this vehicle that NASA received from the Air Force on March 15, 1967.

LENGTH:
WING SPAN:
WEIGHT, LOADED:
THRUST:

57.6 m
32 m
227,000 kg
800,000 newtons

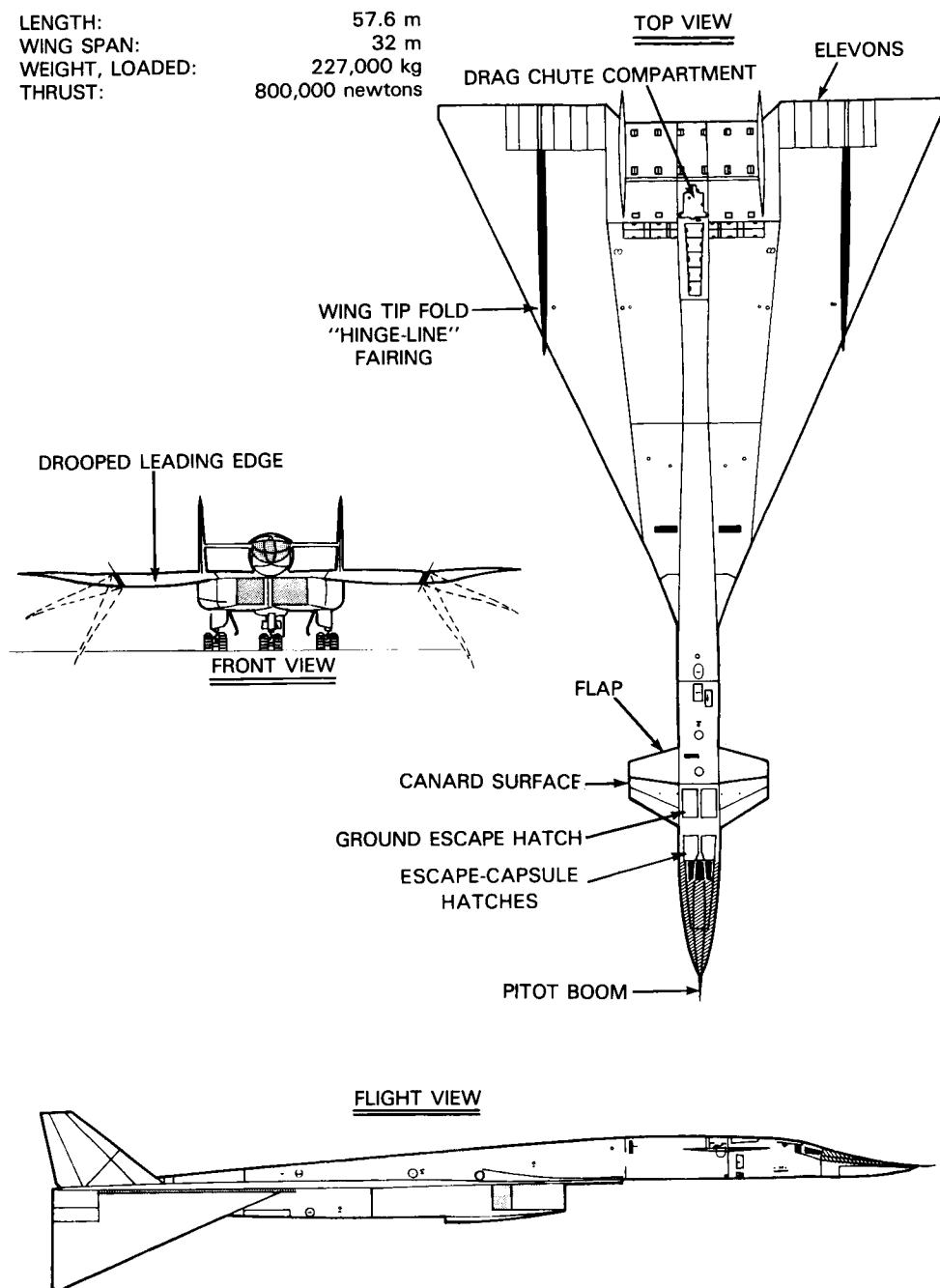

Figure 4-7. Configuration of the XB-70 Research Aircraft

wing design instead. There were other problems, as well. Environmentalists were concerned over the excessive noise an SST would make. NASA participated in sonic boom studies and concluded that the SST design would have to be tailored considerably to minimize the magnitude of the shock waves. NASA, the FAA, and the Air Force had also joined together to measure the cosmic and solar radiation environment at the altitudes an SST would fly. But money was probably the supersonic transport managers' greatest worry. The government had funded a great many expensive studies and tests, and by the end of the 1960s it was obvious that a private concern such as Boeing would need federal assistance to build an SST assembly line, if an SST design was ever found that proved satisfactory to all parties. By 1971, Congress had had enough. It dropped its support of the project, and the enterprise was too large for a nongovernment body to pick up alone.

As far as NASA was concerned, its participation in the SST program had been worthwhile. Its aeronautics team had been funded for several years to support the activity, and it had collected data on high-speed flight and aircraft design that were applicable to several fields of research. NASA had been able to procure special instrumentation for the XB-70 and other aircraft and extend its ground- and air-simulation studies considerably. By December 1968, the agency had moved to terminate its XB-70 flight program. It had been exploited to its potential in support of SST; the aircraft was expensive to operate; and another Mach 3+ aircraft would soon be available for FRC's research program. Personnel at the Flight Research Center had been participating in tests of the Lockheed YF-12A Blackbird high-speed reconnaissance aircraft since 1967, and the center would acquire two of them in 1969.

NASA participated in one other high-speed aircraft testing project during the 1960s that deserves mention here. It was the agency's only project that followed the old NACA tradition of the 1950s of using civilian flight-test specialists to iron out technical problems in a new weapons system. In January 1967, the Air Force sent the sixth production F-111 (made by General Dynamics/Convair Aerospace) to FRC. The advanced fighter had been suffering engine problems. FRC's testing program led to a major engine inlet redesign.²²



CHAPTER FIVE
**TRACKING AND DATA
ACQUISITION**

CHAPTER FIVE

TRACKING AND DATA ACQUISITION

Tracking and communicating with spacecraft was hardly as glamorous an assignment as launching powerful Saturn rockets, examining the first close-up images of Mars, or participating in the recovery of a manned crew that had just returned from the moon. But these tasks in particular and the exploration of space in general would have been impossible without a sophisticated system for monitoring the trajectory and orbital path of vehicles in space, and for sending commands to and receiving data from them.

During man's first decade as space explorer, spacecraft designers and scientific investigators put together increasingly complex packages of hardware to collect data on the environment in which the spacecraft operated and to photograph—even televise—the scenes it encountered as it circled earth or made its way to distant bodies. Such missions called for carefully timed commands to the spacecraft and the reception of great streams of electronically relayed data. To the tracking specialists' growing number of tasks, manned spaceflight added the demand of real-time communication between mission control and orbiting astronauts. NASA accomplished these critical tracking and data acquisition activities through three tracking networks and a global communications system. The Space Tracking and Data Acquisition Network (STADAN) primarily served the needs of earth satellites. The agency established a Manned Space Flight Network (MSFN) to support Project Mercury. And at the Jet Propulsion Laboratory (JPL) in California, specialists managed a Deep Space Network (DSN) by which to communicate with spacefaring vehicles destined for the moon and beyond. These networks were never static: they responded to specific mission objectives, new technology, and budgetary constraints by expanding, taking on new equipment, or contracting as the situation dictated. Linking NASA's many tracking stations and mission control centers was a communications system called NASCOM.

Tracking is the process of determining the location and motion (speed and direction) of a vehicle during all phases of flight. Initial tracking observations are especially important; from these data, controllers at the launch site and elsewhere can determine if the vehicle is on the proper flight path and if it subsequently attains the prescribed orbit (if that is a requirement of the mission). During early manned flights, medical experts were concerned that prolonged space travel might adversely affect the crews and they cautioned that 24-hour tracking and real-time communications were a must. If the crew were forced to make an emergency reentry and landing, ground personnel would need precise information on the craft's location to

make a speedy recovery possible. Under "routine" circumstances, reentry and landing was not as exact an operation as some manned spaceflight personnel would have liked; but trying to find a bobbing capsule on the high seas in an emergency situation without an initial estimate of its location provided by tracking data was unthinkable. In the case of communications, weather, and scientific satellites, knowing the exact location of the spacecraft at certain times was likewise critical to mission objectives; antennas, instruments, and camera had to be in just the right place pointing just the right way. Tracking could be accomplished optically or by one of several radio-wave techniques.

Data acquisition, the other half of the tracker's job, is the reception at a ground station of scientific and engineering data generated by a spacecraft. The process of conveying data from spacecraft to earth via radio waves is called radio telemetry. Raw data, often stored on spacecraft recorders until it can be conveniently relayed, are coded (a common coding method used in the 1960s was the binary number system) and converted into usable information by data reduction equipment at mission control facilities. Information is sent to the spacecraft (uplinked) in a similar fashion. In response to commands, the spacecraft will perform some particular task: downlink telemetry, take a pressure reading, point an antenna.¹ The process of sending messages to a spacecraft and receiving information from it is generally known as command and control.

These many tracking and data acquisitions procedures required that network tracking stations have extensive arrays of antennas, radar devices, interferometers, computers, consoles, and a small jungle of relays, switches, and other "black boxes." But not all stations performed every possible function. Some provided only radar support or voice communications; others acted as complete nerve centers; some were mobile to add extra tracking hardware for special missions. All were in direct, real-time contact with the appropriate mission control center (Goddard Space Flight Center for earth orbital satellites; JPL for lunar and interplanetary spacecraft; Kennedy Space Center for Project Mercury; and the Manned Spacecraft Center for Projects Gemini and Apollo).

NASA's tracking stations were by necessity positioned all over the globe so that contact with a spacecraft could be maintained throughout its mission, not just when its orbit brought it over the United States (see fig. 5-1 for the location of NASA's tracking facilities in 1966). Several of NASA's centers helped define the networks and locate sites for stations; Goddard and JPL operated the networks (Goddard was responsible for STADAN and MSFN, JPL for DSN). But overall management authority for development and operations went to the Office of Tracking and Data Acquisition (OTDA) at NASA Headquarters, where Edmond C. Buckley was in charge. Buckley, who joined the National Advisory Committee for Aeronautics (NACA) in 1930 as an instrumentation specialist at the Langley Memorial Aeronautical Laboratory helped establish tracking facilities at Wallops Island and at the Edwards Air Force Base-NACA High-Speed Flight Station complex. In 1959, he came to NASA Headquarters as assistant director of spaceflight operations. The next year Buckley's office staff was shuffled and increased, but the November 1961 agencywide reorganization brought a more significant change. Buckley's new title was director of tracking and data acquisition; Gerald M. Truszynski became his deputy. Truszynski had also been a NACA instrumentation expert, having worked on ground instrumentation for the X-series aircraft range at the California test-flight station. Reporting to Buckley and his deputy were chiefs or directors for

various aspects of the program: coordination and resources, operations and facilities, communications, advanced systems. In 1968, Truszynski took the lead position, which had been relabeled associate administrator for tracking and data acquisition in 1965. H. R. Brockett, formerly in charge of network operations, moved up to the deputy's slot. Because tracking was a global business, Buckley and Truszynski spent much of their time preparing for or participating in international negotiation sessions required before NASA could operate a tracking station in a foreign country, working closely with NASA's International Programs Office. But most importantly, they coordinated the tracking and data acquisition needs of NASA's several flight projects, ensuring that the networks evolved with the agency's programs. (See table 5-1 for details on how the management of the tracking and data acquisition program changed over the decade.)

In addition to cooperating with foreign governments (and the U.S. Department of State) in establishing tracking stations overseas, OTDA also coordinated its requirements with the Department of Defense (DoD). Since the 1940s, the military services had been actively supporting missile research and had built tracking facilities along their several missile ranges. When NASA began its search for station sites in the late 1950s, agency managers agreed that where possible it would be advantageous to use military stations and equipment to augment the civilian networks. In addition, NASA required tracking ships for the Mercury manned network (and aircraft instrumented with tracking equipment for Apollo). DoD provided the space agency with this mobile tracking equipment and the personnel to operate them. In September 1960 when the interagency Aeronautics and Astronautics Coordinating Board came into being, a Space Flight Ground Environmental Panel was charged with coordinating the tracking requirements and talents of NASA and DoD. At NASA Headquarters, Frederick B. Bryant served OTDA for many years as director of DoD coordination. The Smithsonian Astrophysical Observatory was another organization with which OTDA had a special working relationship. Under contract to NASA, the Smithsonian's 12-station network, equipped with Baker-Nunn cameras designed for optical satellite tracking, supported the agency's satellite network.

When NASA was established in 1958, it inherited along with several satellite and probe projects some rudimentary systems for tracking and acquiring data. The Vanguard team from the Naval Research Laboratory had their Minitrack radio interferometer system in operation for the International Geophysical Year. Supporting the Army's competing satellite effort, Explorer, JPL had developed a tracking scheme called Microlock. Also at JPL, specialists had started designing a tracking system for the Pioneer lunar probe project, with construction under way in the Mojave Desert on the first large antenna. In addition, NACA had been working with the Air Force on the X-series research aircraft program. As part of this joint enterprise, NACA instrumentation experts had been active in defining a tracking range for the supersonic X-15 at the High Speed Flight Station. This partnership, going even further, had also begun to examine the tracking and data acquisition needs of the Air Force's proposed Dyna-Soar reusable orbital vehicle. One of the new civilian agency's first tasks was to sift through these several tracking schemes, evaluate the technology available, and take what it needed to support its first ventures into space.

Table 5-1.
Four Phases of Tracking and
Data Acquisition Management, NASA Headquarters

Phase I
1959-June 1960

Administrator/Deputy Administrator/Associate Administrator
 Director, Space Flight Development (Abe Silverstein)
 Assistant Director, Space Flight Operations (Edmond C. Buckley)
 Chief, Tracking Programs (Francis B. Smith)

Phase II
July 1960-Oct. 1961

Administrator/Deputy Administrator
 Associate Administrator
 Director, Space Flight Development (Silverstein)
 Assistant Director, Space Flight Operations (Buckley)
 Chief, Advanced Development (vacant)
 Manager, Tracking Systems (Clarence R. Morrison)
 Manager, Telemetry Systems (Wallace Ikard)
 Manager, Data and Computing Systems (John Sterrett)
 Chief, Operations (Gerald M. Truszynski)
 Manager, Network Operations (H. R. Brockett)
 Manager, Interagency Operations (Norman Pozinsky)
 Manager, Flight Mission Operations (Victor W. Hammond)
 Manager, Communications Operations (Paul A. Price)

Phase III
Nov. 1961-mid-1965

Administrator/Deputy Administrator
 Associate Administrator
 Director, Tracking and Data Acquisition (Buckley)
 Deputy Director, Tracking and Data Acquisition (Truszynski)
 Chief, Program Coordination and Resources Management (David Williamson, Jr.; Thomas V. Lucas, 1963)
 Chief, National Range Support (Hammond; Frederick B. Bryant, July 1963); office dropped in early 1965
 Director, Network Operations and Facilities (Brockett, Jan. 1962)
 Chief, Network Operations (James C. Bavelly)
 Chief, Communications and Frequency Management (Price)
 Chief, Facilities and Station Implementation (Pozinsky)
 Director, Program Support and Advanced Systems (Truszynski, acting; Clarence R. Morrison, 1963)
 Chief, Program Support (Robert D. Briskman); office added in 1963
 Chief, Advanced Systems (Robert R. Stephens); office added in 1963
 Director, DoD Coordination (Bryant); office added in early 1965

Table 5-1.
Four Phases of Tracking and
Data Acquisition Management, NASA Headquarters (Continued)

Phase IV Fall 1965-1968
Administrator/Deputy Administrator
Associate Administrator
Associate Administrator, Tracking and Data Acquisition (Buckley; Truszynski, Jan. 1968)
Deputy Associate Administrator, Tracking and Data Acquisition (Truszynski; Brockett, March 1968)
Director, Systems Planning and Development (Morrison; Robert T. Hynes, 1967; Truszynski, acting, 1968)
Director, Program Coordination and Resources Management (Lucas)
Director, Operations, Communications, and ADP (Brockett; Charles A. Taylor, 1968)
Chief, Network Operations (Bavely)
Chief, Communications and Frequency Management (Price)
Chief, ADP Management (Kenneth Webster)
Director, DoD Coordination (Bryant)
Director, Network Support Implementation (Pozinsky)

BUDGET

OTDA's budget was divided among three basic categories: research, operations, and equipment. This organization was intact for most of the 1958-1968 period. The network operations and equipment-components monies were divided among the satellite, manned, and deep space networks, the communications system that linked the stations with the control centers, data processing, and other instrumentation needs, such as the X-15 range in California. For the first years of Project Mercury, part of the funding for the manned tracking network came from the manned spaceflight budget. Starting with the FY 1963 budget request, the MSFN was being funded only by OTDA. For a more detailed breakdown of the tracking and data acquisition budget, consult the NASA yearly budget estimates. Also, review the bottom notes of the following tables carefully before making conclusions about totals for any particular aspect of the program.*

*It would also be useful to review the introduction to the budget section of chapter 1 for general information on NASA's budget and on the sources and format used for the budget tables in this book.

Table 5-2.
Total Tracking and Data Acquisition Funding History
(in thousands of dollars)

Year	Request	Authorization	Programmed
1959	---	---	3096
1960	11 500	11 500	16 189 ^a
1961	27 100 ^b	27 100	44 330 ^c
1962	38 650 ^d	38 650	67 302
1963	158 410	158 410	122 142
1964	231 500	218 200	194 347
1965	267 900	261 900	253 236
1966	246 200	242 321	231 065
1967	279 300	270 850	270 850
1968	297 700	290 000 ^e	275 850

^aIn addition, \$2 840 000 was programmed for Mercury network operational implementation and network operations in the Mercury budget.

^bIn addition, \$5 450 000 was requested by the manned spaceflight program for the operation of Mercury stations.

^cIn addition, \$25 254 000 was programmed for tracking, data acquisition, and control network in the Mercury budget.

^dIn addition, \$20 385 000 was requested for Mercury network operational implementation and network operations in the Mercury budget.

^eThe appropriations conference committee further reduced the total to \$270 000 000 in October 1967.

Table 5-3.
Programmed Cost by Tracking and Data Acquisition Projects
(in thousands of dollars)

	1959	1960	1961	1962	1963	1964	1965	1966	1967	1968
Supporting research and technology	856 ^a	4266 ^b	11 512 ^c	9097	13 277	12 890	13 500	13 800	13 800	12 800
Network operations										
Satellite network	2060 ^d	5705 ^e	9620	9374	12 252	23 464	25 063	27 640	37 700	41 488
Manned flight network	---	---	293 ^g	15 183	16 495	18 795	23 118	37 909	65 650	71 079
Deep space network	---	1341	4233	6743	8117	11 833	19 040	25 350	35 500	37 290
Communications	---	580	6915	8393	10 821	12 026	17 478	23 890	39 500	42 118
Data processing	---	3400 ^h	3006	1660	4240	6277	4625	6101	10 200	13 608
Other instrumentation	180 ⁱ	1477 ^j	000	000	4018 ^k	5736	5930	6620	6506	5900
Equipment and components										
Satellite network	---	---	7346	3940	9390	15 297	17 995	14 500	11 700	9478
Manned flight network	---	---	---	10 253	28 100	56 234	98 348	48 523	27 700	24 181
Deep space network	---	---	1179	000	7636	12 004	15 168	13 420	7500	9354
Communications	---	---	226	967	1925	4036	4755	7200	6000	3090
Data processing	---	---	---	300	3316	11 065	3916	2612	5100	2164
Other instrumentation	---	---	---	892 ^l	2555 ^m	4690	4300	3500	4000	3300

^a For advanced technical development.

^b Includes \$190 600 for advanced research and \$4 074 600 for advanced technical development.

^c For systems development.

^d Includes \$610 000 for the operation of optical tracking stations.

^e Includes \$1 450 000 for the Smithsonian Astrophysical Observatory network.

^f \$2 840 000 was programmed for Mercury network operational implementation and network operations from the Mercury budget.

^g In addition, \$25 254 000 was programmed for tracking, data acquisition, and control network from the Mercury budget.

^h For computation and data reduction.

ⁱ For the operation of a non-NASA station (Jodrell Bank).

^j Includes \$800 000 for the operation of non-NASA stations, \$400 000 for special operations and services, and \$276 760 for spare parts, repairs, and maintenance.

^k Includes \$3 568 000 for Wallops and Ft. Churchill instrumentation and \$450 000 for an aerodynamics test range.

^l For launch area instrumentation.

^m Includes \$1 545 000 for Wallops and other instrumentation, and \$1 010 000 for an aerodynamics test range.

Table 5-4.
Tracking and Data Acquisition Supporting Research and Technology Funding History
(in thousands of dollars)

Year	Request	Authorization	Programmed
1959	---	---	856 ^a
1960	---	---	4266 ^b
1961	7220 ^a	---	11 512 ^c
1962	13 071 ^d	13 071 ^d	9097
1963	15 950 ^c	15 950 ^c	13 277
1964	17 000	12 000	12 890
1965	15 500	15 500	13 500
1966	14 500	14 500	13 500
1967	13 800	13 800	13 800
1968	13 800	---	12 800

^a For advanced technical development.

^b Includes \$190 600 for advanced research and \$4 074 600 for advanced technical development.

^c For systems development.

^d Includes \$2 862 500 for advanced research and \$10 208 000 for advanced technical development.

^e Neither the authorization nor the appropriation was broken down to indicate where the reductions were made.

Table 5-5.
Total Network Operations Funding History
(in thousands of dollars)

Year	Request	Authorization	Programmed
1959	---	---	2240
1960	---	---	11 923 ^a
1961	19 880 ^b	---	24 067
1962	25 580 ^c	25 580 ^c	41 853
1963	67 815	67 815	55 943
1964	80 500	78 500 ^d	78 131
1965	99 800	96 300 ^d	95 254
1966	129 300	125 421 ^d	127 510
1967	199 000	190 550 ^d	195 050
1968	228 800	--- ^e	211 483

^a Includes \$580 200 for network communications and \$3 400 440 for computation and data reduction.

^b In addition, \$5 450 000 was requested by the manned spaceflight program for the operation of Mercury stations.

^c Includes \$9 122 900 for network communications and \$2 350 000 for computation and data reduction.

^d Authorizations were not broken down further to indicate where the reductions were made.

^e Neither the authorization nor the appropriation was broken down to indicate where the reductions were made.

Table 5-6.
Network Operations—Satellite Network Funding History
(in thousands of dollars)

Year	Request	Programmed
1959	---	2060 ^a
1960	---	5705 ^b
1961	9100 ^c	9620
1962	10 322 ^d	9374
1963	17 794	12 252
1964	17 000	23 464
1965	25 600	25 063
1966	32 300	27 640
1967	33 700	37 700
1968	38 500	41 488

^a Includes \$610 000 for the operation of optical tracking stations.

^b Includes \$1 450 000 for the Smithsonian Astrophysical Observatory network.

^c Includes \$3 500 000 for the operation of optical tracking stations.

^d Includes \$2 250 000 for the Smithsonian Astrophysical Observatory network.

Table 5-7.
Network Operations—Manned Flight Network Funding History
(in thousands of dollars)

Year	Request	Programmed
1960	---	--- ^a
1961	--- ^b	293 ^c
1962	--- ^d	15 183
1963	24 047	16 495
1964	24 000	18 795
1965	25 400	23 118
1966	35 100	37 909
1967	60 000	65 650
1968	78 000	71 079

^a \$2 840 000 was programmed for Mercury network operational implementation and network operations from the Mercury budget.

^b \$5 450 000 was requested by the manned spaceflight program for the operation of Mercury stations.

^c In addition, \$25 254 000 was programmed for tracking, data acquisition, and control network from the Mercury budget.

^d \$20 385 000 was requested for Mercury network operational implementation and network operations in the Mercury budget.

Table 5-8.
Network Operations—Deep Space Network Funding History
(in thousands of dollars)

Year	Request	Programmed
1960	---	1341
1961	3500	4233
1962	3322	6743
1963	9272	8117
1964	10 000	11 833
1965	14 600	19 040
1966	23 700	25 350
1967	32 800	35 500
1968	39 800	37 290

Table 5-9.
Network Operations—Other Instrumentation Funding History
(in thousands of dollars)

Year	Request	Programmed
1959	---	180 ^a
1960	---	1477 ^b
1961	7280 ^c	---
1962	3247 ^d	---
1963	---	4018 ^c
1964	800 ^f	5736
1965	6100 ^g	5930
1966	6300	6620
1967	7000	6500
1968	7300	5900

^aFor the operation of a non-NASA station (Jodrell Bank).

^bIncludes \$800 000 for operation of non-NASA stations, \$400 000 for special operations and services, and \$276 760 for spare parts, repairs, and maintenance.

^cIncludes \$1 400 000 for operation of non-NASA stations (Jodrell Bank, Ft. Churchill, and others), \$2 100 000 for operations at the Atlantic and Pacific Missile Ranges, and \$3 780 000 for miscellaneous operational costs.

^dIncludes \$1 850 000 for operation of non-NASA stations, \$500 000 for special operations and services, \$897 300 for spare parts, repairs, and maintenance.

^eIncludes \$3 568 000 for Wallops and Ft. Churchill instrumentation and \$450 000 for an aerodynamics test range.

^fFor an aerodynamics test range.

^gIncludes \$5 300 000 for Wallops and Ft. Churchill instrumentation and \$800 000 for an aerodynamics test range.

Table 5-10.
Network Operations—Communications Funding History
(in thousands of dollars)

Year	Request	Programmed
1960	---	580
1961	---	6915
1962	9123	8393
1963	13 234	10 821
1964	16 000	12 026
1965	18 700	17 478
1966	23 800	23 890
1967	57 000	39 500
1968	52 700	42 118

Table 5-11.
Network Operations—Data Processing Funding History
(in thousands of dollars)

Year	Request	Programmed
1960	---	3400 ^a
1961	---	3006
1962	2350	1660
1963	3468	4240
1964	7700	6277
1965	9400	4625
1966	8100	6101
1967	8500	10 200
1968	12 500	13 608

^aFor computation and data reduction.

Table 5-12.
Total Equipment and Components Funding History
(in thousands of dollars)

Year	Request	Authorization	Programmed
1961	---	---	8751
1962	---	---	16 352
1963	74 645	74 645	52 922
1964	134 000	127 000 ^a	103 326
1965	152 600	150 100 ^a	144 482
1966	102 400	102 400	89 755
1967	66 500	66 500	62 000
1968	55 100	--- ^b	51 567

^a Authorization was not broken down further to indicate where the reductions were made.

^b Neither the authorization nor the appropriation was broken down to indicate where the reductions were made.

Table 5-13.
Equipment and Components—Satellite Network Funding History
(in thousands of dollars)

Year	Request	Programmed
1961	---	7346
1962	---	3940
1963	20 230	9390
1964	22 000	15 297
1965	15 900	17 995
1966	14 700	14 500
1967	14 500	11 700
1968	10 000	9478

Table 5-14.
Equipment and Components—Manned Flight Network Funding History
(in thousands of dollars)

Year	Request	Programmed
1962	---	10 253
1963	35 950	28 100
1964	84 000	56 234
1965	106 900	98 348
1966	64 000	48 523
1967	26 500	27 700
1968	24 000	24 181

Table 5-15.
Equipment and Components—Deep Space Network Funding History
(in thousands of dollars)

Year	Request	Programmed
1961	---	1179
1962	---	000
1963	17 000	7636
1964	10 000	12 004
1965	12 000	15 168
1966	9800	13 420
1967	10 500	7500
1968	9800	9354

Table 5-16.
Equipment and Components—Other Instrumentation Funding History
(in thousands of dollars)

Year	Request	Programmed
1962	---	892 ^a
1963	---	2555 ^b
1964	4000 ^c	4690
1965	5400 ^d	4300
1966	5500	3500
1967	4500	4000
1968	4500	3300

^a For launch area instrumentation.

^b Includes \$1 545 000 for Wallops and other instrumentation and \$1 010 000 for an aerodynamics test range.

^c For launch area instrumentation.

^d Includes \$3 900 000 for Wallops and other instrumentation and \$1 500 000 for an aerodynamics test range.

Table 5-17.
Equipment and Components—Communications Funding History
(in thousands of dollars)

Year	Request	Programmed
1961	---	226
1962	---	967
1963	1465	1925
1964	4000	4036
1965	3300	4755
1966	4400	7200
1967	7500	6000
1968	4700	3090

Table 5-18.
Equipment and Components—Data Processing Funding History
(in thousands of dollars)

Year	Request	Programmed
1962	---	300
1963	---	3316
1964	10 000	11 065
1965	9100	3916
1966	4000	2612
1967	3000	5100
1968	2100	2164

DESCRIPTION—SPACE TRACKING AND DATA ACQUISITION NETWORK (STADAN)

During the 1940s, the Peenemunde rocket team in Germany adapted the astronomer's methods for optical tracking and radio Doppler techniques to suit its needs for tracking the V-2 rocket, a less than perfect but revolutionary tool of war used against England. After the Second World War, tracking experts in the U.S. not only improved the conventional radar and optical tracking methods employed during the war, but also looked to a new field: radio astronomy. Using radio astronomy techniques, specialists could find and follow objects launched into space. The objects of interest were ballistic missiles.

In the late 1940s, the Army Air Corps and the Naval Research Laboratory (NRL) were particularly interested in techniques whereby they could measure interference: the effect produced by the combination or superposition of two systems of waves (sound or light) in which the waves reinforced, neutralized, or in other ways interfered with each other. The instrument used to measure the velocity and absorption of sound waves in a gas or liquid or to compare unknown light-wave

lengths with a standard wave length was called an interferometer (acoustic or optical). While NRL's initial studies concentrated on measuring sound waves under water, the Army Air Corps team was interested in devising a radio wave interferometer that could be used for tracking missiles. A radio interferometer, two or more radio telescopes (antennas) separated by known distances, could pinpoint sources of radiation, such as that transmitted by a beacon fixed on a vehicle in space, in the radio range (see figs. 5-2 and 5-3). The Azusa interferometry system developed by the Army Air Corps with the assistance of Consolidated Vultee Aircraft Corporation was successfully put to use on American missile ranges. During the early 1950s, the Navy borrowed Azusa technology for its Viking missile tracking system, and communications experts at NRL began to consider the usefulness of the radio interferometer in some future satellite tracking scheme.

NRL soon had an opportunity to put its advanced studies to work. A trackable artificial satellite was the ambitious goal of the United States as part of its contribution to the International Geophysical Year (IGY, 1957-1958). The Army and the Navy both submitted serious proposals for a launch vehicle and spacecraft that might meet that goal ahead of the Soviet Union, which had also expressed an interest in launching a satellite.

The Navy's Project Vanguard, suggested in 1955, included plans for a radio tracking network; Project Orbiter, the Army's bid, originally called for optical tracking only. John T. Mengel, a member of the Vanguard team, coined the name Minitrack for its satellite tracking scheme. The spacecraft beacon by which Vanguard would be followed on its orbits would be of *minimum* weight (0.37 kilogram), thus *Minitrack*. Telemetry reception and command would be accomplished by Yagi antennas fixed so that they could track the craft from horizon to

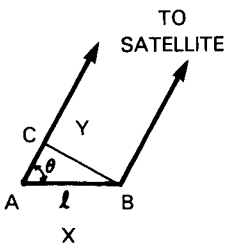

Figure 5-2.

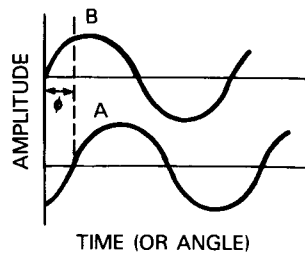

Figure 5-3.

horizon (rocking horse antennas). Mengel likened the Vanguard tracking antennas to ears: "An individual locates the source of sound by virtue of the phase differences in the sound waves, arriving at different times at his two ears. Similarly the listening units of the minitrack system are pairs of receiving antennas, set a measured distance apart, which indicates the direction of the signal by phase differences in the radio waves. . . ."² Processing the data that these pairs of antennas gathered would fall to an IBM 704 computer based in a computing facility in Washington, D.C.

By late 1955 after authorization for Vanguard had been secured—due in part to the maturity of the radio tracking plan—and after Mengel had been put in charge of NRL's Radio Tracking Branch, the Navy tracking specialists were busy defining where Vanguard ground stations should be built. The proposed number of stations had grown from four to a network of nine stations that would create a "radar fence"—a chain of overlapping antenna patterns through which an orbiting satellite that had been launched from Cape Canaveral would have to intersect frequently. A long north-south fence was not financially feasible for NRL, but nine stations, several of which were to be strung along the 75th meridian within 45 degrees north or south of the equator, would enable the trackers to compile sufficient orbital data on satellites whose orbits did not incline more than 45 degrees. Early in 1956, the laboratory was ready with a team that would travel to South America to locate sites and negotiate agreements with foreign government officials.*

In March and April, NRL had negotiations under way for stations in Havana, Panama, Quito, Antofagasta, and Santiago. Responsibility for construction was assigned to a Project Vanguard Task Force of the Army Map Service. At the urging of NRL, all participants had agreed to a radio frequency of 108 megahertz for the IGY activities. In the United States, stations would be built at Blossom Point, Maryland, at San Diego, and on two islands (Antigua and Grand Turk) near Cape Canaveral, the launch site. This brought the number of station locales to 10, with an 11th being added at Woomera, Australia, for the collection of geodetic data, shortly after the network became operational in October 1957, well in advance of the first successful mission the following March.†

After NASA assumed authority for Vanguard in October 1958, Mengel and his tracking specialists were assigned to the new Beltsville Space Center, soon to be renamed the Goddard Space Flight Center. Mengel was appointed assistant director for tracking and data systems at Goddard; and Minitrack, over the next several years, was transformed into a global satellite tracking network. The net was always in a state of change: stations were added (Winkfield, Alaska, Johannesburg, Mojave, East Grand Forks, St. John's, Ft. Myers, Rosman, Brazilia) to support satellites with orbits that took them further away from the equator or to supplement the existing net; others were phased out (Havana, Ft. Stewart, Antofagasta, San

*The Minitrack ground equipment required at least 0.093 square kilometer with a minimum gradient of less than 1 degree in the area of the antenna arrays. For 8 kilometers in all directions from the equipment, the elevation angle could not exceed 20 degrees. The site also had to be isolated from heavy electric power installations and airways.

† See chapters 1 and 3 for more information on Project Vanguard.

Diego) when they were no longer needed or when conditions at the station became unfavorable; collateral stations established by other countries became part of the network as they were needed (see table 5-20 for a chronology of these events and table 5-27 for a complete list of NASA's tracking stations). New telemetry reception and command equipment that corresponded with new hardware and scientific instruments carried by NASA's satellites was added to certain stations as it became available. Telemetry antennas grew in size. Station operations became more complex. Reliable communications between stations and mission control became more critical. In 1960, the network switched to a frequency range of 136-137 megahertz, a range set aside by the International Telecommunications Union for space research. The Rosman, North Carolina, station, which became operational in 1963, was the

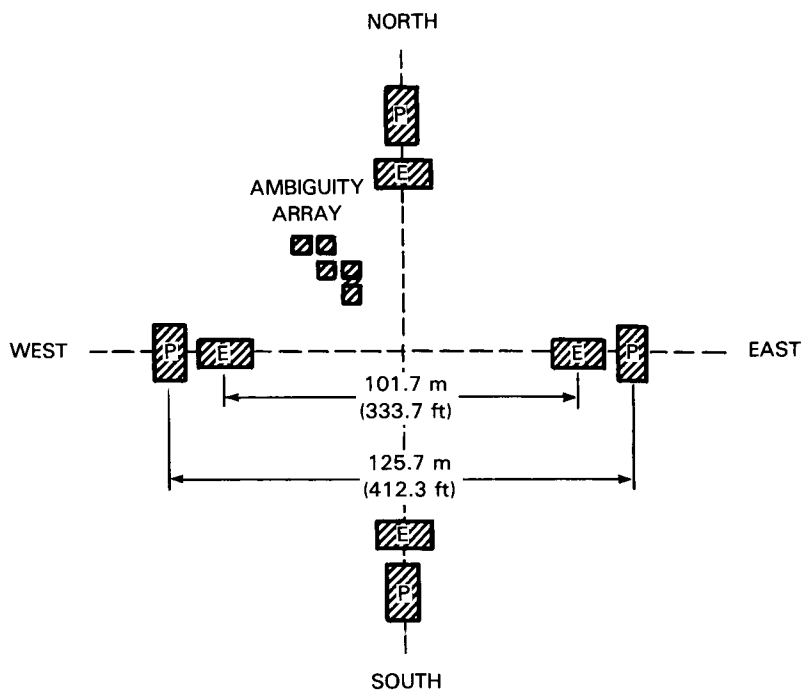

Figure 5-4. Layout of a typical Minitrack station. A set of four antennas positioned in a particular configuration (in this instance, a cross) can detect signals from a spacecraft entering a fan-shaped volume (about 10.8 degrees in one direction and 76 degrees in a direction at right angles). A Minitrack station had two such sets of antennas so that there were two fan-shaped volumes (at an angle of 90 degrees to one another) in which a vehicle could be detected. One set, called equatorial (E), had the narrow dimensions of the fan beam arranged east-west; the second set, called polar (P), was oriented north-south. Equipment at a Minitrack station included the fixed arrays for angle tracking, one fixed antenna array for telemetry reception, a rhombic communications antenna, a ground station electronics trailer, a telemetry trailer, and associated power sources and maintenance units.

first of a second generation of satellite tracking facilities that did not require an interferometer. Its 26-meter pointable antenna would support the new observatory class of satellites (OGO, OSO, OAO).*

As NASA's satellites became more sophisticated, data acquisition rather than tracking became the more critical of the network's tasks, and the equipment added to the stations reflected the change. Satellite Automatic Tracking Antennas (SATAN)—one type for telemetry reception, a second for command—replaced the Yagi arrays to serve either as a complement to the large dish antennas or as the prime receiver-command antenna at stations where there were no large dishes. Since the original Minitrack system could not cope with spacecraft sent into highly eccentric or synchronous orbits (the latter a popular orbit for communications and weather satellites), Goddard specialists devised an alternate tracking device called Goddard Range and Range Rate Equipment (GRARR).† The GRARR sent a signal to the spacecraft, which replied through a transponder. By recording the time of signal transit to and from the satellite, distance could be determined, while Doppler measurement could provide range rate.³ With all these changes, Minitrack was hardly a suitable name for the network any longer.

By 1964, NASA officials were using the name Space Tracking and Data Acquisition Network (STADAN) for the satellite net. Along with the new title came a new trend. STADAN managers would work toward maintaining a minimum number of stations, but they would equip those stations with the most efficient instrumentation available. The streamlining of the net precipitated the closeout of Blossom Point, College, East Grand Forks, and Woomera stations, the transfer of one of Alaska's 26-meter antennas to the Environmental Sciences Services Administration, and the transfer of Kano station to the Manned Space Flight Network. From 22 stations in 1965, the system was reduced to 17 (plus a training facility at Goddard and two collateral stations) in 1968, with more closings planned for the next year (see table 5-19). Increased automation was one of the key tools the Office of Tracking and Data Acquisition used to improve the remaining stations and to cut costs. If done manually, most tracking tasks (e.g., prepass checkouts, station switchovers from one satellite to another, recording operations) required a great amount of switch-throwing and careful monitoring and timing. During the mid-1960s, automation began to increase the stations' flexibility and reliability. The end of the decade brought increased computerization to many of the stations' tracking operations. OTDA's program for implementing the first level of station computerization was known as Station Technical Operations Control. During the 1970s, the use of computers to handle tracking and data acquisition tasks would increase greatly.

Goddard Space Flight Center served as mission control for the satellites that STADAN supported.⁴ Before communications between the stations and Goddard

*NASA's first 26-meter pointable antenna was built at the Alaska station in 1962 to support Nimbus operations. Minitrack's telemetry reception antennas could not handle the large amounts of data that were produced by picture-taking weather satellites. Rosman's two 26-meter antennas were completed in 1962 and 1964. Another was erected at Orroval Valley, Australia, in 1965.

† Under contract, Space Technology Laboratories built the first GRARR in 1961. Motorola, General Electric, and General Dynamics/Electronics also built GRARR units for NASA. GRARR equipment was installed at Carnarvon, Santiago, Tananarive, Fairbanks, and Rosman.

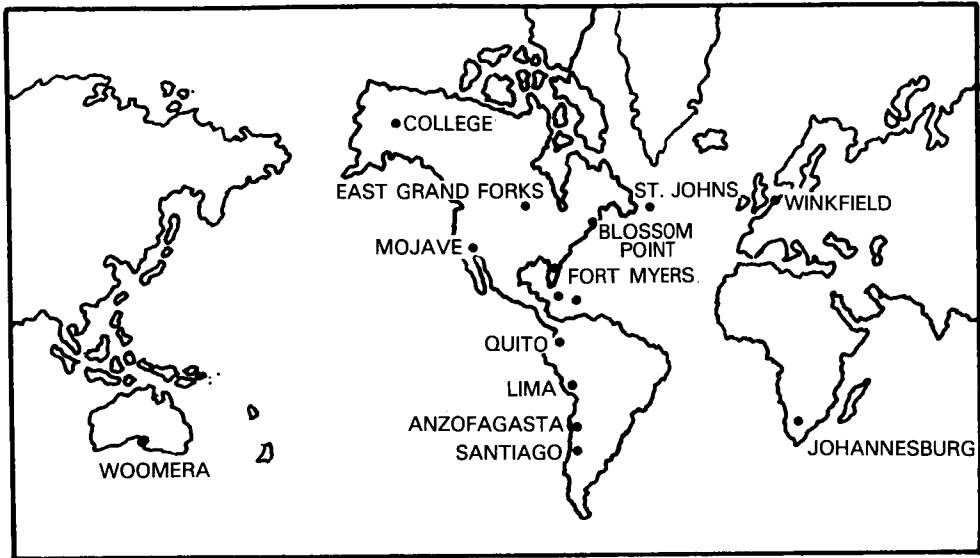

Figure 5-5. Minitrack stations, 1961. By this time, five of the original Minitrack stations had been phased out and replaced (Antigua, Ft. Stewart, Grank Turk, Havana, and San Diego). A collateral station was also in operation at South Point, Hawaii.

Source: From Samuel Glasstone, *Sourcebook on the Space Sciences* (New York: D. Van Nostrand, Co., Inc., 1965), p. 218.

were completely reliable, the individual stations often played the role of flight controllers. But by 1964–1965, the NASA communications system (NASCOM) was in operation, and project participants could command their satellites from one control center. The trend at Goddard's mission control facility in the mid-1960s was toward establishing "project unique" control areas (i.e., separate centers for OGO, ATS, Tiros, and other projects). Nine of these posts were in operation in 1967. To conserve funds, however, the control operations were being centralized in the late 1960s into a Multisatellite Operations Center (the control of meteorology satellites would remain separate from the others).

Goddard was also the site of the Network Test and Training Facility (NTTF). Here new equipment destined for tracking stations was tested and new personnel trained. Equipment from the Blossom Point, Maryland, prototype Minitrack station was transferred to NTTF in 1966. Tracking and data acquisition was one of Goddard's primary functions, and John Mengel as assistant director for tracking and data systems orchestrated the many tasks it involved. Ozro M. Covington, who had helped instrument DoD's White Sands Missile Range in the 1940s, was Mengel's deputy for most of the center's first decade. A 1967 reorganization that divided satellite and manned operations left Covington as assistant director for manned flight support.

One other element that played a part in satellite tracking from the Vanguard days through NASA's first decade was the Smithsonian Astrophysical Observatory

Table-5-19.
NASA Satellite Tracking Stations

Station	Original Minitrack station	Primary STADAN station with increased capabilities over Minitrack*	Collateral station	Years operational
Ahmedabad			x	1962
Alaska		x		1962-?
Antigua	x			1957-61
Antofagasta	x			1957-63
Blossom Point †	x			1956-66
Brazilia		Project SERB		1962
Carnarvon		x		1964-74
College		High-inclination		1960-66
College Park**				1962-64
Darwin		OGO		1966-69
East Grand Forks		High-inclination		1960-66
Ft. Myers		x		1959-72
Ft. Stewart	x			1957-59
Grand Turk	x			1957-61
Havana	x			1957-59
Johannesburg		x		1958-75
Kano		ISIS		1965-66
Kasima Machi			x	1967-70
Kauai		ISIS		1965-
Lima	x	x		1957-69
Majunga		Indian O.-inclination		1963-64
Mojave		x		1960-69
Network Test and Training Facility**				1966-
Orroral Valley		x		1965-
Quito	x	x		1957-
Rosman		x		1963-81
San Diego	x			1957-60
Santiago	x	x		1957-
Singapore			x	1963-70
Solant			x	1963-?
South Point			x	1961-66
St. John's		x		1960-70
Tananarive		x		1965-75
Toowoomba		x		1966-69
Winkfield		x		1961-?
Woomera	x			1957-66

*Special use indicated.

†Prototype Minitrack station.

**Not a regularly scheduled station.

Tracking Network.* This optical tracking network could be used only at dawn and dusk under clear conditions when the sky was fairly dark (the satellite was made visible by reflected sunlight). Though its use was restricted, optical trackers could provide highly accurate data with their Baker Nunn cameras. Although the approximate position of the satellites had to be known beforehand, the optical system was also called on to track vehicles that did not carry radio beacons. The Smithsonian network provided support to NASA's tracking operations under contract.

*The 12 SAO stations were located at Arequipa, Peru; Comodoro Rivadavia, Argentina; Debre Zeit, Ethiopia; Dionysos, Greece; Dodaira, Japan; Island Lagoon, Australia; Maui, Hawaii; Mt. Hopkins, Arizona; Naini Tal, India; Natal, Brazil; Olifantsfontein, South Africa; and San Fernando, Spain. For a history of the SAO, officially in existence since 1890, see Bessie Zaban Jones, *Lighthouse of the Skies; the Smithsonian Astrophysical Observatory: Background and History, 1846-1955* (Washington: Smithsonian Institution, 1965). See also Constance McLaughlin Green and Milton Lomask, *Vanguard: A History*, NASA SP-4202 (Washington, 1970), pp. 149-54.

Table 5-20.
Chronology of Space Tracking and Data
Acquisition Network (STADAN) Development and Operations

Date	Event
1948	As part of the Army Air Corps MX-774 project (a forerunner of the Atlas ICBM program), a radio interferometry tracking system was established (called the Azusa system). A Naval Research Laboratory (NRL) team working on underwater sound (acoustic) interferometers was in contact with the Azusa group; they informally exchanged ideas about the technology involved in their respective projects.
Early 1950s	The Navy borrowed the Azusa technology for its Viking missile project.
1950-1955	The Air Force, in establishing its missile range near Cape Canaveral, set up tracking and instrumentation stations along an 8000-kilometer stretch. The stations included Grand Bahama, Grand Turk, the Dominican Republic, and Mayaguana. Tracking instruments also were installed on aircraft and ships to augment the range.
1955	Of the two serious American proposals for orbiting an International Geophysical Year (IGY) satellite, NRL's Vanguard included a radio tracking scheme derived from the Navy's Viking experiences; the Army's Orbiter proposal suggested optical tracking.
April 1955	NRL specialists generated a document entitled "Proposal for Minimum Trackable Satellite (Minitrack)." An appendix of this document discussed the proposed Vanguard tracking system, Minitrack (the name was coined by John Mengel, one of the report's authors).
Sept. 9, 1955	The Department of Defense (DoD) authorized NRL to proceed with its Project Vanguard and the Minitrack system (Mengel would lead the NRL Radio Tracking Branch).
Dec. 1955	The number of proposed Minitrack stations in a network primarily along the 75th meridian grew from two to nine.

Table 5-20.
Chronology of Space Tracking and Data
Acquisition Network (STADAN) Development and Operations (Continued)

Date	Event
Spring 1956	An NRL team led by Winfred Berg toured South America and negotiated agreements for six Minitrack stations (Havana, Panama, Quito, Lima, Antofagasta, and Santiago). Construction would be the responsibility of a Project Vanguard Task Force of the Army Map Service. Plans were also under way for the operation of U.S. stations (Blossom Point, Maryland, San Diego, and downrange stations near Cape Canaveral—Antigua and Grand Turk). This put the number of stations at 10.
July 1956	Blossom Point station went into operation, serving as a training center for tracking operations and as a test facility for Minitrack equipment and procedures.
Oct. 1, 1957	The Minitrack network became operational. The stations included Antigua, Antofagasta, Blossom Point, Ft. Stewart, Grand Turk, Havana, Lima, Quito, San Diego, Santiago, and Woomera.
Nov. 8, 1957	In response to delays with Vanguard and the success of Sputnik, the Secretary of Defense announced that the Army with the support of the Jet Propulsion Laboratory (JPL) would also participate in the IGY attempt to launch a satellite. Their project was renamed Explorer. The original optical tracking scheme had been replaced by a system developed at JPL called Microlock, which combined Doppler tracking and interferometer receivers. For the early Explorer satellites (1958), three Microlock tracking stations were established in a network called Spheredrop.
March 17, 1958	<i>Vanguard 1</i> was successfully launched and tracked by NRL.
Oct. 1, 1958	The newly established NASA assumed responsibility for Vanguard, including its tracking network. Mengel became assistant director for tracking and data systems at the Goddard Space Flight Center.
1958-1961	Minitrack was used successfully to track NASA's early scientific satellites. Antigua and Grand Turk were phased out in July 1961; stations were added in Alaska and East Grand Forks in 1960; Ft. Myers replaced Ft. Stewart in 1959; Cuba station was phased out in 1959; Johannesburg, Mojave, and St. John's were added in 1960; the San Diego facility was phased out in August 1960; South Point, Hawaii, began serving as a collateral station in 1961.
Spring 1961	NASA Headquarters managers began to search for a more appropriate name for the satellite network; suggestions included Satellite Tracking and Instrumentation Network and Satellite Instrumentation Network.
1962	Although Minitrack continued to be suitable for NASA's early satellite program, the agency's plans for the future called for more sophisticated payloads and orbits that would demand more support than the Minitrack net could give. Ahmedabad, a collateral station in India, was added; Alaska station got a 26-meter antenna; telemetry reception equipment was erected at Brazilia to support Project SERB (Study of the Enhanced Radiation Belt); telemetry receiving and tape recording equipment was installed at a NASA data processing facility at College Park, Maryland; a 26-meter dish was under construction at Rosman, North Carolina. The tracking stations continued to be called Minitrack (M/T) stations, with the entire system being generally referred to as the satellite network (or less frequently as the electronics satellite system).

Table 5-20.
Chronology of Space Tracking and Data
Acquisition Network (STADAN) Development and Operations (Continued)

Date	Event
1963	The first of a new generation of satellite tracking stations was dedicated in October. Rosman station was established specifically to receive telemetry from the new observatory-class satellites (OGO, OSO, OAO). Rosman did not have a Minitrack-type interferometer. Antofagasta and Brazilia were phased out, with equipment from the latter being installed in a new station at Majunga, Madagascar. Collateral stations on Singapore and Solant were put into operation.
1964	The trend in satellite tracking was toward fewer stations, with a greater emphasis on data acquisition. Attempts were made to consolidate stations and supply the facilities that remained in the net with improved equipment to control and handle the high data output rates of new scientific satellites. NASA's satellite tracking system came to be known officially as the Space Tracking and Data Acquisition Network (STADAN). A second 26-meter dish went into operation at Rosman, and range and range-rate equipment was installed at Carnarvon. Majunga and College Park stations were closed.
1965	Activity was under way at three new stations in Australia: at Darwin to support OGO, in the Orroral Valley where a 26-meter dish was installed, and at Toowoomba in support of ATS. Kano station in Nigeria was opened to get better coverage for ISIS, an ionospheric research program. Kauai, Hawaii, was used for the same purpose. Range and range-rate equipment was being installed at Tananarive station. At Goddard, specialists were investigating methods of computerizing STADAN stations so that they could process the greater amounts of data expected from new satellites (the program for implementing the first level of station computerization was called Station Technical Operations Control).
1966	Six STADAN stations were phased out during the year (Blossom Point, College Park, East Grand Forks, Woomera, Kano, and one of the Alaska station's 26-meter dishes). Blossom Point's equipment was transferred to the new Network Test and Training Facility at Goddard. Additional equipment and a 12-meter antenna were installed at Tananarive. Transportable equipment, including a 12-meter antenna, was put into place at Toowoomba for the ATS program. This was the last year of operation for the South Point station.
1967	A new collateral station was put into operation at Kasima Machi by the Japanese. At mission control at Goddard, nine project-unique control centers were established for OSO, OGO, OAO, space physics, multisatellite operations, atmospheric studies Explorers, ATS, Tiros, and geodetic satellites.
1968	At the end of NASA's first decade, 16 STADAN stations were in operation: Alaska, Carnarvon, Darwin (phased out in 1969), Ft. Myers, Goddards' test and training facility, Kauai, Lima (phased out in 1969), Mojave, Orroral Valley, Quito, Rosman, Santiago, St. John's, Tananarive, Toowoomba (phased out in 1969), and Winkfield. In addition, three collateral stations supported STADAN at Kasima Machi, Singapore, and Solant.

DESCRIPTION – MANNED SPACE FLIGHT NETWORK (MSFN)

More than a decade before NASA Headquarters managers named the members of the Space Task Group and charged them with leading the agency's manned space program, the National Advisory Committee for Aeronautics and the military were working on ground instrumentation that could be used for tracking high-speed aircraft and guided missiles. NACA's Pilotless Aircraft Research Station at Wallops Island tracked experimental aircraft and rockets with radar as they made their way over the Atlantic. The military established ranges in the deserts of New Mexico and across the south Atlantic from Florida to the islands of the Bahamas (1600-kilometer range) and later on to Barbados (8000-kilometer range). The Air Force set up radar and telemetry equipment at several locations along the Atlantic missile range and connected the stations by undersea cable. Equipment borne by aircraft and ships augmented the island-station system.

In the 1950s, NACA and the Department of Defense established a joint high-speed research aircraft program that called for sophisticated tracking and communications gear. In the opinion of many, the logical extension of this joint program was earth orbital flight, and accordingly, tracking specialists began to define the global tracking network such a mission would require. To pull together the several teams that were working on tracking schemes and instrumentation, NACA Director Hugh L. Dryden in the spring of 1958 suggested establishing an interagency Working Group on Ranges, Launch, and Tracking Facilities. At about the same time, the Advanced Research Projects Agency (ARPA), in answer to great interest being shown by the military, formed an ad hoc Ground Based Information System for Support of Manned Space Flight Committee (known as GBIS). In October 1958 when President Dwight D. Eisenhower assigned the exploration of space to the new civilian space agency, it had a respectable well of tracking-data acquisition knowledge from which to draw. But the steps from range to network, from studies to operations would be giant ones.

The Space Task Group (STG), housed at Langley from its beginnings in 1958 until November 1961 when it became the nucleus of the new Manned Spacecraft Center in Houston, had a huge task ahead of it, of which tracking was only one of several critical parts. STG's mission planners established the base requirements for manned flight tracking operations and put a team of specialists, the Tracking Systems Study Group of Langley's Instrumentation Research Division, to work to find the means and techniques to meet these criteria. Project Mercury, the first step in NASA's manned program, had four broad tracking needs: (1) continuous coverage by all systems from launch to orbital insertion and again during reentry maneuvers; (2) periods of no contact not to exceed 10 minutes during the first one or two orbits; (3) at least one contact of several minutes per orbit (preferably per hour) during later orbits; and (4) reliance on state-of-the-art hardware that required little or no further development. Manned spaceflight demanded two-way voice communications, telemetry trajectory measurements, and uplinked commands, and it made these demands around the globe.

The man responsible for Mercury tracking in the early days was Edmond C. Buckley, an instrumentation expert from Langley who had helped set up the ranges at Wallops and at the High-Speed Flight Station in California. In January 1959, the Space Task Group was formally relieved of the tracking responsibility for Mercury,

and Buckley and his people were established as the Tracking and Ground Instrumentation Unit (TAGIU), an organizational entity at Langley separate from the STG. Buckley, however, was assigned a management role at NASA Headquarters soon thereafter, and G. Barry Graves, Jr., an electronics engineer, was named TAGIU's new leader. In addition to their own skills and knowledge, the Mercury tracking team had two groups from whom to tap ready expertise—the satellite trackers at the Goddard Space Flight Center, and members of the electronics industry who were already familiar with tracking requirements and equipment through their work for the military. Specialists from Goddard were soon applying their experiences with communications and computers to Mercury's unique problems. Representatives from interested companies attended a preliminary bidders' conference on tracking, telemetry, and telecommunications needs for Mercury in early April 1959; the next month they had in their hands official specifications for the ground instrumentation, a plan called S-45. Formal competition among potential contractors began in June.

S-45 stressed conservative design principles and astronaut safety. Mercury tracking stations around the globe would be equipped with proven C-band (RCA FPS-16) and S-band (Reeves Instrument Corp. Verlor) radar units.* A new piece of hardware, an active acquisition aid, would assist the narrow-band radars in locating the orbiting spacecraft. Additionally, Mercury would be equipped with transponders to ensure a strong return signal. The telemetry receivers would, of course, be compatible with the transmitters carried on the spacecraft, all of which would be built with off-the-shelf components. Manufacturers of the uplink command equipment were to follow the same guidelines. UHF (ultrahigh frequency) radio was specified for the primary communications link between the spacecraft and ground stations, with an HF (high frequency) backup and a second set of UHF equipment available at each ground station. Communications on the ground (telemetry, commands, radar acquisition data, tracking data, voice messages, teletype) were to be real-time. Two IBM 7090 computers would operate at Goddard's computing center to make the computations necessary for real-time monitoring and spacecraft control. A backup computer would be installed at Bermuda station to help make the go/no go decision for orbital insertion if communications to and from the island should fail during that critical juncture. The Mercury Control Center would be located at Cape Canaveral.⁵ Industry would not be called

*Radar (a contraction of "radio detection and ranging") was used to locate a spacecraft and determine its velocity and direction of movement by means of radio waves. Pulses of electromagnetic waves were transmitted by a directional antenna at a ground station, rotated or scanned over a certain sector at a constant rate. The pulses were reflected back to earth by the spacecraft. In the case of Mercury, the pulses triggered a repeater radar set on the capsule, which transmitted a stronger return signal via a radio transponder. Range was determined by measuring the time it took the radar signal to reach the target and return. The spacecraft's direction in respect to the radar unit was determined from the direction in which the pulse was transmitted. Velocity was determined by applying the Doppler principle and making the appropriate calculations: if the object were approaching the unit the frequency of the returned signal was greater than the frequency of the transmitted signal; if receding the returned frequency was less; if not moving the returned and transmitted frequencies were the same. The S-band radar operated at frequencies of 2700-3000 megacycles, the C-band at 5400-5700 megacycles. Verlor radar units were utilized for long-range (1100 kilometers) tracking; the FPS-16s pinpointed the capsule within half a degree at 920 kilometers (as modified for NASA).

on to build the total package outlined in S-45 for a global network of 17 stations, since some of the facilities needed to support Mercury were already in existence as part of the military ranges. The new sites would connect the Pacific Missile Range (California) with the Atlantic Missile Range (Florida), continue the net across Africa, the Indian Ocean, Australia, and the Pacific. S-45 made general recommendations for the locations of new stations, but following the satellite trackers' lead the Mercury specialists would send survey teams to choose the precise sites for their overseas facilities. Again, NASA's International Programs Office would play a key role in negotiating agreements in the many foreign countries that would host Mercury stations.

It did not take TAGIU long to choose a group of contractors for the construction of the Mercury network. The planned completion date of the net, June 1, 1960, did not leave time for lengthy evaluations. A team composed of Western Electric, Bell Telephone Laboratories, Bendix Corporation, IBM, and Burns and Roe—doing business as WECO—was awarded a letter contract in July 1959.* WECO was directed to construct and equip stations at Bermuda; Canton Island in the Pacific; Corpus Christi, Texas; Grand Canary Island; Guaymas, Mexico; Kano, Nigeria; Kauai, Hawaii; Muchea and Woomera, Australia; and Zanzibar. NASA-owned equipment was also needed for facilities at Cape Canaveral, Grand Bahama Island, Grand Turk Island, Eglin Air Force Base, Point Arguello, and the White Sands Missile Range. The contractors also supplied the Wallops Island demonstration site station with equipment, where hardware and new procedures were tested. DoD would contribute additional ground support, plus two tracking ships (*Rose Knot* Victor and *Coastal Sentry Quebec*) for the Atlantic and Indian Oceans.

That summer, NASA requested the assistance of eight foreign governments in establishing sites for its Mercury tracking stations, with the first technical visits taking place during the late summer and fall of 1959.† Although formal agreements were not always speedily obtained, actual construction was under way at all sites in 1960. For several reasons independent from the tracking operations, Mercury's flight schedule slipped several times, giving the NASA-contractor team extra months to ready all the ground stations and train personnel to operate them. The final master plan called for an operational network by June 1, 1961. The last station,

*WECO (from Western Electric Company) was also sometimes called the Systems Engineering Group. The five participants were assigned separate responsibilities as follows: Western Electric—overall management, equipment procurement, installation and testing, ground communications system design, and personnel training; Bell—systems analysis, command and control display design for Cape Canaveral and Bermuda, and a flight controller-astronaut simulation system; Bendix—telemetry and site display equipment, radar units, and capsule communication equipment; IBM—computer programming and operation at Goddard and Bermuda and maintenance and operation of Cape Canaveral's launch and display data subsystem; and Burns and Roe—construction, management, logistics, and operation of nonelectric equipment. The radar units Bendix was to modify for the Mercury net were to come from RCA and Reeves Instrument Corp. Since the relationship between RCA and Bendix, who were competitors, was not a good working one, NASA directly acquired the seven RCA FPS-16 units it required; Bendix then modified them according to plan, lengthening their range from 460 to 920 kilometers and adding a display and control package (the Instrumentation Radar Acquisition Kit).

†Original plans called for a station on Guadalcanal, and contact with the appropriate authorities was made. However, for reasons of economy, this potential site was dropped for consideration before a technical visit was made.

Kano, was finished in March 1961; the net was operating in July (table 5-21 lists the manned tracking stations; more complete information is provided in table 5-27).

By early 1961, it had become apparent that Langley was not the best place for the Tracking and Ground Instrumentation Unit. The Space Task Group would be leaving for Texas soon; it was also time for TAGIU to find a new home that was less isolated from NASA Headquarters and tracking operations. Goddard Space Flight Center was the logical choice. Tracking and data systems personnel under John Mengel were already overseeing satellite tracking operations and Mercury communications and were slated to assume responsibility for operating the Mercury network during the third quarter of 1961. Assisting the specialists who transferred to Goddard from Virginia was Niles R. Heller, chief of manned spaceflight support for Mengel until 1967, when Ozro Covington took the newly created post of assistant director for manned flight support. Only a small contingent of TAGIU personnel remained at Langley.* At headquarters in late 1961, the management of tracking and data acquisition was centralized under Edmond Buckley. Planning and construction over, the time had come for operations.

A concentration of five tracking facilities monitored the initial phases of a Mercury mission (see fig. 5-6). Through the Bermuda station, flight controllers determined if the conditions were satisfactory for inserting the spacecraft into orbit. If they were not, the mission could be aborted, with the capsule making an emergency splashdown in the Atlantic or on the African continent. If the spacecraft were put into orbit successfully, it made its way over the Atlantic, looping over Africa heading for Australia; from Australia the orbits swept north near the Hawaiian Islands heading for Mexico and the southern U.S. On the final orbit, retrofire maneuvers preparatory for landing took place as the spacecraft approached North America, with splashdown occurring in the Atlantic. Eighteen stations were prepared to track the typical three-orbit missions planned for Mercury.

Before the first manned orbital mission in 1962, the network had several tests. Individual stations calibrated their equipment by tracking aircraft equipped with Mercury-type electronics gear. Stations practiced procedures and simulated missions. The entire network participated in computer-controlled practice runs, during which the specialists at Goddard analyzed response times and data flows, made suggestions for improvements, and called for more simulations. Mercury-Redstone ballistic missions gave the Atlantic area stations a workout in December 1960 and March 1961 and again in May and July when NASA put its first two astronauts into space. The first orbital mission came on September 13, 1961. *MA-4* (unmanned) was tracked successfully by the net during its single orbit of earth. Network and STG personnel had hoped to conduct a more thorough test of the tracking system via a small instrumented satellite, but Mercury-Scout 1 was destroyed seconds after liftoff on November 1, 1961. A technical error had caused the vehicle to behave erratically, and the range safety officer had been forced to terminate the launch (see table 5-22).† There was no opportunity for a second try.‡ When the day finally came for the first orbital manned flight, however, all network systems proved themselves.

* TAGIU leader Graves resumed his work with Langley's Instrument Research Division.

† At Langley, Barry Graves took part in planning this test.

MA-6 with John H. Glenn, Jr., aboard made three orbits on February 20, 1962, while the network below tracked, communicated, and received data as it was designed to.†

†See chapter 2 for more information on the manned spaceflight program.

Table 5-21.
NASA Manned Spaceflight
Tracking Stations

Station	Original Mercury station	Used during Gemini	Used during Apollo	DoD support station	Colocated w/STADAN or DSN station	Years operational (NASA only)
Antigua ^a			x		x	1967-70
Antigua ^a		x	x	x		
Ascension ^a		x	x		x	1967-
Ascension ^a			x	x		
Bermuda	x	x	x			1961-
Canton Island	x	x				1960-67
Cape Canaveral/ Cape Kennedy	x	x	x		x	1961-
Carnarvon		x	x		x	1964-74
Corpus Christi	x	x	x			1961-74
East Island ^b				x		
Eglin	x	x		x		
Goldstone			x		x	1967-
Grand Bahama ^a			x			1967-70
Grand Bahama ^a	x	x	x	x		
Grand Canary	x	x	x			1961-75
Grand Turk	x	x	x		x	1961-?
Guam			x			1966-
Guaymas	x	x	x			1961-70
Honeysuckle Creek			x			1967-
Kano	x	x			x	1961-67
Kauai	x	x	x		x	1961-
Kwajalein ^b				x		
Madrid			x		x	1967-
Merritt Island			x			1973-
Muccha	x					1961-64
Patrick			x	x		
Point Arguello	x	x	x			1961-?
Pretoria		x	x		x	1967-?
San Nicolas ^b				x		
Tananarive		x	x		x	1965-75
TEL-4			x	x		
Vandenberg			x	x		
Wake Island ^b				x		
Wallops Island	x	x				1961-67
White Sands	x	x	x	x		
Woomera	x	x			x	1961-66
Zanzibar	x					1961-64

Table 5-21.
NASA Manned Spaceflight
Tracking Stations (Continued)

Station	Original Mercury station	Used during Gemini	Used during Apollo	DoD support station	Colocated w/STADAN or DSN station	Years operational (NASA only)
Tracking ships:						
<i>American Mariner</i> ^e				x		
<i>Coastal 1 Sentry Quebec</i> ^d	x	x		x		
<i>Huntsville</i> ^e			x			
<i>Kingsport</i>		x		x		
<i>Mercury</i> ^d			x			
<i>Range Tracker</i> ^b		x		x		
<i>Redstone</i> ^d			x			
<i>Rose Knot Victor</i> ^d	x	x		x		
<i>Twin Fall Victory</i>				x		
<i>Vanguard</i> ^d			x			
<i>Watertown</i> ^e			x	x		
Tracking aircraft:						
ARIA (8)			x			

^a Both NASA and DoD operated tracking facilities here that were used to support NASA missions. The code letters used for the two stations always differed. See table 5-27 for information on how the stations were equipped.

^b Used during *Mercury 9* only.

^c Used during *Mercury 8* only.

^d All or part of the tracking and data acquisition instrumentation was owned by NASA.

^e Used during *Mercury 8* and later modified for Apollo.

Table 5-22.
Mercury-Scout 1 (MS-1) Characteristics

<i>Date of launch</i> (location):	Nov. 1, 1961 (ETR)
<i>Launch vehicle:</i>	Scout (Air Force Blue Scout)
<i>Weight (kg):</i>	68
<i>Shape:</i>	Rectangular
<i>Dimensions (m):</i>	.3 × .3 × .4
<i>Power source:</i>	Battery
<i>Date of reentry:</i>	N/A
<i>Cognizant NASA center:</i>	LaRC (Space Task Group)
<i>Contractor:</i>	Ford Aeronautics Div., special Mercury instrumentation (C-band and S-band beacons, 2 Minitrack beacons, 2 command receivers, 2 telemetry transmitters)
<i>Objectives:</i>	To provide a dynamic orbital target with which to test the Mercury tracking network (18½ hours of power available for testing operations).
<i>Results:</i>	Because of a technician's error before launch (connectors between pitch and yaw rate gyros were transposed), the vehicle behaved erratically, and the range safety officer destroyed it 43 seconds after liftoff.
<i>Remarks:</i>	Also called Mercury Network Test Vehicle (MNTV). The Air Force provided the launch vehicle and the launching operations to give the launch crews extra experience; NASA paid for the payload.

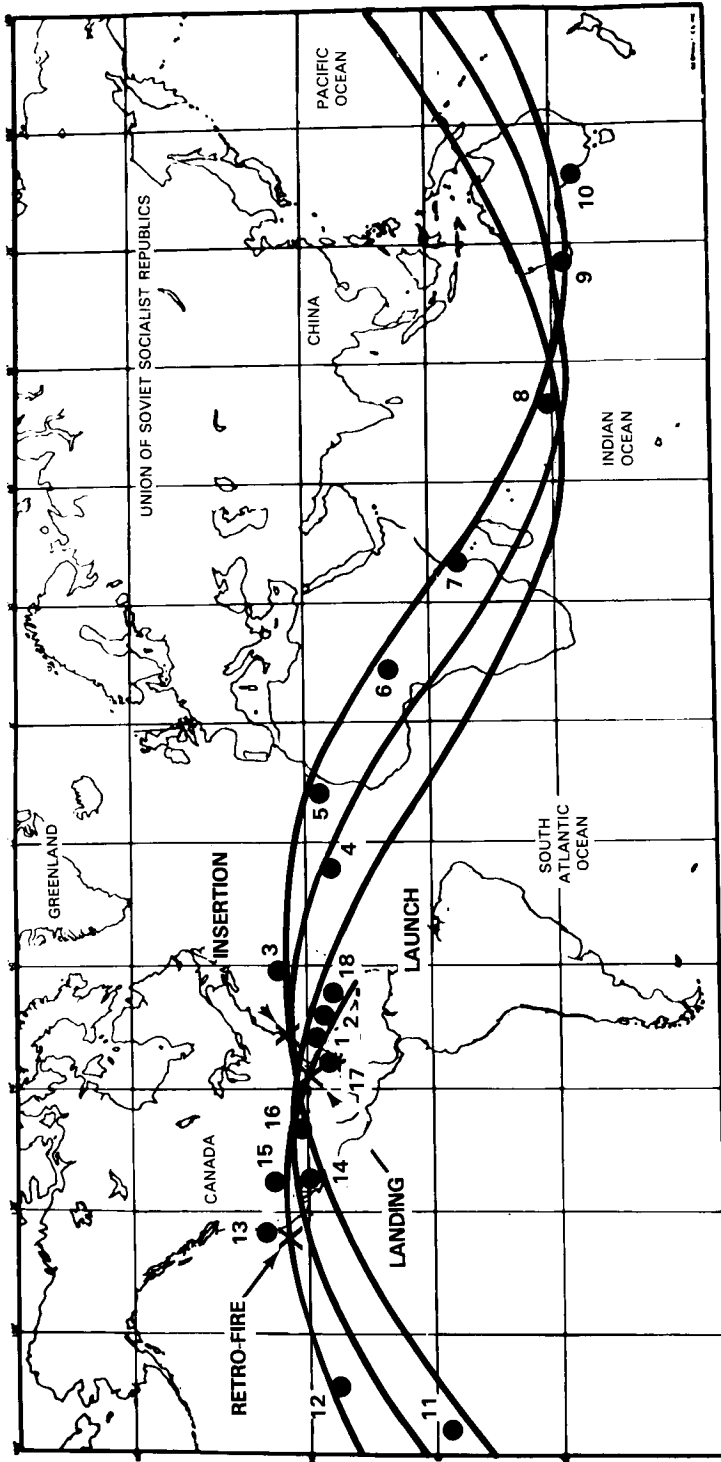

PROJECT MERCURY GROUND STATIONS

- | | | |
|------------------------|------------------------|--------------------------------|
| 1. CAPE CANAVERAL | 7. ZANZIBAR | 13. POINT ARGUELLO, CALIFORNIA |
| 2. GRAND BAHAMA ISLAND | 8. INDIAN OCEAN SHIP | 14. GUAYMAS, MEXICO |
| 3. BERMUDA | 9. MUCHEA, AUSTRALIA | 15. WHITE SANDS, NEW MEXICO |
| 4. MID-ATLANTIC SHIP | 10. WOOMERA, AUSTRALIA | 16. CORPUS CHRISTI, TEXAS |
| 5. CANARY ISLANDS | 11. CANTON ISLAND | 17. EGLIN, FLORIDA |
| 6. KANO, NIGERIA | 12. KAUAI, HAWAII | 18. GRANK TURK |

Figure 5-6. Project Mercury Ground Stations.

Like the satellite tracking system, the manned network changed to meet new mission profiles. There were only two three-orbit manned Mercury flights. Since astronauts Glenn and M. Scott Carpenter (*MA-7*, May 24, 1962) and their Mercury spacecraft had experienced few problems during the first two missions, the third flight was lengthened to 6 orbits, the fourth to 22 orbits. Since the tracks of the orbits for all missions would stay in a band of latitude of almost 66 degrees (roughly 33°N by 33°S), NASA did not have to provide a great amount of extra support for the longer missions, but the network needed beefing up, especially in the Pacific. For *MA-8*, the *Rose Knot Victor*, carrying new command equipment, was moved from the Atlantic to the Pacific, south of Japan. Three other DoD instrumented ships (*American Mariner*, *Huntsville*, and *Watertown*) were positioned near Midway Island. These four ships assisted the network with both voice and telemetry operations. To support *MA-9*'s 22 orbits, DoD provided NASA with supplementary coverage from ships and ground stations. In the Pacific, *Coastal Sentry Quebec*, *Range Tracker*, and *Rose Knot Victor* were added to the net, along with stations on Wake Island, Kwajalein Island, and San Nicolas Island, California (voice only). *Twin Falls Victory* operated in the Atlantic range, as did DoD facilities at Ascension Island, Antigua, and East Island, Puerto Rico. In addition, DoD aircraft with voice relay and radar equipment assisted during reentry and landing.

Before the Mercury stations were even operational, the Space Task Group was thinking beyond earth orbital missions to lunar expeditions. They established an Apollo Technical Liaison Group for Instrumentation and Tracking to study the new problems they would face tracking and communicating with a manned spacecraft near and on the moon. But NASA did not leap from Mercury to Apollo without an intermediate step that allowed the agency to gain expertise with two-man crews in larger and more sophisticated spacecraft, rendezvous maneuvers involving two vehicles, and lengthier missions. The manned network had to expand its operations as well during Project Gemini. By early summer 1962, specialists at Goddard were ready with recommendations for how the Manned Space Flight Network (MSFN) should be changed to support the next step in manned flight, keeping in mind that the network should be evolving toward a configuration that could eventually meet Project Apollo's tracking requirements. Because Gemini's long missions would repeatedly take the spacecraft beyond the normal limits of the Mercury stations, the network would have to expand geographically if the project managers wanted voice-communication time comparable to that required during Mercury. Goddard trackers proposed less frequent voice contact, and the Gemini personnel in Houston agreed to this constraint. For Mercury, several different frequencies had been used for the communications subsystems (voice, telemetry, command, tracking); for the trackers, unifying all these into a single frequency was highly desirable. But for the designers and engineers at the Manned Spacecraft Center, this was an impossible—albeit admirable—goal that would require too many onboard systems changes. For now, this idea was shelved. Both parties agreed to convert the analog telemetry system to a more efficient digital system (pulse code modulation, or PCM). Likewise, the tracking group in Maryland wanted the uplink commands in a digital form so that station computers could handle both telemetry and command. Because they feared software errors with the station computers, Gemini personnel refused to go along with the command half of this scheme. Computer-driven alphanumeric displays, however, was another area of agreement at Goddard and

Houston.* The tracking stations would require more equipment to track and communicate with two vehicles (either a Gemini spacecraft and an unmanned target vehicle or two Gemini spacecraft) during rendezvous maneuvers. In addition, these two-vehicle missions would need increased computer support at mission control. For most of Project Gemini and all of Apollo, mission control and mission computing would be centralized at the center in Houston, where new facilities were being built. Goddard would continue its role as the tracking operations center.

The move toward increased computerization and decreased voice support made possible a more centralized network with fewer primary stations and more secondary stations. Some sites that had been necessary for Mercury could be dropped during Gemini, although those major facilities that stayed in the net would have to be better equipped. Some of the hardware from Woomera station and the entire facility at Muchea were combined to make a new primary Australian station at Carnarvon. Other primary stations included Cape Kennedy, Bermuda, Grand Canary, Kauai, Guaymas, and Corpus Christi. Adding their support to the launch area were Eglin, Grand Bahama, Grand Turk, Antigua, Ascension, and *Rose Knot Victor* (with command capabilities). In Africa, secondary stations were operated at Kano and Pretoria. When the Zanzibar station had to be abandoned in 1964 because of a revolution that threatened the safety of the personnel, Tananarive in the Malagasy Republic off the east coast of Africa became that locale's secondary station. Woomera offered radar and voice support in Australia. Canton Island and *Coastal Sentry Quebec* (with command capabilities), positioned south of Japan, helped bridge the Pacific. At the end of the orbital track were Point Arguello and White Sands, now secondary stations. A large industry team had the Gemini network "on line" by the spring of 1964, in time for practice runs during a Saturn vehicle test (SA-6), the first Gemini-Titan flight (GT-1, unmanned), and a Centaur vehicle development mission (AC-3). All was ready in 1965 for the first manned Gemini flight.†⁷

Gemini's first manned mission (*Gemini 3*), a three-orbit check-out flight, took place on March 23, 1965. The next two flights gave the network its first lengthy exercise—62 and 120 orbits (*Gemini 4* and *5*, June and August 1965). In December, *Gemini 7* and *6-A* conducted rendezvous maneuvers. The net was kept especially busy in 1966 with five missions, all of which included rendezvous and docking operations by the Gemini spacecraft with unmanned target vehicles. The centralized network with its reduced number of primary stations proved adequate for Gemini. Apollo, however, would force further changes on the system.

Apollo activities would include operations near earth, in cislunar space, in lunar orbit, and on the moon's surface, most of which was beyond the manned network's grasp as it was configured for Mercury and Gemini. But NASA had begun to consult

*During their first meeting in June 1962, Goddard tracking specialists and Project Gemini personnel from MSC did not agree on many items on the trackers' list of proposed changes. By the time of their next major session in June 1963, the two sides were able to work out an agreement on how the network should be instrumented.

†The companies participating in the construction and equipping of the Gemini network were ITT, Canoga Electronics Corp., Bendix Corp., Electro-Mechanical Research, Inc., RCA, IBM, AT&T, Collins Radio Co., Radiation, Inc., and UNIVAC.

with deep space tracking experts regarding Apollo's unique requirements as early as 1961. The Jet Propulsion Laboratory in Pasadena, California, had been in the tracking and data acquisition business since the early 1950s and had begun construction of its first 26-meter diameter dish antenna for tracking lunar probes before NASA was established. In 1961 when the Apollo Technical Liaison Group for Instrumentation began its work, the Deep Space Network was already four stations strong with a fifth under construction. The Mercury-Gemini stations could be adapted for Apollo's near-earth operations, and JPL's 26-meter antennas or ones like them could reach out to Apollo spacecraft on and near the moon. However, there was some doubt as to whether there were enough conventional MSFN stations to enable the controllers to monitor two critical events: the transition from earth orbit to a lunar trajectory and the narrow-corridor, high-speed reentry into earth's atmosphere. And Apollo, with its requirement for television, would be sending back more telemetry than the Mercury-Gemini stations could receive. NASA would have to uprate the equipment at existing stations and augment the ground communications system before the network was ready for lunar missions.

In 1962, Edmond Buckley, director of the Office of Tracking and Data Acquisition at NASA Headquarters, appointed Gerald Truszynski to lead an Apollo Task Group composed of specialists from headquarters, Goddard, and JPL. Working with spacecraft designers at the Manned Spacecraft Center and at North American, where spacecraft design studies were being prepared under contract, this task group shaped the Apollo network. Their decision to introduce a unified (and higher) frequency band, the S-band, for Apollo communications was especially important.* Unified S-band (USB) might have been too great a leap for Gemini, but the experts considered it a necessity for the manned lunar venture. One unified carrier system on the spacecraft would take less space, weigh less, cause less heating, and require less power than a multicarrier system. Another consideration was the better signal-to-noise ratio the ground crews and astronauts would experience at the higher S-band frequency.† By November 1962, the tracking people were ready with an instrumentation support plan for near-earth Apollo operations, and OTDA had officially requested JPL's assistance with the lunar portion of the flight plan and with the development of a USB system. Planning over the next year called for the expansion of Gemini stations with the installation of 9-meter USB antennas and associated equipment and the construction of three 26-meter USB stations roughly 120 degrees apart around the globe, located near Deep Space Network antennas at Goldstone

*S-band is that band of radio frequencies extending from 1550 to 5200 megacycles (in the upper portion of the ultra-high frequency spectrum and the lower portion of the super-high frequency). The Federal Communications Commission (FCC) wanted space communications moved out of the crowded VHF range and into higher frequencies.

†The original Deep Space Network stations were equipped with L-band rather than S-band equipment, but in 1962 the decision was made to convert to the higher frequency. Because of ongoing missions (primarily Ranger) that would suffer from an immediate changeover, an L/S conversion system was devised. New facilities were provided with S-band; older stations were equipped with the L/S converter. Complete transition to S-band was completed by 1967. This commitment to S-band by the DSN influenced the MSFN planners' decision to adopt the higher frequency for Apollo.

(Mojave Desert, California), Canberra, Australia, and Madrid.* USB instrumentation and C-band radar would be installed on 5 tracking ships and VHF/UHF and USB equipment on 8 aircraft. These mobile stations would add flexible support in areas where there were no ground stations. As it had for Mercury and Gemini, DoD would augment the network with its stations, especially in the south Atlantic. The Office of Manned Space Flight and the Office of Tracking and Data Acquisition had an enormous number of requirements to juggle and a great many participants to oversee. Their efforts to implement the Apollo instrumentation plan were complicated further by the ongoing Gemini activity in which they could not interfere.

Apollo and network managers planned to streamline the Apollo network after the new equipment (especially the USB) proved itself and after lunar exploration missions became more "routine." But for the first round of manned Apollo flights the network was a large one, with 14 primary stations (11 of which were equipped with 9-meter USB antennas), 5 ships (see fig. 5-7), 5 aircraft (see fig. 5-8), 4 secondary stations, and 9 DoD support stations. Along the launch path, Antigua, Ascension, Bermuda, Grand Bahama, Merritt Island, Grand Canary, and the *Vanguard* were prime; secondary support came from DoD stations at Cape Kennedy, Antigua, Ascension, Grand Bahama, Merritt Island, and Patrick Air Force Base. The Madrid MSFN station was the primary tracking facility in Europe, with support coming from a nearby DSN antenna (Cebreros). Off the African coast, STADAN's Tananarive station added its equipment to the net, while DoD's Pretoria operated on the mainland. In Australia, Carnarvon and the new Canberra station were backed up by the DSN works at Tidbinbilla. Across the Pacific were Guam and Kauai, plus the *Huntsville*, *Mercury*, and *Redstone*. The last primary stations on the track were Goldstone, Guaymas, and Corpus Christi. Secondary support was available for the DSN Pioneer antenna at Goldstone and DoD's Vandenburg Air Force Base and White Sands Missile Range (see fig. 5-9).

Network managers insisted that the Manned Space Flight Network be given a thorough examination before it supported an Apollo mission. As with other network configurations before it, NASA tested the Apollo system with simulations and calibrated the stations with the help of instrumented aircraft. But to exercise the near-earth components of the network and evaluate how well the stations and mission control in Houston worked together, network specialists called for the launching of a satellite that MSFN could use as a tracking target. In contrast to the hastily pulled-together Mercury Scout, four Test and Training Satellites (TTSs) were planned for Apollo, to be launched in 1967, 1968, 1969, and 1971, thereby exercising the network as it evolved during the program. Designed to be launched piggyback-style along with another payload by the improved Thor-Delta vehicle, the small tracking satellite was equipped with a radio transponder that allowed it to receive radio signals and return them on a different frequency. *TTS 1* and *2* were launched and tracked successfully prior to the *Apollo 5* (unmanned) and *Apollo 8* (first manned

*By locating the MSFN 26-meter antennas near existing DSN facilities, the manned network could rely on the deep space antennas as backups in case of equipment failure and as a means for communicating with two lunar spacecraft simultaneously, as would be the case when Apollo's lunar module separated from the command module and descended to the moon's surface. New MSFN support wings were built at the three DSN stations so that Apollo ground operations would not interfere with scientific missions they might be supporting.

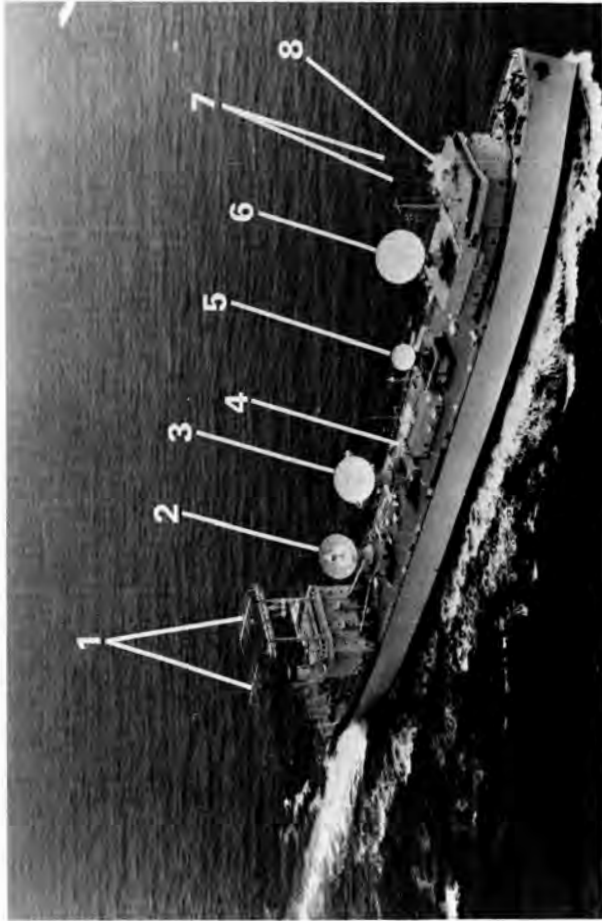

STDN TRACKING SHIP

- | | | | |
|---------------------------------------|----------------------------|-----------------------------|-----------------------------|
| (1) LOG PERIODIC ANTENNA | (3) UNIFIED S-BAND ANTENNA | (5) C-BAND TRACKER ANTENNA | (7) HF WHIP ANTENNA |
| (2) MEDIUM GAIN UHF TELEMETRY ANTENNA | (4) STAR TRACKER DOME | (6) SATCOM TERMINAL ANTENNA | (8) COMMAND CONTROL ANTENNA |

Figure 5-7. Apollo Instrumented Tracking Ship. NASA contracted with General Dynamics in 1964 to convert three retired World War II T-2 tankers into instrumented tracking ships for Apollo. Measuring 181 meters overall and 23 meters at the beam, the Vanguard, Redstone, and Mercury carried 9-meter USB antennas, radar units, and telemetry and command equipment. For Apollo 8 and 9, Vanguard was positioned in the Atlantic, Redstone and Mercury in the Pacific, where they could support injection, earth orbital and near-space activity and reentry. Two other tracking ships with 3.7-meter USB antennas, the Huntsville and Watertown, supported reentry. They were equipped for Apollo by the Range Systems Division of Ling-Temco-Vought Aerospace under contract to the Navy. NASA released the Watertown from its Apollo role in October 1968. Except for the Watertown, which was part of the Air Force's tracking network, the Apollo ships were operated by civilian crews of the Military Sea Transport.

1. ANTENNA CONTROL
2. SPACECRAFT COMM
3. TLM RECORDING
4. SYSTEMS MONITOR
5. GROUND COMM
6. TIMING
7. POWER CONTROL

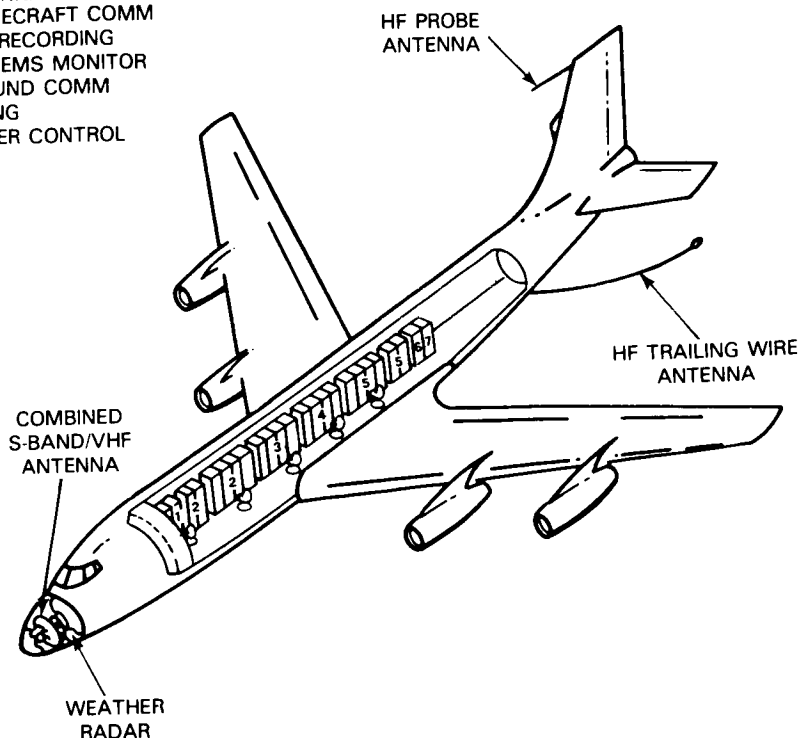

Figure 5-8. Apollo Range Instrumentation Aircraft (ARIA)

lunar orbital) missions (see table 5-23). To test MSFN's new lunar operations station, NASA exacted a double duty from Lunar Orbiter spacecraft that were photographing the moon in search of safe and scientifically interesting landing areas for Surveyor (unmanned) and Apollo. The new facilities at Goldstone, Madrid, and Canberra, along with MSFN 9-meter stations, passively and actively tracked Lunar Orbiters in 1966-1967, a valuable experience for the technicians operating the stations and extra insurance for Apollo.*

There was a hiatus of almost two years between the last Gemini and the first manned Apollo missions. The trackers spent the time installing new equipment, training personnel, and practicing the many new procedures Apollo would demand of them. When *Apollo 7*'s crew of three orbited earth in October 1968 in a successful test of spacecraft operations, the network was also proven operational. In December, *Apollo 8* took its crew to the moon, orbiting earth's natural satellite 10 times. Scientific and engineering telemetry, photographic images, voice communications—all were received in good order by MSFN ground stations. Apollo was on its way to meeting the ambitious goal President John F. Kennedy had established for NASA.

*See chapter 3 for information on the five Lunar Orbiter missions.

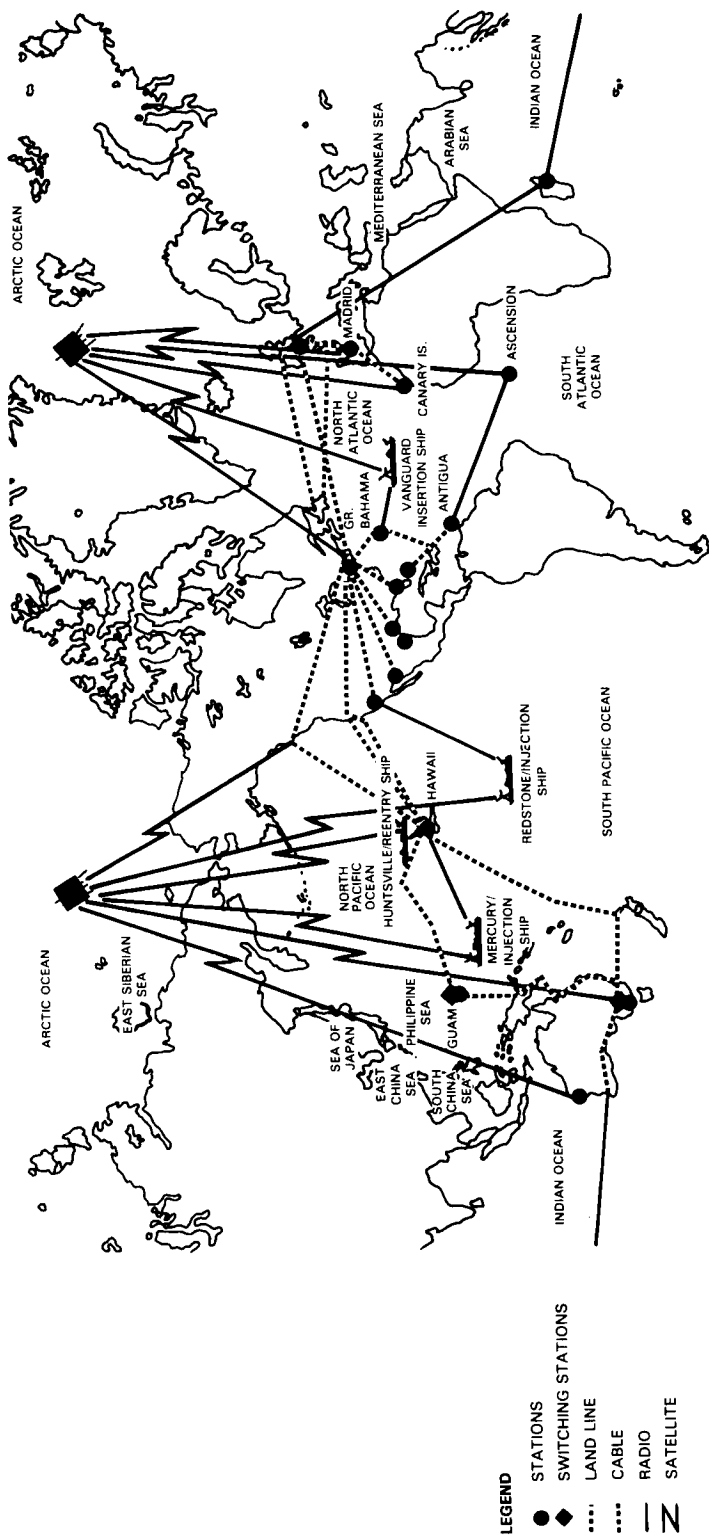

Figure 5-10. NASCOM, NASA's Communications System (1968) During Mercury, flight controllers manned consoles at tracking stations around the world, ready to take over the mission if communications failed between distant stations and mission control, leaving a station suddenly isolated. But improvements in NASCO, NASA's ground communications system, allowed both the satellite and the manned tracking nets to centralize and automate their operations. This map indicates the NASCOM links as of Apollo 8 (1968). While a single NASA Syncom satellite was used during Gemini for real-time heavy-volume data transmissions, two INTELSAT communications satellites were included in the Apollo system. This made possible the utilization of 6 voice-data and 2 telemetry circuits to each station, simultaneous transmission by 2 stations in each sector, simultaneous reception by all stations in a sector, and 100 voice frequency channels. NASCOM's communications satellite support of Apollo was designed for 99.8 percent circuit reliability by using redundant spacecraft subsystems and backup ground station equipment. NASCOM control was at the Goddard Space Flight Center.

Table 5-23.
Test and Training Satellite (TTS) Characteristics

	<u>TTS-1</u>	<u>TTS-2</u>
<i>Date of launch (location):</i>	Dec. 13, 1967 (ETR)	Nov. 8, 1968 (ETR)
<i>Launch vehicle:</i>	Thrust-augmented	Improved Thor-Delta (TAID)
<i>Weight (kg):</i>	18.14	18.14
<i>Shape:</i>	Octahedral	
<i>Dimensions (m):</i>		
Height:	.61	
Each side:	.279	
<i>Power source:</i>	NiCd batteries plus solar cells	
<i>Date of reentry:</i>	April 28, 1968	Sept. 19, 1979
<i>Cognizant NASA center:</i>	GSFC	
<i>Objectives:</i>	To serve as a target for the Apollo tracking network. Equipped with a transponder, the satellite could receive radio signals and return them on a different frequency.	
<i>Results:</i>	The two satellites successfully simulated Apollo earth orbital characteristics, giving the Apollo network opportunities to practice tracking and communicating with Apollo-type spacecraft.	
<i>Remarks:</i>	Also called <i>TETR-1</i> and <i>-2</i> . The two satellites were launched with <i>Pioneer 8</i> and <i>9</i> , respectively.	

Table 5-24.
Chronology of Manned Space Flight Network
(MSFN) Development and Operations

<u>Date</u>	<u>Event</u>
Spring 1945	The National Advisory Committee for Aeronautics (NACA) established the Pilotless Aircraft Research Station at Wallops Island, Virginia. PARD, the division assigned to the new station, was charged with testing model aircraft and aerodynamic shapes. Using the Atlantic as their test range, the specialists tracked experimental vehicles with radar and analyzed the telemetry signals they received. PARD launched its first rocket on July 4, 1945.
May 1946	An Army Signal Corps team led by Ozro M. Covington began instrumenting the White Sands Missile Range.
1950	Guided missile launchings were begun at Florida's Long Range Proving Ground (LRPG). Downrange tracking and observation stations were established in the Bahamas and on other nearby islands (1600-kilometer range). After the Air Force announced its plans in August for the acceleration of its missile program, steps were taken to establish additional tracking stations in Jamaica and the Dominican Republic.
1952	The Air Force Missile Test Center (AFMTC), formerly the LRPG, was planning to extend its missile range to 8000 kilometers with stations at Barbados, off the coast of Brazil in the south Atlantic, and at Dutch Guiana and French Guiana. These stations would be connected by an undersea cable communications system. The expanded tracking-data acquisition system would include equipment borne by aircraft and ships.

Table 5-24.
Chronology of Manned Space Flight Network
(MSFN) Development and Operations (Continued)

Date	Event
1955-1957	The Naval Research Laboratory planned and put into operation its Minitrack satellite tracking system. At White Sands and other missile ranges in the U.S., the radar and communications equipment used for tracking operations were becoming increasingly sophisticated. The system employed at White Sands was called MINSTREL (Missile Instrumentation by Electronic Means), a centralized real-time system. Both Air Force and NACA personnel had begun to investigate a global tracking scheme for the Air Force's proposed Dyna-Soar orbital lifting body.
1958	The Advanced Research Projects Agency (ARPA) approved the Department of Defense's (DoD) Discoverer satellite project, which was originally planned as part of an investigation of the technological problems the Air Force would face in putting man into space. Although Discoverer did not lead to an Air Force manned program, it did provide NASA and the services with data on a number of topics and was instrumental in establishing a worldwide radar network that would benefit the newly established civilian space agency's Project Mercury.
Spring 1958	In March, NACA Director Hugh Dryden suggested that NACA, the military, and others interested in the subject establish a Working Group on Ranges, Launch, and Tracking Facilities. ARPA also established an ad hoc committee known as GBIS (Ground Based Information System for Support of Manned Space Flight). At NACA's Langley center, Edmond C. Buckley of the Instrument Research Division directed a group of specialists (the Tracking System Study Group) to study spaceflight instrumentation problems, including ground and range instrumentation.
June 1958	The Air Force published a report entitled "Ground Based Information Systems for the Support of Manned Space Flight."
November 1958	On the 5th, NASA established the Space Task Group (STG) to implement the civilian manned spaceflight program. STG was to have become a part of the new Beltsville Space Center (later Goddard Space Flight Center), but in the interim the group was housed at Langley Research Center. NASA set up an Atlantic Missile Range Operations Office at AFMTC.
Jan. 1959	It was recommended that STG be relieved of the responsibility for developing the manned tracking network for Mercury. On the 26th, Buckley's tracking group was enlarged and became known as the Tracking and Ground Instrumentation Unit (TAGIU). Buckley was assigned to NASA Headquarters as assistant director for spaceflight operations. G. Barry Graves, Jr., was named the new leader of TAGIU. Also in January, NASA and DoD officials signed an agreement regarding global tracking centers.
April 2, 1959	A preliminary bidders' briefing on tracking, telemetry, and telecommunications plans for Project Mercury was held at Langley.
May 21, 1959	TAGIU issued its "Specifications for Tracking and Ground Instrumentation for Project Mercury" (S-45).
Summer 1959	NASA contracted with four companies to accomplish tracking and data acquisition tasks: Ford Aeronutronics—radar and trajectory computation study; RCA Service Corp.—network specification writing; Space Electronics—mission control center design; and MIT Lincoln Laboratories—general consultation and proposal evaluation. TAGIU also sought the assistance of Goddard computing and communications specialists (under the management of Goddard's Niles R. Heller).

Table 5-24.
Chronology of Manned Space Flight Network
(MSFN) Development and Operations (Continued)

Date	Event
June 22, 1959	Langley sent requests for proposals to industry based on S-45.
July 1959	The X-15 High-Range was put into operation with its three radar tracking facilities. Edmond Buckley had been responsible for much of this work (he had also worked on the instrumentation of the NACA Wallops Island facility).
July 29, 1959	A second edition of the network specifications was issued (S-45A).
July 30, 1959	NASA awarded a letter contract to an industry team—Western Electric, Bell Telephone Laboratories, Bendix, Burns and Row, and IBM—for the development of the manned spaceflight network.
July-Aug. 1959	NASA informed the following foreign governments that it required their cooperation in establishing tracking stations: Bermuda, Nigeria, Zanzibar, Australia, Guadalcanal, Canton Island, Mexico, and Spain (for Grand Canary Island).
Oct. 30, 1959	A third edition of the network specifications was issued (S-45B).
Jan. 11, 1960	NASA executed a definitive contract with WECO, the industry team.
April 1960	Construction was begun on the first foreign Mercury tracking station.
July 7, 1960	The first meeting of the Mercury Network Coordination Committee was held at Cape Canaveral. This group was assigned the task of overseeing problems, primarily operational, that faced the network.
Sept. 14, 1960	A Space Flight Ground Environment Panel, part of the newly created Aeronautics and Astronautics Coordinating Board (interagency), was established to handle network coordination matters.
Oct. 1960	Operational testing was begun at the Mercury stations.
Jan. 6, 1961	The newly created Apollo Technical Liaison Group for Instrumentation and Tracking (established by STG) held its first meeting. This body was in charge of studying the problems of tracking, commanding, and communicating with a manned lunar spacecraft.
Spring 1961	Construction of all foreign Mercury tracking stations was completed. Plans were made to assign responsibility for the operation of the Mercury network to Goddard during the third quarter of 1961.
Mid-1961	Ozro Covington and other personnel from White Sands were transferred to Goddard to assist with the conversion of the Mercury network into a more advanced system capable of supporting manned projects beyond Mercury. Covington became deputy assistant director for tracking and data systems at Goddard.
Sept. 13, 1961	The Mercury network functioned as planned during the first orbital flight (MA-4, unmanned). There were 19 stations in operation (Cape Canaveral, Grand Bahama, Grand Turk, Bermuda, Grand Canary, Kano, Zanzibar, Muchea, Woomera, Canton Island, Kauai, Pt. Arguello, Guaymas, White Sands, Corpus Christi, and Eglin, plus 2 instrumented ships in the Indian and Atlantic Oceans. The communications center was at Goddard.
Nov. 1961	STG moved to the new Manned Spacecraft Center (MSC) in Houston, Texas.
Nov. 1, 1961	An attempt to test the Mercury network with a small communications satellite (Mercury-Scout 1) failed because of a technician's error prior to launch. The vehicle was destroyed 43 seconds after liftoff.

Table 5-24.
Chronology of Manned Space Flight Network
(MSFN) Development and Operations (Continued)

Date	Event
Feb. 20, 1962 May 24, 1962	The standard Mercury network functioned as planned during the first two orbital missions (<i>MA-6</i> and <i>7</i>).
June 1962	Goddard engineers advised Project Gemini personnel of the changes that would be required in the tracking network to support more advanced missions.
July 20, 1962	NASA announced that a new mission control center would be built at MSC for Gemini. This center would also assume the mission computing tasks that had been performed at Goddard.
Summer-fall 1962	Goddard specialists worked on definition studies of an Apollo network. At MSC and at North American Aviation where designers were working on studies for the Apollo spacecraft, a decision was made to employ unified S-band (USB) for Apollo communications. Network people had already been considering the S-band option, and once the decision was made they directed their plans for the network accordingly.
Oct. 3, 1962	The <i>MA-8</i> mission was six orbits long; three instrumented DoD ships were added to the net. MSC requested the support of the Jet Propulsion Laboratory (JPL) in developing a tracking and communications network for Apollo. JPL personnel (Eberhardt Rechtin and Walter Victor) had been serving as consultants to the Apollo Technical Liaison Group for Instrumentation and Tracking since early 1961 because of their experience with deep space tracking. Apollo's network would require the technology and services represented by the Deep Space Network for lunar operations support.
Nov. 23, 1962	Goddard contributed its plans for an Apollo network in the form of a report, "A Ground Instrumentation Support Plan for the Near-Earth Phases of Apollo Missions" (X-520-62-211).
March 11, 1963	In a NASA Headquarters Apollo management plan, JPL was identified as a major participant in the MSFN, along with Goddard.
April 23, 1963	The <i>MA-9</i> mission was 22 orbits long. Various adjustments were made in the network to support the additional orbits (DoD sites provided extra tracking and telemetry capabilities).
June 1963	Goddard tracking and data acquisition personnel met again with Gemini managers to discuss their proposed changes to the tracking network, which had not been met with enthusiasm in Houston the previous year. At this meeting, project managers agreed to the network plan with two stipulations: station computers would be used for telemetry processing only, and the USB proposal could not be implemented. The Gemini net would require fewer prime stations than had Mercury's, but the primary stations that were planned would be better equipped (secondary stations with limited facilities would support the main stations).
Late 1963	Plans for the Apollo network called for the expansion of 7 Gemini stations to include 9-meter USB equipment; the construction of 9-meter USB stations at Merritt Island, Ascension, Antigua, and Guam; the construction of 3 26-meter USB stations at Goldstone, Canberra, and Madrid; the addition of wings to existing Deep Space Network stations at Goldstone (Pioneer station), Cebreros (Madrid), the Tidbinbilla (Canberra); the conversion of 5 ships to provide USB and C-band radar; and the conversion of 8 aircraft to provide VHF/UHF and USB. The Apollo Network Implementation Plan was drawn up on November 11.

Table 5-24.
Chronology of Manned Space Flight Network
(MSFN) Development and Operations (Continued)

Date	Event
April 20, 1964	In answer to plans for an accelerated flight schedule and other changes suggested by MSC, the Office of Tracking and Data Acquisition at NASA Headquarters issued a second Apollo Network Implementation Plan.
March 23, 1965	The first manned Gemini mission (<i>Gemini 3</i>), only three orbits, took place successfully. The tracking network functioned as planned.
May 1965	NASA and DoD officials signed a document outlining cooperative activities the two organizations would be participating in during Apollo: "DOD-NASA Agreement regarding Land-based Tracking, Data Acquisition, and Communications Facilities."
June 3-7, 1965	The first lengthy manned Gemini mission (<i>Gemini 4</i>) was tracked successfully by the MSFN during its 62 orbits.
Aug. 21-29, 1965	During <i>Gemini 5</i> , the new mission control center in Houston assumed responsibility for the computing aspects of the mission.
Dec. 4-18, 1965	<i>Gemini 6A</i> and <i>7</i> accomplished rendezvous maneuvers on Dec. 15-16. The tracking network successfully coped with the double load.
March-Nov. 1966	Five Gemini missions (<i>Gemini 8, 9A, 10, 11, and 12</i>) took place in which the Gemini spacecraft rendezvoused (and at times docked) with target vehicles. The network tracked these pairs of spacecraft successfully.
Sept.-Dec. 1966	The following MSFN stations became operational for Apollo: Carnarvon, Bermuda, Corpus Christi, Cape Kennedy, Kauai, Guaymas, Guam, and one of five instrumented ships.
Jan.-June 1967	The following MSFN stations became operational for Apollo: Ascension, Goldstone, Canberra, and Grand Bahama.
July 1967-Feb. 1968	The following MSFN stations became operational for Apollo: Antigua, Madrid, Grand Canary, and the remaining four ships.
Nov. 9, 1967	The Apollo net participated in the <i>Apollo 4</i> mission, an unmanned orbital test of the launch vehicle and spacecraft (command module).
Dec. 13, 1967	The launch of <i>TTS-1</i> was successful. This small satellite served as a training target for the Apollo network.
Oct. 11-22, 1968	The first manned Apollo mission (<i>Apollo 7</i>), earth orbital, took place successfully, and the tracking net functioned as planned. (Parts of the MSFN had been used in 1966-1968 to track unmanned Apollo-Saturn development flights and Lunar Orbiter spacecraft.)
Nov. 8, 1968	The launch of <i>TTS-2</i> was successful. This was a second training satellite for the Apollo net.
Dec. 21-27, 1968	The first lunar orbital Apollo mission (<i>Apollo 8</i>) took place successfully with a crew of three. MSFN tracked the spacecraft as planned during its 10 orbits of the moon.

DESCRIPTION—DEEP SPACE NETWORK

Tracking a man-made object beyond the confines of earth orbit became an official requirement in March 1958 when the Advanced Research Projects Agency (ARPA) approved the Pioneer lunar probe series, with both the Army and the Air Force participating independently. Communications specialists at the California Institute of Technology's Jet Propulsion Laboratory (JPL) had been alerted to the possibility of participating in such a mission in late 1957 when Cal Tech's president and JPL's director had suggested to the Department of Defense that the country pursue this particular goal.* Having been involved as a partner in the Army's early missile and satellite work, JPL's experienced tracking-communications team was able to suggest two possible schemes for tracking a spacecraft that would be operating at such distances from earth that it would appear as a star, rising and setting each day.

One of JPL's deep space radio tracking plans called for a single station in the U.S. equipped with a large parabolic dish antenna. The station would be in contact with the spacecraft during a single period daily when it was in view. Another scheme included three stations. A network of three antennas located roughly 120 degrees apart in longitude would provide continuous support for lunar and planetary spacecraft. Obviously, the three-station plan would give project personnel more opportunities for receiving data, monitoring spacecraft systems, and controlling the vehicle. But implementing such a network would require facilities in foreign countries and a reliable global ground communications system. Because the Army's first Pioneer lunar probe was scheduled for launch in late 1958, JPL could not build an entire network, but the tracking specialists did have time to erect a 26-meter-diameter antenna (Pioneer station) in southern California's Mojave Desert and deploy a mobile station near Mayaguez, Puerto Rico, for the first mission (see fig. 5-11). Unfortunately, none of the early Pioneer probes was successful. The Army's *Pioneer 3* did not achieve the velocity required for a lunar trajectory; *Pioneer 4* did not pass close enough to the moon for its experiments to record lunar data. The tracking system, however, operated as planned, following *Pioneer 4* some 651 200 kilometers.

JPL's tracking team, under the overall direction of NASA Headquarters and the local leadership of telecommunications expert Eberhardt Rechtin, was occupied over the next several years with building and improving the three components of their deep space tracking system: a mission control center at JPL (the Space Flight Operations Facility); a communications system that linked the tracking stations with

*Because of its increasing interest in advanced propulsion, the Guggenheim Aeronautical Laboratory (GALCIT) of the California Institute of Technology was renamed the Jet Propulsion Laboratory in 1943. Rocket propulsion and its possible applications to spaceflight was a natural extension of JPL's work in aeronautics. The lab's relationship with the Army and other organizations was a contractual one. When NASA assumed responsibility for the Pioneer lunar probe series and other projects in 1958, it also assumed authority for JPL's facilities and personnel. Although technically JPL continued in its role as a contractor, operating a government-owned facility, functionally NASA Headquarters dealt with the lab as if it were another field center.

mission control and operated as part of the broader NASCOM (the Ground Communications Facility); and the network of stations (the Deep Space Instrumentation Facility). The original three-station plan had been altered somewhat. Antennas that were to have been placed in Nigeria and the Philippines were destined for Spain and Australia. A South African site was also added to the net. These locations would offer the best support for NASA's lunar and planetary missions. But before construction of the first foreign station was begun, the Mojave Desert site (Goldstone) was expanded. Echo station, built to track NASA's passive communications satellites, became operational in April 1960. That fall, a 26-meter antenna near Woomera, Australia, became the first overseas facility to begin operations. In time for the first attempt at sending Ranger probes to the moon, Johannesburg station and a mobile compatibility test station at Cape Canaveral were added to the list. These additions gave the network the strength to support two deep space missions simultaneously, which it did during the fall of 1962 with *Ranger 5* and *Mariner 2* (Venus flyby). A second Australian station, Tidbinbilla near Canberra, and one in Spain, Robledo near Madrid, plus a large 64-meter antenna at Goldstone (Mars station) were all under construction in 1963. The manager of the Deep Space Network (DSN), as this expanding system came to be called, received permission to erect a permanent test station at the Cape in 1964. Goldstone saw one more DSN station put into operation; Venus station with a 26-meter antenna would serve the net as a research and development facility.

It was at this juncture that Project Apollo and the Office of Manned Space Flight intruded on the deep space trackers' world of scientific missions. The Manned Space Flight Network (MSFN) would be able to support relatively simple earth orbital operations, such as Mercury and Gemini flights, but Apollo planners proposed operating two spacecraft simultaneously, one in lunar orbit and one on the moon. Tracking lunar spacecraft was not possible with the manned network as configured for Gemini; JPL's special expertise with deep space communications was in demand on two fronts. Top-level managers at JPL were understandably reluctant to become deeply involved in the Apollo enterprise, especially since the coming years promised to be very active ones at the Pasadena center. Besides supporting JPL's Ranger lunar probes, Surveyor lunar landers, and Mariner interplanetary craft, the Deep Space Network would also be called on to participate in the Pioneer interplanetary probe series being managed at Ames Research Center and the Lunar Orbiter project of the Langley center. DSN personnel and facilities would assist with Apollo's operations, but in a manner that did not negatively influence their primary roles.

The end result of the combined JPL-manned network effort was a hybrid. Apollo's near-earth activities were supported by existing MSFN stations; lunar operations were the task of three new 26-meter antennas built near DSN stations at Goldstone, near Madrid, and in Australia. New wings that housed duplicate control equipment were built at the three DSN stations so that the manned network could augment its system or use the DSN antennas as backups without disturbing ongoing ground operations. At Goldstone, a MSFN wing was added to Pioneer station in 1964. A new station being built near Madrid, Cebreros, was also equipped with a dual wing. Tidbinbilla near Canberra was the last to get the extra ground equipment it would need to support Apollo. A joint DSN-MSFN station with a 9-meter antenna was also established on Ascension Island in 1965. As discussed elsewhere in this chapter, the Apollo net proved successful in supporting the first manned spacecraft to orbit the moon in 1968.

In addition to its traditional role as spacecraft tracker, the DSN was put to use as a radio astronomy tool. Goldstone's Venus station was especially active in this area. Built to serve as an advanced engineering and development facility with a high-power radio transmitter, the antenna beamed radar signals to the moon, Venus, Mercury, Mars, and Jupiter. By measuring the returned signals, scientists speculated on the surface characteristics of the bodies and added to their knowledge of the planets' positions and locations. In addition to the 26-meter reflector antenna, Venus station was equipped with a 1/7-scale model of the large antenna built for the Goldstone Mars station (see fig. 5-12). With the model, technicians tested the design and operation of the 64-meter antenna's feed system. After Mars station became operational in 1966, 5 percent of its working time was also allocated to radio science experiments. DSN equipment could also be used for other investigations; for example, by measuring the Doppler shift and signal attenuation characteristics of a signal that has passed through a planetary atmosphere scientists can obtain a temperature-pressure profile of the atmosphere.

JPL's Space Flight Operations Facility was the functional center of the network (see fig. 5-14). As the net evolved, the operations facility changed with it. Old computers were exchanged for new ones; new ones were used in series; more efficient techniques for data storage were put to use. The transition from single-mission to multimission support demanded a multimission telemetry system. And network managers wanted equipment and procedures that could accommodate the Mariner Mars 1969 goal of telemetering of 16 200 bits of data to earth during each second of transmission. In 1968, prototype high-rate telemetry hardware was installed and checked out at JPL and elsewhere in the net.

Eberhardt Rechtin, leader of the tracking group at JPL throughout most of the decade, joined JPL in 1949. In a 1963 reorganization of the lab, Rechtin's title was changed from chief of telecommunications (division 33) to assistant laboratory director for tracking and data acquisition. In addition, he served as director of the Deep Space Instrumentation Facility. Also vital to the management of the DSN in a number of capacities were Walter K. Victor, Nicola A. Renzetti, and J. W. Thatcher. William H. Bayley was general manager of the network from 1963 until 1967, when he took the lead position from Rechtin, who left JPL to become director of the Advanced Research Projects Agency. One person at the laboratory was usually assigned to manage the tracking operations for each individual project or group of related projects (e.g., in 1965, there was a tracking and data systems manager for Lunar Orbiter, one for Mariner, Surveyor, and Ranger, and another for Pioneer and Apollo). The field stations all had directors; supervisors for communications, data systems, USB systems, and facilities answered to them. The NASA Headquarters Office of Tracking and Data Acquisition had overall management authority for the Deep Space Network and its operations.⁸

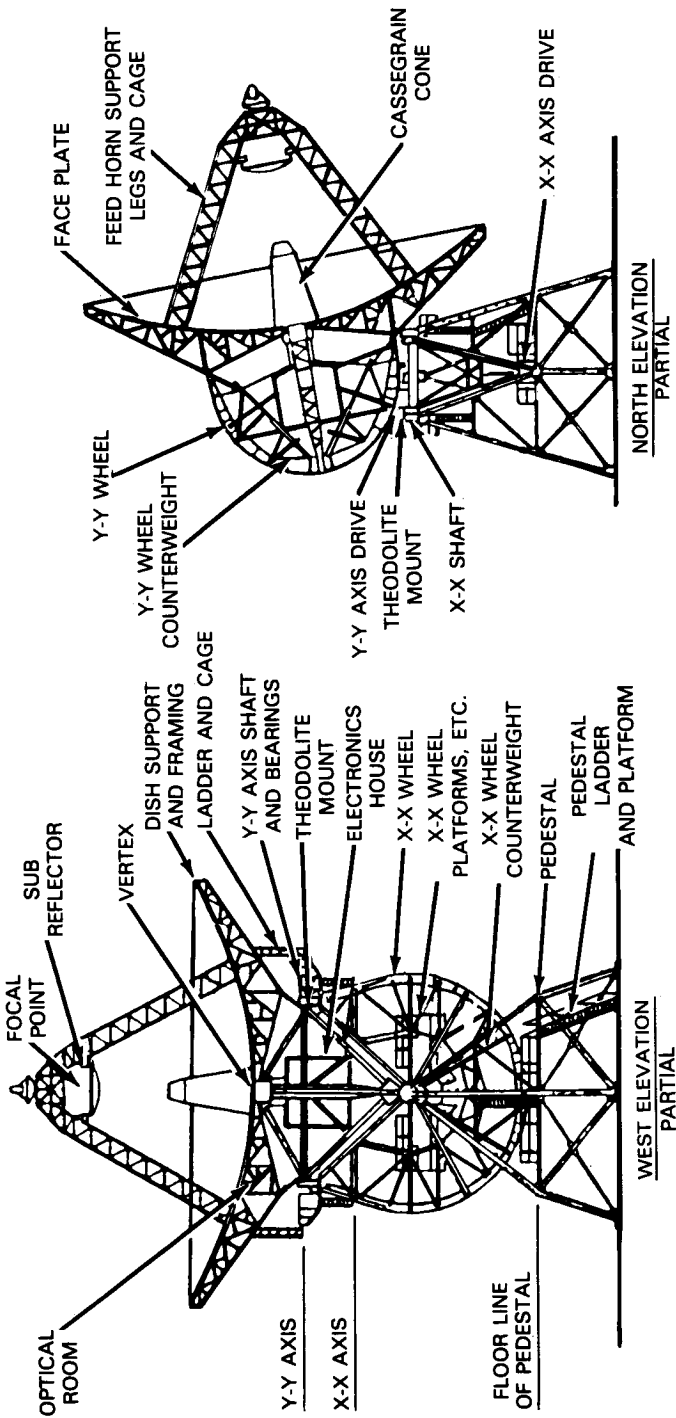

Figure 5-11. Deep Space Network 26-meter Antenna. The 26-meter-diameter steerable parabolic dish antennas erected at JPL's deep space stations were patterned after the radio astronomy antennas in use at the Carnegie Institute and elsewhere in the late 1950s with three significant modifications. A closed-loop device for automatically pointing the antenna at the target was added, as was an electrical feed apparatus for driving the servocontrol system, which responded to a signal from the spacecraft. The antenna's gear system was simplified for the space tracking role. A polar mount could steer the antenna from one horizon to the other at a sidereal rate; a smaller declination gear wheel controlled pivot movement up and down (low speed— 0.001 - 0.03 deg/sec for both axes; high speed— 0.02 - 1.0 deg/sec for hour-angle and 0.02 - 0.8 for declination). Made of aluminum, the parabolic dish offered a focal length of about 11 meters and a pointing accuracy of better than 0.02 degrees. The acquisition antenna had a diameter of 1.8 meters. The entire structure weighed over 450 000 kilograms and was 37 meters tall. Precision operation was possible in winds up to 32 kilometers per hour; accurate operation was still feasible in winds up to 48 kilometers per hour. The antenna could survive in any position during 113-kilometer-per-hour winds, and it could be stowed in a survival position (reflector at zenith) to withstand harsher conditions. Operating at a radio frequency band of 2090-2120 megahertz, for transmission and 2270-2300 for reception, the antenna had an average power capability of 20 kilowatts, 40 kilowatts at peak (Goldstone's Venus station had a special high-power transmitter).

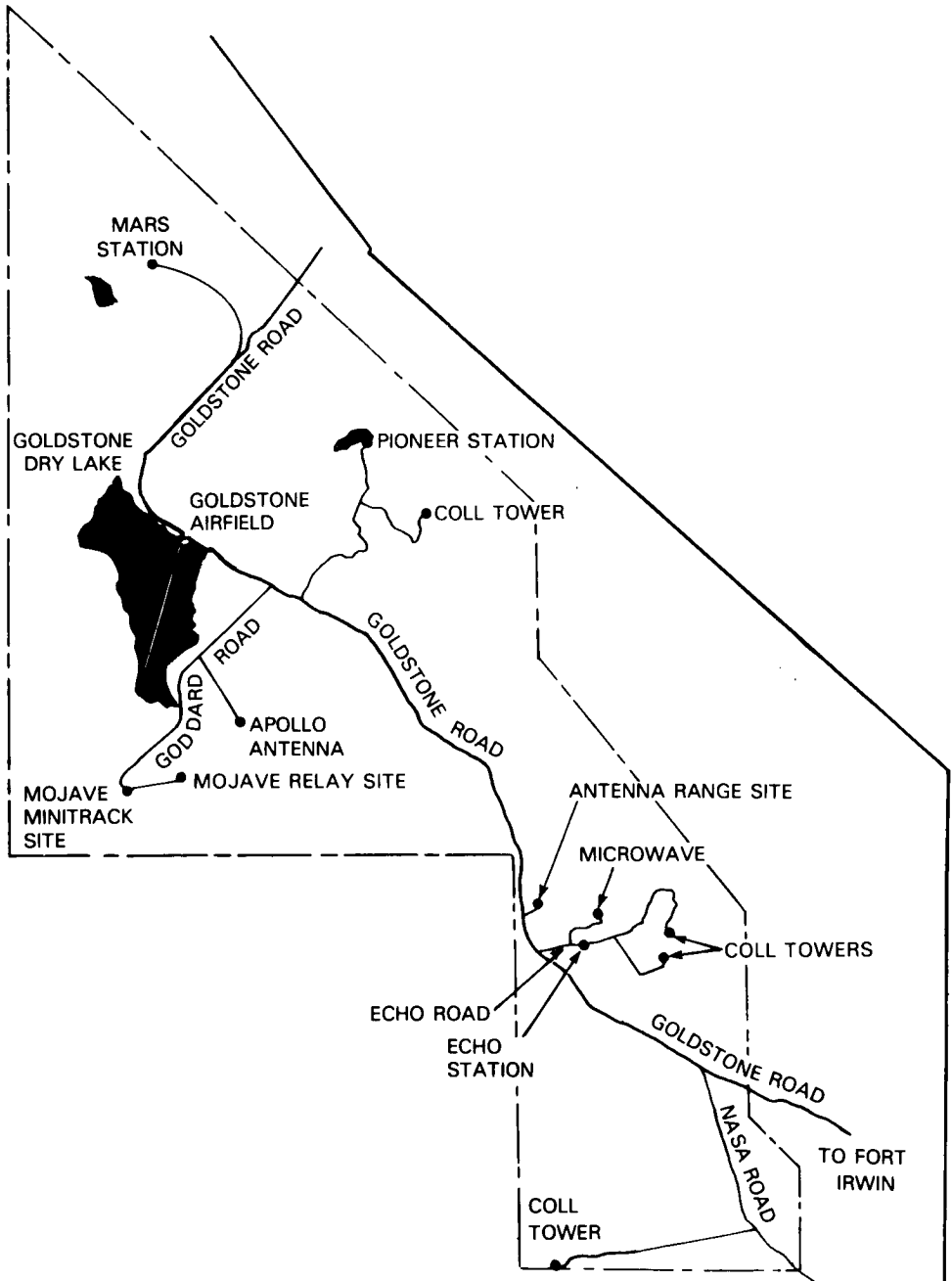

Figure 5-12. Deep Space network 64-meter Antenna. The Deep Space Network extended its range to the most distant planets of the solar system with the addition of a 64-meter-diameter antenna at Goldstone. The Mars station parabolic antenna could maintain spacecraft communications to a distance of $2\frac{1}{2}$ to 3 times the range achieved by the 26-meter antennas and had $6\frac{1}{2}$ times more transmitting and receiving capability. Standing 71 meters tall, the structure weighed 7.2 million kilograms. Its azimuth-elevation mount and motors (1300 horsepower) could move the giant dish from a horizon-pointing attitude to a straight-up position in 3 minutes. Mars station went into operation in 1966, and NASA planned two additional 64-meter stations for Australia and Spain.

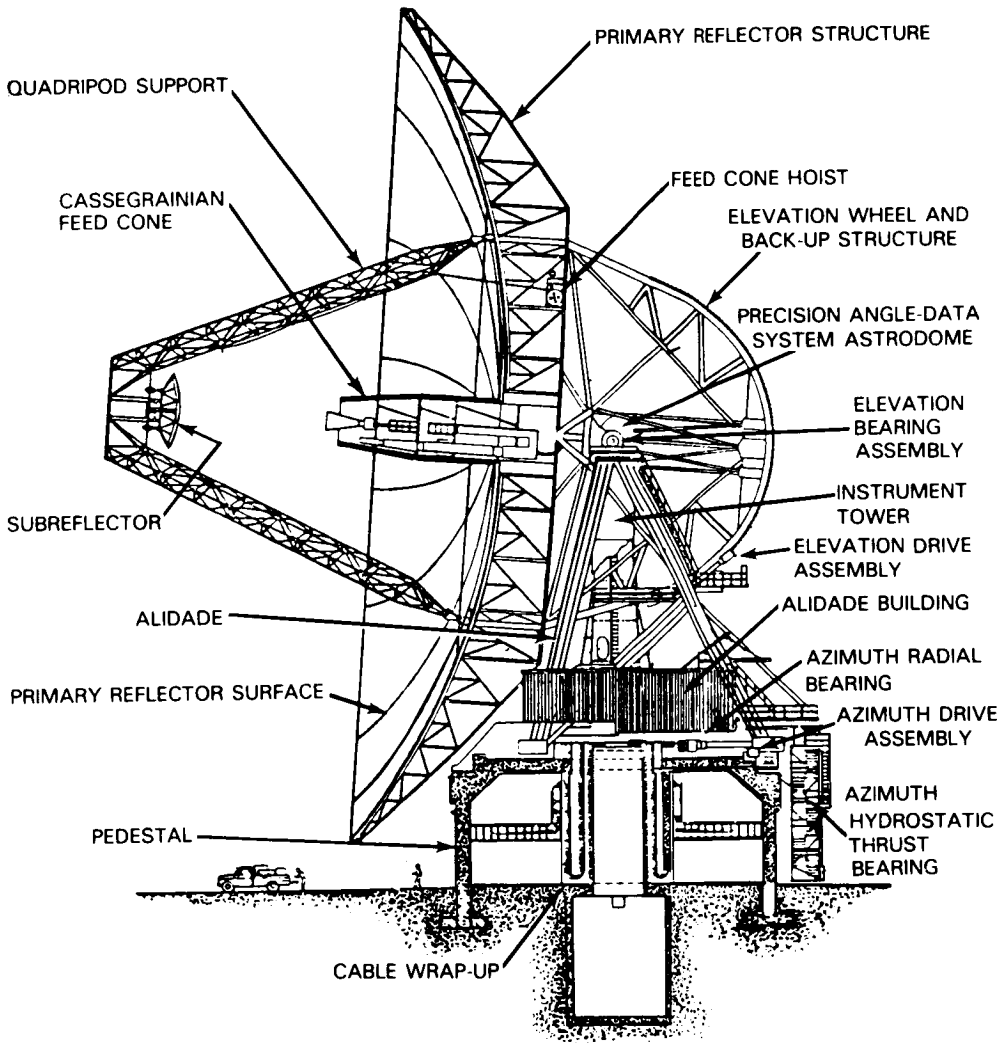

Figure 5-13. The Jet Propulsion Laboratory's Goldstone Space Communications Station in southern California's Mojave Desert was the site of the largest collection of NASA tracking equipment. In addition to the Mojave STADAN satellite station and the Apollo station with its 26-m antenna, there were four deep space stations at this location: Mars (64-m antenna), Pioneer (26-m), Echo (26-m), and Venus (26-m). These facilities were built on a 176-square-kilometer plot of land leased by NASA from DoD.

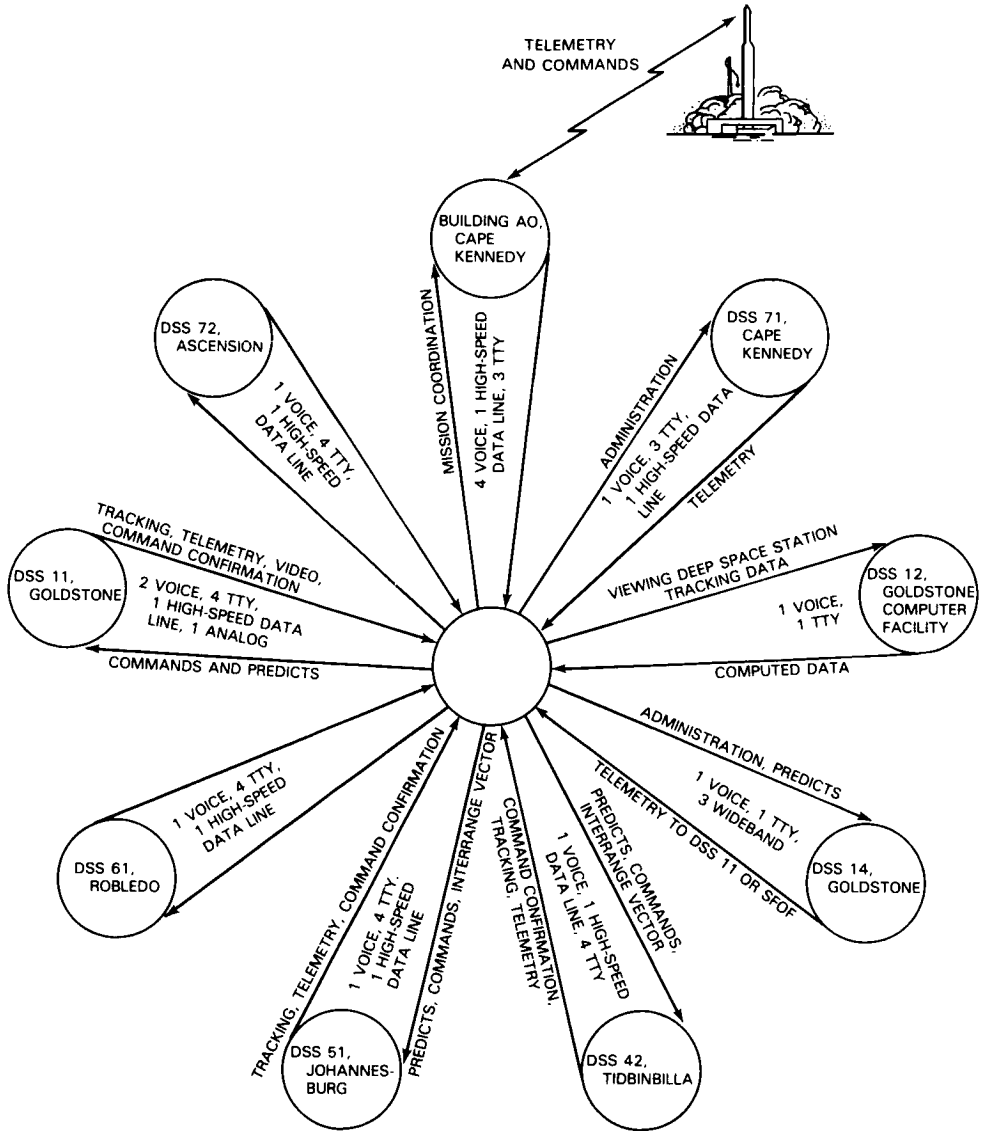

Figure 5-14. Deep Space network Mission Operations. during a mission, the several deep space stations fed data to the Space Flight Operations Facility at JPL. In turn, the flight controllers at JPL coordinated the tracking and data acquisition needs of the mission and commanded the spacecraft through the ground stations. This figure depicts the Deep Space Network as it was configured for the Surveyor lunar landing missions. The arrows indicate what form or forms the interaction between mission control and the stations took. Note that the communications links available at each station are also indicated.

Table 5-25.
Deep Space Network Stations

Station	Number	Antenna (m)	MSFN equipment	Years operational
Ascension Island	72	9	x	1966-68
Cape Kennedy Compatibility Test Station*	71	1.3		1965-
Cebreros†	62	26	x	1967-
Goldstone Echo	12	26		1960-
Goldstone Mars	14	64		1966-
Goldstone Pioneer	11	26	x	1958-
Goldstone Venus	13	26		1962-
Johannesburg	51	26		1961-74
Robledo†	61	26		1965-
Tidbinbilla	42	26	x	1965-
Woomera	41	26		1960-72

*Before the permanent facility was built, DSN had a temporary station at the Cape.

†Cebreros and Robledo were both sometimes referred to as Madrid station.

Table 5-26.
Chronology of Deep Space Network (DSN)
Development and Operations

Date	Event
1944-1947	As part of their work for the Army in developing the Corporal missile, specialists at the Jet Propulsion Laboratory (JPL) in California devised guidance and telemetry systems for the liquid propellant missile (Sperry Gyroscope Co. assisted with the design of the guidance system). The telemetry system used frequency modulation and phase modulation techniques. Testing of the Corporal began in 1947, with operational deployment in 1954.
March 15, 1953	In a report, F.W. Lehan and Robert J. Parks of JPL suggested using a phase-locked loop as a narrow-band tracking filter in the recovery of Doppler data. Eberhardt Rechtin and Richard Jaffe, also of JPL, followed up this research and refined the concept.
Early 1954	In a proposal to the Army for the design of the Sergeant missile, JPL suggested a radio system that would provide range and velocity information (Coded Doppler and Ranging Communications).
Summer-fall 1955	The Army Ballistic Missile Agency (ABMA) submitted a proposal to the Department of Defense (DoD) for an earth orbital International Geophysical Year (IGY) satellite (Project Orbiter) to be launched by a Redstone booster and a JPL-designed upper stage. JPL had also devised a telemetry system for the proposal; tracking would be done optically. DoD chose instead the Navy's Vanguard proposal, which included a radio tracking scheme. However, ABMA and JPL continued to work on their design (the launch vehicle was subsequently designated Jupiter C).
Sept. 1956	As part of the Reentry Test Vehicle Program, the first Jupiter C was successfully launched down the Atlantic missile range in a test of the vehicle design and the JPL phase-locked telemetry-tracking system (Microlock). The Jupiter C test program was completed in August 1957.
Nov. 1957	In answer to the Soviet Union's success with Sputnik and to delays with Vanguard at the Naval Research Laboratory, DoD authorized the Army to

Table 5-26.
Chronology of Deep Space Network (DSN)
Development and Operations (Continued)

Date	Event
	revive their satellite proposal. JPL's Microlock tracking and data acquisition system was part of the revised plan, which was renamed Project Explorer. Also in November, JPL Director William H. Pickering and California Institute of Technology President Lee A. DuBridge proposed to DoD that the U.S. send a probe to the moon by June 1958.
Jan. 31, 1958	The successful launch of the Army's <i>Explorer 1</i> took place; the Microlock system ensured the return of data from James Van Allen's radiation-measuring experiment.
March 1958	The newly created Advanced Research Projects Agency (ARPA) announced that the U.S. would conduct a lunar program with both the Air Force (three launch attempts) and the Army (two launch attempts) participating. Verifying a tracking and communications design was one of the program's objectives. Specialists at JPL had determined that a large steerable parabolic antenna would be necessary for ground stations to support a lunar mission. A JPL survey team chose southern California's Mojave Desert as the site for the first antenna.
Early 1958	In response to the government's growing interest in space exploration, JPL specialists suggested a three-station network (each station 120 degrees apart in longitude) for tracking deep-space probes. Suggested station sites included Goldstone, California, Nigeria, and the Philippines. ARPA approved JPL's plans for a network (Tracking and Communication Extraterrestrial, or TRACE).
Summer 1958	Construction of the Goldstone 26-meter antenna station was begun, and a mobile tracking station was located near Mayaguez, Puerto Rico, for support of Pioneer. In addition, support was sought from the managers of the Jodrell Bank (England) 76-meter radio astronomy antenna.
July 1958	To render their planned three-station network more useful to other future space projects, its designers proposed that the Nigerian site be shifted to southern Portugal or Spain and the Philippine site to Australia.
Nov. 1958	JPL's Ground Communications Facility, which had served as a combined operations and communications center for <i>Explorer 1</i> , became established as a separate entity within the laboratory. The Pioneer deep space station at Goldstone was completed.
Dec. 3, 1958	The newly created National Aeronautics and Space Administration (NASA) assumed responsibility from the Army for the facilities and personnel of JPL (as per Executive Order 10793).
Dec. 6, 1958	The attempt to send <i>Pioneer 3</i> to the moon was unsuccessful because the launch vehicle failed. The tracking crews successfully followed the probe in its try to escape earth's gravity and during its reentry into the atmosphere 38 hours later.
March 3, 1959	In its second attempt, the Army sent a probe, <i>Pioneer 4</i> , beyond earth's gravitational pull but not close enough to the moon for its experiments to record data concerning it. Again the tracking system functioned well, working for 41 hours until the probe's battery went dead at 651 200 kilometers.
July 1959	Construction of a second 26-meter antenna at Goldstone commenced.
Late 1959	Tracking experts proposed that a deep space station be located near Johannesburg, South Africa, so that continuous coverage could be provided missions. A site was chosen near the existing Minitrack station.

Table 5-26.
Chronology of Deep Space Network (DSN)
Development and Operations (Continued)

Date	Event
Dec. 1959	Goldstone's second station, Echo, was completed in time to support NASA's Echo communications satellite experiments (passive).
March 1960	Construction of a deep space station was begun near Woomera, Australia, also the site of an IGY Minitrack station.
April 1960	Goldstone's Echo station became operational.
Sept. 1960	Woomera station was completed.
Nov. 1960	Woomera station became operational.
Jan. 1961	Construction of the Johannesburg station was begun.
March 1961	A Goldstone antenna was used for radar astronomy experiments (signals were bounced off Venus).
May 1961	A mobile compatibility test station was established at Cape Canaveral.
July 1961	Johannesburg station became operational, supporting <i>Ranger 1</i> prelaunch tests.
Mid-1962	A decision was made to develop a standard S-band (2388 megahertz) frequency configuration for the deep space tracking network, replacing the lower L-band (960 megahertz). However, because of existing L-band equipment and the desire not to interfere with ongoing L-band Ranger spacecraft communications, an L/S conversion system was devised.
Aug. 1962	Plans for another station in Australia had been approved in early 1962, and in August Canberra was selected as the general locale for the network's newest 26-meter antenna. A specific site, Tidbinbilla, had been chosen by Jan. 1963. At Goldstone, a research and development station, Venus, went into operation.
Oct. 1962	For the first time, two deep space missions, <i>Ranger 5</i> and <i>Mariner 2</i> , were supported simultaneously.
Mid to late 1962	Specialists from JPL began searching for a station site in Italy, but after further analysis they determined that Spain would be a better location.
Dec. 1962	Deep space tracking officials proposed to convert their temporary launch station at Cape Canaveral into a permanent one and prepared a preliminary site plan for approval. The NASA site was rejected, but an alternate site was selected on Air Force property nearby.
Jan. 1963	Radar contact was made with Mars via a Goldstone antenna.
Feb. 1963	Of the several possible locales for stations in Spain, Robledo, an area southwest of Madrid, was chosen by the tracking experts.
July 1963	Construction began on the Tidbinbilla station. At JPL, Deep Space Network (DSN) officials agreed to support the Manned Space Flight Network (MSFN) during Apollo. Three DSN-type antennas would be required to track Apollo spacecraft. Existing DSN stations in California, Spain, and Australia would be modified to serve as backups or supplements to the manned network.
Oct. 1963	Construction began at Goldstone on a 64-meter antenna for Mars station. At JPL, the New Space Flight Operations Facility was completed.
Dec. 24, 1963	The Deep Space Network was officially established as a separate directorate at JPL under the direction of Eberhardt Rechtin.
Feb. 12, 1964	A conference was held at Cape Kennedy to establish procedures and initiate action for the procurement of a site for the Cape Kennedy DSN station.

Table 5-26.
Chronology of Deep Space Network (DSN)
Development and Operations (Continued)

Date	Event
March 1964	Construction began on the MSFN support wing at Goldstone's Pioneer station.
April 1964	An initial investigation was made on Ascension Island to find a site for an Integrated Apollo and Deep Space Station. A site was approved in July.
May 6, 1964	Final plans for the Cape Kennedy DSN station were delivered to the U.S. Army Corps of Engineers.
July 1964	The first L/S-band conversion unit became operational at Woomera.
Sept. 1964	To support the MSFN and provide for improved deep space tracking, a second DSN station was proposed for the Madrid area. The site chosen for the antenna was Cebreros.
Oct. 1964	Construction began at Cape Kennedy on the DSN Compatibility Test Station.
Jan. 1965	Construction of the joint MSFN-DSN facility on Ascension Island was begun.
March 1965	Tidbinbilla station became operational, supporting <i>Mariner 4</i> .
May 1965	The Cape Kennedy station became operational.
July 1, 1965	Robledo station became operational.
Jan. 1966	Construction of the station at Cebreros was begun.
April 1966	The Ascension station became operational. At Tidbinbilla, construction of an MSFN support wing got under way.
May 1966	Goldstone's Mars station became operational.
Jan. 1967	Cebreros became operational.
April 1967	Transition of the DSN to the S-band configuration was completed throughout the network (Johannesburg was the last station to be converted to full S-band operation),
Nov. 1967	At JPL, construction of the DSN Compatibility Test Facility was begun. Communications testing between the DSN and spacecraft would be conducted at this facility.
Jan. 1968	Prototype multiple-mission, high-rate telemetry equipment was installed at JPL for testing.

Table 5-27.
Tracking and Data Acquisition Stations

Station (location)	Code Name/ No.	Latitude Longitude	STADAN	MSFN	DSN	Established	Phased Out	Equipment	Remarks
Ahmedabad (India)		23°15'N 73°10'E	x			1962	1962		Collateral station.
Alaska (near Fairbanks)	ALASKA	64°59'N 147°31'W	x			1962		Minitrack GRARR and MOTS SATAN receivers and command 12-, 14-, 26-m dish antennas	Also unofficially referred to as Fairbanks station. The Weather Bureau (later ESSA) also operated a sta- tion equipped with a 26-m antenna (Gilmore) nearby. Alaska's 12-meter antenna and Minitrack were trans- ferred from College station in 1966.
Antigua (British West Indies)	ANG	17° 9'N 61°47'W	x			1957 1967	1961 1970	Minitrack 9-m USB VHF telemetry links telemetry recording	DoD also operated a track- ing station on Antigua, which was active during Gemini and Apollo.
Antigua (DoD)	ANT							C-band radar VHF telemetry links telemetry recording	DoD also operated Microlock equipment on Antigua. Antigua station, operated jointly by the Army and Navy, supported NASA activities until 1970.
Antofagasta (northern Chile)	AGASTA	23°37'S 70°16'W	x			1957	1963	Minitrack	Phased out when Santiago and Quito stations were im- proved.

Table 5-27.
Tracking and Data Acquisition Stations (Continued)

Station (location)	Code Name/No.	Latitude Longitude	STADAN	MSFN	DSN	Established	Phased Out	Equipment	Remarks
Ascension Island (south Atlantic)	72	7°57'S 14°35'W			x	1966	1968	9-m antenna	Established as an Integrated Apollo and Deep Space Station; equipment transferred to MSFN in 1968.
	ASN		x	x		1967		9-m USB VHF telemetry links FM remoting telemetry decommutators telemetry recording data processing communications: voice, VHF air/ground, teletype, video, high-speed data	Primary USB station for near-earth Apollo operations. In addition, DoD operated a station on Ascension.
Ascension (DoD) Bermuda (Atlantic)	ASC BDA	32°15'N 64°50'W					1961	C-band radar C-band radar 9-m USB VHF telemetry links FM remoting telemetry decommutators telemetry recording data processing communications:	Data received at Bermuda were crucial in making the go/no-go decision for orbital insertion. The station could also provide reentry tracking for Atlantic recovery situations. During Mercury, a computing and control center was also

Table 5-27.
Tracking and Data Acquisition Stations (Continued)

Station (location)	Code Name/ No.	Latitude Longitude	STADAN	MSFN	DSN	Established	Phased Out	Equipment	Remarks
Blossom Point (Maryland)	BPOINT	38°26'N 77°05'W	x			1956	1966	voice, VHF air/ground, teletype, video, high-speed data	located here to serve as a backup if communications with mission control were interrupted.
Brazilia (Brazil)								Minitrack	Prototype Minitrack station. Equipment transferred to the Network Test and Train- ing Facility in 1966.
Canary Island. See Grand Canary.									
Canberra. See Honeysuckle Creek.									
Canton Island (Pacific)	CTN	2°47'S 171°41'W		x	x	1960	1967	acquisition aid PAM telemetry telemetry recording communications: voice, spacecraft	Supported Project SERB (Study of the Enhanced Radiation Belt). Equipment transferred to Majunga sta- tion in 1963.

Table 5-27.
Tracking and Data Acquisition Stations (Continued)

Station (location)	Code Name/No.	Latitude Longitude	STADAN	MSFN	DSN	Established	Phased Out	Equipment	Remarks
Cape Canaveral/ Cape Kennedy (Florida)	CNV	28°28'N 80°34'N		x x x		1961		9-m USB radar; FPS-16, ODOOP, optical acquisition aid telemetry reception data processing communications: voice, VHF air/ground, telemetry	NASA and DoD tracking facilities were located at the Cape; DoD supported NASA's missions with their equipment. Mercury mission control (MCC) was located at the Cape.
Cape Kennedy DSN Compatibility Test Station (Florida)	71	28°29'N 80°34'W			x	1965		1.3-m antenna	A temporary DSN station was located at the Cape before this facility was constructed.
Carnavon (western Australia)	CARVON CRO	24°54'S 113°43'E	x			1964	1974	GRARR	For Project Biosatellite, Yagi command equipment was also used here.
				x x		1964	1974	9-m USB C-band radar VHF telemetry links FM remoting telemetry decom- mutators telemetry recording data proc- essing communica- tions: voice, VHF	Equipment from Muchea and Woomera stations was consolidated here.

Table 5-27.
Tracking and Data Acquisition Stations (Continued)

Station (location)	Code Name/ No.	Latitude Longitude	STADAN	MSFN	DSN	Established	Phased Out	Equipment	Remarks
Cebreros (near Madrid, Spain)	62	40°27'N 4°22'W			x	1967		air/ground, teletype, video, high-speed data 26-m antenna	Together, Cebreros and the nearby Robledo station were often referred to as Madrid station. The collocated MSFN facility was officially designated Madrid station.
College (near Fairbanks, AL)		64°58'N 147°31'W	x			1960	1966	Minitrack	Added to the original Minitrack network to track high-inclination satellites, such as Nimbus. Equipment transferred to Alaska Sta- tion.
College Park (Maryland)		38°59'N 76°56'W	x			1962	1964	telemetry receiving telemetry recording	Not a regularly scheduled station. Equipment installed at a NASA data processing facility near GSFC for telemetry tests.

Table 5-27.
Tracking and Data Acquisition Stations (Continued)

Station (location)	Code Name/ No.	Latitude Longitude	STADAN	MSFC	DSN	Established	Phased Out	Equipment	Remarks
Corpus Christi (Texas)	TEX	27°39'N 97°23'W	x	x	x	1961	1974	9-m USB VHF telemetry links FM remoting telemetry decom- mutators telemetry recording data proc- essing communica- tions: voice, VHF air/ground, teletype, video, high-speed data	
Darwin (north- central Australia)	DARWIN	12°17'S 130°49'E	x			1965	1969	4.3-m antenna Yagi command	Mobile station located here to support <i>OGO 3</i> (1966) and <i>OGO 5</i> (1968), eccentric-orbit satellites. The dish antenna was transferred to Kauai station.
East Grand Forks (Minnesota)	GFORK	48°01'N 97°01'W	x			1960	1966	Mimirack	Established to support high- inclination satellites.
East Island (DoD) (Puerto Rico)				x				FPS-16 Radar	Used to support <i>MA-9</i> .
Eglin (DoD) (Florida)	EGL	30°25'N 86°48'W		x				radar acquisition aid PAM telemetry telemetry recording voice communica- tions	DoD owned the radar facilities; NASA owned on- site the acquisition aid, telemetry, and communica- tions equipment used during Mercury and Gemini (in operation in 1961)

Table 5-27.
Tracking and Data Acquisition Stations (Continued)

Station (location)	Code Name/ No.	Latitude Longitude	STADAN	MSFN	DSN	Established	Phased Out	Equipment	Remarks
Fairbanks. See Alaska.									
Ft. Myers (Florida)	FTMYRS	26°33'N 81°52'W	x			1959	1972	Minitrack SATAN receivers and com- mand 3 Yagi com- mand MOTS	Replaced the Ft. Stewart sta- tion in the Minitrack net- work. Most of the equip- ment used here was trans- ferred from the Havana sta- tion.
Ft. Stewart (Georgia)		31°51'N 81°35'W	x			1957	1959	Minitrack	Equipment was transferred to St. John's station. The Air Force erected an active Minitrack system here in 1958.
Gilmore. See Alaska.									
Goddard. See Network Test and Training Facility.									
Goldstone (California)	GDS	35°20'N 116°54'W		x		1967		26-m USB FM remoting telemetry decommutators telemetry recording data processing communications: voice, teletype, video, high-speed data	MSFN station was located near the DSN Goldstone sta- tions and the STADAN Mo- jave station, making it the largest concentration of NASA tracking and data ac- quisition equipment.

Table 5-27.
Tracking and Data Acquisition Stations (Continued)

Station (location)	Code Name/ No.	Latitude Longitude	STADAN	MSFC	DSN	Established	Phased Out	Equipment	Remarks
Goldstone - Echo	12	35°18'N 116°49'W			x	1960		26-m antenna	Initially supported Project Echo communications experiments.
Goldstone - Mars	14	35°26'N 116°44'W			x	1966		64-m antenna	NASA's first 64-m antenna; others were planned for stations in Spain and Australia. Used to support planetary missions.
Goldstone - Pioneer	11	35°23'N 116°51'W			x	1958		26-m antenna	First deep space station constructed by JPL. Used initially to support Project Pioneer (pre-NASA).
Goldstone - Venus	13	35°26'N 116°53'W			x	1962		26-m antenna	Used to support interplanetary missions.
Grand Bahama (south Atlantic)	GBM	26°38'N 78°16'W		x		1967	1970	9-m USB VHF telemetry links FM remoting telemetry decommutators telemetry recording data processing communications: voice, VHF air/ground, tele- type, video	Critical station during the launch phase. DoD also operated a tracking facility on Grand Bahama that supported NASA missions.

Table 5-27.
Tracking and Data Acquisition Stations (Continued)

Station (location)	Code Name/No.	Latitude Longitude	STADAN	MSFN	DSN	Established	Phased Out	Equipment	Remarks
Grand Bahama (DoD)	GBI			x x x				C-band radar VHF telemetry links telemetry recording	
Grand Canary (near the coast of Morocco)	CYI	27°44'N 15°36'W		x x x		1961	1975	C-band radar 9-m USB VHF telemetry links FM remoting telemetry decommutators telemetry recording data processing communications: voice, VHF air/ground, tele- type, video, high- speed data	
Grand Turk (British West Indies)	GTI GTK	21°27'N 71°09'W	x			1957	1961	Minitrack	Provided radar coverage during the final reentry phase during Mercury and Apollo flights. DoD also operated a station on Grand Turk.
				x x x		1961		USB C-band radar VHF telemetry links FM remoting telemetry decommutators telemetry recording data processing communications: voice, VHF	

Table 5-27.
Tracking and Data Acquisition Stations (Continued)

Station (location)	Code Name/ No.	Latitude Longitude	STADAN	MSFN	DSN	Established	Phased Out	Equipment	Remarks
Guam (Pacific)	GWM	13°18'N 144°44'E		x		1966		air/ground, tele- type, video, high- speed data 9-m USB VHF telemetry links FM remoting telemetry decommutators telemetry recording data processing communications: voice, VHF air/ground, tele- type, video, high- speed data	
Guaymas (Mexico)	GYM	27°57'N 110°43'W		x x x		1961	1970	9-m USB VHF telemetry links FM remoting telemetry decommutators telemetry recording data processing communications: voice, VHF air/ground, tele- type, video, high- speed data	

Table 5-27.
Tracking and Data Acquisition Stations (Continued)

Station (location)	Code Name/ No.	Latitude Longitude	STADAN	MSFN	DSN	Established	Phased Out	Equipment	Remarks
Havana (Cuba)	x	23°20'N 82°13'W				1957	1959	Minitrack	Station was closed in anticipation of the Cuban revolution. Equipment transferred to Ft. Myers.
Hawaii. See Kauai.									
Honeysuckle Creek (southeastern Australia)	HSK	35°24'S 148°59'E		x		1967		26-m USB FM remoting telemetry decom- mutators telemetry recording data pro- cessing communica- tions: voice, video, teletype, high-speed data	Colocated with Tidbinbilla station, part of the DSN network. Used to support the lunar operations during Apollo. The 26-meter antenna was transferred to the DSN at the close of the Apollo Program.
Johannesburg (South Africa)	JOBURG	25°53'S 27°42'E	x			1958	1975	Minitrack 14-m dish antenna SATAN receivers and command Yagi command MOTS	Minitrack equipment was first installed at Esselen Park, 29 km northeast of Johannesburg. Equipment moved in 1960 to Hartebeesthoek, 64 km northwest of Johannesburg. A DSN station was at Hartebeesthoek. DoD operated a station known as Pretoria. The Smithsonian Astrophysical Observatory

Table 5-27.
Tracking and Data Acquisition Stations (Continued)

Station (location)	Code Name/ No.	Latitude Longitude	STADAN	MSFN	DSN	Established	Phased Out	Equipment	Remarks
	51				x	1961	1974	26-m antenna	also maintained a facility in the area at Olifantsfontein, 6 km from Esselen Park.
Kano (Nigeria)	KNO	11°58'N 8°28'E	x			1965	1966	mobile	Supported ISIS missions.
				x	x	1961	1967	acquisition aid PAM telemetry telemetry recording communications: voice, spacecraft	Not required for Apollo operations.
Kasima Machi (Japan)		35°57'N 140°40'E	x			1967	1970		Collateral station.
Kauai (Hawaii)	KAUAIH	22° 7'N 157°40'W	x			1965		2 Yagi command 4.3-m dish antenna	Supported ISIS missions.
	HAW			x	x	x	1961	C-band radar 9-m USB VHF telemetry links FM remoting telemetry decommutators telemetry recording data processing communications:	Also referred to as Kokee Park.

Table 5-27.
Tracking and Data Acquisition Stations (Continued)

Station (location)	Code Name/ No.	Latitude Longitude	STADAN	MSFN	DSN	Established	Phased Out	Equipment	Remarks
Kokee. See Kauai.									
Kwajalein (DoD) (Pacific)		9°15'N 166°12'E		x				voice, VHF air/ground, tele- type, video, high- speed data	Provided voice support for MA-9.
Lima (Peru)	LIMAPU	11°47'S 77° 9'W	x			1957	1969	Minitrack SATAN receivers and command Yagi command MOTS	
Madagascar. See Tananarive.									
Madrid (Spain)	MAD	40°27'N 4°10'W		x		1967		26-m USB FM remoting telemetry decom- mutators telemetry recording data proc- essing communica- tions: voice, video, teletype, high-speed data	Used to support lunar operations during Apollo. Located near the Robledo and Cebreros DSN stations.

Table 5-27.
Tracking and Data Acquisition Stations (Continued)

Station (location)	Code Name/ No.	Latitude Longitude	STADAN	MSFN	DSN	Established	Phased Out	Equipment	Remarks
Majunga (near Madagascar)		15°30'S 46°15'E	x			1963	1964	telemetry reception	Used to support satellites injected into orbit over the Indian Ocean. Equipment from Brazilia was used here, then moved to Tananarive.
Merritt Island (Florida)	MIL	28°25'N 80°40'W		x		1973		3.7-m USB C-band radar VHF telemetry links FM remoting telemetry decom- mutators telemetry recording data processing communications: voice, VHF air/ground, tele- type, video, high- speed data	Located near the Cape Kennedy launch area.
Mojave (California)		35°20'N 116°54'W	x			1960	1969	Minitrack 14-m dish antenna SATAN receivers and command	Located in the Goldstone complex of tracking facilities. The station was phased down in 1969.
Muchea (western Australia)	MUC	31°36'S 115°56'E		x		1961	1964	Verlort radar telemetry reception command/control air/ground voice communications: voice, telemetry	Equipment transferred to Carnarvon.

Table 5-27.
Tracking and Data Acquisition Stations (Continued)

Station (location)	Code Name/No.	Latitude Longitude	STADAN	MSFN	DSN	Established	Phased Out	Equipment	Remarks
Network Test and Training Facility (Maryland)	NTTF	38°59N 76°51'W	x	x	x	1966			At GSFC, this facility was used only to test new equipment bound for the networks and train new station personnel until 1974, when it was made part of the operational network.
Orroral Valley (southeastern Australia)	ORORAL	35°38'S 148°57'E	x			1965		Minitrack 26-m dish antenna 2 SATAN receivers and command 1 Yagi command MOTS C-band radar	Provided geodetic data for the south Pacific area.
Patrick (DoD) (Florida)	PAT	28°14'N 80°36'W			x				DoD supported Apollo launch operations from this station.
Point Arguello (California)	CAL	34°35'N 120°34'W		x	x	1961		C-band radar spacecraft and voice communications	Located at DoD's Western Test Range.
Pretoria (DoD) (South Africa)	PRE	25°57'S 28°21'E			x			C-band radar telemetry reception	Telemetry reception equipment was active during Gemini only. For Apollo, this DoD station provided tracking support only.

Table 5-27.
Tracking and Data Acquisition Stations (Continued)

Station (location)	Code Name/ No.	Latitude Longitude	STADAN	MSFN	DSN	Established	Phased Out	Equipment	Remarks
Quito (Ecuador)	QUITOE	37'S 78°35'W	x			1957		Minitrack 12-m dish antenna SATAN receivers and command 3 Yagi command MOTS	
Robledo (near Madrid, Spain)	61	40°26'N 4°15'W			x	1965		26-m antenna	Together Robledo and the nearby Cebreros station were often referred to as Madrid station. The co- located MSFN facility was known as Madrid station.
Rosman (North Carolina)	ROSMAN	35°12'N 82°52'W	x			1963	1981	2.26-m dish anten- nas GRARR 3 SATAN receivers and command MOTS ATS telemetry and command	Station was established to receive high-data-rate telemetry from observatory- class satellites.
San Diego (California)		270°46'N 98°14'W	x			1957	1960	Minitrack	Equipment moved to Mo- jave station when Brown Field, where the San Diego station was located, was closed in 1960.

Table 5-27.
Tracking and Data Acquisition Stations (Continued)

Station (location)	Code Name/ No.	Latitude Longitude	STADAN	MSFN	DSN	Established	Phased Out	Equipment	Remarks
San Nicolas (DoD) (California)									Provided voice coverage for M4-9. Part of DoD's Pacific Missile Range.
Santiago (Chile)	SNTAGO	33° 9'S 70° 40'W	x			1957		Minitrack 12-m dish antenna GRARR 2 SATAN receivers 1 SATAN command Yagi command MOTS	
Singapore (Southeast Asia)		01° 15'N 103° 47'E	x			1963	1970		Collateral station.
Solant (South Atlantic)			x			1963			Collateral station. Supported primarily British and Cana- dian satellite projects.
South Point (Hawaii)			x			1961	1966		Collateral station.
St. John's (Newfoundland)	NEWFLD	47° 44'N 52° 43'W	x			1960	1970	Minitrack 3 Yagi command MOTS	
Tananarive (Malagasy Rep.)		19° S 47° 18'E	x			1965	1975	Minitrack 14-m dish antenna GRARR	This STADAN station also supported Gemini and Apollo operations.

Table 5-27.
Tracking and Data Acquisition Stations (Continued)

Station (location)	Code Name/ No.	Latitude Longitude	STADAN	MSFC	DSN	Established	Phased Out	Equipment	Remarks
TEL-4 (DoD) (Florida)	TEL-4	28°29'N 80°34'W		x	x			VHF telemetry links FM remoting telemetry telemetry recording	This DoD telemetry station was located at Cape Ken- nedy.
Tidbinbilla (southeastern Australia)	42	35°24'S 148°59'E			x	1965		26-m antenna	Tidbinbilla is near Canberra.
Toowoomba (eastern Australia)	TOOMBA	27°24'S 151°56'E	x			1966	1969	14-m antenna SATAN receivers Yagi command transportable ATS equipment	Used primarily to support ATS. Also referred to as Cooby Creek.
Vandenberg AFB (DoD) (California)	CAL	34°40'N 120°35'W			x			C-band radar communications: voice, VHF air/ground, teletype	
Wake Island (DoD) (Pacific Ocean)	19° 7N 199°37E			x					Provided voice coverage for MA-9.
Wallops Island (Virginia)	WLP	37°51'N 75°31'W		x	x	1961	1967	radar acquisition aid telemetry recording display consoles digital command modulation communications: voice, spacecraft	Used as a Mercury demonstration site to test equipment and for Gemini radar and communications support.

Table 5-27.
Tracking and Data Acquisition Stations (Continued)

Station (location)	Code Name/ No.	Latitude Longitude	STADAN	MSFN	DSN	Established	Phased Out	Equipment	Remarks
White Sands (New Mexico)	WHS	32°21'N 106°22'W	x	x	x	1961 (NASA)		C-band radar communications: voice, teletype	This station provided prime support during Mercury and Gemini but only radar support during Apollo. Located on the Army's White Sands Missile Range, the station was equipped with DoD radar and NASA-owned acquisition aids.
Winkfield (England)	WNKFLD	51°27'N 42'W	x			1961		Minitrack 4.3-m antenna SATAN receivers SATAN command Yagi command MOTS	Only Minitrack-STADAN station in Europe. Operated by British personnel.
Woomera (southern Australia)	WOM	30°49'S 136°50'E	x	x	x	1957 1961	1966 1966	Minitrack radar acquisition aid telemetry reception voice	Minitrack equipment was moved to Ororral Valley in 1966. MSFN equipment was transferred to Carnarvon. This station was located near Australia's major launch facility.
	41	31°23'S 136°53'E			x	1960	1972	26-m antenna	

Table 5-27.
Tracking and Data Acquisition Stations (Continued)

Station (location)	Code Name/ No.	Latitude Longitude	STADAN	MSFN	DSN	Established	Phased Out	Equipment	Remarks
Zanzibar (Indian Ocean, off the African coast)	ZZB	6°13'S 39°18'E	x			1961	1964	acquisition aid telemetry reception air/ground voice	A rebellion on the island forced station personnel to evacuate in Jan. 1964. Subsequently some of the equipment was moved to Tananarive's STADAN sta- tion to support Gemini and Apollo.
Tracking ships:									
<i>American Mariner</i>									DoD ship used to support MA-8 in the Pacific Ocean.
<i>Coastal Sentry</i> <i>Quebec</i>	IOS CSQ		x						Used in the Indian Ocean. NASA-owned equipment was installed on this refitted freighter.
<i>Huntsville</i>	HTV		x						DoD gave MA-8 support with this ship in the Pacific Ocean; it was later modified for Apollo and used by NASA until 1969.
<i>Kingsport</i>									DoD ship used for voice support via the <i>Syncom 2</i> satellite during <i>GT-8</i> .

Table 5-27.
Tracking and Data Acquisition Stations (Continued)

Station (location)	Code Name/ No.	Latitude Longitude	STADAN	MSFN	DSN	Established	Phased Out	Equipment	Remarks
<i>Mercury</i>	MER			x					Instrumented by NASA, this refitted tanker was used in the Pacific Ocean for Apollo; retired in 1969.
<i>Range Tracker</i>	RTK		x	x					DoD ship used during <i>MA-9</i> and for Gemini.
<i>Redstone</i>	RED				x				Instrumented by NASA, this refitted tanker was used in the Indian Ocean for Apollo; retired in 1969.
<i>Rose Knot Victor</i>	ATS RKV		x		x				DoD ship used in the Atlantic and Pacific (<i>MA-8</i>) during Mercury and Gemini. NASA-owned equipment was installed on this tracker.
<i>Twin Falls Victory</i>							x		DoD ship used during <i>MA-9</i> .
<i>Vanguard</i>	VAN								Instrumented by NASA, this refitted tanker was used in the Atlantic Ocean for Apollo; retired in 1978.

Table 5-27.
Tracking and Data Acquisition Stations (Continued)

Station (location)	Code Name/ No.	Latitude Longitude	STADAN	MSFN	DSN	Established	Phased Out	Equipment	Remarks
Watertown	WTN		x	x					DoD gave MA-8 support with this ship in the Pacific Ocean; it was later modified for Apollo.
Tracking aircraft: Apollo Range Instrumentation Aircraft	ARIA						x		Eight instrumented aircraft were used by NASA as communications relays to support Apollo in areas where there were no stations, especially during reentry and landing operations.

NOTES

1. Propulsion Staff, NASA, "A National Space Vehicle Program; A Report to the President," Jan. 27, 1959; and Aeronautics and Astronautics Coordinating Board, "National Launch Vehicle Program Summary," Feb. 14, 1961.
2. NASA borrowed launchers from the Air Force, Army, and Navy during its first decade. In 1961, DoD assigned the Air Force the major responsibility for development, production, and launching of military space boosters (DoD Directive 5160.32, "Development of Space Systems," March 6, 1961). The Army Ballistic Missile Division, which also supplied the new space agency with boosters, lost its most important element when the von Braun team was transferred to NASA in 1960. The Navy through NRL supplied NASA with the Vanguard vehicle. For more information on military vehicles, see Ernest G. Schweibert, *A History of the U.S. Air Force Ballistic Missiles* (New York et al.: Frederick A. Praeger, 1965); and David Baker, *The Rocket: The History and Development of Rocket & Missile Technology* (New York: Crown Publishers, Inc., 1978).
3. Abraham Hyatt, "NASA Launch Vehicle Development Program," paper, Conference on Physics of the Solar System and Reentry Dynamics, Virginia Polytechnic Institute, Aug. 1, 1961; NASA, *Second Semiannual Report of the National Aeronautics and Space Administration*, 86th Cong., 2d sess. (henceforth 86/2), House Doc. 361 (Washington, 1960), pp. 19-22; and Senate, Committee on Aeronautical and Space Sciences, NASA Authorization Subcommittee, *NASA Authorization for Fiscal Year 1961; Hearings*, pt. 2, 86/2 (Washington, 1960), pp. 777-91.
4. Arnold Levine, *Managing NASA in the Apollo Era (1963-69)*. NASA SP-4102 (Washington, 1982), chap. 7; and Jane Van Nimmen and Leonard C. Bruno with Robert L. Rosholt, *NASA Historical Data Book, 1958-1968*, vol. 1, *NASA Resources*, NASA SP-4012 (Washington, 1976), pp. 113-14.
5. House of Representatives Subcommittee on Space Science and Applications of the Committee on Science and Technology, *United States Civilian Space Programs, 1958-1978*, 97/1 (Washington, 1981), pp. 143-60.
6. Subcommittee on Space Science and Applications, *U.S. Civilian Space Programs*, pp. 199-205; Loyd S. Swenson, Jr., James M. Grimwood, and Charles C. Alexander, *This New Ocean; A History of Project Mercury*, NASA SP-4201 (Washington, 1966), pp. 167-90; General Dynamics, "Centaur Technical Handbook," report GD/A-BPM64-001, Feb. 15, 1964; Lockheed Missiles & Space Co., "Standard Agena Space Vehicle Technical Description," report LMSC-A397890, Dec. 1, 1964; and Barton C. Hacker and James M. Grimwood, *On the Shoulders of Titans: A History of Project Gemini*, NASA SP-4203 (Washington, 1977), pp. 297-321.
7. Subcommittee on Space Science and Applications, *U.S. Civilian Space Programs*, pp. 185-87.
8. Swenson, Grimwood, and Alexander, *This New Ocean*, pp. 208-13; and Courtney G. Brooks, Grimwood, and Swenson, *Chariots for Apollo: A History of Manned Lunar Spacecraft*, NASA SP-4205 (Washington, 1979), pp. 91-93, 141-42.
9. Swenson, Grimwood, and Alexander, *This New Ocean*, pp. 167-90; MSFC, Saturn/Apollo Systems Off., "The Mercury-Redstone Project," TMX 53107, Dec. 1964; and Subcommittee on Space Science and Applications, *U.S. Civilian Space Programs*, p. 186.
10. NASA-DoD, "Large Launch Vehicle Planning Group Summary Report," vol. 1, LLVPG 105, Sept.

- 24, 1962; Subcommittee on Space Science and Applications, *U.S. Civilian Space Programs*, pp. 216-17.
11. Roger E. Bilstein, *Stages to Saturn: A Technological History of the Apollo/Saturn Launch Vehicles*, NASA SP-4206 (Washington, 1980); and Frederick O. Ordway III and Mitchell R. Sharpe, *The Rocket Team* (New York: Thomas Y. Crowell, 1979).
 12. Vought Corp., "100 Scout Launches," July 27, 1979; and Subcommittee on Space Science and Applications, *U.S. Civilian Space Programs*, pp. 195-99.
 13. Subcommittee on Space Science and Application, *U.S. Civilian Space Programs*, pp. 187-95; and GSFC, "Delta, 1960-1980; America's Busiest and Most Versatile Launch Vehicle" [n.d.].
 14. Subcommittee on Space Science and Applications, *U.S. Civilian Space Programs*, pp. 205-10.
 15. Constance McLaughlin Green and Milton Lomask, *Vanguard: A History*, NASA SP-4202 (Washington, 1970). Most sources agree that Vanguard was built on the technology of Viking and Aerobee sounding rockets. Milton W. Rosen, who was NASA Headquarters's first chief of rocket vehicle development (1958-59), believes this is a myth "generated by the NRL people who were trying to sell the Vanguard project to the Stewart committee, in order to mitigate the impression that much of the project was new development." See Rosen to Monte D. Wright, May 7, 1981.

Chapter 2

NOTES

1. Thomas A. Sturm, *The USAF Scientific Advisory Board: Its First Twenty Years, 1944-1964* (Washington, 1967), pp. 80-88. Also see Loyd S. Swenson, Jr., James M. Grimwood, and Charles C. Alexander, *This New Ocean; A History of Project Mercury*, NASA SP-4201 (Washington, 1966), pp. 23-26, 69-74, 77-82, 91-93.
2. Wernher von Braun and Frederick I. Ordway III, *History of Rocketry & Space Travel*, rev. ed. (New York: Thomas Y. Crowell Co., 1969), pp. 159-67; Erik Bergaust, *Werhner von Braun* (Washington: NSI, 1976), pp. 2, 4-19, 239-47, 269-78; and von Braun, "The Redstone, Jupiter, and Juno," *Technology and Culture* 4 (fall 1963): 452-65. Also see Alice C. Cole et al., eds., *The Department of Defense; Documents on Establishment and Organization, 1944-1978* (Washington, 1979), pp. 171-75, 311.
3. Swenson, Grimwood, and Alexander, *This New Ocean*, pp. 20, 29, 41-42, 50, 100-01. For the story of this country's early satellite programs, also see Constance McLaughlin Green and Milton Lomask, *Vanguard: A History*, NASA SP-4202 (Washington, 1970).
4. Joseph A. Shortal, *A New Dimension; Wallops Island Flight Test Range: The First Fifteen Years*, NASA Ref. Pub. 1028 (Washington, 1978), pp. 35-46, 93-97, 237-41, 590-99; and Robert R. Gilruth, "From Wallops Island to Project Mercury, 1945-1958: A Memoir," in R. Cargill Hall, ed., *Essays on the History of Rocketry and Astronautics; Proceedings of the Third through the Sixth History Symposia of the International Academy of Astronautics*, vol. 2, NASA Conf. Pub. 2014 (Washington, 1977), pp. 445-76.
5. Alfred J. Eggers, Jr., H. Julian Allen, and Stanford E. Neice, "A Comparative Analysis of the Performance of Long-Range Hypervelocity Vehicles," NACA Tech. Rep. 1382, also appearing in a modified version as Allen, "Hypersonic Flight and the Reentry Problem," *Journal of the Aeronautical Sciences* 25 (Apr. 1958): 217-30.
6. Swenson, Grimwood, and Alexander, *This New Ocean*, pp. 75-106.
7. *Public Papers of the Presidents of the United States; John F. Kennedy, Containing the Public Messages, Speeches, and Statements of the President, Jan. 20 to Dec. 31, 1961* (Washington, 1962), pp. 396-406. For a discussion of the Soviet and American manned programs, see Edward C. Ezell and Linda N. Ezell, *The Partnership; A History of the Apollo-Soyuz Test Project*, NASA SP-4209 (Washington, 1978), pp. 61-96.
8. John M. Logsdon, *The Decision to Go to the Moon; Project Apollo and the National Interest* (Cambridge: MIT Press, 1970); Logsdon, "The Apollo Decision in Historical Perspective," in Richard P. Hallion, ed., *Apollo: Ten Years since Tranquility Base* (Washington: Smithsonian Institution Press, 1979), pp. 3-9; and Walter Sullivan, *America's Race for the Moon* (New York: Random House,

- 1962). Also helpful is U.S. House of Representatives, *Toward the Endless Frontier; History of the Committee on Science and Technology, 1959-79* (Washington, 1980), pp. 63-93.
9. For an outline of NASA's early management schemes, see Robert L. Rosholt, *An Administrative History of NASA, 1958-1963*, NASA SP-4101 (Washington, 1966). Also useful is Arnold Levine, *Managing NASA in the Apollo Era (1963-69)*, NASA SP-4102 (Washington, 1982).
 10. Swenson, Grimwood, and Alexander, *This New Ocean*, pp. 114-16; and Gilruth, "From Wallops Island," pp. 469-71.
 11. NASA, *This Is NASA*, NASA EP-155 (Washington, 1979), p. 20; and Thomas O. Paine to Clinton P. Anderson, Nov. 21, 1969. Also see Swenson, Grimwood, and Alexander, *This New Ocean*, pp. 508, 643; Barton C. Hacker and Grimwood, *On the Shoulders of Titans; A History of Project Gemini*, NASA SP-4203 (Washington, 1977), pp. 173-75, 387-88, 581-82; and Courtney G. Brooks, Grimwood, and Swenson, *Chariots for Apollo; A History of Manned Lunar Spacecraft*, NASA SP-4205 (Washington, 1979), pp. 25, 110-11, 167-68.
 12. The following document will give the reader a thorough look at the early planning for Mercury: U.S. Senate, *Project Mercury: Man-in-Space Program of the National Aeronautics and Space Administration; Report of the Committee on Aeronautical and Space Sciences, U.S. Senate, 86th Cong., 1st sess. (hereafter 86/1)* (Washington, 1959).
 13. Shortal, *A New Dimension*, pp. 633-63, describes the various support, including the Little Joe I launches, that Wallops gave to Mercury. Other testing included balloon drops of Mercury capsule models, flight stability investigations, high-altitude parachute drops, and aerodynamic heating measurements.
 14. Systems design for Mercury, Gemini, and Apollo is compared in John H. Boynton and Kenneth S. Kleinknecht, "Systems Design Experience from Three Manned Space Programs," paper 69-1077, AIAA 6th Annual Meeting, Anaheim, CA, Oct. 20-24, 1969.
 15. The Mercury training equipment included the following: attitude control analog trainers (NASA), centrifuges (Navy), an air-lubricated free-altitude attitude control trainer (NASA), a slowly revolving room (Navy), the Multi-Axis Inertia Facility trainer (NASA) an egress trainer (McDonnell), an environmental control system trainer (McDonnell), a ground recognition trainer (NASA), a yaw recognition trainer (NASA), a vertical image celestial display (Farrand Optical Co.), and two Mercury procedures trainers (manufactured by McDonnell; one was in use at Langley, the other at the Cape). See Robert B. Voas, Harold I. Johnson, and Raymond Zedekar, "Astronaut Training," in NASA, *Mercury Project Summary including Results of the Fourth Manned Orbital Flight, May 15 and 16, 1963*, NASA SP-45 (Washington, 1963), pp. 171-98; and Swenson, Grimwood, and Alexander, *This New Ocean*, pp. 240-48, 413-19. For biographical information on the astronauts, see U.S. House of Representatives, *Astronauts and Cosmonauts; Biographical and Statistical Data, Report Prepared for the Committee on Science and Technology, 97/1* (Washington, 1981).
 16. Charles A. Berry, "Aeromedical Preparations," in NASA, *Mercury Project Summary*, pp. 199-209; and Mae Mills Link, *Space Medicine in Project Mercury*, NASA SP-4003 (Washington, 1965), pp. 44-63, 85-111, 135-68.
 17. Leighton I. Davis, "Operational Support from the Department of Defense," in NASA, *Mercury Project Summary*, pp. 155-70. For further background material on NASA-DoD relations, see W. Fred Boone, "NASA Office of Defense Affairs, the First Five Years," NASA HHR-32, Dec. 1970, pp. 6-9, NASA Hq. History Off. files.
 18. Section III of NASA, *Mercury Project Summary*, deals with flight operations. See also part 3 of Swenson, Grimwood, and Alexander, *This New Ocean*.
 19. The importance of rendezvous as it related to lunar missions is discussed in Brooks, Grimwood, and Swenson, *Chariots for Apollo*, pp. 61-86; and Hacker and Grimwood, *On the Shoulders of Titans*, pp. 35-38.
 20. Hacker and Grimwood, *On the Shoulders of Titans*, pp. 125-27, 139-44, 181-89; Alfred J. Gardner, "Launch and Target Vehicle Support by the Department of Defense," in MSC, *Gemini Summary Conference*, NASA SP-138 (Washington, 1967), pp. 167-84; MSC, *Gemini Midprogram Conference, including Experiment Results*, NASA SP-121, pt. B (Washington, 1966), pp. 103-52; and Martin Marietta Corp. "Gemini-Titan II Air Force Launch Vehicle Press Handbook," Feb. 2, 1967.
 21. Hacker and Grimwood, *On the Shoulders of Titans*, pp. 157-62, 297-303. In response to continued problems with the GATV main engine, Lockheed and Bell Aerosystems, supplier of the engine, undertook an extensive series of test firings in 1965-1966 called Project Sure-fire. The 76 firings led

- to modifications to the model 8247 engine. See also Gardner, "Launch and Target Vehicle Support," in *Gemini Midprogram Conference*, pp. 167-84.
22. For details on EVA equipment and operations, see Reginald M. Machell, ed., *Summary of Gemini Extravehicular Activity*, NASA SP-149 (Washington, 1967); and MSC, *Gemini Summary Conference*, pp. 67-148.
 23. See Donald K. Slayton, Warren J. North, and C. H. Woodling, "Flight Crew Procedures and Training," in MSC, *Gemini Midprogram Conference*, pp. 201-12.
 24. For details about the Gemini experiments program, see the following papers in *Gemini Summary Conference*: Norman G. Foster and Olav Smistad, "Gemini Experiments Program Summary," pp. 221-30; Richard W. Underwood, "Space Photography," pp. 231-90; Jocelyn R. Gill and Willis B. Foster, "Science Experiments Summary," pp. 291-306; and "DoD/NASA Gemini Experiments Summary," pp. 307-20.
 25. Hacker and Grimwood, *On the Shoulders of Titans*, pp. 76-77, 117-22.
 26. Brooks, Grimwood, and Swenson, *Chariots for Apollo*, pp. 4-16. Meeting from May to Dec. 1959, the Research Steering Committee for Manned Space Flight headed by Harry Goett influenced the authors of the 10-year plan. Also active at this time was the New Projects Panel of the Space Task Group, chaired by H. Kurt Strass. For information on special committees, see Ivan D. Ertel and Mary Louise Morse, *The Apollo Spacecraft; A Chronology, Volume I through November 7, 1962*, NASA SP-4009 (Washington, 1969), pp. 207-22.
 27. The mission mode decision is discussed in depth in Brooks, Grimwood, and Swenson, *Chariots for Apollo*, pp. 61-86.
 28. Convair/Astronautics' study depicted a three-module lunar-orbiting spacecraft based on the lifting body concept; GE's study utilized a semi-ballistic blunt-body reentry vehicle design; Martin Company's five-part design was similar to the Apollo spacecraft that finally emerged. See Brooks, Grimwood, and Swenson, *Chariots for Apollo*, pp. 27-29.
 29. Brooks, Grimwood, and Swenson, *Chariots for Apollo*, pp. 212-14.
 30. The fire is covered in Brooks, Grimwood, and Swenson, *Chariots for Apollo*, pp. 213-27; and Ertel and Roland W. Newkirk with Brooks, *The Apollo Spacecraft; A Chronology, Volume IV, January 21, 1966-July 13-1974*, NASA SP-4009 (Washington, 1978), pp. 63-126. Original review board members were Floyd L. Thompson (LaRC), chairman, Frank Borman (MSC), Maxime A. Faget (MSC), E. Barton Geer (LaRC), George Jeffs (NAA), Frank A. Long (PSAC), Charles F. Strong (USAF), George C. White (NASA Hq.), and John Williams (KSC). The 21 task panels were instructed to address the following subjects: spacecraft and ground support equipment configuration, test environments, sequence of events, disassembly activities, origin and propagation of fire, historical data, test procedures review, materials review, design reviews, analysis of fracture areas, medical analysis, witness statements, ground emergency provisions, security of operations, board administrative procedures, special tests, final board report, integration analysis, safety of investigation operations, in-flight fire emergency provisions, and service module disposition. Basic documents relating to the investigation of the accident include "Report of Apollo 204 Review Board to the Administrator, National Aeronautics and Space Administration," Apr. 5, 1967, with appx. A-G; U.S. Senate, Committee on Aeronautical and Space Sciences, *Apollo Accident: Hearings*, 8 pts., 90/1, 90/2 (Washington, 1967-1968); U.S. House of Representatives, Committee on Science and Astronautics, Subcommittee on NASA Oversight, *Investigation into Apollo 204 Accident: Hearings*, 3 vols., 90/1, 90/2 (Washington, 1967); and U.S. Senate, Committee on Aeronautical and Space Sciences, *Apollo 204 Accident: Report*, 90/2 (Washington, 1968).
 31. For more information on Gemini and Apollo crew assignments, see Brooks, Grimwood, and Swenson, *Chariots for Apollo*, pp. 373-80. Astronauts who joined in 1962 were Neil A. Armstrong, Frank Borman, Charles Conrad, Jr., James A. Lovell, Jr., James A. McDivitt, Elliot M. See, Jr., Thomas P. Stafford, Edward H. White II, and John W. Young; in 1963, Edwin E. Aldrin, Jr., William A. Anders, Charles A. Bassett II, Alan L. Bean, Eugene A. Cernan, Roger B. Chaffee, Michael Collins, R. Walter Cunningham, Donn F. Eisele, Richard F. Gordon, Jr., Russell L. Schweickart, David R. Scott, and Clifton C. Willims, Jr.; in 1965, Owen K. Garriott, Edward G. Gibson, Joseph P. Kerwin, and Harrison H. Schmitt; in 1966, Vance D. Brand, John S. Bull, Gerald P. Carr, Charles M. Duke, Jr., Joe H. Engle, Ronald E. Evans, Fred W. Haise, Jr., James B. Irwin, Don L. Lind, Jack R. Lousma, Thomas K. Mattingly II, Bruce McCandless II, Edgar D. Mitchell, William R. Pogue, Stuart A. Roosa, John L. Swigert, Paul J. Weitz, and Alfred M. Worden; and in 1967, Joseph P.

- Allen IV, Philip K. Chapman, Anthony W. England, Karl G. Henize, William B. Lenoir, F. Story Musgrave, and Robert A. R. Parker. For biographical data, consult House of Representatives, Committee on Science and Technology, *Astronauts and Cosmonauts Biographical and Statistical Data*, 97/1 (Washington, 1981). Selection and training is discussed in Brooks, Grimwood, and Swenson, *Chariots for Apollo*, pp. 178-80, 260-65, 320-26; a popular account of astronaut training and mission operations is provided in Michael Collins, *Carrying the Fire: An Astronaut's Journeys* (New York: Farrar, Strauss, and Giroux, 1974).
32. JSC, "Apollo Program Summary Report," JSC-09423, Apr. 1975, p. 3-1; section 3 of this report presents a science summary.
 33. For a detailed account of activities at KSC during the Apollo years, see Charles D. Benson and William B. Faherty, *Moonport: A History of Apollo Launch Facilities and Operations*, NASA SP-4204 (Washington, 1978); Launch Complex 39 is described on pp. 535-37. Roger E. Bilstein, *Stages to Saturn: A Technological History of the Apollo/Saturn Launch Vehicles*, NASA SP-4206 (Washington, 1980), tells the Marshall Space Flight Center story. The early contributions of the Langley Research Center can be found in LaRC, *Conference on Langley Research related to Apollo Mission*, NASA SP-101 (Washington, 1965).
 34. Brooks, Grimwood, and Swenson, *Chariots for Apollo*, p. 169.

Chapter 3

NOTES

1. Homer E. Newell, *Beyond the Atmosphere: Early Years of Space Science*, NASA SP-4211 (Washington, 1980), pp. 11-13.
2. Office of the General Counsel, NASA Hq., "National Aeronautics and Space Act of 1958, as Amended, and Related Legislation," July 1, 1969, p. 1.
3. Newell, *Beyond the Atmosphere*, p. 96.
4. For more on this subject, see Newell, *Beyond the Atmosphere*, chap. 2. Newell discusses the working relationship of the space scientists and the manned spaceflight specialist in *Beyond the Atmosphere*, pp. 290-95.
5. For more on the organization of space science and applications, see Arnold Levine, *Managing NASA in the Apollo Era (1963-69)*, NASA SP-4102 (Washington, 1982), pp. 167-72; and Newell, *Beyond the Atmosphere*, pp. 101-15.
6. Newell, *Beyond the Atmosphere*, pp. 394-95, 408-10.
7. Jesse L. Mitchell, "Physics & Astronomy Programs Program Review Document," Oct. 26, 1965.
8. [NASA Hq.], "Areas of Research in the NASA Space Sciences Program," Feb. 10, 1959, p. 44; and Off. of the Assistant Director for Space Sciences, NASA Hq., "The NASA Space Sciences Program," April 16, 1959, pp. 25-29.
9. [Langley Memorial Aeronautical Laboratory, NACA], "Preliminary Langley Staff Study, NASA Space Flight Program," May 15, 1958; and Off. of Space Sciences, NASA Hq., "Office of Space Sciences Ten Year Program," Aug. 17, 1959.
10. [Langley, NACA], "Preliminary Langley Staff Study."
11. Ernst Stuhlinger, "Lunar and Planetary Surface Exploration," in Robert M. L. Baker, Jr., and Maud W. Makemson, eds., *XIIth International Astronautical Congress, Washington, D.C., 1961* (New York and London: Academic Press, Inc., 1963), pp. 801-05; and Senate Committee on Aeronautical and Space Sciences, *NASA Authorization for Fiscal Year 1963, Hearings*, 87th Cong., 2d sess. (henceforth 87/2) (Washington, 1962), pp. 256-744, 749.
12. Off. of Programs, Management Reports, NASA Hq., "Program Review, Office of Applications, Meteorology," June 2, 1962.

13. House of Representatives, Committee on Appropriations, Subcommittee on Independent Offices, *National Aeronautics and Space Administration Appropriations, Hearings*, 86/1 (Washington, 1959), pp. 37-40, 148-53.
14. NASA, *Space Communications and Navigation, 1958-1964*, NASA SP-93 (Washington, 1966) pp. v, 1.
15. [Langley, NACA], "Preliminary Langley Staff Study," pp. 22-25.
16. See Phillip N. Larsen, "The Management of Commercial Satellite Communications," *Perspectives in Defense Management* (Nov. 1967): 29-43.
17. William J. O'Sullivan, interview by Edward Morse, Aug. 28, 1964, in O'Sullivan biog. file, NASA History Off.
18. George R. Thompson, "NASA's Role in the Development of Communications Satellite Technology," NASA HHM-8, Jan. 31, 1966; and Edgar W. Morse, "Preliminary History of the Origins of Project Syncom," NASA HNN-40, Sept. 1, 1964.
19. Eugene T. Jilg, "Engineering Designs for a Commercial Communications Satellite," paper, AIAA Unmanned Spacecraft Meeting, Los Angeles, March 1, 1965.
20. B. I. Edelson, H. W. Wood, and C. J. Reber, "Cost Effectiveness in Global Satellite Communications," paper, International Astronautical Federation 26th Congress, Lisbon, Sept. 21-27, 1975.
21. Ronald L. Weitzel, "The Origins of ATS," NASA HHN-83, Aug. 1968; and Gilbert D. Bullock, comp. and ed., "ATS Program Summary," rev. April 1968.

Chapter 4

NOTES

1. Alex Roland, *Research by Committee: A History of the National Advisory Committee for Aeronautics, 1915-1958*, NASA SP-4103 (Washington, 1985), pp. 80-87.
2. Irwin Hersey, "Research and Technology: Aeronautics and Space (1963-1968)," in "Preliminary History of the National Aeronautics and Space Administration of President Lyndon B. Johnson, November 1963-January 1969," unpublished NASA administrative histories project, Jan. 15, 1969, p. V-4; also available as Hersey, "Advancing the Technology of Flight; Research and Development in NASA, 1963-1968," NASA Historical Note 38, Oct. 1968.
3. *Ibid.*, pp. V-4 through V-5.
4. Arnold Levine, *Managing NASA in the Apollo Era (1963-69)*, NASA SP-4102 (Washington, 1982), pp. 163-67.
5. Helen T. Wells, Susan H. Whiteley, and Carrie Karegeannes, *Origins of NASA Names*, NASA SP-4402 (Washington, 1976), pp. 138-41, 150-53.
6. See NASA budget estimates, research and development volumes, for FY 1965-1968.
7. *Ibid.*; "Statement of Dr. Hermann H. Kurzweg, Director of Research, Office of Advanced Research & Technology, National Aeronautics and Space Administration, before the Subcommittee on Advanced Research & Tracking [sic], Committee on Science & Astronautics, House of Representatives," March 3, 1964; and "Statement of Dr. Hermann H. Kurzweg, Director of Research, Office of Advanced Research and Technology, National Aeronautics and Space Administration, before the Subcommittee on Advanced Research and Technology, Committee on Science & Astronautics, House of Representatives," March 16, 1967.
8. See NASA budget estimates, research and development volumes, FY 1965-1968; and "Statement of Milton B. Ames, Jr., Director of Space Vehicles, Office of Advanced Research and Technology, National Aeronautics and Space Administration, before the Subcommittee on Advanced Research and Technology, Committee on Science and Astronautics, House of Representatives," Feb. 22, 1968.

9. Francis Ragallo, "Flexible Wings," *Aeronautics & Aeronautics* 6 (Aug. 1968): 50-54; *Aerospace Technology* 21 (June 3, 1968), is a special report on parachute technology; and Richard P. Hallion, *On the Frontier: Flight Research at Dryden, 1946-1981*, NASA SP-4303 (Washington, 1984), pp. 137-40.
10. See Clarence J. Geiger, "History of the X-20A Dyna-Soar," Historical Div., Information Off. Aeronautical Systems Div., Air Force Systems Com., 3 vols., AFSC Hist. Pubs. Series 63-50-I, 63-50-II, 63-50-III, Oct. 1963, available on microfilm, Air University Library, Maxwell AFB; vol. I at JSC History Off.
11. The site selection process is outlined in Thomas P. Murphy, "NASA's Electronics Research Center," unpublished paper, ERC file, NASA History Off.
12. For more on NASA's changing life sciences program, see John Pitts, *The Human Factor: Biomedicine in the Manned Space Program to 1980*, NASA SP-4213 (Washington, 1985).
13. "Transcript of the Briefing for Industry on NASA Space Power and Electric Propulsion Programs," April 27, 1967; and a four-part series on electric propulsion in *Aviation Week & Space Technology* 80 (Jan. 27, Feb. 3, Feb. 10, Feb. 17), gives a good summary of the many projects under way in this field sponsored by industry, DoD, and NASA.
14. For a look at the nuclear rocket program, see James A. Dewar, "Project Rover: A Study of the Nuclear Rocket Development Program, 1953-1963," unpublished Ph.D. dissertation, Kansas State Univ., 1974; and Keith Boyer, "Nuclear Rockets," paper, AIAA 4th Annual Meeting and Technology Display, Anaheim, CA, Oct. 23-27, 1967. For information on reactor and engine testing, see Robert W. Schroeder, "NERVA—Entering a New Phase," *Aeronautics & Aeronautics* 6 (May 1968): 42-53. A useful general introduction to nuclear propulsion is William Corliss, *Nuclear Propulsion for Space*, part of a series "Understanding the Atom" (Oakridge, TN: AEC, 1967).
15. For general introductory materials, see Corliss and Robert L. Mead, *Power from Radioisotopes*, part of a series "Understanding the Atom" (Oakridge, TN: AEC, 1971); and Corliss, *SNAP: Nuclear Space Reactors*, part of a series "Understanding the Atom" (Oakridge, TN: AEC, 1966).
16. House of Rep., Com. on Science and Astronautics, *Research and Development in Aeronautics: Interim Report*, 87th Cong., 1st sess. (henceforth 87/1) (Washington, 1961); Mac C. Adams to Directors, Ames, Lewis, Langley, and Flight Research Centers, "Aeronautics Program," Oct. 14, 1965, and Charles W. Harper, "Prospects in Aeronautics Research and Development," paper, AIAA Aircraft Design for 1980 Operations Meeting, Washington, Feb. 12-14, 1968.
17. For a brief overview of aeronautics, see David A. Anderton, *Sixty Years of Aeronautical Research, 1917-1977* (Washington, 1978). A good introductory work on the mechanics of flight is NASA, *Exploring in Aeronautics, an Introduction to Aeronautical Sciences Developed at the NASA Lewis Research Center, Cleveland, Ohio* (Washington, 1971).
18. For a look at the variety of research that falls into the operating problems category, refer to NASA, *Conference on Aircraft Operating Problems, Langley Research Center, May 10-12, 1965*, NASA SP-83 (Washington, 1965).
19. *Aeronautics & Aeronautics* 6 (Sept. 1968) was devoted to V/STOL technology. Also see NASA, *Conference on V/STOL and STOL Aircraft, Ames Research Center, Moffett Field, California, April 4-5, 1966*, NASA SP-116 (Washington, 1966).
20. Wendell H. Stillwell, *X-15 Research Results*, NASA SP-60 (Washington, 1965), contains an excellent bibliography. Another source is Myron B. Gubitz, *Rocketship X-15: A Bold New Step in Aviation* (New York; Julian Messner, Inc., 1960). Ronald H. Smith, "Antecedents and Analogues—Experimental Aircraft," in Jay D. Pinson, ed., *Diamond Jubilee of Powered Flight: The Evolution of Aircraft Design* (Dayton, OH: Dayton-Cincinnati Section, AIAA, 1978), pp. 80-86, gives a short history of the early X-series, the X-15, and lifting bodies. Hallion, *Supersonic Flight: The Story of the Bell X-1 and Douglas D-558* (New York: MacMillan Co., 1972), thoroughly discusses the early research aircraft program.
21. For a very readable account of NASA's research aircraft story, see Hallion, *On the Frontier*, chaps. 4-6, 8.
22. For information on the F-111, the XB-70, and other aircraft, consult John W. R. Taylor, ed., *Jane's All the World's Aircraft, 1968-69* (New York: McGraw-Hill Book Co., 1968), pp. 278-80, 341-42.

Chapter 5

NOTES

1. For further information on tracking and data acquisition techniques, see Samuel Glasstone, *Sourcebook on the Space Sciences* (New York et al: D. Van Nostrand Co., Inc., 1965), pp. 217-39.
2. John T. Mengel and Paul Herget, "Tracking Satellites by Radio," *Scientific American* 198 (Jan. 1958): 23-29, deal specifically with the Minitrack system. See also Constance McLaughlin Green and Milton Lomask, *Vanguard: A History*, NASA SP-4202 (Washington, 1970), pp. 145-63. Green and Lomask relate how the Smithsonian Astrophysical Observatory optical tracking system was also used for Vanguard, pp. 149-54.
3. William R. Corliss, "Histories of the Space Tracking and Data Acquisition Network (STADAN), the Manned Space Flight Network (MSFN), and the NASA Communications Network (NASCOM)," NASA CR-140390, June 1974, pp. 24-57, discusses the evolution of STADAN equipment. For information on communications and data handling operations and equipment, see Corliss, *Scientific Satellites*, NASA SP-133 (Washington, 1967), pp. 133-63. For technical information regarding equipment and facilities, see the following Goddard Space Flight Center reports: "Satellite Instrumentation Facilities Report," GSFC report X-530-62-3, April 1962; "Satellite Tracking and Data Acquisition Network Facilities Report (STADAN)," GSFC report X-539-64-159, June 1964; and "Space Tracking and Data Acquisition Network Facilities Report (STADAN)," GSFC report X-530-66-33, Dec. 1965.
4. For more on Goddard's Space Operations Control Center and other data acquisition and tracking facilities, see Alfred Rosenthal, *Venture into Space; Early Years of Goddard Space Flight Center*, NASA SP-4301 (Washington, 1968), pp. 65-78.
5. For information on Mercury tracking, communications, and data acquisition equipment, see Howard C. Kyle, "Manned Spaceflight Communications Systems," in A. V. Dalakrishnan, ed., *Advances in Communication Systems*, vol. 2 (New York: Academic Press, 1966), pp. 195-204.
6. Loyd S. Swenson, Jr., James M. Grimwood, and Charles C. Alexander, *This New Ocean: A History of Project Mercury*, NASA SP-4201 (Washington, 1966), pp. 392-97.
7. For more on the Gemini network, see Corliss, "Histories of the Space Tracking and Data Acquisition Network (STADAN), the Manned Space Flight Network (MSFN), and the NASA Communications Network (NASCOM)," pp. 140-61; and Barton C. Hacker and Grimwood, *On the Shoulders of Titans: A History of Project Gemini*, NASA SP-4203 (Washington, 1977), pp. 584-92. Kyle, "Manned Spaceflight Communications Systems," pp. 205-10, describes the equipment and techniques used for Gemini tracking and data acquisition.
8. For information on the Deep Space Network, see Nichola A. Renzetti, ed., "A History of the Deep Space Network, from Inception to January 1, 1969," JPL tech. report 32-1533, vol. 1, Sept. 1, 1971, which has a 7-page bibliography; JPL, "DSIF: Goldstone," JPL tech. memo 33-205, 1965; and Corliss, "A History of the Deep Space Network," NASA CR-151915, May 1, 1976. R. Cargill Hall, *Lunar Impact: A History of Project Ranger*, NASA SP-4210 (Washington, 1977), pp. 81-91, relates how the DSN supported Ranger.

NOTES ON SOURCES

The authors of the NASA Historical Data Book series have necessarily relied on hundreds of sources to compile the many tables and charts presented. In Volume II, no attempt was made to list the sources used for each table because the notes would have overwhelmed the content in many cases. The number of source notes supporting the narrative has also been kept to a minimum. This note on sources will serve as a guide for the researcher interested in pursuing the material from which this volume was compiled.

The author relied heavily on the subject and biographical files of the NASA Headquarters History Office, Washington, D.C., for primary documents from which to glean the facts and figures. For most topics, the following kinds of documents can be found in these files: NASA press releases, speeches, congressional testimony, contractor reports, related articles from periodicals and newspapers, correspondence, and photographs. Mission operations reports and midterm and prelaunch reviews are an important part of the many "mission" files. When the author was confronted with conflicting data—not uncommon when working with material that dates from NASA's first years—mission operations reports (or their equivalents) and contractor reports were considered the most authoritative sources. Also very useful was the document collection of the Johnson Space Center History Office, Houston, Texas.*

In addition to primary sources and project chronologies and histories published by NASA, the author frequently used a number of general reference works. Most helpful was the series *Astronautics and Aeronautics, Chronology on Science, Technology, and Policy*. Compiled by staff members of the NASA Headquarters History Office, a volume is available for each year, starting with 1963.† A handy guide to NASA projects and installations is Helen Wells, Susan H. Whitely, and

*Many of the records formerly held at JSC that pertain to the Mercury and Gemini projects have been loaned to the Fondern Library, Rice University, Houston, Texas, where they will be catalogued and made available to scholars.

†The following chronologies were also useful: Eugene M. Emme, *Aeronautics and Astronautics; An American Chronology of Science and Technology in the Exploration of Space, 1915-1960* (Washington, 1961); NASA, *Aeronautical and Astronautical Events of 1961; Report to the Committee on Science and Astronautics, U.S. House of Representatives, 87th Cong., 2d sess. (henceforth 87/2)* (Washington, 1962); and NASA, *Astronautical and Aeronautical Events of 1962; Report to the Committee on Science and Astronautics, U.S. House of Representatives, 88/1* (Washington, 1963).

Carrie E. Karegeannes, *Origins of NASA Names*, NASA SP-4402 (Washington, 1976). For a quick look at NASA and its predecessor organization, the National Advisory Committee for Aeronautics, the author relied on Frank W. Anderson, Jr., *Orders of Magnitude; A History of NACA and NASA, 1915-1980*, NASA SP-4403 (Washington, 1981). Also useful was a reference work that covers the first 20 years of U.S. involvement in aerospace activities: House of Representatives, Committee on Science and Technology, Subcommittee on Space Science and Applications, *United States Civilian Space Programs, 1958-1978; Report* (Washington, 1981). A standard reference on NASA's early organization is Robert L. Rosholt, *An Administrative History of NASA, 1958-1963*, NASA SP-4101 (Washington, 1966). A report that proved especially helpful was Kennedy Space Center, "A Summary of Major NASA Launchings," KSC Historical Report 1, revised in 1970. NASA's semiannual reports to Congress, the last of which was submitted in 1969, were useful guides. "Pocket Statistics," compiled monthly by NASA (from 1960), provided selected technical, financial, and manpower data. Another research tool that was brought out again and again was the History Office's collection of NASA Headquarters and center telephone directories.

The budget tables for all five chapters of Volume II were compiled from two sources: NASA Chronological History Fiscal Year Budget Submissions, prepared annually by the Budget Operations Division of the Office of Administration, NASA Headquarters; and the Budget Estimates (research and development volumes only) prepared for Congress by NASA each fiscal year. As noted in the introduction to the budget section of Chapter 1, this volume is only concerned with research and development monies. This approach reflects advice given the author by the NASA Headquarters Office of the Comptroller.

The author used the following publications as source material for five chapters of Volume II. For additional sources, see the source notes. Refer also to the descriptive sections of each chapter.

Chapter 1:

- Baker, David. *The Rocket: The History and Development of Rocket & Missile Technology*. New York: Crown Publishers, 1978.
- Bilstein, Roger E. *Stages to Saturn: A Technological History of the Apollo/Saturn Launch Vehicles*. NASA SP-4206, Washington, 1980.
- Brooks, Courtney G., Grimwood, James M., and Swenson, Loyd S. *Chariots for Apollo: A History of Manned Lunar Spacecraft*. NASA SP-4205, Washington, 1979.
- Green, Constance McLaughlin and Lomask, Milton. *Vanguard: A History*. NASA SP-4202, Washington, 1970.
- Hacker, Barton C. and Grimwood. *On the Shoulders of Titans: A History of Project Gemini*. NASA SP-4203, Washington, 1977.
- Levine, Arnold. *Managing NASA in the Apollo Era (1963-69)*, NASA SP-4102, Washington, 1982.
- Marshall Space Flight Center. *Saturn Illustrated Chronology; Saturn's First Eleven Years, April 1957 through April 1968*. MHR-5, Huntsville, 1971.
- Swenson, Grimwood, and Alexander, Charles C. *This New Ocean: A History of Project Mercury*. NASA SP-4201, Washington, 1966.

Chapter 2:

- Bilstein, Roger E. *Stages to Saturn: A Technological History of the Apollo/Saturn Launch Vehicles*. NASA SP-4206, Washington, 1980.
- Brooks, Courtney G., Grimwood, James M., and Swenson, Loyd S. *Chariots for Apollo: A History of Manned Lunar Spacecraft*. NASA SP-4205, Washington, 1979.
- Brooks and Ertel, Ivan D. *The Apollo Spacecraft: A Chronology, Volume III, October 1, 1964–January 20, 1966*. NASA SP-4009, Washington, 1976.
- Ertel and Morse, Mary Louise. *The Apollo Spacecraft: A Chronology, Volume I, through November 7, 1962*. NASA SP-4009, Washington, 1969.
- Ertel, Newkirk, Roland W., with Brooks. *The Apollo Spacecraft: A Chronology, Volume IV, January 21, 1966–July 13, 1974*. NASA SP-4009, Washington, 1978.
- Grimwood. *Project Mercury: A Chronology*. NASA SP-4001, Washington, 1963.
- Grimwood, Hacker, Barton C., with Vorzimmer, Peter J. *Project Gemini Technology and Operations: A Chronology*. NASA SP-4002, Washington, 1969.
- Hacker and Grimwood. *On the Shoulders of Titans: A History of Project Gemini*, NASA SP-4203, Washington, 1977.
- Logsdon, John M. *The Decision to Go to the Moon; Project Apollo and the National Interest*. Cambridge: MIT Press, 1970.
- Manned Spacecraft Center, *Gemini Summary Conference*. NASA SP-138, Washington, 1967.
- Morse and Bays, Jean Kernahan. *The Apollo Spacecraft: A Chronology, Volume II, November 8, 1962–September 30, 1964*. NASA SP-4009, Washington, 1973.
- NASA. *Mercury Project Summary including Results of the Fourth Manned Orbital Flight, May 15 and 16, 1963*. NASA SP-45, Washington, 1963.
- Swenson, Grimwood, and Alexander, Charles C. *This New Ocean: A History of Project Mercury*. NASA SP-4201, Washington, 1966.

Chapter 3:

- Corliss, William R. *NASA Sounding Rockets, 1958–1968: A Historical Summary*. NASA SP-4401, Washington, 1971.
- _____. *Scientific Satellites*. NASA SP-133, Washington, 1967.
- Ezell, Edward C. and Ezell, Linda N. *On Mars: Exploration of the Red Planet, 1958–1978*. NASA SP-4212, Washington, 1983.
- Green, Constance McLaughlin and Lomask, Milton. *Vanguard: A History*. NASA SP-4202, Washington, 1970.
- Hall, R. Cargill. *Lunar Impact: A History of Project Ranger*. NASA SP-4210, Washington, 1977.
- Hartman, Edwin P. *Adventures in Research: A History of Ames Research Center, 1940–1965*. NASA SP-4302, Washington, 1970.
- Newell, Homer E. *Beyond the Atmosphere: Early Years of Space Science*. NASA SP-4211, Washington, 1980.
- Pitts, John. *The Human Factor: Biomedicine in the Manned Space Program to 1980*, NASA SP-4213 (Washington, 1985).
- Richter, Henry L. *Space Measurements Survey; Instruments and Spacecraft, October 1957–March 1965*. NASA SP-3028, Washington, 1966.

- Rosenthal, Alfred. *Venture into Space: Early Years of Goddard Space Flight Center*. NASA SP-4301, Washington, 1968.
- Rosenthal and Corliss. *Encyclopedia of Satellites and Sounding Rockets, August 1959 to December 1969*. Beltsville, MD: Goddard Space Flight Center, 1970.
- Shortal, Joseph A. *A New Dimension; Wallops Island Flight Test Range: The First Fifteen Years*. NASA Ref. Pub. 1028, Washington, 1978.

Chapter 4:

- Anderton, David A. *Sixty Years of Aeronautical Research, 1917-1977*. Washington, 1978.
- Hallion, Richard P. *On the Frontier: Flight Research at Dryden, 1946-1981*. NASA SP-4303 (Washington, 1984).
- Roland, Alex, *Model Research: The National Advisory Committee for Aeronautics, 1915-1958*. NASA SP-4103, Washington, 1985.

Chapter 5:

- Corliss, William R. "Histories of the Space Tracking and Data Acquisition Network (STADAN), the Manned Space Flight Network (MSFN), and the NASA Communications Network (NASCOM)." NASA CR-140390, June 1974.
- Thomas, Shirley. *Satellite Tracking Facilities: Their History and Operation*. New York: Holt, Rinehart and Winston, 1963.

Since 1973, NASA has used the metric system in its publications. Although many metric weights and measurements are now commonly used in the United States, some may still sound foreign to the reader. Probably the most frequently questioned measurement is newtons of thrust (pounds thrust $\times 4.448 =$ newtons). A useful publication for the reader not familiar with the metric system is E. A. Mechtly, *The International System of Units, Physical Constants and Conversion Factors*, NASA SP-7012, 2d rev. (Washington, 1973). Also note that weights of launch vehicles and spacecraft are "wet weights"; that is, vehicle and fuel. Dates and times of mission events are local; ground elapsed time is the amount of time (hours:minutes:seconds) that has elapsed since launch.

The following individuals assisted the author by commenting on the manuscript or assisting with the research. By so doing, they became valuable "sources."

- | | |
|------------------------|--------------------|
| Frank W. Anderson, Jr. | Eleanor H. Ritchie |
| Edward C. Ezell | Alex Roland |
| James M. Grimwood | Milton W. Rosen |
| Carl R. Huss | Lee D. Saegesser |
| Carrie E. Karegeannes | Arthur L. Sigust |
| Albert Matelis | Monte D. Wright |
| Homer E. Newell | |



APPENDIX A

ORGANIZATION CHARTS

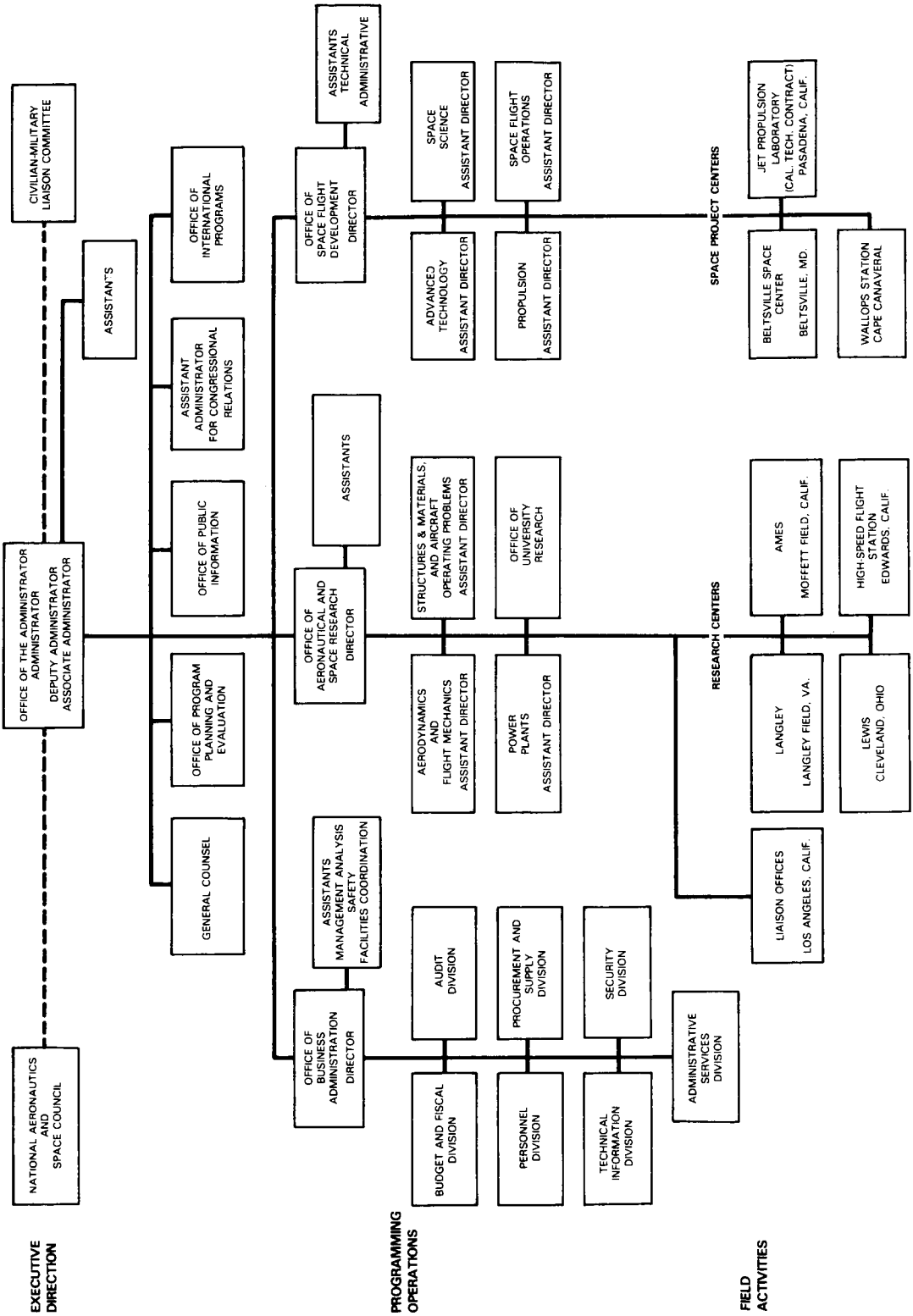

EXECUTIVE DIRECTION

PROGRAMMING OPERATIONS

FIELD ACTIVITIES

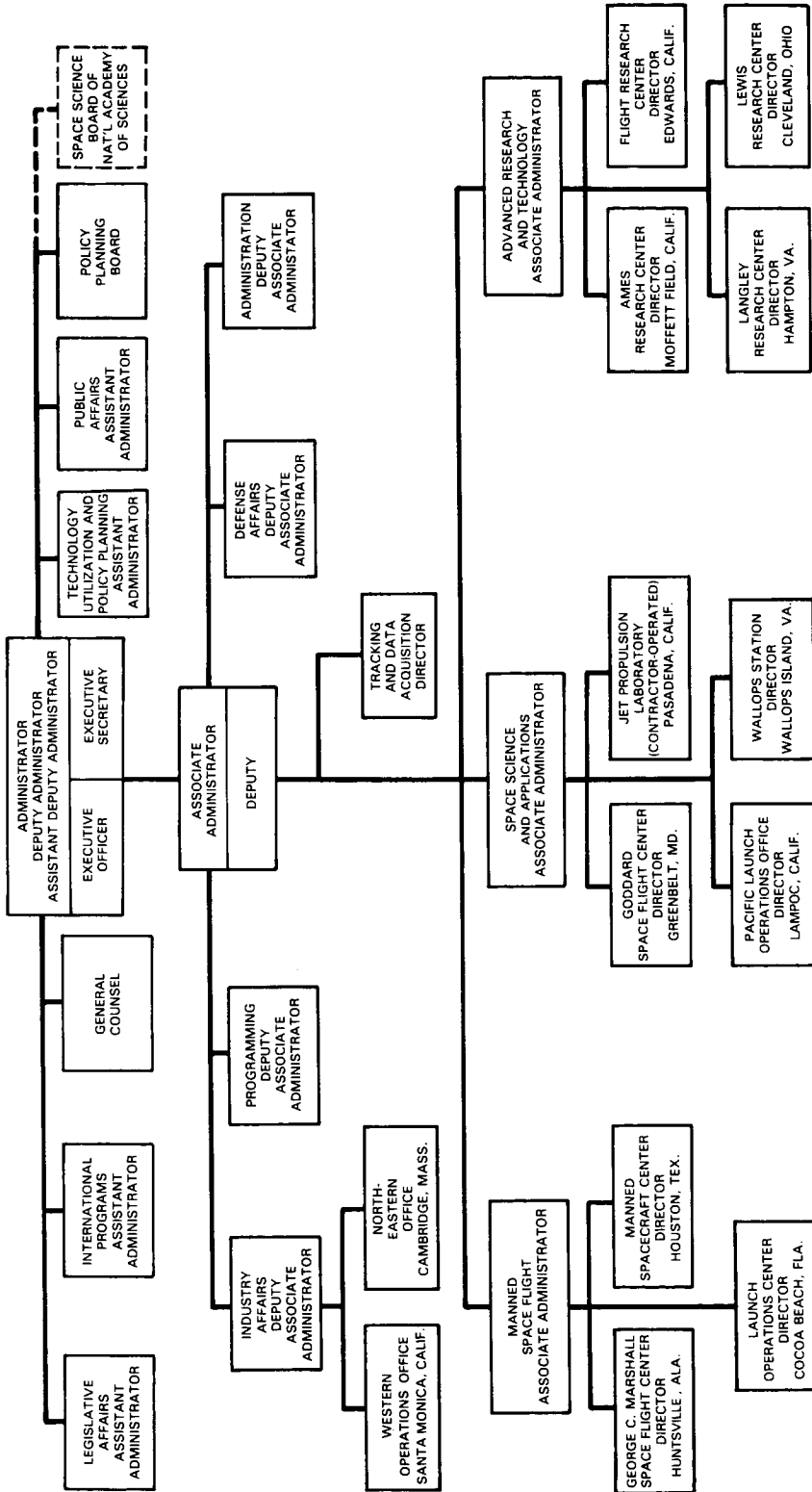

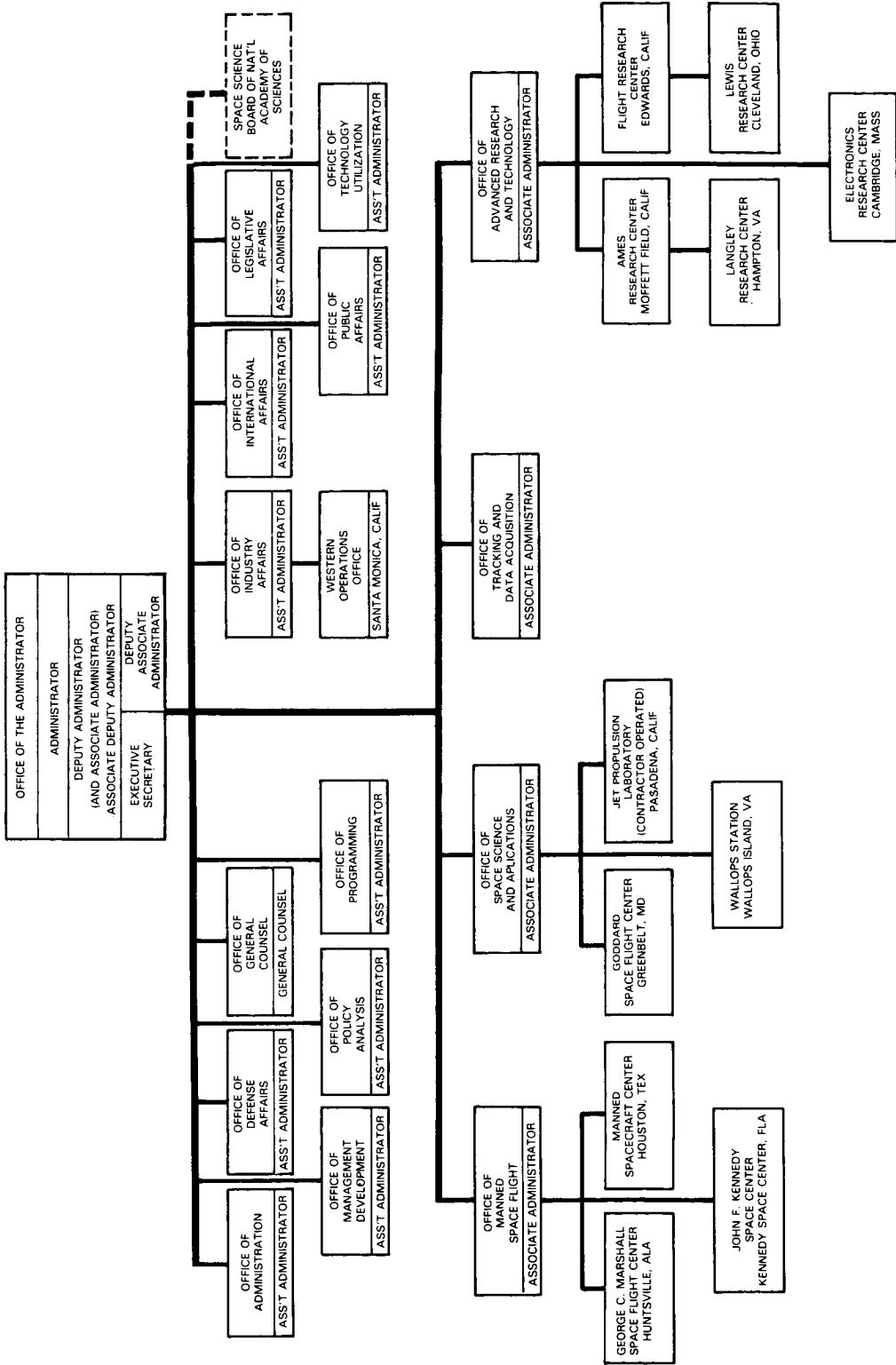

INDEX

Page references to illustrations or photographs are in italics.

A

- Abernethy, L. K., 110
Abbott, Ira H., 5, 406
Abbott Committee. *See* National Advisory Committee for Aeronautics
Able, 24, 29, 67, 68, 72; *Able 2*, 305; *Able 3*, 237, 305; *Able 6*, 307. *See also* Atlas-Able, Thor-Able
Adams, Mac C., 6, 404, 407
Adams, Michael, Jr., 503, 508, 513, 514
Advanced Applications Satellite. *See* Applications Technology Satellite
advanced research and technology, 403-517; aerospace medicine, 466; basic research programs, 431-35; budget, 404, 408-31; electronics and control programs, 459-66; human factor systems, 340-46, 466-69; management, 405-07; space power and propulsion program, 1, 25, 26, 175, 176, 178, 470-94; space vehicle systems, 435-59; supporting research and technology (SRT), 404, 437
Advanced Research and Technology, Office of (OART) (formerly, Office of Aeronautics and Space Research and Office of Advanced Research Programs), 4-6, 153 n, 299, 340, 403-08, 431-34, 436-39, 442, 445, 449, 453, 459-62, 464-70, 473, 474, 479, 482, 488-94, 497; Ames Life Sciences Laboratory, 468; Division of Biotechnology and Human Research, 468; Organization, 498
Advanced Research Projects Agency (ARPA), 44, 54, 56, 93, 95, 98, 99, 301, 303, 348, 351, 544, 560, 566, 572; Ground Based Information System for Support of Manned Flight Committee (GBIS), 544, 560
Advanced Technological Satellite. *See* Applications Technology Satellite
Advent, 370, 371, 376, 378, 379, 382; Advent Management Agency, 382; Project Advent, 380
Aerobee. *See* sounding rocket program
Aero Geo Astro Corporation, 372
Aerojet-General Corporation, 34, 35, 50, 53, 54, 62, 63, 66, 72, 73, 80, 84, 86, 87, 192, 272, 275, 277-79, 480-85, 489-93; Aerojet General-Nike, 277; Space Propulsion Division, 192
Aerolab Corporation, 280, 281
Aeromedical Field Laboratory, 96, 98, 137 n, 467 n; Space Biology Branch, 96
Aeronautics and Astronautics Coordinating Board (AACB), 2, 377, 455, 488, 524, 561; Launch Vehicle Panel, 2; Manned Space Flight Panel, 455; Space Flight Ground Environment Panel, 524, 561; Unmanned Spacecraft Panel, 377
Aerospace Corporation, 382, 395
Africa, 136, 546, 547, 552, 554
Agena, 5, 6, 9-11, 24, 29-46, 67, 98, 151-54, 156, 158, 166-68, 193, 313, 320, 476; Agena B, 29, 67, 68, 74, 155, 311, 448; Agena D, 29, 67, 68, 156, 158
Aggson, T. L., 395
Ahmedabad, India, 540, 542, 575
Aiken, William S., Jr., 497, 498
aircraft: B-52, 452, 455, 457, 502, 506, 514, 515; C-47, 452, 455; D-558-1, 502; D-558-2, 502; X-series, 502, 522, 524; XS-1 research aircraft, 92, 501
Airborne Instruments Laboratory, 244
AiResearch Manufacturing Company, 192
Air Force, U.S. Department of the, 1, 29, 33, 35, 36, 39, 40, 54, 61, 66, 67, 84, 91-94, 96-99, 134, 150, 152, 154-56, 165, 197, 275-77, 279, 340 n, 343, 347, 364, 372, 382, 405, 451, 452, 456, 476, 479, 486, 488, 501-03, 505-07, 509, 511, 513, 515, 517, 524, 541, 544, 547, 555 n, 560, 564, 572, 573, 581; Aerospace Test Pilots School, 469; AF 609A, 27; Air Materiel Command Aircraft Division, 506; Air Research and Defense Command, 94; Air Research and Development Command (ARDC), 44, 97-99, 454, 483; Aviation (later Aerospace) Medical Laboratory, 467 n; Ballistic Missile Division (AFBMD), 35, 39, 99, 139, 302, 303, 305, 307; Blue Scout, 66, 465 n, 549; Cambridge Research Laboratory, 237, 254, 258, 278, 282; Clark AFB, 381; Edwards AFB, 94, 405, 451, 452, 469, 496, 502, 506, 507, 515, 521; Eglin AFB, 547, 548, 550, 552, 561, 580; Flight Test Center, 451, 453; Headquarters, 99; Hickam AFB, 343; Holloman AFB, 91 n, 96, 98, 467; Human Factors, Division of, 97; IRBM, 68, 72, 74-76; "Man-in-Space-Soonest" scheme, 99; Manned

- Orbiting Laboratory (MOL), 177 n;
 Missile Test Center (AFMTC), 559,
 560; Nuclear Missile Propulsion, Ad
 Hoc Committee on, 482; Patrick AFB,
 548, 554, 589; Randolph AFB, 96;
 School of Aviation Medicine, 467 n;
 Scientific Advisory Board, 97, 482,
 483, 505; Space Medicine, Department
 of, 96; Space Systems Division, 155,
 489, 490; Systems Command, 101,
 102; Trailblazer, 463 n, 464; USAF
 MX-770, 482; Vandenberg AFB, 548,
 554, 592; Wright Air Development
 Center, 137 n, 483, 484, 505; Wright-
 Patterson AFB, 96, 467 n
- Air Force-NASA Joint Conference on
 Lifting Manned Hypervelocity and
 Reentry Vehicles, 454
- Alabama, 171, 172
- Alaska, 538, 540, 542, 543, 575, 581;
 Alaska Station, 579
- Albuquerque, New Mexico, 137 n, 480,
 485
- Alcor, 279, 465 n
- Aldrin, Edwin A., Jr., 153, 158, 161,
 165, 166, 168, 169
- Algol I and IIB, 62, 63, 66
- Algranti, Joseph S., 115, 120
- Alleghany Ballistics Laboratory, 34, 41,
 62, 72, 80, 86, 87
- Allen, Harry B., 107
- Allen, H. Julian, 94, 96, 97
- Allenby, R. J., 109, 302
- Almy, Donald C., 107
- Alouette, 38, 296; *Alouette 1*, 69, 74,
 288-90; *Alouette 2*, 74, 249, 288, 290
- Alphonsus (crater), 318
- Altair, 62, 63, 72, 77
- American Mariner* (tracking ship), 549,
 551
- American Rocket Society, 97, 454
- American Science and Engineering, Inc.,
 254
- American Standard: Advanced
 Technology Division, 264
- American Telephone & Telegraph Com-
 pany (AT&T), 364, 373-75, 552 n
- Ames, Milton B., 406, 407, 435, 436,
 439, 453
- Ames Research Center (ARC) (formerly,
 Ames Aeronautical Laboratory and
 Moffett Field Laboratory), 94, 96-98,
 100 n, 103 n, 135, 155-57, 180, 240,
 241, 243, 250, 251, 254, 256-58, 260,
 302-04, 307-09, 341, 342, 344-46, 407
 n, 431, 433-35, 437, 439, 450-52,
 454-57, 469, 495-97, 499-501, 515,
 565; Movingbase Landing-Approach
 Simulator, 499; Solar Probe Team,
 304
- Ampex, 264
- Anders, William A., 167, 168, 177, 185,
 189
- Anderson, Clinton P., 479
- Anderson, George M., 111
- Anderson, Melvin S., 102 n
- Andover, Maine, 376
- Andrus, A. Marion, 366
- Antarctica, 400
- Antares, 10, 13, 24, 29, 41, 448-50; An-
 tares II, 62, 63; X-254-A1, 465 n
- Antigua, B. W. I., 523, 536, 539 n, 540,
 542, 548, 552, 554, 557, 558, 562, 563,
 575
- Antofagasta, Chile, 536, 539, 540, 542,
 543, 575
- Apache, 272, 273, 281
- Apollo, 4, 6, 12, 13, 16-18, 22-24, 48, 50,
 53, 56-59, 101-03, 112, 116, 121-23,
 128 n, 151, 152, 156, 171-94, 197, 203,
 248, 272, 301, 302, 308-10, 319,
 321-23, 325-27, 329, 338, 339, 390,
 438, 441, 444, 445, 448-50, 461, 473,
 474, 481, 490, 524, 548, 549, 552-57,
 559, 562, 563, 565, 566, 568, 569 n,
 573-75, 583, 585, 587, 589, 591, 593,
 595, 596; Apollo 204 Review Board,
 176, 184; *Apollo 4*, 61, 101, 174, 176,
 184, 563; *Apollo 5*, 59, 176, 184, 554;
Apollo 6, 61, 176, 185; *Apollo 7*, 55,
 59, 176, 177, 179 n, 185, 188, 556,
 557, 563; *Apollo 8*, 2, 61, 101, 177,
 178, 179 n, 185, 189, 554-57,
 563; *Apollo 9*, 555 n; *Apollo 12*, 494;
 Apollo Experiments, Ad Hoc Working
 Group on, 177; Apollo Instrumented
 Tracking Ship, 555; Apollo Lunar
 Surface Experiments Package
 (ALSEP), 494, 495; Apollo Mission Plan-
 ning Panel, 183; Apollo Network Im-
 plementation Plan, 562, 563; Apollo
 Project Office, 179; Apollo Range In-
 strumentation Aircraft (ARIA), 549,
 556; Apollo-Saturn, 182, 563; Apollo-
 Soyuz Test Project, 121; Apollo
 Spacecraft Project Office (ASPO),
 172, 179, 182, 185; Apollo Task
 Group, 553; Apollo Technical Liaison
 Group for Instrumentation and Track-
 ing, 551, 552, 561, 562; astronauts,
 176-78, 183-85, 188, 189, 494;
 characteristics and chronology, 171-94,
 203; funding, 122, 123, 128-32; Project
 Apollo, 17, 18, 22-24, 100, 384, 522,
 551, 565; Skylab, 55, 461
- Applications Technology Satellite (ATS),

- 13, 29, 37, 38, 40, 43, 44, 206, 221 n, 224-26, 368, 384, 408, 461, 474, 539, 543, 590, 592
- Appropriations Conference Committee, 128
- APT (automatic picture transmission) system, 349, 356-59, 363
- Arabian; Donald D., 116, 119
- Archives, U.S. National: National Weather Records Center, 350
- Arctic Ocean, 557, 558
- Arequipa, Peru, 523, 541
- Argentina, 272
- Ariel, 437; *Ariel 1, 2, and 3*, 64, 65, 68, 288, 291-93
- Arizona, University of, 316-18
- Armstrong, George G., Jr., 120
- Armstrong, Harry G., 96, 110
- Armstrong, Neil A., 153, 158, 161, 164, 165, 167, 189, 510, 511
- Army, U.S. Department of the, 1, 46, 47, 52, 54, 91-93, 96, 140, 180, 235, 276, 286, 303, 306, 501, 524, 542, 564, 571-73, 575, 593; Army Ordnance Missile Command (AOMC), 52, 56, 99, 180; Corps of Engineers, 574; Guided Missile Center, 52; Map Service, 536, 542; Ordnance Department, 275; Plum Brook Nuclear Rocket Dynamics Test Facility, 477, 486; Signal Corps, 275, 559; Signal R&D Laboratory, 287
- Army Air Corps, U.S., 534, 535, 541; MX-774 project, 541
- Army Ballistic Missile Agency (ABMA), 1, 46-48, 54, 56, 87, 91-93, 96, 134, 138, 139, 171, 180, 232, 235, 238, 286, 302, 306, 347, 348, 351, 571; Development Operations Division, 1, 180. *See also* Marshall Space Flight Center
- Ascension Island, 347, 449, 523, 548, 551, 552, 554, 557, 558, 562, 563, 565, 570, 571, 574, 576
- Ashley, William T., 104, 106
- Ashworth, C. Dixon, 254, 260, 264
- Asia, 380, 382
- Asmara, Ethiopia, 381
- Astronautics Avco Corporation, 182
- Astronomy Missions Board, 198
- Atlantic 2*. *See* International Telecommunications Satellite Consortium
- Atlantic (coast and ocean), 91, 136, 138, 157, 158, 381, 385, 390, 391, 393, 398, 444, 449, 544, 546, 547, 550-52, 554, 555 n, 557-59, 561, 576, 582, 595
- Atlantic Missile Range (AMR), 102, 138, 140, 531, 544, 546, 571; Operations Office, 560. *See also* Eastern Test Range
- Atlantic Research Corporation, 72, 192, 278-80
- Atlas, 1-3, 9-12, 14-16, 24, 27-45, 51, 74, 83, 84, 92, 94, 96, 98-100, 121, 134, 136-39, 145-48, 153, 155, 171, 446, 449, 453, 489, 541; Atlas-Able, 3, 10, 11, 27, 214 n, 217 n, 301, 303, 304; Atlas-Agena, 9-11, 19-21, 27, 29, 121, 156, 158, 206, 223 n, 334; Atlas-Agena B, 13, 20, 156, 209, 223 n, 270, 309, 311, 313-18, 332, 335, 336, 443, 448, 450; Atlas-Agena D, 13, 20, 22, 158, 262, 270, 321-25, 332, 337-39, 397, 398; Atlas-Antares, 10, 174, 186, 438, 448, 451; Atlas-Centaur, 2, 3, 10, 27-29, 262, 263, 326-31, 334, 387, 398, 474, 491; Atlas D, 29, 450; Atlas-Hustler, 3, 36; Atlas SLV-3, 29; Atlas-Vega, 29; Atlas-X259, 27; "FLOX Atlas" project, 30
- Atomic Energy Commission (AEC), 64, 405, 438, 470, 473-81, 483, 485, 486, 488, 494, 495; Albuquerque Operations Office, 478, 484; Argonne National Laboratory, 478; Chicago Operations Office, 478; Division of Reactor Development, 478, 482; Oak Ridge National Laboratory, 438, 482. *See also* Space Nuclear Propulsion Office
- Atoms for Peace program, 485
- Atwood, J. L., 184
- Aucremann, Marcel T., 233, 249, 264, 303
- Augerson, William S., 137 n
- Augmented Target Docking Adapter (AT-DA), 165
- Aurora 7*, 146
- Aurorae*. *See* European Space Research Organization
- Australia, 244, 272, 283, 343, 546, 547, 552, 554, 561, 565, 568, 572, 573, 582, 585, 589, 595
- Authorization Conference Committee, 204
- Avco Corporation, 192, 340; Space Systems Division, 192
- AVCS (advanced vidicon camera system), 349, 358, 359, 361-63, 395
- Aviation Medical Acceleration Laboratory, 467
- Azusa, 535, 541

B

- Baby Wac (Corporal), 275, 571
 Bahamas, 544, 559
 Baker, John V., 505
 Baker-Nunn cameras, 524, 541
 Ball Brothers Research Corporation, 254-59
 Baltic Sea, 557
 Baltimore, Maryland, 154
 Barbados, 554, 559
 Barents Sea, 557
 Barking Sands, Hawaii, 284
 Bassett, Charles A., 11, 157, 162, 165
 Bauer, Siegfried J., 293, 297, 298
 Baumann, Robert C., 271, 291, 293
 Bavely, James C., 525, 526
 Bayer, William J., 102 n
 Bayley, William H., 566
 Bay St. Louis, 179 n
 Beacon, 66, 69, 288, 299, 368; *Beacon 1*, 47; *Beacon 2*, 48; Beacon Explorer, 245, 247; *Beacon Explorer A*, 81, 463
 Bean, Alan L., 162, 166, 167
 Beaufort Sea, 557
 Beckman, Edward L., 118, 120
 Beckwith, Walter C., 109
 Beggs, James M., 6, 404, 407
 Behring, W. E., 258, 259
 Belgium, 288 n
 Bell, Persa R., 118, 120
 Bell Aerospace Corporation, 36, 37, 39, 74-76, 192, 393, 396
 Bell Aerosystems Company, 192
 Bell Aircraft, 501, 502, 505, 506
 Bellcomm, Inc., 192
 Bell Telephone Laboratories (BTL), 242, 247, 251, 369, 372-75, 378, 379, 382, 384, 388, 395, 546, 561. *See also* WECO
 Beltsville, Maryland, 197
 Beltsville Space Center, 271, 286, 536, 560. *See also* Goddard Space Flight Center
 Bendix Corporation, 192, 361, 546, 552 n, 561; Eclipse Pioneer Division, 264. *See also* WECO
 Berg, Winfred, 542
 Bergen, University of (Norway), 294
 Berglund, René A., 119
 Bering Sea, 557
 Berliner, Joseph, 377, 378
 Bermuda, 145, 444, 445, 523, 545-47, 550, 552, 554, 557, 561, 563, 576
 Berry, Charles A., 113, 114, 116, 118, 120
 Berry, Secrest L., 105, 106
 Bethpage, New York, 260
 B. F. Goodrich Company, 138, 140, 156, 193, 439
 Big Joe mission, 28, 33; Big Joe 1, 140, 142
 Bilke, Paul F., 451
 Bingman, Charles J., 108
 Bioletti, Carlton, 344
 Biosatellite, 21, 70, 82, 206, 227, 340, 342-46; *BIOS 1*, 340; *Biosatellite 1*, 2, and 3, 343, 345, 346; Biosatellite C and D, 345; Project Biosatellite, 344, 378
 Bioscience Advisory Committee, 341
 Birmingham, University of (U.K.), 291, 293
 Bisplinghoff, Raymond L., 5, 6, 404-06
 Bland, William M., Jr., 102 n, 112, 114-17
 Block I-V, 176, 183-85, 309-16, 326
 Blossom Point, Maryland, 536, 538-40, 542, 543, 577
 Boehm, Joseph, 238
 Boeing Company, 53, 55, 60, 61, 192, 319, 321-25, 452, 515, 517
 Bogart, Frank A., 107, 108
 Bolce, William J., 108
 Bolender, Carroll H., 110, 116, 119
 Bolger, Philip H., 111
 Bollerud, Jack, 108
 Bond, Aleck C., 102 n, 112-15, 117, 119
 Booz-Allen Company, 261
 Borman, Frank, 153, 157, 160, 162, 177, 184, 185, 189
 Bothmer, Clyde, 104, 105, 108
 Boulder, Colorado, 254
 Bourdeau, R. E., 238, 245, 247, 291, 299
 Brace, L. H., 250
 Brand, Vance D., 189
 Brandon, G., 285
 Brazil, 272, 373, 559
 Brazilia, 536, 540, 542, 543, 577, 588
 Bredt, Irene, 505
 Briggs, Thomas W., 115, 117
 Briskman, Robert D., 525
 Bristol Aerospace, 279
 Brock, 114, 117, 119
 Brockett, H. R., 524-26
 Brown, B. Porter, 110
 Brown, Clinton, 505
 Brown, Harvey H., 497, 498
 Brown, J. Robert, 105, 106
 Brown Field, California, 590
 Brownstein, Herbert S., 108
 Brussels, University of, 297
 Bryant, Frederick B., 524-26
 Buckley, Edmond C., 200, 522, 524-26, 544, 545, 547, 553, 560, 561
 Budd Company, 243

- Budget, U.S. Bureau of the (BoB), 6, 7, 203, 362, 392, 475, 485, 490
- Buglia, James J., 98, 100 n
- Bunze, H. F., 483
- Burcham, Donald P., 340
- Burke, J. D., 310-16
- Burke, John R., 107
- Burke, Joseph R., 366, 370, 373, 376, 380, 393
- Burlage, Henry, 471
- Burns and Roe, 546, 561. *See also* WECO
- Bussard, R. W., 482
- Butler, H. I. 352
- Butler, Paul, 240, 243, 245, 248, 251
- C**
- Cain, Dwight C., 109
- Cain Springs, 483
- Cajun, 272, 276, 282
- California, 145-47, 154, 156, 341, 369, 451, 475, 522, 526, 544, 546, 553, 571-73, 589, 592
- California, University of, 243, 259; at Berkeley, 395; at La Jolla, 379; at Los Angeles (UCLA), 250, 251, 337, 395; at San Diego (UCSD), 242, 243, 247, 254, 256, 257, 314, 316-18, 395
- California Institute of Technology (Cal Tech), 313, 314, 329, 330, 335, 337, 564, 572; Guggenheim Aeronautical Laboratory (GALCIT), 564 n. *See also* Jet Propulsion Laboratory
- Calio, Anthony J., 119
- Cambridge, Massachusetts, 405, 460
- Cambridge, University of (U.K.), 292
- Camp Roberts, California, 381
- Canada, 233, 236, 249, 272, 277, 288, 550, 591; Defence Research Telecon Establishment, 289, 290; Defense Research Board, 289, 290; Transportation, Department of, 354
- Canary Islands, 550, 557, 558, 577
- Canberra, Australia, 523, 554, 556, 557, 562, 563, 565, 573, 577, 592
- Cannetti, Anthony, 108
- Canoga Electronics Corporations, 552 n
- Canright, Richard B., 6, 104
- Canton Island, 523, 546, 548, 550, 552, 561, 577
- Cape Canaveral/Kennedy, Florida, 1, 33, 44, 52, 57, 138, 143, 153, 154, 157, 159-62, 164-68, 179, 523, 536, 541, 542, 545, 546, 548, 550, 552, 554, 557, 561, 562, 565, 570, 571, 573, 574, 577, 588, 592. *See also* Kennedy Space Center
- Caporale, A. J., 299, 300
- Capsule Coordination Committee, 139, 141 n
- Carnarvon, Australia, 523, 538 n, 540, 543, 548, 552, 554, 557, 563, 577, 588, 593
- Carnegie Institute, 567 n
- Carpenter, M. Scott, 116, 137 n, 138, 141, 145-48, 551
- Carr, Gerald P., 189
- Case Institute of Technology, 433
- Castor I and II, 62, 63, 75
- Catterson, A. D., 120
- Causse, Jean-Pierre, 296
- Ceberos, 554, 562, 565, 571, 574, 579, 587, 590
- Centaur, 1-3, 5, 9, 24, 29-31, 33, 41-45, 171 n, 223 n, 262, 326, 327, 331, 379, 399, 470, 473, 491, 552
- Central Radio Propagation Laboratory, 244
- Cernan, Eugene A., 153, 158, 162, 165, 168, 188
- Chaffee, Roger B., 159, 176, 184
- Chamberlin, James A., 102, 113-15, 117, 119, 139, 141 n, 154, 157
- Chance Vought Aircraft Corporation, 61, 62, 181, 182, 449-51. *See also* Ling-Temco-Vought Aerospace Corporation
- Cherrick, Irwin, 254
- Chicago, University of, 237, 243, 307, 309, 313, 328, 330, 337, 433
- Chickering, John B., 105, 107
- Chilton, Robert G., 102 n
- China Lake, California, 444
- Christiansen, Everett E., 107, 110
- Chrysler Corporation, 46, 47, 51, 52, 55-59
- Chukchi Sea, 557
- Civilian-Military Liaison Committee, 2, 45. *See also* Aeronautics and Astronautics Coordinating Board
- Clark, John F., 200, 201, 232, 301
- Clarke, Arthur C., 364
- Clements, Henry E., 116, 118
- Cleveland, Ohio, 40, 44, 405, 477, 480, 485, 495
- Clummons, D. L., Jr., 298
- Coastal Sentry Quebec* (tracking ship), 147, 148, 546, 549, 551, 552
- Cobby Creek, Australia, 592
- Coffee, Claude W., Jr., 244, 246, 253
- Cohen, Aaron, 119
- Cohen, Haggai, 111
- Cohen, William, 471
- Cole, 106
- College, Alaska, 538-40, 575, 577

- College Park, Maryland, 540, 542, 543, 577
- Collins, Michael, 153, 158, 162, 166, 189
- Collins Radio Company, 192, 372, 552 n
- Coll Towers, 568
- Colorado, University of, 339
- Columbia University, 314, 355, 433
- command and service module (CSM), 172 n, 174-76, 178, 183, 185-94
- command module (CM), 173, 188, 189
- Commerce, U.S. Department of, 248, 348, 349, 351, 368, 399
- Communication by Moon Relay, 364
- communications projects, 199, 222, 224, 244, 246, 364-91
- Communications Satellite Corporation (COMSAT), 364, 366, 368, 371, 382, 384, 385, 388-92, 396
- Comodoro Rivadavia, Argentina, 523, 541
- Condor Committee, 483
- Congress, U.S., 2, 7, 93, 95, 99, 128 n, 172, 181, 198, 203, 225, 301, 310, 338, 339, 343, 360, 364, 369, 384, 387, 392, 396, 403, 460, 467, 470, 475, 482, 484-90, 495, 517; Joint Committee on Atomic Energy, 484, 486
- Conlon, Emerson W., 406
- Connor, Joseph, 105, 106
- Conrad, Charles, Jr., 153, 157, 158, 161, 164, 167, 168
- Consolidated Vultee Aircraft Corporation (Convair), 29, 30, 33, 34, 36, 37, 41, 42, 44, 45, 48, 50, 57, 92, 94, 96, 481, 484, 485, 535. *See also* General Dynamics
- Control Data Corporation, 393, 396
- Coogan, John, 240
- Cooley, J. E., 243
- Cooley, William, 5
- Cooney, Thomas V., 437
- Coons, D. Owen, 116, 118, 120
- Cooper, L. Gordon, 137 n, 138, 141, 145-48, 153, 157, 159, 161, 166, 168, 364
- Cooper Development Corporation, 282
- Cornell Aeronautical Laboratory, 515
- Cornell University, 337
- Corporal. *See* Baby Wac
- Corpus Christi, Texas, 523, 546, 548, 550, 552, 554, 561, 563, 580
- Cortright, Edgar M., 107, 109, 200, 201, 301
- Cotton, Paul E., 104-08, 407
- Coulter, John M., 107
- Cover, Joseph W., 110
- Covington, Ozro M., 539, 547, 559, 561
- Coyne, C. C., 108
- Critzos, Chris C., 112
- Cross, Carl S., 515 n
- Crossfield, A. Scott, 502 n, 507, 509, 510
- Crowley, John W., 404, 406
- Cuckoo-Raven II, 283
- Culbertson, Philip E., 110, 111
- Cummings, C. I., 311
- Cunningham, Newton W., 310, 332
- Cunningham, R. Walter, 164, 176, 185, 188
- Curfman, Howard J., Jr., 464
- Cutler-Hammer Corporation, 244, 476; Airborne Instruments Division, 476
- D
- D'Aiutolo, Charles T., 241, 445
- Dallow, Thomas P., 344
- Dana, William H., 456, 457, 513, 514
- Danberg, James E., 431
- Darcey, Robert J., 380, 384, 393, 397, 398
- Darwin, Australia, 540, 543, 580
- David Clark Company, 157, 192
- Davis, Leo R., 247
- Davis, William P., 108
- Day, LeRoy E., 6, 108, 109
- Dayton, Ohio 137 n
- D. B. Milliken Company, 193
- Deacon, 276
- Debre Zeit, Ethiopia, 523, 541
- Debus, Kurt H., 179
- Decker, James L., 114
- Decker, Ralph S., 471
- Deep Space Network (DSN), 332, 521-23, 548, 549, 553, 554, 562, 564-96; Compatibility Test Station, 574; Deep Space Instrumentation Facility, 565, 566; Deep Space Stations, 574
- Defense, U.S. Department of (DoD), 1, 4, 17, 29, 86, 87, 93 n, 98, 138, 140, 153, 154, 156, 235, 248, 286, 302, 303, 348, 360, 362, 366, 368, 370, 376, 378, 379, 382-84, 392, 393, 399, 465, 487, 488, 490, 497, 500, 514, 524, 539, 541, 544, 546, 548, 549, 551, 554, 560, 562-64, 569, 571, 572, 575, 576, 578, 580, 583, 585, 589, 592, 593, 595, 596; Armed Forces Special Weapons Project, 483; Communications Agency, 366; Discoverer, 39, 560; Research and Development Board, 403 n; Scientific Satellite Project, 1; Secretary of Defense, 95, 98, 138, 303, 542; Special Capabilities, Committee on (Steward Committee), 87, 235

- De Haviland Aircraft Company, 289, 290
 Delta, 1-3, 5, 6, 10, 11, 13, 19-21, 24, 67, 68, 77-80, 83, 299
 DeMerritte, Fred J., 439
 Denicke, Bert A., 105, 110
 Denmark, 288 n; Technical University of, 294
 Deutsch, George C., 434
 Diaz, Rodolfo A., 105, 106, 108
 Dickerson, Joe T., 107
 Dietlein, Lawrence F., 118, 120
 Dionysos, Greece, 541
 Disher, John H., 6, 104, 106, 110, 111, 179
 Dixon, Franklin P., 110
 Dodaira, Japan, 541
 Dominican Republic, 541, 559
 Donahue, T. M., 284
 Donlan, Charles J., 102, 107, 109, 112, 137 n
 D'Onofrio, Gus A., 6, 104
 Doppler, 534, 542, 545, 566, 571; Coded Doppler and Ranging Communications, 571
 Dorfman, Herman, 107
 Dornberger, Walter, 505
 Dotts, Homer W., 117, 119
 Douglas, W. Harry, 117, 119
 Douglas, William K., 112
 Douglas Aircraft Company (McDonnell Douglas), 53, 55-61, 67, 68, 72, 74-76, 80, 83, 181, 182, 351, 481, 484, 485, 501, 502, 505, 506; El Segundo Division, 505
 Douglas Sparrow, 278
 Dow, N. F., 505
 Drake, Hubert, 507
 Dreoscher, John J., Jr., 120
 Dryden, Hugh L., 369, 370
 Dubin, M., 284
 DuBridge, Lee A., 572
 Dumbo (reactor), 484
 Duncan, Robert C., 115, 117
 Dunkelmann, Lawrence, 292
 Dunseith, Lynwood C., 118, 120
 Dupont. *See* E. I. Dupont
 Dutch Guiana, 559
 Dyna-Soar (X-20), 92, 93, 456 n, 502, 524, 560; Project Dyna-Soar, 93, 98, 99, 452. *See also* lifting body program
- E**
- Eagle-Picher Company, 192
 Eaker, Herbert L., 294, 295, 372
Early Bird, 81, 385. *See also* International Telecommunications Satellite Consortium
 Earth, 307, 330, 338, 472
 East China Sea, 557, 558
 Eastern Test Range (ETR), 137, 142-48, 157-68, 186-89, 198, 233, 235-45, 247, 248, 250, 251, 254, 256-59, 262, 263, 266-68, 270, 287, 291, 297, 299, 305-09, 313-18, 321-26, 328-31, 335-39, 345, 346, 348, 351, 353-58, 372, 375, 378-80, 383, 384, 389, 397-99, 443, 449, 451, 549, 559. *See also* Atlantic Missile Range
 East Grand Forks, Minnesota, 536, 538-40, 542, 543, 580
 East Island, Puerto Rico, 548, 551, 580
 Eastman, Ford, 113
 Eastman-Kodak Company, 319-25
 East Siberian Sea, 557, 558
 Echo, 19-21, 38, 67-69, 80, 81, 205, 239, 244, 246, 253, 368, 376, 565, 569; *Echo 1*, 68, 81, 83, 369, 371, 372; *Echo 2*, 69, 74, 369, 371, 372; Echo Station, 569, 571, 582; Project Echo, 21, 582
 Edwards, John A., 108, 109, 111
 Eggers, Alfred J., Jr., 94, 96, 97, 450, 451, 453, 454
 EGO (elliptic orbits), 264, 266, 268, 270
 Ehrlich, Eugene, 366
 E. I. Dupont, 369, 372
 Eisele, Donna F., 176, 185, 188
 Eisenhower, Dwight D., 93, 95, 98, 99, 102, 302, 364, 544
 El Centro, California, 439
 Electro-Mechanical Research, Inc., 192, 247, 248, 552 n
 Electronics Research Center (ERC), 405, 433, 437, 460-62, 499; Computer Laboratory, 463; Control and Information Systems Laboratory, 461; Electronics Components Laboratory, 463; Guidance Laboratory, 461; Instrumentation Research Laboratory, 462; Microwave Radiation Laboratory, 462; Space Optics Laboratory, 462
 Electro-Optical Systems, Inc., 396, 476
 Elms, James C., 107, 114, 115
 Emerson Electric, 442
 engines: ABL, 67, 280, 448 n; Bell ("Hustler"), 36, 37, 39, 501; Castor E-8, 465 n, Castor XM 33E3, 465 n; F-1, 1, 22, 23, 53, 54, 180, 489, 491; H-1, 22, 23, 54, 56, 59, 182, 492; J-2, 22, 23, 59, 61, 491; M-1, 473, 491, 492; Recruit XM-19, 465 n; RL-10, 24, 491; RP-1/LOX, 489; S-10, 489 n; XE-1, 487; XE-2, 487; XLR, 456;

- XLR-11, 452, 455-58, 502, 509, 510;
XLR-99, 502, 503, 506, 507, 509; XM
45, 465 n
- England. *See* United Kingdom
- Engle, Joe H., 511-13
- Environmental Science Services Ad-
ministration (ESSA), 70, 80, 347-51,
357-59, 393, 538, 575; *ESSA 1 - 9*, 82,
348, 349, 352, 357-59; National En-
vironmental Satellite Center, 349, 350 n
- Esselen Park, South Africa, 585, 586
- Europe, 389, 554, 593
- European Satellite Triangulation Net-
work, 399
- European Space Research Organization
(ESRO), 288, 294, 297; *ESRO 1*
(*Aurora*), 65, 288, 294, 295; *ESRO*
2A, 65, 295; *ESRO 2B* (IRIS), 65,
274, 280, 294, 295
- Evans, Albert J., 407, 497, 498
- Evans, Harry L., 107
- Evans, Ronald E., 188
- Evans, Thomas C., 110
- Evans, Wyendell B., 117, 119
- Explorer, 19, 21, 38, 46-48, 62, 64, 65,
67-70, 80-82, 93, 197, 205, 210,
232-53, 271, 288, 331, 437, 441 n, 493,
524, 542, 543; *Explorer 1*, 1, 46, 87,
235, 286, 572; *Explorer 2*, 47; *Ex-
plorer 3*, 47, 235; *Explorer 4*, 47, 235;
Explorer 5, 47, 235; *Explorer 6* (S-2),
68, 73, 210, 235, 237, 370; *Explorer 7*
(S-1a), 48, 210, 235, 238; *Explorer 8*
(S-30), 48, 235, 238; *Explorer 9*
(S-56a), 64, 66, 235, 237, 288, 368;
Explorer 10 (P-14), 68, 216 n, 235,
239; *Explorer 11* (S-15), 48, 235, 240;
Explorer 12 (S-3), 68, 235, 240, 241;
Explorer 13 (S-55a), 64, 236, 241, 437;
Explorer 14 (S-3a), 69, 236, 241, 242;
Explorer 15 (S-3b), 69, 236, 242; *Ex-
plorer 16* (S-55b), 64, 236, 242, 437,
440; *Explorer 17* (S-6), 69, 236, 243;
Explorer 18 (IMP-A), 69, 236, 243,
245, 248; *Explorer 19* (AD-A), 64,
236, 244, 288, 368; *Explorer 20* (S-48),
64, 236, 244, 299; *Explorer 21* (IMP-
B), 69, 236, 245; *Explorer 22* (BE-B),
64, 236, 245, 247, 288, 462, 463; *Ex-
plorer 23* (S-55c), 64, 236, 246, 437;
Explorer 24 (AD-Injun B), 64, 236,
246, 288; *Explorer 25*, 64, 236, 246;
Explorer 26 (EPE-D), 69, 236, 247;
Explorer 27 (BE-C), 64, 236, 247, 288,
462, 463; *Explorer 28* (IMP-C), 69,
236, 248; *Explorer 29* (GEOS-A), 69,
236, 248, 288, 400; *Explorer 30* (SE-
A), 64, 236, 249; *Explorer 31* (DME-
A), 69, 236, 249; *Explorer 32* (AE-B),
69, 236, 250; *Explorer 33* (IMP-D),
70, 236, 250; *Explorer 34* (IMP-F), 70,
236, 251; *Explorer 35* (IMP-E), 70,
236, 251; *Explorer 36* (GEOS-B), 69,
236, 252, 288, 400; *Explorer 37* (SE-
B), 65, 236, 252; *Explorer 38* (RAE-
A), 70, 236, 253; *Explorer 39* (AD-
Injun E), 69, 236, 253, 288, 368; *Ex-
plorer 40*, 64, 236, 253; *Explorer S-1*,
235; S-45, 235; S-45a, 235; S-46, 235;
S-66, 236; Project Explorer, 572
- extravehicular activity (EVA), 152, 157,
158, 160, 164-66, 168, 192
- F
- Faget, Maxime A., 94, 97, 98, 100 n, 102
n, 103, 112-15, 117, 119, 134, 171 n,
505
- Fairbanks, Alaska, 523, 538 n, 575, 581
- Fairchild-Hiller Corporation (formerly,
Fairchild Stratos Corporation), 397,
440, 442, 443, 476; Space and Elec-
tronics Division, 253
- Far East, 384
- Fastie, W. G., 284
- Faith 7, 148
- Federal Aviation Agency (FAA), 366,
368, 405, 497, 514, 515
- Federal Communications Commission
(FCC), 364, 373, 374, 388, 552 n
- Fero, Lester K., 110
- Field, J. Pemble, 108
- Fielder, Dennis E., 119
- Fields, Edison M., 102 n
- Finger, Harold B., 5, 6, 406, 407, 470,
471, 479, 480, 487
- Fischetti, Thomas L., 264
- Flannagan, James R., 471
- Flight Investigation of Apollo Reentry
Environment (FIARE), 443-44, 448,
450; Project FIARE (Project Calorie),
443, 446, 448, 450
- Flight Investigation Reentry Environment
(FIRE), 32, 41, 183, 186; *FIRE 1* and
2, 186, 449-51; Project FIRE, 14, 29,
41, 121, 435, 439, 448-50, 451
- Flight Research Center (FRC), California,
94, 156, 405, 439, 451-57, 496, 497,
503, 504, 507, 508, 515, 517; High-
Speed Flight Station, 496, 497, 502,
522, 524, 544
- Florence, University of, 299, 300
- Florida, 351, 544, 559
- Fong, Louis B. C., 201

Ford Motor Company: Aeronautics Division, 310, 311, 549; Aeronutronic Division, 314-16, 560
 Fordyce, Don V., 393, 399
 Formosa Bay, 300
 Forsythe, Dixon L., 5, 254
 Fort Churchill, Canada, 272, 277, 282, 284, 285, 531 n
 Fort Irwin, 568
 Fort Myers, Florida, 523, 536, 539, 540, 542, 543, 581, 585
 Fort Stewart, Georgia, 536, 539 n, 540, 542, 581
 Foster, Norman G., 118
 Foster, Willis B., 201
 France, 272, 288, 295, 296, 373, 375-77; Centre d'Etudes Nucleaires de Saclay, 295, 297; Centre d'Etudes des Telecommunications, 296; Centre National d'Etudes Spatiales (CNES), 296; satellites, 64, 221, 288, 296
 Freden, S., 119
 Freedman, Carl, 201
Freedom 7, 143
 Freitag, Robert F., 5, 106-08
 French Guiana, 559
 Frick, Charles W., 113, 179, 182
 Friebaum, Jerome, 366, 385
Friendship 7, 100
 Fry, W. J., 107
 Fucino, Italy, 376

G

Gagarin, Yuri A., 100, 102, 141
 Galileo, 259
 Gamble, Allen O., 137 n
 Gangler, James J., 434
 Garbacz, Michael L., 348, 349
 Garbarini, Robert F., 201
 Gardiner, Robert A., 117, 119
 Garland, Benjamin J., 98, 100 n
 Garrett Corporation, 192
 Gartrell, Harold E., 117, 119
 Gassiot High Altitude Vehicle, 283
 Gautraud, John A., 104, 106
 Gay, Clarence C., Jr., 109
 Gemini, 2, 11, 13, 22, 24, 28, 29, 32, 38, 83, 102, 103, 174, 176, 177, 182, 190-94, 355, 441, 450, 548, 549, 552, 554, 556, 562, 563, 565, 575, 580, 589, 591-93, 595; astronauts, 152-70, 174, 442; characteristics and chronology, 149-70; funding, 122, 126, 127, 133 n; *Gemini 3*, 464, 552, 563; *Gemini 4*, 552, 563; *Gemini 5*, 161, 552, 563;

Gemini 6, 163, 552, 563; *Gemini 7*, 162, 552, 563; *Gemini 8*, 164, 563; *Gemini 9*, 165, 563; *Gemini 10*, 166, 563; *Gemini 11*, 167, 563; *Gemini 12*, 168, 563; Gemini-Agena D, 157; Gemini Agena Target Vehicle, 38, 151, 163-68; Gemini Experiments Office, 153; Gemini Launch Vehicle (GLV), 84, 158-61, 163-68; Gemini Mission Evaluation Team, 159-68; Gemini Operational and Management Plan, 156; Gemini Project Office, 153-55, 157, 158, 174; Gemini-Titan (GT), 152-54, 157-63, 166, 552; Project Gemini, 30, 37, 40, 85, 100, 101, 439, 522, 551, 552, 562
 General Dynamics, 29, 30, 34, 36, 37, 41, 42, 44, 45, 48, 50, 53, 54, 57, 182, 331, 555 n; Astronautics, 261, 262, 449, 450; Convair/Astronautics Division, 172, 180, 181. *See also* Consolidated Vultee Aircraft Corporation
 General Dynamics/Astronautics, 261, 262, 449-51, 469, 485
 General Dynamics/Convair Aerospace, 517
 General Dynamics/Electronics, 538 n
 General Electric Corporation (GE), 45, 86, 87, 150, 172, 180, 181, 192, 260-62, 340, 343-46, 361, 362, 378, 393, 396, 397, 445, 446, 462, 494, 515, 538 n; Missile and Space Vehicle Department, 182, 446, 448; Spacecraft Department, 360, 363
 General Motors Corporation, 193; AC Electronics Division, 193
 General Purpose Airborne simulator, 505
 General Services Administration, 366
 Gentry, Jerould R., 457-59
 Geodynamics Experimental Ocean Satellite (GEOS), 248, 252, 288, 400. *See also* Explorer
 Geophysics Corporation of America: Viron Division, 372
 George C. Marshall Space Flight Center. *See* Marshall Space Flight Center
 Germany, Federal Republic of, 272, 288 n, 534; Army, 275; Junkers Flugzeug- und Motorenwerke GmbH, 297; Peenemünde, 505; 534; rockets, 91, 93, 275, 534; scientists, 505; West German Post Office, 374, 377
 Gessow, Alfred, 432
 Gibberson, Walker E., 326
 Gillam, I. T., 6
 Gilmore, Alaska, 575, 581
 Gilruth, Robert R., 95, 96, 99, 102, 103, 112, 113, 115, 116, 118, 120, 137 n,

- 138, 141
 Gilstead, Douglas A., 440
 Ginter, Roll D., 5, 6, 407
 Glahn, Earl W., 332
 Glaser, H., 252
 Glenn, John H., Jr., 100, 137 n, 138, 141, 143-45, 147, 148, 548, 551
 Glennan, T. Keith, 102, 137 n, 139, 341, 382, 467
 Glenn T. Martin Company, 275
 Goddard, Robert H., 270, 275; *A Method of Reaching Extreme Altitudes*, 275
 Goddard Space Flight Center (GSFC), 102, 179, 197, 233, 237-72, 276, 278, 285-300, 302, 307-09, 313, 328, 335, 337, 339, 340, 348, 349, 351-57, 360, 361, 363, 366, 370, 372, 373, 375, 377-80, 382-85, 389-93, 395-99, 433, 438, 462, 494, 522, 536, 538, 539, 542, 545, 547, 551-53, 558-62, 579, 589;
 Goddard Range and Range Rate Equipment (GRARR), 538, 575, 590-93; Network Test and Training Facility (NTTF), 539, 543, 577, 589; Tiros Technical Control Center, 350
 Goett, Harry J., 155, 180
 Gold, Harold, 477
 Goldstone, California, 523, 548, 553, 554, 557, 558, 562, 563, 565-74, 581, 582, 588
 Golovin, Nicholas E., 181
 Goodrich Company. *See* B.F. Goodrich Company
 Goodyear Aerospace Corporation, 298
 Goodyear Aircraft Corporation, 155
 Goonhilly Downs, England, 376
 Goozh, Paul E., 6
 Gordon, Richard F., Jr., 153, 158, 164, 165, 167
 Graduate Research Center of the Southwest, 307-09
 Grand Bahama Island, 523, 541, 546, 548, 550, 552, 554, 557, 558, 561, 563, 582, 583
 Grand Canary Island, 523, 546, 548, 552, 554, 561, 563, 577, 583
 Grand Central Rocket Company, 86, 87, 140
 Grand Turk Island, 536, 539 n, 540-42, 546, 548, 550, 552, 561, 583
 Graves, G. Barry, Jr., 114, 115, 545, 547 n, 560
 Gray, Edward Z., 109
 Great Britain. *See* United Kingdom
 Great Lakes, 349
 Greenbelt, Maryland, 102
 Greene, William D., 110
 Greenhorn, Alvin E., 107
 Greenland, 400, 550
 Greever, Bill, 240
 Gregory, Don T., 113-15
 Grissom, Virgil I., 137 n, 138, 141, 144-48, 152, 157, 159-61, 163, 176, 184
 Gross, R.J., 297
 Grosz, P., 110
 Ground Based Information System (GBIS). *See* Advanced Research Projects Agency
 Ground Communications Facility. *See* NASCOM
 Grumman Aircraft Engineering Corporation, 174, 176, 179, 181-84, 193, 260-63, 361, 369, 372
 GT&E, 382
 G.T. Schjeldahl Company, 239, 244, 246, 253, 298, 369, 371, 442, 443
 Guadalcanal, 546, 561
 Guam, 523, 548, 554, 557, 558, 562, 563, 584, 594
 Guaymas, Mexico, 146-48, 523, 546, 548, 550, 552, 554, 561, 563, 584, 594
 Guild, Warren A., 5, 6
 Gulton Industries, 264
- ## H
- Hage, George H., 109
 Hagen, John P., 286, 287
 Haglund, Howard H., 326, 329-31
 Hagner, Donald R., 111
 Haise, Fred W., Jr., 189, 456
 Halaby, Najeeb E., 514
 Haley, Richard L., 348, 360
 Hall, Charles F., 303, 307-09
 Hall, Eldon W., 5, 104, 106, 108, 110
 Hall, Harvey, 104
 Hallissy, Joseph M., 445, 447
 Halpern, Richard E., 254
 Hammock, Jerome B., 102 n, 118, 120
 Hammond, Victor W., 526
 Hampton, Victor W., 526
 Hanes, Thomas E., 110
 Hanna, William E., Jr., 407
 Hanson, W. B., 284
 Harper, Charles W., 407, 497, 498
 Harrison, Harry, 433
 Hartebeesthoek, South Africa, 585
 Harvard University, 254, 257, 259, 285, 460; Harvard College Observatory, 437
 Hastings, Earl C., Jr., 242, 246, 445, 448
 Hathcock, Juanita, 105, 106

- Havana, Cuba, 536, 539 n, 540, 542, 581, 585
- Havenstein, P. L., 111
- Hawaii, 147, 148, 343, 381, 523, 547, 557, 558, 585
- Hawkins, Willard R., 118, 120
- Hearth, Donald P., 202, 302, 332, 340
- Heaton, Donald H., 4, 5, 105, 200
- Heberlig, Jack C., 102 n, 171 n
- Hecht, Kenneth F., 117, 119
- Hedrick, Walter R., 107
- Heikkila, W. J., 284
- Heller, Niles R., 547, 560
- Henry, Richard C., 108
- Heppner, James P., 239, 270
- Hercules, 282, 283
- Hercules Powder Company, 34, 41, 62, 72, 86
- Hermes, 275; Hermes C-1, 52
- Hess, Wilmot N., 117, 119, 242
- Hexcel Products, Inc., 193
- Hibbert, John, 110
- Hicks, Clairborne R., Jr., 102 n
- Highly Eccentric Orbiting Satellite (HEOS), 70, 80, 82, 288, 297
- Hipsher, Harold P., 471
- Hittan Associates, Inc., 362
- Hjornevik, Wesley L., 113-15, 117, 118, 120
- Hoag, Peter, 457
- Hodge, John D., 116, 118-20
- Hoffman Electronics, 264
- Hogarth, L. T., 257-59
- Holcomb, John K., 6, 104, 106, 109
- Holmdel, New Jersey, 370
- Holmes, D. Brainerd, 5, 101, 104, 105
- Holmes, Jay, 108
- Holtz, John R., 233, 252, 271
- Honest John, 280
- Honeysuckle Creek, 548, 577, 585
- Honeywell, Inc., 193; Honeywell MH-96 Adaptive Flight Control System, 507; Honeywell Systems & Research Division, 464
- Horizon Definition Research Project. *See* SCANNER
- Horowitz, R., 284
- Horton, Vic, 456
- Houbolt, John C., 174, 181, 182
- House of Representatives, U.S., 7, 209, 214 n, 217, 361; Committee on Science and Astronautics, 198, 265, 312, 362; Select Committee on Astronautics and Space Exploration, 370; Subcommittee on NASA Oversight, 265, 363; Subcommittee on Science and Astronautics Applications, 361; Subcommittee on Space Science and Applications, 198. *See also* Congress, U.S.
- Houston, Texas, 100, 103, 134, 139, 141, 154, 156, 159-62, 164-68, 172, 174, 176, 179, 439, 466, 544, 551, 552, 554, 561-63. *See* Manned Spacecraft Center
- Howard, Brian T., 110
- Howe, John T., 432
- Hubbard, Samuel H., 108, 109, 111, 154
- Hugenia, G. R., 285
- Hughes Aircraft Company, 182, 311, 320, 325-31, 371, 378, 379, 382-85, 388-90, 392, 396-99
- Hughes Research Laboratories, 475-77
- Hugh L. Dryden Flight Research Center. *See* Flight Research Center
- Humphreys, James W., 108
- Huntsville (tracking ship), 549, 551, 554, 555 n, 557, 558
- Huntsville, Alabama, 1, 39, 93, 100, 557
- Hyatt, Abraham, 2, 4, 5, 505
- Hymoqitz, Emil, 292
- Hynes, Robert T., 526

I

- Ikard, Wallace, 525
- Illinois, University of, 245
- Image Dissector Camera System (IDCS), 395
- Imperial College (U.K.), 291, 295, 297
- India, 272, 542
- Indian Ocean, 381, 382, 385, 546, 550, 557, 558, 561, 588, 595
- Indochina, 481; conflict, 499
- Injun Explorer, 233, 246, 253. *See also* Explorer
- Instrumentation Radar Acquisition Kit, 546 n
- Integrated Apollo and Deep Space Station, 576
- Intelligence Agency, U.S. (USIA), 368
- Interagency Aircraft Noise Abatement Program, 499
- Interagency Chemical Rocket Propulsion Group, 488
- intercontinental ballistic missiles (ICBM), 30, 35, 73, 84, 85, 92, 93, 97, 134, 151, 156, 483, 541 n, 561; IBM 704 computer, 536; IBM 7090 computer, 545. *See also* WECo
- International Geophysical Year (IGY), 47, 86, 87, 93, 197, 235, 271, 276, 282, 283, 286, 303, 347, 524, 535, 536, 541, 542, 571, 573
- International Ground Station Committee, 376

- International Latex Corporation, 193
 International Quiet Sun Year, 249, 302;
 World Magnetic Survey, 267
 International Telecommunications
 Satellite Consortium (INTELSAT), 67,
 69, 70, 80-82, 202, 364, 366, 384-91,
 558 n; *INTELSAT I - III*, 385, 387-91
 International Telecommunications Union
 (ITU), 368, 537
 International Telephone and Telegraph
 Company (ITT), 382, 384, 388, 552 n;
 Industrial Products Division, 264
 Interservice Group for Flight Vehicle
 Power, 405 n
 Iowa, State University of, 235, 236, 238,
 240, 241, 246, 250, 251, 253, 286, 313,
 335, 337, 339, 378
 Ireland, Fred, 104, 106
 Isbaraki Prefecture, Japan, 376
 Island Lagoon, Australia, 541
 Israel, 272
 Italy, 288, 299, 300, 373, 573; Centro
 Ricerche Aerospaziale, 299, 300
 IVA, 280
- J**
- Jackass Flats, Nevada, 477, 480, 483
 Jackson, Bruce G., 118, 120
 Jackson, John E., 249, 289, 290, 297,
 298
 Jackson, John L., 244
 Jaffe, Leonard, 201, 202, 366, 370, 376,
 379, 380, 382, 396
 Jaffe, Richard, 571
 J.A. Maurer, Inc., 193
 Jamaica, 559
 James, Jack N., 332, 335-38
 James, Lee B., 109
 Janus, 351; Janus II, 348; Project Janus,
 348
 Japan, 272, 373, 551, 552
 Jenkins, Thomas E., 109
 Jet Propulsion Laboratory (JPL) (former-
 ly, Guggenheim Aeronautical
 Laboratory), 1, 45-48, 61, 172, 235,
 275, 288, 302, 307-10, 312-18, 320,
 321, 325-32, 334-40, 369, 372, 393,
 432, 433, 434, 461, 462, 475, 489, 494,
 521, 522, 524, 542, 552, 562, 564-67,
 569-73, 582; Functional Design Group,
 311; Goldstone Space Communications
 Station, 569 n; New Space Flight
 Operations Facility, 573; Space Flight
 Operations Facility, 566, 570
 Jodrell Bank, England, 292, 531, 572
 Johannesburg, South Africa, 523, 536,
 539, 540, 542, 565, 570-74, 585
 Johns Hopkins University, 284, 433; Ap-
 plied Physics Laboratory (APL), 245,
 247-49, 252, 275, 277, 299, 482
 Johnson, Bernard L., 108
 Johnson, Edwin G., 471
 Johnson, Lyndon B., 95, 98, 481, 487,
 499
 Johnson, Vincent L., 4-6, 201, 202
 Johnson, William G., 442, 443
 Johnston, Richard, 114, 115, 117, 118
 Joint Parachute Test Facility, 439
 Jones, Allen, 109
 Jones, Alton E., 380, 383
 Jones, David M., 107, 110
 Jones, Walton L., 407, 469
 Jones, William W., 349, 358
 Juno, 2, 15, 24, 47, 54; Juno I, 3, 46-51,
 93, 288, 368; Juno II, 3, 10, 14, 27,
 46-50, 209, 238, 240, 288, 303, 306,
 351, 368, 489; Juno IV, 348, 351;
 Juno V, 3, 99, 171. *See also* Saturn
 Jupiter, 3, 10, 15, 48, 51, 87, 121, 134 n,
 139, 140, 206, 212 n, 235; Jupiter C,
 27, 46, 47, 93, 97, 235, 348, 351, 571;
 Jupiter IRBM, 47, 48; planet, 330,
 470, 472
 Jupiter, Florida, 523
- K**
- Kahao, M. J. Barkdull, 108
 Kaiser-Fleetwings, Inc., 369, 372
 Kano, Nigeria, 540, 543, 546-48, 550,
 552, 561, 585
 Kashima, Japan, 399
 Kasima Nachi, Japan, 540, 543, 586
 Kauai, Hawaii, 540, 543, 546, 548, 550,
 554, 561, 563, 580, 585, 586
 Keating, Gerald M., 246
 Kehlet, Alan B., 102 n, 180
 Kelleher, John J., 366, 385
 Keller, J. Warren, 439
 Kelley, Albert J., 406, 407, 460
 Kemmerer, Walter K., Jr., 120
 Kennedy, John F., 100-02, 141, 149, 172,
 181, 182, 185, 203, 379, 480, 485, 514,
 556
 Kennedy Space Center (KSC), 59, 61,
 116, 174, 179, 184, 265, 304, 320, 334,
 522. *See also* Cape
 Canaveral/Kennedy
 Kenya, 300
 Kerr, Thomas B., 471
 Khrushchev, Nikita, 364
 Kinetics, 264

- Kingsport* (tracking ship), 549
Kingsport, Tennessee, 381
 Kinny, Archer W., 110
 Kiwi, 473, 476, 478-88; Kiwi A, B, and C, 479-81, 483-88; Kiwi Transient Nuclear Test, 486
 Klein, Milton S., 407, 471
 Kleinknecht, Kenneth S., 113-16, 119, 141, 154
 Knauf, George M., 105, 106, 108
 Knight, William J., 513, 514
 Kochendorfer, Fred D., 332
 Kock, Winston E., 460
 Koenig, Charles E., 108
 Kokee Park, 586, 587
 Kolenkiewicz, Ronald, 102 n
 Kollsman Instrument Corporation, 260-62
 Konecci, Eugene B., 406, 407, 469
 Korean conflict, 499
 Kotanchik, Joseph N., 115-17, 119
 Kraft, Christopher C., Jr., 102 n, 103, 112-16, 118, 120
 Kranz, Eugene F., 120
 Kreplin, R. W., 249, 252
 Krueger, A., 284
 Kubat, Jerald R., 6, 108, 109
 Kupperian, James E., Jr., 240, 262
 Kurzweg, Richard V., 406, 407, 431
 Kwajalein, Marshall Islands, 548, 551, 587
- L**
- La Gow, H. E., 238
 Lakehurst, New Jersey, 380
 Lamont Geological Observatory, 328
 Lance, 281
 Lang, Dave W., 118
 Langley Memorial Aeronautical Laboratory, 62, 92, 94-96, 100, 261, 300, 301, 368-70, 403, 404, 505, 506, 522, 560; Dynamic Loads Division, 102 n; Flight Research Division, 102 n; Full-Scale Tunnel Research Division, 102 n; Stability Research Division, 102 n; Structures Research Division, 102 n. *See also* Langley Research Center
 Langley Research Center (LaRC), 1, 29, 33, 47, 49, 61, 66, 92, 102, 134, 137, 139, 141, 171, 174, 181, 184, 197, 233, 239, 241, 242, 244, 246, 253, 265, 288, 298, 302, 319-25, 327, 328, 370-72, 404, 432-34, 436-39, 441-52, 454, 457, 462, 464-66, 468, 469, 495-97, 499, 500, 502, 503, 508, 515, 544, 545, 547, 560, 565; Instrument Research Division, 102 n, 544, 547, 560; Source Evaluation Board, 320; Tracking Systems Study Group, 544
 Langmuir probes, 243, 466
Lani Bird. *See* International Telecommunications Satellite Consortium
 Lanzkron, Rolf W., 115-18
 LaRue, William A., 109
 Lasser, Herbert, 303
 Launch Complex, 34, 184
 launch vehicles, 1-87, 122, 123; Administrative Operations (AO), 7, 8; budget, 6-24; Budget Operations Division, 7; characteristics, 24-87; Construction of Facilities (CoF), 7, 8; launch escape system (LES), 173, 186, 187; propulsion systems, 17, 18, 22-25; Research and Development (R&D), 7-9, 25, 26, 31, 33
 Lauten, William T., Jr., 102 n
 Lazar, James, 471
 Lederer, Jerome, 111
 Lee, Chester M., 109, 110
 Lee, John B., 102 n
 Lee, William A., 105, 106, 115, 116, 179
 Leeds, University of (U.K.), 295
 Lehan, F. W., 571
 Leicester, University of (U.K.), 291, 295
 Lemke, George A., 6, 109
 Levenson, Stephan S., 111
 Levine, Jack, 445, 465
 Levine, Robert S., 471
 Lewis Research Center (LeRC) (formerly, Lewis Flight Propulsion Laboratory and Aircraft Engine Research Laboratory), 40, 44, 102 n, 134, 241, 242, 334, 393, 405, 432-34, 436, 438, 454, 470, 473, 476-79, 481, 482, 486, 489-96, 499, 515, 549; Safety Research and Data Institute, 436
 Levy, Edwin Z., 137 n
 Liberty Bell, 7, 144
 Liccardi, Anthony L., 108
 life sciences program, 340-46, 466-69
 lifting body program, 94, 121, 435, 450-59; HL-10, 439, 452-59; M-1, 94, 97, 450, 454, 473; M-2, 439, 452, 453, 455; M2-F1, 451, 452, 454-56; M2-F2, 452, 453, 455-59; M2-F3, 452, 456, 457; SV-5D Prime (Precision Recovery Including Maneuvering Entry), 452; X-20 (Dyna-Soar), 92, 93, 454, 456, 502, 524, 560; X-24, 24, 453, 456; X-24A, 439, 453, 456. *See also* Dyna-Soar
 Lilly, William E., 105, 106, 108
 Lima, Peru, 523, 539, 540, 542, 543, 587

Lindell, Keith G., 112
 Lindsay, John C., 237, 256, 257, 307
 Ling-Temco-Vought Aerospace Corporation, 62, 449, 466; Range Systems Division, 555 n; Vought Astronautics, 61, 66
 Link Group of General Precision, 184
 Little, Albert P., 108
 Little Joe I, 11, 12, 15, 16, 24, 48-50, 121, 134, 140; Little Joe II, 16, 24, 27, 48, 50, 121, 140, 182, 186
 Livermore Radioation Laboratory, 476, 483
 Lockheed Missiles and Space Company, 29, 36, 37, 39, 57, 67, 74-76, 151, 154, 155, 182, 193, 260, 262, 320, 334, 343, 344, 389, 397, 476, 481, 484, 485, 490, 515
 Loftus, Joseph P., Jr. 119
 London, University of (U.K.), 295, 297
 Longanecker, Gerald W., 247
 Long Range Proving Ground (LRPG), 559
 Looney, C. H., 248
 Lord, Douglas R., 105, 106, 109, 110
 Los Alamos Scientific Laboratory, 476, 478, 480, 483-85; Reactor Division, 482; Weapons Division, 482
 Los Angeles, California, 98
 Love, Eugene S., 453
 Lovejoy, W. L., 6
 Lovelace, W. Randolph, 108
 Lovelace Foundation for Medical Education and Research, 137 n
 Lovell, James A., Jr., 153, 157, 158, 160, 162, 164, 165, 168, 177, 185, 189
 Lovell, Powell M., 407
 Low, George M., 102, 104-06, 108, 115, 116, 118, 176, 179-81, 185, 200
 Lucas, Thomas V., 525, 526
 Ludwig, George H., 266, 268, 286
 Lunar and Planetary Missions Board, 198
 Lunar Mission Planning Board, 184
 lunar module (LM), 173-76, 179, 184, 187-94
 Lunar Orbiter, 29, 32, 37, 39, 40, 176, 205, 214 n, 215, 310, 319-25, 327, 556, 563, 565, 566; *Lunar Orbiter 1* through 5, 319-25; Project Office, 320
 Lunar Science Institute, 301
 Luskin, Harold T., 107, 110
 Lutman, C. C., 106
 Lyle, John, 108

M

McClintock, J. G., 116, 119
 McCollough, Chester, 506
 McDivitt, James A., 152, 157, 160, 161
 McDonald, F. B., 240, 241, 243, 246, 248, 251
 McDonnell Aircraft Corporation, 102, 137, 138, 140-43, 149, 150, 153-58, 182, 193, 455. *See also* Douglas Aircraft Company
 MacDougall, George F., Jr., 102 n
 McElmurry, Thomas U., 110
 McGolrick, Joseph E., 6
 McGuire, Charles W., 109
 Mach speeds, 92, 96, 501-03, 506-08
 Machell, Reginald M., 119
 McKay, John B., 509-13
 McKee, Daniel D., 104, 106
 Mackey, Robert J., Jr., 118, 119
 McMullen, Thomas H., 109
 McMurdo Sound, Antarctica, 347
 McTigue, John, 453, 457
 Madagascar, 543, 587, 588
 Madrid, Spain, 523, 548, 554, 556-58, 562, 563, 565, 571, 573, 579, 587, 590
 Magin, Betsy F., 102 n
 Magnetometer-Plasma Probe, 239
 Mahon, Joseph B., 4-6, 202
 Maine, 376
 Majunga, Malagasy Republic, 540, 543, 577, 588
 Manhattan Project, 482
 Manke, John A., 457-59
 Manchester, University of (U.K.), 292, 293
 "Manned Earth Reconnaissance" mission, 94
 Manned Lunar Landing, Ad Hoc Task Group for Study of, 181
 Manned Spacecraft Center (MSC), Houston, 100, 103, 134, 139, 141, 154-57, 170, 172, 174, 176, 179, 182-84, 188, 189, 285, 439, 466, 468, 469, 494, 522, 544, 551-53, 561, 563; Experiments Program Office, 153; Florida Operations Office, 179; Lunar Surface Experiments Panel, 183; organization, 112-20. *See also* Space Task Group
 Manned Spacecraft Criteria Board, 183
 Manned Space Flight, Office of (OMSF), 4-6, 11, 13, 23, 24, 101, 102, 111 n, 121, 130 n, 179, 182, 301, 319, 320, 340, 341, 405, 466-68, 491, 492, 554, 565; Division of Aerospace Medicine, 468; launch vehicle and propulsion systems, 17, 18, 22-25

- Manned Space Flight Network (MFSN), 141 n, 521-23, 526, 538, 544-63, 565, 573-96
- manned spaceflight program, 15, 16, 33, 48, 51, 52, 91-194; budget, 121-33; characteristics, 134-94; creation and early years, 94-101; management, 101-20; military proposals, 92-94
- Manos, Nicholas E., 200
- Manville, R. W., 6
- Marcotte, Paul G., 241, 250, 251
- Mardel, A. D., 117, 119
- Mariner, 9, 13, 14, 29, 31, 32, 36-40, 205, 216, 301, 331-38, 355, 565, 566, 573; Advanced Mariner 1969, 332-35; *Mariner 1*, 331, 333-35, 565; *Mariner 2*, 331, 333, 334, 336, 573; *Mariner 3*, 332-34, 337; *Mariner 4*, 303, 332-35, 338, 438, 462, 574; *Mariner 5*, 303, 332, 333, 335, 339; *Mariner 6*, 333, 335; *Mariner 7*, 333, 335; *Mariner 8*, 333, 335; *Mariner 9*, 333, 335; *Mariner 10*, 333, 335; Mariner A, 333, 334; Mariner B, 333, 334; Mariner Mars, 216 n; Mariner Mars 1962, 334; Mariner Mars 1964, 332-34; Mariner Mars 1966, 332-34; Mariner Mars 1967, 332, 333; Mariner Mars 1969, 332-34, 566; Mariner Mars 1971, 332, 333, 335; Mariner Pioneer, 302; Mariner Venus 1962 (Mariner R), 13, 331, 333; Mariner Venus 1967, 332; Mariner Venus-Mercury 1973, 332, 333, 335
- Markley, J. Thomas, 112, 115, 116
- Marquardt Corporation, 193
- Mars, 42, 44, 61, 216 n, 217 n, 301, 311, 331, 332, 334, 335, 337-41, 406, 443-40, 470, 472, 475, 481, 493, 494, 566, 573; Mars Station, 566, 568, 569 n, 571, 574, 582; Mars Voyager, 301, 439
- Marshall Space Flight Center (MSFC), Alabama, 1, 39, 40, 44, 48, 52-54, 57-59, 61, 156, 172, 179, 181, 182, 238, 240, 433-35, 437, 440-43, 461, 473, 475, 476, 478, 481, 484-86, 489-92; Future Projects Office, 54
- Martin, Frank T., 245, 247, 299
- Martin, James A., 497, 498
- Martin Company, 83, 84, 86, 87, 151, 154, 155, 172, 180-82, 238, 320, 433, 441, 442, 455, 456, 481, 484, 485, 508; Nuclear Division, 494
- Martin Marietta Corporation, 53, 54, 57, 84, 327, 452
- Maryland, 286, 551, 589
- Maryland, University of, 251, 285
- Massachusetts Institute of Technology (MIT), 239, 240, 243, 250, 251, 254, 258, 260, 262, 307, 337, 339, 433, 460, 462, 560; Instrumentation Laboratory, 172 n, 193; Lincoln Laboratories, 560
- Mathews, Charles W., 102, 107, 110, 112-16, 154, 157, 182, 285
- Mathews, Wayne C., 366, 385
- Mattingly, Thomas K., II, 189
- Maui, Hawaii, 541
- Maurer, Inc. *See* J.A. Maurer, Inc.
- May, Ralph W., Jr., 436, 439, 449
- Mayaguana Island, 541
- Mayaguez, Puerto Rico, 564, 572
- Mayer, John P., 102 n, 116, 118, 120
- Mayer, Norman J., 440
- Maynard, Owen E., 115-18
- Mayo, Alfred M., 105, 200, 407 n
- Max Plank Institute, 297
- Mead, Merrill H., 407
- Mediterranean Sea, 557, 558
- Medrow, Karl R., 271
- Mendel, J. T., 379
- Mengel, John T., 535, 539, 541, 542, 547
- Mercury, 2, 11, 12, 15, 16, 24, 27, 31, 48-51, 100, 103, 112, 116, 121-23, 149, 154, 155, 174, 190-94, 281, 364, 448, 450, 456 n, 466, 467, 470, 472, 524, 544, 545, 547-96; astronauts, 29, 141-48, 152; Capsule Coordinator Office, 140; Capsule Review Board, 140; characteristics and chronology, 134-49; funding, 122-26; *Mercury* (tracking ship), 549, 554, 555, 557, 558, 595; *Mercury 8*, 549 n; *Mercury 9*, 549 n; Mercury-Atlas (*MA-4*, 6, 7, 8, 9), 33, 36, 37, 137, 140-42, 547, 549 n, 551, 562, 580, 587, 591, 592, 596; Mercury Control Center (MCC), 144, 146, 148, 545, 578; Mercury-Gemini, 553; Mercury Mark II, 149, 150, 155; Mercury Mission Center, 145, 147; Mercury Network Coordination Committee, 561; Mercury Network Test Vehicle (MNTV), 66, 549; Mercury-Redstone, 46, 49, 51, 52, 137, 138, 140, 143, 491, 547; Mercury-Scout, 1, 66, 547, 549, 554, 561; Mercury Support Planning Office, 139, 171; planet, 333, 566; Program Planning Office, 139, 171; Project Mercury, 30, 49, 51, 66, 100-02, 134-49, 171, 341, 354, 355, 448, 521, 522, 526, 544, 560
- Meredith, L. H., 294, 295
- Merritt Island, Florida, 174, 523, 548, 554, 562, 588
- Meteorological Flight Experiments, 205
- meteorology program, 346-63

- Mexico, 547, 561
 Michel, Douglas, 440
 Michigan, University of, 254, 258, 276, 282, 433; Aeronautical Engineering Department, 276; Observatory, 261
 Michigan State University, 433
 Michoud Assembly Facility (New Orleans), 179 n
 Microlock (tracking scheme), 524, 542, 571, 572, 575
 Middle East, 364
 Middleton, Roderick O., 110
 Midway Island, Hawaii, 347, 551
 Milan, University of, 297
 Military Sea Transport, 555 n
 Miller, James E., 107
 Miller, William E., 110
 Millick, Tom, 456
 Milliken Company. *See* D.B. Milliken Company
 Milwitsky, Benjamin, 109, 326
 Minitrack (M/T) network, 373, 524, 535-37, 539-42, 549, 560, 568, 572, 573, 575, 577, 579-81, 583, 585, 587, 588, 590
 Minneapolis-Honeywell Regulator Company, 66, 193, 264
 Minnesota, University of, 237, 254, 257, 308, 309, 395
 Mississippian Instrumentation by Electronic Means (MINSTREL), 560
 Mississippi Test Facility, Bay St. Louis, 179 n, 183
 Mitaka, Japan, 523
 Mitchell, Elliot, 5
 Mitchell, Harry, 108
 Mitchell, Jesse, 201, 202, 232
 Modisette, Jerry, 118, 119
 Moffett Field, California, 302, 342, 405
 Mohave, California, 376, 381, 393, 524, 536, 539, 540, 542, 543, 554, 564, 565, 568, 569, 572, 581, 588, 590
 Molly Brown (spacecraft), 159
 Monitor, 19, 21
 Moore, Roger C., 302
 Moore, William F., 108
 Morocco, 583
 Morris, Owen G., 115, 116, 118
 Morrison, Clarence R., 407, 525, 526
 Morrison, Richard B., 4-6, 200, 201
 Morton, D. C., 284
 Motorola, Inc., 193, 538 n
 MOTS (receiver), 575, 581, 587, 590-93
 Mount Hopkins, Arizona, 541
 Muchea, Australia, 145, 146, 546, 548, 550, 561, 578, 588
 Mueller, George E., 4-6, 102, 108, 109, 154, 179
 Muhly, William C., 102 n
 Multisatellite Operations Center, 539
 Munich, Germany, 297, 374, 377
 MX-774 (missile), 96
 Myers, Boyd, II, 406, 407
 Myers, Richard H., 105
 Mylar, 288, 369, 372
- N
- Nagy, Alex P., 105
 Naini Tal, India, 523, 541
 Navy, Xavier, 296
 NASCOM (NASA Communications System), 521, 539, 558 n, 565, 572
 Nash, Ralph, 434
 Natal, Brazil, 282, 285, 523
 National Academy of Science, 97, 177, 198, 397, 405; Space Science Board, 198, 333, 335, 342, 344
 National Advisory Committee for Aeronautics (NACA), 1, 8, 29, 49, 61, 62, 91-99, 197, 261, 265, 280, 300, 320, 364, 368, 403-05, 454, 476, 483, 494, 496, 497, 505, 506, 522, 544, 559, 560; Aerodynamics, Committee on, 96, 98, 505; Aircraft Engine Research Laboratory, 405; Aircraft, Missile, and Spacecraft Aerodynamics, 98; Ames Aeronautical Laboratory, 96; Headquarters, 95, 404; High-Speed Aerodynamics, 98; Lewis Flight Propulsion Laboratory, 96; NASA Organization, Ad Hoc Committee on (Abbott Committee), 404 n; Pilotless Aircraft Research Division (PARD), 49, 62, 66, 94, 96-98, 102, 280, 281, 403, 544, 559; Ranges, Launch, and Tracking Facilities, Working Group on, 560; Research Airplane Projects Panel, 501, 505; Space Technology, Special Committee on, 98
 National Aeronautics and Space Act, 1, 95, 99
 National Aeronautics and Space Administration (NASA): Advanced Technology Program, 101; animals, use of, 142, 143, 343; Applications, Office of, 218 n, 221 n, 271, 347, 366; Applications and Manned Flights Program Office, 347; Bioresearch, Office of, 407 n; Bioscience Program Office, 342, 344; budget, 6-24, 121-33, 203-31, 301, 339, 374, 408-31, 490, 526-34; Chemical Propulsion Office, 491; Communications and Navigation Pro-

- grams, 376, 377; cooperation with other countries, 272, 288-99; creation of, 95, 99-103, 134, 197, 232, 270, 301, 347, 572; Fleming Committee, 181; Headquarters, 5-7, 53, 54, 101, 102, 104-11, 139, 150, 153, 154, 171, 174, 179, 180, 182, 233, 249, 252, 254, 260, 261, 264, 271, 299, 302, 303, 305, 306, 310, 311, 319, 326, 332, 334, 340-42, 344, 347, 360, 361, 366, 370, 373, 376, 380, 382, 385, 392, 393, 396, 399, 431, 439, 442, 445, 446, 449-51, 453, 455-57, 475, 476, 492, 496, 503, 522, 542, 544, 545, 547, 553, 560, 562-64, 566; Hypersonic Lifting Vehicle, Ad Hoc Committee on, 455; International Affairs Office, 364; International Programs Office, 524, 546; Launch Vehicle Programs Office, 4, 491, 492; Life Sciences, Office of, 341; Lunar Exploration, Working Group of, 180; Lunar and Planetary Programs, Office of, 302, 310, 319, 326, 332; Lunar Program Office, 311; Lundin Committee, 181; Manned Space Flight, Research Steering Committee on, 180; Manned Space Flight Experiments Board, 153; Manned Space Flight Management Council, 182; Meteorological Office, 393; Missile Firing Laboratory, 1; North Eastern Office, 460 n; Nuclear Rocket Development Station (NRDS), 474, 478, 481, 482; Nuclear Vehicle Project Office, 481; Program Planning Office, 171; Propulsion, Office of, 5, 6, 492; Space Applications Program Office, 348, 366; Space Flight Development, Office of, 5, 35, 199, 271, 366; Space Flight Programs, Office of, 344, 347; Space and Information Systems Division, 172, 182, 193; Space Medicine Office, 153 n; Space Nuclear Propulsion Office (SNPO), 470, 475, 478-80, 484-87; Space Science, Office of (OSS), 4, 5, 259, 265, 301, 319, 320, 344, 467, 468; Space Science and Applications, Office of (OSSA), 4, 6, 11, 13, 14, 17, 18, 20, 153 n, 204, 218 n, 219 n, 221 n, 231, 302, 326, 340, 344, 347, 348, 366, 367, 397, 405, 438, 440, 466, 469, 473, 491; Space Science and Applications Steering Committee, 198, 344; Space Science and Satellite Applications, Office of, 348; supersonic research, 501-17
- NASA-ARPA Manned Satellite Panel, 95, 99
- NASA-Canadian Defense Research Board project, 233, 236, 249, 289, 290
- NASA-Environmental Science Services Administration experiment, 393
- NASA-DoD Gemini Program Planning Board, 154, 156
- NASA-DoD Large Vehicle Planning Group, 181
- NASA-Hughes-DoD team, 378-80
- NASA-Industry Apollo Technical Conference, 181
- NASA-Industry Program Plans Conferences, 180
- NASA-NRL project, 36, 249, 252
- NASA-State University of Iowa project, 236, 246, 253
- NASA-U.K. project, 291-93
- NASA-Weather Bureau-DoD project, 360, 361
- National Communications System, 364, 365
- National Environmental Satellite Center, 349
- National Geodetic Satellites Program, 298, 399
- National Geodetic Survey, 399
- National Research Council (Canada), 289, 397
- National Space Council, 368
- National Space Establishment, 97
- Naugle, John E., 199, 201, 232
- Naval Electronics Laboratory, 372
- Naval Equipment Center, 467
- Naval Ordnance Test Station, 156, 284, 433, 444, 447
- Naval Radiological Defense Laboratory, 282
- Naval Research, Office of, 278, 505
- Naval Research Laboratory (NRL), 1, 86, 87, 91, 93, 197, 233, 235, 238, 249, 252, 254, 259, 271, 272, 276, 280, 286, 287, 290, 313, 347, 372, 524, 534-36, 541, 560, 571; Aviation Medical Acceleration Laboratory, 98; Radio Tracking Branch, 536, 541; School of Aviation Medicine, 96, 467; Vanguard Division, 1
- Navigation Satellite Committee, 368
- Navy, U.S. Department of the, 1, 66, 67, 91, 94, 96, 99, 138, 154, 235, 275-77, 364, 501, 506, 509, 535, 536, 541, 555, 571, 575; Bureau of Aeronautics, 278, 506
- Neise, Stanford E., 94, 96
- Nelson, Alfred M., 5
- Nelson, Clifford H., 319-25
- Nelson, Evart D., 249, 290
- Neptune, 472

- Ness, Norman F., 250, 251
 Netherlands, the, 288 n, 295
 Nevada, 474, 483-85
 Newell, Homer E., Jr., 5, 6, 199-201
 New Hampshire, University of, 240-42, 247
 New Jersey, 369
 New Mexico, 544
 New Mexico, University of, 254, 257
 New Orleans, Louisiana, 179 n
 Newton, R., 247
 New Zealand, 272
 Nicks, Oran W., 201, 301, 340
 Nicolaides, John D., 201
 Nigeria, 561, 565, 572
 Nimbus, 20, 38, 69, 70, 75, 77, 205, 220, 226 n, 347, 348, 360-63, 473, 493, 494, 538, 579; *Nimbus 1* (Nimbus-A) and *Nimbus 2* (Nimbus-C), 360, 362, 363; *Nimbus 3*, 494; Nimbus B, 360, 362, 494; Nimbus Operational System (NOS), 360, 361; Project Nimbus, 360
 Nolan, James P., Jr., 105, 106, 110
 Norris, Theodore B., 5, 6
 North, Warren J., 104, 113-15, 120, 137 n
 North America, 389, 547
 North American Aviation Corporation, 48, 49, 52, 56, 58, 60, 134, 140, 152, 155-57, 176, 179, 180, 182, 183, 311, 327, 482, 502, 506-10, 515, 553, 562; Los Angeles Division, 506; Rocketdyne Division, 29, 30, 34, 36, 37, 41, 42, 45-47, 51, 53-56, 59, 61, 68, 70, 72, 74-76, 80, 193; Rocketdyne engines, 30, 41, 45, 46, 55, 72, 74-79
 North American Rockwell, 508
 Northrop Corporation, 193, 312, 343, 344, 452, 455, 457; Norair Division, 452, 455; Ventura Division, 193, 439
 North Sea, 557
 Norway, 272, 294; Norwegian Institute of Cosmic Physics, 294; Norwegian Space Committee, 294
 Nova, 3, 10, 16, 24, 171, 172, 180, 182, 491 n
 Nuclear Engine for Rocket Vehicle Applications (NERVA), 473, 479-88
 Nutley, New Jersey, 376
- O
- O'Bryant, William T., 109
 Ocean of Storms area, 328
 Ohio State University Research Foundation, 463 n
 Olifantsfontein, South Africa, 541, 586
- Olympic games, 369, 376
 OMEGA Position Location Experiment (OPLE), 395
 O'Neill, James E., 105, 106
 Operation Lost Ball, 343
 Oppenheim, A. G., 285
 Optical Tracking Network (OTN), 523
 orbital attitude and maneuvering system (OAMS), 152
 Orbiter, 235, 301, 541; Project Orbiter, 535, 571
 Orbiting Astronomical Observatory (OAO), 13, 29, 32, 37, 39, 43, 44, 205, 209, 211, 232, 254, 288, 362, 538, 543; characteristics and chronology, 259-63
 Orbiting Geophysical Observatory (OGO), 11, 13, 20, 29, 31, 32, 36, 38-40, 69, 70, 75, 205, 209, 211, 232, 288, 362, 437, 538-40, 543, 580; characteristics and chronology, 264-70
 Orbiting Solar Observatory (OSO), 11, 13, 21, 67-70, 80-82, 205, 209, 211, 232, 288, 538, 543; characteristics and chronology, 254-59
 Organ Pass, Arizona, 523
 Orroral Valley, Australia, 538 n, 540, 543, 589, 593
 Ostrander, Ron R., 4, 5
 O'Sullivan, William J., 239, 244, 368-70, 505
- P
- Pacific 2. See* International Telecommunications Satellite Consortium
 Pacific Missile Range, 281, 531, 591. *See also* Wallops Island
 Pacific (coast and ocean), 177, 178, 185, 343, 379, 381, 385, 390, 391, 397, 546, 550-52, 554, 555 n, 557, 558, 577, 584, 587, 589, 594-96
 Pad Abort-1 and 2, 178, 183, 186
 PAEGOS 1, 38, 40, 70, 75, 298, 400
 Pakistan, 272
 Panama, 536, 542
 Panel on Operation Meteorological Satellites, 361
 paraglider landing system, 152, 155-57, 435, 439
 Parkinson, John B., 497, 498
 Parks, Robert J., 326, 328
 Parsons, John F., 103 n
 Pasadena, California, 1, 197, 340, 553, 565
 Patterson, Herbert G., 102 n
 Paul VI, Pope, 364

PCM (pulse code modulation), 551
 Pearce, Fred T., Jr., 118, 120
 Pearson, Ernest O., Jr., 436, 439
 Pegasus, 57, 437, 440-43; *Pegasus 1*, 2, and 3, 58, 441-43; Project Pegasus, 435, 437
 Penrod, Paul R., 117
 Petersen, Forrest S., 509, 510
 Peterson, Bruce, A., 456-58
 Philco Corporation, 393, 396
 Philippine Islands, 381, 565, 572
 Philippine Sea, 559
 Phillips, Samuel C., 6, 109, 179, 184
 Phoebus (reactor), 476, 478, 479 n, 482, 486-88
 Pickering, John, 108
 Pickering, William H., 572
 Pierce, John R., 369
 Piland, Joseph V., 118
 Piland, Robert O., 112, 114-18, 120, 179, 180
 Pioneer, 12, 21, 29, 31, 33-35, 198, 205, 216, 232, 301-09, 332, 566, 569 n, 572; *Pioneer 1*, 68, 73, 303, 305; *Pioneer 2*, 68, 73, 303, 305; *Pioneer 3*, 48, 303, 306, 564, 572; *Pioneer 4*, 48, 301, 303, 306, 564, 572; *Pioneer 5*, 68, 73, 216 n, 302, 304, 307; *Pioneer 6*, 70, 82, 304, 307, 308; *Pioneer 7*, 70, 82, 304, 308; *Pioneer 8*, 82, 304, 308, 559; *Pioneer 9*, 82, 304, 309, 559; Pioneer Station, 568, 571, 582; Project Pioneer, 582
 Pittsburgh, University of, 284
 planetary quarantine, 228
 Pleumeur-Bodou, France, 376
 Pluto, 470, 472
 POGO (polar orbits), 264, 267, 269
 Point Barrow, 282, 347
 Poland, 364
 Polaris, 1
 Pollux, 281
 Pontiac, 451
 Portugal, 572
 Pozinsky, Norman, 525, 526
 Press, Harry, 361, 363
 Preston, G. Merritt, 112-15
 Pretoria, South Africa, 548, 552, 554, 585, 589
 Price, Paul A., 525, 526
 Princeton University, 261, 284
 Prochard, Reuben P., Jr., 110
 Prodan, John, 110
 Project Adam, 93 n, 99
 Project Big Shot, 369, 371
 Project Calorie. *See* Flight Investigation Reentry Environment (FIRE)
 Project Highwater, 57

Project Horizon, 180
 Project Man Very High, 93 n, 98
 Project MER, 94
 Project MX-1953, 33
 Project RAND, 351
 Project SERB (Study of the Enhanced Radiation Belt), 236, 242, 540, 542, 577
 Project Score, 33, 364
 Project Shotput, 369-71
 Project START (Spacecraft Technology and Advanced Reentry Test), 452
 Project Swift Stride, 355
 propellants and propulsion units, 1, 25, 26, 175, 176, 178, 470-94; chemical, 488-92; electric, 474, 475, 492-94; FLOX, 473, 491; nuclear, 475-88
 Propulsion Laboratory, 483
 Prospector, 205, 215, 338
 Pryor, Harold E., 108
 Puerto Rico, 272
 Purser, Paul E., 94, 97, 102 n, 112, 114-16, 118, 140
 Pyrazol, 369

Q

Quass, B. E., 445
 Quimby, Freeman H., 200
 Quinn, Joseph R., 104
 Quito, Ecuador, 523, 536, 539-41, 543, 575, 590

R

radar units, 545, 546, 549, 553-55, 562, 566, 573-96
 Radiation, Inc., 552 n
 Radio and Space Research Station (U.K.), 294
 Radio Attenuation Measurements (RAM), 461, 464-66; Project RAM, 121; RAM A, B, and C, 464-66; RAM C-1 and C-2, 65
 Radio Corporation of America (RCA), 101, 194, 260-62, 310-12, 319, 321-25, 347, 348, 351-57, 361, 372, 376, 377, 384, 388, 545, 546 n, 552 n; Aerospace Communications and Controls Division, 194; Astro-Electronics Division, 264, 314-18, 352, 377-79, 476, 477; RCA-ABMA project, 347; Service Corporation, 560
 Radio Research Laboratory, 399

- Radio Research Station, 293
 Rados, Robert M., 349, 353-57
 Rafel, Norman, 108
 Raffensperger, Maurice J., 110
 Raines, Martin L., 116, 118, 120
 Raisting, Germany, 376
 Randt, Clark T., 200, 341
 Ranger, 13, 29, 31, 32, 36, 38, 203, 205, 301, 309, 319, 326, 338, 355, 553 n, 565, 566, 573; Project Ranger, 309, 312, 318, 319, 462; *Ranger 1*, 40, 309, 311, 313, 573; *Ranger 2*, 40, 309, 311, 313; *Ranger 3*, 40, 310, 311, 314; *Ranger 4*, 40, 310, 311, 315; *Ranger 5*, 40, 310, 312, 316, 565, 573; *Ranger 6*, 40, 310, 312, 316; *Ranger 7*, 40, 301, 310, 312, 317; *Ranger 8*, 40, 310, 312, 317; *Ranger 9*, 40, 310, 312, 318
Range Tracker (tracking ship), 549, 551, 595
 Raymond Engineering Laboratory, 240-42
 Raytheon Company, 194
 Reaction Motors, Inc., 275, 501, 502, 506
 Rebound, 13, 205, 206, 223 n, 377
 Rehtin, Eberhardt, 562, 564, 566, 571, 573
 Redondo Beach, California, 264
 Red Planet, *See* Mars
 Redstone, 2, 10-12, 15, 16, 24, 27, 48, 51, 52, 84, 93, 96, 97, 99, 100, 121, 134 n, 138-40, 142, 235, 286, 491, 571; Arsenal, 56, 93, 96, 97; *Redstone* (tracking ship), 549, 554, 555 n, 557, 558, 595
 Reed, Robert Dale, 451, 454, 456
 Reentry Test Vehicle Program, 571
 Reeves Instrument Corporation, 545, 546 n
 Reiff, Glenn A., 302, 303, 332
 Rekos, Nelson F., 497, 498
 Relay, 21, 69, 80, 81, 205, 206, 223, 367, 368, 373, 374, 376-78; Project Relay, 21, 376, 377; *Relay 1* and 2, 364, 376-79
 Rendezvous Techniques, 181
 Renzetti, Nichola A., 566
 Republic Aviation Corporation, 254, 255, 361, 449-51, 502, 506
 Research Airplane Committee, 503, 506, 508
 research and development, 31, 33, 42-44, 52, 56, 64, 66, 67, 85, 121, 171, 177, 199, 203, 207, 213, 219, 222, 362; R&D launch, 31, 33, 42-44, 52, 56, 64, 66, 67, 85. *See also* advanced research and technology
 Research and Technology Advisory Council, 405 n
 Reynolds, Orr E., 201, 202, 341, 344, 469
 Rhode, Richard V., 406, 436, 437
 Rice University, 103 n, 395
 Ricke, William B., 107
 Ricker, Harry H., Jr., 102 n
 RIFT (Reactor-in-Flight Test), 476, 479, 486; Project RIFT, 473
 Rio de Janeiro, Brazil, 376
 Risso, William P., 105, 106
 Ritland, Osmond J., 105, 107
 Roadman, Charles H., 105, 106
 Robbins, M. O., 291, 292
 Robert, Frank C., 102 n
 Roberts, Leonard, 407
 Robledo, 565, 570, 571, 573, 574, 579, 587, 590
 Rochelle, R. W., 296
 Rochester, University of, 254, 256, 258
 Rogallo, Francis M., 439 n
 Rogers, Donald P., 376
 Roman, Nancy, 252, 261, 284
 Rome, University of, 299, 300
 Roosa, Stuart A., 168
 Rosche, Melvin G., 436, 440
Rose Knot Victor (tracking ship), 546, 549, 551, 552, 595
 Rosen, Harold A., 378, 382
 Rosen, Milton W., 4, 5, 104, 182
 Rosenberg, Jerome D., 252, 399
 Rosenberry, John W., 5
 Rosman, North Carolina, 393, 523, 536-38, 540, 542, 543, 590
 Roth, Gilbert L., 109
 Round Hill, Massachusetts, 370
 Rover, 476, 479, 485, 487; Project Rover, 473, 476, 479-84, 486; Rover Coordination Group, 484
 RTG (radioisotope generators), 473, 493-95
 Ruff, George E., 137 n
 Runge-Kutta method, 435
 Rushworth, Robert A., 509-13
 Russell, Harold G., 109-11
 Ryan Aeronautical Company, 155
- S
- SA-10 (vehicle), 442
 S-45 (ground instrumentation plan), 545, 546, 561
 Saigon, R.V.M., 381
 Sailplane Corporation of America, 451, 454, 456
 St. John's, Newfoundland, 523, 536, 539, 540, 542, 543, 581, 591
 St. Lawrence River, 354
 St. Louis, Missouri, 102, 137, 143, 154,

- 156, 157
 Salisbary, Australia, 381
 Salmanson, J. A., 5, 6
 Sanders, Newell D., 101, 104, 200
 Sandia Corporation, 283, 313
 San Diego, 536, 537, 539 n, 540, 590
 San Fernando, Spain, 523, 541, 542
 Sanger, Eugen, 505
 Sanger-Bredt design, 505
 San Marco, 5, 6; *San Marco I*, 64, 288, 299; *San Marco II*, 27, 288, 300
 San Nicolas Island, California, 548, 551, 591
 Santa Barbara, California, 494
 Santiago, Chile, 523, 536, 538-40, 542, 543, 575, 591
 Sartor, Ronelda F., 102 n
 Sasser, James H., 120
 Satellite Automatic Tracking Antennas (SATAN), 538, 575, 581, 587, 588, 590-93
 Satellite Tracking and Data Acquisition Network (STADAN). *See* Space Tracking and Data Acquisition Network
 satellites: Aeronomy Satellite, 243; Atmospheric Density Satellite, 244; Cooperative Applications Satellite, 205, 221; Direct Measurements Satellite, 249; geodetic satellites and investigations, 21, 206, 226, 288, 399, 400, 543; intermediate-altitude, 224 n; international ionospheric (UK-1), 206, 212 n; international project (UK-2 & 3), 206, 212 n; International Radiation Investigation Satellite (IRIS), 65, 274, 280, 294, 295; International Satellite for Ionospheric Studies (ISIS), 249, 290, 543, 586; Micrometeoroid Detection Satellite (MDS), 440; Midas, 2, 40; OV3-IV research, 65; radiation measurement, 224 n; scientific, 15, 19, 20, 47, 227, 232, 235; S-66, 462, 463; transitional satellite system, 224 n; voice broadcasting, 226 n. *See also* Geodynamics Experimental Ocean Satellite (GEOS), Tiros
 Saturn, 1, 4, 17, 23, 24, 53-61, 84, 85, 101, 179, 215 n, 338, 472, 474, 481, 491 n; Advanced Saturn, 3; Saturn I, 3, 10, 17, 27, 54, 56-58, 60, 121, 183, 186, 441, 443; Saturn 1B (Up-rated Saturn), 3, 10, 17, 28, 55, 56, 58-61, 121, 174, 183-85, 187, 188; Saturn 1B-Centaur, 441, 442, 474; Saturn V, 2, 3, 10, 18, 28, 56, 60, 61, 100, 101, 121, 174, 176, 178, 187, 189; Saturn C-1, 3, 54, 57, 180, 186, 444, 489; Saturn C-2, 54, 59, 181; Saturn C-3, 59; Saturn C-5, 16, 54, 60, 61, 174, 182; Saturn S-11, 184; Saturn SA-1 through Saturn SA-5, 182, 183; Saturn SA-6, 552; Saturn Vehicle Evaluation Committee, 57; Saturn Vehicle Team, 180
 Savage, Melvin, 6, 109
 Sawyer, Ralph S., 115, 117, 119
 SCANNER, 461; Project SCANNER, 463, 464
 Schaibley, John R., 104-06, 109
 Scheib, Walter S., 471
 Scherer, Lee R., 109, 319
 Schilling, Gerhard F., 200
 Schirra, Walter M., Jr., 137 n, 141, 146, 147, 153, 157, 159, 163, 185, 188
 Schjeldahl Company. *See* G.T. Schjeldahl Company
 Schmerling, E. R., 284
 Schmidt, H. R., 471
 Schneider, William E., 108-10
 Schneiderman, Dan, 332, 339
 Schnyer, A. Daniel, 110
 Schonstedt Engineering Company, 239
 Schubert, W., 5
 Schurmeier, Harris M., 310, 312, 316-18
 Schwartz, I. R., 471
 Schwenk, F. C., 471
 Scientific Experiments Panel, 156
 Scott, David R., 153, 158, 164
 Scott, Walter C., 407, 471
 Scout, 1-3, 5, 6, 10, 11, 19-21, 24, 27, 28, 41, 46, 61-67, 174, 210, 233, 239, 241, 242, 244-47, 249, 252, 253, 292-99, 378, 444, 447, 448, 463, 465-77, 549; R-1 through R-6, 444-48; Reentry Heating Project (Supercircular Reentry Research Project), 121, 186, 435, 438, 443-48; Scout X, 27; Turbulent Heating Experiment Project, 445
 Scull, Wilfred E., 266-70
 Seamans, Robert C., 155, 182
 Sea of Clouds (area), 317
 Sea of Japan, 557, 558
 Sea of Okhotsk, 557
 Sea of Tranquility (area), 316, 317, 330
 Seaton, C. H., 471
 Seccomb, Milo L., 6, 109
 See, Elliott M., Jr., 157, 161, 162, 165
 Selvaggi, Philip S., 106
 Senate, U.S., 7, 95, 209, 214 n, 217 n, 382; Commerce Committee, 374; Committee on Aeronautical and Space Sciences, 198; Preparedness Investigating Committee, 98. *See also* Congress, U.S.

- Sergeant, 1, 47, 64, 235, 571; Sergeant-Delta, 370
- SERT (Space Electric Rocket Test), 1, 64, 475; Project SERT, 472, 475, 476; SERT 1, 64, 476, 477; SERT 2, 475, 476
- service module (SM), 193
- Shea, John T., 253
- Shea, Joseph F., 104-06, 113-16
- Sheffield, University of (U.K.), 293
- Shelton, Harvey W. C., 105, 107
- Shepard, Alan B., Jr., 15, 120, 137 n, 138, 141, 143-48
- Sherburne, R. K., 6
- Shows, James C., 119
- Shulman, Fred, 471
- Sigma 7, 147
- Silverstein, Abe, 2, 5, 35, 101, 104, 137 n, 180, 200, 525
- Sims, Theo E., 465, 466
- Singapore, 540, 543, 591
- Sinus Medii (area), 330
- Sjoberg, Sigurd A., 116, 118, 120
- Skaggs, James B., 6, 109
- Skylab. *See* Apollo
- Slayton, Donald K., 103, 114-16, 120, 137 n, 141, 143, 146, 147
- Slidell, Louisiana, 179 n
- Slidell Computer Facility, 179 n
- Slivka, William R., 471
- Sloan, James E., 105
- Sloop, John L., 5, 406, 471
- Small, John W., 118, 119
- Smith, Arvin H., 471
- Smith, Charles P., 373, 375, 385, 389-91
- Smith, Earl K., 117
- Smith, Francis B., 525
- Smith, G. Dale, 104, 200
- Smith, Henry J., 201, 205
- Smith, Norman F., 112
- Smith, W. S., 285
- Smithsonian Astrophysical Observatory (SAO), 260, 261, 399, 524, 539-41, 585; Telescope, 263; Tracking Network, 541
- Smolensky, Stanley M., 6, 104, 106, 108
- Smull, Thomas L. K., 200, 201
- Smylie, Robert E., 119
- Snyder, Samuel, 5, 471
- SOCS (spacecraft orientation control system) project, 419
- Solant, 540, 543, 591
- Solar Electric Propulsion Systems Technology (SEPST), 475
- Sorlie, Donald, 457, 458
- Soule, Hartley, 505
- sounding rocket program, 205, 206, 209, 220, 228-31, 270-85, 288; Aerobee, 87, 272-74, 276-78, 284; Aerobee-Hi, 35, 73, 275, 276; Arcas, 272-74, 276, 278, 284, 444, 445; Arcon, 274, 279; Argo, 272, 280, 281; Asp, 272, 281; Astrobee, 272-74, 279, 285; Black Bryant, 272-74, 276, 279, 280, 285; Iris, 274, 280; Javelin, 272-74, 280, 284; Journeyman, 272, 274, 281, 340; Nike, 272, 276, 280-82, 438, 439; Nike-Apache, 274, 281, 284; Nike-Asp, 274, 282; Nike-Cajun, 273, 274, 276, 282, 285, 370; Nike-Deacon, 276; Nike-Tomahawk, 273, 274, 283, 285; Skylark, 272, 274, 283; Tomahawk, 272, 273; vs. earth-orbiting satellites, 271
- South Africa, 565
- South America, 136, 542
- South China Sea, 557, 558
- Southeast Asia, 591
- South Point, Hawaii, 539 n, 540, 542, 543, 591
- Southwest Center for Advanced Studies, 251, 284
- Soviet Union. *See* Union of Soviet Socialist Republics
- Spacecraft Integration and Sounding Rocket Division, 271
- Space Electronics, 560
- Space-General (Aerojet-General), 278
- space science and applications, 197-400; ATS program, 392-99; budget, 203-31; communications program, 364-91; life sciences program, 340-46, 466-69; lunar and planetary program, 300-40; meteorology program, 346-63; physics and astronomy program, 232-300
- Space Task Group (STG), 102, 103, 134, 137-41, 144, 149, 155, 171 n, 172, 181, 466, 467, 545, 547, 549, 551, 560, 561; Advanced Vehicle Team, 180; Aeromedical Consultants Staff, 466; Engineering and Contract Administration Division, 112 n; Flight Systems Division, 112 n, 155; New Projects Panel, 155, 180; Operations Division, 112 n, 113 n; organization, 112-20; Technical Liaison Groups, 181. *See also* Manned Spacecraft Center
- Space Technology Laboratories, Inc. (STL), 34, 35, 72, 182, 194, 237, 255, 265, 266, 302, 303, 305, 307, 320, 327, 376, 377, 485, 538. *See also* TRW
- Space Tracking and Data Acquisition Network (STADAN), 395, 521-23, 534-43, 569 n, 575-96
- Spain, 288 n, 561, 565, 568, 572, 573, 582

- Sparrow, 276
 Special Committee on Life Sciences, 341
 Spencer, N. W., 243, 250, 267, 269
 Sperry Gyroscope Company, 571
 Spin Scan Cloud Cover Experiment (SSCCE), 395
 Spreen, William C., 271, 348
 Stack, John P., 406, 497, 498
 Stafford, Henry N., 380
 Stafford, Thomas P., 153, 157-59, 163, 165, 188
 Stampfl, Rudolf A., 349
 Stanford Research Institute, 378, 382
 Stanford University, 237, 307-09, 337, 339
 Starfish (high altitude nuclear test), 242, 375
 State, U.S. Department of, 364, 366, 368, 524
 Station Technical Operations Control, 543
 Stephens, Robert R., 525
 Sternfield, Leonard, 497, 498
 Sterrett, John, 525
 Stevens, Samuel R., 296
 Stevenson, John D., 110
 Stever, H. Guyford, 98
 Steward Committee. *See* Defense, U.S. Department of
 Stoddard, David H., 105, 106
 STOL (short takeoff and landing), 501
 Stoller, Morton J., 200, 271
 Stone, David G., 395, 449, 451
 Stone, Robert G., 253
 Stoner, George, 109
 Stoney, William E., 109, 114, 115, 117
 Strass, H. Kurt, 180, 436
 Stroud, William G., 348, 349, 352, 361
 Strughold, Hubertus, 96
 Studebaker-Packard Corporation: Cincinnati Testing and Research Laboratory, 194
 Stuhlinger, Ernst, 238, 440
 Sullivan, Francis J., 407, 460
 Summerfelt, William A., 108
 Sunblazer, 212 n
 Sunderlin, Wendell S., 377, 379
 supersonic/hypersonic transport, 501-17;
 Douglas FSD-1 skylancer, 515 n;
 F-100C Super Sabre, 515 n; F-104, 515 n;
 F-111, 517; Lockheed YF-12A Blackbird, 515 n, 517; North American A-5A Vigilante, 515 n;
 SCAT (Supersonic Commercial Air Transport), 515; SST, 514-17; SST Advisory Board, 514; X-15, 502-14; XB-70, 515-17. *See also* SCANNER
 Sures, Allan H., 260
 Surveyor, 14, 29, 31, 32, 42-44, 176, 205, 214 n, 215, 301, 310, 319-23, 325-31, 338, 493, 565, 566, 570; *Surveyor 1* through 7, 326-31
 Swanson, Andrew G., 445, 447
 Sweden, 272, 294; Kiruna Geophysical Observatory, 43
 Sweeney, William R., 108
 Swigert, John L., 188
 Switzerland, 288 n
 Sylvania, 393
 Syncom, 13, 21, 67, 69, 81, 205, 206, 224, 364, 367, 368, 380, 393, 396; Advanced Syncom, 392, 393, 396; Project Syncom, 377, 379, 385; *Syncom 1*, 380, 382, 383, 396; *Syncom 2*, 380-82, 384, 396; *Syncom 3*, 364, 381, 382, 384, 396
 Systems Engineering Group. *See* WECO
 Systems for Nuclear Auxiliary Power (SNAP), 360-62, 473, 494, 495
 Syverston, Clarence A., 453
- T
- Talbot, John M., 105
 Talentino, J., 294, 295
 Tananarive, Malagasy Republic, 523, 538 n, 540, 543, 548, 552, 554, 557, 587, 588, 591
 Tasman Sea, 343, 557
 Taylor, B., 297
 Taylor, Charles A., 526
 Taylor, Eldon D., 201, 202
 Taylor, Paul D., 102 n, 111
 Taylor, William B., 105, 106, 109, 111
 TEL-4 (tracking station), Florida, 548, 592
 Telstar, 68, 69, 81, 202, 364, 367, 373-75, 377; *Telstar 1* and 2, 373-75
 Temco, 361
 Temple University, 251, 337
 Tepper, Morris, 201, 346, 347, 349
 Test and Training Satellites (TTSs), 554;
 TTS-1 (TETR-1), 308, 554, 559, 563;
 TTS-2 (TETR-2), 309, 554, 559, 563
 Test Cell A, 483
 Texas A&M University, 355
 Textron, 36, 37, 74-76
 Thatcher, J. W., 566
 Thibodaux, Joseph G., Jr., 115, 117, 119
 Thiokol Chemical Corporation, 49, 50, 62, 63, 67, 75, 76, 78-80, 194, 279-83, 489, 490, 502, 506
 Thome, Pitt, 202
 Thompson, Floyd L., 176, 184

- Thompson, Milton O., 453, 456-58, 511-13
- Thompson, Robert F., 110, 116-19
- Thompson, Thomas H., 6, 109
- Thor, 1, 2, 19, 24, 27, 40, 67-83, 98, 223 n, 491; Thor-Able, 3, 10, 19, 20, 27, 206, 209, 217 n, 237, 302, 303, 305, 307, 351, 352; Thor-Able Star, 3; Thorad, 67; Thorad-Agena D, 360, 362; Thor-Agena, 3, 11, 13, 19, 20, 27, 223 n, 371; Thor-Agena B, 3, 10, 11, 20, 209, 249, 289, 290; Thor-Agena D, 10, 267, 269; Thor-Delta, 1-3, 10, 19, 21, 27, 67, 233, 239-43, 245, 247, 248, 250-54, 256-59, 291, 297, 299, 300, 307-09, 344-46, 353-59, 371, 372, 375, 376, 379, 380, 383, 384, 387, 389-91, 554, 559; Thor-Hustler, 3; Thor-Jupiter, 54, 56; Thor-Vanguard, 303
- Tidbinbilla, 554, 562, 565, 570, 571, 573, 574, 585, 592
- Tikhonravov, Mikhail K., 270, 275
- Tiros (Television Infra-Red Observation Satellite), 20, 21, 80, 347, 349, 351, 360, 539, 543; Project Tiros, 347, 348; *Tiros I* through *10*, 67-69, 73, 81, 348-57; Tiros A-1, 351; Tiros Operational System (TOS), 348, 351, 357, 362; TIROS-TOS, 220
- Tischler, Adelbert O., 5, 6, 104, 106, 407, 470, 471
- Titan, 1, 2, 150, 155, 157, 452, 472; Titan II, 3, 11, 13, 22, 24, 27, 83-85, 121, 151, 154, 156, 158; Titan IIC, 3, 474; Titan Launch Vehicle (TLV), 165-68
- Titania, 472
- Tokyo, Japan, 364
- Toll, Thomas, 505
- Toowoomba, Australia, 393, 523, 540, 543, 592
- Townsend, John W., Jr., 242
- tracking and data acquisition, 521-96; budget, 526-34; characteristics, 534-96; management, 525, 526; tracking facility sites, 523, 539, 540. *See also* Deep Space Network, Manned Space Flight Network, Satellite Tracking and Data Acquisition Network
- Tracking and Data Acquisition, Office of (OTDA), 522, 524, 526, 538, 553, 554, 563, 566; Station Technication Operations Control, 538
- Tracking and Communication Extraterrestrial (TRACE), 572
- Tracking and Ground Instrumentation Unit (TAGIU), 545-47, 560
- Trailblazer. *See* Air Force, Scout Transportation, U.S. Department of, 405, 406 n
- Treasury, U.S. Department of the, 368
- Trimble, George S., 109, 116, 118
- Triolo, J., 395
- Triton, 472
- TRW Systems, Inc., 194, 251, 264-70, 302-04, 307-09, 320, 384, 385, 388, 389, 391. *See also* Space Technology Laboratories
- Truszynski, Gerald M., 522, 525, 526, 553
- Tsander, F. A., 275
- Turner, W. R., 105
- Turnock, James H., Jr., 6, 104, 106, 109
- Twin Falls Victory* (tracking ship), 549, 595
- Tycho (crater), 331
- U
- Underwood, Jack F., 105, 106
- Underwood, William J., 437
- Union of Soviet Socialist Republics (USSR), 91 n, 92, 95, 97, 100, 101, 271, 275, 286, 300, 309, 348, 376, 479, 550, 571; cooperation with the United Kingdom, 370; cooperation with the United States, 370-72; Luna, 300; Sputnik, 300, 479, 542, 571; *Sputnik I* and 2, 97; *Vostok 1*, 100, 141
- United Aircraft Corporation: Hamilton Standard Division, 194; Pratt & Whitney Aircraft Division, 42, 44, 54-57, 194
- United Kingdom, 272, 274, 283, 373, 375, 377, 382, 534, 593; Air Ministry, 292; cooperation with the United States and USSR, 370; Royal Aircraft Establishment, 293; Science Research Council, Space Research Management Unit, 293
- United States, 149, 271, 276, 375, 481, 489, 535; cooperation with USSR, 370-72; General Accounting Office, 255, 362; Geodetic Satellite Program, 233, 236, 248, 252; Geological Survey, 316-18, 328-30; link with Far East, 384; manned mission, 100; National Bureau of Standards, 244, 403; peaceful space exploration, 470; vs. Soviet Union, 100, 101, 480
- United Technology Center (UTC), 62, 80
- UNIVAC, 552
- USNS Kingsport*, 380

- USS Champlain*, 143, 161
USS Essex, 188
USS Guadalcanal, 166
USS Guam, 167
USS Intrepid, 159
USS Kearsarge, 147, 148
USS Mason, 164
USS Noa, 145
USS Pierce, 146
USS Randolph, 144
USS Wasp, 160, 162, 163, 165, 168
USS Yorktown, 189
 University College, London, 244, 249,
 259, 291, 294
 Uranus, 472
 Utrecht, University of (the Netherlands),
 295
- V
- V-2 Upper Atmosphere Research Panel,
 275
 Vale, Robert E., 117
 Van Allen, James, 235, 286
 Van Allen Belt, 237, 247, 287, 305, 306,
 373, 375, 443
 Vanguard, 1-3, 24, 27, 29, 34, 35, 67, 72,
 73, 83, 86, 87, 197, 198, 204, 206,
 207, 209, 212 n, 235, 288, 368, 370,
 437, 491, 536, 539, 541, 542, 571;
 characteristics and chronology, 86, 87,
 286, 287; Project Vanguard, 86, 87,
 93, 271, 535, 541; *Vanguard 1*, 87,
 286, 399; *Vanguard 2*, 87, 286, 287,
 347; *Vanguard 3*, 87, 212 n, 286, 287;
Vanguard (tracking ship), 549, 554,
 555 n, 557, 558, 595
 Van Ness, Harper E., 104, 106, 108
 Varian Associates, 239
 Vavra, Paul H., 114, 115, 117
 Vega, 1, 3, 11, 22, 24, 29, 39, 45, 171 n,
 309, 311
 Venus, 42, 44, 301, 306, 331-36, 339,
 341, 438, 440, 470, 472, 565, 566, 573;
 Venus Station, 567 n, 569 n, 582
 Vessely, Jack E., 109
 Victor, Walter K., 562, 566
 Vietnam: conflict, 217; South, 481
 Viking, 86, 87, 235, 275, 339, 494, 535,
 541; Project Viking, 301, 339, 341
 Vinograd, Sherman P., 108
 Virginia, University of, 433
 Virginia Associated Research Center, 438;
 Space Radiation Effects Laboratory,
 438
 Virginia Polytechnic Institute, 433
- Voas, Robert B., 112-14, 137 n
 Vogely, Arthur, 506
 von Braun, Wernher, 1, 54, 56, 93, 97,
 99, 100, 171, 179, 180, 182
 Voris, Frank B., 105, 200
 Voyager, 61, 205, 216 n, 217, 332, 339;
 Project Voyager, 341
 V/STOL (vertical/short takeoff and lan-
 ding), 499-501
 VTOL (vertical takeoff and landing), 501
- W
- Wac Corporal. *See* Baby Wac
 Waddel, Dr., 395
 Wagner, Robert L., 6, 109
 Wake Island, 548, 551, 592
 Walker, Joseph A., 502, 503, 509-11, 515 n
 Wallops Flight Center (Wallops Island,
 Virginia), 48, 61, 62, 94, 96, 134, 140,
 142, 186, 233, 239, 242, 246, 247, 249,
 252, 261, 272, 277-83, 285, 292,
 297-99, 405 n, 444, 447, 448, 463-66,
 477, 522, 531, 533, 544, 546, 548, 559,
 561, 562
 Wallops Research Station, 66, 96, 179 n,
 405 n
 Washington, D.C., 93, 95, 101, 341, 479,
 481, 482, 536
 Washington, University of, 433
 Washington Technological Associates,
 291, 292
Watertown (tracking ship), 549, 555 n,
 596
 Watkins, Julia R., 102 n
 Waugh, Merle G., 104, 109
 Weather Bureau, U.S., 347-51, 354, 357,
 360-62, 437; National Weather
 Satellite Center, 348, 350; Panel on
 Observations over Space Data
 Regions, 361
 Webb, James E., 141, 341, 460
 Weber Aircraft Corporation, 194
 Webster, Kenneth, 526
 WECO (also Systems Engineering Group),
 546, 561
 Weiss, Stanley P., 115
 West, Julian M., 116, 118
 Western Electric, 546, 561. *See also*
 WECO
 Western Test Range (WTR), 198, 233,
 244-46, 249, 251-53, 289, 290, 293-96,
 298, 358, 359, 363, 371, 372, 589
 Westinghouse Electric Corporation, 194,
 260-62, 292, 476, 480-82, 485;
 Aerospace Division, 251; Aerospace