

ALS  
**Beamline  
Design  
Guide**

**INFORMATION FOR BEAMLINER DESIGNERS**

**MARCH 1998**

Revision 2

**Advanced Light Source  
Ernest Orlando Lawrence Berkeley National Laboratory  
University of California  
Berkeley, CA 94720**

## DISCLAIMER

This document was prepared as an account of work sponsored by the United States Government. While this document is believed to contain correct information, neither the United States Government nor any agency thereof, nor The Regents of the University of California, nor any of their employees, makes any warranty, express or implied, or assumes any legal responsibility for the accuracy, completeness, or usefulness of any information, apparatus, product, or process disclosed, or represents that its use would not infringe privately owned rights. Reference herein to any specific commercial product, process, or service by its trade name, trademark, manufacturer, or otherwise, does not necessarily constitute or imply its endorsement, recommendation, or favoring by the United States Government or any agency thereof, or The Regents of the University of California. The views and opinions of authors expressed herein do not necessarily state or reflect those of the United States Government or any agency thereof, or The Regents of the University of California.

Ernest Orlando Lawrence Berkeley National Laboratory  
is an equal opportunity employer.

Documentation referred to in this document and additional copies of this manual are available from the ALS User Office, 510-486-7745, Fax: 510-486-4773.

The ALS values your suggestions. Please send any comments about this publication to Elizabeth Moxon at [ejmoxon@lbl.gov](mailto:ejmoxon@lbl.gov).

---

# Contents

<b>About This Manual</b>	v
<b>Introduction</b>	vii
<b>Beamline Definitions</b>	
Beamline Component Groups	1
Responsibility for Beamline Components	3
<b>Guidelines For Beamline Reviews</b>	
General Information	5
Review Process	6
<b>Conceptual Design Review</b>	
General Information	7
<b>Beamline Design Review</b>	
General Information	9
Documentation Package	9
1. Beamline/Endstation Layout	10
2. Radiation Shielding	11
3. Hutches	12
4. Vacuum Components and Safety	13
5. Equipment-Protection System	14
6. Electrical Safety	16
7. Liquid-Cooled Components	17
8. Seismic Safety	18
9. Thin Vacuum Windows	19
10. Utility Requirements	19
11. Mechanical Safety	20
12. Typical Experiment	20

# **Construction Begins**

**General Information** 23

# **Beamline Readiness Review**

**General Information** 25

# **Beamline Readiness Review Walkthrough**

**General Information** 27

# **Appendices**

29

**Appendix A: Criteria For Beamline Bremsstrahlung Shielding**

**Appendix B: Advanced Light Source Vacuum Policy and Vacuum Guidelines for Beamlines and Experiment Endstations (LSBL-280)**

**Appendix C: Survey and Alignment Information for ALS Users**

**Appendix D: Information Sheets and Checklists for Beamline Review Committee Beamline Reviews (Procedure BL 08-16, Appendices I-VI)**

**Appendix E: Contacts for Additional Information and Technical Questions**

**Appendix F: Checklist and Timeline for Building a Beamline**

**Appendix G: ALS User Advisories**

**Appendix H: Radiation Hazards at the ALS**

**Appendix I: Guidelines for Meeting Seismic Requirements for User Equipment at the ALS**

**Appendix J: Design Criteria for O-Rings in High-Radiation Areas**

**Appendix K: UV Light Hazards from Synchrotron Radiation**

**Appendix L: Disassembly of Beamline Sections**

---

# About This Manual

## PURPOSE

This manual (formerly known as *ALS Beamline Design Requirements*) is written as a guide for those involved in the design and construction of beamlines and endstations acceptable for use at the ALS. It contains guidelines and policies related to personnel safety and equipment and vacuum protection. All equipment and procedures must ultimately satisfy the safety requirements in the Berkeley Lab (LBNL) *Health and Safety Manual* (PUB-3000) which is available on the internet from the Berkeley Lab home page ([www.lbl.gov](http://www.lbl.gov)).

## ABBREVIATIONS

<b>BDR</b>	Beamline Design Review
<b>BRC</b>	Beamline Review Committee
<b>BRR</b>	Beamline Readiness Review
<b>CDR</b>	Conceptual Design Review
<b>EH&amp;S</b>	Environment, Health, and Safety
<b>EPS</b>	Equipment Protection System
<b>LCW</b>	Low-Conductivity Water
<b>MOU</b>	Memorandum of Understanding
<b>PRT</b>	Participating Research Team
<b>PSS</b>	Personnel Safety Shutter
<b>RGA</b>	Residual Gas Analyzer
<b>RSS</b>	Radiation Safety System
<b>UHV</b>	Ultra-High Vacuum



---

# Introduction

## **ABOUT THE ADVANCED LIGHT SOURCE**

The Advanced Light Source (ALS) is a national user facility for scientific research and development located at the Lawrence Berkeley National Laboratory (LBNL) of the University of California. Its purpose is to generate beams of very bright light in the ultraviolet and soft x-ray regions of the spectrum. Funded by the U.S. Department of Energy, the ALS is open to researchers from industry, universities, and government laboratories.

## **RESEARCHERS AT THE ALS**

A researcher at the ALS can work as a member of a participating research team (PRT) or as an independent investigator. PRTs (collaborative groups of people from industry, universities, and/or government laboratories) are responsible for the design and construction of one or a combination of the following: insertion device, beamline, endstations (experiment chambers). Independent investigators may bring experiment endstations to the ALS from other locations, or may use endstations provided by the ALS facility or by a PRT.

In either case, any team or independent investigator who brings a beamline or related equipment to the ALS must design the equipment such that it:

- Conforms with all applicable safety regulations
- Incorporates measures for the protection of the storage-ring vacuum and of costly beamline components.





# Beamline Definitions

## BEAMLINE COMPONENT GROUPS

### Definition of a Beamline

Beamlines are photon delivery systems that begin at the storage ring vacuum chamber and extend onto the experiment floor to include the experiment endstations. This definition of a beamline includes configurations with multiple branchlines and endstations.

A beamline might have multiple branchlines to accommodate different optical instrumentation. Each branchline might have multiple endstations to optimize timesharing of the beam. The simplest beamline configuration would have no branching and a single endstation.

### Beamline Configuration

The figure below represents a generalized combination of configurations.

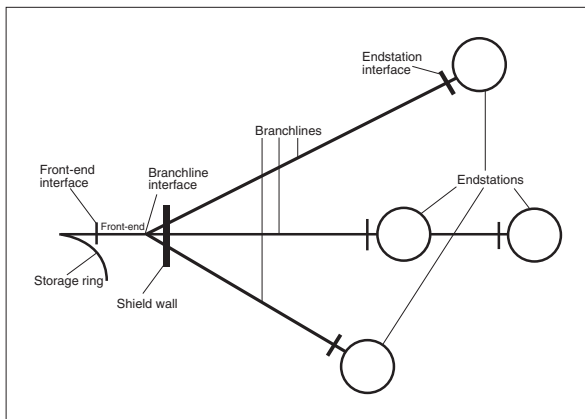

The three major beamline component groups are:

- Front end
- Branchlines
- Endstations

Even in the simplest configuration with no branching, the component group between the front end and the endstation will be called a branchline in this manual.

### Front End

The front end begins at the storage ring vacuum chamber and ends at the branchline interface, which is generally located immediately downstream (toward the experiment) from the personnel safety shutter(s) at the shield wall. (In some cases the branchline interface may occur further downstream or further upstream.)

Each beamline has one front end shared by all branchlines. The major components of a front end are:

COMPONENT	FUNCTION
Water-cooled apertures	Pass the entire or a partial width of the beam to downstream components while protecting equipment from thermal damage.
Vacuum valves	Permit isolation of the beamline vacuum environment from that of the storage ring.
Water-cooled photon shutter	Closes to interrupt transmission of the synchrotron-radiation beam.
Personnel safety shutter	Closes to provide bremsstrahlung radiation shielding for the beamline.

**Note:** For bend-magnet beamlines, space in the front end will be reserved for a possible mirror chamber.

**Branchlines**

The branchline component group begins at the branchline interface and ends at the endstation interface, which is immediately upstream from the first endstation component.

Although the branchline section begins at the branchline interface, it need not begin branching at that point. On some beamlines with multiple branchlines, a region beginning at this interface and extending downstream for a distance may contain instrumentation that is shared by all the branchlines. For example, a single mirror tank or aperture tank may be used to service all the branchlines.

The following component types are found in branchlines:

COMPONENT	FUNCTION
Personnel safety shutter	Closes to provide bremsstrahlung radiation shielding for the branchline.
Optics	Focus and filter the synchrotron-radiation beam. Focusing mirrors and monochromators are examples.
Vacuum valves	Isolate components for installation, servicing, and equipment protection. Isolate the branchline vacuum from the attached endstation(s).
Diagnostics	Align and qualify optical components. Provide data on the properties of the beam.

**Endstations**

The endstation component group begins at the endstation interface. It may consist of one or more experiment stations. The components will vary depending on the type of experiments being conducted.

Certain endstations, for example those on white-light beamlines, must be surrounded by a hutch to protect personnel from radiation.

## RESPONSIBILITY FOR BEAMLINE COMPONENTS

### Policy

The responsibility for the design, construction, and installation of the major beamline components will be specifically defined in a memorandum of understanding (MOU) executed by the ALS Scientific Program Head and each PRT developing a beamline. In general, responsibility is assigned as follows:

COMPONENT GROUP	RESPONSIBILITY
Front end	<p>The ALS will design all front-end components.</p> <p>The ALS staff or a PRT may build a front end depending on the agreement reached in the MOU for that PRT. In either case, construction of the front end will be based on designs provided by the ALS, with no modifications.</p> <p>The ALS staff will install the front end for all beamlines.</p>
Branchlines	<p>The ALS or PRT will design, build, and install all branchline components, except as stated below or in the MOU.</p> <ul style="list-style-type: none"> <li>• The ALS will design, build, and install all branchline interlocks and controls related to radiation safety.</li> <li>• The ALS will oversee survey and alignment of branchline components during installation.</li> </ul>
Endstations including hutches	<p>The PRT or an independent investigator will design, build, and install all endstation components, except as stated below or in the MOU.</p> <ul style="list-style-type: none"> <li>• The ALS will design, build, and install all endstation interlocks and controls related to radiation safety.</li> </ul>



# Guidelines For Beamline Reviews

## GENERAL INFORMATION

### Types of Beamline Reviews

The development of beamlines for use at the ALS is monitored by the Beamline Review Committee (BRC). Every ALS beamline is subject to four reviews:

- Conceptual Design Review (CDR) at the start of beamline development. This is an informal review at which the conceptual design of the beamline, without the engineering details, is outlined.
- Beamline Design Review (BDR) before installation of any beamline equipment. This review examines the beamline design, including the design of all equipment.
- Beamline Readiness Review (BRR) following installation of the beamline and a few days prior to initial operation. The BRR checks that all design changes have been reviewed and that all documentation and BDR requirements have been fulfilled.
- Beamline Readiness Review Walkthrough (BRRW) immediately prior to operation. The walkthrough examines the hardware as built and completely installed and is the last step before final approval for beamline operation.

These reviews may be repeated if modifications are made that warrant review or if significant issues require further clarification.

### Purpose of Beamline Reviews

Beamlines are reviewed to ensure that their components and equipment satisfy all ALS, LBNL, and DOE requirements for safe operation. The documentation developed for the reviews and during the review processes is kept on file and is accessible for reference whenever information about the beamline is required.

### Who Conducts Reviews?

Conceptual Design Reviews, Beamline Design Reviews, Beamline Readiness Reviews, and Beamline Readiness Review Walkthroughs are conducted by the ALS Beamline Review Committee. This committee consists of the ALS Environment, Health, and Safety (EH&S) Program Manager; the ALS Mechanical Group Leader; members of the ALS staff who have expertise in beamline design, construction, and operation; and members of Berkeley Lab's EH&S Division.

### How Long Does the Process Take?

Typically, development of a beamline from concept to implementation takes many months. A Conceptual Design Review (CDR) should be scheduled as soon as the beamline concept is defined. The Beamline Design Review (BDR) should take place while the beamline is still in the design stage and before ordering components, so that no hardware will have to be altered.

It is recommended that the BDR be conducted 6 months (absolute minimum is 3 months) before the tentative date of the first operation of the beamline.

The documentation package for the BDR, described in the Beamline Design Review section of this document, must be received at least 2 weeks before the BDR is scheduled. The Beamline Readiness Review (BRR) takes place a few days prior to first operation. The Beamline Readiness Review Walkthrough (BRRW) takes place just prior to operation after all components are installed and the beamline is complete. The Beamline Review Committee intends that the review process should not cause any delay to the design and implementation of a new beamline.

### Scheduling a Beamline Review

To schedule a review, please contact the head of the Beamline Review Committee. This position rotates annually; for the name of the current chair contact:

Beamline Review Committee  
Advanced Light Source, MS2R0400  
Berkeley Lab  
Berkeley, CA 94720  
(510) 486-4067  
(510) 486-7696 [Fax]

## REVIEW PROCESS

The beamline review process is outlined in the following flowchart:

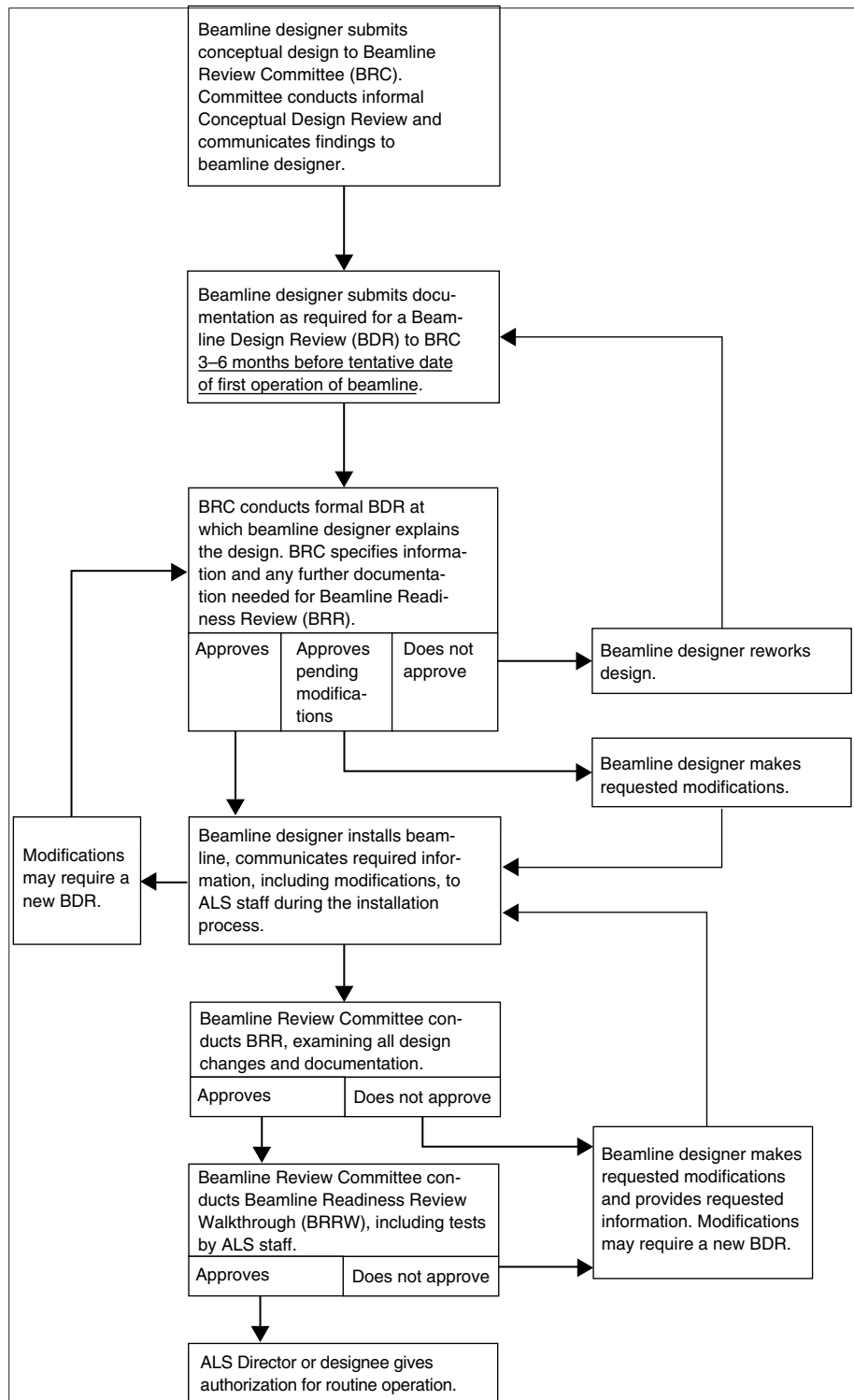

---

# Conceptual Design Review

## GENERAL INFORMATION

### Definition and Purpose

The Conceptual Design Review (CDR) is an informal review conducted by the Beamline Review Committee at the earliest possible stage of beamline development. It is intended to:

- Allow the beamline designer to communicate the conceptual outline of the proposed beamline, minus the engineering details, to ALS staff.
- Give ALS staff the opportunity to examine the preliminary designs and offer suggestions on how

best to utilize allocated space and materials in order to fully exploit the special properties of the ALS synchrotron radiation source.

- Establish lines of communication between the beamline designer and ALS staff to facilitate and coordinate subsequent steps in the beamline development process.

### When is a Conceptual Design Review Conducted?

A Conceptual Design Review (CDR) should be scheduled as soon as the beamline concept is defined.





# Beamline Design Review

## GENERAL INFORMATION

### Definition and Purpose

At the Beamline Design Review (BDR), the beamline designer presents the detailed design to the Beamline Review Committee which examines the design of all equipment before installation begins to ensure that the beamline will:

- Operate safely in accordance with all applicable regulations on radiation, electrical safety, fire safety, hazardous materials, and seismic safety.
- Maintain the quality of the vacuum in the storage ring and protect costly components of the beamline itself.
- Be configured to allow access or egress to/from surrounding areas, conform with space allocation, and not interfere with the safe operation of the ALS.

A Beamline Design Review is distinct from an Experiment Safety Review. The former evaluates “permanent beamline components,” whereas the latter evaluates the equipment and materials brought to the ALS to conduct specific experiments. Only one BDR per beamline will be required unless substantial changes are made to the beamline design. In contrast, an experiment safety review will be conducted for each experiment performed on a beamline.

### When is a Beamline Design Review Conducted?

The Beamline Design Review for a beamline will be conducted before any equipment is installed on the ALS floor. It is recommended that the BDR be done 6 months (absolute minimum is 3 months) before the tentative date of first operation of the beamline (and before funds are committed to fabricate expensive components). Thus, the beamline developers should schedule the BDR through the Beamline Review Committee well before any beamline equipment is due to be installed on the ALS floor. A beamline is also subject to a Beamline Design Review after its installation if substantial modifications have been made.

## DOCUMENTATION PACKAGE

### Contents of Package

Each item on the following list (if applicable) must be prepared by the beamline designer and the complete documentation package must be submitted to the Beamline Review Committee at least two weeks before the BDR is scheduled. See Appendix E for persons to contact for specific items on the list.

1. Scale drawing of the beamline/endstation layout.
2. Anamorphically scaled ray-trace drawings of bremsstrahlung radiation shielding and exclusion zones.
3. Assembly drawings of hutches.
4. Schematic diagram of the vacuum system components and safety measures.
5. Schematic diagrams of the equipment-protection system.
6. List of hazardous electrical components.
7. List and description of liquid-cooled components.
8. List of structures > 200 kg with seismic safety information.
9. List of thin vacuum windows with vacuum and thermal-integrity calculations.
10. Special utility requirements.
11. List of components with mechanical safety concerns.
12. Description of a typical experiment.

### For More Information

The following sections give information on the details to be included in each documentation category together with additional information to assist the beamline designer. A checklist and a suggested timeline for completion of beamline documentation and construction are given in Appendix F. A sample BDR document package is available from the ALS User Office; for contact information see Appendix E. ALS User Advisories containing additional information about design and installation requirements of beamline equipment are in Appendix G.

## 1. BEAMLINE/ENDSTATION LAYOUT

### Scope of the Review

The information presented at the Beamline Design Review should include drawings of the overall beamline layout. Drawings should show locations of:

- Storage ring
- Front end
- Beamline shielding, showing labeling
- Exclusion zones, showing labeling
- Vacuum valves, with names as used for the equipment-protection system (EPS)
- Ion gauges, with names as used for the EPS
- Fast valve sensors, with names as used for the EPS
- RGA locations, with labeling
- Water flow switches and other equipment-protection devices
- Hutches (if appropriate)
- Endstations
- Support equipment (e.g., racks, tables, etc.)
- Walkways around beamline and endstation(s), and an escape aisle.

**Required Documentation:** Scale drawing(s) of the beamline layout, including vacuum and optical components, location of endstations, electronics racks, desks, hoods, workstations/workspace, and walkways for access.

### Guidelines

- a. All major components and shielding must be labeled. Shielding and exclusion zone labels should be labeled according to the format described both in the Radiation Shielding section of this document, and in Appendix A. Equipment-protection system (EPS) components should be labeled with EPS system mnemonics as described in the EPS section of this document.
- b. In addition to the detailed beamline drawings, a plan-view drawing of the entire beamline, including control racks and space requirements, must be provided to the ALS in electronic form. ALS staff will apply the “footprint” of the new beamline to the ALS master floor layout drawing.
- c. Beamline drawings should include sound level estimates, in decibels (dBA), of all equipment capable of producing significant amounts of noise. In order to keep sound levels within an acceptable range on the experiment floor, noise from beamline equipment should not exceed 65 dBA at a distance of three (3) feet from the source.

## 2. RADIATION SHIELDING

### Scope of the Review

The information presented at the Beamline Design Review must describe the radiation shielding that will be used on the beamline components. Please include the following:

- Anamorphically scaled ray-trace drawings with dimensions, showing the important lines-of-sight through the opening in the storage ring shield wall, and the shielding against bremsstrahlung radiation. These drawings will be used to verify the adequacy of the shielding and to check the location of the shielding once the beamline has been installed. All major components and shielding must be labeled using the method described below.
- Anamorphically scaled drawings of exclusion zones and description of equipment for preventing personnel entry into line-of-sight bremsstrahlung radiation when the personnel safety shutter is open. The drawings should include dimensions from the shield/exclusion zones to beamline reference points so that their locations can be verified during the BRR Walkthrough.

The ray-trace drawings are prepared by the beamline designer with assistance from the ALS Mechanical Engineering staff as required. It is strongly recommended that beamline builders start communicating the information related to shielding as soon as the preliminary design for the beamline is completed as it may take a few iterations before the shielding design is finalized.

**Required Documentation:** Anamorphically scaled ray-trace drawing(s) of bremsstrahlung radiation shielding and exclusion zones.

### Labels

The labels for the bremsstrahlung shielding and exclusion zones should follow the format described below.

*B(ring sector number)\_BSxx*  
*B(ring sector number)\_EZxx*

Where xx indicates the number of the shield or exclusion zone. The bremsstrahlung shields and exclusion zones should be numbered sequentially starting from the storage ring.

**Examples: B7.0\_BS101** specifies the first bremsstrahlung shield on branchline 1 of the undulator beamline in storage ring sector 7.

**B9.3\_EZ108** specifies the eighth exclusion zone on branchline 1 of the bend-magnet beamline coming off the fourth port in storage ring sector 9.

These identifiers should be written on permanent labels and affixed to the most accessible side of the shielding or exclusion zone to provide quick and easy identification. The lettering should be large enough to make the labels easy to read from a distance. The drawings should also include a Beamline Review Committee approval sign-off box.

### Guidelines

- Personnel safety shutters (PSS) are installed by the ALS as part of the front end of almost every beamline. When the PSS are closed, there is sufficient overlap of shielding elements inside the storage ring shield wall to prevent any radiation from emerging onto the experiment floor during normal operation. When the PSS are opened to permit synchrotron radiation into the beamline, there is also a component of high energy bremsstrahlung which emerges along lines-of-sight from the storage ring. This radiation must be collimated by lead shields and contained inside the beampipe or exclusion zones until the synchrotron light can be deflected by a mirror so that the remaining bremsstrahlung can be intercepted and absorbed.
- Personnel safety shutters must be fail-safe, with redundant electrical controls interlocked to position-indicator switches in order to afford maximum safety for personnel. Beamline designers are required to use an ALS design for personnel safety shutters. The ALS will also design, build, and install all personnel safety interlocks.
- Some beamlines require a hatch because bremsstrahlung radiation is present at the endstation.

- d. Routine user access may be required to the interior of hutches and to other regions in which radiation is present during beamline operation. These situations call for additional radiation safety interlock systems and possibly additional personnel safety shutters to ensure that the PSS are closed during controlled access.

**For More Information**

For information on preparing anamorphic drawings and additional details on requirements for bremsstrahlung shielding, see Appendix A. For contact information for assistance in designing radiation shielding, see Appendix E. Radiation safety requirements and estimates of synchrotron radiation can be found in *ALS Synchrotron Radiation Shielding* (LBL-37801), available from the ALS User Office; see Appendix E for contact information. For a general discussion of radiation hazards and mitigations at synchrotron light sources, see Appendix H.

### 3. HUTCHES

**Scope of the Review**

The information presented at the Beamline Design Review should include a description of the hutch design, if applicable, including the following details:

- Materials used (specify thickness)
- Penetration lengths
- Window materials
- Door security
- Fire safety measures
- Ventilation system
- Structural stability.

**Required Documentation:** Assembly drawings of hutches in scale, showing doors, windows, major structural members, dimensions, and materials. Include a Beamline Review Committee sign-off box.

**Guidelines**

A hutch is required whenever routine access is to be available to an area in which radiation is present during beamline operation, and the method of access does not preclude a radiation hazard. At the ALS this situation arises when access is required to an area which receives bremsstrahlung radiation on a line-of-sight through the opening in the storage ring shield wall or when high energy synchrotron radiation passes into air through a thin window. Hutches may admit personnel, or smaller enclosures may be necessary which admit only hands and arms. In either case, the ALS will design and build a special radiation safety system to ensure safe access. Access to a

vacuum enclosure in a low-energy beamline in a location where there is no bremsstrahlung and where the synchrotron light cannot penetrate the vacuum valves is not considered a radiation hazard.

Beamlines which allow white synchrotron radiation to pass through a beryllium window into air will produce significant amounts of ozone. Without the use of restricting apertures and ventilation, ALS white synchrotron radiation passing through air will quickly exceed the safety guidelines that limit personnel exposure to ozone to 0.1 ppm. Beamline designers must therefore ensure that their hutch beamlines do not produce ozone concentrations above this limit. For detailed information on how to determine and restrict ozone production for an ALS bend magnet beamline, see Appendix H.

Interlocks to ensure radiation safety must be developed such that their circuits and components are fail-safe to the greatest extent practicable. That is, in case of a component or power failure in the interlock system, it must react to render the area safe. The interlock system must also be redundant; that is, two independent sets of components and circuits must be developed to ensure safety in the event of a failure of one circuit. Because these systems are so critical to personnel safety, the ALS will design, build, install, and test the radiation-safety interlocks for hutches.

#### **For More Information**

Additional information regarding estimates of ALS synchrotron radiation and radiation safety requirements can be found in *ALS Synchrotron Radiation Shielding*, (LBL-37801), available from the ALS User Office; see Appendix E for contact information. For a general discussion of radiation hazards (bremsstrahlung and synchrotron radiation, ozone production), and mitigations at synchrotron light sources, see Appendix H.

## **4. VACUUM COMPONENTS AND SAFETY**

### **Scope of the Review**

The information presented at the Beamline Design Review must include a description of the vacuum components of the beamline and endstation(s), including the following details:

- Schematic diagram of vacuum chambers, valves, and connections
- Description of materials used in ultra-high-vacuum (UHV) systems
- Description of ion gauges
- Types of pump(s), locations, speeds, and interlock systems
- Fast-valve sensor locations
- Design of gas cells
- Design of cooling systems.

**Required Documentation:** a) Schematic diagram(s) of the vacuum system chambers, valves, pumps, gauges, fast-valve sensor locations, gas cells, and thin windows, and b) list of materials used in the UHV system.

### **Guidelines**

Preventing contamination of beamlines and the storage ring is an important concern at the ALS. For example, as little as 0.1 cc of pump oil could permanently ruin the entire storage ring vacuum chamber. Only a single fast valve protects the storage ring from sudden beamline vacuum accidents. Beamline designers and ALS users must recognize that a high level of vacuum safety is needed for all equipment connected to the ALS vacuum chamber.

**For More Information**

See Appendix B, *ALS Vacuum Policy and Vacuum Guidelines for Beamlines and Experiment Endstations* (LSBL-280), for information covering all aspects of vacuum safety in beamline design, and Appendix G, *ALS User Advisories* for detailed guidelines on vacuum policy, interlock requirements for turbo pumps, and vacuum safety when toxic or corrosive gases are in use. The requirements for vacuum components and safety detailed in these appendices must be incorporated into the design of the beamline.

**5. EQUIPMENT-PROTECTION SYSTEM****Scope of the Review**

For a Beamline Design Review, the information presented about the equipment-protection system (EPS) for a branchline or endstation should include:

- An instrumentation diagram describing all major equipment-protection components
- A complete description of all equipment-protection interlocks
- A description of the interface between the beamline equipment-protection system; and the ALS-designed parts of the beamline control system and the ALS-designed radiation safety system (RSS).

**Required Documentation:** Schematic diagrams of the equipment-protection system, showing all major equipment-protection components.

**Guidelines**

The purpose of an equipment-protection system for a beamline is to prevent damage to components that would be very expensive to replace and to protect the storage-ring vacuum.

- a. Beamline designers are expected to design, build, and install equipment-protection systems (including interlocks) to work on all branchlines. These systems must automatically respond to equipment-protection faults, which generally fall into two categories: vacuum and thermal. Vacuum interlocks must be provided to protect the integrity of the beamline vacuum. Thermal interlocks and water-flow interlocks must be provided to protect cooled components.
- b. The equipment-protection system should perform three major functions:
  - Permit operation of the beamline only if protection devices are operating correctly. If the equipment-protection devices fail, a control fault is produced and the equipment-protection system takes

appropriate action in response to the fault. For example, if an ion-gauge controller detects a leak in the vacuum system, valves must close to isolate the leak and the photon shutter must close to protect the valve from beam heating.

- Partition selected areas with beam stops so that sources may operate while some beamlines/branchlines are off-line for maintenance or experiment setup.
  - Mediate signals between the branchline's equipment-protection system and the radiation-protection control system.
- c. The equipment-protection systems for beamlines designed by the ALS use programmable logic

controllers and interface with the operator station and instrument-control system through a dedicated RS485 network. Beamline designers may wish to use the same standard.

- d. The use of manual vacuum valves along the beam path is strongly discouraged because they interfere with effective automated EPS responses.
- e. Equipment-protection systems that require action in the front end (for example, those that require the photon shutter to close) must communicate with the ALS front-end control system. This communication can be implemented by the following signals which interface the equipment-protection system (EPS) of the front end (FE-EPS) with that of a given branchline (BR-EPS):

	SIGNAL	FUNCTION
INPUTS FROM BR-EPS TO FE-EPS	BRFE_VAC_PERMIT	Indicates safe vacuum conditions in the branchline. When FALSE, the front-end EPS will close the branchline isolation valve BR_VVRI, the first vacuum isolation valve for the branchline.
	BRFE_NONVAC_PERMIT	Indicates safe non-vacuum conditions in the branchline. When FALSE, the front-end EPS will close the branchline photon shutter BR_PSI.
OUTPUTS TO BR-EPS FROM FE-EPS	BRFE_VAC_OPEN	Indicates that branchline isolation valve BR_VVRI is open.
	BRFE_VAC_CLOSED	Indicates that branchline isolation valve BR_VVRI is closed.
	BRFE_NONVAC_OPEN	Indicates that branchline photon shutter BR_PSI is open.
	BRFE_NONVAC_CLOSED	Indicates that branchline photon shutter BR_PSI is closed.
	BRFE_PASS_BEAM	Indicates that beam may pass through front end to branchline.

## 6. ELECTRICAL SAFETY

### Scope of the Review

The information presented at the Beamline Design Review must include a list of all electrical equipment that will be part of the branchline(s) and endstation(s) and give the function, voltage, and power requirements for each item.

Example	
Function	Specification
Ion pump power supply	<u>Output voltage</u> 5 kVDC
Sublimation pump power	<u>Output current</u> 60 amps <u>Output voltage</u> 10 VDC

**Required Documentation:** List of electrical components with a Berkeley Lab *Health and Safety Manual* (PUB-3000) hazard rating of 2B or 3B (Class 2B: voltage  $\leq 50$  V and current  $>100$  A; or  $50$  V  $<$  voltage  $\leq 250$  V and current  $> 5$  mA; or voltage  $>250$  V and current  $\leq 500$  W/voltage (in volts). Class 3B: voltage  $> 250$  V and current  $> 500$  W/voltage (in volts); or  $> 5$  J stored energy).

### Guidelines

All electrical equipment used in conjunction with beamlines must satisfy the electrical safety requirements established in the Berkeley Lab *Health and Safety Manual* (PUB-3000), Chapter 8, "Electrical Safety," and Chapter 21, "Lockout/Tagout," and in the current edition of *National Electrical Code*, ANSI/NFPA 70. Following are a few important guidelines from these sources.

- a. Wiring installed in open cable trays must be labeled as suitable for cable trays.
  - b. Exposed terminals  $\leq 50$  volts must be isolated by enclosures, covers, screw-on panels, or by interlocked doors. Appropriate warning signs must be affixed to all doors and covers.
  - c. Energy-storage devices (such as capacitors) capable of storing more than 5 joules of energy must be equipped with automatic discharge devices such as shorting relays or bleeder resistors that discharge to safe voltage ( $\leq 50$  volts) when the equipment is de-energized or when the capacitor enclosure is opened. The energy must be discharged within a time no greater than the time needed for personnel to gain access to the voltage terminals. In no case must this time be longer than 5 minutes.
  - d. To eliminate the danger of lethal voltages appearing between the vacuum chamber and electronic ground when ionization gauges and ion pumps are in operation, the vacuum chamber must have a common electrical ground with the gauge control or ion pump power supply.
  - e. Beamline components must be properly grounded, especially during bakeout. All heaters used for bakeout must be protected by a ground fault circuit interrupter (GFCI). The ALS routinely installs GFCI at convenient locations along the beamline.
  - f. Split heater-tape connectors must be permanently bonded together to form one assembly or replaced with a single, unified connector; split connectors are not allowed.
  - g. Due to the high voltage supplied to ion pumps, certain cables and connectors may require an ALS retrofit. For example, where exposed cables could be damaged on vacuum systems using Perkin-Elmer equipment exclusively, the high-voltage cable (RG142 coax) must be contained along with a #12 ground wire in a 5/6" (21 mm) flexible armor conduit. A specially designed safety cable clamp (ALS #23W1734) is installed on the ion pump end of the high-voltage cable and a conduit clamp is installed on the controller end. The ground wire is then terminated to both the ion pump and the controller. Similar protective measures may be required for other manufacturers' equipment; contact ALS Electrical Engineering staff for more information.
- When terminating cables with connectors intended for use on circuits with hazardous voltage such as



ion-pump cables, care should be taken to terminate the supply end last. If the load (pump) end is being modified or re-terminated, the supply-end connector should be isolated in a lock-out device.

#### **For More Information**

Additional information on electrical safety at the ALS can be found in ALS User Advisories in Appendix G, and in the *ALS Safety Handbook* (PUB-745), available from the ALS User Office; see Appendix E for contact information.

## **7. LIQUID-COOLED COMPONENTS**

### **Scope of the Review**

The information presented at the Beamline Design Review must include the design of liquid-cooled components, including the following information:

- Location of the components
- Design of the cooled components
- Anticipated heat loads and power densities
- Features which minimize the danger of contaminating the beamline and storage-ring vacuum system.

**Required Documentation:** List of liquid-cooled components with calculations or other evidence that the heat loads imposed are within acceptable mechanical and thermal limits.

### **Guidelines**

Preventing contamination of beamlines and the storage ring is an important concern at the ALS. For this reason, the use and installation of liquid-cooled components into the vacuum system require special examination. The issues surrounding the use of such components include: 1) the strength of the component to withstand the pressure of the liquid, especially while under thermal stress or after many thermal cycles; and 2) the integrity of the joints and connections which separate the coolant from the vacuum system.

Beamline designers must present the design of all liquid-cooled components. In general, no brazed, welded, or other direct connections between the liquid and UHV system of the beamline or front end are allowed. The use of intermediate air or vacuum "guards" between the coolant passages and the UHV system is highly encouraged. Beamline designers must present calculations of the anticipated heatloads on all liquid-cooled components, along with estimates of the strength of the materials used, both under thermal strength and after many thermal cycles.

### **For More Information**

For assistance with the design and use of liquid-cooled components, see the Mechanical Engineering contacts identified in Appendix E.

## 8. SEISMIC SAFETY

### Scope of the Review

The information presented at the Beamline Design Review must describe the measures taken for seismic safety. Please include a description of the beamline and endstation components and equipment from the standpoint of seismic stability. Include an estimate of the mass and the height of center of gravity for each major component.

**Required Documentation:** List of structures >200 kg with calculations or other evidence that the structures will withstand 1.0 g of lateral acceleration.

### Guidelines

All experiment equipment installed at the ALS must be in compliance with the seismic-safety criteria specified in the Berkeley Lab *Health and Safety Manual* (PUB-3000), Chapter 23. The intent of these criteria is to ensure that the equipment is designed to resist, without collapse, earthquakes of magnitude 7.0 Richter on the Hayward fault and those of magnitude 8.3 Richter on the San Andreas fault. For convenience these criteria are summarized here; however, this summary is not intended to be comprehensive.

For equipment which, due to size or unique structure, requires specialized seismic stabilization, additional criteria may be required. Any such criteria will be reviewed by ALS Engineering staff.

*General Criteria.* Objects not easily restrained by one person must be prevented from lateral movement and from overturning without reliance on friction when the object is subjected to a 0.7 g lateral acceleration through its center of gravity. It is recommended that equipment be designed to withstand a lateral acceleration of 1.0 g or greater.

*Dynamic Analysis.* For heavy equipment or other objects mounted on support stands, the dynamic load during an earthquake may, because of resonance, greatly exceed the maximum ground acceleration. Support structures should be designed with enough rigidity to achieve natural frequencies above 20 Hz. For structures with natural frequencies below 20 Hz, the effect of the resonance can be significant. Structures in this category may require a dynamic structural analysis to be done by the ALS Engineering Group.

### For More Information

Refer to Appendix I, "Guidelines for Meeting Seismic Requirements for User Equipment at the ALS" for additional information regarding seismic safety requirements for user equipment.

## 9. THIN VACUUM WINDOWS

### Scope of the Review

When thin vacuum windows are used, the information presented at the Beamline Design Review must include the following:

- Location of the window
- Design of the window
- Anticipated heat loads and mechanical stresses on the windows
- Calculations or other evidence that the windows will maintain integrity.

**Required Documentation:** List of thin vacuum windows with calculations or other evidence that each window will withstand the expected heat loads and mechanical stresses.

### Guidelines

Preventing contamination of beamlines and the storage ring is an important concern at the ALS. For this reason, the installation and use of thin windows undergoes special review. The major issue surrounding the use of thin windows is the ability of the window to withstand the expected pressure and vacuum loads, especially while under thermal stress or after many thermal cycles.

Beamline designers must present the design of all thin windows. Beamline designers must present calculations of the anticipated heatloads on all thin windows, along with estimates of the strength of the windows, both under thermal stress and after many thermal cycles.

### For More Information

For assistance with thin vacuum window design, see the Mechanical Engineering contacts identified in Appendix E.

## 10. UTILITY REQUIREMENTS

### Scope of the Review

The information presented at the Beamline Design Review must include a list of all utility requirements for the beamline, for example:

- Electrical power requirements
- Distribution layout
- Compressed air or nitrogen distribution requirements
- Low-conductivity water (LCW) requirements including flow, temperature and pressure
- Exhaust manifold layout.

**Required Documentation:** Electric utility power requirements in excess of 50 A or 208 V for individual units.

### Guidelines

Utilities and services available at the ALS include:

- Electrical power: 480 VAC, 208 VAC, 120 VAC, single and 3 phase, 60 Hz
- Low-conductivity (deionized) water
- Compressed air or nitrogen
- Exhaust manifold system
- Machine shops, including plating and welding
- UHV facilities, including vacuum brazing
- Electrical and electronic fabrication shops.

Beamline utility racks should be numbered as described in *ALS Beamline Rack Numbering Scheme* (LSEE-107A), available from the ALS User Office; see Appendix E for contact information.

## 11. MECHANICAL SAFETY

### Scope of the Review

The information presented at the Beamline Design Review must include a description of any potentially hazardous mechanical components so as to document the associated safety measures. Examples of such potential hazards are:

- Lifting fixtures and rigging
- Vacuum viewports which are custom designed or have apertures that are >15 cm (6 in.)
- Moving components with potential to injure personnel
- Pressure vessels
- Enclosed spaces
- Ladders and steps
- Platforms and gantries.

**Required Documentation:** A list of all vacuum and pressure-vessel view ports that are custom-designed or in excess of 15 cm in diameter, a list of all pressure vessels, and a list of moving components.

## 12. TYPICAL EXPERIMENT

### Scope of the Review

The information presented at the Beamline Design Review should briefly describe a typical experiment conducted on the beamline. Describe the following as appropriate:

- Major pieces of equipment particular to the experiment and how they are used
- Duration of the experiment
- Pressures and temperatures at various locations in the endstation
- Hazardous equipment and protection
- Hazardous materials used or generated.

**Required Documentation:** Schematic diagram of a typical experiment, identifying large or “permanent” mechanical apparatus and high-voltage equipment, and a list of hazardous materials expected to be in routine use.

**Note:** The BDR does not review the planned experiments. That review is requested via an *ALS Experiment Form* available from the ALS User Office. This form requests specific information about potentially hazardous materials to be used or generated and about potentially hazardous equipment to be used. A form for each experiment must be completed and returned to the User Office before work begins.





# Construction Begins

## GENERAL INFORMATION

### Overview

After the Beamline Design Review (BDR), construction of the beamline may begin. It is expected that the beamline designer will remain in close contact with ALS staff during beamline construction. To ensure that the beamline being developed is installed in the most efficient way, it is important that the beamline designer communicate details related to all aspects of the beamline to ALS staff in a timely manner, as outlined below. Requests for modifications of anything approved during the BDR must be submitted to the Beamline Review Committee chair before the modification is made.

### Communication Items During Beamline Installation

The following information should be communicated to ALS staff during beamline construction (see Appendices E and F for contact and scheduling information).

- a. Beamline instrumentation details, including the location of all vacuum valves, photon shutters, fast sensors, position monitors, ion gauges, residual gas analyzers, and motors.
- b. Electrical requirements including wireway layout, rack profile, cables/terminations, and electrical power requirements. Beamline utility racks should be numbered as described in *ALS Beamline Rack Numbering Scheme* (LSEE-107A), available from the ALS User Office; see Appendix E for contact information.
- c. Vacuum requirements, including all vacuum needs related to clean room facility, assembly of components, bakeout requirements, and installation.
- d. Radiation safety systems are designed and implemented by ALS staff and are unique to each beamline. The beamline designer must inform the ALS staff of special requirements.
- e. Details of the equipment protection system (EPS) and branchline control system (hardware and software). One of the most important aspects is the installation and testing of the fast valve sensors.
- f. Interlock checkout procedures for the equipment protection system.
 

**Note:** The execution of these procedures may require a specific sequence and may be carried out only on shutdown days.
- g. A key-enable checklist must be provided by the beamline designer in collaboration with ALS staff. This is a list of checks to be performed by the ALS Operations Coordinator each time the beamline operator requests that the beamline be enabled for operation. The first key-enable is performed as part of the BRRV. Subsequently, the beamline will need to be enabled after each instance when it is taken off-line for maintenance.

### Inspection and EPS Testing of a Partially Completed Front End

If a partially installed front end is ready to accept radiation from the storage ring before the beamline itself is completed, an inspection of equipment protection systems and radiation shutters, and an RGA scan of any new vacuum sections must be conducted by ALS staff before the storage ring is filled. This ensures that the integrity of the storage ring vacuum is not compromised by the addition of new equipment. The requirements for this procedure are detailed in *Inspection and EPS Testing for a Partially Completed Front-End* (BL 08-04), available from the ALS User Office; see Appendix E for contact information.





---

# Beamline Readiness Review

## GENERAL INFORMATION

### Definition and Purpose

Each beamline must undergo a formal Beamline Readiness Review (BRR) to verify that the beamline has been built according to the design approved at the Beamline Design Review (BDR). It is the first of a two-part final review of the design and installation of a new or modified beamline. In the BRR, design changes required by the Beamline Review Committee (BRC) are reviewed and verified, documentation is checked for completeness, and it is verified that all requirements stipulated at BDRs have been met.

### When is a BRR Conducted?

A BRR for a new beamline will be conducted after the beamline is installed, usually a few days before it is scheduled for first operation. An operational beamline must undergo a BRR whenever it is modified. As part of a BRR, all new or modified beamlines must undergo a radiation survey. A survey checklist must be prepared at least one week before the BRR is scheduled; see the Radiation Survey contact identified in Appendix E for assistance.



# Beamline Readiness Review Walkthrough

## GENERAL INFORMATION

### Definition and Purpose

The Beamline Readiness Review Walkthrough (BRRW) is the second of a two-part final review of the design and installation of a new or modified beamline, and is also part of the annual inspection process for existing beamlines.

A comprehensive walkthrough inspection of the beamline is conducted by the ALS once all documentation and design requirements have been satisfied. The BRRW follows the *ALS Beamline Readiness Review Walkthrough Information Sheet and Checklist* (BL 08-16, Appendix IV, reproduced here in Appendix D).

### When is a BRRW Conducted?

A BRRW occurs after a BRR, after all required documentation has been provided and all hardware has been installed. All beamlines will also undergo a BRRW as part of an annual inspection. In addition, beamlines which have undergone repairs or modifications will require a BRRW once work is completed; see User Advisory 13 "Inspection and Beamline Work and Repairs," and the *Annual or Supplemental Beamline Readiness Review Walkthrough Checklist* (BL 08-16, Appendix VI, reproduced here in Appendix D).

Items checked or executed during this procedure include:

1. Verification that the beamline as constructed is consistent with the required documentation presented at the BDR.
2. Verification that all procedures mandated by the BRC have been approved.
3. Verification that radiation safety qualifications have been completed. These include:
  - a. Radiation shielding. The position and size of the bremsstrahlung shielding and exclusion zones are checked against the approved shielding drawings.
  - b. Radiation safety system (RSS) specific to each beamline. These systems are tested by ALS staff every six months.
4. Electrical safety qualification to ensure safety of electrical components and wiring and to check for proper grounding and connections to vacuum vessels.
5. Mechanical qualification to check for hazards related to motorized motions and seismic safety.
6. Verification that installed hardware meets ALS safety requirements.
7. Vacuum qualification to ensure that ion gauge readings and the residual gas analyzer (RGA) scan conform to vacuum requirements and that protection systems are in place.
8. Equipment-protection system (EPS) qualification, specific to each beamline. These systems are tested annually by ALS staff.
9. For insertion device beamlines, a dynamic test of the errant photon beam interlock (EPBI).
10. Key-enable procedure. The beamline is enabled for the first time.
11. Radiation survey of the beamline, following the approved checklist (see Beamline Readiness Review), to check for measurable levels of scattered bremsstrahlung radiation.

### Authorization for Routine Operation

Following a successful walkthrough, the ALS Director or designee gives authorization for routine operation. Future modifications to the beamline will require another BRR to examine the modified components.



---

# Appendices

- Appendix A: Criteria For Beamline Bremsstrahlung Shielding**
- Appendix B: Advanced Light Source Vacuum Policy and Vacuum Guidelines for Beamlines and Experiment Endstations (LSBL-280)**
- Appendix C: Survey and Alignment Information for ALS Users**
- Appendix D: Information Sheets and Checklists for Beamline Review Committee Beamline Reviews (Procedure BL 08-16, Appendices I-VI)**
- Appendix E: Contacts for Additional Information and Technical Questions**
- Appendix F: Checklist and Timeline for Building a Beamline**
- Appendix G: ALS User Advisories**
- Appendix H: Radiation Hazards at the ALS**
- Appendix I: Guidelines for Meeting Seismic Requirements for User Equipment at the ALS**
- Appendix J: Design Criteria for O-Rings in High-Radiation Areas**
- Appendix K: UV Light Hazards from Synchrotron Radiation**
- Appendix L: Disassembly of Beamline Sections**



# Appendix A – Criteria For Beamline Bremsstrahlung Shielding

## INTRODUCTION

This document describes the bremsstrahlung radiation shielding criteria for insertion-device and bend-magnet beamline designs outside the storage ring shield walls. These criteria are very similar to those proposed at the National Synchrotron Light Source (NSLS) at Brookhaven National Laboratory<sup>1</sup> and by earlier work here.<sup>2,3</sup> The front-end shielding (inside the storage ring shield wall) has been designed such that beamline shielding designers need only know the source size, the distance to the shield wall, and the size of the penetration through the shield wall.

Each beamline must undergo a Conceptual Design Review, a Beamline Design Review, and a Beamline Readiness Review by the ALS Beamline Review Committee. Beamline designers must prepare a package of documentation for these reviews. Among the most important components of this documentation package are bremsstrahlung shielding anamorphic drawings. These are drawings on which perpendicular directions have differing magnifications or scales. These drawings allow easy visualization and verification of ray tracings since beamline lengths are many times greater than their pertinent transverse dimensions. These drawings will be used during the Beamline Design Review to ensure all bremsstrahlung radiation has been adequately attenuated, and during the Beamline Readiness Review to ensure proper installation of the shields.

As a point of clarification for previously written or in-progress ALS documentation, two terms are defined: primary shielding and secondary shielding. Primary shielding is the shielding required to maintain the bremsstrahlung dose outside the shield wall to less than 40 mrem for a single worst-case catastrophic event. This was the basis for the design of the transition walls, and it is therefore applied to the design of the front-end shielding. Secondary shielding is the shielding required to reduce the normal, continuous gas bremsstrahlung dose rates outside the storage ring shield walls to less than 200 mrem (2000 hr) per year. This document considers only secondary shielding and does not address primary shielding (front-end shielding) or the design of personnel safety shutters.

## SOURCE SIZE

During injection, the personnel safety shutters on a beamline are closed. Once they are opened, the major source of unwanted radiation to the experiment area results from electrons scattering off residual gas molecules and creating highly forward-peaked bremsstrahlung photons. This radiation is termed “gas bremsstrahlung.” The source size is dictated by the cross-sectional area of the electron beam—a few millimeters horizontally and about three times smaller vertically. However, for conservatism, it should be assumed that the minimum gas bremsstrahlung source size is a rectangle 4 cm (1.6 in.) high and 6 cm (2.4 in.) wide, representative of the entire electron beam vacuum chamber excluding the antechamber. The location of the source depends on the type of front end:

### Insertion-device front ends

- The source is to be located 2.7 m upstream of the outside surface of the storage ring exit flange for port 0. This corresponds roughly to the entrance to the first bend magnet.

### Bend-magnet front ends

- The source for the first port should be located 3.5 m upstream of the outside surface of the storage ring exit flange for port 1, along the centerline of the beam port. This corresponds roughly to the downstream end of the first bend magnet.
- The source for the second port should be located 3.3 m upstream of the outside surface of the storage ring exit flange for port 2, along the centerline of the beam port. This corresponds roughly to the midpoint of the second bend magnet.
- The source for the third port should be located 3.5 m upstream of the outside surface of the storage ring exit flange for port 3, along the centerline of the beam port. This corresponds roughly to the downstream end of the second bend magnet.

## SHIELD DIMENSIONS

All lead radiation shields required to reduce the gas bremsstrahlung must have at least 254 mm (10 in.) of lead along the longitudinal path<sup>4</sup> and 50.8 mm (2 in.) of lead as the minimum transverse distance between the extreme ray and the outside of the shield.<sup>5</sup> This is shown in Figure 1. No partial credit is taken for rays passing through less than the full 254 mm lead equivalent in any one shield. The 254 mm lead-equivalent requirement is meant to apply to all beamline designs, whether they are bend-magnet or insertion-device beamlines. Beamlines which have been bent by beamline components such as monochromators, and which penetrate the shield wall above or below the lead belly band, may not require additional shielding outside the shield wall if the front-end shielding is shown to be adequate.

Other shielding materials may be used if shown to be of equivalent thickness. The equivalent lead thickness is calculated as the ratio of the mean free paths at the Compton-minimum in the photon cross sections.

Gas bremsstrahlung dose rates are directly proportional to the length of the straight section traversed by the electron beam. Due to the shorter drift length of bend-magnet beamlines, lower dose rates downstream would be anticipated. However, for conservatism, consistency, and to eliminate any possibility of crosstalk between insertion-device and bend-magnet beamlines, the 254 mm lead requirement applies to both.

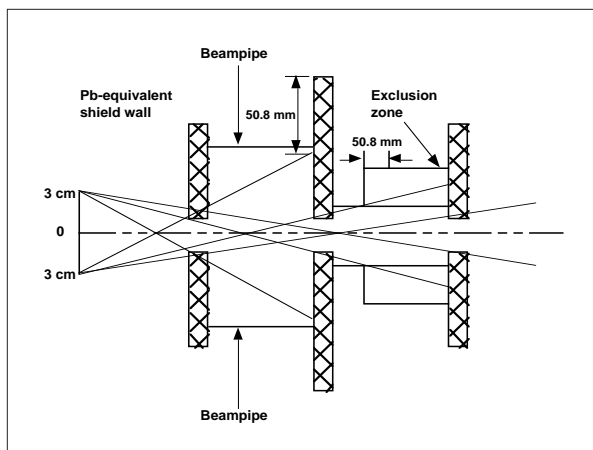

**Figure 1.** Example of extreme ray layout plan view for a beamline (azimuthally symmetric).

## ANAMORPHIC DRAWING

The anamorphic drawing is used by the Beamline Review Committee to verify the adequacy of the shielding and to check the location of all shielding once the beamline has been constructed. An example of an anamorphic shielding drawing is shown in Figure 1. All drawings should include a Beamline Review Committee approval box, either drawn or created by use of an appliqué that will be available at the ALS. The drawing should show the extreme trajectories of bremsstrahlung x rays from the source model described above, through the penetration in shield wall, and then through the beamline collars/shields to the backstop. As described above, all bremsstrahlung shields should be 254 mm thick and extreme rays should be no less than 50.8 mm from the outside of the shield. Extreme rays are those rays that define the extent of the bremsstrahlung cone (one set for plan views, one set for elevation views) which passes through the required 254 mm lead equivalent (see Figure 1).

The divergence of the bremsstrahlung radiation for beamline shielding is defined by the size of the source (given above) and the distance from the source to the inside corner of the penetration through the shield wall. The drawings must include both plan and elevation views. The elevation view should represent the view from the most accessible side of the beamline. Each should fit on a single, large, standard-size sheet of paper such as an E-size drawing. The drawing should start from the bremsstrahlung source and extend to a point where all bremsstrahlung x rays have been attenuated by the required lead equivalent of 254 mm. Note that in some cases this may extend to a hutch backstop at the end of the beamline, whereas in other cases it may extend only to the point at which the synchrotron radiation has been deflected from the bremsstrahlung cone and terminated in a lead shield wall.

When preparing the drawing, all bremsstrahlung shields must be labeled and must show transverse and longitudinal dimensions, as well as the distance from the source point, the storage ring shield wall, and the beampipe centerline. Both the longitudinal and transverse scales should be indicated. All bremsstrahlung shields should have unique designations associated with them.



The labels for the bremsstrahlung shielding and exclusion zones should follow the format:

**B(ring sector number)\_BSxx** (for shielding)  
**B(ring sector number)\_EZxx** (for exclusion zones)

Where xx indicates the number of the shield or exclusion zone. The bremsstrahlung shields and exclusion zones should be numbered sequentially starting from the storage ring. For example: B7.0\_BS101 specifies the first bremsstrahlung shield on branchline 1 of the undulator beamline in storage ring sector 7, and B9.3\_EZ108 specifies the eighth exclusion zone on branchline 1 of the bend-magnet beamline coming off of the fourth port in storage ring sector 9.

Shields should have their composition and density specified either individually or in a general note. Shielding should be designed such that it cannot be inadvertently moved by simple means (*e.g.*, carrying away lead bricks). Lead shields should be coated to prevent excessive lead exposures. The ALS Environmental Health and Safety Program Manager should be notified before installation of all lead shields (see Appendix E for contact information). All shields should comply with seismic safety rules and procedures established in the LBNL *Health & Safety Manual* (PUB-3000). Examples of ALS anamorphic drawings can be requested from ALS Mechanical Engineering.

## EXTREME RAYS

The extreme-ray bremsstrahlung cone, shield wall, beampipe, and hutches/endstations should be clearly identified on all views. In any area where the bremsstrahlung cone is outside the beampipe or shield, access must be limited. Such an area is called an exclusion zone.

Physical barriers preventing access to an exclusion zone must be constructed and may consist of materials such as corrugated metal or Plexiglas to eliminate possible exposure to bremsstrahlung x rays. All exclusion zones should be clearly labeled on the anamorphic drawing and their overall dimensions should be indicated. It is acceptable to use the beampipe itself as an exclusion zone. In certain areas it may be desirable to oversize the beampipe to include all extreme rays. However, this practice is not recommended through the shield wall because it may result in an unnecessarily large opening in the transition wall.

A sketch of an extreme-ray bremsstrahlung cone is shown in Figure 2. Note that the extreme rays are defined from the inside corner of the lead shield. No partial credit is taken for rays passing through less than the full 254 mm lead equivalent in any one shield. In addition, no credit is taken for longer path length through the lead due to the ray's oblique incident angle (which appears greatly exaggerated on the anamorphic drawing). As mentioned earlier, the

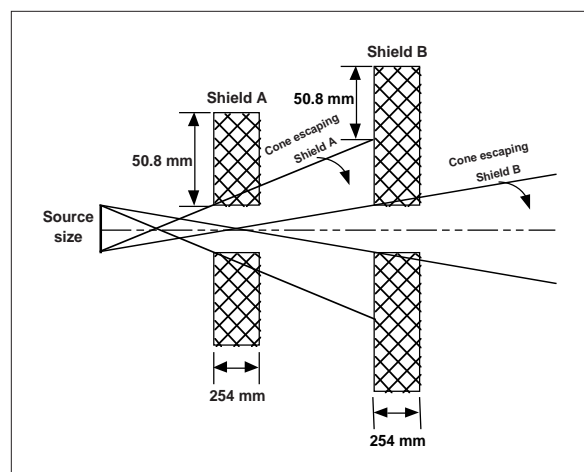

**Figure 2.** Example of extreme rays through two bremsstrahlung radiation shields.

transverse distance from the extreme ray incident on a shield to the outside of the shield should not be less than 50.8 mm. As can be seen from Figure 2, exclusion zones will most often be required just upstream of shields where the bremsstrahlung cone has reached its largest transverse extent. The distance from the extreme ray to the outside of the exclusion zone should also not be less than 50.8 mm (2 in). The "2 inch" rule is meant to apply in cases where the extreme ray has been intercepted by a shield, flange, or beampipe, and does not apply when the extreme ray is contained inside the beampipe.

Figure 3 shows that sometimes simple plan and elevation views are not enough to identify exclusion zones. It is the responsibility of the designer to identify all problem areas.

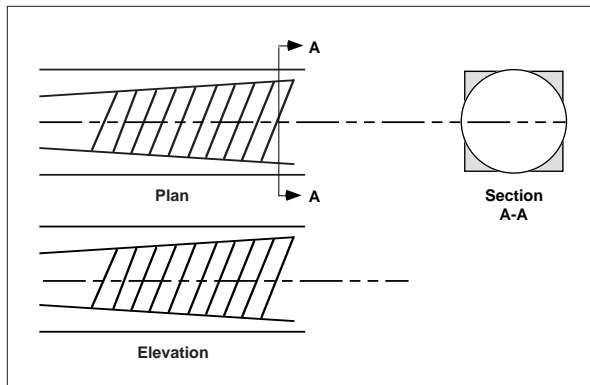

**Figure 3.** Plan and elevation views show the bremsstrahlung core clearly confined, while the section view shows a portion of the core outside the beampipe, requiring the identification of an additional exclusion zone.

R.J. Donahue  
July 1993, revised May 1996.

<sup>1</sup> P. Stefan, NSLS-BNL, personal communication.

<sup>2</sup> T. Warwick, "Bremsstrahlung Collimation and Shielding for ALS U5 and U8 Beamlines," (LSBL-058A).

<sup>3</sup> T. Warwick, et al., "Radiation Safety Shutters, Collimation and Shielding for ALS Beamlines," (LSBL-073).

<sup>4</sup> R.J. Donahue, "Gas Bremsstrahlung Estimates for ALS Hutch Backstops," (LSBL-162).

<sup>5</sup> P. Stefan, op. cit.

# Advanced Light Source Vacuum Policy and Vacuum Guidelines for Beamlines and Experiment Endstations Revision 2

Beamline Review Committee  
August 22, 1995  
(Supersedes LSBL #116)

## Contents:

1. Introduction.....	2
2. Policy and Requirements.....	2
2.1 Storage Ring Vacuum.....	2
2.2 Means Used for Ensuring the Quality of the Storage Ring Vacuum .....	3
2.3 ALS Vacuum Requirements .....	3
3. Performance Test .....	7
4. Review of Vacuum Design.....	8
5. Vacuum Guidelines for Beamline and Endstation Experiment Chamber Vacuum Systems.....	8
5.1 Materials.....	8
5.2 Bellows .....	9
5.3 Feedthroughs .....	9
5.4 Gauges .....	10
5.5 Vacuum Pumps.....	10
5.6 Valves and Flanges.....	11
5.7 Fabrication .....	11
5.8 Assembly of UHV Components.....	12
5.9 Venting.....	12
5.10 Leak Checking and Bakeout .....	12
References .....	13

## Abbreviations:

**BRC** Beamline Review Committee  
**CDR** Conceptual Design Review  
**EPS** Equipment Protection System  
**LCW** Low Conductivity Water  
**PRT** Participating Research Team  
**PSS** Personnel Safety Shutter  
**RGA** Residual Gas Analyzer  
**RSS** Radiation Safety System  
**UHV** Ultra High Vacuum

**Front end** Front end components serve to define a beam aperture for synchrotron radiation and provide necessary beam on/off, radiation safety, and vacuum-isolation systems for each beamline for both insertion device and bending magnet sources. The front end components generally reside inside the storage ring shielding and physically connect the ring vacuum chamber to the first valve of the beamline.

# 1. Introduction

The purpose of this document is to:

1. Explain the ALS vacuum policy and specifications for beamlines and experiment endstations.
2. Provide guidelines related to ALS vacuum policy to assist in designing beamlines which are in accordance with ALS vacuum policy.

This document supersedes LSBL-116.

The Advanced Light Source is a third generation synchrotron radiation source whose beam lifetime depends on the quality of the vacuum in the storage ring and the connecting beamlines. The storage ring and most of the beamlines share a common vacuum and are operated under ultra-high-vacuum (UHV) conditions. All endstations and beamline equipment must be operated so as to avoid contamination of beamline components, and must include proper safeguards to protect the storage ring vacuum from an accidental break in the beamline or endstation vacuum systems.

The primary gas load during operation is due to thermal desorption and electron/photon induced desorption of contaminants from the interior of the vacuum vessel and its components. The desorption rates are considerably higher for hydrocarbon contamination, thus considerable emphasis is placed on eliminating these sources of contaminants.

All vacuum components in a beamline and endstation must meet the ALS vacuum specifications. The vacuum design of both beamlines and endstations must be approved by the ALS Beamline Review Committee (BRC) before vacuum connections to the storage ring are made. The vacuum design is first checked during the Beamline Design Review (BDR) held before construction of the beamline equipment begins. Any deviation from the ALS vacuum specifications must be approved by the BRC prior to installation of the equipment on the ALS floor. Any modification that is incorporated into a vacuum assembly without the written approval of the BRC is done at the user's risk and may lead to rejection of the whole assembly.

**Note:** All pressure values described in this document are  $N_2$  equivalent values, i.e., all pressures are measured setting the sensitivity in the ion gauge controller for  $N_2$  gas.

## 2. Policy and Requirements

### 2.1 Storage Ring Vacuum

The ALS storage ring vacuum system consists of all-metal, chemically cleaned, bakeable components. It generally operates at pressures of less than  $2 \times 10^{-10}$  mbar ( $2 \times 10^{-8}$  Pa, 1 mbar = 0.76 torr) without beam, and at pressures of less than  $1 \times 10^{-9}$  mbar ( $1 \times 10^{-7}$  Pa) with beam.

## 2.2 Means Used for Ensuring the Quality of the Storage Ring Vacuum

The main objective of the ALS vacuum policy is to ensure that the vacuum connection of any beamline and its associated experiment endstations will not degrade the quality of the storage ring vacuum. Generally, beamlines may be separated into two broad categories. The ALS vacuum requirements differ for each category.

Category 1: **UHV beamlines** that share the same vacuum as the storage ring.

Category 2: **Non-UHV beamlines** in which the vacuum is completely or partially separated from the front end components and storage ring vacuum by using either a window or differential pumping.

For both categories, the storage ring vacuum integrity is ensured by checking that the following three items meet the requirements described in detail in Section 2:

- a. The base pressure in various parts of the beamline.
- b. The contribution of high mass gases to this pressure at appropriate places as checked by the residual gas spectral analysis (RGA), if and when required.
- c. The vacuum interlocks which protect the storage ring in the event of accidental vacuum failure.

For non-UHV beamlines, it may also be necessary for users to provide calculations ensuring that, in case of a vacuum failure, the vacuum interlocks will adequately protect the ALS vacuum integrity.

All beamline components are required to be manufactured according to the guidelines described in Section 5 of this document.

## 2.3 ALS Vacuum Requirements

This section describes the three requirements that must be met for both categories of beamlines:

### 2.3.1 UHV Beamlines (Category 1)

This category of beamline normally shares the same vacuum as the storage ring and operates under UHV conditions.

#### (a) Pressure Requirement

The base pressure in all vacuum components that will be directly exposed to the storage ring vacuum must be less than  $2 \times 10^{-9}$  mbar ( $2 \times 10^{-7}$  Pa) and it is expected that this pressure requirement will be maintained during the normal operation. However, during the initial scrubbing period of the beamline components with synchrotron radiation, an increase in pressure by an order of magnitude may be allowed, with the exception that at the storage ring exit port, the pressure must be  $2 \times 10^{-9}$  mbar or less at all times.

### **(b) Residual Gas Analysis (RGA) Requirement**

The beamline or the vacuum system must be checked for gas analysis, using a residual gas analyzer (RGA), before it is opened to the storage ring vacuum. For beamline qualification, the RGA check is generally done downstream of the first vacuum isolation valve outside the shielding wall. For experiment chambers, the test may be done in the chamber itself or in the first beamline chamber upstream of the experiment system. The RGA used must be sensitive to a partial pressure of  $1 \times 10^{-14}$  mbar ( $1 \times 10^{-12}$  Pa) or less and be capable of scanning in a range of at least 1-200 atomic mass units (AMU). The RGA scan must indicate that the sum of the partial pressures of gases having a mass of 46-and-greater (46 AMU) does not exceed  $1 \times 10^{-11}$  mbar ( $1 \times 10^{-9}$  Pa).

All new systems as well as beamlines that have been changed and brought up to air must be checked to ensure that they meet the above vacuum and RGA requirements before they are allowed to be opened to the storage ring vacuum.

However, under certain conditions as determined by the ALS vacuum group, a waiver for RGA requirements may be provided to a beamline and/or experiment endstation which normally operate under UHV condition. These conditions include opening of a beamline vacuum chamber or experiment chamber for minor changes, such as replacing a burnt ion gauge filament, and changing solid samples which have similar outgasing characteristics. In all cases, a waiver will only be granted to vacuum systems which have previously been qualified at least once for meeting RGA requirements, and have achieved a pressure below  $3.0 \times 10^{-10}$  mbar ( $3 \times 10^{-8}$  Pa) after necessary pumpdown and bakeout.

In any case, it is at the discretion of the ALS Vacuum Group or BRC to make the decision regarding a waiver.

### **(c) Vacuum Interlocks Requirement (Protection in the Event of Vacuum Failure)**

The storage ring vacuum is protected from accidental vacuum failures by fast sensor interlocks in case of catastrophic failure, and by ion gauge pressure interlocks in the event of a relatively slow leak.

Each beamline has one or two fast sensors. The recommended distance for the fast sensor to be from the fast valve is 10 m or more, to allow enough time for the fast valve to close before arrival of the gas wave front in the event of a vacuum break. The fast sensors are interlocked with the front-end valves and shutters. The front end contains one or more all-metal isolation valves, a fast-closing valve, and a pneumatically actuated photon shutter (which is between the storage ring and the fast valve).

If there is an accidental break in the beamline vacuum system, a fast-response vacuum sensor will detect the break, and the fast valve will close in less than 10 ms. This also requires the stored beam on insertion device beamlines to be dumped to protect the fast valve from being exposed to the large power of synchrotron radiation. The primary vacuum isolation valve between the storage ring and the beamline will pneumatically close and seal the ring vacuum in about

3.5 seconds. The photon shutter located between the storage ring and the isolation valve will also close. These components are controlled by the Equipment Protection System (EPS) for the front end and the beamline. More details related to the EPS are given in "*ALS Beamline Design Requirements*," PUB-3114.

All vacuum interlocks on beamline components supplied by experimenters must meet ALS design specifications. The ALS will advise users about vacuum requirements and interlock procedures for monochromators and endstations. Generally, these should operate under UHV conditions similar to those of front ends and the storage ring. Electrical connections between user vacuum interlocks and front-end components will be made and tested by authorized ALS staff. Fast sensors should be installed outside of the shielding wall and downstream of the monochromators in positions approved by the BRC.

For each beamline there must be at least one fast sensor located downstream of the first isolation valve near the outside of the shield wall. Another fast sensor may be located upstream of the endstation (a suitable place would be downstream of an exit slit or any other conductance-limiting component).

The fast sensors are set as follows:

**Fast Sensor Set Point:** A set point of  $1 \times 10^{-5}$  mbar ( $1 \times 10^{-3}$  Pa) protects against catastrophic failure. If the pressure at any sensor is above this value, the corresponding fast valve/s is triggered, which simultaneously closes the photon shutter and the isolation valve. On insertion device beamlines, the stored beam must be dumped to protect the fast valve from being exposed to the large power of synchrotron radiation, as well as to protect personnel from bremsstrahlung radiation.

In addition, ion gauges (located on either side of the isolation valve) are interlocked (using ion gauge controllers at set values) to protect the storage ring against high pressure due to excessive outgasing, a slow leak, power failure, etc.

The ion gauge controller interlock set points are such that:

**Ion Gauge Controller Set Point:** Set at  $2 \times 10^{-8}$  mbar ( $2 \times 10^{-6}$  Pa) or lower such that, if the pressure exceeds this value, the isolation valve upstream of the ion gauge will close and seal. The fast valve may remain open. The stored electron beam will not be affected.

Please note that the above pressure values set for interlocks are higher than the normal operating pressures.

If any one of the interlocks is triggered, the isolation valves along with other shutters will close. They should not be re-opened unless:

1. The pressure in that section is below the pre-approved limit, and
2. The pressure in the front end is below  $2 \times 10^{-9}$  mbar ( $2 \times 10^{-7}$  Pa).

If the fast sensor is triggered, the operations coordinator will have to be contacted before beamline can be brought back on line.

### **2.3.2 Non-UHV Beamlines with Vacuum Window/s or a Differential Stage (Category 2)**

A beamline downstream from the front end may operate in a helium atmosphere or oil-free rough vacuum under the following conditions:

- i. A window capable of withstanding at least 1 atmosphere pressure isolates the storage ring vacuum from the beamline vacuum.
- ii. A thin window with appropriate interlocks isolates the storage ring vacuum from the low vacuum side of the beamline.
- iii. Efficient differential pumping allows downstream components to operate at higher pressure without affecting the low vacuum requirement of the front end.

The design of these devices must be approved by the BRC.

#### **(a) Pressure Requirement**

The base pressure in all vacuum components upstream of non-UHV equipment which is directly exposed to the storage ring vacuum must be less than  $2 \times 10^{-9}$  mbar (less than  $2 \times 10^{-7}$  Pa). This pressure requirement must be met at all times during the normal operation of the beamline.

However, during the initial scrubbing period of the beamline components with synchrotron radiation, an increase in pressure by a maximum of an order of magnitude may be allowed.

The maximum pressure downstream of the vacuum window or differential stage or conductance limiting component may be of any sub-atmospheric value, as long as the above condition is always maintained.

#### **(b) Residual Gas Analysis (RGA) Requirement**

The vacuum system is to be tested using a residual gas analyzer (RGA) upstream of the vacuum window or the differential stage. The RGA used must be sensitive to a partial pressure of  $1 \times 10^{-14}$  mbar ( $1 \times 10^{-12}$  Pa) or less and be capable of scanning in a range of at least 1-200 atomic mass units (AMU). The RGA scan must indicate that the sum of the partial pressures of gases having a mass of 46-and-greater (46 AMU) does not exceed  $1 \times 10^{-11}$  mbar ( $1 \times 10^{-9}$  Pa). The RGA scan must be performed by the ALS Vacuum Group for each new experiment before the isolation valve is opened. For experiments involving materials of potential hazard, the RGA will be monitored either continuously or intermittently during operation (at the discretion of the ALS beamline coordinator and or vacuum group).

#### **(c) Vacuum Interlock Requirements (Protection in the Event of Vacuum Failure)**

The storage ring vacuum is protected from accidental vacuum failures by fast sensor interlocks in case of catastrophic failure, or by ion gauge pressure interlock(s) in the event of a relatively slow leak.



For non-UHV beamlines, one fast sensor must be installed and it is recommended that two be installed. The first must be downstream of the first isolation valve outside the shield wall. The second sensor should be at a place with potential vacuum break, such as just upstream of a vacuum isolating window or differential stages.

All vacuum interlocks on beamline components supplied by experimenters must meet ALS design specifications. Electrical connections between user vacuum interlocks and front end components will be made and tested by authorized ALS staff members.

Both fast sensors and ion gauge controllers are set as follows:

- i. Fast Sensor Set Point:** If the pressure at any sensor is above  $1 \times 10^{-5}$  mbar ( $1 \times 10^{-3}$  Pa), the corresponding fast valve/s is triggered, which simultaneously closes the photon shutter and the isolation valve. On insertion device beamlines, the stored beam must be dumped to protect the fast valve from being exposed to the large power of synchrotron radiation, as well as to protect personnel from bremsstrahlung radiation.
  
- ii. Ion Gauge Controller Set Point:** Set at  $2 \times 10^{-8}$  mbar ( $2 \times 10^{-6}$  Pa) or lower on all ion gauge controllers measuring the pressure upstream of the vacuum isolation window or differential stage. If the pressure exceeds this value, the isolation valve upstream of the ion gauge will close and seal. The fast valve will remain open. The storage ring will not be dumped. Ion gauges located downstream of the window or differential stage may be set at any value, provided the above conditions are met.

Please note that the above set points for interlocks are considerably higher than the normal operating pressures.

If any of the interlocks is triggered, the isolation valves and the other shutters will close and must not be opened unless:

1. The pressure in that section is below the pre-approved limit, and
2. The pressure in the front end is below  $2 \times 10^{-9}$  mbar ( $2 \times 10^{-7}$  Pa).

If the fast sensor is triggered, the operations coordinator will have to be contacted before beamline can be brought back on line.

### 3. Performance Test

The beamline and/or front end must be checked for compliance with the three ALS vacuum requirements (Vacuum, RGA scan, and Vacuum Interlocks) by the ALS Vacuum Group, if:

- i. The front end is to be opened to the storage ring for the first time.
- ii. The branchline is to be opened to the front end for the first time.

- iii. Any part of the beamline is changed or brought up to air and is ready for re-connection to the storage ring vacuum.

For UHV beamlines, the RGA requirement may be waived under special circumstances. (When it is decided by the ALS Vacuum Group and/or BRC that checking the RGA requirement is unnecessary and would not provide information of any practical use. See Section 2.3.)

## **4. Review of Vacuum Design**

The vacuum design of each beamline is reviewed by the BRC during a beamline design review. The experiment group (PRT) must demonstrate that the design will not degrade the quality of the storage ring vacuum and that it follows the ALS vacuum policies outlined in this document. The PRT should submit:

- i) Beamline assembly drawings or suitable sketches to scale.
- ii) A list of vacuum components and materials of construction.
- iii) A list of pumps, their specifications, and locations.
- iv) Information related to vacuum interlock system.
- v) Calculations showing that in case of a vacuum failure, the vacuum interlock will adequately protect the ALS vacuum integrity.

The PRT must obtain BRC approval before ordering any non-standard, non-UHV vacuum components and before fabricating any beamline components.

Approval of a PRT beamline design by the ALS Beamline Review Committee does not allow the PRT group to bypass the performance tests outlined in Section 3.

## **5. Vacuum Guidelines for Beamline and Endstation Experiment Chamber Vacuum Systems**

ALS beamlines must have all-metal, hydrocarbon-free front end components. UHV design criteria must be used for the hardware downstream of the front end, if the hardware and the front end share a common vacuum. The BRC must approve any deviations from the requirements in this section.

The following is a partial list of items which will help in developing a UHV system compatible with ALS requirements. Questions or requests for additional information should be directed to the BRC or the ALS Vacuum Group.

### **5.1 Materials**

Standard UHV-compatible materials must be used in all beamlines sharing the same vacuum as the storage ring. The following is a list of materials that are and are not

acceptable for UHV. Any material not listed must be approved.

<b>Acceptable</b>	<b>Not Acceptable</b>	<b>Marginal</b>
<u>Pure metals:</u> aluminum copper (incl. Glidcop) gold silver molybdenum tungsten titanium	Zinc- and cadmium-bearing metals and alloys are not UHV-compatible.	Stainless Steel: SS containing excessive amounts of sulfur or selenium must be avoided.
<u>Stainless Steel:</u> 300 series (preferred types are: 304, 316, 321, and 347).	Organic materials are not permitted unless they are specifically authorized by the BRC.	Elastomers such as viton may be allowed in the seat of a gate valve with metal bonnet seals. These valves are only allowed in the places where there is no chance for the elastomer to be exposed to radiation.
<u>Alloys:</u> Ampco 18 beryllium copper inconel 600 or 718 mu-metal Kovar		
<u>Ceramics:</u> Alumina ceramics sapphire machinable glass ceramic		

All components must be inspected and leak-tested after fabrication.

## 5.2 Bellows

Both welded and formed bellows are allowed, provided they are manufactured using UHV standards.

Since welded bellows are made of thin stainless steel diaphragms welded on the inside and outside diameters to form a series of convolutions, proper UHV techniques are required during manufacturing to avoid trapping of hydrocarbons or contaminants in the crevices of the convolutions. It is strongly recommended that the bellows be chemically degreased and baked in vacuum before being installed in the beamline.

Formed bellows are relatively easy to clean, but must be fabricated for UHV applications.

## 5.3 Feedthroughs

Ceramic-to-metal type electrical feedthroughs are allowed for making electrical connections into the vacuum system. No glass-to-metal feedthroughs are permitted. Voltages and current carried through the feedthroughs must not exceed the

manufacturer's ratings. External covers and cable restraint are required to protect against the accidental breaking of ceramics (which is a major cause of vacuum failure).

Bellows-type mechanical rotary and linear feedthroughs manufactured for UHV applications are allowed. **Feedthroughs with a single elastomer seal are not permitted.** However, two-stage differentially pumped feedthroughs with elastomer seals may be allowed, with approval by BRC.

## 5.4 Gauges

**Glass ionization gauges are not permitted in beamlines.** Nude ionization gauges with two independent filaments and controllers with electron bombardment degassing capability are recommended. It is recommended that the cable connection to the gauge head be bakeable to 200° C and have an enclosed connector or cable restraint. Cold cathode, thermocouple, or Vactron gauges may be allowed, if they meet UHV requirements.

## 5.5 Vacuum Pumps

Any one or combination of the following primary pumps may be used:

Sputter-ion pumps: Ion pumps (either diode, triode, or differential ion) are the most reliable pumps for UHV use. Differential ion pumps which contain both titanium and tantalum filaments are recommended, due to their ability to pump inert gases.

Titanium sublimation pumps (TSP): TSP, in combination with ion pumps, are very effective in creating UHV.

Non-evaporable getter (NEG) pumps: NEG pumps are made of UHV-compatible, active metals which pump by chemisorbing gases.

Cryo pumps: May be used with appropriate isolation valves and interlocks, which must be approved by the BRC.

Turbomolecular pumps: It is strongly recommended that both the turbo and the backing pump be oil-free. They must be equipped with appropriate interlock isolation valves for protection in case of pressure and/or power failures. The use of a turbo pump as a primary pump in the beamline is discouraged and must be approved by BRC. A turbo pump system (preferably oil-free) with appropriate interlocks may be used in the endstation experimental chamber.

Diffusion pumps: **These are not permitted due to their inherent risks of oil contamination.**

Roughing Pumps: **Only oil-free mechanical pumps may be used as roughing pumps.** Under extreme circumstances where no alternative exists, an exception may be given by the BRC. During the initial rough-pumping and/or bake-out of the beamline, turbo pumps, cryo pumps, sorption pumps and or any other oil-free pumps as approved by the BRC or Vacuum Group may be used. This is allowed only when the front end isolation valve is closed. They may also be used at the endstations. When used at an endstation, a

pump must be equipped with appropriate interlock isolation valves for protection in case of a pressure and/or power failure.

**Backing Pumps: It is strongly recommended that only oil-free mechanical pumps be used as backing pumps.** Under extreme circumstances where no alternative exists, an exception may be given by the BRC.

The vacuum requirements as outlined in Section 2 must always be satisfied.

## 5.6 Valves and Flanges

All-metal, bakeable UHV valves, flanges, and seals are acceptable. Flanges with elastomer seals are not allowed in the beamline. Metal bonnet valves with elastomer seals are not allowed in beamlines where the seal may be exposed to direct synchrotron radiation. If approved by the BRC, they may be used in places where radiation exposure is not a problem.

## 5.7 Fabrication

Fabrication of any component which becomes part of the vacuum environment of the beamline directly exposed to storage ring vacuum must be done using UHV compatible materials and following UHV-accepted techniques, including:

**Surface Preparation:** No machining or polishing operation which might result in contaminants being embedded in the material should be used. All tapped holes should be vented.

**Machining Lubrication:** No cutting lubricant may be used which results in contamination that cannot be removed by standard cleaning methods. The use of cutting fluid containing sulfur or silicone compounds is not recommended. Refer to ALS engineering notes LSME-479 (Light Source Beamlines Vacuum System—General: Fabrication, Handling, and Cleaning Parts Before Brazing, Stress-Relief Annealing, or Preliminary Bake-Out at High Temperatures for Ultra-High Vacuum Service) and LSME-500B (Light Source Beamlines Vacuum Systems General: Fabrication, Cleaning, and Certification of Stainless Steel Vacuum Chambers for Weldments for UHV) for the recommended procedures.

**Water Cooled Optics:** Vacuum-to-water joints are not permitted in the ALS beamline vacuum systems, unless there is an intermediate guard vacuum. Refer to ALS technical note M7184 (Mirror Brazing Technique). Vacuum-to-water joints must be avoided as much as possible in the users' vacuum chamber systems.

**Chemical Cleaning:** All UHV components must be vapor degreased, electropolished, and/or chemically cleaned before installation in the beamline. Refer to ALS technical note LSME-421A (Light Source Photon Beam Lines—BNL/NSLS XI Beamline Mirror System M-Zero Mirror System: General Cleaning and Brazing Procedures for Furnace-Brazed U.H.V. Parts).

## **5.8 Assembly of UHV Components**

It is highly recommended that assembly of UHV components take place in a clean room or in a clean laminar flow hood. There are many sources of contaminants. The single largest sources during assembly are perspiration, body oils, hair, perfume, etc. Thus, the use of clean gloves, face masks, lab coats, and head covers during assembly is recommended.

Lint-free paper or cloth wipes are recommended for use with UHV parts. Ethanol should be used as a wiping solvent, if necessary.

All UHV components which may get exposed to contaminants should be protected by clean, oil-free aluminum foil or lint-free paper.

No cadmium-plated, brass, lead, or wood tools should be used during assembly.

If a chamber is to be opened to air and cannot be moved to the clean room, it is recommended that the chamber be purged continuously with dry nitrogen gas. A liquid nitrogen source is the best choice to get the quantities of dry nitrogen required. The ALS will provide such a source.

## **5.9 Venting**

If a UHV chamber is to be vented, dry nitrogen should be used for venting the system. A pressure relief valve is required in the venting system, especially to protect view ports from exploding. A safe recommendation for the relief pressure valve setting is 30 mbar (0.5 psi) above atmosphere (a recommendation by Varian).

## **5.10 Leak Checking and Bakeout**

It is highly recommended that the whole system be leak-checked before going through the thorough bakeout. The recommended temperature for bakeout of a stainless steel chamber is 200° C. There may be other constraints which may limit the bakeout temperature to a lower value.

For a system which may give high outgassing loads, it is generally recommended that a nitrogen bake be done, followed by a vacuum bake. During a nitrogen bake, dry nitrogen gas from an evaporated liquid nitrogen source is pumped through the assembly while the components are heated.

## References:

For further details concerning ultra-high vacuum practice, the user may consult:

1. *Practical Vacuum Techniques*, by W.F. Brunner and T.H. Batzer, published by Krieger, 1974.
2. *A User's Guide to Vacuum Technology*, by J.F. O'Hanlon, published by John Wiley & Sons, 1980.
3. *High Vacuum Technology: A Practical Guide*, by Marsbed H. Hablanian, published by Marcel Dekker, Inc., New York, 1990.
4. *Basic Vacuum Practice*, Third Edition, Varian Vacuum Products Training Department, Varian Associates, 1992.
5. *Vacuum Policy for ALS Beamlines and Experimental Systems*, by R.C.C. Perera, K.D. Kennedy, J.R. Meneghetti, LSBL-116
6. *Light Source Beamlines Vacuum System—General: Fabrication, Handling, and Cleaning Parts Before Brazing, Stress-Relief Annealing, or Preliminary Bake-Out at High Temperatures for Ultra-High Vacuum Service*, by D. DiGennaro, LSME-479.
7. *Light Source Beamlines Vacuum Systems General: Fabrication, Cleaning, and Certification of Stainless Steel Vacuum Chambers for Weldments for UHV*, by D. DiGennaro, LSME-500B.
8. *Mirror Brazing Technique*, by D. DiGennaro, M7184.
9. *Light Source Photon Beam Lines—BNL/NSLS XI Beamline Mirror System M-Zero Mirror System: General Cleaning and Brazing Procedures for Furnace-Brazed U.H.V. Parts*, by D. DiGennaro, LSME-421A.
10. *ALS Beamline Design Requirements*, PUB-3114.





# APPENDIX C

## Survey and Alignment Information for ALS Users

---

Three distinct types of coordinate systems are used for the survey and alignment of beamlines and experiment equipment at the ALS. The umbrella *Global Coordinate System* is used to specify the location of all position-sensitive items at the ALS. A *Beamline Coordinate System* is related to the direction of the beamline, and is the basis for the layout of beamlines. A *Local Coordinate System* is dedicated to specific accelerator and beamline components, and is used primarily for the definition of fiducial offsets.

---

### Global Coordinate System

The three-dimensional Global Cartesian Coordinate System (also known as "ALS Coordinates") is aligned with the University of California grid system that is used for building construction at the University of California at Berkeley and Lawrence Berkeley National Laboratory. The Global, or ALS System has the following characteristics:

- The units of measurement are meters (m).
- The origin of the coordinate system is defined by the center point of the storage ring at nominal beam elevation (1.4 m above the floor).
- The *Y*-axis is up, or vertical, and parallel to the direction of gravity. The *Y*-axis increases in value in the "up" direction.
- The *X*-axis lies in a horizontal plane, points north, is 90° to the *Y*-axis, and increases in value in a northerly direction.
- The *Z*-axis lies in a horizontal plane, is perpendicular to the *Y*-axis and *X*-axis, and increases in value in an easterly direction.

The origin of the coordinate system at the center point of the storage ring has the following values:

$$X = 1500 \text{ m} \quad Y = 3500 \text{ m} \quad Z = 2500 \text{ m}$$

Large coordinate values were chosen to avoid negative numbers. Since the project extends no more than 500 meters in any direction, the coordinates  $X = \underline{1}500$ ,  $Y = \underline{3}500$ , and  $Z = \underline{2}500$  allow an axis to be easily identified by its leading digit.

ALS surveyors have access to the Global Coordinate System through a system of over 100 floor markers called *monuments*. The positions of monuments are surveyed on a regular basis to ensure measurement accuracy.

---

### Beamline Coordinate System

For the design and layout of beamlines, rectilinear beamline coordinates are described as  $(R, S, T)$  with the following characteristics:

- Units are given in both meters (m) and inches (in.).
  - The  $(R, S, T)$  coordinates at the beamline source point are  $(0, 0, 0)$ .  
(It is essential that the beamline source point and direction are first defined in Global or ALS Coordinates.)
  - The  $R$ -axis is radially outward from the storage ring.
  - The  $S$ -axis is vertically upward, in the direction of gravity.
  - The  $T$ -axis is the forward direction of the photon beam.
- 

### Local Coordinate System

Three-dimensional Local Cartesian Coordinate Systems can be used to make measurements on individual components and are especially useful for fiducialization. They have the following characteristics:

- The units of measurement are millimeters (mm).
- The origin of a local coordinate system is typically the center point (or another functional point) of the individual item at nominal beam elevation. The origin should be noted on a drawing of the assembly.
- The  $V$ -axis is up, or vertical, and in the direction of gravity. The  $V$ -axis increases in value in the “up” direction.
- The  $W$ -axis of the local coordinate system lies in a level plane, is perpendicular to the  $V$ -axis, points in the direction of the beam, and increases in value in the beam direction.
- The  $U$ -axis of the local coordinate system lies in a level plane, is perpendicular to both the  $V$ -axis and  $W$ -axis, always points in a direction away from the center of the accelerator, and increases in value in that direction.

The origin of a Local Coordinate System is defined as  $V= 0.0$  mm,  $W= 0.0$  mm and  $U= 0.0$  mm. It is important that the Local Coordinate System be clearly shown on an engineering drawing of the assembly to avoid later confusion.

---

**Position-Sensitive Elements:  
Fiducialization**

Most beamline instrumentation and vacuum components must be aligned at installation. To make position surveying possible, all position-sensitive components must be equipped with external targets. These targets are called *fiducials*, and are the reference points used for the measurements done by ALS survey and alignment personnel.

In general, the components of a branchline that require precision alignment (e.g., mirrors, slits, masks, and gratings) are inside vacuum chambers and are not directly accessible from outside for survey and alignment. Consequently, these components require "fiducialization" during assembly, that is, the position of important internal features must be measured precisely relative to accessible fiducial references outside the vacuum chamber. These fiducials are then used for survey and alignment at installation. For a given component, fiducialization generates a set of *Local Coordinates* ( $U$ ,  $V$ , and  $W$ ) for each fiducial.

Three fiducials are required for placing a component in space with 6 degrees of freedom, but four fiducials are highly desirable for redundancy, allowing a check on the survey and alignment. Fiducials are generally a precision 1/4 in. hole which accepts a "tooling ball" (Figure 1) for mechanical contact and measurement and an optical target (Figure 2) for direct sighting with an optical instrument.



Figure 1. Fiducials must be configured to accept a tooling ball.

The optical targets are constructed such that their optical center exactly coincides with the center of the tooling ball when interchanged in the same hole. This center point is the actual fiducial point with the local coordinates  $U$ ,  $V$ , and  $W$ .

Convenient weld-on fiducial posts that accept the optical targets and the tooling balls are described in LBNL Mechanical Engineering Drawing 20 Q 5363. These fiducial posts have been used successfully throughout the ALS and are recommended. It is also acceptable to provide precision 1/4 in. holes directly in the components. The fiducials should be located with as large a separation from each other as possible, and with a clear vertical path above them in order for elevation measurements to be taken.

Accurate and well-defined fiducialization of beamline components will ensure that each component origin (i.e., mirror center, etc.) can be aligned precisely to its specified location in the Beamline Coordinate System.



Figure 2. Fiducials accept a tooling ball or an optical target (above) for direct sighting with survey instruments.

## Appendix I — Conceptual Design Review Information Sheet

### What requires a CDR?

A new beamline.  
Modification to an existing beamline resulting in increased hazard level or requiring increased ALS support.

### What is a CDR?

Outline of the beamline concepts presented by the beamline designers. No detailed documentation is presented.

### When should it take place?

Eight to eighteen months before new beamline operation and before any large procurements have been made.  
For modified beamlines, as soon as users are aware of changes to be made.

### What will happen at the CDR?

- Evaluation of the general scheme of the beamline.
- Identification of issues that may need detailed consideration at the BDR.
- Advice given about design approaches, use of allocated space, and how best to fully exploit ALS beam properties.
- Opening of communication lines between beamline designers and ALS staff for development of the beamline.
- Requirements placed, if necessary, on the design.
- Requirements placed, if necessary, on the review process, e.g., such as requiring a review of experimental apparatus if a hutch and/or RSS are involved.

### Which BRC members<sup>†</sup>, or their designees, are required to attend a CDR?

Chairman, Chairman-past, Chairman-select (only 1 required)  
Accelerator Operations Designee  
ALS EH&S  
Beamline Engineering  
Beamline Coordination  
Electrical Safety  
Equipment Protection Systems — software  
Health Physics  
Mechanical Safety  
Radiation Safety Systems  
Radiological Control  
Scientific Program Head\*  
Vacuum Technology

<sup>†</sup>See Appendix V for list of members and designees. \*Attendance is optional

### What happens after the CDR?

Chairman will ensure minutes and any pertinent documentation is sent to all persons attending the CDR.  
Beamline designers will begin preparing documentation for next review, the BDR.

## Appendix IIa — Beamline Design Review Information Sheet

### What is a BDR?

Presentation by the beamline designer of the 12 documentation items (see BDR checklist) for a comprehensive review.

### What requires a BDR?

A new beamline.

An endstation with a hutch and/or RSS.

An endstation **with** unusual safety/operational concerns that is a permanent (> 1 year) part of the beamline.

Modification to an existing beamline or permanent endstation.

### What modifications to an existing beamline or endstation would require it to have a BDR? (Based on the changes made, the BRC Chairman may waive a BDR or call a meeting of a subgroup of the technical experts.)

- Changes in the following documentation noted on the attached BDR Checklist: Items 1.a., 2.a.b., 3.a., 4.a., 5.a., 6.a., 7.a., 8.a., 9.a., 10.a.b.c., and 11.a.
- A new endstation system will be added to the existing beamline for more than a year and has unusual safety/operational concerns.
- Modification to an endstation with a hutch and/or RSS.
- Modification to an endstation **with** unusual safety/operational concerns that is a permanent (> 1 year) part of the beamline.

### When should it take place?

Six months before beamline operation. The absolute minimum time before operation is three months.

### When should the documentation be submitted? How many copies needed?

Submit original and eleven copies to the BRC Chairman one week before the BDR.

### What will happen at the BDR?

- Examination of detailed design and use of all beamline equipment.
- Assessment of proposed beamline to surrounding beamlines and how it interacts with ALS accelerator/storage ring systems.
- Presentation of endstation requirements.
- Assessment of proposed beamline in relation to ALS supplied/maintained equipment.
- Restrictions or prohibitions may be placed on the design, e.g. elastomer seals not permitted in certain parts of the beamline.
- Mitigations may be imposed, e.g., additional vacuum monitoring for high risk windows.
- Additional requirements may be imposed.
- Additional BDR's may be required if design changes affect required documentation or aspects of design require additional study. Follow-up BDR's may involve only technical subgroups of the BRC.

## Which BRC members<sup>†</sup>, or their designees, are required to attend a BDR?

Chairman, Chairman-past, Chairman-select (2 out of 3)  
Accelerator Operations  
ALS EH&S  
Beamline Coordination  
Beamline Engineering  
Electrical Safety  
Equipment Protection Systems — software and hardware  
Health Physics  
Mechanical Safety  
Radiation Safety Systems  
Radiological Control  
Vacuum Technology

<sup>†</sup>See Appendix V for list of members and designees.

## What happens after the BDR?

- Chairman will ensure minutes are sent to all persons attending the BDR.
- Beamline designers begin beamline construction.
- Beamline designers **must** keep BRC chairman informed of construction progress and design changes affecting documentation listed on page 1 of the BDR Information Sheet.
- BRC Chairman assesses if modifications made after initial BDR requires new BDR; requirement may be waived if notification is timely and safety is not compromised.
- Beamline designers **must** provide BRC chairman with a complete set of technical drawings **before** the next review, the BRR, can be scheduled.

## Appendix IIb — Beamline Design Review Documentation Checklist

The beamline design team is responsible for bringing all items on the checklist to the BDR.

### Required Documentation for Beamline Design Review for BL \_\_\_\_\_

(Refer to ALS Beamline Design Guide, pp. 9-20, for detailed information)

#### 1. Beamline Layout

- a. Scale drawing(s) (size 6 or E, 34" × 44") of the overall beamline layout, including radiation shielding, exclusion zones, optical components, location of experiment endstations, electronics racks and wireways, workspace (e.g. computer consoles, hoods, desks, etc.), and access walkways

#### 2. Typical Experiment

- a. Schematic diagram of a typical experiment
- b. Identification of large or "permanent" mechanical apparatus
- c. Identification of hazardous materials
- d. Identification of high voltage equipment

#### 3. Vacuum Components

- a. Schematic diagram of vacuum chambers, valves, pumps, gauges, fast valve sensor locations, gas cells, and thin windows
- b. List of materials used in UHV systems

#### 4. Radiation Shielding

- a. Scaled ray-trace drawings of bremsstrahlung radiation shielding, exclusion zones, and synchrotron radiation shielding (if a superbend beamline)
- b. Description of hutch/endstation safety shutter, if present, including thickness and composition.

#### 5. Liquid-Cooled Components

- a. Location and drawings of liquid-cooled components
- b. Calculations of expected heat loads on these components

#### 6. Thin Windows

- a. Location and drawings of thin vacuum and pressure windows
- b. Calculations of the heat loads strength of and expected mechanical loads on these windows

#### 7. Endstation with Hutch and/or RSS

- a. Assembly drawing of hutch showing doors, windows, major structural members, dimensions, and materials

#### 8. Equipment Protection System

- a. A schematic instrumentation diagram describing all major equipment protection components



**9. Seismic Safety**

- a. Drawings of structures > 200 kg
- b. Calculation of seismic stresses or evidence from comparable installations/  
apparatus to demonstrate the integrity of these structures

**10. Mechanical Safety**

- a. Identify vacuum and pressure vessel viewports that are custom designed or with  
apertures > 15 cm
- b. Identify pressure vessels
- c. Identify moving components

**11. Hazardous Electrical Components**

- a. List of all electrical equipment/components with a Berkeley Lab PUB-3000 hazard  
rating of 2B (> 50 volts and > 5 mA or < 50 volts and > 100 A) or 3B (> 250 volts and  
a current > 500 W/V or 5 J stored energy).

**12. Utility Requirements**

- a. Electric power requirements in excess of 50 A for individual units
- b. Electric power requirements in excess of 208 volts AC
- c. Exhaust manifold requirements

**Checklist complete, all Documentation presented:** \_\_\_\_\_  
BRC Chairman's Signature Date

**Distribution:**

All BRC Members  
Beamline Design Team Members

**Appendix IIc — Beamline Design Review Corrective Action Sheet**

**Corrective Action Sheet for Beamline Design Review for BL \_\_\_\_\_**

**CORRECTIVE ACTIONS:**

Item	Inspector (Print Name)	Recommendations, Comments, and Restrictions	Inspector's Initials / date when complete
			date
			date
			date
			date
			date
			date
			date
			date
			date
			date

Sheet complete, all Action Items entered: \_\_\_\_\_

BRC Chairman's Signature

Date

**Distribution:**

- All BRC Members
- ALS Procedure Center Manager
- Beamline Design Team Members

## Appendix IIIa — Beamline Readiness Review Information Sheet

### What is a BRR?

- The first of a two-part final review of the design and installation of a new beamline/endstation or modified beamline/endstation.
- Presentation by the beamline designer of the documentation items in the BRR checklist.

### What requires a BRR?

A new beamline or any portion of a new beamline ready to receive beam.

An endstation with a hutch and/or RSS.

An endstation **with** unusual safety/operational concerns that is a permanent (> 1 year) part of the beamline.

Modification to an existing beamline or permanent endstation.

### When should it take place?

A few days before beamline operation is planned.

### When should the documentation be submitted?

Submit final copies to the BRC Chairman at least two weeks before design team requests a BRR. If documentation is complete, the Chairman will schedule the BRR.

### What will happen at the BRR?

- Detailed review of beamline design with emphasis on the design changes required by BDR(s).
- Review of design changes not discussed in a BDR — unless changes are minor, another BDR may be required.
- Ensure all BDR action items (item 2 on BRR checklist) are completed.
- Review of design documentation — must be final and complete copies.
- Review of BRR checklist documentation, items 3 through 6.

### Which BRC members<sup>†</sup>, or their designees, are required to attend a BRR?

Chairman

Accelerator Operations

ALS EH&S

Beamline Coordination

Electrical Safety

Equipment Protection Systems — hardware and software

Mechanical Safety

Radiological Control

Vacuum Technology

<sup>†</sup>See Appendix V for list of members and designees.

### What happens after the BRR?

- Chairman will ensure minutes are sent to all BRC members.
- Chairman will request a BRRW be scheduled by the Beamline Coordination Section Leader if the BRR is completed satisfactorily.

## Appendix IIIb — Beamline Readiness Review Documentation Checklist

The beamline design team is responsible for bringing items 1.c., 2, 3.a. and b., 5, and 6 on the checklist to the BRR, and checking to ensure BRC technical experts have completed items 3.c. and 4 .

The BRC Chairman is responsible for items 1.a., b., d., entering action items in 2, and 7 on the checklist.

### Required Documentation for Beamline Readiness Review for BL \_\_\_\_\_

(Refer to ALS Beamline Design Guide, p. 25, for detailed information)

**1. Design Changes** (check those that apply):

- a. No design changes since the BDR.
- b. Design changes since the BDR, but none which require a new BDR.
- c. Design changes in 1.b. have appropriate documentation prepared.
- d. Design changes since the BDR, which require a new BDR.

**2. BDR Action Items Completed** (taken from BDR Appendix IIc, review action items entered). Procedures required from the BDR are final, approved documents. Distribution of the completed BDR Corrective Action Sheet, Appendix IIc, may be used in lieu of entering items.

	<input type="checkbox"/>
	<input type="checkbox"/>
	<input type="checkbox"/>
	<input type="checkbox"/>
	<input type="checkbox"/>
	<input type="checkbox"/>
	<input type="checkbox"/>
	<input type="checkbox"/>

**3. Radiation**

- a. Final ray-trace drawings, approved by R. Donahue, are completed.
- b. Beamline Specific Checklist for BL Commissioning/Modification Survey, prepared by the BL scientist and B. Fairchild, approved by R. Donahue, is written.
- c. Procedure for testing the RSS interlocks is finalized and approved by A. Ritchie/  
A. Lindner.

**4. Equipment Protection System**

- a. Procedures for checking EPS interlocks have been prepared and reviewed by K. Woolfe

**5. Beamline Layout**

- a. Final scale drawing(s) of the overall beamline layout (item 1 on the BDR checklist) is done.

**6. Beamline Key-Enable**

- a. Key-enable procedure, prepared by the BL scientist and D. Hamamoto, is written.

**7. Beamline Readiness Review Walkthrough**

- a. The BRRW Checklist requirements has been reviewed.
- b. The beamline is ready for a BRRW.
- c. The beamline is not ready for a BRRW; a second BRR is required and is scheduled for \_\_\_\_\_   
Date
- d. Action items from this BRR (must be completed before the BRRW) **Must be completed**  
are entered on the BRR Corrective Action Sheet, Appendix IIIc. **by this date:**  
\_\_\_\_\_

**Checklist complete, BRRW is scheduled for:** \_\_\_\_\_  
Date

\_\_\_\_\_  
BRC Chairman's Signature Date

**Distribution :**

- All BRC Members
- Beamline Design Team Members
- Beamline Scientist (Experimenter-in-Charge)

**Appendix IIIc — Beamline Readiness Review Corrective Action Sheet**

**Corrective Action Sheet for Beamline Readiness Review for BL \_\_\_\_\_**

**CORRECTIVE ACTIONS:**

Item	Inspector (Print Name)	Recommendations, Comments, and Restrictions	Inspector's Initials / date when complete
			date
			date
			date
			date
			date
			date
			date
			date
			date
			date

**Sheet complete, all Action Items entered:** \_\_\_\_\_

BRC Chairman's Signature

Date

**Distribution:**

- All BRC Members
- ALS Procedure Center Manager
- Beamline Design Team Members

## Appendix IVa — Beamline Readiness Review Walkthrough Information Sheet

### What is a BRRW?

- The second of a two-part final review of the design and installation of a new beamline/endstation or modified beamline/endstation.
- A comprehensive walkthrough inspection of beamline using the BRRW checklist and initial operational check before the beamline becomes routinely operational .

### What requires a BRRW?

A new beamline or any portion of a new beamline ready to receive beam.  
An endstation with a hutch and/or RSS.  
An endstation **with** unusual safety/operational concerns that is a permanent (> 1 year) part of the beamline.  
Modification to an existing beamline or permanent endstation.  
All beamlines require an annual BRRW.

### When should it take place?

A few days after the BRR, when beamline hardware is completely installed and before beam is accepted. However, if the BRR imposed further documentation requirements, the BRRW cannot occur until those documents are submitted, in final and approved form, to the BRC Chairman.

### When should the documentation be submitted?

The documentation was submitted for the BRR. If the BRR imposed further documentation requirements, it should be submitted to the BRC Chairman by the date(s) entered in item 7.d. of the BRR checklist.

### What will happen at the BRRW?

- Inspection of beamline/endstation hardware to ensure it is consistent with approved documentation presented to the BRC. Beamline operation will be denied and a new BDR will be required if differences between design and installation are found.
- Ensure final front-end inspection is completed by checking Tab 7 in the BL Checklist Notebook.
- Inspection of beamline/endstation hardware to ensure it meets ALS requirements.
- Check of key beamline functions for first-time operation.
- Key-enabling of the beamline per item 6 on the BRR checklist.
- Beamline-specific radiation survey per item 12 on the BRRW checklist .
- Ensure that all items on the BRRW checklist are complete — items must be signed and dated.

### Which BRC members<sup>†</sup>, or their designees, are required to attend a BRRW?

Chairman	Radiological Control
Accelerator Operations	Vacuum Technology
ALS EH&S	
Beamline Coordination	
Beamline User Operator/Scientist	
Electrical Safety	
Equipment Protection Systems — hardware and software	
Mechanical Safety	

<sup>†</sup>See Appendix V for list of members and designees.

## **What happens after the BRRW?**

- The completed key-enable procedure and BRRW checklists are placed in the appropriate Beamline Checklist Notebook in the Control Room in Bldg. 80.
- The Beamline Coordination Leader makes an entry in both the Control Room Log and Beamline Operations Log that the beamline has undergone a satisfactory BRRW and can be operational.
- The design and installation of the beamline is considered complete.
- Any BRRW action items will be tracked by the Beamline Coordination Section Leader, who ensures they are completed in the time frame allotted.



**Appendix IVb — Beamline Readiness Review Walkthrough Checklist**  
**for Beamline \_\_\_\_\_**

- [1] **Front End Final Check:** Inspection of front end per BL 08-04 checklist (filed behind Tab 7 in the BL Checklist Notebook) has been completed and no changes were made since the final inspection.

Comments: \_\_\_\_\_  
\_\_\_\_\_  
\_\_\_\_\_

\_\_\_\_\_  
Signature/BRC Chairman

\_\_\_\_\_  
Date

- [2] **Installation Consistent with Documentation:** Inspection of beamline/endstation hardware is consistent with the approved documentation listed in the BDR checklist.

Comments: \_\_\_\_\_  
\_\_\_\_\_  
\_\_\_\_\_

\_\_\_\_\_  
Signature/BRC Chairman

\_\_\_\_\_  
Date

- [3] **Beamline-Specific Procedures**

**Approved Documents and Training:** Procedures mandated by the BDR/BRR are posted at the beamline and are "red stamped" APPROVED FILE COPY. Users requiring training have signed an ALS Training Documentation Sheet, a copy of which is posted at the beamline.

Comments: \_\_\_\_\_  
\_\_\_\_\_  
\_\_\_\_\_

\_\_\_\_\_  
Signature/Beamline Coordination

\_\_\_\_\_  
Date

- [4] **Radiation**

**Shielding Qualification:** The position and size of the bremsstrahlung shielding and of the exclusion zones will be checked against the shielding drawing noted in items 1.a. and 4.a. on the BDR checklist.

Comments: \_\_\_\_\_  
\_\_\_\_\_  
\_\_\_\_\_

\_\_\_\_\_  
Signature/Radiological Control

\_\_\_\_\_  
Date

**[4] Radiation, Continued**

**Interlocks:** It has been confirmed that the Radiation Safety System (RSS) has been qualified during the past 6 month period.

\_\_\_\_\_  
Signature/Beamline Coordination

\_\_\_\_\_  
Date

**[5] Electrical Qualification:** The beamline has been checked for electrical safety and compliance with wiring and safety standards.

Comments: \_\_\_\_\_  
\_\_\_\_\_  
\_\_\_\_\_

\_\_\_\_\_  
Signature/Electrical Safety

\_\_\_\_\_  
Date

**[6] Mechanical Qualification:** The beamline has been checked for compliance with all relevant mechanical requirements for personnel safety and equipment protection such as seismic/structural safety, hazards relating to mechanical motions, pressure vessel safety, visible light hazards, and covers to protect viewports and bellows from accidental damage.

Comments: \_\_\_\_\_  
\_\_\_\_\_  
\_\_\_\_\_

\_\_\_\_\_  
Signature/Mechanical Safety

\_\_\_\_\_  
Date

**[7] ALS Safety Requirements:** Installed hardware meets ALS safety requirements.

Comments: \_\_\_\_\_  
\_\_\_\_\_  
\_\_\_\_\_

\_\_\_\_\_  
Signature/ALS EH&S

\_\_\_\_\_  
Date

**[8] Vacuum Qualification:** Ion gauge readings and an RGA scan confirm that it is safe to open the beamline to storage ring vacuum.

Comments: \_\_\_\_\_  
\_\_\_\_\_  
\_\_\_\_\_

\_\_\_\_\_  
Signature/Vacuum Accelerator Technology

\_\_\_\_\_  
Date

**CAUTION:** *It is imperative that the branchline vacuum valve, VVR1, not be opened until the vacuum qualification is completed.*

- [9] **Equipment Protection System (EPS) Qualification:** The EPS has undergone a performance test for the sector, beamline front-end, branchline front-end, and branchline.

Comments: \_\_\_\_\_  
\_\_\_\_\_  
\_\_\_\_\_

<b>Sector:</b>	_____	_____
	Signature/EPS — hardware	Date
<b>Beamline Front-end:</b>	_____	_____
	Signature/EPS — hardware	Date
<b>Branchline Front-end:</b>	_____	_____
	Signature/EPS — hardware	Date
<b>Branchline:</b>	_____	_____
	Signature/EPS — hardware	Date

- [10] **EPBI (Errant Photon Beam Interlock) Dynamic Test:** Performed for Insertion Device beamlines prior to initial operation. Test is documented in CR Operations Log.

\_\_\_\_\_  
Signature/Accelerator Operations                      Date

- [11] **Key-enable Procedure** has been executed for the first time.

\_\_\_\_\_  
Signature/Beamline Coordination                      Date

- [12] **A radiation survey** has been conducted per ALS Procedure HP 01-05.

Comments: \_\_\_\_\_  
\_\_\_\_\_

\_\_\_\_\_  
Signature/Radiological Control                      Date

- [13] **BRRW Checklist** is complete and beamline is ready for operation.

\_\_\_\_\_  
Signature/BRC Chairman                      Date

- [14] **Final BRRW Documentation:** An entry has been made in both the ALS BL Log at the beamline and the BL Coordination Log in the CR that the BRRW is complete and the beamline can be made operational. The completed, original BRRW Checklist is filed in the appropriate BL Checklist Notebook in Bldg. 80 CR.

Comments: \_\_\_\_\_  
\_\_\_\_\_

\_\_\_\_\_  
Signature/Beamline Coordination                      Date

Appendix IVc —  Annual or  Supplemental\*  
**Beamline Readiness Review Walkthrough Checklist for Beamline \_\_\_\_\_**

\*Delineate work/repairs: \_\_\_\_\_

**[1] Documentation and Training:** Drawing of beamline is up to date and posted. Any required training documentation is also appropriately posted.

Comments: \_\_\_\_\_  
 \_\_\_\_\_  
 \_\_\_\_\_

\_\_\_\_\_  
 Signature/Beamline Operations Date

**[2] Electrical Qualification:** The beamline has been checked for electrical safety and compliance with wiring and safety standards.

Comments: \_\_\_\_\_  
 \_\_\_\_\_  
 \_\_\_\_\_

\_\_\_\_\_  
 Signature/Electrical Safety Date

**[3] Mechanical Qualification:** The beamline has been checked for compliance with all relevant mechanical requirements for personnel safety and equipment protection such as seismic/structural safety, hazards relating to mechanical motions, pressure vessel safety, visible light hazards, and covers to protect viewports and bellows from accidental damage.

Comments: \_\_\_\_\_  
 \_\_\_\_\_  
 \_\_\_\_\_

\_\_\_\_\_  
 Signature/Mechanical Safety Date

**[4] ALS Safety Requirements:** Installed hardware meets ALS safety requirements.

Comments: \_\_\_\_\_  
 \_\_\_\_\_

\_\_\_\_\_  
 Signature/ALS EH&S Date

**[5] Key-enable Procedure** for this beamline has been checked/updated for consistency with the current beamline configuration and beamline components referenced in the key-enable are appropriately labeled.

\_\_\_\_\_  
 Signature/Beamline Operations Date

[6] **Vacuum Qualification:** Ion gauge readings and an RGA scan confirm that it is safe to open the beamline to storage ring vacuum.

Comments: \_\_\_\_\_  
\_\_\_\_\_  
\_\_\_\_\_

\_\_\_\_\_  
Signature/Vacuum Accelerator Technology      Date

[7] **Equipment Protection System (EPS) Qualification:** The EPS has undergone a performance test for the sector, beamline front-end, branchline front-end, and branchline.

Comments: \_\_\_\_\_  
\_\_\_\_\_  
\_\_\_\_\_

\_\_\_\_\_  
Signature/EPS — hardware      Date

[8] **A Radiation Survey** has been conducted per ALS Procedure HP 01-05.

Comments: \_\_\_\_\_  
\_\_\_\_\_  
\_\_\_\_\_

\_\_\_\_\_  
Signature/Radiological Control      Date

[9] **BRC Chairman's approval:** The BRC Chairman has completed his/her own inspection of the beamline and has reviewed the above signatures on the BRRW checklist.

Comments: \_\_\_\_\_  
\_\_\_\_\_  
\_\_\_\_\_

\_\_\_\_\_  
Signature/BRC Chairman      Date

[10] **Final BRRW Documentation:** An entry has been made in both the ALS Beamline Log at the beamline and the BL Operations Coordinators Log in the CR that the annual/supplemental BRRW is complete. The completed, original annual/supplemental BRRW Checklist is filed in the appropriate Beamline Checklist Notebook in Bldg. 80 CR.

Comments: \_\_\_\_\_  
\_\_\_\_\_  
\_\_\_\_\_

\_\_\_\_\_  
Signature/Beamline Operations      Date

<b>Appendix V — Current BRC Members and Designees</b>
---

This list will be updated every two years on January 1, or as needed.  
Next update is scheduled for January 1, 2004.

<b>BRC Role</b>	<b>Member</b>	<b>Designee</b>
Chairman	Wayne McKinney	
Chairman-Select	Michael Martin	
Chairman-Past	Al Thompson	
<b>Technical Experts:</b>		
Accelerator Operations	Bruce Samuelson	Terry Byrne
ALS EH&S	Georgeanna Perdue	Ken Barat
Beamline Coordination	Donna Hamamoto	Alex Lobodovsky
Beamline Engineering	Will Thur	Mike Kritscher
Electrical Safety	Bob Mueller	Barry Bailey, Art Ritchie
EPS — Hardware	Ken Woolfe	Jonathan Elkins
EPS — Software	Ken Fowler	Ken Woolfe, Harry Scheid
Health Physics	Rick Donahue	Keith Heinzelman
Mechanical Safety	Will Thur	Mike Kritscher
Radiation Safety Systems	Art Ritchie	Al Lindner, Bob Mueller
Radiological Control	Brian Fairchild	Rick Donahue
Survey and Alignment	Richard DeMarco	Bill Baldock
Vacuum Technology	Frank Zucca	Dan Colomb <sup>1</sup> Tony Catalano <sup>2</sup>
<b>Ex-Officio:</b>		
Division Deputy for Planning	Jim Krupnick	Joe Harkins
ESG Leader	Howard Padmore	Tony Warwick
Operations Head	Benedict Feinberg	David Robin
Scientific Program Head	Neville Smith	
Scientific Support Head	Zahid Hussain	
User Services Head	Gary Krebs	

**NOTE: All BRC members are not required for every review. Refer to Appendices I-IV for required attendance list at each review.**

**Distribution:**

All BRC Members and Designees

Annual

or

Supplemental\*

**Beamline Readiness Review Walkthrough Checklist for Beamline \_\_\_\_\_**

\*Delineate work/repairs: \_\_\_\_\_

- [1] **Documentation and Training:** Drawing of beamline is up to date and posted. Any required training documentation is also appropriately posted.

Comments: \_\_\_\_\_  
\_\_\_\_\_  
\_\_\_\_\_

\_\_\_\_\_  
Signature/Beamline Operations Date

- [2] **Electrical Qualification:** The beamline has been checked for electrical safety and compliance with wiring and safety standards.

Comments: \_\_\_\_\_  
\_\_\_\_\_  
\_\_\_\_\_

\_\_\_\_\_  
Signature/Electrical Safety Date

- [3] **Mechanical Qualification:** The beamline has been checked for compliance with all relevant mechanical requirements for personnel safety and equipment protection such as seismic/structural safety, hazards relating to mechanical motions, pressure vessel safety, visible light hazards, and covers to protect viewports and bellows from accidental damage.

Comments: \_\_\_\_\_  
\_\_\_\_\_  
\_\_\_\_\_

\_\_\_\_\_  
Signature/Mechanical Safety Date

- [4] **ALS Safety Requirements:** Installed hardware meets ALS safety requirements.

Comments: \_\_\_\_\_  
\_\_\_\_\_  
\_\_\_\_\_

\_\_\_\_\_  
Signature/ALS EH&S Date

- [5] **Key-enable Procedure** for this beamline has been checked/updated for consistency with the current beamline configuration and beamline components referenced in the key-enable are appropriately labeled.

\_\_\_\_\_  
Signature/Beamline Operations

\_\_\_\_\_  
Date

- [6] **Vacuum Qualification:** Ion gauge readings and an RGA scan confirm that it is safe to open the beamline to storage ring vacuum.

Comments: \_\_\_\_\_  
\_\_\_\_\_  
\_\_\_\_\_

\_\_\_\_\_  
Signature/Vacuum Accelerator Technology

\_\_\_\_\_  
Date

- [7] **Equipment Protection System (EPS) Qualification:** The EPS has undergone a performance test for the sector, beamline front-end, branchline front-end, and branchline.

Comments: \_\_\_\_\_  
\_\_\_\_\_  
\_\_\_\_\_

\_\_\_\_\_  
Signature/EPS — hardware

\_\_\_\_\_  
Date

- [8] A **Radiation Survey** has been conducted per ALS Procedure HP 01-05.

Comments: \_\_\_\_\_  
\_\_\_\_\_  
\_\_\_\_\_

\_\_\_\_\_  
Signature/Radiological Control

\_\_\_\_\_  
Date

- [9] **BRC Chairman's approval:** The BRC Chairman has completed his/her own inspection of the beamline and has reviewed the above signatures on the BRRW checklist.

Comments: \_\_\_\_\_  
\_\_\_\_\_  
\_\_\_\_\_

\_\_\_\_\_  
Signature/BRC Chairman

\_\_\_\_\_  
Date

- [10] **Final BRRW Documentation:** An entry has been made in both the ALS Beamline Log at the beamline and the BL Operations Coordinators Log in the CR that the annual/supplemental



BRRW is complete. The completed, original annual/supplemental BRRW Checklist is filed in the appropriate Beamline Checklist Notebook in Bldg. 80A.

Comments: \_\_\_\_\_  
\_\_\_\_\_

\_\_\_\_\_  
Signature/Beamline Operations                      Date

**Sample Beamline Commissioning Radiation Survey Checklist BL 5.0.2**

**Prepared by:** Carl Cork, Keith Heinzelman

**Reviewed by:** Rick Donahue

**First Survey**

Beam Energy _____ GeV	Beam Current _____ mA	initials
1. Survey taken all along beamline with PSS201 open, DIAG201 out, and M201 adjusted through full range of motion		
2. Survey taken at PSS201 with PSS201 closed		
3. Survey taken at AP003 with PSS 201 open		
4. Survey taken at DIAG201 with DIAG201 in and PSS201 open		
5. Survey taken at AP201 with DIAG201 in and PSS201 open		
6. Survey taken at AP201 with DIAG201 out and PSS201 open		
7. Survey taken around MONO201 with MONO201 adjusted through full range of motion, including zero angle at low current		
8. Survey taken at DIAG202 with MONO201 at zero angle		

**ALS RCT signature**

\_\_\_\_\_ **Date** \_\_\_\_\_

**Survey at full current**

Beam Energy _____ GeV	Beam Current _____ mA	initials
1. Survey taken all along beamline with PSS201 open, DIAG201 out, and M201 adjusted through full range of motion		
2. Survey taken at PSS201 with PSS201 closed		
3. Survey taken at AP003 with PSS 201 open		
4. Survey taken at DIAG201 with DIAG201 in and PSS201 open		
5. Survey taken at AP201 with DIAG201 in and PSS201 open		
6. Survey taken at AP201 with DIAG201 out and PSS201 open		
7. Survey taken around MONO201 with MONO201 adjusted through full range of motion, including zero angle at low current		
8. Survey taken at DIAG202 with MONO201 at zero angle		

**ALS RCT signature**

\_\_\_\_\_ **Date** \_\_\_\_\_

**Survey at 1.9 GeV**

Beam Energy 1.9GeV	Beam Current _____ mA	initials
1. Survey taken all along beamline with PSS201 open, DIAG201 out, and M201 adjusted through full range of motion		
2. Survey taken at PSS201 with PSS201 closed		
3. Survey taken at AP003 with PSS 201 open		
4. Survey taken at DIAG201 with DIAG201 in and PSS201 open		
5. Survey taken at AP201 with DIAG201 in and PSS201 open		
6. Survey taken at AP201 with DIAG201 out and PSS201 open		
7. Survey taken around MONO201 with MONO201 adjusted through full range of motion, including zero angle at low current		
8. Survey taken at DIAG202 with MONO201 at zero angle		

**ALS RCT signature**

\_\_\_\_\_ **Date** \_\_\_\_\_

**Survey at full field**

Beam Energy _____ GeV	Beam Current _____ mA	initials
1. Survey taken all along beamline with PSS201 open, DIAG201 out, and M201 adjusted through full range of motion		
2. Survey taken at PSS201 with PSS201 closed		
3. Survey taken at AP003 with PSS 201 open		
4. Survey taken at DIAG201 with DIAG201 in and PSS201 open		
5. Survey taken at AP201 with DIAG201 in and PSS201 open		
6. Survey taken at AP201 with DIAG201 out and PSS201 open		
7. Survey taken around MONO201 with MONO201 adjusted through full range of motion, including zero angle at low current		
8. Survey taken at DIAG202 with MONO201 at zero angle		

**ALS RCT signature**

\_\_\_\_\_ **Date** \_\_\_\_\_

<b>Survey Completed</b> _____ <b>Date</b> _____
---

---

# Appendix E – Contacts for Additional Information and Technical Questions

**Surface mail should be addressed to the recipient at:**

Advanced Light Source  
MS 6R2100, Berkeley Lab  
Berkeley, CA 94720

## **ALS Business Manager**

Jerry Kekos  
MS 80R0114  
510-486-6889  
510-486-4960  
jmkekos@lbl.gov

## **ALS User Services Office**

For copies of all referenced documentation.  
Jeffrey Troutman  
MS 6R2100  
510-486-2001  
510-486-4773 (fax)  
alsuser@lbl.gov

## **Beamline Review Committee**

To schedule a review, please contact:

### **Beamline Review Committee (BRC) Chair**

Michael Martin  
MS 6R2100  
(510) 495-2231  
(510) 495-2067  
mcmartin@lbl.gov

### **BRC Co-Chair**

Tony Warwick  
MS 2R0400  
(510) 486-5819  
(510) 486-7696  
t\_warwick@lbl.gov

### **BRC Coordinator**

Cathy Cooper  
MS 2R0400  
(510) 486-4067  
(510) 486-7696 [Fax]

## **Beamline Scientist**

The Beamline Scientist is the person in charge of an individual beamline who has in-depth understanding of the beamline and who is the representative and contact person for the beamline. Contact the ALS User Services Office for the name of the person in charge a specific beamline.

## **Beamline Controls**

Ed Domning  
MS 10R0110  
510-486-5117  
510-486-7374 (fax)  
EEDomning@lbl.gov

## **Beamline Design**

Howard Padmore  
MS 2R0400  
510-486-5787  
510-486-7696 (fax)  
hapadmore@lbl.gov

Alastair MacDowell  
MS 2R0400  
510-486-4276  
510-486-7696 (fax)  
aamacdowell@lbl.gov

Tony Warwick  
MS 2R0400  
510-486-4276  
510-4867696 (fax)  
t\_warwick@lbl.gov

## **Electrical (wireway, cabling, etc.)**

Barry Bailey  
MS 46R0125  
510-486-5817  
510-486-5775 (fax)  
bjbailey@lbl.gov

## **Electronic Engineering**

Mike Fahmie  
MS 48R0125  
510-486-4030  
510-486-5775 (fax)

---

### **Environment, Health, and Safety**

Georgeanna Perdue  
MS 80R0114  
510-486-7407  
510-486-5800 (fax)  
gmperdue@lbl.gov

### **Equipment Protection System**

Ken Wolfe  
MS 46R0125  
510-486-7739  
510-486-5775 (fax)  
kdwolfe@lbl.gov

### **Laser Safety**

Ted DeCastro  
MS 75B0101  
510-486-5265  
510-486-4776 (fax)  
tmdecastro@lbl.gov

### **Mechanical Engineering**

Rob Duarte  
MS 46R0161  
510-486-7229  
510-486-4873 (fax)  
rmduarte@lbl.gov

Dave Plate  
MS 46R0161  
510-486-7232  
510-486-4873 (fax)  
dwplate@lbl.gov

### **Mechanical System Safety**

William Thur  
MS 80R0114  
510-486-5689  
510-486-4873 (fax)  
gwthur@lbl.gov

Mike Kritscher  
MS 46R0161  
510-486-8647  
510-486-4873 (fax)

### **Beamline Coordinator**

The Beamline Coordinators are the first contact for questions or assistance on the experiment floor during ALS operations. They are knowledgeable about ALS operations, safety regulations and training, and beamline inspection and documentation.

Beamline Coordinator On Duty  
510-486-7464

### **Procedures for ALS Operations**

Rita Jones  
MS 80R0114  
510-486-7723  
510-486-5800 (fax)  
rcjones@lbl.gov

#### Interlock Procedures

Ken Woolfe  
MS 46-125  
510-486-7739  
510-486-5775 (fax)  
kdwoolfe@lbl.gov

#### Key-Enable Procedure

Donna Hamamoto  
MS 80R0114  
510-486-5527  
510-486-4102 (fax)  
djhamamoto@lbl.gov

### **Radiation Safety System (RSS)**

Bob Mueller  
MS 46R0125  
510-486-2929  
510-486-5775 (fax)

### **Radiation Shielding**

#### Ray-Trace Drawings and Shielding Construction

Rick Donahue  
MS 2R0400  
510-486-5597  
510-486-7304 (fax)  
rjdonahue@lbl.gov

---

**Radiation Survey**

ALS Radiological Engineer  
Brian Fairchild  
MS 80R0114  
510-486-6212  
510-486-5800 (fax)  
bsfairchild@lbl.gov

**Seismic**

William Thur  
MS 80R0114  
510-486-5689  
510-486-4102 (fax)  
gwthur@lbl.gov

Mike Kritscher  
MS 460R0161  
510-486-8647  
510-486-4873 (fax)

**Survey and Alignment**

Alex Gavidia  
MS 10R0110  
510-486-5469  
510-486-6017  
alex\_gavidia@lbl.gov

**Technical Assistance, Work Order Requests,  
Hookups and Repairs**

Under Beamline Coordination Section Leader:  
Donna Hamamoto  
MS 80R0114  
510-486-5527  
510-486-4102 (fax)  
djhamamoto@lbl.gov

**Vacuum**

Frank Zucca  
MS 80R0114  
510-486-4552  
510-486-4102 (fax)  
fazucca@lbl.gov

Dan Colomb  
MS 80-101  
510-486-4240  
510-486-4990 (fax)  
dhcolomb@lbl.gov

Beamline Coordination Section Leader  
Donna Hamamoto  
MS 80R0114  
510-486-5527

**Utilities** Bruce "Sam" Samuelson

Barry Bailey  
MS 460R0161  
510-486-4738  
510-486-5817  
510-486-5775 (fax)  
bjbailey@lbl.gov

**Operations Scheduling**

ALS Operations schedules are posted every Monday morning at <http://www-als.lbl.gov/als/schedules/>

Jan Pusina  
MS 80R0114  
510-486-4738  
510-486-4102 (fax)  
jlpusina@lbl.gov

**Additional Sources of Information Available from:**

ALS User Services Office  
MS 6R2100  
510-486-7745  
510-486-4773 (fax)  
alsuser@lbl.gov

ALS Beamline Rack Numbering Scheme (LSEE-107A)

*ALS Experiment Form*

*ALS Synchrotron Radiation Shielding (LBL-37801)*

Berkeley Lab *Health and Safety Manual (PUB-3000)*;  
available on the World Wide Web from:

<http://www.lbl.gov>

*Bremsstrahlung Collimation and Shielding for ALS U5 and U8 Beamlines (LSBL-058A)*

*Gas Bremsstrahlung Estimates for ALS Hutch Backstops (LSBL-162)*

---

*Inspection and EPS Testing for a Partially Completed  
Front-End (BL 08-04)*

*LBNL Chemical Hygiene and Safety Plan (PUB-5341)*

*LBNL Mechanical Engineering Drawing 20 Q 5363*

*Radiation Safety Shutters, Collimation and Shielding for  
ALS Beamlines (LSBL-073)*

Sample copy of the Beamline Design Review  
document package

# Appendix F – Checklist and Timeline for Building a Beamline

Step		ALS Contact (Extension)	When	X
<b>Conceptual Design Review (CDR)</b>	Outline of beamline concepts, minus engineering details	Beamline Review Committee Chair (4067)	As soon as concept is clear	
<b>X</b>				
<b>Beamline Design Review (BDR)</b>	Designs of beamline components and equipment presented and evaluated <u>at least 3–6 months before tentative date of first operation of beamline</u>	Beamline Review Committee Chair (4067)	Submit with BDR	
	<b>1. Beamline/Endstation Layout</b> Drawing of beamline components and overall layout including shielding exclusion zones, valves, gauges, interlock components, and walkways	Mike Kritscher (8647) Will Thur (5689)		
	<b>2. Radiation Shielding</b> Final ray-trace drawings showing shielding and exclusion zone dimensions and positions.	Rick Donahue (5597)		
	<b>3. Hutches (if used)</b> Description of hutch design	Rick Donahue (5597)		
	<b>4. Vacuum Components</b> Description of vacuum components used in beamline and endstation	Frank Zucca (4552) Will Thur (5689)		
	<b>5. Equipment-Protection System (EPS)</b> Description of equipment protection interlocks to maintain storage ring integrity (including fast valves)	Ken Woolfe (7739)		
	<b>6. Electrical Equipment</b> Description of electrical equipment including access and lighting requirements	Barry Bailey (5817)		
	<b>7. Liquid-Cooled Components</b> Description of liquid-cooled components, including heat load calculations	Mike Kritscher (8647) Will Thur (5689)		
	<b>8. Seismic Safety Measures</b> Description of seismic restraints to ensure equipment withstands 0.7 g lateral acceleration.	Will Thur (5689) Mike Kritscher (8647)		
	<b>9. Thin Vacuum Windows</b> Description of think vacuum windows including heat load calculations	Will Thur (5689) Mike Kritscher (8647)		
	<b>10. Utilities</b> Requirements for each utility	Barry Bailey (5817)		
	<b>11. Mechanical Safety Measures</b> Provide verification of compliance with LBNL requirements for mechanical systems	Rob Duarte (7229)		
	<b>12. Typical Experiment</b> Brief description of typical experiment	Beamline Review Committee Chair (4067)		

Step	Brief Description of What Is Needed	ALS Contact (Extension)	When	X
<b>Construction Begins</b>	<b>1. Instrument Details</b> Implement beamline instruction in collaboration with ALS staff	Ken Woolfe (7739)	Before BRR	
	<b>2. Electrical Wiring and Power</b> Install wireways, cables, terminations, and electrical power in collaboration with ALS staff.	Barry Bailey (5817)		
	<b>3. Vacuum Needs</b> Arrange to meet vacuum needs related to clean room facility, assembly of components, bakeout requirements, and installation of components in collaboration with ALS staff	Frank Zucca (4552) Dan Colomb (4240)	2 weeks before needed	
	<b>4. Radiation Safety System</b> Communicate special RSS requirements during design and implementation of system by ALS staff	Bob Mueller (2919)	Before BRR	
	<b>5. EPS and Branchline Control System)</b> Implement EPS and branchline control system in collaboration with ALS staff	Ken Woolfe (7739)		
	<b>6. Interlock Procedures for EPS</b> Write EPS interlock checkout procedures in collaboration with ALS staff	Ken Woolfe (7739)		
	<b>7. Key-Enable Checklist</b> Provide key-enable checklist of all items to be checked by ALS staff including shielding, exclusion zones, RGA scan and ion gauges	Donna Hamamoto (5527)		
	<b>8. Partially Completed Front End</b> Inspection and EPS testing of partially completed front end capable of accepting radiation; to be completed prior to storage ring fill (see checklist in Procedure BL 08-04, available from ALS User Office; Appendix E).	Ken Woolfe (7739)	When front end ready to accept radiation	
				X
<b>Checkout of Completed Systems</b>	<b>1. Radiation Safety System</b> Implement beamline instruction in collaboration with ALS staff	Bob Mueller (2919)	Before BRR	
	<b>2. Beamline Front-End EPS</b> Check of interlocks of beamline front-end equipment protection system by ALS staff.	Ken Woolfe (7739)		
	<b>3. Branchline EPS</b> Check of interlocks of branchline equipment protection system performance jointly by ALS staff and beamline designer	Ken Woolfe (7739)		



<b>Step</b>	<b>Brief Description of What Is Needed</b>	<b>ALS Contact (Extension)</b>	<b>When</b>	<b>X</b>
<b>Beamline Readiness Review (BRR)</b>	Review of documentation submitted to BRC at the time of the initial Beamline Design Review (BDR), and discussion of BRR walkthrough procedures	Beamline Review Committee Chair (4067)	When construction is complete	
	<b>1. Changes</b> Documentation, provided by beamline designer, or any changes to the beamline since the BDR	Beamline Review Committee Chair (4067)	Decided at BRR	
<b>X</b>				
<b>Beamline Readiness Review Walkthrough (BRRW)</b>	Walkthrough to check key functions of beamline prior to the first-time operation (see checklist in Procedure BL 08-16, Appendix D)	Beamline Review Committee Chair (4067)	1–2 / days before operation	
	<b>1. Beamline Approval</b> Verification that beamline is consistent with specifications presented at BDR	BRC Chair		
	<b>2. Procedures Approval</b> Verification that all BRC-mandated procedures have been approved	BRC Chair		
	<b>3. Radiation Shielding</b> a. Final check of shielding and exclusion zones b. Final check of RSS	Rick Donahue (5997)		
	<b>4. Electrical Safety Qualification</b> Final check for electrical safety	Barry Bailey (5817)		
	<b>5. Mechanical Qualification</b> Final check for seismic safety and motions hazards	Will Thur (5689) Mike Kritscher (8647)		
	<b>6. Hardware Qualification</b> Final check of vacuum and RGA			
	<b>7. Vacuum Qualification</b> Final check of vacuum and RGA	Frank Zucca (4552)		
	<b>8. Equipment-Protection System (EPS)</b> Final check of EPS system	Ken Woolfe (7739)		
	<b>9. Errant Photon Beam Interlock (EPBI) Test</b> Dynamic test for insertion device beamlines			
	<b>10. Key-Enable</b> Key-enable procedure and checklist completed to permit beamline operation	Donna Hamamoto (5527)		First operation
	<b>11. Radiation Safety</b> Check during initial operation	ALS Radiological Engineer (5527)		



## Appendix G: ALS User Advisories

This Appendix provides a list of the ALS User Advisories related to beamline design. Copies of the advisories listed below can be found on the Web at:

<http://www-als.lbl.gov/als/user-advis/index.html>

This list is current as of **March 1, 2005**. Updated versions of the advisories are available at the Web page noted above, at the User Services Area near Beamline 4 in the ALS, or from the ALS User Services Office:

ALS User Services Office  
Advanced Light Source, MS 6R2100  
Berkeley Lab  
Berkeley, CA 94720

Email: [alsuser@lbl.gov](mailto:alsuser@lbl.gov)  
Tel: 510-486-7745  
Fax: 510-486-4773

Category	Advisory Number	Title
<b>Design, Installation, and Operation of Equipment</b>	2	Electrical Cable Wire and Routing Requirements
	4	Guidelines for Meeting Seismic Requirements for User Equipment at the ALS
	9	Vacuum Policy for User Endstations for Protection of Beamline Components and Storage Ring Vacuum
	14	Interlock Requirements for Turbo Pump Systems on ALS Endstations
<b>Electrical Safety</b>	3	Avoiding Overloads on AC Circuits
	5	Beamline Electrical Safety Guidelines
<b>Laser Safety</b>	6	Laser Safety Policies for Class 3b and Class 4 Lasers



APPENDIX H: RADIATION HAZARDS AT THE ALS

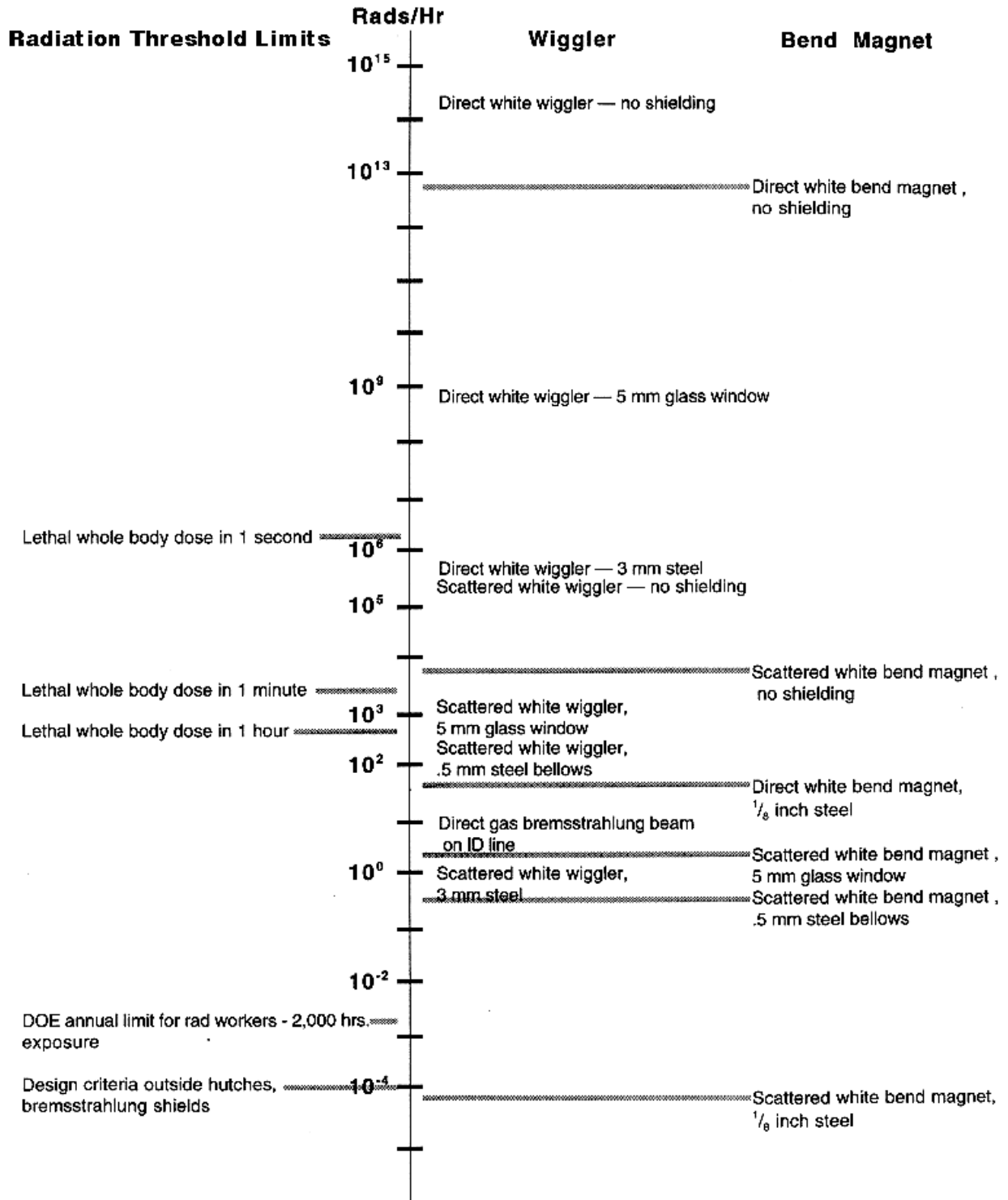

## 1. Radiation Hazards

There are two different sources of ionizing radiation at the ALS which can pose a hazard if not properly dealt with: bremsstrahlung radiation and synchrotron radiation. Bremsstrahlung radiation consists of high energy photons produced when high energy electrons interact with matter. Synchrotron radiation is produced when an electron beam is deflected by magnets, producing very intense, low energy photon beams. In addition, beamlines which allow white synchrotron radiation to pass through a beryllium window into air will produce significant and potentially hazardous amounts of ozone.

These direct sources of ionizing radiation, their scattered radiation, and the production of significant amounts of ozone can pose unique and distinct radiation hazards and are therefore discussed separately below. Some generic knowledge of the associated hazards of these sources of radiation is necessary by beamline designers to ensure a safe workplace for all those working at the ALS.

## 2. Bremsstrahlung Radiation Hazards

There are two common forms of bremsstrahlung radiation at electron storage rings: thin-target (gas) bremsstrahlung, and thick-target bremsstrahlung. When a high energy electron interacts in a thick target, one or more bremsstrahlung photons are created. These photons can have energies up to the energy of the incident electron. In addition to interaction via bremsstrahlung, the incident electron or secondary electrons undergo many coulomb collisions with the surrounding atoms. This influences the angular distribution of the bremsstrahlung photons created, producing photons at all angles. The walls and roof of the storage ring are designed mainly to attenuate these high energy, thick-target photons. Thin-target bremsstrahlung is a special condition whereby the target is so thin that coulomb interactions can be neglected, resulting in the production of bremsstrahlung photons at very small angles in the direction of the electron beam. An example of this in storage rings is the interaction of the electron beam with the residual gas molecules inside the vacuum chamber, termed "gas bremsstrahlung." This may seem like a rare occurrence given that the vacuum pressure is on the order of  $10^{-9}$  Torr, but there are approximately  $10^{12}$  electrons stored in the ring circulating over a million times per second, thereby providing many opportunities for interaction with the residual gas molecules. In a storage ring, the production of gas bremsstrahlung is directly proportional to the gas pressure and the target thickness. Therefore, one should expect gas bremsstrahlung to be a much larger problem on insertion device beamlines with 6 to 7-meter straight sections (especially for a straight section with poor vacuum), than on bend magnet beamlines. Gas bremsstrahlung photons are produced with roughly the same angular divergence as the synchrotron beam. But, since they are of much higher energy, they cannot be reflected by mirrors or other optical elements in the path of the synchrotron beam. Instead, they interact with these components producing potential sources of scatter radiation.

As an example of the order of magnitude of gas bremsstrahlung dose rates, consider a beamline with a 6-meter insertion device straight section with the storage ring operating at 1.9 GeV, 800 mA and 1 nTorr pressure. The dose rate 20 meters downstream of the source standing directly in the gas bremsstrahlung beam (neglecting the synchrotron beam) would be about 20 rads/hr. To attenuate this beam by a factor of ten requires about 2 inches of lead. If this gas-bremsstrahlung beam were impinging on a thick optical element, the unshielded scatter dose rate at 1 meter to the side would be about 0.1 rad/hr (100 mrad/hr). To put this in perspective it would take about 15 minutes standing in the direct gas bremsstrahlung beam to reach the DOE annual limit for a radiation worker (5 rad), and about 50 hours to reach the same limit if standing one meter to the side. The criteria and methodology for designing gas bremsstrahlung shielding is given in Appendix A.

### 3. Synchrotron Radiation Hazards

Synchrotron radiation at the ALS can be produced by the storage ring bend magnets or by specially designed insertion devices such as wigglers or undulators. This radiation can be generally characterized as low energy (few hundreds of eV to few tens of keV) and extremely high intensity. The photon intensity at any energy from these different devices can vary by several orders of magnitude. An example is shown in Figure 1.

This is shown for illustrative purposes only as the undulator spectra include only the envelope of the first, third and fifth harmonics. Because of these unique spectral characteristics, the synchrotron shielding requirements can vary from beamline to beamline.

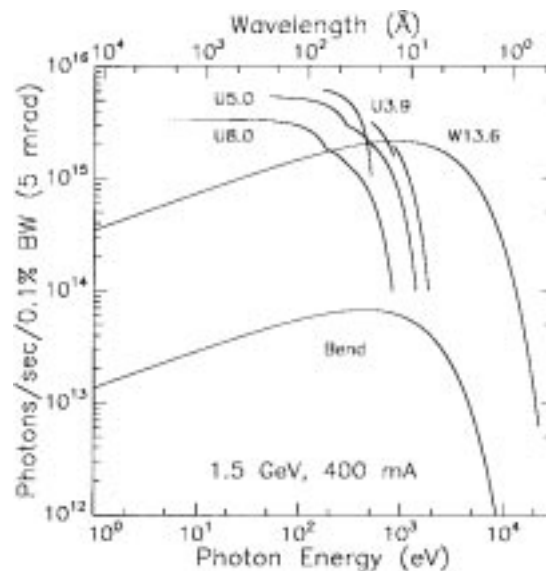

Figure 1: Comparison of spectral flux for 3 undulators, one wiggler and an ALS bend magnet. Wiggler and bend magnet spectra assume 5 mradian collection angle. Undulator spectra represent the envelope of the first, third and fifth harmonics. (ALS Handbook-A Summary of the Capabilities and Characteristics of the Advanced Light Source, PUB-643, Rev 2. April 1989).

In addition, a beamline may contain a number of filtering elements (e.g. Be windows) and/or optical elements (mirrors, monochromators, etc.) that can change the shielding requirements along the length of a given beamline. Therefore, the shielding requirements can be roughly grouped by potential radiation hazard as follows: white (unreflected) wiggler, reflected wiggler and white bend magnet and white undulator, reflected bend magnet and reflected undulator, followed by monochromatic beamlines. The radiation shielding criteria are given in the following sections.

To give an idea of the potential level of hazard, consider an unshielded, white (unreflected), bend-magnet beamline that accepts about 7 mradian of horizontal radiation and has a 2.5 mm Be vacuum window that absorbs very low-energy photons and provides vacuum protection. The unshielded dose rate at 30 cm to the side of the scatter point inside the required hutch or endstation is about 1000 rads/hr due to the synchrotron beam scattering off a piece of aluminum or lead. The dose rate in the direct synchrotron beam is many orders of magnitude higher. This scattered dose rate drops to less than 0.1 mrad/hr (7 orders of magnitude) when shielded by just 1/8" steel (3 mm). Note that even the scattered synchrotron dose rate is several orders of magnitude higher than the direct gas-bremsstrahlung beam, but not nearly as penetrating due to the differences in photon energy. This is why it is imperative that endstations, mirror tanks, and other sources of scattered synchrotron radiation be properly shielded and personnel access to these synchrotron beams, in particular white beams, be prevented. There may be certain experimental conditions where such access may be allowed under strict procedural control. An example would be to make adjustments in an endstation on a large angle reflected monochromatic beamline. **Such an exception to the rules requires the expressed written permission from the ALS Beamline Review Committee.**

#### **4. Ozone Hazards and Guidelines**

Beamlines which allow white synchrotron radiation to pass through a beryllium window into air will produce significant amounts of ozone. Relevant guidelines require that personnel may not be exposed to ozone levels above 0.1 ppm. Without the use of restricting apertures and ventilation, ALS white synchrotron radiation passing through air will produce ozone concentrations which quickly exceed the 0.1 ppm limit.

The amount of ozone produced depends on the amount of beam energy absorbed by the air. The ozone production rate is the absorbed beam energy multiplied by the "G" value. Measurements have shown that between 7.4 and 10.3 molecules of ozone are produced per 100 eV absorbed in air. This number is referred to as the "G" value. To be conservative, the ALS will use a G value of 10.3.

Beamline designers must ensure that their hunched beamlines will not produce ozone concentrations above 0.1 ppm. Components which restrict beam opening and beam path length in air to achieve permissible ozone concentrations must be fixed in place, and the beamline cannot be allowed to operate without these restrictions in their designed position. In addition, ozone measurements will be taken by the ALS to verify that the controls are effective.



Ozone concentration can be found by:

$$C(t) = \frac{P}{V(\alpha + \beta + kP)} [1 - e^{-(\alpha + \beta + kP)t}]$$

Where  $C(t)$  is the ozone concentration as a function of time,  $t$  is the time,  $P$  is the ozone production rate,  $V$  is the hutch volume,  $a$  is the chemical decay constant for ozone,  $b$  is the ventilation rate divided by the effective volume, and  $k$  is the constant related to the destruction of ozone by the synchrotron beam. To be conservative, the value of  $k$  is taken to be zero. 1/50 minutes is the assumed value of  $a$ .

To find the ozone production rate for an ALS bend magnet beam, the following parameters were used: 400 mA; 2 mradH; 3.24 keV critical energy; 3 foot beam path length in air. The dependence of path length quickly flattens out after 500 mm as shown in Figure 2. The energy absorbed by the air was determined using the PHOTON program. The production rate is found to be 0.018 grams/min. Assuming no ventilation in a 900 cubic foot hutch, ozone concentration will reach a saturation level of 17 ppm ozone after about 3 hours, but will exceed the 0.1 ppm limit after only 0.3 minutes.

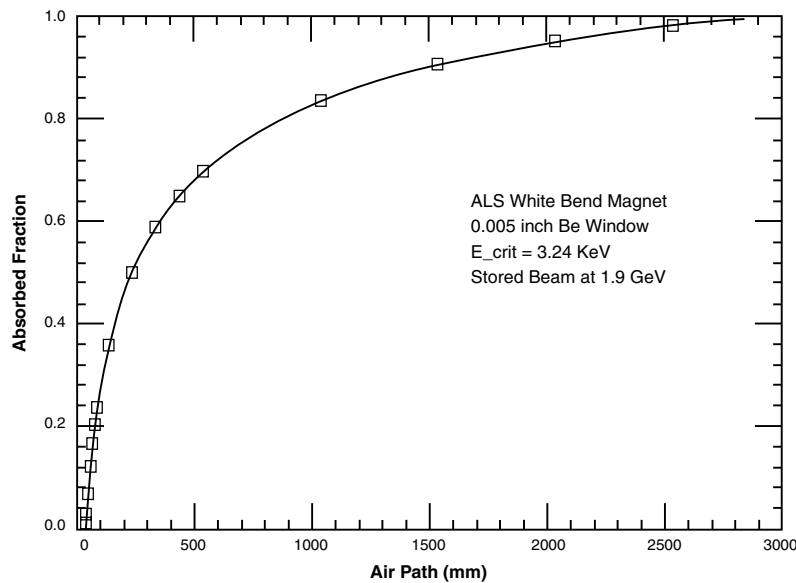

Figure 2

Ozone levels can be reduced by adding ventilation, shortening the path length in air, and/or by reducing the horizontal opening angle of the radiation. As an example, if 200 cfm ventilation is added, the opening is restricted to allow only 0.34 mradH, and the beam path length in air is restricted to 100 mm, the ozone saturation level calculated above will be reduced to 0.1 ppm. Different combinations of opening angles, path lengths in air and ventilation rates which achieve the 0.1 ppm ozone limit are shown in Figure 3. The requirement is to design the experimental setup to be lower than the relevant ventilation curve.

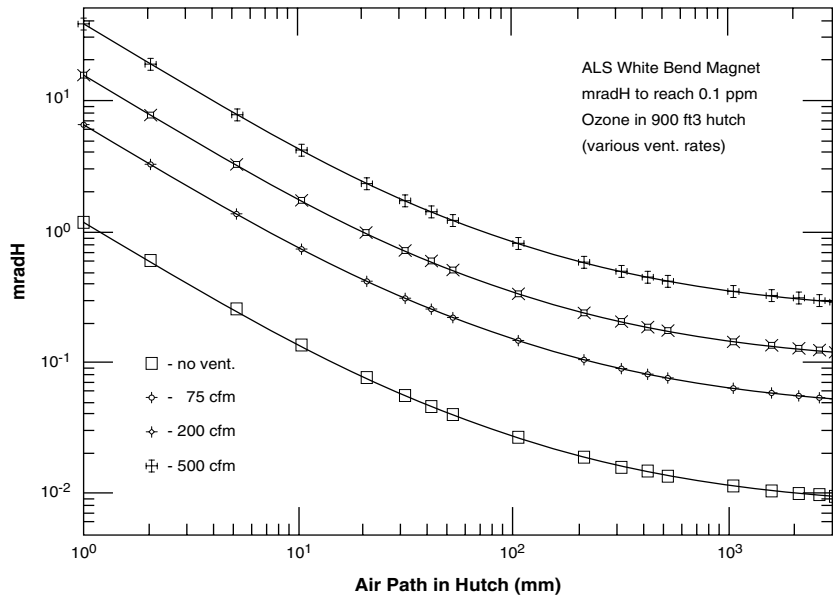

Figure 3

See the Radiation Survey contact identified in Appendix E for additional information about safety procedures relating to unsafe levels of ozone production.

## 5. Synchrotron Radiation Shielding

Synchrotron radiation can be generated by dipole bend magnets, wigglers and undulators. Wigglers and undulators will have various period distances, number of periods and magnetic field strengths, all of which greatly affect the photon energy spectrum. An attempt is made in the following sections to group these various types of beamlines into categories for radiation protection purposes. The Beamline Review Committee should be consulted as early as possible regarding specific beamline shielding concerns or questions.

### 5.1 Bend Magnet Beamline Shielding

Typical bend magnet shielding criteria have been established in "*ALS Synchrotron Shielding*," R.J. Donahue LBL-37801, Oct 1995. Results indicate that hutch/endstation walls for white beamlines constructed of 1/8" steel (3 mm) will reduce scattered dose rates to acceptable low levels. For transport tubes and covers over flex bellows in white light sections a minimum of 1/16" steel (1.5 mm) should be used. Consideration should be given to using 1/8" steel transport tubes which house components likely to produce a source of scattered synchrotron radiation. Viewport windows in white light sections should be 0.5 mm lead in equivalent thickness. White beam hutch backstops should be a minimum of 4 mm lead and should be large enough in area to cover a +2 degree reflected beam as measured from the entrance of the hutch. For example, a 3-meter long hutch should have a 4 mm lead backstop with lateral dimensions of no less than 21 cm by 21 cm, centered about the beam.

Shielding thickness on reflected bend-magnet beamlines may be reduced due to the decreasing reflectance of mirrors with increasing photon energies. A reflected beam for radiation purposes is defined as any beam with a single mirror with a minimum incident grazing angle (defined as the angle between the incident beam and the mirror plane, which is half the total reflected angle) of greater than or equal to 1 degree, or series of mirrors whose combined reflectance is less than  $10^{-3}$  for photon energies greater than 40 keV. A minimum hutch/endstation/beam pipe thickness of 1/16" steel is required. Hutch backstop thickness should be no less than 2 mm equivalent lead. In order for the reflectance of one or more mirrors on a given beamline to be used in consideration for radiation protection, it must be demonstrated that the mirror cannot be retracted from the beam path or that the angle of the mirror cannot be reduced to less than 1 degree under any condition.

For monochromatic bend magnet beamlines the criteria are further reduced since the energy acceptance ( $\Delta E/E$ ) is typically on the order of  $10^{-3}$ . For these beamlines a minimum wall thickness should be 1/16" steel to provide structural integrity of these personnel protection barriers. No backstop is required for these beamlines.

## 5. 2 Undulator Beamline Shielding

Undulators produce much higher ( $10^2$ ) photon intensities at low-photon energies as compared to existing ALS bend magnet beamlines. However, the intensity above a certain energy is lower. Figure 4 compares the spectra from a 1.31T bend magnet with the 90 pole, 1T U10 undulator (on axis).

It can be seen here that at about 40 keV the photon intensities are roughly equal. Above 40 keV the intensity from the bend magnet is higher. In a previous report (*ALS Synchrotron Shielding*, op.cit.) it was shown that the portion of the energy spectrum which produces the radiation dose rates through 1-3 mm steel is in the range of 40-50 keV. Based on these observations it is acceptable for synchrotron radiation protection purposes to apply the same criteria developed for bend magnet beamlines to undulator beamlines.

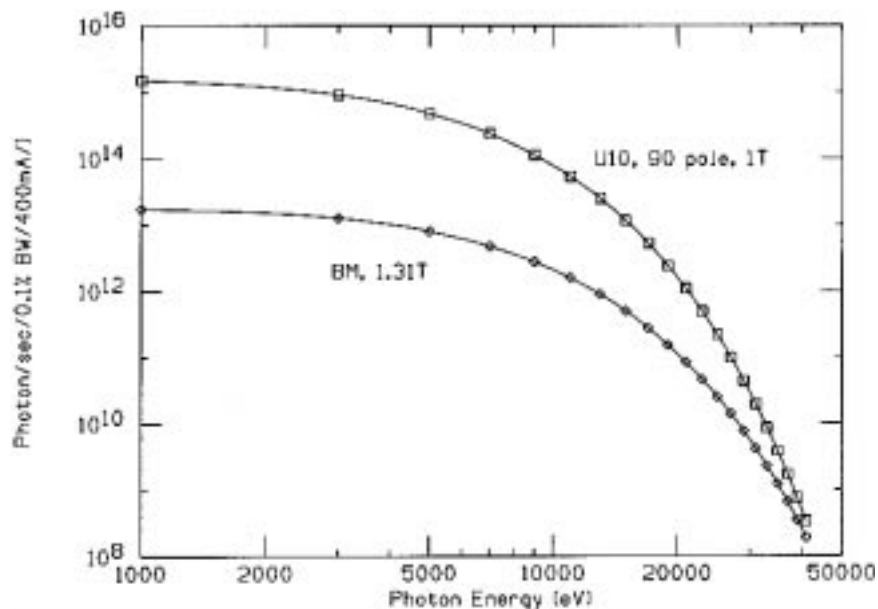

Figure 4: Comparison of the spectral flux for the ALS 1.3 1T bend magnet with the 90 pole, 1T U10 undulator (on axis).

## 5. 3 Wiggler Beamline Shielding

To date, one wiggler beamline has been constructed at the ALS. It consists of a 16 cm period, 2.1T, 38 pole wiggler with one fixed mirror inside the storage ring shield wall with one mirror and monochromator outside the shield wall. Shielding requirements have been determined in LBL-37801. Wigglers can produce very high intensities of hard x rays. Shielding requirements are higher than for undulator and bend-magnet beamlines. Because of the need for specialized shielding, and because only one wiggler to date has been constructed at the ALS, wiggler requirements will be handled on a case-by-case basis.

## **5. 4 Guidelines For Hutch Construction**

A hutch can be loosely defined as a structure housing experimental equipment/apparatus exposed to the synchrotron beam, that is designed to prevent personnel access to areas where there is a potential for the synchrotron beam to generate high-radiation levels. Hutches can be large room-like enclosures or they can be much smaller enclosures designed to allow only extremity access. Hutches are designed to reduce the direct and scattered beam dose rates to acceptably low levels. Special ALS-designed redundant interlocks on doors or access hatches are designed to prevent access inside the hutch under certain conditions. Hutches should be constructed of stainless steel. Thickness depends on the type of beamline and have been specified in the previous sections. All joints should be overlapped to minimize leakage. Utility access penetrations should be out of reach from the experimental floor, and provide adequate baffling such that a hand cannot be extended into a utility access to such a distance that it is exposed to single scattered synchrotron radiation. A small, thin-lead backstop may be required on the back wall depending on the type of beamline. White beam hutches also require a gas-bremsstrahlung backstop on the back wall. Access into these hutches is only allowed when the Personnel Safety Shutter is closed in order to reduce the dose rate from gas bremsstrahlung.

## **5. 5 General Beamline Safety Requirements**

UHV beamlines rely on the vacuum interlock system to prevent inadvertent exposure due to the dismantling of an operational beamline. Beamlines, or sections of beamlines, downstream of vacuum windows require additional protection. Two possible options are vacuum-trip interlocks, and flange locks. An approved method of one of these options should be used. Endstation vessels, mirror and monochromator tanks should provide a similar means or protections. The flexible bellows on beamlines should be covered with bellows covers to meet the shielding thickness requirements of that section of beamline. Viewports on white light sections of bend magnet and undulator beamlines should be covered with 0.5 mm lead equivalent covers.

## **5. 6 Focused Beamlines**

Department of Energy rules<sup>1</sup> state that for non-uniform exposures of ionizing beams to skin areas less than 10 cm<sup>2</sup> the dose may be averaged over an area equal to 1 cm<sup>2</sup>. This makes intuitive sense since a person exposed to or walking through a small area focused beam, by virtue of normal body movements, will expose a much larger area of skin than the cross sectional area of a very focused beam. Therefore, for purposes of determining radiation protection requirements, focused beams of area less than 1 cm<sup>2</sup> will be uniformly averaged over an area equal to 1 cm<sup>2</sup>.

---

<sup>1</sup>1.10 CFR Part 835 "Occupational Radiation Protection: Final Rule", published in the Federal Register, December 14 (1993)



# Synchrotron Radiation Shielding Estimates for the ALS Super Bend Beamlines

R. J. Donahue and K. M. Heinzelman

Ernest Orlando Lawrence Berkeley National Laboratory  
University of California  
Berkeley, CA 94720

## **Abstract**

The Advanced Light Source is proposing to replace 3 of its bending magnets with superconducting magnets. This will substantially increase the required radiation shielding for these magnet's beamlines. In this report we outline the radiation shielding requirements for these "superbend" beamlines.

## **1 Introduction**

The Advanced Light Source is proposing to replace 3 of its room temperature bending magnets with superconducting magnets [1]. The magnetic field strength will increase from 1.25 T to 5 T. The synchrotron beam critical energy will increase from the present 3.25 keV to 12 keV. This will greatly increase the high-energy flux of the bend magnet synchrotron beam. In this report we categorize the shielding requirements into three groups: white beam (unreflected), pink beam (once reflected), and monochromatic. Within each category we calculate shielding requirements for a fully scattered beam as well as the shielding

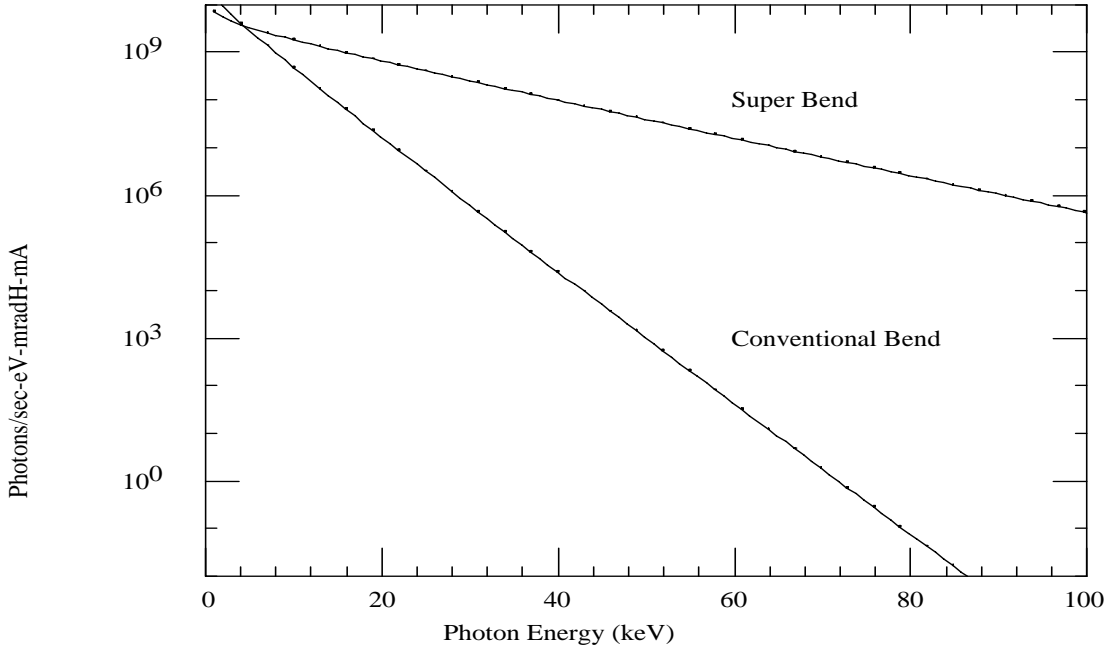

Figure 1: A comparison of the photon fluxes from both the conventional bend magnet source and the superbend source.

requirements for a direct beam stop or mask. The superbend beamlines will make an ideal source for protein crystallography which requires a useful flux to well above 20 keV. An indication of the potential impact on radiation safety can be seen in Fig. 1. This shows the photon flux from both the conventional room temperature bend magnet and the superconducting magnet. In the energy range of interest to experimenters there may be 10-40 times more flux from the superbend source. In the energy range of interest to radiation shielding (60-88 keV) there may be 6-9 orders of magnitude more flux from the superbend. Because of the desire for harder x-rays, the incident grazing angle on beam mirrors is quite small. Grazing angles are assumed to vary between 3 and 5 mradians. The resulting radiation dose rates are examined as a function of shield thickness and material. Typical superbend beamline layouts are described elsewhere [2]. Shielding calculations are performed with the PHOTON program[3].



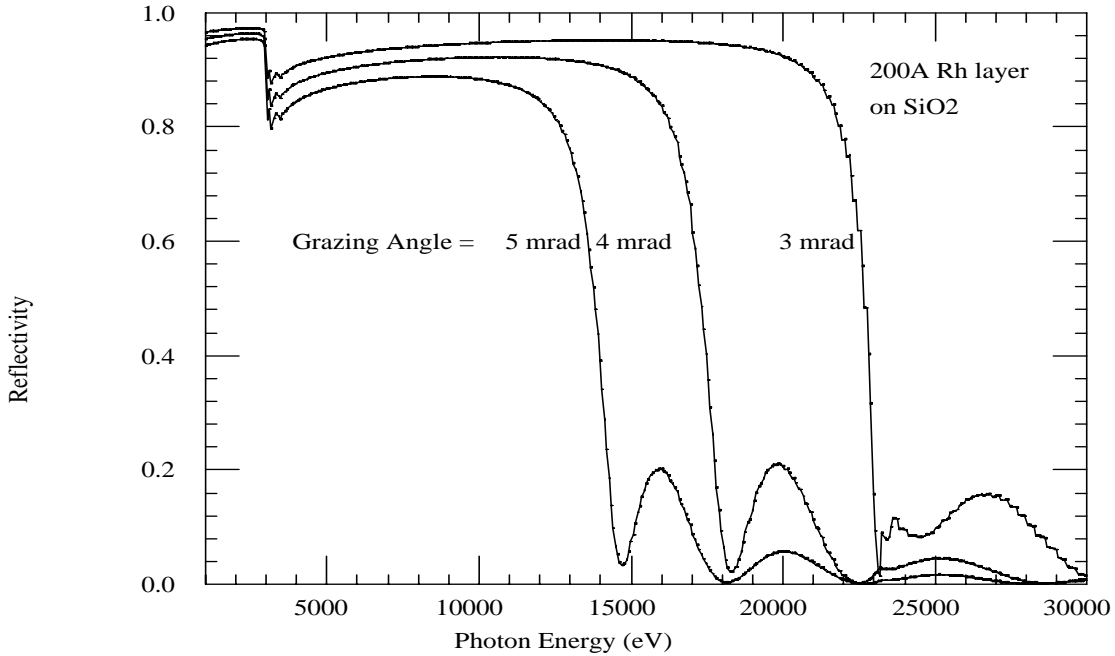

Figure 2: Calculated reflectivity for a 200Å Rh coating on SiO<sub>2</sub> with incident grazing angles of 3, 4 and 5 mradians.

## 2 Reflectivity

We assume the beamline optical layout can be characterized as containing in most cases a mirror and a pre-mirror followed by monochromator. In some cases there may be only the two mirrors. Because of the need to reflect the harder x-rays, these mirrors will consist mostly of small grazing angle single layer mirrors such as Rh. We will use [5] the calculated reflectivities of a 200Å Rh coating on SiO<sub>2</sub> with incident grazing angles varying between 3 and 5 mradians to characterize the radiation shielding requirements. These are shown in Fig. 2 and are taken from Henke[6]. A  $1/E^4$  scaling of the reflectivity at 30 keV is used for photon energies above 30 keV. This approximation is reasonable[4] above the K-edge of elements in the mirror coating. Rh K-edge is at 23 keV.

These reflectivities are folded into white beam dose rate energy spectra and summed over energy to determine dose rates from reflected beams.

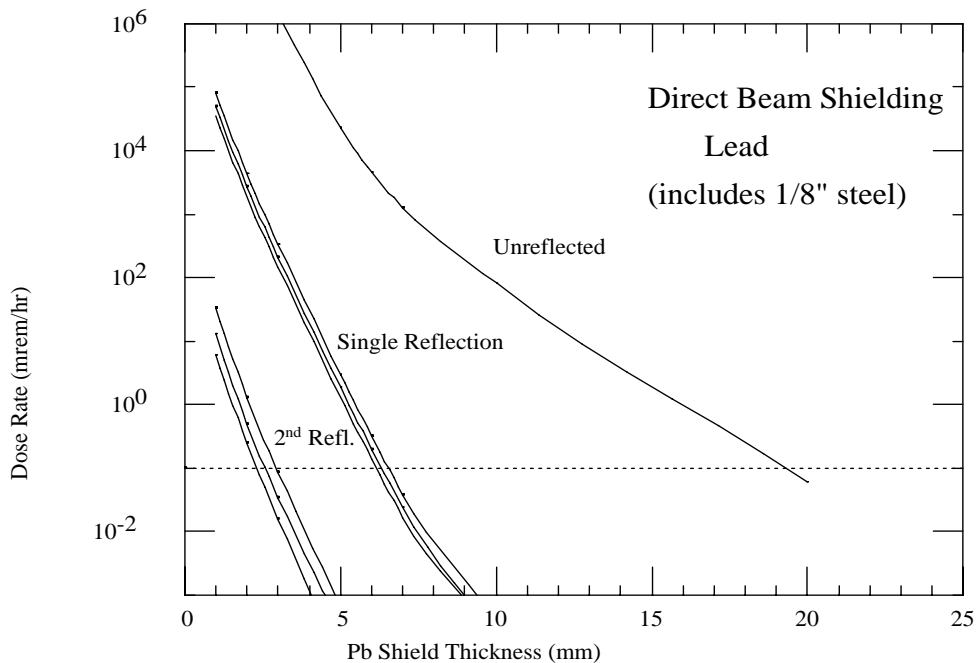

Figure 3: Direct beam Pb shielding. This includes a 1/8" steel beampipe/hutch wall.

### 3 Direct Beam Shielding

In this section we calculate dose rates through copper and lead shielding. Direct white beam masks must be water-cooled and constructed of copper. The same may be true for reflected beams. Lead results are presented mostly for information and comparison. All results assume 3 mradH acceptance, 1.9 GeV and 800 mA stored beam current. All shield thicknesses include 1/8" steel shielding to account for a hutch wall or beampipe.

PHOTON assumes an isotropic angular distribution for Compton scattered photons. This may be conservative for estimating dose rates at large angles but may underestimate the dose rate in the forward direction from the direct beam. For example, at 50 keV the Compton scattering cross section is two times higher for photons scattering at  $0^\circ$  than for photons scattering at  $90^\circ$ . For this reason we will use the same shielding criteria of 0.1 mrem/hr for the direct beam even though the downstream attenuated beam may still be contained in the beampipe.

The resulting required shield thicknesses are summarized in Table 1.

In contrast to these results are the shielding requirements for the present 1.3 T bend

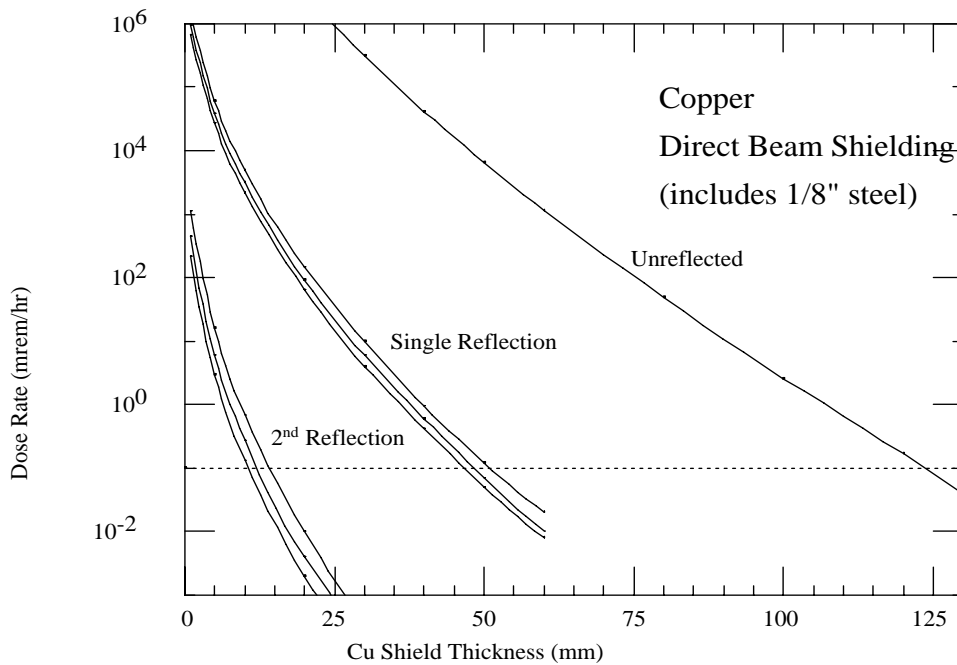

Figure 4: Direct beam Cu shielding. This includes a 1/8" steel beampipe/hutch wall.

magnets[7] which require only 3 mm of Pb to reduce the direct beam dose rates to below acceptable levels.

Table 1: Summary of Direct Beam Shielding Requirements. For reflected beams angles refer to the mirror incident grazing angle. For twice-reflected beam the first reflection is assumed to be 3 mrad in all cases.

Shield	Unreflected	Reflected			Twice-Reflected		
		3 mrad	4 mrad	5 mrad	3 mrad	4 mrad	5 mrad
Cu	125mm	50mm	50mm	50mm	15mm	14mm	13mm
Pb	20mm	7mm	7mm	6mm	3mm	3mm	3mm

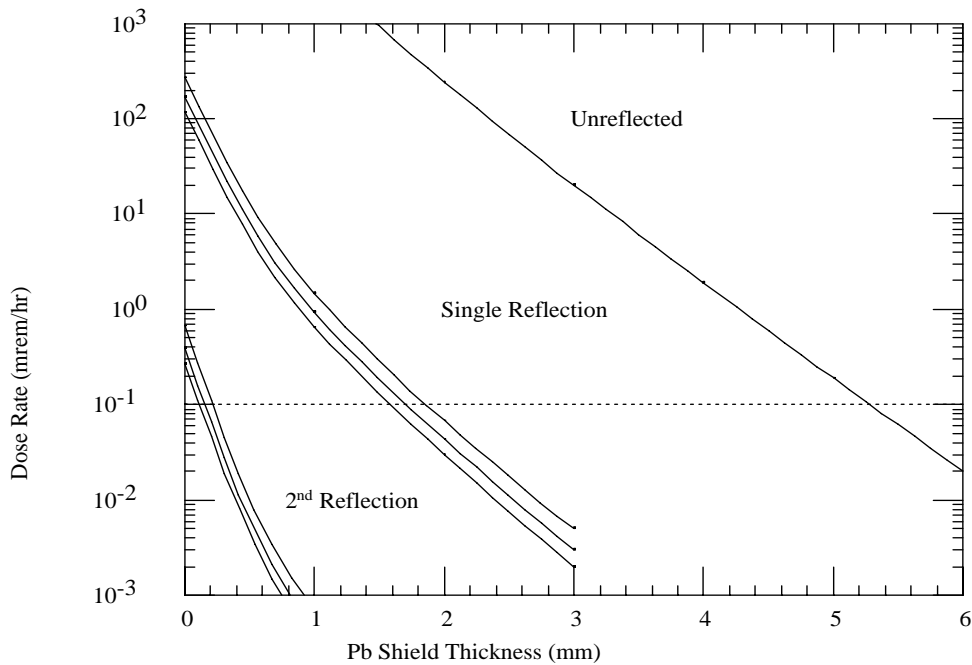

Figure 5: Scattered beam Pb shielding. This includes a 1/16” steel beampipe/hutch wall.

## 4 Scattered Beam Shielding

In this section we calculate the minimum shielding requirements for a fully scattered beam. For conservatism no self-absorption is assumed in the target material. Results are presented in Table 2 for white and reflected beams using Pb shielding. These values have been plotted in Fig. 5. The horizontal dotted line at 0.1 mrem/hr represents the shielding criteria.

No shielding is required for a twice-reflected beam if each reflection is  $\geq 3$  mrad incident grazing angle. In Fig. 5 it can be seen that without Pb shielding (only 1/16” steel) the dose rate from a doubly scattered beam is  $\leq 0.6$  mrem/hr. Because of the relatively low possible dose rate and the conservatism built into the scatter calculations no shielding is required. Radiation surveys may indicate areas of chronic low level scatter which can be locally shielded.

The photon dose rate spectra for various beamline configurations are shown in Figs. 6, 7, and 8. Results are shown for white beam in Fig. 6, pink beam in Fig. 7, and twice/reflected beam (two 3 mrad mirrors) in Fig. 8. For each plot the 4 curves represent the dose rate spectra unshielded (1/16” beampipe/wall only) as well as for 1, 2 and 3 mm of Pb. The Pb K-edge is evident at approximately 88 keV.

Table 2: Summary of Scattered Beam Shielding Requirements. For reflected beams angles refer to the mirror incident grazing angle. For twice-reflected beam the first reflection is assumed to be 3 mrad in all cases.

Shield	Unreflected	Reflected			Twice-Reflected		
		3 mrad	4 mrad	5 mrad	3 mrad	4 mrad	5 mrad
Pb	5mm	2mm	2mm	2mm	0	0	0

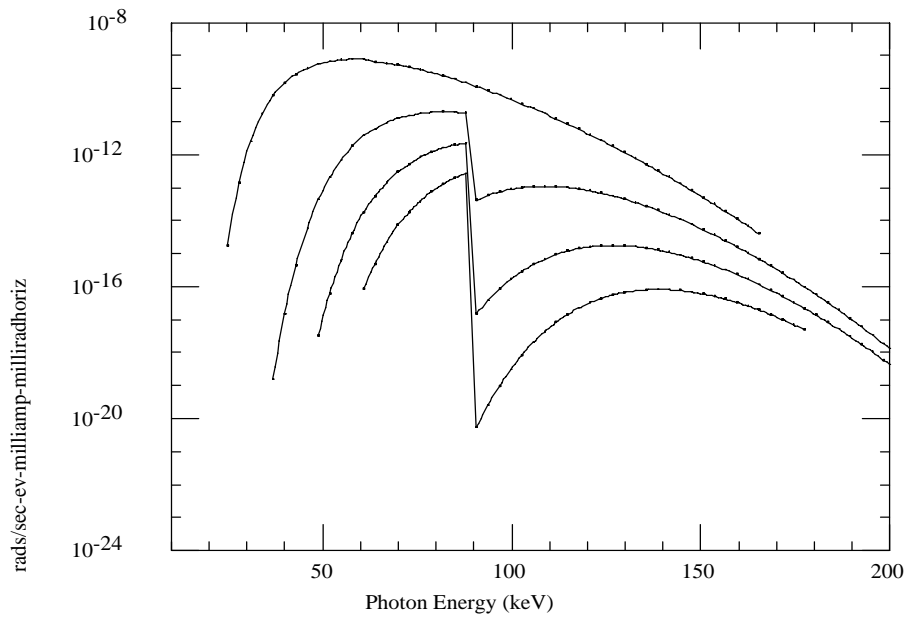

Figure 6: Photon dose rate spectra from scattered white (unreflected) Superbend beamline. Curves represent the spectra through 0, 1, 2 and 3 mm of Pb.

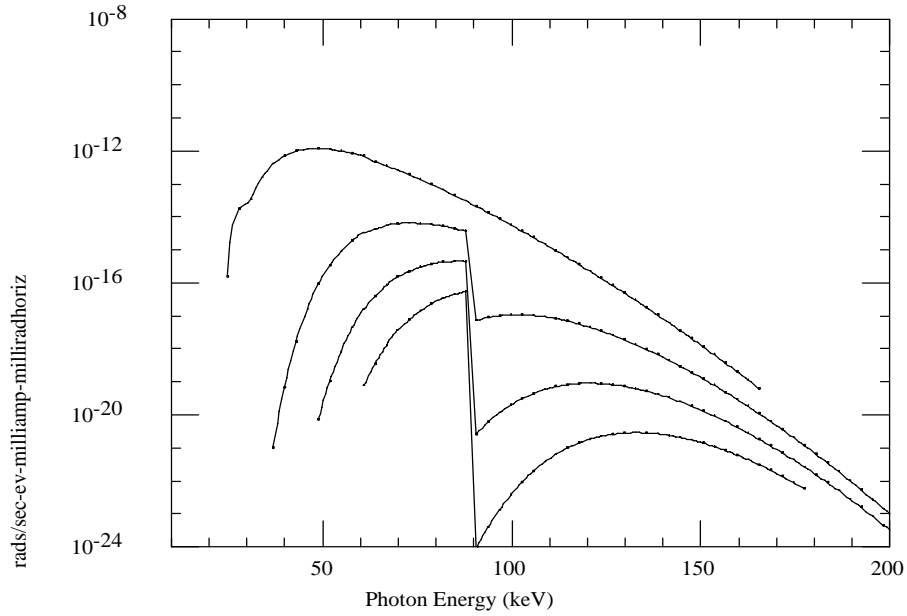

Figure 7: Photon dose rate spectra from scattered pink beam (3 mrad incident grazing angle on 200Å Rh mirror). Curves represent the spectra through 0, 1, 2 and 3 mm of Pb.

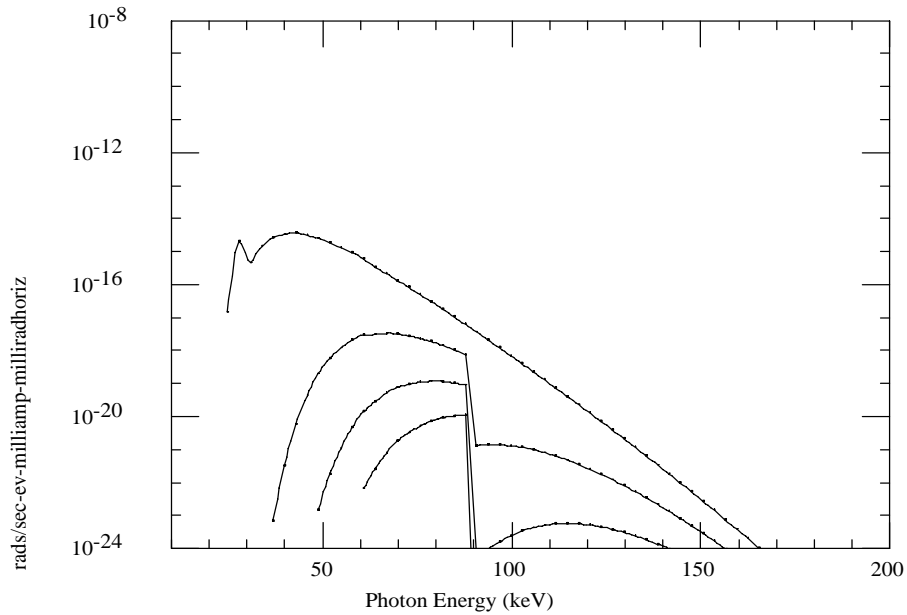

Figure 8: Photon dose rate spectra from scattered twice-reflected (two 3 mrad incident grazing angle on 200Å Rh mirror). Curves represent the spectra through 0, 1, 2 and 3 mm of Pb.

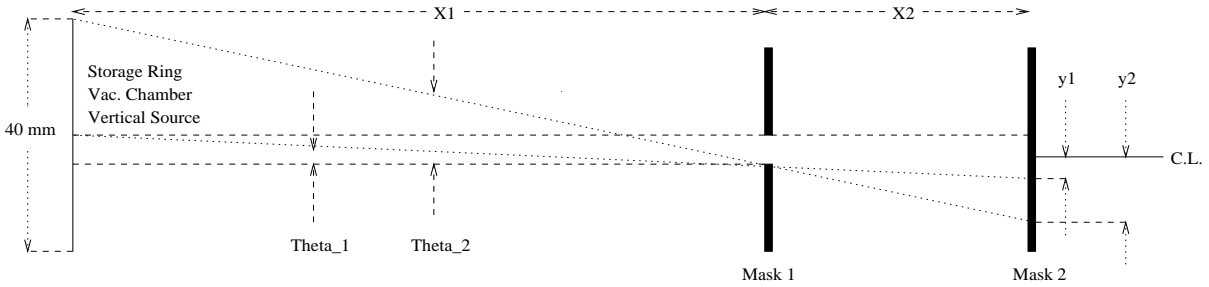

Figure 9: A raytracing...

As can be seen in these dose rate spectra, the dose rate outside Pb shields is dominated by x-rays in the range 60-88 keV. This range can be characterized as being from about 5X the critical energy ( $E_{crit} = 12$  keV) and extending up to the Pb K-edge.

## 5 Masking Requirements

To ensure safe containment of x-rays, ray traces of the superbend synchrotron beam will be required. Fixed masks will be required at various locations to limit and/or stop the beam. In the horizontal plane the source size will be the entire horizontal acceptance of the beamline/frontend as limited by fixed masks. In the vertical plane, there are at least two possible methods of specifying the source size for the synchrotron ray traces. The first method would be to assume an isotropic point source at the center of the bend magnet and then require a 10 mm overlap between white beam edge and physical mask edge. This will be referred to as the ‘point source approach’. The second method would be to assume an isotropic source vertically the size of the vacuum chamber ( $\pm 20$  mm) as is used in the bremsstrahlung ray tracing at the center of the magnet, but then require no overlap between white beam edge and mask edge. This will be referred to as the ‘large source approach’. These two ray tracings are shown in Fig. 9. The ray tracing from a point at the center of the e- beam vacuum chamber to the bottom edge of Mask 1 (creating the angle  $\theta_1$ ) represents the point source approach. The ray tracing from a point at the top of the e- beam vacuum chamber to the bottom edge of Mask 1 (creating the angle  $\theta_2$ ) represents the large source approach.  $X_1$  and  $X_2$  represent the distances from source to Mask 1, and from Mask 1 to Mask 2, respectively. Let  $h$  be the vertical half-height opening at Mask 1.

Table 3: Comparison of ray tracing techniques.

$X_1$	$h$	$\theta_1$	$X_2$	$\theta_2$	$y_1 + 10 \text{ mm}$	$y_2$	$\theta_{mirror}$	$x_{clear}$
7m	2 mm	0.286 mrad	1 m	3.14 mrad	12.3 mm	5.1 mm	6 mrad	2050 mm
			1.5 m		12.4 mm	6.7 mm		2072 mm
			3.0 m		12.9 mm	11.4 mm		2143 mm
8m	2 mm	0.25 mrad	1 m	2.75 mrad	12.3 mm	4.8 mm	6 mrad	2042 mm
			3.0 m		12.8 mm	10.25mm		2125 mm
	4 mm		1.0 m	14.3 mm	6.7 mm	2375 mm		
			3.0 m	14.7 mm	12.3 mm	2485 mm		

To compare the two possible approaches we compare the quantities  $y_1$  ( $= \theta_1 \cdot X_2 + h$ ) and  $y_2$  ( $= \theta_2 \cdot X_2 + h$ ) at the second mask. If we use the point source approach then Mask 2 must overlap the beam by the distance  $y_1 + 10 \text{ mm}$ . If we use the large source approach then Mask 2 must overlap the beam by the distance  $y_2$ . These have been calculated for various values of  $X_1$ ,  $X_2$ ,  $h$ , and mirror incident grazing angle in Table 3. In addition to these values we also calculate the distance from a mirror to Mask 2 at which the reflected beam of angle  $\theta_{mirror}$  (total reflection angle, not the incident grazing angle) clears Mask 2 which has a height of  $y_1 + 10 \text{ mm}$ . This distance is equal to  $(y_1 + 10 \text{ mm})/\theta_{mirror}$ .

One can see from these results that when the masks are placed close to the source and the distance between masks is small then the large source approach ( $y_2$ ) may only require an overlap of  $\sim 5 \text{ mm}$ , whereas the point source approach provides a greater overlap and more consistency.

To provide a larger safety factor and margin of design error we recommend that synchrotron ray traces in the vertical plane use a point isotropic source in the center of the e- beam vacuum chamber. A combination of two masks must be used downstream of a reflected beam if a reduction in radiation shielding requirements is desired. The first mask serves to limit the trajectory of the unreflected beam, and the second mask stops the unreflected beam. An overlap of 10 mm is required from the edge of the unreflected beam, as defined by using a point isotropic source at the center of the e- vacuum chamber, and the physical



edge of the second mask. For reflected beams the ray tracing reflected source should be isotropic in angular distribution from the surface of the mirror through the first downstream aperture.

## 6 Summary

Shielding requirements for the direct synchrotron beam have been summarized in Table 1 for both Pb and Cu. These include results for white beam, pink beam and twice-reflected beam.

Shielding requirements for scattered synchrotron radiation have been summarized in Table 2 for Pb. These include results for white beam, pink beam and twice-reflected beam.

Synchrotron beam ray traces must be drawn for superbend beamlines. Any reduction in white beam shielding requirements must be done with the use of two masks. White beam shielding requirements extend to the end of the 2nd mask. Ray traces of this idealized synchrotron beam must be drawn using the above described source sizes for vertical and horizontal planes. Masks must be placed such that ray traces show that all extreme unreflected ray traces are defined by the first mask downstream of the mirror and blocked by the 2nd mask. The slit opening in the two masks which allows the beam(s) (white+reflected for 1st mask, reflected only for 2nd mask) should be minimized. The masks should cover the entire beamline cross sectional area except for the slit. All masks used for safety purposes must be fixed in place. It is acceptable to use the frontend beamline aperture, AP001, as the first white light shielding mask.

Any reduction in pink beam shielding is performed in the same manner with 2 masks and ray tracings. The major difference is that the source size for the pink beam should be the extreme edges of the reflecting mirror and the ray traces are defined by the 1st and 2nd white masks. The 2 masks are put downstream of the second reflecting mirror. Everything from the shield wall to the 2nd white mask is assumed to be white beam transport and shielded as such. Everything from the downstream edge of the 2nd white beam mask to the 2nd pink beam mask is shielded using the pink beam (once reflected) shielding requirements. Everything downstream of the 2nd pink mask requires only 1/8" steel construction.

Ray trace drawings must be submitted for approval to the ALS Beamline Review Committee as part of the standard beamline design review package. Both vertical and horizontal plane ray tracings should be included. A copy of the first approved super bend synchrotron ray trace (Beamline 8.3.1, Dwg #25F5686) is attached.

## References

- [1] H. A. Padmore, *A Superconducting Bending Magnet Source for Protein Crystallography*, ALS Light Source Note LSBL-486, September 22, 1998.
- [2] H. A. Padmore, *Optical Layout of Superbend Beamlines 4.2 and 4.3*, ALS Light Source Note LSBL-487, September 23, 1998.
- [3] D. Chapman, N. Gmür, N. Lazarz and W. Thomlinson, *PHOTON: A Program For Synchrotron Radiation Dose Calculations*, NIM **A266**, 191-194 (1988).
- [4] E. Gullikson, Center For X-ray Optics, LBNL, personal communication.
- [5] H. A. Padmore, ALS Experimental Systems Group, LBNL, personal communication.
- [6] B. L. Henke, E. M. Gullikson, and J. C. Davis, *X-ray interactions: photoabsorption, scattering, transmission, and reflection at  $E=50-30000$  eV,  $Z=1-92$* , Atomic Data and Nuclear Data Tables, July 1993, vol.54, (no.2):181-342 (see [http://www-cxro.lbl.gov/optical\\_constants/](http://www-cxro.lbl.gov/optical_constants/)).
- [7] R. J. Donahue *ALS Synchrotron Radiation Shielding*, LBL-37801, October 1995.



<b>ADVISORY TITLE:</b>	<b>Guidelines for Meeting Seismic Requirements for User Equipment at the ALS</b>	<b>PAGE</b> 1 of 4
<b>ADVISORY NO:</b>	4/Rev. 6	
<b>ISSUE DATE:</b>	January 1, 2005	
<b>REVIEW DATE:</b>	January 1, 2007	
<b>CURRENT INFO:</b>	This Advisory is valid for two years from Issue or Review Date(s), at which time it is reviewed for relevancy and accuracy. Copies of all current user advisories are available at the ALS User Services Office, (510) 486-7745.	

---

## Overview

The ALS has seismic anchoring requirements for user equipment which are intended to minimize hazards to people and equipment in the event of a serious earthquake.

The guidelines in this document will help users design their equipment to meet ALS seismic requirements, thus avoiding the need for modifications at the ALS. This document does not replace Berkeley Lab and ALS official procedures and policies concerning seismic safety.

---

## Policy

**All experimental equipment installed at the ALS must be designed to resist earthquakes of magnitude 7.0 Richter on the Hayward fault which runs near LBNL and those of magnitude 8.3 Richter on the San Andreas fault, and be in compliance with the seismic-safety criteria specified in the *Health and Safety Manual*, PUB 3000 (available on the web from the Berkeley Lab home page at: [www.lbl.gov](http://www.lbl.gov)), Chapter 23.**

**All equipment at the ALS will be reviewed before use to check whether the equipment is in compliance with Berkeley Lab and ALS seismic-safety requirements.**

---

## Guidelines

Violent earth motions in both the vertical and horizontal directions are to be expected during earthquakes. In critical designs, computer simulations are used to explore equipment vibration resonances relative to a design basis earthquake frequency spectrum. However, this detailed analysis is not necessary for most beamline and experiment equipment used at the ALS.

The *Health and Safety Manual* states that "Proper anchorage is the key to earthquake safety." In simple terms, this means: **Bolt it to the floor.** Although some designers may imagine that freedom of movement via rollers or resilient mountings might protect delicate equipment from seismic accelerations, experience shows that this is not the case. In many instances, freedom of movement will amplify ground motion, increasing the risk of damage and injury.

---

<b>ADVISORY TITLE:</b>	<b>Guidelines for Meeting Seismic Requirements for User Equipment at the ALS</b>	<b>PAGE</b> 2 of 4
<b>ADVISORY NO:</b>	4/Rev. 6	

**Horizontal and Vertical Accelerations**

Designing equipment to withstand horizontal accelerations is the primary consideration in meeting seismic-safety requirements. A simple guideline which may be used to meet ALS requirements is: “Design and mount all hardware to withstand a 0.7 g horizontal acceleration.” (A “g” represents the acceleration of gravity. A 0.7 g horizontal acceleration generates a horizontal force equal to 70% of the weight of the restrained object.)

This 0.7 g guideline eliminates the need for resonance simulations in most cases. As a side benefit, designing for 0.7 g horizontal loading provides a more rigid structure, with higher natural frequencies of vibration. In choosing structural elements for 0.7 g horizontal accelerations, materials must be stressed below their expected yield points, with a limit of 50% of yield stress at welded joints. A helpful concept is to imagine the completed system rotated 90° and bolted to a wall instead of a floor. If the device could be cantilevered in this fashion without damage or parts coming loose, it will be earthquake resistant when it is bolted to the floor.

It is up to the designer to provide adequate spacing of anchor bolts to withstand the toppling moment created by a 0.7 g horizontal force acting on the assembled equipment’s center of mass. Provisions for six anchor bolts are recommended for stands and pedestals, since obstructions embedded in the ALS concrete floor sometimes prevent the use of some bolt holes. ALS technicians will provide flush, “female,” threaded floor anchors. Detailed information about anchors and floor obstructions is available in LSME Note 745, *“Concrete Floor Anchor Applications.”*

Special structural provisions for vertical accelerations are seldom necessary, since the structure and anchoring needed to withstand horizontal accelerations usually provides more than adequate strength in the vertical dimension. However, loose components which merely “sit” on their mountings must be avoided, since objects will be thrown upward in a severe earthquake.

<b>ADVISORY TITLE:</b>	<b>Guidelines for Meeting Seismic Requirements for User Equipment at the ALS</b>	<b>PAGE</b> 3 of 4
<b>ADVISORY NO:</b>	4/Rev. 6	

*Figure 1. Example of typical anchor--bolt application.*

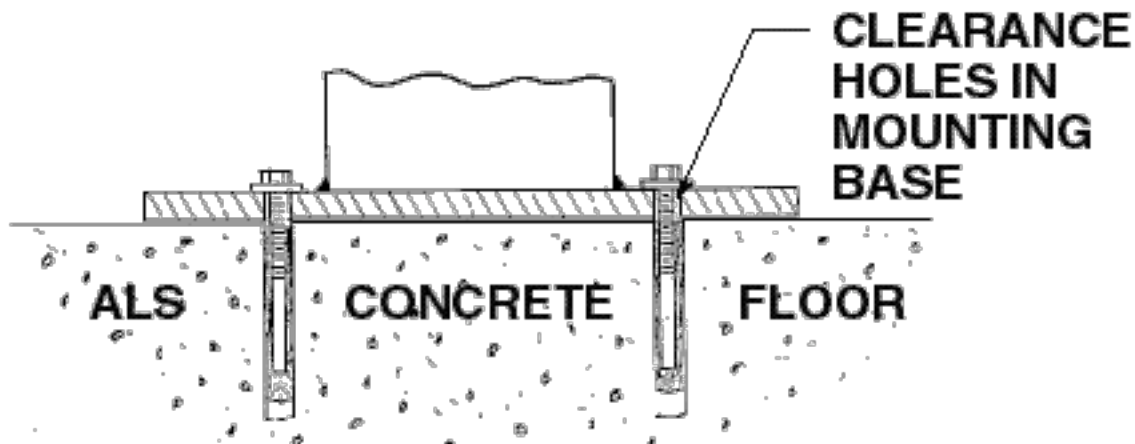

### **Alignment and Vibrations**

Many ALS experiments have demanding alignment and vibration isolation requirements, and the need for rigid bolting of the equipment to the floor for earthquake reasons would seem to conflict with these requirements. One solution is using the ALS "six strut system" for support of position-sensitive equipment in the beamline. This support system allows secure bolting to the floor and precise alignment in all six degrees of freedom, and can usually be made rigid enough to avoid natural frequencies of vibration below 20 Hz. In practice, this solves almost all vibration difficulties. For advice and help in implementing the system, contact ALS engineer William Thur (Phone: 510-486-5689, Fax: 510-486-4102, Email: [thur@lbl.gov](mailto:thur@lbl.gov)).

Soft, resilient suspension systems for extreme vibration isolation will not meet ALS seismic requirements unless close-fitting restraint "bumpers" are provided for all degrees of freedom. Several mm of working clearance is acceptable, and the rigid bumper surfaces should be faced with an elastic material such as neoprene to absorb and distribute impact loads.

<b>ADVISORY TITLE:</b>	<b>Guidelines for Meeting Seismic Requirements for User Equipment at the ALS</b>	<b>PAGE</b> 4 of 4
<b>ADVISORY NO:</b>	4/Rev. 6	

---

**Electronic Racks**

Electronics racks at the ALS are not exempt from seismic requirements. Racks which will be in place for longer than four weeks must be bolted to the floor, with the heaviest components placed as low in the rack as possible. Single-width racks can often be anchored with a single 16 mm (5/8 in) anchor bolt that is centered through a base plate in the bottom of the rack. Some slack should be left in cables to allow for differential motion during an earthquake. Low electronics carts which are moved frequently must have casters with locking wheels.

---

**More Information**

For more information about ALS seismic safety requirements, contact ALS engineer William Thur (Phone: 510-486-5689, Fax: 510-486-4102, Email: Thur@lbl.gov).

---

Approved by

Date

*Signed by Ross Schlueter*

02/04/2005

\_\_\_\_\_  
Ross Schlueter, Acting Mechanical Engineering Group Leader

*Signed by Ben Feinberg*

02/17/2005

\_\_\_\_\_  
Ben Feinberg, Division Deputy for Operations



### Design Criteria for O-Rings in High Radiation Areas

Deterioration of elastomer materials that are exposed to high radiation is a concern for the longevity of seals for valves, flanges, water fittings, pneumatic components, and other equipment located within the ALS shield wall or in direct line-of-sight to a potential bremsstrahlung source.

Experiments done at Fermi National Accelerator Laboratory by Glenn Lee (IEEE Tran. on Nucl. Sci., Vol. NS-32, No. 5, October 1985) suggest that ethylene propylene diene monomer (EPDM) is a preferred material for elastomer seals that are at or near the ALS electron beam elevation where radiation levels are potentially the highest. The report concludes that EPDM elastomers "were found to exhibit acceptable properties for o-rings after radiation levels of  $5 \times 10^8$  .rads, while Viton failed at  $1 \times 10^7$  rads. Vacuum tests were also favorable, so EPDM o-rings were chosen as seals in the Energy Saver cryostat vacuum system." The EPDM o-rings performed satisfactorily, "but they are slightly permeable to helium, very similar to neoprene. This has to be noted when leak-checking." Several variations of EPDM material are available from o-ring suppliers, usually referred to as simply ethylene propylene.

Viton has relatively poor radiation resistance, but withstands higher temperatures (e.g., bakeouts). Some trade-offs must be considered for any specific application, and Viton may be suitable depending on factors such as the amount of radiation shielding, distance from the source, and acceptable risk of failure.

Although EPDM is the preferred o-ring material in a radiation area, under certain conditions Viton (or possibly other elastomers) may be allowed. Beamline designers should consult with the Beamline Review Committee (BRC) chair, beamline engineering staff, and/or mechanical safety staff for assistance; see Appendix E for contact information.



## APPENDIX K: UV LIGHT HAZARDS

### UV Light Hazards from Synchrotron Radiation

The ultraviolet (UV) part of the spectrum is typically defined as the wavelength range from 400 nm-40 nm. ALS bend magnets and wigglers are intense sources of UV radiation. In addition, the U10 undulator's fundamental can be tuned into the ultraviolet range. UV radiation is primarily an eye hazard, but can have a damaging effect on skin as well.

In general, ultraviolet radiation will be contained inside the beamlines and endstations. However, viewports have a transmission cut-off which depends upon their material. Glass viewports transmit wavelengths > 250 nm, while quartz and sapphire viewports transmit wavelengths > 160 nm. UV radiation with these wavelengths between 160 and 400 nm can also pass through air because the energy is less than the first ionization potential of nitrogen or oxygen. Scattering of ultraviolet radiation from polished optical surfaces is weak. Consequently, a hazard exists if the beamline optics steer the beam onto a viewport or if the beam otherwise undergoes a specular reflection. This situation is more likely if there is a viewport at the end of the beamline or at the back of an endstation.

For reference, the ultraviolet powers emitted by several existing ALS beamlines are:

ALS undulator beamline (BL 9.0.2) (white light):	20 mW
ALS undulator beamline (BL 9.0.2) (monochromatic light):	2 $\mu$ W
ALS undulator beamline (BL 9.0.2) (monochromator in zero order):	2 mW
ALS bend magnet beamline (BL 9.3.2) (monochromatic light):	2 $\mu$ W

The permissible exposures are functions of wavelength, intensity, and duration. A few typical allowances are:

#### Coherent sources

Wavelength	Duration	Power to eye
180-400 nm	$3 \times 10^4$ sec	2 mW/cm <sup>2</sup>
400-700 nm	0.25	2.5

#### Incoherent sources

Wavelength	Duration	Power to eye
320-400 nm	$1 \times 10^3$ sec	1 mW/cm <sup>2</sup>

Beamline designers must calculate or determine the UV fluxes which could be emitted from their specific beamlines and install appropriate safeguards, such as filters, viewing screens, covers, and enclosures.

For viewports that can receive and then emit hazardous levels of ultraviolet (or visible) radiation, ALS Procedure BL 08-17 must be followed. All such windows will be marked VISIBLE/UV LIGHT HAZARD. It must be verified that all caps and enclosures be in place before operation of the beamline. See BL 08-17 for additional requirements.

For additional information about irradiation exposure levels, contact the BRC chair or the Berkeley Lab Laser Safety Officer; see Appendix E.



### Disassembly of Beamline Sections

Synchrotron radiation in a section of the beamline (or endstation) which has direct line of sight to the storage ring can be extremely hazardous. Access to this area can lead to exposure to either the direct beam, or to bremsstrahlung radiation, especially if a vacuum failure occurs when the storage ring is operating. The interaction of air and the electron beam can produce bremsstrahlung radiation. UHV beamlines rely on the vacuum interlock system to prevent inadvertent exposure caused by the dismantling of an operational beamline. Beamlines, or sections of beamlines downstream of a vacuum window require additional protection to prevent exposure resulting from the dismantling of an operational beamline. Two possible protection systems are a radiation safety system, with interlocks to the appropriate vacuum gauges, or the use of flange locks. The use of flange locks is an administrative procedure. Each method has advantages and distinct disadvantages. The decision on whether to use either a vacuum-based interlock system or flange locks should be made depending on the specifics associated with each beamline section or endstation.

Contact the Beamline Review Committee (BRC) chair for additional information; see Appendix E.