

Current Status of Macromolecular Neutron Crystallography

Or "How to See Hydrogen at Medium Resolution"

Dean Myles
ORNL

[LADI @ ILL](#)

[BIX@JAERI](#)

[PCS @ LANL](#)

[MaNDi @ SNS](#)

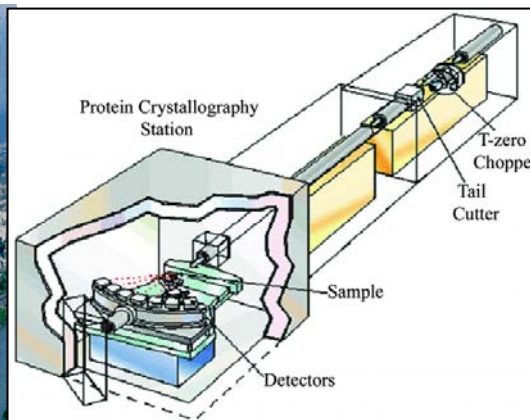

Neutrons and Structural Biology:

ORNL will provide world-leading instruments for neutron scattering at HFIR and at SNS

Neutrons are excellent probes for Hydrogen – and can discriminate between hydrogen and deuterium

Function: **H/D** in enzyme mechanism;
proton shuttling & transfer

Structure: **H/D Labeled protein** in
complex systems

Dynamics: Specific **H-Labeling** in
deuterated systems

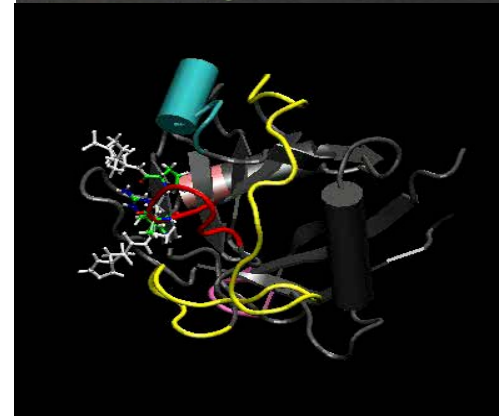
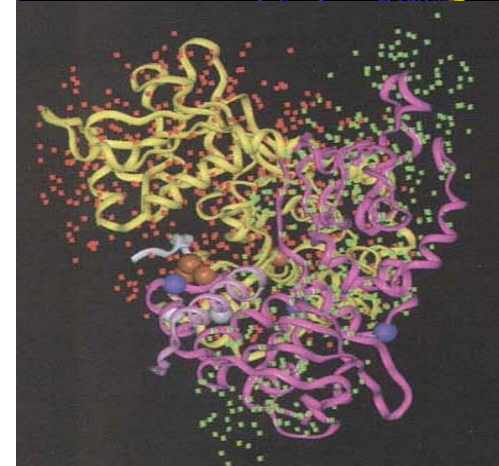
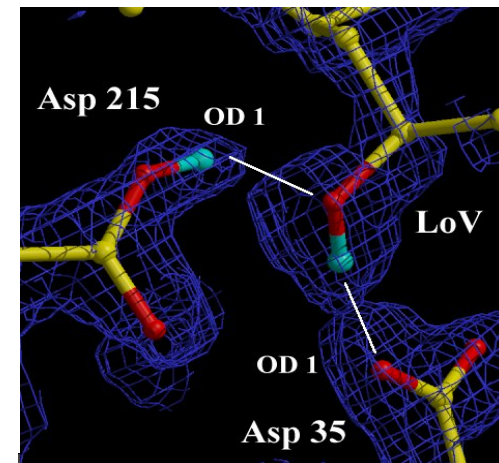

Neutrons in Biology

Atomic Scattering Lengths

Element	Neutrons (10^{-12} cm)	X-rays (10^{-12} cm)	Electrons (Z^2)
^1H	-0.374	0.28	1 ○
^2H (D)	0.667	0.28	1 ○
C	0.665	1.67	6 ●
N	0.940	1.97	7 ●
O	0.580	2.25	8 ●
P	0.520	4.23	15 ●

- X-rays interact with *electron clouds* of atoms
- Neutrons interact with *nuclei*: better spatial resolution
- Large difference in the cross-section among isotopes

Neutrons in Biology

Visualizing hydrogen atoms

X-rays – the need for atomic ($<1.2\text{\AA}$) resolution

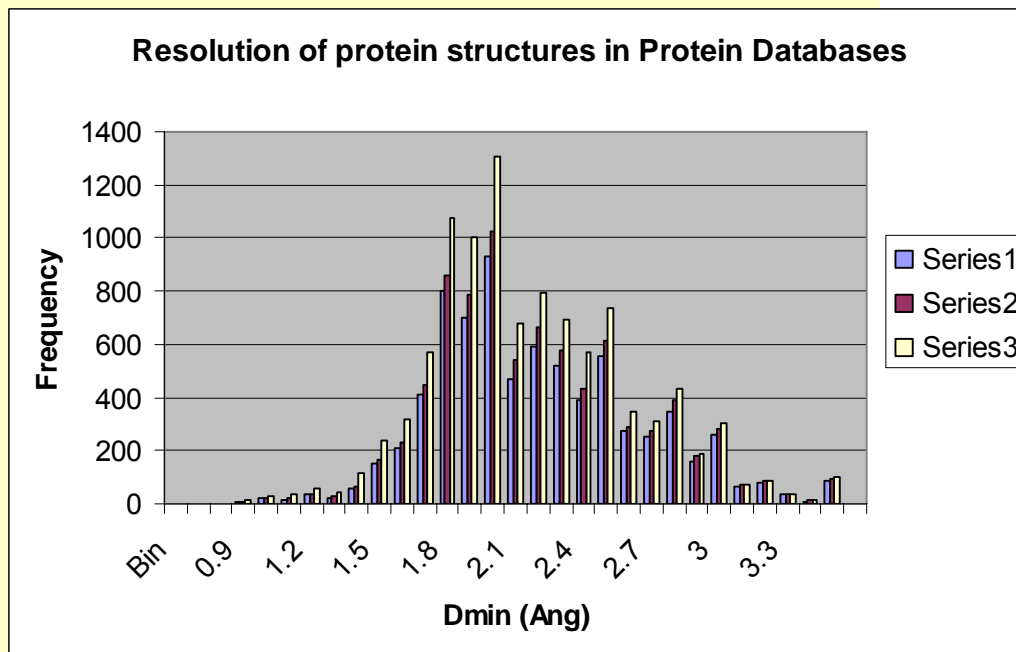
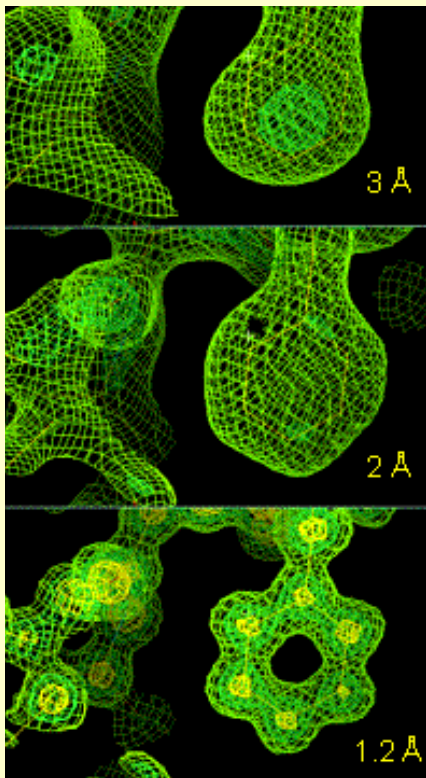

In most ($>>98\%$) cases an X-ray diffraction structure contains no information about the positions of the protons of a particular protein

Neutrons in Biology

Visualizing hydrogen atoms

Neutron data at 2.0Å resolution

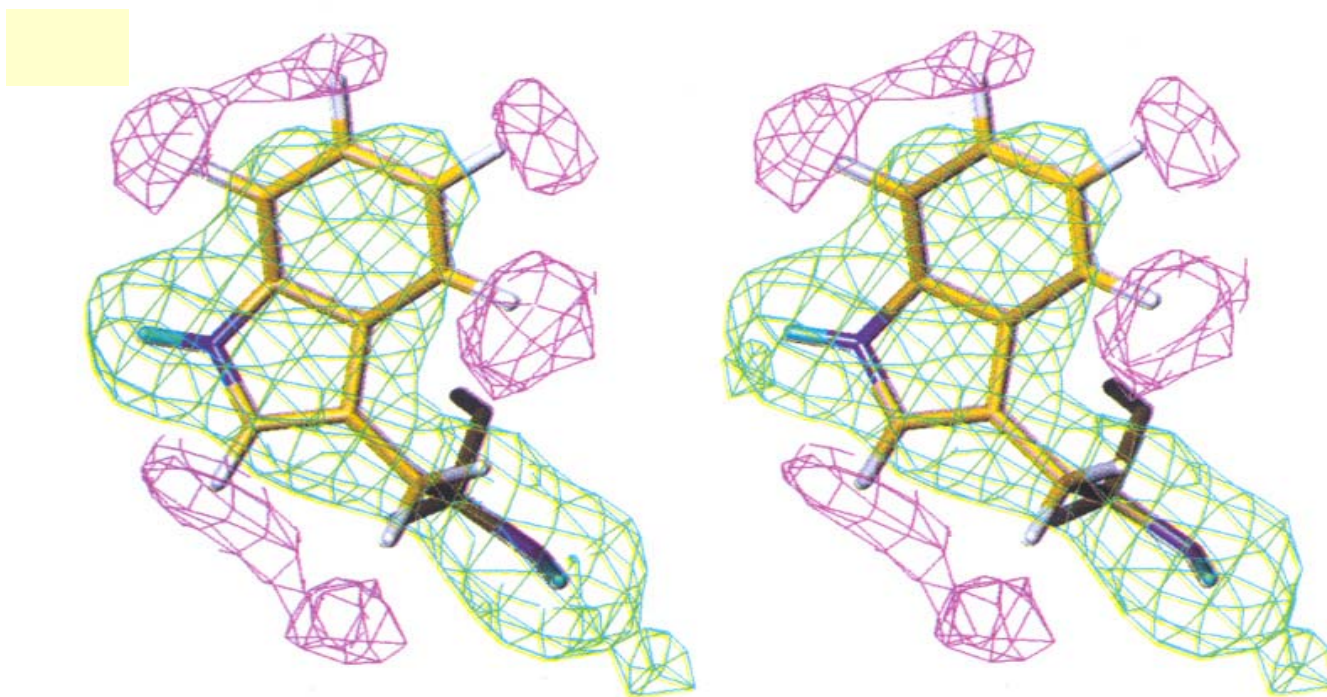

Trp 111 omit map negative scattering density - red: positive density - green
Niimura et al, (1997) Nature Structural Biology,4, 909.

Neutron protein crystallography

Visualizing hydrogen atoms

Resolution 2.1Å

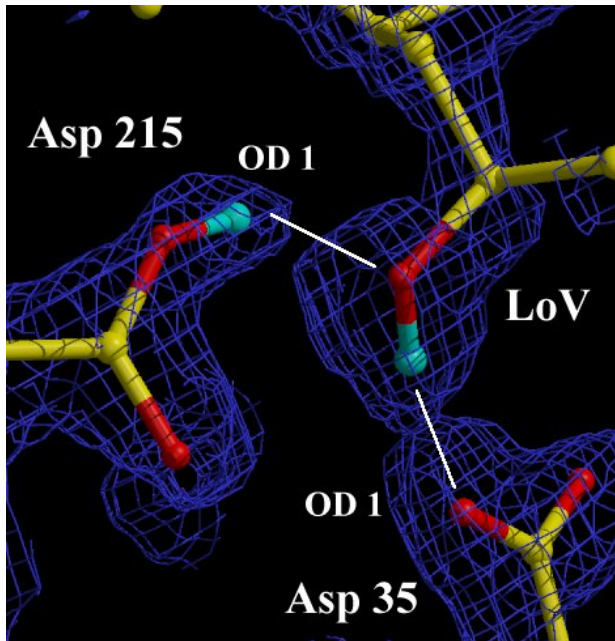

Coates *et al.*, *Biochem*, (2001)
40(44):13149-57

Resolution 1.7Å

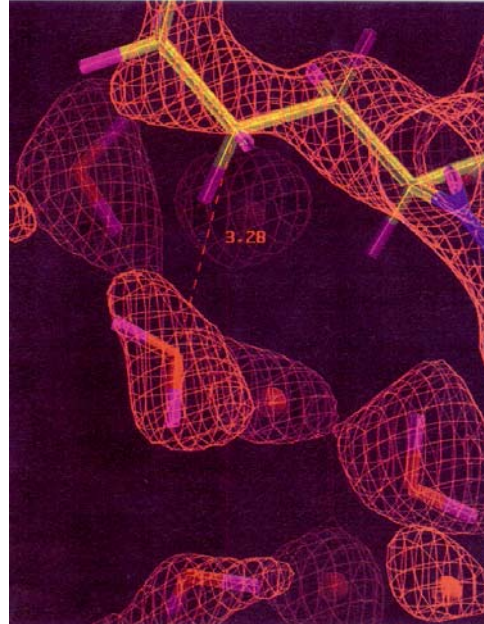

Bon *et al.*, *Acta Cryst* (1999)
D55:978-87

Resolution 1.5Å

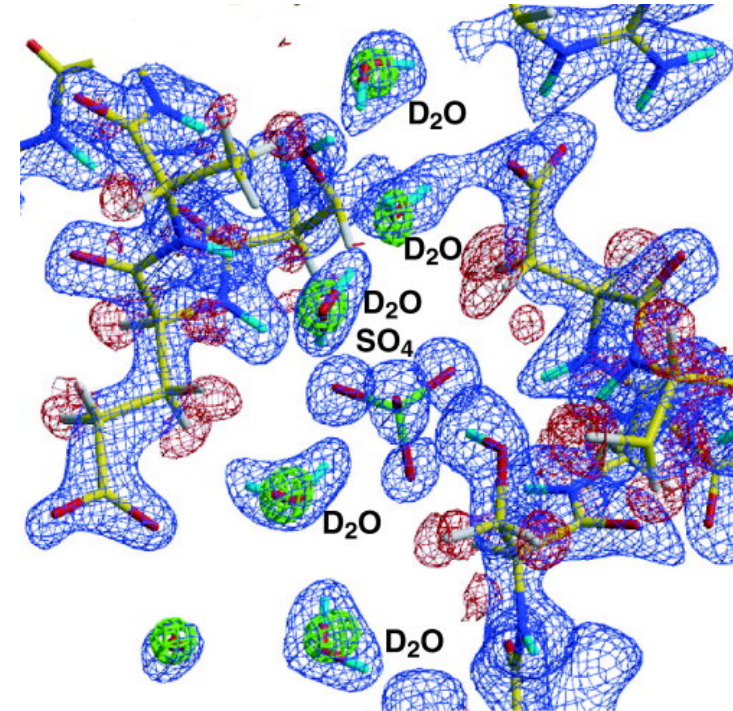

Chatake *et al.*, *Proteins* (2003)
50:516-23

H, D, C, N, O atoms are visible @ ~ 1.5 - 2.0Å



Enzyme mechanism, Ligand binding interactions, Solvent structure

Neutron Protein Crystallography

Advantages:

**H/D more readily visualized than with X-rays
(especially >1.5Å resolution)**

**Able to distinguish between H/D isotopes (solvent exchange)
(group accessibility, mobility, exchange dynamics)**

Strong contrasts are possible (H₂O/D₂O)

(Non-destructive probe – no radiation damage!)

Limitations:

Low flux of neutron beams

Large sample size (>1.0mm³)

Time scales prohibitive –

Few (<20) high resolution studies have been done.

Current Instruments

- BIX-3 & BIX4 – JAERI, Japan
Monochromatic (1.8 & 2.4Å)
2 pi - *Cylindrical Detectors*
Neutron Image Plates
- LADI – ILL, France
Quasi Laue (3.0-4.0Å)
Cylindrical Detectors
Neutron Image Plates
- PCS – LANSCE, USA
TOF Laue (~1-5Å)

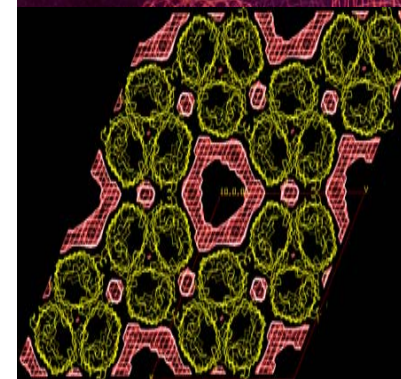
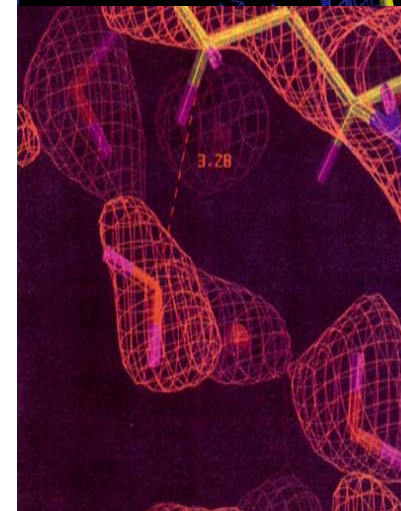
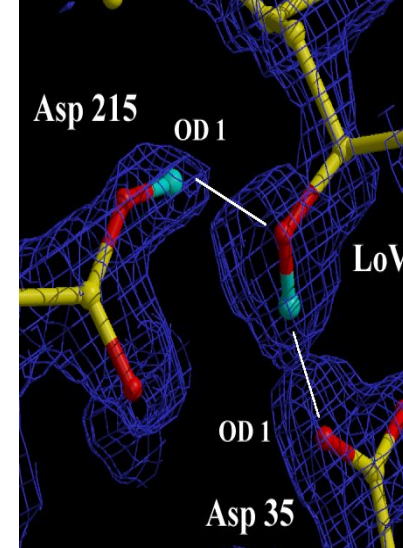

Monochromatic versus LAUE

Count every neutron – make every neutron count!

Monochromatic methods:

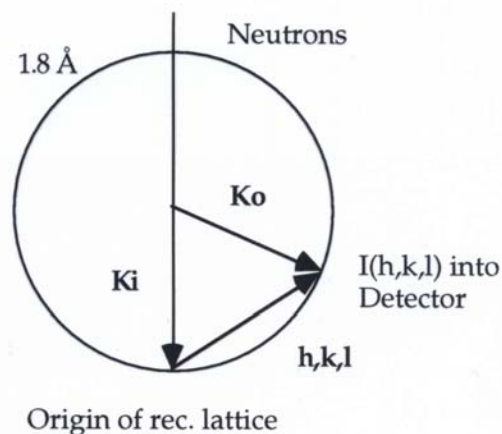

Laue Methods:

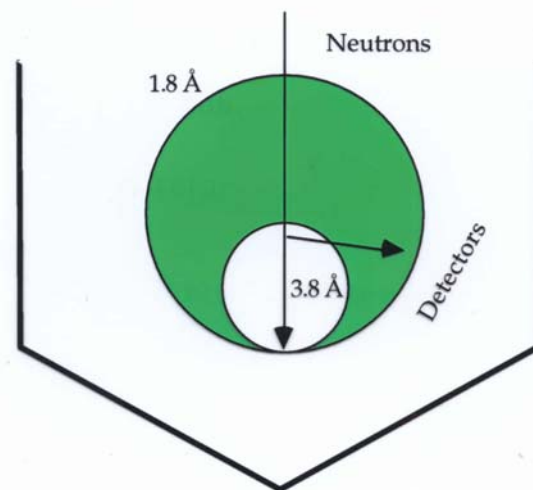

- LAUE** - Rapid survey using ALL neutrons
- LADI** - Large (2π) angular acceptance

LADI - Laue Diffractometer

Image-plates provide 'cheap' large solid-angle neutron detectors with large dynamic range (10^6) high resolution (200um)

Laue diffraction with an image-plate detector on a steady-state reactor can give a 10-100 fold gain in measurement efficiency

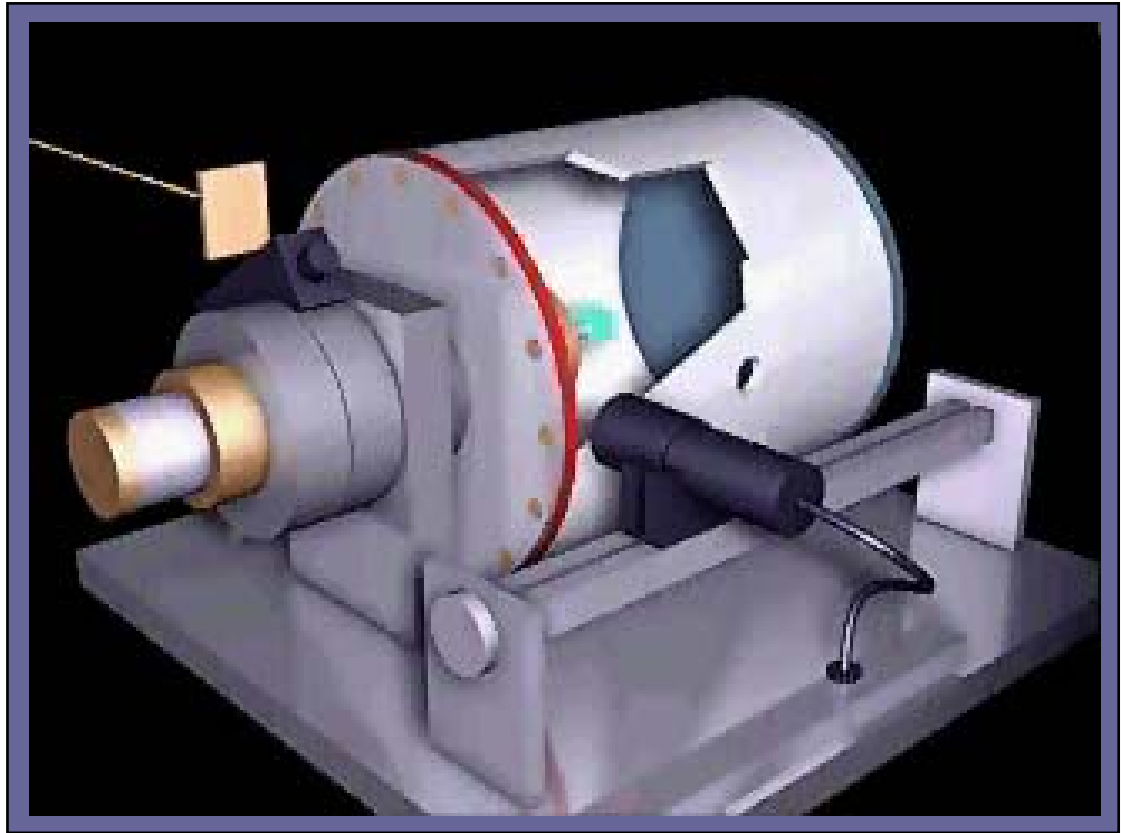

Cipriani et al. J. Neutron Research 4 (1996) 79

- LAUE** - Rapid survey using ALL neutrons
- LADI** - Large (2π) angular acceptance

LADI

Protein crystallography with image plates

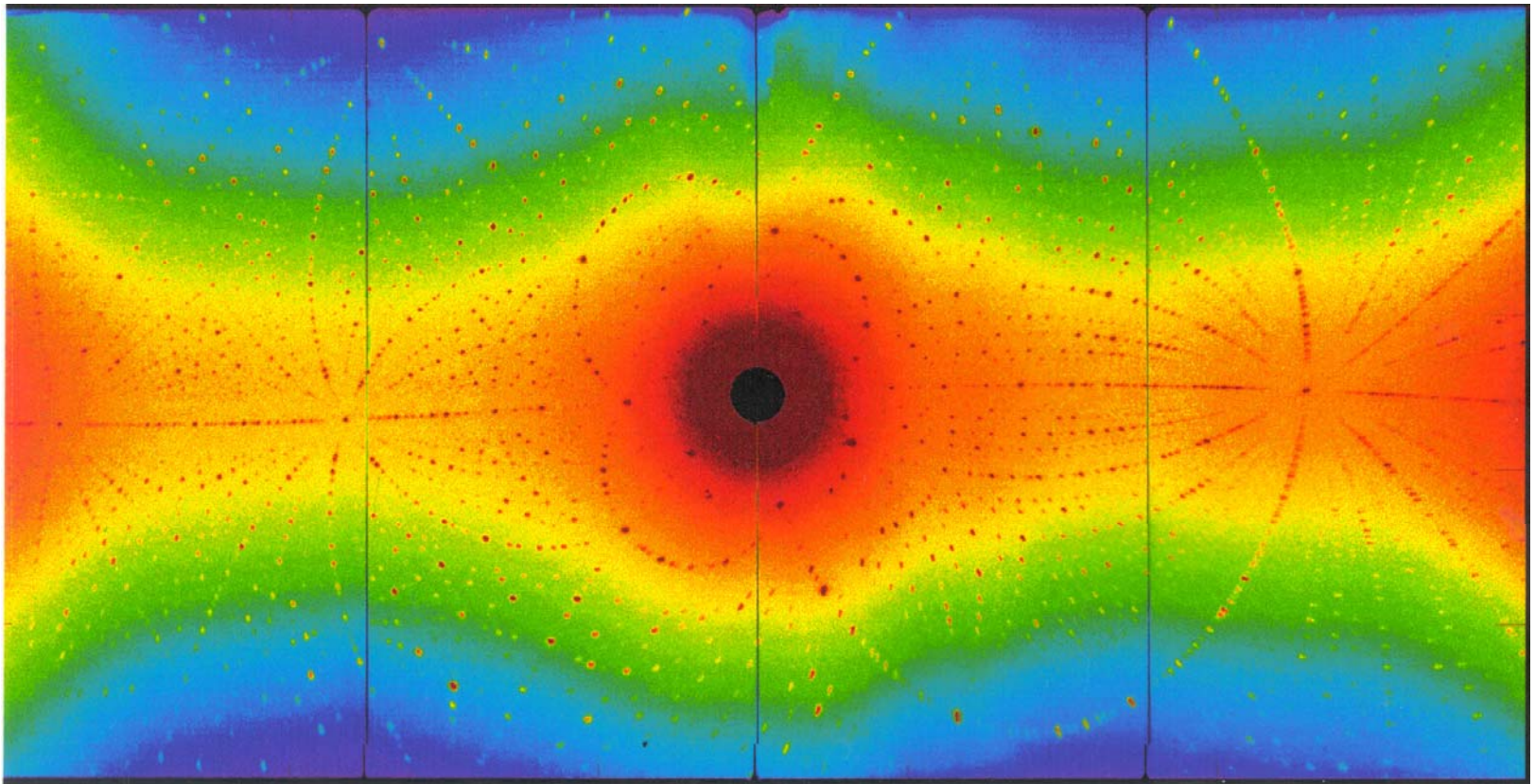

Neutron Laue diffraction from sperm whale myoglobin

Wavelength-resolved Laue Data in Detector Space

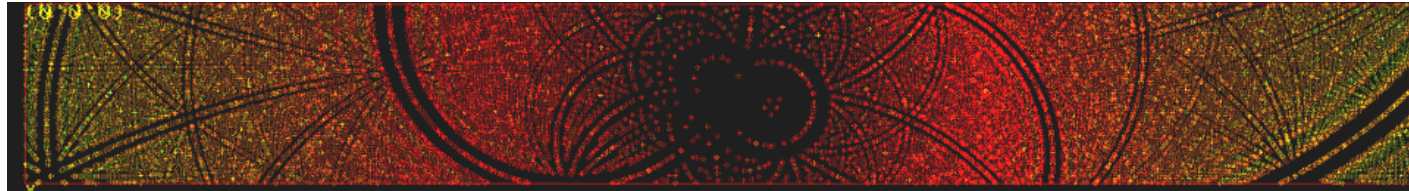

Diffraction patterns
are 3D: (x, y, λ)

Reduced reflection
overlap.

Reduced
background

Enhanced
signal-to-noise

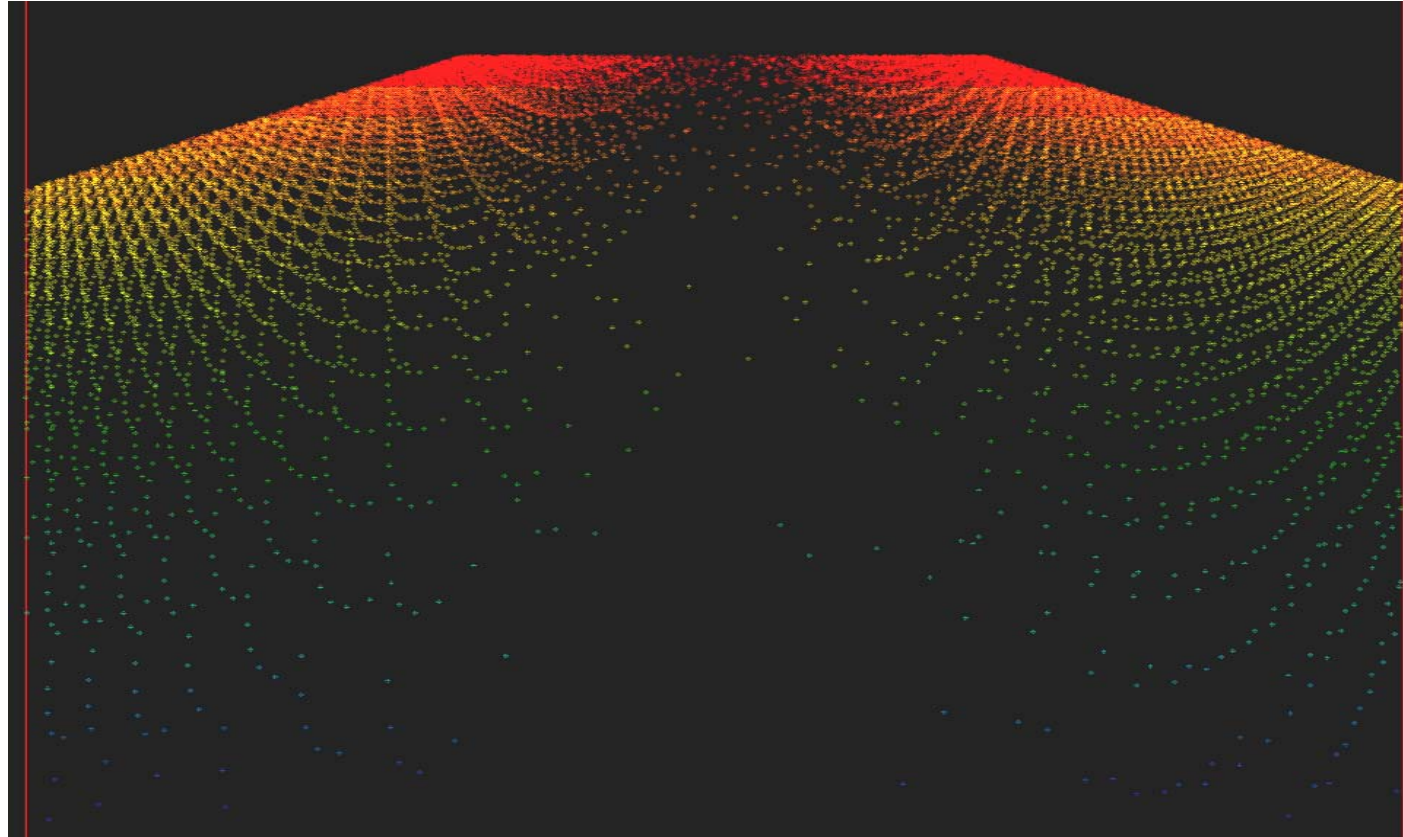

Red-Blue: 0.6Å-6Å



The PCS User Program *Funded by DOE-OBBER*

- Conceptual design 1993
- **Funded 1998**
- 1st beam Dec 2000
- **Commissioned 2001**
- Users August 2002
- **Bio Deuteration Laboratory (BDL) 2005**

3 times oversubscribed



- 160kD enzyme D-xylose isomerase *Hanson et al, Acta D 2004*)
- **Rubredoxin mutant in < 5 days** (*Li et al, Acta D, 2004*)
- 500kDalton Protocatechuate 3,4-dioxygenase (*Brown et al, ACA, 2004*).
- **New blue copper protein** (*Sukumar et al, 2004*)
- Porcin Insulin (*Schoenborn et al, J.Syn.Rad 2004, Tanaka et al J. Syn. Rad, 2004*)



Water Structure of trp repressor

C. Lawson, Rutgers U. & B. Daniels, BNL

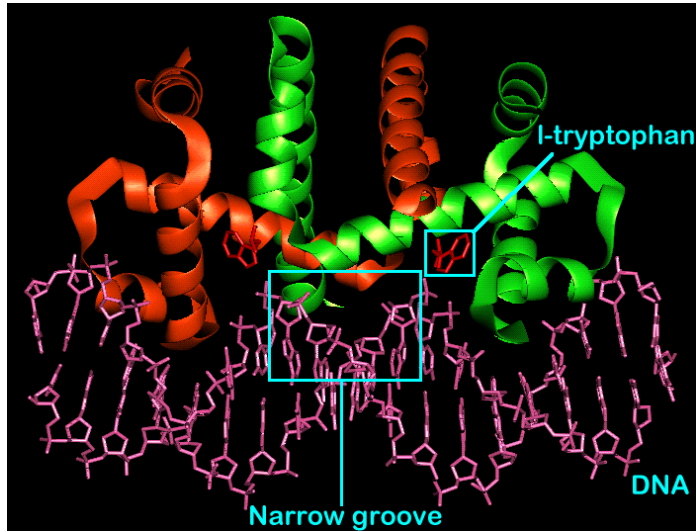

Space Group: $P 2_1 2_1$

Unit Cell: 53.5, 32.8, 53.4 Å

Residues: 101

X-ray Res [Å]: 1.30

Neutron Res [Å]: 2.1

119 water molecules.

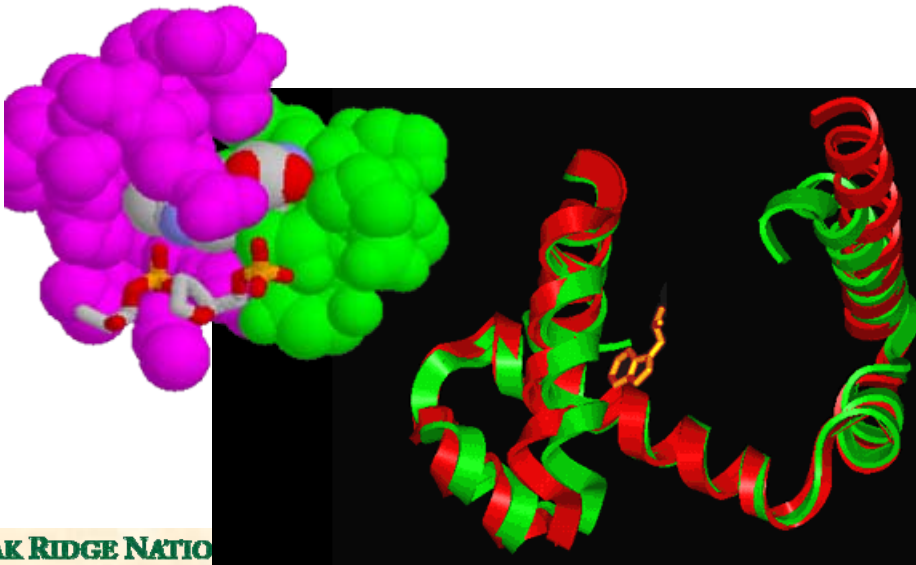
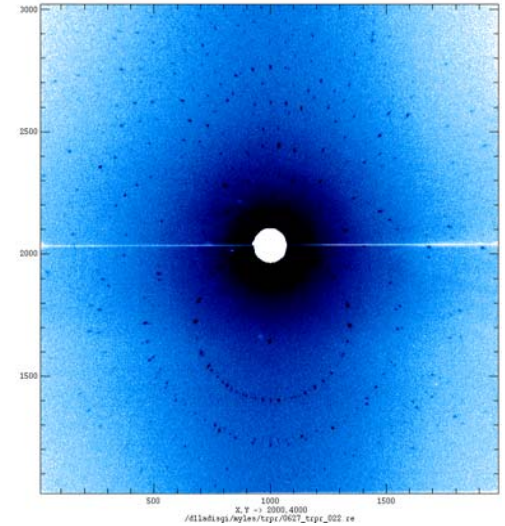

<s>	Dmin	Rfac	Rcum	I/sigma	Complete	Multiplicity
0.0245	6.40	0.069	0.069	7.8	88.7	2.3
0.0389	5.07	0.077	0.073	8.3	90.8	2.8
0.0534	4.33	0.091	0.080	7.2	94.7	3.0
0.0678	3.84	0.093	0.084	6.4	89.7	3.0
0.0823	3.49	0.1	0.087	6.0	89.7	2.9
0.0967	3.22	0.109	0.090	5.7	90.7	2.7
0.1112	3.00	0.117	0.092	5.9	83.0	2.8
0.1256	2.82	0.156	0.096	4.6	79.6	2.5
0.1401	2.67	0.149	0.099	4.8	67.7	2.5
0.1545	2.54	0.156	0.102	4.7	75.0	2.5
0.169	2.43	0.167	0.105	4.5	67.2	2.4
0.1834	2.34	0.185	0.108	3.8	67.6	2.3
0.1979	2.25	0.178	0.110	4.1	61.8	2.1
0.2123	2.17	0.175	0.112	4.1	54.7	1.8
0.2268	2.10	0.205	0.114	3.5	54.3	1.9
		0.114	0.114	5.5	72.6	2.5



Protons in proteins

Catalytic Mechanism of Aspartic Protease

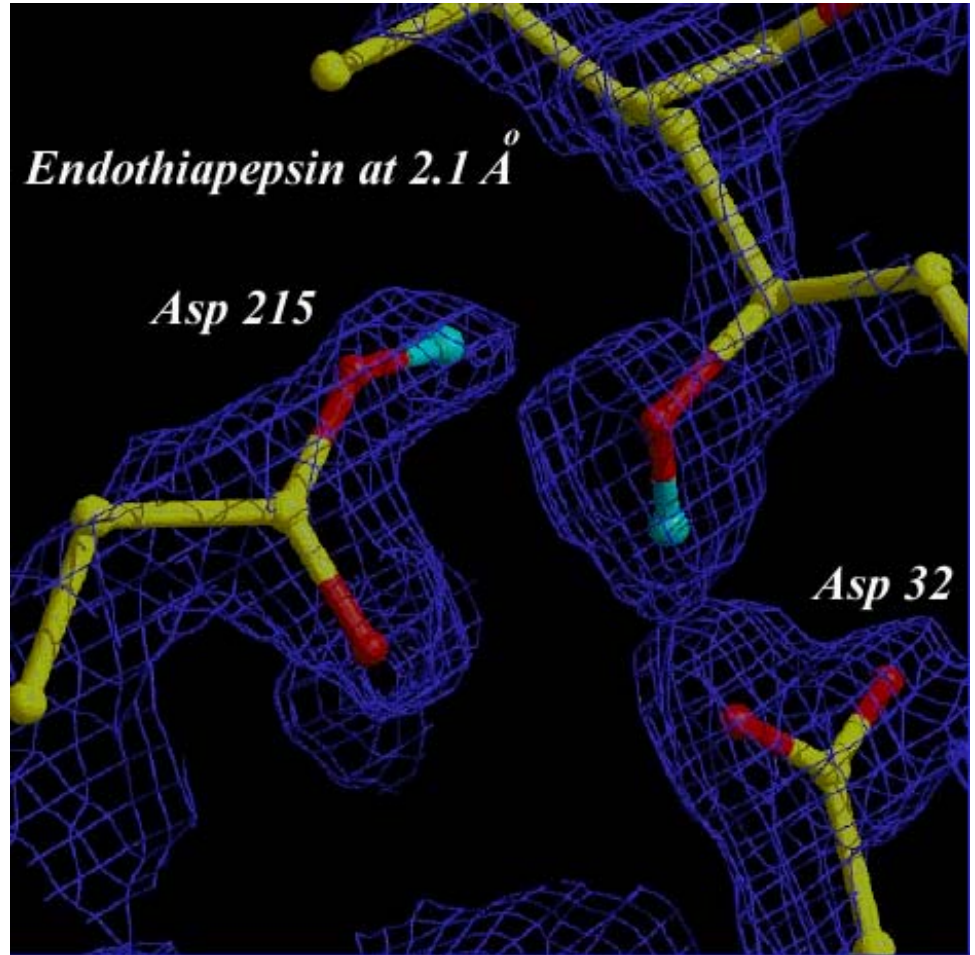
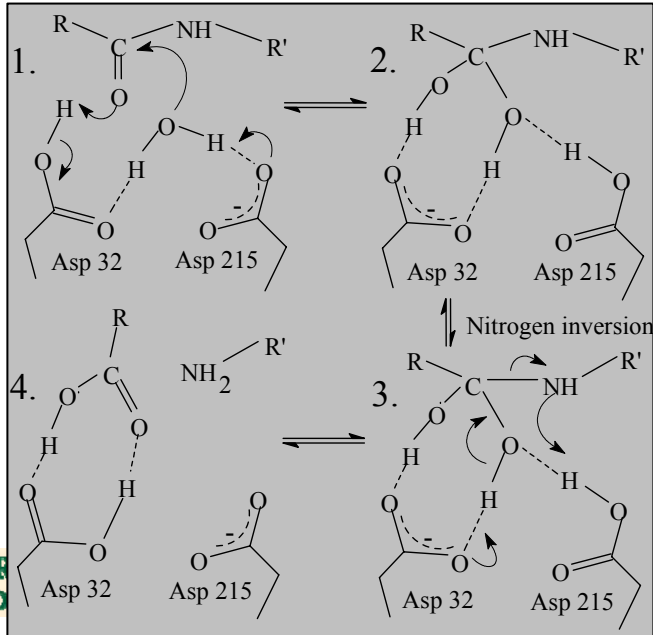

Coates et al., Biochem, (2001)40(44):13149-57

Conserved waters in con A

- Analysed the water structure of various con A structures.
- 22 water sites were found to be conserved.

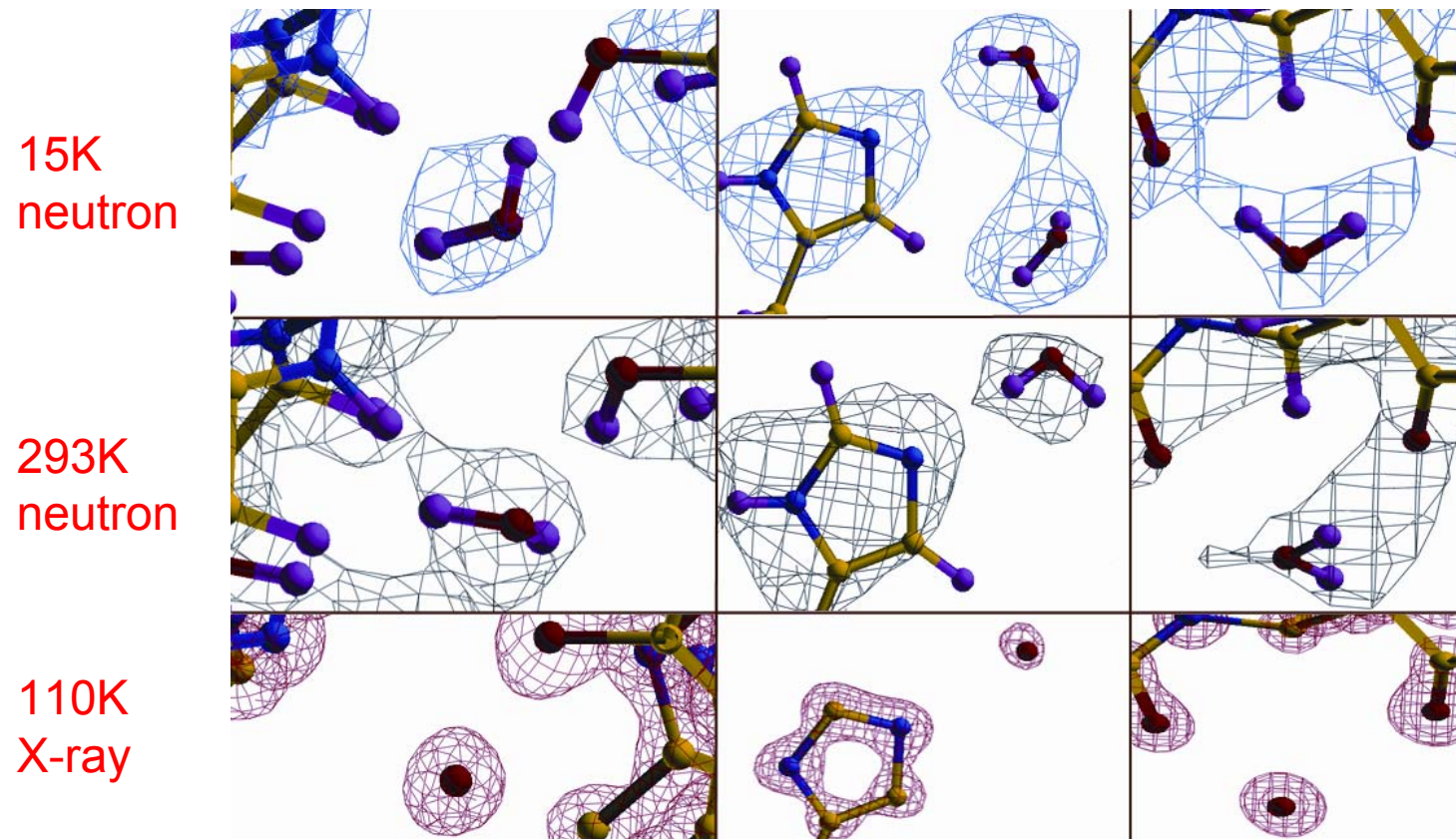

Temp (K)	22 water sites
293	35.0 Å ²
15	22.1 Å ²

→Changes in the orientation of certain D₂O molecules occurs at the two temperatures...may have important consequences for protein crystal structure analysis and ligand design

Larger Unit Cell Systems: Glucose Isomerase

LADI - Mark van der Woerd, Eddie Snell (NASA) & Flora Meilleur (ILL)

PCS- G. Bunick, J. Glusker et al.

Space Group: I222
Unit Cell: 93.9 99.7 102.9 Å
Mol weight: 43.25 kDa
Crystal size: 8 mm³

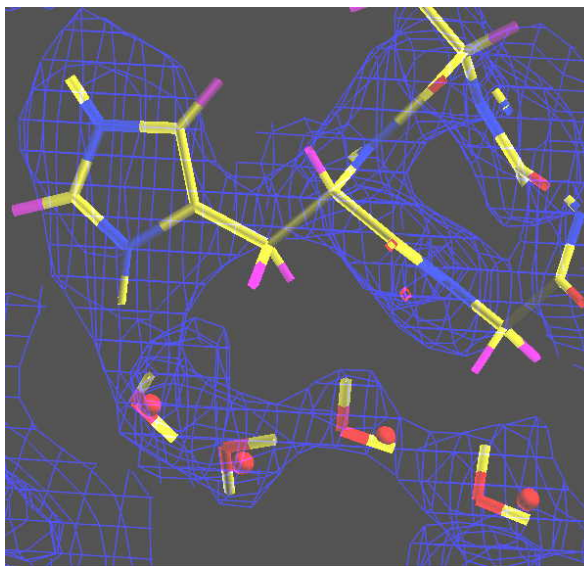

water chain - HIS 230 / GLU 221

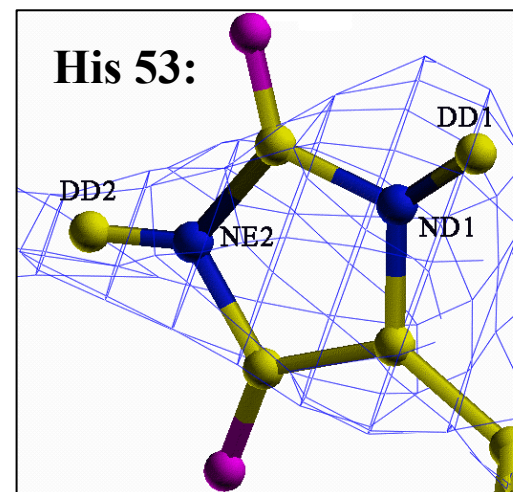
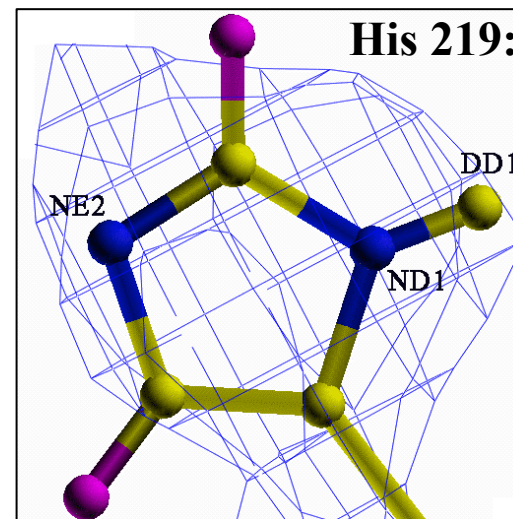

Smaller Crystals Dihydrofolate Reductase-Methotrexate

with Chris G. Dealwis et al., University of Tennessee

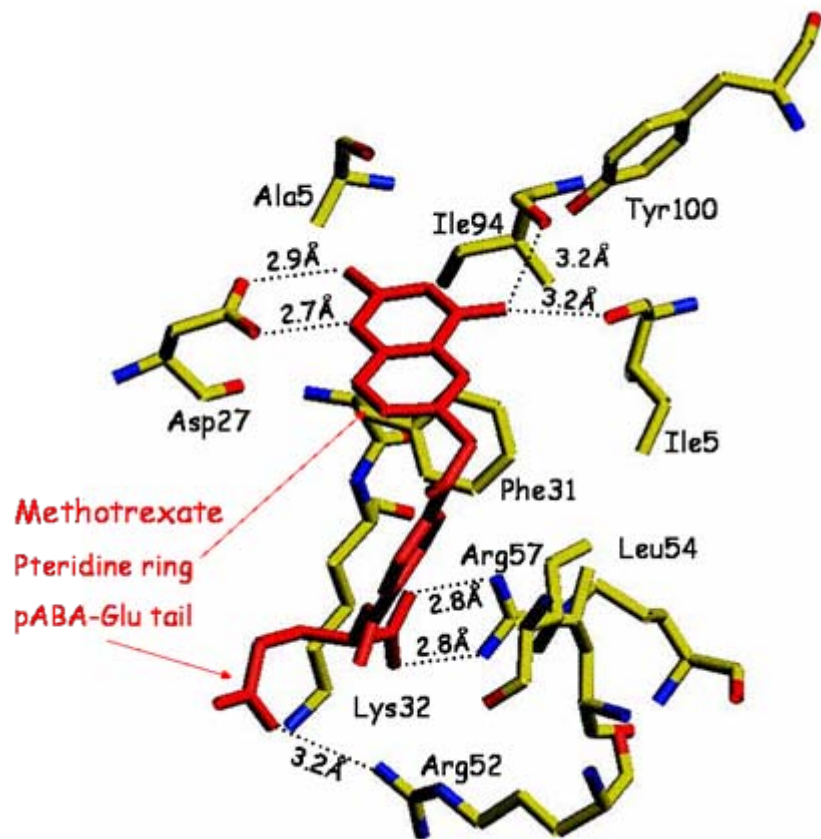

0.9 Å X-ray structure

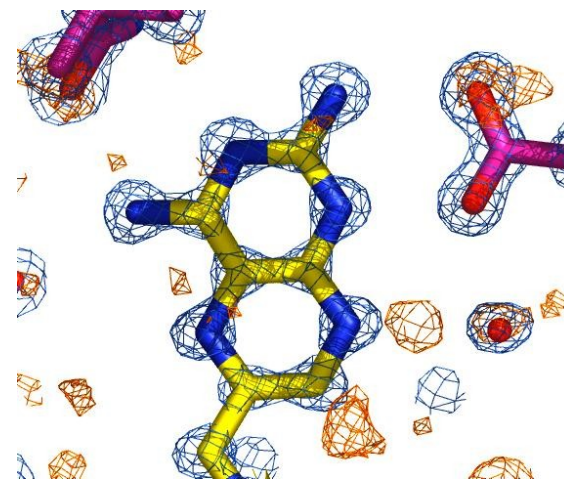

0.9 Å X-ray structure .protons difficult to see

Neutron Diffraction - ecDHFR/MTX

H-protein/D₂O soaked **0.3 mm³**

Resolution range 25.0-**2.20 Å**

Space group P6₁

a=90.93 b=90.93, c=72.36

Future Directions & Improvements

Objective: *Reduce the Threshold* $< 1\text{mm}^3$

Increased efficiency for:

- Shorter collection times (Days, not weeks)
- Larger systems (>50 kDa)
- Larger unit cells (>100 Å)

$$\text{Signal} \sim \langle I_{(hkl)} \rangle \sim \lambda^2 \Phi(\lambda) V_{\text{sample}}/V_{\text{cell}}^2$$

$$\text{Noise} \sim B_{\text{inc}} = d\lambda \Phi(\lambda) V_{\text{sample}}/V_{\text{cell}}^2$$

Solutions:

- More neutrons in : *Increase flux $\Phi(\lambda)$*
- More neutrons out/detected: *New Detectors*
- Reduce background: *Deuterium labelling*

Improving the sample?

Deuteration improves Signal /Noise

coherent scattering : structural information

incoherent scattering: background

$$\left(\frac{\text{signal } I}{\text{noise } \sigma(I)} \right)$$

	C	N	O	H	D
bcoh (fm)	+6.65	+9.36	+5.81	-3.74	+6.67
σ_{coh} (barns)	5.56	11.03	4.23	1.76	5.59
σ_{inc} (barns)	0	0.49	0	80.27	2.05

Bio-Deuteration Laboratory

A Central facility and user program for *in vivo* H-D labeling of macromolecules

- **Develop a Central Deuteration Laboratory** dedicated to specific H/D labeling of cells, proteins, nucleic acids and other bio-molecules.
- **Develop better and faster systems and methods** to produce deuterium labeled biological macromolecules for the biology community
- **Improving downstream technologies** to exploit these reagents (including data collection and interpretation for neutron scattering)
- **Train research students and staff** in application of these powerful techniques

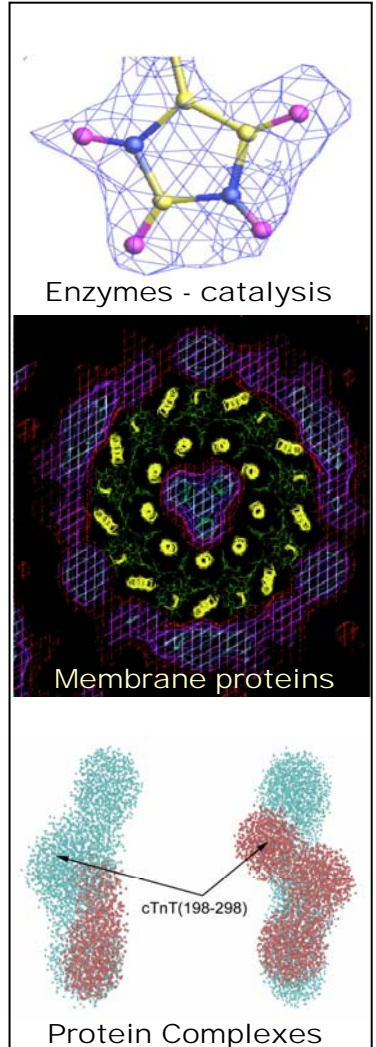

The special case of *aldose reductase*

IGBMC – Isabelle Hazelamnn, Andre Mitschler, Alberto Podjarny

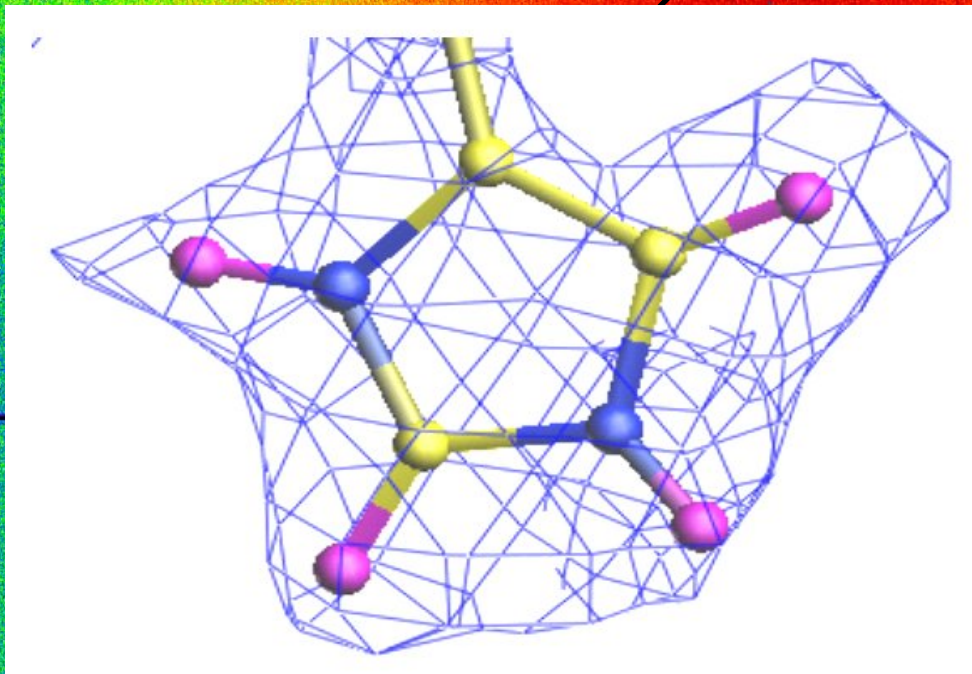

Combining high resolution X-ray/Neutron – locating hydrogen in protein structures

<2.2Å from 0.14mm³ perdeuterated crystal

Next Generation: Instruments/Sources

Objectives

- Larger unit cells ($>100\text{\AA}$)
- Larger proteins/complexes ($>50\text{kda}$)
- Smaller crystals ($<1\text{mm}^3$)
- Rapid data collection

Europe

LADI-III

x~10



PSB

June 2006

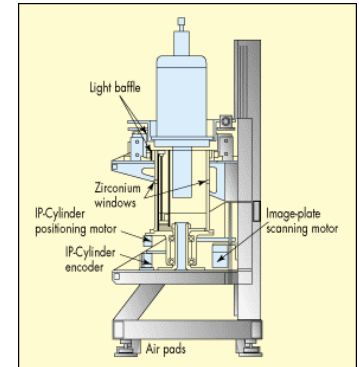

Japan

BIX-P1

x~20

J-PARC

Aug. 2008

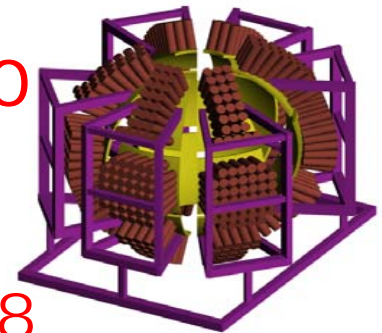

USA

MaNDi

>50

SNS ??

LADI – III at ILL

A new instrument (& beamline?) for protein crystallography

Objectives:

- New high flux beam position (>5)
- Improved detection efficiency (~3)

New applications:

- Larger unit cells (>100Å)
- Larger proteins/complexes (>50kda)
- Smaller crystals (<1mm³)

Available June 2006

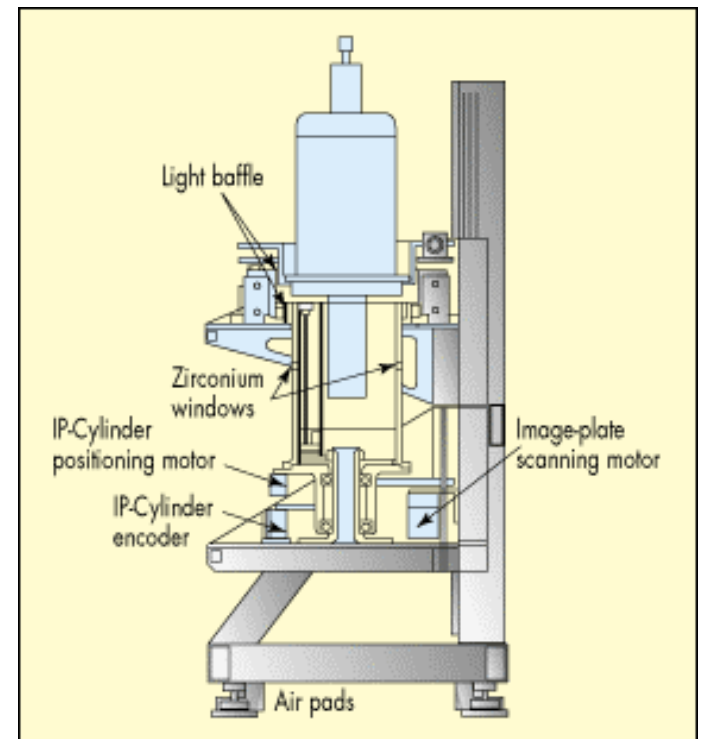

Design Team:

Flora Meilleur, Garry McIntyre, Peter Timmins
Florent Cipriani, Francois Dauvergne

BIX-P1 Design Criteria

- Maximum unit cell dimension 135 Å as sample crystals
- Minimum d-spacings 1.2 Å in biomacromolecules and 0.7 Å in organic compounds
- 3 to 4 days for full data taking of biomacromolecular crystals with about 1 mm³ in volume

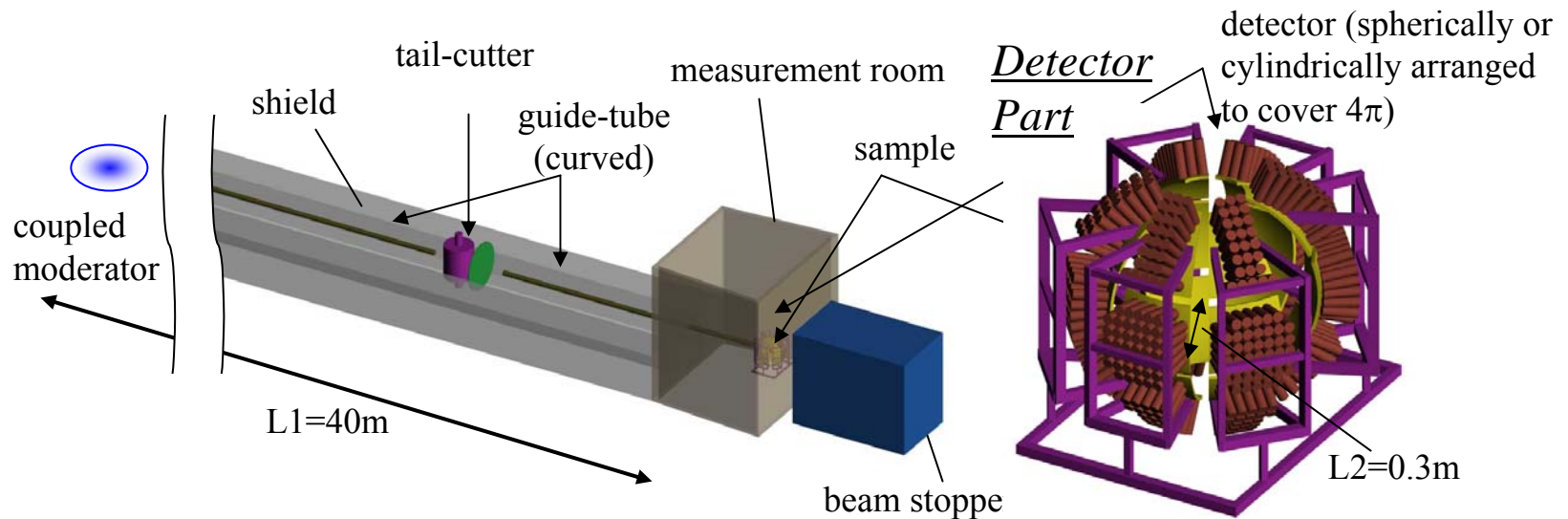

SNS - Spallation Neutron Source



01-03898/arb

Improving the source ! - and the Instrument !

MaNDi - Optimised for large unit cells...

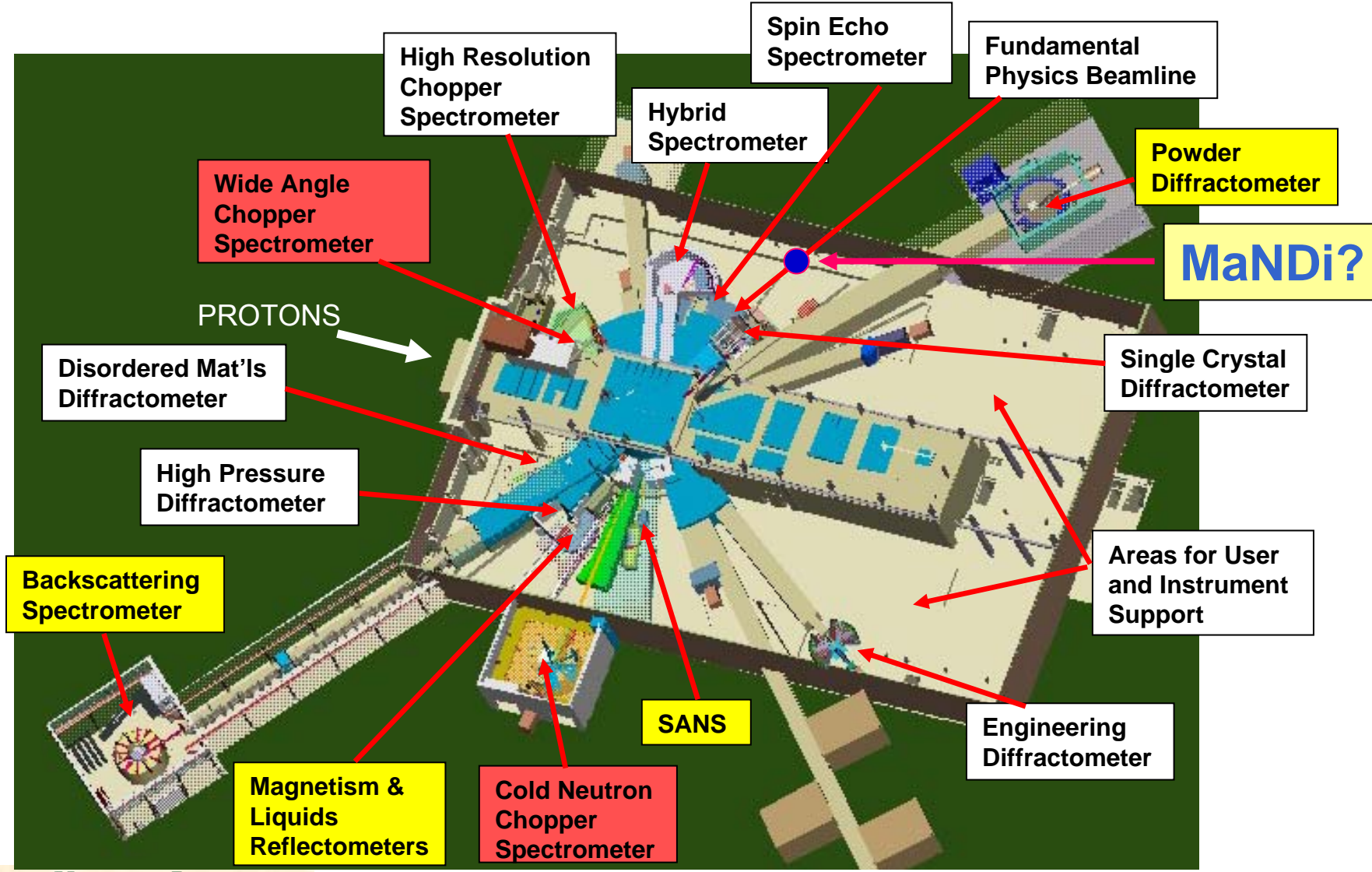

Conceptual Design & Performance of MaNDi

P. Thyagarajan, A.J. Schultz (IPNS, Argonne), A.Mesecar (Chicago) C. Rehm, J. Hodges, W. Lee, SNS

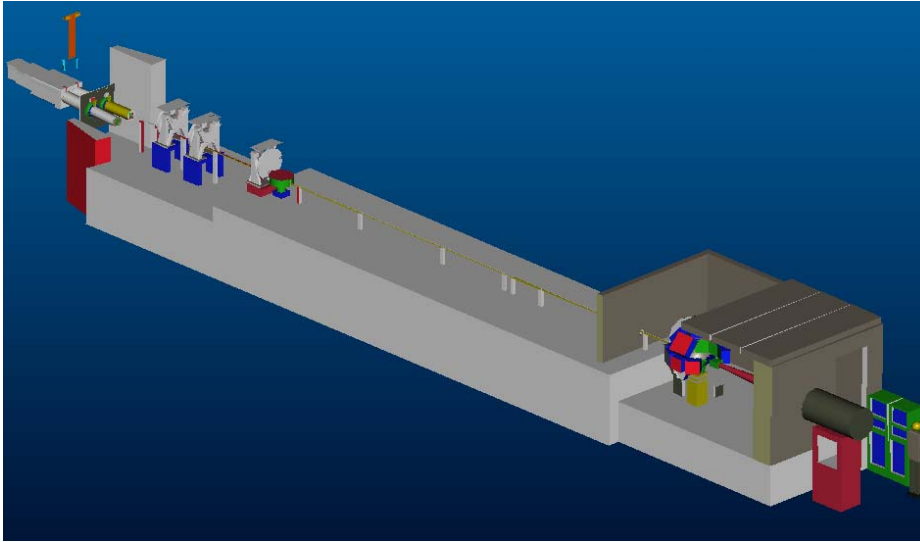

Solid Volume of Q Space (\AA^{-3}) for MaNDi

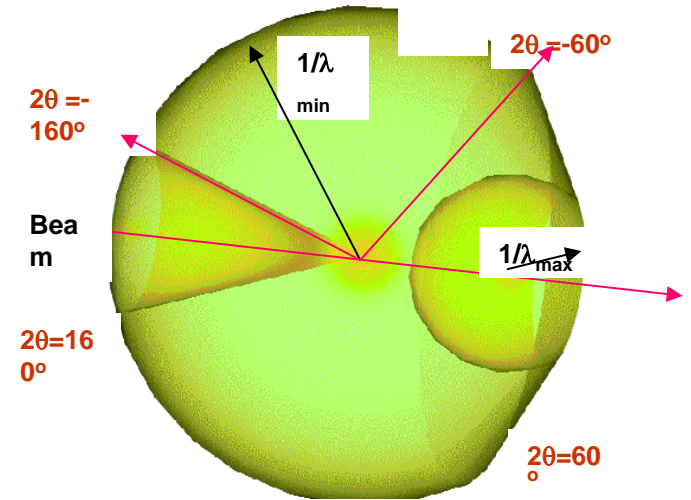

- High data rates (10 to 50X of existing facilities) and high resolution
- Analysis of larger proteins/complexes
- 1 mm³ crystals with lattice repeat up to 150 Å and $d_{min} = 2.0 \text{ \AA}$ in a week
- 0.125 mm³ crystals of deuterated proteins

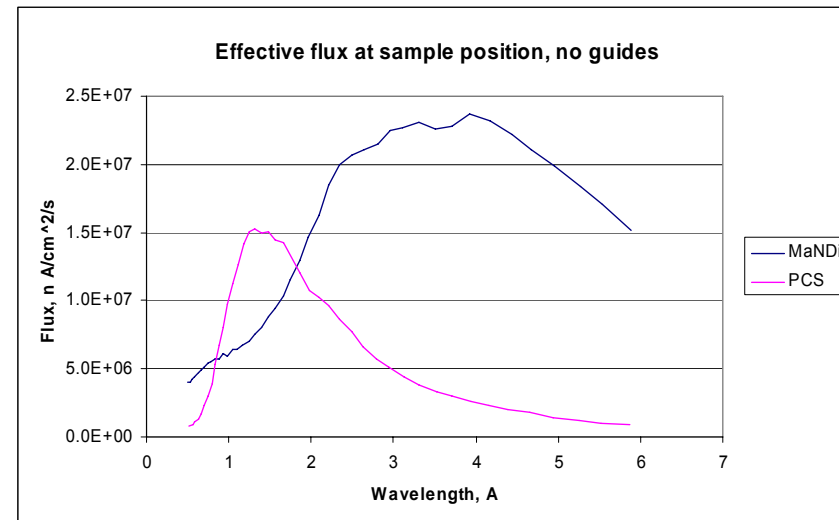

Conclusion

New Opportunities

- **The present:**
 - LADI/BIX/PCS**
 - 10-100 gains**
 - 30-50 kDa**
 - ~1mm³ crystals**
- New developments:**
 - Sources > 10**
 - Instrumentation >10**
 - Deuteration >10**

The future:

- Larger proteins/complexes (>50kDa)**
- Larger unit cells (>100Å)**
- Smaller crystals (<<1mm³)**

New opportunities in Structural Biology