

TECHNIQUES FOR DEVELOPING CHILD DUMMY PROTECTION REFERENCE VALUES

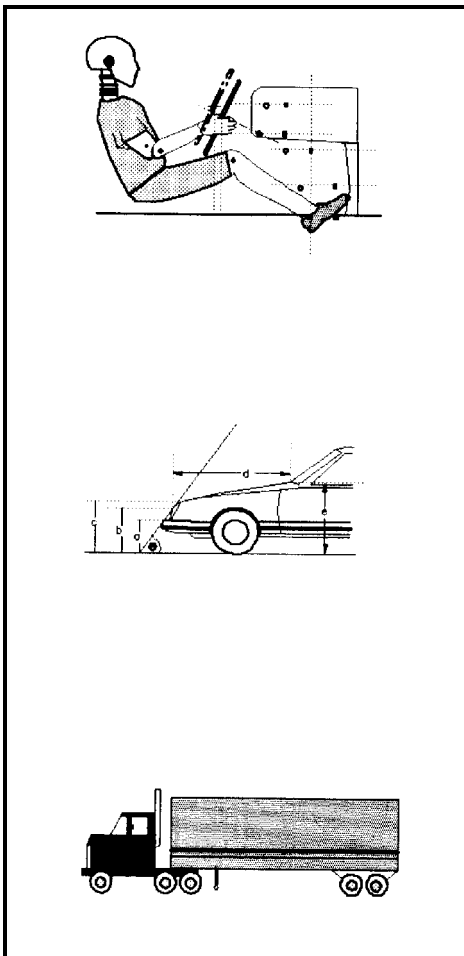

EVENT REPORT



CHILD INJURY
PROTECTION TEAM

OCTOBER 1996

**TECHNIQUES FOR DEVELOPING
CHILD DUMMY
PROTECTION REFERENCE VALUES**

by

Kathleen DeSantis Klinich TRC

Roger A. Saul

NRD-20

Gaston Auguste NPP

Stanley Backaitis NRM

Michael Kleinberger NRD-10

TABLE OF CONTENTS

Section	Page
1.0 INTRODUCTION.....	1-1
2.0 BACKGROUND.....	2-1
2.1 Child Physiology and Injury Mechanisms	2-1
2.2 Biomechanical Properties as Functions of Age.....	2-3
2.3 Epidemiology of Child Automotive Injuries.....	2-6
2.4 Child Anthropomorphic Test Devices (Crash Test Dummies).....	2-10
2.4.1 Infant Dummies	2-10
2.4.2 Three-Year-Old Dummies.....	2-13
2.4.3 Six-Year-Old Dummies	2-15
3.0 APPROACHES FOR DEVELOPING INJURY CRITERIA AND PROTECTION REFERENCE VALUES	3-1
3.1 Cadaver Testing	3-3
3.2 Surrogate Testing	3-5
3.3 Accident Reconstructions	3-10
3.4 Scaling of Adult Data	3-29
4.0 CHILD PROTECTION REFERENCE VALUES: ADDITIONAL SCALING AND SUMMARY	4-1
4.1 Scaled Child Protection Reference Values from Adult Data.....	4-1
4.2 Summary of Child Injury Protection Reference Values	4-5
5.0 CONCLUSIONS.....	5-1
6.0 RECOMMENDATIONS	6-1
7.0 REFERENCES	7-1
APPENDIX A: General Motors Injury Assessment Reference Values for Child Dummies	A-1

LIST OF FIGURES

		Page
Figure 1	Skull profiles showing changes in size and shape (Burdi et al., 1969) .	2-1
Figure 2	Modulus of elasticity vs. age for femoral bone	2-4
Figure 3	Modulus of elasticity vs. age for cranial bone	2-5
Figure 4	CRABI Six-Month-Old (FTSS)	2-11
Figure 5	TNO dummy structure	2-12
Figure 6	Part 572 3YO	2-13
Figure 7	Hybrid III 3YO	2-14
Figure 8	Part 572 6YO	2-15
Figure 9	Hybrid III 6YO	2-16
Figure 10	Theoretical scaling of rotational velocity and acceleration for 50 percent probability of onset of cerebral concussion from subhuman primates to humans	3-6
Figure 11	Proposed DAI injury criteria	3-8
Figure 12	Prasad & Daniel proposed neck protection reference value for three-year-old's	3-9
Figure 13	Kahane et al. HIC values	3-20
Figure 14	Kahane et al. average torso g's measurements	3-20
Figure 15	Six-year-old dummies in rigid seat with 5-pt harness in Ford evaluation tests	3-21
Figure 16	Three-year-old dummies in Bravera booster seat with Taurus 3-pt belts in Ford evaluation tests	3-21
Figure 17	3YO head resultants, Ford tests	3-23
Figure 18	6YO head resultants, Ford tests	3-23
Figure 19	3YO HIC values, Ford tests	3-24
Figure 20	6YO HIC values, Ford tests	3-24
Figure 21	6YO chest clips, Ford tests	3-24
Figure 22	3YO chest clips, Ford tests	3-24
Figure 23	3YO neck tension, Ford tests	3-25

LIST OF FIGURES- continued

Figure 24	6YO neck tension, Ford tests	3-25
Figure 25	6YO neck flexion, Ford tests	3-25
Figure 26	3YO neck flexion, Ford tests	3-25
Figure 27	3YO neck extension, Ford tests.	3-26
Figure 28	6YO neck extension, Ford tests.	3-26
Figure 29	Janssen et al. scaled neck force tolerances.	3-30
Figure 30	Janssen et al. scaled neck moment tolerances	3-30
Figure 31	Estimating neck ratio for infants	4-2
Figure 32	Neck axial load vs. extension moment PRV	6-4
Figure 33	Neck axial load vs. flexion moment PRV	6-4
Figure 34	Neck axial load vs. time duration PRV	6-6
Figure 35	Fore/aft neck shear vs. Time duration (from GM IARV)	6-6
Figure 36	Normalized tension vs. moment requirement	6-7
Figure 37	Neck tension/extension time duration requirement.	6-8

LIST OF TABLES

	Page
Table 1	Tensile Properties of Tendons 2-5
Table 2	Restraint Use of Children in 1988-1991 NASS 2-6
Table 3	MAIS Scores of Children in 1988-1991 NASS 2-7
Table 4	Body Region Injured for Child Injuries in 1988-1991 NASS. 2-8
Table 5	Restrained Children in 40-56 kph NASS Crashes 1988-1994 2-9
Table 6	Child Cadaver Test Subject Summary 3-3
Table 7	Child Cadaver Test Conditions Summary. 3-4
Table 8	Ommaya Head Angular Injury Criteria, Scaled. 3-7
Table 9	Sturtz Scaled Angular Acceleration Tolerances (r/\bar{s}) 3-7
Table 10	Injury-Assessment Reference Values from Mertz et. al (1982). 3-9
Table 11	Planath et al. Selected Cases 3-10
Table 12	Planath et al. Reconstruction Data. 3-11
Table 13	Severe Injuries from Newman & Dalmotas Reconstruction Cases . . . 3-11
Table 14	Newman and Dalmotas Reconstructions: Neck Loads 3-12
Table 15	Weber et al. Reconstruction Data 3-13
Table 16	Trosseille and Tarriere Selected Cases 3-14
Table 17	Troiselle & Tarriere Reconstruction Cases 3-15
Table 18	Janssen et al. Peak Average Neck Load Comparison 3-15
Table 19	Janssen et al. Reconstruction Data 3-16
Table 20	Sturtz PRV Developed from Pedestrian Reconstruction Tests 3-17
Table 21	Restraint Conditions Kahane et al. (1987). 3-19
Table 22	VRTC Part 572 Six-year-old Tests 3-27
Table 23	VRTC Misuse/Incompatibility Testing 3-27
Table 24	Weber CRABI 12MO Test Results 3-28
Table 25	6MO CRABI Tolerance Estimates (Melvin 1995) 3-31
Table 26	General Motors 6-year-old IARVs 3-32
Table 27	Revised Scaled Neck Moments (Nm) 3-32
Table 28	Anthropomorphic Measurements 4-1
Table 29	Length and Modulus Scaling Factors 4-3
Table 30	Scaled Adult Protection Reference Values 4-3

LIST OF TABLES- continued

	Page
Table 31	6YO Scaled OOP Values4-4
Table 32	Scaling of Melvin’s 6MO OOP Criteria to 12MO 4-5
Table 33	Dummy Head Measurements4-6
Table 34	Estimated Head Protection Reference Values: Translational. 4-7
Table 35	Estimated Head Protection Reference Values: Rotational. 4-8
Table 36	Dummy Neck Measurements 4-9
Table 37	Estimated Neck Protection Reference Values 4-10
Table 38	Dummy Chest Measurements4-11
Table 39	Estimated Chest Protection Reference Values. 4-12
Table 40	Hybrid III/CRABI OOP Child Protection Reference Values 6-2
Table 41	Neck Measurement Critical Values for Child Dummies 6-3

1.0 INTRODUCTION

The purpose of this report is to present background information and techniques for developing protection reference values (PRV) to use with child dummies in out-of-position (OOP) child/air bag interaction testing. Biomechanics experts agree that OOP PRV in the literature should not apply to frontal belt-restrained child occupants (using child restraints or belts). However, given the very limited amount of data available, all sources of information were used to extract child injury PRV.

An important point of distinction is the difference between injury criteria and protection reference values. Injury criteria apply to humans, while PRV apply to crash test dummies. If dummies were perfectly biofidelic, the injury criteria and PRV would be the same. Since dummies only approximate human response to varying degrees, PRV are usually different from injury criteria. In addition, PRV developed for a particular dummy in a particular situation may or may not apply to other dummies of that size, nor to other impact conditions. The dummies' structures particularly emphasize their different responses to direct and indirect loading.

This report summarizes the literature on injury criteria and protection reference values as it pertains to children. As the first part of the background section, child anatomy and physiology are examined with respect to impact injuries (Burdi et al., 1969, Eichelberger, 1993). Epidemiology on the types of injuries that children receive in automotive accidents is also reviewed. In addition, data on how human tissue mechanical properties vary with age are presented. The characteristics and capabilities of different child dummies are documented as well. The next section assesses injury and PRV development techniques. A literature review on how these techniques have been applied to children follows. Data from regular test programs using child dummies are included for comparison. The last sections employ different scaling techniques to estimate PRV for child dummies. These, together with values from the literature survey, are summarized and presented as proposed reference values.

2.0 BACKGROUND

2.1 Child Physiology and Injury Mechanisms

A major difference in anatomy between children and adults is the proportion of total mass in the head. At birth, the head comprises 30% of body weight while the adult head makes up only 6% of body weight. Lengthwise, an infant's head is 1/4 the total height, while an adult's head is 1/7 the total height. The relative proportions of a human skull from birth to maturity are shown in Figure 1. The relatively large head may particularly affect neck loads, as a larger proportion of mass is being supported by a smaller structure.

The skull structure in children is markedly different from adults. At birth, an infant's skull is flexible, and consists of six sections called fontanelles which eventually grow together. Bone growth joins some of the sections within two to three months of birth, although they do not completely fuse until about 18 months. The infant skull can deform more easily under load, which might make it less susceptible to fracture. However, other injury mechanisms may be possible.

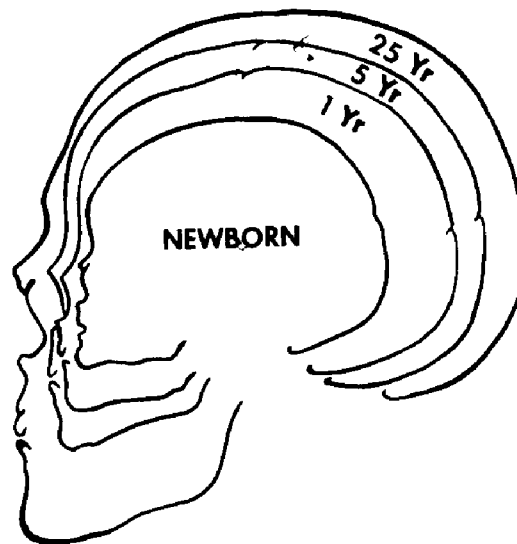

Figure 1-- Skull profiles showing changes in size and shape (Burdi et al., 1969)

The fontanelles allow volume changes in the skull that can lead to large motions of the brain relative to the skull, which are not possible in older children and adults. This may lead to shearing injuries of brain tissue. However, the fontanelles may allow an “escape valve” for increased intracranial pressure. These features make the rigid skull assumption used in development of adult injury criteria incorrect when applied to infants. (The HIC is primarily based on research which links the likelihood of brain injury to skull fracture; this correlation may not be applicable to children or infants.) The shape of the child’s head as an infant is also distinctly different from an adult’s, which makes the assumption of geometrical similarity used in scaling somewhat inappropriate as well.

At birth, the neck vertebrae consist of three different bones joined by cartilage. They typically grow together during the third year. However, the atlas (C1) and the axis (C2) do not complete their joining until age 4 to 6. By puberty, the vertebrae reach their adult size, but do not finish developing until age 25. During the first few years, the facet joints in the upper neck are nearly horizontal (unlike adults), allowing partial dislocation under minimal forces. In addition to differences in cervical spine structure, infant neck muscles are not well developed, and most children cannot hold up their heads until about three months. Infant ligaments tend to be more lax as well. As mentioned before, even as a child’s muscles develop, they have a relatively bigger head to support; this may allow more neck injuries if not properly supported. An injury found in children which most likely results from the difference in neck structure is spinal cord stretch injury. Under impact, a child’s flexible vertebrae can displace more without fracture, but allow the spinal cord to stretch. For this reason, children can have spinal cord injury without vertebral damage, which is rarely found in adults. Another difference in neck injury between adults and children is the point where most cervical spine fractures occur. About 60-70% of pediatric cervical fractures occur at C1 or C2, compared to about 16% of adult cervical spine fractures. This occurs because the natural neck pivot of children is at C2 or C3, while in adults it occurs near C6.

Because of the larger proportion of mass found in the heads of children, their overall centers of gravity are higher. This can lead to a different interaction with a restraint system compared to adults, as a child is more likely to bend over a lap belt or around a shoulder belt in a crash. A child’s ribs are generally more flexible than those of adults. This has two potential effects: a lower probability of rib fracture, but a higher probability of thoracic organ damage from compression. Because of rib flexibility, a child with broken ribs is a sign of high impact energy, so internal organ damage is likely.

A child’s abdomen protrudes more than an adult’s, and the liver and spleen are not as protected by the rib cage as they will be later in life. Children may be more likely to suffer a higher incidence of multiple organ injury, because kinetic energy is dissipated into a smaller mass. The iliac crests of the pelvis do not develop until approximately age 10. The absence of the iliac crests to help position lap belts properly over the pelvis poses a particular challenge to restraint designers.

Overall, two conflicting theories on child impact injury exist (Brun-Cassan 1993, Foust 1977, Snyder, 1969, Sturtz, 1980, Eichelberger, 1993) . The first is that children are smaller and must be correspondingly more delicate than adults, which would lead to a lower tolerance to injury. The second is that children are more durable or more resilient than adults; the frequent survival of children in falls from heights that kill adults is one of the situations that support the second approach. Reality is probably between these two extremes, and depends on the type of impact and injury mechanism.

2.2 Biomechanical Properties as Functions of Age

Mechanical properties of biological tissues, such as modulus of elasticity, ultimate strength, and percent elongation are useful in both determining dummy design characteristics and aiding in scaling different injury criteria or reference values. These mechanical properties often vary with age, although adult characteristics are not always stronger than children's. Because of this variation with age, they provide some guidance on how impact responses and injury mechanisms might be expected to change. The mechanical characteristics as they pertain to impact biomechanics are included in this section.

Currey and Butler (1975) conducted tests on femoral bone taken from subjects aged 2 to 48. The child samples had lower modulus of elasticity and lower bending strength, but deflected more and absorbed more energy before and after breaking. Children seem to experience more plastic deformation before fracture compared to adults. Their modulus data are included in Figure 2. All of the subjects were accident victims, except for the 6-year-old child, who had diabetes, which may have affected response.

Hirsch and Evans (1966) conducted axial tension tests with samples of compact bone taken from femurs. The specimens' ages were mostly newborns (8 samples), although a six-month-old (1 sample) and 14-year-old (4 samples) were also included. The fresh samples were frozen and not allowed to dry during the quasistatic testing. The authors reported the tangent modulus, rather than the modulus of elasticity, so the results cannot be directly compared with the Currey and Butler data. The average tangent modulus for the 14-year-old was about twice that of those of the newborns. The Currey and Butler data show that the elastic modulus for the 14-year-old is about 1.5 times that of a two-year-old, so the Hirsch and Evans tangent modulus data seem consistent with the Currey and Butler data.

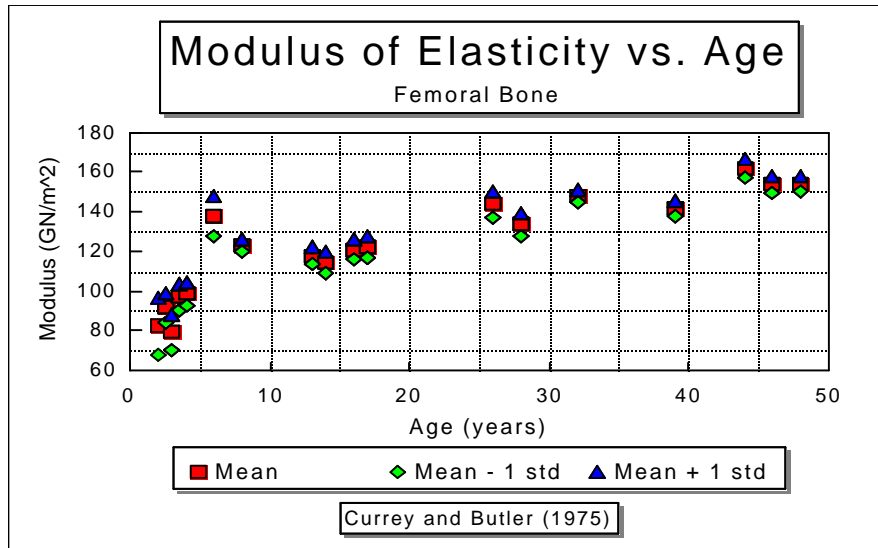

Figure 2 -- Modulus of elasticity vs. age for femoral bone

McPherson and Kriewall (1978) studied the mechanical properties of fetal cranial bone in 3-point bending. They used three specimens aged between 24 and 29 gestational weeks, three specimens from 38-40 gestational weeks old, plus one six-year-old specimen for comparison. The fresh samples were first frozen until preparation, then stored in saline solution, and tested at room temperature under a saline drip. Running at a quasistatic rate, the authors found a difference in modulus between the samples cut parallel to and perpendicular to the bone grain. Their results are shown in Figure 3. After averaging all the samples (both parallel and perpendicular) for each child, then averaging the values for each age, the mean values for the premature, newborn, and six-year-old were 1.16, 2.70, and 6.62 GPa, respectively.

Several sources have studied cranial bone modulus for adults. Wood (1971) calculated the bending modulus for adult cranial bone samples at a variety of different rates. A difference in technique was that the fresh samples were frozen until use, then prepared and tested under normal humidity in axial tension. The samples from 30 subjects ranged in age from 25 to 95 years. Unlike the fetal data, no directional differences occurred. The modulus values for all subjects at quasistatic rate levels appeared to fall between 12.4 and 16.6 Gpa.

Another source for adult cranial modulus data is Hubbard (1971). He tested specimens from four embalmed adult specimens of unknown age. Quasistatic 3-point bending tests were employed, with the samples stored in a humid environment at room temperature. The average modulus is reported as 9.93 Gpa

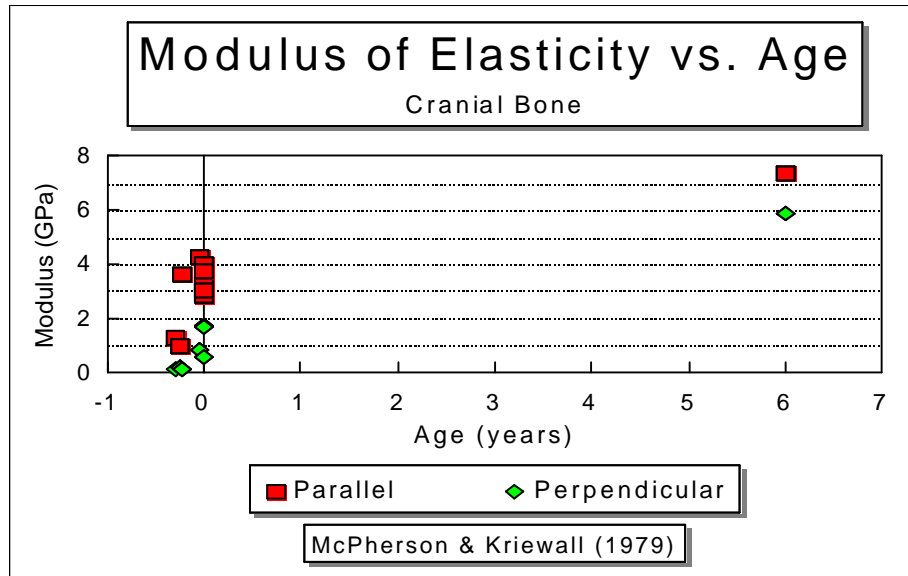

Figure 3 -- Modulus of elasticity vs. Age for cranial bone

Yamada (1970) reports ultimate strength and ultimate elongation tensile properties of tendons according to age, as seen in Table 1. The stress-strain curve for the 20-29-year-old's is included in the reference, and the ultimate stiffness estimated from the curve. The technique for deriving the remaining ultimate stiffnesses follows Melvin's approach. The stiffness ratio to adult value was determined by dividing the strength ratio by the elongation ratio. The stiffnesses are then calculated by multiplying the derived stiffness ratio to the 20-29-year-old value.

Age	Ultimate Strength		Ultimate Elongation		Derived Ultimate Stiffness	
	kg/mm ²	ratio to adult value	%	ratio to adult value	kg/mm ²	ratio to adult value
Birth	3.5	.63	12.9	1.30	45.3	.48
0-9	5.3	.95	11.0	1.11	81.1	.86
10-19	5.6	1.0	10.0	1.01	93.4	.99
20-29	5.6	1.0	9.9	1.00	94.3	1.0

2.3 Epidemiology of Child Automotive Injuries

A review of the injuries received by children in automotive accidents will help show which dummy measurements may be most relevant. Overall, the variety of sources summarized in Beusenberg et al. (1993) indicate that the head is the most frequently injured body region for restrained and unrestrained children. Since skull and brain injuries are the leading cause of severely or fatally injured children in automotive accidents, the head may be the body region that requires the most attention.

The most recent detailed analysis of child injury patterns was conducted by Klinich et al. (1993, 1994). They used the 1988-1991 NASS database to extract information regarding the injury patterns of children in automotive accidents. The main goal of this work was to compare the injuries incurred by older (ages 6-12) and younger (ages 0-5) children. Impact direction (frontal, side, rollover) was not considered in this study; none of these results involved children injured by air bags. The NASS weighting factors were applied in the analysis of the data. Because injury patterns are strongly affected by restraint type, the distribution of restraint use for older and younger children appears in Table 2.

Table 2 -- Restraint Use of Children in 1988-1991 NASS		
Restraint	Younger (0-5)	Older (6-12)
Unrestrained	25.7%	38.6%
Lap Belt Only	19.8%	26.9%
Lap/Shoulder Belt	9.9%	26.5%
Other Belt	2.0%	2.5%
Child Restraint	34.6%	0.3%
Unknown	8.0%	5.1%

Table 3 contains data regarding the most severe AIS score received by the children in the NASS database. The distributions are broken out by restrained and unrestrained older and younger children. Overall, the majority of children (58.5%) in accidents receive no injuries, and 35.1% have a maximum AIS of 1. Only 1.2% of all children received more severe injuries (MAIS 3-6).

Focusing now on the injuries, the body region that received each injury is shown in Table 4. All levels of injury severity are included. Again, the data are subdivided into injuries to older and younger restrained and unrestrained children. Across all categories, the face is the most frequently injured body region. The head, pelvis/abdomen, and lower extremities follow in injury frequency.

The thorax, upper extremities and neck are the body regions in children that receive the fewest injuries. About three-fourths of all injuries received by children are to the skin. Correspondingly, contusions, lacerations, and abrasions make up the majority of injuries received by children.

Table 3 -- MAIS Scores of Children in 1988-1991 NASS					
MAIS	Younger (0-5) Restrained	Younger (0-5) Unrestrained	Older (6-12) Restrained	Older (6-12) Unrestrained	Total
0	70.8%	44.6%	62.8%	36.7%	58.5%
1	24.8%	45.3%	31.1%	55.2%	35.1%
2	1.2%	3.5%	2.8%	3.6%	2.4%
3	0.5%	1.2%	0.5%	1.5%	0.8%
4	0.2%	0.3%	0.1%	0.2%	0.2%
5	0.0%	0.2%	0.1%	0.2%	0.1%
6	0.1%	0.2%	0.0%	0.1%	0.1%
7	2.4%	4.6%	2.5%	2.6%	2.8%

Table 4 -- Body Region Injured for Child Injuries in 1988-1991 NASS					
Body Region	Younger (0-5) Restrained	Younger (0-5) Unrestrained	Older (6-12) Restrained	Older (6-12) Unrestrained	Total
Head	12.7%	13.3%	11.3%	12.5%	12.5%
Face	39.7%	47.0%	40.0%	42.5%	42.6%
Neck	4.0%	2.2%	7.5%	4.6%	4.4%
Thorax	8.3%	6.1%	9.3%	7.8%	7.7%
Pelvis/Abdomen	20.6%	13.5%	11.0%	5.2%	11.5%
Whole Body	2.7%	2.9%	1.2%	3.1%	2.6%
Lower Extremities	6.6%	9.0%	13.7%	15.0%	11.5%
Upper Extremities	5.1%	5.2%	5.9%	8.9%	6.6%
Unknown	0.3%	0.8%	0.1%	0.4%	0.4%

A subset of children of particular interest, identified by the NHTSA's crash investigation programs, are those who may have incurred injuries from deploying passenger side air bags. These "out-of-position" children fall into two categories: infants restrained in rear-facing child seats placed in the front passenger seat, and unrestrained (or improperly restrained) older children who appear to be positioned too close to the passenger dash board during air bag deployment. This second configuration seems to occur most frequently when a child is unbelted in the front passenger seat and the driver brakes suddenly to avoid an accident. It is hypothesized that during braking, the child moves toward the dashboard, and becomes located directly in front of the air bag when impact occurs and the air bag deploys. Because these child occupants make up only a small portion of children involved in accidents, but tend to suffer injuries more severe than expected for a given crash severity, a special study of these children has been implemented.

Several cases of infants in rear-facing child restraints in front of deploying air bags have produced skull fractures and associated brain injuries. For the older children, the injuries may result in a combination of head and neck injuries. Basilar skull fractures and C1/C2 vertebral fractures appear to be associated with injuries to the brain stem and proximal spinal cord. Dislocation at the head-neck junction (OC-C1) may lead to transection of the spinal cord. One additional mechanism of injury with older unrestrained children is that under certain conditions, the air bag contacts the child and may lift them up to the roof area; in case of head contact, this interaction could result in skull fractures and associated brain injuries.

When reviewing all of the literature regarding automotive injuries in children, child seats are found to be highly effective at preventing injury. From these data, one might assume that measurements made with child dummies properly restrained in child seats could be considered “safe” levels and give guidance for developing realistic PRV for frontal impact situations.

To investigate more closely how children are injured in real crashes of severities near 48 kph, all of the NASS cases involving restrained occupants under 13 years of age were extracted for the years 1988-1994. Cases with recorded velocities between 40 and 56 kph were selected, and a description of their injuries retrieved. Direction of impact was not considered, although a check of the AIS 3+ cases indicated that they were all frontal impacts. Of the 50 cases that met the criteria, 17 were in child seats, 21 used a lap belt, and 12 used a 3-point belt. Their maximum AIS scores are summarized in Table 5. Since the crash pulses in these accidents would likely be softer than those in laboratory tests, one could speculate from the data of Table 5 that the measurements taken in such tests might indicate less than 8% chance of serious (AIS 3-6) injury for children. However, this quick check of the NASS cases has not been shown to be statistically valid, and should be considered an extremely rough guideline.

Table 5 -- Restrained Children in 40-56 kph NASS Crashes 1988-1994		
MAIS	Number	Percent
0	7	14%
1	26	52%
2	8	16%
3	2	4%
4	1	2%
5	0	0%
6	1	2%
Unknown	5	10%

2.4 Child Anthropomorphic Test Devices (Crash Test Dummies)

Because some techniques of developing PRV employ testing with crash dummies, and they all have differing degrees of biofidelity and measurement capabilities, a review of the various child dummies is included as background. Dummy drawings are taken from TNO dummy manuals and the First Technology Safety Systems catalog.

2.4.1 Infant Dummies

Two sizes of CAMI (originally developed at the Civil Aeromedical Institute, now the FAA) dummies are available. They approximate newborns and six-month-old infants in size, shape, and mass but not necessarily in response. They are specified in CFR 49 Part 572 and in FMVSS No. 213 for testing child restraints intended for infants. The dummies' structures have a weighted leather skeleton, padded flesh, and canvas skin. No instrumentation is available.

The CRABI (Child Restraint/ Air Bag Interaction) infant dummies model six-, twelve, and eighteen-month-old children. They were designed to study child restraint/air bag interaction (CRABI) impact conditions. As seen in Figure 4, the design style of the dummies somewhat resembles the Hybrid III 50th percentile adult male dummy, and includes some of the skeletal structures. Measurement capabilities include triaxial head, chest, and pelvis accelerometers; head angular acceleration; and upper neck, lower neck, and lumbar spine forces and moments.

TNO has two infant dummies, the P0 and P3/4, which represent newborns and 9-month-old children, respectively. The P0 construction consists of a sorbothane structure with a steel spring spine that has provisions for mounting a head triaxial accelerometer. An exploded view of the P3/4 structure appears in Figure 5. Most of the structures are made of polyurethane rubber. Triaxial head and chest measurements are possible. In addition, a 3-channel neck load cell has been designed for the P3/4.

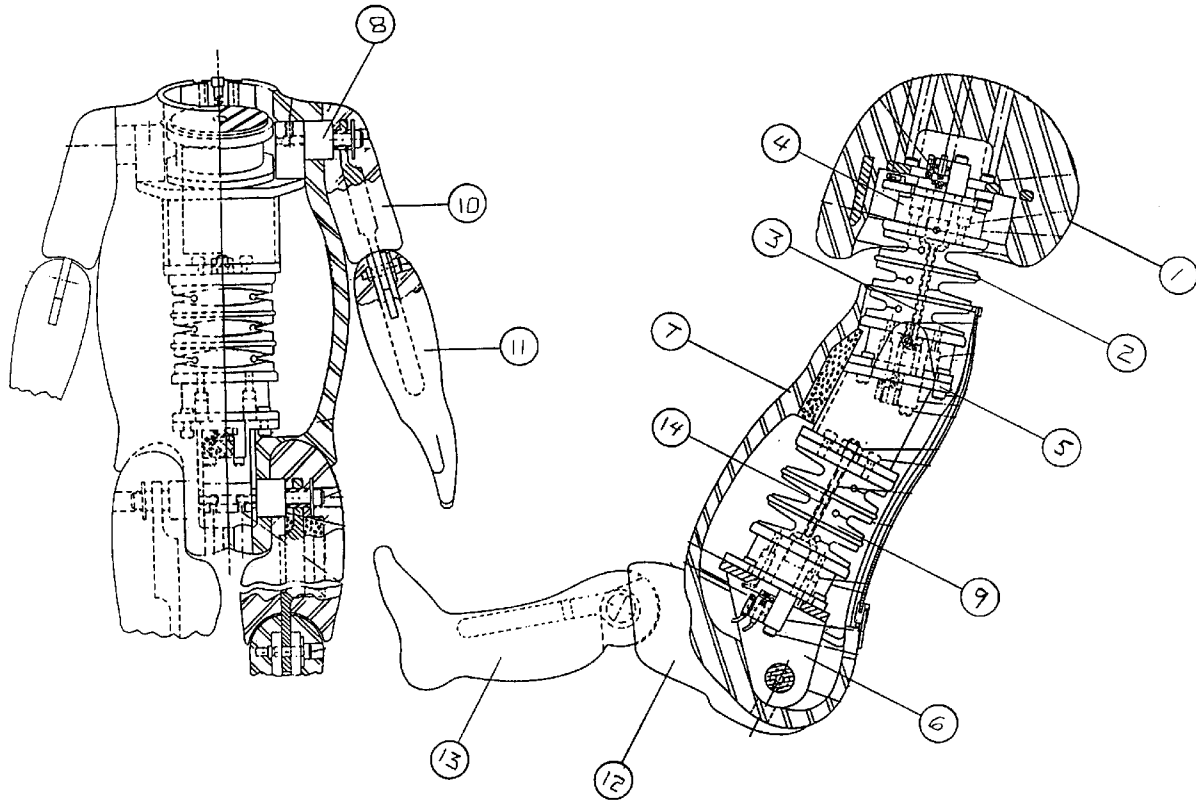

**Six-Month-Old "CRABI"
Item Reference Diagram**
(For Reference Use Only - Not to Scale)

ST-15

May 1, 1993
reldia: REV 5/93

**FIRST TECHNOLOGY
SAFETY SYSTEMS, INC.**

Figure 4 -- CRABI Six-Month-Old (FTSS)

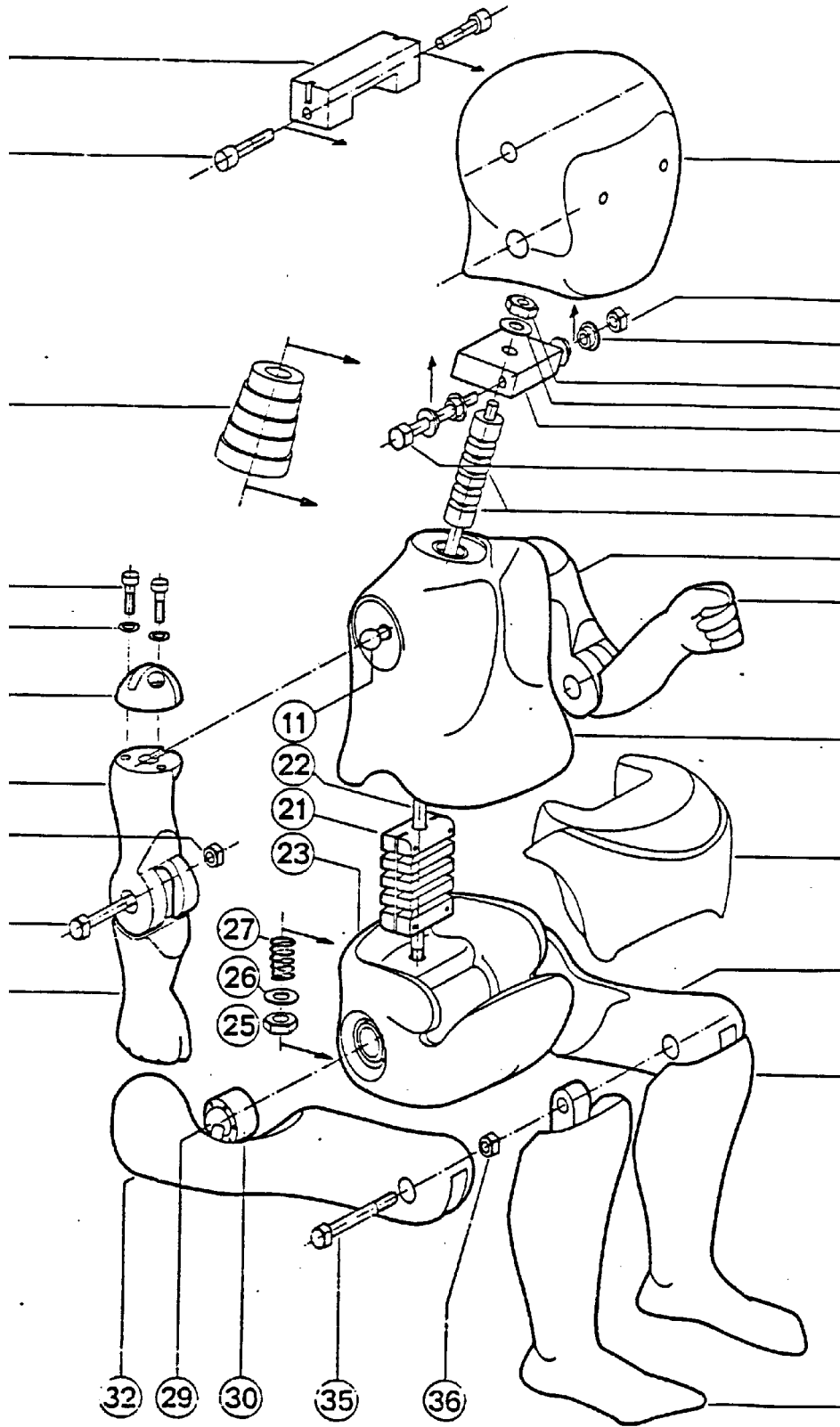

Figure 5 -- TNO dummy structure

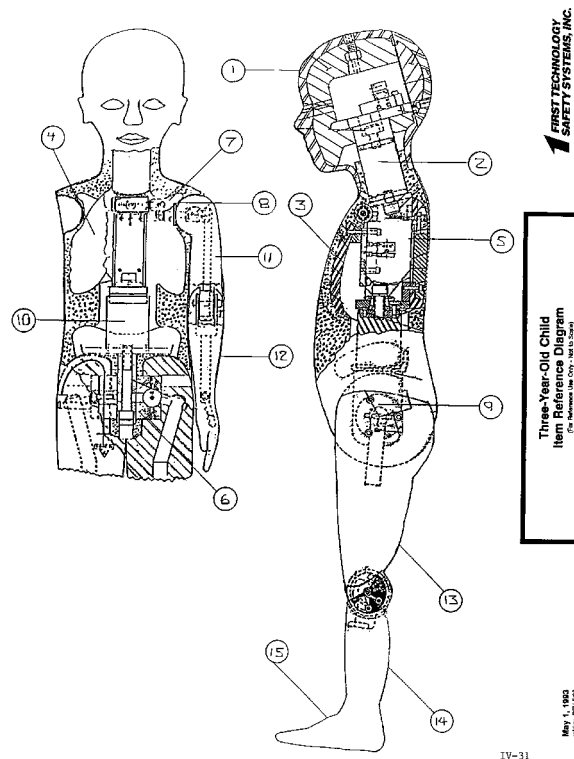

Figure 6 -- Part 572 3YO

2.4.2 Three-Year-Old Dummies

Many different three-year-old size dummies have been developed. One of the earliest was the Alderson Research Laboratories VIP-3C. This dummy, with slight modifications, became the CFR 49 Part 572 three-year-old dummy, shown in Figure 6. The most significant change from the VIP-3C was in the head, which was switched from a urethane to a fiberglass skull. This dummy is also available in an updated version, with improved anthropometry and a Hybrid III style neck with an upper neck load cell, which is known as the CRABI 3-year-old or the 3-year-old with an “air bag neck”. All versions can use triaxial head and chest accelerometers.

Another dummy in this size range is known as the General Motors instrumented three-year-old, described by Wolanin et al. (1982). General Motors specifically developed this dummy for testing passenger air bag interaction with out-of-position children. It began with an Alderson VIP-3C dummy and made the following changes in a two-phase program:

- 1) Adding an upper neck load cell and a more human-like neck (defined by scaling adult neck moment-angle corridors)
- 2) Adding additional head accelerometers to measure angular acceleration
- 3) Adding an array of surface-mounted torso masses and accelerometers to measure air bag onset forces
- 4) Modifying the spine and torso construction to account for the extra torso masses
- 5) Changing the head to an aluminum/urethane structure with more biofidelic characteristics.

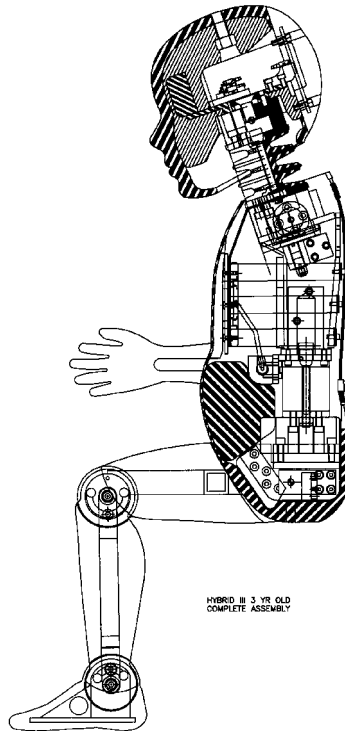

Figure 7 -- Hybrid III 3YO

Instrumentation consisted of head, upper spine, and lower spine triaxial accelerometers; two extra head accelerometers, a four-axis upper neck load cell, and nine surface-mounted torso accelerometers. A later change made (because of ringing problems in the head) substituted a modified VIP-6C head. This design also became known as the three-year-old air bag dummy.

The most recent permutation of this size of dummy is known as the Hybrid III three-year-old. It is still in the prototype stage. Pictured in Figure 7, it follows the design style of the Hybrid III adult dummies. However, some of the instrumentation features of the GM instrumented dummy, such as upper and lower triaxial spine accelerations and surface-mounted torso accelerometers, have been incorporated so it can be used to study the out-of-position child. Besides the standard head, chest, and pelvis triaxial accelerometers found in Hybrid III style dummies, the dummy has provisions for mounting load cells in the upper and lower neck, shoulders, lumbar spine, pubis, acetabulum, and iliac spines, most intended for measuring loads from child seat harness straps.

TNO also has a three-year-old dummy, P3. Its structure and instrumentation capabilities are essentially the same as those as the P3/4. However, a recent option includes a different neck to allow incorporation of an upper neck load cell.

2.4.3 Six-Year-Old Dummies

The oldest six-year-old dummy referred to in this report was made by Alderson Research Laboratories and known as the VIP-6C. It has the same structural design as the VIP-3C discussed earlier. The next evolution of this size of dummy was a scaled down version of the Hybrid II 50th percentile male dummy. This style was adopted in CFR 49 Part 572 for use in testing safety restraints for older children, and is pictured in Figure 8. Standard instrumentation includes triaxial head and chest accelerometers, plus uniaxial femur load cells in each leg. Optional instrumentation includes triaxial pelvis accelerometers, uniaxial ankle accelerometers, and a modified neck that allows insertion of an upper neck load cell without changing head/neck response.

The latest six-year-old dummy is a scaled down version of the Hybrid III 50th percentile male dummy, shown in Figure 9. Instrumentation consists of triaxial head, chest, and pelvis accelerometers; upper neck, lower neck, lumbar spine, and femur load cells; and chest deflection.

TNO also manufactures a six-year-old dummy, with structure and instrumentation capabilities the same as the P3.

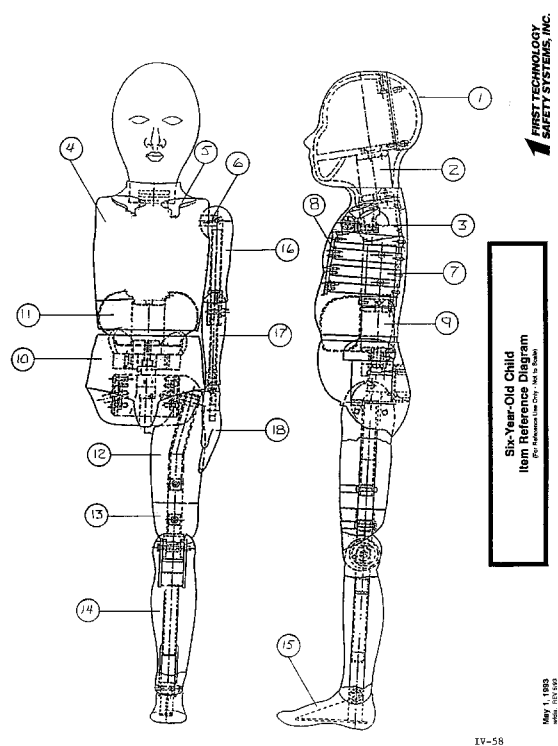
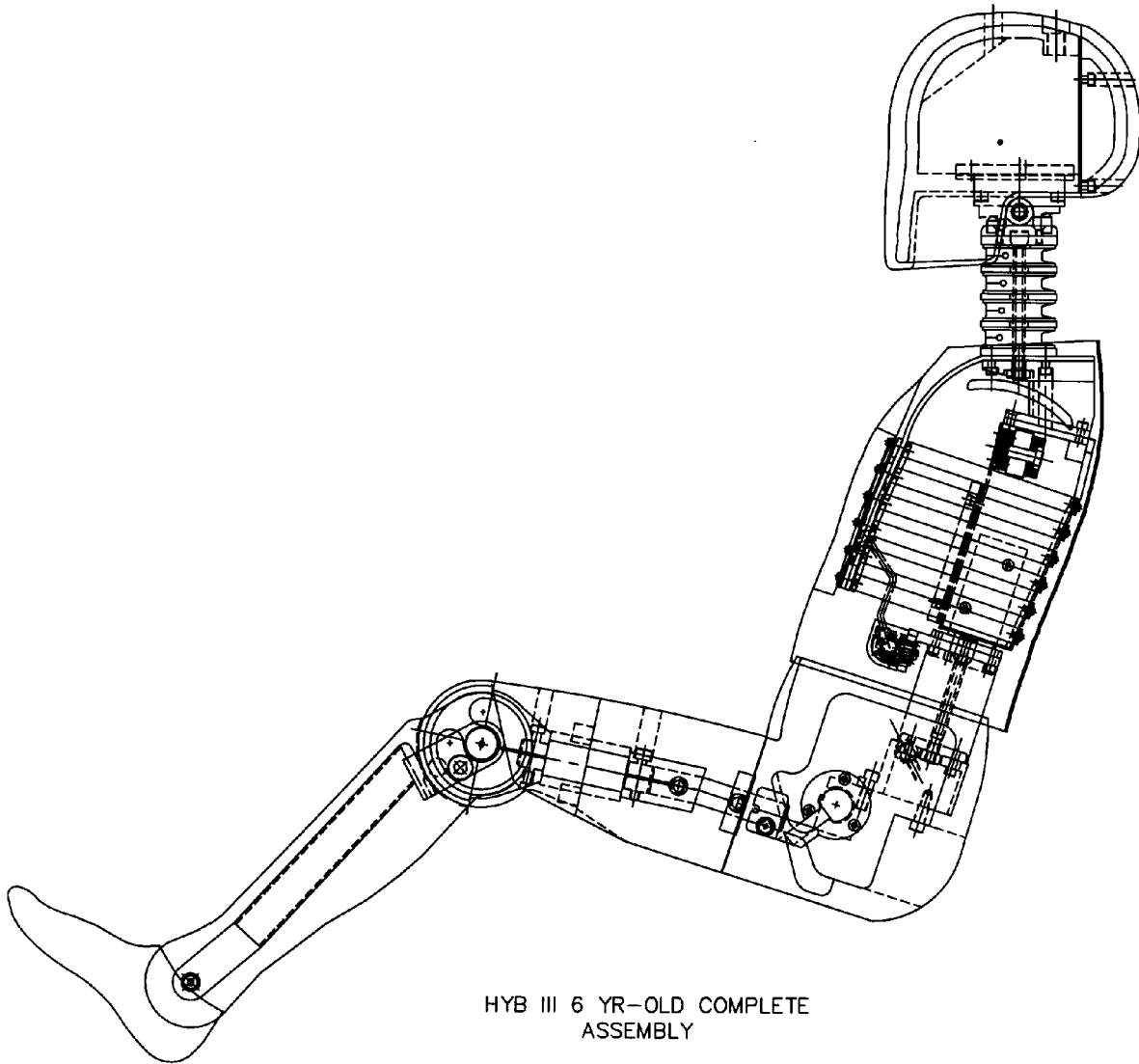

Figure 8 -- Part 572 6YO



HYB III 6 YR-OLD COMPLETE
ASSEMBLY

Figure 9 -- Hybrid III 6YO

3.0 APPROACHES FOR DEVELOPING INJURY CRITERIA AND PROTECTION REFERENCE VALUES

Several techniques for estimating injury criteria have been developed. The first is through volunteer testing. Human volunteers are instrumented and subjected to impact forces. The injuries, or lack of injuries, are correlated to the measurements taken. To avoid injuring the volunteers, or to limit them only to minor injuries, the measurements taken indicate a threshold of reversible injury. Information on the forces required to cause more severe injuries is generally not available through volunteer testing. This technique has some additional drawbacks. Inaccuracies may result from affixing the instrumentation so it does not injure the volunteer, which may lead to less reliable data. Individual differences among volunteers also lead to difficulties in determining injury thresholds for the average population. The effects of muscle tension and involuntary reactions are also difficult to ascertain. Results may have a bias since the majority of volunteer tests have been run on military personnel, who do not necessarily represent the average population.

The next technique for determining human injury response is through cadaver testing. Cadavers are instrumented and subjected to impact forces. Autopsies show the injuries incurred, which researchers attempt to correlate with the measurements. Problems exist with this technique as well. Available subjects are generally older and of more depreciated physiomy than the average population, which may not give an average response. Subjects are also in short supply. The cadaver response depends on the way it was handled (frozen, embalmed, fresh, etc.). Unless special techniques are used to simulate muscle tension, the effects from musculature are absent. Signs of injury on a living subject (pain, loss of consciousness) are not available from cadavers either.

Another technique involves using animal surrogates to estimate human response characteristics. Past research has typically used primates and pigs to study automotive injury. The biggest draw-back of these techniques is how to translate the animal's anatomy and injuries into human injury criteria. However, using anesthetized animals can provide more information on how injury and vital signs are related.

Yet another technique for developing injury criteria is through accident reconstruction. This technique in some ways is more useful for developing protection reference values, although some insight into injury tolerances may be gained. If the conditions of an accident are well recorded, and the victim's injuries are documented, accidents can be reconstructed with anthropomorphic test devices. The measurements taken from the dummies can be paired with the recorded injuries (or lack of injuries) from the victim. Judging whether a researcher has

truly reproduced an accident is a somewhat subjective process. Another complication is that dummies are not perfectly biofidelic, and can only be used to approximate occupant response. Because dummies have different degrees of biofidelity, PRV developed through reconstructions may not necessarily apply to humans, and may apply only to the dummy used in the reconstruction.

A variation of the reconstruction technique uses computer models rather than dummy simulations to reproduce a well-documented accident. Again, the reliability of the procedure is limited by how well the computer simulation mimics the victim's characteristics. While improving, human models still suffer from the minimal amount of biomechanical data available to create computer simulations. A possible advantage of using computer models rather than dummies allows matching the accident victim's physical characteristics more closely.

Combinations of these techniques have led to development of injury criteria for adults and protection reference values for 50th percentile adult male dummies. Most researchers agree that more data would be beneficial, and that both the injury and PRV could be improved and refined. Developing injury criteria for children and PRV for child dummies poses additional challenges. For various reasons, volunteer impact testing on children is not an option. Previous cadaver testing of child subjects has also raised ethical objections, making subjects extremely rare. Only eleven cadaver tests on children have ever been reported (Brun-Cassan et al., 1993). Though controversial, animal testing offers a bit more information, since most of the animals used are actually closer in size to children than adults. However, differences in anatomy still exist and must be accounted for. Reconstruction of accidents is one of the more viable approaches for child injury assessment. However, since biomechanical data on children are scarce, the child dummies generally have even less human-like characteristics than adult dummies, which makes accurate reconstructions a problem. Computer models of children have similar drawbacks.

An additional technique which can be applied to developing injury criteria or PRV for children is scaling adult data. Using geometry, mass, and biomechanical material property ratios, PRV for the smaller dummies can be estimated by scaling adult values with dimensional analysis (Melvin, 1995). This technique assumes geometrical similitude and rigid body characteristics, both which become less appropriate as child size decreases because of the anthropometric differences in children. The scarcity of biomechanical property information as a function of age also requires some approximations. This technique has been used to develop design specifications for constructing the smaller dummies (Mertz et al., 1989; Irwin, 1993).

A point of caution regarding PRV development should be noted. Dummy measurements and the estimates of injury probability from corresponding PRV should be checked against real world accident statistics. For example, if a PRV predicts high probability of neck injury for a given loading condition, yet no neck injuries are seen in the field under these conditions, the PRV may not be appropriate.

The following sections summarize the different approaches of developing injury criteria and PRV as they have been applied to children. As mentioned previously, no volunteer tests have been conducted on children.

3.1 Cadaver Testing

All of the child cadaver impact tests reported are summarized by Brun-Cassan et al. (1993). Their summary discusses eight tests from the University of Heidelberg (Kallieris 1976, Brun-Cassan et al. 1993), two tests by APR (Dejeammes 1984), and one test by HSRI (Wismans 1979). Table 6 lists the pertinent information about each test subject, while Table 7 summarizes the test conditions. All of the tests simulated frontal impact conditions without air bags.

The limited amount of instrumentation on the cadavers makes injury criteria recommendations speculative. Qualitatively, head tolerance is apparently higher for children than for adults. Conservative thoracic deceleration levels were approximated to be 50 to 80 g.

Table 6 -- Child Cadaver Test Subject Summary					
Test #	Age (yr)	Sex	Weight (kg)	Height (cm)	Instrumentation
HD36-75	2.5	M	16	97	none
HD38-75	6	F	27	125	none
HD39-75	6	M	30	124	3 head accelerometers
HD41-75	11	M	31	139	3 head accelerometers
HD89-12	2.5	F	17	91	4 head accelerometers
HD5	10	M	39	139	
HD8	13	M	39	162	9 head, 3 spine, 1 sacral accelerometers
HD9	12	F	52	144	none
APR1	2	F	13	87	6 head, 3 spine, 1 sacral accelerometer
APR2	2	F	13	87	6 head, 3 spine, 1 sacral accelerometer
HSRI	6	M	17	109	9 head, 3 spine accelerometers

Table 7 -- Child Cadaver Test Conditions Summary				
Test #	Velocity (km/h)	Average Decel. (g)	Restraint System	Comparable tests run with...
HD36-75	31	18	Romer Vario	CRABI 3-year-old, TNO P3
HD38-75	40	20	Romer Vario	
HD39-75	40	21	Romer Vario	Alderson VIP-6C
HD41-75	40	21	Romer Vario	Alderson VIP-6C
HD89-12	49.4	17.8	Romer Peggy	CRABI 3-year-old, TNO P3
HD5	46	15	4-pt harness CRS	
HD8	49	15	3-pt belt	
HD9	49	25	3-pt belt	
APR1	48	13	Integral 2	
APR2	50	13	Tot Guard	
HSRI	48	20	5-pt harness CRS (Strolee Wee Care)	3-year-old Part 572 and TNO dummies

The Heidelberg sled tests with the Romer Vario were originally run with both cadavers and the VIP-6C dummies. Two tests were later run with more modern dummies: the TNO P3, and CRABI 3-year-old. Kinematic comparison between the Heidelberg cadavers and VIP-6C child dummies indicated that the cadaver spines were considerably more flexible relative to the dummy motion (90° bending angle at the thoracic-lumbar boundary compared to a 25° for the Alderson VIP-6C dummy). However, movements of the head, neck and shoulder were very close. Head deceleration forces showed good agreement. With the tests run with the more modern dummies (TNO P3 and CRABI 3-year-old), the head trajectories of both dummies seemed reasonable compared to the cadavers in the Romer Vario seat, especially when the height difference between cadaver and dummies is considered. In the Romer Peggy restraint, the cadaver had greater head excursions. Comparing the cadaver neck injuries with the measured axial neck loads indicates that a suggested limit of 1000 N for three-year-old dummies as the threshold for injury may be reasonable. The modern dummies' thoracic resultant accelerations remained below 45 g, which correspond with no injuries in the cadaver tests. The peak head resultants between the two dummies were quite different, so correlations between the measurements and lack of injuries were not suggested.

In the HSRI test, one sled test was run with the cadaver and a 3-year-old Part 572 dummy. The test was then repeated with the Part 572 and TNO dummies in the same configuration. The HSRI test had similar peak acceleration responses between the Part 572 dummy and cadaver, although the pulse shapes showed some differences. The HIC values were nearly identical. Kinematically, the cadaver had more motion of the head and upper torso. In the subsequent tests with the two dummies, the TNO P3 had more spine deformation and downward head excursion. Horizontal head and hip excursions were the same for both dummies. The P3 accelerations were all slightly higher than those measured in the Part 572 dummy. Overall, the Part 572 measured data matched the cadaver better, but the TNO P3 kinematics matched the cadaver visually.

Though some measurements were taken in the remaining cadaver tests, the authors did not think them sufficient to suggest any type of injury criteria. Since no dummies were tested in the same configurations, corresponding dummy measurements are not available either.

Although no other impact tests of child cadavers have been run, an 1874 study by Duncan (reported in Melvin 1995) on stillborn infants offers some insight into neck tolerance from direct loading. The goal of the study was to provide guidance to physicians on how hard they could pull in a breech birth without causing neck injury. Four stillborn infants, and one who died two weeks after birth, were statically loaded until their cervical spines failed. Average failure load was 507 N. This number represents a high probability of neck fracture for static loading in real infants. However, since child dummies generally have poor neck biofidelity, this injury criteria cannot necessarily be considered a protection reference value.

3.2 Surrogate Testing

Several programs for determining adult tolerance levels have tested primates in impact conditions and scaled the subsequent injury criteria estimates to match human adults using mass and size ratios. Since this procedure neglects interspecies differences, scaling to child levels should be possible too. One objection to this might be that a fully formed primate skull cannot be scaled to a partially ossified infant skull. However, since this problem is true when scaling any adult data (human or primate) to children, it should be noted but not necessarily eliminated as entirely invalid.

A major area of this type of research deals with human tolerance to head angular acceleration. Researchers have found that diffuse axonal injury (DAI) of the brain corresponds to rotational acceleration. DAI ranges from concussion to coma and can occur without head impact. Ommaya et al. (1967, 1971) has performed numerous studies on primates to determine threshold levels of angular acceleration and velocity. Results from these studies were then scaled to create an injury threshold curve for an adult human. This is shown in Figure 10 (Fig. 4, p. 263 from Ommaya's Biomechanics of Head Injury paper).

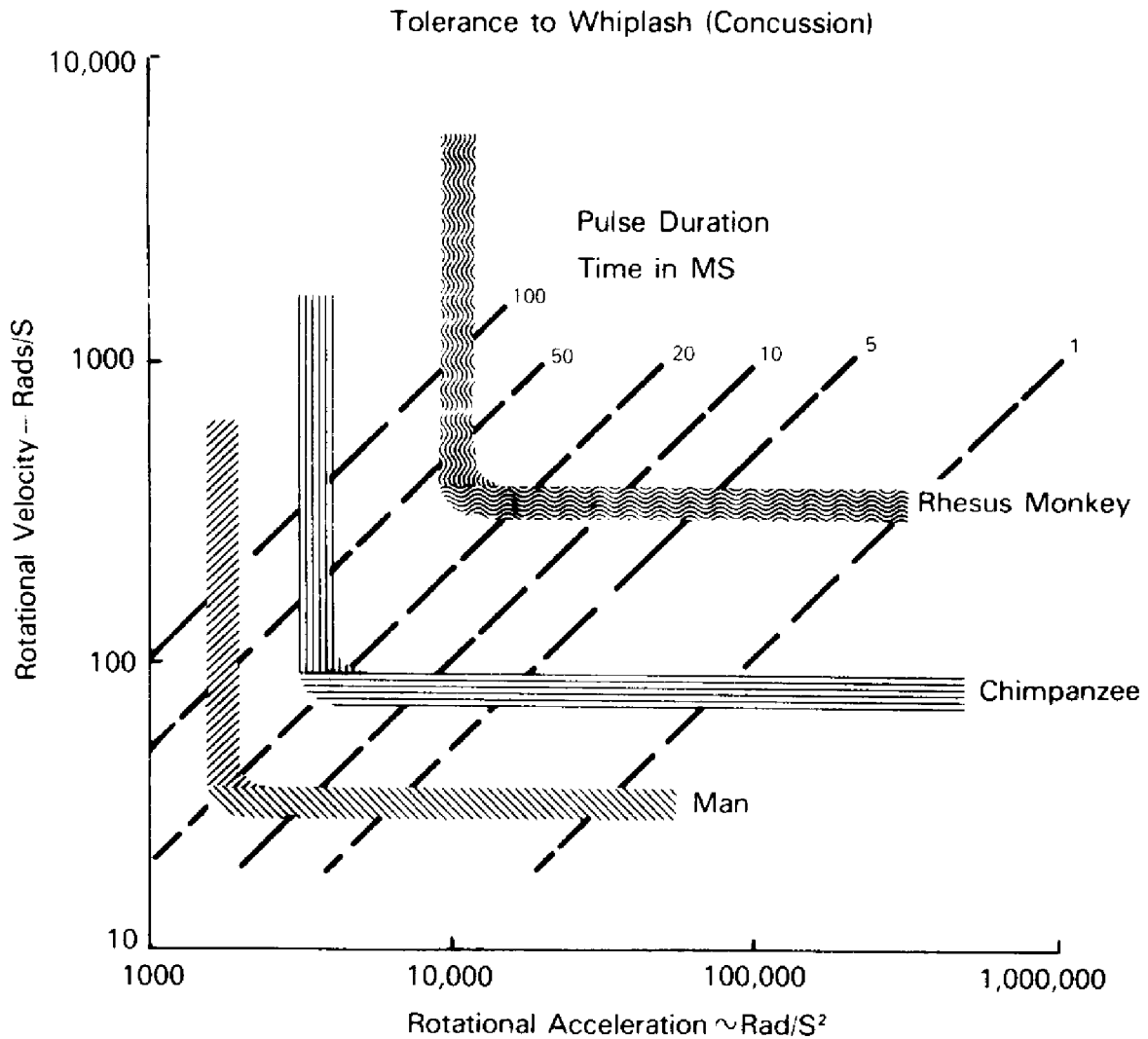

Figure 10 -- Theoretical scaling of rotational velocity and acceleration for 50 percent probability of onset of cerebral concussion from subhuman primates to humans

From this, Ommaya et al. (1985) developed these recommendations for rotational head injury criteria (AIS levels below 3) for adults:

- If $\dot{\theta} < 30$ rad/sec, then $\ddot{\theta}$ must remain below 4500 rad/sec²
- If $\dot{\theta} \geq 30$ rad/sec, then $\ddot{\theta}$ must remain below 1700 rad/sec²

Scaling laws for angular acceleration and velocity are given below,

$$\ddot{\theta}_m = \ddot{\theta}_p * (1/\lambda_M)^{2/3}$$

$$\dot{\theta}_m = \dot{\theta}_p * (1/\lambda_L)$$

where λ_M = head mass scaling ratio and λ_L = head length scaling ratio. Using these scaling laws and the scale factors presented in Table 8, injury threshold criteria were calculated for 6, 3, and 1 year old children. These criteria are also included in Table 8.

Table 8 -- Ommaya Head Angular Injury Criteria, Scaled				
	Head Mass Scaling Ratio λ_M	Head Length Scaling Ratio λ_L	Angular Velocity Limit (rad/sec)	Angular Acceleration Limit (rad/sec ²)
Adults	1.000	1.00	> = 30	< 1700
6-year-old	0.725	0.90	> = 33	< 2106
3-year-old	0.655	0.87	> = 34	< 2255
12-month-old	0.553	0.81	> = 37	< 2524

Sturtz (1980) scaled an earlier formulation of this criteria using Ommaya's formula and brain masses of 1.09 and 1.26 kg for 3- and 6-year-old children, respectively. The earlier version set levels of 50% probability of brain injury for different durations of angular acceleration for impact and non-impact conditions. Results of Ommaya's earlier criteria and Sturtz's scaling appear in Table 9.

Table 9 -- Sturtz Scaled Angular Acceleration Tolerances (r/s²)					
Duration	Impact	Rhesus Monkey	Adults	6-Year-Old	3-Year-Old
10 ms	Indirect	40,000	7020	7390	8140
3 ms	Indirect	400,000	70200	73900	81400
10 ms	Direct	11,000	1732	1823	2008
3 ms	Direct	50,000	7900	8300	9100

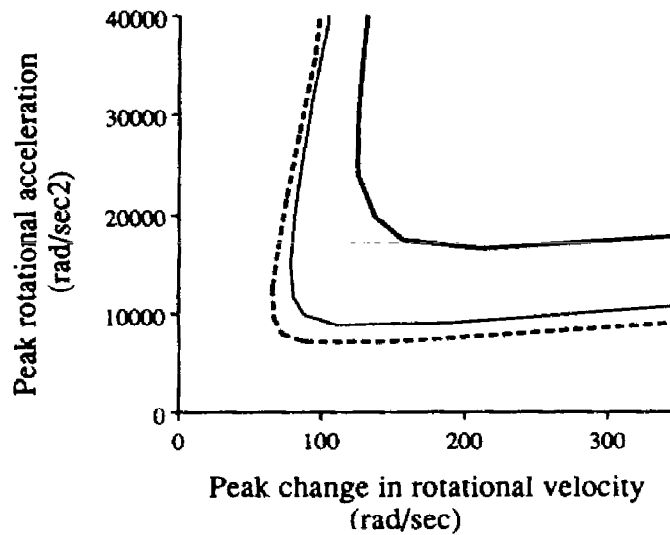

Fig. 6. DAI thresholds for a range of human brain masses. DAI tolerances for infant (500 g brain mass, heavy solid line) and adult (1067 g, solid line; 1400 g, dashed line).

Figure 11 --Proposed DAI injury criteria

Margulies and Thibault (1991) have also conducted extensive studies on associating DAI with rotational acceleration and velocity measurements. They used primate tests, physical models, and analytical models to determine a critical strain for injury. They then employed human physical and analytical models to simulate generation of the critical strain to come up with a human tolerance criterion for DAI. Their proposed DAI thresholds for different head masses appears in Figure 11.

Mertz et al. (1982) conducted surrogate tests to specifically develop tolerance data for out-of-position children being struck by deploying passenger side air bags. They used anesthetized pigs and baboons placed in typical out-of-position configurations, and conditions were adjusted to give a wide range of injury severities. The tests were then duplicated with a GM 3-year-old instrumented dummy. The injury severities for different body regions received by the animals were plotted against the corresponding dummy response measurements. Based on these tests, the PRV for this dummy under these conditions were recommended to be the following:

Prasad and Daniel (1984) conducted a surrogate test program very similar to that described by Mertz et al. They include the data from the Mertz tests in their analysis. In general, they concur with the criteria in Table 10, but recommend a combined neck tension/neck moment limit rather than just the neck tension. Their recommended PRV is pictured in Figure 12. From these tests, they also found that 29 Nm may be appropriate for a limiting extension moment.

Table 10 -- Injury-Assessment Reference Values from Mertz et. al (1982)				
Body Region	Parameters	Risk of Serious Injury		
		1%	10%	25%
Head	HIC (15 ms)	1480	1530	1570
Neck	Axial tension (N)	1060	1125	1160
Thorax	Upper spine acceleration (g)	55	59	62
	Upper and midsternal delta V (km/h)	9	16	19
Abdomen	Lower spine acceleration (g)	34	42	45
	Lower sternal delta V (km/h)	19.5	19.9	20.4

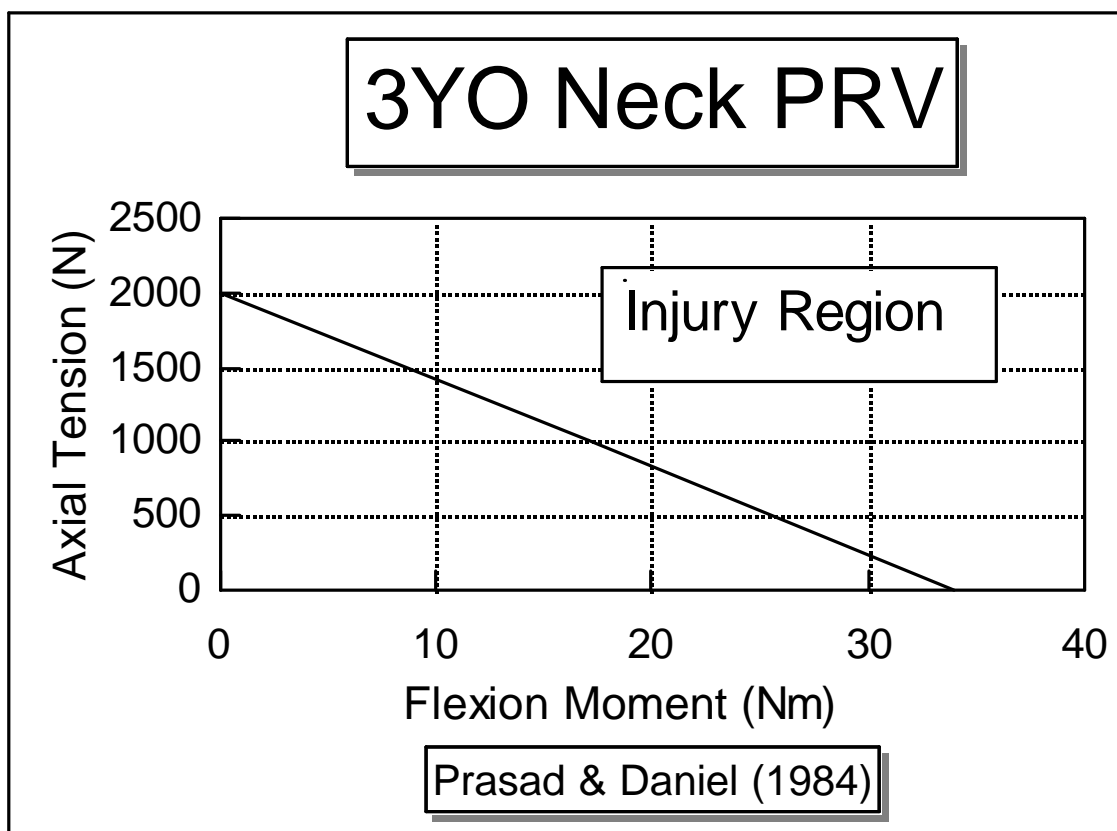

Figure 12 -- Prasad & Daniel proposed neck protection reference value for three-year-old's

3.3 Accident Reconstructions

Planath et al. (1992) performed a synthesis of literature review, scaling and reconstruction to come up with protection reference values for 3-year-old size dummies. Two accidents were reconstructed that had severe neck and head injuries. Since their accident reporting team has not recorded any severe neck injuries to children seated in rearward child restraints, they also tested a generic accident condition without injury for comparison. Table 11 lists the characteristics of each accident.

Table 11 -- Planath et al. Selected Cases				
Test No.	Age	Restraint	Delta V	Injury
Case 1	19 months	forward 4-pt harness CRS	40 km/hr	C1-C2 separation macerated spinal cord
Case 2	15 months	forward 4-pt harness CRS	55 km/hr	brain contusion without skull fracture
“Case 3”		rearward CRS	50 km/hr	no severe neck injuries reported in the field

A Part 572 3-year-old dummy with a substituted 3-year-old air bag dummy neck was used for the reconstructions. This allowed measurements of x and z neck forces and moments about the y-axis. Three tests were run under each condition. The results for the reconstruction are reported in Table 12. The results of these tests, coupled with literature review of other sources, led the authors to suggest neck PRV for three-year-old dummies at 1000 N axial tension, 300 N shear force, and 30 Nm flexion bending moment.

Table 12 -- Planath et al. Reconstruction Data					
	Case 1		Case 2		Case 3
	Mean	std	Mean	std	Mean
Delta V (km/h)	40		50		50
HIC (36 ms)	319	79	809	58	
Chest resultant (g)	50	1.5	54	1.0	
Upper neck shear force (N)	370	60	280	60	+208 -70
Upper neck tension force (N)	1150	40	2570	16	201
Upper neck compression force (N)					404
Upper neck y moment (Nm)	31	1.51	33	1.53	14 flex 23 ext

Newman and Dalmotas (1993) studied two cases in which four girls were killed from spinal cord transection injuries while restrained in lap belts in the rear seat of a minivan. The equivalent barrier velocities for the two crashes were estimated to be 40-50 and 35-45 km/hr. The details of their severe injuries appear in Table 13.

Table 13 -- Severe Injuries from Newman & Dalmotas Reconstruction Cases											
#	Age (yr)	Ht. (cm)	Diffuse Edema	Basal Hemo-rrhage	Brain stem trauma	C1 fracture dislocation	Spinal cord transection	Lower neck fracture	Hemo-thorax	Hydro-thorax	Internal abdomen contusion
1a	2	86	x	x		x	x	x	x	x	x
1b	4	99	x	x		x	x	x	x	x	x
1c	6	112	x		x	x	x		x	x	x
2	5	114		x	x	x	x		x		x

In addition to trying to replicate the accident conditions, they tested several other restraint conditions to learn the difference in dummy response between injury producing and non-injury producing cases. A modified 6-year-old Part 572 dummy was used in the tests. The dummy was equipped with a different neck that allowed use of a six-axis upper neck load cell. Triaxial head and chest accelerations were also recorded. The test was reconstructed first with an actual crash test, then through several sled tests that varied the restraint conditions. The results appear in Table 14. The values do not clearly differentiate between the different systems, indicating that three- or four-point belts would appear to offer the same levels of protection as just a lap belt. Since both intuition and field data do not support this finding, it suggests that this dummy and instrumentation may not be sufficient for detecting neck injury potential.

Table 14 -- Newman and Dalmotas Reconstructions: Neck Loads				
	Flexion Moment (Nm)	Axial Tension (N)	Shear X (N)	Shear Y (N)
Crash test (head strikes legs)	56	2388	1185	606
Lap belt (head strikes legs)	26.4	2145	325	156
Lap belt (no head/leg interaction)	24.9	2554	-254	236
Three-point belt	30.5	2238	400	240
Four-point belt	31.5	3604	494	97

Weber, Dalmotas, and Hendrick (1993) conducted tests using the 6-month-old CRABI dummy instrumented with head and chest accelerometers and upper and lower neck transducers.

An actual accident in which an infant in a forward-facing child restraint incurred a spinal cord contusion at T2 that resulted in paraplegia was reconstructed. The six-month-old child, weighing 8.6 kg, was loosely strapped into a forward facing child restraint that was improperly tethered. The change in velocity was estimated to measure 50-55 km/hr. The accident was first replicated in a crash test. A series of sled tests was then run with variations on the restraint condition to determine differences in measurement between injury and non-injury producing systems. The dummy measurements from the crash test appear in Table 15.

Table 15 --Weber et al. Reconstruction Data		
Head accel resultant (g)	53	
HIC (no limit)	411	
Chest accel resultant (g)	41	
Neck Data	Upper	Lower
Fx (N)	-317	-763
Fy (N)	-88	237
Fz (N)	1248	903
My (Nm)	-6	45
F resultant (N)	1260	1159
M resultant (Nm)	6	46

The measurements from the sled tests are presented graphically, so the trends relative to this initial test are related here. The test conditions examined proper and misuse modes of the child seat. They found that while individual components of neck measurements had some variance, the resultant neck forces and moments for the first batch of test conditions fell within the range of normal repeatability (+/- 10%) for any sled test program. A second batch of similar tests did not show drastic changes in resultants either. They were not able to detect major differences in dummy measurements when the dummy was tested in the injury-producing configuration. This might indicate that this test dummy is not sophisticated enough to reconstruct the conditions of this accident.

Trosseille and Tarriere (1993) reconstructed four accidents in an effort to estimate appropriate neck tolerance levels. Details of the accidents chosen for study are found in Table 16. Three different dummies were used to reconstruct the accidents: the 6-month-old CRABI, the 3-year-old CRABI (air bag head and neck on a Part 572 body), and a Part 572 6-year-old adapted to hold an upper neck load cell.

Table 16 -- Trosseille and Tarriere Selected Cases				
Test No.	Age/Wt.	Restraint	Delta V (km/h)	Injury
Case 1	6 months 8.6 kg	forward CRS w/ 5-pt harness	50-55	T2 spinal cord contusion
Case 2	23 months	forward CRS w/ 4-pt harness	40	C1/C2 fracture
Case 3	6 months 8 kg, 70 cm	forward CRS w/ 5-pt harness	60-65	C7/T1 vascular injury
Case 4a	6 month 8.5 kg, 68 cm	rear-facing CRS w/ 3-pt harness	70	skull fracture AIS 2 right femur fracture
Case 4b	4 year 19 kg, 107 cm	booster seat w/ 3-pt belt	70	head concussion AIS 3 optical damage
Case 4c	6 year 24 kg, 120 cm	booster seat w/ 3-pt belt	70	head concussion AIS 2 head laceration

Sled tests were run using the restraints of the accident victims and pulses developed from the vehicles involved in the crashes. Results from the dummy measurements appear in Table 17. The measurements in bold are thought to be the measurements that most likely reflect the injury mechanism. From these data, the authors summarize the following: 1) With 6-month-old child dummy measurements, they found no injury under $F_x=950$ N and $M_y=41$ Nm, but injury over $F_z=1200$ N. 2) With three-year-old child dummy measurements, they agree with a proposed F_x limit of 300 N. They found no injury with $F_z=2500$, which they found unreasonably high. They suggest an M_y limit of 35 Nm. 3) With the one six-year-old dummy case without neck injury, they measured $F_x=550$ N, $F_z=3300$ N, and $M_y=13$ Nm. They recommend that extensive reconstruction testing be conducted to obtain more information and generate child protection reference values.

Janssen et al. conducted a two-part study on neck loads in restrained children (Janssen 1991, 1993). The first phase of the program compared measured neck loads in rear-facing child restraints with those from forward-facing child seats with harness or shield restraints under ECE Regulation 44 test conditions. The TNO P3/4 dummy with an upper neck load cell was used in the sled program. The average neck loads measured in the different styles of child restraints appear in Table 18.

Table 17 -- Troiselle & Tarriere Reconstruction Cases						
	1	2	3	4a	4b	4c
Dummy used	6MO	3YO	6MO	6M O	3YO	6YO
Delta V (km/h)	51	40	56.6	72.7	72.7	72.7
HIC (36 ms)	399		772	2220	1122	634
Head resultant (g)	53	68	70	233	83	71
Chest resultant (g)	41	30		186	51	46
Upper neck shear force (N)	-317	-670	-953	-563	-744	-547
Upper neck tension force (N)	1248	1400	2933		3274	1589
Upper neck compression force (N)				-462		
Upper neck y moment (Nm)	-6	-22	-41	-18	-13	-14
Lower neck shear force (N)	-763					
Lower neck tension force (N)	903		1526			
Lower neck compression force (N)						
Lower neck y moment (Nm)	45					

Table 18 -- Janssen et al. Peak Average Neck Load Comparison				
Restraint	Fx (N)	Fz (N)	My, Flexion (Nm)	My, Extension (Nm)
Forward 4-pt harness	830	1550	2.5	3.4
Forward Shield	920	1710	2.0	4.1
Rearward-facing	250	730	4.0	1.4

Rearward-facing seats generally have extremely good results in the field data, so these measurements could definitely be considered below an injury-producing level. The forward-facing restraints, though generally offering good protection, have had some rare cases with severe neck injury at moderate crash severities (on the order of ECE Reg. 44 levels). These values may represent a threshold level for neck injury. This testing program also varied the way the head was attached to the load cell, which was shown to have a major effect on results, particularly moment measurements. This illustrates how dummy design can influence measurements.

In their second series of tests, Janssen et al. reconstructed a particular accident. The 10-month-old girl was restrained in a forward-facing CRS with a 4-point harness belt. Delta V was estimated to be 39-58 km/hr. The victim incurred serious cervical spine injuries resulting in tetraplegia from the C5/C6 level. The P3/4 dummy was used to reconstruct the accident, although it weighed 2.2 kg less than the child involved in the accident. The test (run twice at 49 km/h) led to average values as listed in Table 19.

Table 19 -- Janssen et al. Reconstruction Data		
Head accel resultant 3 ms (g)	77	
HIC	947	
Chest accel resultant 3 ms (g)	56.5	
Neck Data	Peak	30 ms
Fx (N)	990	620
Fz (N)	1765	1245
My (Nm) flexion	2.2	
My (Nm) extension	4.05	
F resultant (N)	1990	

Sturtz (1980) reconstructed 10 pedestrian accidents using a VIP-6C dummy with modifications to include extra instrumentation. From his results, he estimated two levels of PRV for each body region. The "SK0" values give tolerance limits for only reversible (AIS 1) injuries, while the "SK1" numbers would indicate 25% irreversible injuries. Table 20 summarizes his PRV for six-year-old children developed through pedestrian impact testing.

Pedestrian accident reconstructions conducted at NHTSA’s Vehicle Research and Test Center also offer some information on potential PRV(MacLaughlin 1987). Instead of using an entire dummy, which is difficult to control precisely to duplicate an accident, researchers conducted component level tests with physical models of child heads and thoraxes. When Enouen (1986) conducted child pedestrian accident reconstructions involving head impacts using variable mass head forms, she found reliable correlation to injury with the Mean Strain Criterion (MSC). The MSC calculation program predicted head AIS values that corresponded with the actual head AIS value recorded in the accident. In the report on child thorax reconstructions conducted with thorax surrogates, Elias and Monk (1989) found that the onset of 20% probability of death (between AIS 4 and AIS 5 thorax injuries) was estimated to occur with 25% chest deflection, V*C of 15 in/sec, or average peak rib and spine accelerations of 60 g.

Body Region	Measurement	SK0	SK1
Head	HIC	350	600
	3 ms clip acceleration (g)	60	70
	peak resultant acceleration (g)	70	110
Neck	shear force (N)	880	990
	moment (Nm)	90	100
	axial force (N)	1900	2300
Thorax	3 ms clip acceleration (g)	55	85
	peak resultant acceleration (g)	55	105
Abdomen	3 ms clip acceleration (g)	55	65
	peak resultant acceleration (g)	70	90
Pelvis	3 ms clip acceleration (g)	60	85
	peak resultant acceleration (g)	85	115

In addition to reconstructions of specific accidents, “generic” reconstructions can give some insight on whether proposed PRV are reasonable. For example, epidemiology studies have shown that child restraints are highly effective in reducing the chance of injury (Henderson et al., 1994, Kahane 1986, Melvin et al., 1980). Although it varies with child size, lap belts and three-point belts generally offer some degree of protection. Misused child restraints usually offer reduced protection, and unrestrained children would be expected to have the highest probability of incurring injuries. Exceptions to these trends exist (Stalnaker 1993, Huelke 1992), and impact severity has a major effect, but these observations hold true for a majority of cases. Running tests with a dummy in these types of different restraint environments can help determine the range of dummy measurements found in typical injury and non-injury producing environments. For example, if a 6-month-old dummy tested in a rear-facing child seat has a neck tension above a proposed threshold for injury, but the field data do not show six-month-old children in rear-facing child seats receiving neck injuries, it raises the question of how appropriate the PRV are. This type of generic reconstruction test may prove particularly useful when trying to develop PRV for various dummies, whose different structures may affect response.

An example of this type of work is found in Kahane et al. (1986, 1987). They conducted a series of sled tests with 3-year-old GM dummies. Three velocities (15, 25, and 35 mph) were tested, and the restraint conditions listed in Table 21 were employed. When trying to apply the PRV .

Proposed by Mertz and Weber (1982) and developed using OOP testing, they found it over-estimated both injury risk and restraint effectiveness when compared to actual injury data for children in the NASS database. This reinforces the idea that different PRV are needed for OOP and belt-restrained frontal impact testing, and that studies done in one mode cannot necessarily apply to the other. Figures 13 and 14 contain the average results of their HIC values and average torso g’s, which give a range of the dummy responses in different frontal restraint systems at varying impact levels. Their neck forces and moments were reported to be almost negligible

Table 21 -- Restraint Conditions, Kahane et al. (1987)		
#	Restraint	Category
1F	Unrestrained in front seat	Unrestrained
1R	Unrestrained in rear seat	Unrestrained
2	Lap belt only	Restrained
3	Tethered CRS	Restrained
4	Tethered CRS (no tether)	Misuse
5	Tethered CRS (no tether, no harness)	Misuse
6	Tethered CRS (no tether, vehicle belt	Misuse
7	wrong)	Misuse
8	Tethered CRS (no tether, no vehicle belt)	Restrained
9	Tetherless CRS	Misuse
10	Tetherless CRS (vehicle belt wrong)	Restrained
11	Shield CRS	Restrained
12	Booster seat	Misuse
	Booster seat (no tether, no shoulder belt)	

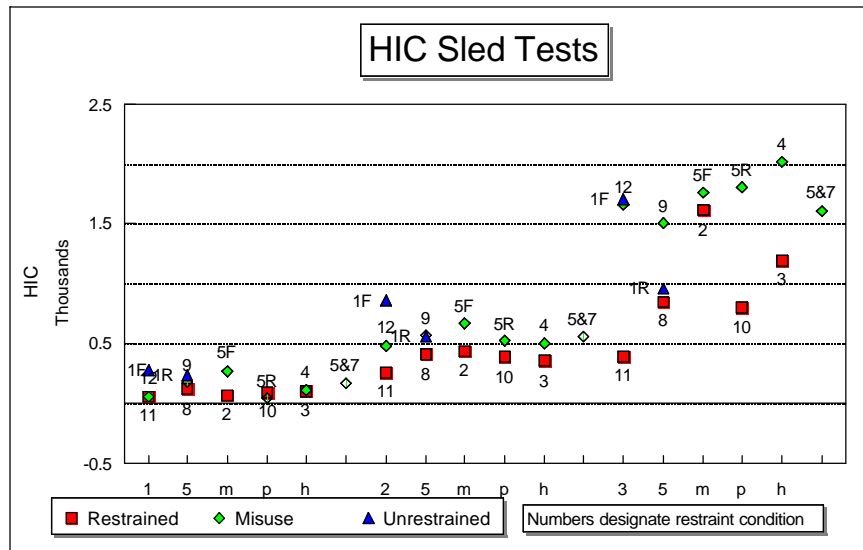

Figure 13 -- Kahane et al. HIC values

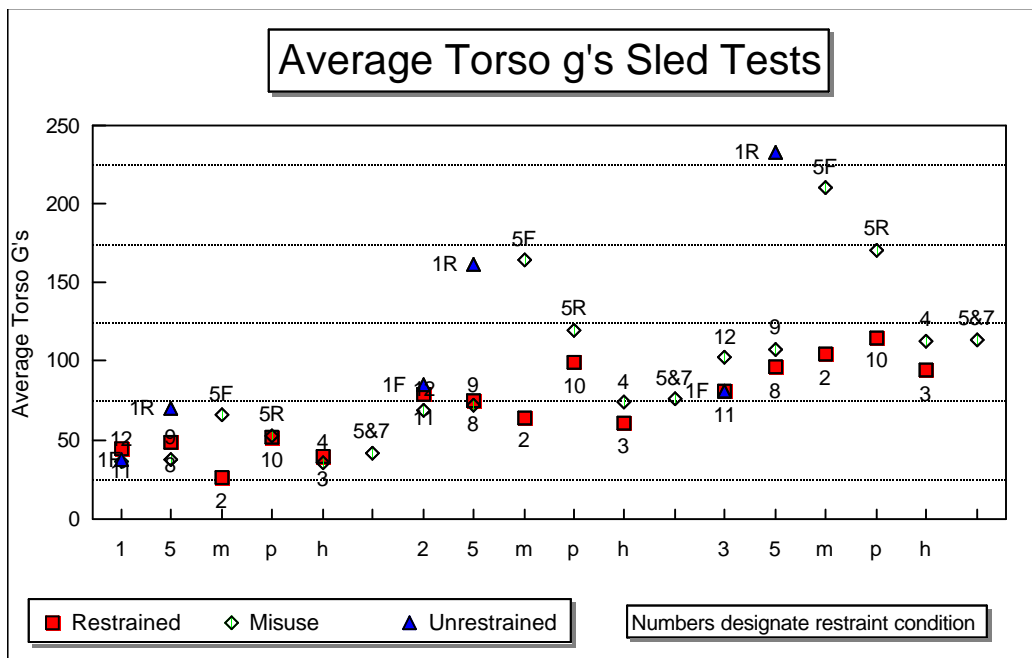

Figure 14 -- Kahane et al. average torso g's measurements



Figure 15 --Six-year-old dummies in rigid seat with 5-pt harness in Ford evaluation tests



Figure 16 --Three-year-old dummies in Bravera booster seat with Taurus 3-pt belts in Ford evaluation tests

Kirkish (1995, 1996) ran comparison tests between the Hybrid III and Part 572 3- and 6-year-old dummies. These tests conducted at Ford Motor Co. were intended to check for differences in response between the two models of dummies. (Some improvements to the dummies have been made since these tests.) However, they can be used as examples of the range of responses in the four dummies when tested under the particular restraint conditions. The FMVSS No. 213 pulse was used as the input acceleration, which can be considered a severe but realistic crash pulse. Two restraint conditions were tested; they are shown in Figure 15 with the six-year-old dummies and Figure 16 with the three-year-old dummies. The first was a generic rigid seat equipped with a 5-point harness belt. It does not necessarily copy any particular child restraint, and is more rigid than most available designs. The second restraint was more realistic. A Century Bravera booster seat was installed in a rear seat of a Taurus. This booster seat either restrains the child with a built-in harness, or positions the child so the vehicle three-point belt fits better. Both the 3- and 6-year-old size dummies were restrained in the seat with a Taurus 3-point-belt. This restraint combination is probably the best type available for the six-year-old size child, but might be considered a misuse for the 3-year-old, who is most likely too small to use a vehicle 3-point-belt appropriately even when positioned in a booster seat. The readings would be representative of those from a moderately severe crash.

The data from these tests appear in Figures 17 through 28. They show two types of information. First, the tests illustrate typical 48 kph test readings for the dummies when restrained in child restraints. Second, they show how different dummies respond in identical test conditions. In each graph, the x-axis labels of R1-R4 refer to tests run in the rigid seat, while B1-B4 designate tests run in the booster seat.

The peak head resultant acceleration in Figure 17 for both three-year-old dummies was higher with the booster seat compared to the rigid seat. The values overall between the dummies were similar, except for one test with the Part 572 dummy where a spike affected the peak value. Neglecting this particular test, the peak resultant values were below 100 g for the rigid seat, and about 125 g for the booster and 3-pt belt. For the six-year-old dummies shown in Figure 18, the Hybrid III head resultants were larger than the Part 572 dummies, and were higher in the rigid seat than the booster seat. One test with the Hybrid III six-year-old also had a spike which affected its peak. Most of the values were below 75 g, with the two rigid seat Hybrid III tests up to 125 g.

Two different HIC values were calculated for each test and are shown in Figures 19 and 20. The calculations used either a 15ms or 36 ms pulse width. For both three-year-old dummies, the 15 ms HIC values were below 500 for the rigid seat and below 800 for the booster seat. The 36 ms values were all below 1000 except for one instance. With the six-year-old dummies, the 15 ms values remained below 500, as did most of the remaining 36 ms tests. The four tests with the booster and the Hybrid III six-year old ranged between 800 and 1000 36 ms HIC.

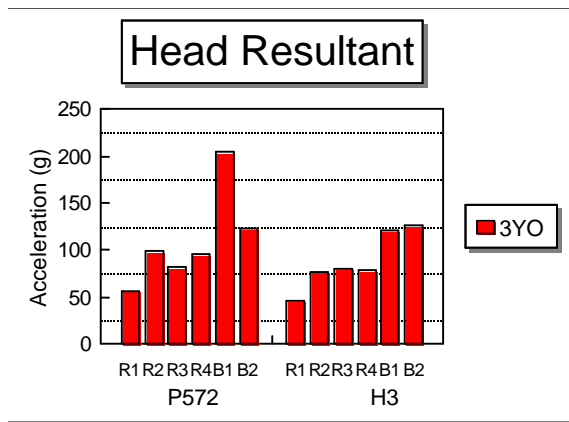

Figure 17 -- 3YO head resultants, Ford tests

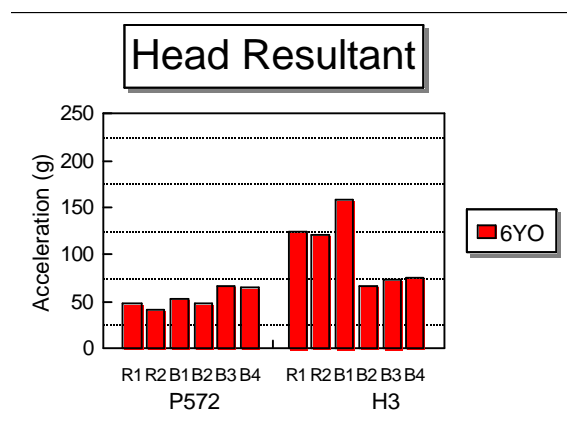

Figure 18 -- 6YO head resultants, Ford tests

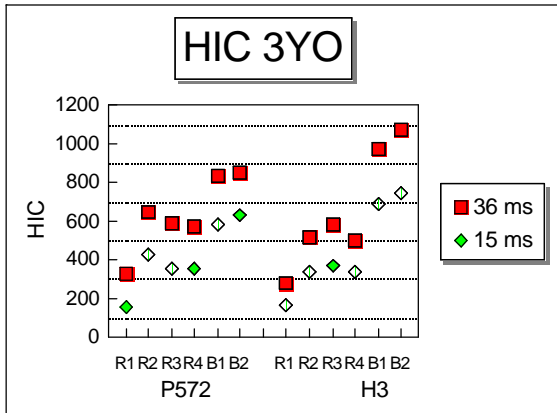

Figure 19 -- 3YO HIC values

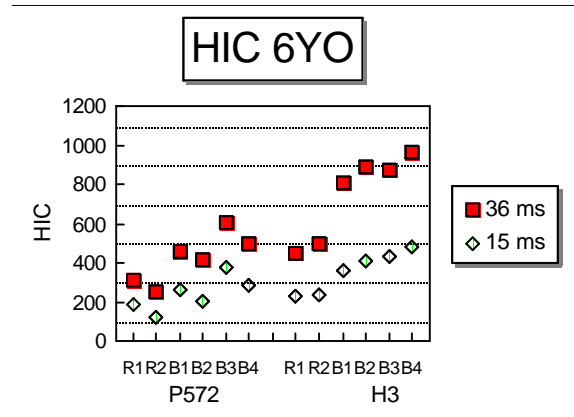

Figure 20 --6YO HIC values, Ford tests

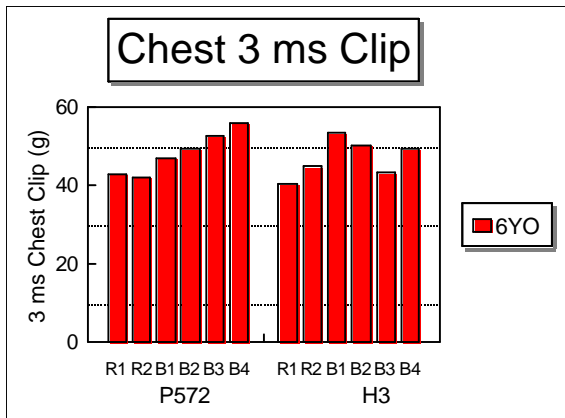

Figure 21 -- 6YO chest clips, Ford tests

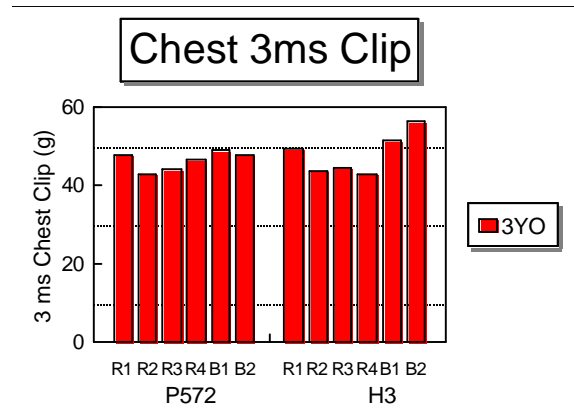

Figure 22 -- 3YO chest clips, Ford tests

The 3 ms chest clip values were among the most consistent over all tests. As seen in Figures 21 and 22, the values stayed between 40 and 60 g's in all cases.

The available neck measurements for axial tension appear in Figures 23 and 24. The smallest values in the three-year-old dummies start range from just over 1000 N (the proposed Planath PRV) and reach up to 3000 N. The six-year-old Hybrid III values begin at levels near 1500 N and also approach 3000 N.

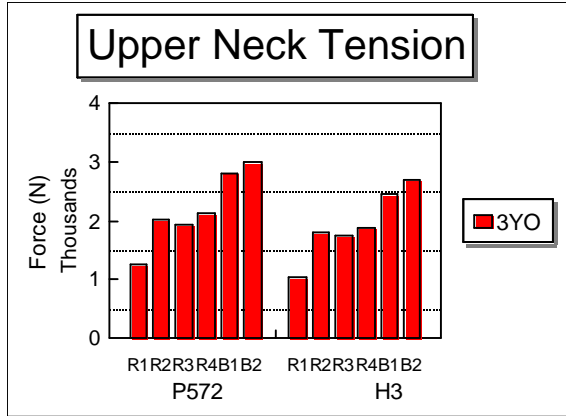

Figure 23 -- 3YO neck tension, Ford tests

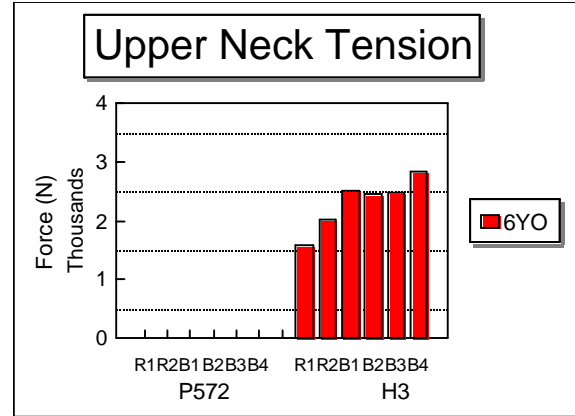

Figure 24 -- 6YO neck tension, Ford tests

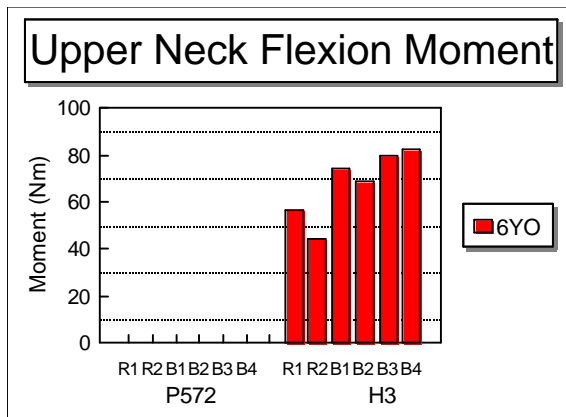

Figure 25 -- 6YO neck flexion, Ford tests

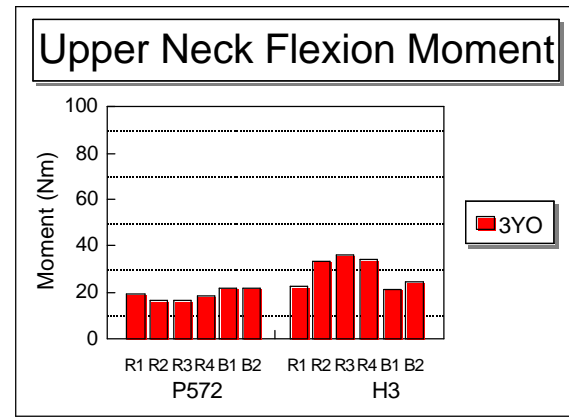

Figure 26 -- 3YO neck flexion, Ford tests

The flexion moment values measured in all of the dummies appear in Figures 25 and 26. The three-year-old values range from 15 to 40 Nm, with the Hybrid III values usually higher than the Part 572's. For the Hybrid III six-year-old, the values begin at 40 Nm and reach up to 85 Nm.

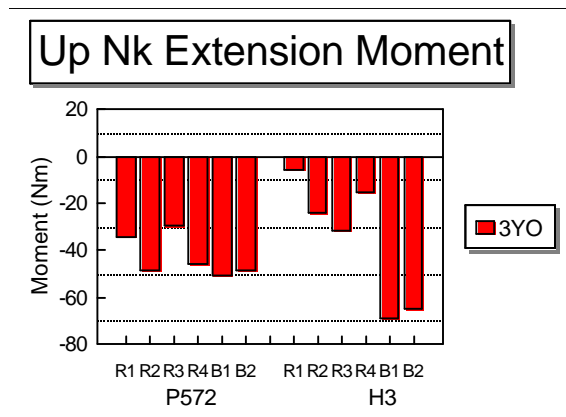

Figure 27 -- 3YO neck extension, Ford tests

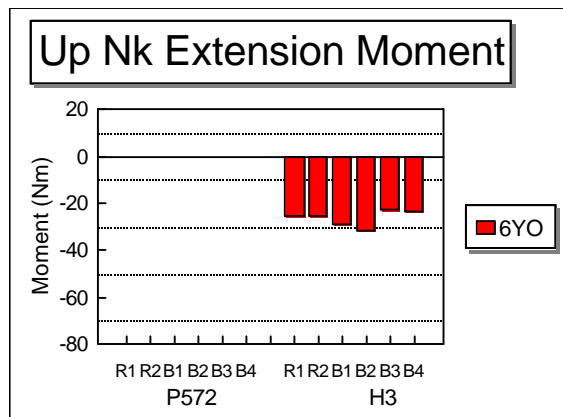

Figure 28 -- 6YO neck extension, Ford tests

Figures 27 and 28 contain the extension moment values. The opposite relationship seems to be true for the dummies, with the three-year-old moments generally much higher than the six-year-old's. While partly resulting from the relative position within the seat and restraint, these values may indicate a difference in dummy neck construction that may affect response among different types of dummies. The 3-year-old values range from -5 to -70 Nm, while the six-year-old ranges approximately from -20 to -35 Nm.

Additional 48 kph child restraint tests conducted at VRTC can help estimate the range of values found in typical testing. Much of the research at VRTC has studied the effects of misused child restraints. Values for the six-year-old Part 572 dummy (including tests run with a special load cell neck) under a variety of restraint conditions (Klinich 1992, Sullivan 1995) are listed in Table 22. Values for the TNO 9-month-old and Part 572 3-year-old in several different misuse/ incompatibility conditions (Sullivan 1995) appear in Table 23. All tests were conducted at 48 kph.

Table 22 -- VRTC Part 572 Six-year-old Tests					
	Lap belt only	3-pt-Belt	Belt-positionin g booster	Safety belt Positioning Devices	Booster misuse/ incompatibility
Peak head resultant (g)	253	59-66	46-70	53-80	62-285
HIC	1410	507-657	287-536	414-769	599-1900
Chest 3 ms Clip (g)	46	48-50	39-58	46-65	42-53
Neck Shear Force (N)		-754	-365/-566	-371/-576	
Neck Axial Force (N)		4325	2521-4486	3593-3697	
Neck Y Moment (Nm)		17	8-14	18-25	

Table 23 -- VRTC Misuse/Incompatibility Testing		
	TNO 9-month-old	Part 572 3-year-old
Peak head resultant (g)	49-426	58-249
HIC	312-3015	381-2314
3 ms Chest Clip (g)	43-61	34-60

Weber conducted tests with the CRABI 12-month-old in a variety of restraint conditions to evaluate the dummy. Both rear-facing and forward facing configurations were evaluated. Table 24 contains the range of values measured. In some cases, not all channels were recorded, so the range of values listed do not apply to all of the tests.

Table 24 -- Weber CRABI 12MO Test Results				
	Forward-facing (16 tests)		Rear-facing (8 tests)	
HIC (19 ms)	301-830		104-192	
HIC (unlimited)	457-764		364-436	
Chest 3 ms Clip (g)	30-46		35-41	
	Upper	Lower	Upper	Lower
Neck Force X (N)	-1002/-386	-884/-746	-531/386	158-419
Neck Force Y (N)	-128/117	-104/804	-76/28	-61/241
Neck Force Z (N)	1089/2408	645/1274	325/999	688/1196
Neck Resultant Force (N)	1241/2430	1022/1416	565/1070	725/1199
Neck Moment X (Nm)	-5/7	-15/13	1/4	-6/1
Neck Moment Y (Nm)	-13/46	45/108	-18/21	-13/-7
Neck Moment Z (Nm)	1/3	1/4	-1/1	-1/4
Neck Resultant Moment (Nm)	13/37	47/108	9/18	7/13

Another approach to gaining insight about child injury tolerances is through reconstruction of free-fall situations. Using computer simulations to reconstruct free-fall accidents (generally simpler to reconstruct compared to automotive impacts) gives an estimate of impact forces that can be correlated with documented child injuries. Several references have employed this approach to study child impact tolerance (Foust et al. 1977, Snyder, 1969). Most give qualitative comparisons of the relative frequencies of different types of injuries incurred by children and adults. However, Mohan et al. estimates head tolerance limits of 150-200 g 3 ms average accelerations and 200-250 g peak accelerations (reported in Beusenberget al. 1993). They caution that the computer model's incomplete biofidelity requires that these values be estimates only.

3.4 Scaling of Adult Data

One technique of scaling adult data uses dimensional analysis (Melvin 1995). Dimensional analysis is based on the fact that all engineering units can be broken down into combinations of mass, time, temperature, and length. For example, head acceleration units are length/time². If we know the length and time ratios between two dummies, we can scale the acceleration limits. We know the length ratios between an adult and six-year-old child from measuring a characteristic head length. Time ratios must be derived from some other known relationship between the two sizes. Since this is a structural problem, the ratio of modulus of elasticity (units of mass/ (length*time²) between adults and 6-year-old children is applicable. The time ratio can therefore be derived as the square root of (mass ratio * length ratio / modulus ratio). The acceleration ratio becomes:

$$A_r = \frac{L_r}{(T_r)^2} = \frac{L_r}{\frac{(M_r L_r)}{E_r}} = \frac{E_r}{M_r}$$

If equal densities are assumed, the mass ratio is the length ratio cubed. Similar relationships can be derived for force, moment, velocity, and HIC using the length, mass, and modulus ratios.

Dimensional analysis itself does not require assumptions. The chance for possible error results instead from choices and approximations made by the individual analyzing the problem. For example, when scaling head acceleration, assumptions include:

- * the small amount of published skull modulus data is sufficient and appropriate for defining the modulus ratio between all adults and all six-year-old's
- * the skull structures of adults and six-year-old's are essentially the same
- * the characteristic length selected to determine the length ratio is appropriate (one can use circumference, depth, height, width, or a combination)
- * the mass ratio is directly related to the length ratio, and head densities do not change between adults and children.

Two slightly different approaches to dimensional analysis scaling are available, which we will term "human-based" and "dummy-based". A "human-based" approach starts with adult injury criteria or protection reference values, and uses published anatomical and human material modulus data to scale according to dimensional analysis. The "dummy-based" scaling approach assumes that the design of child dummies has been scaled from adult data, so the effects of differing modulus should already be accounted for in the child dummy response. Only the dimensional data are used to scale the PRV, because the adult and child dummies are essentially constructed of the same materials.

Another way to scale adult information is by modeling an adult body structure mechanically and scaling the model. This technique was used to develop the design specifications for the Hybrid III family of dummies (Mertz et al. 1989, Irwin 1993). For example, the dummy's neck was modeled as a beam in bending, and the moment-angle response corridors were adjusted down to six-year-old size by applying scaling factors to the relationships governing moments and angular deflection behaviors of beams.

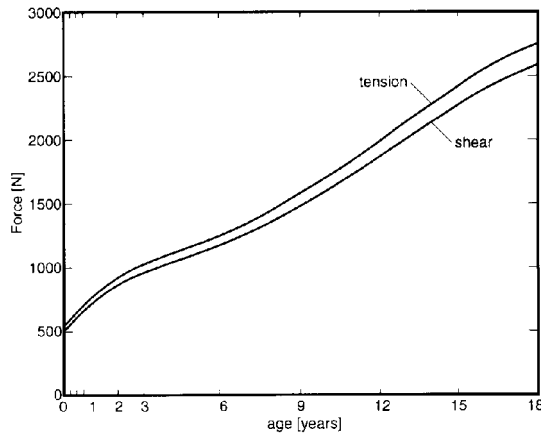

Figure 29 -- Janssen et al. scaled neck force tolerances

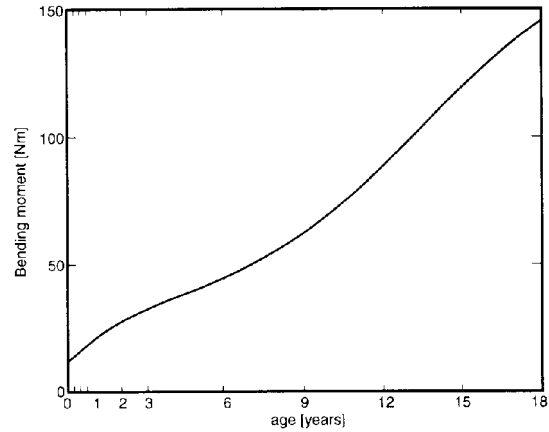

Figure 30 -- Janssen et al. scaled neck moment tolerances

Several authors have used such scaling techniques to develop injury criteria and PRV from adult data. Janssen et al. (1993) derived neck injury tolerances by age as shown in Figures 29 and 30. They applied the geometric scaling factor to the Hybrid III 50th percentile male adult neck PRV.

Among many other approaches, Sturtz (1980) employs scaling to estimate injury tolerances. He scaled the ECE Regulation 21 adult head protection limit of head acceleration 3 ms value of 80 g to be 86.1 g for 3-year-old's, and 82.1 g for 6-year-old's using the cubic root of brain mass ratios as the scaling factor. As mentioned previously in the discussion of rotational head injury tolerances, he also scaled the head rotational acceleration values found in Table 9.

Melvin (1995) took data from numerous sources and scaled it (using the human-based approach) to estimate PRV for the CRABI 6-month-old dummy (Table 25). He not only scaled from adult PRV, but scaled estimates in the literature for other sized children as well. Because he was developing PRV for the dummy when used in a rear-facing infant restraint with passenger air bag deployment, he used the scaled values as a starting point, then checked his values against test data in rear-facing situations. He then adjusted his values (scaled from frontal impact conditions) to agree with data from the rear-facing mode. His recommendations for tolerance estimates. As seen in Appendix A, these PRV have been adopted by General Motors for use in their testing with this dummy in this configuration (Kromrei 1996).

Table 25 -- 6MO CRABI Tolerance Estimates (Melvin 1995)			
Body Region	Measurement	Units	Proposed Limit
Head	HIC		390
	HIC (t2-t1)	ms	22
	Peak resultant acceleration	g	50
Upper Neck	Flexion moment	Nm	16.4
	Extension moment	Nm	5
	Axial tension	N	500
	Axial compression	N	606
	Shear	N	470
Chest	Resultant acceleration	g	50

Researchers at General Motors have scaled Injury Assessment Reference Values (IARVs; their term for protection reference values) from the adult 50th percentile Hybrid III dummy down to the six-year-old size Hybrid III dummy (Mertz 1993, Kromrei 1996). These dummy-based scaling techniques were also employed for developing IARVs for the 5th female and 95th male Hybrid III dummies. The results they use for the six-year-old are presented in Table 26 and Appendix A. They are scaled from adult frontal impact data, and would most appropriately be used on the six-year-old only in this configuration.

The adult neck data from which the six-year-old values were scaled are based on cadaver research, so neck muscle tone is not considered. Since the scaled neck moment values have been called extremely conservative, Mertz (1996) recalculated the values using adult human volunteer data as a starting point. He also noted that earlier scaling practices used a torso scaling factor for the neck moments. The revisions use neck dimensions to form the scale factors instead. The results for both sets of data appear in Table 27.

Table 26 -- General Motors 6-year-old IARVs			
Body Region	Measurement	Units	Proposed Limit
Head	HIC		1140
	HIC (t2-t1)	ms	15
Upper Neck	Flexion moment	Nm	45
	Extension moment	Nm	13
	*Axial tension	N	1300
	*Axial compression	N	1500
	*Shear	N	1200
Chest	Resultant acceleration	g	97
	Sternal Deflection	mm	60

* Numbers listed are maximum allowable short duration values. Plots of allowable force levels vs. duration are found in the Figures of Appendix A.

Table 27 -- Revised Scaled Neck Moments (Nm)					
	Neck Scale Factor	Cadavers		Volunteers	
		Flexion	Extension	Flexion	Extension
50th percentile male	1	190	57	225	81
6-year-old	.302	57	17	68	24
3-year-old	.258	49	15	58	21

**4.0 CHILD PROTECTION REFERENCE VALUES:
ADDITIONAL SCALING AND SUMMARY**

In the first part of this section, techniques similar to those described previously are used to scale adult PRV used on the Hybrid III dummies to be applicable to the 6-year-old, 3-year-old, and 12-month-old Hybrid III style dummies. Both the human-based and dummy-based techniques are employed. The purpose of repeating some of the scaling done in the literature is to provide numbers scaled in the same way for the three dummies of interest, and to strictly document the values used to develop the scaling factors. In addition, the numbers developed for a three-year-old dummy using surrogate tests in out-of-position configurations are scaled up to fit a six-year-old dummy. The tolerances recommended in the literature for the 6MO dummy in out-of-position conditions are scaled up to apply to the 12MO dummy. The second section includes tables comparing all of the published suggestions for protection reference values with the scaled estimates. Values from “normal” child test data are also included.

4.1 Scaled Child Protection Reference Values from Adult Data

The steps taken to scale adult PRV used in frontal impact configurations for the 6-year-old, 3-year-old, and 12-month-old child dummies are outlined in this section. Both human-based and dummy-based techniques are applied.

Table 28 contains the pertinent measurements for each size of child. The child measurements were taken from the 1977 child anthropometry study conducted by the University of Michigan (Snyder et al., 1977). Data on head length and neck circumference were not recorded for infants in this study. The adult measurements come from the 1983 adult anthropometry study also conducted by the University of Michigan Transportation Research Institute (Schneider 1983).

Table 28 -- Anthropomorphic Measurements				
Dimensions (cm)	50th	6YO	3YO	12MO
Head circumference	57.1	51.1	49.5	46.6
Head breadth	15.8	13.9	13.4	12.7
Head length	19.7	18.2	17.5	16.7
Head height	23.1	18.4	17.3	
Neck circumference	38.3	25.7	23.8	
Chest circumference	103.9	57.3	50.7	46.3

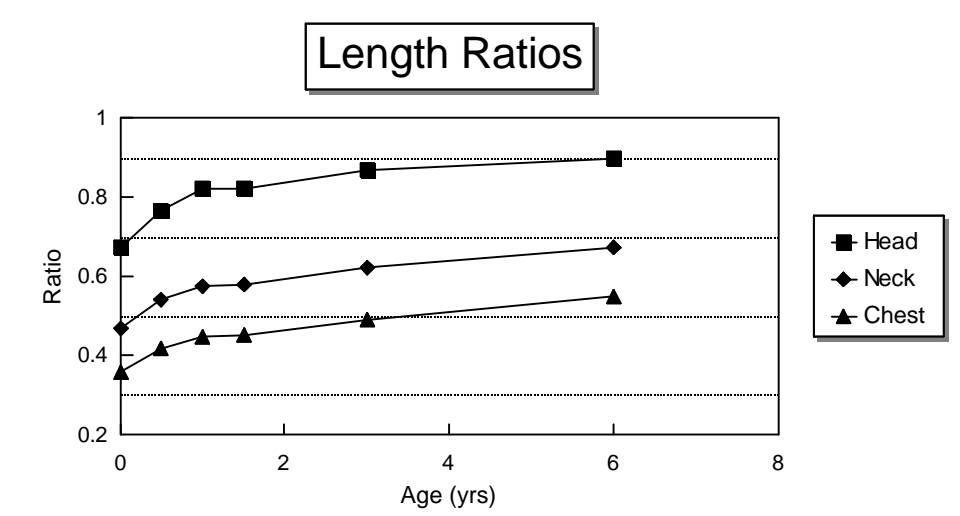

Figure 31 -- Estimating neck ratio for infants

The chest length ratios are simply the chest circumference (measured at the axilla) of the child divided by the fiftieth percentile chest circumference. For the head several options for choosing the characteristic length are available. Melvin (1995) used the cube root of head mass ratios for his head characteristic length. However, the source of his mass estimates is unclear, so this technique was not attempted. Estimating the head volume by multiplying the breadth, length, and height, then taking the cube root of that product is another choice. However, this would require estimating the head height of the 12MO child. A third choice is to sum the circumference, breadth, and length for each size and use the ratios of this sum. This technique requires no estimation, and was used by Irwin (1993) to scale the six-year-old child dummy specifications. Since this approach requires no estimates, it was selected to determine the head length scaling ratios. Because the infant neck circumferences were not recorded in the anthropometry study, they require an approximation. As seen in Figure 31, the head, neck, and chest length ratios for the 3- and 6-year-old's seem to form parallel lines. The following formula was derived from the two older sizes of children and applied to the infant data to calculate neck ratios:

$$\text{neck ratio} = \text{chest ratio} + 0.347 * (\text{head ratio} - \text{chest ratio})$$

The other ratios required for human-based scaling are those for bone and tendon modulus. The child cranial bone modulus data reported in the background section were used to calculate the ratio. Choosing which adult modulus to use has a major effect on the calculations. Neither the Wood nor the Hubbard cranial data are ideal for comparing to the available child data. The child samples were fresh, tested in three-point bending, and kept wet with saline during storage and testing. The Wood samples were fresh, tested axially, stored frozen, and tested under ambient conditions. The Hubbard samples were embalmed, tested in three-point bending, stored in a humid, room temperature environment, and tested under ambient conditions. The Hubbard modulus was selected for use in calculating the modulus scaling because it employed the same three-point bending test as the child samples. This value was also the one used to scale the child dummy responses. Because no chest bone modulus by

age data are available, the same ratios from the cranial data are assumed to estimate the characteristics of the chest bone. For the neck, the modulus data for tendons reported by Yamada is used, assuming that neck tendon properties vary the same way with age as those reported in his study. For the dummy scaling, the material property ratios are set to 1, because the changing modulus values have been designed into the dummy responses. Table 29 lists all of the length and modulus scaling factors used in this procedure.

Table 29 -- Length and Modulus Scaling Factors								
Ratios	Human Data				Dummy Data			
	50th	6YO	3YO	12MO	50th	6YO	3YO	12MO
Head length (LH)	1	.8985	.8683	.8207	1	.8985	.8683	.8207
Neck length (LN)	1	.6710	.6214	.5758	1	.6710	.6214	.5758
Chest length (LC)	1	.5515	.4880	.4456	1	.5515	.4880	.4456
Bone modulus (EB)	1	.667	.474	.322	1	1	1	1
Tendon modulus (ET)	1	.96	.85	.70	1	1	1	1

Table 30 contains the adult PRV, the formulas used for scaling, and the scaled values for the child sizes.

Table 30 -- Scaled Adult Protection Reference Values									
Parameter	Formul a	Human Data				Dummy Data			
		50th	6YO	3YO	12MO	50th	6YO	3YO	12MO
Head acceleration (g)	EB/LH	85	63	46	33	85	95	98	104
HIC	$\frac{EB^2}{LH}$	1000	522	278	139	1000	1174	1236	1345
HIC time 1 (ms)	LH/EB^{-5}	15	16.5	18.9	21.7	15	13.5	13.0	12.3
HIC time 2 (ms)	LH/EB^{-5}	36	39.6	45.4	52.1	36	32.3	31.3	29.5
Neck tension (N)	$ET*LN^2$	3300	1426	1083	765	3300	1486	1274	1094
Neck compression (N)	$ET*LN^2$	4000	1729	1313	927	4000	1801	1545	1326
Neck shear (N)	$ET*LN^2$	3100	1340	1018	718	3100	1396	1197	1028
Neck flexion moment (Nm)	$ET*LN^3$	190	55	39	25	190	57	46	36
Neck extension moment (Nm)	$ET*LN^3$	57	17	12	8	57	17	14	11

Table 30 -- Scaled Adult Protection Reference Values									
Chest acceleration (g)	EB/LC	60	73	58	43	60	109	123	135
V*C (m/s)	EB ⁵	1.0	.82	.69	.57	1	1	1	1

The data show that the two scaling approaches have almost opposite results: the human-based approach tends to lower the maximum PRV for each age, while the dummy-based approach increases the PRV levels.

Many biomechanics experts agree that PRV for out-of-position testing should be developed using out-of-position testing configurations. The three-year-old data from the Ford and GM pig tests is the primary source for out-of-position testing. These data are scaled up to six-year-old size using both dummy and human based techniques as shown in Table 31. The scaling factor of 6YO/3YO was calculated by dividing the 6YO/50th ratio by the 3YO/50th ratio.

Table 31 -- 6YO Scaled OOP Values											
Parameters	3YO OOP Values			6YO Dummy-Scaled Values				6YO Human-Scaled Values			
	1%	10%	25%	λ	1%	10%	25%	λ	1%	10%	25%
HIC (15 ms)	1480	1530	1570	0.95	1406	1453	1491	1.88	2785	2878	2953
Axial tension (N)	1060	1125	1160	1.17	1236	1256	1353	1.32	1396	1482	1528
Upper spine acceleration (g)	55	59	62	0.88	49	52	55	1.25	68	73	77
Upper and midsternal delta V (km/h)	9	16	19	1.00	9	16	19	1.87	11	19	23
Lower spine acceleration (g)	34	42	45	0.88	30	37	40	1.25	42	52	56
Lower sternal delta V (km/h)	19.5	19.9	20.4	1.00	19.5	19.9	20.4	1.87	23.1	23.6	24.2

The other PRV developed specifically for an out-of-position configuration is Melvin's data for the CRABI 6-month-old for use in a rear-facing child seat plus passenger air bag deployment. These estimates are scaled to the 12-month-old CRABI for use under the same conditions using the dummy- and human-based approaches in Table 32.

Table 32 -- Scaling of Melvin's 6MO OOP Criteria to 12MO					
Measurement	6MO	12MO			
		Dummy-based		Human-based	
	Value	λ	Value	λ	Value
HIC	390	.907	354	1.141	445
HIC (t2-t1) (ms)	22	1.067	23	1.007	22
Peak resultant acceleration (g)	50	.937	47	1.051	53
Flexion moment (Nm)	16.4	1.215	19.9	1.287	21.1
Extension moment (Nm)	5	1.215	6.1	1.287	6.4
Axial tension (N)	500	1.139	570	1.206	603
Axial compression (N)	606	1.139	690	1.206	731
Shear (N)	470	1.139	535	1.206	567
Chest Resultant acceleration (g)	50	.937	47	1.052	53

4.2 Summary of Child Injury Protection Reference Values

Using the format developed by Beusenberget al. (1993), the recommended PRV from the literature and results from both techniques of scaling the adult criteria are summarized in Tables 33-39. The tables also values from typical frontal impact tests and from reconstruction tests. Since most of the data deals with frontal impact environments, they could be used to develop an expanded set of PRV for child dummies in frontal impacts (with dummies restrained in child restraints or belt systems), although some information provides guidance for out-of-position testing PRV. The sections highlighted in bold type can be directly applied to out-of-position testing.

Table 33 -- Dummy Head Measurements

Source	Test Type	Delta V (km/h)	Ages	Maximum Acceleration (g)	HIC	Time (ms)
Planath et al.	Reconstruction w/ neck injuries	40	3YO		319	36
	Reconstruction w/ head injuries	50	3YO		809	36
Weber et al.	Reconstructions w/ neck injuries	50-55	6MO	53	411	
Troiselle & Tarriere	Reconstructions w/ neck injury	51	6MO	53	399	36
	neck injury	57	6MO	70	772	36
	head injury	73	6MO	233	2220	36
	neck injury	40	3YO	68	NA	NA
	head injury	73	3YO	83	1122	36
	head injury	73	6YO	71	634	36
Janssen et al.	Reconstruction w/ neck injury	49	9MO	77	947	
Kahane	FMVSS 213 type restrained	24	3YO		56-120	
	misuse	24	3YO		42-270	
	unrestrained	24	3YO		229-277	
	restrained	40	3YO		254-435	
	misuse	40	3YO		481-667	
	unrestrained	40	3YO		559-856	
	restrained	56	3YO		393-1612	
	misuse	56	3YO		1506-2014	
unrestrained	56	3YO		959-1709		
Kirkish	FMVSS 213 type rigid or booster	48	3YO	46-205	279-1070	36
			6YO	40-159	155-747	15
						251-965
				121-485	15	
VRTC	FMVSS 213 type restrained (3-pt or booster)	48	6YO	46-80	287-769	36
	misuse		6YO	62-285	599-1900	36
	misuse		3YO	58-249	381-2314	36
	misuse		9MO	49-426	312-3015	36
Weber	FMVSS 213 type forward-facing CRS	48	12MO		457-764	19
					301-830	
	rear-facing CRS				364-436	
					104-192	19

Table 34 -- Estimated Head Protection Reference Values: Translational						
Source	Approach	Estimated Degree of Injury	Ages	Maximum acceleration (g)	Time (ms)	HIC
VRTC	Scaling Hybrid III 50th: human-based	Low probability of serious injury	50th 6YO 3YO 12MO	85 63 46 33	15 16.5 18.9 21.7	1000 522 278 139
VRTC	Scaling Hybrid III 50th: dummy-based	Low probability of serious injury	6YO 3YO 12MO	95 98 104	13.5 13.0 12.3	1174 1236 1345
Melvin	Scaling, test & literature comparison	Low probability of serious injury	6MO	50	22	390
Mertz	Animal/dummy comparison	1% risk 10% risk 25% risk	3YO		≤15 ≤15 ≤15	1480 1530 1570
General Motors	Scaling Hybrid III 50th: dummy-based	Low probability of serious injury	6YO		15	1140
Mohan	Reconstruction of free falls			150-200 200-250	3 peak	<3000
Sturtz/ (Fayon/ Tarrriere)	Scaling	+/- x +/- y	3-6	44-74 37-58	8.2-7.7 6.0-5.6	
Sturtz	Scaling ECE		50th 6YO 3YO	80 82.1 86.1	3 3 3	
Foust	fall reconstruction	AIS2 (50% prob) AIS5 (50% prob)	< 8 yrs	350-400 600	3 2.5-3	1700-2800 11000
Mohan	fall reconstruction	AIS 2 (low probability)	1-10 yr	150-200 200-250	3 peak	< 3000
Sturtz	Scaling ECE R 21	low probability of serious injury	adult 6YO 3YO	80 82.1 86.1	3 3 3	
Sturtz	Pedestrian reconstructions	AIS 2 (50% probability)	~6 yr	60 70	3 peak	350
Sturtz	pedestrian reconstructions	AIS 2 (50% probability)	< 15 yr	109	7	

Table 35 -- Estimated Head Protection Reference Values: Rotational						
Source	Approach	Estimated Degree of Injury	Ages	Maximum Acceleration (r/s ²)	Maximum Velocity (r/sec)	Time (ms)
Margulies & Thibault	Scaling primates, indirect load	Threshold for serious injury	See Figure 10			
Sturtz	Scaling Ommaya indirect load	Threshold for serious injury	adult	7020		10
				70200		3
			6YO	7390		10
				73900		3
			3YO	8140		10
				81400		3
Sturtz	Scaling Ommaya direct load	Threshold for serious injury	adult	1732		10
				8900		3
			6YO	1823		10
				8300		3
			3YO	2008		10
				9100		3
VRTC	Scaling revised Ommaya	Threshold for serious injury	adult	< 4500	< 30	
				< 1700	≥ 30	
			6YO	< 5574	< 37.2	
				< 2106	≥ 37.2	
			3YO	<5970	< 39.8	
				<2255	≥ 39.8	
			12MO	<6680	< 44.5	
				<2524	≥ 44.5	

Table 36 -- Dummy Neck Measurements

Source	Test Type	Delta V (km/h)	Ages	Axial Force (N)	Y Moment (Nm)	Shear Force (N)
Planath et al.	Reconstruction w/ neck injuries	40	3YO	1150	31	370
	head injuries	50	3YO	2570	33	280
	no neck injuries	50	3YO	201/-404	14/-23	208/-70
Newman & Dalmotas	Reconstructions w/ head & neck injuries + variations	35-50	6YO	2145-3604	30.5-56	325-1185
Weber et al.	Reconstructions w/ neck injuries	50-55	6MO	1248	-6	-317
Troiselle & Tarriere	Reconstructions w/ neck injury	51	6MO	1248	-6	-317
	neck injury	57	6MO	2933	-41	-953
	head injury	73	6MO		-18	-563
	neck injury	40	3YO	1400	-22	-670
	head injury	73	3YO	3274	-13	-744
	head injury	73	6YO	1589	-14	-547
Janssen et al.	Reconstruction w/ neck injury	49	9MO	1765	2.2/-4.1	990
	Forward 4-pt CRS			1550	2.5/-3.4	830
	Forward shield CRS			1710	2.0/-4.1	920
	Rearward-facing CRS			730	4.0/-1.4	250
Kirkish	FMVSS 213 type rigid or booster	48	3YO	1047-3015	16-36	465-1822
				-10/-251	-6/-69	
			6YO	1572-2833	44-82	741-1326
				-42/-131	-23/-31	
VRTC	FMVSS 213 type restrained(3-pt or booster)	48	6YO	2521-4325	8-25	-365/-754
Weber	FMVSS 213 type forward-facing CRS rear-facing CRS	48	12MO	1089-2408 325-999	-13/46 -18/21	-1002/117 -531/386

Table 37 -- Estimated Neck Protection Reference Values						
Source	Approach	Estimated Degree of Injury	Ages	Load	Maximum	Time (ms)
VRTC	Scaling Hybrid III 50th: human-based	Low probability of serious injury	adult 6YO 3YO 12MO adult 6YO 3YO 12MO adult 6YO 3YO 12MO	axial force (N) shear force (N) y moment (Nm)	3300/-4000 1426/-1729 1083/-1313 765/-927 3100 1340 1018 718 190/-57 55/-17 39/-12 25/-8	
VRTC	Scaling Hybrid III 50th: dummy-based	Low probability of serious injury	6YO 3YO 12MO 6YO 3YO 12MO 6YO 3YO 12MO	axial force (N) shear force (N) y moment (Nm)	1486/-1801 1274/-1545 1094/-1326 1396 1197 1028 57/-17 46/-14 36/-11	
Mertz	Animal/dummy comparison	1% risk 10% risk 25% risk	3YO	axial force (N)	1060 1125 1160	≤15 ≤15 ≤15
Prasad/ Daniel	Animal/dummy comparison	Low risk	3YO	tension/ moment moment	see Figure 11 -29	
Sturtz	Pedestrian reconstructions	low probability of serious injury	~6	shear force (N) axial force (N) x/y moment (Nm)	880 -1900 90	
Planath et al.	Reconstructions	low probability of serious injury	3YO	shear force (N) axial force (N) x/y moment (Nm)	300 1000 30	
Janssen et al.	Scaling Hybrid III 50th	low probability of serious injury	0-18	See Figures 29 & 30		
Mertz	Scaling of adult volunteer data	low probability of serious injury	6YO 3YO 6YO 3YO	flexion moment (Nm) extension moment (Nm)	68 58 24 21	

Table 38 -- Dummy Chest Measurements						
Source	Test Type	Delta V (km/h)	Ages	Peak Resultant Acceleration (g)	Chest 3ms Clip (g)	Defl. (mm)
Planath et al.	Reconstruction w/ neck injuries head injuries	40 50	3YO 3YO	50 54		
Weber et al.	Reconstructions w/ neck injuries	50-55	6MO	41		
Troiselle & Tarriere	Reconstructions w/ neck injury neck injury head injury neck injury head injury head injury	51 57 73 40 73 73	6MO 6MO 6MO 3YO 3YO 6YO	41 NA 186 30 51 46		
Janssen et al.	Reconstruction w/ neck injury	49	9MO		56.5	
Kahane	FMVSS 213 type (avg. torso g's) restrained misuse unrestrained restrained misuse unrestrained restrained misuse unrestrained	24 24 24 40 40 40 56 56 56	3YO 3YO 3YO 3YO 3YO 3YO 3YO 3YO 3YO	26-52 61-99 81-115 37-66 69-164 102-210 38-70 85-161 81-232		
Kirkish	FMVSS 213 type rigid or booster	48	3YO 6YO	46-57 42-59	43-57 41-56	19-28 17-32
VRTC	FMVSS 213 type restrained(3-pt or booster) misuse misuse misuse	48	6YO 6YO 3YO 9MO		39-65 42-53 34-60 43-61	
Weber	FMVSS 213 type forward-facing rear-facing	48	12MO		30-46 35-41	

Table 39 -- Estimated Chest Protection Reference Values

Source	Approach	Estimated Degree of Injury	Ages	Maximum Acceleration (g)	V*C (m/s)	Delta V (m/s)	Time (ms)
VRTC	Scaling Hybrid III 50th: human-based	Low probability of serious injury	adult	60	17		3
			6YO	73	11.5		3
			3YO	58	12.0		3
			12MO	43	13.4		3
VRTC	Scaling Hybrid III 50th: dummy-based	Low probability of serious injury	6YO	109	9.4		3
			3YO	123	8.3		3
			12MO	135	7.6		3
Mertz	Animal/dummy comparison (upper spine acceleration)	1% risk 10% risk 25% risk	3YO	55		2.50	≤4
				59		4.44	≤4
				62		5.28	≤4
Sturtz	Pedestrian reconstruction	Low probability of serious injury	6YO	55			300
ECE R 44		Low probability of serious injury	children	55			3

5.0 CONCLUSIONS

From this overview of protection reference values development approaches, no single method or set of data stands out clearly as the best choice, because actual biomechanical data are insufficient and of limited applicability. The following points should be considered when choosing a technique for developing PRV:

- ◆ PRV estimates generated from a particular loading condition with a specific dummy may not apply directly to other dummies or loading conditions. In particular, frontal impact test results are not necessarily suited to develop out-of-position PRV.
- ◆ Injury criteria for humans will most likely not apply directly to dummies because of the dummy's imperfect biofidelity.
- ◆ When developing PRV for a particular dummy, reconstruction tests should preferably be run with that particular model of dummy to account for possible dummy differences.
- ◆ Both biomechanical and accident reconstruction testing is needed to provide more information about injury criteria and PRV.
- ◆ Different techniques for developing PRV are available, although they are not necessarily consistent with each other.

6.0 RECOMMENDATIONS

The information in this report is incomplete and has many shortcomings. In addition, many of the methods of applying these data as described in the following paragraphs have not been substantiated through biomechanical testing. These methods, as well as the basic criteria, are subject to change with future analyses and testing. However, this represents the best available collection of data for establishing estimates of injury potential to children in out-of-position (OOP) impact environments. To choose from among the different options, engineering judgement was applied to select those values that were the most appropriate and reasonably supportable for the intended purpose. These values may be used as references in research programs but should not necessarily be used as rigid limits. Most of the values are rounded off, since extra significant digits imply a certainty that is not characteristic of these data. Whenever possible, data from specific dummies in similar impact environments were pooled together, because dummy design characteristics can lead to response differences. While additional research is suggested, use of the protection reference values developed in this section for OOP children is recommended until more substantive data becomes available. A brief discussion of the rationale for each specific selection is also included.

These recommendations are intended for use with the CRABI 12-month-old and the Hybrid III 3- and 6-year-old child dummies. The CRABI dummy is considered to be “out-of-position” when it is restrained in a rear-facing child seat in front of a deploying passenger side air bag. The primary source of reference values for the 12 month CRABI dummy was through scaling of Melvin’s data for the 6 month CRABI (see Table 32). Both dummy-based and human-based approaches were taken, with relatively small differences between them. Before accepting these scaled numbers, the values were compared to rear-facing child restraint data collected by Weber (Table 24) using the CRABI 12MO. The primary sources for out-of-position testing on the larger dummies is the Mertz et al. and Prasad/Daniel pig testing. Comparable tests were subsequently conducted using three-year-old dummies; the values were scaled up to a six-year-old size in Table 31. Recommended protection reference values for these three dummies for OOP testing are summarized in Table 40. A discussion and rationale for these recommendations follows.

Reconciliation of the HIC values from the various sources is very difficult due to the wide variety of approaches taken to establish reference values. The 12 mo. CRABI HIC value of 500 was based upon scaling of adult PRV by Melvin and comparison with dummy HIC response measurement in sled testing. Mertz (Table 10) associated a 1480 HIC (15 msec) for the three year old dummy with a 1% risk of serious injury based upon comparison with OOP animal tests. HIC of 1000 has been an established limit for both adult and child dummies for many years, and is proven to be effective in limiting serious injury. Analysis of adult cadaver head impacts by the U.S. delegation to the ISO working group [Prasad and Mertz] included injury risk estimates for given levels of HIC. They found that a HIC level of 1500 was associated with a 56 percent risk of serious injury, while the risk of serious injury for HIC of

1000 was reduced to 16 percent. Another approach was developed by NHTSA using the concept of censored data, and a lognormal distribution (NHTSA, Final Economic Assessment, FMVSS No. 201, Upper Interior Head Protection, Office of Regulatory Analysis, Plans and Policy, June 1995). This approach acknowledges the fact that all registered HICs are within, but not equal to, the injury threshold level. These lognormal curves predict a 43 percent change of a MAIS 3 or greater injury at a HIC level of 1500 and a 23 percent chance of injury at a HIC level of 1000. These injury risks are in stark contrast to the animal based HIC vs. injury risk noted above. More data are needed to resolve these differences and gain further insight into the validity of assumptions which must be made to establish with certainty child injury HIC reference values. For the purposes of consolidating this information into a unified PRV for the child dummy, Table 40 recommends a HIC(36) value of 500 for the 12 month CRABI, and a HIC of 1000 for the three and six year old dummies. While scaling suggests consideration of higher HIC levels might be warranted for the older child dummies, uncertainties related to the appropriateness of this process from adult to children leads us to recommend that the level of 1000 be retained to assure adequate protection levels. The HIC of 1000 has been shown to be effective, and would tend to provide a conservative level of protection. The HIC of 500 for the 12 month CRABI is justified based upon the Melvin studies and upon the observation in accident data which shows the occurrence of bi-lateral parietal bone fractures for OOP children in rear facing child restraints.

Table 40 -- Hybrid III/CRABI OOP Child Protection Reference Values			
Dummy Size	12 MO	3 Year	6 Year
HIC(36)	500	1000	1000
Peak Head Acceleration (g)	80	80	80
Head Angular Velocity I (r/s)	≥ 37	≥ 34	≥ 33
Head Angular Acceleration I (r/s ²)	<2500	<2200	<2100
Neck Tension/Extension, N_{TE} Neck Tension/Flexion, N_{TF} Neck Compression/Extension, N_{CE} Neck Compression/Flexion, N_{CF}	$N_{ij} \leq 1$ and, $N_{ij} \leq 1 - 0.02222 \Delta t$ for $0 < \Delta t < 30 \text{ msec}$ $N_{ij} \leq 0.333$ for $\Delta t \geq 30 \text{ msec}$ See Table 41 and Figure 35-36		
Chest Acceleration (g) (Spinal)	60	60	60
V*C (m/sec)	1.0	1.0	1.0

Reference values for both head translational and rotational accelerations are recommended for further consideration. PRV for head translational accelerations are based upon the various sources found in Table 34. However, the human and dummy based scaling approaches provided considerably different values. A level of 80 g seemed to be a general average of these two scaling approaches, and was in general agreement with the Sturtz studies which indicated low probability of head injury associated with an 80 g acceleration level. The rotational acceleration limits, although containing significant uncertainties, were based upon scaling of the Ommaya recommendations (Table 8).

Both accident and laboratory data suggest that multiple neck loadings occur in OOP test conditions. These neck loadings can be combinations of shear, either axial tension or compression, and flexion or extension. The analysis of Prasad and Daniel indicate that the amount of neck tension and moment which can be sustained is interdependent. The interdependency was represented as a linear relationship between peak tension and peak moment when these parameters were cross plotted. Testing by Kirkish and Klinich show tolerance to higher moments in flexion. GM Injury Assessment Reference Values (Appendix) show time duration dependencies for neck axial and fore/aft shear loadings. The neck loading information taken from the various sources are summarized in Figures 32 - 35 with scaled values included for all three child dummies. These data were used as critical measurement parameters. The critical values used to establish neck PRV for the child dummies were taken from these figures and are shown in Table 41. They were specifically selected for each individual dummy and do not represent actual human injury thresholds.

Table 41 -- Neck Measurement Critical Values for Child Dummies				
Dummy	Tension (N)	Compression (N)	Flexion Moment (N-m)	Extension Moment (N-m)
12 month	2000	2000	50	20
3 year	2500	2500	60	30
6 year	3000	3000	70	35

As indicated above, assessment of neck injury potential requires consideration of axial load, shear load, and moments measured in the neck. The most notable fatal injury observed in real-world crashes involving out-of-position airbag interaction with children is the atlanto-occipital dislocation. This injury can be related to a combination of axial tension force and extension moment. A normalized neck PRV for tension/extension is defined below to assess the risk of neck injury. The 6 year old child dummy values are used to demonstrate the process

Neck Tension vs. Extension

Child Dummy PRV

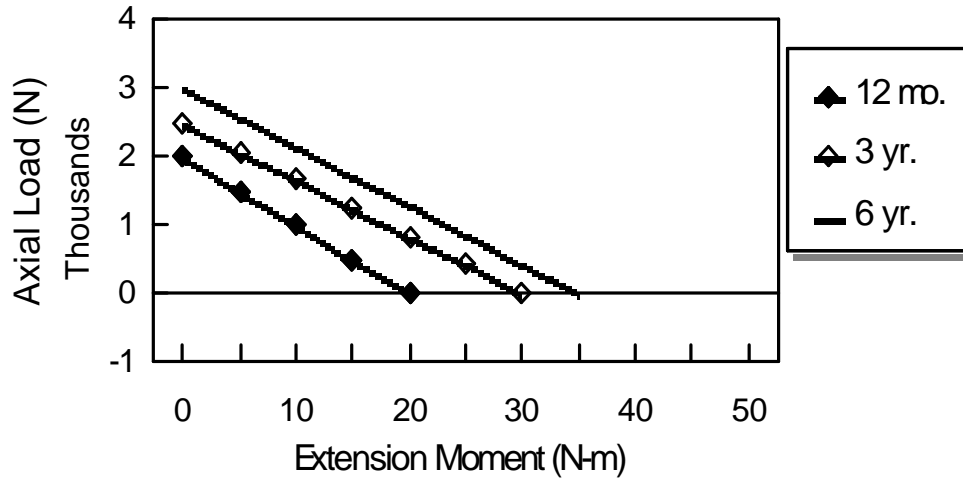

Figure 32 -- Neck axial load vs. extension moment PRV

Neck Tension vs. Flexion

Child Dummy PRV

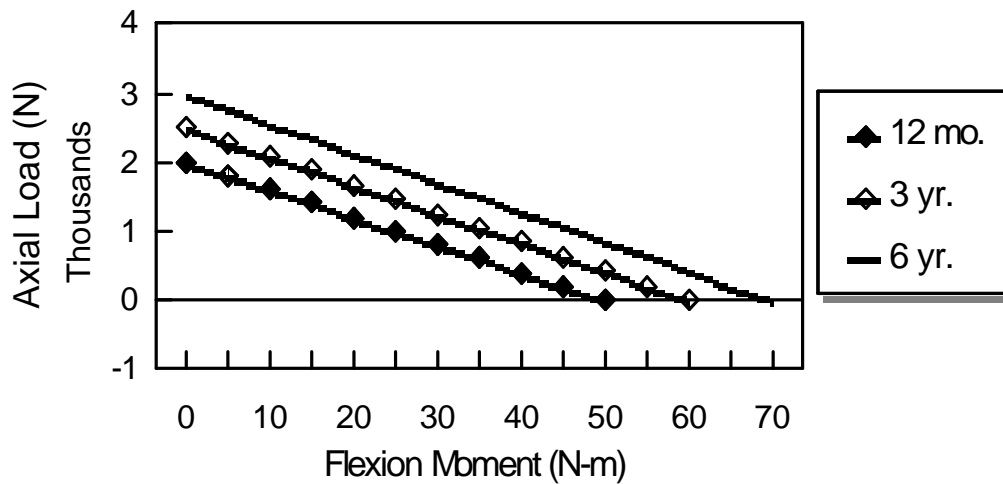

Figure 33 -- Neck axial load vs. flexion moment PRV

Axial tension and extension moment are used for this injury mode. To compensate for rotation of the head with respect to the neck, the resultant of tension and shear loads measured in the head mounted load cell is used to represent axial tension.

$$F_R = \sqrt{F_x^2 + F_z^2}$$

where F_R = resultant load, F_x = measured fore/aft shear load, and F_z = measured axial tension load. The normalized axial load, F_R' , is equal to the resultant axial load divided by the reference value from Table 41 (3000N for the 6 year old dummy):

$$F_R' = \frac{F_R}{3000} \quad (6 \text{ yr. old dummy})$$

The normalized extension moment (M'_{ext}) is equal to the measured extension moment (M_{ext}) divided by the reference value from the table (35 N-m for the 6 year old dummy).

$$M'_{\text{ext}} = M_{\text{ext}} / 35 \quad (6 \text{ yr. old dummy})$$

A normalized tension versus moment plot (Figure 36) can be constructed, where the limits for both axes are unity. If the data plotted on these axes falls above the straight line connecting (0,1) with (1,0) for any period of time, then the neck PRV for the dummy test has been exceeded. In equation form, this requirement becomes:

$$N_{TE} = F'_R + M'_E \leq 1$$

where, N_{TE} denotes the neck requirement for the tension/extension condition.

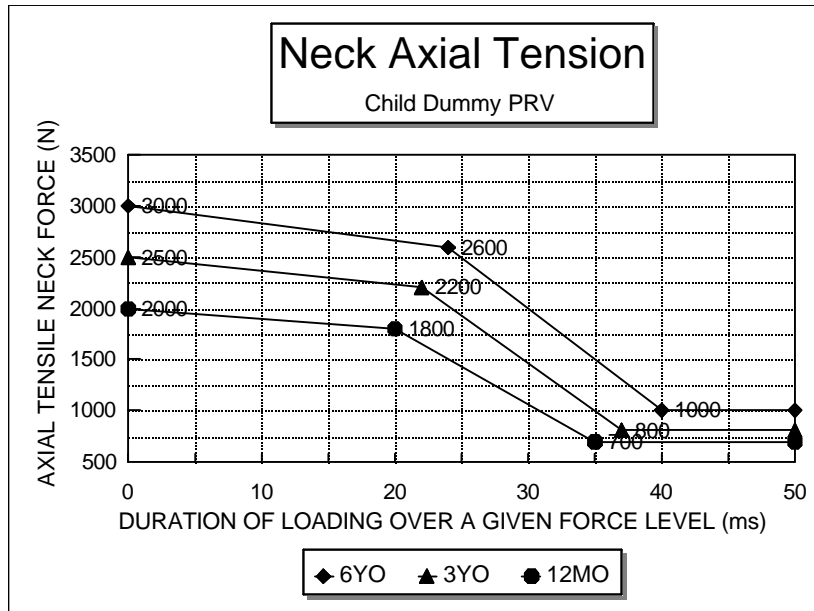

Figure 34 -- Neck axial load vs. time duration PRV

INJURY ASSESSMENT REFERENCE CURVE FOR FORE/AFT
NECK SHEAR FORCE MEASURED AT THE OCCIPITAL CONDYLES

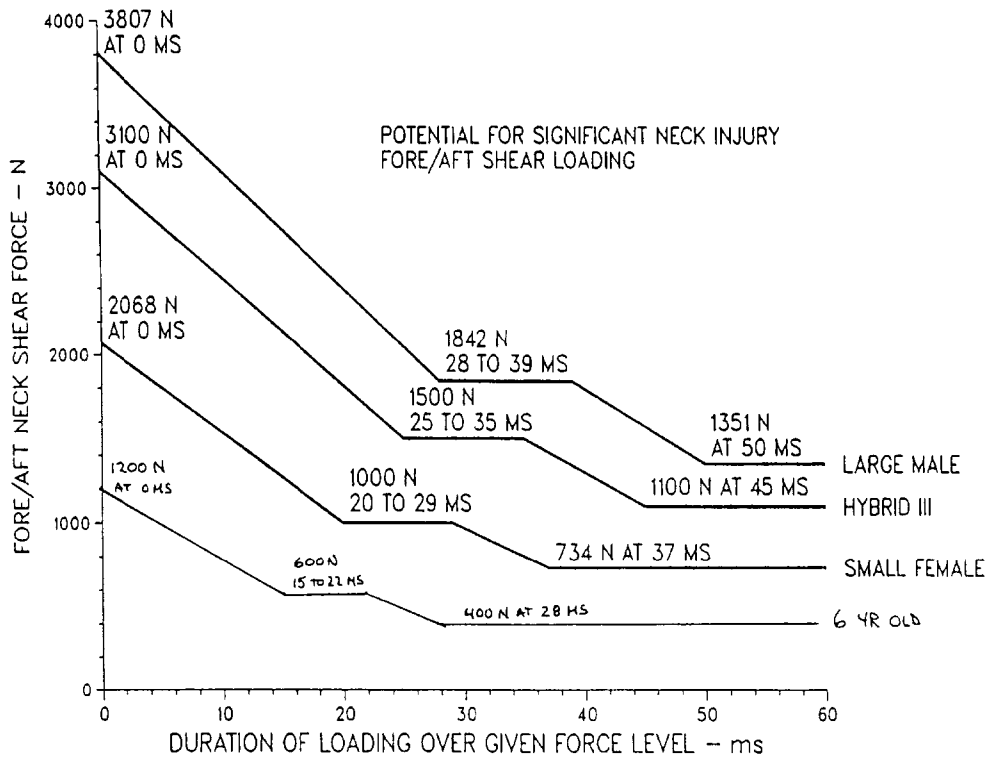

Figure 35 -- Fore/aft neck shear vs. Time duration (from GM IARV)

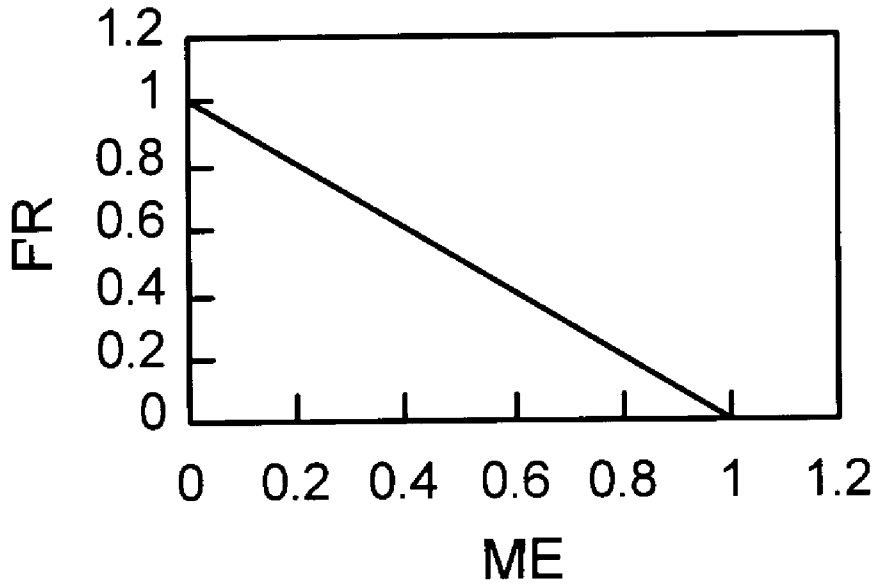

Figure 36 -- Normalized tension vs. moment requirement

The sum of the normalized axial tension and normalized moment are then plotted against the time duration that each sum exceeds a certain value, and this becomes the requirement to be met (Figure 36). The instantaneous limit for this sum equals 1.0 and drops down to 0.333 at a time duration of 30 msec. The 30 msec limit and the 3 to 1 ratio of instantaneous to long duration force values was based upon the observation from Figures 34 and 35 that the loads which could be sustained beyond approximately 30 msec were about one-third the instantaneous loading levels. As in the normalized tension versus moment plot, if the data fall above the bilinear reference curve, then the test has failed.

The normalized neck PRV plots (Figures 36 and 37) will look identical for all of the dummies and for all injury modes (tension-flexion, compression-flexion, tension-extension, and compression-extension). The only differences are that the critical values from Table 41 will vary and that different components of the measured loads will be used in the equations. For example, for compression-flexion injury risk assessment, a normalized axial compression (resultant of measured negative Fz and Fx) will be combined with a normalized flexion moment, using the appropriate numbers from the table for a given dummy.

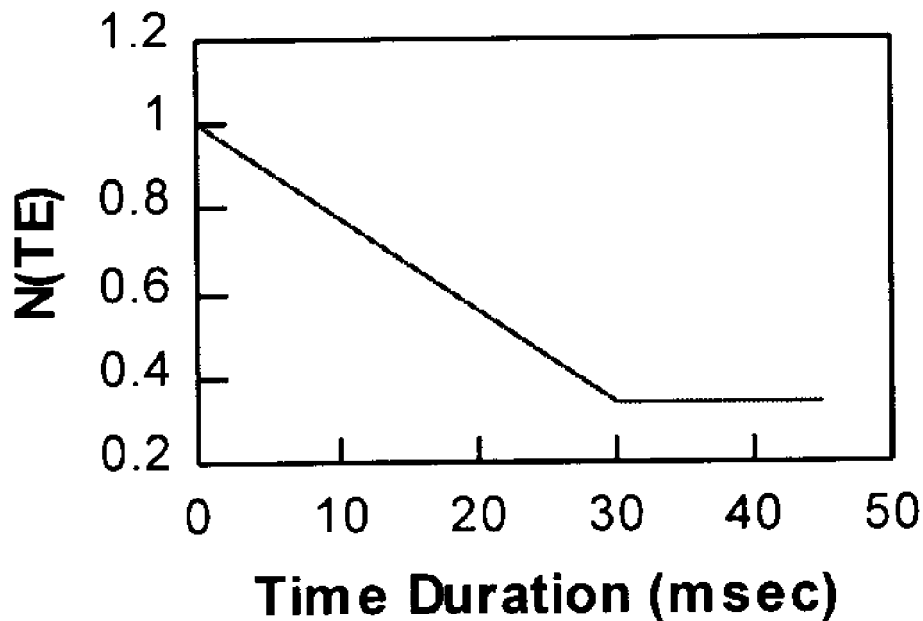

Figure 37 -- Neck tension/extension time duration requirement

Finally, for the chest PRV, the 60g spinal acceleration limit was applied based upon the Mertz reference values from Table 10. Mertz also suggested reference values for sternal velocity. However, rather than using the sternal velocity, the more recently developed viscous criterion was adopted as a limit.

In summary, the PRV shown in Table 40 represent tolerance levels derived from the literature for out-of-position testing with the 12 month CRABI and Hybrid III 3 and 6 year old dummies. While considerable gaps exist in the knowledge base for child injury tolerance levels, these protection reference values appear to encompass the existing information. Further biomechanical and accident reconstruction work is recommended to expand the existing data base, which would support the development of improved injury criteria and more substantiated protection reference values.

7.0 REFERENCES

- Beusenberg, M. C. et al., *Status of Injury Biomechanics for the Development of Child Dummies*, **Child Occupant Protection**, SAE #933104, 1993.
- Brun-Cassan, F., et al., *Comparative Study of Restrained Child Dummies and Cadavers in Experimental Crashes*, **Child Occupant Protection**, SAE #933105.
- Burdi, A. R. et al, *Infants and Children in the Adult World of Automobile Safety Design: Pediatric and Anatomical Considerations for Design of Child Restraints*, **Journal Biomechanics**, Vol. 2, pp. 267-280, 1969.
- Currey, J. D., Butler, G., *The Mechanical Properties of Bone Tissue in Children*, **J Bone Joint Surgery**, Vol 57A, no. 6, pp. 810-814., 1975.
- Daniel, R. P., Prasad, P., personal communication to K. D. Klinich, 4-96.
- Dejeammes, M. et al., *Exploration of Biomechanical Data Toward a Better Evaluation of Tolerance for Children Involved in Automotive Accidents*, **Twenty-Eighth Stapp Car Crash Conference Proceedings**, SAE #840530.
- Eichelberger, M. R., **Pediatric Trauma: Prevention, Acute Care, Rehabilitation**, Mosby-Year Book, Inc., 1993.
- Elias, J. C., Monk, M. W., *NHTSA Pedestrian Thoracic Injury Mitigation Program-Status Report*, **12th ESV Conference Proceedings**, 896148, 1989.
- Enouen, S. W., *Development of Experimental Head Impact Procedures for Simulating Pedestrian Head Injury*, Thirtieth Stapp Car Crash Conference Proceedings, SAE #861888, 1986.
- First Technology Safety Systems, Product Catalog, 1995.
- Foust, D. R., Bowan, B. M., Snyder, R. G., *Study of Human Impact Tolerance Using Investigations and Simulations of Free-falls*, **Twenty-first Stapp Car Crash Conference Proceedings**, SAE #770915, 1977.
- Henderson, M., Brown, J., Paine, M., *Injuries to Restrained Children*, **38th Annual Proceedings Association for the Advancement of Automotive Medicine**, 1994.

Hirsch, C., Evans, F., G., *Studies on Some Physical Properties of Infant Compact Bone*, **Acta Orthop. Scandinav.**, Vol. 35, pp.300-313, 1965.

Hubbard, R. P., *Flexure of Layered Cranial Bone*, **Journal Biomechanics**, Vol 4, pp. 251-263, 1971.

Huelke, D. F., et al. *Cervical Fractures and Fracture Dislocations without Head Impacts Sustained by Restrained Occupants*, **36th Annual Proceedings Association for the Advancement of Automotive Medicine** 1992.

Irwin, A. L., personal communication to K. D. Klinich, regarding techniques used to scale response requirements for 6-year-old Hybrid III dummy, October 6, 1993.

Janssen, E. G., et al., *Cervical Spine Loads Induced in Restrained Child Dummies II*, **Child Occupant Protection**, SAE #933102, 1993.

Janssen, E. G., et al., *Cervical Spine Loads Induced in Restrained Child Dummies*, **Thirty-fifth Stapp Car Crash Conference Proceedings**, SAE #912919, 1991.

Kahane, C. J., **An Evaluation of Child Passenger Safety: The Effectiveness and Benefits of Safety Seats**, National Traffic Safety Administration, DOT HS 806 890, 1986.

Kahane, C. J., Clark, C. C., Khadilkar, A., *Evaluation of Child Safety Seats Based on Sled Tests*, **Thirty-first Stapp Car Crash Conference Proceedings**, SAE #872210, 1987.

Kallieris, D., et al., *Comparison Between Child Cadavers and Child Dummy by Using Child Restraint Systems in Simulated Collisions*, **Twentieth Stapp Car Crash Conference Proceedings**, SAE #760815, 1976.

Kirkish, S., *Comparison of the NHTSA & Hybrid III Child Dummies*, attachment I to minutes of the Hybrid III Dummy Family Task Group, October 18, 1995.

Kirkish, S., personal communication to K. D. Klinich, regarding Ford dummy evaluation tests, February 1996.

Klinich, K. D., Beebe, M. S., **Feasibility of a Six-Year-Old Dummy Upper Neck Load Cell**, National Highway Traffic Safety Administration Vehicle Research and Test Center, 1994.

Klinich, K. D., Burton, R. W., *Injury Patterns of Older Children in Automotive Accidents*, **Child Occupant Protection**, SAE #933082, 1993.

Klinich, K. D., et al., **Study of Older Child Restraint/Booster Seat Fit and NASS Injury Analysis**, National Highway Traffic Safety Administration, DOT HS 808 248, 1994.

Kromrei, J. E., personal communication to K. D. Klinich, regarding General Motors' Injury Assessment Reference Values for Hybrid III 3-year-old, 6-year-old, and CRABI 6-month old, February 2, 1996.

MacLaughlin, T. F., Hoyt, T. A., Chu, S., *NHTSA's Advanced Pedestrian Protection Program*, **11th ESV Conference Proceedings**, SAE #876100.

Margulies, S. S., Thibault, L. E., *A Proposed Tolerance Criterion for Diffuse Axonal Injury in Man*, **Journal Biomechanics**, Vol. 25, No.8, pp. 917-923, 1991.

McPherson, G. K., Kriewall, T. J., *The Elastic Modulus of Fetal Cranial Bone: A First Step Toward an Understanding of the Biomechanics of Fetal Head Molding*, **Journal Biomechanics**, Vol 13, No. 1, pp. 9-16, 1978.

Melvin, J. W., Weber, K., Lux, P., *Performance of Child Restraints in Serious Crashes*, **24th Annual Proceedings Association for the Advancement of Automotive Medicine**, 1980.

Melvin, J. W., **Injury Assessment Reference Values for the CRABI 6-month Infant Dummy in a Rear-Facing Infant Restraint with Air Bag Deployment**, SAE International Congress and Exposition, SAE # 950872, 1995.

Mertz, H. J., personal communication to K. D. Klinich, 4-96.

Mertz, H. J., *Anthropomorphic Test Devices*, **Accidental Injury--Biomechanics and Prevention**, ed. Nahum, Springer-Verlag, 1993.

Mertz, H. J., et al., *Responses of Animals Exposed to Deployment of Various Passenger Inflatable Restraint System Concepts for a Variety of Collision Severities and Animal Positions*, **Ninth ESV Conference Proceedings**, SAE #826047, 1982.

Mertz, H. J., Weber, D. A., *Interpretations of the Impact Responses of a 3-year-old Child Dummy Relative to Child Injury Potential*, **Ninth ESV Conference Proceedings**, SAE #826048, 1982.

Mertz, H. J., et al., *Size, Weight, and Biomechanical Impact Response Requirements for Adult Size Small Female and Large Male Dummies*, SAE International Congress and Exposition, SAE #890756, 1989.

Newman, J. A., Dalmotas, D., *Atlanto-occipital Fracture Dislocation in Lap-Belt Restrained Children*, **Child Occupant Protection**, SAE #933099.

Ommaya, A. K., *Biomechanics of Head Injury: Experimental Aspects*, **The Biomechanics of Trauma**, eds. Nahum, A. M, Melvin, J., Prentice-Hall, 1985.

Ommaya, A. K., Hirsch, A. E., *Tolerance for Cerebral Concussion from Head Impact and Whiplash in Primates*, **Journal Biomechanics**, Vol. 4, pp. 13-21, 1971.

Ommaya, A. K., et al., *Scaling of Experimental Data on Cerebral Concussion in Subhuman Primates to Concussion Threshold for Man*, **Eleventh Stapp Car Crash Conference Proceedings**, SAE #670906, 1967.

Planath, I., Rygaard, C., Nilsson, S., *Synthesis of Data Towards Neck Protection Criteria for Children*, **IRCOBI Conference Proceedings**, 1992.

Prasad, P., Daniel, R. P., *A Biomechanical Analysis of Head, Neck and Torso Injuries to Child Surrogates Due to Sudden Torso Acceleration*, **Twenty-eighth Stapp Car Crash Conference Proceedings**, SAE #841656, 1984.

Schneider, L. w., et al., **Development of Anthropometrically Based Design Specifications for an Advanced Adult Anthropomorphic Dummy Family**, Department of Transportation, 1983.

Snyder, R. G., *Impact Injury Tolerances of Infants and Children in Free-fall*, **13th Annual Proceedings Association for the Advancement of Automotive Medicine**, 1969.

Snyder, R. G., et al., **Anthropometry of Infants, Children and Youths to Age 18 for Product Safety Design**, Highway Safety Research Institute, UM-HSRI-77-17, 1977.

Stalnaker, R. L., *Spinal Cord Injuries to Children in Real World Accidents*, **Child Occupant Protection**, SAE #933100, 1993.

Sturtz, G., *Biomechanical Data of Children*, **Twenty-fourth Stapp Car Crash Conference Proceedings**, SAE #801313, 1980.

Sullivan, L. K., **Investigation of Child Restraint Misuse and Incompatibility and Evaluation of ISOFIX Child Restraints**, National Highway Traffic Safety Administration, memorandum report VRTC-82-0236, May 11, 1995.

TNO Child Dummy Manual

Trosseille, X., Tarriere, C., *Neck Injury Criteria for Children from Real Crash Reconstructions*, **Child Occupant Protection**, SAE #933103, 1993.

Weber, K, Dalmotas, D., Hendrick, B., *Investigation of Dummy Response and Restraint Configuration Factors Associated with Upper Spinal Cord Injury in a Forward-facing Child Restraint*, **Child Occupant Protection**, SAE #933101, 1993.

Weber, K., *CRABI 12 Month Dummy Evaluation*, Submitted to SAE CRABI Task Force, 11-94.

Wismans, J. S. H. M., et al., *Child Restraint Evaluation by Experimental and Mathematical Simulation*, **Twenty-third Stapp Car Crash Conference Proceedings**, SAE #791017, 1979.

Wood, J. L., *Dynamic Response of Human Cranial Bone*, **Journal Biomechanics**, Vol 4, pp. 1-12, 1971.

Wolanin, M. J., et al., *Description and Basis of a 3YO Child Dummy for Evaluating Passenger Inflatable Restraint Concepts*, **9th ESV Conference Proceedings**, 1982.

Yamada, H., **Strength of Biological Materials**, Williams & Wilkins Co., 1970.

APPENDIX A

General Motors Injury Assessment Reference Values for Child Dummies

**Application of
Injury Assessment Reference Values
(IARVs)**

Injury Assessment Criteria	Dummy Type		
	CRABI 6 month old	Hybrid III ⁽¹⁾ 3 year old	Hybrid III 6 year old
<u>HEAD</u>			
HIC (t ₂ - t ₁) limit	390 (22 ms)	1000 (15 ms)	1140 (15 ms)
Peak Res. Accel. (G)	50	--	--
<u>NECK</u>			
Flexion (Nm)	16.4	35	45
Extension (Nm)	5	10	13
Tension (N)	500	1000	Figure 1
Compression (N)	606	1212	Figure 2
Shear (N)	470	939	Figure 3
<u>CHEST</u>			
Resultant Accl. (G)	50	--	97
Sternal Deflect. (mm)	--	--	60
Upper Spine (G)	--	50	--
Lower Spine (G)	--	35	--
Upr Sternum ΔV (km/h)	--	10	--
Lwr Sternum ΔV (km/h)	--	20	--
<u>FEMUR</u>			
Compression (N)	--	--	Figure 4

(1) Development of Hybrid III 3-year-old is not completed. A prototype dummy is available and could be used in NHTSA's program if SAE Hybrid III Dummy Family Task Group agrees.

INJURY ASSESSMENT REFERENCE CURVE FOR AXIAL NECK TENSION LOADING

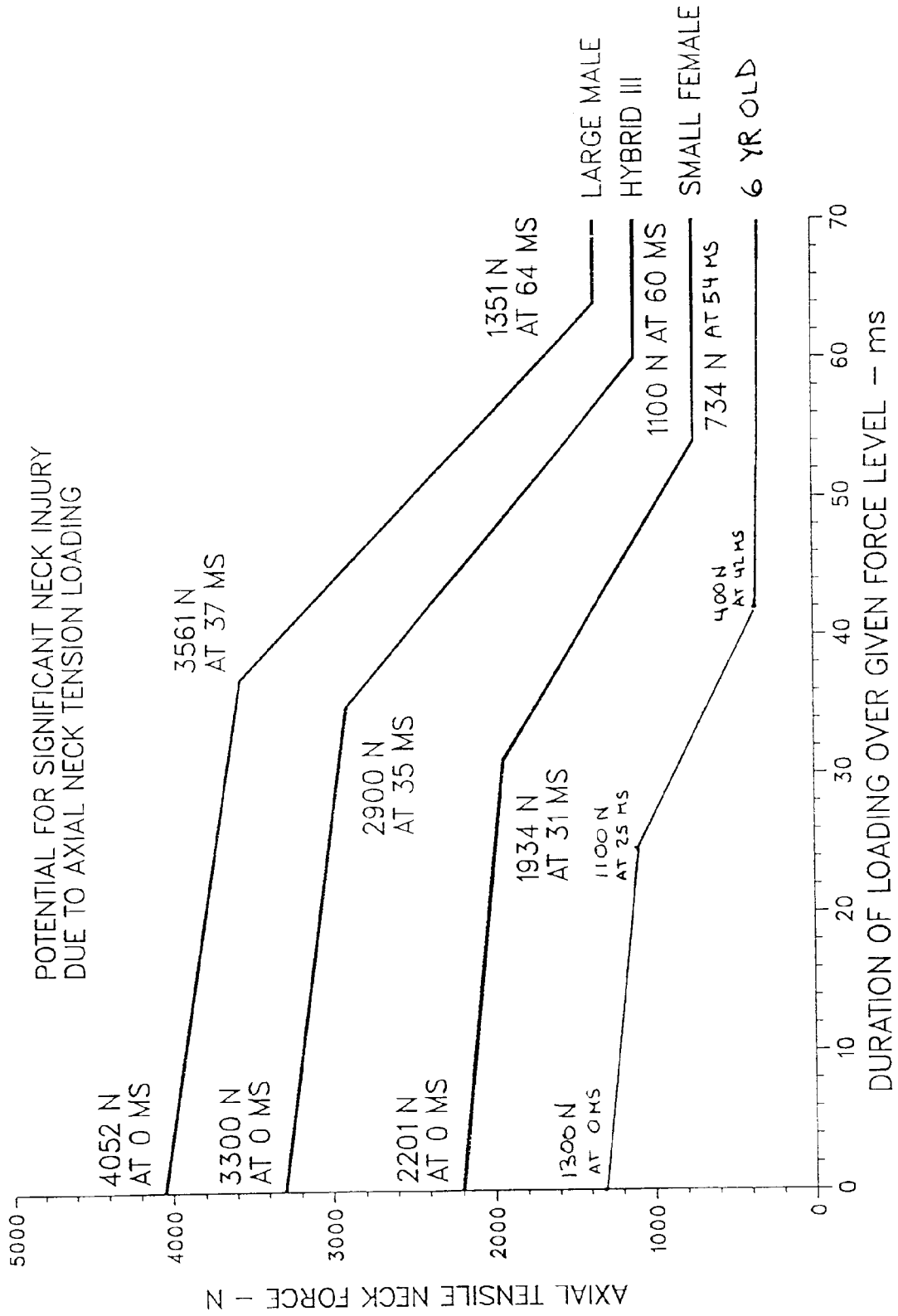

Figure A1

INJURY ASSESSMENT REFERENCE CURVE FOR AXIAL NECK COMPRESSION LOADING

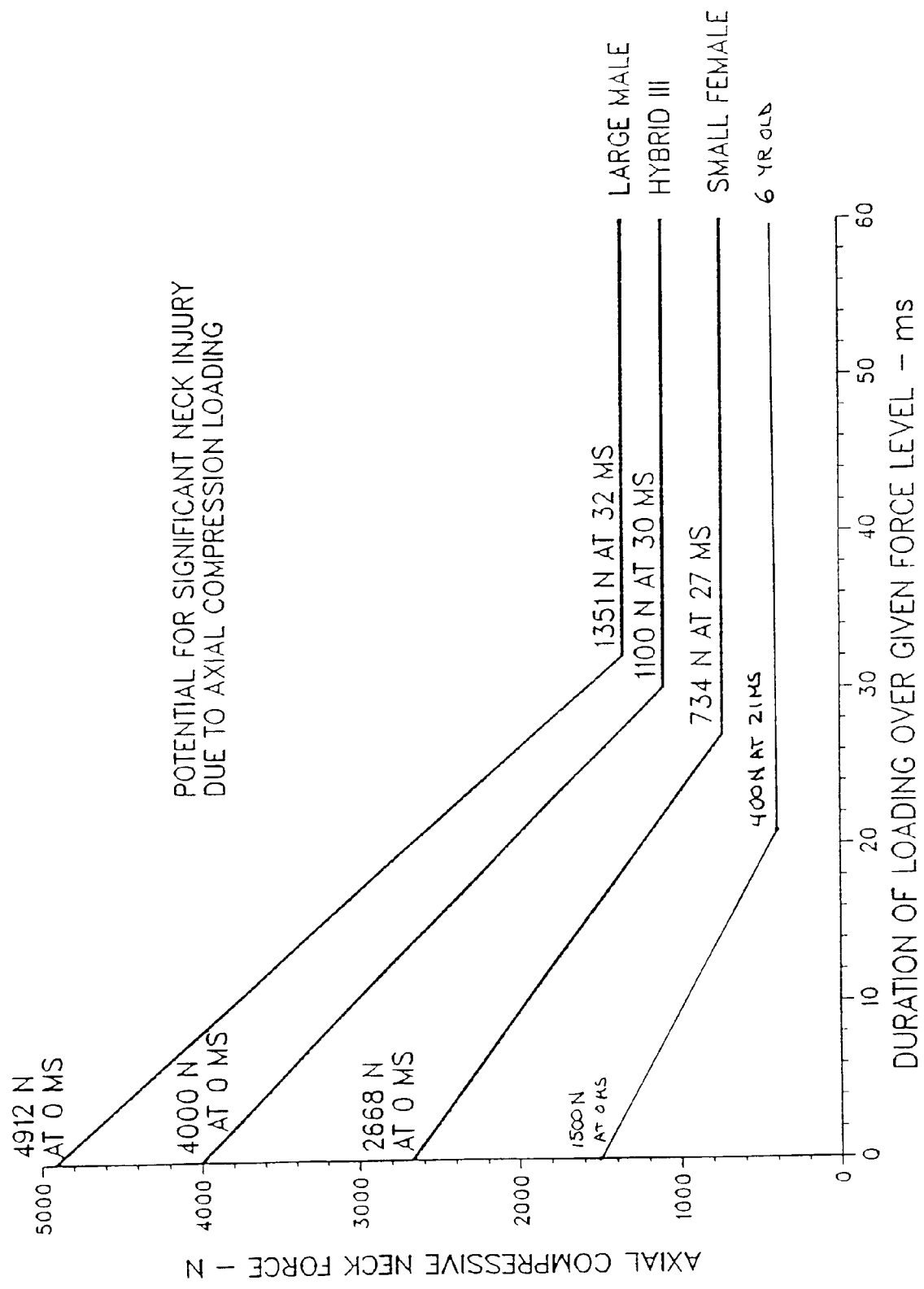

Figure A2

INJURY ASSESSMENT REFERENCE CURVE FOR FORE/AFT
NECK SHEAR FORCE MEASURED AT THE OCCIPITAL CONDYLES

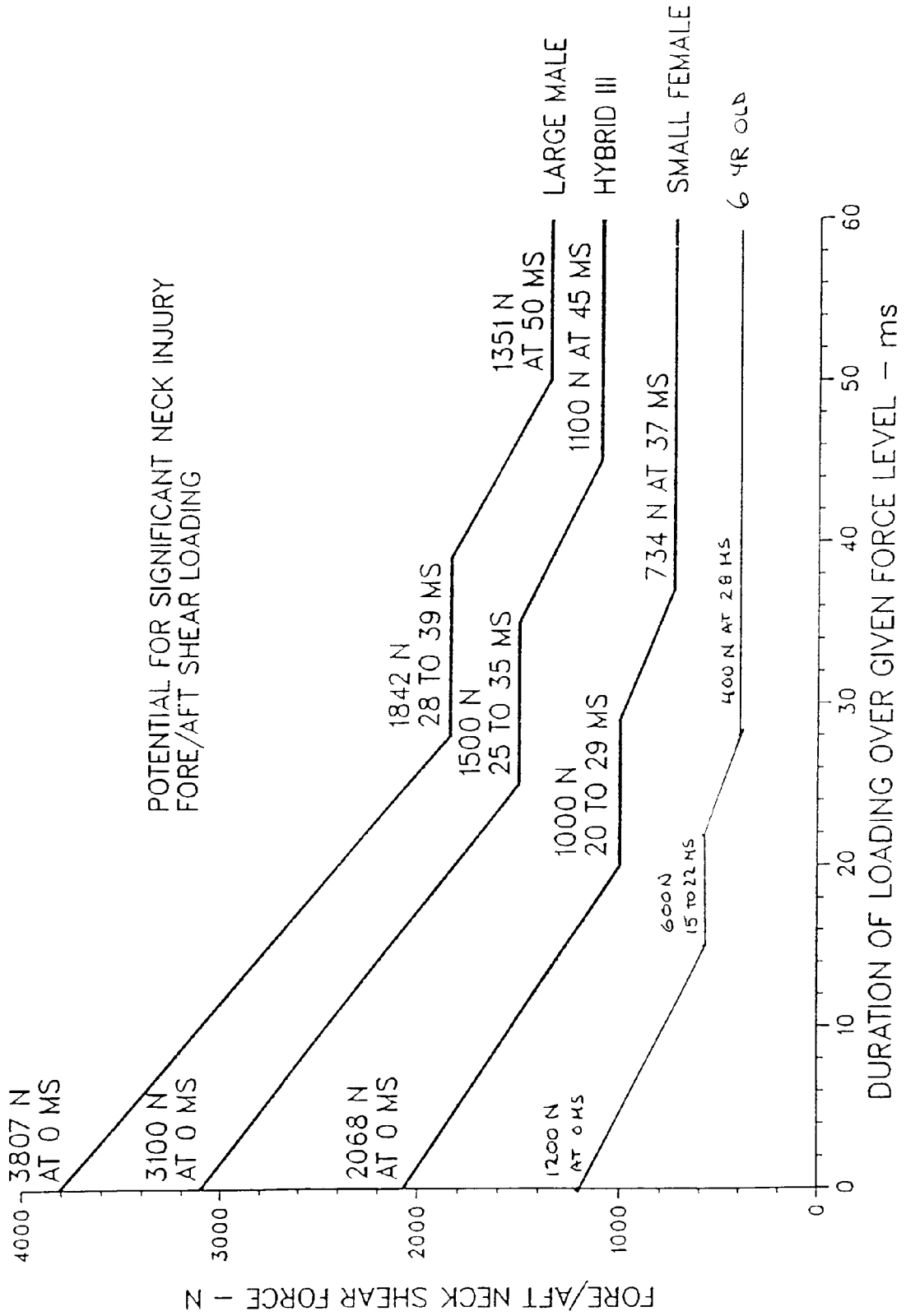

Figure A3