



PART 10

Traffic Controls for Highway-Light Rail Transit Grade Crossings

MUTCD 2000

Manual on Uniform Traffic Control Devices

m i l l e n n i u m e d i t i o n

December 2000

Including Errata No. 1 dated June 14, 2001



U.S. Department
of Transportation

**Federal Highway
Administration**

PART 10. TRAFFIC CONTROLS FOR HIGHWAY-LIGHT RAIL TRANSIT GRADE CROSSINGS

TABLE OF CONTENTS

	<u>Page</u>
CHAPTER 10A. GENERAL	Dec. 2000
Section 10A.01 Introduction	10A-1
Section 10A.02 Use of Standard Devices, Systems, and Practices	10A-2
Section 10A.03 Uniform Provisions	10A-2
Section 10A.04 Highway-Light Rail Transit Grade Crossing Elimination	10A-3
Section 10A.05 Temporary Traffic Control Zones	10A-3
CHAPTER 10B. HIGHWAY-LIGHT RAIL TRANSIT GRADE CROSSING CONTROL SYSTEMS	Dec. 2000
Section 10B.01 Introduction.....	10B-1
CHAPTER 10C. SIGNS, ILLUMINATION, AND MARKINGS	Dec. 2000
Section 10C.01 Introduction.....	10C-1
Section 10C.02 LOOK Sign (R15-8).....	10C-1
Section 10C.03 STOP or YIELD Signs (R1-1, R1-2, W3-1a, W3-2a).....	10C-1
Section 10C.04 DO NOT STOP ON TRACKS Sign (R8-8).....	10C-2
Section 10C.05 STOP HERE ON RED Sign (R10-6)	10C-2
Section 10C.06 Light Rail Transit-Activated Blank-Out Turn Prohibition Signs (R3-1a , R3-2a).....	10C-4
Section 10C.07 Divided Highway With Light Rail Transit Crossing Signs (R15-7 Series).....	10C-4
Section 10C.08 No Vehicles On Tracks Signs (R15-6, R15-6a)	10C-5
Section 10C.09 Light Rail Transit Only Lane Signs (R15-4 Series).....	10C-5
Section 10C.10 Do Not Pass Light Rail Transit Signs (R15-5, R15-5a).....	10C-6
Section 10C.11 Highway-Rail Advance Warning Signs (W10 Series)	10C-8
Section 10C.12 Light Rail Transit Approaching-Activated Blank-Out Warning Sign (W10-7).....	10C-9
Section 10C.13 Light Rail Station Sign (I-12).....	10C-9
Section 10C.14 Illumination at Highway-Light Rail Transit Crossings	10C-9
Section 10C.15 Dynamic Envelope Delineation Markings	10C-9
CHAPTER 10D. HIGHWAY-LIGHT RAIL TRANSIT ACTIVE TRAFFIC CONTROL GRADE CROSSING SYSTEMS	Dec. 2000
Section 10D.01 Introduction	10D-1
Section 10D.02 Four-Quadrant Gate Systems	10D-2
Section 10D.03 Automatic Gates	10D-3
Section 10D.04 Flashing-Light Signals	10D-4

Section 10D.05 Traffic Control Signals10D-5
 Section 10D.06 Traffic Signal Preemption Turning Restrictions10D-6
 Section 10D.07 Use of Traffic Control Signals for Control of Light Rail Transit
 Vehicles at Grade Crossings10D-7
 Section 10D.08 Pedestrian and Bicycle Signals and Crossings.....10D-9

FIGURES

CHAPTER 10C. SIGNS, ILLUMINATION, AND MARKINGS

Figure 10C-1 Light Rail Transit Vehicle Dynamic Envelope.....10C-10
 Figure 10C-2 Typical Light Rail Transit Vehicle Dynamic Envelope
 Delineation Pavement Markings10C-10
 Figure 10C-3 Typical Light Rail Transit Car Dynamic Envelope
 Delineation Pavement Markings10C-12
 Figure 10C-4 Typical Light Rail Transit Vehicle Dynamic Envelope
 Delineation Contrasting Pavement Texture.....10C-12

CHAPTER 10D. HIGHWAY-LIGHT RAIL TRANSIT ACTIVE TRAFFIC CONTROL GRADE CROSSING SYSTEMS

Figure 10D-1 Typical Light Rail Transit Signals.....10D-8
 Figure 10D-2 Typical Light Rail Transit Flashing-Light Signal Assembly
 for Pedestrian Crossings.....10D-10
 Figure 10D-3 Typical Pedestrian Gate Placement Behind the Sidewalk.....10D-11
 Figure 10D-4 Typical Pedestrian Gate Placement with Pedestrian Gate Arm10D-11
 Figure 10D-5 Typical Placement of Pedestrian Traffic Gates10D-12
 Figure 10D-6 Typical Swing Gates.....10D-13
 Figure 10D-7 Typical Pedestrian Barriers at an Offset Highway-Light Rail
 Transit Crossing.....10D-13
 Figure 10D-8 Typical Examples of Pedestrian Barrier Installation at an Offset
 Nonintersection Light Rail Transit Crossing10D-14

CHAPTER 10A. GENERAL

Section 10A.01 Introduction

Support:

Part 10 provides standards and guidelines for the design, installation, and operation of traffic control devices at grade crossings of highway traffic and light rail transit vehicles to facilitate the safe, orderly, and integrated movement of all traffic. The principles in Section 8A.01 are the same but, because light rail vehicles sometimes operate along streets and highways in mixed traffic with automotive vehicles, the traffic controls and associated standards and guidelines for highway-light rail transit vehicle grade crossings presented in Part 10 can be different than those presented in Part 8.

Light rail transit is a mode of metropolitan transportation that employs light rail transit cars (commonly known as light rail vehicles, streetcars, or trolleys) that operate on rails in streets in mixed traffic, in semiexclusive rights-of-way, or in exclusive rights-of-way. Grade crossings with light rail transit can occur at intersections or at midblock locations, including public and private driveways.

An initial educational campaign along with an ongoing program to continue to educate new drivers is beneficial when introducing light rail operations to an area and, hence, new traffic control devices.

Light rail alignments can be grouped into one of the following three types:

- A. Exclusive: A light rail transit right-of-way that is grade-separated or protected by a fence or traffic barrier. Motor vehicles, pedestrians, and bicycles are prohibited within the right-of-way. Subways and aerial structures are included within this group. This type of alignment does not have grade crossings and is not further addressed in Part 10.
- B. Semiexclusive: A light rail transit alignment that is in a separate right-of-way or along a street or railroad right-of-way where motor vehicles, pedestrians, and bicycles have limited access and cross at designated locations only.
- C. Mixed-Use: An alignment where light rail transit operates in mixed traffic with all types of road users. This includes streets, transit malls, and pedestrian malls where the right-of-way is shared.

Standard:

Where light rail transit and railroads use the same tracks or adjacent tracks, the traffic control devices, systems, and practices for highway-rail grade crossings described in Part 8 shall be used.

Section 10A.02 Use of Standard Devices, Systems, and Practices

Support:

Because of the large number of significant variables to be considered, no single standard system of active traffic control devices is universally applicable for all highway-light rail transit grade crossings.

Guidance:

The appropriate traffic control system required at a highway-light rail transit grade crossing should be determined by an engineering study.

Standard:

Traffic control devices, systems, and practices shall be consistent with the design and application of the Standards contained herein.

The traffic control devices, systems, and practices described herein shall be used at all highway-light rail transit grade crossings.

Before any new highway-light rail transit grade crossing traffic control system is installed or modifications are made to an existing system, approval shall be obtained from the local agencies having statutory authority to grant such approval.

Guidance:

To stimulate effective responses from drivers, pedestrians, and bicyclists, these devices, systems, and practices should use the five basic considerations employed generally for traffic control devices and described fully in Section 1A.02: design, placement, operation, maintenance, and uniformity.

Support:

Many other details of highway-light rail transit grade crossing traffic control systems which are not set forth in Part 10 are contained in the references listed in Section 1A.11.

Section 10A.03 Uniform Provisions

Standard:

All signs used in highway-light rail transit grade crossing traffic control systems shall be retroreflectorized or illuminated as described in Section 2A.08 to show the same shape and color to an approaching road user both by day and night.

Guidance:

Such signs or signals should be installed with a clearance of at least 0.6 m (2 ft) from the face of the curb to the edge of the sign or signal head, except as allowed in Section 2A.19.

Section 10A.04 Highway-Light Rail Transit Grade Crossing Elimination**Guidance:**

Since highway-light rail transit grade crossings are a potential source of congestion, agencies should conduct engineering studies to determine the cost and benefits of eliminating these crossings.

Standard:

When a highway-light rail transit grade crossing is eliminated, the traffic control devices for the crossing shall be removed.

Guidance:

Where a roadway is removed from a grade crossing, the roadway approaches in the light rail transit right-of-way should also be removed or barricaded.

Where light rail transit is eliminated at a highway-light rail transit grade crossing, the tracks should be removed or paved over.

At multiple track crossings, if one or more tracks are eliminated, existing traffic control devices should be removed or modified, as appropriate.

Option:

The TRACKS OUT OF SERVICE (R8-9) sign may be temporarily installed until the tracks are removed or paved over.

Section 10A.05 Temporary Traffic Control Zones**Support:**

Temporary traffic control planning provides for continuity of operations (such as movement of traffic, pedestrians and bicycles, transit operations, and access to property/utilities) when the normal function of a roadway at a highway-light rail transit grade crossing is suspended because of temporary traffic control operations.

Standard:

Temporary traffic control operations on highways with highway-light rail transit grade crossings shall be as outlined in Part 6.

Guidance:

The agencies responsible for the operation of the light rail transit and highway should be contacted when the initial planning begins for any temporary traffic control zone that may directly or indirectly influence the flow of traffic on mixed-use facilities where light rail transit and road users operate. Responsible agencies, along with others affected, such as emergency services and businesses, should meet to plan appropriate traffic detours, necessary signing, marking, and flagging requirements for operations during temporary traffic control activities.

Considerations should include length of time for the crossing to be closed, roadway classification, type of vehicle and traffic affected, time of day, roadway materials, and techniques of repair.

Temporary traffic control operations should minimize the inconvenience, delay, and crash potential to affected traffic. Prior notice should be given to affected public or private parties, including emergency services and businesses, before blockage or infringement of the free movement of vehicles or light rail transit.

Temporary traffic control activities should not be permitted to cause prolonged closing of a crossing.

Standard:

When a highway-light rail transit grade crossing exists either within or in the vicinity of a temporary traffic control zone, lane restrictions, flagging, or other operations shall not be performed in a manner that would cause vehicles to stop on the light-rail transit tracks, unless a law enforcement officer or flagger is provided at the highway-light rail transit grade crossing to minimize the possibility of vehicles stopping on the tracks, even if automatic warning devices are in place.

CHAPTER 10B. HIGHWAY-LIGHT RAIL TRANSIT GRADE CROSSING CONTROL SYSTEMS

Section 10B.01 Introduction

Support:

The combination of devices selected or installed at a specific highway-light rail transit grade crossing is referred to as a Light Rail Transit Traffic Control System.

For the safety and integrity of operations by highway and light rail transit users, the highway agency with jurisdiction, the regulatory agency with statutory authority, if applicable, and the light rail transit authority jointly determine the need and selection of traffic control devices and the assignment of priority to light rail transit at a highway-light rail transit grade crossing.

The normal rules of the road and traffic control priority identified in the Uniform Vehicle Code govern the order assigned to the movement of vehicles at an intersection unless the local agency determines that it is appropriate to assign a higher priority to light rail transit. Examples of different types of light rail transit priority control include separate traffic signal phases for light rail transit movements, restriction of movement of roadway vehicles in favor of light rail transit operations, and preemption of roadway traffic signal control to accommodate light rail transit movements.

Standard:

Highway-light rail transit grade crossings in semi-exclusive alignments shall be equipped with a combination of traffic gates and flashing-light signals, or flashing-light signals only, or traffic control signals, unless an engineering study indicates that the use of STOP, YIELD, or advance warning signs alone would be adequate.

Option:

Highway-light rail transit grade crossings in mixed-use alignments may be equipped with traffic control signals unless an engineering study indicates that the use of STOP, YIELD, or advance warning signs alone would be adequate.

Support:

Section 10C.03 describes the appropriate conditions for the use of STOP or YIELD signs alone at a highway-light rail transit grade crossing.

CHAPTER 10C. SIGNS, ILLUMINATION, AND MARKINGS

Section 10C.01 Introduction

Support:

Signs and markings regulate, warn, and guide the road users so that they, as well as light rail transit car operators, can take appropriate action.

Standard:

The design and location of signs shall conform to Chapter 2A.

Section 10C.02 LOOK Sign (R15-8)

Option:

A LOOK (for light rail transit vehicles) (R15-8) sign may be mounted at highway-light rail transit grade crossings.

The LOOK sign may be mounted as a supplemental panel on the Crossbuck (R15-1) sign post, or as a separate sign in the immediate vicinity of the highway-light rail grade crossing on the light-rail transit right-of-way.

Section 10C.03 STOP or YIELD Signs (R1-1, R1-2, W3-1a, W3-2a)

Standard:

For all highway-light rail transit grade crossings where STOP (R1-1) or YIELD (R1-2) signs are installed, the placement shall conform to the requirements of Sections 2B.06 and 2B.10. Stop Ahead (W3-1a) or Yield Ahead (W3-2a) Advance Warning signs shall also be installed in accordance with Section 2C.26.

Guidance:

The use of STOP or YIELD signs for road users at highway-light rail transit grade crossings should be limited to those crossings where the need and feasibility is established by an engineering study. Such crossings should have all of the following characteristics:

- A. The crossing roadways should be secondary in character (such as a minor street with one lane in each direction, an alley, or a driveway) with low traffic volumes and low speed limits.

- B. The road user has sufficient sight distance at the stop line to permit the vehicle to cross the tracks before the arrival of the light rail transit vehicle.
- C. If at an intersection of two roadways, the intersection does not meet the warrants for a traffic control signal as specified in Chapter 4C.

If a STOP or YIELD sign is installed beyond the light rail transit crossing such that vehicle queues are likely to extend into the path of the light rail transit, a DO NOT STOP ON TRACKS sign (R8-8) should be posted in accordance with Section 10C.04.

Option:

When a STOP or YIELD sign is installed at a highway-light rail transit grade crossing, it may be installed on the Crossbuck post or on a separate post at the point where the vehicle is to stop, or as near thereto as practical.

Section 10C.04 DO NOT STOP ON TRACKS Sign (R8-8)

Guidance:

A DO NOT STOP ON TRACKS (R8-8) sign should be installed whenever an engineering study determines that the potential for vehicles stopping on the tracks at a highway-light rail transit grade crossing is significant. Placement of the R8-8 sign should be determined as part of the engineering study. The sign, if used, should be located on the right side of the road on either the near or far side of the grade crossing. The decision as to placing the sign on the near or far side should be based upon which position provides better visibility to the road users to observe the sign and be able to comply with its message.

Option:

On divided highways and one-way streets, a second sign may be placed on the left side of the road at the grade crossing to further improve visibility of the sign.

Section 10C.05 STOP HERE ON RED Sign (R10-6)

Support:

The STOP HERE ON RED (R10-6) sign defines and facilitates observance of the stop lines at traffic signals or traffic gates.

Option:

A STOP HERE ON RED sign may be used at locations where vehicles frequently violate the stop line or where it is not obvious to road users where to stop.



R15-8



R8-8



R10-6



R3-1a
Activated Blank-Out

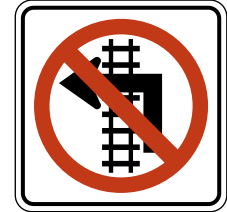

R3-2a
Activated Blank-Out

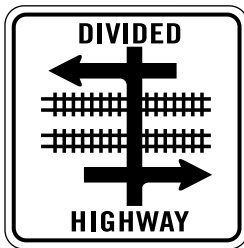

R15-7

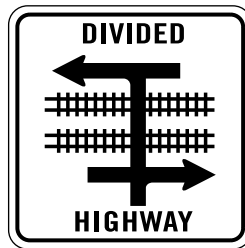

R15-7a



R15-6



R15-6a



R15-4a



R15-4b

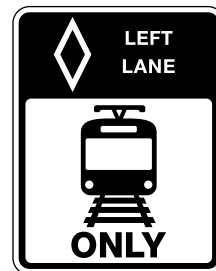

R15-4c

Guidance:

If possible, stop lines should be placed at a point where the vehicle driver has adequate sight distance along the track.

Section 10C.06 Light Rail Transit-Activated Blank-Out Turn Prohibition Signs (R3-1a, R3-2a)

Support:

Light rail transit operations can include the use of activated blank-out sign technology for turn prohibition signs (R3-1a, R3-2a). The signs are typically used on roads paralleling a semiexclusive or mixed-use light rail transit alignment where road users might turn across the light rail transit tracks. A blank-out sign displays its message only when activated. When not activated, the sign face is blank.

Guidance:

A light rail transit-activated blank-out turn prohibition sign should be used where an intersection adjacent to a highway-light rail transit crossing is controlled by STOP signs, or is controlled by traffic control signals with permissive turn movements for road users crossing the tracks.

Option:

A light rail transit-activated blank-out turn prohibition sign may be used for turning movements that cross the tracks.

As an alternative to light rail transit-activated blank-out turn prohibition signs at intersections with traffic control signals, exclusive traffic control signal phases such that all movements that cross the tracks have a red indication may be used in combination with NO TURN ON RED (R10-11a) signs.

Section 10C.07 Divided Highway With Light Rail Transit Crossing Signs (R15-7 Series)

Option:

The Divided Highway With Light Rail Transit Crossing (R15-7) sign may be used as a supplemental sign on the approach legs of a roadway that intersects with a divided highway where light rail transit cars operate in the median. The sign may be placed beneath a STOP sign or mounted separately.

Guidance:

The number of tracks shown on the R15-7 sign should be the same as the actual number of tracks.

Standard:

When the Divided Highway With Light Rail Transit Crossing sign is used at a four-legged intersection, the R15-7 sign shall be used. When used at a T-intersection, the R15-7a sign shall be used.

Section 10C.08 No Vehicles On Tracks Signs (R15-6, R15-6a)**Support:**

The No Vehicles On Tracks (R15-6) sign is used where there are adjacent traffic lanes separated from the light rail transit lane by a curb or pavement markings.

Guidance:

The DO NOT ENTER (R5-1) sign should be used where a road user could wrongly enter a light rail transit only street.

Option:

A No Vehicles On Tracks sign may be used to deter vehicles from driving on the trackway. It may be installed either on a 1 m (3 ft) flexible post between double tracks, on a post alongside the tracks, or overhead.

Instead of the R15-6 symbol sign, a regulatory sign with the word message DO NOT DRIVE ON TRACKS (R15-6a) may be used.

A reduced size of 300 x 300 mm (12 x 12 in) may be used if the R15-6 sign is installed between double tracks.

Standard:

The smallest size for the R15-6 sign shall be 300 x 300 mm (12 x 12 in).

Section 10C.09 Light Rail Transit Only Lane Signs (R15-4 Series)**Support:**

The Light Rail Transit Only Lane (R15-4 series) signs are used for multilane operations, where roadway users might need additional guidance on lane use and/or restrictions.

Option:

Light Rail Transit Only Lane signs may be used on a roadway lane limited to only light rail transit use to indicate the restricted use of a lane in semiexclusive and mixed alignments.

Guidance:

If used, the R15-4a, R15-4b, and R15-4c signs should be installed on posts adjacent to the roadway containing the light rail transit tracks or overhead above the light rail transit only lane.

Option:

If the trackway is paved, preferential lane markings (see Section 3B.22) may be installed but only in combination with light rail transit only lane signs.

Support:

The trackway is the continuous way designated for light rail transit, including the entire dynamic envelope. Section 10C.15 contains more information regarding the dynamic envelope.

Section 10C.10 Do Not Pass Light Rail Transit Signs (R15-5, R15-5a)**Support:**

A Do Not Pass Light Rail Transit (R15-5) sign is used to indicate that vehicles are not allowed to pass light rail transit vehicles that are loading or unloading passengers where there is no raised platform or physical separation from the lanes upon which other motor vehicles are operating.

Option:

The R15-5 sign may be used in mixed-use alignments and may be mounted overhead where there are multiple lanes.

Instead of the R15-5 symbol sign, a regulatory sign with the word message DO NOT PASS STOPPED TRAIN (R15-5a) may be used.

Guidance:

If used, the R15-5 sign should be located immediately before the light rail transit boarding area.



R15-5

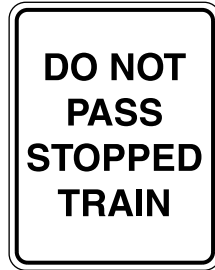

R15-5a



W10-1

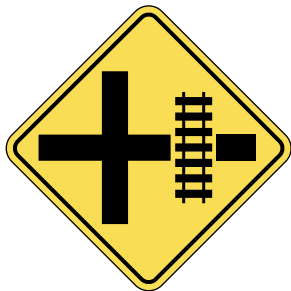

W10-2

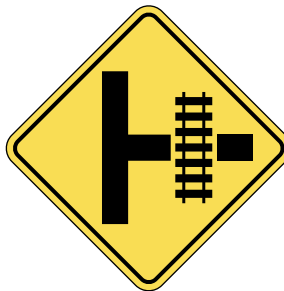

W10-3

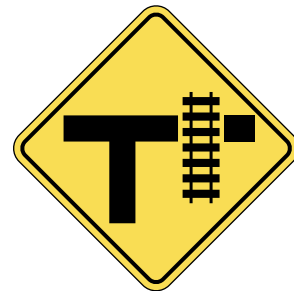

W10-4



W10-7
Activated Blank-Out



I-12

Section 10C.11 Highway-Rail Advance Warning Signs (W10 Series)**Standard:**

A Highway-Rail Advance Warning sign (W10-1) shall be used on each highway in advance of every highway-light rail grade crossing except in the following circumstances:

- A. On low-volume, low-speed highways crossing minor spurs or other tracks that are infrequently used and are flagged by train/transit crews; and**
- B. In business districts where active highway-light rail grade crossing traffic control devices are in use.**

Placement of the Highway-Rail Advance Warning sign shall be in accordance with Chapter 2A and Table 2C-4.

Option:

On divided highways and one-way streets, an additional W10-1 sign may be installed on the left side of the roadway.

W10-2, W10-3, or W10-4 signs may be installed on highways that run parallel to light rail transit to warn road users making a turn that they will encounter a highway-light rail transit grade crossing soon after making the turn.

Standard:

If the W10-2, W10-3, or W10-4 signs are used, sign placement shall be in accordance with Table 2C-4 (using the speed of the turning maneuver), and shall be measured from the highway intersection.

Guidance:

If the distance between the track and the parallel highway, from the edge of the track to the edge of the roadway, is 30 m (100 ft) or more, a W10-1 sign should be installed in advance of the highway-light rail transit grade crossing, and the W10-2, W10-3, or W10-4 signs should not be used on the parallel highway.

Support:

Where the distance between the track and the parallel highway, from edge of track to edge of highway, is less than 30 m (100 ft), it is not necessary to install a W10-1 sign if the W10-2, W10-3, or W10-4 signs are used on the parallel highway.

Section 10C.12 Light Rail Transit Approaching-Activated Blank-Out Warning Sign (W10-7)**Support:**

The Light Rail Transit Approaching-Activated Blank-Out warning (W10-7) sign supplements the traffic control signal to warn road users turning across the tracks of an approaching parallel light rail transit vehicle.

Option:

A Light Rail Transit Approaching-Activated Blank-Out warning sign may be used at signalized intersections near grade crossings or at crossings controlled by STOP signs or automatic gates.

Section 10C.13 Light Rail Station Sign (I-12)**Option:**

The Light Rail Station (I-12) sign may be used to direct road users to a light rail station or boarding location. It may be supplemented by the name of the transit system and by arrows as provided in Section 2D.08.

Section 10C.14 Illumination at Highway-Light Rail Transit Crossings**Guidance:**

Where light rail transit operations are conducted at night, illumination at and adjacent to the highway-light rail transit grade crossing should be considered.

Support:

Recommended types and location of luminaires for highway-railroad (light rail transit) grade crossings are contained in the American National Standards Institute's (ANSI) "Practice for Roadway Lighting RP-8," available from the Illuminating Engineering Society (see Section 1A.11).

Section 10C.15 Dynamic Envelope Delineation Markings**Support:**

The dynamic envelope delineation markings indicate the clearance required for the light rail transit car overhang resulting from any combination of loading, lateral motion, or suspension failure (see Figure 10C-1).

Figure 10C-1. Light Rail Transit Vehicle Dynamic Envelope

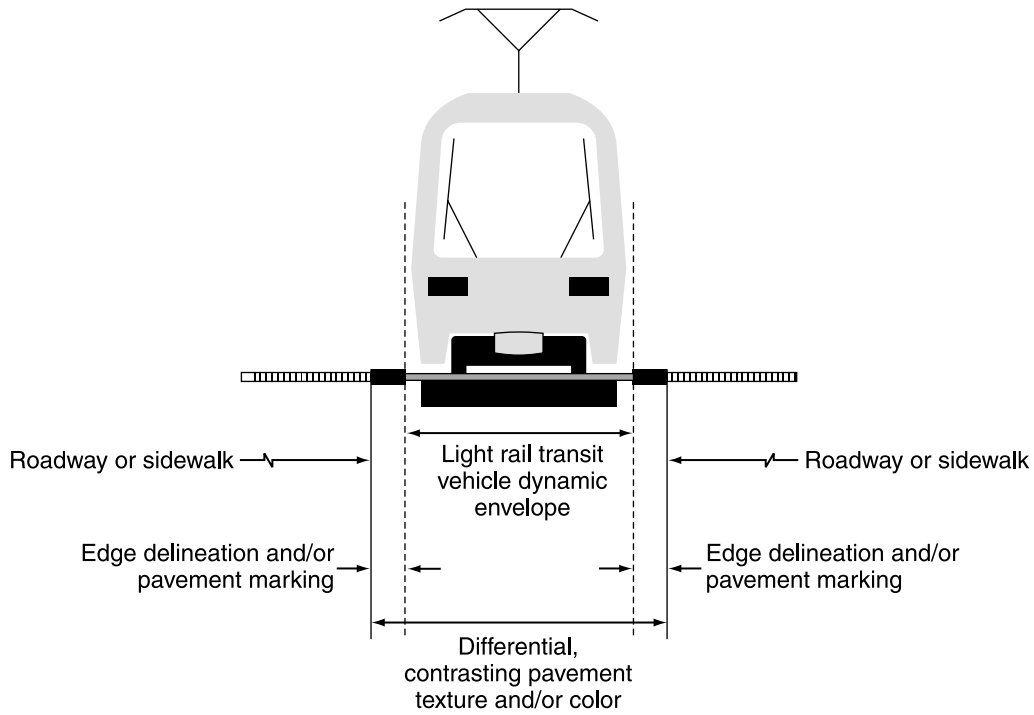
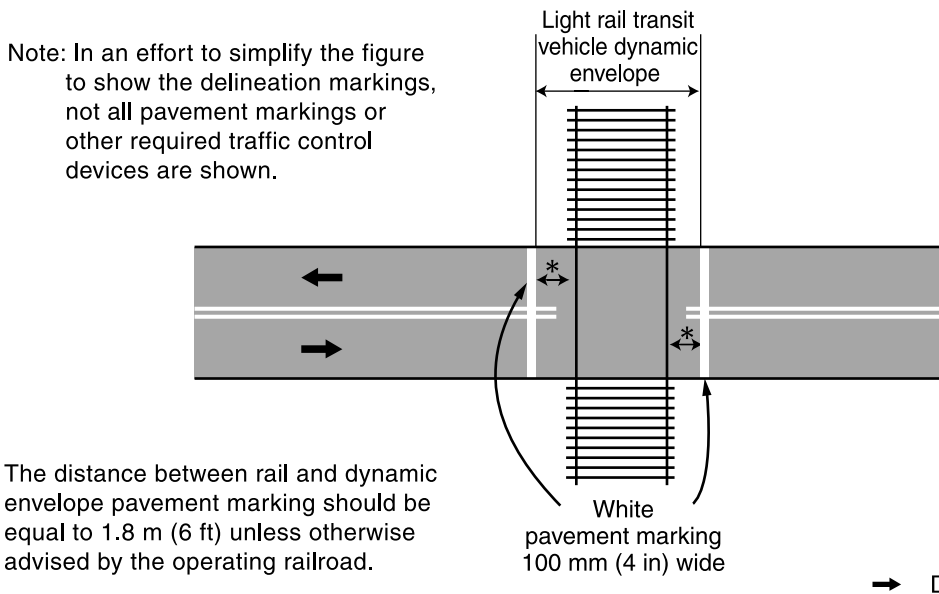

Figure 10C-2. Typical Light Rail Transit Vehicle Dynamic Envelope Delineation Pavement Markings



Option:

The dynamic envelope may be delineated on the pavement using pavement markings (see Figures 10C-2 and 10C-3) or contrasting pavement color and/or contrasting pavement texture (see Figure 10C-4).

Standard:

If pavement markings are used for indicating the dynamic envelope delineation, they shall conform to Part 3 and shall be a 100 mm (4 in) normal solid white line.

Guidance:

If pavement markings are used to convey the dynamic envelope, they should be placed completely outside of the dynamic envelope. If used at light-rail transit grade crossings, dynamic envelope pavement markings should be placed on the highway 1.8 m (6 ft) from the nearest rail and installed parallel to the tracks, unless the transit authority and/or operating railroad company advises otherwise. The pavement markings should extend across the roadway as shown in Figure 10C-2.

Option:

In semiexclusive alignments, the dynamic envelope may be delineated along the light rail transit trackway between intersections where the trackway is immediately adjacent to travel lanes and no physical barrier is present.

In mixed-use alignments the dynamic envelope may be delineated continuously between intersections.

Dynamic envelope markings may be installed at all highway-light rail transit grade crossings, unless a four-quadrant gate system (see Section 10D.02) is used.

Pavement markings for adjacent travel or parking lanes may be used instead of dynamic envelope delineation if the lines are outside the dynamic envelope.

Figure 10C-3. Typical Light Rail Transit Car Dynamic Envelope Delineation Pavement Markings

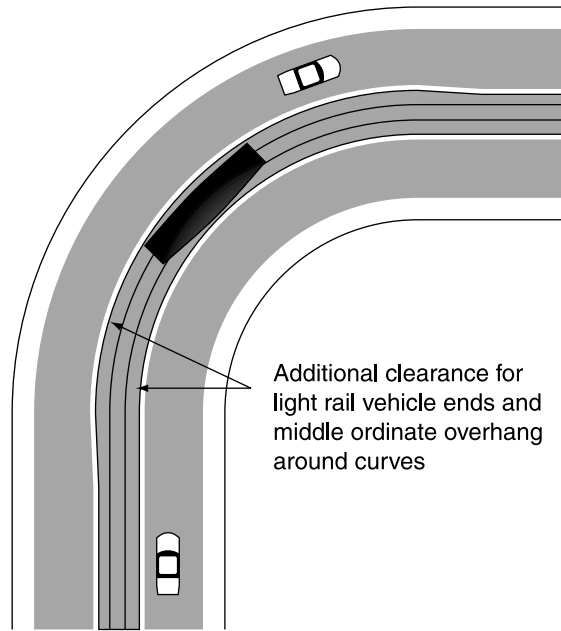
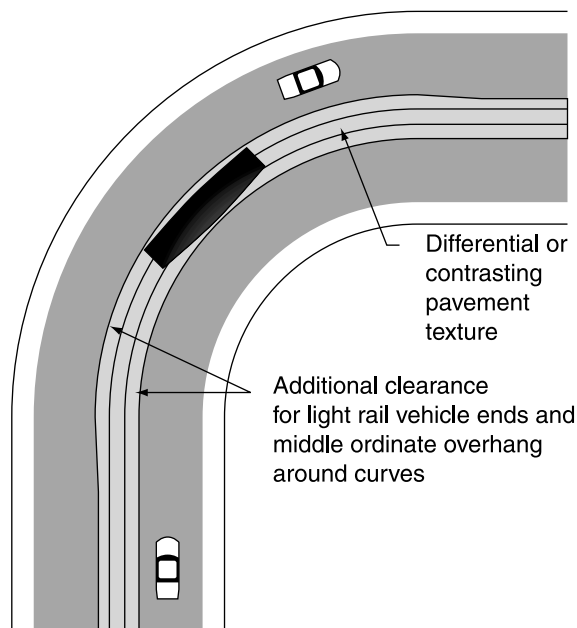

Figure 10C-4. Typical Light Rail Transit Vehicle Dynamic Envelope Delineation Contrasting Pavement Texture



CHAPTER 10D. HIGHWAY-LIGHT RAIL TRANSIT ACTIVE TRAFFIC CONTROL GRADE CROSSING SYSTEMS

Section 10D.01 Introduction

Support:

Active light rail transit traffic control systems inform drivers, bicyclists, and pedestrians of the approach or presence of light rail transit at highway-light rail transit grade crossings. These systems include four-quadrant gate systems, automatic gates, flashing-light signals, traffic control signals, actuated blank-out and variable message signs, and other active traffic control devices.

Standard:

Where light rail transit and railroads use the same tracks or adjacent tracks, the traffic control devices, systems, and practices for highway-rail grade crossings described in Part 8 shall be used.

Guidance:

Where both traffic control signals and flashing-light signals (with or without traffic gates) are in operation at the same highway-light rail transit grade crossing, the operation of the devices should be coordinated to avoid any display of conflicting signal indications.

If a pedestrian route is provided, sufficient clearance from supports, posts, and gate mechanisms should be maintained for pedestrian travel.

Option:

Audible devices may be operated in conjunction with the flashing lights or traffic control signals.

Support:

Light rail transit typically operates through grade crossings in semiexclusive and mixed-use alignments at speeds between 15 km/h (10 mph) and 105 km/h (65 mph).

When light rail transit speed is cited in this Part, it refers to the maximum speed at which light rail transit cars are permitted to traverse a particular grade crossing.

Section 10D.02 Four-Quadrant Gate Systems

Option:

Four-Quadrant Gate systems may be installed to improve safety at highway-light rail transit grade crossings based on an engineering study when less restrictive measures, such as automatic gates and channelization devices, are not effective.

Standard:

A Four-Quadrant Gate system shall consist of a series of automatic gates used as an adjunct to flashing-light signals to control traffic on all lanes at the highway-light rail transit grade crossing.

The Four-Quadrant Gate system shall consist of a drive mechanism and fully retroreflectorized red- and white-striped gate arms with lights, and which in the down position extends individually across the approaching and exit lanes of highway traffic as shown in Figure 8D-2. Standards contained in Sections 8D.01 through 8D.03 for flashing-light signals shall be followed for signal specifications, location, and clearance distances.

In the normal sequence of operation, the flashing-light signals and the lights on the gate arms (in their normal upright positions) shall be activated immediately upon detection of the approaching light rail transit vehicle. The gate arms for the approaching lanes of traffic shall start their downward motion not less than 3 seconds after the flashing-light signals start to operate and shall reach their horizontal position at least 5 seconds before the arrival of the light rail transit vehicle. Exit lane gate arm activation and downward motion shall be based on timing requirements established by an engineering study of the individual site. The gate arms shall remain down as long as the light rail transit vehicle occupies the highway-light rail transit crossing.

When the light rail transit vehicle clears the highway-light rail transit grade crossing, and no other light rail transit vehicle is detected, the gate arms shall ascend to their upright positions, following which the flashing lights and the lights on the gate shall cease operation.

Gate arm design, colors, and lighting requirements shall be in accordance with the Standards contained in Section 8D.04.

The exit lane gate arms shall be designed to fail-safe in the up position.

At locations where gate arms are offset a sufficient distance for vehicles to drive between the entrance and exit gate arms, median islands shall be installed in accordance with needs established by an engineering study.

Guidance:

The gate arm should ascend to its upright position in not more than 12 seconds.

Four-Quadrant Gate systems should only be used in locations with constant-warning-time light rail transit vehicle detection.

Where an engineering study determines the need, vehicle intrusion detection devices should be installed at the crossing.

At locations where sufficient space is available, exit gates should be set back from the track a distance that provides a zone long enough to accommodate at least one design vehicle between the exit gate and the nearest rail.

Four-Quadrant Gate systems should include remote health (status) monitoring capable of automatically notifying railroad signal maintenance personnel when anomalies have occurred within the system.

Option:

Exit lane gate arms may fail in the down position if the highway-rail grade crossing is equipped with remote health (status) monitoring.

Four-Quadrant Gate system installations may include median islands between opposing lanes on an approach to a highway-light rail transit grade crossing.

Guidance:

Where sufficient space is available, median islands should be at least 18 m (60 ft) in length.

Section 10D.03 Automatic Gates**Support:**

An automatic gate is a traffic control device used as an adjunct to flashing-light signals.

Section 8D.04 contains further details regarding automatic gates.

Guidance:

Highway-light rail transit grade crossings in semiexclusive alignments should be equipped with automatic gates and flashing-light signals (see Chapter 8D) where light rail transit speeds exceed 60 km/h (35 mph).

Option:

Where the crossing is at a location other than an intersection, where light rail transit speeds exceed 40 km/h (25 mph), automatic gates and flashing-light signals may be installed.

Traffic control signals may be used instead of automatic gates at highway-light rail transit grade crossings within highway-highway intersections where light rail transit speeds do not exceed 60 km/h (35 mph). Traffic control signals or flashing-light signals without traffic gates may be used where the crossing is at a location other than an intersection and where light rail transit speeds do not exceed 40 km/h (25 mph) and the roadway is a low-volume street where prevailing speeds do not exceed 40 km/h (25 mph).

Traffic gates may be supplemented by cantilevered flashing-light signals (see Figure 8D-1) where there is a need for additional emphasis or better visibility.

Support:

The effectiveness of gates can be enhanced by the use of channelizing devices or raised median islands to discourage driving around lowered automatic gates.

Section 10D.04 Flashing-Light Signals**Support:**

Sections 8D.02 and 8D.03 contain additional details regarding flashing-light signals.

Standard:

Highway-light rail transit grade crossings in semiexclusive alignments shall be equipped with flashing-light signals where light rail transit speeds exceed 60 km/h (35 mph). Flashing-light signals shall be clearly visible to drivers, pedestrians, and bicyclists.

Guidance:

Where the crossing is at a location other than an intersection, where light rail transit speeds exceed 40 km/h (25 mph), flashing light signals should be installed.

Option:

Traffic control signals may be used instead of flashing-light signals at highway-light rail transit grade crossings within highway-highway intersections where light rail transit speeds do not exceed 60 km/h (35 mph). Traffic control signals or flashing-light signals may be used where the crossing is at a location other than an intersection, where light rail transit speeds do not exceed 40 km/h (25 mph), and when the roadway is a low-volume street where prevailing speeds do not exceed 40 km/h (25 mph).

Section 10D.05 Traffic Control Signals

Support:

There are two types of signals for controlling vehicular and light rail transit movements at interfaces of the two modes. The first is the standard traffic control signal described in Part 4, which is the focus of this section. The other type of signal is referred to as a light rail transit signal and is discussed in Section 10D.07.

Standard:

The provisions of Parts 4 and 8 relating to traffic control signal design, installation, and operation, including interconnection with nearby traffic gates or flashing-light signals, shall be applicable as appropriate where traffic control signals are used at highway-light rail transit grade crossings.

Guidance:

When a highway light-rail transit grade crossing equipped with a flashing-light signal system is located within 60 m (200 ft) of an intersection or midblock location controlled by a traffic control signal, the traffic control signal should be provided with preemption in accordance with Section 4D.13.

Coordination with the flashing-light signal system should be considered for traffic control signals located more than 60 m (200 ft) from the crossing. Factors to be considered should include traffic volumes, vehicle mix, vehicle and light rail transit approach speeds, frequency of light rail transit vehicles, and queue lengths.

If the traffic signal has emergency vehicle preemption capability, it should be coordinated with light rail transit operation.

Where light rail transit operates in a wide median, vehicles crossing the tracks and being controlled by both near and far side traffic signals should receive a protected left-turn green phase from the far side signal to clear vehicles from the crossing when light rail transit vehicles are approaching the crossing.

Option:

Green indications may be provided during light rail transit phases for vehicle, pedestrian, and bicycle movements that do not conflict with light rail transit movements.

Traffic control signals may be installed in addition to four-quadrant gate systems and automatic gates at a highway-light rail transit crossing if the crossing occurs within a highway-highway intersection and if the traffic control signals meet the warrants described in Chapter 4C.

At a location other than an intersection, when light rail transit speeds are less than 40 km/h (25 mph), traffic control signals alone may be used to control roadway users at highway-light rail transit grade crossings only when justified by an engineering study.

Typical circumstances may include:

- A. Geometric conditions preclude the installation of highway-light rail transit grade crossing warning devices.
- B. Light rail transit vehicles share the same roadway with road users.
- C. Traffic control signals already exist.

Support:

See Section 4D.13 for considerations regarding traffic control signals at or near highway-light rail transit grade crossings that are not equipped with highway-light rail transit grade crossing warning devices.

Section 10D.06 Traffic Signal Preemption Turning Restrictions

Guidance:

When a light rail transit grade crossing exists within a signalized intersection, consideration should be given to providing separately controlled Protected Only Mode turn phases for the movements crossing the tracks.

Standard:

Signal faces that are provided for separately controlled Protected Only Mode turn movements toward the crossing shall display a red indication during the approach and/or passage of light rail transit vehicles.

Guidance:

When a signalized intersection that is located within 60 m (200 ft) of a highway-light rail transit grade crossing is preempted, all existing turning movements toward the highway-light rail transit grade crossing should be prohibited.

Support:

Part 4 contains information regarding signal phasing and timing requirements.

Option:

An activated blank-out or changeable message sign and/or an appropriate traffic signal display may be used to prohibit turning movements toward the crossing during preemption.

Standard:

Messages on the activated blank-out or changeable message signs shall be visible only when the highway-light rail transit intersection restriction is in effect.

Section 10D.07 Use of Traffic Control Signals for Control of Light Rail Transit Vehicles at Grade Crossings**Guidance:**

Light rail transit movements in semiexclusive alignments at nongated grade crossings that are equipped with traffic control signals should be controlled by special light rail transit signal indications.

Support:

Typical light rail transit traffic control signals, used to control light rail transit movements only, are shown in Figure 10D-1.

Option:

Standard traffic control signals may be used in lieu of light rail transit traffic control signals to control the movement of light rail transit vehicles (see Section 10D.05).

Standard:

































If a separate set of standard traffic control signal indications (red, yellow, and green circular and arrow indications) is used to control light rail transit movements, the indications shall be positioned so they are not visible to drivers, pedestrians, and bicyclists (see Section 4D.17).

If the light rail transit crossing control is separate from the intersection control, the two shall be interconnected. The light rail phase shall not be terminated until after the light rail transit vehicle has cleared the crossing.

Option:

Light rail transit signals may be used at grade crossings and at intersections in mixed-use alignments in conjunction with standard traffic control signals where special light rail transit signal phases are used to accommodate turning light rail transit vehicles or where additional light rail transit clearance time is desirable.

Figure 10D-1. Typical Light Rail Transit Signals

	Three-Lens Signal	Two-Lens Signal
<p>SINGLE LRT ROUTE</p> 	<p>STOP </p> <p>PREPARE TO STOP  <i>Flashing</i></p> <p>GO </p>	<p> STOP</p> <p>⁽²⁾ GO</p>
<p>TWO LRT ROUTE DIVERSION</p> 	<p></p> <p> <i>Flashing</i></p> <p> ⁽¹⁾</p>	<p></p> <p> ^{(1),(2)}</p>
	<p></p> <p><i>Flashing</i> </p> <p> ⁽¹⁾</p>	<p></p> <p> ^{(1),(2)}</p>
<p>THREE LRT ROUTE DIVERSION</p> 	<p></p> <p> <i>Flashing</i></p> <p>  ⁽¹⁾</p>	<p></p> <p>  ^{(1),(2)}</p>

Notes:

All aspects are white.

(1) Could be in single housing.

(2) "Go" lens may be used in flashing mode to indicate "prepare to stop".

Guidance:

Light rail transit signal heads should be separated vertically or horizontally from the nearest traffic signal head for the same approach by at least 1 m (3 ft).

Section 10D.08 Pedestrian and Bicycle Signals and Crossings**Standard:**

Pedestrian signals shall be in accordance with Section 4E.04.

Guidance:

Where light rail transit tracks are immediately adjacent to other tracks or a road, pedestrian signalization should be designed to avoid having pedestrians wait between sets of tracks or between the tracks and the road. If adequate space exists for a pedestrian refuge and is justified based on engineering judgment, additional pedestrian signal indicators, signing, and detectors should be installed (see Section 4E.07).

Flashing-light signals (see Figure 10D-2) with a Crossbuck (R15-1) sign should be installed at pedestrian and bicycle crossings where an engineering study has determined that the sight distance is not sufficient for pedestrians and bicyclists to complete their crossing prior to the arrival of the light rail transit vehicle at the crossing, or where light rail transit speeds exceed 60 km/h (35 mph).

Option:

If an engineering study shows that flashing-light signals alone would not provide sufficient notice of an approaching light rail transit vehicle, the LOOK (R15-8) sign (see Figure 10D-2) and/or pedestrian gates may be considered (see Figures 10D-3, 10D-4, and 10D-5).

Support:

A pedestrian gate is similar to an automatic gate except the gate arm is shorter.

The swing gate alerts pedestrians to the light rail transit tracks that are to be crossed. Swing gates are designed to open away from the tracks, requiring users to pull the gate open to cross, but permitting a quick exit from the trackway, and to automatically close.

Option:

Swing gates may be installed across pedestrian and bicycle walkways (see Figure 10D-6).

Pedestrian barriers at offset crossings may be used at pedestrian and bicycle crossings as passive devices that force users to face approaching light rail transit before entering the trackway (see Figures 10D-7 and 10D-8).

Figure 10D-2. Typical Light Rail Transit Flashing-Light Signal Assembly for Pedestrian Crossings

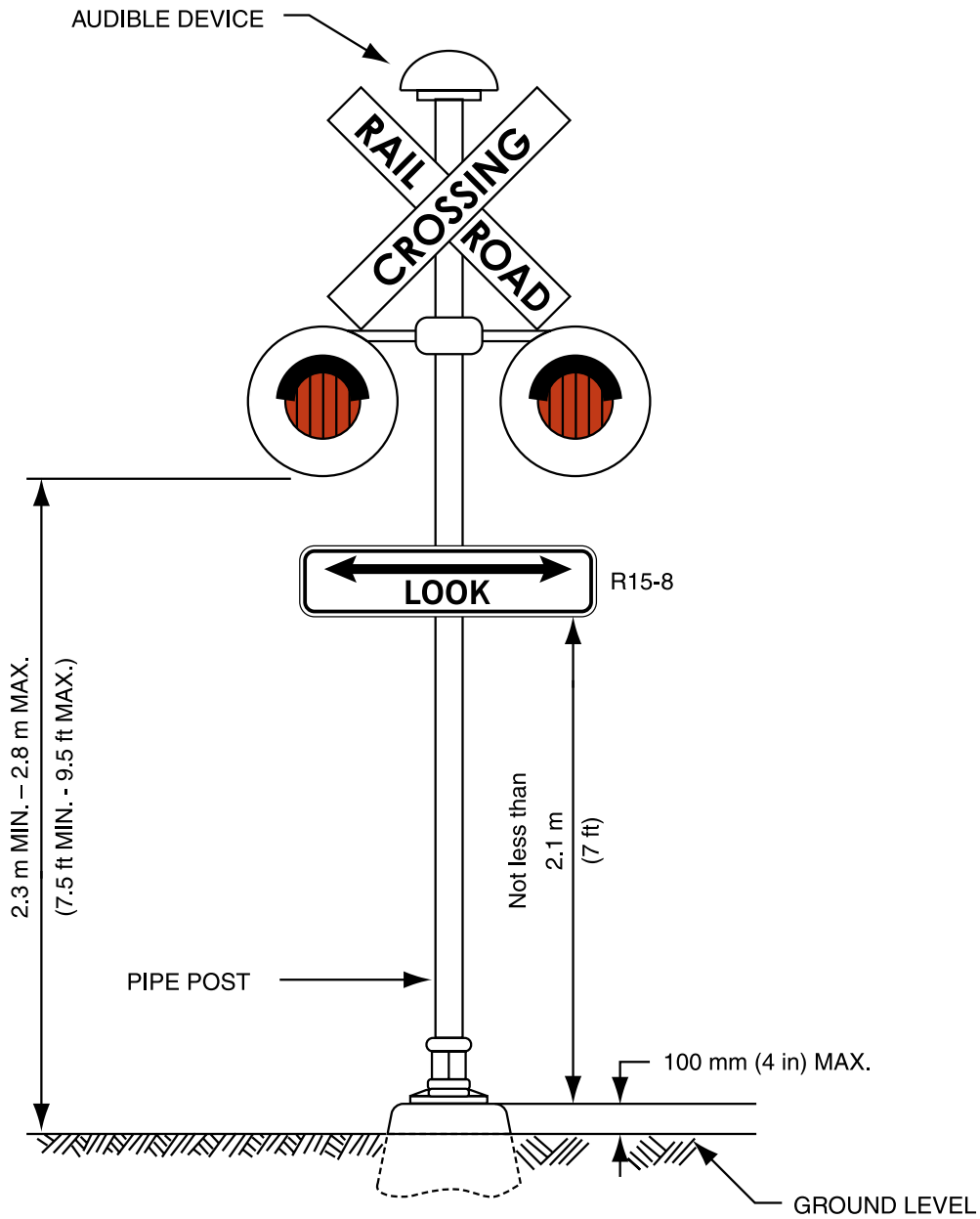

Figure 10D-3. Typical Pedestrian Gate Placement Behind the Sidewalk

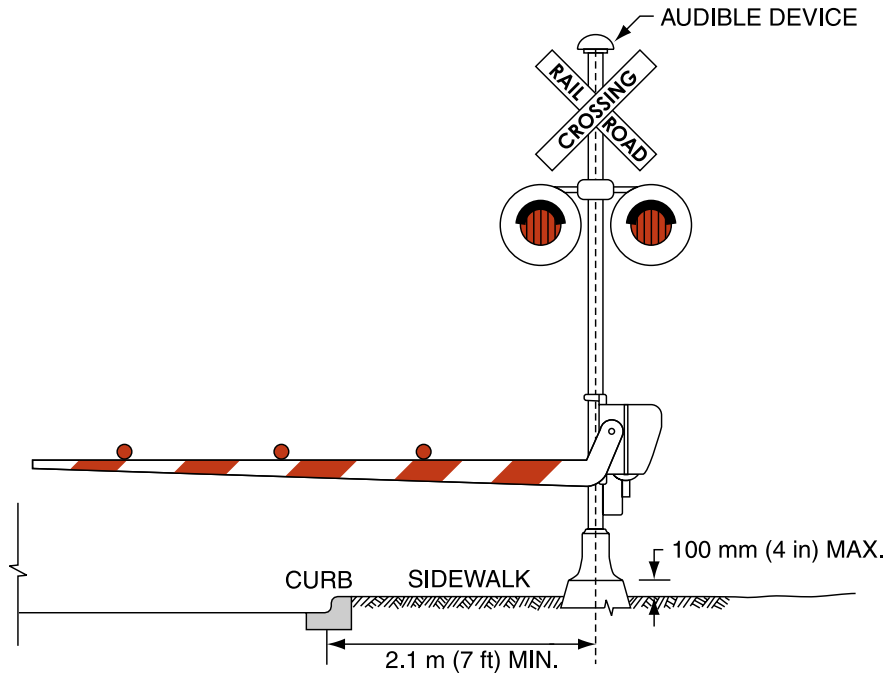

Figure 10D-4. Typical Pedestrian Gate Placement with Pedestrian Gate Arm

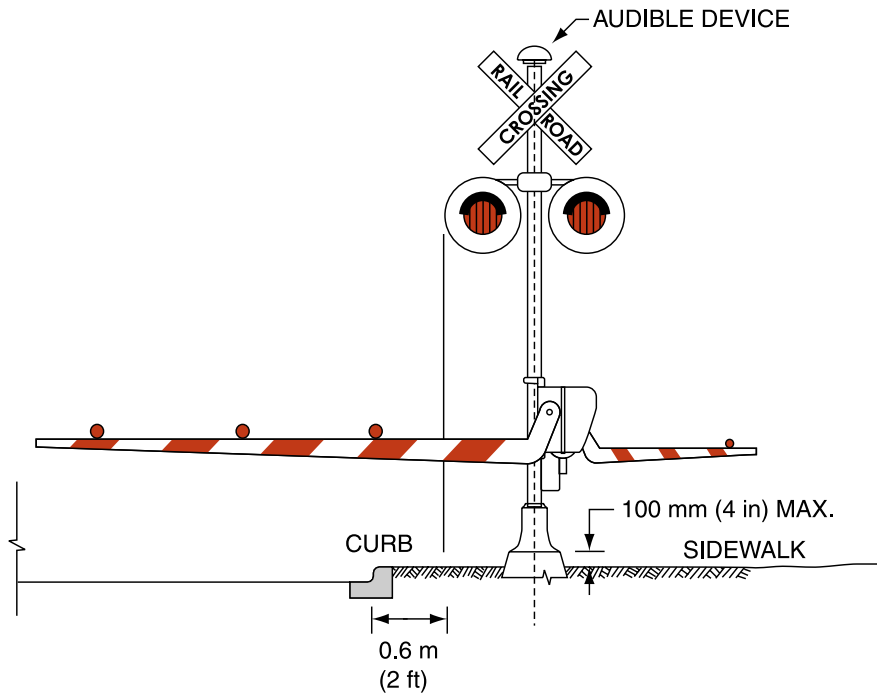
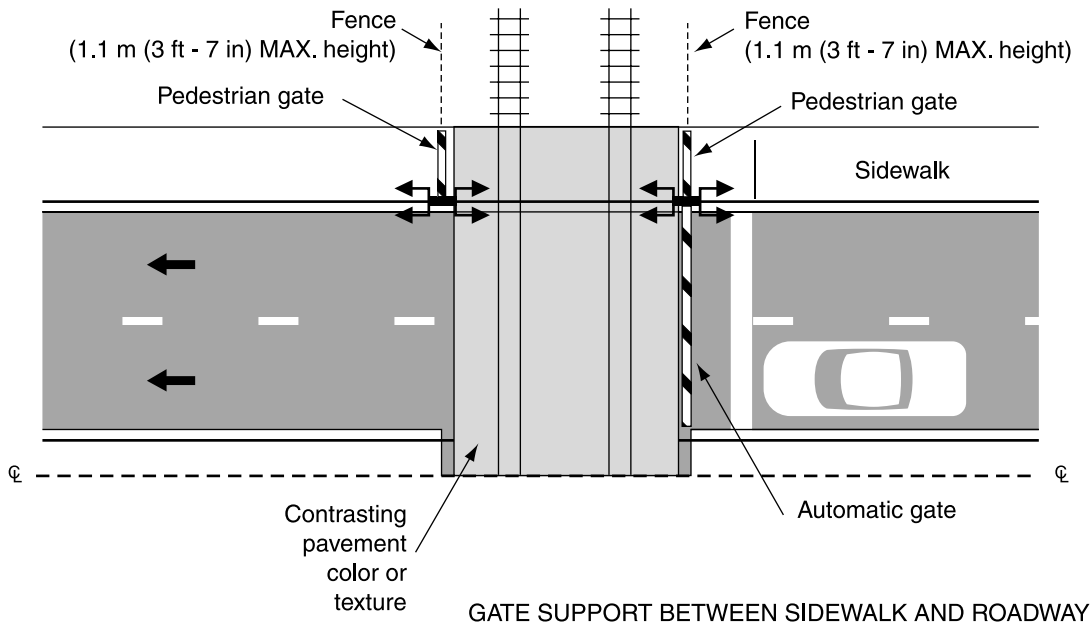
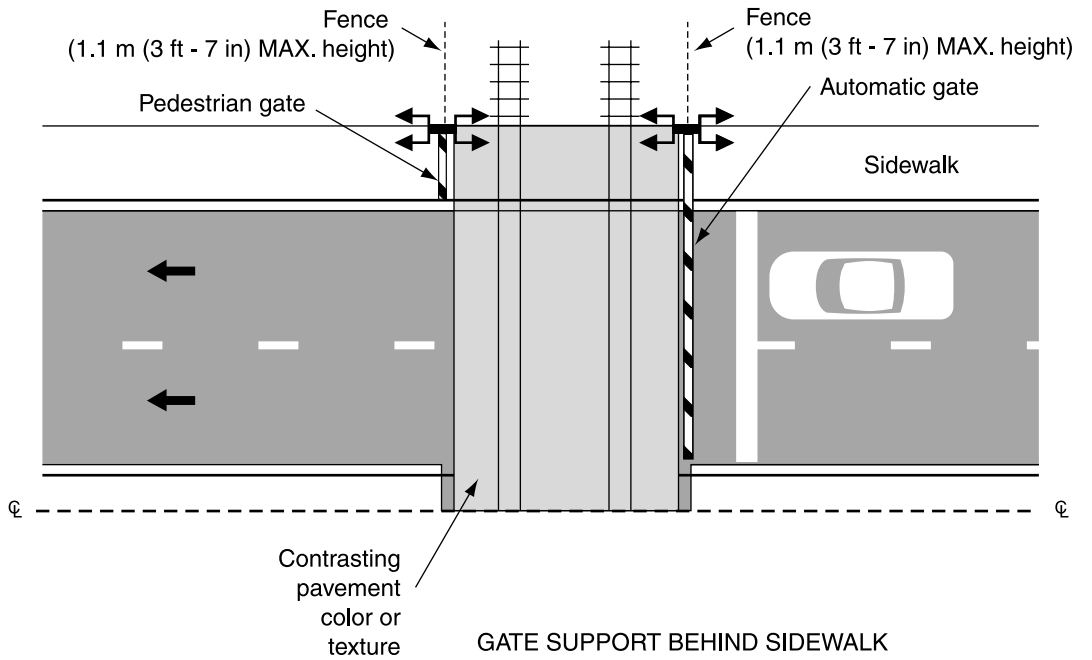

Figure 10D-5. Typical Placement of Pedestrian Traffic Gates



Legend
→ Direction of travel

Figure 10D-6. Typical Swing Gates

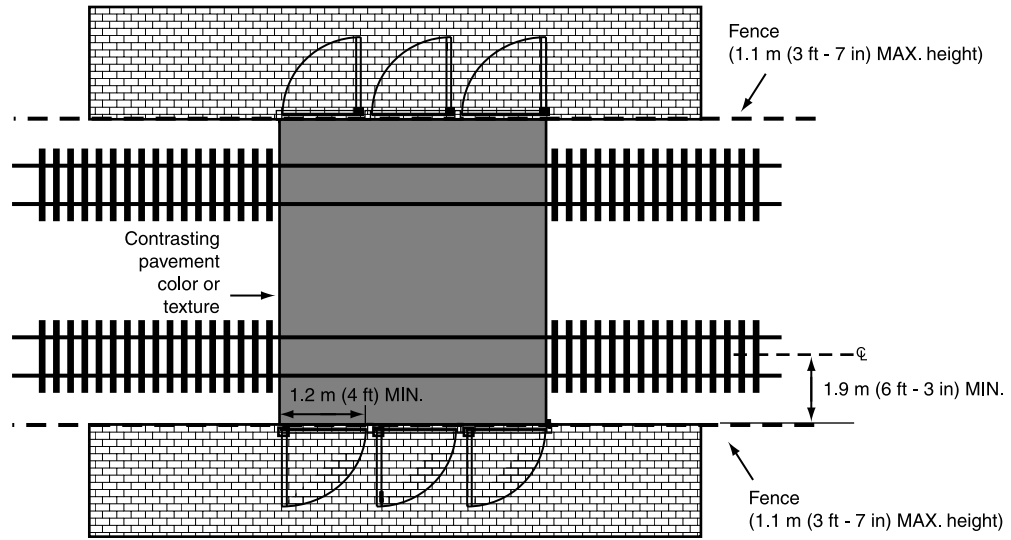

Figure 10D-7. Typical Pedestrian Barriers at an Offset Highway-Light Rail Transit Crossing

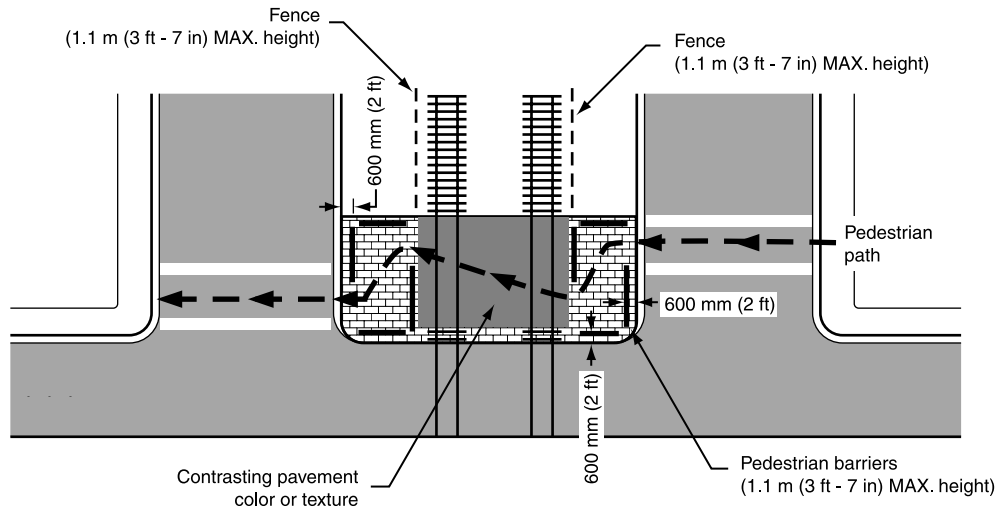

Figure 10D-8. Typical Examples of Pedestrian Barrier Installation at an Offset Nonintersection Light Rail Transit Crossing

