



The Earth Observer. September - October 2007. Volume 19, Issue 5.

## Editor's Corner

*Michael King*

*EOS Senior Project Scientist*

On June 15, 2007, NASA Headquarters released a report compiling the results of the *2007 Earth Science Senior Review* held April 25-27, to evaluate 11 ongoing NASA Earth observing satellite missions—ACRIMSAT; Aqua; CloudSat; Earth Observing-1 (EO-1); Gravity Recovery and Climate Experiment (GRACE); Ice, Clouds, and land Elevation Satellite (ICESat); Jason-1; Quick Scatterometer (QuikSCAT); Solar Radiation and Climate Experiment (SORCE); Terra; and Tropical Rainfall Measuring Mission (TRMM). Eight of these missions are now operating beyond their prime mission periods, while Aqua, CloudSat, and SORCE will transition to extended mission mode between Fiscal Year (FY) 2008 and FY 2009.

The Call for Proposals directed the mission teams to prepare two separate proposals: one for continuation of the basic or *core* mission and the other for an *enhanced* mission. The *core* mission includes complete mission operations activities and established data product deliveries without embellishment or additional research, while the *enhanced* mission provides for development of new and improved science data products.

Two distinct panels reviewed each mission's proposal. One panel, called the Senior Science Review Panel (SSRP), reviewed the entire proposal, (i.e., the *core* mission and the *enhanced* mission together) while the second panel, called the Core Mission Review Panel (CoMRP) concentrated on the *core* mission proposal only. The evaluation

continued on page 2



During its almost 30-year lifespan, the Total Ozone Mapping Spectrometer (TOMS) program provided unique and valuable information that shaped public policy and international perspectives on the environment. The instrument was important because its data established the geographical extent of the "ozone hole" over the Antarctic, and monitored its year-to-year evolution.

With the recent decommissioning of the last of the three TOMS instruments, Earth Probe TOMS, the TOMS program closed on May 30, 2007. The legacy TOMS leaves behind will not be forgotten.

the earth observer

eos.nasa.gov

**In This Issue****Editor's Corner**

Front Cover

**Feature Articles**

Ocean Surface Topography: Past, Present, and Future	04
Dutch Students Contribute to OMI Aerosol Validation	07
Changing Arctic Observed by CERES Instruments and MODIS Expedition to Siberia: A Firsthand Account	13
Interpreting Land Cover Change by Combining NASA and Commercial Satellite Data	22
NASA DEVELOP Students Use EOS Data to Study Air Quality on the U.S.–Canadian Border	25

**Meeting/Workshop Summaries**

Summary of the 31st ASTER Science Team Meeting	28
OMI Science Team Meeting Overview	30
Landsat Science Team Meeting Summary	36

**In The News**

Scouting Out Aerosols in Oklahoma: NASA Langley Researchers Use Lidar to Support Department of Energy Field Campaigns	42
NASA Web Page, Video Gives Educators An In-Depth Look At Hurricanes	44
Billowing Smoke Blankets Montana and Idaho	45
NASA Helps Texas Respond to Most Widespread Flooding in 50 Years	46
Long-Term Increase in Rainfall Seen in Tropics	48
ESIP Federation Elects New Leadership	50

**Regular Features**

EOS Scientists in the News	52
NASA Science Mission Directorate— Science Education Update	54
Science Calendars	55
<i>The Earth Observer</i> Information/ Inquiries	
Back Cover	

NASA research funding is being considered, only the applicability of the proposed activities to NASA science objectives was evaluated. Neither of these panels reviewed the Education and Public Outreach (E/PO) aspects of missions, as E/PO was evaluated separately.

The CoMRP review included representatives from NASA and external representatives from the National Oceanic and Atmospheric Administration (NOAA), U.S. Geological Survey (USGS), and the Department of Defense (Navy and Air Force). CoMRP was further subdivided into two separate subpanels, one that focused on the utility of the core mission data products to operational organizations with predictive or forecast responsibilities, and a second that focused on the satellite and instrument current and projected health and performance. Each subpanel met in Washington, DC in April, and the CoMRP summary assessment was presented to the SSRP on April 26, prior to the individual mission teams' presentations to the SSRP. CoMRP's full report can be viewed at: [science.hq.nasa.gov/earth-sun/docs/2007NASAEarthScienceCoMRP\\_Report\\_508\\_8-28-07.pdf](http://science.hq.nasa.gov/earth-sun/docs/2007NASAEarthScienceCoMRP_Report_508_8-28-07.pdf)

Representatives of each mission had the opportunity to present their proposal for mission extension to the SSRP. This also provided an opportunity for representatives to provide additional information not included in their proposals and to field questions from the panel members. There were several overarching findings common to most, if not all, missions which are summarized below:

- NASA could be more proactive in facilitating the integrated use of the measurement constellation via competed research proposals [e.g., NASA Research and Analysis (R&A)] Program].
- Basic continuation of all missions is critically important at least through FY 2009 so that NASA can meet its stated science objectives.
- A detailed analysis of basic mission science budgets could be conducted to verify cost-effectiveness of current core mission activities, and to determine what budgets could be decreased while maintaining production of routine data streams.
- Nearly all proposed enhanced mission products were viewed as being more appropriate products that mission teams are uniquely suited to provide.

The full report from the SSRP includes more details on the general findings as well as an assessment of each individual mission and can be seen at: [science.hq.nasa.gov/earth-sun/docs/2007NASAEarthScienceSeniorReviewReport\\_508\\_8-28-07.pdf](http://science.hq.nasa.gov/earth-sun/docs/2007NASAEarthScienceSeniorReviewReport_508_8-28-07.pdf)

of the *core* mission explicitly included the utility of the mission data products to both NASA and operational partner agency applications and to the greater national interest. For the *enhanced* mission, where additional

In other news relating to Earth science, the House Science and Technology Committee's Subcommittee on Space and Aeronautics convened in June to explore whether NASA's FY 2008 budget request of \$1.497 billion for Earth Science and Applications Programs

would enable the space agency to implement the recommendations of the January National Academies' *decadal survey*—the first such survey for Earth Science.

**Michael Freilich** testified before the committee and explained that his primary objective as Director of NASA's Earth Science Division was to expand NASA's leading role in Earth system science by reinvigorating the flight mission portfolio; hastening the transition to operational satellite systems; and expanding research and analysis, technology development, and education. The National Academies' *decadal survey*, he said, would be NASA's primary guide in developing the FY 2009 budget request and for the program over the next 10-15 years. Based on the survey, NASA would be issuing an update to its Earth Science Plan later this year.

Non-NASA witnesses included **Eric Baron**, Dean of the Jackson School of Geosciences at the University of Texas, Austin, and a long-time participant in NASA's Earth Observing System activities who said "We will enter the next decade with an [Earth] observing system that is substantially less capable than we had at the start of the 21st century." Another non-NASA witness was **Richard Anthes**, President of the University Corporation for Atmospheric Research (UCAR), who said that the program was adequately balanced across elements, and that NASA was "doing a good job with what they have, but they just don't have enough."

Continuity of measurements was a key topic during the question-and-answer period that followed Freilich's and the other non-NASA witnesses' testimony. Freilich explained that some instruments would require on-orbit overlap with their replacements for calibration purposes, while other measurements "could survive with a [data] gap or degradation." He acknowledged that essential continuity "is number one on our list" because it is "essential for us to redeem the nation's previous investment" in Earth science measurements.

Another major topic of discussion was the National Polar-orbiting Operational Environmental Satellite System (NPOESS); a recent restructuring of the NASA-NOAA joint project had reduced its focus to weather forecasting and deleted or reduced much of the climate science capability. Freilich reported that NASA and NOAA are working with the Office of Science and Technology Policy (OSTP) and the National Academies to understand the implications of this restructuring, to determine what climate measurements are most critical, and develop plans for mitigating the impacts and restoring the highest priority capabilities in some way. NASA and NOAA have already agreed to share costs to restore an ozone profiler on the NPOESS Preparatory Project (NPP). The witnesses noted that the *decadal survey* was almost complete before the implications of the NPOESS restructuring were fully understood. The survey committee had

assumed that a basic set of climate observations would be performed by NPOESS; the survey's recommendations were built on that foundation. Freilich concurred that many of the recommended missions rely on measurements that initially were planned for NPOESS.

I also wish to recognize the end of an era. With the recent decommissioning of the last of the four Total Ozone Monitoring Spectrometer (TOMS) instruments, following failure of the transmitter on Earth Probe TOMS in late 2006, the TOMS program officially closed on May 30, 2007.

The data from the TOMS instruments were critical to the detection and monitoring of long-term damage to the ozone layer. These discoveries contributed to the passage of the Montréal Protocol in 1987, an international agreement restricting the production of ozone-depleting chemicals. TOMS data were also key in confirming the destruction of the ozone at the South Pole each year, the *ozone hole*, which is now an annual occurrence.

"TOMS was unique because it was a total ozone mapper. It measured ozone on every spot on the Earth every day. That is why it was so valuable, it saw everything," said **Richard McPeters**, the Principal Investigator for Earth Probe TOMS, at NASA's Goddard Space Flight Center. McPeters worked on TOMS from the earliest days of the program.

I tip my hat to McPeters and to all who have been involved in the TOMS program over the past few decades and worked so hard to make it successful. The TOMS data have ceased but the instrument's legacy lives on.

The Ozone Monitoring Instrument (OMI), a more advanced spectrometer that flies on the Aura satellite, has taken over the work done by the TOMS program. Launched in 2004, this instrument was created through collaboration between Goddard and the Netherlands Agency for Aerospace Programs working with the Finnish Meteorological Institute. Like TOMS, OMI records total ozone and other atmospheric data related to ozone chemistry and climate.

Last, but certainly not least, I would like to announce that the EOS Project Science Office website has been completely redesigned and is now live on the web. The revised site has up-to-date information on EOS Missions, Data Services, Personnel, and other relevant links to information on EOS activities. The information is also organized in terms of target audiences, including sections for Kids, Scientists, Educators, and the Media. I encourage you to visit the new site at: [eos.nasa.gov](http://eos.nasa.gov). I would like to recognize the hard work and dedication of the EOSPSO staff that has been working on this revision over the past few months, in particular our web designer, **Maura Tokay**. The site looks very nice; congratulations on a job well done. ■

## Ocean Surface Topography: Past, Present, and Future

Laura Faye Tenenbaum, NASA Jet Propulsion Laboratory, [fayelaura@charter.net](mailto:fayelaura@charter.net)

Annie Richardson, NASA Jet Propulsion Laboratory, [Annie.H.Richardson@jpl.nasa.gov](mailto:Annie.H.Richardson@jpl.nasa.gov)

TOPEX/Poseidon was the first major oceanographic research vessel to sail into space instead of out to sea. The satellite was a joint effort between NASA and the French Space Agency, Centre National d'Etudes Spatiales (CNES). In 1979, NASA was developing the Ocean Topography Experiment (TOPEX) mission, while CNES was planning a similar mission called Poseidon. In 1983, the two agencies decided to pool their resources into a single mission: hence the name TOPEX/Poseidon. On August 10, 1992, the satellite launched aboard an *Ariane II* rocket from the European Space Agency's launch facility in French Guiana. The California Institute of Technology's Jet Propulsion Laboratory (JPL) managed the U.S. portion of the mission for NASA.

TOPEX/Poseidon vastly exceeded its objectives and transformed our understanding of ocean currents and their roles in global climate change. The satellite's radar altimeter measured global ocean surface topography while its Global Positioning System (GPS) receiver

and additional instruments determined precision orbit. With these instruments, the satellite achieved an unprecedented accuracy—better than 5 cm in ocean surface topography, or sea-surface height. Planned as a five-year mission, TOPEX/Poseidon operated successfully for more than 13 years. It provided over 98% of the scientific data it was designed to collect for an international team of more than 600 scientists representing 54 countries.

With TOPEX/Poseidon's considerable success, NASA and CNES agreed to extend the time series and update the instrumentation, so Jason-1 was launched on December 7, 2001, and Jason-2 and Jason-3 are currently in development. TOPEX/Poseidon and Jason-1 data revolutionized the way we study the global ocean. During a period when the two satellites operated in a tandem mission mode, they were able to collect twice the amount of data, revealing details of smaller-scale ocean phenomena such as coastal tides, ocean eddies, and ocean currents.

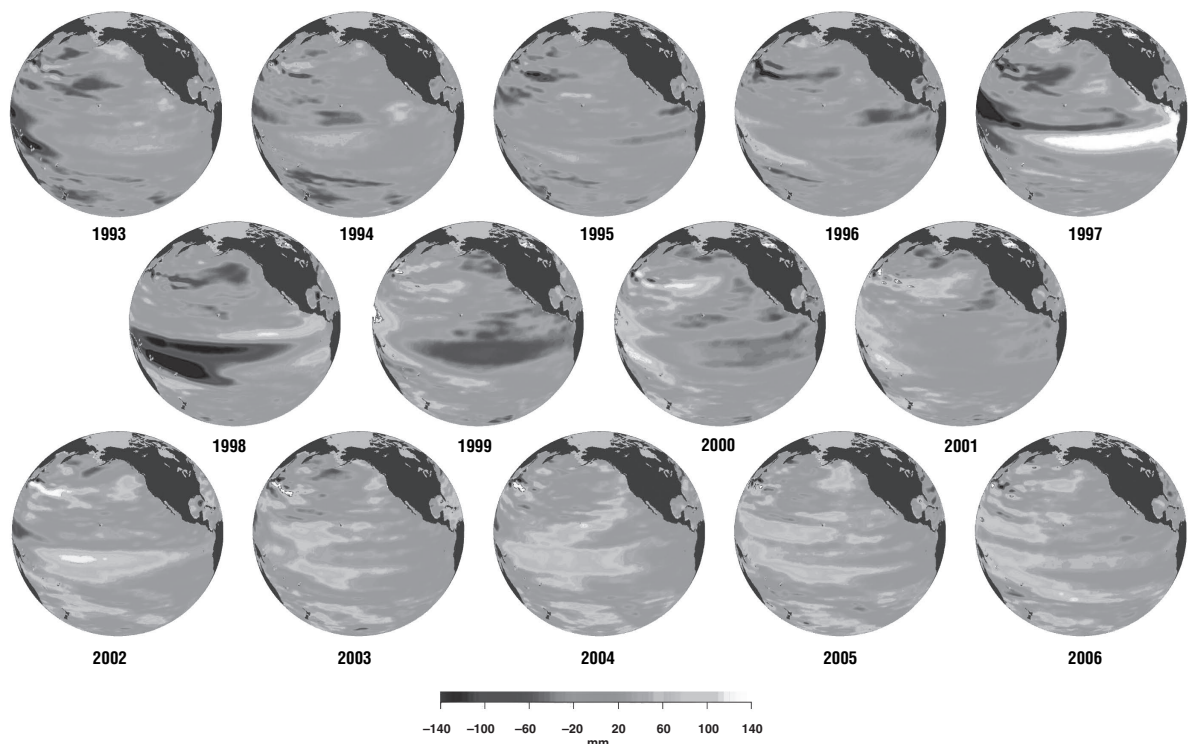

**Figure 1. Faces of a Changing Ocean.** These data globes show the annual average sea-surface height anomalies for the period from 1993 to 2006. An *anomaly* refers to the difference between the height of the sea surface measured by the satellites and the scientifically accepted normal sea-surface height. In these images, the white areas represent sea surface heights between 8 and 24 centimeters above normal, indicating warmer expanded water. Dark areas represent sea surface heights between 8 and 24 centimeters below normal, indicating cooler contracted water. Sea-surface heights move up and down in a regular yearly pattern as the Sun warms the water of the upper ocean in accordance with the seasons. The seasonal signal was removed from these maps to highlight year-to-year variations. For a color version go to: [sealevel.jpl.nasa.gov/gallery/posters/gifs/14-globe\\_Litbo.pdf](http://sealevel.jpl.nasa.gov/gallery/posters/gifs/14-globe_Litbo.pdf).

One of the most important achievements of TOPEX/Poseidon and Jason-1 has been the highly accurate determination of global patterns of ocean circulation and heat transport in the ocean—see **Figure 1**. “The oceans are Earth’s heat capacitors, absorbing over 80% of global warming heat,” states oceanographer **Josh Willis** [NASA/JPL]. Thermal expansion is one of the causes of elevated sea-surface height, and therefore signifies the amount of heat stored in the upper ocean. Ocean altimeters measure changes in sea-surface height, and consequently heat storage can be inferred based on these measurements. **The top three meters of the ocean can store as much heat as the entire atmosphere**, and for that reason, oceanographers maintain that ocean circulation is the most important driving force in climate regulation.

TOPEX/Poseidon and Jason-1 have provided the most complete, long-term, global record of sea-level changes, ocean circulation, and basin-wide current variations ever collected. With this invaluable data, scientists can compare computer models of ocean circulation with actual global observations and use this information to better understand changes in sea-level as well as the effects of currents on global climate, and to make improvements in climate predicting ability.

TOPEX/Poseidon also gave us the first global perspective on El Niño and La Niña, part of a cycle that repeats every 3–7 years in the Pacific Ocean and has profound effects on world climate. This global view presented ocean and climate scientists with the opportunity to observe the development of these events and to follow their evolution. For example, observations from TOPEX/Poseidon—e.g., **Figure 2**—enabled scientists to forecast some of the impacts of the 1997–1998 El Niño. Additionally, the data record from TOPEX/Poseidon and Jason-1 supplied unprecedented views of ocean variability on decadal scales, revealing large-scale patterns of ocean circulation and air-sea interactions in the global oceans. These data provide evidence of longer-lasting phenomena, such as the Pacific Decadal Oscillation, a fluctuation in the Pacific Ocean that waxes and wanes over a 20–30 year period.

Additionally, the data from TOPEX/Poseidon and Jason-1 benefit society in several respects including operational applications, such as hurricane prediction, navigation, marine mammal research, offshore operations, fisheries, mapping global tides, and other scientific research in physical oceanography.

In October 2005, TOPEX/Poseidon’s *pitch reaction wheel*, which helps keep the spacecraft in its proper orbital orientation, stopped working which prevented further science operations. Ground controllers transmitted the final command terminating the historic

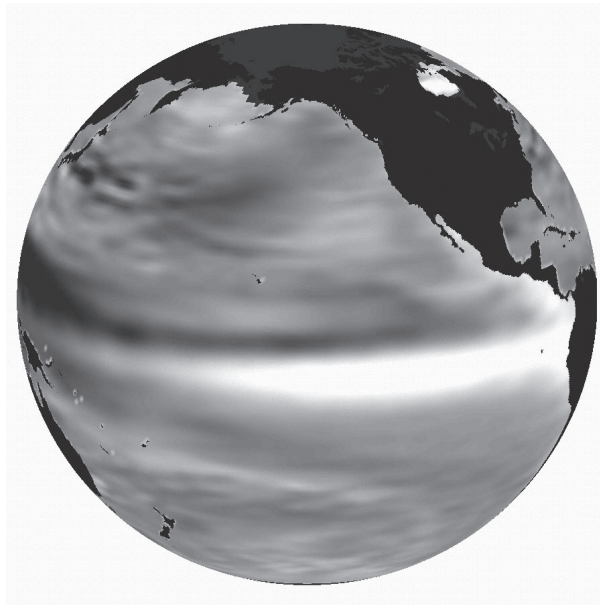

**Figure 2.** The TOPEX/Poseidon satellite produced this image of the Pacific Ocean in the winter of 1997 during a strong El Niño. The large bright white band that stretches from the eastern Pacific across the center of the ocean represents an immense area of unusually warm water.

mission in January 2006. Today, the satellite remains safely in orbit 1,336 kilometers above Earth. Jason-1 flew in a tandem mission with TOPEX/Poseidon for nearly three years before the older spacecraft ceased operations. Now flying solo, Jason-1 will continue to collect valuable data on ocean circulation and ocean topography for researchers and operational users worldwide. The expectation is that Jason-1 continues to function well and will be able to fly in tandem with Jason-2 for a time after it launches.

Ongoing science investigations for Jason-1 include studying ocean variability on decadal scales in relationship to climate; understanding how changes in the ocean’s heat content and mass affect global sea-level; producing better tide models for the coastal oceans where the scales of tides are too small to be resolved by a single altimeter; and studying ocean eddies and their effects on large-scale ocean circulation and heat transport. Another objective of the Jason-1 satellite is to determine the characteristics of deep-water tides. Tides are the most visible change in the ocean on a daily basis and play a significant role in navigation; they are the main source of mixing in the ocean, and influence biological activity. Jason-1 has demonstrated that high accuracy radar altimetry is no longer experimental; the data are fundamental to NOAA and many other operational entities.

The successes of the TOPEX/Poseidon and Jason-1 satellites continue to motivate further investigation. A comprehensive view of the world ocean is the only way to measure global climate change and other large-scale changes in ocean conditions. Changes in sea-level are

the primary indicators of global warming, yet according to Willis; "Sea-level rise is the most highly visible and poorly predicted impact of global warming." We need to find out how global sea-level is affected by natural variability as well as by human influence.

Changes in oceanic thermohaline circulation are another aspect of climate change that requires further study. In order to understand the relationship between climate change and change in global ocean circulation, we first need to understand how global ocean circulation varies on interannual, decadal, and longer time scales. Our ability to improve climate forecasting depends on the extent of the data collection time series; therefore, as we lengthen the time series we improve our ability to anticipate future conditions. Furthermore, as the climate continues to change, the data that form the basis of our present predictions may no longer be relevant, so our methods of forecasting must adapt to the most recent observations.

The best way to obtain these vital global-scale observations is from satellite altimetry. The next NASA ocean altimetry mission slated to expand the efforts of TOPEX/Poseidon and Jason-1 is the Ocean Surface Topography Mission (OSTM) on Jason-2—see **Figure 3**. OSTM/Jason-2 is scheduled for launch in June 2008 from Vandenberg Air Force Base. This new mission, also a collaborative effort between NASA and CNES, includes two new partners: the European Organization for the Exploitation of Meteorological Satellites (EUMETSAT), and the National Oceanic and Atmospheric Administration (NOAA). With new partners, and improved instrumentation and satellite tracking, OSTM/Jason-2 will extend the ocean-surface topography time series even further to accomplish two decades of observations, and move closer to the goal of establishing operational as opposed to experimental satellite radar altimetry for oceanographic applications. The OSTM/Jason-2 satellite will carry the next generation instruments including CNES's Poseidon-3 dual-frequency radar altimeter to measure sea-surface height, NASA/JPL's Advanced Microwave Radiometer (AMR) to measure total water vapor along the altimeter path to correct for pulse delay, and NASA/JPL's Global Positioning System Payload (GPSP) receiver, which provides precise orbit ephemeris data. These instruments will have lower noise and be programmed with algorithms that enable better tracking over land and ice. NOAA will provide management of flight operations during the routine operational phase, archival and distribution services for the OSTM/Jason-2 raw mission data, near-real-time operational products, and will acquire, produce, and distribute geophysical data to all interested users.

The benefits of OSTM/Jason-2 are many, ranging from high-resolution, small-scale views of eddies and coastal

conditions, to the largest global-scale measurements of sea-level rise, changes in ocean circulation, and open-ocean tides. It will help us improve our understanding of El Niño, La Niña, droughts, and floods. OSTM/Jason-2 will also extend the length of the record of sea-surface height, improving our understanding of long timescale climate events such as the Pacific Decadal Oscillation (PDO) and our ability to predict and understand long-term changes to Earth's climate.

Because long-term, time-series climate data are of such vital importance, scientists are already preparing for the follow-on to Jason-2, even before Jason-2 is launched next year. Jason-3, also proposed as a joint CNES, EUMETSAT, and NOAA mission, will launch in 2012 and should overlap in tandem with Jason-2, thus ensuring continuity. As climate conditions become ever more pertinent in this changing world, the next two ocean-surface topography missions will extend this invaluable data into the coming decades, improve our understanding of the ocean's role in climate, and provide for continued operational successes. ■

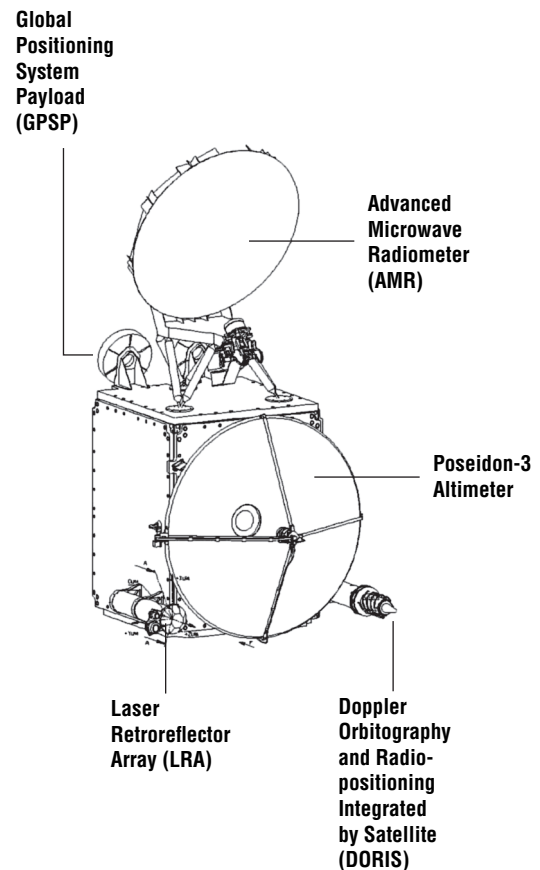

**Figure 3.** OSTM/Jason-2 is currently undergoing extensive testing in preparation for a June 2008 launch. It will be a follow-on to the two previous ocean topography missions that will extend our understanding of long-term oceanographic conditions.

## Dutch Students Contribute to OMI Aerosol Validation

Tim Vlemmix, Royal Netherlands Meteorological Institute (KNMI), [vlemmix@knmi.nl](mailto:vlemmix@knmi.nl)

Ellen Brinksma, KNMI, [brinksma@knmi.nl](mailto:brinksma@knmi.nl)

Joris de Vroom, KNMI, [vroom@knmi.nl](mailto:vroom@knmi.nl)

Pietermel Levelt, KNMI, [levelt@knmi.nl](mailto:levelt@knmi.nl)

We've all been there. The sun is shining brightly outside but we are forced to stay inside for school or for our job. How we wish we could take our work or have our class outside! Well, some high school students in the Netherlands now have a legitimate reason to be outside on those bright sunny days. Their schools are participating in the GLOBE-aerosol project. Two or three students head outside a couple of minutes before NASA's Aura satellite is scheduled to pass over. Once outside, they take a measurement of the intensity of the sunlight using a hand-held Sun photometer, from which the amount of aerosols can be derived. The results are used for the validation of the aerosol retrieval of the Ozone Monitoring Instrument (OMI) on Aura.

OMI measures the aerosol concentrations (along with various trace gasses, and clouds) worldwide, on a daily basis. *Aerosols*—particles or droplets in the air with a typical diameter of 1  $\mu\text{m}$ —scatter and absorb sunlight, and ultraviolet radiation from the surface of the Earth, and thus play an important role in the radiative balance of the atmosphere and impact the temperature of the atmosphere. Moreover, without aerosols it would be almost impossible for clouds to form in our atmosphere.

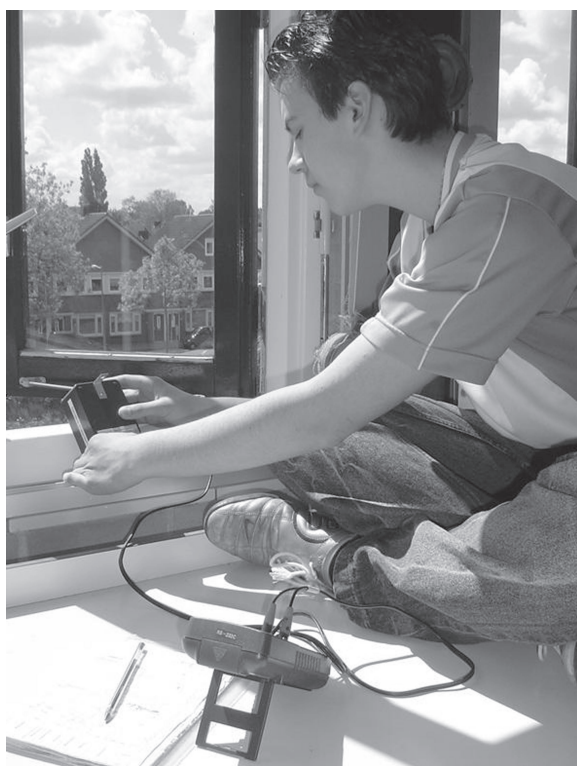

A student from Amsterdam takes an aerosol measurement out of the classroom window.

In order to understand climate and climate change, one obviously needs to investigate the role of aerosols. For this purpose, satellite observations are indispensable.

The students, who range in age from 14 to 17, use a simple hand-held Sun photometer to measure the direct sunlight. This instrument uses light emitting diodes (LED's) as photocells. **David Brooks** [Drexel University, Philadelphia, PA] and **Forest Mims** [Sun Photometer Atmospheric Network, Seguin, TX] developed the instruments that the students use. Although operating the instrument is not that difficult, the students have to make accurate measurements in order to have the lowest possible error due to misalignment of the instrument. From their measurement, the *total extinction* can be determined. [Following are details on how extinction is calculated.]

*Extinction* of sunlight is caused by *absorption* and *scattering* of sunlight due to the various atmospheric constituents (clouds, water vapor, aerosols, other trace gases). In terms of physics, the *total extinction* is defined as the exponential factor by which the intensity of sunlight decreases as it propagates through the atmosphere. It is a product of the *relative path length* of the sunlight through the atmosphere (which is defined to be unity (1) when the sun is located directly above an observer) and the *optical thickness*. The *optical thickness* can be decomposed in a contribution due to Rayleigh scattering (Rayleigh optical thickness), a part that is due to ozone absorption (ozone optical thickness) and a remaining part attributed to aerosols (aerosol optical thickness) which can only be measured in the absence of clouds. (The students measure aerosol optical thickness with the Sun photometers.)

Since aerosol extinction can only be measured under cloud-free conditions, the students must first observe the sky conditions and make a decision whether or not to take a measurement with the Sun photometer. Clouds are sometimes very difficult to detect with human eyes, so the largest source of potential error in the student's measurements is from cloud contamination.

Students fill in a data sheet with every measurement, making notes of the output voltages of the instrument, and also the meteorological conditions, e.g., cloud cover, cloud type, the number of contrails in the sky, etc.

During Fall and Winter 2006 we noticed a sharp drop-off in the number of measurements coming from the schools. This is not surprising, since winter in the Netherlands tends to be very grey and overcast with very few cloud-free days to take observations. Sometimes during the winter the students have to wait for weeks to get a good day for making observations, and even those rare days where one could obtain a good measurement during an OMI overpass were often missed because the teachers and students had gotten out of the daily routine of taking measurements.



Four pairs of eyes keep a close watch on the instrument. The students lean on each other for support.

which all the participating schools were on the alert all the time. We chose this period to start in the first week of March, and to end in the second week of May—that time of year tends to be sunny in the Netherlands. Twelve schools participated in the campaign.

We could not have chosen a better period for a campaign, since after some very good days in March, this year's April became a record breaking month in the Netherlands with lots of sunshine (280 hours of sun versus 162 normal). The schools were obviously ready this time, since we received lots of measurements that were taken right at the moment when OMI passed over (twice a day). At the moment we are in the process of analyzing the data and inspecting the calibration of the instruments that were used during the campaign. Preliminary results with well calibrated instruments



Students from Houten work together efficiently, bending over backwards to help one another.

To solve this problem, we introduced the *campaign format* this year. The main idea was to organize a shorter period (two months rather than the whole year) in

**GLOBE-OMI coincidences of selected schools (508 nm)**

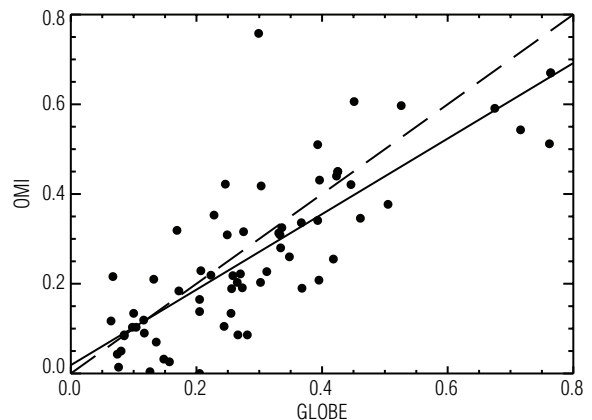

A scatter plot of coincident GLOBE [hand-held Sun photometers] and OMI [satellite] Aerosol Optical Thickness [AOT] measurements at 508 nm [the OMI AOT values have been extrapolated from 483.5 nm to this wavelength]. For points on the dashed line, there is no difference between the GLOBE and the OMI measurement. The skew line is the best linear fit through the points. The correlation coefficient of these 66 measurements is 0.80.





All students presented the results of their measurements during the campaign period on a poster at KNMI.

look very promising: there is a good correlation (0.80) between aerosol measurements from the ground—see graph on page 8—taken by the students, and measurements taken by OMI. This correlation is comparable to the results obtained by professional Sun photometers. It confirms the quality of the OMI-aerosol retrieval.

At the end of the campaign, the students and their teachers came to the Royal Netherlands Meteorological Institute (KNMI) to present a poster on which they

showed what they had learned, and to understand from KNMI how they had contributed to the OMI aerosol validation research. It was a nice meeting and everybody was enthusiastic about the success of the campaign.

After the summer holidays, a new campaign will start to continue the research. Hopefully, we will have a lot of sunshine in September and October so we will be able to gather just as many valuable measurements. ■

### ABOUT THE GLOBE PROGRAM

Global Learning and Observations to Benefit the Environment (GLOBE) is a worldwide hands-on, primary and secondary school-based science and education program. GLOBE's vision promotes and supports students, teachers, and scientists to collaborate on inquiry-based investigations of the environment and the Earth system, working in close partnership with NASA and the National Science Foundation's Earth System Science Projects (ESSPs) in study and research about the dynamics of Earth's environment. For more info please visit [www.globe.gov/](http://www.globe.gov/).

Internationally, GLOBE is implemented through bilateral agreements between the U.S. government and governments of partner nations. To date, 109 countries have signed GLOBE agreements, including the Netherlands. The GLOBE-aerosol project in the Netherlands started in 2002 with the scientific support of the Royal Netherlands Meteorological Institute [Koninklijk Nederlands Meteorologisch Instituut (KNMI)], and the organizational support of the Environmental Consultants Agency (SME-Advies). KNMI helps to train the teachers and students, calibrate the Sun photometers, and process the data that the schools submit. During the first couple of years of the project, the focus was on the validation of the Moderate Resolution Imaging Spectroradiometer (MODIS) instrument on NASA's Aqua satellite. The GLOBE measurements confirmed that MODIS aerosol retrieval was more accurate over land than over coastal areas. This finding resulted in a scientific article in the *Journal of Geophysical Research* (October 2006) by **Folkert Boersma** [Harvard University, Massachusetts] and **Joris de Vroom** [KNMI].

## Changing Arctic Observed by CERES Instruments and MODIS

Seiji Kato, Science Systems & Applications Inc., Hampton VA, [seiji.kato-1@nasa.gov](mailto:seiji.kato-1@nasa.gov)

Global climate change is occurring most rapidly in the Arctic and can be studied using satellite data—read a first-hand account of an expedition to Siberia on page 13 of this issue. Many channels available from the Moderate Resolution Imaging Spectroradiometer (MODIS) on Aqua and Terra are used to identify clouds and retrieve their properties over polar regions. Better cloud identification helps to reduce the uncertainty in the top-of-atmosphere (TOA) irradiance estimate compared with the irradiance estimates from the Earth Radiation Budget Experiment [Loeb et al. 2006]. Seiji Kato [NASA Langley Research Center, SSAI] and some of his colleagues are trying to bring together newer cloud detection capabilities of MODIS and better irradiance estimates from the Clouds and the Earth's Radiant Energy System (CERES) instruments to help them investigate the atmospheric response to a large change in snow and sea ice covers.

Passive microwave measurements from satellites show that Arctic sea ice cover decreased at a rate of 6.4% per decade from 1978–2000 [Comiso, 2002]. A more recent analysis [Stroeve et al., 2005] reveals that the September ice extent is decreasing at an even faster rate of 7.7% per decade. Because detecting clouds and retrieving their properties over a bright surface such as snow and sea ice is difficult, scientists don't understand seasonal variations of cloud cover and their properties and their interannual variability over polar regions as well as they do in other regions. Not only that, since estimating the irradiance from radiance measurements requires knowledge of scene type such as cloud, snow, and sea

ice cover [Kato and Loeb, 2005], the seasonal variation of radiation at the top of atmosphere (TOA) and its interannual variability is also difficult to accurately measure in polar regions.

There have been earlier efforts to study cloud cover trends over the Arctic [Wang and Key, 2005a, 2005b] using the Advanced Very High Resolution Radiometer Polar Pathfinder (APP). Unfortunately though, research results show that there is a significant difference in the seasonal cycle of cloud cover depending upon which satellite instruments and algorithms you use to derive cloud cover [Kato et al., 2006]—see **Figure 1**. Therefore, for the current study, the researchers want to investigate the trend in the cloud cover and TOA reflected shortwave using well-calibrated MODIS and CERES instruments [Loeb et al., 2007].

To understand changes in cloud cover and the impact on the TOA irradiance, Kato and his colleagues needed to define the *mean state*—an average amount of cloud cover, shortwave irradiance, and longwave irradiance for each month. They computed the *monthly mean* cloud cover and TOA shortwave and longwave irradiances over the Arctic and Antarctic. Once they calculated the *mean state*, they subtracted these monthly mean values from monthly values and computed de-seasonalized anomalies. In this study, the researchers defined the Arctic as the region between 60°N and 90°N and the Antarctic as the region between 60°S and 90°S. A CERES data set from March 2000 through

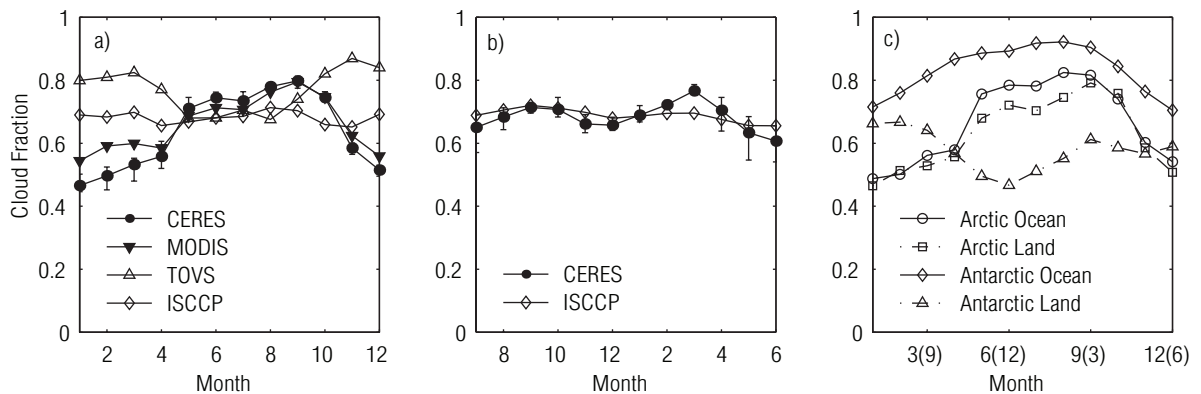

Kato et al. (2006)

**Figure 1.** a) Monthly mean cloud fractions derived from MODIS radiances by the CERES cloud algorithm (Minnis et al., 2004) and by the MODIS Collection 4 algorithm (King et al., 2003) for the Arctic. The cloud fraction is derived from data taken between March 2000 and February 2004. The cloud fraction derived from TOVS (Schweiger et al., 2002) and International Satellite Cloud Climatology Project (ISCCP, Schiffer and Rossou, 1983) for the same period are also shown. b) Monthly mean cloud fractions derived from MODIS radiances by the CERES cloud algorithm and from ISCCP for the Antarctic. The vertical bars in a) and b) represent the maximum and minimum values for a given month as derived from Terra data. c) Monthly mean cloud fractions derived from MODIS radiances by the CERES cloud algorithm over ocean surfaces and over land surfaces.

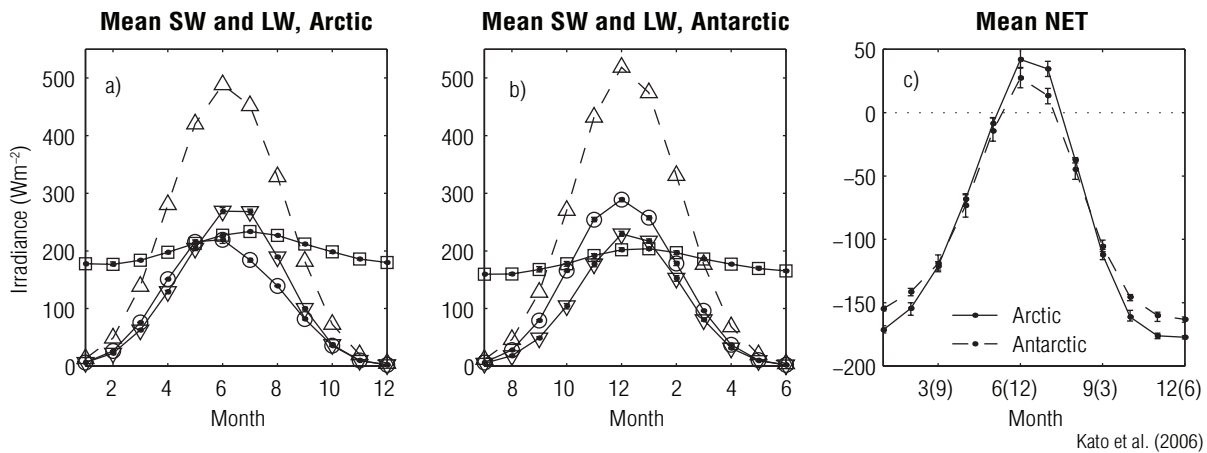

**Figure 2.** Monthly mean TOA reflected shortwave irradiances (open circles), absorbed shortwave irradiances (solid circles), longwave irradiances (open squares) and downward shortwave irradiances (open triangles) for *a*) the Arctic, for *b*) the Antarctic, and *c*) net irradiance (absorbed shortwave irradiance – longwave irradiance) at the top of the atmosphere; the months in parenthesis are for the Antarctic. The vertical bars represent the maximum and minimum values for a given month as derived from Terra data.

February 2004 taken from the Single Scanner Footprint (SSF) *Edition2B, Revision1 (Ed2B<sub>rev1</sub>)* product was used for the study.

**Figure 1** shows that *cloud fraction* derived from MODIS using two different algorithms agree well but those two values do not agree well with cloud fraction derived from other datasets. In addition, the seasonal cycle of *cloud fraction* is different over the Arctic and Antarctic.

While cloud fraction varies quite a bit in the Arctic, ranging from approximately 0.5 in winter to approximately 0.8 in summer, it is relatively constant in the Antarctic, ranging between 0.6 and 0.75 throughout the year. The scientists speculate that this is caused by the difference of land and ocean coverage between two regions. The cloud fraction over the Arctic ocean, however, shows a larger seasonal variation than the cloud fraction over the Antarctic ocean. The seasonal variation in the cloud cover over the Arctic land is larger than that over the Antarctica. The seasonal snow cover variation over the Arctic land might explain a larger seasonal variation of cloud cover over the Arctic land. The difference in the seasonal variation of surface properties, however, does not explain the difference of cloud cover over the Arctic and Antarctic oceans.

The ice sheets over the Antarctic do not melt and that keeps the snow cover fairly constant throughout the year. Conversely, there are fairly large seasonal variations in the snow and sea ice cover in the Arctic. As a result, the TOA reflected shortwave radiation over the Arctic is smaller than that over the Antarctic. On the other hand, because the Antarctic has a higher mean elevation than the Arctic, the TOA longwave radiation over the Antarctic is smaller than that over the Arctic. The net effect of all this is that the net TOA irradiance over the Arctic shows a larger seasonal variation than that over the Antarctic—see **Figure 2**. When the TOA net irradiance is averaged over a year, the annual mean TOA net

irradiance is  $-92.6 \text{ W/m}^2$  over the Arctic and  $-90.1 \text{ W/m}^2$  over the Antarctic.

The trend of daytime cloud cover over the Arctic computed from de-seasonalized anomalies from March 2000 through February 2004 shows that the cloud fraction increased at a rate of  $0.047 \pm 0.041 \text{ W/m}^2$ , while snow and sea ice fraction decreased at a rate of  $0.064 \pm 0.055 \text{ W/m}^2$  both at a 80% confidence level—see **Figure 3**. The trend of reflected shortwave over the Arctic during the same period is statistically less significant,  $-2.0 \pm 2.0 \text{ W/m}^2$ —see **Figure 3**. These results suggest that the presence of clouds and increasing their coverage reduce the TOA shortwave irradiance and at least partially (if not completely) mitigates the influence of reduced Arctic snow and sea ice cover on the TOA reflected shortwave

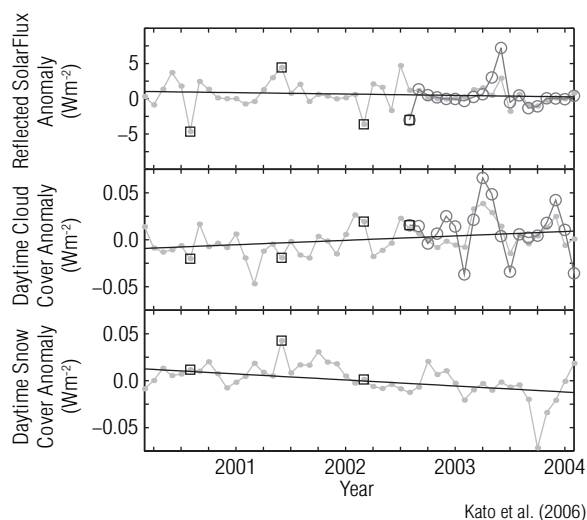

**Figure 3.** Reflected TOA shortwave irradiance, daytime cloud fraction, and daytime snow and sea ice fraction, anomalies as a function of month for the Arctic. Terra data are represented by the solid line with dots, and Aqua data (SSF *Ed1B*) by the light solid line with open circles. Open squares indicate months with missing days. The horizontal lines are linear regression fit to Terra data.

irradiance. The implications are that any ice-albedo feedback cloud be dampened because of increased cloud cover and such responses should be studied in climate simulations. The cloud fraction and TOA reflected shortwave irradiance over the Antarctic show no significant trend during the same period.

### For Further Study

These results illustrate what is happening over polar regions viewed from CERES instruments and from MODIS on Terra, posing some interesting questions for further study. For example, scientists wonder if there may be a limit to how long changes in land cover will be able to offset changes in TOA albedo that are associated with changes in the amount of sea ice cover. Although the trend in the data is not statistically significant, a slight negative trend might indicate that there is a limit for their compensation. Are there any trends in the TOA longwave and net irradiances? We will investigate longwave and net irradiance trends using the *Edition 3* CERES data set in the future.

The findings about mean net irradiance over the Arctic and Antarctic also raise some interesting questions about energy transport to the poles. Our study shows that the annual mean net irradiance over the Arctic and Antarctic differ by less than 3%, which would suggest that the rate of energy transport at 60°N and 60°S is about the same. However, the annual mean albedo over the Arctic and Antarctic is 0.45 and 0.57 respectively, and annual mean longwave is 201 W/m<sup>2</sup> and 180 W/m<sup>2</sup>. In addition, the land and ocean distribution and fraction in the northern and southern hemispheres are completely different. Furthermore, the Sun-Earth distance is smaller in the southern hemisphere summer than the northern hemisphere summer, which makes a difference in the annual TOA downward shortwave irradiance over the Arctic and Antarctic of 2.6 W/m<sup>2</sup>. Given all these differences, why does the annual mean energy transport rate at 60°N and 60°S only differ by less than 3%? A simple sensitivity study of energy transport using a general circulation model might give a clue to some answers to this question.

### Acknowledgement

This article is based on the work that was supported by a grant from the CERES project (NNL04AA26G), NASA grants (NNG04GL93G, NNG04GL94G, NNG04GL96G), and a Jet Propulsion Laboratory, California Institute of Technology, contract (1259588).

### References

Comiso, J., 2002; A rapidly declining perennial sea ice cover in the Arctic, *Geophys. Res. Lett.*, **29(20)**, 1956, doi:10.1029/2002GL015650.

Kato, S., N.G. Loeb, P. Minnis, J.A. Francis, T.P. Charlack, D.A. Rutan, E.E. Clothiaux, S. Sun-Mack, 2006: Seasonal and Interannual Variations of Top-of-Atmosphere Irradiance and Cloud Cover over Polar Regions Derived from the CERES Data Set, *Geophys. Res. Lett.*, **33**, L19804, doi:10.1029/2006GL026685.

Kato, S., and N.G. Loeb, 2005: Top-of-atmosphere shortwave broadband observed radiance and estimated irradiance over polar regions from Clouds and the Earth's Radiant Energy System (CERES) instruments on Terra, *J. Geophys. Res.*, **110**, D7, D07202 10.1029/2004JD005308.

King, M.D., and co-authors, 2003: Clouds and aerosol properties, precipitable water, and profiles of temperature and humidity from MODIS, *IEEE Trans. Geosci. Remote Sens.*, **41**, 442-458.

Loeb, N.G., B.A. Wielicki, W. Su, K. Loukachine, W. Sun, T. Wong, K. Priestley, G. Mathews, W.F. Miller, R. Davies, 2007; Multi-instrument comparison of top-of-atmosphere reflected solar radiation, *J. Climate*, **20**, 575-591.

Minnis, P., D.F. Young, S. Sun-Mack, Q.Z. Treppe, R.R. Brown, S. Gibson, and P. Heck, 2004: Diurnal, seasonal, and interannual variations of cloud properties derived for CERES from imager data. Proc. 13th AMS Conf. Satellite Oceanogr. and Meteorol., Norfolk, VA, September 20-24, CD-ROM, P6.10.

Schiffer, R.A., and W.B. Rossow, 1983: The International Satellite Cloud Climatology Project (ISCCP): The First Project of the World Climate Research Programme, *Bull. Amer. Meteor. Soc.*, **64**, 779-784.

Schweiger, A.J., R.W. Lindsay, J.A. Francis, J. Key, J. Intrieri, and M. Shupe, 2002: Validation of TOVS Path-P data during SHEBA, *J. Geophys. Res.*, **107**, 8041, 10.1029/2000JC000453.

Stroeve, J.C. M.C. Serreze, F. Fetterer, T. Arbetter, W. Meier, J. Maslanik, and K. Knowles, 2005; Tracking the Arctic's shrinking ice cover: Another extreme September minimum in 2004, *Geophys. Res. Lett.*, **32**, L04501, doi:10.1029/2004GL021810.

Wang, X., and J. Key, 2005a: Arctic surface, cloud and radiation properties based on the AVHRR polar pathfinder dataset. part I: Spatial and temporal characteristics, *J. Climate*, **15**, 2558-2574.

Wang, X., and J. Key, 2005b: Arctic surface, cloud and radiation properties based on the AVHRR polar pathfinder dataset. part II: Recent trend, *J. Climate*, **15**, 2575-2593. ■

## Expedition to Siberia: A Firsthand Account

Jon Ranson, NASA Goddard Space Flight Center, [Jon.Ranson@nasa.gov](mailto:Jon.Ranson@nasa.gov)

Slava Kharuk, Sukachev Forest Institute, [kharuk@ksc.krasn.ru](mailto:kharuk@ksc.krasn.ru)

Joanne Howl, [JoVet@aol.com](mailto:JoVet@aol.com)

### Introduction

Nowhere on Earth is warming faster than the Arctic. In northern Siberia, average temperatures have risen 3–5°F over the past 30 years, whereas the worldwide average increase in that time is 1°F.

Between July 28 and August 12, 2007, a small international team of remote sensing and forest ecosystem scientists from NASA and Russia's Academy of Science set off on a three-week scientific expedition through the heart of the remote, wild forests of Siberia. They traveled southward down the Kochechum River observing the gradual transition from tundra to taiga, taking inventory of plant species along the way, and making ground-truth measurements to validate data being collected by several NASA satellites flying 700 kilometers overhead.

**Jon Ranson**, Head of the Biospheric Sciences Branch at NASA's Goddard Space Flight Center, and **Slava Kharuk**, of the Sukachev Forest Institute were the co-leaders of the expedition. Ranson and Kharuk have been collaborating since 1991, when Ranson first visited the Forest Institute's field camp; this is the pair's seventh Siberian expedition together.

While he was on the expedition, Ranson compiled a blog that reported on the team's activities to give a day-by-day record of their journey. Ranson phoned in each day to report on the team's progress so updates could be posted on *The Earth Observatory* website. (It's the first time *Earth Observatory* has posted a blog reporting on science research as it happens.) *The Earth Observer* has obtained permission to print a summary of the expedition, including excerpts from the blog, for our audience. The reader can see the complete account along with color photos at: [earthobservatory.nasa.gov/Study/SiberiaBlog](http://earthobservatory.nasa.gov/Study/SiberiaBlog).

### Why Study Siberia?

As you might imagine, the team had to put forth a great deal of effort and planning to access and explore a remote place like Siberia, but it was well worth the effort. The Russian forest is of particular interest to scientists studying Earth's carbon cycle, land ecosys-

tems, and biodiversity because it contains about 43% of the world's temperate and boreal forests, and yet scientists estimate that two-thirds of its area is being disturbed by natural or man-made stresses. As Earth's temperature rises, scientists want to know what is happening to the great northern forests? Will the trees in this ecosystem (called *taiga*) begin to grow faster and to gradually extend their reach farther north into the treeless *tundra*, as some scientists predict? Or will hotter, drier conditions stress the trees, thereby inhibiting growth and leaving the forest prone to invasive species and wildfires, as new evidence suggests?

Siberia is a great place to explore to find out answers to these and other questions. Thick stands of spruce, pine, aspen, and larch trees occupy a vast stretch of land across northern Asia and Europe, straddling roughly half of the Arctic Circle. It is a place of stunning natural beauty and biodiversity that serves as a *living laboratory* where scientists can learn whether or not the measurements they get from satellites in space actually match what they see with their own eyes.

### The Team's Itinerary

The expedition team's journey to study these forests started above the Arctic Circle near the source of the Kochechum River. There are no roads there, so the team flew in by helicopter, piled their gear into the three boats they brought, and then set off down river. They rode the river for 15 days and ended their trek at Tura, a small town of about 5,000 people. Until they reached Tura, they had to be completely self-sufficient. Their satellite phone was their only link to civilization.

At specific points along their journey, team members took measurements that will be used to validate the forest height measurements made by the Geosciences Laser Altimeter System (GLAS) onboard NASA's Ice, Cloud, and land Elevation Satellite (ICESat). To reach these locations, the team had to traverse through rugged terrain, carrying all of their equipment, and pinpoint the precise locations measured by ICESat's laser. At each site they used standard forestry equipment (e.g., diameter tapes, 50-meter tapes, and laser angle-finder devices) to collect data to compare to the satellite observations.

## DAILY PROGRESS REPORTS FROM JON RANSON'S BLOG

**Saturday, July 28, 2007**  
8:25 p.m. Siberia (8:25 a.m. EDT)

*Ranson and Kharuk met at Krasnoyarsk Airport in Siberia. They spent the day attending to last-minute details, including a shopping trip for boots and other gear for Jon, whose bag was lost in travel. Then it was off to the hotel for a short night's rest before departure for Tura, where his team boarded a helicopter to take them to their first camp site on the Kochechum River.*

The expedition team is pictured here on the helipad in Tura on July 28 beside the M8 helicopter that flew them to their start point above the Arctic Circle. From left to right: Slava Kharuk, Paul Montesano, Sergei Im, Pasha Oskorbin, Jon Ranson, and Guoqing Sun.

Hello to all! We are now above the Arctic Circle!

It is fantastic to be here, and how beautiful it is! The sky is sunny and blue with a few clouds. It is warm with a good breeze at times. We've set up camp on a rocky gravel sandbar beside the Kochechum River. I see green forest all around and there are big moose tracks going through our camp.

The ride in was good. As soon as we touched down, all hands tossed the gear out. Within ten minutes the helicopter was gone. We are in the middle of forest—but not like the forest I'm used to. The trees are quite small and very far apart. Our camp is close to the base of a small mountain. We'll do a transect up [the mountain] tomorrow. We'll measure tree size, how many trees are in a given area, how old they are, and how fast they have been growing over the last 40 years. We should get some good data on how the forest changes due to elevation and also due to warmer temperatures.

Right now two of our Russian colleagues are putting the boats together and making sure they work. Slava is setting nets for fish. We need the fresh protein to supplement the food we brought. We're all very excited. It's always great to start an expedition.



**Sunday, July 29, 2007**  
9:10 p.m.

*Today the scientists spent their first full day in the wilderness studying the forest ecology. They had to push through thick underbrush and hike over fields of boulders, stopping often to measure the height, circumference, and age of trees, and to observe variations in the forest related to elevation gain and warming temperatures.*

This has been one tough but interesting day. We walked up the mountain beside our camp with the idea that we'd see the tundra that was supposed to be at the top. **But there was no tundra.** Just forest. We've got a Russian map from 50 years ago, and it clearly states this mountain is tundra. The maps were based on aerial photography. It's also interesting that today's age measurements showed some of the trees were 90 years old.

The forests are larch here, which is the only tree that is well adapted to conditions this far north. We also see some willow, alder, and juniper—all in small, bushy forms due to the harsh environment. As we head to the south, the species will begin to change. That's exactly why we wanted to start this far north, so we could observe the changes. This transition between two different ecosystems is called an *ecotone*. The ecotone changes with latitude and elevation.

**What strikes me today is just how tenacious life is.** Every place in which it's possible, something is growing. We've seen signs of moose, bear, and elk, and we hear birdsong everywhere. The forest is stark, but it teems with life. It also seethes with mosquitoes. We are dressed head to toe in protective bug gear. I glanced over at a colleague earlier. They had swarmed his mosquito netting and it looked like he was wearing a carpet of bugs on his head.

Speaking of feasting, Slava caught a pike and something that looks like trout. We had fish soup for breakfast and fish soup for lunch.

Tomorrow we plan to move down river to locate and verify measurements made by NASA satellites. But that's tomorrow. Now it's supper time. Mmm...fish soup.

Pasha Oskorbin and Paul Montesano measure the height of a fallen larch tree, July 29, 2007.



**Monday, July 30, 2007**  
9:15 p.m.

It is a quiet day here on the Kochechum River. We broke camp this morning, packed all our gear into the boats and headed down river. Our mission of the day was to locate the areas where GLAS has made prior measurements. Tomorrow we'll begin taking ground-truth measurements to validate the satellite data.

The GLAS system measures tree height and produces what is called a *wave form*. That wave form can be used to measure *canopy closure*—the percentage of land covered by forest. The best way to verify the satellite's measurements is to come here and make those same measurements by hand with old-fashioned forestry instruments. Of course, it is really hard and time-consuming to travel here, force our way through this tough terrain, and swim through mosquitoes, but it's worth it.

If GLAS is actually accurate here, then we'll verify that and be happy. But even if we find error, it's good. We'll bring home lots of *ground-truth* data and field observations that will help NASA scientists and engineers design a better instrument. So we can't lose. Still, it's hard work.

Jon Ranson at the "helm" as the team cruises down the Kochechum River.



It was also great to rest my feet after yesterday's extreme hike up the mountain. The rocks were slippery and the underbrush seemed to grab and tear at our clothes and gear. But the pain in my feet was more than offset by the incredible beauty of this place. I really love it here.

**Tuesday, July 31, 2007**  
10:06 p.m.

*Rainy weather can be a nuisance to all of us but when one is on a science expedition in a remote location, rain has another, more critical, impact. To stay in touch with the outside world, the scientists rely on satellite phones and a small laptop computer. These need frequent recharging, so the team brought along two portable solar panels. There is sunlight 24 hours a day above the Arctic Circle, but to work well the panels require bright daylight. Cloudy days won't work. The dimmer light of the polar night doesn't do so well, either.*

*The computer has been offline since day two—recharging simply takes too long. The phones charge quickly, but several rainy days could deplete the phone's charge as well and sever the team's last link to civilization.*

**Wednesday, August 1, 2007**  
9:05 p.m.

Today we traveled about 35 km down river. We have made camp on a rocky island. On one side is an 800-m mountain that Slava will study tomorrow. Just upriver are many GLAS points that I will visit. It's still raining. The river is rising too. We actually had to move our camp to higher ground this afternoon.

The view is beautiful from here. The mountain tops are covered with basalt, which is a dark black rock.

We crossed below the Arctic Circle today. Just below the line we were greeted by a raven and a family of geese. A little bird, probably a red-throated pipit, has joined us in camp. He eats mosquitoes so we like him. We attract mosquitoes so he seems to like us too.

As we traveled down river, I saw what the Siberians call a *drunken forest*. This area is *permafrost*, where the soil stays firmly frozen year round. When permafrost melts, the trees lose their footing and tilt to the side. It's a curious sight, but it's also a **clear sign that the temperature in that spot has been warm enough to melt the permafrost.**

The river had also exposed a nice cross section of peat bog, several meters thick. A huge pool of carbon is stored in peat bogs and similar areas. Trapping this much carbon helps keep global temperatures down. But if the climate warms, then rapid decomposition could release lots of carbon dioxide and methane—both greenhouse gases—thus fueling greater temperature rise.

Paul took a turn in the kitchen today. I never knew he could cook! There's just no end to today's remarkable discoveries.

**Thursday, August 2, 2007**  
9:20 p.m.

*Because the rain and the gray skies persist, it has been impossible to charge the phone from the solar-panel charger. This means that until the sun shines again, the team has lost the ability to communicate with the outside world. So today's communication from the field is quick and short.*

I was looking at the forest and just was blown away by the beauty. That larch forest was so very green and it looked as if it was actually glowing—as if sun were shining on it even on this gray day. Just amazing!

But then I wondered, how it could be glowing like that? As we got nearer, we could see the glow actually was from the soil, UNDER the trees. In fact, it turns out that the soil was covered with very tiny, very light, lichens. The lichens reflect the sunlight extremely well.

This **background reflectance is important to how GLAS measures forest canopies**; if the reflectance of the soil changes significantly from place to place or season to season then the height measurements may also change. The lichens are present only at certain times of the year because of snow cover so the background reflectance is changing significantly throughout the year—something we do not allow for yet in our analysis.



I'm not saying this is the answer to the anomalies we've seen in our data, but it is sure worth studying! This is what we come here for; this is why we get in the field.

**Saturday, August 4, 2007**

10:32 p.m.

**From Slava Kharuk ...**

Today's rains began gently, and then a single thunderclap brought hard rain. This will be the last thunderstorm of summer, I am sure. The river is as high as it is in spring thaw, and that is a concern. We boated through a lot of choppy white water today. In one spot, the river narrowed tightly and the rapids became quite significant. We did fine, but I am happy to arrive at this campsite tonight.

Slava Kuruk pilots the lead boat down the Kochechum River.



**From Jon Ranson ...**

This morning we headed downstream to make our measurements. We pulled the boat well ashore, then started into the forest. But we didn't get very far. Floodwater had broken away from the main riverbed and was cutting a new channel right where we needed to go. The water was fast and too deep to wade.

We decided it was best to only take samples of the fire-scarred trees, then to get as far downriver as we could. From our boats, we again observed many large fire scars on the land. This evening we found a safe camp near many GLAS sites, so we will take measurements tomorrow.

For the first time we heard sounds of our own species. We paused to listen to a jet, very faint and far away. It is a reminder that our species, too, is part of one great ecosystem. That **we are, truly, all connected.**

The team takes time out from the river to share refreshments with Valeri and his assistant, who are preparing a nature camp for a Tura high school on the Kochechum River. These are the first people the team has seen since the expedition started 11 days ago.



**Monday, August 6, 2007**  
10:15 p.m.

This morning we had the hardest rain yet... Finally, about 9 a.m., it lightened up enough to start the day... And then it turned gorgeous. The sky is a beautiful blue. It feels great to be in sunlight again!

We worked 11 GLAS footprints today and measured over 600 trees. We're in an area scarred by fire. The regenerated forest here is about the same height and age as the old forest was when the fire burned it down. So **we see the green and the blackened trees, the living and the dead, all standing at similar heights.**

It is a great opportunity to use our *ground-truth* to see how the satellite lidar system records an area like this. The tree heights are similar, but the dead trees don't have any branches, so we aren't sure that the system will even take a reading from them. We'll take our measurements back to the lab and compare data, and we'll see.

This is one great reason to get out in the field. We have the data for this area from various satellite systems. We did know it was a fire scar. But **it's our time and our eyes on the ground that let us know there are unusual conditions here**—conditions that our remote-sensing tools may not be designed to handle.

Not only to understand present conditions, but also to make future predictions, we need to make sure our remote-sensing systems can both record standing dead wood and differentiate it from living trees.

So this has been an important day for our science. But that's not the only thing important about today. One year ago today Gouqing became a grandfather for the first time. He wants to be with his first granddaughter, Jasmine, on her first birthday. But he is here, a half-world away, measuring trees to help understand the forest, the carbon cycle, the local forest ecosystems, and how they all combine in the global ecosystem of which we are each a vital part.

We are studying changes here, in this remote and wild world. The world you grow up in, Jasmine, may be much different than the world we knew as children. Your Grandfather let me know that he is here with us not because he loves you less, but because he longs to see your Earth be vibrant, beautiful, and healthy. **We have a responsibility, each person in this world, to pass on to you a world worth living in.**

So today, Jasmine, in Russian tradition, we raise a toast to you from the wilderness—**С днём рождения!** Happy Birthday!

Gouqing Sun (left) and Jon Ranson (right) plan the day's work. One of the major goals of the expedition is to acquire ground-truth data to verify tree height measurements made by the Geosciences Laser Altimeter System (GLAS) on NASA's ICESat Satellite. To decide how to reach these GLAS "footprint" areas, they use a combination of topographic maps and images from sensors on NASA's Landsat and Terra satellites.



**Tuesday, August 7, 2007**  
10:20 p.m.

It is another wonderful day! We woke up to fantastic sunshine, got into dry clothes, then went to work. We spent about three hours collecting samples for the fire-return-interval study, broke camp, then went about 20 km down river to the GLAS footprint sites.

For the first time, we saw willows that are grown enough to be called trees. We've seen willow before but they were all quite small and shrubby. **This is the first sign of the change into the more southerly forests.**

Ever since we started on this journey, I've been looking at the boat motors. I keep wondering—to myself and out loud—why can't these motors do more than one thing? Why can't we use that power for something else, too?

Well, just a little while ago Slava very quietly revealed to me that the motors do, in fact, have a 12-volt outlet of sorts. Gouqing and I think we have what we need to convert that 12-volt DC outlet to 110-volt AC. If that is the case, then I will be able to get the computer up soon! Of course, I don't have a surge suppressor, so I suppose it's possible that we could end up frying the computer, but—no—won't happen. We'll try to make it work.

Speaking of home, Paul keeps talking about pizza. He has been on this topic for days now . . . pizza! Now I hear that the vegetable supply is getting low but there is plenty of canned beef left. Lots of it. Hmmm. I suspect I will be wishing for fish soup very soon.

**Wednesday, August 8, 2007**  
10:38 p.m.

*The Kochechum is a curious river. The chilly headwaters begin in snowmelt and rain in the basaltic mountains north of the Arctic Circle. These waters flow southerly to the town of Tura and join the Lower Tunguska River. The Lower Tunguska heads northwest until the waters spill into the Yenisey River near the town Turukhansk. The Yenisey turns northerly, ending at the Kara Sea which opens to the Arctic Ocean. After looping away from the Arctic Circle and back, the waters of the Kochechum end up farther north than they begin.*

We met our first people today! We stopped by a new structure on the riverbank, and soon a man and a teenaged boy motored in on their boat. It turns out they are working on a camp for high school students from Tura. They gave us dried fish, and we shared what we had with them. It was nice to hear other people talking and to get the latest news of the river lands.

Speaking of boats and motors, our experiment with re-wiring the 12-volt plug on our motors has not worked. I don't know why—everything looks exactly right. I have learned that next time I'll bring extra batteries for the computer. I'll bring a volt-meter, too, in case I want to do some more experiments on the wiring. We are here to learn, aren't we?

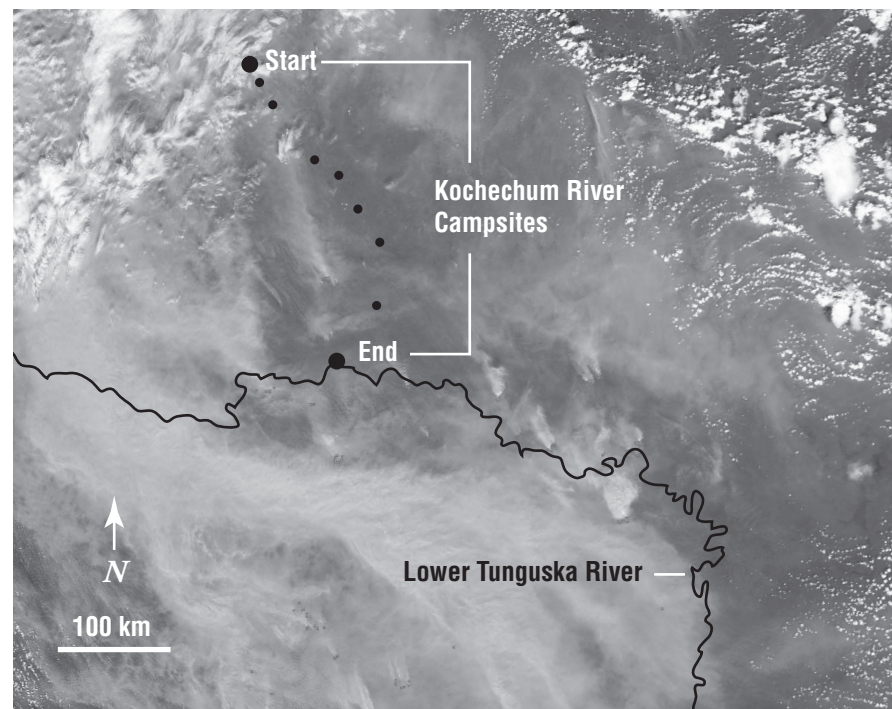

*Thursday, August 9, 2007*  
10:48 p.m.

Tonight I'm calling in from my sleeping bag! It's late already, and I am tired, so I snuggled in before I called. My impressions from here: the ground is stony, but better than farther north. This beach has a bit of gravel between the rocks, and the stones are smaller than other beaches we've been on. I'll sleep just fine.

Also, the mosquitoes aren't as bad here as upriver. It's a habit now each morning to check the net on my tent to see how many mosquitoes wait for me to "come out and play." There are definitely many less hanging on that net now. Before sometimes I saw a carpet of them. Here, just handfuls. I guess you could say I have plenty of friends in Siberia.

We still have about 200 km to go to arrive in Tura and to end the expedition. Let me put that another way. When we were in our lab in Maryland, we identified 35 GLAS points of interest on the river, places we would investigate if we could. They are measured from north to south. The most northerly was #1. Today we made it to site 19. So you can see that there is a long way to go yet. We won't measure much more on this trip, but we still need to pass by all those points before we reach Tura.

We spent all day making our tree measurements. We were able to complete 10 GLAS plots today—over 600 trees. **This area is one of the best we could hope for in terms of allowing us to understand the satellite data.**

*Friday, August 10, 2007*  
10:15 p.m.

It has been a long day on the river. The weather was blustery. Wind came up the river at us on and off all day. For the first time we were covered in spray from the river, and I got pretty chilly.

Yesterday we saw our first birch tree; it was very small, but still a birch. Today we saw more birch and our first spruce. The forest is still dominated by larch, but it is changing.

The Kochechum looks really big to me; it's over 100 m wide in many spots. That's about the length of an American football field. But for Russia, this is a very small river. The waters run into the Lower Tunguska, which is a big river, and then to the Yenisey, which is huge—see map on previous page. Then into the Arctic Ocean.

These rivers carry a huge volume of fresh water into the salty Arctic Ocean each day. As the temperatures in Siberia increase, there will be more melting of snow and permafrost. The rivers will carry a greater volume of fresh water, spilling it into the ocean. What happens to the ocean as the salinity drops? What changes will we see in the ocean ecosystems? How might that change affect Earth—the climate and the ecosystems? Hydrologists want to know, and they are actively studying the changes in the world's rivers and oceans. **There is much to learn, here in Siberia.**

*Saturday, August 11, 2007*  
11:56 p.m.

I've said our destination was Tura, but that isn't exactly precise. We are in a cabin just north of [Tura] at a field camp run by the Sukachev Forest Institute. It's still basically wilderness, but instead of rocks and tents we have beds and a cabin. We also have running water and electricity here, so I should be able to get online, finally!

On the river today we saw boats coming towards us for the first time. I guess everyone was feeling good, because they started some teasing. "Look, they are delivering Paul's pizza!" someone shouted. Then to my surprise, someone said, "Oh, maybe they are delivering Jon's bag!" Now, I know Paul has talked about pizza non-stop for days, but I thought I'd been quite stoic about that lost bag of mine. Well, maybe not!

**Today's amazing find was a huge area of burned forest.** It was tens of kilometers wide and long. It was fairly freshly burned—sometime in the spring we think. In the lab I'll look at data from our remote-sensing systems—especially MODIS and GLAS—and be able to tell the date and extent of the fire.

When we entered the area, we could smell smoky, charred ashes. The ground was covered by dried, fallen needles from the dead larch. The fire had been a low, hot ground fire that burned all moss, brush, and grass from the ground and scorched the tree trunks. It killed the larch trees by heating the soil and scalding the shallow roots, but it left the crowns of the trees untouched. With all the trees dead, the needles slowly dried and fell down like Christmas trees left too long in a house after the holiday.

**It had struck me just how much impact forest fires here have on erosion.** Of course, this forest sediment then gets carried from this little river to other rivers far, far downstream. Could this sediment make it into the Arctic Ocean? Or will it be deposited elsewhere? If so, how will it change the shape of the land? We have come on this expedition to find answers to our questions, and we have made great progress. It is clear, however, that **there are many, many more questions begging to be studied.**

---

*Sunday, August 12, 2007*  
10:06 p.m.

I still can't believe we are here! It's amazing, having a bed and hot water. And fine food, too! Our dinner last night was bread and butter. We haven't had bread or butter in so long—how wonderful it tasted.

Today was a day of packing up, cleaning up, sorting out, and getting ready to leave the river. **It is time to leave the Kochechum to return to my office.** There I'll check out this great data we collected, work for understanding of it, then share the information with the science community.

We celebrated the end of the expedition (as well as my birthday) by simply sitting around the forestry camp, eating and talking. It was the only time we actually sat down together, all six of us, to just relax. In the woods, someone was always working. They offered toasts to my health—maybe too many toasts! It was a fabulous birthday.

Looking back, I have to say **the expedition was quite a success.** We did everything we came here to do and more. We have good, solid data that will really help us understand our remote-sensing systems better, fire samples, and excellent, unexpected observations. It was hard and exhausting work, but it was worth it.

Before we sign off, I want to mention some of our sponsors. These groups have been essential to this expedition: NASA Terrestrial Ecology Program, the Land Cover–Land Use Change Program, Northern Eurasia Earth Science Partnership Initiative (NEESPI), and, of course, the Russian Academy of Sciences, Siberia Branch; and the Sukachev Forest Institute. We could not have accomplished so very much without the support of these organizations. ■

## Interpreting Land Cover Change by Combining NASA and Commercial Satellite Data

Christopher Potter, NASA Ames Research Center, [Chris.Potter@nasa.gov](mailto:Chris.Potter@nasa.gov)

Vanessa Genovese, California State University Monterey Bay, [vanessa@gaia.arc.nasa.gov](mailto:vanessa@gaia.arc.nasa.gov)

Peggy Gross, California State University Monterey Bay, [pgross@mail.arc.nasa.gov](mailto:pgross@mail.arc.nasa.gov)

*Characteristics of Earth's land cover can have important impacts on local climate, radiation balance, biogeochemistry, hydrology, and the diversity and abundance of terrestrial species [Randerson et al., 2006]. Consequently, scientists seek to understand trends in land-cover conversion at local scales so they can make useful predictions about other regional and global changes. Scientists need to understand where, when, and why natural land-cover is converted to human uses [Foley et al., 2005]. The following report describes a technique that researchers at NASA Ames Research Center and California State University Monterey Bay have developed to study land-cover change in California combining 250-m resolution data from Terra MODIS and other high-resolution images such as those from Google Earth.*

The launch of NASA's Terra satellite platform in 1999 with the Moderate Resolution Imaging Spectroradiometer (MODIS) instrument on-board has been a significant milestone for land-cover change research, as it has enabled the collection of daily images of the entire Earth land surface and led to advances in our understanding of land cover change and its impacts on climate. Operational MODIS algorithms have been used to generate the Enhanced Vegetation Index (EVI) at 250-m spatial resolution from 2000 to the present [Huete et al., 2002]. EVI represents an optimized land-cover index, whereby the vegetation reflectance properties in red and near infrared spectral bands are designed to approximate canopy radiative transfer theory. EVI was developed to optimize the *greenness* signal—a measure of the area-averaged canopy photosynthetic capacity—with improved sensitivity in high biomass cover areas. Global MODIS EVI data sets are available free of charge from NASA-supported data centers.

Regions experiencing rapid population growth and changing economic activities are logical places to evaluate the effectiveness of the MODIS time series for characterizing land-cover changes. One such area is the state of California, whose population increased by 75% between 1970 and 2005, resulting in rapid and extensive urbanization and significant loss of natural cover types [Beck and Kolankiewicz, 2001]. For example, of all land urbanized in 42 of the state's 58 counties between 1984 and 1990, an estimated 13% of the urbanization occurred on irrigated prime farmland, whereas 48% occurred on wildlands or fallow marginal farmlands [Charbonneau and Kondolf, 1993].

Our experiment used a large MODIS 250-m resolution time series of EVI data (running from 2001 to 2005)

covering the majority of California for land cover change detection, but in order to use the data it was necessary to apply some quality control filter methods. The *EVI usefulness index (EUI)* is a high resolution quality indicator whose value for a pixel is determined from several conditions, including: 1) aerosol quantity; 2) atmospheric correction conditions; 3) cloud cover; 4) shadow; and 5) sun-target-viewing geometry. About 80% of the EVI values in this California data set were found to have high values of EUI and deemed useful for our study.

The MODIS EVI time series that we examined over individual yearly periods covering January through December showed that natural vegetation cover in California has a characteristic seasonal profile of greenness levels that is influenced strongly by precipitation and temperature variations over an annual cycle [Potter et al., 2005]. A large portion of the state's forested land cover was seen to reach maximum greenness levels (*EVI<sub>max</sub>*) somewhere between June and August—i.e., when the temperature is highest—whereas rangelands and mixed grassland-woodland areas reach maximum EVI levels earlier in the calendar year, typically between January and April—i.e., when rainfall is highest—see **Figure 1**. When we break things down by region, *EVI<sub>max</sub>* most commonly occurred in April in the Sacramento and San Joaquin Valleys and the Sierra Nevada Foothills, whereas the *EVI<sub>max</sub>* occurred

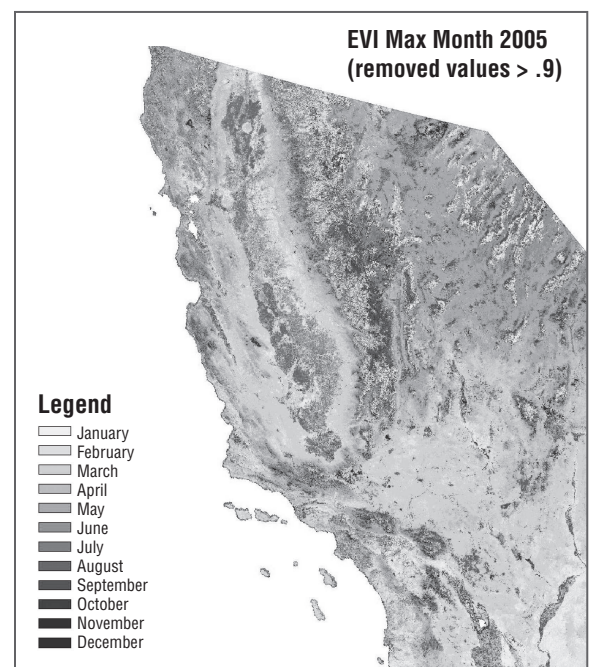

**Figure 1.** Month of maximum MODIS EVI observed during the calendar year 2005.



**Figure 2.** Map of the locations (black dots) where MODIS 250-meter time series showed continuous decreases in both  $EVI_{diff}$  and the  $EVI_{max}$  over the period 2003-2005.

in June in the Sierra Nevada Mountain Range and the Coastal Redwood Forest Belt [*Major Land Resource Areas, Source:* U. S. Geological Survey (USGS)].

We characterized the annual cycle of vegetation greenness further by examining the changes in seasonal amplitude of EVI during a year. This attribute was computed as the EVI difference ( $EVI_{diff}$ ) between the maximum ( $EVI_{max}$ ) and minimum ( $EVI_{min}$ ) greenness values measured over each of the single calendar years that comprise the entire 2001-2005 time series available to date. **By identifying areas where both the annual  $EVI_{diff}$  and the  $EVI_{max}$  values both changed continuously over the five year MODIS time series, locations of potential land cover change could be extracted from the statewide data set.**

Over the entire period 2001 to 2005, locations that showed continuous decreases in both the  $EVI_{diff}$  and the  $EVI_{max}$  made up more than 5170 km<sup>2</sup> over the MODIS image area—see **Figure 2**. These locations were distributed across land cover types as follows: forest (46%), shrublands (29%), and herbaceous cover (7%) [USGS, 1999]. Forest and shrubland areas together remained the predominant land cover types over which most of the locations (60-70%) of continuous decreases in both the  $EVI_{diff}$  and the  $EVI_{max}$  were detected, regardless of which three or four year sub-period of the 2001-2005 MODIS time series was extracted for analysis. In contrast, locations that showed continuous increases in

both the  $EVI_{diff}$  and the  $EVI_{max}$  made up only 366 km<sup>2</sup> over the MODIS image area analyzed for this study. We, therefore, consider only cases of continuous decreases in both the  $EVI_{diff}$  and the  $EVI_{max}$  for the remainder of this report.

Once we identified areas of potential land cover change using the MODIS data, we conducted a more detailed examination of localized land use change records through an analysis of high-resolution commercial images available—e.g., *Google Earth*. The 50 largest contiguous areas of concurrent  $EVI_{diff}$  and  $EVI_{max}$  decrease—see map in **Figure 2**—were examined for visual evidence of disturbance in the land cover. In 15 of these 50 cases, the satellite imagery at spatial resolution of less than 10 m revealed **a recent wildfire burned area**. In another seven of these 50 cases, the satellite imagery revealed **extensive cutting of the forested land cover**. An example of what appears to be extensive forest harvest is shown in high-resolution imagery as a patchwork of land cover types near Sly Creek Reservoir in the Plumas National Forest, CA—see **Figure 3**. Extensive forest cutting patterns similar in appearance to **Figure 3** were readily identified from areas of concurrent  $EVI_{diff}$  and  $EVI_{max}$  decrease locations—see **Figure 2**—in Mendocino, Butte, and Amador counties.

The methods of image analysis that we describe in this study are developing as a leading fusion of NASA data with high-resolution commercial images to identify areas of recent land cover change over regional scales. The approach is to combine the frequent (daily) repeat time series of MODIS 250-m image data with the detailed “snapshots” of the *Google Earth* imagery to show when,

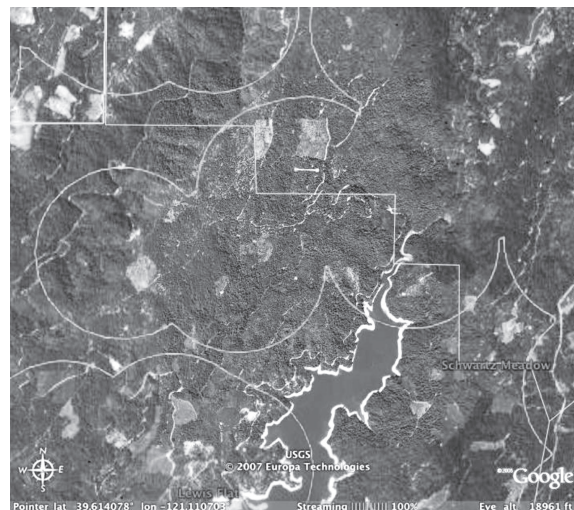

**Figure 3.** High-resolution satellite image showing cleared patches of land in the Plumas National Forest, CA, near Sly Creek Reservoir. For scale, the white line at the top-center of the image (just below a large cleared patch of forest) is 250 m in length. Circle lines are 1-km buffer boundaries around the center locations of MODIS 250-m areas where the most recent land-cover change has been detected. *Google Earth* imagery © Google Inc.—used with permission.

where, and what types of changes in land use have occurred. This application can take full advantage of scientific importance of NASA satellite data in tandem with the compelling visual details of high-resolution color imagery from commercial sources. By using NASA MODIS time series to pinpoint extensive areas of land cover change, underlying images in tools such as *Google Earth* are given unique, dynamic attributes, and in the process, made much more exciting to interpret by consumers and land use planners.

#### References

- Beck, R. and L. Kolankiewicz, 2001, *Out Smarting Smart Growth: Immigration, Population Growth and Suburban Sprawl*. Paper 18, Center for Immigration Studies. Washington DC.
- California Department of Conservation (CDC), 2004, *A Guide to the Farmland Mapping and Monitoring Program*, 2004 Edition, Sacramento, CA, 30 pp.
- Charbonneau, R. and G.M. Kondolf, 1993, Land use change in California, USA: Nonpoint source water quality impacts, *Environmental Management*, **17**, 453-460.
- Foley, J.A., R. DeFries, G.P. Asner, C. Barford, G. Bonan, S.R. Carpenter, F.S. Chapin, M.T. Coe, G.C. Daily, H.K. Gibbs, J.H. Helkowski, T. Holloway, E.A. Howard, C.J. Kucharik, C. Monfreda, J.A. Patz, I.C. Prentice, N. Ramankutty, and P.K. Snyder, 2005, Global consequences of land use, *Science*, **309**, 570 – 574.
- Jain, A.K. and R.C. Dubes. 1988. *Algorithms for Clustering Data*. Prentice Hall.
- Huete, A., K. Didan, T. Miura, E.P. Rodriguez, X. Gao, L.G. Ferreira, 2002, Overview of the radiometric and biophysical performance of the MODIS vegetation indices, *Remote Sensing of Environment*, **83**, 195–213.
- Potter, C., P. Tan, V. Kumar, C. Kucharik, S. Klooster, V. Genovese, W. Cohen, S. Healey, 2005. Recent history of large-scale ecosystem disturbances in North America derived from the AVHRR satellite record, *Ecosystems*, **8(7)**, 808-827.
- Randerson, J.T., H. Liu, M.G. Flanner, S.D. Chambers, Y. Jin, P.G. Hess, G. Pfister, M.C. Mack, K.K. Treseder, L.R. Welp, F.S. Chapin, J.W. Harden, M.L. Goulden, E. Lyons, J.C. Neff, E.A.G. Schuur, and C.S. Zender 2006, The impact of boreal forest fire on climate warming, *Science*, **314 (5802)**, 1130. [DOI: 10.1126/science.1132075].
- U.S. Geological Survey (USGS) and U.S. Environmental Protection Agency (USEPA) 1999, *National Land Cover Data (NLCD)*, download from [landcover.usgs.gov/us-landcover.php](http://landcover.usgs.gov/us-landcover.php) ■

Two large forest fires raged on the Canary Islands on the afternoon of July 30, 2007, when the Moderate Resolution Imaging Spectroradiometer (MODIS) on NASA's Aqua satellite captured this photo-like image. Thick plumes of smoke blow southwest over the Atlantic Ocean from the fires on the islands of Tenerife (left) and Gran Canaria (right). More than 2,000 people were evacuated from the fire on Gran Canaria, which had burned through 8,645 acres of woodland, reported the Associated Press on July 30. **Credit:** MODIS Rapid Response Team.





## NASA DEVELOP Students Use EOS Data to Study Air Quality on the U.S.–Canadian Border

Jennifer DeWinter, NASA DEVELOP Program, [jennifer.l.dewinter@gmail.com](mailto:jennifer.l.dewinter@gmail.com)

Kim Keith, NASA Langley Research Center, [kim.e.keith@gmail.com](mailto:kim.e.keith@gmail.com)

*Students at the NASA DEVELOP National Program are using MODIS (Terra, Aqua) optical depth retrievals to examine aerosol trends over the United States-Canada border region.*

From asthma patients to National Parks patrons, public awareness of environmental, cultural, economic, and health concerns resulting from poor air quality is increasing. Air quality concerns also include urban industrial growth, large-scale wildfire events, and *transboundary* pollution—where pollution is transported from one state to another or even from one country to another. These and other concerns motivate federal, state, and local efforts to improve analyses and prediction of current and historical air quality conditions and associated trends, despite air quality assessment challenges.

One particularly daunting challenge is identifying pollution sources in Earth's vast and dynamic atmosphere. Pollutants are transported far from their sources by winds and washed away by rains, making local regulation, prediction, and health risk warnings difficult to administer. Yet these are the kinds of issues that decision makers must deal with on a regular basis and, clearly, there are no simple answers.

To aid decision makers and serve the public in addressing air pollution crossing the U.S. and Canada border, the 1991 Air Quality Agreement was put in place between the Government of Canada and the Government of the United States of America (mediated by the International Joint Commission). In April, 2007, the U.S. and Canada announced the start of negotiations on a Particulate Matter Annex to the 1991 U.S.-Canada Air Quality Agreement. Particulate matter can cause significant health effects in adults and children, and is linked to other environmental problems such as haze in national parks and acidic deposition. When completed, a Particulate Matter Annex would complement the 2000 annex negotiated between the U.S. and Canada to address ground-level ozone, as well as the original annexes on acid rain and scientific cooperation. The Agreement and associated annexes signify an internationally coordinated effort to monitor transboundary air pollution and serve as a commitment by both nations to make and monitor progress in improving air quality. On-going research initiatives, supported by the International Joint Commission, facilitate continued partnership.

Other international efforts include NARSTO (formerly North American Research Strategy for Tropospheric

Ozone), a government, private industry, and research partnership between Canada, the United States, and Mexico for improving North American air quality management. In 2004, NARSTO released the *Particulate Matter Assessment for Policy Makers*, a review of current scientific knowledge about particulate matter (PM) and the implementation of strategies for controlling atmospheric PM—[www.narsto.org/section.src?SID=6](http://www.narsto.org/section.src?SID=6).

NASA is lending a hand to this international effort through its DEVELOP program. DEVELOP is a NASA Science Mission Directorate Applied Sciences Program that fosters human capital development to extend NASA Earth science research to local communities—[develop.larc.nasa.gov](http://develop.larc.nasa.gov). Students demonstrate to community leaders prototype applications of NASA science measurements and predictions addressing local policy issues. The activities relate to the Applied Science Program's 12 National Applications (including Air Quality) and are student led, with advisors and mentors from NASA and other partner organizations providing expert advice to guide the students' efforts.

Students at NASA DEVELOP have partnered with the U.S. Environmental Protection Agency (EPA) and Environment Canada to explore the application of data from NASA's Earth Observing System (EOS) to inform air quality issues along the U.S.–Canadian border region. Specifically, DEVELOP students are using the Level 2, *Collection 5* Aerosol Optical Depth (AOD) parameter derived from the Moderate Resolution Imaging Spectroradiometer (MODIS) on Terra and Aqua satellites to construct an aerosol climatology to assess aerosol trends in the warm months of May-September, 2000-2006, along the U.S.-Canadian border. The goal of this study will benchmark the use of MODIS AOD in assessing aerosol trends and determine how the trends can be used as an additional data source to support the Air Quality Agreement objectives.

Initially, the team compared MODIS *Collection 4* and *Collection 5* data to assess qualitatively the differences between the two Collections. The differences between the *Collection 4* AOD can be seen in a visualization produced for the project. To facilitate the trends analyses the students mapped the MODIS data onto a standard model-defined grid [the 21 x 21 km, Canadian Hemispheric and Regional Ozone and NO<sub>x</sub> System (CHRONOS), air quality model grid] currently utilized by their Environment Canada partner. MODIS AOD in the border region was correlated to AOD measured by a well-calibrated ground-based system of Sun photometers

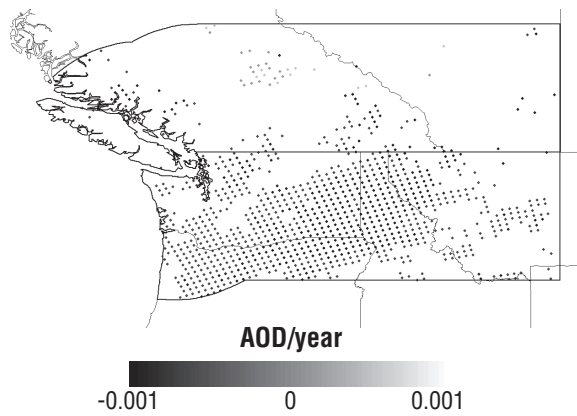
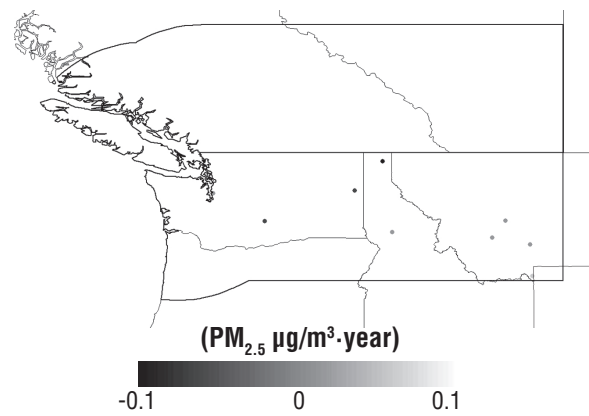

**Figure 1.** This image shows the significant trends in AOD for the month of July (2002-2006) for each 21 x 21 km CHRONOS grid cell. The trends were calculated using the AOD derived from Terra and Aqua's MODIS data combined.

called the Aerosol Robotic Network (AERONET, *aeronet.gsfc.nasa.gov*; the Canadian AERONET sites are referred to as AEROCAN) to validate the relationship between ground and satellite trends at each AERONET site. MODIS AOD was then utilized to determine monthly and seasonal trends of aerosols over the western Canada border region for each CHRONOS grid point—see **Figure 1**. Trends for MODIS Terra and Aqua AOD were calculated, both separately and together, by averaging the morning and afternoon AOD data and using simple linear regression. Because wildfires are a frequent occurrence within the region and can cause extremely high aerosol loading, only the data below the 99<sup>th</sup> percentile was used. This provided a simple approach to screen out outliers or extreme high values from wildfires.

Because previous studies have shown good correlation between MODIS AOD and measurements of surface PM<sub>2.5</sub>, Particulate Matter with an aerodynamic diameter less than 2.5 μm, *in situ* PM<sub>2.5</sub> trends (< 99<sup>th</sup> percentile) were also calculated at the EPA PM<sub>2.5</sub> monitors, and compared to the MODIS AOD trends—see **Figure 2**.

Next steps will involve an in-depth comparison of how well the MODIS and PM<sub>2.5</sub> trends compare, an extension of the MODIS AOD trends analysis to the eastern coast, the addition of Canadian PM<sub>2.5</sub> data, and in-depth analysis of the results. This benchmark analysis on the use of MODIS AOD to assess aerosol trends may provide a new data set to inform air quality assessments in the border region and will help facilitate the use of MODIS AOD trends to inform the up and coming *Progress Reports and Particulate Matter Annex* to the 1991 Air Quality Agreement. The current efforts address the western most U.S.–Canada border region identified in the Agreement, but future efforts will include the central and eastern border regions in the assessment. This analysis will also potentially facilitate and precede further studies utilizing NASA instruments



**Figure 2.** This image shows the significant trends in PM<sub>2.5</sub> for the month of July (2002-2006) for each CHRONOS grid cell within which an EPA ground PM<sub>2.5</sub> monitor is located.

such as CloudSat and Cloud Aerosol Lidar and Infrared Pathfinder Satellite Observations (CALIPSO), allowing assessment of aerosol trends in the third dimension.

#### Additional NASA DEVELOP Program Contributors

Brian Tisdale, Amanda Ross, Elizabeth Hodges, Derek Smith, Jonothan Lister, Destiny Rainney, Meral Sarper, Dawn Jackson.

The authors also acknowledge all science advisory at DEVELOP and partner organizations for their guidance.

#### Background Science Articles used by NASA DEVELOP Participants

Al-Saadi J., J. Szykman, R.B. Pierce, C. Kittaka, D. Neil, D.A. Chu, L. Remer, L. Gumley, et al., 2005. Improving national air quality forecasts with satellite aerosol observations. *Bulletin of the American Meteorological Society* **86(9)**: 1249-1261 DOI: 10.1175/BAMS-86-9-1249.

Engel-Cox, J. A., et al., 2004. Qualitative and Quantitative Evaluation of MODIS Satellite Sensor Data for Regional and Urban Air Quality. *Atmos. Environ.*, **38**, 2495–2509.

Hutchinson, K., S. Smith, S. Faruqui, 2004. The use of MODIS data and aerosol products for air quality prediction. *Atmospheric Environment* **38(30)**:5057-5070; DOI:10.1016/j.atmosenv.2004.06.032 [Online October 8, 2006]

Wang, J. and S. Christopher, 2003. Intercomparison between satellite-derived aerosol optical thickness and PM<sub>2.5</sub> mass: Implications for air quality studies. *Geophysical Research Letters*, **30(21)**:4-1 - 4-4. doi:10.1029/2003GL018174 ■

## New ASTER Products & Services

### **EROS Release of the *TerraLook***

A *TerraLook* collection consists of georegistered Advanced Spaceborne Thermal Emission and Reflection Radiometer (ASTER) images and the Tri-Decadal Global Landsat Orthorectified images from three epochs (circa 1975, 1990, and 2000), selected from satellite images archived at U.S. Geological Survey Center for Earth Resources Observation and Science (EROS) using the *GloVis* search and order tool [glovis.usgs.gov](http://glovis.usgs.gov) and selecting TerraLook Collection.

The *TerraLook* product expands and broadens the remote sensing user community by providing a user-selectable collection of satellite images, distributed as simulated natural color JPEG images. *TerraLook* images can be viewed in any program that can open JPEG images. Examples include web browsers, word processors, and graphic software. A Viewer and Toolkit designed for use with *TerraLook* Collections can be downloaded at [terralook.sourceforge.net/](http://terralook.sourceforge.net/).

Refer to [terralook.cr.usgs.gov/](http://terralook.cr.usgs.gov/) for ordering instructions and additional information.

### **ASTER Orthorectified Product Release**

On March 15, 2007, the Land Processes Distributed Active Archive Center (LP DAAC) started offering a new suite of ASTER Level-3 on-demand Orthorectified Image Products. An orthorectified image is similar to a map with near-vertical views for every location. These products are generated using ASTER Level-1A data and a Digital Elevation Model (DEM) derived from the same data. Two product suites are offered:

1. *AST 14OTH* is the short name of the ASTER on-demand Level-3 Orthorectified Image Product, which includes fifteen orthorectified ASTER Level-1B calibrated radiance images, one per each band, including Band 3B, all in GeoTiff format. Refer to [lpdaac.usgs.gov/aster/AST14OTH.asp](http://lpdaac.usgs.gov/aster/AST14OTH.asp) for additional information.
2. *AST 14DMO* is the short name of the ASTER on-demand product comprised of both the Level-3 DEM and the Orthorectified Image Product. The distributed product is a multi-file containing both DEM, and fifteen orthorectified Level-1B calibrated radiance images, one per each band. Refer to [lpdaac.usgs.gov/aster/AST14DMO.asp](http://lpdaac.usgs.gov/aster/AST14DMO.asp) for additional information.

### **ASTER Media Release**

On March 28, 2007, the LP DAAC began offering DVD as an option for ASTER distribution. The DVD ordering option for ASTER is available through the EOS Data Gateway (EDG). LP DAAC User Services can answer questions related to ASTER distribution on media. Refer to [lpdaac.usgs.gov/support/contact.php](http://lpdaac.usgs.gov/support/contact.php) for contact information.

### **ASTER DAR Tool Release Vs. 1.1**

The improved ASTER DAR Tool can be accessed through links provided at [elpdl01.cr.usgs.gov/index.php](http://elpdl01.cr.usgs.gov/index.php)

### **ASTER Level-2/3 Release in *GloVis* plus DVD distribution option**

On May 9, 2007, the LP DAAC began offering ASTER On-Demand Level-2 and Level-3 products through the USGS Global Visualization Viewer [glovis.usgs.gov/](http://glovis.usgs.gov/). Additionally, all ASTER products on *GloVis* now include a DVD media ordering option. ASTER products requested via FTP cost \$80 (U.S.) per granule and \$91 (U.S.) per granule for DVD. ASTER DEM and Orthorectified (DMO) products—see above—requested via FTP cost \$160 (U.S.) per granule and \$162 (U.S.) per granule for DVD. The LP DAAC assesses all media orders a \$5 (U.S.) handling fee, and a \$20 (U.S.) shipping fee for all international orders. Please contact LP DAAC User Services for more information: [LPDAAC@eos.nasa.gov](mailto:LPDAAC@eos.nasa.gov), 605-594-6116, [lpdaac.usgs.gov/support/contact.php](http://lpdaac.usgs.gov/support/contact.php).

## Summary of the 31st ASTER Science Team Meeting

*T. Tachikawa, Earth Remote Sensing Data Analysis Center (ERSDAC), tachikawa@ersdac.or.jp*

*The 31st Advanced Spaceborne Thermal Emission and Reflection Radiometer (ASTER) Science Team Meeting was held at TEPIA Hall in the AOYAMA district, Tokyo, Japan on June 5-7, 2007. Seventy ASTER science team members attended the meeting as well as other relevant participants. The meeting began with an Opening Plenary during which related projects were reported and the issues to be addressed at this meeting were reviewed. Splinter sessions of each working group took place after the plenary session, after which the group reconvened as a whole for a Closing Plenary to hear reports from each working group. Additionally, on June 8 an ASTER workshop took place to present the research achievements of the science team members, including presentations from a broad range of researchers.*

### Opening Plenary

**H. Tsu** [Earth Remote Sensing Data Analysis Center (ERSDAC)—*Japan ASTER Science Team Leader*] and **M. Abrams** [Jet Propulsion Lab (JPL)—*U.S. ASTER Science Team Leader*] made opening remarks. **M. Kato** [ERSDAC] explained the meeting schedule.

**W. Turner** [NASA Headquarters] reported on NASA's current status, which covered NASA's organization and future projects, and included a detailed presentation of the current status of Landsat-related plans.

**T. Sato** [Japan Resources Observation System and Space Utilization Organization (JAROS)] reported on the instrument status. He presented details about the temperature increase in the Short Wave Infrared (SWIR) element and the associated instrument operation to correct the problem on May 17 and 18. Following this, there was some discussion on the measures to be taken in the future. Results of an ongoing analysis of the instrument operation were going to be revealed on June 17 and then reported in mid-July. The appropriate countermeasures will be determined after obtaining the analysis results.

**B. Bailey** [U. S. Geological Survey Land Processes Distributed Active Archive Center (USGS LPDAAC)] updated the recent distribution status at LPDAAC, mainly after on-demand processing of the Level-1B (L1B) and orthorectified products. Expedited Data Set (EDS) change was also reported, which would be confirmed with Ground Data System (GDS).

**M. Hato** [ERSDAC] reported on GDS status. He presented the assumed future operation scenarios for the temperature increase in the SWIR detector and also reported on the production/distribution status.

**M. Fujita** [ERSDAC] presented the Science Scheduling Support Group/Operations and Mission Planning (SSSG/OMP) report. He reported the analysis results of observation status in association with the Global Mapping Science Team Acquisition Request (STAR).

**M. Abrams** reported on the recent Earth Science Senior Review, gave an update on the Data Downlink (DDL), and discussed the Solid State Recorder (SSR) status. He reported the upcoming memory swap and resultant memory size reduction for SSR, and the resolution of all problems noted by the test of the previous year as well as a scheduled retest in July for DDL.

To close the plenary, **Y. Yamaguchi** [Nagoya University] raised three points for further discussion in the working groups. These included discussing: (1) the effects of SSR change and pointing; (2) future observation plans—e.g., the third round of Global Map (GM) acquisitions including night Thermal Infrared (TIR) GM settings, and prioritized SWIR observation in certain areas; and (3) contingency plans in the event the SWIR detector must be turned off.

### Working Group Sessions

#### *Level 1/Geometric/Digital Elevation Model (DEM) Working Group*

The first half of the session was used to discuss results and improvements of the Level-1/DEM/ortho software. There have been no problems to date.

The second half of the session was devoted to a discussion of the ASTER global DEM project. **H. Fujisada** [Sensor Information Laboratory Corporation (SILC)] proposed having fully automated DEM generation using all existing data with no human interface. **T. Tachikawa** [ERSDAC] and **B. Bailey** presented the validation results of the generated DEM.

#### *Radiometric Calibration Working Group*

The instrument team reported on results of ongoing onboard calibration efforts. Regarding Visible-Near Infrared (VNIR) and SWIR, there is no need to change the radiometric database. As for TIR, the consensus of the group was that the radiometric database should be updated as soon as possible. Following the discussion about calibration, **K. Arai** [Saga University] reviewed the roles/responsibilities with regard to the SWIR issue and selected the issues that should be discussed at this working group. There followed a discussion

about any action that should be taken with the instrument settings.

This working group also heard a presentation on results of the current field campaign results as well as plans for the next field campaign. **K. Thome** [University of Arizona] and **K. Arai** reported on the status of the web page on radiometric calibration coefficients derived from vicarious calibration. The group decided that it was preferable to have the data open to the public through the ASTER Science Project web site.

#### *Atmospheric Correction Working Group*

**B. Eng** [JPL] reported on the status of the U.S. ASTER Level-2 software. Level-2 software is operating in *Version 3.1-3* from August 2006. The next update includes interpolation of aerosol correction to remove visible boundaries; three new ozone sources—the Total Ozone Mapping Spectrometer (TOMS); Total Ozone Analysis from Solar Backscatter Ultraviolet Instrument-2 [SBUV-2] (TOAST); and TIROS Operational Vertical Sounder (TOVS) data from the SeaWiFS Data Analysis System archive (SeaDAS)—and a new interface that corresponds to the latest Moderate Resolution Imaging Spectroradiometer (MODIS) product. Future plans are to include an update of TIR recalibration and MODIS aerosol usage.

#### *Temperature-Emissivity Separation (TES) Working Group*

The first half of the session consisted of many presentations on the TES accuracy validation results and research accomplishments using TES products. In the second half of the session, participants heard a presentation on the status of TIR nighttime STAR and discussed plans for future acquisitions. The group agreed that the areas shown on the Original Priority Map of TIR STAR should receive highest priority, starting with West Africa and the Central U.S., and that this issue would be revisited in two months via e-mails when more observation results are available.

#### *Operations and Mission Planning (OMP)/Science Scheduling Support Group (SSSG)*

**K. Okada** [ERSDAC] and **H. Tonooka** [Ibaraki University] reported on the statistical results of observation. **Y. Yamaguchi** stated that the third round of Global Mapping STAR should be continued. The methods for data acquisition for Global DEM STAR were discussed based on this result.

After hearing some reports on some operational adjustments, the group sought to develop an operation plan without the SWIR subsystem. As a result of discussion, the group decided that: (1) Having only visible or only thermal mode is unacceptable. (2) Pseudo visible/ther-

mal mode is needed. (The instrument and GDS teams must determine how to best achieve this). (3) A SWIR gain change is desirable, but the final decision will have to be made by SSSG/ERSDAC.

#### *STAR Committee*

A *two-week automatic approval* rule was confirmed. Global Land Ice Measurement from Space (GLIMS) STAR will be resubmitted. **J. Kargel** [University of Arizona] makes some revisions and SSSG checks the parameters.

#### *Ecosystem/Oceanography Working Group*

After a review of STAR status, the group heard nine research reports. After the research reports, the group discussed the eventual turn-off of SWIR and the implications on studies of Ecosystems and Oceanography using ASTER, and concluded that they had no specific/new observation request plans in light of the potential SWIR turn-off.

#### *Geology/Spectral Working Group*

This group heard reports on research results using ASTER data in the fields of resources, hazards, geomorphology, volcanology and mapping. Following the presentations, the group discussed the potential impact of a SWIR turn-off on Geology/Spectral research using ASTER. The group concluded that Low Gain Mode should be used for all future data acquisition requests.

#### **ASTER Workshop**

An ASTER Workshop was held on June 8 in conjunction with the ASTER Science Team Meeting, greeting 144 participants from the Japan and U.S. ASTER Science Teams, private corporations, universities and research institutes, among others. ASTER and surroundings were introduced by project team members. **Y. Yamaguchi** opened the workshop and gave an overview of ASTER. **M. Abrams** reported on the NASA Earth Observing System (EOS) status. **M. Hato** presented the ASTER GDS status. After those introductory reports, the remainder of the workshop was dedicated to reports on **research activities related to ASTER**. Workshop participants heard 14 reports on various research projects that showcased some of the practical applications that can be studied using ASTER data.

These included:

- studying various natural disasters (e.g., volcanoes, glaciers and floods);
- monitoring of urban and natural environments; and
- detecting metal and energy resources.

continued on page 35

## OMI Science Team Meeting Overview

Joanna Joiner, NASA, Goddard Space Flight Center, [joanna.joiner@nasa.gov](mailto:joanna.joiner@nasa.gov)

The twelfth Ozone Monitoring Instrument (OMI) Science Team meeting was held from June 5-8 at University of Maryland, Baltimore County in Catonsville, Maryland. OMI is one of the four instruments flying on the NASA Earth Observing System (EOS) Aura platform. The number of people who registered for the meeting was 75. The first day began with an OMI Core Group meeting and ended with an ozone session. The second day consisted of aerosol/radiation and nitrogen dioxide sessions. Other trace gases and general science were covered on the third day. The meeting wrapped up with a final OMI Core Group meeting. A detailed summary of the meeting follows. Additional information is available at: [www.knmi.nl/omi/research/project/meetings/](http://www.knmi.nl/omi/research/project/meetings/)

### June 5

**P. K. Bhartia** [NASA Goddard Space Flight Center (GSFC)—U.S. Science Team Leader] gave opening remarks. He emphasized that it is important to discuss and understand the needs of the OMI user community and develop our products to meet its needs. Such interaction was crucial in making the Total Ozone Mapping Spectrometer (TOMS) project such a success.

**Pieterneel Levelt** [Koninklijk Nederlands Meteorologisch Instituut (KNMI), a.k.a., Dutch Royal Meteorological Institute—OMI Principal Investigator (PI)] presented the OMI status and outlook. Almost all products have been publicly released or will be soon. She emphasized that potential OMI data users should contact the product PIs and consult the README files before using the data. Among the OMI highlights mentioned were the continuation of ozone hole measurements, observation of nitrogen dioxide (NO<sub>2</sub>) hot-spots that correspond to power-plants, observations of absorbing aerosol above clouds, and tracking of sulfur dioxide (SO<sub>2</sub>) plumes from volcanoes. OMI operations have been extremely smooth with only three days of missing data since launch. Reprocessing of the third collection (*Collection 3*) of Level 1B data is now complete. OMI has been radiometrically stable to better than 1% over the instrument lifetime. Levelt's talk concluded with a summary of the validation activities. While ozone has been well validated using ground-based data, only limited validation can be carried out for other trace gases such as NO<sub>2</sub>, SO<sub>2</sub>, formaldehyde (HCHO), and bromine monoxide (BrO) due to the lack of correlative measurements. Validation of OMI ozone profiles and surface ultraviolet-B (UV-B) is in the initial phase.

**Marcel Dobber** [KNMI] presented the status of the Level 1B data. The number of radiation-damaged pixels

is increasing linearly with time. Approximately 30% have permanently increased dark current to date, but can be corrected by using a recent dark current map. Only ~1% of the pixels are considered unusable. The *Collection 3* Level 1B data set contains new stray-light corrections and radiometric calibration. The dark current images and bad pixels are now updated daily rather than monthly. Public release of the *Collection 3* Level 1B data is planned for August/September 2007. A paper describing the data set has been submitted to the *Journal of Geophysical Research* special Aura validation issue.

**Glen Jaross** [Science Systems and Applications, Inc. (SSAI)] described how radiance measurements over ice were used for the *Collection 3* calibration.

**Jacques Claas** [KNMI] gave an overview of OMI operations and reprocessing. No anomalies or data loss has taken place during the previous year. Investigations into the folding mirror mechanism anomaly that occurred previously have not revealed the cause, but operations have been revised to prevent bouncing of the mechanism. The various instrument mechanisms are well within their lifetime budgets. There are many customers using near-real-time data including several numerical weather prediction centers as well as NASA for field campaigns. *Collection 2* will cease on August 1, 2007. After that, *Collection 3* data will be available from the Goddard Data and Information Services Center (DISC)—[disc.sci.gsfc.nasa.gov/Aura/](http://disc.sci.gsfc.nasa.gov/Aura/).

**Johanna Tamminen** [Finnish Meteorological Institute (FMI)] discussed the Finnish OMI products. These include global surface UV radiation and very fast delivery (VFD) products that are produced using direct broadcast data received by the Sodankylä ground station. VFD products include UV index, daily dose, and total ozone, and are available within 15 minutes of overpass from [omivfd.fmi.fi](http://omivfd.fmi.fi). (The global surface UV data also will be available from the Goddard DISC in the near future.) The Finnish products cover most of Europe, are well known in Europe, and are being used for a variety of applications—e.g., they are used to trigger UV-B warnings in Finland.

**Dan Kahn** [SSAI] and **Pepijn Veeffkind** [KNMI] discussed the OMI pixel size. The OMI pixels can be modeled accurately using an elliptical shape. The speakers noted that the center of the ellipse is not exactly the same as the pixel center reported in the Level 1B data set due to curvature of the Earth and they acknowledged that many users would like to plot the data as rectangles and would prefer that the pixel corners be provided. An IDL routine to do this is

available from Veefkind. Veefkind and Kahn then discussed issues associated with OMI zoom mode where the spatial sampling is increased by a factor of 2 in the cross-track direction and the swath width is reduced. OMI operates in the zoom mode once every 32 days such that the same points on the Earth are always measured. This mode can be used as a demonstration for higher spatial resolution instruments planned for the future. Veefkind showed an example of trapped pollution in Mexico City from zoom mode data. Because a special calibration mode is tied to the zoom mode, there are no plans to eliminate the regular zoom mode measurements. Veefkind noted that special requests for extra zoom mode data could be accommodated with 48-hour notice.

**Richard McPeters** [NASA/GSFC] and **Mark Kroon** [KNMI] gave summaries of the validation of OMI-Total Ozone Mapping Spectrometer (TOMS) and OMI-Differential Optical Absorption Spectroscopy (DOAS) total ozone products, respectively. The OMI-TOMS comparisons are focused on ground-based and satellite-to-satellite comparisons that have a large number of samples. OMI-TOMS is very stable with respect to northern hemisphere ground stations and will add to the long-term record that begins with the Nimbus 7 TOMS in 1979. There is no bias as a function of latitude or solar zenith angle, but a slight bias with respect to total ozone, thought to be due to a scattered light problem found in the ground-based instruments. Kroon focused on OMI-DOAS comparisons that have been made with the various aircraft-based instrumentation as part of the Polar and Costa Rica Aura Validation Experiments (PAVE/CRAVE). Problems with OMI-DOAS over snow/ice and at high solar zenith angles have been identified and improved. There are still issues for both total ozone algorithms over clouds. Kroon also mentioned OMI objectives for the upcoming Tropical Composition, Cloud and Climate Coupling (TC4) field campaign—**Editors Note:** TC4 is now complete. These include measurements of ozone mixing ratios in the vicinity of deep convective clouds and an assessment of lightning generated  $\text{NO}_2$ . There will also be targets of opportunity including  $\text{SO}_2$  from outgassing volcanoes and smelters and aerosol single scattering albedo in dust and smoke plumes.

**Johan de Haan** [KNMI] discussed the OMI ozone profile algorithm that has been provisionally released and is slated for public release in the fall of 2007. The algorithm uses on-line radiative transfer for wavelengths between 270–330 nm. Due to the computationally intensive nature of the algorithm, 20% of the data will be processed. A new radiative transfer algorithm is 2–5 times faster than the one used previously. Preliminary validation shows some differences with the Aura Microwave Limb Sounder (MLS) stratospheric column and profile and generally good agreement with the OMI-

DOAS total column. **Xiong Liu** [Harvard/Smithsonian] discussed a profiling algorithm that is used to determine tropospheric ozone from OMI or other backscatter UV instruments alone. He found a bias in tropospheric ozone between the Aura Tropospheric Emission Spectrometer (TES) and OMI that is yet unexplained.

**Jerry Ziemke** [University of Maryland, Baltimore County (UMBC)/Goddard Earth Science and Technology Center (GEST)] described an interpolation method of combining OMI and MLS data to give daily maps of tropospheric ozone. These data are available from [hyperion.gsfc.nasa.gov/Data\\_services/cloud-slice/index.html](http://hyperion.gsfc.nasa.gov/Data_services/cloud-slice/index.html). He compared results in El Niño and non-El Niño years and showed that suppressed convection leads to more tropospheric ozone and less upper tropospheric humidity and vice-versa. Some validation of his product has been completed and is reported in journal articles, but Ziemke pointed out that there is more work to be done.

**Pepijn Veefkind** and **P.K. Bhartia** gave the status and outlook for the OMI-DOAS and OMI-TOMS algorithms, respectively. The OMI-DOAS performs well in the presence of aerosol and volcanic  $\text{SO}_2$ . *Collection 3* will include improved air mass factor lookup tables and new handling over snow-ice. Future work includes a re-evaluation of cloud models and the DOAS fitting window. The next version of OMI-TOMS will be released towards the end of the year. It will include a new cloud climatology derived from OMI, updated ozone absorption cross-sections, and a new (simplified) scheme for generating the *a priori* data. In addition, error bars will be added and two values of total ozone will be reported: 1) The more traditional total ozone above sea-level pressure with the ghost column included; and 2) Ozone above a variable effective pressure that is geared towards tropospheric ozone studies without adding the ghost column.

## June 6

**Nick Krotkov** [UMBC/GEST] opened the aerosol and radiation session with a talk on aerosol validation. He pointed out that one of the most comprehensive aerosol validation sites in the world is located atop Building 33 at Goddard Space Flight Center. This includes AEROSOL RObotic NETwork (AERONET), shadowband, and Brewer radiometers. The latter instrumentation can measure UV aerosol absorption throughout the day and can characterize the wavelength dependence of the single scattering albedo from the visible to the UV. These measurements are important for the calculation of surface UV and photolysis of  $\text{NO}_2$  and  $\text{O}_3$  as well as for  $\text{O}_3$  and  $\text{SO}_2$  retrievals. His group will participate in the upcoming East Asian Study of Tropospheric Aerosols (EAST-AIRE) campaign in Asia. Krotkov also showed some exciting new results on the potential of OMI to retrieve organic aerosols at UV wavelengths.

**Tim Vlemmix** [KNMI] discussed one of the Aura outreach projects taking place in the Netherlands. The Global Learning and Observations to Benefit the Environment (GLOBE) program shows students from secondary schools how to perform aerosol measurements using hand-held photometers—see article on page 7 of this issue for more details. These measurements provide information that can be used to validate the OMI aerosol products. This is a follow-on effort to a similar program directed at Moderate Resolution Imaging Spectroradiometer (MODIS) aerosol validation that resulted in a refereed journal article. The campaign was very successful with a relatively large number of coincidences in good weather conditions. A new campaign will be held this September where the instrumentation will be rotated between different schools in order to identify possible problems with individual photometers.

**Omar Torres** [UMBC/Joint Center for Earth Systems Technology (JCET)] discussed the *OMAERUV* products that include aerosol extinction and absorption optical depth from observations at 388 and 354 nm. Since the public release of this data set, a significant amount of validation has been performed. The retrievals are converted to equivalent quantities at 500 nm for comparison with other satellite instruments and ground-based measurements such as AERONET, Terra and Aqua MODIS, and the Terra Multiangle Imaging SpectroRadiometer (MISR). AERONET comparisons are also carried out at 380 nm. OMI optical depths tend to be higher than MODIS for smoke and dust with a reasonable correlation. Cloud contamination may partially explain the differences. For dust, the OMI retrievals appear to be noisy owing to uncertainty in the aerosol height.

**Pepijn Veeffkind** and **Remco Braak** [both from KNMI] gave the status, outlook and overview of the validation for the UV/Visible *OMAERO* product that is scheduled for public release this summer. *OMAERO* uses 14 wavelengths and multiple aerosol models that include height and size distribution to derive aerosol properties. A theoretical study shows that there are 2–4 degrees of freedom from OMI measurements on aerosols.  $O_2-O_2$  absorption provides one of these pieces, presumably having to do with aerosol height. Cloud masking is an issue since the OMI pixel size is not ideal for aerosol retrieval. Comparisons with MISR and MODIS also show a positive bias that may be partially explained by cloud contamination. Comparisons with AERONET are good for a northern European site, but less so for other regions. There is better agreement with other satellite data over ocean than land that may point to surface albedo effects. Future work includes the use of height information from the A-train Cloud-Aerosol Lidar and Infrared Pathfinder Satellite Observation (CALIPSO), and new models for non-spherical dust.

**Alkiviadis Bais** [Aristotle University, Greece] and **Mario Blumthaler** [Innsbruck Medical University, Austria] provided talks on UV-B validation with various ground-based instrumentation. They found that OMI is higher by ~25% than the ground-based measurements. The agreement was somewhat better for high altitude stations.

**Aapo Taskanen** [FMI] gave the UV-B product status and outlook. There is currently no correction for aerosol. Overpass data are available for ~100 sites. The validation shows that the bias may be partially explained by aerosol and trace gas absorption. There are negative biases for high altitude sites such as Mauna Loa when there are clouds below. Surface albedo may play a role in other areas such as Antarctica. High latitude sites such as Barrow, Alaska may be affected by Arctic haze. Future versions will include improved surface albedo climatology and better accounting for aerosol using climatology or OMI.

**Pieter Levelt**, on behalf of **Hester Volten** [KNMI] and **Ellen Brinkma** [KNMI], opened the  $NO_2$  session with a talk on the successful Dutch Aerosol and Nitrogen Dioxide Experiments for validation of OMI and SCIAMACHY (DANDELIONS) campaign that took place in Cabauw near Utrecht in the Netherlands in September of 2006. The objectives of the campaign included validation of satellite measurements and intercomparison of ground-based instruments. The instrumentation included an  $NO_2$  lidar, *in-situ* measurements (including  $O_3$  sondes), a suite of (mini) Multi-Axis Differential Optical Absorption Spectrometer (MAXDOAS) instruments, direct sun measurements, and sun photometers. Large variations in  $NO_2$  were observed between clean and polluted days where regional meteorology plays a role. Data from the campaign will be made available on the Aura Validation Data Center website—[avdc.gsfc.nasa.gov](http://avdc.gsfc.nasa.gov).

**Henny Kelder** [KNMI] presented an overview of the Dragon campaign that focuses on monitoring of air pollution over China. Dragon I will take place from 2005–2008 while Dragon II will continue from 2008–2012. Ten institutes are partnering in the campaign including several from both Europe and China. Validation of satellite retrievals with ground-based instruments will be a component along with model comparisons and algorithm development. Participating instrumentation includes AERONET, Brewer for  $SO_2$ ,  $O_3$  sondes, Dobson,  $NO_2$  *in situ* measurements and carbon monoxide from a sun spectrometer. Goals include updated emission inventories, validation of increases in  $NO_2$  observed with satellites, and improvements in air quality forecasting.

**Farren Thorpe** [Washington State University (WSU)] presented results on  $NO_2$  from a regional air pollution



model in the Pacific Northwest and comparisons with OMI. He found that OMI was useful for evaluating NO<sub>2</sub> from a high-resolution regional air pollution model. Fire data provided by the forest service generally produces overestimates of NO<sub>2</sub> as compared with OMI, and sometimes OMI observes NO<sub>2</sub> that appears to be from fires that are not reported. There are two separate OMI NO<sub>2</sub> products: near-real-time—available from [www.knmi.nl/omi](http://www.knmi.nl/omi)—and standard—available from [disc.sci.gsfc.nasa.gov/Aura/OMI/](http://disc.sci.gsfc.nasa.gov/Aura/OMI/). The two algorithms sometimes produce significantly different results and algorithm developers are currently investigating the causes of these differences.

**Alexander Cede** [University of Maryland, College Park/Earth System Science Interdisciplinary Center (ESSIC)/SSAI] presented NO<sub>2</sub> validation results from a comparison campaign held at NASA Goddard Space Flight Center (GSFC) in May 2007 that included George Mount's WSU Multi-functional (MF) DOAS and Jay Herman's (GSFC) small Pandora instruments. The WSU Multi-Function Differential Optical Absorption Spectrometer (MFDOAS) instrument looks both at scattered sky in MAXDOAS mode and direct sun sequentially with the direct sun measurements providing accurate total column retrievals (no air mass factor path length uncertainty). The scattered sky measurements emphasize tropospheric air pollution with interpretation required via the Linearized Discrete Radiative Transfer (LIDORT) code. The Pandora instruments as used during the campaign, observed the direct sun. Comparison of the instrument data was very encouraging. Cede also reported on direct sun measurements of O<sub>3</sub>, SO<sub>2</sub>, aerosol, and H<sub>2</sub>O in addition to NO<sub>2</sub>, with Pandora that were obtained during the Stratosphere–Climate Links With Emphasis On The Upper Troposphere and Lower Stratosphere (SCOUT-O3) campaign in Thessaloniki, Greece in July 2006.

**Stan Sanders** [Jet Propulsion Laboratory (JPL)] discussed an NO<sub>2</sub> instrument inter-comparison that will take place this summer at JPL's Table Mountain facility. The participating instruments include those used in the Goddard inter-comparison as well as the JPL Fourier-transform ultraviolet spectrometer (FTUVS). The FTUVS allows for the separation of atmospheric gases from the solar spectra by observing Doppler shifts associated with East-West side observations of the sun. This JPL campaign will include overflights of the NASA DC8 and ER2 aircraft, and OMI will operate in both normal and zoom modes during this two-week campaign.

**Pepijn Veeffkind** and **James Gleason** [NASA/GSFC] gave the product status and outlook for the standard NO<sub>2</sub> algorithm. Veeffkind noted that the along track striping in the current *Collection 2* data is improved in *Collection 3*. Gleason mentioned that the long-

term comparisons over Goddard (the only polluted site) show a 25% offset. He pointed out that uncertainties in the surface albedo could significantly affect the retrievals.

### June 7

In the session covering other trace gases, **Russ Dickerson** [University of Maryland, College Park] discussed his group's aircraft measurements of O<sub>3</sub>, SO<sub>2</sub> and aerosol properties that have been made in the mid-Atlantic region of the U.S. as well as over China. The observations have been compared with model output. The models overestimate SO<sub>2</sub> in and just above the boundary layer. He noted that sulfur chemistry associated with fair weather cumulus clouds at the top of the boundary layer might be an important process that is not represented well in the models. Dickerson showed that OMI SO<sub>2</sub> retrievals agree with the aircraft *in situ* observations that show high concentrations ahead of a cold front and lower concentrations behind it. He stressed that the OMI operational SO<sub>2</sub> product can be improved by better accounting for the SO<sub>2</sub> profile, viewing geometry, and aerosol effects.

**Marianne Guffanti** [U.S. Geological Survey (USGS)] talked about incorporating OMI data into USGS volcano monitoring. The USGS is a partner of a multi-agency project funded by NASA and led by the UMBC to provide near-real-time (within 3 hours of overpass) volcanic cloud data for a variety of users including some involved with aviation safety. SO<sub>2</sub> in the atmosphere is a distinctive marker of volcanic activity data in two modes: 1) SO<sub>2</sub> and ash as hazard indicators; and 2) Pre-eruptive degassing of SO<sub>2</sub> as a forecast indicator. The improved spatial and spectral resolution of OMI as compared with previous instruments allows insight into both of these modes. Guffanti showed how an OMI detection of SO<sub>2</sub> degassing by Simon Carn [UMBC] helped personnel at the Alaska Volcano Observatory to confirm the volcanic nature of an unusual cloud observed in the vicinity of the Fourpeaked volcano that was thought to be dormant. In the future, her group plans to examine whether OMI data can be used to validate ash-dispersion models.

**Nick Krotkov** [UMBC/GEST] presented the SO<sub>2</sub> product status and outlook. There are three SO<sub>2</sub> products from OMI: 1) explosive volcano; 2) passive degassing; and 3) pollution. He stressed that much of the information in the 2006 *Institute of Electrical and Electronics Engineers (IEEE) SO<sub>2</sub>* paper is now obsolete as the algorithm has undergone significant evolution. He noted that with the Global Ozone Monitoring Experiment 2 (GOME2) now in a morning orbit on the operational European MetOp platform, there are 2 UV measurements per day. These observations may be useful for tracking a volcanic plume to determine its

altitude. He also mentioned that OMI would monitor changes in Chinese emissions as the Olympic games approach. Power plant emissions in Greece, Bulgaria, Turkey, and the Ohio River valley in the U.S. can be seen in OMI data, as well emissions from Persian Gulf refineries, pollution plumes in the Tula industrial complex 80 km north of Mexico City, and volcanic degassing in Mexico. Unknown sources are also being identified. Krotkov cautions users to wait for the *Collection 3* data that will contain algorithm improvements. Information on the algorithm and validation is included in two papers that have been submitted to the *JGR* Aura validation issue. He notes that the current flags can sometimes reject real pollution. He also mentioned the desire to conduct aircraft measurements in the high SO<sub>2</sub> area over China.

**Thomas Kurosu** [Harvard/Smithsonian] discussed the status and outlook for trace gases BrO, formaldehyde (HCHO), chlorine dioxide (OCIO), and glyoxal (CHOCHO). All of these products are affected by striping due to the low mixing ratios of the gases that produce very small signals in the data. The stripes and fitting residuals have improved in the *Collection 3* data. In *Collection 2*, HCHO and BrO remain ~35% low compared with GOME and SCIAMACHY, while OCIO slant columns are higher. However, changes in the fitting windows planned for *Collection 3* have brought the retrievals into closer agreement with the other satellites.

**Mark Schoeberl** [NASA GSFC—*Aura Project Scientist*] gave the opening talk in a general science session. He discussed his method of combining MLS and OMI data to provide daily tropospheric ozone columns using a forward trajectory scheme. Comparison with both sondes and TES shows good agreement in the tropics, but more variability in his product at mid-latitudes than sondes. A potential explanation for the enhanced variability in the OMI/MLS product is that the MLS ozone amount at 215 hPa is too variable, because stratospheric ozone variability is sometimes mis-assigned to the troposphere. Studies by the MLS team support this hypothesis. Comparisons of total tropospheric ozone columns to the Global Modeling Initiative (GMI) Combo model show overall good agreement. Differences in the extra-tropics may be due to more vigorous circulation in GMI, while differences in tropics are due to different emissions and convection.

**Kris Wargan** [Science Applications International Corporation (SAIC)] showed the results of the assimilation of MLS and OMI data at the NASA Global Modeling and Assimilation Office (GMAO). One diagnostic quantity produced by the assimilation is the OMI total ozone increment (observed minus forecast total ozone column). The increments in 2005 were larger than in 2004 over South America and appear to be

related to differences in tropospheric ozone produced from biomass burning. His group is also conducting experiments to assess the impact on forecast skill due to different ozone data sets.

**Matt Deland** [SSAI] showed how OMI could be used to detect polar mesospheric clouds (PMCs) at 80–85 km altitude near the mesopause where temperatures are extremely low (~140 K). These clouds can only be observed visually at high latitudes during sunrise or sunset. Most previous measurements of these clouds have been made with limb-viewing instruments, but Deland has used the nadir-viewing Solar Backscatter UltraViolet (SBUV) instrument to detect them. There appear to be increases in PMCs over time and an anti-correlation with solar activity with a phase lag. The smaller pixel size of OMI as compared with SBUV provides a better chance of seeing the clouds. OMI observations can help to evaluate data from Aeronomy of Ice in the Mesosphere (AIM) that was launched in April 2007 to study PMCs.

**Craig Long** [NOAA] presented the results of OMI ozone assimilation at the National Centers for Environmental Protection (NCEP). OMI serves as preparation for the operational GOME2 on the EUMETSAT Operational MetOp satellite and the Ozone Mapping and Profiler Suite (OMPS) that will be launched on the National Polar-orbiting Operational Environmental Satellite System (NPOESS) and its precursor, the NPOESS Preparatory Project (NPP). He noted that there is now no requirement at NOAA to use only operational satellites so that near-real-time data from OMI can be assimilated operationally. In order to reduce the data volume, only 1 out of every 41 OMI observations is used. This thinning procedure does not impact ozone analyses. The assimilation of OMI is expected to become part of the NCEP operational weather forecasting system in fall of 2007. Use of OMI leads to better ozone hole forecasts. The Aura MLS is being used for validation.

**Folkert Boersma** [Harvard] addressed the question: *Can we observe fast photochemistry and changes in emissions from space?* To answer this, he used the same basic algorithm to retrieve NO<sub>2</sub> with both OMI and SCIAMACHY (the KNMI near-real-time algorithm) which are separated in time by ~3.5 hours. NO<sub>2</sub> is higher in the afternoon in regions of biomass burning, while it is lower in most areas dominated by urban pollution. These differences are larger than the expected observational uncertainties. The observed differences generally agree with the diurnal variations predicted by the GEOS-CHEM model when the biomass burning cycle is included in the model.

**Don Lucas** [Texas A&M University] described the results of tagged sulfur tracer simulations using a global 3D-model. The tagged tracers were used to quantify the

contributions of sulfur from natural and anthropogenic sources to atmospheric SO<sub>2</sub>, sulfuric acid (H<sub>2</sub>SO<sub>4</sub>) gas, and new particle formation. Lucas also briefly discussed future applications of this modeling system to constraining sulfuric acid from observations of SO<sub>2</sub> and aerosols.

**Jae Kim** [Pusan University, Korea/University of Alabama, Huntsville (UAH)] presented work done in collaboration with Mike Newchurch [UAH] on deriving tropospheric ozone by making use of observations from different satellite viewing angles. This was accomplished in the tropics with TOMS and more recently with OMI. He showed differences between his method and the OMI-MLS residual method. He then applied singular value decomposition to examine correlations between the derived tropospheric ozone and carbon monoxide retrievals from the Terra Measurements Of Pollution In The Troposphere (MOPITT) instrument.

### June 8

In the final core group meeting, **Maarten Sneep** [KNMI] and **Joanna Joiner** [NASA] led a discussion on clouds.

- **P. K. Bhartia** gave a historical perspective showing how clouds alter the spectral dependence of Rayleigh and Raman scattering. He stressed that more than one approach to handling clouds may be necessary to meet different algorithmic needs. For example, while the Mixed Lambertian Equivalent Reflectivity (MLER) model works well for the OMI DOAS total ozone algorithm, the plane-parallel cloud model may work better for OMI TOMS O<sub>3</sub>.
- **Sneep** expanded upon his presentation of the previous day in which he discussed the meaning of the MLER cloud properties (effective cloud fraction and pressure) reported in the current OMI cloud data products. He mentioned possible uses of the OMI cloud products outside of the OMI science team. He also showed that distributions of cloud pressure from the OMI O<sub>2</sub>-O<sub>2</sub> algorithm are similar to those derived from GOME using the O<sub>2</sub>-A band and significantly different from thermal infrared (IR) MODIS retrievals of cloud top pressure.
- **Johan de Haan** showed that the MLER approach gives relatively small errors for O<sub>3</sub> and NO<sub>2</sub> DOAS-type retrievals. He also showed that path lengths are similar for O<sub>2</sub>-O<sub>2</sub>, O<sub>2</sub>-A band and Raman scattering. Joiner discussed how CloudSat data are being used to explain that OMI retrieves pressures deep inside convective clouds and sometimes near the lower of two cloud decks. She closed by mentioning that in the future the synergistic use of the different A-train cloud observations, including those from OMI, will be further explored.

**P. K. Bhartia** led a discussion of OMI calibration.

- **Changwoo Ahn** [SSAI] presented results of a comparison of OMI and MODIS Level 1B data at the overlapping wavelength of 470 nm. There is a significant swath angle dependence of the differences that is yet to be completely explained.

**Pieter Levelt** wrapped up the meeting by noting that *Collection 3* will be operational starting August 1 and by the end of the year all of the Level 2 products from launch until this date will be regenerated using this improved data set. This will lead to a full set of OMI Level 1B and Level 2 *Collection 3* data. ■

## Summary of the 31st ASTER Science Team Meeting

continued from page 28

Also included among the 14 presentations were results of a study on the effectiveness of the ASTER user interface. General discussion took place after the presentations were finished, and it was commented that the continuous observation was expected. ■

## Landsat Science Team Meeting Summary

*Thomas R. Loveland, U.S. Geological Survey Center for Earth Resources Observation and Science, Loveland@usgs.gov*

*James R. Irons, NASA Goddard Space Flight Center, James.R.Irons@nasa.gov*

*Curtis E. Woodcock, Department of Geography and Environment, Boston University, curtis@bu.edu*

### Meeting Overview

The Landsat Science Team sponsored by the U.S. Geological Survey (USGS) and NASA met June 12-14, 2007, at Oregon State University in Corvallis, OR.

**Warren Cohen** [U.S. Forest Service (USFS)] hosted the meeting. The goal of the meeting was to discuss the scientific and engineering issues associated with ensuring the success of the Landsat Data Continuity Mission (LDCM). The specific meeting objectives offered by **Tom Loveland** [USGS—*Landsat Project Scientist, USGS*] and **Jim Irons** [NASA Goddard Space Flight Center (GSFC)—*LDCM Project Scientist, NASA*] were to:

- Review the status reports of key Landsat 1-7 and LDCM topics.
- Review and receive Landsat Science Team input on LDCM requirements with particular emphasis on the ground system.
- Discuss issues identified during the January 2007 Landsat Science Team meeting.

The meeting agenda and presentations are available at [ldcm.usgs.gov/june2007MeetingAgenda.php](http://ldcm.usgs.gov/june2007MeetingAgenda.php).

### Summary of Status Reports

**Bill Ochs** [NASA GSFC—*LDCM Project Manager, NASA*] and **Mike Headley** [USGS—*LDCM Project Manager, USGS*] provided reports on the status of LDCM planning and implementation. The NASA and USGS team is working toward a launch readiness date of July 2011.

Ochs provided an update on the status of the procurement of launch and space segment elements. The evaluation of proposals for the Operational Land Imager (OLI)—the next generation sensor—is in the final stage and an award is expected by mid-July, 2007<sup>1</sup>. Ochs stated that the spacecraft accommodation study is underway with an award expected in late-2007. He also said that the launch vehicle Request for Proposals had been released and an award was planned for late this summer. Regarding the mission operations element, a statement of work has been released for industry comment and current plans are for award of contracts by mid-2008.

An outcome of the January 2007 Landsat Science Team meeting was a strong statement of support for adding a stand-alone thermal imaging capability to the LDCM. Ochs said that the team's letter has generated more discussion on the importance of this capability and support is gaining momentum. However, no firm commitments have been made.

Headley summarized three topics associated with USGS ground system planning and implementation: (1) USGS acquisition strategy and procurement status; (2) ground system concept review results; and (3) ground system requirements review plans. The ground system includes the flight operations and data processing and archive segments, as well as interfaces to the International Cooperators Network (i.e., Landsat ground stations) and the Landsat user community. Requests for proposals for key elements, including the ground network, flight operation team, mission operations center, and archive and user portal elements will be released throughout 2008. The collection planning (i.e., long-term acquisition plan), image processing and infrastructure elements will be developed by USGS Earth Resources Observation Systems (EROS) technical services support contractors. Details on the USGS ground systems acquisition strategy are available at—[ldcm.usgs.gov/acquisitionStrategy.php](http://ldcm.usgs.gov/acquisitionStrategy.php).

Headley also reported that the ground system concept review was held in February 2007 and provided a means to gauge progress toward the upcoming ground system requirements review. The result of the concept review was the identification of issues needing further policy or scientific, technical, or engineering clarification. Key issues included LDCM standard product definition and access strategies, acquisition strategies, support of the International Cooperators Network, and backup archive concepts. The resolution of the issues is an important preparation step for the September 2007 ground system requirements review. The requirements review will assess the readiness to begin the ground system design and will address the maturity and completeness of segment level and overall ground system requirements.

**Rachel Kurtz** [USGS—*Acting Landsat Acquisitions Manager*] provided an update on activities associated with Landsats 5 and 7 and the Landsat archive. Landsat 5 and 7 are functioning although both have experienced periodic problems. Landsat 7 data are being acquired routinely for the global land surface but the data are affected by the 2003 scan-line corrector (SLC) failure that results in data gaps in each scene. Landsat 5 acquisitions continue over areas of the globe where

<sup>1</sup>On July 16, 2007, NASA announced that Ball Aerospace and Technologies Corp. of Boulder, CO was selected to develop the OLI.

direct broadcast of acquisitions to ground stations are possible. As a 24-year-old mission, there are a number of technical problems that periodically disrupt Landsat 5 operations but team engineers have been very successful in correcting or managing problems associated with power supply, transmitters, and star trackers. Engineering studies indicate that both satellites have sufficient fuel to continue operations into 2011.

Kurtz reported that there are now more than two million Landsat scenes spanning 1972–2007 in the USGS archive. The USGS is developing plans to make all Landsat data more accessible. As a first step, all Landsat 7 data from 2003–present (i.e., SLC-off era) over the United States are being made available via the web at no cost to users. The data are terrain corrected and are in a Universal Transverse Mercator (UTM) projection. Results from the pilot phase of this initiative will be used to determine the next steps in expanding web access to additional Landsat data.

**Jeff Masek** [NASA GSFC—*Deputy LDCM Project Scientist*] gave an update on the NASA-USGS Mid-Decadal Global Land Survey (MDGLS) initiative. The MDGLS is a continuation of the Landsat *GeoCover* orthorectified global data set (1975, 1990, and 2000 epochs) and will add global Landsat and other moderate resolution data from 2004–2007 to the *GeoCover* archive. This effort is in support of Climate Change Science Program requirements, will support global assessments of landscape dynamics, and will serve as a pilot project for routine global monitoring in the LDCM era. The first phase of the MDGLS is the acquisition of Landsat 5 and 7, Advanced Spaceborne Thermal Emission and Reflection Radiometer (ASTER), and Earth Observing-1 (EO-1) imagery. This effort is progressing and the USGS is initiating the second phase, data processing. All acquisitions will be processed to *GeoCover* standards—i.e., orthorectified, terrain corrections, 28.5-m resolution, and Universal Transverse Mercator (UTM) projection. Orthorectified data sets will start becoming available in 2008. NASA planning is underway to advance the third phase of the activity, which involves the development of global land cover change products.

**Ray Byrnes** [USGS—*Liaison for Satellite Missions*] gave an update on the progress of the Landsat Data Gap Study Team. The team's objective is to identify, assess, and recommend alternative data sources that can best provide recurring global land observations, sufficiently consistent in terms of acquisition extent, frequency, and quality, as that of the Landsat Program. Based on recent investigations, the team concludes that:

- The Landsat Program is unique and serves as the most consistent single source of systematic, global

land observations but that alternate sources can reduce the impact of a Landsat data gap.

- Data quality of potential candidate systems is unverified; however, based on preliminary analysis, India's ResourceSat and China/Brazil's Earth Resources Satellite (CBERS) are the leading candidates for reducing the impact of a Landsat data gap.
- There are technical challenges associated with receiving and archiving data from new source(s), data characterization and cross-calibration, and differentiating land cover change from multiple disparate sources.

The Landsat Data Gap Study Team is now developing plans for filling the data gap should Landsat 5 and 7 fail prior to the launch of LDCM.

**Ray Byrnes** and **Ed Grigsby** [NASA Headquarters—*Landsat Program Executive*] updated the team on the status of the Office of Science and Technology Policy, Executive Office of the President study on *The Future of Land Imaging*. The study is complete and publication of findings is pending<sup>2</sup>. The report calls for the establishment of a National Land Imaging Program (NLIP), led by the Department of the Interior, and endorses a strong U.S. role in moderate resolution Earth imaging.

**Ron Beck** [USGS—*Program Information Specialist*] and **Anita Davis** and **Laura Rocchio** [both at NASA GSFC—*Education and Public Outreach*] provided overviews of their respective Landsat-related outreach activities. Beck emphasized USGS efforts to provide science support to the public policy process. Davis and Rocchio presented activities associated with formal and informal education, news stories, and partnerships. NASA and the USGS, with National Science Foundation support, are involved in the Integrated Geospatial Education and Technology Training (iGETT) program that is geared toward faculty at two-year colleges.

Following the programmatic status reports, the 18 Landsat Science Team members provided brief summaries of their research activities that are related to LDCM.

**Rick Allen** [University of Idaho] summarized research on his development of operational evapotranspiration (ET) algorithms. Specific elements of this research include the development of a model for calculating surface energy balance for ET mapping (METRIC) at Landsat scale resolution, the interoperability of Landsat data and ET with other satellite system data and resolutions, and the use of ET to calibrate reflectance-based procedures.

<sup>2</sup> This report was released on August 14, 2007.

**Sam Goward** [University of Maryland, College Park (UMCP)] provided an update on his work to improve the Long-Term Acquisition Plan (LTAP) that governs the global collection of Landsat data. He concluded that LTAP-7 used for Landsat 7 acquisitions has provided good global coverage on a quarterly basis but that there now needs to be improvements covering key areas such as the boreal and tropical regions.

**John Schott** [Rochester Institute of Technology] is investigating the potential for using LDCM for Great Lakes water resources assessment. Preliminary results show that the OLI blue band will be useful in the retrieval of suspended materials, and that the addition of 12-bit quantization offers significant advances associated with water constituent retrieval.

**Jennifer Dungan** on behalf of **Rama Nemani** [Both with the NASA Ames Research Center] presented research focused on developing an operational capability to produce vegetation green leaf area index (LAI) from Landsat data by adapting a physically based approach conceived and implemented by the Moderate Resolution Imaging Spectroradiometer (MODIS) Science Team. Dungan's discussion addressed the importance of understanding measurement errors and uncertainties.

**Prasad Thenkabail** [International Water Management Institute] reviewed the status of the Global Irrigated Area Map, an initiative to map irrigated lands across the globe. A 10-km resolution global map of irrigated lands was produced using Advanced Very High Resolution Radiometer (AVHRR) and MODIS data, and research is underway to develop a global 30-m map using Landsat data.

**Charlie Walthall** on behalf of **Martha Anderson** [Both with the U.S. Department of Agriculture Agricultural Research Service] reported on research for mapping drought and evapotranspiration using Landsat and Geostationary Operational Environmental Satellite (GOES) thermal imagery. They are developing a multi-satellite drought product that ranges between 30-m and 10-km resolution and also developing techniques to sharpen thermal band imagery to shortwave band resolutions.

**Lazaros Oraopoulos** [University of Maryland Baltimore County] summarized his research on cloud detection and avoidance. The work is assessing MODIS cloud climatology as an input to the LTAP, transferring the lessons learned from MODIS cloud detection research to LDCM, and evaluating automatic cloud cover assessment algorithms.

**Jim Vogelmann** [Science Applications International Corporation (SAIC)/USGS Earth Resources

Observation System (EROS)] is studying strategies for monitoring forest and rangeland change using Landsat and alternative sources of satellite data. The research is evaluating *at-sensor* reflectance data as a function of seasonality for assessing landscape-level trends between 1988 and 2006.

**Eilileen Helmer** [U.S. Forest Service (USFS)] is investigating tropical forest monitoring using cloud-free image mosaics. In her research, Helmer is filling cloud gaps with models that normalize inter-date differences with mutually clear pixels. She has found that regression tree normalization more closely matches inter-date image differences than results using other approaches.

**Mike Wulder** [Canadian Forest Service] is engaged in research geared toward conversion of Landsat imagery into resource management information. In his investigations, he is conducting cross-sensor change detection, comparing Landsat 7 SLC-on / SLC-off data for change detection, monitoring insect disturbance and recovery, grizzly bear habitat monitoring and modeling, and generation of national fragmentation products.

**Feng Gao** [Earth Resources Technology, Inc.] is developing a consistent Landsat data set from Multispectral Scanner (MSS), Thematic Mapper/Enhanced Thematic Mapper Plus (TM/ETM+), and international data sources for land cover change detection. This involves processing moderate resolution data sources into a consistent orthorectified surface reflectance data set, testing consistent surface reflectance data set for land-cover change detection, simulating Landsat surface reflectance using MODIS and Landsat data, and evaluating the potential for using data for filling a possible Landsat data gap.

**Dennis Helder** [South Dakota State University] is developing a strategy for a systematic radiometric calibration approach for LDCM and the Landsat archive. His approach involves: (1) consistent calibration of the Landsat archive through use of pseudo-invariant sites; (2) techniques for relative gain calibration/correction of large linear arrays; and (3) vicarious calibration of LDCM and Landsat TM/ETM+ instruments.

**Eric Vermote** [UMCP] is conducting research that leads to a surface reflectance standard product from LDCM and supporting data. The strategy calls for the development of an operational, globally applicable, sharable, and fully automated approach for integration into the LDCM processing chain.

**Randolph Wynne** [Virginia Polytechnic Institute and State University] presented a status report on his research on the use of Landsat data for forest

science and management, with particular focus on the southeast United States and forest industry. Wynne is developing approaches for mapping areas of rapid forest change, assessing forest carbon management, rating southern pine beetle hazards, and monitoring reforestation of abandoned mine lands.

**Curtis Woodcock** [Boston University—*Landsat Science Team Leader*] reported on his research to understand SLC-off *gap filled* data. Woodcock is documenting the magnitude of errors (i.e., differences between observed and synthetic values) and is using *variograms* to estimate the magnitude of errors. He also updated the team on planning to expand land cover mapping and land-change assessments to the globe.

As the meeting host, **Warren Cohen** [USFS] and his Oregon State University and USFS colleagues organized a comprehensive summary of their remote sensing research activities. Topics included carbon balance assessments, national parks monitoring, land cover dynamics including forest disturbance and regrowth, sampling strategies, and validation.

### Technical Issues Discussions

The USGS, NASA, and Landsat Science Team members assessed a series of requirements concepts issues associated with ground systems plans. There are several important issues that must be resolved in advance of the upcoming ground systems requirements review.

**Doug Daniels** [Aerospace Corp.] and **Jim Nelson** [SAIC/USGS] provided an overview of efforts by the USGS to resolve ground system requirements design issues that were raised during the winter 2007 ground system concept review. The issues discussed were:

*Data acquisition scheduling*—The USGS plans to support up to five priority and off-nadir acquisition requests per day. While these types of requests are important, it is also important that the long-term global acquisition plan be maintained in order to consistently extend the global Landsat record. The USGS agreed to develop a *white paper* on recommended acquisition priorities for review by the Landsat Science Team and the USGS and NASA mission operations groups.

*Bulk data access and distribution*—This issue deals with the provision of very large amounts of Landsat images (more than 400 per transaction) to high volume data users. There are no clear precedents for estimating the impact on planned electronic delivery systems. The USGS LDCM team proposes that at launch, a manual capability be used to address bulk data access on a case-by-case basis, and that more robust capabilities be established as experience is gained in the post-launch era.

*Data products*—The USGS plans to produce a single standard LDCM Level 1T (L1T) product that is precision and terrain corrected with top-of-atmosphere correction. The products will be made available via the web at no cost to users. The Landsat Science Team will contribute to the identification of possible higher level products including surface reflectance transformations, cloud-reduced composites, and multi-temporal data cubes.

*Applying the USGS cost of fulfilling user requests (COFUR) policy*—The current COFUR policy states that data must be provided at no more than cost of fulfilling user requests. Plans to distribute a single LDCM standard product at no cost are consistent with the current guidelines.

*User registration*—In order to understand the demographics and requirements of LDCM users, the USGS will require users accessing web-enabled products to provide basic demographic and applications information. The USGS plans to keep the registration process simple in order to reduce impacts on users.

*Calibration and validation*—LDCM data will be routinely evaluated in order to maintain and report image quality data to users. Current USGS plans call for: (1) cross calibration to Landsat 7 ETM+ data; (2) characterization of the on-orbit radiometric, spatial, and geometric performance of the LDCM sensors and data; (3) assessment of image data quality throughout mission life; and (4) derivation and application of calibration throughout mission life. In addition, the USGS will develop a strategy to reprocess data as appropriate.

*International Cooperators Network roles and participation*—Historically, a network of international ground stations have directly received Landsat data over their areas of interest. For LDCM, the USGS recommends a hybrid strategy that retains the current network model, provides direct downlink as the primary data delivery mechanism, and includes internet and a high capacity media delivery option that delivers archive and L1T data from the U.S. archive holdings.

*Data processing and archive continuity of operations*—The issues involve the form of the backup archive and the length of time that should be planned to rebuild processing and archive systems in the event of the loss of system capabilities. Plans are to establish a low-cost off-site tape archive for data and critical system software, documentation, and calibration/validation parameters. In addition, capabilities to rebuild the ingest and archive functions within 90 days is needed.

*Latency and availability*—This governs the length of time users must wait for data. Plans are that U.S.

priority acquisitions be available for distribution within six hours of acquisition and global priority scenes will be available within 12 hours of observation. All other scenes will be available for search and order within 24 hours of observation.

**John Dwyer** [SAIC/USGS] added a detailed discussion of LDCM standard product plans. The planned L1T standard product uses a single fixed recipe that was developed based on discussions and recommendations with data users and a review of historical image ordering preferences. The planned specifications are:

Parameter	Specification
Pixel Size	14.25m pan, 28.5m VNIR
Media Type	Download (no cost) – no plans for other media
Product Type	L1Gt or L1T (decision pending assessment of ground control point needs)
Output Format	GeoTIFF
Map Projection	Universal Transverse Mercator
Datum	WGS84
Orientation	North up
Resampling	Cubic convolution
Geometric Accuracy	~12m circular error (90%) global

The products will continue to be based on the World Reference System-2 scene structure. The relief displacement will be based on the best available digital elevation models (DEM).

Dwyer also led a short discussion about the potential for generating user-specified products from LDCM and other Landsat data. Currently, the USGS does not plan to produce additional products but offered to consider recommendations from the Landsat Science Team.

#### **Landsat Science Team Working Group Recommendations**

The final day of the meeting was devoted to working group discussions. At the end of the meeting, each working group presented recommendations to NASA and the USGS. The working groups and conclusions each offered include:

##### *Instrument Engineering*

The image engineering working group led by **Dennis Helder** and **John Schott** addressed issues associated with LDCM calibration/validation, development reviews, and the status of the thermal instrument.

Specific recommendations from this group include:

- Yaw maneuver capabilities should be a calibration requirement for the instrument and spacecraft and should be factored into the LTAP.
- Access to flight hardware (i.e., engineering samples of key system components) and initial burn-in data on detectors and/or filters should be considered.
- Landsat Science Team engineering representatives should participate in critical instrument reviews.
- Calibration continuity for the entire Landsat archive is needed. This strategy should involve the use of pseudo-invariant (i.e., desert) sites.
- While the status of the thermal instrument on LDCM is still unknown, early consideration of instrument registration issues should be addressed.

##### *Data Products*

This working group led by **Warren Cohen** is dealing with the types and characteristics of Landsat data products in the LDCM era. Recommendations from this working group include:

- The L1T standard product should include top-of-atmosphere (TOA) reflectance processing. Provision of ancillary information and tools that permit users to convert TOA reflectance to surface reflectance should be considered.
- There should be more consideration for providing Level 0 or similar products.
- The LDCM standard product should include a public domain DEM. However, the terrain correction process should use the best available DEM.
- Spatially explicit, pixel-level quality assurance information, should be provided.
- There should be more consideration of the potential for creating user-specified data products.
- The processing used to generate LDCM standard products should be applied to all archived Landsat data. This is critical for enabling an in-depth understanding of global land surface changes.

##### *Mission Operations*

This working group led by **Sam Goward** is focusing on issues associated with ensuring the collection of global coverage that meets the mission's science objectives. Goward provided a summary of the key capabilities and needs of the LTAP and presented the following working group recommendations:

- Analysis of the potential impacts of the LDCM off-nadir imaging capabilities on the LTAP is



needed. A plan for referencing off-nadir non-World Reference System-2 scenes in the Landsat metadata archive must be developed.

- Improving the seasonality of global acquisitions is important. This should include incorporation of the location of irrigated areas in deserts and use of continuous variable normalized difference vegetation index inputs.
- Cloud screening without thermal infrared data will be problematic. Additional investigation of cirrus-clearing strategies is needed.

#### *Future Missions, Outreach, and Advocacy*

This working group met informally to discuss long-term opportunities and Landsat Science Team outreach and advocacy functions. Opportunities identified include opening access to the Landsat archives and the role of science associated with NLIP implementation.

#### **Final Recommendations and Next Steps**

The Landsat Science Team reviewed the working group reports and concluded that the primary outcomes of the meeting were the validation of the recommendations associated with the ground system requirements, and the identification of new opportunities for expanding access to Landsat data. Given the encouraging movement toward the formation of a new National Land Imaging Program, the Landsat Science Team outlined a broad goal and two objectives that should be considered by the leadership of the National Land Imaging Program. The team recommended that **by the launch of the LDCM in mid-2011, all the existing imagery collected by prior Landsats be consolidated in the U.S. archive and made equally accessible as LDCM imagery.** The Team identified two steps needed to achieve this goal.

**The first step is to consolidate past images collected by Landsat satellites in the U.S. archive at the USGS EROS.** Only approximately half the images collected by Landsat satellites to date are safely archived in the U.S. The other images are in archives managed by foreign receiving stations. These holdings are not necessarily in secure archives and it is likely that there are holdings in danger of being irrevocably lost. The best solution to this problem is to bring copies of these foreign holdings into the USGS archive.

**The second step is to make the existing Landsat images as accessible as the LDCM images.** The recent history of the Landsat Program has shown that improved access to Landsat imagery enhances its value to society. The explosion in the use of Landsat data after the *GeoCover* datasets were made freely available has demonstrated that free access to the imagery leads to creative and productive new uses. To maximize benefit from the LDCM, it is necessary for the existing images within the U.S. archive to be equally accessible as the LDCM images and in formats compatible for use with LDCM images.

The Landsat Science Team sent a letter to the Department of the Interior, USGS, and NASA leadership regarding these recommendations.

Because of the importance of Landsat archive issues to the overall success of LDCM, the team concluded that the winter Landsat Science Team meeting should concentrate on the goal and objectives concluded during the Corvallis meeting. In order to have access to the full range of USGS Landsat archive expertise, the next meeting is tentatively set for January 8-10, 2008, at USGS EROS near Sioux Falls, SD. ■

## NSIDC Media Advisory: Fall 2007 Arctic Sea Ice News Launched

The National Snow and Ice Data Center has launched our second annual news and commentary Web site as we follow the Arctic sea ice melt season. From August 10, 2007, through the end of the summer melt season, we will post updates as events warrant. To find out the latest sea ice conditions and to read press information, visit the site at [nsidc.org/news/press/2007\\_seaiceminimum/20070810\\_index.html](http://nsidc.org/news/press/2007_seaiceminimum/20070810_index.html).

The National Snow and Ice Data Center (NSIDC) is part of the Cooperative Institute for Research in Environmental Sciences at the University of Colorado at Boulder.

To be added to the NSIDC Press Release Notification list, send an e-mail to [srenfrow@nsidc.org](mailto:srenfrow@nsidc.org) with *Subscribe press release list* in the subject and full contact information in the body of the message.

## Scouting Out Aerosols in Oklahoma: NASA Langley Researchers Use Lidar to Support Department of Energy Field Campaigns

Katie Lorentz, NASA Langley Research Center, [Katherine.E.Lorentz@nasa.gov](mailto:Katherine.E.Lorentz@nasa.gov)  
Lynne Roeder, Pacific Northwest National Laboratory, [lynne.roeder@pnl.gov](mailto:lynne.roeder@pnl.gov)

Slicing through the atmosphere from 28,000 ft (~8530 m), High Spectral Resolution Lidar (HSRL) from NASA's Langley Research Center can see some of the smallest atmospheric particles, including natural and human-made components.

HSRL's perspective—the three-dimensional view—brought a new dimension to the recent Cumulus Humilis Aerosol Processing Study (CHAPS) in Oklahoma. Researchers were scouting out the aerosol plumes from metropolitan areas like Oklahoma City.

*Cumulus humilis* is the scientific term used to describe the small, fair-weather clouds that dot the summer skies over Oklahoma. During June, the NASA team and other scientists sponsored by the U.S. Department of Energy's Atmospheric Science Program used aircraft and ground-based instruments to obtain information about the physical and chemical properties of these clouds and the small airborne particles—called *aerosols*—within and around them. Aerosols, particularly those associated with human activity, are thought to be changing the brightness, the lifetime, the amount of precipitation, and other properties of clouds.

During the campaign, the HSRL instrument flew on a NASA *King Air B200* aircraft, based at Langley. This twin-engine turboprop flew at altitudes of around 28,000 ft, conducting scouting missions to identify the Oklahoma City plume. The *King Air* also flew with the Department of Energy's *Gulfstream-1* aircraft to make simultaneous remote observations of fields of clouds and aerosols. These coordinated measurements were important for the CHAPS team to better understand the interaction of clouds and aerosols.

Unfortunately for the researchers, aerosols were somewhat elusive during most of the month-long campaign due to an unusually rainy period. “We were trying to locate plumes coming out of the city,” said **Mike Obland**, NASA postdoctoral fellow working on the project. “Unfortunately, the plume had lower aerosol loading than expected. The rain was really cleaning out the atmosphere.”



Mike Obland, postdoctoral candidate with the HSRL team, with the HSRL instrument on the NASA King Air B200.

Despite the inclement weather, Obland notes that they were still able to meet their science goals during the mission. “It was successful from the standpoint that our instrument and aircraft worked really well. We got a lot of data during the campaign.”

The HSRL technique provides a picture of a slice of the sky, highlighting atmospheric layers and components. The instrument is similar to radar. However, with lidar, radio waves are replaced with laser light. The advanced HSRL makes measurements that can even distinguish among different aerosol types and their sources.

The *King Air* was specially equipped so that the researchers can transmit the laser out of a window in the bottom of the airplane and use a telescope to measure the amount of light that scatters back from aerosols and other atmospheric components like water droplets in clouds.

During the campaign, the HSRL team adopted some new capabilities, downlinking data in real time to the ground and to the Web.

“We felt that being able to broadcast our real-time data on the Web was a really important mechanism to incorporate, and it worked out well,” said **John Hair**, co-principal investigator for HSRL. “People who

weren't actually there in Oklahoma could be a part of what was going on and view data essentially real-time for the HSRL instrument."

With their new downlinking capabilities, members of the instrument team were able to share data with their field campaign collaborators while making real-time flight track decisions. These real time flight track decisions were essential in tracking plumes and in choosing flights with the best observation opportunities.

This study was part of a larger campaign, the Cloud and Land Surface Interaction Campaign (CLASIC) to investigate how changes in land use affect clouds through changes in surface heating. At the request of the CLASIC investigators, the NASA *King Air* also flew flight patterns coordinated with the other CLASIC aircraft so that HSRL data could be used to help understand how aerosols and clouds interact. The NASA *King Air* flew several flights to acquire data to validate measurements from the Cloud-Aerosol Lidar with Orthogonal Polarization (CALIOP) instrument on board the Cloud-Aerosol Lidar and Infrared Pathfinder Satellite Observation (CALIPSO) satellite.

These campaigns represent the culmination of nearly two years of preparation and coordination among the participating organizations, including NOAA, NASA, Department of Energy (DOE), the U.S. Department of Agriculture and numerous national laboratories and universities. ■



A view from the inside of the *King Air B200* showing pilots Rick Yasky and Les Kagey. Other crew members who made the flights possible were co-pilots Mike Wusk and Howard Lewis, and mechanics Dale Bowser and Scott Sims.

## Experience NASA Science at the 2007 Fall AGU

Please join us at the NASA booth (#132) during this year's Fall Meeting of the American Geophysical Union (AGU), where we will offer a wide variety of science presentations, interactive demonstrations, and tutorials for a variety of data tools and services. This year's program begins on **Tuesday, December 11** and will continue through **Thursday, December 13, 2007**.

In recognition of NASA's 50th anniversary, our exhibit activities will showcase the past, present, and future of NASA Science. Presentations will cover the full range of research topics, science disciplines, and programs within NASA's Science Mission Directorate. Interactive data-oriented demonstrations will include sessions on data accessibility and data search-and-order capabilities, and will feature selected data conversion and manipulation tools.

A daily agenda will be posted on the Earth Observing System Project Science Office (EOSPSO) web site—[eos.nasa.gov](http://eos.nasa.gov)—in early December.

We look forward to seeing you in San Francisco!

## NASA Web Page, Video Gives Educators An In-Depth Look At Hurricanes

Rob Gutro, NASA, Goddard Space Flight Center, [Robert.J.Gutro@nasa.gov](mailto:Robert.J.Gutro@nasa.gov)

Educators will have the opportunity to bring a hurricane expert into their classroom with the release of a new NASA web page and video. The web page and video were created from a 1.5 hour live, 2006 interactive lecture involving a NASA hurricane expert and teachers. Internet-2 technology was used.

Both the web page and the 58-minute video can be used by teachers in classrooms. The web page will contain the most information, including 35 separate, 1–4-minute-long, video segments that were derived from the live program.



This image shows the Internet-2 teacher audience on the large left screen, while the screen on the right shows Jeffrey Halverson explaining a NASA QuikSCAT satellite image behind him that shows wind speed and direction of a storm. Note that Halverson is actually standing in the studio (far right) in front of a green screen, which is the same that television meteorologists use. Computers are used to make the satellite image appear behind him. **Credit:** NASA

The live program was recorded on November 20, 2006, at the University of Pennsylvania for the Franklin Institute Science Center in Philadelphia, PA. The Franklin Institute hosted a professional development event for in-service teachers of science. The event connected 20 teachers (grades 6-8), from the Philadelphia metropolitan region, with Professor **Jeffrey Halverson** of the University of Maryland – Baltimore County’s (UMBC) Department of Geography and UMBC/NASA’s Joint Center for Earth System Technology (JCET). This activity was part of an ongoing National Science Foundation grant inquiry by the Franklin Institute into the use and efficacy of emerging cyber-infrastructure—particularly Internet-2—as a new channel for teacher professional development, specifically within a science center environment.

The website will be the primary tool for educators. It contains short pre-produced video segments, teaching segments, and question and answer (Q&A) sections, all of which are packaged for use by teachers and students.

“The Education Office is pleased to make this hurricane information available in a visual format as a tool for teachers, students, museums and science centers in addressing the national science standards,” said **Bob Gabrys**, Chief Education Officer at NASA Goddard Space Flight Center.

Broken down by key concepts, each segment is linked to national education standards. An index describing each segment, the media content and linkages to national standards is provided. The pre-produced videos give an overview of topics. The teaching segments include Halverson explaining and using the scientific visualizations to teach concepts about hurricanes. Each of the teaching segments contains a *factoid* at the end that gives additional related information in the form of a graphic. The Q & A, generated in part by the teacher audience during the original event, help clarify additional questions.



Professor Jeffrey Halverson of the University of Maryland - Baltimore County notes the path that Hurricane Katrina took in 2005 after it made landfall in Mississippi and Louisiana. Behind him is an image that was created using various NASA satellites. **Credit:** NASA

The video segments and the media content, which includes visualizations, graphics and images used by Halverson during the presentation, are described and available for viewing and download on the webpage. Much like a television meteorologist, the images are projected on a “green screen” behind Halverson. The 58-minute video, which is an edited version of the

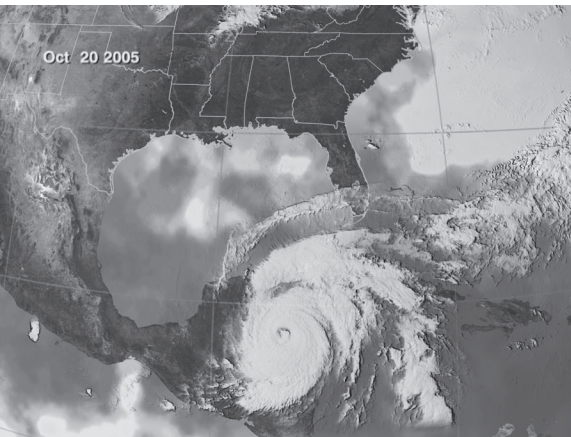

On October 20, 2005, ocean temperatures surrounding Hurricane Wilma were hovering near 85° F, about three degrees higher than the temperature required to fuel a hurricane. This image shows sea surface temperatures (SSTs). The darkest areas of the ocean represent temperatures of 82° F or above. The data came from the Advanced Microwave Scanning Radiometer (AMSR-E) instrument on NASA's Aqua satellite. **Credit:** NASA

whole program, will be running on NASA's Education Channel and educators can record the program. It may also be available on DVD. Teachers interested should contact **Sarah Dewitt** of NASA-TV at 301-286-0535, or [Sarah.L.Dewitt@nasa.gov](mailto:Sarah.L.Dewitt@nasa.gov).

To produce the original 1.5-hour live, interactive lecture, members of NASA Goddard Space Flight Center's Public Affairs and Education offices teamed with members of UMBC JCET Goddard Earth Science and Technology Center, the Imaging Research Center and New Media Studio at UMBC. The team—including a practicing scientist; a Science, Technology, Engineering and Math education specialist; a science video producer; and a senior media producer—developed the visually and intellectually immersive presentation around myriad scientific visualizations produced by NASA Goddard's Scientific Visualization Studio in support of NASA missions.

The web page is located on NASA's Hurricane Resource Web Page at: [www.nasa.gov/mission\\_pages/hurricanes/features/hurricane\\_educ\\_links.html](http://www.nasa.gov/mission_pages/hurricanes/features/hurricane_educ_links.html)

To access the Hurricane Education event web page, please visit on the Web: [www.nasa.gov/mission\\_pages/hurricanes/features/hurricane\\_educ\\_links.html](http://www.nasa.gov/mission_pages/hurricanes/features/hurricane_educ_links.html)

To access NASA's Hurricane Resource Web Page, visit: [www.nasa.gov/hurricane](http://www.nasa.gov/hurricane). ■

## Billowing Smoke Blankets Montana and Idaho

*Laura Spector, NASA, Goddard Space Flight Center, [Laura.A.Spector@nasa.gov](mailto:Laura.A.Spector@nasa.gov)*

Thick smoke, billowing from dozens of wildfires throughout Montana and Idaho, blanketed the landscape as the Moderate Resolution Imaging Spectrometer (MODIS) on NASA's Aqua satellite passed overhead on Sunday, August 12, 2007, capturing this image.

The light gray smoke from the numerous fires spread across both states. Fires appeared especially active in the Frank Church River of No Return Wilderness area, south of the Salmon River.

According to the August 12 report from the National Interagency Fire Center (NIFC), 31 large fires were burning more than 753,000 acres in Montana and Idaho alone. The NIFC predicted the fire activity would increase, as sustained winds of 15-20 miles per hour were forecasted to race across the Great Basin and Northern Rockies.

According to news reports, the fires forced hundreds to evacuate and closed down highways throughout several western states. ■

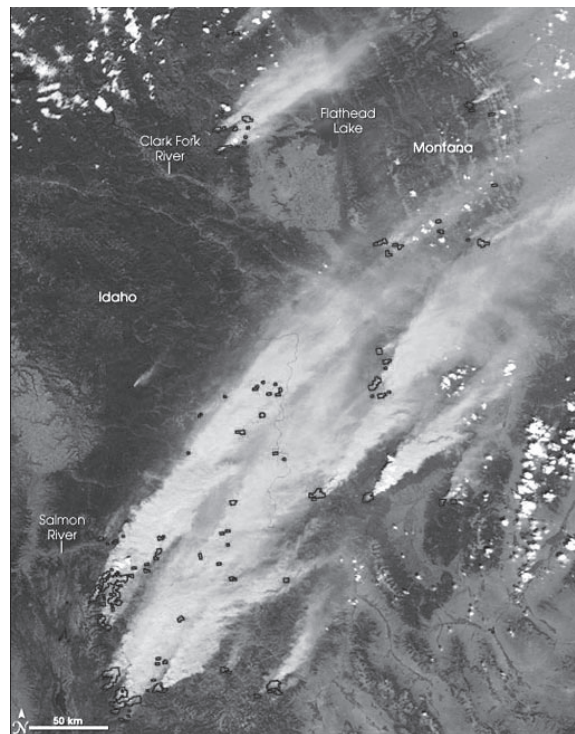

**Credit:** NASA/MODIS Rapid Response.

## NASA Helps Texas Respond to Most Widespread Flooding in 50 Years

Gretchen Cook-Anderson, NASA, Goddard Space Flight Center, Gretchen.R.Cook-Anderson@nasa.gov

On July 3, 2007, a NASA aircraft equipped with a state-of-the-art sensor provided emergency response officials with critical soil moisture data for several regions across Texas that were threatened by flooding. NASA responded to the heavy rains and flooding in Texas by redirecting a NASA research aircraft, the *P-3B*, to Texas after it completed an interagency project in Oklahoma.



The NASA *P-3B* supports Earth science investigations, and tests state-of-the-art instruments that may one day fly aboard satellites to observe Earth's systems. **Credit:** NASA

The aircraft had been flying a sensor developed by the University of Colorado at Boulder, NOAA, and U.S. Department of Agriculture that could provide detailed maps of ground surface water. At the request of researchers at the University of Colorado's Center for Environmental Technology, which built the sensor, NASA detoured the plane to Texas to help emergency response teams there better track the areas subject to flash flooding.

On June 13, a low-pressure weather system entered Texas from the Rocky Mountains and persisted until July 7, triggering storms across the state that flooded every major river basin. The state received more than three times the average rainfall for the period. Nearly two dozen people were killed in the flooding. At one point during the crisis, officials measured 19 inches of rainfall in just 24 hours. Eight inches of rain fell in one hour over Marble Falls, a town 70 miles west of Austin.

During the first week of July, Texas officials accepted an offer from the University of Colorado and NASA to fly the sensor over a large area. During the day-long mission, the Polarimetric Scanning Radiometer, an airborne remote-sensing system, enabled researchers to quickly create soil moisture maps identifying areas where additional rainfall could lead to flooding.

"During the floods, the instrument aboard NASA's *P-3B* aircraft flew over areas where the greatest rainfall had been forecast and informed us of the degree of

saturation of the soil in urban and rural locations at a time when we had no other means of making those judgments for such a broad area," said **Gordon Wells**, program manager at the Center for Space Research at the University of Texas, Austin. "The data enabled the state to stage Coast Guard and Department of Public Safety helicopters in those areas to stand by for search-and-rescue should it have been necessary."

"We're always concerned about when and where the next flooding conditions may occur, especially if it may affect major metropolitan areas like Austin or San Antonio, or a remote, hard-to-access rural area where only air evacuation may be possible," said Wells. Wells works with state officials regularly in search-and-rescue emergencies, overseeing field teams that must decide what resources to deploy—including several hundred boats and several aircraft—depending on the nature and extent of the crisis.

According to Wells, NASA's *P-3B* and the onboard sensor contributed to officials' full awareness of the flood situation, and became an extra tool they used to make decisions. "It's important to pre-plan how to prevent casualties and injuries. So the more we know and the sooner we know it, the more casualties can be avoided," said Wells.

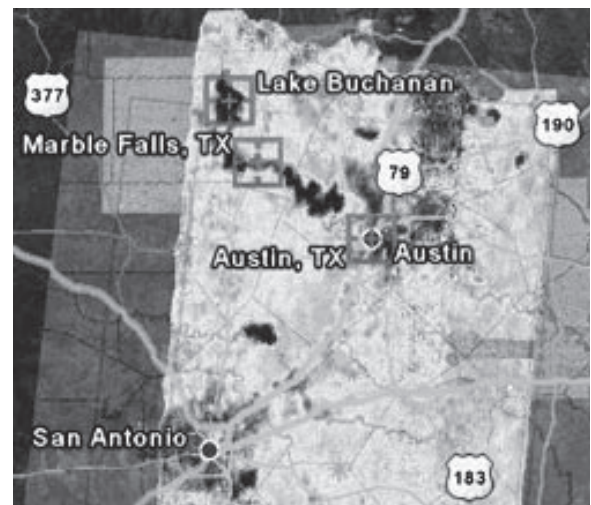

On July 3 NASA *P-3B* flew over flood-prone areas of Texas. The imagery was delivered to the Texas Office of Emergency Management for Flood Relief Planning within less than 24 hours time from observation. Soil saturation in flood-prone regions near San Antonio, south of Austin, and northwest of Corpus Christi are seen here as dark pixels. **Credit:** University of Colorado at Boulder

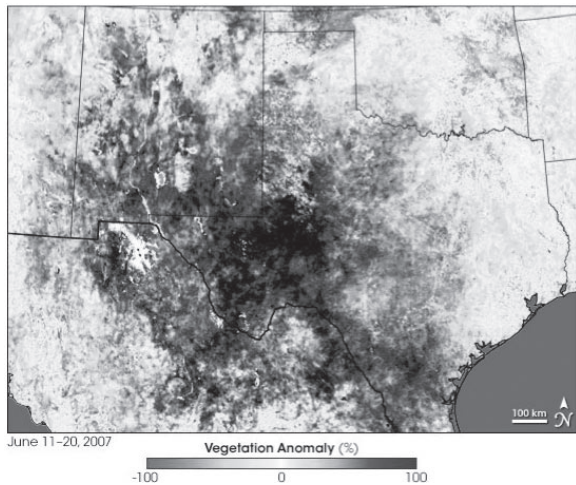

NASA created this image of areas of Texas where lush, green vegetation grew due to the same heavy rains that caused floods statewide. NASA collected data from the U.S. Department of Agriculture's Foreign Agricultural Service, captured by France's Satellite Pour l'Observation de la Terre (SPOT) satellite between June 11 and June 20, 2007. **Credit:** NASA

State officials typically would have relied on reports of flooding on roads and highways to help them predict the likelihood of future flooding in the affected areas, as well as imaging radar data to identify the location of pooled water and the level of reservoirs. "The first-cut

data product sent to Wells' team from the *P-3B* provided them with images of precise, geographically identifiable points of concern for flooding," said **Al Gasiewski**, Principal Investigator for the sensor at the University of Colorado and director of the school's Center for Environmental Technology. "Our team has worked with NASA over several years to develop airborne microwave mapping technology. We're pleased to see it used for humanitarian purposes."

"From the Sabine River near the eastern Texas-Louisiana border to the Nueces River in the southwest, the Red River to the north and the Colorado River that cuts across the state, heavy rains these last few weeks unleashed some of the worst flash flooding this state has seen. We're very pleased and grateful that NASA and the university offered to assist with a mission that very well may have helped save lives," said Wells.

"This was really a joint effort between NASA, the University of Colorado, and the University of Texas of which all of our organizations can be proud," said Gasiewski. "It was an important demonstration of new technology, close teamwork, rapid response, and inter-agency coordination. There are many positive lessons that can be learned from it." ■

The Moderate Resolution Imaging Spectroradiometer (MODIS) on NASA's Terra satellite acquired this photo-like image of Hurricane Humberto at 11:55 a.m. local time on September 12, 2007, several hours before the storm came ashore at the Texas-Louisiana state line. Humberto had the general shape of a hurricane, with spiral arms, cloud bands, and a distinct center. Humberto was only a minimal strength hurricane (category one on the Saffir-Simpson intensity scale) and will not go in the record books for its ferocity, but according to National Hurricane Center records, no storm has ever developed to hurricane strength so rapidly so close to landfall. Forecast discussions reported that the storm went from a tropical depression with wind speeds of 30 knots (about 55 kilometers/hour, or 35 miles/hour) at 10:00 a.m. U.S. Central Daylight Time on September 12 to a 75-knot hurricane (139 kilometers/hour, 86 miles/hour) at 4:00 a.m. on September 13. **Credit:** Earth Observatory, data provided courtesy of the MODIS Rapid Response team.

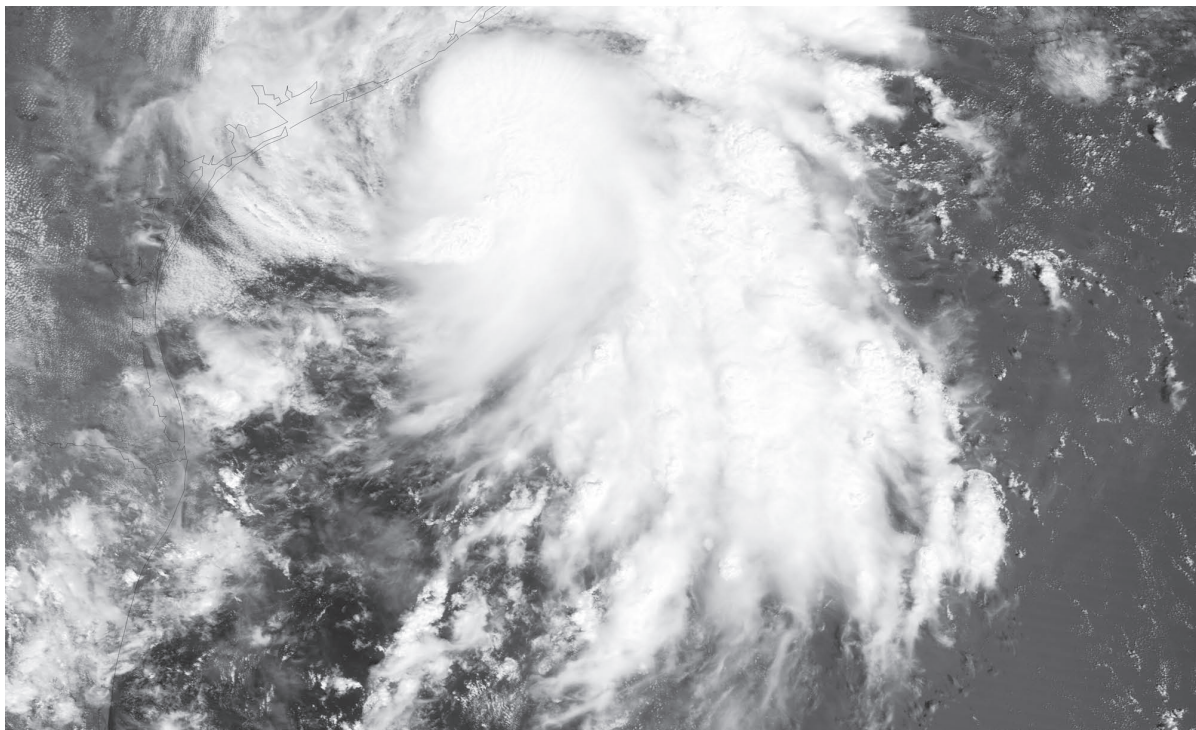

## Long-Term Increase in Rainfall Seen in Tropics

Stephen Cole, NASA Goddard Space Flight Center, [Stephen.E.Cole@nasa.gov](mailto:Stephen.E.Cole@nasa.gov)

NASA scientists have detected the first signs that tropical rainfall is on the rise with the longest and most complete data record available.

Using a 27-year-long global record of rainfall assembled by the international scientific community from satellite and ground-based instruments, the scientists found that the rainiest years in the tropics between 1979 and 2005 were mainly since 2001. The rainiest year was 2005, followed by 2004, 1998, 2003 and 2002, respectively.

“When we look at the whole planet over almost three decades, the total amount of rain falling has changed very little. But in the tropics, where nearly two-thirds of all rain falls, there has been an increase of 5%,” says lead author **Guojun Gu**, a research scientist at Goddard Space Flight Center. The rainfall increase was concentrated over tropical oceans, with a slight decline over land.

Climate scientists predict that a warming trend in Earth’s atmosphere and surface temperatures will produce an accelerated recycling of water between land,

sea, and air. Warmer temperatures increase the evaporation of water from the ocean and land and allow air to hold more moisture. Eventually, clouds form that produce rain and snow.

“A warming climate is the most plausible cause of this observed trend in tropical rainfall,” says co-author **Robert F. Adler**, senior scientist at Goddard’s Laboratory for Atmospheres. Adler and Gu are now working on a detailed study of the relationship between surface temperatures and rainfall patterns to further investigate the possible link. The study appears in the August 1, 2007, issue of the American Meteorological Society’s *Journal of Climate*.

Obtaining a global view of our planet’s rainfall patterns is a challenging work-in-progress. Only since the satellite era have regular estimates of rainfall over oceans been available to supplement the long-term but land-limited record from rain gauges. Just recently the many land- and space-based data have been merged into a single global record endorsed by the international scientific community: the Global Precipitation Climatology Project, sponsored by the World Climate

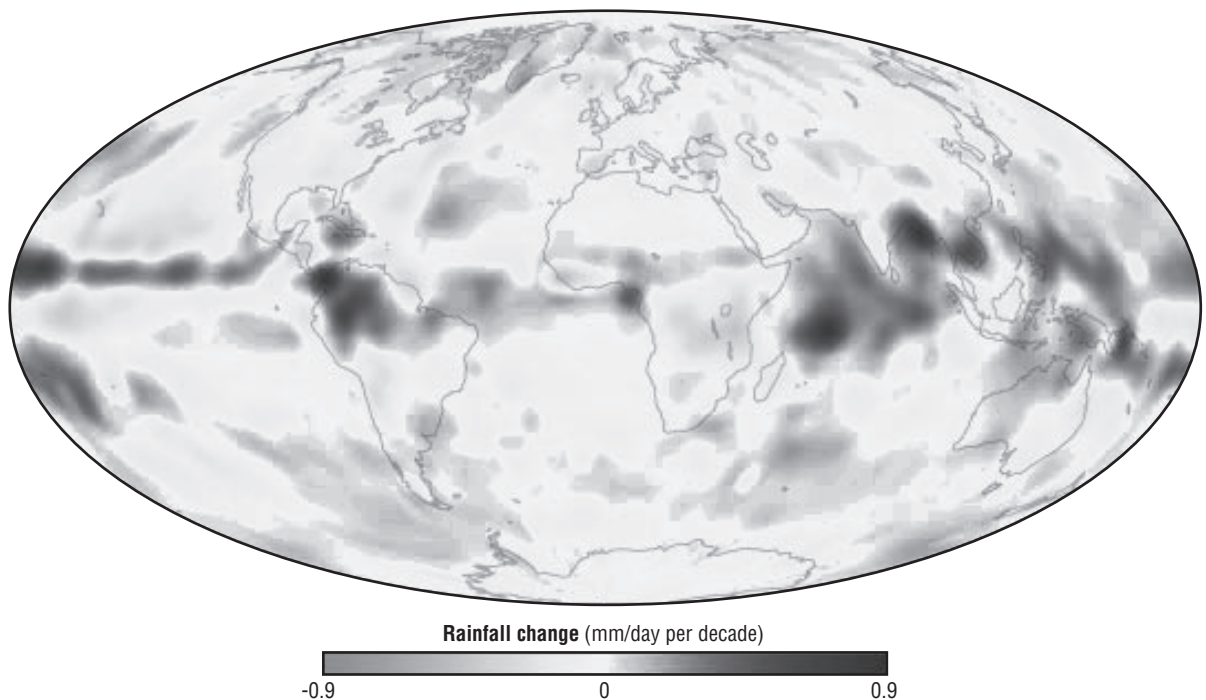

The map above shows patterns of rainfall change between 1979 and 2005. Tropical oceans experienced the greatest increases. In large areas of the Pacific and Indian Oceans, rainfall increased by more than half-a-millimeter per day each decade. Northern South America and Southeast Asia also experienced wetter weather. Most land areas, however, experienced decreasing rainfall amounts. This unevenness in rainfall changes is not unexpected. Many models predict that rising temperatures will make wet areas wetter and dry areas drier. Global average rainfall may increase, but the increase may come in fewer, but heavier storms. For color image please see: [earthobservatory.nasa.gov/Newsroom/NewImages/images.php3?img\\_id=17761](http://earthobservatory.nasa.gov/Newsroom/NewImages/images.php3?img_id=17761). **Credit:** NASA’s Earth Observatory, based on data from Guojun Gu, NASA GSFC.



The trend of increasing rainfall over the tropics was clearer once NASA scientists removed from the data record the effects on rainfall of major volcanic eruptions and El Niño. This figure shows how much each year's tropical rainfall differed from the long-term average rainfall over the entire 27-year period. **Credit:** Guojun Gu, NASA GSFC.

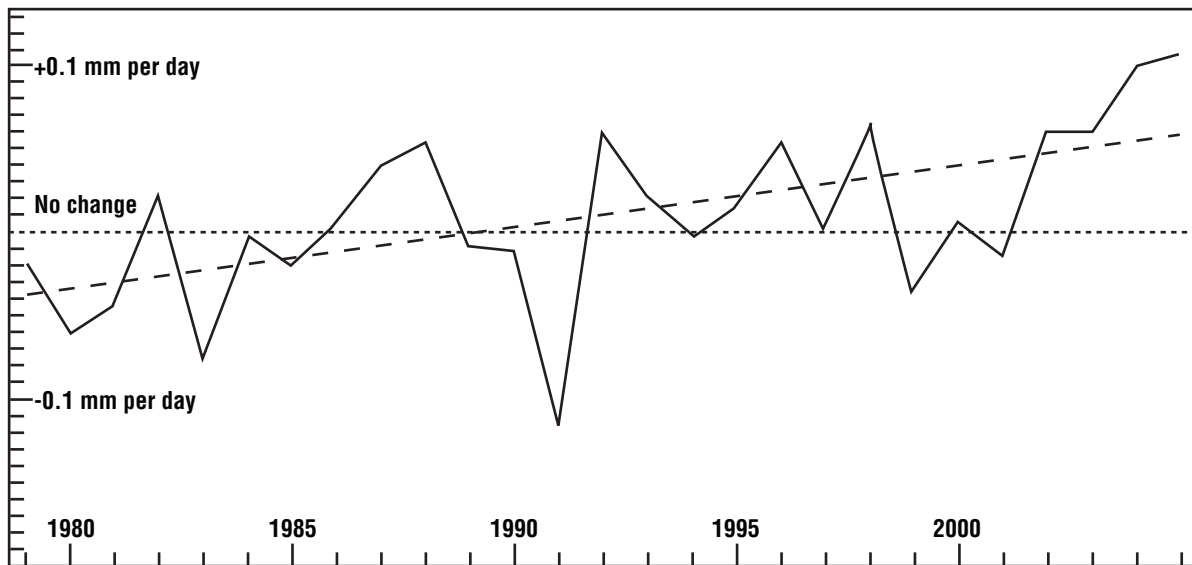

Research Program. Adler's research group at NASA produces the project's monthly rainfall updates, which are available to scientists worldwide.

Using this global record, Gu, Adler and their colleagues identified a small upward trend in overall tropical rainfall since 1979, but their confidence was not high that this was an actual long-term trend rather than natural year-to-year variability. So they took another look at the record and removed the effects of the two major natural phenomena that change rainfall: the El Niño–Southern Oscillation and large volcanic eruptions.

El Niño is a cyclical warming of the ocean waters in the central and eastern tropical Pacific that generally occurs every three to seven years and alters weather patterns worldwide. Volcanoes that loft debris into the upper troposphere and stratosphere create globe-circling bands of aerosol particles that slow the formation of precipitation by increasing the number of small cloud drops and temporarily shielding the planet from sunlight, which lowers surface temperatures and evaporation that fuels rainfall. Two such eruptions—El Chicon in Mexico and Mount Pinatubo in the Philippines—occurred during the 27-year period.

The scientists found that during El Niño years, total tropical rainfall did not change significantly but more rain fell over oceans than usual. The two major vol-

canoes both reduced overall tropical rainfall by about 5% during the two years following each eruption. With these effects removed from the rainfall record, the long-term trend appears more clearly in both the rainfall data over land and over the ocean.

According to Adler, evidence for the rainfall trend is holding as more data come in. The latest numbers for 2006 show another record-high year for tropical rainfall, tying 2005 as the rainiest year during the period.

“The next step toward firmly establishing this initial indication of a long-term tropical rainfall trend is to continue to lengthen and improve our data record,” says Adler, who is Project Scientist of the Tropical Rainfall Measuring Mission (TRMM), a joint mission between NASA and the Japan Aerospace Exploration Agency. The three primary instruments on TRMM are currently providing the most detailed view of rainfall ever provided from space. Adler's group has been incorporating TRMM rainfall data since 1997 into the global rainfall record.

NASA plans to extend TRMM's success of monitoring rainfall over the tropics to the entire globe with the Global Precipitation Measurement mission, scheduled for launch in 2013. This international project will provide measurements of both rain and snow around the world with instruments on a constellation of spacecraft flying in different orbits. ■

## ESIP Federation Elects New Leadership

*Carol Meyer, Foundation for Earth Science, carol.meyer@earthsciencefoundation.org*

### ESIP Federation Elects New Leadership

On July 20, 2007, the Federation of Earth Science Information Partners (ESIP) elected a new slate of officers during its annual meeting in Madison, WI. The new officers will serve one-year terms on the Federation's Executive Committee, finishing at the end of the Summer 2008 conference. Each will be involved in policy development and planning for the Federation. The offices marked with an asterisk in the list below also serve on the Board of Directors of the Foundation for Earth Science.

**Charles Hutchinson** [University of Arizona—*Office of Arid Lands Studies*] is serving his second year as President and will preside over the continued growth and diversification of the Federation. Hutchinson noted that, "The National Research Council's recently-issued report, *Earth Science and Applications from Space: National Imperatives for the Next Decade and Beyond* has presented the Federation with an opportunity to help showcase the many benefits of Earth observation. The broad community represented by the Federation is uniquely qualified to assist our NASA, National Oceanic and Atmospheric Agency (NOAA), and Environmental Protection Agency (EPA) partners in implementing the recommendations in the report within their individual agencies and internationally."

The ESIP Federation's leadership is diverse, with several new members being represented among the leadership. New officers:

- President\*, **Charles Hutchinson** [University of Arizona]
- Vice President\*, **Robert Raskin** [Jet Propulsion Laboratory (JPL)]
- Type I Representative\*, **Chris Lenhardt** [Columbia University—*Center for International Earth Science Network (CIESIN)*]
- Type II Representative\*, **Jami Montgomery** [University of Illinois, Urbana-Champaign—*WATER and Environmental Research Systems (WATERS) Network*]
- Type III Representative\*, **Kerry Handron** [Museums Teaching Planet Earth]

Committees:

- Chair of Constitution & Bylaws, **Sam Bacharach** [Open Geospatial Consortium]
- Chair of Finance & Appropriations\*, **Bruce Caron** [The New Media Studio]
- Chair of Partnership, **Thomas Yunck** [JPL]

- Commercial Development, **Stefan Falke** [Northrop Grumman]
- Chair of Education, **Tamara Ledley** [TERC, an education research and development organization]
- Chair of Information Technology and Interoperability, **Karl Benedict** [University of New Mexico]
- Chair of Products and Services, **Jeff Arnfield** [NOAA—*National Climatic Data Center*]

On July 23, 2007, the Federation elected three new partners for full membership. The following represent the newest class of ESIP Federation partners:

CHRONOS, **Cinzia Cervatos** [Iowa State University, Ames, IA]

Interdisciplinary Center for Research in Earth Science Technologies (ICREST), **Verne Kaupp** [University of Missouri, Columbia, MO—*Missouri Spatial Data Information Service*]

Thetus Corporation, **Danielle Forsyth** [Portland, OR]

"The ESIP Federation continues to attract interest from diverse groups including applied researchers, data centers, and commercial partners," says Hutchinson. "We are teaming up with new partners who are leaders in technology innovation, data management, and science research. Organizations come to the ESIP Federation because of its interagency breadth and the collaborative environment in which partners share knowledge to advance the Earth science field."

The Federation now numbers 106 partners representing a wide range of Earth science data interests. Federation partners include science data centers, environmental research groups, innovators in the application of environmental data, educators, and technologists. Across these diverse interests, public, private, and non-profit organizations are represented.

The Federation is a consortium of Earth science data centers, researchers, scientists, technologists, educators, and applications developers. The Federation promotes increased accessibility, interoperability, and usability for Earth science data and derivative products. Initiated by NASA in 1997, the Federation provides data, products, and services to decision makers and researchers in public and private settings. The Foundation for Earth Science provides administrative and staff support to the Federation of Earth Science Information Partners. ■

## AIRS Collection 5 Data Now Available

The AIRS Project and Goddard Earth Sciences Data and Information Service Center (GES DISC) are pleased to announce the release of *Collection 5* of the AIRS Data Products.

*Collection 5*, derived from the AIRS Project's latest software release, *Version 5*, contains many additions and refinements when compared to AIRS *Collection 3 (Version 4)* data products. These include enhanced Level-2 temperature data products over land and polar regions, first-time retrievals of carbon monoxide and methane, improvements to ozone retrievals, and improved error and quality flag parameterization overall.

A summary of *Collection 5* improvements is available at:

[disc.sci.gsfc.nasa.gov/AIRS/documentation/notices/Notice.v5release.shtml#v005whatsnew](http://disc.sci.gsfc.nasa.gov/AIRS/documentation/notices/Notice.v5release.shtml#v005whatsnew)

### Collection 5 Data Processing

The GES DISC is already actively processing the AIRS forward stream for *Collection 5*. In addition, all the Level-1 AIRS products have been reprocessed, and reprocessing of higher level products (Levels-2 and -3) is well under way.

AIRS *Collection 5* data is available through:

Data Product  
[disc.gsfc.nasa.gov/AIRS/data\\_products.shtml](http://disc.gsfc.nasa.gov/AIRS/data_products.shtml)

Data Access  
[disc.gsfc.nasa.gov/AIRS/data\\_access.shtml](http://disc.gsfc.nasa.gov/AIRS/data_access.shtml)

### Collection 3 Data Processing

The GES DISC will continue producing the AIRS *Collection 3 (Version 4)* products through August 31, 2007, completing five-years of AIRS data in *Collection 3*. After this date, only the *Collection 5* will continue to be produced. All AIRS *Collection 3* products will continue to be orderable from the GES DISC through October 31, 2007. After that date, *Collection 3* Level-1B data products will no longer be available. AIRS Level-2 and Level-3 data products from *Collection 3* will continue to be available beyond this date.

If you have any questions please contact the GES DISC user services:

GES DISC Help Desk  
Code 610.2  
NASA Goddard Space Flight Center  
Greenbelt, MD 20771  
[help-disc@listserv.gsfc.nasa.gov](mailto:help-disc@listserv.gsfc.nasa.gov)

### Register as an AIRS Data User

By registering at [airs.jpl.nasa.gov/DataRegistration/data/index.cfm](http://airs.jpl.nasa.gov/DataRegistration/data/index.cfm) as an AIRS Data User, you will receive announcements of discovered data product features and caveats which are directly applicable to your area of research. You will also receive the AIRS newsletters.

### Got a Question, Ask AIRS

Got a question for which there is no ready answer in the documentation? Post it at [airs.jpl.nasa.gov/AskAirs](http://airs.jpl.nasa.gov/AskAirs) and the AIRS Project will endeavor to provide the answer.

**Congratulations to the entire AIRS Team!**

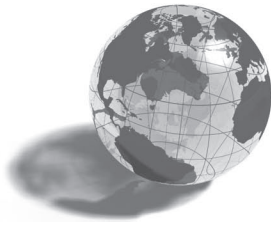

## EOS Scientists in the News

*Stephen Cole, NASA Earth Science News Team, Stephen.E.Cole@nasa.gov*

*Kathryn Hansen, NASA Earth Science News Team, khansen@sesda2.com*

**Study Predicts More Severe U.S. Storms**, August 30; *Associated Press*. As the world warms, the United States will face more severe thunderstorms with deadly lightning, damaging hail, and the potential for tornadoes, say researchers, including **Tony Del Genio** (NASA GISS).

**As Predicted, Global Warming Fuels More Tropical Rainfall**, August 28; *United Press International, LiveScience*. Scientists had predicted that global warming ought to increase rainfall in the tropics, and now a 27-year global record of rainfall from satellite observations and ground-based instruments compiled by **Guojun Gu** and **Robert Adler** (NASA GSFC), demonstrates that increase\*.

**“Brown Clouds” Contribute to Himalaya Glacier Melt**, August 1; *National Geographic News*. Soot-filled “brown clouds” over the Indian subcontinent warm the lower atmosphere just as much as greenhouse gases do, say researchers, including **David Winker** (NASA Langley).

**Scientists Examine African Dust Link to Hurricanes**, August 9; *Reuters*. Scientists are taking a closer look at whether giant dust clouds from the Sahara act as a leading indicator of the ferocity of Atlantic hurricane seasons, as preliminary research shows a correlation between sandy plumes and tropical cyclones, says **William Lau** (NASA GSFC).

**Temps Hit Triple Digits in Parts of Southland**, August 14; *Los Angeles Times*. **Bill Patzert** (NASA JPL) says that despite the mid-August heat wave in Southern California, the region remains a rare cool spot in a summer of extreme heat elsewhere in the nation.

**Night Shining Clouds No Longer Just Near Poles**, July; *Earth & Sky Radio*. Night shining clouds, also known as noctilucent clouds, are being seen more frequently and at lower latitudes than ever before—an indication of a changing Earth, according to **James Russell** (Hampton University) who leads NASA’s AIM mission.

**Ancient Lake Discovered Beneath Darfur**, July; *Earth & Sky Radio*. **Farouk El-Baz**, Director of the Center for Remote Sensing at Boston University, dis-

covered a lake the size of Massachusetts below Darfur using Landsat satellite data combined with radar images and topographic data of the region.

**Extreme Summer Warming Possible by 2080**, July; *Earth & Sky Radio*. A new study found that by the 2080s, summertime temperatures in cities such as Chicago and Atlanta could hover above 100° Fahrenheit, especially if the frequency of rainfall is below average, says **Barry Lynn** (NASA GISS).

**NASA Scientists Can Warn of Famine**, July 23; *United Press International*. **Molly Brown** (NASA GSFC) and colleagues have developed a computer model that can predict food shortages caused by droughts.

**Looking for Heat? Go East**, July 18; *Los Angeles Times*. In a front page story, **Bill Patzert** (NASA JPL) discusses the reasoning behind the discrepancy in temperatures between coastal and inland regions of California.

**Global Warming: How Do Scientists Know They’re Not Wrong?** July 16; *LiveScience*. In a discussion about how scientists can be sure about the cause of global warming, **Gavin Schmidt** (NASA GISS) notes that predictions by those who doubted global warming have failed to come true.

**The Temperature’s Climbing**, July 5; *ABC World News with Charles Gibson*. **Bill Patzert** (NASA JPL) was interviewed by reporter Miguel Marquez in a national segment discussing the heat wave and the cities that set record high temperatures.

*Interested in getting your research out to the general public, educators, and the scientific community? Please contact Steve Cole on NASA’s Earth Science News Team at [scole@pop600.gsfc.nasa.gov](mailto:scole@pop600.gsfc.nasa.gov) and let him know of your upcoming journal articles, new satellite images or conference presentations that you think the average person would be interested in learning about.*

\*For more details on this topic see full “In the News” story in this issue. ■

Hurricane Dean was the fourth named storm and the first hurricane of the 2007 Atlantic season. It was also one of the strongest hurricanes ever observed in the Atlantic Basin. Dean reached *Category Five* status on August 20 as it passed over the deep, warm waters of the Caribbean headed for the Yucatan Peninsula. When it came ashore on August 21, it was the first storm to make landfall as a *Category Five* hurricane in the Atlantic basin since Hurricane Andrew in 1992, said the National Hurricane Center.

This image of Hurricane Dean arriving at the Yucatan is a combination of observations from NASA and National Oceanic and Atmospheric Administration (NOAA) satellites. The clouds, including Hurricane Dean, were observed by NOAA's Geostationary Operational Environmental Satellite (GOES-12) at 2:45 p.m. local time in Belize (on the Yucatan Peninsula) on August 20. The land surface is a summertime image from the NASA Blue Marble image collection. Hurricane Dean filled the western Caribbean, and the outermost bands of spiraling clouds were already brushing the coasts of the Yucatan in the west and Cuba in the north.

**Credit:** NASA's Earth Observatory

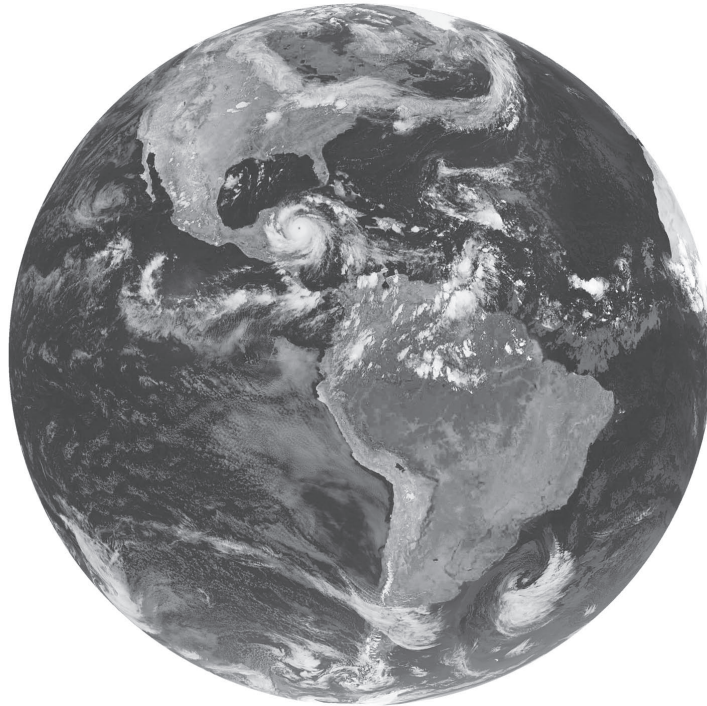

## Public Release of CloudSat Data Products

The CloudSat Data Processing Center (DPC) has released the reprocessed (R04) version of the Level 1B, 2B-GEOPROF and the 2B-GEOPROF-Lidar products. These products are now available to the General Science Community via the CloudSat Data ordering system.

The reprocessed 2B-GEOPROF products were generated using the new Level 1B algorithm that has an improved clutter removal scheme for the detection of low cloud over oceans.

In addition, the DPC has also released, to the General Science Community, the R04 2B-CLDCLASS product, and the R04 ECMWF-AUX and MODIS-AUX products.

Watch the DPC website for news and current status of subsequent R04 product releases. We anticipate the release, to the CloudSat Science Team of the R04 2B-CWC-RO and 2B-FLXHR products by the end of September, with releases to the general science community shortly thereafter.

Watch the DPC website for news and current status of other R04 product releases.

All data users are asked to review the updated documentation. In addition, please visit the "Known Issues" page of the DPC website and familiarize yourself with these issues before using the results in publications or presentations. This page is located at [www.cloudsat.cira.colostate.edu/dataIssues.php](http://www.cloudsat.cira.colostate.edu/dataIssues.php).

In addition, we ask that you report any anomalies or questions to the DPC at: [cloudsat@cira.colostate.edu](mailto:cloudsat@cira.colostate.edu)

The on-line product specifications for these updated products are located at: [www.cloudsat.cira.colostate.edu/dataSpecs.php](http://www.cloudsat.cira.colostate.edu/dataSpecs.php)

To access the released data, use the DPC data ordering system interface found at: [cloudsat.cira.colostate.edu/data\\_dist/OrderData.php](http://cloudsat.cira.colostate.edu/data_dist/OrderData.php). This site requires a username and password.

If you have any questions concerning the ordering process, contact the DPC at: [cloudsat@cira.colostate.edu](mailto:cloudsat@cira.colostate.edu)

## NASA Science Mission Directorate – Science Education Update

Ming-Ying Wei, NASA Headquarters, [mwei@hq.nasa.gov](mailto:mwei@hq.nasa.gov)

Liz Burck, NASA Headquarters, [Liz.B.Burck@nasa.gov](mailto:Liz.B.Burck@nasa.gov)

Theresa Schwerin, Institute of Global Environment and Society (IGES), [theresa\\_schwerin@strategies.org](mailto:theresa_schwerin@strategies.org)

### NASA EXPLORER SCHOOLS APPLICATIONS NOW AVAILABLE

*Applications due: Jan. 31, 2008*

Applications are now available for educators interested in joining the *NASA Explorer Schools* (NES) program during the 2008-2009 school year. Schools from the 50 states, the District of Columbia, Puerto Rico, and the Virgin Islands may apply for the NES 2008-2009 school year. Teams composed of full-time teachers and a school administrator develop and implement a three-year action plan to address local challenges in science, technology and mathematics education for grades 4-9. Schools that are selected are eligible to receive funding during the three-year partnership to purchase technology tools. For more information, visit [explorerschools.nasa.gov/portall/site/nes/menuitem.3a9dc5f6e0302a448258f708c41a5ea0/](http://explorerschools.nasa.gov/portall/site/nes/menuitem.3a9dc5f6e0302a448258f708c41a5ea0/)

### NEW UNIT LESSON PLAN FROM MY NASA DATA

Another Unit Lesson has been added to the Teacher Plans collection: *Lesson #49* “Using Atmospheric Data Sets in the Classroom: Investigating Ozone, Aerosols, and Clouds” by Diana Soehl, [mynasadata.larc.nasa.gov/unit\\_lessons.html](http://mynasadata.larc.nasa.gov/unit_lessons.html). Each Unit Plan on MY NASA DATA provides an implementation guide including at least three lessons, related activities, and resources. The Unit Plans provide students a more in depth opportunity for learning to access and use authentic satellite data. MY NASA DATA is an effort to develop microsets of Earth science data that are interesting and useful to the K-12 and citizen scientist communities.

### EARTH OBSERVATORY: Global Warming-Questions and Answers

[earthobservatory.nasa.gov/Study/GlobalWarmingQandA/](http://earthobservatory.nasa.gov/Study/GlobalWarmingQandA/)

From why global warming is a problem to whether increased solar activity could be behind it, this Q&A article includes responses to common questions about global warming.

### NASA SPONSORS 2008 ODYSSEY OF THE MIND PROBLEM

For the past seven years NASA has sponsored an *Odyssey of the Mind* long-term problem, reaching an estimated 2.5 million students, teachers, parents, and coaches.

The 2007 NASA problem was the most popular student choice, selected by about 40% of participating teams. To read a story about the 2007 *Odyssey of the Mind* World Finals, go to: [www.nasa.gov/audience/foreducators/9-12/features/F\\_Around\\_the\\_World\\_Odyssey.html](http://www.nasa.gov/audience/foreducators/9-12/features/F_Around_the_World_Odyssey.html).

In 2008, NASA will sponsor Problem 5: *The Eccentrics!* The performance will include a team-created *problem* within or involving an Earth system—the atmosphere, biosphere, cryosphere, geosphere, or hydrosphere. The Eccentric Characters, which seem to be misfits, will solve the problem. As a reward, a celebration is held in their honor and they end up launching a new fad. For more information, go to: [www.odysseyofthemind.com/materials/2008problems.php](http://www.odysseyofthemind.com/materials/2008problems.php).

### WEB PAGE, VIDEO GIVES EDUCATORS AN IN-DEPTH LOOK AT HURRICANES

Educators will have the opportunity to bring a hurricane expert into their classroom with the release of a new NASA Web page and video. For more information, please read the news story on page 44 of this issue and visit: [earthobservatory.nasa.gov/Newsroom/NasaNews/2007/2007081425515.html](http://earthobservatory.nasa.gov/Newsroom/NasaNews/2007/2007081425515.html).

### NASA EARTH EXPLORERS SERIES: THE CHILLS AND THRILLS OF ICE

Few people know cold and ice like NASA scientist **Robert Bindschadler** does. In more than a dozen research trips to Antarctica, he has slept in tents through blizzards and bitter cold, and avoided falling into hidden cracks in ice. What's more, he enjoys it. Read more about Bindschadler and his exploration of ice in the latest Earth Explorers Series article at [science.hq.nasa.gov/education/earth\\_explorers/](http://science.hq.nasa.gov/education/earth_explorers/).

Anyone can be a scientist, no matter the challenges that may stand in the way. That's the message NASA communicates through its Earth Explorers and Space Science Explorers series, both of which appear on the NASA web site. In an effort to show that a science career is a worthy and attainable goal, both series profile real-life scientists, young and old, with a variety of backgrounds and interests. Most articles are presented in three different versions according to reading level—one for grades 9-12 and up, one for grades 5-8, and one for grades K-4. ■

## EOS Science Calendar

2007

### October 22-25

A-Train Lille Symposium 2007, Lille Grand-Palais, France. URL: [www.a-train-lille2007.org](http://www.a-train-lille2007.org)

### November 6-8

HDF & HDF-EOS Workshop XI, "Connections: Bringing together data users, providers, developers and stewards," Landover, MD. Contact: [Daniel.J.Marinelli@nasa.gov](mailto:Daniel.J.Marinelli@nasa.gov)

### November 12-16

CERES-II Science Team Meeting, Victoria, British Columbia, Canada. Contact: [Shashi.K.Gupta@nasa.gov](mailto:Shashi.K.Gupta@nasa.gov)

2008

### January 8-10

Landsat Science Team Meeting, USGS EROS Data Center, Sioux Falls, SD. Contact: [Thomas.Loveland@usgs.gov](mailto:Thomas.Loveland@usgs.gov)

### February 5-7

SORCE Science Team Meeting, "SORCE's Past, Present, and Future Role in Earth Science Research," Santa Fe, NM. URL: [lasp.colorado.edu/sorce/news/2008ScienceMeeting/](http://lasp.colorado.edu/sorce/news/2008ScienceMeeting/)

### October 17-19

First International Conference on Networks for Grid Applications, Lyon, France. URL: [www.gridnets.org/2007](http://www.gridnets.org/2007)

### October 28-30

First International Conference on Autonomic Computing and Communication Systems, Rome, Italy. URL: [www.autonomics-conference.eu/](http://www.autonomics-conference.eu/)

### December 3-12

The Second International Joint Conferences on Computer, Information, and Systems Sciences, and Engineering. Will be held on-line. URL: [www.cisse2007online.org/](http://www.cisse2007online.org/)

### December 10-14

American Geophysical Union (AGU) Fall Meeting, San Francisco. URL: [www.agu.org/meetings/fm07/](http://www.agu.org/meetings/fm07/)

2008

### January 20-24

American Meteorological Society (AMS) Annual Meeting, New Orleans, LA. URL: [www.ametsoc.org/meet/annual/index.html](http://www.ametsoc.org/meet/annual/index.html)

### March 11-13

Oceanology International Global Ocean Forum, London. URL: [www.oceanologyinternational.com](http://www.oceanologyinternational.com)

## Global Change Calendar

2007

### October 17-November 3

UNESCO 34th session of the General Conference, *Planet Earth: from Space to Place*, Paris, France, UNESCO Headquarters. Contact: [a.candau@unesco.org](mailto:a.candau@unesco.org)



Data retrieved by the Atmospheric Infrared Sounder (AIRS) revealed the carbon monoxide signature that emanated from extensive fires in Greece. From August 24 – 28, 2007, a significant plume moved southeast across the Mediterranean Sea and over North Africa, arcing westward over the Sahara Desert, and around toward Sardinia and Corsica. To view a full color visualization go to: [www-air.s.jpl.nasa.gov//index.cfm?fuseaction=ShowNews\\_DynamicContent&NewsID=17](http://www-air.s.jpl.nasa.gov//index.cfm?fuseaction=ShowNews_DynamicContent&NewsID=17). **Credit:** NASA/Goddard Space Flight Center Scientific Visualization Studio.



Code 610  
National Aeronautics and Space Administration

**Goddard Space Flight Center**  
Greenbelt, MD 20771

PRSR STD  
Postage and Fees Paid  
National Aeronautics and Space Administration  
Permit 396

Official Business  
Penalty for Private Use: \$300

(affix mailing label here)

[eos.nasa.gov](http://eos.nasa.gov)

### **The Earth Observer**

*The Earth Observer* is published by the EOS Project Science Office, Code 610, NASA Goddard Space Flight Center, Greenbelt, Maryland 20771, telephone (301) 614-5561, FAX (301) 614-6530, and is available on the World Wide Web at [eospsoc.gsfc.nasa.gov/eos\\_observ/pdf/](http://eospsoc.gsfc.nasa.gov/eos_observ/pdf/) or by writing to the above address. Articles, contributions to the meeting calendar, and suggestions are welcomed. Contributions to the calendars should contain location, person to contact, telephone number, and e-mail address. To subscribe to *The Earth Observer*, or to change your mailing address, please call Steve Graham at (301) 614-5561, or send a message to [steven.m.graham.2@gsfc.nasa.gov](mailto:steven.m.graham.2@gsfc.nasa.gov), or write to the address above.

### **The Earth Observer Staff**

Executive Editor: Alan Ward ([award@sesda2.com](mailto:award@sesda2.com))

Technical Editors: Tim Suttles ([tsuttles@bellsouth.net](mailto:tsuttles@bellsouth.net))  
Charlotte Griner ([clgriner@earthlink.net](mailto:clgriner@earthlink.net))  
Chris Chrissotimos ([cchrissotimos@sesda2.com](mailto:cchrissotimos@sesda2.com))

Design, Production: Deborah McLean ([Deborah.FMcLean@nasa.gov](mailto:Deborah.FMcLean@nasa.gov))



Printed on Recycled Paper