

# Preface

*“Terrorists can try to kill the innocent, but they cannot kill the desire for liberty that burns in the hearts of millions across the earth. The power of freedom defeated the ideologies of fascism and communism in the last century, and freedom will defeat the hateful ideologies of the terrorists in this century.”*

*President George W. Bush  
May 23, 2007*

It’s a movie cliché: the hero disarms the bomb at the last second, saving the city, averting the crisis, and embracing the love interest as the credits roll.

But the credits never roll in real life. The successes unheralded, the heroes just go quietly back to work. And the terrorists don’t wait two years for the sequel. Attacks, both successful and failed, are posted on the internet and analyzed. The attack that failed today may have provided key information about force protection techniques that can be used in next week’s effort on a different continent.

Twenty-five years ago, the Technical Support Working Group (TSWG) was born out of three key principles. First was the idea that many agencies had similar requirements for combating terrorism, thus allowing the pooling of resources. Second was the focus on near-term requirements; emphasizing a quick turnaround to allow an overburdened acquisition system to move closer to the speed of its opponents. And the final key was to go to the hero and ask for help.

*I’ve been very impressed by the soldiers — American soldiers that I’ve met and talked to. This morning I had an excellent briefing on the effort that we’re making against the IEDs.*

*Secretary of Defense Robert Gates  
December 22, 2006*

This final key principle makes TSWG rare. Numerous organizations claim multiple agencies as “stakeholders”, and it is rare that an agency does not have an arm specifically designed for high-priority acquisitions. But even as the Combating Terrorism Technology Support Office (CTTSO) grew to encompass TSWG, Explosives Ordnance Disposal/Low-Intensity Conflict & Interdependent Capabilities (EOD/LIC & IC), and the Irregular Warfare Support (IWS) program, the focus has always been on the user – the technician who disarms bombs for a living, the crime lab researcher using forensic evidence to break a case, the Special Forces warrior who is hunting al Qaeda, and the law-enforcement officer or first

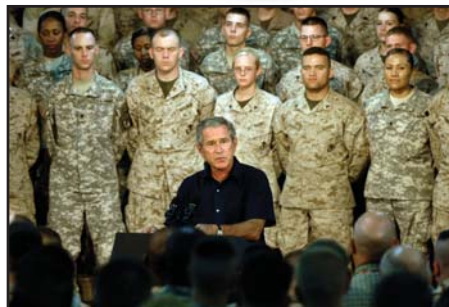

Defense Dept. photo by Cherie A. Thurby

***“...we must provide our troops with the help and support they need to get the job done.”***

***George W. Bush  
Oct. 22, 2007***



U.S. Air Force photo by Airman 1st Class Jonathan Steffen (Released)

# Preface



DoD photo by Airman 1st Class Kathrine McDowell,  
U.S. Air Force (Released)

*“The question I’m going to ask is, do our professionals have the tools necessary to do the job to protect the American people from further attack?”*

*George W. Bush  
Sept. 19, 2007*



Defense Dept. photo by U.S. Air Force Staff Sgt. D. Myles Cullen

responder seeking to address an event that is occurring or just occurred. CTTSO brings together these people and asks them what works and what does not. What they need, when compiled with responses from their peers in other agencies, becomes the priority list for the next year.

You will find in the following pages that this process works. Firefighters worked to assess the **Next-Generation Fire Fighter Protective Ensemble** (p. 21), which provides protection against fires as well as against chemical, biological, radiological, and nuclear threats. Police officers helped to develop the **Digital Automotive Image System** (p. 42), which now provides a means of quickly searching data to reveal pictures of vehicles related to a terrorist investigation. Those tasked with protecting VIPs are helping to develop the **Field-Installable Inconspicuous Vehicle Armor Kit** (p. 67), which provides security while not advertising that a protectee is traveling in an armored vehicle.

And TSWG has not marched in place over the years. Concern over the quality of training and the desire to ensure that valuable equipment was not ignored due to questions over its effective use led to the development of the **Training Technology Development** subgroup (p. 57). This subgroup has worked with users to develop quick-reference guides on subjects such as the **Adaptive Simulation Agents for Adversarial Behaviors** (p. 61) and the **IED Awareness for First Responders Training Support Package** (p. 59).

But these are only a handful of visible success stories; the easy ones to discuss since they involve a specific product. More difficult to document is the value of placing people from a variety of different agencies, all of whom focus on one part of the fight against terrorism, in the same room. Tactics get discussed, as do future threats. The usual bureaucratic stereotype, of offices trying to grab “turf”, dies as officials from local government meet with branches of the Federal Government and international partners with the goal of providing everyone with better ways to respond to terrorist threats – whether by defending against an attack, picking up evidence after a thwarted one, or bringing the fight to crush the network. As one example, TSWG has repeatedly assisted the FBI in conducting **Critical Incident Response Technology Seminars** (p. 74) to allow for the better exchange of key information and tactics, techniques, and procedures between improvised device defeat professionals.

*The world recognized that these attacks were vicious and unfounded crimes against humanity itself. The attackers’ reign of terror knows no boundaries, neither of territory nor of morality. This battle is not directed at one country or at one religion or at one race, but against us all. Indeed, over the past five years we have seen horrific scenes of people being killed, innocent people, in places like Spain*

# Preface

*and Great Britain and Egypt and Indonesia and Turkey and Iraq and in Russia. The attacks only reinforce the clear lesson of September 11th: The fight against terrorism is global and in order to prevail together, we must unite together and we must fight together.*

*Secretary of State Condoleezza Rice  
September 11, 2006*

CTTSO is also in its second decade of international cooperation. What works domestically – bringing people together from different agencies to determine requirements – similarly has expanded into an international arena. CTTSO staff meet with Australians, Brits, Canadians, Israelis, and Singaporeans – for what can work north of the border, in the Middle East, in Europe, and Asia-Pacific can work in New York and Omaha. Such cooperation leads to reduced costs and improved capability for all freedom-loving countries.

The credits never roll, but the terrorists are doing their best to make sure that the next scene is more to their liking. There are many ways to make sure that the terrorists do not succeed. CTTSO is leading the way by ensuring that U.S. counterterrorist efforts are backed up by the best that the U.S. and foreign partner technologies have to offer.

*The enemies of America – the enemies of our values and our liberty – will never again rest easy, for we will hunt them down relentlessly and without reservation.*

*Secretary of Defense Robert Gates  
September 11, 2006*



U.S. Navy photo by Petty Officer 1st Class Brandon W. Schulze





# Table of Contents

<b>The Combating Terrorism Technology Support Office</b>	
Overview and Organization.....	4
International Program.....	5
<b>The Technical Support Working Group</b>	
History and Mission .....	8
Organization and Structure.....	8
Program Funding.....	10
<b>The Technical Support Working Group Subgroups</b>	
Blast Effects and Mitigation.....	13
Chemical, Biological, Radiological, and Nuclear Countermeasures.....	19
Concept Development .....	27
Explosives Detection.....	29
Improvised Device Defeat.....	33
Investigative Support and Forensics.....	39
Physical Security .....	45
Surveillance, Collection, and Operations Support .....	51
Tactical Operations Support .....	53
Training Technology Development .....	57
Very Important Person Protection .....	63
<b>The Explosive Ordnance Disposal/Low-Intensity Conflict &amp; Interdependent Capabilities Program</b>	
Organization and Funding .....	70
Focus Areas .....	71
Selected Completed Projects .....	72
Selected Current Projects .....	72
<b>The Irregular Warfare Support Program</b>	
Mission and Focus Areas.....	78
<b>CTTSO Product Development and Delivery</b>	
Featured Project Updates.....	80
Technology Transition.....	83
2007 Meetings and Conferences .....	84
BAA Information Delivery System.....	85
CTTSO Portal Web Site .....	87
<b>Appendix</b>	
2007 Membership.....	90
TSWG 2007 Membership by Subgroup.....	94
2007 Performers .....	103
Glossary of Acronyms .....	113





*Combating Terrorism  
Technology Support Office*





# Combating Terrorism Technology Support Office

## Overview

*“Identify meaningful combating terrorism needs and satisfy them better than anyone else.”*

The Combating Terrorism Technology Support Office (CTTSO) has used the above guidance to craft programs that are constantly adjusting to fill the needs presented by its customers. Following the example set by expeditionary combat units as the first elements to enter unknown territory and then displacing when the larger force is in place, CTTSO provides rapid capabilities while the larger research and development (R&D) community is mobilizing. When other organizations set up the infrastructure to provide long-term programs of record, CTTSO recalibrates to provide solutions to rapidly evolving requirements in new areas of the Global War on Terror (GWOt) that would otherwise go unmet.

As a program office under the Assistant Secretary of Defense (ASD) for Special Operations and Low-Intensity Conflict & Interdependent Capabilities (SO/LIC & IC), CTTSO is uniquely positioned to contribute to the success of the GWOt. With overall supervision of the Special Operations and Low-Intensity Conflict & Interdependent

## CTTSO Organization

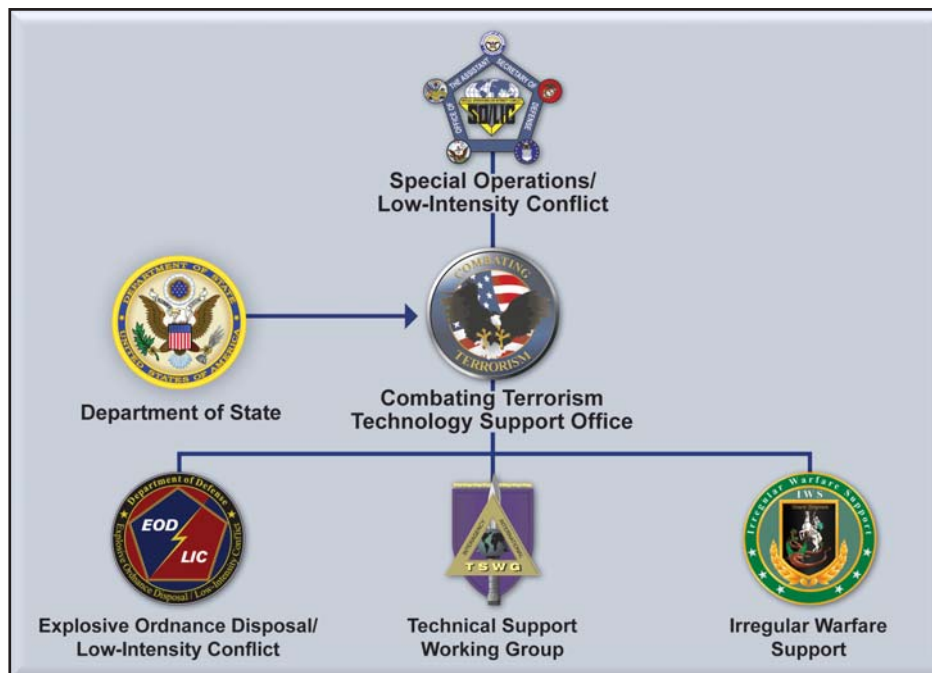



Capabilities activities of DoD, including oversight of policy and resources, the ASD acts as the principal civilian advisor to the Secretary of Defense on SO/LIC & IC matters. This allows CTTSO to take operational requirements from warfighters, incorporate policy objectives that flow down from the Department, and marshal technical expertise resident in its program managers, subject matter experts, and developers to provide capabilities that are fieldable and sustainable over the “Long War.” This fortuitous balance of political direction, operational relevance, and technical expertise has enabled CTTSO to respond with agility and speed to changing requirements.

In 1999, CTTSO was assigned program management functions for the Technical Support Working Group (TSWG), the organization named by the *Wall Street Journal* as “...the nation’s talent scouts for antiterrorism” technologies. More recently, CTTSO’s responsibilities have grown to include the Explosive Ordnance Disposal/Low-Intensity Conflict & Interdependent Capabilities (EOD/LIC & IC) program and Irregular Warfare Support (IWS) program. Numbering close to 100 dedicated managers, subject matter experts, and direct support personnel and over 400 active projects, CTTSO is positioned to sustain the success it has realized over the past seven years far into the future.

## ***CTTSO’s International Program***

Terrorism is a worldwide problem. Al Qaeda and its subsidiary organizations have been associated with plots in countries ranging from Indonesia to Germany to Algeria to Canada. Fighting this scourge is a multi-pronged effort, ranging from the sharing of intelligence to cooperative operations to collaborative development. CTTSO specifically works with other countries to cooperatively share requirements and develop capabilities to leverage US taxpayer dollars into projects that work better and are developed faster.

In 1993, the U.S. Congress – recognizing the international nature of the terrorist threat – authorized TSWG, to cooperate internationally in research and development to combat terrorism. Cooperative agreements were subsequently concluded with Israel, Canada, and the United Kingdom. In 2006, agreements were likewise signed with Australia and Singapore. Such international cooperation allows CTTSO to leverage foreign experience, expertise, and resources in the fight against terrorists and their infrastructure.

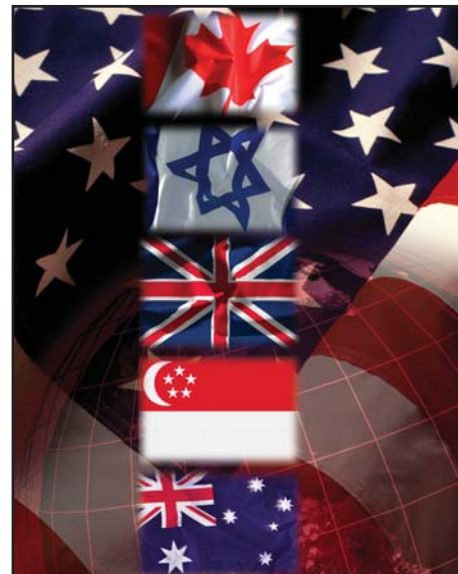

*Technical Support Working Group*



*Technical Support  
Working Group*





## Technical Support Working Group

### History and Mission

In April 1982, National Security Decision Directive 30 assigned responsibility for the development of overall U.S. policy on terrorism to the Interdepartmental Group on Terrorism (IG/T), chaired by the Department of State (DOS). TSWG was an original subgroup of the IG/T, which later became the Interagency Working Group on Counterterrorism (IWG/CT). In its February 1986 report, a cabinet-level Task Force on Counterterrorism, led by then Vice-President Bush, cited TSWG as assuring “the development of appropriate counterterrorism technological efforts.”



DoD photo by Petty Officer 3rd Class Patrick M. Bonafede, U.S. Navy (Released)

Today, TSWG still performs that counterterrorism technology development function as a stand-alone interagency working group. TSWG’s mission is to conduct the national interagency research and development (R&D) program for combating terrorism requirements. It also has commenced efforts to conduct and influence longer-term R&D initiatives and, reflecting the shift to a more offensive strategy, balance its technology and capability development efforts among the four pillars of combating terrorism: antiterrorism, counterterrorism, intelligence support, and consequence management.

### Organization and Structure

TSWG operates under the policy oversight of the Department of State’s Coordinator for Counterterrorism and the management and technical oversight of the Department of Defense Assistant Secretary of Defense for Special Operations and Low-Intensity Conflict & Interdependent Capabilities. While TSWG’s core funds are derived principally from CTTSO and DOS, other departments and agencies contribute additional funds and provide personnel to act as project managers and technical advisors.



U.S. Army photo by Staff Sgt. Antonieta Rico

TSWG has successfully transitioned capabilities to the Departments of Agriculture, Defense, Justice, State, and Treasury; the Intelligence Community; the Transportation Security Administration; the Public Health Service; and many other departments and agencies. Additionally, TSWG has transitioned many systems to State and local law enforcement and first-responder agencies.

TSWG membership includes representatives from over 100 government organizations. Participation is open not only to Federal departments and agencies, but also to first responders and appropriate representatives from State and local governments and international agencies. These departments and agencies work together by participating in one or more subgroups. A comprehensive listing of member organizations by subgroup is provided in the appendix.

# Technical Support Working Group

Each TSWG subgroup is chaired by a senior representative from a Federal agency with special expertise in that functional area. Chairmanship of three subgroups is shared as indicated in the organizational chart below. Descriptions of some of the activities of each subgroup are provided in the succeeding pages.

## TSWG Organization



## Technical Support Working Group

### Program Funding

In FY 2007 funding for the TSWG program totaled over \$202 million. The Department of Defense provides the bulk of funding for TSWG activities. The Department of State contributes annually to TSWG core funding, while other departments and agencies share the costs of selected projects. Funding for programs with international partners is shared on a 50/50 basis.

### TSWG FY 2007 Program Funding (\$202 Million)

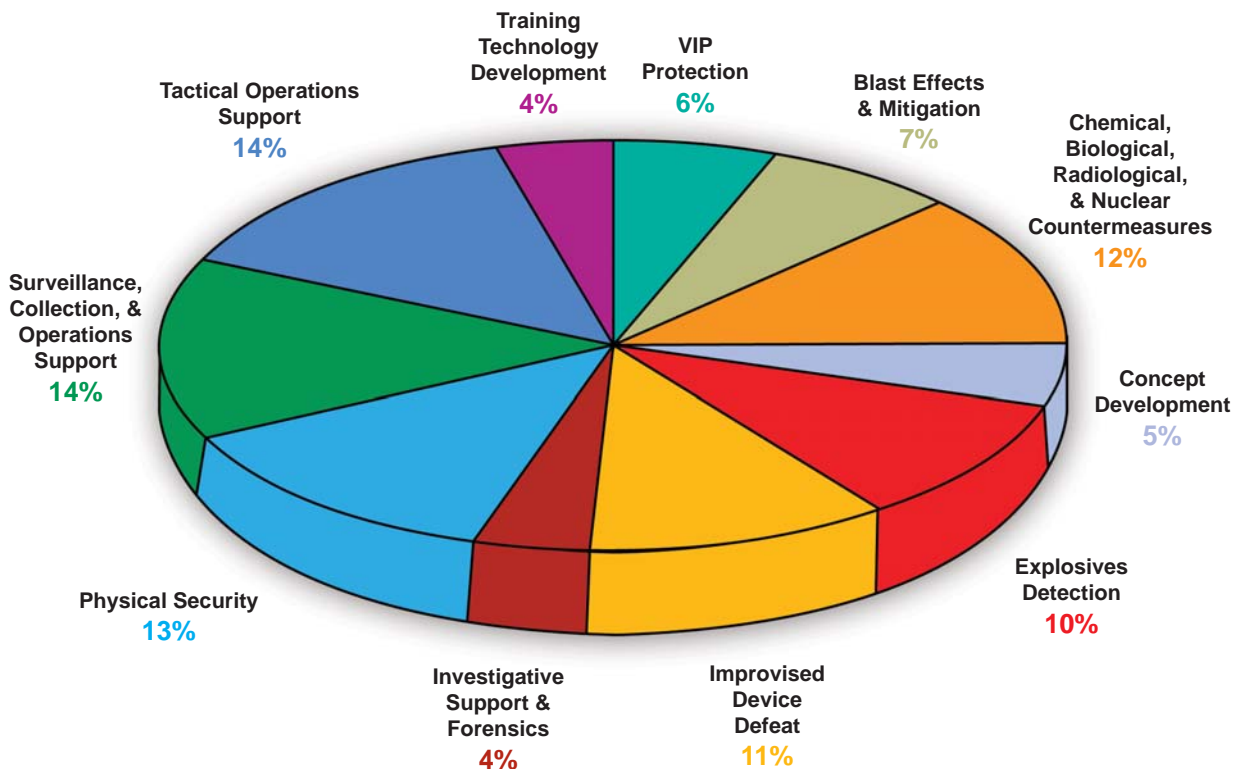

# *Technical Support Working Group Subgroups*



U.S. Army photo by Spc. Eric Jungels





## *Blast Effects & Mitigation*



## Blast Effects & Mitigation

### Membership

NEW YORK CITY MASS TRANSIT AUTHORITY

PORT AUTHORITY OF NEW YORK/NEW JERSEY

U.S. DEPARTMENT OF DEFENSE  
AFIP (OAFME), DTRA, USA (ARL, CE-PDC, SSC, USAISR), USAF (AFRL), USN (NAVFAC, NHRC)

U.S. DEPARTMENT OF HOMELAND SECURITY  
S&T

U.S. DEPARTMENT OF JUSTICE  
ATF, FBI

U.S. DEPARTMENT OF STATE  
DS

### Mission

*Identify, prioritize, and execute research and development projects that satisfy interagency and international requirements to define and mitigate the potential damage mechanisms from conventional and enhanced explosive mixtures.*

The Blast Effects and Mitigation (BX) subgroup identifies and develops technologies and techniques to evaluate the conventional and enhanced explosive effects on representative targets, including structures, critical infrastructure, vehicles, and humans. Projects conducted through this group characterize and provide interagency coordination of near-term solutions for emerging explosive threats. A representative from the U.S. Department of Justice's Bureau of Alcohol, Tobacco, Firearms, and Explosives chairs the subgroup.

### Focus Areas

The BX subgroup focus areas reflect the prioritized requirements of Federal engineering activities responsible for high-risk facilities, the owners of critical infrastructure, and the needs of military personnel exploring new concepts in body armor and ballistic protection. During FY 2007, these focus areas were:

#### **Conventional and Enhanced Novel Explosive Mitigation**

Investigate and characterize both conventional and novel explosives to fully understand the potential damage and to identify mitigation strategies. Emphasize the development, design, and construction of retrofit techniques for new and existing buildings, field fortifications, vehicles, and barriers in order to strengthen these structures and to reduce debris hazards and structural collapse.

#### **Advanced Instrumentation**

Develop new, repeatable, and sustainable test protocols, instrumentation suites, and models that capture and characterize the dynamic environment of emerging threats. Use data and information obtained through comprehensive instrumentation test efforts to develop new protection and mitigation methodologies to specifically address enhanced novel explosives.

#### **Human Lethality in a Blast Environment**

Quantify the effects of conventional and enhanced blast damage mechanisms to the human body. Evaluate the effectiveness of blast injury prevention and mitigation concepts from an injury perspective. Develop new methodologies to protect against blast fragmentation, fire, and overpressure injury.

## Blast Effects & Mitigation

### Critical Infrastructure Security

Test and evaluate critical structural systems in buildings, bridges, tunnels, and other critical infrastructure components using both full-scale blast testing and blast simulator technologies. Assess the level of protection that is sufficient to mitigate various threats to enable military planners and stakeholders in critical transportation systems to make more informed decisions.

### Selected Completed Projects

#### Bridge Tower Testing

The blast mechanisms responsible for damage to bridges are not completely understood. The bridge tower testing project evaluated the performance of bridge components and connections to develop a database of the effects of a blast on a bridge and its surrounding environment. The Energetic Materials Research and Testing Center (EMRTC) developed modeling tools to determine performance capabilities of existing bridge infrastructure, plan for retrofits, and develop new construction methods. The software tool provides a rational alternative to the simplified single degree of freedom methods currently in use by incorporating explicit rate dependent dynamic material models, as well as incorporating design guidelines based on section compactness, plastic rotation capacity, shear failure modes, and presence or absence of a splice in the column. The software is available in a user-friendly GUI format that provides easy input and almost immediate output of the results. The software assesses the vulnerability of existing buildings for engineers not specifically trained in blast-resistant design methods. Requests for additional information should be sent to [bxsubgroup@tswg.gov](mailto:bxsubgroup@tswg.gov).



#### Tunnel Mitigation Strategies

In the past, there was no way to evaluate the performance of retrofit mitigation solutions for the tunnels built in the early part of the 20<sup>th</sup> century, specifically those created of cast-iron and embedded in saturated soil. TSWG and EMRTC performed research to evaluate the vulnerability of cast-iron lined tunnels subjected to various explosive charges and determined the effectiveness of retrofit schemes to these same charges. The key failure mode under consideration was breach of the tunnel wall. The results of this study provide needed vulnerability estimates for tunnel wall systems, information that is an essential component to the development of practical and effective retrofit strategies for tunnels. The data are available to tunnel owners and operators to provide enhanced understanding of the response of the infrastructure to blast overpressure. The database of information will be used to develop better predictive-modeling computer software. Requests for additional information should be sent to [bxsubgroup@tswg.gov](mailto:bxsubgroup@tswg.gov).



## Blast Effects & Mitigation

### Explosive Effects

TSWG and an international partner worked together to research near-contact conventional and homemade explosive blast threats. The project encompassed several aspects of threat evaluation and blast effects. TSWG and its partner gauged the effectiveness of the screening points at airports and border crossings at identifying potential explosives threats. The researchers also determined the impact of various explosive charge weights in different indoor and outdoor scenarios. The final key consideration was to develop laboratory capability to perform research and development with improvised explosives, such as triacetone triperoxide (TATP) and other homemade explosives. The results of the research and testing are available to government, military, and civilian organizations to make informed decisions about building and perimeter security as well as measures for protection and mitigation. Requests for additional information should be sent to [bxsubgroup@tswg.gov](mailto:bxsubgroup@tswg.gov).



### Selected Current Projects

#### Advanced Instrumentation: Breacher Injury Study

In both training and operations, warfighters and law enforcement personnel are repeatedly exposed to blast events in the course of their duties. Very little data exists on the effect of this exposure on the physiological function of the human body, and none of the available data address the risk of cognitive impairment as a result of multiple blast exposures. The U.S. Marine Corps' Weapons Training Battalion Dynamic Entry School, which trains the majority of the military breachers in the United States, offered their basic breacher training course and students as the test bed and test subjects for the Breacher Injury Study. This study will determine whether breachers are incurring injuries during standard training practices. If evidence of injury is detected, the team will make recommendations regarding mitigation measures for application in the training environment. In addition, this project developed the wireless, remote triggering system needed to prevent interference in the training exercises and to miniaturize the personnel-borne data acquisition systems that will enable instrumentation of each breacher during breaching events. Results of this study will direct future research into safe stand-off distances and protective gear for breachers.



#### Entry Control Point Technology Demonstrations

The TSWG Entry Control Point (ECP) demonstration project involves the design and construction of state-of-the-art entry control facilities in the CENTCOM AOR. The ECP will be built using the Explora Group's Dynasystems (including Dynablok and Dynatower), two blast mitigation construction materials, and Metalith vehicle barriers created by Infrastructure Defense Technologies. The ECP will integrate force protection, screening, and security systems in a design created specifically for the U.S. Marine Corps. The ECP



## Blast Effects & Mitigation

will demonstrate new technologies in blast mitigation, ballistic protection, remote vehicle inspection and pedestrian screening systems, vehicle barriers, and tactical defensive measures required in a high-threat environment. Technical drawings required for this ECP design have been developed with the U.S. Army Corps of Engineers' Protective Design Center. The prototype ECP will be ready for testing and evaluation in Spring 2008.

### Warfighter Battle Damage Assessment

Although body armor offers a measure of protection in battle, areas of the body most in need of protection vary dependent upon the warfighter's situation and activities. The Surface Wound Mapping™ (SWM) Software Suite was developed in 2006 to provide a set of tools to enable people to view graphical and statistical patterns of wounding and injury in selected populations. The Warfighter Battle Damage Assessment program expands the capabilities of SWM to (1) enable wound drawing and display on digital bodies of different genders and morphological types, (2) perform what-if analysis on trade-offs between increased body armor weight vs. increased protection (reduced mortality and injury severity), and (3) integrate with existing epidemiological data collection software to eliminate redundant data entry. In addition, the SWM data set will be increased from the current number of approximately 1000 cases to a few thousand cases. This upgraded version of the software will be delivered to personal protective equipment designers and analysts at Army and Navy laboratories in 2008.



### Evolving Terrorist Threats Using Homemade Explosives

Recent intelligence and world events have demonstrated the ability of terrorists to obtain or manufacture enhanced novel explosives in an effort to achieve blast effects comparable to that of current conventional high explosives, and making detection more difficult. TSWG is partnering with the FBI, DHS, and several international partners to identify render-safe and disposal tactics, techniques, and procedures to develop field methods or standard operating guides to neutralize the chemical components and/or final product. Through regularly scheduled working group meetings, the homemade explosives (HME) program is leveraging individual agency efforts. As part of this effort, TSWG created an online HME forum for domestic and international partners to share information, hold discussions, and coordinate research and testing activities. An HME test program has been developed to fill in data gaps and clarify discrepancies. Information obtained through these comprehensive tests will be used to develop new protection and mitigation techniques. Data will be compiled into law-enforcement-sensitive training and information aids for distribution to bomb technicians and law enforcement personnel. Classified compilations will also be made available to the intelligence community.

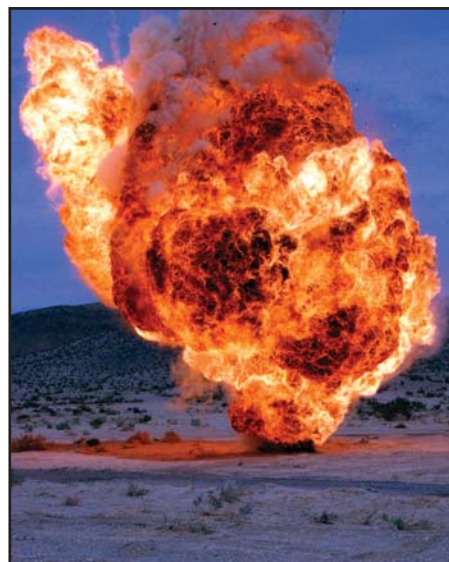

## Blast Effects & Mitigation

### Blast and Fragment Resistant Construction

Expeditionary structures must be strong enough to protect their occupants, yet still maintain portability. TSWG and the Air Force Research Laboratory (AFRL) are developing an expeditionary construction method that provides blast and fragmentation protection for the walls and roof. The goal is to provide a structure that can be assembled with minimally skilled labor and without the need to build compartmentalization walls and overhead protection. AFRL research has shown that soil-filled, stay-in-place PVC forms provide high value blast and ballistic protection. AFRL is investigating the use of this construction method to create a load-bearing wall design that supports a roof system with inherent blast and ballistic protection. Component-level and full-scale experiments will be conducted to confirm this protection and validate the analytical models and associated engineering tools used in construction design. A field manual will include the engineering tools along with construction drawings, a materials list, and assembly instructions for the final prototype design.

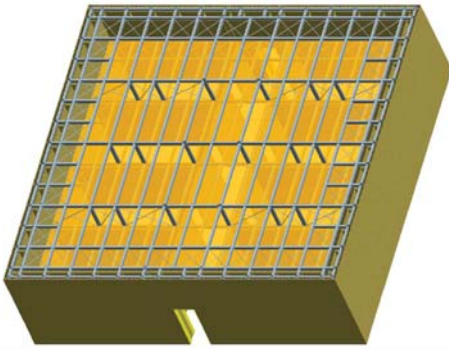

### Contact Information

[bxsubgroup@tswg.gov](mailto:bxsubgroup@tswg.gov)

## *Chemical, Biological, Radiological, & Nuclear Countermeasures*



Soldiers come under a simulated chemical attack and must don, clear and check the seals of their masks as the seconds tick away. Photo by Marine Corps Sgt. Andrew D. Pendracki. Courtesy of the DoD photo archive.

## Chemical, Biological, Radiological, & Nuclear Counter Measures

### Membership

ENVIRONMENTAL PROTECTION AGENCY  
 FAIRFAX COUNTY (VA) FIRE DEPARTMENT  
 FEDERAL RESERVE BOARD  
 FIRE DEPARTMENT OF NEW YORK  
 INTELLIGENCE COMMUNITY  
 INTERAGENCY BOARD  
 NEW YORK CITY POLICE DEPARTMENT  
 SEATTLE (WA) FIRE DEPARTMENT  
 U.S. CAPITOL POLICE  
 U.S. DEPARTMENT OF AGRICULTURE  
 APHIS, FSIS  
 U.S. DEPARTMENT OF COMMERCE  
 NIST  
 U.S. DEPARTMENT OF DEFENSE  
 ATSD (NCBD), ATSL, DIA, DTRA,  
 JCS, JIEDDO, NSA, PFFA, SOCOM,  
 USA (20th SUPCOM (CBRNE), 22nd  
 CML Bn (TE), AMEDD, CMLS,  
 MANSCEN, NGIC, RDECOM-ECBC),  
 USAF (ACC), USMC (CBIRF), USN  
 (BUMED, NAVCENT, NAWC, NSWC)  
 U.S. DEPARTMENT OF ENERGY  
 HSS  
 U.S. DEPARTMENT OF HEALTH AND HUMAN  
 SERVICES  
 CDC, FDA, NIOSH  
 U.S. DEPARTMENT OF HOMELAND SECURITY  
 FEMA, FPS, HSI, S&T, TSA, USCG,  
 USSS  
 U.S. DEPARTMENT OF JUSTICE  
 FBI, NIJ, USMS  
 U.S. DEPARTMENT OF STATE  
 DS, OBO, S/CT  
 U.S. DEPARTMENT OF TRANSPORTATION  
 RITA (Volpe Center)  
 U.S. POSTAL INSPECTION SERVICE  
 U.S. SENATE SERGEANT AT ARMS  
 WHITE HOUSE  
 HSC

### Mission

*Identify, prioritize, and execute interagency chemical, biological, radiological, and nuclear combating terrorism requirements and deliver technology solutions for detection, protection, decontamination, mitigation, containment, and disposal.*

The Chemical, Biological, Radiological, and Nuclear Countermeasures (CBRNC) subgroup identifies and prioritizes multi-agency user requirements and competitively seeks technological solutions for countering the terrorist employment of CBRN materials. Through its participation in the InterAgency Board for Equipment Standardization and Interoperability and in coordination with DHS, NIJ, EPA, and other DoD components; the CBRNC subgroup integrates technology requirements from the fire, hazardous materials, law enforcement, and emergency medical services communities into its process. Senior representatives from DoD and FDA co-chair the subgroup.

### Focus Areas

The CBRNC subgroup focus areas reflect the prioritized requirements of the CBRN incident prevention and response community. During FY 2007, these focus areas were:

#### Detection

Improve the sampling, detection, and forensic analysis of chemical, biological, and radiological threat agents in the air, in food or water, and on surfaces.

#### Protection

Improve the operating performance and reduce the costs of individual and collective protection. Develop and enhance personal protective equipment (PPE), including respiratory protection systems and suits. Develop analysis and design tools for CBRN protection for building engineers and architects. Develop and evaluate advanced filter materials.

#### Consequence Management

Develop technologies and procedures to mitigate the effects of a life-threatening or destructive event. Develop and improve response activities and related equipment to counter a terrorist use or accidental release of CBRN materials, to include short- and long-term decontamination and restoration.

#### Information Resources

Develop shared information management tools to provide a common "picture of the scene". Facilitate the efficient integration of diverse emergency and consequence management elements from Federal, State, and local agencies.



## Chemical, Biological, Radiological, & Nuclear Counter Measures

### Selected Completed Projects

#### Next-Generation Fire Fighter Protective Ensemble

In addition to conventional sources, fires may be caused by improvised explosive devices designed to distribute chemical or biological weapons of mass destruction. Fire fighters may respond to explosions, fires, or other emergencies with little or no indication of the presence of chemical, biological, or radiological/nuclear (CBRN) hazards. Working in parallel project teams, the International Association of Fire Fighters (IAFF) and North Carolina State University (NCSU) have each designed structural fire fighting gear to meet the 2007 Edition of National Fire Protection Association (NFPA) 1971 CBRN option, Standard on Protective Ensemble for Structural and Proximity Fire Fighting. The project teams of users, material designers, and clothing-design experts are addressing deficiencies in current fire fighter protective clothing, which provides only limited protection against a liquid threat and no dermal protection to hazardous materials exposures. The NFPA 1971 CBRN option includes rigorous requirements for barrier material performance, as well as demanding requirements for the overall integrity of the ensemble. Ensemble elements must also meet all of the base requirements that apply to ordinary structural fire fighting apparel, including criteria addressing heat/flame protection, physical protection, and breathability (for heat stress relief). Intense field evaluations (including live fire usage) of both prototypes suits occurred in FY 2007. Results from the field tests directed changes in both ensembles to meet users needs. The IAFF suit will be manufactured by Total Fire Group and will be available at: <http://www.totalfiregroup.com>. The NCSU suit will be manufactured by Globe and will be available at: <http://www.globefiresuits.com>. Both ensembles will be submitted for certification to the NFPA 1971 CBRN option in December 2007.



#### Genomics of Canine Detection – Smell Starts Here

Trained dogs are one of the most common, sensitive and versatile means for detecting concealed contraband, such as explosives. What makes a particular dog or breed good or bad at sensing odorant molecules has remained a mystery. The first step is understanding the genetic diversity of the canine olfactory receptors. These olfactory receptors (ORs), which interact with odorant molecules, form the largest known gene superfamily in most mammals. These are expressed on the surface of the cilia of the olfactory sensory neuron lining the nasal cavity. Researchers at the University of Rennes in France have begun to understand this and to answer the crucial questions: Are there any means of identifying animals with olfactory receptors before beginning costly training programs? Do some breeds have better overall sensing abilities? Can breeding further enhance the sensing capabilities of dogs? Can we offer breeders suitable genetic tests? Building on the National Institutes of Health Dog Genome Project sequence, the researchers in France

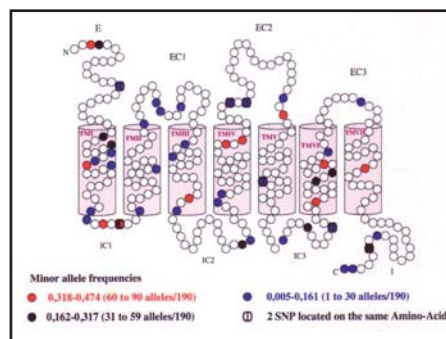

#### Olfactory Receptor Sequence Polymorphism Within and Between Breeds of Dogs

SANDRINE TACHER, PASCALE QUIGNON, MALO RIBBAULT, STEPHANE DREANO, CATHERINE ANDRE, AND FRANCIS GALBERT

From UMR 6061, Génétique et Développement CNRS-Université de Rennes 1, France.

Address correspondence to Francis Galbert at the address above, or e-mail: galbert@univ-rennes1.fr.

## Chemical, Biological, Radiological, & Nuclear Counter Measures

conducted a comprehensive analysis of the canine olfactory receptor repertoire. They assessed canine breed olfactory genetic diversity, developed a preliminary list of OR genes that are essential for the recognition of explosives and laid the basis for the development of a genetic test that is based on a selected subset of OR genes. The diagram shows an olfactory receptor protein with the positions of 55 single nucleotide polymorphisms from <http://jhered.oxfordjournals.org/cgi/reprint/96/7/812>.



Esensors - Environmental / Toxic Gas Monitor	
<b>PPM - ACTIVE SENSORS</b> .. Hydrogen sulfide ●● .. Sulfur dioxide ●● .. Hydrogen cyanide ●●●● .. Nitric oxide ●● .. Nitrogen dioxide ●●●● .. Hydrogen chloride ●●●●	<b>PPM - ACTIVE SENSORS</b> .. Ozone ●●●● .. Hydrogen peroxide ●●●● .. Phosgene ●●●● .. Smoke ●●●● .. Carbon dioxide ●●●● .. VOC/Methyl bromide ●●●●
<<PREV-1 2 3 4 5 6-NEXT>> Page 2 of 6	
Safe Level Present = ●●	Approaching Dangerous Level = ●●●●
Dangerous Level = ●●●●	NO Level Detected = "NO DOT"

### Wired/Wireless Multi-Sensor Environmental Monitor

Building decontamination efforts in recent years have identified the need for improved monitoring of environmental conditions during decontamination. Esensors, Inc. developed a distributed sensor system for the real-time monitoring of critical physical parameters and chemical concentrations to ensure the effective gas-phase decontamination of large buildings. The portable sensor system has six interchangeable sensors and supports both wired and wireless internet connections for remote monitoring. Each unit can be powered by batteries or by AC power. Several of these units can be readily deployed for applications such as monitoring gases during building decontamination processes, monitoring air quality under multiple conditions, or investigating a suspicious container. The easily movable system also provides response personnel with the information needed to maximize the efficient use of resources. Additional information is available by contacting Esensors at <http://eesensors.com/sales.html> or by contacting [cbnrcsugroup@tswg.gov](mailto:cbnrcsugroup@tswg.gov).

### Agricultural Biomass Disposal Handbook; Best Practices and Guidance

Recent events highlight the susceptibility of the agriculture industry to bioterrorism, and large scale loss brought about by natural disasters. Proper management of the post event state will ensure public safety and mitigate the length of time needed for the restoration of public confidence in the commodities and agriculture markets. The Agricultural Biomass Disposal Manual is a field guide for managing contaminated agriculture waste after a terrorist or natural event. The manual was created by the Texas Agricultural Experiment Station and provides clear, concise, easy-to-use information relating to the disposal of large-scale animal mortalities and other related agriculture waste. The handbook provides guidance based on engineering, economics, and regulatory analysis of options, leveraging past experiences, and lessons learned from responses to foreign and domestic natural outbreaks. A Web-based decision support system is currently being developed to augment the manual. Requests for additional information should be sent to [cbnrcsugroup@tswg.gov](mailto:cbnrcsugroup@tswg.gov).



## Chemical, Biological, Radiological, & Nuclear Counter Measures

### Portable Biotoxin Detector

Few technologies exist for the rapid identification of biological toxins by emergency responders and hospital triage personnel. The Institute for Applied Science, together with the International Science and Technology Center, coordinated the Shemyakin-Ovchinnikov Institute of Bioorganic Chemistry and the Engelhardt Institute of Molecular Biology to develop a portable detector for biological toxins. The simple-to-use, standard piece of equipment is for use by emergency responders and hospital triage personnel at the Federal, State and local level. The unit provides a quick multiplexed array positive/negative test for the presence of toxins and the capability for subsequent testing of a sample to determine concentration. The antibody-based system tests for ricin; *Staphylococcus aureus* enterotoxins A, B, C, G and I; and Botulinum neurotoxins A and E. Requests for additional information should be sent to [cbrncsugroup@tswg.gov](mailto:cbrncsugroup@tswg.gov).



### Multiplexed High-Density Bio-Agent Arrays

The ability to determine the presence and identity of a biological warfare agent dictates the initial response and decontamination efforts that will be required to mitigate the release. The multiplexed, high-density array was developed to be a universal sensing platform for BW pathogens. The platform is based on an array of microsensors displayed on the end of an optical imaging fiber. Each microsensor possesses chemistry and/or biochemistry enabling it to perform an analysis for different species' DNA sequences and can also be adapted to proteins using immunoassays. Replicate microsensors for each analysis provide low false positive and false negative results. The technology has been demonstrated to perform these analyses using specific molecular recognition, biosensing, immunoassays, and DNA microarray chemistries. Multiplexing of over 1500 different selectivities for DNA sequences has been demonstrated, as well as multiplexing of immunoassays and small molecules. This technology has been licensed from Tufts University to Illumina, Inc., which is developing next generation genotyping arrays. Requests for additional information should be sent to [cbrncsugroup@tswg.gov](mailto:cbrncsugroup@tswg.gov).

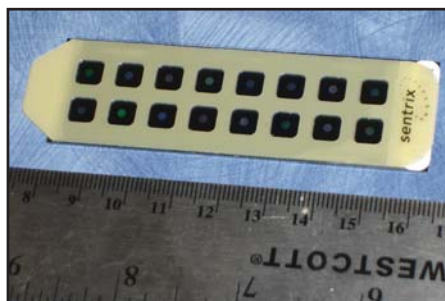

### Selected Current Projects

#### Transportable Gasifier for the Destruction of Contaminated Biomass

Recent events highlight the susceptibility of the agriculture industry to bioterrorism, and large scale loss brought about by natural disasters. Proper management of the post-event state will ensure public safety and will mitigate the length of time needed for the restoration of public confidence in the commodities and agriculture markets. The transportable gasifier provides the means to dispose of large-scale animal mortalities, and contaminated biomass, through a unique continuous-feed, two-chamber, high-temperature gasification process. The system is mobile and can be transported on COTS low-boy



## Chemical, Biological, Radiological, & Nuclear Counter Measures

trailers for on-site sanitary and environmentally friendly destruction of contaminated agricultural waste. The system is currently undergoing field trials.

### PCR-Less Biological Agent Detection System

The first line of defense against terrorist acts is the ability to detect that a threat exists and determine whether it is a credible threat or a hoax. Numerous suspect incidents occur in the United States every year, and knowing whether the threat is real or not is critical, because false alarms are frequent. Currently there are limited resources available to perform confirmatory testing against a wide range of agents in these situations. Long delays in threat confirmation are unacceptable and may require closing of a facility or prophylactic treatment of exposed individuals until test results are definitive. Nanosphere developed a system for the confirmatory detection of bioagents and select toxins to meet the needs of first responders and other terrorism-response personnel, both field- and laboratory-based. The system does not require PCR, is easy to use, is reliable, and can test for multiple agents of concern in a single test (multiplexed). Samples are loaded into self-contained cartridges and then processed and analyzed in a ruggedized instrument system. The system provides excellent specificity and sensitivity, reducing false positives and negatives, and can specifically identify the agent or toxin.



### On-line Inexpensive Total Organic Carbon Detector

Most inorganic products have a detectable organic background when added to a water system. Total Organic Carbon (TOC) analysis is a non-specific measurement with multiple applications. TOC measurement provides a basis for identifying changes in water that result from nearly anything that can be added to the system. Current TOC analysis techniques require a combination of hazardous reagents, high temperatures, and compressed gasses. In addition, the devices are highly sensitive to environmental factors, vibration, and user adjustments. These factors require the equipment to be used by skilled operators in laboratory environments, far from the field monitoring points where the data would be most useful. The absence of a robust, portable TOC analyzer leaves the largest sections of our water infrastructure – distribution – unmonitored. This effort serves to close this gap in analytical coverage and to provide a novel TOC analysis device with the potential to be packaged in a robust, field installable, continuous monitoring package. OI Analytical is developing a detection system that quantitatively responds to all types of organic carbon dissolved or suspended in water. The system will be used to detect the contamination of field water or domestic water supply systems. The detector system will provide quantification in non-chlorinated, chlorinated, and chloraminated potable and source waters.



## *Chemical, Biological, Radiological, & Nuclear Counter Measures*

### **Advanced Alpha and Beta Radiation Detector for Water**

While unlikely to cause death or acute illness, introduction of soluble or fine particulate radioactive material into source water or a municipal water supply system has the potential to cause massive economic disruption, displace populations and erode confidence of the people in the ability of the government to protect them. Water utilities currently monitor the concentration of alpha- and beta-emitting radionuclides on a monthly or quarterly basis using a batch sample process routinely sent to an outside laboratory. This approach is suitable for monitoring slowly changing natural sources of alpha- and beta-emitting radionuclides. In the face of a potential terrorist threat, more frequent sampling, automated analysis and reporting is needed to detect, warn and protect the public. Savannah River National Laboratory is designing and building a brass-board prototype of an advanced radiation detector to be used for the automated, unattended monitoring of flowing or static field and domestic water supplies for radiological contamination. This will provide an affordable, enhanced capability for regularly, accurately and automatically detecting alpha and beta emitting radionuclides in concentrations at or above regulatory thresholds set by the EPA. The system being developed may also be used for monitoring water used in initial response and decontamination in the aftermath of a radiological dispersion device attack.

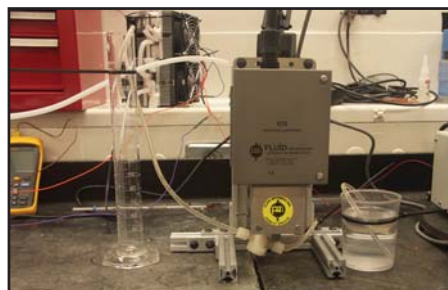

### **Vehicle Retrofit**

Hurricane Katrina, the 2006 Chicago subway train derailment, and the 2007 southern California wildfires highlighted municipalities' unmet needs to be able to handle the emergency evacuation of large numbers of residents/victims. Retro-fit equipment is needed to support evacuation without compromising vehicle safety standards and avoiding injury to installers and users. Raytheon Technical Services is developing a prototype that will provide the U.S. Government with the capability to quickly transform various transportation conveyances, including school buses and transit buses, into evacuation vehicles for injured or special-needs citizens following a large-scale terrorist attack or natural disaster. One of the key features of the Transit Bus Quick Response Kit (QRK) is speed; it takes approximately 60 minutes or less to transform a transit bus into a Mass Casualty Evacuation Unit (MCEU). The QRK is capable of being installed by two trained personnel and does not require special tooling. The QRK will support up to 16 backboards loaded with patients and will provide space for mounting IVs and standard emergency oxygen bottles. The QRK will accommodate wheelchairs and the use and storage of wheelchair ramps. The final design will be offered royalty-free to bus manufacturers.

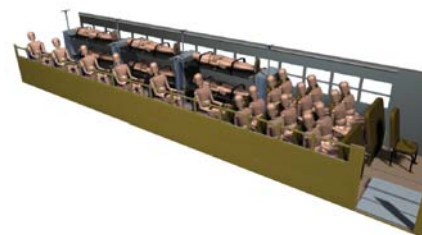
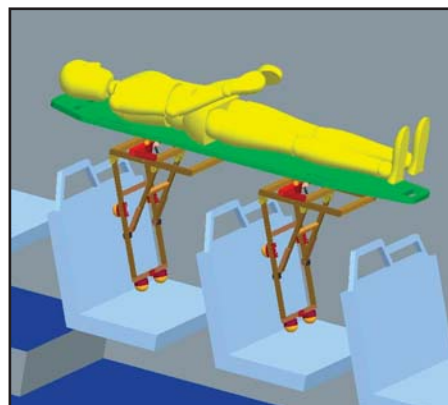

### **Contact Information**

[cbrncsubgroup@tswg.gov](mailto:cbrncsubgroup@tswg.gov)



# Concept Development



U.S. Air Force photo by Tech. Sgt. Cecilio Ricardo

## Concept Development

### Membership

INTELLIGENCE COMMUNITY

U.S. DEPARTMENT OF DEFENSE  
DDRE

### Mission

*Identify, prioritize, and execute research and development projects that satisfy interagency requirements to increase national counterterrorism capabilities. Foster emerging technology programs that complement traditional subgroup mission areas.*

The Concept Development (CD) subgroup identifies user requirements and facilitates interagency coordination of near-term solutions and long-term direction. CD research and development efforts provide novel technologies and methods that enhance current counterterrorism and counterintelligence capabilities and strategies.

### Focus Areas

#### Nontraditional Capability Design

Develop unique operational, intelligence, and technical capabilities that are tailored to support counterintelligence and counterterrorist operational and tactical forces.

### Program Highlights

CD programs are classified or highly sensitive. Program requirements, the success of programs, and specific program capabilities cannot be discussed in an unclassified document.

### Contact Information

[csubgroup@tswg.gov](mailto:csubgroup@tswg.gov)



## *Explosives Detection*

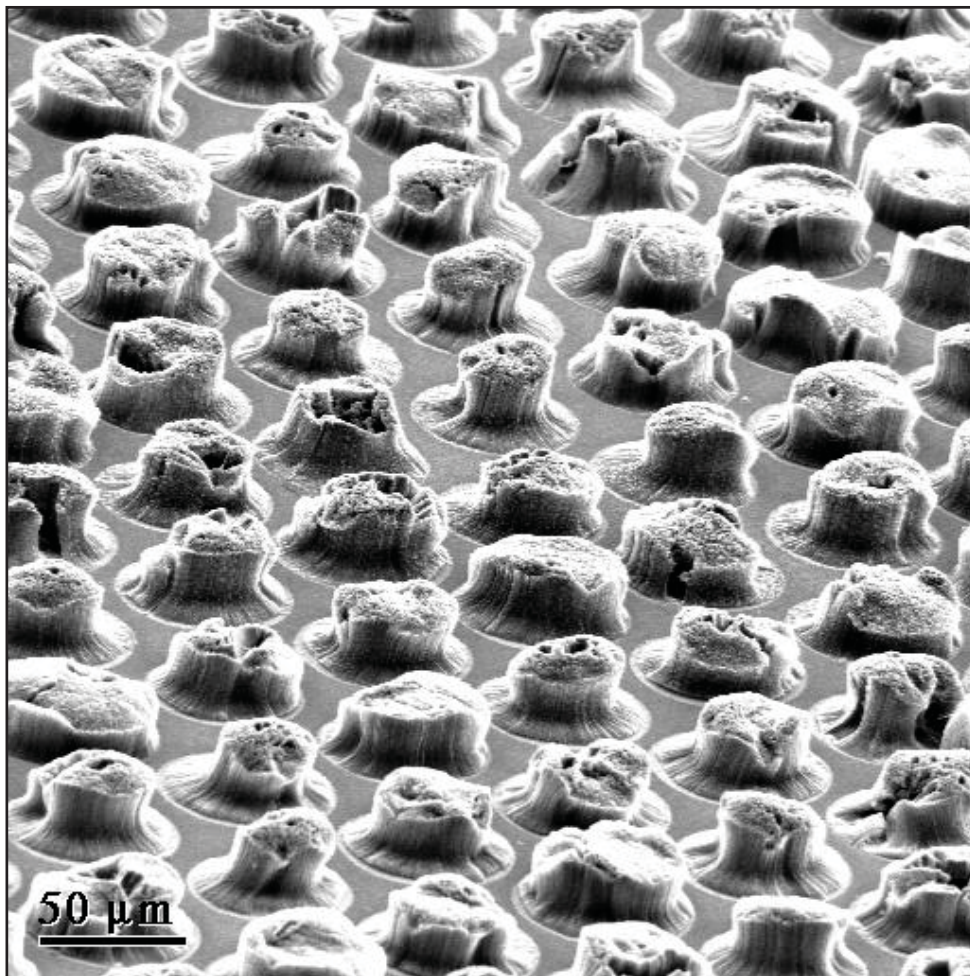

Photo by NASA Ames Research Center,  
Center for Nanotechnology

## Explosives Detection

### Membership

U.S. DEPARTMENT OF COMMERCE  
NIST

U.S. DEPARTMENT OF DEFENSE  
DIA, JIEDDO, NSA, PFFA, USA  
(ECBC), USAF (AFESC, AFRL),  
USMC (EOD), USN  
(NAVEODTECHDIV, NRL, NSWC)

U.S. DEPARTMENT OF HOMELAND  
SECURITY  
S&T, TSA, USCG, USSS

U.S. DEPARTMENT OF JUSTICE  
ATF, FBI

U.S. DEPARTMENT OF STATE  
DS

### Mission

*Identify, prioritize, and execute research and development projects that satisfy interagency requirements for existing and emerging technologies in explosives detection and diagnostics. Emphasis is placed on a long-term, sustained approach leading to new and enhanced technologies for detection and identification of improvised explosive devices, including vehicle-borne devices.*

The Explosives Detection (ED) subgroup identifies and develops technologies to enhance the operational capability of both military and civilian applications. A representative from the Transportation Security Administration chairs the subgroup.

### Focus Areas

The ED subgroup focus areas reflect the prioritized requirements of a broad range of interagency customers, including those responsible for physical security and forensic analysis. During FY 2007, these focus areas were:

#### Vehicle-Borne IED Detection

Develop technologies necessary to provide a stand-off detection capability for explosives in large volumes at a distance. Investigate unique physical and chemical phenomena that identify the presence of explosives, the physical limits for sensor technology to respond to these phenomena, and enhancements to detection technology. Develop techniques to improve both stand-off distance and the types of explosives that can be detected. Evaluate remote techniques, in which a system is downfield from the operator but near the objects of interest. Explore technologies leading to a true stand-off detection capability.

#### Suicide Bomber Detection

Improve systems that detect the presence of improvised explosive devices concealed by persons engaged in suicide attacks against government installations and public facilities, both domestic and international. Programs in this area are highly sensitive; specific capabilities generally cannot be discussed in a public document.

#### Short-Range Detection

Develop new explosive detection capabilities and improvements to existing systems for detection and diagnosis of concealed terrorist devices. Emphasize technologies that support entry-point screening. Improve detection rate, throughput, and accuracy in identification of explosives, as well as safety for both operators and the general public.

## Explosives Detection

### Canines

Develop training tools, protocols, and technologies that support and enhance canine detection of explosives. Improve canine team effectiveness and consistency through better understanding of both canine detection ability and canine/human interaction.

### Selected Completed Projects

#### Stand-off Suicide Bomber Detection using Active Radar

SET Corporation designed and built a prototype system that integrates video and low-power radar for automated detection of suicide bombers at distances up to 100 meters. The multisensor human-carried explosives detection system automatically tracks persons in its field of view and assesses the threat in real-time, allowing the response team to manage potential threats from a safe distance. The prototype system is currently under evaluation. Requests for additional information should be sent to [counterbomber@SETcorp.com](mailto:counterbomber@SETcorp.com).



#### Combined X-Ray and Quadrupole Resonance Detection

Rapiscan Systems designed and built a prototype system for inspection of hand-carried baggage that integrates a quadrupole resonance (QR) capability for the detection of explosives with an X-ray system certified by the Transportation Security Administration. An initial evaluation was completed at the DHS Transportation Security Laboratory, and three systems have been accepted by the Government for deployment in a military application. Requests for additional information should be sent to [sales@rapiscansystems.com](mailto:sales@rapiscansystems.com).



### Selected Current Projects

#### Hardened Explosives Trace Detectors

In a cooperative effort between TSWG and the Joint IED Defeat Organization, Smiths Detection and GE Homeland Security developed hardened handheld and benchtop trace explosives detection systems. These systems are designed for military and civilian use in severe environments, including dust, rain, salty air, and extreme temperature conditions. The hardened systems will also allow more types of explosives to be detected in a single test and include both new detector designs and modifications to existing systems. The first prototype systems are undergoing Government evaluation.



## *Explosives Detection*

### **Carbon Nanotube X-Ray Sources**

Xintek, Inc. and NASA Ames Research Center are developing compact X-ray sources based on carbon nanotube technology. This technology is expected to provide efficient, low-maintenance systems for security screening, including aviation checked baggage applications. Carbon nanotube sources are expected to produce images with very high resolution but with reduced system size, power, heat load, and cost compared to current systems.

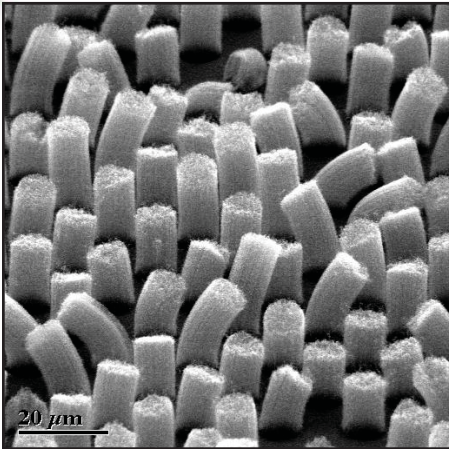

Photo by NASA Ames Research Center,  
Center for Nanotechnology

### **Contact Information**

[edsubgroup@tswg.gov](mailto:edsubgroup@tswg.gov)

## *Improvised Device Defeat*



## Improvised Device Defeat

### Membership

FAIRFAX COUNTY (VA) POLICE DEPARTMENT

INTELLIGENCE COMMUNITY

MARYLAND STATE POLICE

MICHIGAN STATE POLICE

NATIONAL BOMB SQUAD COMMANDERS  
ADVISORY BOARD

U.S. CAPITOL POLICE

U.S. DEPARTMENT OF DEFENSE  
USA (EOD Tech Det), USAF (ACC,  
EOD Det 63), USMC (CBIRF,  
NAVEOTECHDIV-MCD),  
USN (NAVEODFLTLAU,  
NAVEOTECHDIV)

U.S. Department of Homeland Security  
PD (G&T), S&T, USSS, TSA

U.S. DEPARTMENT OF JUSTICE  
ATF, FBI, NIJ, USMS

### Mission

*Identify, prioritize, and execute research and development projects that satisfy interagency requirements to more safely and effectively render terrorist devices safe. Particular emphasis is placed on technologies to access, diagnose, and defeat terrorist improvised explosive devices (IEDs); improvised chemical, biological, radiological, and nuclear devices; and vehicle-borne improvised explosive devices (VBIEDs).*

The Improvised Device Defeat (IDD) subgroup delivers advanced technologies, tools, and information to increase the operational capabilities of the U.S. military explosive ordnance disposal (EOD) community and Federal, State, and local bomb squads to defeat and neutralize terrorist devices. In collaboration with military, Federal, State, and local agencies, the IDD subgroup identifies and prioritizes multi-agency user requirements through joint working groups and thorough validation processes. A representative from the Federal Bureau of Investigation's Bomb Data Center chairs the subgroup.

### Focus Areas

The IDD subgroup focus areas reflect the joint priorities of military and civilian responders. During FY 2007, these focus areas were:

#### Access and Diagnostics

Develop advanced technologies for diagnostic analysis of IEDs in the areas of improved tools and equipment. Develop technologies to access and accurately locate and/or identify components and composition within an improvised terrorist device to facilitate timely response and device neutralization.

#### Defeat

Develop advanced technologies to defeat IEDs, VBIEDs, and improvised CBRN dispersal devices. Develop low-cost solutions that are readily available to the bomb squad community. Increase stand-off capabilities, reduce collateral damage, and provide EOD and bomb disposal technicians with precision disruption and disablement capabilities and techniques.

#### EOD Operational Tools

Develop improved tools and equipment to increase the safety and effectiveness of EOD and bomb technicians during a response. Enhance command and control and situational awareness. Improve tactical and personal protective equipment and other critical technologies to counter emergent explosive threats.

## *Improvised Device Defeat*

### **Information Resources**

Develop information resources and delivery systems for consolidated and expeditious threat intelligence collection, storage, and distribution to bomb disposal technicians for enhanced response capabilities. Provide equipment performance evaluations, database resources, operational response technology information, and automated information systems to communicate the most current tactical and operational response procedures.

### **Remote Controlled Vehicles and Tools**

Improve the performance and reliability of robotic systems for the bomb technician. Develop advanced robotic platforms with improved manipulation capabilities, control systems, navigation technologies, payloads, and communications. Advance TSWG's Common System Architecture, the foundation of these systems, which for the first time enables all robotic components, regardless of the developer, to be "plug-and-play". Develop technologies that allow bomb technicians to conduct as much of their mission as possible by remote means.

### **Emerging Threats**

Develop innovative solutions to address emerging threats involving a broad spectrum of operational needs of the military or State and local bomb squads against IEDs. Develop effective countermeasures to neutralize or defeat radio controlled IEDs (RCIEDs) and to provide safety to the bomb squad technician when conducting operations in close proximity to suspect RCIED devices. Identify and test effective solutions to detect, render safe, or neutralize improvised homemade explosives.

### ***Selected Completed Projects***

#### **Robotic Simulator for Multi-EOD RCV**

U.S. Air Force EOD personnel rely on the operation of their All-Purpose Remote Transport System (ARTS) to complete training with the vehicle. Extensive use naturally reduces the operational service life of the robot, so the majority of Air Force EOD technicians do not receive enough training time to gain and maintain proficiency in operating the robot. Additionally, robotics training has historically been limited to a small number of operational scenarios because of the expense of building the infrastructure needed for those scenarios. The robotic simulator for the ARTS provides an easy-to-use, computer-based robotics training program with highly realistic training environments and scenarios, throughout the EOD and bomb squad communities at an affordable cost. The ARTS Robotic Training Simulator can be obtained through the Air Force Air Combat Command/EOD. Requests for additional information should be sent to [iddsubgroup@tswg.gov](mailto:iddsubgroup@tswg.gov).



## Improvised Device Defeat

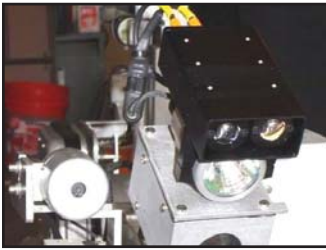

### Robotic White Light/Infrared Switching System Upgrade

Robotic platforms employed by EOD and bomb technicians use incandescent white lights for illumination in dark spaces and night operations. While these lights provide vehicle-mounted cameras with enough light to effectively function, certain tactical situations prohibit the use of traditional white light. QinetiQ developed systems for ANDROS F6A, RONS, Talon, and Vanguard Robotic platforms to provide the capability to switch from white light (spotlights) to low-level infrared (IR) light as the situation dictates. These systems were delivered to Joint Service EOD and several civilian bomb squads for testing and evaluation. Currently the Air Force is acquiring additional units to be sent into theatre. Additional information on this product can be obtained by completing a Web inquiry form at the QinetiQ Web site: <http://www.qinetiq.com>.



### Power Hawk Integration for Robotic Platforms

The threat of vehicle-borne IEDs has created new challenges for bomb squads and military EOD units around the world. This has led to innovative countermeasures to disrupt and render these devices safe. Currently there are several robotic platforms available to U.S. military and civilian technicians; however, they lack the ability or the integrated tools to non-explosively gain access to suspect items, vehicles, or containers. This program launched the integration of the COTS Power Hawk Rescue System as a remotely operated access tool onto the ANDROS F6A robotic platform to achieve these capabilities and further increase the margin of safety for the bomb technicians. Both the Power Hawk Rescue System and the integration kit are available through Remotec. Requests for additional information should be sent to [iddsubgroup@tswg.gov](mailto:iddsubgroup@tswg.gov).



### IED Wire Attack Tools

State and local bomb squads and military EOD personnel need capabilities for situations where manual/hands-on and semi-remote approaches are required to render improvised explosive devices safe. A-T Solutions designed, developed, and tested the KUKRI, which monitors the electrical system and remotely severs the detonator leads if the IED attempts to function. Under this effort A-T Solutions also developed the SABER, which provides the capability to determine the state of the switch or the threat from the detonator and provides the technician with the proper render-safe action to take. The Wire Attack Kit is available through A-T Solutions at: <http://www.a-t-solutions.com>

### Advance Aiming and Stand-off Measurement for Disruptors

Disruption of IEDs requires precision aiming in order to dynamically remove sensitive components of the device. To meet this need an advanced aiming and stand-off measuring system was developed to enhance the precision-aiming capability of EOD and bomb squad



## Improvised Device Defeat

personnel with currently fielded percussion-activated disruptor systems against suspect IEDs. The aiming system is designed to allow mounting and use from standard RCV vehicles currently used by EOD and bomb technicians. Requests for additional information should be sent to [iddsubgroup@tswg.gov](mailto:iddsubgroup@tswg.gov).



### Selected Current Projects

#### Single-Sided Imaging

Improvised explosive devices are becoming more advanced in their design, use, and employment. Builders of IEDs study the tactics used by EOD technicians to detect, set up, and disarm an IED and are discovering new ways to interrupt missions. These factors force the technician to apply remote means to investigate and interrogate the makeup of the suspect device. Existing interrogation technologies are large, bulky, and expensive. In many cases, the bomb technician is still required to approach the IED to use these types of systems to place film cassettes and equipment. During this effort a single-sided, noninvasive X-ray imaging system will be delivered by an unmanned robotic platform for IED identification at a safe, stand-off distance. The developed system will provide the bomb technician with internal images of the potential threat object displayed at the operator control unit of the robotic platform.

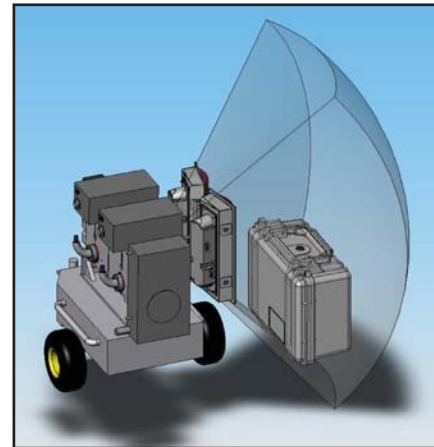

#### Next-Generation EOD Remote-Controlled Vehicle NEOMOVER II

The unique and often dangerous tasks associated with the EOD mission require personnel to make quick decisions and often adapt their tools in the field to combat a variety of threats. The tools must be readily available, robust, and yet still provide surgical precision when required. This project will develop an advanced platform with articulated track, intelligent center of gravity that provides stability for the payload with changing ground conditions, and integrates Joint Architecture for Unmanned Systems and TSWG Common Architecture components. There are two goals of this effort; first, is advance the level of maturity of the NEOMOVER hardware, firmware, software and environmental ruggedness and secondly, maintain a level of architecture for future component integration with other TSWG common architecture components.



#### Remington Eye Ball Integration onto Robotic Platforms

The lack of adaptability and limited capability of existing robotic systems has frustrated bomb technicians worldwide. There are currently several robotic platforms available to U.S. military and civilian technicians; however, they lack the ability to provide adequate situational awareness or assistance in making informed decisions from a remote location. This program launches the integration of an advanced remotely operated camera system onto the extensively



## Improvised Device Defeat

fielded Remotec ANDROS F6A robotic platform to achieve these capabilities and further increase the margin of safety for the bomb technicians. This integration will provide the ability to communicate with the two Eye Balls, control all current Eye Ball functions through the operational control unit of the robotic platform, and will provide operation of the Eye Ball system and robotic platform in the wireless mode.

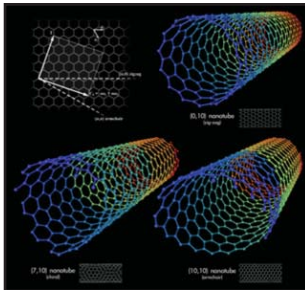

### Non-Explosive IED Defeat Tool

Civilian bomb technicians and military explosive ordnance disposal (EOD) technicians need better tools to safely and remotely disarm improvised explosive devices (IEDs) without using a dynamic explosive disruption tool. The technology that is currently being investigated is carbon nanotubes which could be injected into the body of an IED, thereby short-circuiting its electronics and/or draining current and power from its circuits and batteries before it can activate.

### Multi-Purpose Collapsible EOD Tool Cart

In render-safe operations having rapid access to the necessary tools is essential. The purpose of this effort is to develop a relatively inexpensive Multi-Purpose Collapsible EOD Tool Cart that will enable bomb technicians to carry all the necessary EOD equipment to an incident site to allow quick access and disablement of threats. Additionally, the cart will have the capability to adapt to aid in the remote as well as manual application of render-safe techniques and, if necessary, function as a gurney in the event of casualties. The system will be collapsible in design and easily transportable in a typical bomb squad response vehicle. The cart will assist in the delivery of multiple items such as X-ray equipment, chemical vapor detection, explosives vapor detection, video or still camera equipment, mineral water bottles, counter charges, lights, and a variety of sensors.

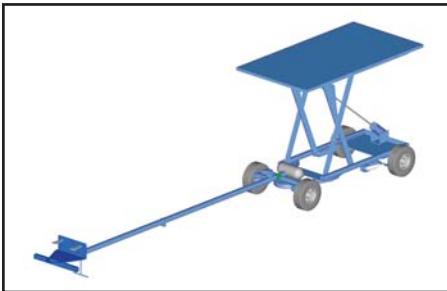

### Rapid Access Neutralization Tool

The Rapid Access Neutralization Tool (RANT) is a robotically deployed, modular system that disables the timing and power units of improvised explosive devices located in vehicles (VBIEDs). The RANT is placed in the front compartment of most vehicles and initiated by either electric or non-electric methods. Once deployed the resultant blast overpressure adds a secondary contributory effect and is largely responsible for compromising the vehicle's exterior (roof, windshield, and doors). Ideal Tool Company is currently assessing the transition phase to manufacture and market the RANT.



### Contact Information

iddsubgroup@tswg.gov

*Investigative Support  
& Forensics*

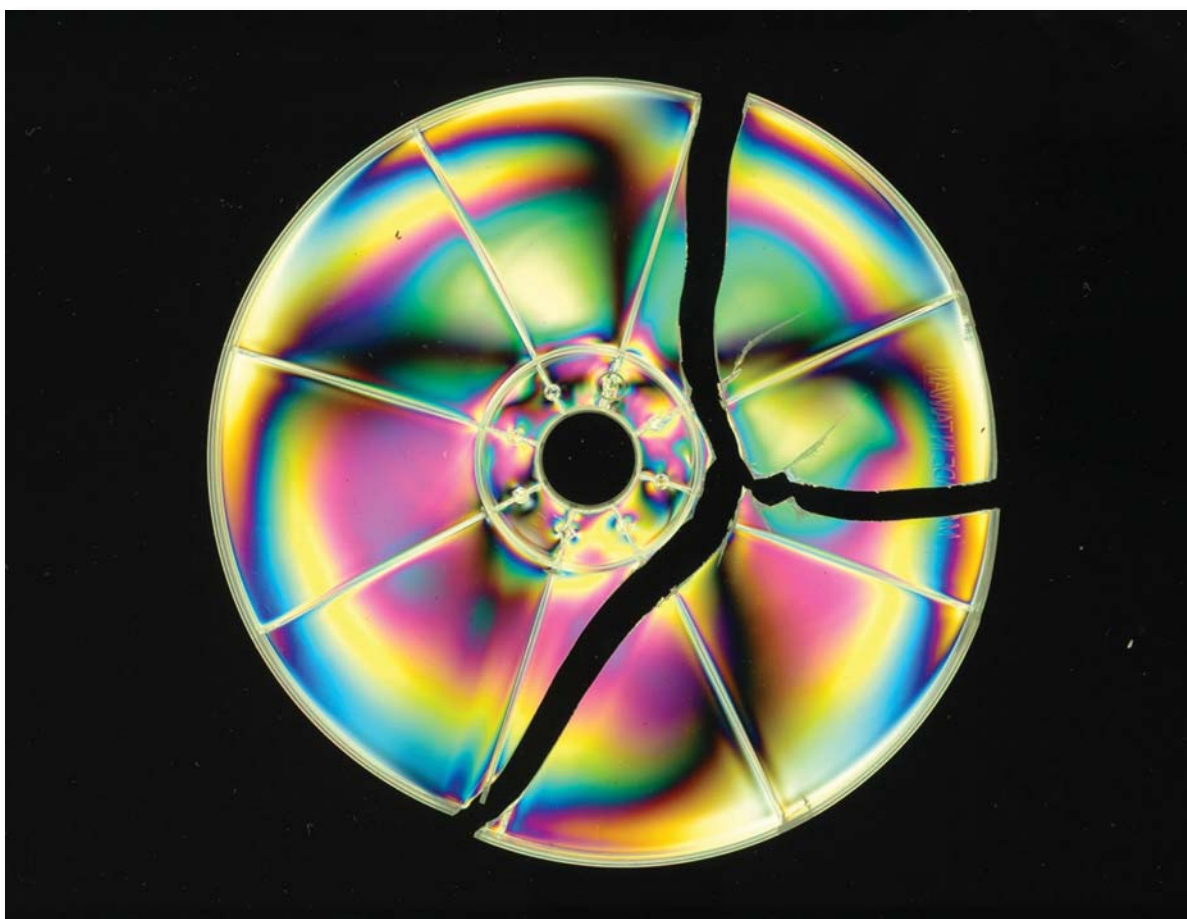

## Investigative Support & Forensics

### Membership

ENVIRONMENTAL PROTECTION AGENCY  
NEIC

Federal Reserve Board

Intelligence Community

Long Beach (CA) Police Department

Los Angeles County (CA) Sheriff's  
Department

National Transportation Safety Board

South Pasadena (CA) Police Department

U.S. Capitol Police

U.S. Department of Commerce  
NIST (OLES)

U.S. DEPARTMENT OF DEFENSE  
CIFA, DACA, DCFL, DCIS, NGA,  
PFPA, USA (CID, ISC), USAF (OSI),  
USMC (CID), USN (NCIS)

U.S. DEPARTMENT OF ENERGY  
HSS

U.S. DEPARTMENT OF HOMELAND SECURITY  
FLETC, ICE (FDL, FPS), TSA (FAMS),  
USSS

U.S. DEPARTMENT OF JUSTICE  
ATF, DEA, FBI, NIJ (NCFS, NFSTC),  
USMS

U.S. Department of State  
S/CT

U.S. Department of the Treasury  
IRS, OIG

U.S. POSTAL INSPECTION SERVICE

### Mission

*Identify, prioritize, and execute research and development projects that satisfy interagency requirements for criminal investigation, law enforcement, and forensic technology applications in terrorism related cases.*

The Investigative Support and Forensics (ISF) subgroup implements research and development projects that provide new capabilities to law enforcement personnel, forensic scientists, and intelligence operatives responsible for investigating and interdicting terrorist incidents. Projects conducted through this group have had a major impact on forensic investigations and intelligence operations throughout the law enforcement community. A representative from the U.S. Army Criminal Investigation Laboratory chairs the subgroup.

### Focus Areas

The ISF subgroup focus areas reflect the prioritized requirements of the military and civilian law enforcement communities. During FY 2007, these focus areas were:

#### Crime Scene Response

Improve the quality of recognition, documentation, collection, and preservation of evidence as well as the safety of first responders at a scene. Train first responders and forensic examiners and improve their capabilities to process and record terrorist incident scenes for future prosecution. Support scientific and technical efforts not assigned to other ISF focus areas.

#### Electronic Evidence

Develop computer forensic hardware, software, decryption tools, and digital methods to investigate terrorism. Develop advanced methods to extract and enhance audio recordings and video images from surveillance sources. Identify computer systems and media used by terrorists and extract the maximum amount of evidence from them. Improve techniques for the analysis of electronic devices to obtain the most forensic information.

#### Explosive and Hazardous Materials Examination

Improve methods for assessing the size, construction, and composition of explosive devices or other energetic hazardous materials. Identify and analyze explosive residue and other trace evidence present at blast scenes, especially those requiring rapid protection and processing to preserve the evidentiary value. Develop advanced techniques for post-blast scene and evidence examinations.

## Forensic Biochemistry

Develop analytical methods for biological evidence found at terrorist scenes to make identifications and extract the maximum information such as origin or age. Enhance the use of DNA or other person-specific identifiers to track, identify, or profile persons or other biological material. Use stable isotope ratios to determine the geographic origin of organic material.

## Friction Ridge Analysis

Improve latent print and related biometric techniques used in terrorism cases. Emphasize processes involving the automation of techniques that are tedious, expensive, non-portable, or reliant upon hazardous chemicals. Create better visualization and development of latent prints using lasers or more versatile and affordable reagents. Support better comprehension of latent prints and their molecular content as well as the scientific validation of fingerprint examinations.

## Questioned Document Examination

Develop advanced document and handwriting analysis techniques, devise standardized identification criteria, and establish a legal scientific basis for these examinations. Improve the techniques for investigating forgeries, counterfeit documents, disguised handwritings, and writing in different languages and character sets. Develop software to analyze questioned documents and match documents, authors, and document-generation hardware by handwriting analysis or pattern-recognition algorithms.

## Surveillance Technology

Produce new and advanced surveillance and tracking techniques for law enforcement use. Develop better communication capabilities for tactical operations. Improve voice identification and speaker recognition capabilities. Advance credibility assessment interviewing techniques and technologies.

## Selected Completed Projects

### Statistical Verification of Camouflage Clothing Patterns

Terrorists and criminals often commit crimes while wearing clothing with camouflage patterns such as military Battle Dress Uniforms. Much like identifying an individual through fingerprints, forensic investigators can expertly match uniforms appearing in crime-scene surveillance images to those recovered from suspects. Such a match is a strong piece of courtroom evidence, but to maximize its usefulness one must know how close the match really is—that is, how many other uniforms may also appear to match. The Military Uniform Uniqueness Statistical Evaluator (MUUSE) is a new, state-of-the-art tool that answers this question for investigators. MUUSE,

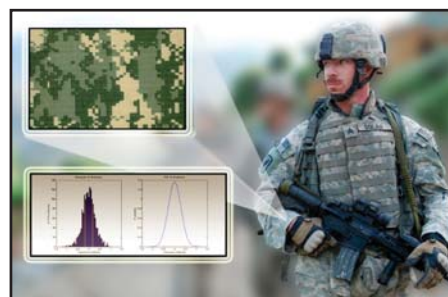

## Investigative Support & Forensics

developed by Quantum Signal, LLC, provides statistical data on the uniqueness of match, enabling investigators to better understand the strength of their garment-match evidence and thus whether to include/exclude suspects from the investigation. MUUSE is currently used for US DOD uniforms, and can also be adapted to other camouflage uniforms and clothing. Requests for additional information should be sent to Quantum Signal at [info@quantumsignal.com](mailto:info@quantumsignal.com).

### Digital Automotive Image System

Solving a terrorist investigation involving motor vehicles often requires quick access to images and data about cars. Southwest Research Institute developed a system that gives investigators this capability. The system, which fits entirely on one DVD, has front, side, and rear photos of motor vehicles commercially manufactured in the last twenty years. The data is searchable by vehicle category, body style, number of doors and other characteristics. It can generate “Be on the Lookout”-type posters and produce photo line-ups. The basic design allows for periodic updating to keep the database current. The DVD permits an unlimited number of downloads of the system to computer hard drives. The developer has distributed about 20,000 of the DVDs to Federal, State and local law enforcement and counterterrorism agencies throughout the United States. Requests for additional information should be sent to [DAIS@fbiacademy.edu](mailto:DAIS@fbiacademy.edu).

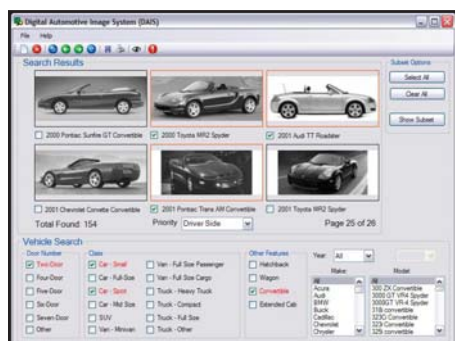

### Avatar for Credibility Assessment Implementation

The facial features, skin color, or voice pitch of an interviewer may affect the results of an interview. However, research to improve credibility assessment by mitigating gender and cultural biases has been difficult—no two live interviews can be identical, even with the same interviewer and interview script. To enable systematic studies of these multiple variables, Battelle developed a computer-generated three-dimensional avatar of a human head. The Avatar for Credibility Assessment Implementation software enables an interviewer to create a fully-customizable avatar and script an interview, including the details of the avatar’s appearance, voice, speech, and gestures, through an easy-to-use graphical interface. Avatar’s use of a single-base mesh modified with overlays and shades provides avatar-independent pseudo-real-time animation and co-articulation effects. The software can interpret a subject’s yes and no verbal answers, conduct a branching interview based upon them, and log each query and response for later detailed analysis. Requests for additional information about the Avatar tool should be sent to [avatar@battelle.org](mailto:avatar@battelle.org).

## Text Attribution

Frequently, acts of terrorism involve messages that do not contain handwriting, preventing the use of forensic handwriting comparison to identify the author. Appen Pty, Ltd. developed the Text Attribution Tool (TAT) to analyze text to predict information about the author. The automated system evaluates vocabulary, spelling, writing style, linguistics and other indicators. These indicators yield traits about the author, such as age, sex, education, religion, geographic orientation and native language. The TAT has the ability to analyze text in both English and Arabic. The Text Attribution Tool can also compare a received message with those stored in its database for a positive identification that the same author wrote both documents. The tool can also give statistical probabilities on the results derived from the database to allow for defensibility in a court of law. Requests for additional information on the Text Attribution Tool should be sent to [appen@appen.com.au](mailto:appen@appen.com.au).



## Best Practices for Retrieval of Video Evidence from Digital CCTV Systems

Present-day security and surveillance systems often use digital closed-circuit television (DCCTV). Because of its value as possible evidence, as well as its potential significance for intelligence and security matters, it is imperative that law enforcement officials recognize, protect, and properly collect video from DCCTV systems. Several law enforcement agencies collaborated to produce a best-practices guide that contains established and proven techniques for evidence collection from DCCTV. The pocket-sized booklet contains guidelines meant to inform agencies of the best practices, guidelines and recommendations to retrieve recorded data from crime scenes while maintaining its integrity. It also serves as an excellent training reference for first responders. Requests for the guide should be sent to [pubs@tswg.gov](mailto:pubs@tswg.gov).

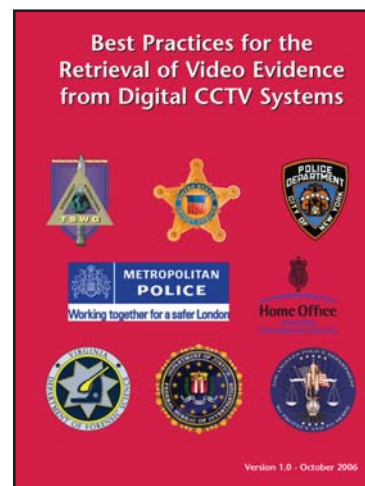

## Selected Current Projects

### Steganography Decryption

Terrorists can communicate secretly over the Internet by using steganography, which is the process of hiding messages in innocent-looking e-mails, images, or files. AccessData is producing a software tool that detects messages containing steganography, then isolates and decrypts them. In addition to having advanced detection and decryption capabilities, the tool will use distributive network attack, a feature that harnesses the unused processing power of computers on a network to provide greater decryption abilities. The system will decrypt nearly every known steganographic process and will be able to analyze many file types. The software tool will also allow for the addition of new decryption processes as they become available in the future.



## Investigative Support & Forensics

### Sensitive Site Exploitation Kit

Soldiers performing Sensitive Site Exploitation need to be able to collect more information from captured material in less time. Blackbird Technologies is developing a compact, rugged, all-in-one kit to exploit in real-time the information available from evidence while soldiers are still on the objective in combat zones and sensitive areas. They have developed a software application that integrates “best-in-class” off-the-shelf sensors to allow rapid forensic collection, matching, and transmission of data from an objective including biometric data, cell phone and hard drive data, photographs and scanned documents. The system also tags and associates all output files from the sensors with all the other files collected on the objective, as well as the target GPS location and date/time of the event, thus allowing for a more thorough analysis of data when the mission permits.



### Portable Ruggedized Cooled and Heated Canine Kennels

Extreme temperatures can cause operational canines to perform for shorter periods of time and far less effectively than in moderate environmental conditions. To maximize the dog’s performance and prevent health hazards such as heat stroke and bloat, Technical Products, Inc. is developing a portable, ruggedized, temperature-controlled canine kennel. With its heating and cooling capability, it ensures that the dogs will maintain their proper core temperature before and after mission sets. The lightweight kennel is easily portable and readily fits into military vehicles, including large and small aircraft. These next-generation kennels can operate off of wall outlets, batteries, and military vehicle electrical outlets while withstanding the challenging demands of a tactical environment.

### Contact Information

isfsubgroup@tswg.gov



## *Physical Security*



## Physical Security

### Membership

ENVIRONMENTAL PROTECTION AGENCY  
NHSRC

FEDERAL RESERVE BOARD

INTELLIGENCE COMMUNITY

NEW YORK POLICE DEPARTMENT

NUCLEAR REGULATORY COMMISSION

PORT AUTHORITY OF NEW YORK/NEW  
JERSEY

U.S. CAPITOL POLICE

U.S. DEPARTMENT OF DEFENSE  
ATSD (NCBD), CENTCOM, DATSD  
(NM), DIA, DTRA, JIEDDO, NSA,  
OASD-HD (DCIP), OUSD (I), PFFA,  
PSEAG, USA (CECOM, COE-PDC,  
PM-FPS, REF), USAF (AFSFC, FPSS),  
USMC (MARCENT,  
MARCORSYSCOM), USN  
(NAVEODTECHDIV, NAVEUR,  
NCIS, NSWC, ONR, SPAWAR)

U.S. DEPARTMENT OF ENERGY  
HSS, NNSA

U.S. DEPARTMENT OF HOMELAND  
SECURITY  
FEMA, NCSO, S&T, TSA, USCG,  
USSS

U.S. DEPARTMENT OF JUSTICE  
BOP, NIJ

U.S. DEPARTMENT OF STATE  
DS

U.S. DEPARTMENT OF TRANSPORTATION  
FAA, RITA (VOIPE CENTER)

U.S. POSTAL INSPECTION SERVICE

### Mission

*Identify, prioritize, and execute research and development, testing, evaluation, and commercialization efforts that satisfy interagency requirements for physical security technology to protect personnel, vital equipment, and facilities against terrorist attacks.*

The Physical Security (PS) subgroup identifies the physical security requirements of Federal, State and local agencies, both within the United States and abroad, and develops technologies to protect their personnel and property from terrorist attacks. The subgroup creates prototype hardware, software, and systems for technical and operational evaluation by user agencies. A Department of Defense representative from the Physical Security Equipment Action Group and a Department of Energy representative co-chair the subgroup.

### Focus Areas

The PS subgroup focus areas reflect the prioritized requirements of the physical protection community. During FY 2007, these focus areas were:

#### Entry-Point Screening and Access Controls

Develop multiple technologies and techniques to detect explosives, weapons, and other contraband on or in personnel, vehicles, vessels, cargo, and mail entering protected facilities. Increase detection rates, throughput, and safety through remote automation while reducing the reliance upon security forces to perform the screening process. Develop expeditionary access control for admissible personnel and vehicles; integrating identity management, radio frequency identification, license plate reader, automated image anomaly detection technology, and remote communications.

#### Intrusion Detection, Assessment, Delay, and Response

Develop improved intrusion detection systems, video alarm assessment systems, specialized intrusion-delay barriers, and subsequent armed response capabilities for protecting outer perimeters, building perimeters, and key assets from terrorist attacks. Develop prototype security systems with fewer false alarms, improved reliability, higher probability of detection and assessment, lower operation and maintenance costs, and more effective response capabilities.

#### Infrastructure Protection

Develop technological solutions for the protection and assurance of defense-critical infrastructure systems vital to national and economic security. Prevent and mitigate threats to computer networks; standardize methodologies and decision aids for the analysis of elements to secure the nation's infrastructure, including power generation, utilities transmission, water supplies, and health services.

## Physical Security

### Maritime Security

Develop technologies to protect ships, boats, docking facilities, offshore platforms, shore-side loading facilities, power plants, bridges, marine cables, and pipelines from any form of terrorist attack. Develop and test technologies to include manned or unmanned long-range and short-range sensors for detection and tracking; physical barriers and stopping devices; underwater, surface and air vehicles; weapons; armor; communications and command and control systems; life support; diving and underwater systems; and mammal systems.

### Selected Completed Projects

#### Forwardscatter Detector System

Non-intrusive inspection imaging systems are used by military and law enforcement security operations to view the interiors of vehicles and cargo at checkpoints and facility entry control/access points. American Science & Engineering, Inc. developed the Forwardscatter Detector (FSD) System to complement its existing Z-Backscatter X-ray Systems, including the Z-Backscatter X-ray Van (ZBV). While the Z-Backscatter technology is designed to detect bulk organic objects, the FSD System provides an additional capability for detecting bulk metallic objects by positioning FSDs opposite the x-ray source to capture forward-scattered x-rays. The FSD System is suitable for use with fielded ZBVs; can be mounted on a fixed barrier or on a military trailer; and is operable in portal mode by having the vehicle/cargo move between the FSD and the Z-Backscatter X-ray source. In addition, system operators are able to simultaneously view the Z-Backscatter and Forwardscatter images, thus enhancing their ability to examine vehicles and cargo for concealed weapons, contraband, and other threat items. Requests for additional information should be sent to [pssubgroup@tswg.gov](mailto:pssubgroup@tswg.gov).



#### Protected Aircraft Communications Addressing and Reporting System

The Communications Management Unit (CMU) of an airplane manages the automated communications of the planes data link with ground stations. This data link allows for tracking of the plane's air speed, altitude, destination, wheels heavy/light, and other information. Over time, the amount of data link traffic has become increasingly sensitive. Honeywell and Rockwell, working with Arinc, developed an encryption capability for Protected Aircraft Communications Addressing and Reporting System (P-ACARS) for military CMUs. In 2006 the system was successfully tested to encrypt simulated messaging up to 10,000 simultaneous transmissions. This significant success with P-ACARS prompted a new pilot project with the Air Force for porting the application into their CMUs, with testing on various military aircraft throughout 2007. Requests for additional information should be sent to [pssubgroup@tswg.gov](mailto:pssubgroup@tswg.gov).



## Physical Security

### Automated Cyber Assessment



This assessment software, developed by RiskWatch, automates the government's existing paper-based cyber vulnerability assessment methodologies. This cyber assessment tool enables the end user to categorize the security requirements and assets to be protected. The software automatically links these requirements and assets to fully customizable cost and threat values for many types of government facilities. This automated product has the potential to save the government money by analyzing the return on investment of specific security alternatives and creating standardized report templates tailored to the user. In early 2007, a successful pilot test based on Government regulations demonstrated the effectiveness of the software. In addition, the system is affordable and costs far less than most customized software applications. Requests for additional information should be sent to [pssubgroup@tswg.gov](mailto:pssubgroup@tswg.gov).



### Selected Current Projects

#### Tri-Fusion Camera

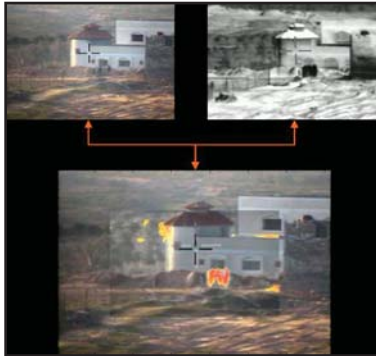

Though there are many imaging systems on the market, each has a specific purpose. For physical security and surveillance missions, the U.S. Armed Forces need a single camera that digitally fuses CCTV, image-intensified, and thermal feeds into one view for greater definition and detail for security personnel. TSWG and an international partner are currently developing a system that will provide greater image definition for enhanced threat analysis and prevent security lapses by mitigating the need to switch between camera systems as ambient light conditions change. Maximum image clarity will be achieved through automated blending software algorithms. The operator will also have the ability to manually adjust the amount of video, image-intensified, and thermal images in a single display.

#### Potomac Basin Security System

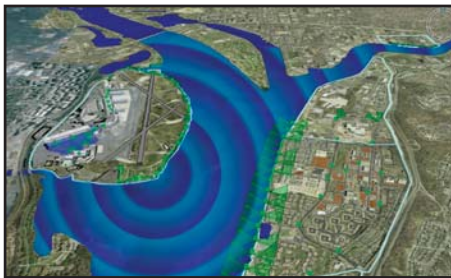

Currently, there is no method for adjacent military bases to exchange surveillance and other security information. Security personnel at these sites would benefit from sharing information, allowing for greater standoff detection and reaction times to hostile forces. The Potomac Basin Security System is a demonstration project that will allow security personnel at various sites on the Potomac River within the Military District of Washington, D.C. to increase their surveillance capabilities by gathering and disseminating data from various existing sensors. The system will combine the data from multiple users at different agencies into a single output. By designing a scalable command and control structure, the security personnel will gain total domain awareness outside their immediate area of surveillance.

## Physical Security

### Underwater Inspection System

Seaports have long been vulnerable to underwater threats that are undetectable from above the surface. To combat such threats, TSWG initiated the design of an Underwater Inspection System (UIS) for use on small vessels to conduct rapid, comprehensive searches of ship docking facilities, port seawalls, and other shallow water structures. The UIS will provide the port security community with an increased rapid-imaging capability for underwater structures in order to detect damage, indications of tampering, or emplacement of explosive devices. The UIS is a small-boat 3-D sonar system based on the Echoscope II sonar, and will provide geo-referenced sonar images in real-time for immediate indication of potential underwater threats or other problems. Three prototypical UIS systems will be delivered to the U.S. Coast Guard in late 2007 for immediate evaluation.

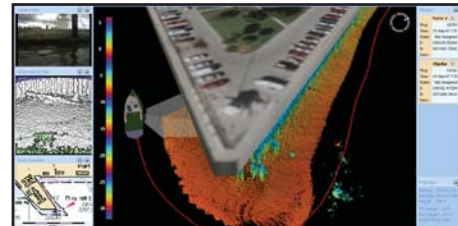
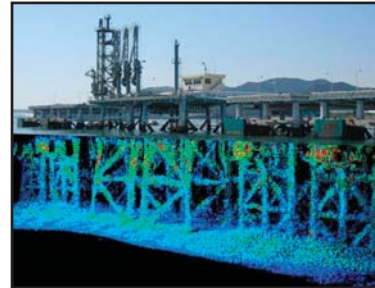

### Digital Observation Guard

Standard surveillance equipment typically is not small or portable enough to be used anywhere but a base or installation. Small tactical military teams operating outside of the range of permanent base facilities require a rapidly deployable, recoverable, self-contained video surveillance system for use in open areas and around safe houses. The Digital Observation Guard is an automated intrusion detection and alerting system comprised of four miniature all-weather day/night cameras hardwired to a central command and control station. All cameras will have pan/tilt/zoom capabilities and 360-degree rotation for greater situational awareness. The system is expected to undergo testing in mid-2008.

### Ruggedized Non-Intrusive Inspection Imaging Systems

The drawback to most inspection imaging systems is that they are neither portable nor rugged enough for use at ad-hoc checkpoints in austere environments. In parallel efforts, American Science & Engineering, Inc. and Science Applications International Corporation are developing ruggedized trailer-based systems that offer force protection officials the capability to conduct interdiction efforts apart from fixed facilities. Both systems will be capable of being transported on C-130 aircraft. They will be operable in locations with fine particulate dust and in temperatures of  $-20^{\circ}\text{C}$  to at least  $50^{\circ}\text{C}$  and will be able to function on primary, secondary, and unimproved road surfaces. Another important feature will be the remote operation capabilities. The systems were scheduled to undergo Government performance, safety, and environmental testing in late 2007.



## Physical Security

### Knowledge Display Aggregation System

Within the broad military context, access to accurate and up-to-date geospatial information is absolutely critical. Within the context of Defense Critical Infrastructure Program (CIP), the DoD risk management program for CIP seeks to ensure the availability of key assets critical to DoD missions. Because of the pervasive nature of geospatial information within our government and society, processes and procedures are required by which authoritative geospatial information can be developed, maintained, and shared across a wide range of functions and mission areas. As a requirement from the Office of the Assistant Secretary of Defense Homeland Defense (OASD-HD), a prototype desk-top touch table display and data integration tool called the Knowledge Display and Aggregation System (KDAS) was unveiled at the Defense Industrial Base CIP conference in Miami. The success of the project has led to a request for KDAS prototypes to be delivered to OASD-HD by January 2009.

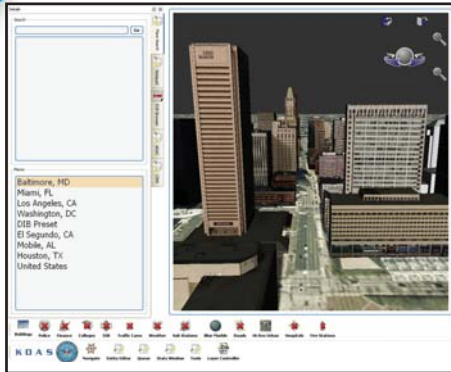

### Electrical Power Transmission Line Security Monitor

The energy infrastructure is one of several critical terrorist targets that, when disrupted, impact the economy, safety, and national security of the U.S. government, military, private industry, and general public. The ability to alert local and regional utility transmission operators to attacks in real time may provide sufficient warning to allow for preemptive system control, thereby preventing regional outages and giving the military and/or law enforcement agencies a chance to terminate the attack in process or capture the adversaries in the area of the attack. Idaho National Labs will produce technology for testing and deploying a pilot sensor platform with multiple security sensors on board. The sensors will be installed on electrical power transmission lines for an extended period of time in order to perform a durable system operational test for detecting tower intrusions or attempts to sabotage power line towers. A prototype is expected to be available in 2008.

### Contact Information

pssubgroup@tswg.gov

## *Surveillance, Collection, & Operations Support*



Photo by USMC Lance Cpl. Wayne Edmiston

## *Surveillance, Collection, & Operations Support*

### **Membership**

INTELLIGENCE COMMUNITY

U.S. DEPARTMENT OF DEFENSE  
USSOCOM

U.S. DEPARTMENT OF JUSTICE  
FBI

### **Mission**

*Identify, prioritize, and execute research and development projects that satisfy interagency requirements supporting intelligence gathering and special operations directed against terrorist activities.*

The Surveillance, Collection, and Operations Support (SCOS) subgroup identifies high-priority user requirements and special technology initiatives focused primarily on countering terrorism through offensive operations. SCOS R&D projects enhance U.S. intelligence capabilities to conduct retaliatory or preemptive operations and reduce the capabilities and support available to terrorists. A representative from the Intelligence Community chairs the subgroup.

### **Focus Areas**

The SCOS subgroup focus areas reflect the prioritized requirements of the Intelligence Community. During FY 2007, these focus areas were:

#### **Traditional Surveillance**

Improve the quality of intelligence collection. Develop and advance capabilities for the collection and enhancement of video, imagery, and audio surveillance.

#### **Analytical Surveillance**

Improve automated tools for terrorist identification using biometrics, pattern recognition, speech and speaker recognition, and information retrieval from multiple sources.

#### **Command, Control, Communications, Computers, Intelligence, Surveillance, and Reconnaissance**

Develop and improve the capability to locate, identify, and track terrorists and terrorist activities. Support programs and initiatives critical to intelligence and law enforcement operations, such as tagging, tracking, and locating; special sensors; and clandestine communications.

#### **Information Operations Support**

Develop and improve tools to degrade, disrupt, deny, or destroy both analog and digital adversary information and information systems.

### **Program Highlights**

SCOS projects are classified or highly sensitive. Program requirements, the success of projects, and specific capabilities cannot be discussed in an unclassified document.

### **Contact Information**

scossubgroup@tswg.gov



## *Tactical Operations Support*



Defense Dept. photo by U.S. Army Staff Sgt. Michael L. Casteel

## Tactical Operations Support

### Membership

NATIONAL TACTICAL OFFICERS  
ASSOCIATION

STATE AND LOCAL SWAT TEAMS

U.S. DEPARTMENT OF DEFENSE  
USSOCOM

U.S. Department of Energy  
HSS, NNSA

U.S. Department of Homeland Security  
TSA (FAMS), USCG, USSS

U.S. Department of Justice  
FBI (HRT), USMS

U.S. Department of State  
DS

### Mission

*Identify, prioritize, and execute research and development projects that enhance the capabilities of DoD and interagency special operations tactical teams engaged in identifying, attacking and eliminating terrorists. This includes the development of non-sensitive capabilities for State and local law enforcement agencies to combat domestic terrorism.*

The Tactical Operations Support (TOS) subgroup provides technology solutions to assist “direct action” operational personnel in a variety of tactical missions and environments. Most often these solutions are in the form of rapidly prototyped and specialized equipment. Each material solution is specifically designed to provide enhanced mission effectiveness while assisting operational personnel in maintaining “situational awareness.” A representative from the Department of Energy chairs the subgroup.

### Focus Areas

The TOS subgroup focus areas reflect the prioritized requirements of offensive counterterrorism forces. During FY 2007, these focus areas were:

#### Advanced Imaging Systems

Develop solutions that improve reduced-visibility imaging in all operating environments. Provide high-quality images under reduced-lighting conditions to enhance tactical forces’ ability to operate more effectively.

#### Specialized Access Systems

Develop technologies that assist tactical assault forces in gaining rapid access to objectives, improve evaluation of tactical options, and support efficiency of operations, while providing added safety for personnel.

#### Chemical and Radiation Detectors

Develop chemical and radiological detection instruments that are specifically designed to support the tactical user in the field. Design systems that are smaller, lighter, robust, and more covert than conventional technologies. Coordinate these efforts with the CBRNC subgroup.

#### Offensive Systems

Develop equipment and capabilities that enhance the effectiveness of small offensive tactical teams engaged in specialized operations.

## Tactical Operations Support

### Tactical Communications Systems

Develop flexible communications capabilities specifically designed for tactical forces. Emphasize reducing the size of equipment, while improving operator mobility and efficiency.

### Selected Completed Projects

#### M4A1/MK18 Modified Upper Receiver Group (MURG) and 6.8mm Evaluation

At the request of U.S. and foreign military, law enforcement, and special operations forces deployed in the GWOT, TSWG procured and evaluated commercial off-the-shelf (COTS) 6.8x43mm Remington SPC (.270 caliber) drop-on U.S. M4/16-style upper receiver groups and commercial ammunition performance with government off-the-shelf (GOTS) M4/M16-style weapons to address documented combat failures of 5.56x45mm NATO small arms and ammunition. Standard issue 5.56x45mm NATO M855 ammunition is designed for rifles and machine guns with barrel lengths greater than 18". The short-barreled U.S. M4 Carbine (14.5") and MK18 CQBR (10") exhibit unpredictable and relatively poor wound ballistics, terminal effects, and incapacitation/lethality on threat personnel targets and barriers because of the reduced striking velocity and effects on target. Prospective MURG users desired enhanced terminal effects, improved accuracy and increased barrier penetration on target from concealable rifle-caliber small arms often required when operating from mobility platforms or conducting Close Quarters Battle operations. TSWG sponsored a six-month joint interagency project that assessed test articles from nine commercial vendors during 22 test phases. The project demonstrated that select COTS 6.8x43mm Remington SPC MURGs can be installed on GOTS M4 Carbine lower receivers by operators in the field quickly and without tools for an immediate, considerable increase in projectile weight, surface area, and on-target terminal performance. The 6.8mm MURG offers improved combat capability and user survivability over comparable 5.56mm platforms. Several MURG platforms met over 95% of established threshold and objective performance specifications. Test data from this project supports 6.8mm platform fielding in some of the participating organizations. Select COTS MURG hardware and ammunition has preliminary U.S. DoD JAG approval for fielding and is available from various commercial vendors. A restricted-distribution report is available to approved personnel by contacting [tossubgroup@tswg.gov](mailto:tossubgroup@tswg.gov).



### Selected Current Projects

#### Enhanced Situational Awareness – EBR1

The Eye Ball R1 (EBR1) is a compact, wireless 360° mobile display system, designed for tactical operations where law enforcement or military personnel need to assess the situation before entering a building, floor, or room. The Eye Ball R1 is rugged, allowing users



## Tactical Operations Support



to roll, toss, lower, or throw it as situations demand. The EBR1 rotates 360° to gradually scan the scene, transmitting streaming video and audio in real time, via wireless communication, to a personal display unit (PDU). The PDU displays the images received from the Eye Ball and controls the rotational direction of the sensor. Each sensor is packed in a handheld durable ball, designed to be thrown to remote and potentially dangerous locations without exposing the operators to the danger. The EBR1 can sustain shocks and vibrations as well as other harsh environmental conditions. It can quickly be attached to a pole or lowering line, providing visibility into ceilings, attics, tunnels and caves, and its near-infrared capability is essential for night or dark operations. Other applications include surveillance operations and search and rescue missions. TSWG is conducting a large-scale assessment of the EBR1 with several interagency tactical organizations to receive feedback on development of an urban operations toolkit. The assessment will be completed in early 2008.

### Universal Communications Converter

Special operations forces need a tactically employable converter that will allow them to connect and pass voice or data transmissions across disparate communications systems. This converter must be capable of operating on either secure or unsecure networks and, in some cases, both simultaneously. The Universal Communications Converter provides that capability to connect between military or civilian systems. It receives transmissions from multiple digital or analog sources, converts it the appropriate format and then routes it to the designated receiver network. Deployed field operators are now able to take advantage of the communications systems and networks available in their local area and, using their existing tactical communications devices, seamlessly connect to distant or local stations.

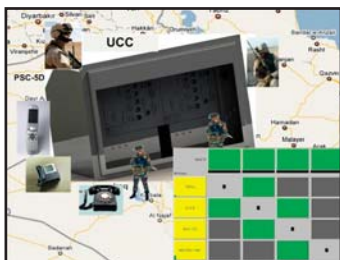

### Fully Integrated Ballistic Helmet

Special Weapons and Tactics (SWAT) teams rely on helmets to provide protection from ballistic, blast, fragmentation, and blunt trauma threats. While several contemporary designs can provide this protection, the helmets are generally bulky and uncomfortable. Discomfort increases with the addition of modular attachments such as lights, night-vision goggles, cameras, and other similar equipment. Irritation caused by an uncomfortable helmet can distract operators during missions. Furthermore, SWAT employs either a military tactical or commercial variant of a military style Kevlar helmet. These helmets often employ retention/suspension attachment systems that are not supportive of the highly aggressive head movements or tactical procedures required of SWAT missions. Consequently, SWAT teams require a comfortable and effective fully integrated ballistic helmet that is also not cost-prohibitive.



### Contact Information

tossubgroup@tswg.gov

## *Training Technology Development*



U.S. Marine Corps photo by Lance Cpl. Michael L. Haas (Released)

## Training Technology Development

### Membership

#### INTERAGENCY BOARD

#### NATIONAL BOMB SQUAD COMMANDERS ADVISORY BOARD

#### NATIONAL VIRTUAL TRANSLATION CENTER

#### U.S. DEPARTMENT OF AGRICULTURE APHIS

#### U.S. DEPARTMENT OF DEFENSE JIEDDO, OUSD (P&R), PFFA, USA (MANSCEN, NGB, RDECOM, TRADOC), USMC, USN, USSOCOM

#### U.S. DEPARTMENT OF ENERGY HQ

#### U.S. DEPARTMENT OF HOMELAND SECURITY CBP, FLETC, FPS, S&T, USCG

#### U.S. DEPARTMENT OF JUSTICE NIJ

#### U.S. DEPARTMENT OF STATE DS

### Mission

*Identify, prioritize, and execute projects that satisfy interagency requirements for the development and delivery of combating-terrorism-related education, training, and mission performance support products and technologies.*

The Training Technology Development (TTD) subgroup delivers training and training technologies to increase mission readiness and enhance operational capabilities in the combating-terrorism community. The strategy behind the mission is to integrate and leverage advanced distributed learning (ADL) technologies to deliver high-quality education and training in the medium best suited to the users' needs and requirements. Representatives from the Department of Defense and the Department of Homeland Security co-chair the subgroup.

### Focus Areas

The TTD subgroup focus areas reflect the prioritized requirements of the military and civilian combating-terrorism communities. During FY 2007, these focus areas were:

#### Delivery Architectures

Develop new, advance emerging, and enhance existing learning, content, and knowledge management technologies. Develop software and hardware technologies, architectures, and infrastructures to deliver information, education, and training to personnel combating terrorism. Emphasize ubiquitous and distributed computing to provide the basis for information and training technology interoperability, the standards needed to provide distributed, on-demand, customized training consistent with future computing infrastructure, and proven methods of effective individualized instruction and electronic performance support.

#### Advanced Training and Education

Develop programs of instruction, training packages, computer- and classroom-based combating-terrorism training courses. Develop the advanced tools, techniques, and guidelines required to analyze needs, develop solutions, and evaluate results. Analyze performance needs to identify applicable solutions. Integrate delivery technologies with combating-terrorism training materials to increase the quality, effectiveness, and accessibility of training.

#### Training and Information Aids and Devices

Develop job aids, training aids, performance improvement solutions, and training support devices to support mission performance and increase mission readiness. Develop pocket guides, flipbooks, and other aids for TSWG products and new areas of research in the combating-terrorism domain. Provide training simulants as aids in training exercises.

## Models and Simulations

Develop interactive models, simulations, and games (MS&G), including tabletop simulations, field exercise simulations, immersive virtual-learning environments, hands-on virtual reality, simulation models, and PC-based, three-dimensional and isometric simulations and games. Develop crowd models, adversarial behavior models, network-based simulations, mini-simulations on specific combating-terrorism related tasks. Incorporate beneficial game characteristics through the full range of game genres (i.e., strategy, first person tactical, massively multiplayer online game, role-playing, etc.). Develop tools, technologies, and techniques for improving MS&G design, development, and validation.

## Selected Completed Projects

### Chemical, Biological, Radiological, Nuclear, and High-Yield Explosives, Advanced Learning, Education, and Response Training (CBRNE ALERT)

Based upon the success of the TSWG-funded, instructor-led courses within the Weapons of Mass Destruction – Response Element Advanced Laboratory Integrated Training and Indoctrination (WMD-REALITI) Program for the National Guard Bureau (NGB), Concurrent Technologies Corporation (CTC) enhanced the delivery of the content by developing a hybrid course (both classroom and web-based). The new course format enhances the overall communities' ability to respond by minimizing time away from duty stations and creating a common learning baseline. CBRNE ALERT converted Level 1 of REALITI – Basic CBRN Identification and Analysis and includes three introductory courses: Biology, Chemistry, and Radiology. These courses are available through Indiana University of Pennsylvania and additional information is available at <http://www.wmdrealiti.iup.edu/index2.html>.



### IED Awareness for First Responders Training Support Package

Improvised Explosive Devices (IEDs) are one of the most significant terrorist threats facing the war fighter. In addition to facing IEDs in current areas of operations, the United States must prepare for the threat of IED attacks against the homeland. Developed by the National Terrorism Preparedness Institute (NTPPI), the IED Awareness for First Responders training support package (TSP) is a complete training package focusing on current IED threats and countermeasures to train first responders on recognizing IEDs, IED components, potential targets, and methods employed by terrorists using IEDs. The TSP contains a train-the-trainer component along with PowerPoint™ presentations, supporting subject matter expert video demonstrations, printable student materials, and student evaluations for an instructor to prepare their students in both the classroom and hands-on training environments. The TSP is available from the Government Printing

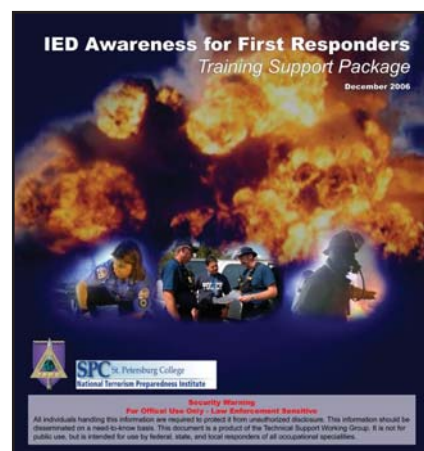

## Training Technology Development

Office, and product procurement information is available at [http://www.tswg.gov/tswg/Prods\\_Pubs/iedatasp.htm](http://www.tswg.gov/tswg/Prods_Pubs/iedatasp.htm).

### Authoring Tool for ADL 3-D Simulations

Both military personnel and civilian first responders share a common need to deliver in-depth equipment training and interaction in realistic situations. To meet this need, Vcom3D, Inc. has developed a suite of authoring tools that produce equipment specific training for any type of equipment. These authoring tools provide the functions necessary to create or import Computer Assisted Drawing (CAD) models, to simulate the functionality of the 3-D devices, and to add a virtual character that demonstrates the equipment's operation and coaches the students on how to operate and use the equipment. The tools provide the capability to rapidly create or integrate 3-D, 360-degree rendering and simulations into web-based and CD-based equipment training. The training is independent of the piece of equipment, level-three interactive, and conforms to the Shareable Content Object Reference Model 2004 specification. Requests for ordering information should be sent to [ttdsubgroup@tswg.gov](mailto:ttdsubgroup@tswg.gov), or visit the Vcom3D Web site at <http://store02.prostores.com/servlet/vcom3dinc/StoreFront>.

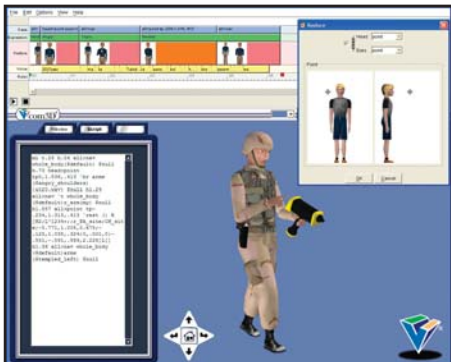

### Preparation for the Suicide/Homicide Bomber Pocket Guide

As the frequency of suicide bombings increases worldwide, U.S. military and civilian personnel need on-the-job accessibility to threat specific information to maintain a threat awareness posture. The National Terrorism Preparedness Institute (NTPI) developed the Preparation for the Suicide/Homicide Bomber Pocket Guide to present information on goals of the suicide/homicide bomber, potential methods of attack, detection, proactive and reactive responses, safety concerns and how to deal with the aftermath of such an attack. This guide is designed as a quick reference guide, based on existing information contained in the Preparation for the Suicide/Homicide Bomber Training Support Package, to detect and reduce the effects of a suicide/homicide bomber attack. The pocket guide is available from the Government Printing Office, and product procurement information is available at [http://www.tswg.gov/tswg/prods\\_pubs/SHBG.htm](http://www.tswg.gov/tswg/prods_pubs/SHBG.htm).

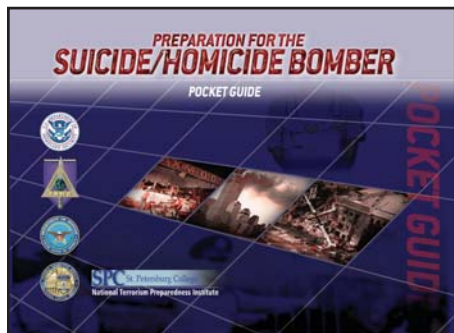

### Selected Current Projects

#### COBALT Quarterly Bomb Squad Training

In order to respond effectively, bomb squad training must target established and evolving threats, and present comprehensive and practical experience with IEDs. Project COBALT provides opportunities for unit level bomb squads to collectively anticipate, recognize, and respond to threats by providing unit level skills practice, response strategy preparation and refinement, and an increase in the overall knowledge required to manage and mitigate existing and emerging threats. The quarterly training modules target the



following four emerging threat areas: Multiple IEDs, Homemade Explosives, Vehicle-borne IEDs, and Suicide Initiated or Carried Devices. In addition to quarterly exercise-based training, an electronic framework has been developed to facilitate rapid development of future exercise-based unit level bomb squad training. Two of the four training modules have been completed in 2007. The remaining two modules will be completed in 2008 as the program is transitioned to end users.

### **Adaptive Simulation Agents for Adversarial Behaviors**

With today's military missions being conducted in urban terrain and against forces using asymmetrical warfare techniques, the current constructive simulation systems commonly used by the military that reflect large-scale, force-on-force warfare doctrine are not sufficient. The Government-Industry-Academia (GIA) Simulation Lab is designing and developing adaptive and autonomous agent-based simulation characters for current and potential threats, such as a Suicide Bomber, Sniper, IED Ambusher, Bomb Maker, and Change of Sides. The program will yield models with representative behaviors, rules, and effects within a distributed training system to prepare individual war fighters, leaders, and staffs for asymmetrical operations and threats and to apply operational lessons learned. The autonomous agents will allow future training systems to adaptively address operational needs based on current and potential future threats and identified in lessons learned from combat-experienced war fighters and leaders. The project will be completed in early 2008.



### **Homemade Explosives Training Initiative**

Homemade Explosives (HMEs) are a growing threat that affects our military personnel and first responders every day. TSWG coordinates an HME working group that incorporates various Federal, State, local, and international partners to combat this threat. Applied Research Associates is conducting a needs analysis and developing performance improvement and training products based on the results of the working group discussions and the needs analysis. Two products emerging from the working group discussions are the Indicators and Warnings for Homemade Explosives Pocket Guide and the Industry Awareness Pamphlet. Other HME-related products will be developed as needs continue to emerge. The Indicators and Warnings for Homemade Explosives Pocket Guide and the Industry Awareness Pamphlet will be available in early 2008 from the Government Printing Office.

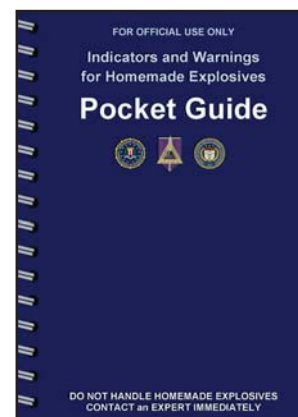

### **Contact Information**

ttdsubgroup@tswg.gov



## *VIP Protection*



Department of Defense photo by Cherie A. Thurlby

## VIP Protection

### Membership

INTELLIGENCE COMMUNITY

U.S. CAPITOL POLICE

U.S. DEPARTMENT OF COMMERCE  
NIST-OLES

U.S. DEPARTMENT OF DEFENSE  
PFPA, USA (SSC, TACOM), USN  
(NCIS), USSOCOM

U.S. DEPARTMENT OF ENERGY

U.S. DEPARTMENT OF HOMELAND SECURITY  
USSS (SSD, TSD)

U.S. DEPARTMENT OF HOUSING AND URBAN  
DEVELOPMENT

U.S. DEPARTMENT OF JUSTICE  
NIJ, USMS

U.S. DEPARTMENT OF STATE

U.S. DEPARTMENT OF THE TREASURY  
IRS

### Mission

*Identify, prioritize, and execute research and development projects that satisfy interagency requirements to provide advanced tools, techniques, and guidelines to enhance security for VIPs and their protectors. Particular emphasis is placed on the development of advanced tools, techniques, and guidelines for the prevention and mitigation of terrorist attacks on personnel, vehicles, and infrastructure.*

The VIP Protection (VIP) subgroup develops hardware, personal protection equipment, reference tools, and standards or protocols to enhance the protection of VIPs. Projects focus on putting new tools such as security systems, mobile surveillance systems and protective equipment in the hands of personnel tasked with the safety of VIPs. The subgroup delivers new technologies to Military, Federal, State and local law enforcement protection details. Representatives from the United States Secret Service and Department of Energy co-chair the Subgroup.

### Focus Areas

The VIP subgroup focus areas reflect the prioritized requirements of the personnel protection community. During FY 2007 these focus areas were:

#### Fixed Security

Develop technologies that enhance the protection of fixed facilities used by VIPs. Provide threat detection, defeat, and mitigation tools for a range of attack scenarios to include incoming missile threats. Develop surveillance and perimeter security systems that can be integrated with existing security architectures.

#### Individual Protection

Augment individual protection levels of VIPs and their protectors against a wide range of threats in multiple venues through the development of protection items such as body armor, enhanced communications, and alert systems. Of particular importance to this focus area is enhancing personal body armor. This includes increasing ballistic protection, improving concealability, and reducing weight.

#### Information Resources

Develop reference materials and information management tools to enhance preparation and response capabilities. Conduct equipment performance evaluations and feasibility studies. Develop standards, protocols, and systems to facilitate decision making among the protective services community.

# VIP Protection

## Mobile Security

Improve the ability of security details to protect their VIPs while traveling away from the high-level security of a fixed installation. Develop tamper detection capabilities, mobile surveillance systems, intrusion detection and alert tools, and transportable threat detection systems to increase protection of vehicles, aircraft, temporary living quarters, meeting venues, and public events. This focus area also seeks to develop armor solutions for enhanced ballistic and blast protection against current and emerging threats. Many of these capabilities entail redeployable and customizable solutions that provide flexibility to meet a range of mission requirements and emergency situations.

## Selected Completed Projects

### VIP Security Kit

VIPs are at greater risk of attack when traveling away from their fixed secured facilities. Security details require a surveillance capability at transient locations to enhance situational awareness. Applied Research Associates, Inc. has developed the VIP Security Kit a transportable, quick to install kit that provides real time surveillance to security details. The kit includes cameras, motion detectors, and break sensors, and transmits the surveillance data to a monitoring station. Details can also receive intrusion detection alerts via cell phone, PDA, or e-mail. The security kit records surveillance footage during intrusion events, allowing details to perform post event analysis. Requests for additional information should be addressed to [vipsubgroup@tswg.gov](mailto:vipsubgroup@tswg.gov).

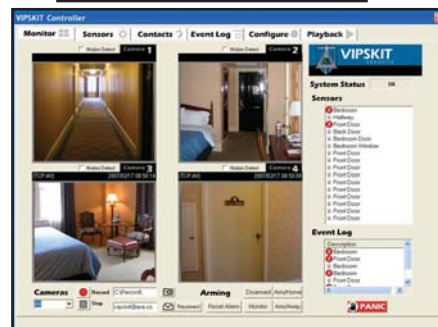

### Indirect Laser Detection and Locating

Lasers are commonly used to initially interrogate a target before a terrorist act is performed. Outfitting security personnel with a tool to detect lasers allows for action prior to a potential attack. Visidyne, Inc. developed an off-axis system that is able to detect lasers in real time and issue a threat alert. The prototype was developed to demonstrate the system at close ranges indoors. To enhance the capabilities of the system the range and outdoor use of the laser requires further development. Requests for additional information should be addressed to [vipsubgroup@tswg.gov](mailto:vipsubgroup@tswg.gov).

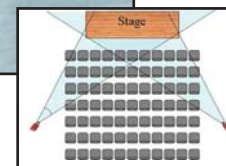

### Multi-Hit Ballistics Test

Body Armor is traditionally validated with single shots in a set pattern at specified distances, with lag time between shots. In combat environments soldiers and law enforcement personnel are subjected to automatic and semi-automatic weapons, generating multiple shots at once. Bosik Technologies, Ltd developed a three-barrel firing fixture and corresponding test protocols to assess multi-hit performance of hard and soft body armor. The test fixture can vary firing rate,



## VIP Protection

angle of obliquity, shot sequence and pattern orientations. This test fixture will be further analyzed for possible inclusion in body armor specification. Requests for additional information should be addressed to [vipsubgroup@tswg.gov](mailto:vipsubgroup@tswg.gov).



### Counter MANPADS Airspace Protection System

Man-Portable Air Defense Systems (MANPADS) are an increasing threat to our military aircraft because they are widely proliferated and are easily concealed and transported. General Dynamics Armament and Technical Products developed a ground-based Counter MANPADS Airspace Protection System that will protect aircraft during ingress and egress operations, where MANPADS are a threat. The system tracks MANPADS upon launch detection and activates a countermeasure laser to disrupt the path of the missile. The ground based system is an economical approach to protecting all aircraft for any landing zone. Live-fire testing of the system was completed October 2007, and the system is being evaluated for transition to the military. Requests for additional information should be addressed to [vipsubgroup@tswg.gov](mailto:vipsubgroup@tswg.gov).



### Portable Armor Wall System

Ballistic and blast attacks are a threat to both military and civilian personnel in remote locations where temporary physical protection is difficult to construct. Dynamic Defense Materials, LLC developed the Portable Armor Wall System (PAWS) a modular system that allows users to assemble a variety of configurations to satisfy mission requirements. PAWS provides ballistic protection up to .50 caliber AP and limited blast protection. The system components are light enough for one man to lift, and can be assembled without special tools. The system can be customized for surveillance requirements by using panels that include windows with ballistic glass. Requests for additional information should be addressed to [vipsubgroup@tswg.gov](mailto:vipsubgroup@tswg.gov).



## Selected Current Projects

### Networked Advanced Vehicle Anti-Tamper and Alert System

Large motor pools are at risk of malicious tampering such as installing tracking devices, vehicle theft, sabotage of the vehicle or its electronics, and attachment of explosive devices. Applied Research Associates, Inc. is developing an anti-tamper and alert system to protect motor pools by integrating sensors with surveillance cameras to alert personnel of possible tampering. The system will integrate with existing facility monitoring and alerting systems, and when the anti-tamper system detects potential events, facility security personnel are automatically notified. The system will integrate with the surveillance capabilities currently available at given facilities.

## VIP Protection

### Wireless Surveillance Earpiece

Government protection personnel rely on communication to maintain situational awareness. Currently protection personnel wear earpieces with conspicuous cords, potentially compromising VIP location information. A wireless earpiece would enable security details to maintain communication without drawing unnecessary attention to VIPs. Science Applications International Corporation (SAIC) is researching and analyzing available wireless earpiece systems against protective personnel requirements. The market assessment has been completed, and the top five candidate earpieces are undergoing lab and user testing. The test report will be finalized during in the first quarter 2008.



### Field-Installable Inconspicuous Vehicle Armor Kit

Personnel conducting low profile missions are often not afforded the safety of armored vehicles. An inconspicuous vehicle armor kit is required to provide ballistic protection without compromising mission security. Global Secure Corporation is developing a versatile armor kit for rapid field installation in a variety of civilian vehicles. The armor will provide multi-hit protection against 7.62 x 39mm PS Ball. The prototype system will be delivered for user evaluation in the first quarter 2008.

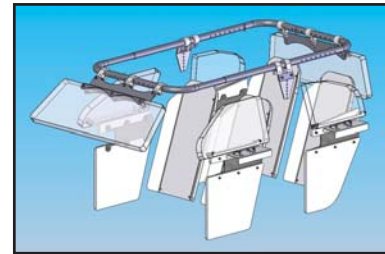

### Advanced Body Armor Test Fixture

Body armor performance is currently tested with a clay backing material to replicate the response of the human torso. Clay provides an idea of behind armor blunt trauma; however a dynamically responsive tool is desired to better understand injury mechanisms. Defense Research and Development Canada and Biokinetics are developing a torso rig test fixture to measure dynamic deflections of bullet impacts. The data collected by the fixture will be correlated to injury models to better assess the probability of injury. The prototype will be delivered for evaluation in the second quarter 2008.



### Contact Information

[vipsubgroup@tswg.gov](mailto:vipsubgroup@tswg.gov)

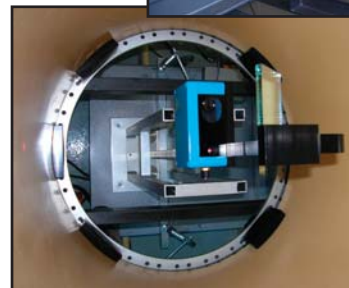







***Explosive Ordnance Disposal/  
Low-Intensity Conflict &  
Interdependent Capabilities***





## Explosive Ordnance Disposal/ Low-Intensity Conflict & Interdependent Capabilities

### Organization and Funding

To counter emerging threats, the Explosive Ordnance Disposal/Low-Intensity Conflict & Interdependent Capabilities (EOD/LIC & IC) program has grown and adjusted to provide new and advanced technologies to counter these threats. EOD/LIC & IC supports Joint Service EOD and Joint Service Special Operations forces by developing new technologies to stay ahead of evolving threats. These Joint Service communities annually submit prioritized requirements, which are then reviewed and approved by the Office of the Assistant Secretary of Defense for Special Operations and Low-Intensity Conflict & Interdependent Capabilities. In FY 2007 EOD/LIC & IC program funding increased to over \$13M. Funding breakdown for FY 2007 by focus area is shown below.

### FY 2007 EOD/LIC & IC Funding by Focus Area

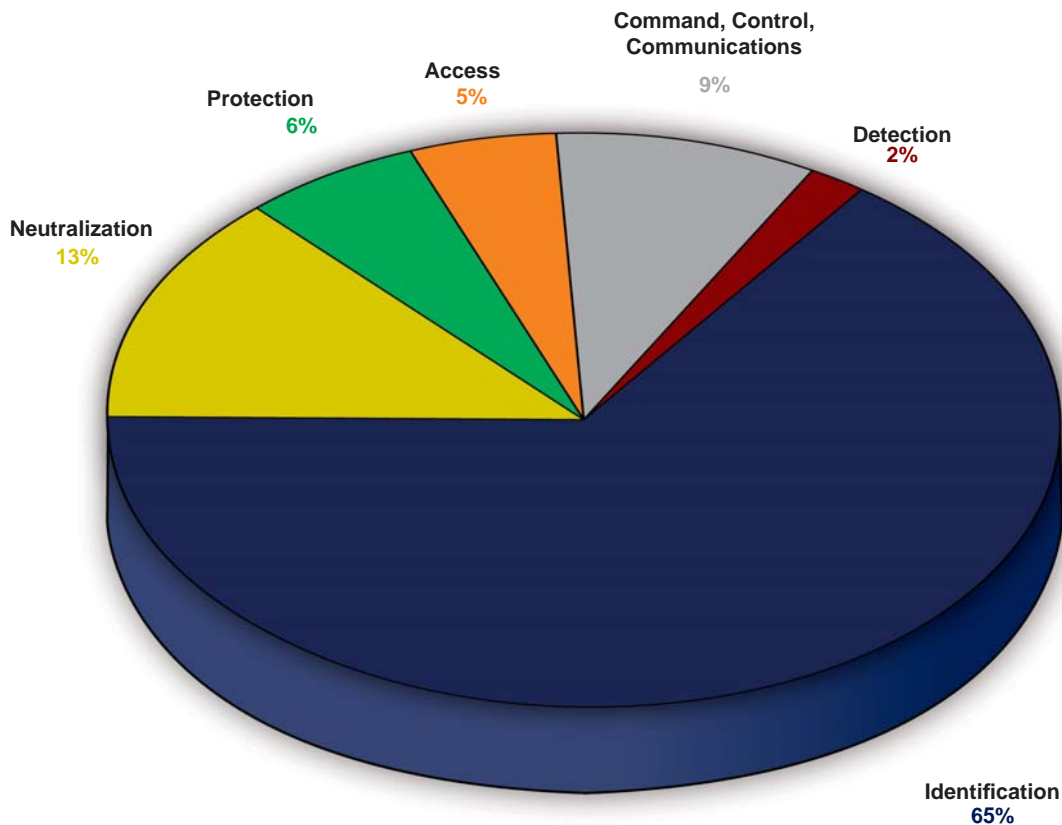

# Explosive Ordnance Disposal/ Low-Intensity Conflict & Interdependent Capabilities

## Focus Areas

### Access

Develop capabilities to safely approach, breach, or enter an area that has explosive threats intended to restrict the access of military personnel. Develop access technologies such as transportation systems; tools for opening containers, vehicles, and walls; and equipment for relocating ordnance to a safe area.

### Detection

Determine the presence of unexploded ordnance (UXO) and establishes location with sufficient accuracy to enable access. Develop detection systems such as imaging systems; explosives sniffers; and nuclear, biological, and chemical sensors.

### Command, Control, and Communications

Develop technology and software to enable military personnel to use command, control, and communications (C3) assets to scan, recon, gather, and store imagery and other digital data and to transmit these to command units and personnel over short distances. Advance and upgrade C3 systems such as radios, computers, personal digital assistants, displays, computer databases, and other software.

### Neutralization

Eliminate explosive threats by destroying them or rendering them inoperable. Develop neutralization systems, including disrupters, rifles, counter-charges, and flails.

### Identification

Determine the specific type and characteristics of UXO, IEDs, and other explosive threats. Determine the condition of UXO and the specific hazards associated with these threats. Promote knowledge of UXO, such as the specific type of ordnance, type and amount of explosive fill, blast and fragmentation radii, condition of the item, and existence of any hidden dangers.

### Protection

Develop technologies for life support and protection of personnel from ballistic and explosive threats. Advance the development of armor systems for personnel, life support equipment, and manned vehicles for land, sea, or air.



U.S. Air Force photo by Master Sgt. Jim Varhegyi



U.S. Air Force photo by Master Sgt. Jim Varhegyi



U.S. Air Force photo by Staff Sgt. Stacy L. Pearsall



U.S. Navy photo by Petty Officer 2nd Class Laura A. Moore

## *Explosive Ordnance Disposal/ Low-Intensity Conflict & Interdependent Capabilities*

### ***Selected Completed Projects***

#### **Night Vision for Bomb Suit**



Explosive Ordnance Disposal (EOD) units are required to conduct search, clearing, and render-safe operations of suspected explosive devices in support of ongoing combat operations. EOD operators are required to conduct these operations during hours of limited or no visibility. As a result, EOD units require an enhanced night-vision capability while using the Advanced Bomb Suit with the EOD-9 helmet. Prototype systems designed for the EOD-8 helmet and face shield were redesigned and modified for specific operation and use with the new EOD-9 helmet and visor using image intensified cameras, short wavelength infrared cameras, non-visible illuminators, and various head-mounted display systems. The prototypes for the EOD-9 helmet were successfully evaluated by the Joint Service EOD. The Naval Surface Warfare Center in Panama City is currently working with Program Manager-Soldier Survivability to complete final product development and field the system in quantities in the second quarter of FY 2008.

#### **Joint Service EOD Firing Device**



Joint Service EOD equipment compatibility and reliability is critical for a successful mission. There is a need for a common remote firing device that combines all services needs into one remote firing kit. MAS Zengrange Ltd. together with A-T Solutions, Inc. developed a remote firing kit that incorporates all of the services' needs with multiple features, eliminating the need for other devices. Some of the features include low-cost disposal receivers to remotely destroy explosive hazards. The receivers will operate on commercially available batteries with a remote arming and disarming feature. Air Force EOD will purchase these kits for fielding, and the Marine Corps EOD are funding safety testing so that they will be authorized to purchase these kits as well. Additional information may be obtained at: [www.a-tsolutions.com](http://www.a-tsolutions.com).

### ***Selected Current Projects***

#### **Navy Ship Hull Database**



The Space and Naval Surface Warfare Systems Command (SPAWAR), along with Oceaneering International, Inc., is continuing the development of a viewer/editor software package for Navy EOD diver use to edit and display composite ship drawings tailored to their needs. This software enables the dive team to eliminate unnecessary information and shows only the underwater and above-water reference point critical to their mission. The diver's findings can then be recorded on the modified drawings and used during render-safe procedures and mission reporting. Bath Iron Works has developed prototype composite drawings of the FFG- and DDG-class warships, for use in evaluating the software package and

# *Explosive Ordnance Disposal/ Low-Intensity Conflict & Interdependent Capabilities*

the field testing with fleet units. A Virtual Program Office is being established by SPAWAR, and this office will act as the repository for the drawings until the final transition is complete. The repository will be accessible worldwide to Navy EOD Dive Teams.

## **Unmanned Aerial Reconnaissance Vehicle**

Military EOD personnel require the ability to conduct remote reconnaissance of hazardous locations beyond the reach of current ground robotic systems. This effort will provide Department of Defense EOD personnel with a readily available, hover-capable, small aerial platform to conduct incident site reconnaissance in areas inaccessible to unmanned ground vehicles and to maintain operational and situational awareness when engaged in EOD operations in hostile or high-risk locations. The EOD community conducted an initial 90-day operational assessment in Iraq, where the platform proved its usefulness in area situational awareness and in locating IEDs. After the assessment was concluded, the users in Iraq requested that the unmanned aerial vehicles (UAVs) be left behind to become theater assets in which they will continue to be deployed on EOD incidents. The continued effort will incorporate the recommended modifications learned during the in-theater assessment into the UAV platform.



## **Self-Developing X-Ray Film**

The X-ray film currently in use by the Joint Service EOD and the civilian bomb squad communities will be discontinued in the near future. Therefore, EOD personnel need replacements for their two-part wet film, film cassettes, and film processors. EOD technicians use this equipment to confirm the contents, configuration, and arming status of suspect packages, devices, and munitions. This effort will provide the EOD communities with the ability to X-ray large packages and devices without using multiple cassettes and building mosaics with multiple photos. Secondary operational advantages include the simplification of radiography procedures and a significant reduction in the equipment required. The enhanced film will be self-developing with no post-exposure treatment required. The film will be easy to cut, immersion-proof, scratch-resistant, stable in the light or dark, and usable in temperatures from 32 to 120 °F. The goal is to provide this film with a cost per sheet that will be comparable to current Polaroid 803 film.

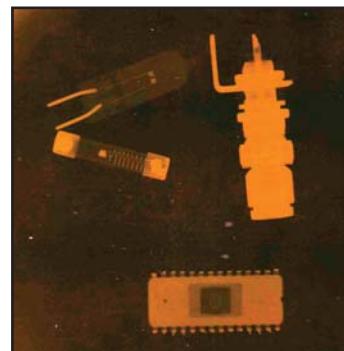

## **Ordnance Penalty Simulator**

The Ordnance Penalty Simulator is a training aid that is being developed by the Naval Surface Warfare Center-Indian Head for use at the Navy EOD School House at Eglin Air Force Base. The simulator will be used during EOD training scenarios to provide a realistic and objective means of evaluating students/technicians who violate safety precautions. The system will be designed to function



## *Explosive Ordnance Disposal/ Low-Intensity Conflict & Interdependent Capabilities*

like an ordnance item to provide real-world simulations. The simulator will have the ability to transmit and receive raw data from each sensor. The computer will translate, analyze, and log raw data to provide objective feedback to the instructor and trainees. This system will be available for military use only.

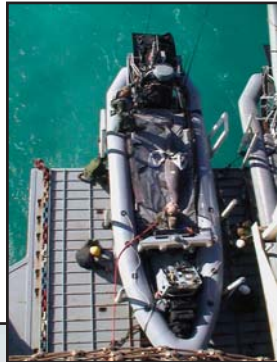

### **11m Rigid Hull Inflatable Boat Launch and Recovery from LPD/LSD Stern Gate**

Navy Special Clearance Team-1 must safely and quickly launch and recover unmanned underwater vehicles (UUVs), mammal equipment, and animals from Landing Platform Dock (LPD) and Landing Ship Dock (LSD) ships. The current configuration requires 11-meter rigid-hull inflatable boats (RHIBs) to be launched over the ship's side because of incompatibility with the standard 11-meter trailer with stern gate layout. SPAWAR-San Diego is designing the safest and most efficient method for loading and off-loading UUVs and mammals from 11m RHIBs and for launching and recovering loaded 11m RHIBs from LSD and LPD ships. The system will be entirely mechanical and specific to the 11m RHIB. The design will have a small footprint and will minimize additional weight to reduce the impact on transportation and storage requirements during deployment.



### **Military Critical Incident Response Technology Seminars**

The Military Critical Incident Response Technology Seminars (MILCIRTS) are EOD/LIC-managed forums designed to gather technology requirements to counter emerging terrorist threats and to support the EOD mission. The seminars bring together subject matter experts (SMEs) and EOD technicians at regional seminars. By using a theme-based approach, the SMEs present up-to-date terrorist threat information that feeds into live-fire scenarios. The EOD teams use their existing tool kits to render-safe the scenario problem. At the conclusion, the users identify technology gaps that, if addressed, would improve the render-safe action by reducing the hazard to the EOD technician. Due to operational tempo and to prevent duplication of effort, MILCIRTS is integrated into an existing pre-deployment training course, the Global Anti-Terrorism Operational Readiness Course (GATOR).

## **Navy Marine Mammal Expeditionary Environmental Control Pen**

During OIF, the force protection MK 6 Marine Mammal system was deployed indefinitely in Bahrain. The extreme water and air temperatures in the area required an in-water climate-controlled enclosure to keep the dolphins healthy and mission capable. SPAWAR designed a large-scale system to fulfill this specific requirement. Following OIF, the Marine Mammal platoon highlighted the need to have a similar system, but one redesigned for use on rapid shipboard deployments. NSCT-1's Marine Mammal platoon requires the ability to deploy for extended periods of time in environments where the ambient water and air temperatures would negatively impact the health and performance of the dolphins. This effort will enable the operation of the Marine Mammal Mine Counter-Mine systems at full effectiveness for the duration of deployment in extreme environments. The pen will be capable of housing four dolphins per system in a climate controlled in-water enclosure from which the dolphins can be efficiently and effectively operated. The system must be capable of rapid deployment and breakdown and must have a small footprint for shipboard transport.



## **Improved Linear Shape Charge**

EOD technicians often need to explosively cut or penetrate an object. The object may be anything from a chain holding a floating mine to an explosive-filled ordnance item. Battelle Memorial Institute is developing, for Joint Service EOD, a modular linear shaped charge container that is effective against a variety of target materials on land and underwater. The design includes a multipurpose housing with an integrated means of attachment that is waterproof to depths of 190 feet. The cutting capabilities are equivalent to the MK 7 series shape charge container and incorporate an integrated initiator holder. Initial testing of the Improved Linear Shape Charge against insensitive high explosive resulted in two options, a high-order or low-order depending on a single charge or a double stack. This continuing effort will take the recommended changes discovered during testing and apply them to the shape charge.



## **Contact Information**

[eodlic@eodlic.cttso.gov](mailto:eodlic@eodlic.cttso.gov)







## *Irregular Warfare Support*



## Irregular Warfare Support

The Irregular Warfare Support Program (IWS) supports Joint, interagency, and international partners who conduct irregular warfare and counterinsurgency efforts within the scope of the Long War. IWSP provides adaptive and agile ways and means to defeat insurgent organizations, motivations, sanctuaries, and enterprises.



### **Mission**

IWSP develops interagency capabilities and capacities for Information Age warfare.

### **Focus Areas**

#### **Motivation**

Motivate, educate, and equip indigenous partner forces to directly combat violent, extremist ideologies and their practitioners.

#### **Organization**

Deter, disrupt, interdict, and disable threat networks using advanced law enforcement tools, training, tactics, techniques, and procedures.



DoD photo by Staff Sgt. Curt Cashour, U.S. Army (Released)

#### **Sanctuary**

Deny adversaries safe operating zones from the physical to the virtual.

#### **Enterprise**

Exploit adversary economic, financial, logistical, and information business processes.

### **Program Highlights**

IWS programs are classified or highly sensitive. Program requirements, the success of programs, and specific program capabilities cannot be discussed in an unclassified document.

### **Contact Information**

[iwsp@iwsp.cttso.gov](mailto:iwsp@iwsp.cttso.gov)



DoD photo by Staff Sgt. Michael Kropiewnicki, U.S. Marine Corps (Released)

# *Product Development & Delivery*



U.S. Air Force photo by Senior Airman Ricky J. Best

## Featured Project Updates

This section of the program review book provides significant updates to past CTTSO projects that have previously been reported on as completed projects. The projects featured in this section have had significant operational improvements, have enjoyed particular commercial success, or have had other developments of note.

### **TOVA™ Open-Path Chemical Detection System for Fixed Security (CBRNC Subgroup)**



Existing chemical sensors for fixed security applications require sampling of air. Therefore they cover only small areas, are often slow to detect and recover and are susceptible to contamination by high concentrations of threats and interferences. The TOVA™ sensor (TS) provides a non-contact, open path IR detection with a line of sight (LOS) of up to 100 m. This long non-contact LOS affords maintenance free and wide area coverage together with fast and sensitive detection of most threat chemicals (TICs and CWAs). The database of the TS is updatable either by remote operation or locally and can include multiple threats and interferences. The wireless communication of the TS allows monitoring and control through the Internet, delivery of alarms to handheld devices or to central controllers. Long-term installations, some exceeding 17 months of continuous operation, demonstrated maintenance-free and low-rate of false alarms operations. Current installations include a defense chemical distribution facility, a large metropolitan subway station and a carbonated beverage company. Pending installations include a U.S. Government facility and a transportation station in a major metropolitan area. The TS can be integrated with an ion mobility spectrometer (IMS) to provide orthogonal detection and further validation. Recommended applications include building ventilation systems, transportation facilities (subways, airports), perimeter protection, environmental monitoring. The sensor is being manufactured commercially by an ISO 9001 certified manufacturer. Additional information is available at <http://www.avirsensors.com>.

### **Vehicle Inspection Guide (PS Subgroup)**

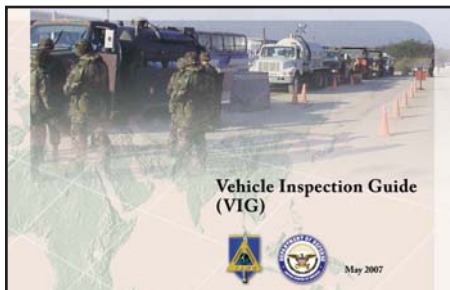

TSWG has updated the original Vehicle Inspection Checklist (VIC) now in use by thousands of military, Federal, State, and local agencies and has renamed it the Vehicle Inspection Guide (VIG). The guide describes various indicators of suspected improvised explosive devices (IEDs) on a range of vehicle types, identifies typical representative IED types, and includes a training section on recognition of explosives and IEDs. New information and labeled graphics that were suggested or requested by users of the highly successful VIC make this new VIG more than a basic update. It offers guidelines in interviewing vehicle occupants and focusing attention on the “hot spots” of most types of personal and commercial

## Featured Project Updates

vehicles. One unique feature of the presentation is guidance on taking note of the absence of usual items as well as the presence of suspicious items in or on a vehicle or occupants before deciding the level of inspection to conduct. Supplemental information includes a section on weapons of mass destruction and an expanded section on explosive materials and devices. For additional information contact [pssubgroup@tswg.gov](mailto:pssubgroup@tswg.gov).

### Improved Chemical Protective Ensemble (CBRNC Subgroup)

The threat of chemical, biological, and radiological (CBR) agents being used for international and domestic terrorism has expanded the need for enhanced protective clothing. This threat challenges the performance limitations of current personal protective equipment (PPE). First responders are restricted to the use of commercial-off-the-shelf (COTS) ensembles certified under the National Fire Protection Association (NFPA) 1994 standard, which only remain effective for one hour or less, are compromised by exposure to fire and sharp hazards in the environment, are difficult to don on the scene, and have visibility and dexterity issues. An optimized ensemble is critical to the mission of first responders. The Interspiro Chemical Ensemble (ICETM) is a certified NFPA 1994, Class 2 ensemble. The ICE is a fully integrated system including a chemical protective suit, chemical-resistant boots, and a self-contained breathing apparatus (SCBA), which is worn outside the suit. The ensemble can be in atmospheres deficient in oxygen or with immediately dangerous to life or health (IDLH) concentrations of substances that present severe inhalation hazards, as well as in CBRN environments. The original suit was developed for integration with the Interspiro SCBA. Continued work has focused on integration with Drager SCBAs and military respirators. Information on the Gore™ ChemPak® family of products is available at: [http://www.goremilitary.com/tech\\_02\\_mil.html](http://www.goremilitary.com/tech_02_mil.html).



### Heat Stress Calculator (CBRNC Subgroup)

When wearing PPE, users such as first responders to emergency situations are concerned not only with the hazardous agents they may face, but also with ancillary issues such as physical stress and overexertion. The Heat Commander (formerly called the Heat Stress Calculator) provides a planning tool for first responders to assess and manage heat risk will wearing PPE. This personal digital assistant (PDA) allows the users to input workload, PPE configuration, and environmental conditions into the device to obtain optimal work/rest cycles for the first responder. The Heat Commander is commercially available from GEOMET Technologies, Inc. at: <http://heatcommander.com>.



## Featured Project Updates

### Chemical Risk Assessment Tool CBRNC Subgroup

There is no single, standard personal protective equipment (PPE) ensemble for use by first responders when entering hazardous environments contaminated with chemical agents. Organizations maintain different inventories of chemical protective clothing and respirators suitable to individual budgetary and operational requirements. The Georgia Tech Research Institute developed a mobile emergency response tool that provides first responders with decision support for working in environments contaminated with chemical agents. The Chemical Companion system allows incident commanders to evaluate and select the best PPE ensemble given the chemical agent, concentration, and ambient conditions faced. Incident commanders can make rapid, accurate decisions regarding isolation, protective action distances, and hot-zone stay times. The software tool incorporates initial symptoms of exposure, odor thresholds, PPE breakthrough times, and exposure guidelines. Version 2 of the Chemical Companion is now available for both pocket-PC and desktop/laptop computers. This software is free to government employees and first responders at: <http://www.chemicalcompanion.org>.



## Technology Transition

The TSWG charter identifies technology transition assistance throughout the development cycle as essential to supporting national combating terrorism objectives. CTTSO has formalized the technology transition process into every aspect of its R&D programs. CTTSO requires that every proposal received address technology transition as a principal task and that each new project include a technology transition plan. A dedicated technology transition manager works with CTTSO developers to prepare the plans and to address the issues associated with a successful transition to production, such as:

- Exploration of all applications and markets for the technology;
- Understanding and managing intellectual property (patents, trademarks, copyrights, trade secrets, and licensing; to include data and software rights and options);
- Market evaluations for Military, Federal, State, local, and commercial users;
- Environmental, safety, and health issues;
- Liability risk reduction and consideration of SAFETY Act Applications;
- Security and Export Control provisions;
- Regulatory restrictions to include electronic emissions, environmental, safety, health, transportation, and others;
- Test and evaluation planning and independent operational testing by users;
- Transition to production, including partnering, investment capital, licensing, and finding markets and distributors; and
- Operational suitability and operational support planning.

A number of administrative technology transition tools and methodologies are used to assist the developer with resolving issues, such as:

- Commercialization assessments and transition plan formats;
- Publication of handbooks and special primers;
- Non-disclosure agreements;
- Provisional patents versus full patents;
- Liability risk reduction techniques;
- Tailored license application forms and licensee/partner selection board assistance;
- Technical data and software package rights and management techniques;
- Federal Business Opportunity announcements;
- Licenses and Cooperative Research and Development Agreements (CRADAs).

A disciplined process; available assistance; and teamwork among project manager, technology transition manager, and developer are the keys to the rapid acceleration of the complicated process of moving many prototypes to production. Additional information is available at the Technology Transition section of the CTTSO Web site, <http://www.cttso.gov>.



Tactical Timed Firing Device



API Food Poison Detection Kit™

## 2007 Meetings and Conferences

The following is a list of selected meetings and conferences sponsored in whole or in major part by CTTSO in 2007.

### February 2007

#### Homemade Explosives Workshop

The Homemade Explosives (HME) International Workshop was designed to share the latest information on threat, end-user requirements, and current research. The keynote speaker, Rear Admiral Jay Cohen, DHS Undersecretary for Science and Technology (S&T) provided an overview of DHS' S&T program and vision. Twenty-five agencies and five allies participated in the event.



Defense Dept. photo by Cherie A. Thurlby

Presentations addressed scientific, programmatic, law enforcement and military perspectives. Threat overviews highlighted evolving threats around the globe. End-user requirements that were presented will help shape future research projects. Project briefings described the foundation of each country's HME program and showed great potential for information sharing. Breakout sessions encouraged group discussion and consensus on the path forward. Deliverables from the event included an international work breakdown structure and identification of gaps to focus future research.

### November 2007

#### Personal Protective Equipment Conference

TSWG hosted its first Personal Protective Equipment (PPE) Conference in November 2007. This conference provided TSWG and its partners with a forum to highlight emerging technologies in the area of PPE. The conference included an exhibition and briefings of new technologies from PPE vendors, a seminar series on standards and next-generation tools, as well as an international forum on capabilities and needs. The conference was co-sponsored by the Department of Homeland Security, the National Institute of Occupational Safety and Health, the National Institute of Justice, the National Fire Protection Association, and the International Safety Equipment Association. Responders and developers from the United States, United Kingdom, Israel, Japan, Australia, Canada, Korea, Singapore, and Sweden participated in the event. The educational workshops and round-table discussions will drive the future directions of PPE research and design.



## BAA Information Delivery System (BIDS)

The BAA Information Delivery System, better known as BIDS, works to support the CTTSO mission through the electronic publication of its annual Broad Agency Announcements (BAAs). BAAs are the solicitation method of choice to bring the most urgent combating terrorism requirements forward for publication. CTTSO staff monitors BAA package instruction in light of submitter responses and feedback, and implement improvements as needed each year to elucidate the submission process.

To ensure the widest possible distribution to potential submitters, BAAs are downloadable at the BIDS web site (<http://www.bids.tswg.gov>) and are also advertised at the Federal Business Opportunities website ([www.fedbizopps.gov](http://www.fedbizopps.gov)). In addition to conventional Government solicitation notices, the BIDS website provides a BIDS Advisory and Announcement area that posts BAA news, coming events, and partnering agency solicitations. In addition to the advisory, the RSS (Really Simple Syndication) news feed allows interested users to receive real time broadcast information at a local computer when connected to the Internet.



BIDS is a rich source of submitter information providing small business outreach, online training, user forums for teaming opportunities, and most recently guidance for offerors proposing the use of human subjects in research. Overall BAA statistics are posted once the BAA closes.

BIDS not only functions as a response collection system, but also provides for submission evaluation and submitter notification. Submitter data is fully protected in a 128-bit point-to-point encrypted environment. Evaluators must comply with source selection data handling requirements and accept a nondisclosure agreement to access BIDS. In addition to the non-disclosure, evaluators must also certify that there is no conflict of interest before access is granted to any submissions. The evaluation process is monitored for timely notice to submitters with the typical response via automated e-notice complete within 90 days.

BIDS continues to serve as a leading solicitation process model for other Federal programs by providing a streamlined electronic solution to receive proposals, provide access for subject matter expert evaluation, process submissions through the approving authority, notify the submitter of status, and maintain a record of solicitation results.

## BAA Information Delivery System (BIDS)

### Doing Business with the Government



Vendors that contract with the Federal Government must comply with several prerequisites **before** a contract is awarded. [click here](#) 

### Submitter Resources



View the **Submitter Quick Card** and **Web-based Training**. Also, the **Teaming and Partnership Forum** is provided as a discussion tool for potential submitters to TSWG BAAs.

## CTTSO Portal Web Site [www.cttso.gov](http://www.cttso.gov)

Earlier this year, as part of the CTTSO initiative to unite current program elements under the CTTSO authority, a portal Web page ([www.cttso.gov](http://www.cttso.gov)) was introduced that works to centralize comprehensive program resources while maintaining the individual technical expertise of each sector.

Featured program elements, to date, include the Technical Support Working Group (TSWG), Explosive Ordnance Disposal/Low-Intensity Conflict & Interdependent Capabilities (EOD/LIC & IC), and Irregular Warfare Support (IWS) program. Each program maintains its own website and is easily accessed through the portal. Most recently, the TSWG site has been re-engineered to focus on the transition of available products to end users. EOD/LIC & IC and IWS are slated for re-work in the coming fiscal year.



Portal visitors can freely navigate several information pages to learn about the CTTSO, or review business opportunities for product commercialization. Helping small businesses and nontraditional defense contractors to find opportunities and do business with the Government is one of several information focuses. A Technology Transition page is provided for CTTSO contract awardees to help in the transition to production or commercialization of products. Links to BIDS and other Government sites such as NATO and the Terrorism Research Center are also available. The Contract Award page details information on current performers, recent contract awards, and BAA statistical data.

CTTSO Forums, an access controlled site for data sharing among mission area participants, is linked from the portal.

# CTTSO Portal Website [www.cttso.gov](http://www.cttso.gov)



Portal visitors can freely navigate several information pages to learn about the CTTSO, or review business opportunities for product commercialization. Helping small businesses and nontraditional defense contractors to find opportunities and do business with the Government is one of several information focuses. A Technology Transition page is provided for CTTSO contract awardees to help in the transition to production or commercialization of products. Links to BIDS and other Government sites such as NATO and the Terrorism Research Center are also available. The Contract Award page details information on current performers, recent contract awards, and BAA statistical data.

CTTSO Forums, an access controlled site for data sharing among mission area participants, is linked from the portal.

# ***APPENDIX***



U.S. Marine Corps photo by Cpl. Michael J O'Brien

## 2007 Membership

### FEDERAL AGENCIES

#### U.S. DEPARTMENT OF DEFENSE

- Armed Forces Institute of Pathology
  - Office of the Armed Forces Medical Examiner
- Counterintelligence Field Activity
- Defense Academy for Credibility Assessment
- Defense Computer Forensics Laboratory
- Defense Criminal Investigative Service
- Defense Intelligence Agency
- Defense Threat Reduction Agency
- Joint Chiefs of Staff
- Joint Improvised Explosive Device Defeat Organization
- National Geospatial-Intelligence Agency
- National Security Agency
- Office of the Assistant Secretary of Defense for Homeland Defense
  - Defense Critical Infrastructure Program
- Office of the Assistant Secretary of Defense for Special Operations and Low-Intensity Conflict & Interdependent Capabilities
- Office of the Assistant to the Secretary of Defense for Nuclear and Chemical and Biological Defense
- Office of the Deputy Assistant to the Secretary of Defense for Nuclear Matters
- Office of the Director of Defense Research & Engineering
- Office of the Under Secretary of Defense for Acquisition, Technology, and Logistics
- Office of the Under Secretary of Defense for Intelligence
- Office of the Under Secretary of Defense for Personnel and Readiness
- Pentagon Force Protection Agency
- Physical Security Equipment Action Group
- U.S. Air Force
  - Air Combat Command
  - Air Force Electronic Systems Center
  - Air Force Research Laboratory
  - Air Force Security Forces Center
  - Explosive Ordnance Disposal Detachment 63
  - Force Protection Systems Squadron
- U.S. Army
  - 20<sup>th</sup> Support Command (Chemical, Biological, Radiological, Nuclear, and High-Yield Explosives)
  - 22<sup>nd</sup> Chemical Battalion (Technical Escort)
  - Army Medical Department
  - Army Research Laboratory
  - Chemical School
  - Communications Electronics Command
  - Corps of Engineers

## 2007 Membership

- Protective Design Center
- Criminal Investigation Command
- Explosive Ordnance Disposal Technical Detachment
- Intelligence and Security Command
- Maneuver Support Center
- National Ground Intelligence Center
- National Guard Bureau
- Product Manager for Force Protection Systems
- Rapid Equipping Force
- Research, Development, & Engineering Command
  - Edgewood Chemical Biological Center
- Soldier Systems Center (Natick)
- Tank-Automotive and Armaments Command
- Training and Doctrine Command
- U.S. Army Institute of Surgical Research
- U.S. Central Command
- U.S. Marine Corps
  - Chemical Biological Incident Response Force
  - Criminal Investigation Division
  - EOD Detachment
  - Marine Corps Central Command
  - Marine Corps Systems Command
  - Naval Explosive Ordnance Disposal Technology Division, Marine Corps Division
- U.S. Navy
  - Bureau of Medicine and Surgery
  - Naval Air Warfare Center
  - Naval Criminal Investigative Service
  - Naval Explosive Ordnance Disposal Fleet Liaison Office
  - Naval Facilities Engineering Command
  - Naval Forces Central Command
  - Naval Health Research Center
  - Naval Research Laboratory
  - Naval Sea Systems Command
    - Naval Explosive Ordnance Disposal Technology Division
    - Naval Surface Warfare Center
  - Office of Naval Research
  - Space and Naval Warfare Systems Command
  - U.S. Naval Forces Europe
- U.S. Special Operations Command

### ENVIRONMENTAL PROTECTION AGENCY

- Criminal Investigation Division
- National Enforcement Investigations Center
- National Homeland Security Research Center

### FEDERAL RESERVE BOARD

## 2007 Membership

### INTELLIGENCE COMMUNITY

### INTERAGENCY BOARD FOR EQUIPMENT STANDARDIZATION AND INTEROPERABILITY

### NATIONAL VIRTUAL TRANSLATION CENTER

### NUCLEAR REGULATORY COMMISSION

### U.S. DEPARTMENT OF AGRICULTURE

- Animal and Plant Health Inspection Service
- Food Safety and Inspection Service

### U.S. DEPARTMENT OF COMMERCE

- National Institute of Standards and Technology
  - Office of Law Enforcement Standards

### U.S. DEPARTMENT OF ENERGY

- Headquarters
- National Nuclear Security Administration
- Office of Health, Safety, and Security

### U.S. DEPARTMENT OF HEALTH AND HUMAN SERVICES

- Centers for Disease Control and Prevention
- Food and Drug Administration
- National Institute for Occupational Safety and Health

### U.S. DEPARTMENT OF HOMELAND SECURITY

- Customs and Border Protection
- Federal Emergency Management Agency
- Federal Law Enforcement Training Center
- Homeland Security Institute
- Immigration and Customs Enforcement
  - Federal Protective Service
  - Forensic Document Laboratory
- National Cyber Security Division
- Preparedness Directorate
  - Grants and Training
- Science and Technology Directorate
- Transportation Security Administration
  - Federal Air Marshal Service
- U.S. Coast Guard
- U.S. Secret Service
  - Special Services Division
  - Technical Security Division

### U.S. DEPARTMENT OF HOUSING AND URBAN DEVELOPMENT

### U.S. DEPARTMENT OF JUSTICE

- Bureau of Alcohol, Tobacco, Firearms, and Explosives
- Drug Enforcement Administration
- Federal Bureau of Investigation



## 2007 Membership

- Federal Bureau of Prisons
- National Institute of Justice
  - National Center for Forensic Science
  - National Forensic Science Technology Center
- U.S. Marshals Service

### U.S. DEPARTMENT OF STATE

- Bureau of Diplomatic Security
- Office of the Coordinator for Counterterrorism
- Overseas Buildings Operations

### U.S. DEPARTMENT OF TRANSPORTATION

- Federal Aviation Administration
- Research and Innovative Technology Administration
  - Volpe National Transportation Systems Center

### U.S. DEPARTMENT OF THE TREASURY

- Internal Revenue Service
- Office of the Inspector General

### U.S. POSTAL INSPECTION SERVICE

### WHITE HOUSE

- Homeland Security Council

## LEGISLATIVE BRANCH

### U.S. CAPITOL POLICE

### U.S. SENATE SERGEANT AT ARMS

## STATE AND LOCAL AGENCIES

### FAIRFAX COUNTY (VA) FIRE DEPARTMENT

### FAIRFAX COUNTY (VA) POLICE DEPARTMENT

### FIRE DEPARTMENT OF NEW YORK

### LONG BEACH, CA POLICE DEPARTMENT

### LOS ANGELES COUNTY SHERIFF'S DEPARTMENT

### MARYLAND STATE POLICE

### MICHIGAN STATE POLICE

### NEW YORK CITY MASS TRANSIT AUTHORITY

### NEW YORK CITY POLICE DEPARTMENT

### PORT AUTHORITY OF NEW YORK/NEW JERSEY

### SEATTLE (WA) FIRE DEPARTMENT

### SOUTH PASADENA, CA POLICE DEPARTMENT

### STATE AND LOCAL SWAT TEAMS

## NON-GOVERNMENTAL ORGANIZATIONS

### NATIONAL BOMB SQUAD COMMANDERS ADVISORY BOARD

### NATIONAL TACTICAL OFFICERS ASSOCIATION

## *TSWG 2007 Membership by Subgroup*

### **BLAST EFFECTS AND MITIGATION**

**NEW YORK CITY MASS TRANSIT AUTHORITY**

**PORT AUTHORITY OF NEW YORK/NEW JERSEY**

**U.S. DEPARTMENT OF DEFENSE**

- Armed Forces Institute of Pathology
  - Office of the Armed Forces Medical Examiner
- Defense Threat Reduction Agency
- U.S. Air Force
  - Air Force Research Laboratory
- U.S. Army
  - Army Research Laboratory
  - Corps of Engineers
    - Protective Design Center
  - Soldier Systems Center (Natick)
  - U.S. Army Institute of Surgical Research
- U.S. Navy
  - Naval Facilities Engineering Command
  - Naval Health Research Center

**U.S. DEPARTMENT OF HOMELAND SECURITY**

- Science and Technology Directorate

**U.S. DEPARTMENT OF JUSTICE**

- Bureau of Alcohol, Tobacco, Firearms, and Explosives
- Federal Bureau of Investigation

**U.S. DEPARTMENT OF STATE**

- Bureau of Diplomatic Security

### **CHEMICAL, BIOLOGICAL, RADIOLOGICAL, AND NUCLEAR COUNTERMEASURES**

**ENVIRONMENTAL PROTECTION AGENCY**

**FAIRFAX COUNTY (VA) FIRE DEPARTMENT**

**FEDERAL RESERVE BOARD**

**FIRE DEPARTMENT OF NEW YORK**

**INTELLIGENCE COMMUNITY**

**INTERAGENCY BOARD FOR EQUIPMENT STANDARDIZATION AND INTEROPERABILITY**

**NEW YORK CITY POLICE DEPARTMENT**

**NUCLEAR REGULATORY COMMISSION**

**SEATTLE (WA) FIRE DEPARTMENT**

**U.S. CAPITOL POLICE**

**U.S. DEPARTMENT OF AGRICULTURE**

- Animal and Plant Health Inspection Service
- Food Safety and Inspection Service

**U.S. DEPARTMENT OF COMMERCE**

- National Institute of Standards and Technology

**U.S. DEPARTMENT OF DEFENSE**

- Defense Intelligence Agency
- Defense Threat Reduction Agency
- Joint Chiefs of Staff
- Joint Improvised Explosive Device Defeat Organization
- National Security Agency

## *TSWG 2007 Membership by Subgroup*

- Office of the Assistant to the Secretary of Defense for Nuclear and Chemical and Biological Defense
  - Pentagon Force Protection Agency
  - U.S. Air Force
    - Air Combat Command
  - U.S. Army
    - 20th Support Command (Chemical, Biological, Radiological, Nuclear, and High-Yield Explosives)
    - 22nd Chemical Battalion (Technical Escort)
    - Army Medical Department
    - Chemical School
  - Research, Development, & Engineering Command
    - Edgewood Chemical Biological Center
    - Maneuver Support Center
    - National Ground Intelligence Center
  - U.S. Marine Corps
    - Chemical Biological Incident Response Force
  - U.S. Navy
    - Bureau of Medicine and Surgery
    - Naval Air Warfare Center
    - Naval Forces Central Command
    - Naval Surface Warfare Center
  - U.S. Special Operations Command
- U.S. DEPARTMENT OF ENERGY**
- Office of Health, Safety, and Security
- U.S. DEPARTMENT OF HEALTH AND HUMAN SERVICES**
- Centers for Disease Control and Prevention
  - Food and Drug Administration
  - National Institute for Occupational Safety and Health
- U.S. DEPARTMENT OF HOMELAND SECURITY**
- Immigration and Customs Enforcement
    - Federal Protective Service
  - Federal Emergency Management Agency
  - Science and Technology Directorate
  - Transportation Security Administration
  - U.S. Coast Guard
  - U.S. Secret Service
- U.S. DEPARTMENT OF JUSTICE**
- Federal Bureau of Investigation
  - National Institute of Justice
  - U.S. Marshals Service
- U.S. DEPARTMENT OF STATE**
- Bureau of Diplomatic Security
  - Office of the Coordinator for Counterterrorism
  - Overseas Buildings Operations
- U.S. DEPARTMENT OF TRANSPORTATION**
- Research and Innovative Technology Administration
    - Volpe National Transportation Systems Center

## ***TSWG 2007 Membership by Subgroup***

### **U.S. POSTAL INSPECTION SERVICE**

### **U.S. SENATE SERGEANT AT ARMS**

### **WHITE HOUSE**

- Homeland Security Council

### **CONCEPT DEVELOPMENT**

### **INTELLIGENCE COMMUNITY**

### **U.S. DEPARTMENT OF DEFENSE**

- Office of the Director of Defense Research & Engineering

### **EXPLOSIVES DETECTION**

### **U.S. DEPARTMENT OF COMMERCE**

- National Institute of Standards and Technology

### **U.S. DEPARTMENT OF DEFENSE**

- Defense Intelligence Agency
- National Security Agency
- Pentagon Force Protection Agency
- U.S. Air Force
  - Air Force Electronic Systems Center
  - Air Force Research Laboratory
- U.S. Army
  - Research, Development, & Engineering Command
  - Edgewood Chemical Biological Center
- U.S. Marine Corps
  - EOD Detachment
- U.S. Navy
  - Naval Research Laboratory
  - Naval Sea Systems Command
    - Naval Explosive Ordnance Disposal Technology Division
    - Naval Surface Warfare Center

### **U.S. DEPARTMENT OF HOMELAND SECURITY**

- Science and Technology Directorate
- Transportation Security Administration
- U.S. Coast Guard
- U.S. Secret Service

### **U.S. DEPARTMENT OF JUSTICE**

- Bureau of Alcohol, Tobacco, Firearms, and Explosives

### **U.S. DEPARTMENT OF STATE**

- Bureau of Diplomatic Security

### **IMPROVISED DEVICE DEFEAT**

### **FAIRFAX COUNTY, VA POLICE DEPARTMENT**

### **INTELLIGENCE COMMUNITY**

### **MARYLAND STATE POLICE**

### **MICHIGAN STATE POLICE**

### **NATIONAL BOMB SQUAD COMMANDERS ADVISORY BOARD**

- Bloomington, Minnesota Police Department (Northern region)

## ***TSWG 2007 Membership by Subgroup***

- Houston, Texas Police Department (Southern region)
- Los Angeles, California Police Department (Western region)
- Philadelphia, Pennsylvania Police Department (Eastern region)

### **U.S. CAPITOL POLICE**

### **U.S. DEPARTMENT OF DEFENSE**

- U.S. Air Force
  - Air Combat Command
  - EOD Detachment 63
- U.S. Army
  - EOD Technical Detachment
- U.S. Marine Corps
  - Chemical Biological Incident Response Force
  - Naval Explosive Ordnance Disposal Technology Division, Marine Corps Division
- U.S. Navy
  - Naval Explosive Ordnance Disposal Technology Division
  - EOD Fleet Liaison Office

### **U.S. DEPARTMENT OF HOMELAND SECURITY**

- Preparedness Directorate
  - Grants and Training
- Science and Technology Directorate
- Transportation Security Administration
- U.S. Secret Service

### **U.S. DEPARTMENT OF JUSTICE**

- Bureau of Alcohol, Tobacco, Firearms, and Explosives
- Federal Bureau of Investigation
- National Institute of Justice
- U.S. Marshals Service

### **INVESTIGATIVE SUPPORT AND FORENSICS**

#### **ENVIRONMENTAL PROTECTION AGENCY**

- National Enforcement Investigations Center

#### **FEDERAL RESERVE BOARD**

#### **INTELLIGENCE COMMUNITY**

#### **NATIONAL TRANSPORTATION SAFETY BOARD**

#### **U.S. CAPITOL POLICE**

#### **U.S. DEPARTMENT OF COMMERCE**

- National Institute of Standards and Technology
  - Office of Law Enforcement Standards

#### **U.S. DEPARTMENT OF DEFENSE**

- Counterintelligence Field Activity
- Defense Academy for Credibility Assessment
- Defense Computer Forensics Laboratory
- Defense Criminal Investigative Service
- National Geospatial-Intelligence Agency
- Pentagon Force Protection Agency
- U.S. Air Force
  - Office of Special Investigations
- U.S. Army

## *TSWG 2007 Membership by Subgroup*

- Criminal Investigation Command
- Intelligence and Security Command
- U.S. Marine Corps
  - Criminal Investigation Division
- U.S. Navy
  - Naval Criminal Investigative Service

### **U.S. DEPARTMENT OF ENERGY**

- Office of Health, Safety, and Security

### **U.S. DEPARTMENT OF HOMELAND SECURITY**

- Federal Law Enforcement Training Center
- Immigration and Customs Enforcement
  - Federal Protective Service
  - Forensic Document Laboratory
- U.S. Secret Service

### **U.S. DEPARTMENT OF JUSTICE**

- Bureau of Alcohol, Tobacco, Firearms, and Explosives
- Drug Enforcement Administration
- Federal Bureau of Investigation
- National Institute of Justice
  - National Center for Forensic Science
  - National Forensic Science Technology Center
- U.S. Marshals Service

### **U.S. DEPARTMENT OF STATE**

- Office of the Coordinator for Counterterrorism

### **U.S. DEPARTMENT OF THE TREASURY**

- Office of the Inspector General
- Internal Revenue Service

### **U.S. POSTAL INSPECTION SERVICE**

### **STATE AND LOCAL AGENCIES**

- Long Beach, CA Police Department
- Los Angeles County CA Sheriff's Department
- South Pasadena CA Police Department

### **PHYSICAL SECURITY**

#### **ENVIRONMENTAL PROTECTION AGENCY**

#### **FEDERAL RESERVE BOARD**

#### **INTELLIGENCE COMMUNITY**

#### **NEW YORK POLICE DEPARTMENT**

#### **NUCLEAR REGULATORY COMMISSION**

#### **PORT AUTHORITY OF NEW YORK/NEW JERSEY**

#### **U.S. CAPITOL POLICE**

#### **U.S. DEPARTMENT OF AGRICULTURE**

- Forest Service

#### **U.S. DEPARTMENT OF DEFENSE**

- Defense Intelligence Agency
- Defense Threat Reduction Agency
- Defense-Wide Information Assurance Program

## *TSWG 2007 Membership by Subgroup*

- Joint Chiefs of Staff
  - U.S. Central Command
- Joint Improvised Explosive Device Defeat Organization
- National Security Agency
- Office of the Assistant to the Secretary of Defense for Nuclear and Chemical and Biological Defense
- Office of the Deputy Assistant to the Secretary of Defense for Nuclear Matters
- Office of the Under Secretary of Defense for Intelligence
- Pentagon Force Projection Agency
- Physical Security Equipment Action Group
- U.S. Air Force
  - Air Force Security Forces Center
  - Force Protection Systems Squadron
- U.S. Air Force
  - Office of Special Investigations
- U.S. Army
  - Communications Electronics Command
  - Corps of Engineers
  - Physical Security Equipment Action Group
  - Force Protection Systems Program Office
- U.S. Central Command
- U.S. Marine Corps
  - Marine Corps Central Command
  - Marine Corps Network Operations and Security Command
- U.S. Navy
  - Naval Criminal Investigative Service
  - Naval Explosive Ordnance Disposal Technology Division
  - Naval Surface Warfare Center
  - Office of Naval Research
  - Space and Naval Warfare Systems Command
  - U.S. Naval Forces Europe

### **U.S. DEPARTMENT OF ENERGY**

- National Nuclear Security Administration
- Office of Electricity Delivery and Energy Reliability
- Office of Health, Safety, and Security

### **U.S. DEPARTMENT OF HOMELAND SECURITY**

- Federal Emergency Management Agency
- Office of the Under Secretary for Preparedness
- Science and Technology Directorate
- Transportation Security Administration
- U.S. Coast Guard
- U.S. Secret Service

### **U.S. DEPARTMENT OF JUSTICE**

- Federal Bureau of Investigation
- Federal Bureau of Prisons

### **U.S. DEPARTMENT OF STATE**

- Bureau of Diplomatic Security

## ***TSWG 2007 Membership by Subgroup***

### **U.S. DEPARTMENT OF TRANSPORTATION**

- Federal Aviation Administration
- Research and Innovative Technology Administration
  - Volpe National Transportation Systems Center

### **U.S. POSTAL INSPECTION SERVICE**

### **SURVEILLANCE, COLLECTION, AND OPERATIONS SUPPORT**

#### **INTELLIGENCE COMMUNITY**

#### **U.S. DEPARTMENT OF DEFENSE**

- U.S. Army Asymmetric Warfare Group
- U.S. Special Operations Command

#### **U.S. DEPARTMENT OF JUSTICE**

- Federal Bureau of Investigation

### **TACTICAL OPERATIONS SUPPORT**

#### **NATIONAL TACTICAL OFFICERS ASSOCIATION**

#### **STATE AND LOCAL SWAT TEAMS**

#### **U.S. DEPARTMENT OF DEFENSE**

- U.S. Special Operations Command

#### **U.S. DEPARTMENT OF ENERGY**

- National Nuclear Security Administration
- Office of Health, Safety, and Security

#### **U.S. DEPARTMENT OF HOMELAND SECURITY**

- Transportation Security Administration
  - Federal Air Marshal Service
- U.S. Coast Guard
- U.S. Secret Service

#### **U.S. DEPARTMENT OF JUSTICE**

- Federal Bureau of Investigation
  - Hostage Rescue Team
- U.S. Marshals Service

#### **U.S. DEPARTMENT OF STATE**

- Bureau of Diplomatic Security

### **TRAINING TECHNOLOGY DEVELOPMENT**

#### **ENVIRONMENTAL PROTECTION AGENCY**

#### **INTERAGENCY BOARD**

#### **NATIONAL BOMB SQUAD COMMANDERS ADVISORY BOARD**

#### **NATIONAL VIRTUAL TRANSLATION CENTER**

#### **U.S. DEPARTMENT OF AGRICULTURE**

- Animal and Plant Health Inspection Service

#### **U.S. DEPARTMENT OF DEFENSE**

- Joint Improvised Explosive Device Defeat Organization
- Office of the Under Secretary of Defense for Personnel and Readiness
- Pentagon Force Protection Agency
- U.S. Army
  - Maneuver Support Center
  - National Guard Bureau



## *TSWG 2007 Membership by Subgroup*

- Research, Development, and Engineering Command
- Training and Doctrine Command
- U.S. Army Reserve
- U.S. Marine Corps
- U.S. Special Operations Command
- U.S. DEPARTMENT OF ENERGY**
  - Headquarters
- U.S. DEPARTMENT OF HOMELAND SECURITY**
  - Federal Protective Service
  - Preparedness Directorate
    - Grants and Training
  - Science and Technology Directorate
  - U.S. Coast Guard
  - U.S. Secret Service
- U.S. DEPARTMENT OF JUSTICE**
  - National Institute of Justice

### **VIP PROTECTION**

#### **ENVIRONMENTAL PROTECTION AGENCY**

#### **INTELLIGENCE COMMUNITY**

#### **OFFICE OF THE U.S. TRADE REPRESENTATIVE**

#### **U.S. DEPARTMENT OF COMMERCE**

- National Institute of Standards and Technology

#### **U.S. DEPARTMENT OF DEFENSE**

- U.S. Army
  - Soldier Systems Center (Natick)
  - Tank-Automotive and Armaments Command
- U.S. Navy
  - Naval Criminal Investigative Service
- U.S. Special Operations Command

#### **U.S. DEPARTMENT OF ENERGY**

#### **U.S. DEPARTMENT OF HOMELAND SECURITY**

- Transportation Security Administration
  - Federal Air Marshal Service
- U.S. Secret Service
  - Special Services Division
  - Technical Security Division

#### **U.S. DEPARTMENT OF HOUSING AND URBAN DEVELOPMENT**

#### **U.S. DEPARTMENT OF JUSTICE**

- National Institute of Justice

#### **U.S. DEPARTMENT OF STATE**

#### **U.S. DEPARTMENT OF THE TREASURY**

- Internal Revenue Service



## 2007 Performers

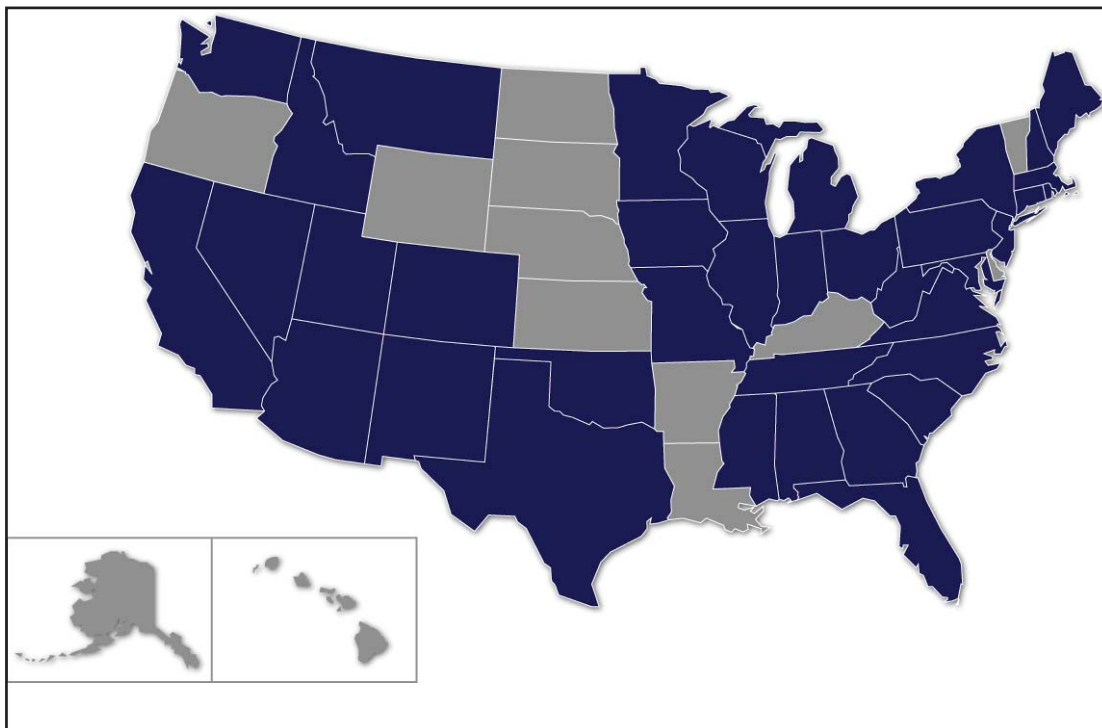

### ALABAMA

Auburn University, Auburn  
U.S. Army Aeromedical Research Laboratory, Fort Rucker

### ARIZONA

Armorworks, Tempe  
General Dynamics C4 Systems, Scottsdale  
Polymicro Technologies, LLC, Phoenix  
University of Arizona, Tucson  
Yuma Proving Ground, Yuma

### CALIFORNIA

ACM Systems, Inc., Rancho Cordova  
AeroAstro, Inc., Littleton  
APIC Corporation, Los Angeles  
Applied Signal Technology, Torrance  
Eloret Corporation, Sunnyvale  
GE Infrastructure Security, San Diego  
Intelligent Optical Systems, Inc., Torrance  
inXitu, Mountain View  
Jet Propulsion Laboratory, Pasadena  
Joint Warfare Program Office, Point Mugu

## 2007 Performers

Karagozian & Case, Burbank  
L-3 Communications Sonoma EO, Santa Rosa  
Lawrence Livermore National Laboratory, Livermore  
Microwave Power Technology, Campbell  
NASA Ames Research Center, Moffett Field  
Naval Air Warfare Station, China Lake  
Physical Optics Corporation, Torrance  
QPC Fiber Optic, Inc., San Clemente  
Raymat Materials, Inc., Fremont  
Rockwell Scientific Company, LLC, Thousand Oaks  
Science Applications International Corporation, San Diego  
Smiths Detection, Pasadena  
Space and Naval Warfare Systems Command, San Diego  
Sparta, Inc., Lake Forest  
Spectrum San Diego, San Diego  
Tactical Survey Group, San Bernadino  
Teledyne Controls, El Segundo  
University of California at Riverside  
University of California at San Diego, La Jolla  
WFI Government Services, Newbury Park

### **COLORADO**

Applied Research Associates, Inc., Littleton  
Colorado State University, Fort Collins  
Directed Energy Solutions, Colorado Springs  
Law Enforcement Technologies, Inc., Colorado Springs  
RadiantBlue Technologies, Inc., Colorado Springs  
Summa Design, LLC, Montrose  
Training Program Developers, Inc., Avondale  
Wilkinson Research, Inc., Golden

### **CONNECTICUT**

Applied Physical Sciences Corporation, New London  
Naval Submarine Medical Research Laboratory, Groton  
United Technologies Research Center, Hartford

### **DISTRICT OF COLUMBIA**

BAE Systems Advanced Technologies, Inc.  
Institute for Applied Science  
International Association of Firefighters  
Naval Research Laboratory  
Perrault Structural Products, Inc.

### **FLORIDA**

46 Test Squadron, Eglin Air Force Base  
Air Force Research Laboratory, Tyndall Air Force Base, Panama City  
Begin Productions, Inc., Sarasota

## 2007 Performers

BMA Production Services, St. Petersburg  
Electro-Optical Imaging, Inc., West Melbourne  
Florida International University, Miami  
General Dynamics, Ordnance and Tactical Systems, Orlando  
Government-Industry-Academia Simulation Lab, Orlando  
Great Creations of Tampa Bay, Inc.  
Harris Corporation, Melbourne  
L-3 CyTerra Corporation, Orlando  
Labock Technologies, Weston  
Lightmaker Group, Ltd., Orlando  
National Institute for Truth Verification, West Palm Beach  
Naval Surface Warfare Center, Panama City  
Octatron, Inc., St. Petersburg  
Scanna MSC, Ltd., Sarasota  
St. Petersburg College, National Terrorism Preparedness Institute, St. Petersburg  
STS International, St. Petersburg  
University of Florida, Gainesville  
VCom3D, Inc., Orlando

### GEORGIA

Emory University, Atlanta  
Georgia Tech Research Institute, Atlanta

### IDAHO

Idaho National Laboratory, Idaho Falls  
proSWAT, Inc., Meridian

### ILLINOIS

Applied Research Associates, Champaign  
Argonne National Laboratory, Argonne  
Nanosphere, Inc., Northbrook  
University of Illinois at Urbana-Champaign

### INDIANA

Creative Business Products, Fort Wayne  
Raytheon Technical Services Company  
Vohne Liche Kennels Canine Security, LLC, Denver

### IOWA

Rockwell Collins, Cedar Rapids

### MAINE

Technology Systems, Inc., Brunswick

### MARYLAND

ARINC, Annapolis  
Army Research Lab, Aberdeen Proving Ground

## 2007 Performers

CeLight, Inc., Silver Spring  
 Eagan, McAllister Associates, Inc., Lexington Park  
 EAI Corporation, Abingdon  
 Edgewood Chemical Biological Center, Aberdeen Proving Ground  
 G3 Technologies, Clarksville  
 Honeywell International, Columbia  
 National Institute of Standards and Technology, Gaithersburg  
 National Oceanographic and Atmospheric Administration, Silver Spring  
 Naval Air Warfare Center, Patuxent River  
 Naval Explosive Ordnance Disposal Technology Division, Indian Head  
 Naval Surface Warfare Center, Indian Head  
 Northrop Grumman Systems Corporation, Baltimore  
 Patton Electronics, Gaithersburg  
 RiskWatch, Annapolis  
 Remington Technologies Division, Rockville  
 SENTECH, Inc., Bethesda  
 SimQuest, LLC, Silver Spring  
 Technology Services Corporation, Silver Spring  
 Techno-Sciences, Inc., Lanham  
 Tektron Micro Electronics, Inc., Hanover  
 TRX Systems, Inc., Lanham  
 U.S. Army CHPPM, Aberdeen Proving Ground  
 W.L. Gore, Elkton  
 Zeus Technology Systems, Inc., Hanover

### MASSACHUSETTS

American Science and Engineering, Inc., Billerica  
 Artisent, Inc., Boston  
 BBN Technologies, Cambridge  
 Charles Stark Draper Laboratory, Inc., Cambridge  
 Excellims Corporation, Maynard  
 FLIR Systems, Inc., North Billerica  
 Force Protection C2 SPO, Hanscom Air Force Base  
 Foster-Miller, Inc., Waltham  
 GE Ion Track, Wilmington  
 Idolon Technologies, Melrose  
 Insight Technology, Inc., Londonderry  
 iRobot, Burlington  
 L-3 CyTerra Corporation, Woburn  
 National Security Innovations, Inc., West Yarmouth  
 Pulmatrix, Inc., Cambridge  
 Surmet Corp., Burlington  
 Technical Products, Inc., Ayer  
 Tufts University, Medford  
 Vanu, Inc., Cambridge  
 Visidyne, Inc., Burlington  
 Volpe National Transportation Systems Center, Cambridge

## 2007 Performers

### MICHIGAN

Quantum Signal, LLC, Ann Arbor

### MINNESOTA

MTS Systems Corporation, Eden Prairie  
University of Minnesota at Minneapolis

### MISSISSIPPI

U.S. Army Engineering Research and Development Center, Vicksburg

### MISSOURI

Clean Earth Technologies, LLC, Earth City  
Essex PB&R Corporation, St. Louis  
University of Missouri at Rolla  
Washington University, St. Louis

### MONTANA

Veridical Research and Design, Bozeman

### NEVADA

University of Nevada, Las Vegas Research Foundation

### NEW HAMPSHIRE

BAE Systems, Nashua  
DTC Communications, Inc., Nashua  
Globe Manufacturing Company, Pittsfield  
Wilcox Industries Corporation, Portsmouth

### NEW JERSEY

International Specialty Products Corporation, Wayne  
JeBen Photonics, Inc., Denville  
JP Laboratories, Middlesex  
Sarnoff Corporation, Princeton

### NEW MEXICO

Applied Research Associates, Inc., Albuquerque  
Honeywell Aerospace Electronic Systems, Albuquerque  
Los Alamos National Laboratory, Los Alamos  
MesoSystems Technology, Inc., Albuquerque  
New Mexico Institute of Mining and Technology, Energetic Materials Research and Testing Center, Socorro  
National Assessment Group, Albuquerque  
Sandia National Laboratories, Albuquerque  
Science Applications International Corporation, Albuquerque  
Stolar Research Corporation, Raton

## 2007 Performers

### NEW YORK

Calspan-UB Research Center, Inc., Buffalo  
Esensors, Inc., Amherst  
Plug Power, Latham  
State University of New York at Buffalo  
Syracuse Research Corporation, North Syracuse  
Tactronics, LLC, Westhampton Beach  
Verint, Melville  
Weidlinger Associates, Inc., New York

### NORTH CAROLINA

Applied Research Associates, Raleigh  
Appealing Products, Inc., Raleigh  
Barrday Corporation, Charlotte  
BGP, Inc., Raleigh  
Camero, Inc., Graham  
Duke Pro, Asheville  
General Dynamics Armament & Technical Products, Inc., Charlotte  
North Carolina State University, Textile Protection and Comfort Center, Raleigh  
Signalscape, Inc., Cary  
Tactical Support Equipment, Inc., Fayetteville  
University of North Carolina, Chapel Hill  
XinRay Systems, Research Triangle Park  
Xintek Inc., Research Triangle Park

### OHIO

Air Force Research Laboratory, Wright-Patterson Air Force Base  
Battelle Memorial Institute, Columbus  
Ohio State University, Virtual Cyber Systems Testing Capability, Columbus  
Total Fire Group/Morning Pride Manufacturing, Dayton  
University of Dayton Research Institute

### OKLAHOMA

Southwest Research Institute, Midwest City

### PENNSYLVANIA

Carnegie Mellon University, Pittsburgh  
Concurrent Technologies Corporation, Johnstown  
Dynamic Defense Materials, LLC, Boothwyn  
Indiana University of Pennsylvania and IUP Research Institute, Indiana  
National Institute for Occupational Safety & Health, National Personal  
Protective Technology Laboratory, Pittsburgh  
Optical Systems Technology, Inc., Freeport  
Pennsylvania State University, University Park  
Saint Joseph's University, Early Responders Distance Learning Center,  
Philadelphia



## 2007 Performers

### RHODE ISLAND

Naval Underwater Warfare Center, Newport  
University of Rhode Island, Narragansett

### SOUTH CAROLINA

Savannah River National Laboratory, Aiken

### TENNESSEE

Animax Designs, Inc., Nashville  
Remotec U.S., Clinton

### TEXAS

Alliant Techsystems, Fort Worth  
Applied Research Associates, Inc., San Antonio  
Force Protection Battle Lab, Lackland Air Force Base  
International Personal Protection, Austin  
Lockheed Martin Missile and Fire Control, Dallas  
OI Analytical, College Station  
Signature Science, LLC, Austin  
Southwest Foundation for Biomedical Research, San Antonio  
Southwest Research Institute, San Antonio  
Texas Agricultural Experiment Station, Bryan  
Texas Transportation Institute, College Station  
University of Texas at Austin  
University of Texas at Dallas, Richardson

### UTAH

AccessData Corporation, Lindon  
IsoForensics Inc., Salt Lake City

### VIRGINIA

A-T Solutions, Inc., Fredericksburg  
Army Evaluation Center, Alexandria  
Avir, LLC, Charlottesville  
Battelle Memorial Institute, Arlington  
Blackbird Technologies, Herndon  
Booz Allen Hamilton, Maclean  
Corporation for National Research Initiatives, Reston  
Digital Signal Corporation, Alexandria  
Gatekeeper, Inc., Reston  
GEOMET Technologies, Inc., Springfield  
Global Secure Corporation, Alexandria  
Harbinger Technologies Group, McLean  
Institute for Applied Science, Reston  
Institute for Defense Analyses, Alexandria  
Institute for Physical Sciences, Maclean  
International Association of Fire Chiefs, Fairfax

## 2007 Performers

L-1 Identity Solutions, Inc., Arlington  
 L-3 Communications Titan Group, Reston  
 Multi-Threaded, Inc., Herndon  
 National Media Services, Front Royal  
 Naval Surface Warfare Center, Dahlgren  
 NexGen Communications, LLC, Dulles  
 Night Vision and Electronic Sensor Laboratory, Fort Belvoir  
 Old Dominion University, Norfolk  
 Praevius Group, Fredericksburg  
 Prime Research, LC, Blacksburg  
 R4 Communications, Maclean  
 QinetiQ, Inc., Arlington  
 SET Associates, Arlington  
 Stratech Systems, Inc., Maclean  
 System Planning Corporation, Arlington  
 Technology Development Group, Inc., Leesburg  
 University of Virginia, Charlottesville

### WASHINGTON

Cascade Designs, Inc., Seattle  
 Isotron Corporation, Seattle  
 MesoSystems Technology, Inc., Kennewick  
 Specialty Products, Inc., Lakewood

### WEST VIRGINIA

Eyemarker Systems, Inc., Morgantown  
 West Virginia High Technology Consortium Foundation, Fairmont  
 West Virginia University, Morgantown

### WISCONSIN

Interspiro, Inc., Pleasant Prairie

### INTERNATIONAL

#### AUSTRALIA

Appen Pty Ltd., Chatswood, New South Wales  
 Australian Federal Police, Canberra  
 Defense Science and Technology Organisation, Fishermans Bend, Victoria  
 Department of the Prime Minister and Cabinet  
 QR Sciences, Ltd., Perth, Western Australia

#### CANADA

Allen-Vanguard Protective Technologies, Ltd., Ottawa, Ontario  
 Argon Security Technologies, Inc., Port Moody, British Columbia  
 Ballard Power Systems, Burnaby, British Columbia  
 Biokinetics and Associates, Ltd., Ottawa, Ontario  
 Bosik Technologies, Ltd., Ottawa, Ontario

## 2007 Performers

Canadian Border Services Agency, Ottawa, Ontario  
Canadian Commercial Corporation, Ottawa, Ontario  
Canadian Explosives Research Laboratory, Ottawa, Ontario  
Canadian Food Inspection Agency, Ottawa  
Defence Research and Development Canada, Suffield  
Defence Research and Development Canada, Valcartier, Quebec  
Department of Public Safety and Emergency Preparedness, Ottawa  
Dragonfly Innovations, Inc., Saskatoon, Saskatchewan  
Med-Eng Systems, Inc., Ottawa, Ontario  
Mining Resources Engineering, Ltd., Kingston, Ontario  
Royal Canadian Mounted Police, Ottawa, Ontario  
Smiths Detection, Mississauga, Ontario  
Tecops, Ltd., Ottawa, Ontario  
University of Ottawa, Ottawa, Ontario

### FRANCE

University of Rennes, Brittany

### GERMANY

Siemens Medical Solutions, Vacuum Technology, Erlangen

### ISRAEL

Controp Precision Technologies, Ltd., Hod Hasharon  
Israel Institute for Biological Research, Ness-Ziona  
Israel National Police, Jerusalem  
ITL Optronics, Tel Aviv  
Ministry of Defense, Tel Aviv  
Ofek Technologies Ltd., Jerusalem  
Rafael Armament Development Authority, Ltd., Haifa  
SOREQ, Tel Aviv

### NEW ZEALAND

Zephyr Technology Limited, Auckland

### SINGAPORE

Defence Science and Technology Agency  
Nanyang Technological University

### SWITZERLAND

Institute de Police Scientifique Ecole des Sciences Criminelles, Lausannes-Dorigny

### UNITED KINGDOM

Defence Science and Technology Laboratories, Fort Halstead, Kent  
Hazard Management Solutions, Ltd., Faringdon, Oxfordshire  
MBDA, Bristol  
QinetiQ, Ltd., Farnborough, Hampshire  
QinetiQ, Ltd., Malvern, Worcestershire



## Glossary of Acronyms

### A

ACC	Air Combat Command
ADL	Advanced Distributed Learning
AFESC	Air Force Electronic Systems Center
AFIP	Armed Forces Institute of Pathology
AFRL	Air Force Research Lab
AFSFC	Air Force Security Forces Center
AMEDD	Army Medical Department
ARL	Army Research Laboratory
ARTS	All-Purpose Remote Transport Systems
ASD(SO/LIC & IC)	Assistant Secretary of Defense for Special Operations and Low-Intensity Conflict & Interdependent Capabilities
ATF	Bureau of Alcohol, Tobacco, Firearms, and Explosives

### B

BAA	Broad Agency Announcement
BIDS	BAA Information Delivery System
BUMED	Bureau of Medicine and Surgery
BX	Blast Effects and Mitigation

### C

CB	Chemical and/or Biological
CBIRF	Chemical Biological Incident Response Force
CBRN	Chemical, Biological, Radiological, and Nuclear
CBRNC	Chemical, Biological, Radiological, and Nuclear Countermeasures
CBRNE	Chemical, Biological, Radiological, Nuclear, and High-Yield Explosives
CDC	Centers for Disease Control and Prevention
CE	Corps of Engineers
CE-PDC	Corps of Engineers Protective Design Center
CENTCOM	U.S. Central Command
CID	Criminal Investigation Division (U.S. EPA)
CID	Criminal Investigation Command (U.S. Army)
CIFA	Counterintelligence Field Activity
CIIMT	Critical Infrastructure Interdependency Modeling Tool
CML Bn(TE)	Chemical Battalion (Tech Escort)
CMLS	Chemical School
COTS	Commercial-off-the-Shelf
CRADA	Cooperative Research and Development Agreement
CTTSO	Combating Terrorism Technology Support Office

### D

DATSD (CBD)	Office of the Deputy Assistant to the Secretary of Defense for Nuclear and Chemical and Biological Defense
DCFL	Defense Computer Forensics Laboratory
DDRE	Office of the Director of Defense Research & Engineering
DEA	Drug Enforcement Administration
DHS	Department of Homeland Security
DIA	Defense Intelligence Agency

## Glossary of Acronyms

DIAP	Defense-Wide Information Assurance Program
DNA	Deoxyribonucleic Acid
DoD	Department of Defense
DOE	Department of Energy
DOJ	Department of Justice
DOS	Department of State
DS	Bureau of Diplomatic Security
DTRA	Defense Threat Reduction Agency
<b>E</b>	
ECBC	Edgewood Chemical Biological Center
ED	Explosives Detection
ED & ER	Electricity Delivery and Energy Reliability
EMRTC	Energetic Materials Research and Testing Center
EOD	Explosive Ordnance Disposal
EOD Tech Det	Explosive Ordnance Disposal Technical Detachment
EPA	Environmental Protection Agency
<b>F</b>	
FAA	Federal Aviation Administration
FAMS	Federal Air Marshal Service
FBI	Federal Bureau of Investigation
FBOP	Federal Bureau of Prisons
FDA	Food and Drug Administration
FDL	Forensic Document Laboratory
FEMA	Federal Emergency Management Agency
FPS	Federal Protective Service
FPSS	Force Protection Systems Squadron
FS	Forest Service
FSIS	Food Safety and Inspection Service
FY	Fiscal Year
<b>G</b>	
G&T	Grants and Training
<b>H</b>	
HSC	Homeland Security Council
HSS	Office of Health, Safety, and Security
HQ	Headquarters
HRT	Hostage Rescue Team
<b>I</b>	
ICE	Immigration and Customs Enforcement
IDD	Improvised Device Defeat
IED	Improvised Explosive Device
IG/T	Interdepartmental Group on Terrorism
IGTA	International Group of Treasury Associations
INSCOM	Intelligence and Security Command

## Glossary of Acronyms

IP	Infrastructure Protection
ISF	Investigative Support and Forensics
IWG/CT	Interagency Working Group on Counterterrorism
IWS	Irregular Warfare Support
<b>J</b>	
JCS	Joint Chiefs of Staff
<b>M</b>	
MANPADS	Man-Portable Air Defense Systems
MANSCEN	Maneuver Support Center
MCD	Marine Corps Detachment
MCNOSC	Marine Corps Network Operations and Security Command
MIT	Massachusetts Institute of Technology
MP SCHOOL	Military Police School
<b>N</b>	
NATO	North Atlantic Treaty Organization
NAVCENT	Naval Forces Central Command
NAVEODFLTLAU	Naval Explosive Ordnance Disposal Fleet Liaison Office
NAVEODTECHDIV	Naval Explosive Ordnance Disposal Technology
NAVEUR	U.S. Naval Forces, Europe
NAVFAC	Naval Facilities Engineering Command
NAWC	Naval Air Warfare Center
NCFS	National Center for Forensic Science
NCIS	Naval Criminal Investigative Service
NEIC	National Enforcement Investigations Center
NFESC	Naval Facilities Engineering Service Center
NFPA	National Fire Protection Association
NFSTC	National Forensic Science Technology Center
NGIC	National Ground Intelligence Center
NHRC	Naval Health Research Center
NIJ	National Institute of Justice
NIOSH	National Institute for Occupational Safety and Health
NIST	National Institute of Standards and Technology
NNSA	National Nuclear Security Administration
NRL	Naval Research Laboratory
NSA	National Security Agency
NSWC	Naval Surface Warfare Center
<b>O</b>	
OAFME	Office of the Armed Forces Medical Examiner
OBO	Overseas Building Operations
OEA	Office of Energy Assurance
OLES	Office of Law Enforcement Standards
OSI	Office of Special Investigations
OUSD (P&R)	Office of the Under Secretary of Defense for Personnel and Readiness
<b>P</b>	

## Glossary of Acronyms

P-ACARS	Protected Aircraft Communications Addressing and Reporting System
PCD-LV	Pallet Charge Disruptor for Large Vehicles
PD	Preparedness Directorate
PDA	Personal Digital Assistant
PDC	Protective Design Center
PFPA	Pentagon Force Protection Agency
PI	Polygraph Institute
PM-FPS	Product Manager for Force Protection Systems
PPE	Personal Protective Equipment
PS	Physical Security
<b>R</b>	
R&D	Research and Development
RCIED	Radio-Controlled Improvised Explosive Device
RCV	Remote Controlled Vehicle
RCVOA	Remote-Controlled Vehicle Operational Assessment
RDECOM	Research, Development, and Engineering Command
RF	Radio Frequency
RFW	Radio-Frequency Weapon
RSS	Really Simple Syndication
<b>S</b>	
S/CT	Department of State Office of the Coordinator for Counterterrorism
S&T	Science and Technology
SAFETY Act	Support Anti-Terrorism by Fostering Effective Technologies Act of 2002
SAVER	System Assessment and Validation for Emergency Responders
SCOS	Surveillance, Collection, and Operations Support
SERVANT	Sense and Report Vehicle Anti-Tamper
SO/LIC & IC	Special Operations and Low-Intensity Conflict & Interdependent Capabilities
SPAWAR	Space and Naval Warfare Systems Command
SSC	Soldier Systems Center (Natick)
SSD	Special Services Division
STF	Shear Thickening Fluid
SWAT	Special Weapons and Tactics
<b>T</b>	
TACOM	Tank-Automotive and Armaments Command
TIC	Toxic Industrial Chemical
TOS	Tactical Operations Support
TOVA™	Totally Optical Vapor Analyzer™
TRADOC	Training and Doctrine Command
TSA	Transportation Security Administration
TSD	Technical Security Division



## *Glossary of Acronyms*

TSWG	Technical Support Working Group
TTD	Training Technology Development
<b>U</b>	
UCSD	University of California at San Diego
USA	United States Army
USAF	United States Air Force
USAISR	United States Army Institute of Surgical Research
USAR	United States Army Reserve
USCG	United States Coast Guard
USMC	United States Marine Corps
USMS	United States Marshals Service
USN	United States Navy
USSOCOM	U.S. Special Operations Command
USSS	United States Secret Service
<b>V</b>	
VBIED	Vehicle-Borne Improvised Explosive Device
VIP	Very Important Person
<b>Z</b>	
ZBV	Backscatter X-Ray Van