

CHAPTER VIII

PLANS AND REPORTS REQUIRED BY THE FEDERAL GOVERNMENT

PLANS REQUIRED BY THE FEDERAL GOVERNMENT

All operators of natural gas systems are required to maintain plans for operations and maintenance and emergency response activities. Most operators comply with this requirement by developing and maintaining a manual that incorporates both plans. The manual must be prepared before operations of a natural gas system commence and must be reviewed and updated annually. The manual must be kept at locations where operations and maintenance activities are conducted. This manual fulfills the requirements of 49 CFR Part 192.605.

OPERATIONS AND MAINTENANCE PLANS

An operations and maintenance plan is required of all natural gas operators by the pipeline safety regulations. The operations and maintenance plan must be written and followed to help the operator comply with the pipeline safety regulations (see 49 CFR §192.603 for further information).

This chapter outlines the procedures that must be addressed in the operations and maintenance plan. For master meter operators, the first 18 of these procedures (lettered A-R) must usually be addressed in the operations and maintenance plan. Four additional procedures (lettered S-V) may apply to some operators of small natural gas systems, but most likely will apply only to larger or more complex systems such as those operated by a small municipality.

Some items addressed in this chapter may not be relevant to every natural gas system. **However, a procedure required by the pipeline safety regulations must be included in the plan.** Some of the key items that pipeline safety inspectors will look for during an audit are:

- completeness of the operations and maintenance procedures;
- omission or deficiency of an applicable portion of the plan;
- not having a plan readily available for review;
- not providing for an annual update and review of the procedures in the plan;
- not having a plan at all.

OPERATIONS AND MAINTENANCE PLANS MUST CONTAIN THE FOLLOWING COMPONENTS:

- A. Determination of Class Location(s) - The operator must determine the Class location for each part of its system. More stringent safety requirements may apply in some locations (see 49 CFR §192.5 for further information).
- B. Public Education - Procedures for educating customers, the general public, local government officials, and excavators about natural gas safety issues must be included in the plan and the operator must retain records of the education program (see 49 CFR §192.16 and §192.616 for further information).
- C. Investigation of Failures - The operator must have procedures for analyzing accidents and failures to determine the cause(s) of the failure and to minimize the probability of a recurrence (see 49 CFR §192.617 for further information).
- D. Maximum Allowable Operating Pressure (MAOP) - This is the maximum pressure at which each segment of a natural gas system may operate. The operator establishes MAOP. If the pipeline is tested to the 100 psig recommended in this guidance manual, the MAOP of the system will be 60 psig (see 49 CFR §192.619 for further information).
- E. Tapping and/or Purging of Pipelines - If tapping and/or purging are performed on the pipeline system, any procedure that is utilized must be in the operations and maintenance plan. Necessary information includes type of equipment, qualified personnel, technique, and the applicable procedures for performing the operation (see 49 CFR §192.627 and §192.629 for further information).
- F. Odorization - (Master Meter Operators).
The plan must contain a provision for the measurement of the odor of natural gas. A quarterly “sniff test” is sufficient if the natural gas company that supplies the gas provides proof of odorization. The operator should ask tenants, especially heavy smokers and the elderly, to smell the gas at an open valve or gas oven burner at various locations in the system. If they cannot detect an odor, the gas supplier should be notified. Make sure to keep records of these tests, including dates, names, and locations. Sample forms are in Appendix B (Form 11) (see 49 CFR §192.625 for further information).

Odorization - (Other than Master Meter Operators).

Operators who must odorize their own gas must ensure that there is enough odorant in the gas to provide a distinct odor when natural gas is present in air at a concentration of one-fifth of the lower explosive limit. The lower explosive limit for natural gas occurs at approximately 4 percent natural gas in air by volume; therefore, odorant must be detectable at approximately 0.8 percent gas in air by volume.

The odorant and its products of combustion must not be toxic to humans or harmful to components of the natural gas system. The odorant must not be soluble in water more than 2.5 to 100 parts by weight.

All operators must follow these basic rules:

- Ensure that all natural gas in distribution mains and service lines is odorized.
- Specify or determine the type of odorant used in the system.
- Specify in the operations and maintenance plan the manufacturer's recommended amount of odorant per million cubic feet (mmcf) of gas.
- Include any maintenance procedures recommended by the manufacturer of the odorization equipment. Odorization equipment must introduce the odorant without wide variation in the amount of odorant per mmcf of natural gas.
- A periodic sampling procedure must be part of the written operations and maintenance plan. This must include periodic testing of the odorant injection rate and testing at various locations, including the outer extremities of the pipeline system, to verify that the odor is distinctive at all locations in all seasons.
- Maintain records of odorant injection rate and odorant sampling. For sample record, see Appendix B, Form 10.

See 49 CFR §192.625 for further information.

G. PATROLLING - Operators must include in the plan provisions for patrolling mains located in places or on structures where anticipated physical movement or external loading (e.g., weight and traffic) could cause failure or leakage. These places include bridges, waterways, landslide areas, areas susceptible to earth subsidence (cave ins), or areas of construction activity.

Patrolling of these mains must be conducted at least four times each year in business districts and twice a year outside business districts (Appendix B, Form 4). Patrolling can be done by walking along the pipeline and observing factors affecting safe operation (see 49 CFR §192.705 for further information).

FIGURE VIII-1

Below is an example of a washout area found by patrol.

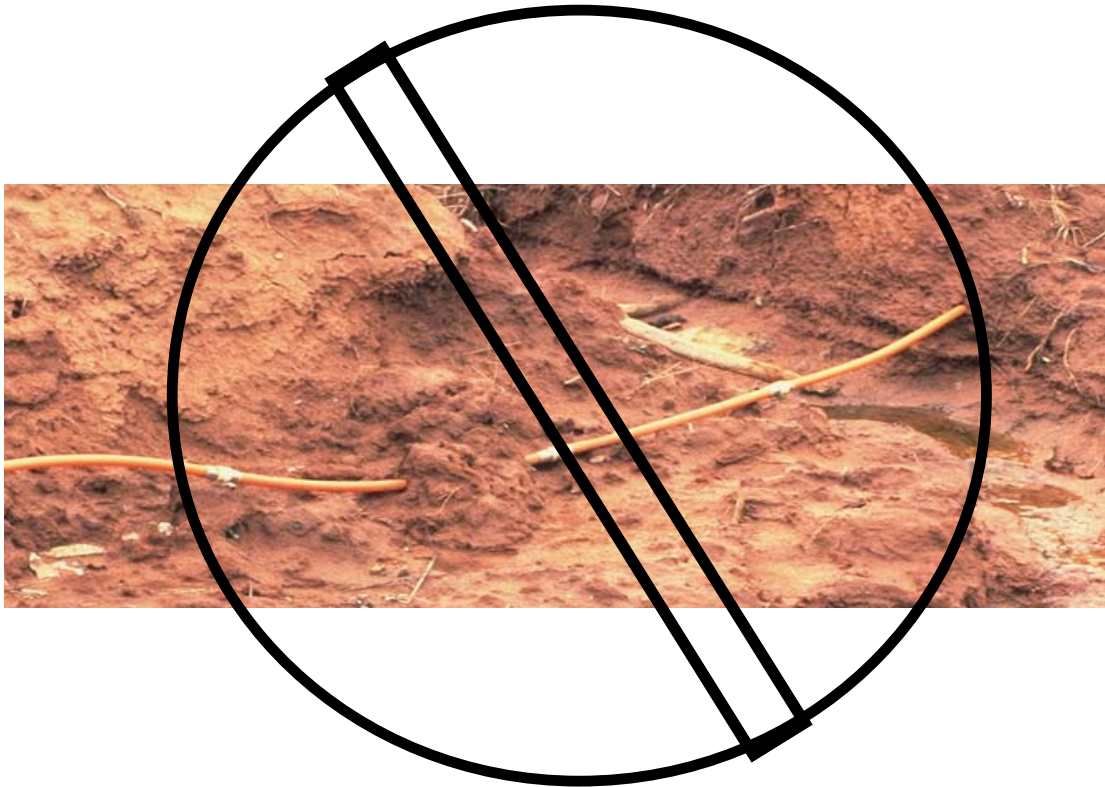

- H. Leak Surveys - A survey of a natural gas distribution system with leak detector equipment (FI or CGI) must be made as frequently as necessary, but at least annually.

Most master meter operators use contractors to leak survey their systems. It is the responsibility of the operator to ensure that the survey is conducted in accordance with the pipeline safety regulations. The operator must retain a report describing the results of each survey.

Leak surveys are the most important way in which a gas system operator protects the safety of the community; therefore, these directions need to be carefully followed:

1. A leak survey must be conducted over an entire residential pipeline system at intervals not exceeding five years. Operators should increase the frequency of surveys based on factors such as:
 - (a) Material makeup of system. Certain materials, not all of which are approved for use with natural gas, may develop a higher than average leakage rate (e.g., unprotected bare steel, PVC plastic pipe, extruded tubing, cast iron with lead joints, and coated steel pipe not cathodically protected).

- (b) Age of pipe (over 20 years) and corrosive soil environment.
- (c) Operating pressures.
- (d) Pipe having a previous history of excessive leakage for which the cause has not been determined or eliminated.
- (e) Pipelines in or near buildings, especially schools, churches, hospitals, or other buildings with high occupancy (see APPENDIX B, FORM 3).
- (f) Pipelines located in areas of construction, blasting, or heavy traffic.
- (g) Pipe located in crawl spaces under apartment buildings or mobile homes.
- (h) Service lines and meters inside buildings.



Operators should designate areas that require more frequent surveys.

Available openings should be used to find gas leaks. These include water, sewer, electric, and telephone systems, manholes, cracks in the pavement, and hollow walls (cinder block construction) in areas near natural gas piping. When conducting leak surveys, it is a good policy to check for leaks near the gas pipe entrance, both inside and outside the building. See CHAPTER 4 for details about gas indicator equipment and types of leak surveys.

2. Heavily populated areas require more frequent leak surveys. If the natural gas system is in a business district, a leak survey (utilizing FI or CGI equipment) must be conducted at least once every year (see FIGURE VIII-3). All leaks must be recorded no matter how minor. Sample forms are in Appendix B (Forms 2 and 3).
3. ALL leaks found must be classified as soon as located. All leaks must be investigated to determine if a hazard exists. If a hazardous condition is found, immediate action must be taken. The operator must take action to protect life and property until the hazardous condition is eliminated. Operators may want to include the Gas Piping Technology Committee's (GPTC) "Leak Classification Guide and Action Criteria" in their operations and maintenance plan. See Chapter IV for further information.
4. Although vegetation surveys do not fulfill the requirements of the pipeline safety regulations, they may be used as a supplementary leak detection measure. CHAPTER 4 contains some details about what to look for in vegetation surveys. All leaks must be recorded. Sample forms are in APPENDIX B (FORMS 2 and 3).
5. A map of the distribution system must be marked annually to show leak surveys conducted and the areas tested. Indicate the approximate location of each leak found. Annotations may be made in accordance with FIGURE VIII-2.

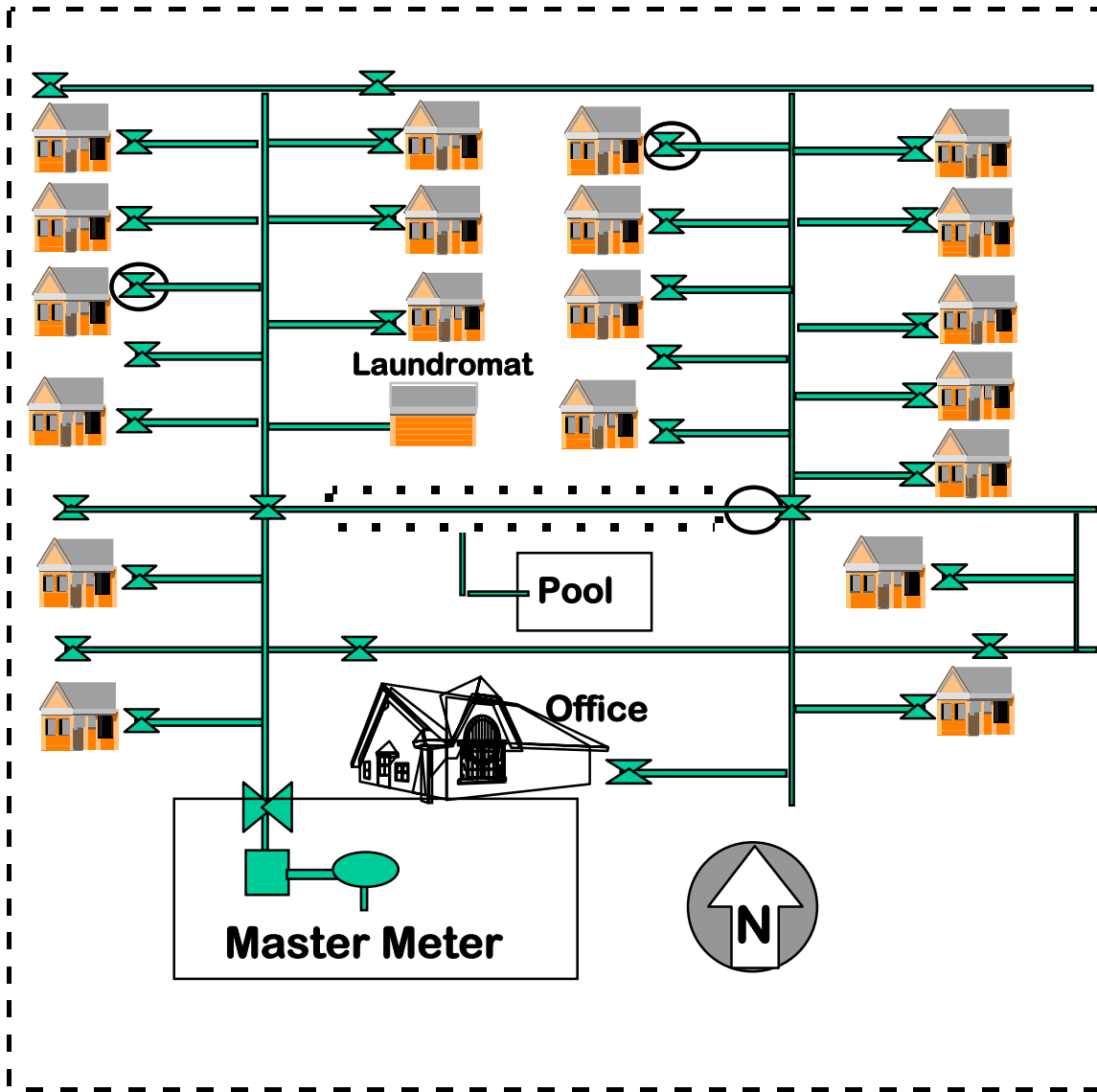
Figure VIII-2 Map of a Distribution Leak Survey



-  Flame Ionization Survey
-  Combustible Gas Indicator
-  Leak

- I. Line Markers - The operations and maintenance plan must specify locations for pipeline markers. The following are the federal requirements:

Buried distribution pipelines. A line marker must be placed and maintained as close as possible over each buried distribution main at each crossing of a highway, street, or railroad. A line marker must also be placed wherever necessary to identify the location of the main to reduce the possibility of damage or interference. Line markers are not required for buried mains in Class 3 or 4 locations where it can be shown to be impractical, or where the pipeline system operator participates in a damage prevention program (such as "one-call" or "call before you dig" system).

Distribution pipelines above ground. Line markers must be placed and maintained along each section of a main that is located above ground in an area accessible to the public. A typical example is an unsecured pressure regulating station.

Markers. The following must be written legibly on a background of sharply contrasting color on each line marker:

1. The word "Warning," "Caution," or "Danger" followed by the words "Gas (or name of gas transported) Pipeline." Letters must be at least one inch high with an approximate stroke of one-quarter inch.
2. The name of the operator and the telephone number (including area code) where the operator can be reached at all times (see FIGURE VIII-3).

FIGURE VIII-3

Below is a pipeline marker that meets the federal requirements (see 49 CFR §192.707 for further information).



- J. Testing for Reinstating a Service Line - The plan must contain a provision for testing each disconnected service line from a main before placing it back into service. For small distribution and master meter operators testing at 100 psig is suggested. See 49 CFR §192.511 for further information.
- K. Abandonment of Facilities - The plan must include provisions for shutdown, abandonment, or inactivation of facilities. When a gas main or service line is abandoned, it must be physically disconnected at both ends and the open ends must be sealed. In addition, the operator must determine if it is necessary to purge the line. This determination should take into consideration the location and size of the main or service. Pipe four inches and larger should always be purged. However, the pipeline need not be purged when the volume of gas is so small that there is no potential hazard (see 49 CFR §192.727 for further information).

Records must be kept on all abandoned facilities. This includes location, date, and method of discontinuing service.

When service to a customer is discontinued, one of the following must be done:

1. The valve must be closed to prevent the flow of natural gas to the customer. This valve must be secured with a lock or some other device to prevent opening of the valve by unauthorized persons. There are numerous locking devices designed for this purpose (see FIGURES VIII-4 and VIII-5).
2. A mechanical device or fitting that will prevent the flow of gas must be installed in the service line or in the meter assembly.
3. The customer's piping must be physically disconnected from the gas supply and sealed at both ends (see FIGURE VIII-6).

FIGURE VIII-4

Below is an example of a service line valve which has been locked to prevent the opening of the valve by unauthorized people.

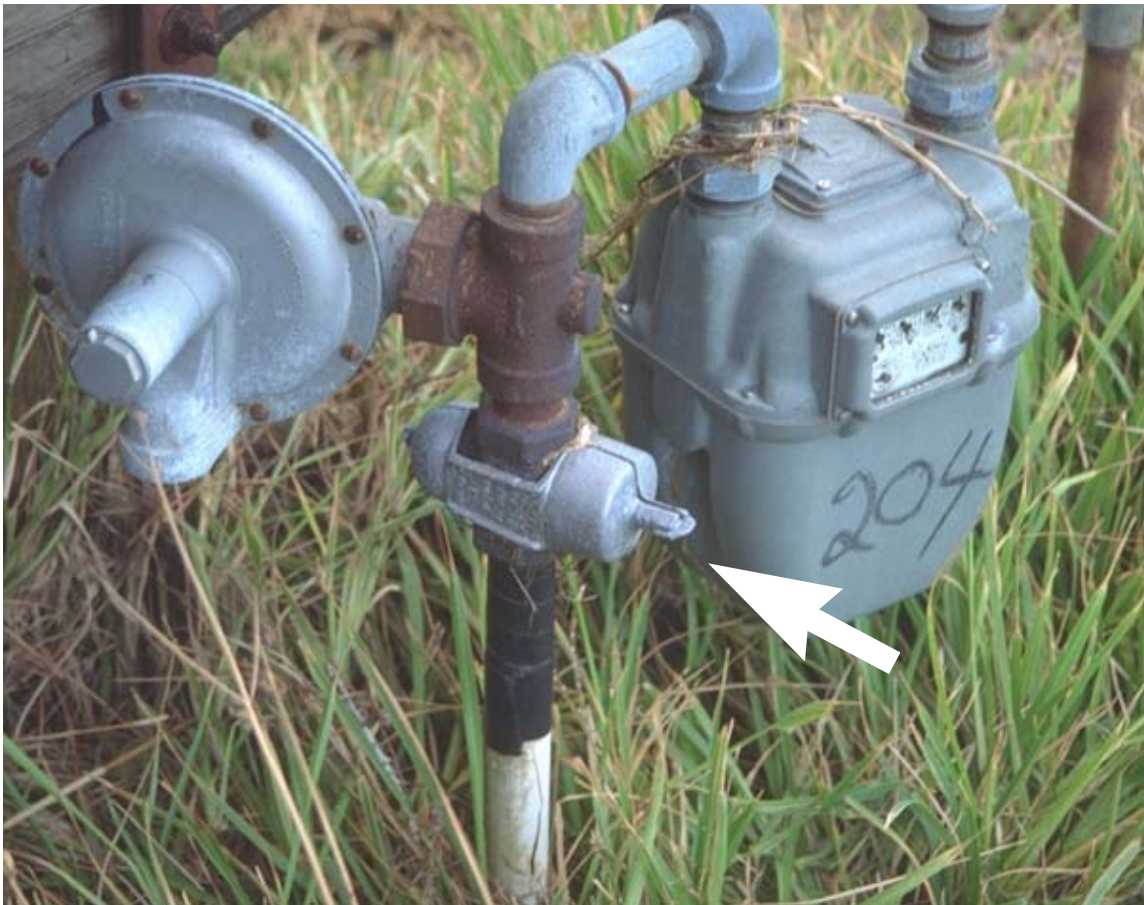

FIGURE VIII-5

Below is an example of a service that has been shut off (note position of meter valve) but not locked to prevent opening. This DOES NOT meet the pipeline safety regulations.

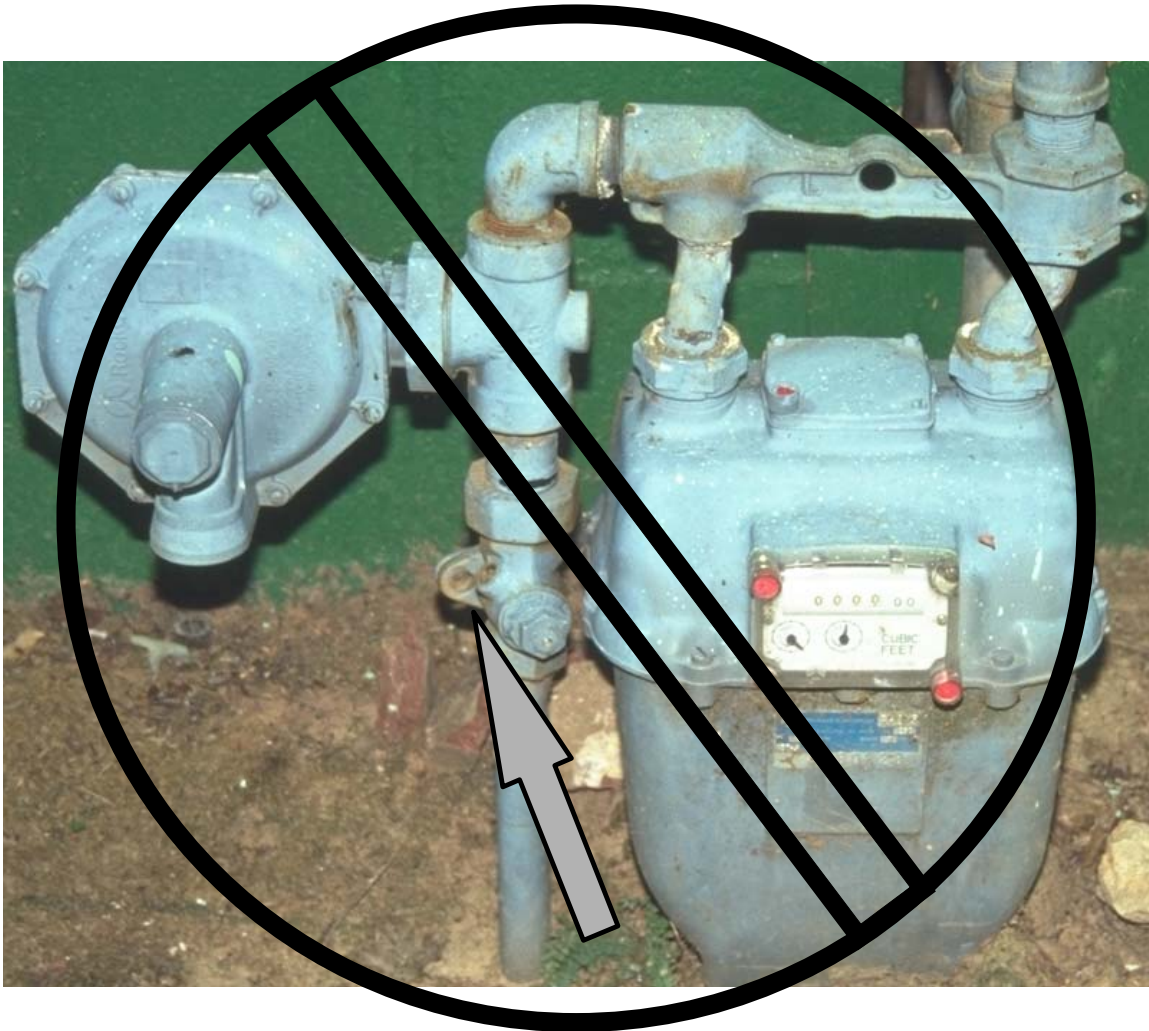
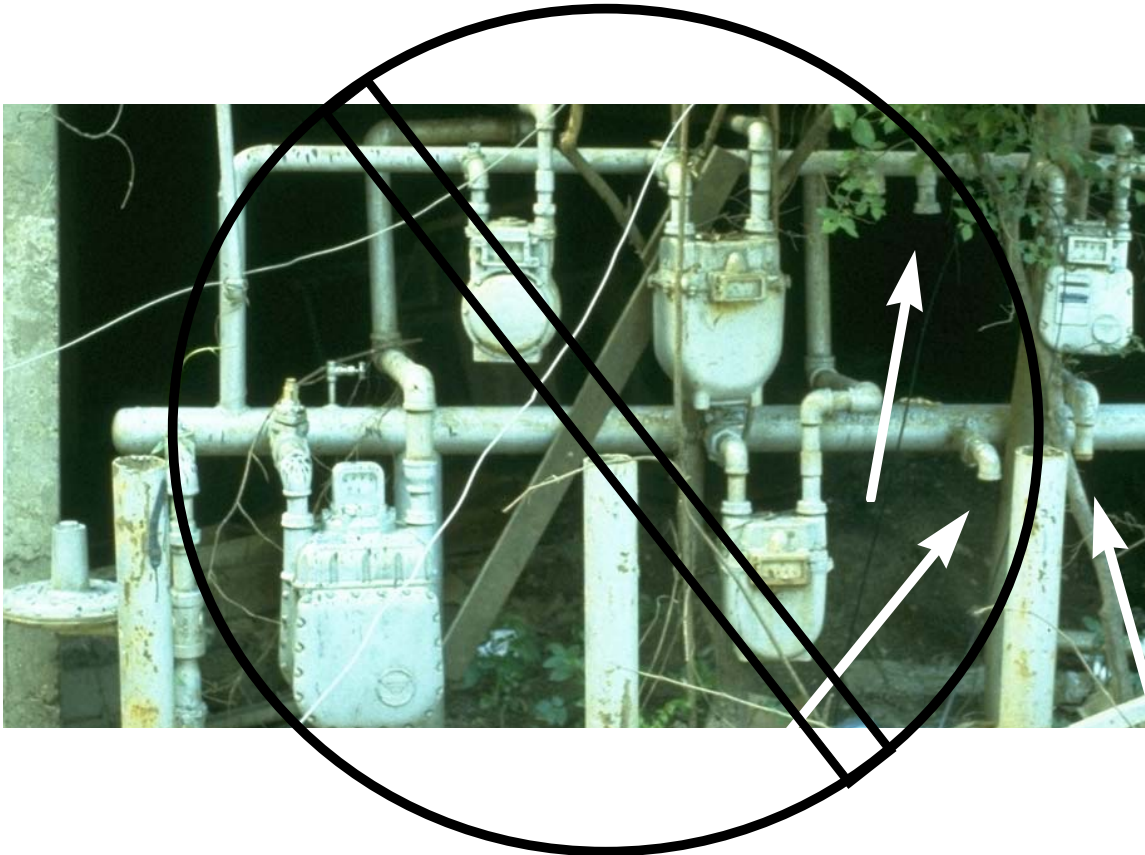

FIGURE VIII-6

Below is an example of service meters that were removed but the shutoff valve of each was not locked, and the pipes were not plugged. This is A VIOLATION of the pipeline safety regulations.



- L. Key Valve Maintenance - Key valves, or critical valves, are the valves needed to shut down the system, or part of the system, in case of an emergency. For most master meter systems, this may involve only one or two valves. Key valves must be checked at least once every year to ensure that they are operable. Procedures for key valve inspections and maintenance of records must be included in the plan. Sample forms are in APPENDIX B (FORMS 8 and 9). See 49 CFR §192.747 for further information.

- M. Accidental Ignition of Gas - The plan must include provisions to prevent the accidental ignition of gas. Gas alone is not explosive, but when mixed with air in a 4 to 15 percent concentration it can ignite or explode. Every precaution should be taken to prevent unintentional ignition of natural gas. When venting a hazardous amount of natural gas, a fire extinguisher must be available and ready for immediate use. See 49 CFR §192.751 for further information.

N. Corrosion Protection - Provisions should be made in the operations and maintenance plan for corrosion protection if the system contains metal pipe. The plan should include procedures for the following:

- Implementing a corrosion control program. This must be under the direction of a person qualified by experience and training in pipeline corrosion control methods.
- Ensuring coating and cathodic protection of new steel pipe (APPENDIX B, FORM 14).
- Ensuring cathodic protection of existing pipe (APPENDIX B, FORM 14).
- Examining pipe when exposed (APPENDIX B, FORM 1).
- Testing the effectiveness of cathodic protection every year (APPENDIX B, FORM 14).
- Inspecting rectifiers, if used in an impressed current cathodic protection system, at least 6 times a year. (APPENDIX B, FORM 15).
- Checking for atmospheric corrosion (APPENDIX B, FORM 13).
- Maintaining records of all tests, surveys, and inspections.

These requirements are discussed in more detail in CHAPTER III. Corrosion theory, practical concepts, and illustrations are contained in CHAPTER III. See 49 CFR §§192.451-192.491 for further information.

O. Construction and Leak Repair - The operations and maintenance plan should contain procedures for construction and leak repair. CHAPTER VI of this manual gives some basic procedures and concepts.

P. Construction Records, Maps and Operating History - The operator must have and follow procedures in the plan to make construction records, maps and operating history of the natural gas system readily available to operating personnel.

Q. Gathering of Data Needed for Reporting Incidents - The plan must include procedures to compile information on pipeline incidents and safety-related conditions. These procedures need to ensure accurate and timely reporting. This information must be readily available. See 49 CFR Part 191 for further information.

R. Starting Up and Shutting Down any Part of the Pipeline - The plan must include step-by-step actions for start-up and shut-down of the pipeline system. This will ensure that the MAOP is not exceeded on any portion of the pipeline system. See 49 CFR §192.605 for further information.

NOTE: THE FOLLOWING SECTIONS WILL NOT USUALLY APPLY TO MASTER METER OPERATORS.

- S. Upgrading - The operations and maintenance plan must contain upgrading procedures only if upgrading is contemplated. If a system requires upgrading, contact the state regulatory agency or the OPS regional office for detailed instructions. See 49 CFR §§192.551-192.557 for further information.
- T. Inspection of Regulating Stations - If regulating stations are a part of the system, the plan must include provisions for their inspection and testing. Many master meter systems will not have a regulating station. This section does not apply if an operator does not lower the gas pressure from the local gas utility delivery pressure except at a customer service regulator.

For operators with regulating stations, provisions must be made in the operations and maintenance plan to inspect and test both regulators and relief devices. These must be inspected every year to determine that they are:

- in good mechanical condition;
- adequate in capacity and reliability of operation;
- set to function at the correct pressure;
- properly installed and protected from vehicular traffic, dirt, liquids, icing, and other conditions that might prevent proper operation.

A record of this annual inspection must be kept. Sample forms are in APPENDIX B (FORM 6). The operator must inspect visually, perform an operation check (stroke and lock up), and check the set pressure of the relief device and regulator. Problems may include:

- low distribution system pressure;
- unsatisfactory operating and maintenance history;
- dirty or wet gas supply;
- inoperative safety devices.

The operator may need technical help to solve these problems, especially if regulator disassembly or station redesign is necessary. THE OPERATOR IS CAUTIONED NOT TO DISASSEMBLE REGULATORS WITHOUT THOROUGH TRAINING BY THE REGULATOR MANUFACTURER OR AN INDEPENDENT CONSULTANT.

The operator should always keep and use the manufacturers' manuals, diagrams, and maintenance procedures for each type of regulator used in the system.

CHAPTER II contains some basic concepts about pressure regulation and relief devices. See 49 CFR §192.739 and §192.743 for further information.

U. Testing of Relief Devices at Regulating Stations - At a minimum, the operations and maintenance must include procedures for the inspection of relief devices. Relief devices should be inspected as follows:

- Existing pressure limiting and regulating stations must be inspected and tested for operating condition at least once a year.
- If the relief device has insufficient capacity, the operator must replace it.
- The stations must be protected from damage from outside forces (cars, trucks, falling objects, etc.).

Usually, the gas pipeline company or the local distribution company owns and maintains the relief devices at regulation stations. However, if an operator owns relief devices at regulation stations, provisions must be made in the plan for capacity testing. If not feasible, the calculations of capacity must be reviewed each year. The operator must maintain a copy of this calculation. The test must show that the relief valve capacity is adequate for the system's MAOP.

The regulations recognize two types of distribution systems: low pressure and other-than-low pressure. The relief capacity for low pressure must protect the customer's gas utilization equipment from overpressure. The gas pressure in the main is approximately the same as the pressure provided the customer - usually 4 to 8 inches water column for natural gas.

In an other than low pressure distribution system, the relief device must be set to operate such that if the MAOP is 60 psig or more, the pressure during an emergency may not exceed the MAOP plus 10 percent. If testing reveals that the relief devices do not have adequate capacity, then new or additional devices must be installed.

Capacity must be checked for each separately controlled section of the natural gas system. The operator must ensure that the MAOP will not be exceeded at any point downstream of the regulator station if the worst condition occurred - that is, if the regulator fails when fully opened. Most small systems have only one MAOP for all piping in the distribution system.

In summary, the combination of minimum customer usage and relief capacity must ensure the MAOP will not be exceeded (except to the extent described above).

To comply with this requirement, many operators of small systems have a consultant analyze their gas system and make the required relief valve capacity calculations. If the

analysis proves that the relief valve has adequate capacity, the operator must keep a copy of this calculation on file. If there have been no changes to upstream regulators, such as different pressure, orifice, or type of regulator, the calculation of capacity need only be reviewed (and initialed) on an annual basis. If a change is made, the new relief valve capacity calculations must be made and kept on file. It is a good idea to keep this capacity calculation with the annual inspection record. Sample forms are in APPENDIX B (FORM 7). For other considerations for relief and regulating stations (see CHAPTER II).

V. Cast Iron Pipe - Operations and maintenance plans must address the unique safety issues of cast iron pipe. Each cast iron caulked bell-and-spigot joint that is subject to pressures of 25 psig or more must be sealed with either a mechanical leak clamp or device which:

- Does not reduce flexibility of the joint;
- Permanently bonds (either chemically, mechanically, or both) with the bell and spigot, metal surfaces, or adjacent pipe metal surfaces;
- Seals and bonds in a manner that meets the strength, environmental, and chemical compatibility requirements of 49 CFR §192.53(a)(b) and §192.143.

Each cast iron caulked bell or spigot joint that is subject to a pressure of less than 25 psig, must be sealed by a means other than caulking if it is exposed for any reason.

If an operator has knowledge that the support for a segment of a buried cast iron pipeline has been disturbed, that segment of the pipeline must be protected as necessary. Examples of disturbances are:

- Vibrations from heavy construction equipment, trains, trucks, buses, or blasting;
- Impact forces by vehicles;
- Earth movement;
- Excavations near the pipeline;
- Other known or foreseeable outside forces that may have or could subject that segment of the pipeline to bending stresses.

Operators of cast iron pipe located in earthquake-prone areas should consider replacing the pipe as soon as practical. Experience has shown that cast iron is prone to failure from severe earth movement. See 49 CFR §192.753 and §192.755 for further information.

EMERGENCY PLANS

General information on developing an emergency plan. See 49 CFR §192.615 for further information.

Each operator is required to keep a written plan of procedures to cope with gas emergencies. The emergency plan should contain the following information:

1. Emergency notification list.
2. Map of key valve locations.
3. Description and location of emergency equipment.
4. How to respond to gas leak reports and interruptions of gas service.
5. Check list for use in emergency situations.
6. Reporting requirements (Telephone Reports).
7. How to restore gas service after an outage.
8. Accident investigation procedures.
9. Education and training plan.

A. Emergency Notification List - The telephone numbers of the operator, fire department, gas company and any other entity whose service may be necessary in an emergency must be readily accessible. For master meter operators, a copy of this list should be posted in a public area. It is recommended that the direct lines to emergency services such as the fire department are included in addition to the general emergency number (i.e., 911). These numbers must be kept up-to-date.

B. Map of Key Valve Locations - A map of the gas pipeline showing the location of master meters and key valves must be included in the emergency plan.

C. Description and Location of Emergency Equipment- Emergency equipment must be available. A description of this equipment and its location must be specified in the plan.

D. Responding to Gas Leak Reports and Interruption of Gas Service - The operator must have written procedures to be followed in response to gas leaks reported by customers. It is the responsibility of the operator of the natural gas distribution system to ensure that all employees are familiar with procedures for responding to gas leak calls and reports.

1. The employee receiving a report of a gas leak must get as much of the information as possible to fill out the leak report (APPENDIX B, FORM 2). Use common sense: saving human life is the first priority, then property.
2. All reports of leaks on customer premises get priority. LEAKS INSIDE A BUILDING GET TOP PRIORITY.
3. After determining that a hazardous leak exists inside a building, remind the customer of the following:

- Do not turn on or off any electrical switches.
 - Do not ring door bells or use telephones.
 - Do not light matches, cigarettes, etc.
 - Do not start automobiles or other engines.
 - Do extinguish all open flames.
 - Do evacuate building to a safe distance (about a block).
 - Do turn off gas supply, if feasible.
4. Dispatch necessary personnel to the location of the reported leak, including local emergency responders, such as the fire department and police.
5. Duties of First Company Employee on the Scene:

TAKE EVERY CORRECTIVE ACTION NECESSARY TO PROTECT LIFE AND PROPERTY FROM DANGER (IN THAT ORDER.) IT IS THE RESPONSIBILITY OF THE PERSON IN CHARGE TO:

- Set up communications.
 - Coordinate the on-scene emergency response operation.
 - Make decisions concerning emergency valves, isolating areas, and use of emergency equipment.
 - Implement the checklist for emergency situations.
6. Minimum Operator Response Actions for Leaks Near Buildings:
- Assess danger to building occupants, to the public and to property.
 - Extinguish all open flames.
 - If necessary, notify fire, police, and gas company.
 - Block street and stop traffic.
 - Notify supervisor or other responsible persons.
 - Leak survey next to foundation of building including the use bar holes.
 - Check neighboring buildings for gas.
 - Implement checklist for emergency situations.
 - Repair leak.
 - Return occupants to buildings only when positively sure it is safe.
7. Minimum Operator Response Actions for Leaks Inside a Building:
- Evaluate immediately to determine concentration of gas and source of leak.
 - Evacuate if necessary.
 - Do not operate electrical switches.

- Do not use telephone.
- Shut off gas meter valve.
- Perform a bar hole leak test of the area especially around foundation. Check water meter and other openings.
- If ground and house are gas free, turn on meter valve. Check all gas piping and appliances for leaks. (Is meter hand turning normally or spinning?)
- Conduct soap bubble test.
- Implement checklist for emergency situations.
- Repair leak.
- If leak cannot be repaired, notify customer. Turn off meter, lock it and tag it.

8. Gas Burning Inside a Building:

- Call fire department.
- Master meter operators should also call local natural gas utility.
- If fire is at an appliance, shut gas off at appliance valve.
- If not possible to shut gas off at appliance valve, shut gas off at meter or stop valve.
- Implement checklist for emergency situations.

E. Checklist for a Major Emergency

- _____ 1. Has fire department been called?
- _____ 2. Have persons been evacuated and area blockaded?
- _____ 3. Has police department been notified?
- _____ 4. Has repair crew been notified?
- _____ 5. Has company call list been executed?
- _____ 6. Has communication been established?
- _____ 7. Has outside help been requested?
- _____ 8. Have ambulances been called?
- _____ 9. Has leak been shut off or brought under control?
- _____ 10. Has civil defense been notified?
- _____ 11. Have emergency valves or proper valves to shut down or reroute gas been identified and located?
- _____ 12. If an area has been cut off from a supply of gas, has the individual service of each customer been cut off?
- _____ 13. Is the situation under control and has the possibility of recurrence been eliminated?
- _____ 14. Has surrounding area, including buildings adjacent to and across streets, been probed for the possibility of further leakage?
- _____ 15. Has proper tag been put on meter?
- _____ 16. Has telephonic report to the state been made?
- _____ 17. Has telephone report to OPS been made?
- _____ 18. Has radio station been given instructions (if necessary)?

Date: _____

- F. Reporting Requirements (Telephonic Report) - In case of an incident, a telephone report must be made immediately to the National Response Center (1-800-424-8802) or in Washington, D.C. (267-2675). An incident is an event involving release of gas from a pipeline and:
1. Death or injury requiring in-patient hospitalization; or
 2. Estimated property damage of \$50,000 or more.
- G. Restoration of Gas Service After an Outage - Qualified persons must follow proper procedures to safely restore gas service after an outage. These procedures must include details of appliance relighting procedures.

Gas service must be restored on a building-to-building basis throughout the affected area. First, service to each customer must be turned off, either at the meter or at street service valves. If street service valves cannot be located, the gas flow can be shut off by squeeze-off, stoppering, etc.

In restoring service to an affected area all gas piping and meters must be purged and appliances relighted. Never turn on gas at the meter unless access is available to ALL appliances on the customer piping. In the event that a customer is not present, notification must be left in a noticeable location requesting the customer to call the natural gas company to arrange for restoration of service. (See Figure VIII-7 for an example of cards.)

The person in charge is to coordinate this operation and be responsible for it. A complete record of the incident, with drawings, etc., must be kept on file.

FIGURE VIII-7

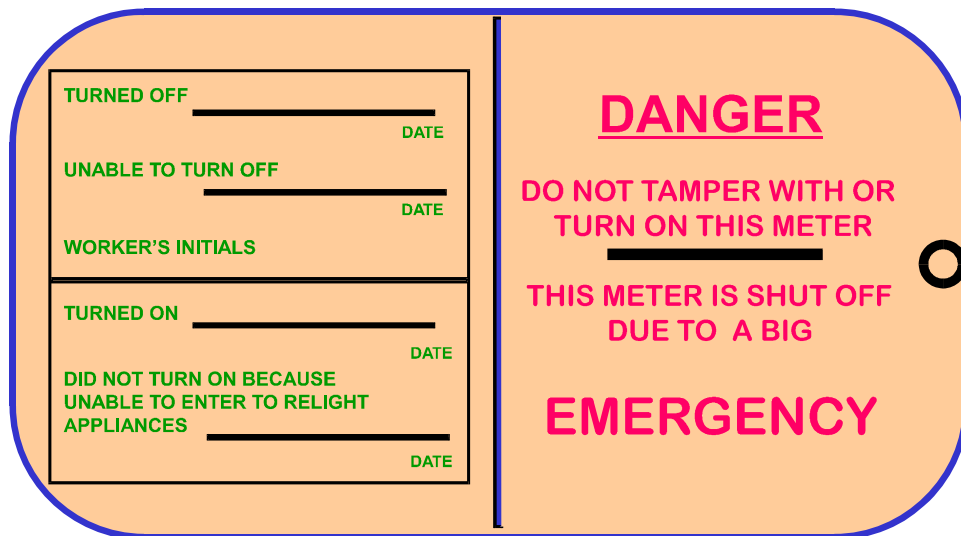

H. Investigation Procedures

Each operator must establish procedures for investigating incidents and failures including:

- Evaluating the situation.
- Protecting life and property.
- Securing the area.
- Conducting a leak survey.
- Conducting pressure tests of piping.
- Conducting meter and regulator checks.
- Questioning persons on the scene.
- Examining burn and debris patterns.
- Testing odorization level.
- Recording meter reading.
- Recording weather conditions.
- Selecting samples of the failed facility or equipment for laboratory examination for the purpose of determining the causes of the failure and minimizing the possibility of recurrence.

I. Education and Training - Operating personnel must be qualified to ensure understanding of and competency in emergency procedures.

Employee Training

Employees must be qualified in emergency procedures, including:

1. Updates of Emergency Plan.
2. Review of responsibilities in an emergency.
3. Review of locations and use of emergency equipment.
4. Properties of natural gas.
5. Review the locations and use of:
 - System maps.
 - Main records.
 - Service records.
 - Valve records.
 - Regulator station schematics.

6. Review of hypothetical emergency situations to reinforce the step-by-step actions to be taken in emergency situations, including how to contact public officials, firefighters, police, gas company, etc.
7. Recordkeeping requirements.
8. Telephone reports (OPS, state agency, etc.)

Public Education

Each operator must have a continuing education program that enables customers, the public, emergency response groups, and persons engaged in excavation activities, to recognize and respond to an emergency situation.

Program material should include:

- Information about gas properties.
- Recognition of gas odors.
- Actions to take when a strong gas odor is present.
- Notification of the gas company prior to excavation.
- Telephone numbers for customers to report gas leaks during both business and non-business hours.

There are many excellent pamphlets published by state and regional gas associations and by the American Gas Association and the American Public Gas Association on the properties of gas and emergency information. This information can be obtained from these organizations at no cost or for a small nominal charge. See the enclosed handout for addresses and telephone numbers of these organizations.

This information may be conveyed to the public by a number of means:

- Radio and television.
- Newspapers.
- Newsletters.
- Meetings.
- Bill stuffers.
- Mailings.
- Hand outs.
- Bulletin board.

If residents do not speak English, the operator must pass the same information in a language they can understand. For examples of information that can be sent to the public, see FIGURES VIII-8, VIII-9, and VIII-10.

The operator must maintain a record of the public education program. See 49 CFR §192.615 for further information.

FIGURE VIII-8

Identify the smell!



**If you ever smell
gas, call your Local
Gas Company promptly!**

Natural gas is odorless in its natural state. We add this disagreeable smell to let you know if any gas is escaping. Gas leakage may occur from faulty appliances, loose connections, service lines inside or outside your home, or from gas mains. Leaks can be dangerous and should be dealt with promptly by experts.

IF YOU EVER SMELL GAS -- even if you do not use it in your home -- take these precautions promptly:

1. Call your local Gas Company.
2. If odor is very strong and you are indoors, go outside.
3. Do not turn any electrical switches on or off.
4. Do not light matches, smoke or create any other source of combustion.

However slim the chances of danger, it doesn't pay to needless risks. At the first sniff of gas, play it safe. Call us!

HOW CAN YOU PREVENT GAS EMERGENCIES

- ① Keep all appliances cleaned, properly vented and serviced regularly.
- ② Make sure everyone in your family knows how to operate gas appliances and shut-off valves.
- ③ Don't use an open gas oven for heating your home or drying clothes.
- ④ Don't use or store gasoline, aerosols or other products with flammable vapors near gas appliances.
- ⑤ Whenever changing your furnace filter be sure to replace the compartment door.
- ⑥ Never cover fresh air vents that supply air to your gas appliances.
- ⑦ Have all gas line alterations and appliance repairs performed by a professional.
- ⑧ Before digging in your yard, be sure you know the location of underground gas lines. Call your local One Call Center.
- ⑨ Write your fire and police department phone numbers and our emergency service number in the front of your phone book.

ANYTIME YOU SUSPECT A GAS LEAK OR GAS EMERGENCY CALL YOUR LOCAL GAS COMPANY. THEY'RE EXPERTS AT THEIR JOB, AND RESPOND TO EMERGENCY CALLS.

FIGURE VIII-10

WHAT IS NATURAL GAS?

Natural gas is a non-toxic, colorless fuel, about one-third lighter than air. Gas burns, but only when mixed with air in the right proportion and ignited by a spark or flame. In its purified state, gas has no smell. For your protection, the Gas Company adds a harmless, distinctive odor so you can detect and report the slightest gas leak.

HOW SAFE IS NATURAL GAS?

Natural gas has an excellent safety record, but like other forms of energy, it requires a certain amount of caution. Gas emergencies are rare, but they can happen:

- * Whenever gas leaks from a pipe or pipe fitting, there is a possibility of fire or explosion.
- * If leaking gas accumulates in a confined space, it can displace air and cause suffocation.
- * If a gas appliance is not working properly, incomplete combustion can produce carbon monoxide and other toxic gases.
- * A pilot light or gas burner can ignite combustible materials and flammable vapors, such as gasoline, paint thinner or aerosols.

**KNOW
WHAT
GAS
SMELLS
LIKE!**



**¡SEPA A
QUE
HUELE
EL
GAS!**

**If you ever smell gas, call
your Local Gas Company
promptly.**

**Si huele a gas alguna vez, llame
inmediatamente a la Compañía
Local de Gas al.**



Local Gas

REPORTS REQUIRED BY THE FEDERAL GOVERNMENT

The federal government requires every gas operator to telephone a report of any "incident," and **except, for master-meter operators**, report by fax or mail of a "safety-related condition" and to file an annual report. This chapter briefly describes each of these reports. REMEMBER to check with your state agency for any additional state reporting requirements.

INCIDENT REPORT

It is required to telephone an incident report at the earliest possible moment, but in any case, within two hours of a release of natural gas from a pipeline which results in:

- a death or personal injury requiring hospitalization or estimated property damage, including the cost of gas lost, of \$50,000 or more;
- an event that is significant in the judgment of the operator, even though it was not described above.

This telephone report of a serious incident should include:

- identity of reporting operator;
- name and phone number of individual reporting the incident;
- location of the incident (city, county, state, and street address);
- time of the incident (date and hour);
- number of fatalities and personal injuries, if any;
- type and extent of property damage;
- description of the incident.

The telephone incident report can be made at anytime to the National Response Center at:

TOLL FREE (800) 424-8802
IN WASHINGTON, D.C.
(202) 267-2675

REMEMBER, WHEN IN DOUBT, MAKE THE CALL!

See 49 CFR §191.5 for further information.

An incident requiring a telephone report must be followed by a written report unless a master meter system operator makes the report.

Address for Incident Reports

All required reports must be submitted to:

Information Resources Manager
Office of Pipeline Safety
Research and Special Programs Administration
Nassif Building, Room 2335
400 Seventh Street, SW
Washington, DC 20590

See 49 CFR §191.9 for further information.

SAFETY-RELATED AND CONDITION REPORTS

NOTE: This rule does not apply to master meter operators.

OPS requires operators of natural gas pipelines to report certain safety-related conditions.

A written report must be filed within 5 working days after the operator first determines that a "safety-related condition" exists, but not later than 10 working days after the day the operator discovers the condition.

Each operator is also required to update its operations and maintenance plan to enable personnel who perform operation and maintenance activities to recognize conditions that may be safety-related conditions.

Typical conditions that need to be reported by operators of small natural gas systems include:

- unintended movement or abnormal loading of pipeline facilities by environmental causes such as earthquakes, landslides, or floods, that impairs the serviceability of a pipeline;
- any malfunction or operating error that causes the pressure of a pipeline to rise above its maximum allowable operating pressure plus the pressure build-up allowed for operation of pressure limiting or control devices;
- a leak that constitutes an emergency and is not repaired within 5 days of determination;
- a safety-related condition that could lead to imminent hazards and cause the operator to make a 20 percent or more reduction in operating pressure.

The above is only a summary. Refer to 49 CFR §191.23(a) for a complete listing of all safety-related conditions that must be reported.

Safety-related conditions that do not require a report include:

- condition on a customer-owned service line;
- a condition resulting in an incident, as defined in 49 CFR §191.3;

- a condition on a pipeline more than 220 yards from any building or outdoor place of assembly, unless it is within the right-of-way of an active railroad, paved road, or highway;
- a condition that is corrected before the report filing deadline, except for certain corrosion related conditions.

See 49 CFR §191.23(b) for further information.

Address for Safety-Related Condition Reports

All required written reports must be submitted to:

Information Resources Manager
Office of Pipeline Safety
Research and Special Programs Administration
Nassif Building, Room 2335
400 Seventh Street, SW
Washington, DC 20590
Fax: (202) 366-4566

In addition, an intrastate operator may be required to file a report with the state agency participating in the pipeline safety program. For further details on the filing requirements, refer to 49 CFR §191.7.

ANNUAL REPORTS

With the exception of master meter operators, each operator of a distribution pipeline system must submit an annual report for that system. This report must be submitted on DOT Form RSPA F7100.1-1. This report must be submitted each year, not later than March 15, for the preceding calendar year.

Address for Annual Reports

All required reports must be submitted to:

Information Resources Manager
Office of Pipeline Safety
Research and Special Programs Administration
Nassif Building, Room 2335
400 Seventh Street, SW
Washington, DC 20590

See 49 CFR §191.11 for further information.